



9697
Nat-m
49

PROCEEDINGS

OF THE

GENERAL MEETINGS FOR SCIENTIFIC BUSINESS

OF THE

///

ZOOLOGICAL SOCIETY

OF LONDON.

1905, vol. II

(MAY—DECEMBER.)

PRINTED FOR THE SOCIETY,
AND SOLD AT THEIR HOUSE IN HANOVER-SQUARE.

LONDON:
MESSRS. LONGMANS, GREEN, AND CO.
PATERNOSTER ROW.

L I S T
OF THE
COUNCIL AND OFFICERS
OF THE
ZOOLOGICAL SOCIETY OF LONDON.
1905.

COUNCIL.

HIS GRACE THE DUKE OF BEDFORD, K.G., *President.*

SIR ALEXANDER BAIRD, BT.	JOSEPH JACKSON LISTER, ESQ., M.A., F.R.S.
GEORGE A. BOULENGER, ESQ., F.R.S., <i>Vice-President.</i>	SIR EDMUND GILES LODER, BT.
THOMAS H. BURROUGHES, ESQ.	E. G. B. MEADE-WALDO, ESQ.
FREDERIC G. DAWTREY DREWITT, ESQ., M.D.	P. CHALMERS MITCHELL, ESQ., M.A., D.Sc., <i>Secretary.</i>
HERBERT DRUCE, ESQ., F.L.S., <i>Vice-President.</i>	E. LORT PHILLIPS, ESQ.
CHARLES DRUMMOND, ESQ., <i>Treasurer.</i>	HOWARD SAUNDERS, ESQ., <i>Vice- President.</i>
SIR EDWARD DURAND, BT., C.B.	H.S.H. PRINCE FRANCIS OF TECK.
FREDERICK GILLET, ESQ.	CHARLES S. TOMES, ESQ., M.A., F.R.S., <i>Vice-President.</i>
F. DU CANE GODMAN, ESQ., D.C.L., F.R.S., <i>Vice-President.</i>	AUGUSTUS F. WIENER, ESQ.
W. R. OGILVIE-GRANT, ESQ.	HENRY WOODWARD, ESQ., LL.D., F.R.S., <i>Vice-President.</i>

PRINCIPAL OFFICERS.

P. CHALMERS MITCHELL, ESQ., M.A., D.Sc., *Secretary.*
FRANK E. BEDDARD, ESQ., M.A., F.R.S., *Prosector.*
R. I. POCOCK, ESQ., F.L.S., *Superintendent of the Gardens.*
CHARLES GABRIEL SELIGMANN, ESQ., M.R.C.S., L.R.C.P.,
Pathologist.
MR. F. H. WATERHOUSE, *Librarian.*
MR. JOHN BARROW, *Accountant.*
MR. W. H. COLE, *Chief Clerk.*
MR. GEORGE ARTHUR DOUBLEDAY, *Clerk of Publications.*
MR. ARTHUR THOMSON, *Assistant Superintendent of the
Gardens.*



590.642
Z877
May-Dec.
1905

LIST OF CONTENTS.

May 2, 1905.

	Page
The Secretary. Exhibition of photographs of Hippopotamuses swimming	1
Mr. R. E. Holding. Exhibition of, and remarks upon, a series of the first-year antlers of certain Deer	1
Mr. R. I. Pocock, F.Z.S. Exhibition of a specimen of the Spanish Tarantula.....	3
Mr. W. Bateson, F.R.S. Exhibition of, and remarks upon, specimens of Fowls illustrating peculiarities in the heredity of white plumage	3
1. On the Sponge <i>Leucosolenia contorta</i> Bowerbank, <i>Ascandra contorta</i> Haeckel, and <i>Ascetta spinosa</i> Lendenfeld. By E. A. MINCHIN, F.Z.S., University College, London. (Plate I.)	3
2. Some Notes upon the Anatomy of the Ferret-Badger, <i>Helictis personata</i> . By FRANK E. BEDDARD, M.A., F.R.S., Prosector to the Society	21
3. Contributions to the Osteology of Birds.—Part VII. <i>Eurylemidae</i> ; with Remarks on the Systematic Position of the Group. By W. P. PYCRAFT, F.Z.S., M.B.O.U. (Plate II.)	30

May 16, 1905.

	Page
The Secretary. Report on the Additions to the Society's Menagerie during the month of April 1905	57
Mr. Oldfield Thomas, F.R.S. Description of a new Golden Mole (<i>Amblysomus corriei</i>) from Cape Colony	57
Mr. H. B. Fantham, F.Z.S. Exhibition of microscopic slides and description of a new Sporozoon, <i>Lankesterella tritonis</i>	58
1. A Contribution to the Knowledge of the Encephalic Arterial System in Sauropsida. By FRANK E. BEDDARD, M.A., F.R.S., Prosector to the Society	59
2. On the Nomenclature of the Anthropoid Apes as proposed by the Hon. Walter Rothschild. By Sir H. H. JOHNSTON, G.C.M.G., K.C.B., F.Z.S.	70
3. On some Bats of the Genus <i>Rhinolophus</i> , with Remarks on their Mutual Affinities, and Descriptions of Twenty-six new Forms. By KNUD ANDERSEN. (Plates III. & IV.)	75
4. On Stridulating Hemiptera of the Subfamily <i>Halyinae</i> , with Descriptions of new Genera and new Species. By Dr. E. BERGROTH, C.M.Z.S., Tammerfors, Finland...	146
5. On the Anatomy of Limicoline Birds; with special Reference to the Correlation of Modifications. By P. CHALMERS MITCHELL, M.A., D.Sc. (Oxon.), Secretary to the Society	155
6. Observations upon a Female Specimen of the Hainan Gibbon (<i>Hylobates hainanus</i>), now living in the Society's Gardens. By R. I. POCOCK, F.L.S., F.Z.S., Superintendent of the Gardens. (Plate V.)	169

June 6, 1905.

The Secretary. Report on the Additions to the Society's Menagerie during the month of May 1905	180
--	-----

	Page
Mr. Oldfield Thomas, F.R.S. Description of a new Bush-buck (<i>Tragelaphus haywoodi</i>) from British East Africa .	180
Mr. Oldfield Thomas, F.R.S. Exhibition of specimens of Mammals and Birds from Japan and description of a new Marten (<i>Mustela melampus bedfordi</i>)	182
Mr. R. I. Pocock, F.L.S. Exhibition of a Jamaican Scorpion (<i>Centrurus insulanus</i>) carrying young on its back	183
Dr. P. Chalmers Mitchell. Notice of a memoir entitled "On the Intestinal Tract of Mammals"	184
1. Rough Notes on the Natural History of the Country West of the Victoria Nyanza. By Lt.-Col. C. DELMÉ-RADCLIFFE, M.V.O., F.Z.S.	184
2. The Distribution of Mexican Amphibians and Reptiles. By HANS GADOW, F.R.S., F.Z.S.	191
3. Descriptions of new Reptiles discovered in Mexico by Dr. H. Gadow, F.R.S. By G. A. BOULENGER, F.R.S., V.P.Z.S. (Plates VI. & VII.)	245
4. On a Collection of Batrachians and Reptiles made in South Africa by Mr. C. H. B. Grant, and presented to the British Museum by Mr. C. D. Rudd. By G. A. BOULENGER, F.R.S., V.P.Z.S.	248
5. Some Notes upon the Anatomy of the Yellow-throated Lizard, <i>Gerrhosaurus flavigularis</i> . By F. E. BEDDARD, F.R.S., Prosector to the Society	256
6. On two Points in the Anatomy of the Lacertilian Brain. By F. E. BEDDARD, F.R.S., Prosector to the Society	267
7. On new Coleoptera from South Africa collected by Dr. H. Brauns and others— <i>Serricornia</i> , <i>Endomychidae</i> , <i>Erotylidae</i> . By H. S. GORHAM, F.Z.S.	271
8. On the Fœtus and Placenta of the Spiny Mouse (<i>Acomys calvirinus</i>). By RICHARD ASSHETON, M.A., F.Z.S., Lecturer in Biology in the Medical School of Guy's Hospital, University of London	280

	Page
9. Remarks on the supposed Clavicle of the Sauropodous Dinosaur <i>Diplodocus</i> . By FRANCIS, BARON NOPCSA, Ph.D.	289

November 14, 1905.

The Secretary. Report on the Additions to the Society's Menagerie during the months of June, July, August, September, and October 1905	295
Col. W. H. Broun. Exhibition of mounted heads of a White Waterbuck and two Rhinoceroses	296
The Hon. Walter Rothschild, F.Z.S. Exhibition of speci- mens of a rare Marsupial (<i>Dactylopsila palpator</i>)	297
The Hon. Walter Rothschild, F.Z.S. Exhibition of two tusks from Abyssinia	297
Mr. A. S. Hirst, F.Z.S. Exhibition of microscopic pre- parations of a new Hæmosporidian (<i>Halteridium</i> <i>crumentum</i>)	297
Dr. Walter Kidd, F.Z.S. Exhibition of lantern-slides illustrating the Papillary Ridges in Mammals	297
Dr. P. L. Selater, F.R.S. Letter from Mr. W. Rodier on the Rabbit-pest in Australia	298
Mr. Henry Scherren, F.Z.S. Exhibition of lantern-slides of, and remarks upon, old pictures of Anthropoid Apes ...	298
1. On a Collection of Mammals brought home by the Tibet Frontier Commission. By J. LEWIS BONHOTE, M.A., F.L.S., F.Z.S.	302
2. Notes on the Geographical Distribution of the Okapi. By Dr. EINAR LÖNNBERG, C.M.Z.S.	309
3. Notes on the Goral found in Burma. By Major G. H. EVANS	311
4. On the Mammals of Crete. By DOROTHEA M. A. BATE ...	315

November 28, 1905.

	Page
Mr. J. T. Cunningham, M.A., F.Z.S. Exhibition of photographs of, and remarks upon, a horse bearing horn-like structures	323
Mr. Frank Slade, F.Z.S. Exhibition of photographs of a Sea-Anemone in the process of division	324
Mr. Douglas English. Exhibition of an albino Field-Vole	324
Mr. G. A. Boulenger, F.R.S. Exhibition of, and remarks upon, a melanistic specimen of the Wall-Lizard	324
Capt. Albert Pam, F.Z.S. Remarks upon a living specimen of the Violet-cheeked Humming-bird.....	324
Mr. W. R. Ogilvie-Grant, F.Z.S. Exhibition of a series of bird-skins from Japan	324
1. Colour Evolution in Guereza Monkeys. By R. LYDEKKER.	325
2. The White-maned Serow. By R. LYDEKKER. (Plate VIII.)	329
3. The Duke of Bedford's Zoological Exploration in Eastern Asia.—I. List of Mammals obtained by Mr. M. P. Anderson in Japan. By OLDFIELD THOMAS, F.R.S. (Plate IX.)	331
4. A Revision of the Fishes of the Family <i>Galaxiidae</i> . By C. TATE REGAN, B.A., F.Z.S. (Plates X.—XIII.).....	363
5. The Mammalian Fauna of China.—Part I. <i>Murinae</i> . By J. LEWIS BONHOTE, M.A., F.L.S.....	384
6. Descriptions of new Species of Phytophagous Coleoptera of the Genera <i>Homophaeta</i> , <i>Asphaera</i> , and <i>Oedionychis</i> . By MARTIN JACOBY, F.E.S. (Plates XIV. & XV.)... 398, 591	
7. Some Additions to the Knowledge of the Anatomy, principally of the Vascular System, of <i>Hatteria</i> , <i>Crocodylus</i> , and certain Lacertilia. By FRANK E. BEDDARD, M.A., F.R.S., Prosector to the Society	461

December 12, 1905.

	Page
The Secretary. Report on the Additions to the Society's Menagerie during the month of November 1905	489
The Secretary. Exhibition of a coloured print of Polito's Royal Menagerie at Exeter 'Change	490
Mr. A. H. Cocks, F.Z.S. Exhibition of a series of photographs of Whales taken in East Finmarken	490
Mr. Geo. P. Mudge, F.Z.S. Exhibition of, and remarks upon, a Dogfish with abnormal viscera	490
Mr. Geo. P. Mudge, F.Z.S. Exhibition of, and remarks upon, an Earthworm with bifid tail	490
Mr. H. B. Fantham, B.Sc., F.Z.S. Exhibition of, and remarks upon, microscopic preparations of a new Hæmosporidian of the genus <i>Piroplasma</i>	491
Mr. Oldfield Thomas, F.R.S., F.Z.S. Exhibition of, and remarks upon, tails of Dormice showing regeneration of the vertebræ	491
Dr. W. G. Ridewood, F.Z.S. Exhibition of microscopic preparations of the regenerated vertebræ of the tails of Dormice.....	494
1. On the Habits and Reactions of Crabs bearing Actinians in their Claws. By J. E. DUERDEN, Ph.D., A.R.C.Sc. (Lond.), Professor of Zoology, Rhodes University College, Grahamstown, Cape Colony	494
2. Notes on a Collection of Snakes from Japan and the Loo Choo Islands. By Captain F. WALL, C.M.Z.S., Indian Medical Service.....	511
3. Description d'un Ophidien nouveau du Mexique (<i>Morenoa orizabensis</i> , g. et sp. nn.). Par ALFRED DUGÈS, M.D., C.M.Z.S.	517
4. On a Collection of Mammals from Persia and Armenia presented to the British Museum by Col. A. C. Bailward. By OLDFIELD THOMAS, F.R.S., F.Z.S. (Plate XVI.) ...	519

	Page
5. On the Colour-Variation of the Beetle <i>Gonioctena variabilis</i> . By L. DONCASTER, M.A., F.Z.S.	528
6. On Species of Crustacea of the Genera <i>Ptychognathus</i> <i>Stimps.</i> and <i>Palæmon</i> Fabr. from Christmas Island. By Dr. J. G. DE MAN, of Ierseke, Holland. (Plates XVII. & XVIII.)	537
7. Note on Heredity in Pigeons. By RICHARD STAPLES- BROWNE, F.Z.S.	550
8. On a new Species of Worm of the Genus <i>Pontodrilus</i> from the Shores of the Red Sea. By FRANK E. BEDDARD, M.A., F.R.S., Prosector to the Society	558
9. On a new Enchytræid Worm (<i>Henlea lefroyi</i> , sp. n.) from India destructive to the Eggs of a Locust (<i>Acridium</i> sp.). By FRANK E. BEDDARD, M.A., F.R.S., Prosector to the Society	562
10. On new and rare British Mites of the Family <i>Oribatidæ</i> . By CECIL WARBURTON, M.A., F.Z.S., and NIGEL D. F. PEARCE, M.A. (Plates XIX. & XX.)	564
11. On some South Australian Spiders of the Family <i>Lycosidæ</i> . By H. R. HOGG, M.A., F.Z.S.	569

ALPHABETICAL LIST

OF THE

CONTRIBUTORS,

With References to the several Articles contributed by each.

	Page
ANDERSEN, KNUD.	
On some Bats of the Genus <i>Rhinolophus</i> , with Remarks on their Mutual Affinities, and Descriptions of Twenty- six new Forms. (Plates III. & IV.)	75
ASSHETON, RICHARD, M.A., F.Z.S., Lecturer in Biology in the Medical School of Guy's Hospital, University of London.	
On the Fœtus and Placenta of the Spiny Mouse (<i>Acomys calirivus</i>)	280
BATE, Miss DOROTHEA M. A.	
On the Mammals of Crete	315

BATESON, WILLIAM, M.A., F.R.S., F.Z.S.

- Exhibition of, and remarks upon, specimens of Fowls illustrating peculiarities in the heredity of white plumage. 3

BEDDARD, FRANK E., M.A., F.R.S., Prosector to the Society.

- Some Notes upon the Anatomy of the Ferret-Badger, *Helictis personata* 21

- A Contribution to the Knowledge of the Encephalic Arterial System in Sauropsida 59

- Some Notes upon the Anatomy of the Yellow-throated Lizard, *Gerrhosaurus flavigularis* 256

- On two Points in the Anatomy of the Lacertilian Brain 267

- Some Additions to the Knowledge of the Anatomy, principally of the Vascular System, of *Hatteria*, *Crocodylus*, and certain Lacertilia 461

- On a new Species of Worm of the Genus *Pontodrilus* from the Shores of the Red Sea 558

- On a new Enchytræid Worm (*Henlea lefroyi*, sp. n.) from India destructive to the Eggs of a Locust (*Acridium* sp.) 562

BERGROTH, Dr. E., C.M.Z.S., of Tammerfors, Finland.

- On Stridulating Hemiptera of the Subfamily *Halyinæ*, with Descriptions of new Genera and new Species 146

BONHOTE, J. LEWIS, M.A., F.L.S., F.Z.S.

- On a Collection of Mammals brought home by the Tibet Frontier Commission 302

- The Mammalian Fauna of China.—Part I. *Murinae* ... 384

BOULENGER, GEORGE ALBERT, F.R.S., V.P.Z.S.

Descriptions of new Reptiles discovered in Mexico by
Dr. H. Gadow, F.R.S. (Plates VI. & VII.) 245

On a Collection of Batrachians and Reptiles made in
South Africa by Mr. C. H. B. Grant, and presented to
the British Museum by Mr. C. D. Rudd 248

Exhibition of, and remarks upon, a melanistic specimen
of the Wall-Lizard 324

BROUN, Col. W. H.

Exhibition of mounted heads of a White Waterbuck
and two Rhinoceroses 296

BROWNE, RICHARD STAPLES-. *See* STAPLES-BROWNE.

COCKS, ALFRED HENEAGE, F.Z.S.

Exhibition of a series of photographs of Whales taken
in East Finmarken 490

CUNNINGHAM, J. T., M.A., F.Z.S.

Exhibition of photographs of, and remarks upon, a
horse bearing horn-like structures 323

DELMÉ-RADCLIFFE, Lt.-Col. C., M.V.O., F.Z.S.

Rough Notes on the Natural History of the Country
West of the Victoria Nyanza 184

DE MAN, Dr. J. G., of Ierseke, Holland.

On Species of Crustacea of the Genera *Ptychognathus*
Stimps. and *Palaemon* Fabr. from Christmas Island.
(Plates XVII. & XVIII.) 537

	Page
DONCASTER, LEONARD, M.A., F.Z.S.	
On the Colour-Variation of the Beetle <i>Gonioctena variabilis</i>	528
 DUERDEN, J. E., Ph.D., A.R.C.Sc. (Lond.), Professor of Zoology, Rhodes University College, Grahamstown, Cape Colony.	
On the Habits and Reactions of Crabs bearing Actinians in their Claws	494
 DUGÈS, ALFRED, M.D., C.M.Z.S.	
Description d'un Ophidien nouveau du Mexique (<i>Morenoa orizabensis</i> , g. et sp. nn.)	517
 ENGLISH, DOUGLAS.	
Exhibition of an albino Field-Vole	324
 EVANS, Major G. H.	
Notes on the Goral found in Burma	311
 FANTHAM, H. B., B.Sc., F.Z.S.	
Exhibition of microscopic slides and description of a new Sporozoon, <i>Lankesterella tritonis</i>	58
Exhibition of, and remarks upon, microscopic preparations of a new Hæmosporidian of the genus <i>Piroplasma</i>	491
 GADOW, HANS, M.A., Ph.D., F.R.S., F.Z.S.	
The Distribution of Mexican Amphibians and Reptiles .	191

GORHAM, The Rev. H. S., F.Z.S.

- On new Coleoptera from South Africa collected by
Dr. H. Brauns and others—*Serricornia*, *Endomychidae*,
Erotylidae 271

GRANT, W. R. OGILVIE-. See OGILVIE-GRANT.

HIRST, A. S., F.Z.S.

- Exhibition of microscopic preparations of a new
Hæmosporidian (*Halteridium crumenium*) 297

HOGG, HENRY R., M.A., F.Z.S.

- On some South Australian Spiders of the Family
Lycosidae 569

HOLDING, R. E.

- Exhibition of, and remarks upon, a series of the first-
year antlers of certain Deer 1

JACOBY, MARTIN, F.E.S.

- Descriptions of new Species of Phytophagous Coleo-
ptera of the Genera *Homophæta*, *Asphæra*, and
Oedionychis. (Plates XIV. & XV.) 398, 591

JOHNSTON, Sir HARRY H., G.C.M.G., K.C.B., F.Z.S.

- On the Nomenclature of the Anthropoid Apes as
proposed by the Hon. Walter Rothschild 70

KIDD, Dr. WALTER, F.Z.S.

- Exhibition of lantern-slides illustrating the Papillary
Ridges in Mammals 297

	Page
LÖNNBERG, DR. EINAR, C.M.Z.S.	
Notes on the Geographical Distribution of the Okapi	309
LYDEKKER, RICHARD, B.A., F.R.S., F.Z.S.	
Colour Evolution in Guereza Monkeys	325
The White-maned Serow. (Plate VIII.)	329
MINCHIN, Prof. E. A., F.Z.S., University College, London.	
On the Sponge <i>Leucosolenia contorta</i> Bowerbank, <i>Ascandra contorta</i> Haeckel, and <i>Ascetta spinosa</i> Lenden- feld. (Plate I.)	3
MITCHELL, P. CHALMERS, M.A., D.Sc., Secretary to the Society.	
Exhibition of photographs of Hippopotamuses swim- ming	1
Report on the Additions to the Society's Menagerie during the month of April 1905	57
On the Anatomy of Limicoline Birds; with special Reference to the Correlation of Modifications	155
Report on the Additions to the Society's Menagerie during the month of May 1905	180
Notice of a memoir entitled "On the Intestinal Tract of Mammals"	184
Report on the Additions to the Society's Menagerie during the months of June, July, August, September, and October 1905	295
Report on the Additions to the Society's Menagerie during the month of November 1905	489
Exhibition of a coloured print of Polito's Royal Menagerie at Exeter 'Change	490

MUDGE, GEORGE P., F.Z.S.

Exhibition of, and remarks upon, a Dogfish with
abnormal viscera 490

Exhibition of, and remarks upon, an Earthworm with
bifid tail 490

NOPCSA, BARON FRANCIS, Ph.D.

Remarks on the supposed Clavicle of the Sauropodous
Dinosaur *Diplodocus* 289

OGILVIE-GRANT, W. R., F.Z.S.

Exhibition of a series of bird-skins from Japan 324

PAM, Capt. ALBERT, F.Z.S.

Remarks upon a living specimen of the Violet-cheeked
Humming-bird 324

PEARCE, NIGEL D. F., M.A., and WARBURTON, CECIL, M.A.,
F.Z.S.

On new and rare British Mites of the Family *Oribatidae*.
(Plates XIX. & XX.) 564

POCOCK, REGINALD INNES, F.L.S., Superintendent of the
Gardens.

Exhibition of a specimen of the Spanish Tarantula 3

Observations upon a Female Specimen of the Hainan
Gibbon (*Hylobates hainanus*), now living in the Society's
Gardens. (Plate V.) 169

Exhibition of a Jamaican Scorpion (*Centrurus insu-
lanus*) carrying young on its back 183

	Page
PYCRAFT, W. P., F.Z.S., M.B.O.U.	
Contributions to the Osteology of Birds.—Part VII. <i>Eurylemidae</i> ; with Remarks on the Systematic Position of the Group. (Plate II.)	30
RADCLIFFE, C. DELMÉ-. See DELMÉ-RADCLIFFE.	
REGAN, C. TATE, B.A., F.Z.S.	
A Revision of the Fishes of the Family <i>Galaxiidae</i> . (Plates X.—XIII.)	363
RIDEWOOD, W. G., D.Sc., F.Z.S.	
Exhibition of microscopic preparations of the regene- rated vertebræ of the tails of Dormice	494
ROTHSCHILD, The Hon. L. WALTER, M.P., D.Sc., Ph.D., F.Z.S.	
Exhibition of specimens of a rare Marsupial (<i>Dacty- lopsila palpator</i>)	297
Exhibition of two tusks from Abyssina	297
SCHERREN, HENRY, F.Z.S.	
Exhibition of lantern-slides of, and remarks upon, old pictures of Anthropoid Apes	298
SCLATER, PHILIP LUTLEY, M.A., D.Sc., F.R.S.	
Letter from Mr. W. Rodier on the Rabbit-pest in Australia	298
SLADE, FRANK, F.Z.S.	
Exhibition of photographs of a Sea-Anemone in the process of division	324

	Page
STAPLES-BROWNE, RICHARD, F.Z.S.	
Note on Heredity in Pigeons	550
THOMAS, OLDFIELD, F.R.S., F.Z.S.	
Description of a new Golden Mole (<i>Amblysomus corrice</i>) from Cape Colony	57
Description of a new Bush-buck (<i>Tragelaphus haywoodi</i>) from British East Africa	180
Exhibition of specimens of Mammals and Birds from Japan and description of a new Marten (<i>Mustela</i> <i>melampus bedfordi</i>)	182
The Duke of Bedford's Zoological Exploration in Eastern Asia.—I. List of Mammals obtained by Mr. M. P. Anderson in Japan. (Plate IX.)	331
Exhibition of, and remarks upon, tails of Dormice showing regeneration of the vertebræ	491
On a Collection of Mammals from Persia and Armenia presented to the British Museum by Col. A. C. Bailward. (Plate XVI.)	519
WALL, Capt. F., C.M.Z.S., Indian Medical Service.	
Notes on a Collection of Snakes from Japan and the Loo Choo Islands	511
WARBURTON, CECIL, M.A., F.Z.S., and PEARCE, NIGEL D. F., M.A.	
On new and rare British Mites of the Family <i>Oribatidæ</i> . (Plates XIX. & XX.)	564

LIST OF PLATES.

1905.—VOL. II.

Plate	Page
I. <i>Clathrina contorta</i>	3
II. Osteology of the <i>Eurylemidae</i>	30
III. } Skulls of <i>Rhinolophi</i>	75
IV. }	
V. <i>Hylobates hainanus</i>	169
VI. 1. <i>Anolis gadovii</i> . 2. <i>Anolis liogaster</i>	{ 245
VII. 1. <i>Sceloporus gadoviae</i> . 2. <i>Leptodira guilleni</i>	}
VIII. White-maned Serow (<i>Nemorhædus argyrochætes</i>)	329
IX. <i>Mustela melampus bedfordi</i>	331
X. 1. <i>Galaxias affinis</i> . 2. <i>G. huttoni</i> . 3. <i>G. punctifer</i> . 4. <i>G. lynx</i>	}
XI. 1. <i>Galaxias weedoni</i> . 2. <i>G. waitii</i> . 3. <i>G. olidus</i> . 4. <i>G.</i> <i>occidentalis</i>	} 363
XII. 1. <i>Galaxias attenuatus</i> . 2. <i>G. covii</i>	}
XIII. 1. <i>Galaxias auratus</i> . 2. <i>G. attenuatus</i> . 3. <i>G. findlayi</i> . 4. <i>G. truttaceus</i>	}
XIV. } New species of Bladder-clawed <i>Halticidae</i>	398
XV. }	
XVI. <i>Calomyscus bailwardi</i>	519
XVII. Figs. 1-5. <i>Ptychognathus pusillus</i> . Fig. 6. <i>P. barbatus</i> ..	}
XVIII. Figs. 7-15. <i>Palaemon</i> (<i>Eupalaemon</i>) <i>lar</i> , var. Figs. 16-19. } <i>P.</i> (<i>Eupalaemon</i>) <i>lar</i>	} 537
XIX. } British <i>Oribatidae</i>	564
XX. }	

LIST OF TEXT-FIGURES.

1905.—VOL. II.

	Page
1. First-year antlers of certain species of Deer.....	2
2. Spicules of a specimen of <i>Clathrina contorta</i> from Roscoff	7
3. Spicules of two specimens of <i>Clathrina contorta</i> from Banyuls..	9
4. Spicules of the "spinosa" variety of <i>Clathrina contorta</i>	13
5. Spicules of <i>Leucosolenia</i> , <i>Sycon</i> , and <i>Clathrina</i>	15
6. Abnormal gigantic spicules of the class of the monaxons from a specimen of <i>Clathrina contorta</i> from Banyuls.....	19
7. Brain of <i>Helictis personata</i> , dorsal aspect	22
8. Brain of <i>Helictis personata</i> , ventral aspect, with the arterial system shown in thicker and thinner black lines	22
9. Pancreas and adjacent regions in <i>Helictis personata</i>	25
10. Pancreas and adjacent region in <i>Galictis barbata</i>	26
11. Intrathoracic aorta of A. <i>Helictis personata</i> ; B. <i>Galictis barbata</i>	27
12. Intrathoracic aorta of <i>Suricata tetradactyla</i>	28
13. Sternum of <i>Calyptomena</i> , showing the simple (unbifurcated) spina externa, etc.	46
14. Portion of the shoulder-girdle of <i>Calyptomena</i>	47
15. Dissection of arm, dorsal aspect, of <i>Eurylæmus ochromelas</i>	54
16. <i>Eumeces algeriensis</i> . Ventral aspect of brain, showing chief arteries	62
17. <i>Gerrhosaurus flavigularis</i> . Ventral aspect of brain, showing chief arteries	62
18. <i>Tupinambis nigropunctatus</i> . Ventral aspect of brain, showing chief arteries	65
19. <i>Python molurus</i> . Ventral aspect of brain, showing chief arteries.	65
20. <i>Testudo vicina</i> . Ventral aspect of brain, showing chief arteries.	68
21. <i>Testudo vicina</i> . Lateral aspect of brain, showing chief arteries.	68
22. Side views of nose-leaves of Bats, showing the principal forms of the connecting process in the <i>Rhinolophus simplex</i> group (<i>a</i>) and the <i>Rh. lepidus</i> group (<i>b, c, d</i>)	121

	Page
23. Wing-structure of <i>Chionis alba</i>	156
24. Diagram of intestinal pattern of <i>Rhynchæa capensis</i>	157
25. Diagram of intestinal pattern of <i>Hydrophasianus chirurgus</i>	158
26. Shoulder-muscles of <i>Edicnemus scolopax</i>	159
27. Biceps of <i>Chionis alba</i>	161
28. Thigh-muscles of <i>Chionis alba</i>	166
29. Map of Mexico	193
30. Diagram of the distribution of 250 Mexican species according to <i>Altitude</i>	229
31. Diagrams to illustrate the contours of Mexico at different geo- logical ages	235
32. Diagrams to illustrate the contours of Mexico at different geo- logical ages	236
33. Liver of <i>Gerrhosaurus flavigularis</i> , ventral aspect	259
34. Liver of a second example of <i>Gerrhosaurus flavigularis</i> , ventral aspect	259
35. Gastro-hepatic ligament of <i>Gerrhosaurus flavigularis</i> , showing course of muscular bundle	261
36. Pancreas of <i>Lucerta ocellata</i> and of <i>Gerrhosaurus flavigularis</i> ..	262
37. Aortic arches and first part of dorsal aorta of <i>Gerrhosaurus</i> <i>flavigularis</i>	263
38. Abdominal region of aorta of <i>Gerrhosaurus flavigularis</i>	264
39. Lateral view of brain of <i>Varanus exanthematicus</i> and of <i>Tupi-</i> <i>nambis nigropunctatus</i>	268
40. Dorsal view of brain of <i>Varanus exanthematicus</i>	268
41. The fœtus of <i>Acomys cahirinus</i>	281
42. The placenta of <i>Acomys</i>	282
43. A section of a portion of the placenta of <i>Acomys</i>	283
44. A section through the junction between trophoblast and tropho- spongia of <i>Acomys</i>	284
45. A diagram of a section through the centre of the placenta of <i>Acomys</i>	285
46. Supposed clavícula of <i>Diplodocus</i>	290
47. Same bone of <i>Diplodocus</i>	290
48. Diagram of penis of <i>Struthio</i>	291
49. Os penis of European Otter	292
50. The <i>Satyros indicus</i> of Tulpius	299
51. Early figure of Chimpanzee, from Astley's 'Travels'	301
52. A, lateral, and B, upper view of the skull of <i>Vulpes ferrilatus</i> ..	304
53. A, upper, and B, lower right molar series of <i>Microtus waltoni</i> ..	307
54. The Black Guereza (<i>Colobus satanas</i>)	325
55. The Mantled Guereza (<i>Colobus palliatus</i>)	326
56. Sharpe's Guereza (<i>Colobus sharpei</i>)	327
57. The White-tailed Guereza (<i>Colobus caudatus</i>)	327
58. The White-thighed Guereza (<i>Colobus vellerosus</i>)	328
59. Principal arteries of <i>Hatteria</i>	463
60. Anterior abdominal and portal veins of <i>Hatteria</i>	465
61. Heart and aortic trunks of <i>Ophisaurus</i> , to illustrate mode of origin of carotid	469

	Page
62. Intestinal arteries and portal of <i>Ophisaurus</i> , from left side	471
63. Renal arteries of <i>Ophisaurus</i>	473
64. Hepatic portal system of <i>Ophisaurus</i>	475
65. Renal veins of <i>Ophisaurus</i>	477
66. Membranes uniting vena cava and left lung in <i>Amphisbæna</i> <i>brasiliانا</i>	481
67. Liver of <i>Amphisbæna brasiliانا</i> , ventral view	483
68. Kidney, testis, and intervening veins of <i>Amphisbæna brasiliانا</i>	486
69. Origin of subclavian in <i>Amphisbæna brasiliانا</i>	486
70. Tail-vertebræ and regenerated appendix of a species of Central Asian <i>Eliomys</i>	493
71. Tail of a species of <i>Graphiurus</i> from Fernando Po showing regenerated appendix	493
72. <i>Melia tessellata</i> from Mauritius, holding an actinian in each claw	495
73. <i>a. Melia tessellata</i> from the Maldive and Laccadive Archipela- goes, bearing in each claw a sea-anemone. <i>b. The "hand"</i> <i>holding an anemone</i>	496
74. <i>Melia tessellata</i> from the Hawaiian Islands, bearing an expanded actinian in each claw	498
75. Claw of <i>Melia tessellata</i> showing the two rows of spines	500
76. <i>Melia tessellata</i> dislodging a fixed actinian by means of its first ambulatory limb	502
77. Tête de <i>Morenoa orizabensis</i> , en dessus et de profil	518
78. Ventral view of <i>Pontodrilus crosslandi</i>	560
79. Ventral view of <i>Pontodrilus laccadivensis</i>	560
80. <i>Lycosa tasmanica</i>	572
81. <i>Lycosa phyllis</i>	574
82. <i>Lycosa molyneuxi</i>	575
83. <i>Lycosa castanea</i>	577
84. <i>Lycosa errans</i>	579
85. <i>Lycosa bicolor</i>	581
86. <i>Lycosa gilberta</i>	582
87. <i>Lycosa stirlingæ</i>	585
88. <i>Lycosa arenaris</i>	587
89. <i>Dolomedes habilis</i>	588

LIST OF NEW GENERIC TERMS

PROPOSED IN THE PRESENT VOLUME (1905, vol. II).

	Page		Page
Dryomys (Mamm.)	348	Hedonistes (Coleopt.)	278
Euryannus (Hemipt.)	153	Levenna (Hemipt.)	151
Glirulus (Mamm.)	347	Morenoa (Ophid.)	517, 518



PROCEEDINGS

OF THE

GENERAL MEETINGS FOR SCIENTIFIC BUSINESS

OF THE

ZOOLOGICAL SOCIETY

OF LONDON.

1905, vol. II.

PART I.



CONTAINING PAPERS READ IN

MAY AND JUNE.

OCTOBER 1905.

PRINTED FOR THE SOCIETY,
SOLD AT THEIR HOUSE IN HANOVER SQUARE.

LONDON:
MESSRS. LONGMANS, GREEN, AND CO.,
PATERNOSTER-ROW.



[*Price Twelve Shillings.*]

LIST OF CONTENTS.

1905.—VOL. II.

PART I.

May 2, 1905.

	Page
The Secretary. Exhibition of photographs of Hippopotamuses swimming	1
Mr. R. E. Holding. Exhibition of, and remarks upon, a series of the first-year antlers of certain Deer	1
Mr. R. I. Pocock, F.Z.S. Exhibition of a specimen of the Spanish Tarantula	3
Mr. W. Bateson, F.R.S. Exhibition of, and remarks upon, specimens of Fowls illustrating peculiarities in the heredity of white plumage	3
1. On the Sponge <i>Leucosolenia contorta</i> Bowerbank, <i>Ascandra contorta</i> Haeckel, and <i>Ascetta spinosa</i> Lendenfeld. By E. A. MINCHIN, F.Z.S., University College, London. (Plate I.)	3
2. Some Notes upon the Anatomy of the Ferret-Badger, <i>Helictis personata</i> . By FRANK E. BEDDARD, M.A., F.R.S., Prosector to the Society	21
3. Contributions to the Osteology of Birds.—Part VII. <i>Eurylemidae</i> ; with Remarks on the Systematic Position of the Group. By W. P. PYCRAFT, F.Z.S., M.B.O.U. (Plate II.)	30

May 16, 1905.

The Secretary. Report on the Additions to the Society's Menagerie during the month of April 1905	57
Mr. Oldfield Thomas, F.R.S. Description of a new Golden Mole (<i>Amblysomus corriæ</i>) from Cape Colony	57
Mr. H. B. Fantham, F.Z.S. Exhibition of microscopic slides and description of a new Sporozoon, <i>Lankesterella tritonis</i>	58
1. A Contribution to the Knowledge of the Encephalic Arterial System in Sauropsida. By FRANK E. BEDDARD, M.A., F.R.S., Prosector to the Society	59
2. On the Nomenclature of the Anthropoid Apes as proposed by the Hon. Walter Rothschild. By Sir H. H. JOHNSTON, G.C.M.G., K.C.B., F.Z.S.	70
3. On some Bats of the Genus <i>Rhinolophus</i> , with Remarks on their Mutual Affinities, and Descriptions of Twenty-six new Forms. By KNUD ANDERSEN. (Plates III. & IV.)..	75
4. On Stridulating Hemiptera of the Subfamily <i>Halyinae</i> , with Descriptions of new Genera and new Species. By Dr. E. BERGROTH, C.M.Z.S., Tammerfors, Finland	146

Contents continued on page 3 of Wrapper.

PROCEEDINGS
OF THE
GENERAL MEETINGS FOR SCIENTIFIC BUSINESS
OF THE
ZOOLOGICAL SOCIETY OF LONDON.
1905, Vol. II. (May to December).

May 2, 1905.

Dr. W. T. BLANFORD, C.I.E., F.R.S., Vice-President,
in the Chair.

The Secretary exhibited three large photographs (now in the Society's Library), presented to the Society by Mr. Howard B. Turner, of Hippopotamuses swimming in a river in their native haunts.

Mr. R. E. Holding exhibited and made remarks upon a series of antlers of the first year of the Roebuck, Red Deer, Fallow Deer, and Wapiti. The exhibit had special reference to a paper read by Mr. Martin A. C. Hinton at the meeting of the Society held on March 21st, on some antlers of the Red Deer (*Cervus elaphus*) which were obtained from the Post-Pliocene deposits in the South of England, and in which it was stated that "these antlers belonged to individuals that had suffered testicular injury at an early period of life, by which the characters of youth were retained for a longer period than usual."

Mr. Holding pointed out from the specimens exhibited (text-fig. 1, p. 2) that the long pedicle, suppression of tines, and presence of rudimentary offshoots were characteristic of the antlers of all the *Cervidae* at the first year or "pricket" stage, and were not therefore due to testicular injury, and that any interference or injury to the generative organs, as in castration, did

Text-fig. 1.

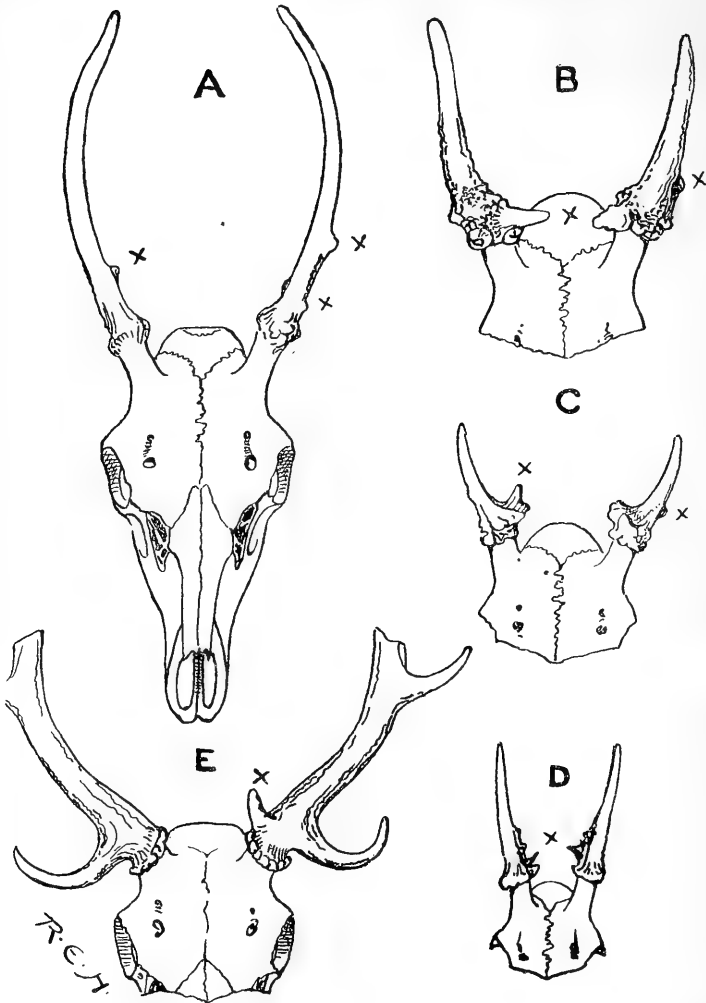

First-year antlers of certain species of Deer.

A, Red Deer; B, Wapiti Deer; C, Fallow Deer; and D, Roe buck—showing adventitious points marked X not being analogous to or the predecessors of the characteristic "tines" of the adult antler. E, lower portion of a pair of antlers of an aged Fallow buck, showing reappearance at the base of the left antler at X of one of these points or characters of the immature stage.

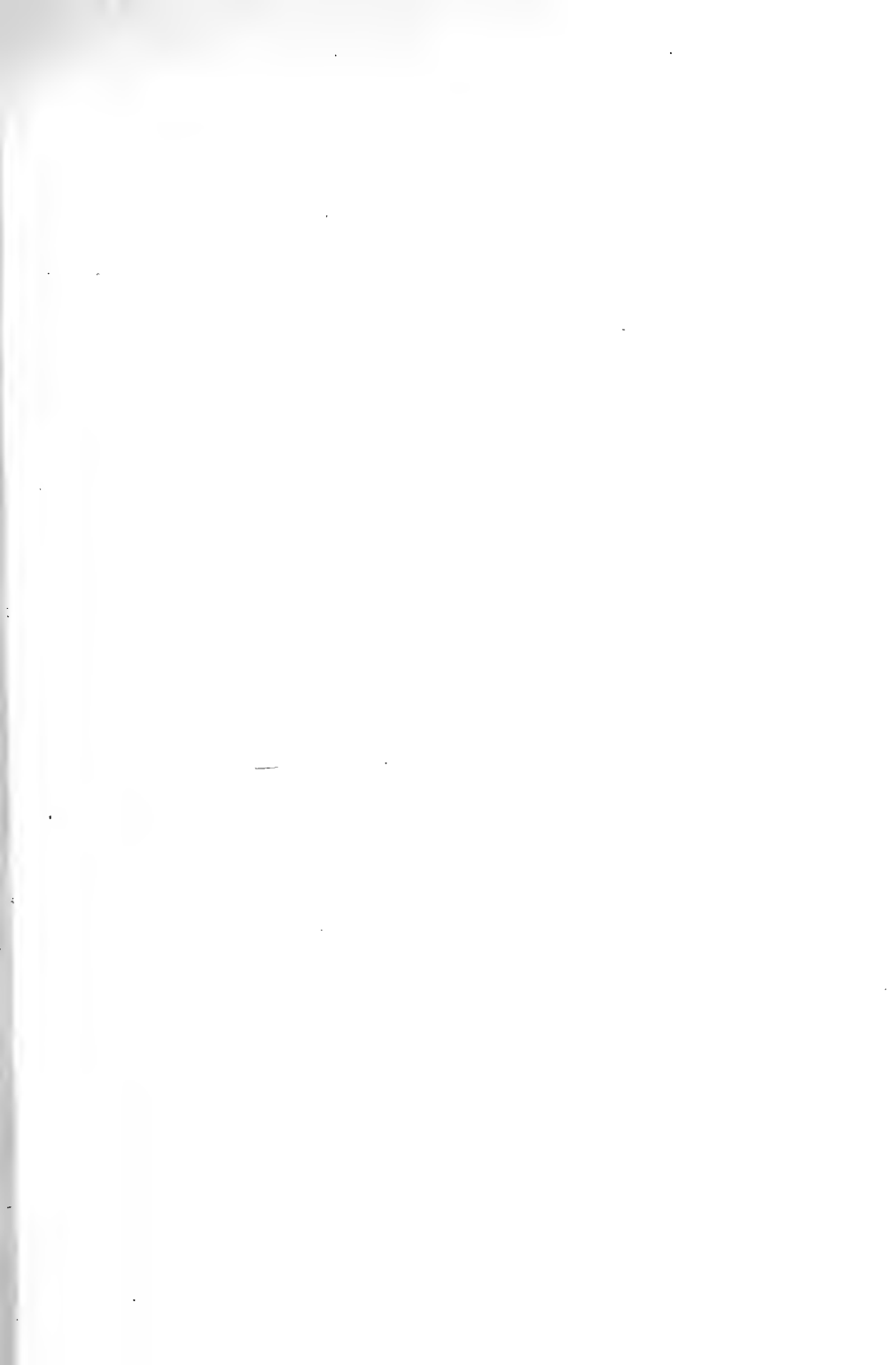

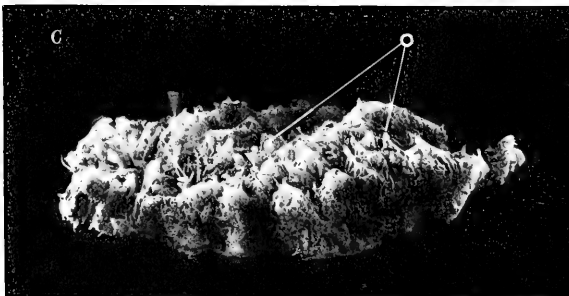
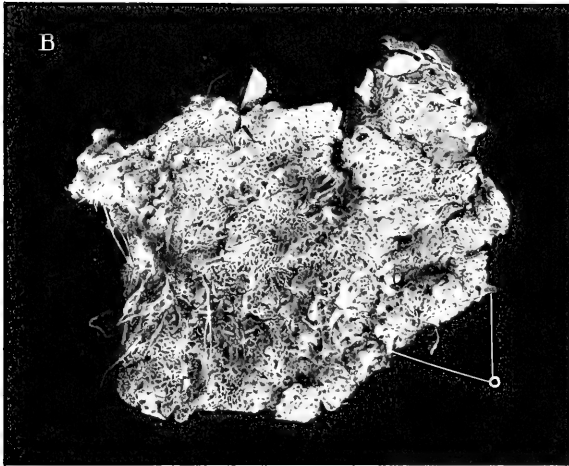
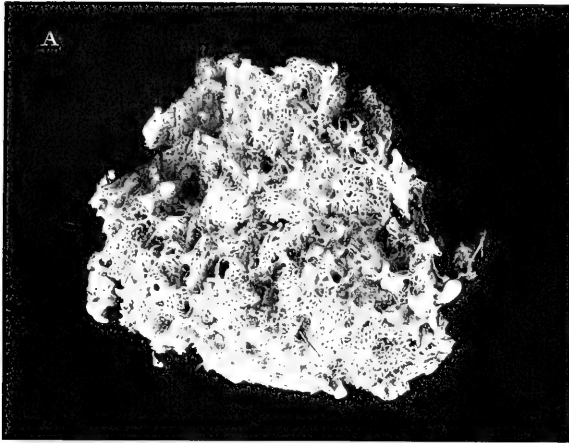

Bale & Danielsson.L.^{td}

CLATHRINA CONTORTA.

not prolong or retain youthful characters of the antlers, but, quite the contrary, caused them to grow irregularly or had the effect of entire suppression of the antler.

He stated that very frequently an aged Stag or Fallow buck would throw up supernumerary snags at the base of the antler (text-fig. 1, E) or along the side of the beam, which somewhat resembled, and were probably a reversion to, these immature characters, and that there were several records of aged or barren hinds growing the simple "pricket" antlers of the first year.

Mr. R. I. Pocock, F.Z.S., exhibited and made remarks on a specimen of the Spanish Tarantula, *Lycosa hispanica*, that had died in the Society's Gardens.

On behalf of Mr. R. C. Punnett, F.Z.S., and himself, Mr. W. Bateson, F.R.S., F.Z.S., exhibited specimens of Fowls illustrating peculiarities in the heredity of white plumage, and made the following remarks:—

A pure white breed such as White Leghorn, crossed with a dark breed such as Brown Leghorn, gives a cross-breed substantially white, the colour being recessive. The White Rose-comb Bantam, however, crossed with a coloured breed gives coloured cross breeds, the white being recessive. But in every specimen examined carefully these recessive whites were found to have one or more minute ticks of black pigment. Though, superficially regarded, these ticked whites would be classified as white, experiment proves them to be entirely different in nature. These facts elucidate the paradoxical accounts given by Darwin and others that Black and White Bantams crossed together give both blacks and whites; for the black may fully dominate over the white in this particular case.

The following papers were read:—

1. On the Sponge *Leucosolenia contorta* Bowerbank, *Ascandra contorta* Haeckel, and *Ascetta spinosa* Lendenfeld. By E. A. MINCHIN, F.Z.S., University College, London.

[Received March 16, 1905.]

(Plate I.* and Text-figures 2-6.)

The Calcareous Sponges have been a very unfortunate group, from the systematic point of view. From the time when Haeckel swept away all previous generic names, in order to found his so-called natural system, up to the present day, scarcely any two

* For explanation of the Plate, see p. 20.

authors have been in agreement as to the names to be employed for the genera or as regards the grouping of the species, especially in the more primitive and interesting section of the Calcarea Homocæla.

The characters, for instance, by which Breitfuss defines the genus *Leucosolenia* of Bowerbank (1864) are such as would exclude from it all, or nearly all, the species which I should refer to it, including, as I have shown elsewhere, even Bowerbank's type species of the genus, *L. botryoides*; while Lendenfeld has always consistently declined to make any use at all of the oldest generic name amongst the Ascons. In short, with the exception, perhaps, of the malarial parasites, there is probably no other group in the animal kingdom in which the nomenclature is in so confused a state as in the Homocæla. The species which forms the subject of the present memoir illustrates well the statement just made. It is a veritable comedy of errors that I have to set forth.

The name *Leucosolenia contorta* was given by Bowerbank in 1866 [1] to certain small sponges from the Channel Islands—Guernsey, and the Guliot Caves, Sark. It is not very clear, however, what Bowerbank considered the distinctive characters of his species, since his diagnosis would apply to almost any Ascon. He states that “the form of this sponge is so distinctly different from that of *L. botryoides* that . . . it cannot well be mistaken for that species . . . *L. contorta* always appears to consist of a mass of contorted inosculating fistulæ.” Further, that “the external surface of *L. contorta* is also sparingly furnished with recumbent acerate spiculæ, mostly disposed in a longitudinal direction, and I have never observed like spiculæ on the surface of *L. botryoides*.” He was a little doubtful if his sponge were not really identical with *Spongia complicata* Montagu (1816), but came to the conclusion that Montagu's figure of *complicata* was “really a very characteristic figure of *Spongia botryoides* of Ellis and Solander,” and that therefore the name *complicata* was to be rejected. Finally, Bowerbank remarks that *contorta* and *coriacea* might be mistaken for each other in the dried condition, but that “the total absence of defensive spiculæ on the cloacal cavity of *L. coriacea*” (meaning apparently the gastral rays of the quadriradiates) readily distinguishes it.

If we put Bowerbank's description into more modern terms, it amounts to this—that *L. contorta* was characterised (1) by form and appearance (contorted inosculating tubes), (2) by the presence of triradiate, quadriradiate, and monaxon spicules. The term “equiangular” applied by him to the triradiate systems need not be taken into account, since he applies the same term to the sagittal spicules of *botryoides*. It is not necessary to point out that the characters given by Bowerbank are not sufficient to define a species of Ascon; and when it is seen that *botryoides* always has monaxon spicules, as I have shown elsewhere, and that *contorta* may frequently lack them; that the specimen of *botryoides* from which Bowerbank figured spicules (Brit. Spong. iii. pl. iii. figg. 3, 4)

was really a specimen of *variabilis*, while the specimen of *contorta* of which the spicules were figured (*l. c.* figg. 8, 9, 10) was really a specimen of *complicata*; and that amongst nine of Bowerbank's specimens examined by me I have found four distinct species confused together—to wit, *complicata*, *variabilis*, *coriacea*, and "*Ascetta spinosa* Lendenfeld": I think it is not necessary to say more in support of the statement that Bowerbank's species *contorta* was of absolutely no systematic value whatever, but represented merely an ill-defined jumble of different species.

In 1872 Haeckel, in his 'Kalkschwämme' [2], used Bowerbank's specific name *contorta* for a sponge which he described in detail. Haeckel pointed out quite rightly that the external characters of *contorta* as set forth by Bowerbank were no guide whatever to its identification, since a quite similar mode of growth characterises other Ascons. Haeckel therefore diagnosed *contorta* by details of its spiculation. The diagnosis given is incorrect in two points, namely, in stating that the monaxons possess a lance-head at their distal extremity, and that the gastral rays of the quadri-radiates are "curved oralwards"; two statements that lead me to suspect that Haeckel's material of *contorta* was, like Bowerbank's, contaminated by admixture of *Leucosolenia complicata*. Haeckel, in his description, also affirmed, in his usual manner, definite characters in the spiculation without taking into consideration the variability which is so marked a feature of the sponge. It is a puzzle to me how Haeckel arrived at the definition which he gave of *Ascandra contorta*, since the specimens named and identified by him which I have seen do not agree with his description, and belong, indeed, to other species—a fact which easily explains any errors of description on his part. It is even more mysterious that Haeckel should have considered his *contorta* identical with Bowerbank's *contorta*, since, of Bowerbank's specimens examined by me, eight in all, not one agrees with Haeckel's diagnosis! These enigmas are not, however, of importance to the present enquiry. Taking Haeckel's description as it stands, and allowing for a certain margin of inaccuracy, I have been able without difficulty to refer to Haeckel's *Ascandra contorta* a sponge extremely abundant on the Mediterranean coasts of France, and occurring elsewhere also. As I have stated in a previous memoir, I consider that where previous writers leave us in doubt as to the characters of a species, Haeckel's description fixes the application of the name. I will proceed now to describe the sponge which I regard as the true *contorta*, and then to consider the synonymy and application of the name.

Ascandra contorta H. is a species which, for reasons stated elsewhere [4, &c.], I refer to the genus *Clathrina* Gray (1867). It has a closely reticulate mode of growth, equiangular triradiate systems, collar-cells with basal nucleus, and parenchymula larva; all these being characters which make up my diagnosis of the genus *Clathrina*.

The specimens of this sponge which I have studied nearly all came from Banyuls-sur-Mer, where this species is extremely abundant. By the kindness of Monsieur Topsent, however, I have seen a specimen from Roscoff, not differing in any respect from the Mediterranean specimens. The sponge therefore has a wide range of distribution, and is almost certainly to be ranked as a member of the British Fauna, though it does not appear to be common on our coasts. Hanitsch has, indeed, recorded it from Liverpool: I have no reason to doubt the correctness of this record beyond the fact that my experience of specimens labelled *contorta* by the most eminent authorities has left me very sceptical as to the correctness of any identification of this species which I have not checked; a scepticism heightened, in the present instance, by the fact that Hanitsch names his specimens *Ascallis contorta*. I may add that the sponges named *Ascandra contorta* by Breiffuss in various memoirs have nothing to do with this species, and should not therefore be taken into account in considering its geographical range.

At Banyuls-sur-Mer *Clathrina contorta* is not only one of the commonest, but also one of the largest Ascons occurring there. Colonies frequently measure 8 centimetres or more across. They consist of a massive or spreading growth of twisted anastomosing tubes, running in all planes, and forming a dense feltwork from which arise at intervals the short, straight, not very conspicuous oscular tubes, which reach two or three millimetres in height, and are of slightly larger calibre than the body-tubes, as the basal growth may be called. The body-tubes are centred round the oscular tubes more or less distinctly, and in the region of the oscular tube the basal system of tubes is usually slightly raised up to form a conulus bearing the oscular tube on its summit; but these conuli are generally very shallow, so that the upper surface of the spreading colony is nearly flat, not lobulated like that of *cerebrum*, nor cushion-like, as in *reticulum*—two species occurring commonly with *contorta*, but both very easily distinguished from it at sight. Photographs will make the external characters of *contorta* clearer than any description (Plate I.). Of its allies, it is perhaps *coriacea* with which *contorta* might be most easily confused, on simple inspection; the latter, however, with its greatly developed gastral rays, is not found contracted up, with closed oscula, like *coriacea*, and when expanded its body-wall is much thicker and less delicate.

The spiculation of *Clathrina contorta* comprises in typical specimens all the three kinds of spicules found in calcareous sponges.

The triradiate systems are equiangular, with the rays straight, tapering imperceptibly for the proximal half or two-thirds; after that tapering more rapidly to a sharp or moderately blunt point (text-fig. 2, 1 *a*-1 *f*). The distal extremities of the rays are often irregular in outline, sometimes markedly so. The rays vary in length from 80 to 130 μ in different specimens, but may be said to average 90-100 μ . The breadth at the proximal end of the

Text-fig. 2.

Spicules of a specimen of *Clathrina contorta* from Roscoff.

Fig. 1 a, triradial; 1 b-1 e, quadriradial in facial aspect; 1 f, abnormal quadriradial with one basal ray wanting; 1 g-1 i, quadriradial in side view, showing gastral rays in profile; 1 j-1 m, monaxons (the spicule represented by 1 m, being too long for the page, has been drawn in two pieces).

ray is usually 8 or 9 μ , but may reach 12 μ ; speaking generally, slender triradiate systems, with rays not exceeding 10 μ in breadth, can be distinguished from thick ones with rays exceeding 10 μ (text-fig. 3, 2 *a*-2 *f*). In some specimens the triradiate systems are all, or nearly all, of the slender type; in others, triradiate systems of the thick type are more abundant.

Some of the triradiate systems develop gastral rays, becoming quadriradiates, and others do not. As a rule the quadriradiates are more abundant than the simple triradiates.

In some specimens there is a tendency for the simple triradiates to be of rather stouter build than the quadriradiates, but in other specimens this cannot be noticed.

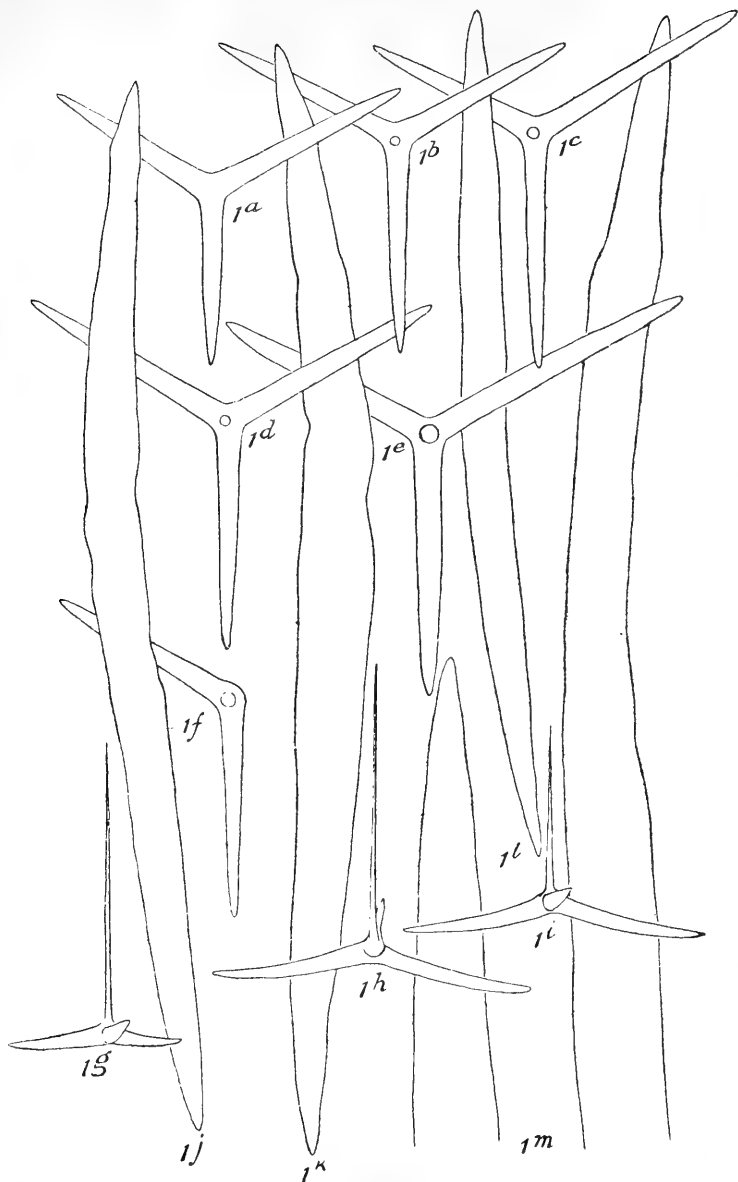
The gastral rays of the quadriradiates are attached at the centres of the triradiate system, and are remarkable for their slenderness and usually also for their length (text-fig. 2, 1 *g*-1 *i*). Arising from a slightly expanded base, the gastral ray sometimes tapers rapidly to a point, then reaching a length equal to about one-half or one-third of that of the basal rays; but more usually the gastral ray is prolonged to a considerably greater length than the basal rays, reaching 130 μ , 140 μ , or even 150 μ in length. The gastral ray then becomes excessively slender for the distal half or two-thirds of its length, and ends in a sharp point; it is not bent oralwards as Haeckel describes it, but it is either quite straight or irregularly curved. Haeckel's figure of a quadriradiate (Kalkschwämme, iii. pl. 14. fig. 6 *c*) obviously represents a spicule of *L. complicata* (compare his fig. 1 *e* on pl. 15, *l. c.*). Quadriradiates are also to be found in which, with gastral rays of great length, are found basal rays much shorter than usual (text-fig. 2, 1 *g*; text-fig. 4, 4 *e*); these are probably young forms in which the rapid growth of the gastral ray* has caused it to attain its full length before the basal rays have done so.

In the thick quadriradiates found in many specimens, I have observed a curious point with regard to the gastral ray, when seen in the facial aspect of the spicule. When the basal system is focussed so that the bases of the rays show sharp contours, the origin of the gastral ray appears as a dark central spot roughly triangular in outline, each side of the triangle being transverse to the base of one of the rays of the triradiate system, and the angles of the triangle rounded off (text-fig. 3, 2 *a*, 2 *b*). If now the focus is slightly raised, the base of the gastral ray appears as a sharp ring, within the triangle. The dark triangle appears to be the expanded base of the gastral ray, but it is only to be seen in the case of the thickened triradiate systems, not in the slender ones.

The monaxon spicules of *Clathrina contorta* vary in the most singular manner, constituting the most remarkable feature of the species. The variations are best considered, first, from the point

* As I have described in a former memoir (Quart. Journ. Micr. Sci., n. s. xi. pl. 42. fig. 55), the elongated gastral rays of *contorta* are covered by a plasmoidal mass containing four nuclei, more than I have observed on the gastral rays of any other Ascon.

Text-fig. 3.

Spicules of two specimens of *Clathrina contorta* from Banyuls.

Fig. 2a & b, thick quadriradiates; 2c & d, slender quadriradiates; 2e & f, triradiates; 2g, quadriradial showing gastral ray in profile; 2h, a monaxon. 3a & b, quadriradiates of another specimen; 3c-3h, monaxons.

of view of substantive variations of form and size; secondly, as regards numerical variation, that is to say abundance of monaxons compared with other types of spicule.

The monaxons are all of large size, being at least twice as thick as the basal rays of the triradiate systems, and not less than $300\ \mu$ in length, allowing for those which are apparently not full-grown. But in some specimens the monaxons reach a size which can only be called gigantic. In a specimen from Banyuls sent me by Topsent (which I will refer to as Topsent 12 e), the monaxons, when drawn to the same scale as the other spicules figured here, come out 32 centimetres in length, corresponding to an actual length exceeding $1000\ \mu$ (1 mm.), with a breadth of about $50\ \mu$ at the thickest part. Even these proportions are exceeded by a specimen in my collection from Banyuls, in which the monaxons when drawn to scale measure 75 centimetres in length, corresponding to an actual length of $2343\ \mu$ (2.3 mm.). I do not think that spicules of such size have been recorded from any Ascon. The large monaxons of *Ascandra densa* and *A. parus* figured by Haeckel (*l. c.* pl. 14. figg. 2 c, 3 f) fall far below those that I have mentioned in dimensions. With these extraordinary variations in size, the form and characters of the monaxons are fairly constant (text-figg. 2 and 3, 1 j-1 m, 2 h, 3 c-3 h). They are spindle-shaped, pointed at both ends, slightly curved, sometimes distinctly so when more slender, or nearly straight when very thick. There is no lancet-head present at the distal extremity, as figured by Haeckel; his figure (*l. c.* pl. 14. figg. 6 d, 6 e) almost certainly refers to *complicata* (compare his figg. 1 g-1 k, on pl. 15). It is, indeed, impossible to say which is the distal end of these monaxons, as they do not project from the sponge like the true (primary) monaxons of other Ascons. Near the middle of the spicule, sometimes at about one-third of the length from one end, a slight constriction can be observed, sometimes very distinct, in others very shallow, in others again represented by an annular thickening, and sometimes not to be made out at all. This constriction is more distinct in young spicules, and appears to become more or less obliterated with growth. In big spicules the contours are often so sinuous and irregular that the primary constriction may be masked by secondary curves. I consider this primary constriction, as I propose to call it, of great morphological importance, as indicating probably that these spicules are not primary monaxons*, comparable to those of *Leucosolenia complicata*, for example, but in reality derived from a triradiate by loss of one ray and shifting of the two others into approximately the same straight line. In very young monaxons of *contorta* I have noticed a delicate transverse line in the region of the constriction (text-fig. 3, 3 e), and I have also found a spicule of which it would be difficult to affirm whether it is a young

* A primary monaxon is derived from a single mother cell which divides into two formative cells, thus originating in exactly the same manner as a single ray of a triradiate system.

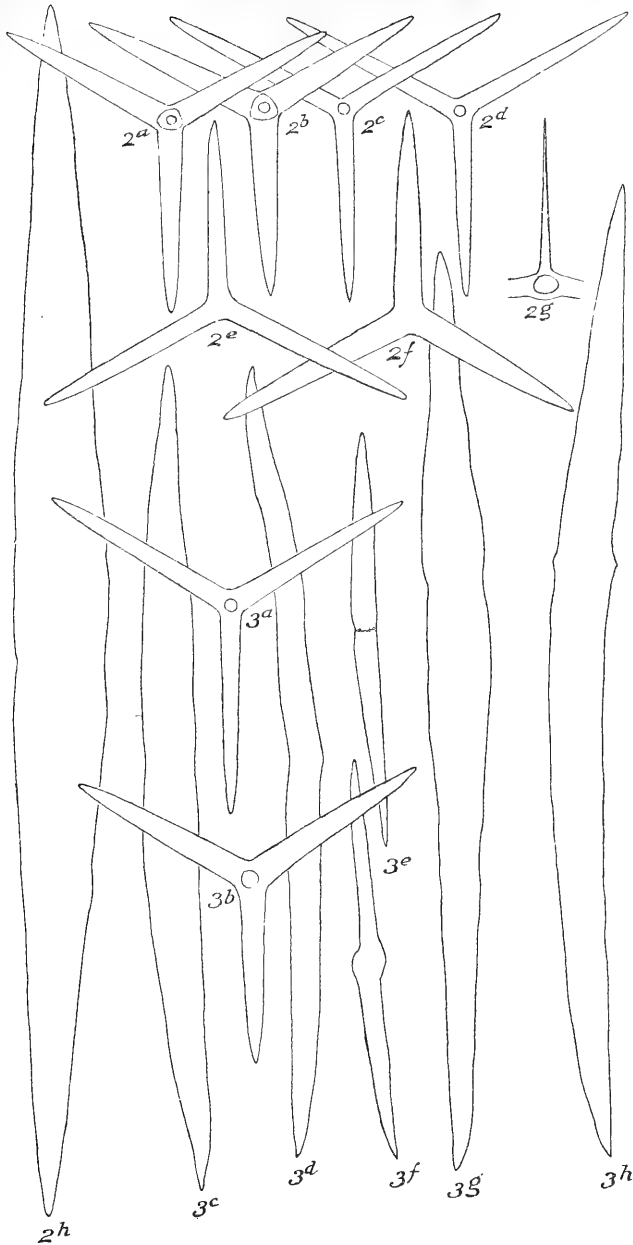
monaxon or an abnormal triradiate (text-fig. 3, 3*f*); probably it is both! My friend Mr. Alford has also found, in the slide of Topsent 12*e*, four abnormal monaxons which have additional rays growing out laterally and thus become triradiates (text-fig. 6, 9*a-9c*). In one of these (9*b*) the three rays are approximately equal in size and meet at the angles of an ordinary triradiate. For all these reasons I consider there is much to be said for regarding the monaxons of *contorta* as secondary monaxons derived from a triradiate system by suppression of one ray and hypertrophy of the two remaining, which become placed in the same straight line, or nearly so.

The numerical variation in the monaxons is not less remarkable. In some specimens scarcely any monaxons are to be found; in others they are extremely abundant. Thus in a specimen recently examined by me, I took a fairly large piece of the sponge, separated the spicules with Eau de Javelle, and mounted all I could get up with the pipette, covering three slides. After prolonged searching I found five monaxons to many thousands of triradiate systems. In another specimen in which I could find no monaxons, Mr. Alford by careful searching found two. It is often extremely difficult to be certain if a specimen has monaxons or not. Mr. Alford has kindly undertaken for me the task of counting the numbers of each kind of spicule found in different specimens, with the following results:—

Specimen.	Triradiates.		Quadriradiates.		Monaxons.		Kind of Monaxons observed.	Total of 3 kinds of Spicules.
	Actual number counted.	—Per-centage of whole.	Actual number counted.	Per-centage of whole.	Actual number counted.	Per-centage of whole.		
No. 1 } (3 3 <i>a-3 h</i>). }	93	3·278+	2727	96·123+	17	·599+	Large.	2837
No. 2 } (3 2 <i>a-2 h</i>). }	311	8·304+	3423	91·402	11	·294+	Large.	3745
No. 3	386	12·512+	2658	86·158+	41	1·329+	Very large.	3085
No. 4 } (Plate I. B). }	247	5·835+	3965	93·668+	21	·496+	Very large.	4233
No. 5	146	5·144+	2686	94·644+	6	·211+	Gigantic.	2838
No. 6 } (Topsent 12 <i>e</i>). }	267	10·349+	2188	84·806+	125	4·844	Gigantic.	2580
Total for } Species. }	1450	7·506	17647	91·35	221	1·144		19318

These results were obtained in the following way:—“Each specimen was put into Eau de Javelle to separate the spicules, and after careful washing, and being allowed to stand for some

considerable time after each washing, the spicules were transferred to the slides by means of a pipette.

"Each slide, when ready, then had marked upon its under surface twenty circular areas, each being brought into the microscopic field in turn and all spicules in each area carefully counted. When all the spicules were counted the circle was erased and the next circular area dealt with.

"The counting was done with the aid of a camera lucida and three differently coloured crayons, thus ensuring that all spicules were counted and counted once only.

"Each quadriradiate spicule had a number in blue marked upon it; the triradiate spicules were marked with successive red numbers and a green number noted a monaxon. At each counting a check could be made, and the counting was complete when each spicule was seen to have one number of a special colour upon it."

The spiculation of *Clathrina contorta* thus shows, on the one hand, comparatively slight variation in the triradiate systems, and, on the other hand, extraordinary differences in number and size of the monaxons in different specimens. The variability is so marked, and the monaxons are frequently so difficult to find, as to suggest at once a possible extreme of variation in which the monaxons would be totally absent. Were this to occur we should have a variety of the sponge characterised by a type of spiculation which would lead to its being placed, in many current systems of classification, in a genus distinct from the variety in which monaxons occur.

As a matter of fact, I may state at once that the variety of *contorta* in which monaxons are completely lacking is very common, and it has been described by Lendenfeld from the Adriatic under the name of *Ascetta spinosa*. This is no mere surmise on my part; I have been able to examine, in the collection of Canon Norman, a slide obtained by him from Lendenfeld, and bearing in Lendenfeld's handwriting the label "*Ascetta spinosa*." Text-fig. 4, 5 a-5 h, represents some spicules drawn by me from this slide. As will be seen, the spiculation differs in no single particular from that of the true *contorta*, except for the lack of monaxons. Since the preparation consists of tubes of the sponge mounted whole, it was not possible to obtain profile views of the gastral rays, except at the torn ends of the tubes, and in no case was I able to see an unbroken gastral ray in side view, but the fragments which I have drawn (5 f-5 h) are sufficient to prove that the gastral rays of this specimen attain the degree of length and slenderness characteristic of the species. Lendenfeld's specimen is, in fact, identical in character with other specimens of "*spinosa*" which I have from Banyuls (text-fig. 4, 6 a-6 g), and these again differ in no respect from the true *contorta* except for the absence of monaxon spicules.

If *Ascetta spinosa* Lend. is to be regarded, as I believe, merely as a variety of *Ascandra contorta* H., how is this variation to be explained? The specimens of *spinosa* that have come under my notice agree perfectly in external characters with *contorta*, but are

Text-fig. 4.

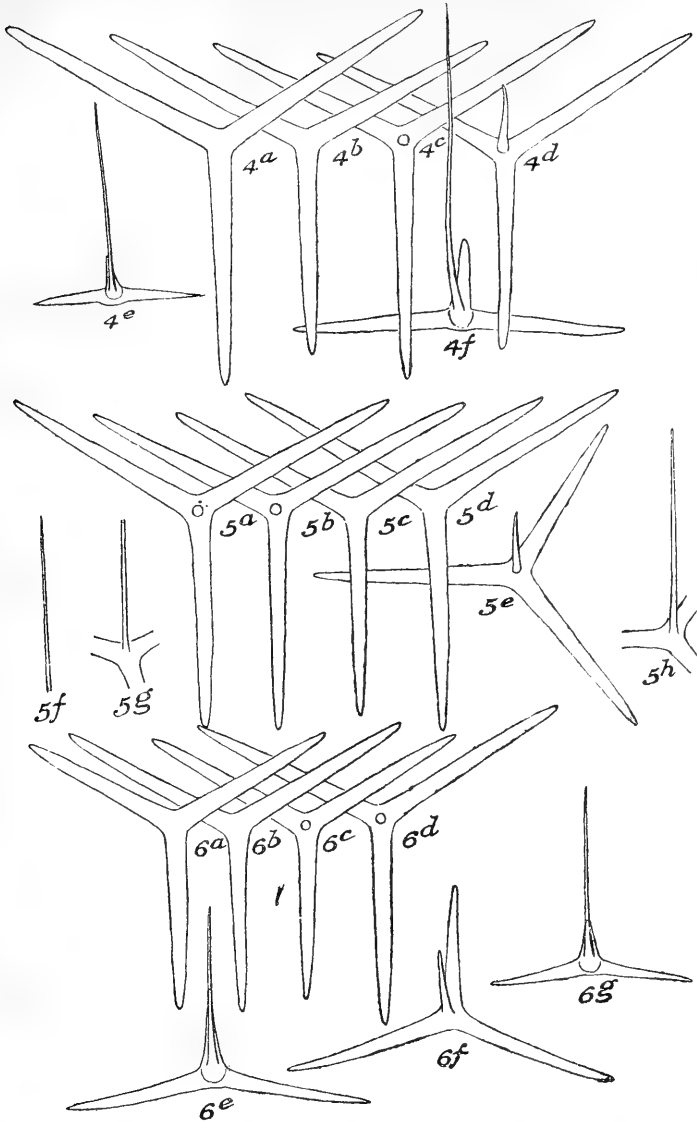
Spicules of the "spinosa" variety of *Clathrina contorta*.

Figg. 4a-4f. Spicules of Bowerbank's type of *Leucosolenia contorta* in the British Museum (Bowerbank Coll. 988), showing gastral rays with tendency to irregular curvature.—Figg. 5a-5h. Spicules of a specimen in Canon Norman's collection labelled "*Ascetta spinosa*" in Lendenfeld's handwriting; the elongated gastral rays (5f-5h) are broken off.—Figg. 6a-6g. Spicules of a specimen from Banyuls.

all of small size. The big, spreading colonies of *contorta* always have monaxons. It is my belief that the absence of monaxons is simply a juvenile feature, so to speak, of the sponge, and that they are only formed when the sponge has grown to a certain size. Such changes of spiculation with age are probably more frequent in sponges than is usually supposed. For a parallel case I need only refer to Topsent's observations on *Cliona celata*.

A point which requires brief discussion, however, is why Lendenfeld found only the *spinosa*-form in the Adriatic, and not the *contorta*-form, if these two forms are really only age-variations in one species. Are we to suppose that in the Adriatic the sponge does not acquire monaxons? In my opinion the explanation of this point is to be sought in quite a different manner. In his 'Kalkschwämme der Adria' [3] Lendenfeld describes another species of *Clathrina* occurring commonly in the Adriatic, namely *C. reticulum*. I have also found this species very abundant at Banyuls, and I possess many specimens of it; but my experience of this species at Banyuls differs sharply in one respect from Lendenfeld's observations upon it in the Adriatic. I find *reticulum* to be more constant in external form and characters than any other species of *Ascon*. All the specimens I have seen—and at one time I had some hundreds of specimens, collected in order to obtain the larval development—are compact, rounded, cushion-like masses of slender, closely-knit tubes, forming a dense and finely-meshed reticulum from which arise one or more oscular tubes of much larger calibre than the tubes forming the body of the sponge. I have figured such a specimen elsewhere (4, p. 6, fig. 6). In short I have never had the slightest difficulty in recognising *reticulum* at sight, though its spiculation often approaches that of *contorta* very closely. My astonishment was therefore great to find that Lendenfeld describes this sponge as occurring (at Sebenica and Lessina) in nearly all the forms generally found in *Ascons*. There is thus a great discrepancy between Lendenfeld's observations and mine with regard to this species, and I am inclined to think that this is to be explained simply by Lendenfeld not having recognised the true *contorta*, but having confused it with *reticulum*. This is a supposition which I am unable to prove or test; but if correct, it would explain why Lendenfeld did not find the true *contorta* occurring in the Adriatic as well as *spinosa*, and also why he finds *reticulum* so variable in form when in my experience it is so extremely constant. I may add, finally, that the figures of monaxons of *reticulum* given by Lendenfeld (3, pl. viii, figg. 7 e-7 f) are more like those of *contorta* than those of *reticulum*, though not exactly like those of either, as these sponges are known to me.

I will now describe some of the historically important specimens to which I have had access, and I begin with the type-specimens of Bowerbank's *Leucosolenia contorta* in the British Museum (Bowerbank Coll. 988). The "type" consists of seven dried specimens, all very small, stuck on a card. The largest specimen,

Text-fig. 5.

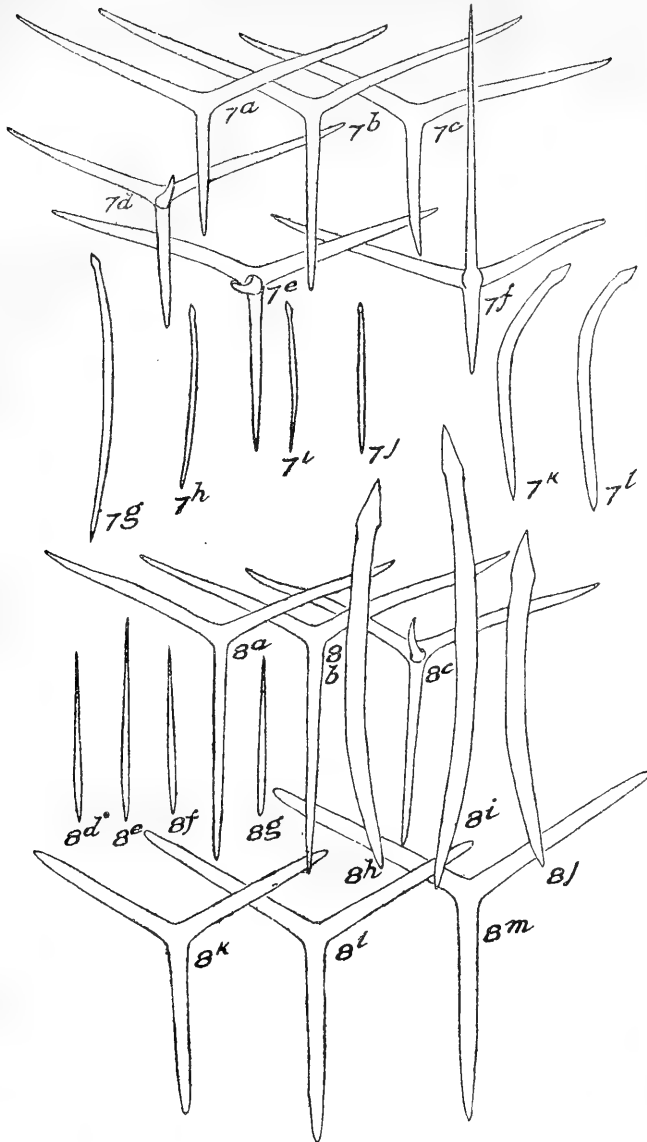
Spicules of *Leucosolenia*, *Sycon*, and *Clathrina*.

Figgs. 7 a-7 l. Spicules of a specimen in Norman's collection, received from Bowerbank with label *Leucosolenia contorta* and identified by Haeckel as *Ascandra contorta*; showing spicules of *Leucosolenia variabilis* (7 a-7 j), mixed with spicules of *Sycon* sp. (7 k, 7 l).—Figgs. 8 a-8 m. Spicules of a specimen in Norman's collection received from Bowerbank with label *Leucosolenia contorta*; showing spicules of *Leucosolenia complicata* (8 a-8 j) mixed with spicules of *Clathrina coriacea* (8 k-8 m).

the original of Bowerbank's fig. 7 on pl. iii. of Brit. Spong. vol. iii., is at the top over the middle of the card; the other six are in two vertical rows of three each to right and left. As I have stated elsewhere, I have examined six out of these seven specimens, and all of them, except the larger one at the top, are quite typical specimens of *Leucosolenia complicata*; the large specimen alone is a true *Clathrina*. I give figures of its spicules (text-fig. 4, 4 a-4 f), and it is not necessary for me to describe them in detail, for it is evident from the figures that this specimen agrees with the true *contorta* in all respects but one, namely, in that the monaxons are wanting. In short, Bowerbank's type-specimen of "*Leucosolenia contorta*," or, to be more accurate, the only one of his type-specimens which does not belong to a species of prior standing, is a specimen of "*Ascetta spinosa*" Lendenfeld!

I have also examined two other specimens of Bowerbank's*, given by him to Canon A. M. Norman, and now in the latter gentleman's collection. The first of these was sent by Canon Norman to Haeckel, and returned by him after examination. It has the following label in Norman's handwriting:—

"*Leucosolenia contorta* Bow.

"Guernsey

"(A type-specimen from Dr. Bowerbank)."

Also a label in Haeckel's handwriting:—

"*Ascandra contorta* H.

"(*Leucosolenia contorta* Bwbk.)

"Guernsey, Bowerbank."

If any specimen in the world ought to have been a specimen of *contorta*, surely this ought, bearing, as it does, a double testimonial to character from the two founders of the species. What, then, was my astonishment, on examining the spicules, to find it a quite typical example of *Leucosolenia variabilis* Haeckel! I figure its spicules in text-fig. 5, 7 a-7 l. The only point to notice about them is a certain admixture of *Sycon* spicules (7 k, 7 l), which, as I have set forth in another place, frequently occurs in preparations of *variabilis*.

The second specimen in Canon Norman's collection bears a label in Bowerbank's handwriting as follows:—

"*Leucosolenia contorta*, Guernsey."

According to information furnished me by Canon Norman, this particular specimen was not sent to Haeckel, but it is one of the same lot as the type sent to him, and has an equal claim to be regarded as a type. Examination of the specimen shows a mixture of *Leucosolenia complicata* and *Clathrina coriacea* (text-fig. 5, 8 a-8 m).

* Bowerbank in his Monograph mentions twenty-eight specimens of *contorta*, but I have had access to only nine of them. I do not know what has become of the others.

From the foregoing it will be seen, I think, that the name-question, in the case of the species under consideration, is a tangled problem, one, indeed, which I feel some diffidence in approaching. I could wish, in fact, as I have said elsewhere, that there were in existence some sort of International Hague Tribunal to which these knotty points of nomenclature could be referred for arbitration and authoritative settlement. In the absence, however, of any such body, I extract from the facts above set forth the following conclusions:—

(1) Bowerbank's *Leucosolenia contorta* was a jumble of different species, and his description could not be used for identification of any particular species. Hence *Leucosolenia contorta* Bowerbank is a *nomen nudum*, of no systematic validity.

(2) Haeckel's *Ascandra contorta*, though not in all respects correctly described, can be applied to an existing species of Ascon, which can be identified by his description. This I consider the true *contorta*: ought the species, however, to be written *contorta* Bwk. or *contorta* H.? Pending the constitution of the International Nomenclature Tribunal, in order to settle this important point, I content myself in following Haeckel in calling it *contorta* Bwk.

(3) *Ascetta spinosa* Lend. is probably the young form, without monaxons, of *contorta*.

I arrive therefore at the following synonymy and diagnosis:—

CLATHRINA CONTORTA (Bowerbank).

? *Nardoa spongiosa* Kölliker *, 1864, Icones Histologicae, Abth. i. pp. 63, 64, pl. vii. fig. 10, pl. ix. figg. 6-8.

Leucosolenia contorta Bowerbank 1866, Mon. Brit. Spong. ii. pp. 29-32; 1874, op. cit. iii. pp. 7-8, pl. iii. figg. 5-10.

Leucosolenia (Nardoa) contorta Gray, 1867, P. Z. S. p. 555.

Leucosolenia (Leuciria) contorta Haeckel, 1870, Jen. Zeitschr. v. p. 243.

Ascandra contorta Haeckel, 1872, Kalkschwämme, ii. pp. 91-93, iii. pl. 14. figg. 6 a-6 e.

? *Ascallis contorta* Hanitsch, 1890, Tr. Biol. Soc. L'pool, iv. pp. 195 & 233.

Ascetta spinosa Lendenfeld, 1891, Zeitschr. wiss. Zool. liii. pp. 203-205, pl. viii. figg. 2, 16, 21, 22.

Leucosolenia contorta Topsent, 1891, Arch. Zool. Exp. (2) ix. p. 525; Bull. Soc. Zool. France, xvi. p. 128; 1892, Résult. Campagnes Sci. Albert 1^{er}, fasc. ii. p. 22; 1894, Rev. Biol. Nord France, vii. pp. 7 & 22.

Clathrina contorta Minchin, 1896, Ann. & Mag. Nat. Hist. (6) xviii. p. 359.

* *Nardoa spongiosa* Kölliker has been put by Haeckel as a synonym of either *Ascallis cerebrum* or *A. gegenbauri*, but the figures of the external form, no less than those of the spiculation, given by Kölliker, seem to me to indicate that the author was dealing with the *spinosa*-form of *contorta*. I have discussed this point elsewhere (Quart. Journ. Micr. Sci. n. s. xl. p. 533, footnote).

Clathrina spinosa Minchin, *ibid.*

Leucosolenia spinosa Breitfuss, 1898, Arch. f. Naturges. lxiii. 1, p. 213.

(The following references, on the other hand, probably do not relate to the true *contorta*.)

Ascandra contorta Barrois, 1876, Ann. Sci. Nat. (6) iii. Article 11, p. 35, probably refers to *Leucosolenia complicata*.

Leucosolenia contorta Carter, 1880, Midland Naturalist, ii. p. 195. The author remarks that "Bowerbank's illustration of the linear spicule is defective. There are *two* forms, quite different from each other and from Dr. Bowerbank's figure." I consider it probable from this statement that Carter was dealing with a specimen of *Leucosolenia complicata*.

Ascandra contorta Breitfuss, 1898, Arch. f. Naturges, lxiii. 1, p. 214, refers to a specimen of *Leucosolenia complicata*; so probably also the sponge described and figured by the same author in Mém. Ac. St. Pétersbourg, 1898 (viii.) vi. p. 15, pl. i. fig. 1, and cited by him in other memoirs.

And finally it should be mentioned that the numerous specimens sent out from Sinel and Hornell's Zoological Station, Jersey, are all, so far as I have seen, specimens of *Leucosolenia complicata*.

Diagnosis.—Triradiate systems equiangular, with or without gastral rays; the quadriradiates generally more numerous than the simple triradiates. Rays of the triradiate systems tapering imperceptibly for the proximal half or two-thirds, then narrowing more rapidly to a sharp or moderately blunt point. Gastral rays sometimes short, more usually longer than the basal rays, very slender, sharp, and straight or irregularly curved.

Monaxons at least twice as thick as the basal rays of the tri-radiate systems,—varying in different specimens from a moderate size to gigantic proportions, spindle-shaped, usually slightly curved, and usually with a distinct constriction near the middle of their length; sometimes very few in number, sometimes absent altogether.

The chief objection that can be made, it seems to me, with regard to my treatment of the species, relates to the position of *spinosa*. Naturalists concerned chiefly with the arrangement of specimens in bottles on shelves will perhaps object to my "lumping" together two forms which can be separated by a definite character, although by one only. Those who reason thus will, no doubt, prefer to retain *spinosa* as a "species" distinct from *contorta*; in that case the type of Bowerbank's *contorta* belongs to the former species, a fact which raises alarming problems of nomenclature. The range of variation seen in *contorta* has its natural and logical termination in the form *spinosa*, and justifies, in my opinion, placing the latter as a synonym. Moreover it is often extremely difficult to be certain that monaxons are really absent in a specimen of "*spinosa*." They may be so scarce that they have been simply overlooked.

After arriving at the above conclusions with regard to the

identity of *contorta* and *spinosa*, it is hardly necessary for me to express my opinion with regard to those systems of classification which define not only species but even genera of Ascons by the presence or absence of monaxon spicules. Before such a character as the presence or absence of monaxons can be used for systematic

Text-fig. 6.

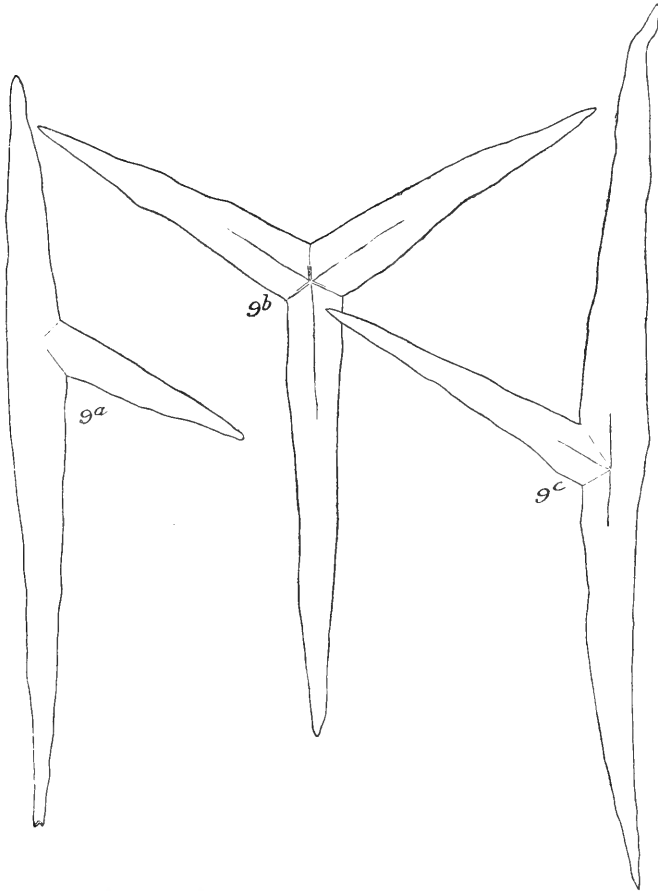

Abnormal gigantic spicules of the class of the monaxons from a specimen of *Clathrina contorta* from Banyuls (Topsent 12 e). Magnified about 150 linear (*i. e.* half as much as the spicules figured in text-figg. 2-5).

purposes, it is necessary to understand clearly what is meant by a monaxon spicule. In calcareous sponges a spicule of this class may be one of two perfectly distinct things. It may be, on the one hand,

a primary monaxon spicule, derived from a single mother-cell, and developing exactly in the same way as a single ray in a tri-radiate system, with which it is strictly homologous. It may be, on the other hand, a secondary monaxon, derived by modification of an entire triradiate system by loss of one ray, perhaps in some cases two rays. Good examples of monaxons undoubtedly of secondary nature are the elbowed monaxons in the stalk of *Clathrina lacunosa* Johnston (renamed *Ascandra angulata* by Lendenfeld). I believe also, as stated above, that the monaxons of *contorta* are to be regarded as secondary. It is clear that a character which is sometimes one thing, in other cases quite another thing, cannot be usefully employed for purposes of systematic classification, not, at least, until more is known about it.

If *Ascetta spinosa* be put as a synonym of *Clathrina contorta*, it is seen that the species has a wide range, extending from the Adriatic round the coasts of France into the English Channel, and probably also on to the coasts of Great Britain.

It is my pleasant duty finally to express my thanks to friends who have assisted me in the preparation of this memoir, put together from observations for the most part of long standing, at a time when the stress of other work, caused by preparations for my departure for the Tropics, was very great. My friend Mr. G. R. Alford, who is making a special study of the variation of this sponge, has given me valuable assistance, as will be evident from the facts I have quoted from him above. Mr. Alford has also kindly undertaken to see this memoir through the press for me. My friend and pupil Mr. L. R. Crawshay has given me great help in preparing the illustrations. Finally, I have to thank Monsieur Topsent, of Caen, for his kindness in sending me specimens from Roscoff and elsewhere and for answering many queries.

BIBLIOGRAPHY.

- (1) BOWERBANK, J. S. A Monograph of the British Spongiadæ, London, Ray Society, 3 vols. : 1864-1874.
- (2) HÆCKEL, E. Die Kalkschwämme. Berlin, 1872; 3 vols.
- (3) LENDENFELD, R. v. Die Spongia der Adria: I. Die Kalkschwämme. Zeitschr. wiss. Zool. liii. (1891) pp. 185-321, 361-433, pls. viii.-xv.
- (4) MINCHIN, E. A. Sponges in: Lankester, 'A Treatise on Zoology,' London, 1900.

Other references are cited in the list of synonymy, p. 17 above.

EXPLANATION OF PLATE I.

Clathrina contorta from Banyuls.

A from above; B from above, and C from the side, to show the oscular tubes (O).

2. Some Notes upon the Anatomy of the Ferret-Badger, *Helictis personata*. By FRANK E. BEDDARD, M.A., F.R.S., Prosector to the Society.

[Received March 21, 1905.]

(Text-figures 7-12.)

The dissection of a female example of *Helictis personata*, which was acquired by the Society on the 4th and died on the 14th November, 1904, enables me to lay before the Society some new facts in the anatomy of this genus of Carnivora.

So far as I am aware, the only zoologist who has investigated the anatomy of the soft parts of the genus *Helictis* is the late Prof. Garrod*, whose memoir deals with the essentials in its structure. The species examined by him was *Helictis subaurantiaca*. It is not therefore unnecessary to report upon the anatomy of another species, though the differences between the two are, as might be expected, but slight. I deal, moreover, with a few points upon which Prof. Garrod did not touch in his account.

§ Brain.

The brain of *Helictis subaurantiaca* has been described and figured (in dorsal and lateral view) by Prof. Garrod in his memoir already referred to†. The figure of the brain of *Helictis personata* submitted herewith (text-fig. 7, p. 22) shows certain differences, which I regard as worthy of record in view of the little knowledge which we possess upon the matter.

The most salient difference which this brain shows from that of *H. subaurantiaca* is the very slight appearance upon the dorsal surface of the intercalary prolongation of the calcarine sulcus. This furrow, as will be seen in the figure (text-fig. 7), only appears dorsally for a short distance quite at the posterior end of the hemispheres, and also of course anteriorly where the two sulci join the crucial sulci.

The precrucial sulcus in my specimen is not so fully developed, particularly upon the left side (text-fig. 7, *Pc.S.*), as in Garrod's specimen of *Helictis subaurantiaca*. It does not entirely delimit the ursine lozenge in front.

The Sylvian fissure on both sides of the brain joins the suprasylvian, the gyrus anterior to the Sylvian being apparently depressed below the surface of the hemispheres. There is a hint of this in Garrod's figure, but hardly in that of Dr. Elliot Smith, though it refers, I imagine, to the same brain. The remaining fissures agree absolutely with those of *Helictis subaurantiaca*. I pass on therefore

* "Notes on the Anatomy of *Helictis subaurantiaca*," P. Z. S. 1879, p. 305.

† This brain is also figured in the Catalogue Physiol. Series Roy. Coll. Surgeons, vol. ii. (2nd ed.) p. 273, by Dr. Elliot Smith.

to the arteries of the brain, which are most satisfactorily injected in my specimen and which show all the Arctoid characters*. The rhomboidal area formed by the bifurcation of the anterior spinal and its junction with the basilar is of considerable calibre and uniform throughout, as in all Carnivora which have been examined.

The vertebral arteries are, however, peculiar in their mode of joining this rhomboidal vessel. Each vertebral artery in fact divides before joining the rhomboidal, and each branch opens separately into it, as is shown in the accompanying figure (text-fig. 8). The carotids join the circle of Willis just before the middle cerebral arteries are given off.

Text-fig. 7.

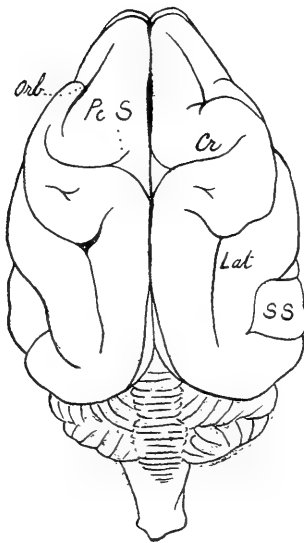
Text-fig. 7.—Brain of *Helictis personata*, dorsal aspect.

Cr. Crucial fissure; Lat. Lateral fissure; Orb. Orbital fissure; Pc.S. Precrucial fissure; S.S. Supra-Sylvian fissure.

Text-fig. 8.

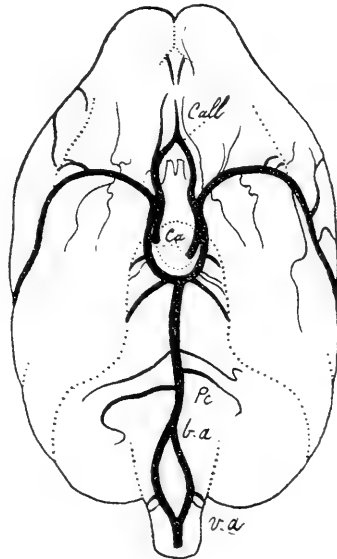

Text-fig. 8.—Brain of *Helictis personata*, ventral aspect, with the arterial system shown in thicker and thinner black lines. The dotted lines delimit regions of the brain.

b.a. Basilar artery; Ca. Carotids; Call. Callosal arteries; Pc. Posterior cerebellar; v.a. Vertebral arteries.

Anteriorly the circle of Willis is completed by the fusion of the two callosal arteries, that of the right side being distinctly smaller than that of the left.

* Beddard, P. Z. S. 1904, vol. i. p. 183.

The posterior cerebellar arteries are asymmetrical in their origin from the basilar, the left being considerably in front of the right.

The middle cerebellar arteries arise in front of the sixth nerve.

§ *Some Notes on the Muscles.*

The muscular anatomy of the Carnivora has been lately treated of in an exhaustive fashion by Messrs. Windle and Parsons*. As a supplement to that paper (which does not deal with *Helictis*) I am able to offer a few notes upon the musculature of *Helictis personata*.

The *Sterno-mastoid* consists from the very beginning of two parts: the larger of these is inserted on to the mastoid next and superficial to the cleido-mastoid muscle; the smaller part crosses the cleido-mastoid and joins the cephalo-humeral. This latter portion of the muscle has been spoken of as a portion of the trapezius, with which, indeed, it is plainly confluent above.

The *Sterno-hyoid* and *Sterno-thyroid* appear to arise from the sternum as one muscle. I could find no tendinous intersection.

The *Omo-hyoid* is apparently completely absent. I could find no trace of it. This muscle is usually present in Mustelidæ.

The *Omotracheian* has exactly the relations described by Windle and Parsons.

The *Rhomboideus profundus*, which arises from the supra-spinous fossa of the scapula near to the root of the spine, is a slender muscle inserted on to the atlas deep of the omotracheal. It is perfectly distinct at its origin from the *Rhomboideus cervicalis*. Its discovery in *Helictis* gives further support to Messrs. Windle and Parson's belief that the muscle is eminently characteristic of the Mustelidæ.

The *Rhomboideus capitis* has only a single origin in common with the *Rhomboideus cervicalis*, not the double origin of *Ictonyx* (a near ally of *Helictis*) as figured by Windle and Parsons.

The *Dorso-epitrochlear* is contiguous to and hardly if at all distinguishable from the extra head of the *Triceps* occurring in this as in many other Carnivora. The *Dorso-epitrochlear* itself is of course part of the *Latissimus dorsi*; in passing by the scapula it receives a mass of fibres from the lower border of that bone and thence becomes continuous with a sheet of fibres arising from the *Teres* and constituting, as I imagine, the "extra head" of the *Triceps* of Messrs. Windle and Parsons, which those anatomists state to be characteristic of the Mustelidæ.

The *Biceps* has only one head.

Helictis appears to possess two distinct *Palmaris longus* muscles.

The *Sartorius* is single and fused at its insertion with the also single *Gracilis*.

The *Pectineus*, often a double muscle, is single in *Helictis*.

* P. Z. S. 1897, p. 370, & 1898, p. 152.

I found it impossible to subdivide the *Adductor* mass.

The *Seminembranosus* is divided into two muscles for some way in front of its obviously double insertion on to the tibia and the femur. I could not find, however, that this muscle was divided at its origin from the ischium.

The *Semitendinosus*, as in some other, but not in all, Mustelidæ, has a very distinct caudal head. There is no *Agitator caudæ*.

The *Tenuissimus* is plainly present.

The *Tibialis anticus* is single.

§ Lungs.

As Prof. Garrod pointed out in *H. subaurantiaca*, the lungs in *H. personata* consist of four lobes on the right side and two on the left. Prof. Garrod, however, made no observations upon the relative sizes of the several lobes. On the right side the first lobe is rather larger than the second; the third is the biggest of all and quite twice the size of the first; the fourth or azygos lobe is the smallest of all.

The two lobes on the left side are more nearly equal in size, but the second or lower lobe is the larger.

§ Liver.

The liver of this species appears to be much like that of *H. subaurantiaca*. The enormous right central lobe is deeply* fissured and exposes the gall-bladder on the diaphragmatic side. This lobe is quite twice the size of the left lateral lobe, which is the next largest; this lobe again is larger than the right lateral, which does not show any great difference of size from either the left central or the caudate. The Spigelian lobe is minute.

§ Pancreas.

The pancreas of *Helictis* is almost exactly like that of the Tayra (*Galictis*), with which Arctoid I have specially compared it. It is not clear from Garrod's description what is the precise form of the gland in the species investigated by himself. In *H. personata* there is a circular portion of the pancreas running right round the duodenal loop †; this ends in a straight piece running parallel with the spleen. The chief difference which *Helictis* shows from *Galictis* is in the mesenterial attachment of the straight part of the pancreas. In *Galictis* a transparent mesentery, apparently anangious, is attached to the whole length of the straight region of the pancreas, and is inserted on to the mesocolon along a line which commences in front of and ends behind the left kidney.

* But not quite so deeply as in *Galictis*.

† As in many Carnivora, cf. *e. g.* Owen's Comp. Anat. vol. iii. p. 496.

In *Helictis*, on the other hand, this membrane is of much less extent. It is only attached to about half the length of the pancreas and is inserted on to the mesocolon along a line which begins a little before the left kidney but ends at about its middle. This characteristic difference is illustrated in the figures (text-figs. 9, 10).

Text-fig. 9.

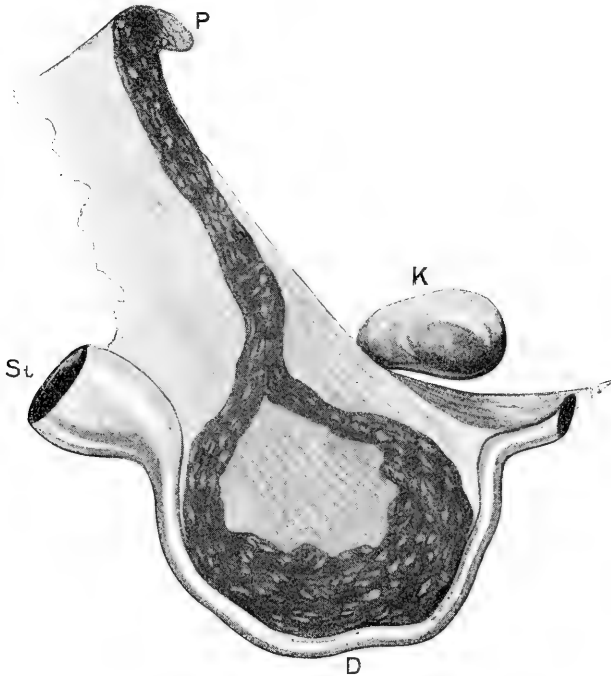
Pancreas and adjacent regions in *Helictis personata*.

D. Duodenum; P. End of pancreas; K. Kidney; St. Stomach.

§ Ovary and Broad Ligament.

As is very frequently, if not constantly, the case with the Arctoidea, the ovary is completely encapsuled and thus continuous, anatomically, with the Fallopian tube.

An interesting point concerns the suspension of the ovary and oviducal canal. The mesoarium is continued forwards for a short distance in front of the ovary, running attached to the parietes to the outside of the kidney. In *Galictis* there is the same forward prolongation of this fold, which has the same position in relation to the kidney, but it extends much further forward on

both sides, in fact nearly to the diaphragm. In *Cynictis levaillanti* and *Arctictis binturong*, which I examined for purposes of comparison, the conditions are a little different. In the former the fold of peritoneum in question runs *over* the kidney instead of avoiding it, and ends on the parietes a little way in front and outside of that gland. In the *Binturong* the mesoarium on the right side extends nearly up to the diaphragm, passing over the

Text-fig. 10.

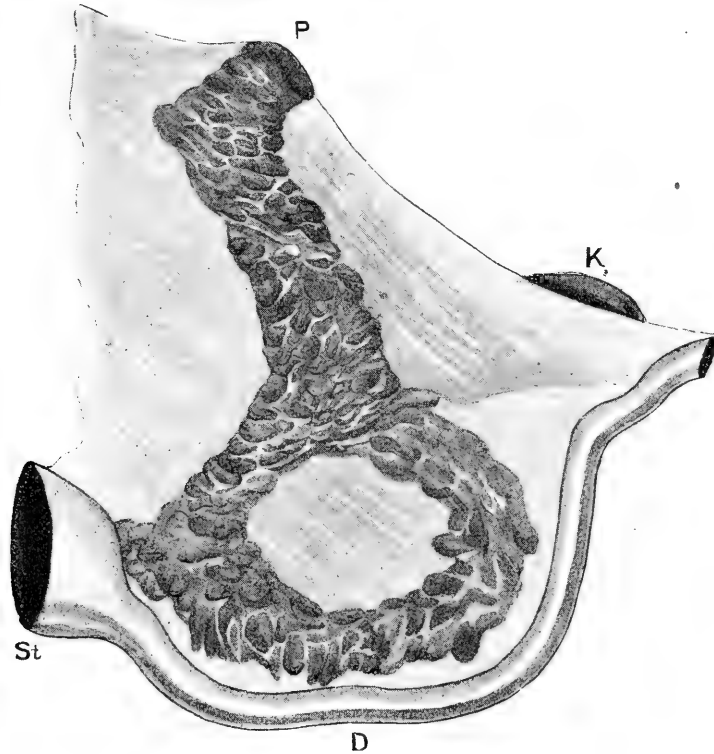
Pancreas and adjacent region in *Galictis barbara*.

Lettering as in text-fig. 9.

kidney and being naturally attached to it on its passage. On the left side, this fold of peritoneum actually reaches the diaphragm, passing also over the kidney of its side. I will not assert at present that there are here characters which serve to differentiate the Arctoid from the Æluroid Carnivora, but they do as a matter of fact differentiate certain Æluroids from certain Arctoids.

§ *Arterial System**.

The *Aortic arch* gives off first an *innominate artery* and then the *left subclavian* separately. These matters are not mentioned

Text-fig 11.

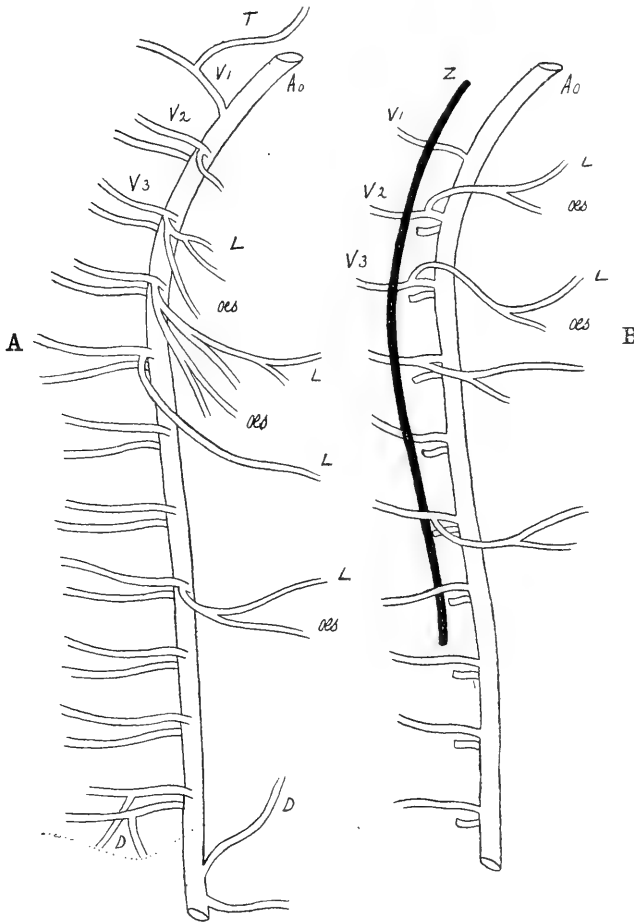

Intrathoracic aorta of **A.** *Helictis personata*; **B.** *Galictis barbara*.

A₀. Aorta; L. Branches to lung; oes. Branches to oesophagus; v. Intercostals;
z. Azygos vein; T. Branch to trachea; D. Phrenic arteries.

by Garrod in his account of *Helictis subaurantiaca*, and indeed

* The arteries of the brain are dealt with under the description of that organ.

he gives no account of the vascular system at all. The innominate first gives off the left carotid, and then very shortly after divides into the right subclavian and right carotid. The aorta in the thoracic region gives off eleven pairs of *intercostal arteries*, the

Text-fig. 12.

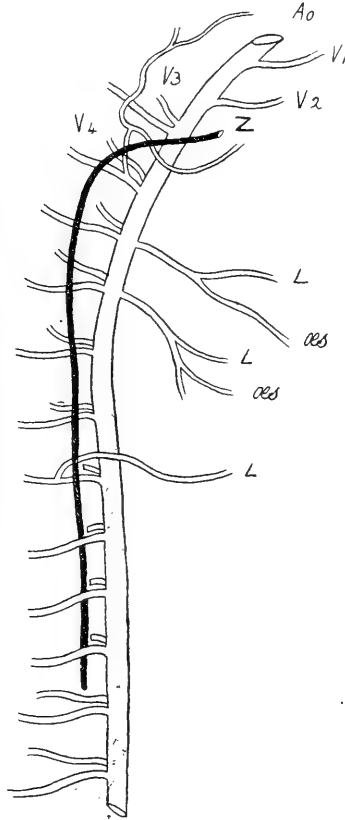
Intrathoracic aorta of *Suricata tetradactyla*.

Lettering as in text-fig. 11.

eleventh being just in front of the diaphragm. It is important to notice that these arteries are paired throughout, each artery of the pair arising separately from the aorta: important because in some mammals (e. g. *Chinchilla*) the intercostals arise as single

arteries and afterwards divide into right and left halves. The first pair of intercostals corresponds to the first branch of the Azygos*. The first six pairs of intercostals lie entirely to the left of the Azygos; the 7th artery on the right side and those which follow lie to the right side of the Azygos. This point, I take it, is where originally the now missing right aortic arch joined the left aortic arch. In this region the aorta also gives off a number of fine slender branches to the œsophagus and to the lungs. The first of these branches arises a little way down the first right intercostal and supplies the windpipe; from or in the immediate neighbourhood of the next four right intercostals arise twigs for œsophagus and lungs; then follows a gap of two intercostals, the last twigs arising from the 8th right intercostal. From the last intercostal in front of the diaphragm arises a diaphragmatic artery on each side; another diaphragmatic artery springs directly from the aorta behind the diaphragm, and independently of an immediately following suprarenal artery.

I have carefully and, I hope, exactly compared the pre-diaphragmatic arteries of *Helictis* with those of its ally *Galictis* and with those of the Æluroid *Suricata*.

The former, as might be expected, shows greater resemblances to *Helictis* than does the latter. There are, however, also differences. There are 10 instead of 11 pairs of intercostals in front of the diaphragm, or, to be more absolutely accurate, 10 on one side and 9 on the other; for the first intercostal has not a fellow and belongs to the left side. The fifth right intercostal is the first which passes to the outside of the Azygos vein. The pulmonary and œsophageal branches arise in every case from the right intercostal vessels, and I counted four of them which have the following position: the first three arise from the first three right intercostals; the fourth springs from the fifth right intercostal.

In *Suricata tetradactyla* there are 12 intercostals on the right side in front of the diaphragm and two additional ones on the left side. The most important pulmonary and œsophageal arteries arise separately from the aorta, though some spring from right intercostals. The 8th right intercostal is the first which passes over the Azygos vein.

* This vessel, as in most mammals, is present only on the right side.

3. Contributions to the Osteology of Birds.—Part VII.*
Eurylæmidæ; with Remarks on the Systematic Position
of the Group. By W. P. PYCRAFT, F.Z.S., M.B.O.U.

[Received March 30, 1905.]

(Plate II. † and Text-figures 13–15.)

CONTENTS.

i. Introductory Remarks, p. 30.	vii. The Pelvic Girdle, p. 48.
ii. The Skull of the Adult, p. 30.	viii. The Pectoral Limb, p. 48.
iii. The Skull of the Nestling, p. 40.	ix. The Pelvic Limb, p. 49.
iv. The Vertebral Column, p. 43.	x. Summary, p. 50.
v. The Ribs, p. 45.	xi. List of Literature referred to, p. 56.
vi. The Sternum and Shoulder-girdle, p. 45.	xii. Explanation of Plate II., p. 56.

i. INTRODUCTORY REMARKS.

The present paper is intended to form the first of a series on the osteology of the Passeres, and, in order to increase its value to the systematist, characters other than osteological will be discussed where necessary. By this means it is hoped that that most difficult of ornithological problems—the classification of the Passeres—will be materially aided.

The labours of Garrod, Forbes, and Fürbringer have resulted in the accumulation of a considerable pile of facts concerning the soft parts of the *Eurylæmidæ*, but comparatively little has been done in the way of osteology.

My work, it may be as well to state here, has been hampered by paucity of material, since several genera are entirely unrepresented in the Collection of the British Museum (Natural History). Doubtless these gaps will be filled in course of time, and the lacunæ, unavoidable in this contribution, can then be filled up. Skeletons of nestlings are especially wanted.

ii. THE SKULL OF THE ADULT.

The skull of the *Eurylæmidæ* is remarkable for the extreme specialisation which it displays, though these birds are of an undoubtedly primitive type. That changes so considerable as are here to be noticed should have taken place in the skull is unfortunate, since thereby valuable evidence on questions of ancestry has been lost.

It is not an easy matter to express exactly what are the characteristic features of the *Eurylæmid* skull, or, rather, it is not easy to set down diagnostic characters, since it presents considerable and often wide differences in different genera. Superficially it

* For Part VI. see P. Z. S. 1903, vol. i. p. 258.

† For explanation of the Plate, see p. 56.

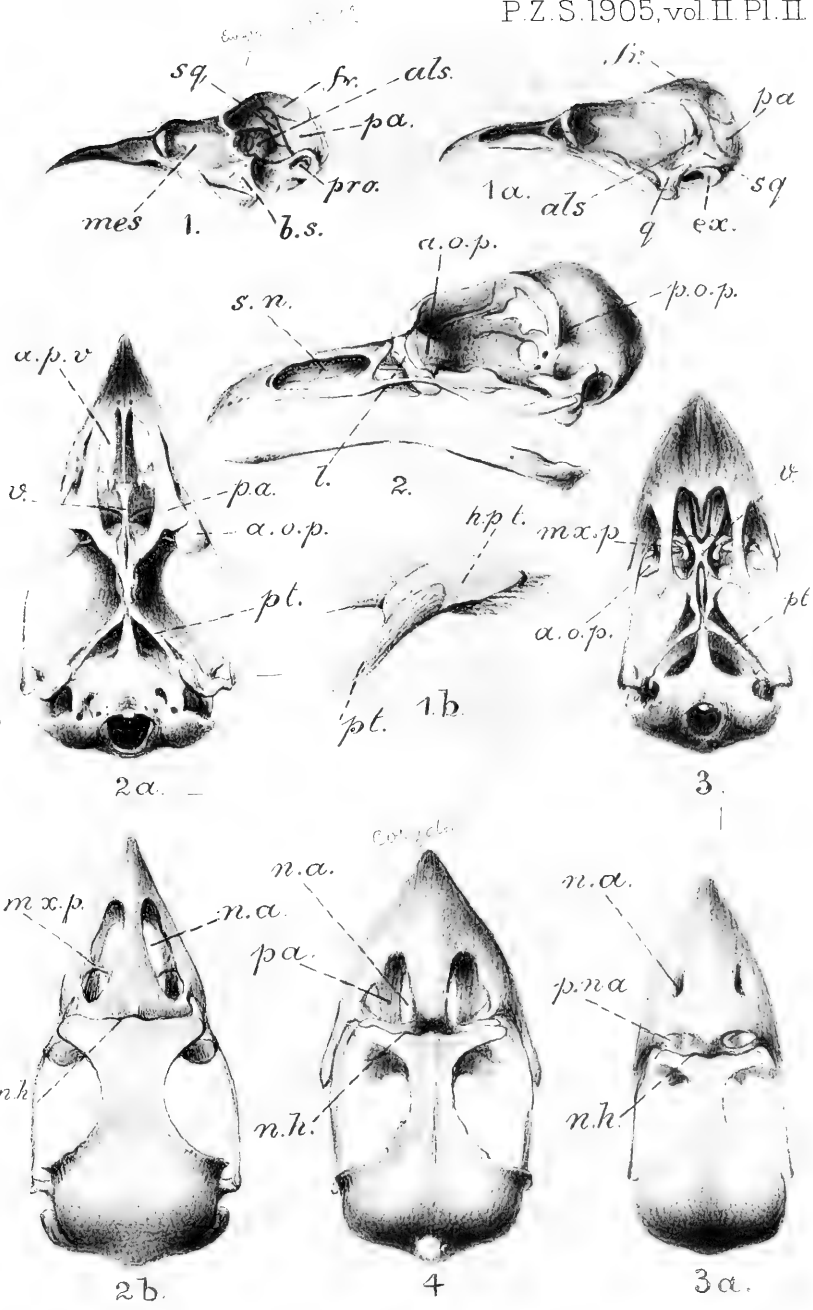

H. Crönvold, del.

Bale & Danielsson, L^{td} coll.

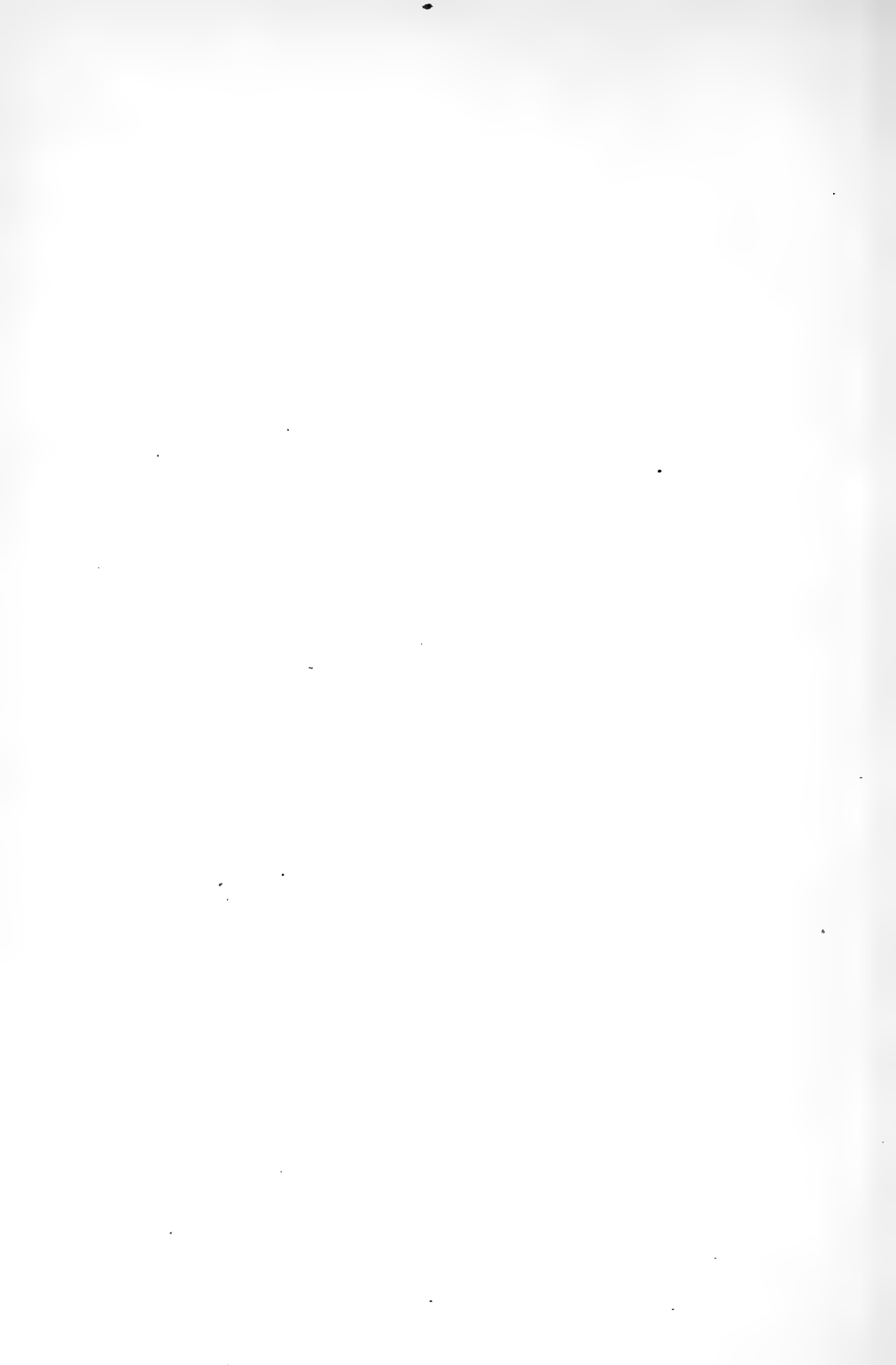

presents an undoubted resemblance, in some respects, to the aberrant *Procnias*, in others to the Swallows.

The following characters will, however, probably suffice:—

The beak is of great size, nearly as broad as long, and joins the cranium by a more or less perfect nasal hinge; free lachrymals are wanting, save in *Calyptomena*; palate ægithognathous; palatines short, broad, wide apart, and produced backward into prominent spurs; vomer truncated, much reduced and terminating posteriorly in a pair of slender limbs; pterygoids and palatines articulating by means of an oblique joint; maxillo-palatine processes reduced to long slender rods slightly expanding at their termination beneath the vomer; basiptyergoid processes wanting; postorbital processes obsolete; squamosal process prominent

The Occipital Region.

The foramen magnum is cordiform, its apex rising only slightly above the level of the superior margin of the rim of the tympanic cavity. The plane of the foramen inclines downwards rather than backwards, as in the Capitonidæ, but not to such an extent as in the Bucconidæ. The base of the foramen is not raised above the level of the basi-cranial axis. The *supra-foraminal ridge* is barely traceable.

There is no lambdoidal ridge, such as is met with in the Capitonidæ for example, but the cranium above the occipital foramen presents a fairly prominent cerebellar dome, bounded on either side by a subcircular depression (the supraoccipital fossa). Above this region the skull rises considerably and presents a gently rounded surface.

The tympanic wings of the exoccipital are considerably developed to form a pair of downwardly directed plates, the *processus alæ exoccipitalis inferior*, having a convex border and a convex surface with recurved free edge: through these plates the semicircular canals can be faintly traced.

The Cranial Roof (Pl. II.).—The cerebral rises vertically above the cerebellar dome and is of considerable width, being wider than long. In regard to the position of the cerebral with relation to the cerebellar dome, the Eurylæmidæ agree with the typical Passeres and the Cypseli, and differ from the Capitonidæ, for example, wherein the cerebral lies *in front* of the cerebellar dome. The parietal region is marked by a moderately well-defined temporal depression, the “temporal fossa,” which, however, does not extend further inwards than the outer margin of the supraoccipital fossa. This is a Passerine feature; in the Coraciiformes these fossæ usually meet in the middle line, forming a more or less well-marked sagittal crest.

The temporal fossæ in the Eurylæmidæ are mainly responsible for the formation of the well-marked squamosal prominences.

The interorbital region is marked with a more or less distinct median groove, sometimes with a low ridge. Immediately behind

the base of the beak it expands considerably and is supported from within by outstanding antorbital plates. Lachrymals, except in *Calyptomena*, are absent, and consequently take no share in the formation of the preorbital region of the skull. In this particular the Eurylæmidæ agree with the bulk of the Passeres, in which, however, vestiges of the lachrymal are frequently present.

The frontals terminate abruptly in front, not extending beyond the level of the anterior border of the mesethmoid. The nasals and nasal-processes of the premaxilla are also sharply truncated caudad; thus, at their meeting with the frontals and mesethmoid a freely moving nasal hinge is formed (Pl. II. figs. 2*b*, 3*a*, 4). The incipient stages in the development of such a hinge can be studied in *Chasmorhynchus*—one of the Cotingidæ.

The Base of the Skull.

The basitemporal plate is slightly hollowed in the middle line, and is continued forward for some distance on to the parasphenoidal rostrum; owing to the small size of the brain its free edge projects beyond the level of the brain-case. To appreciate this point the skull of one of the Eurylæmidæ should be compared with say that of *Menura* or *Corvus*, where, it will be found, the basitemporal plate fails to conceal the brain-case when the skull is seen from below. The edge of this plate is free only at its apex.

Not even vestiges of the basiptyergoid processes remain.

The parasphenoidal rostrum is long and slender.

The occipital condyle is spherical and depends from the roof of a shallow pre-condylar fossa.

The Lateral Aspect of the Cranium. (Pl. II. fig. 2.)

The *tympanic cavity* is small, shallow, and has little or no floor. The constriction of the skull-wall in the temporal region, to form the "temporal fossæ," gives the tympanic cavity the appearance of the aperture of a tube, the cylinder of which is formed by the "squamosal prominence" and lateral occipital wing.

The roof of this cavity is formed by the under surface of the *processus zygomaticus squamosi*. Its floor in part by the lateral occipital wing and in part by the ossification of tissue extending between this wing and the external angles of the basitemporal plate; but this region is much cut away.

Within the cavity three apertures will be found in the dried skull after the removal of the tympanic membrane. The largest of these is the mouth of the *recessus tympanicus anterior*. Immediately outside this, and below the otic articular surface for the quadrate, is the fenestral recess: this is very small, and neither the fenestra ovale nor the rotunda can be distinguished within it, though the columella is in position above; and behind the fenestral recess a cluster of minute pneumatic apertures will be found, corresponding to a similar group commonly found in the higher

Passeres. In shape and position, however, this group of foramina more nearly resembles its counterpart in the Bucconidæ. These foramina form a sort of cribriform plate guarding the mouth of the *recessus tympanicus posterior*, which is much reduced. The *recessus tympanicus superior* is of small size, and opens externally into the tympanic cavity by a small aperture lying between the squamosal and otic heads of the quadrate. The aperture is bounded externally by a short, pointed *processus articularis squamosi*.

The Squamosal Prominence.—It has already been pointed out (p. 32) that the constriction of the temporal region of the cranium has given the tympanic region a sort of individuality not met with in the skulls of the higher Passeres, but common among the lower types, and among the Coraciiformes.

In the Eurylæmidæ the free edge of this prominence projects shelf-like beyond the head of the quadrate. It is continued forwards into a hastate *processus zygomaticus squamosi* directed downwards and outwards. From the base of the inferior surface of this process projects a short pointed *processus articularis squamosi*; between these two processes the head of the quadrate is firmly grasped.

The *temporal fossæ* are especially deep in *Corydon*. As in other genera, they are linguiform in shape and do not extend inwards beyond the outer border of the supraoccipital fossa.

The *trigeminal foramen* pierces the skull-wall at about the level of the otic articular process for the squamosal, but some considerable distance mesiad thereof.

The *orbito-sphenoid* does not ossify. The *interorbital septum* is largely fenestrated.

The interorbital region of the frontals is generally very narrow so that the orbits are only very partially roofed. In front the orbit is bounded by a T-shaped antorbital plate. In *Calyptomena* the interorbital region is wide.

The lachrymal, in *Calyptomena* (Pl. II. fig. 2, *l.*), has the form of a sigmoid rod more or less clubbed at each end. The upper end would perhaps more correctly be described as hammer-shaped, and is completely overshadowed by wide expansions of the frontal. The whole ossicle is embedded in a groove carved out of a very much swollen antorbital plate. The close resemblance between the lachrymal of *Calyptomena* and that of *Chasmorhynchus* is most remarkable. Both are embedded in the antorbital plate, and both have the same sigmoid flexure. Only in the larger size of the orbital end can the lachrymal of *Chasmorhynchus* be distinguished from that of the Eurylæmid *Calyptomena*.

In all the other Eurylæmidæ, however, the lachrymal appears to have been lost; further, the antorbital plate has been reduced to a thin T-shaped plate.

The Ethmoidal Region.—The *mesethmoid* is greatly reduced by the fenestration of the interorbital septum. The *antorbital plate* which bounds the orbit in front is T-shaped and attached to

the mesethmoid by a horizontal plate of bone, almost rod-like in some species. The vertical, hamulate portion of the plate, by its upper limb, considerably adds to the width across the frontal, the lower, descending, process turns outwards to reach the quadrato-jugal bar. In the extraordinarily wide-mouthed genus *Corydon*, however, the quadrato-jugal bar stands far from this descending process.

The olfactory chamber, owing to the extremely reduced condition of the maxillo-palatines, in the macerated skull is without a floor, in the majority of the genera of this group; but in two skulls, *Eurylemus* and *Cymbirhynchus*, in the British Museum Collection, this is more or less filled up by the ossification of a pair of turbinals, one on either side of the septum nasi, which apparently answer to the concha media. Pyriform in shape, each extends from the narial aperture backwards to the anterior horn of the vomer, where it becomes attached. Above and behind this is an oat-shaped and laterally compressed turbinal answering to the concha posterior.

The nasal septum, in *Calyptomena*, is formed by a thin sheet of bone running along the whole length of the under surface of the nasal process of the premaxillæ. In *Eurylemus*, *Cymbirhynchus*, and especially in *Corydon*, this septum becomes greatly swollen and grooved on its under surface.

The Cranial Cavity.—The *mesencephalic fossa* is capacious. Its floor sweeps rapidly upwards to form a strongly marked basin-shaped cavity. This upward rising of the floor is much more conspicuous than in some other genera, e. g. *Menura* or *Corvus*.

The *internal auditory meatus* is represented only by a shallow depression. Immediately above and somewhat in front of this lies the *trigeminal foramen*. This, opening under a strong ridge, leads immediately into a deep groove across the floor of the mesencephalic fossa and thence through the under wall of the skull. All the branches of v leave by this foramen. There is no separate foramen for the ophthalmic (v^1) (orbito-nasal); and in this respect the Eurylemidæ appear to agree with all the other Passeriformes. The *vagus* foramen lies at the bottom of a deep fossa.

The *cerebellar fossa* is small, relatively to the cerebral, sharply defined, and has the supra-occipital region marked with prominent horizontal ridges. The *floccular fossa* forms a conspicuous moderately deep and more or less pyriform depression, sharply bounded caudad by the anterior semicircular canal.

The *mesencephalic fossa* is of considerable size and, as in other Passeriformes, extremely well defined by a strong vertical ridge above, and an equally prominent ridge formed by the *pro-otic* below.

The *pituitary fossa* takes the form of a narrow tube rising vertically from the floor of the skull. The *dorsum selle* is reduced to a knife-like edge. The pre-pituitary region is produced into a moderately well-defined optic platform, triangular in shape.

The *cerebral fossæ* are relatively of considerable size, though relatively smaller than in *Corvus* for example. Thus, in the Eurylæmidæ the cerebral fossa is only distinguishable from the mesencephalic fossa by reason of the boundary-line of the tentorial ridge. In *Corvus* the mesencephalic fossa forms a totally distinct basin-shaped cavity, lying as it were within the cerebral fossa, which dips down to the outer side and below the level of the fossa in question in the form of a deep pocket. *Menura* represents a half-way stage between the Corvidæ and Eurylæmidæ. In *Menura*, moreover, the roof of the cerebral fossa is marked by a low ridge roughly dividing the fossa into two equal parts.

There is a well-developed bony *falx*.

The *olfactory fossæ* are reduced to a pair of small pits. But there are strong impressions of an olfactory tube to be found in the fore part of the cerebral fossa of the Eurylæmidæ.

The Premaxilla.

The premaxilla in the Eurylæmidæ forms the major part of the upper half of the beak. Hooked at the tip, and of extreme breadth, it recalls in many respects that of many of the Coraciidæ, e. g. *Eurystomus*, on the one hand, and of some Caprimulgi, e. g. *Podargus*, on the other. When these several types come to be compared, however, these resemblances will be found to be but slight.

More significant is the close resemblance to the Cotingidæ. This is well brought out in the skull of *Calyptomena*, which, as will be shown presently, presents many features in common with *Chasmorhynchus*. The number of other skeleton characters which these two forms possess in common suggest affinity between the two groups, rather than homoplasy.

In *Calyptomena*, which I propose to take as the typical Eurylæmid for the purpose of comparison, the body of the premaxilla is moderately large. The nasal process, fusing with the nasals, is sharply truncated caudad, and articulates with the frontals by a hinge. In this respect the Eurylæmid skull resembles that of the Podargidæ, and not of the Coraciidæ.

The low position of the skull of *Calyptomena* is indicated by a comparison of the narial aperture with that of the skulls of other Eurylæmid genera.

In *Calyptomena* the nasals are of the typical holorrhinal shape with an obliquely sloping descending process. The nasal fossa, in the dried skull, is a long oval aperture showing, within the cavity, a narrow ridge of bone continued from the palatal border forwards to meet a low septum hanging from the middle line of the nasal process of the premaxilla. The septum represents the ossified remains of the *septum nasi*; the small plate of bone running inwards from the level of the tip of the palatine is a portion of the alinasal cartilage which has become ossified.

Corydon, *Eurylemus*, and *Cymbirhynchus* differ conspicuously from *Calyptomena* in this matter of the narial aperture, as may be seen by a comparison of figs. 2 *b*, 3 *a*, 4, Pl. II.

In all three genera the nasal is reduced to its smallest possible limits, little more than an arcuate bar being left. Of this, one half represents the descending process of the nasal, the other the body of the bone,—now merely a rod joined at its inner end to the nasal process of the premaxilla, and affording the means of articulation with the frontals. This, as I have remarked, takes the form of a nasal hinge. In *Eurylemus* and *Corydon* the nasal fossa, as in *Calyptomena*, is open in the dried skull, the actual position of the nasal orifice in the living bird being indicated by semicircular grooves in the anterior border of the nasal fossa. The circle completing the rest of the fossa in the living bird was roofed by the alinasal wall. In *Cymbirhynchus* this wall almost completely ossifies, leaving an oval narial aperture, and a small semilunar space immediately in front of the nasal (fig. 3, Pl. II.).

In the Eurylemidæ the floor of the olfactory chamber is open behind, revealing in *Calyptomena* an ossified sheet-like nasal septum, which in *Corydon* becomes immensely swollen.

In the Coraciæ, certain Caprimulgi and Pici the floor of the olfactory chamber is more or less ossified. In *Eurystomus* and the Bucconidæ there is a long palatal fissure, which at first sight appears to correspond to the huge palatal cavity of *Eurylemus*. An examination shows, however, that this vacuity leads into a spacious cavity underlying the olfactory chamber and formed by the inflation and absorption of tissue of the nasal septum. In *Podargus* the palatal surface of the premaxilla is completely ossified, and the olfactory chamber is reduced to the smallest possible limits.

In *Corydon* the nasal process of the premaxilla is immensely swollen and rises far above the level of the nasal hinge. The frontal is similarly swollen immediately above this hinge. The intermediate stages between this condition and that found in *Calyptomena* can be studied in *Cymbirhynchus*. *Corydon*, indeed, would appear to have reached the high-water mark of specialisation in the matter of the jaws, among the Eurylemidæ.

The Maxillo-jugal Arch.

The *maxilla*, as usual, is in the adult completely fused with the premaxilla. In *Corydon* the maxillary region of the jaw is highly developed and forms a large semicircular plate, the convexity forming its free edge and projecting downwards far beyond the level of the quadrato-jugal bar.

The *maxillo-palatine processes* in *Calyptomena* take the form of a pair of delicate rods projecting backwards at a very marked angle from the body of the maxilla, which, at this point, is perforated by small pneumatic apertures. These rods, on each

side of the skull, terminate immediately beneath the free end of the vomer.

That these processes are degenerate there can be no doubt. They have probably been derived from a condition precisely similar to what obtains in *Chasmorhynchus*. In the latter, these processes are swollen and spongy in character. Arising from the maxilla at a point almost immediately below the descending process of the nasal (in *Calyptomena* they arise distad of this point), they extend backwards so as to run on either side of and beneath the vomer for nearly one-fourth of its length.

In *Corydon* and *Cymbirhynchus* these processes are more slender than in *Calyptomena*. In *Cymbirhynchus* they are hook-shaped.

Probably, as I have remarked, the maxillo-palatines of *Calyptomena* at an earlier stage closely resembled those of *Chasmorhynchus*. It seems also highly probable that these, in turn, were derived from yet more primitive and much more extensive triangular plates such as have been retained by the Tyrannidæ. The palate of *Tityra*, indeed, shows how easily the Eurylæmiform palate could have obtained its peculiar maxillo-palatines.

The quadrato-jugal bar in *Calyptomena* as in *Chasmorhynchus* is sigmoidally curved, as much so as in some Spheniscidæ. In *Corydon* and *Cymbirhynchus* it is straight. There are no separate elements distinguishable in this bar.

The Vomer, Palatines, and Pterygoids.

The vomer (Pl. II. fig. 2 a), in *Calyptomena*, is roughly oar-shaped in front and terminates caudad in a pair of long, slender limbs, bowed outwardly so as to enclose a space through which the parasphenoidal rostrum may be seen, and fused completely with the palatines. The free end of the blade is truncated, and has the angles produced into minute processes, thus showing that the vomer was earlier of a more pronounced Ægithognathous type.

In *Corydon* the vomer is much reduced, being represented by a short, broad, oblong body produced caudad into a pair of widely separated and slender rods which articulate with the palatines. The free end of the vomer is squarely truncate with prominently produced angles. The dorsal aspect of the vomer is closely applied to the base of the *septum nasi*.

Cymbirhynchus resembles *Corydon* in the shape of the vomer, but differs therefrom in that it is slightly constricted between the free end and the origin of the posterior cornuæ, which fuse completely with the palatines, forcing the parasphenoidal plates thereof away from their normal relationship to the parasphenoid.

In the Coraciidæ the vomer is either wanting or reduced to a mere spicule, e. g. *Eurystomus*.

In *Chasmorhynchus* the vomer is larger than in the Eurylæmidæ. Ægithognathous anteriorly, it terminates posteriorly in a pair of

broad limbs indistinguishably welded with the palatines, agreeing in this with *Calyptomena* and *Cymbirhynchus*.

The *palatine* (Pl. II. fig. 2 a) in *Calyptomena* is a long bone: anteriorly rod-shaped, it extends backwards as far as the under surface of the antorbital plate, when, after sending outwards a prominent, rounded elbow—"transverse bone"—it turns abruptly inwards, ultimately forming a roughly spatulate plate, bent upon itself so as to form a long linear surface running along the parasphenoid rostrum, and fusing mesiad with the vomer and a free downwardly hanging curtain to form a cavernous space in the roof of which is the base of the vomer.

The palatine of *Chasmorhynchus* differs from that of *Calyptomena* in the greater width of the hinder laminated portion and the more extensive development of the inferior free edge, forming the cavernous space beneath the vomer. This edge now appears rather as a shelf-like projection developed from the inner border of the shaft of the palatine.

In *Cymbirhynchus* the palatine shaft is broader than in *Calyptomena*, and this increased breadth is especially noticeable at its junction with the body of the premaxilla. The latter, as has already been pointed out, is much more conspicuous than in *Calyptomena* and terminates in a doubly crescentic free edge synchronously with the palatines. Thus a relatively enormous oblong space is enclosed. In *Corydon* these features are still more exaggerated, the "elbow" is also more strongly marked.

In broadness and the truncated form of the shaft of the palatines, the more specialised Eurylæmidæ recall the Podargidæ, wherein the body of the premaxilla is still more developed and the truncation of the palatine distally more marked. Both in the specialised Eurylæmidæ and the Podargidæ the truncation of the vomer appears to have been brought about to facilitate the movements of the nasal hinge, which in both types lies immediately above the anterior ends of the palatines, while in the more generalised *Calyptomena*, which lacks a nasal hinge, the palatines run far forwards.

The *pterygoid* in *Calyptomena* (Pl. II. fig. 2 a) is a long, slender, rod-shaped bone, laterally compressed, and perforated by a pneumatic foramen at its articulation with the quadrate. At its anterior end it meets its fellow of the opposite side in the middle line; and immediately sends upwards and forwards a sub-crescentic plate which, embracing the parasphenoidal rostrum by its plane surface, affords attachment along its inferior border to the vomer. Late in life the articulation with the vomer is succeeded by ankylosis. Certain points concerning the morphology of the end of the pterygoid will be discussed in the section dealing with the nestling skull (p. 43).

In *Chasmorhynchus* the anterior ends of the pterygoids do not meet in the middle line but impinge instead directly against the parasphenoidal rostrum, forming therewith a pedate articulation, which is largely augmented by "hemipterygoid" elements

corresponding to the sub-crescentic plates of *Calyptomena*. These hemipterygoids, in both the Eurylæmid and Cotingid forms, articulate with the palatines, in the adult, by means of an oblique suture.

Corydon and *Cymbirhynchus* differ in no essential features from *Calyptomena*.

The *quadrate* is peculiar in that, in common with the Tyrannidæ and some other Passerine forms, it sends out a strong spur for the articulation of the quadrato-jugal bar. This spur projects like a buttress laterad of the outer condyle for the lower jaw. The squamosal and otic heads are closely approximated. The former is wedged in between a prominent *processus articularis squamosi* behind, and an equally well-developed *processus articularis zygomaticus* in front. In *Corydon* these processes are expanded laterally so as to overhang the head of the quadrate, but at the same time they afford this element a greater freedom of movement than in *Calyptomena*. *Cymbirhynchus* and *Eurylæmus* are intermediate in character in this respect.

The Mandible.

The mandible, in the Eurylæmidæ, is much bowed outwards to a very considerable extent. In *Calyptomena* it has only a relatively small symphysis: is truncated posteriorly, and shows little or no trace of the separate elements of which it is composed. The internal angular process is moderately well developed, and is perforated by a small pneumatic foramen. The rami, in their general shape, are rod-like, and slightly compressed laterally.

In *Corydon* and *Cymbirhynchus*, however, there is an abrupt transition between the malar region of the mandible and that portion covered by the rhamphotheca, which is most markedly thicker and broader than the hinder region. The symphyseal region is very broad and spoon-shaped. The internal angular process is more spine-like than in *Calyptomena*, and there is a feebly-developed posterior angular process.

The Hyoid.

The hyoid of the Eurylæmidæ resembles that of the higher Passeres. The basihyal (os entoglossum) is made up of a pair of boomerang-shaped ossifications placed *dos à dos*, so that a long free process is produced backward beyond the articulation with the basibranchial 1. Basibranchials 1-2 are fused; the latter, however, is a long cartilaginous style. The ceratobranchial and epibranchials are of moderate length; the latter are cartilaginous at the free ends.

In *Corvus*, for example, among the higher Passeres, the basihyals are long and straight, and run parallel with one another, yet so as to leave a median space between them.

iii. THE SKULL OF THE NESTLING. (Pl. II. figs. 1 & 1a.)

It is a matter for regret that the British Museum Collection of nestling skulls of *Eurylæmidæ* is limited to half-grown specimens of *Eurylæmus ochromelas*, and these have suffered somewhat severely as a consequence of having been preserved in formol.

a. *Cartilage-bones.*

The *basioccipital* cannot, in these skulls, be more than imperfectly traced, having become fused with the lateral occipitals.

The *exoccipital*, or lateral occipital, is a large, more or less linguiform plate presenting a broad convex external border, the inferior segment of which forms the tympanic cavity, while the superior arc of the curve is applied in part to the base of the squamosal and in part to the parietal. It is bounded mesiad by the supraoccipital and the occipital foramen, which excavate a considerable moiety from its internal border. Inasmuch as the exoccipital comes into contact with the parietal, it resembles that of the Cuculidæ.

The *supraoccipital* is short antero-posteriorly, and is not yet ossified; its superior margin being **W**-shaped and leaving a large fontanelle between itself and the parietals. Laterad it has fused with the lateral occipitals, leaving only a faint tell-tale notch to indicate the junction.

The *pro-, epi-, and opisthotic* bones are now completely concealed when the skull is viewed externally.

The *basisphenoid* is also concealed, being underfloored by the basitemporal plate.

The *alisphenoid* appears as an oblong plate, having its long axis horizontal.

The *orbito-sphenoid* is still membranous, while the presphenoid has fused with the basisphenoid.

The *mesethmoid* has only just commenced to ossify, and is represented by a small linguiform plate supporting the yet cartilaginous antorbital plate, and bounded in front by the cranio-facial fissure. The interorbital septum formed by the backward extension of the plate is as yet only outlined in cartilage.

The olfactory cavities occupy less than half of the so-called anterior narial apertures as seen in the dried skull. The actual anterior nares, in *Eurylæmus ochromelas* for example, are small and round, and placed at the extreme anterior angle formed by the divarication of the nasal and maxillary processes of the premaxilla. The superior segment of this circle is formed by membrane, and this extends backwards and inwards as a subtubular sheet to be attached to the antorbital plate. Mesially this tube is shut in by the nasal septum, and inferiorly by membrane forming the roof of the palate. Within the chamber thus formed lies a long, somewhat spatulate cartilaginous turbinal extending backwards, by a short stalk, to the anterior end of the vomer. The free end

of the spatulate process lies on a level with, but mesiad of, the external aperture. Without this chamber is a large sinus roofed by the rhamphotheca, floored by membrane supported by the maxillo-palatine process, and closed posteriorly by the antorbital plate lying external to the nasal chamber. In the dried skull this sinus is included as part of the external narial aperture.

The *quadrate*, though not yet completely ossified, differs in no material particular from that of the adult.

b. *The Membrane-bones.*

The *parietal* is roughly quadrangular in shape; its superior external angle is drawn upwards into a point, its inferior external angle forms a sweeping curve. Its mesial border is not yet ossified in the skull now described. A small portion of its inferior border, lying between the supraoccipital and squamosal, comes into actual contact with the exoccipital.

The *frontal* along its posterior border follows the curve of the parietal: anteriorly, in the mid-orbital region, it becomes reduced to a narrow band, and finally terminates in a strap-shaped process underlying the nasals. Before leaving the cranial cavity its free edge passes downwards and inwards to join the alisphenoid inferiorly. The rim of this inturned plate is overlapped by a long tongue-shaped process of the squamosal (Pl. II. fig. 1 a).

The *squamosal* is a somewhat remarkable bone. Roughly L-shaped, the horizontal region overlaps, mesiad, the lateral occipital and extends so as nearly to reach the supraoccipital; laterad it overhangs the tympanic cavity and terminates in a pointed *processus zygomaticus squamosi*. The vertical shaft arising from this base is roughly sword-shaped, with a slightly decurved pointed tip. About one-third of this blade arises above the level of the parietal to overlap the frontal as already described. Immediately above the level of the superior border of the alisphenoid this blade develops a barely perceptible prominence, which supports a small cartilaginous nodule—the anlage of the postorbital process.

Another most noteworthy feature of the squamosal in this skull is the fact that the greater part thereof appears on the inside of the skull: only, indeed, the extremities of the horizontal and vertical portions being excluded. Compare figs. 1, 1 a (Pl. II.).

In the most primitive types of Avian skull, it will be remembered, the squamosal is either entirely excluded from any participation in the formation of the brain-case, or only a very small area is admitted. Originally a quite superficial bone, it has gradually absorbed the underlying osseous tissue, till eventually it has forced itself into the very walls of the cranial cavity, and this is especially the case in the skull of *Eurylæmus ochromelas*.

I am unfortunately unable at the present time to make any extensive series of comparisons between the form of the squamosal in the Eurylæmidæ and that of the Coraciiformes, or the

Menuridæ and other Passeriform types, owing to lack of material. Such a comparison I believe would be valuable.

So far, the peculiar squamosal of the Eurylæmidæ resembles most nearly, among the Coraciiformes, that of the Capitonidæ. But the likeness is but general, and seems to point to the Capitoniform type as being the more primitive. Herein, this element is roughly quadrangular in type, but has the antero-dorsal angle produced into a point, which, however, does not extend on to the frontal. Its mesial border is, indeed, exactly coterminous with the external lateral border of the parietal. The alisphenoid in this skull is prominent and forms a large triangular block fitting into the deeply concave anterior border of the squamosal on the one hand, and overhung by the postorbital region of the frontal on the other. The postorbital process appears to be formed in part by the alisphenoid, and in part by the frontal. The squamosal takes no part whatever in its formation. These relations can be seen in the skull of *Calorhamphus*.

The resemblance to the squamosal of the Passeriformes is close, but is of a kind such as to leave little doubt but that this element in the Eurylæmidæ is much the more specialised: a fact which is somewhat surprising, and is at the same time not without significance.

Comparing the squamosal of *Eurylæmus ochromelas* with that of the Rook (*Corvus frugilegus*), it will be found that in the latter this element is of considerable size, conical in form, and rises superiorly to overlap the frontal as in *Eurylæmus*. The base of this cone is broad, and its postero-internal angle is produced backwards and inwards to form a wedge between the parietal and lateral occipital.

It is from a squamosal of this type that the squamosal of *Eurylæmus* has been derived. This evolution has resulted in a much greater extension of the base mesiad, between the parietal and exoccipital, and in the lateral reduction of the body of the bone so as to transform the sometime cone into a xiphoid shaft springing from a broad base. These changes will become the more apparent by a reference to fig. 1 *a*, Pl. II.

The *nasal* varies considerably in form in this group. Unfortunately, I have not material at my command which will enable me to make a comparison of the early stages of growth of these several varieties.

The *lachrymal* is not yet ossified.

The *premaxilla* apparently lacks palatine processes. What appear to be vestiges of these seem rather to be ossifications of the membrane forming the floor of the anterior region of the nasal chamber. This point can only be solved by a further examination of well-preserved material.

The *maxilla* appears to be unusually large in the skull, but the decalcification caused by the formalin in which this specimen was preserved has almost obliterated the premaxillary and quadrato-jugal sutures.

The *quadrato-jugal* is long, extending to beyond the middle of the orbit.

The *vomer* is not yet ossified.

The *palatines* differ from those of the adult in that the transpalatine elements (?) are as yet membranous.

The *pterygoid* is rod-shaped, bent at its posterior extremity at an obtuse angle, so as to fit closely to the parasphenoidal rostrum. The free end of this rod is pointed, and bears a small pointed piece of cartilage. Whether this represents the hemipterygoid, or, as seems more likely, the unossified extremity of the shaft, is a point which can only be determined by the examination of somewhat older skulls.

The palatine extends backwards beneath these bent limbs of the pterygoid.

The apparent absence of the hemipterygoid is a point of considerable interest. The interpretation to be placed upon this fact is, I think, not that the pterygoid shaft retains its primitive integrity, but that the hemipterygoid element has been lost, just as it has in many other groups of birds. My reason for this view is that the vomer, which shows various grades of reduction in the Eurylæmidæ, is supported entirely by the palatines, as in all other cases where the hemipterygoid has been greatly reduced or is wanting.

There is nothing remarkable in the absence of this element, because, as has been shown, the skull in this group is highly specialised in many ways.

The elements of the mandible are as yet distinct.

iv. THE VERTEBRAL COLUMN.

All the presynsacral vertebræ are heterocoelous and free.

The cervical vertebræ are characterised by the deeply incised neural plates of the 6th-10th vertebræ, where the posterior zygapophyses are borne upon the under surface of the free ends of long beams.

The atlas has the odontoid ligament perforated.

The axis bears a large tooth-like neural spine and a large pair of hyperapophyses. The second and third have large quadrangular neural plates, the hinder angles of which in the third vertebræ are produced upwards into strong hyperapophyses. The outer borders of these plates are pierced, on each side, by a small foramen. The hyperapophyses of the 5th to 8th vertebræ are placed about midway between the neural spine and the posterior zygapophysis. From the 5th to 11th vertebræ the neural plates are deeply incised both before and behind the neural spine. The neural spines gradually decrease in size from before backwards, so that from the 9th to the 12th they are represented only by the merest tubercle. Hypapophyses are borne by the 2nd, 3rd, 4th, and 5th vertebræ; the 7th to 10th bear catapophyses, feebly developed; hypapo-

physes again succeed from the 11th vertebra and are continued backwards to the thoracic.

The cervical vertebræ are 12 in number. There are three cervico-thoracic; that is to say, there are three vertebræ bearing free cervical ribs. The 1st pair are reduced to the merest vestiges; the 2nd pair are long, bear vestigial uncinates, but no sternal segment; the 3rd pair bear large uncinates and a long styliform sternal segment, which does not, however, reach the sternum. Thus, it is obvious that, at no distant date, these three vertebræ formed part of the thoracic series and articulated with the sternum. They differ, moreover, in form from the true cervicals, and resemble the thoracic series in having broad outstanding diapophyses.

The cervical and cervico-thoracics of the *Eurylæmidæ* differ conspicuously from those of the *Menuridæ* and of the *Coraciiformes*, and resemble rather those of the higher *Passeres*.

The thoracic vertebræ, six in number, have moderately developed, quadrangular, neural spines. Only the 1st thoracic bears a small hypapophysis. The centra are pierced by pneumatic foramina. The last thoracic has been incorporated with the synsacrum.

Twelve vertebræ enter into the composition of the synsacrum in *Calypptomena* and *Cymbirhynchus*; 13 in *Corydon*. The numerical differences are as follows:—

	<i>Calypptomena.</i>	<i>Cymbirhynchus.</i>	<i>Corydon.</i>
Thoracic	1	1	1
Lumbar	2	2	3
Lumbo-sacral	3	2	2
Sacral	2	2	2
Caudal.....	4 + 8 free caudal	5 + 8 free caud.	5 + 8 free caud.
Total	<u>12 + 8</u>	,, <u>12 + 8</u>	,, <u>13 + 8</u>

Thus *Calypptomena* appears to have lost 1 post-sacral and *Cymbirhynchus* 1 pre-sacral. *Corydon* would appear to express the primitive number of these segments.

The 2nd lumbar in *Calypptomena* bears a large pair of ventri-lateral processes abutting against the pre-ilia. The 1st sacral vertebra lies immediately caudad of the hinder margin of the acetabulum. The dorsi-lateral processes of the sacral and caudal vertebræ are long, and, by the ossification of the tendinous tissue overlying them, form a broad bony plate dividing the innominate. There are 8 free caudals, including the pygostyle. The diapophyses of those immediately following the synsacral series are not embraced by the innominate, owing to the fact that these are kept apart by the outstanding dorsi-lateral processes of the synsacral series.

Corydon and *Cymbirhynchus* differ from *Calypptomena* chiefly in that the dorsi-lateral processes of the sacral and post-sacral

components of the synsacral vertebræ are shorter, so that the diapophyses of the first precaudal are overlapped by the hinder ends of the innominate.

Well-marked intercentra appear on caudals 5-7, in each of the three genera here described.

V. THE RIBS.

The cervical ribs extend from the 4th to the 12th vertebræ. The 1st and 2nd, 10th and 12th, are represented by little more than broad pleurapophysial lamellæ; in the remaining vertebræ, however, these lamellæ are narrow and band-like, and the ribs slender and styloform, extending the whole length of the centrum.

There are 3 cervico-thoracic ribs. The first is reduced, only the capitulum and tuberculum remaining connected by a common base. The second is long, but bears no uncinæ; the third bears a short sternal segment, which, however, does not reach the sternum.

There are 5 thoracic ribs, of which 4 only reach the sternum. The uncinaes are long and extend backwards to reach the 3rd rib from their base of attachment.

In *Corydon* the sternal segment of the 5th rib articulates by a special facet with the sternal segment of the rib next in front.

VI. THE STERNUM AND SHOULDER-GIRDLE.

(Text-figs. 13, 14, pp. 46, 47.)

The sternum of the Eurylæmidæ is typically Passeriform, and presents no very close resemblances to that of any other group. In some features it recalls that of the Cuckoos, in others of the Caprimulgi, but these are not of a nature likely to cause difficulty in confounding the sterna of either of these groups with Passerine sterna.

In the Eurylæmidæ the corpus sterni is short and broad—the breadth nearly equal to the length. The posterior lateral processes are long, extending forwards to a point corresponding to a transverse line through the middle of the corpus sterni; the free ends of these processes are spatulate. The metasternum has its free border squarely truncate, so as to form a continuous line with the free ends of the posterior lateral processes; broken only by the notch enclosed by this process. The anterior lateral processes in *Calypptomena* have their free ends truncated and curved slightly backwards. In *Corydon* these processes are long, pointed and directed forwards. *Cymbirhynchus* is intermediate in this respect, the process being long, truncate, and directed forwards. The articular surfaces for the sternal ribs are confined entirely to these processes.

There is no *spina interna*. The *spina externa* shows only the faintest indication of the bifurcate free end which prevails among the Passeriformes (text-fig. 13, *s.e.*). In *Cymbirhynchus* and *Corydon* this spine is triangular in section; in *Calypptomena* it

should rather be described as blade-shaped, the dorsal edge of the blade being much thickened; in other words, the ventrally placed keel of the triangle seen in *Corydon* has in this genus extended downwards. The median line of the dorsal surface of the corpus sterni is deeply grooved, and pierced anteriorly by a large pneumatic foramen. In *Cymbirhynchus*, and to a less extent in *Calyptomena*, the groove is laced across by narrow, irregular bars of bone.

The carina is deep, and has the free (ventral) edge produced forwards. The anterior (vertical) border bears a hollow groove for the reception of the hypocleideum.

The coracoid grooves look directly forwards, and do not meet in the middle line. The dorsal lips are prominent and thickened; the ventral lips are well-defined, but have knife-like edges continued inwards on to the *spina externa*.

Text-fig. 13.

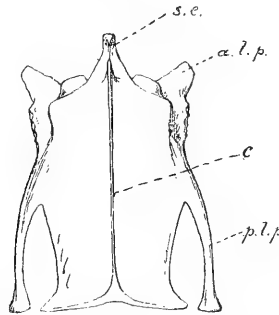

Sternum of *Calyptomena*, showing the simple (unifurcated) spina externa, *s.e.*
a.l.p., anterior lateral process; *c.*, carina; *p.l.p.*, posterior lateral process.

The coracoids are long; as long as, or longer than, the *corpus sterni*. The procoracoid process, though reduced, is still moderately large, and forms a narrow flange of bone, arising beyond the middle of the coracoid shaft and having its free edge directed downwards. Cephalad it articulates with the scapula, and with the clavicle forms the *foramen triosseum*. The procoracoid of the Eurylamidae is larger than in the Cotingidae. In the Picidae the procoracoid appears to be wanting, and in the higher Passeres it is reduced to the merest vestige, e. g. *Corvus*. The breadth of the base of the coracoid is increased by narrow phalanges of bone, one on either side extending forwards, for about one-fourth the length of the shaft. On the dorsal aspect of the shaft a prominent tongue of bone is sent up to abut against the dorsal lip of the coracoid groove. This at least obtains in *Calyptomena*; in *Corydon* and *Cymbirhynchus* it is less marked.

The *scapula* is long, narrow, and scimitar-shaped. The *furcula*

is long, slender, gently arched, and bears a large hypocleideum, roughly quadrangular in form, and articulating with the anterior edge of the carina. The free ends of the furcula are expanded to form flat plates articulating with the acrocoracoid, procoracoid, and acromion process of the scapula (text-fig. 14), thus enclosing the *foramen triosseum*.

In the form of the sternum and shoulder-girdle the Eurylæmidæ closely resemble the Cotingidæ, especially in the form of the spina externa, which is simple, and thereby differs from the typical Passerine form wherein it is forked. In the Eurylæmidæ this process is more or less spike-shaped, whereas in the Cotingidæ it appears to be generally flabellate. In *Chasmorhynchus* the posterior sternal notches are not so deep as in the Eurylæmidæ. The hypocleideum articulates nearer the antero-ventral angle of the carina; and the coracoids do not develop the internal basal flange found in the Eurylæmidæ.

Text-fig. 14.

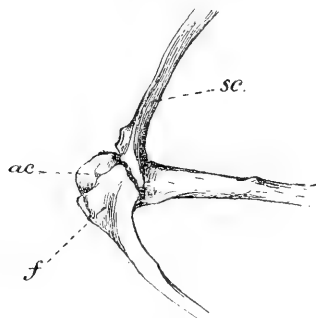

Portion of the shoulder-girdle of *Calypomena*, to show the meeting-point of the scapula, coracoid, and clavicle, forming the inner wall of the *foramen triosseum*.

sc., scapula; *ac.*, acrocoracoid; *f.*, furcula.

In the relations of the articulations between the procoracoid, furcula, and scapula, where these unite to form the foramen triosseum, the Eurylæmidæ are distinctly Passerine, though this arrangement also obtains among the Picidæ—a fact of some significance.

In *Calypomena*, for instance, the acromion process of the scapula extends downwards along the anterior border of the free edge of the procoracoid, and affords an articular surface cephalad, for the posterior angle of the expanded free end of the furcula. In *Chasmorhynchus* this articulation for the furcula is markedly increased; and this increase apparently reaches its maximum in the Corvidæ, where the acromion forms a long beam-like roof to the foramen triosseum, and a very extensive articular surface for the furcula.

vii. THE PELVIC GIRDLE.

Outside the Passerine series the pelvic girdle of the Eurylæmidæ resembles most nearly that of the Capitonidæ; from which, however, it may be distinguished by the fact that whereas in the Eurylæmidæ the post-acetabular ilium is produced caudad into a spine, in the Capitonidæ this backward extension is broad and bifurcate.

Among the Passeres it approximates most closely perhaps to that of *Chasmorhynchus*. *Cymbirhynchus* only, among the Eurylæmidæ, appears to possess even a vestige of the pectineal process. In *Calypptomena* the pre-acetabular ilium is broad throughout its whole length, and sharply truncated anteriorly. The inferior border thereof is markedly sinuous. The pre-acetabulæ of the right and left sides are widely separated one from another; and rise so as to lie nearly level with the ridge of the neural crest of the synsacrum, thus forming a large, open, *canalis ileo-lumbalis*. The post-acetabular region of the ilium is expanded to form a broad dorsal plane, and passing backwards terminates in a long spine, which, in *Cymbirhynchus* and *Corydon*, is closely applied to the free ends of the transverse processes of the post-synsacral caudal vertebræ.

The *ischium* in *Calypptomena* is long, produced backwards considerably beyond the level of the post-acetabular region of the ilium, and terminates in a downwardly-directed hook-shaped process which fuses with the pubis. *Cymbirhynchus* differs but slightly from *Calypptomena* in this respect. In *Corydon* the ischium is shorter antero-posteriorly, and deeper, than in the two genera just described, and does not project beyond the level of the free end of the post-acetabular ilium. Further, the dorsal border of the pre-ilium is much cut away anteriorly so as to expose a great portion of the synsacral neural crest.

The ischio-pubic fissure is closed in all three genera here described; the obturator foramen is shut off therefrom by a bony bar.

The pubis is long and straight, and projects beyond the level of the ischium, especially so in *Calypptomena*.

The close approximation of the post-acetabular ilium to the transverse processes of the free caudal vertebræ is due to the shortness of the transverse processes of the synsacral vertebræ already referred to.

The *fovea lumbalis* is small; and the *fovea ischiadica* and *pubendialis* are confluent.

viii. THE PECTORAL LIMB.

The pectoral limb of the genera here described presents no marked differences by which they can be distinguished one from another.

It resembles that of the Coliidæ and Capitonidæ in that metacarpal II. sends backwards from its proximal end a small triangular bony spur (internmetacarpal process) to abut against

metacarpal III. In the Eurylæmidæ this spur is, however, much larger than in the Coraciiform genera referred to.

The humerus only is pneumatic; and is subequal to, or shorter than, the manus. The forearm is the longest segment of the limb. The *sulcus transversum* or coraco-humeral groove is shallow. The *crista superior* is triangular in form.

The *incisura capitis* is fairly sharply defined; the *fossa subtrochanterica* is large. There is a small ectepicondylar process, which, it is to be noted, is not forked as in the higher Passeres; the entepicondylar process is still smaller. Ventrad of the *tuberculum ulnare* is a prominent spur-like blunt-pointed tubercle directed backwards and outwards so as to interlock with the olecranon process of the ulna in the extended wing.

On the palmar surface immediately above the radial condyle is a small tubercle for the attachment of the inner head of the *extensor metacarpi ulnaris*.

The ulna has a prominent, pointed, olecranon process, and bears a row of small tubercles, for the attachment of the secondary remiges, along its postaxial border.

The radius is slender and slightly bowed. The forearm is the longest segment of the wing.

The manus is well developed. As in the Capitonidæ and the normal Passeres, the base of Mc. II. sends backwards a bony plate to overlap and fuse with the base of Mc. III. In the Eurylæmidæ this plate (intermetacarpal plate) is of considerable size, its base extending down the shaft for some distance.

In some Coraciæ, e. g. *Eurystomus*, there is also an intermetacarpal plate, but feebly developed, and not fused with Mc. III.

ix. THE PELVIC LIMB.

The pelvic limb, in the Eurylæmidæ, has, in common with the Cotingidæ, a syndactyle pes; and in this respect these two families resemble many of the Coraciiformes. None of the bones are pneumatic; in which respect the Eurylæmidæ differ from the Cotingidæ, which have a pneumatic femur, and resemble many of the Coraciidæ.

The femur is long and slender. The popliteal fossa is represented only by a shallow depression.

The tibio-tarsus has moderately well-developed ecto- and ento-nemial crests and a long fibular crest. The shaft is curved first forwards, then inwards, so that the distal end thereof is markedly inflected. The extensor bridge is ossified. The intercondylar gorge is deep. The fibula extends to below the level of the middle of the shaft of the tibio-tarsus.

The tarso-metatarsus is moderately long. The hypotarsus is complex. The distal end of the shaft is flattened from before backwards, and laterally expanded to form the condyle for digits II.-IV. These condyles all extend forwards to practically the same level, the middle condyle scarcely projecting beyond the level

of those on either side. In section the shaft is subcylindrical. Mc. I. is long, as in the Passeres.

The pelvic limbs of the Eurylæmidæ and Cotingidæ can be distinguished from the limbs of the syndactyle members of the Coraciiformes by the fact that, in the latter, the tarso-metatarsus is either broad and flat, or deeply grooved anteriorly, and is more or less triangular in section. Further, the cnemial crests of the tibio-tarsus are, in the Coraciiformes having this type of feet, but feebly developed.

X. SUMMARY.

Regarded, by common consent, as the most lowly of the Passeriformes, the Eurylæmidæ are at the same time an extremely specialised group; much more so than has been hitherto recognised. Such a condition might have been expected indeed, inasmuch as this is a common feature among primitive groups.

Nowhere is this specialisation more conspicuous than in the skull. The basiptyergoid processes have entirely disappeared; the maxillo-palatines have been reduced from broad triangular plates to rod-like splints; and a singularly perfect fronto-nasal hinge has been developed. In some genera, as in *Corydon*, the beak has vastly increased in size, and has acquired a markedly hooked shape, as well as a great increase in breadth. Nor is this all. The vomer presents a number of gradations in the direction of reduction and degeneracy; and this is true also of the nasals, whereby the anterior narial fossa—which, by the way, is only in fact a narial fossa in so far as its extreme anterior end is concerned—is enormously enlarged. The lachrymal has been reduced to a mere vestige embedded, though still free, in the anterior face of the antorbital plate as in *Calyptomena*, or it is wanting as in *Corydon*. The palato-ptyergoid articulation is also specialised; so too is the nature of the vomerine support, this having been transferred from the ptyergoids to that of the palatines. The hemiptyergoid element appears to be wanting, but traces of this may turn up in the nestlings of *Calyptomena*.

Evidence of yet further specialisation is obtained from a study of the nestling skull. Besides the disappearance of the hemiptyergoid just referred to, the squamosal gives unquestionable proof in this direction; yet, at the same time, having preserved the essential characters of its shape, this element, more than any other bone in the skull, affords testimony of no uncertain kind as to the truly Passerine character of the group. Roughly L-shaped, there can nevertheless be no doubt, from the general contours of the bone, that it has been derived from a larger and more conical plate resembling that which obtains in the Corvidæ for example. Further, as in all the Passeres, the long axis of this bone is continued upwards and forwards beyond the parietal so as, in short, to overlap the frontal. So far as I have yet been able to ascertain, such an extension does not obtain anywhere among the Coraci-

formes. A further indication of specialisation is the fact that the squamosal, in all the Passeriformes and most of the Coraciiformes, has absorbed the underlying bones so that it now appears, almost in its entirety, within the cranial cavity. The remarkable variations which obtain in the Class Aves, in the form and arrangement of the membrane-bones are of considerable interest. These changes seem to follow along certain definite lines, and are the more remarkable because, save for the first few weeks of the bird's life (the nestling period in short), these bones, as separate entities, cease to exist, being fused to form one homogeneous tissue. Yet progressive evolution is as obvious as in, say, the sternum or pelvis; though they cannot be individually influenced by the strains and stresses incident to the struggle for existence in the same way as if they maintained their individuality throughout life, or for at least some considerable time after leaving the nest. This is a point to which I propose to return later.

So far we have described only the specialised features of the skull; what of the primitive? It is difficult to speak with any degree of certainty on this point. The small size of the anterior, posterior, and superior tympanic recesses, and of the tympanic cavity, may be reckoned in this category; and so too, probably, should the long narrow vomer as seen in *Calyptomena*. The close approximation of the otic and squamosal heads of the quadrate is an undoubtedly primitive character. These, in the Eurylæmidæ, are barely separated; in the Corvidæ, for example, they are comparatively wide apart. These few points seem to sum up all the evidence that is obtainable on this question.

How far specialisation has gone in the skulls within this group may be seen at a glance by comparing the skull of *Calyptomena* with, say, that of *Corydon*. In the latter the antorbital plate is greatly reduced in size and thickness, and the lachrymal is wanting. The beak is markedly wider, more hooked, and articulates with the frontal by a more pronounced nasal hinge, while the nasal septum is obliterated by the inflation of the nasal processes of the premaxilla.

The simple, unforked condition of the spina externa of the sternum is undoubtedly a primitive character; and in the form of the pelvic girdle this group is less advanced than in the remaining Passeres.

Before proceeding to discuss the relationship of the Eurylæmidæ to the remaining Passeres, it would be well to say a few words as to the wider question, of the probable allies of the Eurylæmidæ outside the Passeres. This is a matter on which it is impossible to dogmatise; at most, one can but throw out suggestions, of a very nebulous character.

It will be found, probably, that Fürbringer (3) has come nearest to the solution of this problem. He points to a relationship between the Eurylæmidæ and the Cypseli, and a yet closer alliance with the Pici. Affinities to the Coraciidæ he regards as remote indeed.

My own work most certainly tends to support Fürbringer's conclusions. It is possible that the Eurylæmidæ will prove to be related both to the Caprimulgi and Cypseli. As regards the connection with the Pici, it is significant to note that the squamosal, in the nestling, closely resembles that of the Passerine type, inasmuch as it overlaps the frontal, an arrangement which does not appear to occur elsewhere among the Coraciiformes.

Coming now to the question of the relationship of the Eurylæmidæ to the remaining Passeres, I would remark, at the outset, that there seems scarcely sufficient ground for separating the former so widely from the latter as has been done by many during recent years. This separation foreshadowed by Garrod, and consummated by Forbes, has been widened even further than either of these distinguished workers would have considered justified.

Forbes, just twenty-five years ago (2), summarised the main features of the Eurylæmidæ, from the systematic point of view, as follows:—" . . . They are *not* Tracheophone; and in that they possess the sciatic instead of the femoral artery, they differ from the Pipridæ and Cotingidæ, with which they have so often been associated. From these, too, they differ, as they do from the Tyrannidæ, Pittidæ, and *Rupicola*, in the *details** of the syrinx as well as in the simple manubrium sterni and other points. As has already been stated, they differ from all the other Passeres in the retention of a vinculum in the deep plantars of the foot . . ." In a second contribution to this subject during the same month these views were repeated. After referring again to the syrinx and syndactyle foot, he goes on to remark:—"The peculiarities of the Eurylæmidæ, and especially their oft-spoken-of retention of the plantar vinculum, are sufficient, I think, to justify their forming a main division of Passeres by themselves, as suggested by Prof. Garrod, which may be termed Desmodactyli, in distinction from the others, Eleutherodactyli . . ."

It seems to me open to question whether so wide a separation is justified.

After all, the existence, or rather we may say the survival, of the plantar vinculum is not so very surprising, not more so than the persistence of basipterygoid processes for example—which crop up sporadically among groups which have, as a whole, long since lost them. In *Calypptomena*, according to Beddard, this vinculum is wanting. Some importance has been given to the statement made by Forbes, that in *Eurylæmus ochromelas* there is a second vinculum: the additional slip "being given off lower down, from the hallux tendon, which joins the tendon of the digital flexor at the point where the latter, splitting into three, receives the main vinculum." Gadow (4), commenting on this statement, remarks that this arrangement closely agrees with what obtains in *Upupa* and *Irrisor*, a fact which suggests the origin of the Passerine plantars from this type.

* Italics mine.—W. P. P.

Though I looked carefully for this slip, I failed to find it, yet I examined three or four specimens.

Forbes showed that, in the matter of the syrinx, the Eurylæmidæ agree most nearly with the Philepittidæ of the Old World; and, after that, with the Cotingidæ, Pipridæ, and Tyrannidæ of the New World. This organ is of the "Mesomyodian," "tracheo-bronchial" type, or, to adopt Gadow's term, the syrinx is tracheo-bronchial and "Anisomyodean."

Had the syrinx instead of the plantar tendons been adopted as the basis of classification for this group, then the Cotingidæ would have been regarded as the more primitive group, inasmuch as in *Lipaugus cineraceus* the intrinsic muscle, according to Beddard, is of great width, "which seems to foreshadow its division in the Oscines into a complex of muscles . . ."

The many characters which the Eurylæmidæ and Cotingidæ share in common—skeletal, muscular, syringeal, pterylogical, &c.—are surely proofs that these two groups are much more nearly allied than is generally supposed to-day: the likenesses are too many and distinct to be put down to convergence or correlated variation.

The fact that the spina externa of the sternum is simple is generally bracketed together with the plantar tendons, and other characters, so as to emphasise the primitive character of the Eurylæmidæ. But this same peculiarity of the sternum occurs again in the Cotingidæ. The pterylosis of the Eurylæmidæ is generally regarded as peculiar: as a matter of fact, it is hard to distinguish from that of the Cotingidæ. The syndactyle foot again turns up—in the Cotingidæ. We have already described the close resemblances which obtain in the skulls of these two groups.

Turning now to the muscular system. The syringeal muscles we have already referred to. They offer no striking peculiarities of structure. Indeed, the only muscles which seem to call for comment in this summary are the *brevis* and *longus* divisions of the *deltoideus*. The separation of this muscle into two distinct parts is nowhere so complete as in the Passeres.

In its primitive (archicentric) condition, this muscle arises, in part from the acromion and inner face of the expanded free end of the clavicle and in part from the *os humero-scapulare* and *crista lateralis* of the humerus. It is inserted by a common tendon into the base of the ectepicondyloid process; the tendon forming the terminal of a practically homogeneous muscle.

I have not yet had time to study the apocentricities of this muscle, but it would appear that as specialisation proceeds it breaks up into two more or less equal and perfectly distinct muscles terminating in a common tendon: later the *brevis* portion becomes suppressed and the *longus* much shortened, each receding farther and farther up the shaft of the humerus.

I have only just realised the potentialities of this muscle as a factor in systematic work, and therefore have no large series of

data to support this interpretation. But the facts, in so far as they are relevant to the present paper, seem to show that the primitive (archicentric) condition is represented fairly well in, say, *Paradisaea*. In *Corvus corax* the longus portion is degenerate and fuses with the brevis just below the middle of the shaft of the humerus, the brevis portion then running downwards, ultimately becoming tendinous and passing to its insertion at the base of the ectepi-

Text-fig. 15.

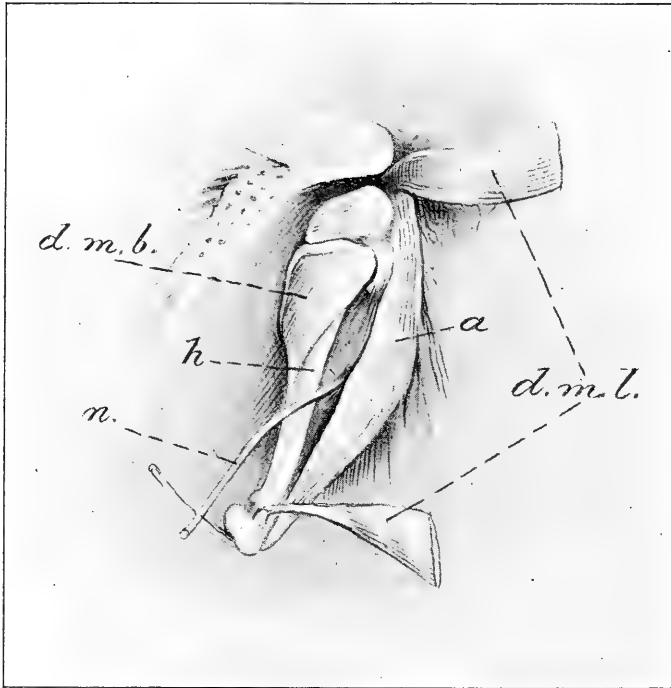

Dissection of arm, dorsal aspect, of *Eurylæmus ochromelas*, to show the *deltoideus major longus* and *brevis*. The longus portion has been cut through the middle, and the two halves drawn in opposite directions. The brevis portion has now become very degenerate and quite functionless.

d.m.b., deltoideus major brevis; *d.m.l.*, deltoideus major longus;
a., anconeus; *h.*, humerus; *n.*, nervus radialis.

condylar process. In *Sturnus* both portions are extremely well developed, and perfectly separate until the distal end is attained, where they fuse in a fleshy insertion in which may be traced two distinct incipient tendons.

In the Eurylemidæ and Cotingidæ—at least in so far as *Rupicola* is concerned—the major portion is well developed, but the brevis portion has now receded, not extending beyond the middle of the humerus, and having an entirely fleshy insertion; the longus portion, on the other hand, is slender and terminates in a long tendon.

This interpretation of the transformations of the *deltoides major et minor*, it will be noticed, runs directly counter to that of Dr. Chalmers Mitchell, who, in a paper “On the Anatomy of Gruiform Birds” (6), contended that apocentricity in this muscle was shown by the gradual extension down the shaft of the major portion. It would seem, rather, as if the archicentric condition were represented by the maximum downward extension, and that apocentricity is represented by the gradual reduction of muscular tissue.

That this reduction and inevitable suppression of the brevis portion represents an extremely specialised condition there can be no doubt; and the fact that it is shared also by the Cotingidæ seems to me, coupled with the numerous other points which these two groups share in common, to show conclusively that the Eurylemidæ and Cotingidæ must henceforth be regarded as very closely related forms.

These two groups differ in some other myological characters, as might be expected. The most noticeable is the fact that the *latissimus dorsi posterior* in the Cotingidæ appears to be wanting, though it must be remarked I have only been able to examine a single specimen of *Rupicola* in this connection. In the Eurylemidæ both muscles are present, strap-shaped in form, and widely separated; therein differing from the Corvidæ, in which they are of considerable size and slightly overlap one another. But this feature is one of many primitive characters which the Corvidæ have retained.

The peculiar myological resemblances which these birds share do not necessarily imply relationship; but, as I have just remarked, there are so many structures in which these two groups agree, that it is impossible to entertain any notion of convergent resemblance between the two. The points of likeness are so peculiar, and affect such different, independent systems, that correlated variation and convergence cannot be regarded as a satisfactory explanation of the case. When two apparently convergent forms come to be particularised, each new point of resemblance which is brought to light is to be regarded as an additional link in the chain of evidence, establishing the common origin of the two forms in question.

Thus, then, I contend there is no evidence which will justify the present isolated position which has been almost universally assigned to this group during the last few years. It is quite possible that further investigation will show that the Eurylemidæ are entitled to rank no higher than a subfamily of the Cotingidæ.

But this point, as well as the status of the "Passeres Clamatores," I propose to deal with in a further communication at no distant date.

xi. LIST OF LITERATURE REFERRED TO.

- (1) BEDDARD, F. E.—The Structure and Classification of Birds.
- (2) FORBES, W. A.—"Contributions to the Anatomy of Passerine Birds." Parts II., III. P. Z. S. 1880.
- (3) FÜRBRINGER, M.—"Zur vergleich. Anat. des Brustschultes-apparates." Jenaisch. Zeitschr. f. Naturwiss. xxxvi. 1902.
- (4) GADOW, H.—Bronn's Thier-Reich. Systemat. Theil, Band vi. Vögel. 1893.
- (5) GARROD, A. H.—"On some Anatomical Characters which bear upon the Major Divisions of the Passerine Birds." Part I. P. Z. S. 1876.
- (6) MITCHELL, P. C.—"On the Anatomy of Gruiform Birds." P. Z. S. 1901, vol. ii. p. 629.
- (7) SHARPE, R. B.—A Review of Recent Attempts to Classify Birds. 1891.

xii. EXPLANATION OF PLATE II.

Fig. 1. Inner aspect of skull of nestling *Eurylæmus* showing the large area occupied by the squamosal.

- 1 a. Outer view of same skull showing the peculiar form of the squamosal.
2. Side view of *Calyptomena viridis* showing the peculiar lachrymal, large narial aperture, and large and spongy antorbital process.
- 2 a. Ventral view of same skull to show the vomer, maxillo-palatine processes, and wide-set palatines.
- 2 b. Dorsal aspect of same skull to show the large size of the nasal fossa and the nasal hinge.
3. Ventral aspect of skull of *Cymbirhynchus* showing the slender maxillo-palatine processes, short vomer, and sharply bent palatines. Note the difference between the palatal surface of this species and that of *Calyptomena*.
- 3 a. Dorsal aspect of same skull to show the closing in of the nasal fossa and the formation of pseudo-nasal apertures.
4. Dorsal aspect of the skull of *Corydon* to show the large size of the narial apertures and nasal hinge.

Explanation of Letters.

a.o.p. = antorbital process.
als. = alisphenoid.
a.p.v. = anterior palatine vacuity.
b.oc. = basi-occipital.
b.s. = basisphenoid.
ex. = exoccipital.
fr. = frontal.
h.pt. = hemipterygoid.
l. = lachrymal.
mes. = mesethmoid.
mx.p. = maxillo-palatine.

na. = nasal.
n.h. = nasal hinge.
p. = parietal.
pa. = palatine.
p.na. = posterior nares.
p.o.p. = postorbital process.
pro. = prootic.
pt. = pterygoid.
s.n. = septum nasi.
sq. = squamosal.
v. = vomer.

May 16, 1905.

G. A. BOULENGER, Esq., F.R.S., Vice-President,
in the Chair.

The Secretary read the following report on the additions that had been made to the Society's Menagerie in April 1905:—

The registered additions to the Society's Menagerie during the month of April were 205 in number. Of these 67 were acquired by presentation and 19 by purchase, 104 were received on deposit, 9 by exchange, and 6 were born in the Gardens. The total number of departures during the same period, by death and removals, was 126.

Amongst the additions special attention may be directed to:—

A young female Chimpanzee (*Anthropopithecus troglodytes*), deposited on April 8th.

A young female Giraffe from Northern Nigeria, probably belonging to the race known as *Giraffa camelopardalis peralta*, purchased on April 7th.

A young male Huanaco (*Lama huanacos*), from Punta Arenas, Tierra del Fuego, presented by Mr. Moritz Braun and Capt. R. Crawshaw on April 10th.

A pair of Concave-casqued Hornbills (*Dichoceros bicornis*) from India, purchased on April 4th.

Mr. Oldfield Thomas, F.R.S., exhibited examples of a new Golden Mole from Knysna, Cape Colony, which had been obtained by Mr. Grant in connection with Mr. C. D. Rudd's exploration of South Africa, and which he proposed to name in honour of Mrs. Rudd, who had taken much interest in the results of the exploration.

AMBLYSOMUS CORRIE Thos. *, Abstr. P. Z. S. No. 20, p. 5,
May 23, 1905.

Rather smaller than *A. hottentottus*. General colour dark smoky blackish, darker than in *A. iris*, with a beautiful iridescent sheen, greenish to coppery violet, over the whole upper surface. Sides and belly not or scarcely lighter, a slight brownish tone occasionally present along the centre of the abdomen. Hairs of back 8–9 mm. in length, their bases dark slaty grey, their ends lighter and more brownish grey subterminally and their tips iridescent blackish brown. Crown and forehead like back. Cheeks paler, greyish or yellowish, but not conspicuously contrasted. Limbs and upper surface of hind feet smoke-grey.

Skull (Pl. XVI. † fig. 3) in its general characters like that of

* [The complete account of the new species described in this communication appears here; but since the name and preliminary diagnosis were published in the 'Abstract,' the species is distinguished by the name being underlined.—EDITH.]

† P. Z. S. 1905, vol. i. p. 254.

A. hottentottus, but markedly narrower across the brain-case; and the zygomata less thickened at their posterior base. As a result, the two skulls being of about the same length, the general outline was much less broadly triangular. Muzzle and inter-orbital region narrow and delicate.

Outer edge of permanent teeth narrow antero-posteriorly, and of milk-teeth broad with conspicuous cusps, as shown in the Plate. The anterior premolar triangular, not extended transversely as in *A. obtusirostris* and *chrysilus*.

Dimensions of the type, measured in the flesh:—Head and body 129 mm.; hind foot 13.

Skull—greatest length 28, basal length 22·6; greatest breadth across brain-case 16·6; greatest height 12·6; interorbital breadth 8; front of i^1 to back of m^2 10·5; palate, breadth across premolars 8·1.

An adult female had a head and body length of 118 mm.; greatest skull length 25·7.

Hab. Knysna, S. Cape Colony. "In Forest."

Type. Old male. Original number 1021. Collected 25 January, 1905, by C. H. B. Grant, and presented to the British Museum by Mr. C. D. Rudd. Ten specimens examined.

This handsome little species was not only a very interesting discovery in itself, but the fine series of it obtained by Mr. Grant, of both sexes and different ages, had enabled Mr. Thomas to identify with confidence the milk and permanent dentitions of the specimen figured in the plate illustrating his paper on the Zululand Mammals collected by Mr. Grant. No proper knowledge of the respective characters of the two dentitions had hitherto existed.

Mr. H. B. Fantham, B.Sc., F.Z.S., exhibited microscopic slides of and made remarks upon *Lankesterella tritonis*, n. sp., a Hæmogregarine parasitic in the red blood-corpuscles of a Newt, *Triton cristatus* (*Molge cristata*). Blackboard sketches were made illustrating the life-history of the parasite so far as was known.

This parasite was found some time ago by the exhibitor while working in the Zoological Laboratory, University College, London. Afterwards his observations were independently confirmed by Dr. A. C. Stevenson. Up to the present the trophozoite and schizogonous stages only had been seen, and the sporogony probably took place in an intermediate host. Schaudinn's and Siegel's recent observations on the sporogony of allied parasites in the lizard and water-tortoise were quoted in support of this view, and mention was made of the inaccuracy of Hintze's account of the sporogony of *L. ranarum* in the intestine of the frog, the cysts therein mentioned probably being Eimerian stages of a Coccidian.

The trophozoites, vermiform in shape, were apparently 5μ to 6μ in length, and slightly over 1μ broad. They became U-shaped

and gave rise to "rosette-stages," about $2.5\ \mu$ to $3.5\ \mu$ in diameter. A "rosette" consisted of a schizont dividing up into merozoites.

This parasite was probably the smallest *Hæmogregarine* yet described, and it occurred in large red blood-corpuscles, those of *Triton cristatus* being about $30\ \mu$ in long diameter. The research on this parasite and allied forms was being continued.

The following papers were read:—

1. A Contribution to the Knowledge of the Encephalic Arterial System in Sauropsida. By FRANK E. BEDDARD, M.A., F.R.S., Prosector to the Society.

, [Received March 29, 1905.]

(Text-figures 16–21.)

The following pages contain some facts relating to the principal vessels of the arterial system of the brain in a number of Lizards, in a Python, and in the giant Tortoise, *Testudo vicina*. Some of these have not been hitherto studied; some have been examined by Rathke and others, and references to these anatomists will be found in the proper place. Most of the brains which I describe are now in the Museum of the Royal College of Surgeons. My principal object has been, next to the recording of new facts, to ascertain how far the characters offered by the distribution of these vessels, which are undoubtedly of use in the systematic arrangement of mammals, are also of use in the remaining Vertebrata for a like purpose.

§ *Brain of Varanus exanthematicus.*

Although the cerebral arterial system of *Varanus griseus* has been described by Corti*, I have a few notes to add to his description and comparisons to make with the other genera treated of in the present communication.

The two vertebral veins are strong and mark the posterior end of the medulla, precisely as is the case with *Iguana*. The posterior pair of cerebellar arteries arise, as in *Iguana*, from the basilar artery at the middle of the medulla, and are larger than the anterior pair, which arise from the fork of the basilar in front. This fork is not quite so symmetrical as in *Iguana*. The left side and the left carotid are rather thicker than the right, and there is thus a suggestion of the marked inequality of these arteries in *Python*. The branches to the corpora bigemina and to the rest of the brain are quite as in *Iguana*; but the large size of the ophthalmic arteries is a point of likeness to *Python*.

* De systemate vasorum *Psammosauri grisei*. 1853.

§ *Brain of Iguana tuberculata.*

The plan of the cerebral arteries in this Lizard differs in a number of particulars from that which will be shortly described. The anterior spinal artery, though of considerable size, is yet of less calibre than the basilar, with which it is nevertheless in perfect continuity. The exit of the posterior pair of cerebellar arteries marks the middle of the medulla. These arteries are slightly asymmetrical, the left being a little in advance of the right. They arise behind the point of origin of the 6th pair of cranial nerves. The anterior pair of cerebellar arteries arise just after the division of the basilar artery to form the carotids on each side; they are distinctly smaller than the posterior pair.

The two branches of the basilar are approximately equal in size, as are the carotids which join them very shortly after the bifurcation of the basilar. The point of junction is just at the point of origin of the anterior cerebellar arteries. In this, it will be observed, is a slight difference from the figure of the cerebral arterial system of this Lizard given by Rathke*. The next artery arising from the circle of Willis is in front of the third nerve (to the inside of which nerve passes the forward continuation of the carotid, as in other vertebrates) and supplies chiefly the corpus bigeminum of its side; but it also gives off a branch each to the cerebellum and to the cerebral hemisphere. A little way anterior to this is a much more slender vessel which is absolutely symmetrical on both sides of the body and which almost at once divides into two branches; one of these ends upon the infundibulum, the other reaches the optic nerve of its side. Beyond this again arises the posterior cerebral artery. This artery reaches the hemisphere just at the furrow which divides it from the corpus bigeminum and runs parallel to the cerebral branch of the bigeminal artery.

A little further forward the carotid finally divides into two arteries. The outer and stronger branch may be termed the middle cerebral; it runs forwards, curving outwards in the middle so as to be crescent-shaped, to the long and slender olfactory bulbs, giving off numerous slender branches to the hemisphere on its way. The inner branch very soon again divides into two: the innermost of them is the ophthalmic artery; the outer runs forward along the median ventral line of the brain in close contact with its fellow of the opposite side.

* "Untersuchungen über die Aortenwurzeln &c. der Saurier," Denkschr. k. Akad. Wiss. Wien, xiii. 1857, p. 51.

[Since this paper was read Mr. R. H. Burne has kindly directed my attention to a paper by Dr. Hofmann in *Zeitschr. f. Morph. u. Anthr.* ii. 1900, in which the arterial system of the brain is described in a number of Fishes, Amphibia, Birds, and Mammals, and in the following Reptiles, viz. *Iguana*, *Tropidonotus natrix*, *Crocodile*, and *Testudo græca*. That of the last alone (among Reptiles) is figured. This paper has been apparently overlooked by the recorders of the Mammalia, Aves, and Reptilia in the 'Zoological Record' for 1900; but it is catalogued by the recorder of 'General Subjects.'—*July 6th.*]

§ *Brain of Tropicurus hispidus.*

In comparing the arterial system of the brain of this Iguanoid with those of the other species of Lacertilia with which I have dealt, I am unable to say anything about the cerebellar arteries, which were not visible in the specimen examined by me. The bifurcation of the basilar artery in front at rather an acute angle consisted of equally-sized vessels, and the carotids which joined these arteries behind the third pair of nerves were also equal. The arteries to the corpora bigemina disappear at once in the groove separating each corpus bigeminum from the hind brain. The other arteries of the brain seem to be as in other Lacertilia.

§ *Brain of Eumeces algeriensis.*

The arrangement of the arteries of the brain in this Skink, which, so far as I am aware, has not been described, shows certain differences from that of both *Varanus* and *Iguana*. These features are illustrated in the accompanying drawing (text-fig. 16, p. 62). The fusion of the vertebral arteries with the basilar marks, as is usual, the end of the medulla. From the basilar artery arise a number of branches of which the posterior cerebellar arteries are the most important; of these the left artery arises in advance of the right and it is shortly reinforced by another branch. The bifurcation of the basilar anteriorly begins further back than in both *Varanus* and *Iguana*; and another difference from the conditions observable in these two genera is to be noted. In these Saurians the carotids join the circle of Willis behind the origin of the third pair of nerves; in *Eumeces* these arteries join the circle of Willis well in front of the third nerves, and therefore also in front of the slender anterior cerebellar arteries, and of the artery supplying the corpus bigeminum on each side. This artery not only supplies the corpus bigeminum but also the cerebellum, and it sends a branch forward which runs parallel to the posterior cerebral artery, and like it is lost in the groove separating the fore brain from the mid brain. Between this artery and the middle cerebral or Sylvian is a slender twig like that of *Iguana* which runs to the base of the optic nerves. The anterior cerebral, which gives off the ophthalmic artery, is considerably thicker than the middle cerebral artery.

§ *Brain of Gerrhosaurus.*

As is the case with *Eumeces*, the basilar artery in *Gerrhosaurus* (see text-fig. 17, p. 62) divides rather further back than it does in either *Iguana* or *Varanus*. There is, moreover, a very distinct inequality of calibre in the two arteries; the right is in fact considerably larger than the left. This inequality does not, however, extend to the two carotids, which are equal in size. These join the circle of Willis only just in front of the point of origin of the anterior

cerebellar arteries, which latter, as in other Lizards, are smaller than the posterior pair. The place at which the carotids join the circle of Willis is only just behind the third pair of cerebral

Text-fig. 16.

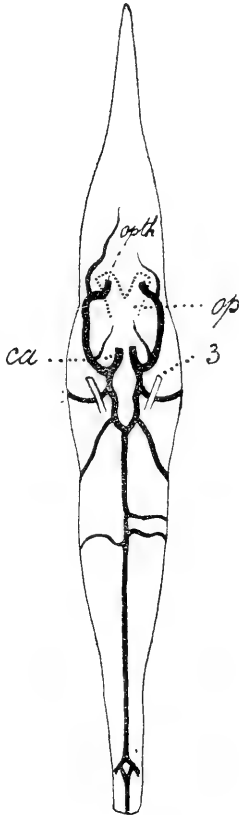

Text-fig. 17.

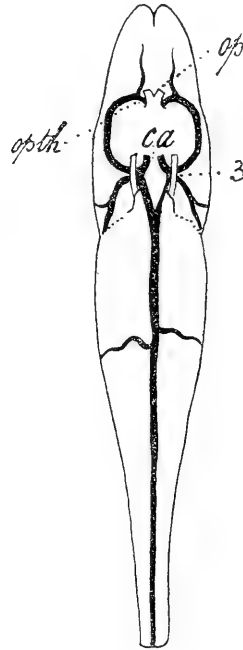

Text-fig. 16.—*Eumeces algeriensis*. Ventral aspect of brain, showing chief arteries. *ca.* Carotids; *op.* Optic nerves; *oph.* Ophthalmic arteries; 3, third nerves.

Text-fig. 17.—*Gerrhosaurus flavigularis*. Ventral aspect of brain, showing chief arteries. Lettering as in text-fig. 16.

nerves. The order in which the remaining arteries of the brain arise is quite similar to that of the other Lizards described here, and there are no particular comments to be made upon them.

§ *Brain of Tupinambis nigropunctatus.*

The most important branches arising on either side from the

basilar artery are the posterior cerebellar, and these arise a little behind the middle of the medulla. The two arteries are perfectly symmetrical with each other as to their point of origin. They are, however, different in their branching. The right artery gives off, shortly after its origin from the basilar, a strong artery running backwards along the side of the spinal cord. This branch exists and pursues the same course on the left side; but on that side of the brain it arises separately from the basilar artery. Between the origin of the posterior cerebellar arteries and the bifurcation of the basilar anteriorly are three pairs of small arteries supplying adjacent regions of the medulla. A slightly larger artery, which is the anterior cerebellar, arises from the fork of the basilar. This fork is **U**-shaped in the Teguexin (text-fig. 18, p. 65), and not **V**-shaped as in the other Lizards described here. The **U**-shape is due to the fact that the two carotids run parallel to and almost in contact with each other for some distance before they join the circle of Willis. The carotids, moreover, lie within the area bounded by the third nerves very close to and about on a level with those nerves. The artery formed by the junction of the basilar and carotid on each side, often spoken of merely as the carotid, passes outwards and slightly backwards at first, when it is practically at right angles with the basilar. In this region the artery shows different relations on the two sides of the body. On the left side it runs in front of the third nerve; on the right side it lies behind that nerve. The first branch arising after the carotid is at the bend of the artery, where it turns forward; this very stout artery supplies the cerebellum and optic lobe; immediately in front of this is the artery of the optic lobe. This state of affairs occurred on the left side of the body; on the right side the two arteries arose by a common trunk. On both sides the artery of the corpus bigeminum gives off an artery to the cerebral hemisphere which buries itself in the furrow between the hemisphere and the optic lobe. From the inner side of the circle of Willis, just opposite to the bigeminal artery on the left side and to the conjoined arteries just mentioned on the right side, arises an artery which runs to the optic chiasma. This artery is precisely like that of other Lacertilia. The next artery to be given off is the posterior cerebral, which plunges at once into the furrow lying between the optic lobe and the cerebral hemisphere. The middle cerebral artery, which is the largest of the cerebral arteries, runs in the usual way along the Sylvian depression, and just in front of the point of origin of this the circle of Willis practically ends in the strong ophthalmic arteries which follow the optic nerves. There are therefore no differences of importance between the arterial system of the brain of *Tupinambis* and of the other genera of Lizards reported upon in the present communication.

§ Cerebral Arteries in the Lacertilia.

We may deduce from the facts just described the chief

characters of the encephalic arterial system in the Lacertilia for purposes of comparison with those of other Vertebrates*.

(1) The entrance of the vertebral arteries into the anterior spinal marks the end of the medulla oblongata.

(2) The posterior cerebellar arteries are the only conspicuous arteries arising from the basilar; they arise at about the middle of the medulla oblongata and behind the 6th pair of cranial nerves; they are occasionally asymmetrical with each other.

(3) The anterior bifurcation of the basilar is at a more or less acute angle according to its position; the slender anterior cerebellar arteries are invariably given off from the bifurcated basilar behind the point of origin of the third nerves; the two branches of the basilar produced by the bifurcation may be inequized.

(4) The point of entrance of the carotids is not invariably the same; it is sometimes in front of and sometimes behind the third pair of nerves.

(5) The artery on each side to the corpus bigeminum sends branches to the cerebellum and to the cerebral hemispheres. It arises in front of the entrance of the carotids.

(6) In front of this artery is one which runs towards the optic chiasma.

(7) There are three cerebral or hemispherical arteries: the posterior reaches each hemisphere just at its junction with the corpus bigeminum; the middle one is Sylvian in position; the anterior cerebral gives off the ophthalmic; there is no distinct completion of the circle of Willis anteriorly.

(8) There is no strongly marked asymmetry in the cerebral arterial system of the Lacertilia.

§ *Brain of Python molurus* †.

I have been able to study two injected brains of this serpent, of which one is more completely injected than the other. The most obvious and plain difference from the brains of other Sauropsida is the marked asymmetry in the arterial system (text-fig. 19, p. 65), which agrees of course with the vascular asymmetry shown elsewhere among the Ophidia. This asymmetry, however, only concerns the carotids. The other arteries of the brain, so far as I have been able to study them, do not show anything of the kind, but indeed a perfect regularity quite comparable to that shown in other Sauropsida. Of the two carotids the left is very much the larger. The basilar artery is single where it runs along the ventral surface of the cord and brain, until of course it bifurcates anteriorly at the commencement of the circle of Willis. The entrance of the vertebral arteries marks the end of the medulla. These arteries, which lie exactly opposite to each other, are very much stouter than the basilar, which they combine with the anterior spinal to

* See below, pp. 66, 67, and 69, for comparison with Ophidia and Testudinata.

† Rathke describes but does not figure brain-arteries of Ophidia in Denkschr. Akad. Wiss. Wien, xi, 1855.

form. In one of the two specimens at my disposal, I could not see very well the actual mode of junction of the vertebral arteries with the basilar. In the other it was plain and very complicated. The basilar artery itself divides and immediately reunites, thus forming a circle; the two vertebrals join below this circle, and from the lower surface of this transversely running trunk two

Text-fig. 18.

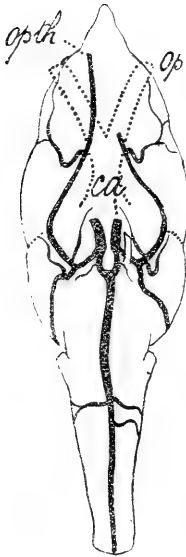

Text-fig. 19.



Text-fig. 18.—*Tupinambis nigropunctatus*. Ventral aspect of brain, showing chief arteries. Lettering as in text-fig. 16.

Text-fig. 19.—*Python molurus*. Ventral aspect of brain, showing chief arteries.
v. Vertebral arteries. Other letters as in text-fig. 16.

To the right of the figure is an enlarged representation of the junction of the vertebral arteries with the basilar.

branches are given off, each of which joins one side of the circle already referred to. I should not like to lay undue stress upon the fact as absolutely characteristic of *Python*, since the arrangement was not obvious in one specimen through deficiency of injection.

A noteworthy difference exists between the two specimens in relation to the course of the large left carotid. In the one brain this artery lies outside of the dura mater for a large part of its course, and gives off at least one branch to the brain which perforated that membrane; thus giving additional proof of the fact that the carotid itself lies outside of the dura mater. In the other brain I did not observe this state of affairs. It follows that the left carotid exhibits an aloofness from the brain which is remarkable, and that the branches therefrom do not run on the same plane with it.

The arteries to the optic lobes arise from the basilar artery after its bifurcation, between this point and the entrance of the carotids, and further back still there is a smaller cerebellar artery. The posterior cerebral artery is small and arises just in front of entrance of the carotids. The next important artery is a cerebral, which arises in front of the inflow of the carotids. This artery is the middle cerebral or Sylvian of other animals, since it runs along the rudimentary Sylvian fissure. The posterior cerebral is also partly represented by several small branches of the artery to the optic lobe. In front of the middle cerebral artery is a smaller anterior cerebral artery.

Anteriorly to this the circle of Willis is completed in the following way: the large left carotid bifurcates to form the two nearly equally stout ophthalmic arteries which of course accompany the optic nerves. Just before this bifurcation the slender right carotid effects a junction with the common trunk. Immediately in front of this a single trunk arises from the point of bifurcation of the left carotid, which at once divides into two. These vessels run closely side by side in the furrow which separates the two hemispheres and rejoin at the extreme anterior end of the brain, their course in fact recalling that of the callosal arteries in mammals. The arteries are by no means inconspicuous, as is shown in the annexed figure (text-fig. 19, p. 65).

I now draw, of course quite in a preliminary and tentative way, a series of comparisons between the Ophidian and Lacertilian brain arteries, enumerating the characters of the former in the same order as already given (on p. 64) for the latter.

§ *Cerebral Arteries in the Ophidia.*

(1) The entrance of the vertebral arteries into the anterior spinal marks the end of the medulla oblongata. These arteries seem to be stouter than in the Lacertilia.

(2) There is no markedly large pair of cerebellar arteries arising from the basilar artery, but a number of more or less equisized arteries supplying the cerebellum and adjacent region.

(3) The two branches produced by the bifurcation of the basilar are equisized. The anterior cerebellar arteries arise from the bifurcated region.

(4) The point of entrance of the carotids appears to be rather

far forward as compared with the Lacertilia; but this appearance is at least partly due to the great length of the bifurcate region of the basilar artery in *Python* as compared with that of any Lacertilian.

(5) The artery to the corpus bigeminum on each side arises behind the entrance of the carotid instead of in front as in Lacertilia. It gives off branches to the cerebrum and also to the cerebellum.

(6) In front of this artery and also in front of the carotid is an artery which runs towards the optic chiasma.

(7) There is a very marked completion of the circle of Willis anteriorly.

(8) There is a strongly marked asymmetry in the arterial system of the brain due to the greater size of the left carotid.

§ *Brain of Testudo vicina.*

The most salient characteristic of the arterial system in this Reptile is the double basilar artery (text-fig. 20, p. 68). The artery is double for the whole of its course beneath the medulla oblongata. The anterior spinal artery in fact divides into two well behind the medulla. The right-hand one of the two branches is not larger than the left; the two arteries do not run close side by side, but are separated by a considerable distance. They are joined each of them by the carotid in front of the origin of the third nerve. Behind the origin of the third nerve a large number of arteries arise from the basilar on each side; there are certainly eight or nine of them on each side, and they supply the cerebellum, the medulla, and the cranial nerves of this region of the brain. The fifth artery (on the right side at any rate), which arises from the basilar behind the third nerve, is *par excellence* the cerebellar artery; it fuses with its fellow of the opposite side at the end of the cerebellum. In front of the third nerve arise two arteries rather close together, of which the anterior has several branches and is the larger artery: it partly supplies the cerebral hemispheres and corresponds, as I imagine, to that artery in the Lacertilia which supplies the corpus bigeminum on each side.

As in the Lacertilia, there are two cerebral arteries on each side. The first and largest of these (text-fig. 21, p. 68) may be termed the Sylvian, as it runs along the lateral groove upon the hemisphere which has been compared to the Sylvian fissure of mammals. The branches of this artery are not altogether symmetrical on the two sides of the body; it is possible, however, to distinguish the main trunk which runs towards the top of the brain, where it divides into a forwardly running and a backwardly running branch, several branches from the main stem which pass backwards over the temporal region of the hemisphere, and a strong branch running forwards to the olfactory lobe. Moreover, there is plain on one side a branch arising immediately after the origin of the Sylvian artery, which plunges at once beneath the hemisphere. A second

cerebral artery arises from the circle of Willis a very short way in front of the Sylvian artery. This vessel runs forwards parallel

Text-fig. 20.



Text-fig. 21.

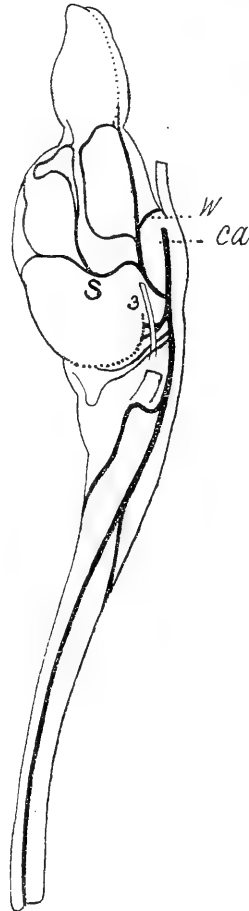

Text-fig. 20.—*Testudo vicina*. Ventral aspect of brain, showing chief arteries.
w. Junction of two halves of the circle of Willis anteriorly.
 Other lettering as in text-fig. 16.

Text-fig. 21.—*Testudo vicina*. Lateral aspect of brain, showing chief arteries.
S. Sylvian. *w*. Junction of two halves of the circle of Willis anteriorly.
 Other lettering as in text-fig. 16.

with and close to the olfactory branch of the Sylvian, and finally ends in an anastomosis with the main stem, from which the

olfactory branch arises beneath the olfactory lobe at the junction of the latter with the cerebral hemisphere; before this point of junction a branch is given off to the olfactory lobe.

The circle of Willis is completed anteriorly; it also ends in two strong branches which run along the under surface of the brain, anteriorly, giving off numerous branches at the junction of the hemispheres with the olfactory lobes. One or more of these bend downwards (as the brain is viewed from beneath) and pass through the gap between the hemispheres running to the dorsal side of the brain in a way which suggests the callosal artery of the mammals. I could not detect anything more than a very small branch arising where the ophthalmic arteries arise in the Lacertilia. I cannot think that this artery is absent, but it is clearly not so conspicuous as in the Lizards.

It is evident that the encephalic arterial system differs quite as much from that of either Lizards or Snakes as do the encephalic arterial systems in the two last mentioned groups.

It is thus plainly possible to distinguish between several types of distribution of the cerebral arteries among the different divisions of the Sauropsida, and there is, as is well known, another type characteristic of mammals. It will be interesting to ascertain how far these several types confirm views as to the relative positions of the groups of Sauropsida under consideration. It will not be held by anyone, I presume, that the class Aves represents a primitive Sauropsidan type; and in agreement with this presumption we find clear evidence of modification in the encephalic arteries*, in the abortion of one or other of the normal two branches of the basilar. On the other hand, the arteries in question of birds are, as I think, undoubtedly primitive in that there is no completion of the circle of Willis anteriorly. A completed circle of Willis appears to me to be a secondary modification mainly for the reason that in mammals, where it occurs universally, it is there brought about in more than one way, and is moreover associated with strong arteries in the anterior region of the brain in close communication, or rather in close apposition, and there is apt to be confluence between closely apposed spaces and vessels. If this view be correct, we can set aside the brain of the Python and that of *Testudo* as showing primitive characters by virtue of the fact that they have a closed circle of Willis. And in addition to this, it may be pointed out that the asymmetry of the arterial system in the Snake indicated by the carotids, and the changes in the disposition of the vessels due to the prevalence of the left carotid, can be fairly regarded as being secondary. This conclusion is obviously in accord with the current views of the relations of the Ophidia to other reptiles. There only remains the Lacertilia.

It is, in my opinion, probable that in this group (and in *Hatteria*) the whole question lies of the antiquity of existing

* P. Z. S. 1905, vol. i. p. 102.

reptiles. And it must be admitted at once that the facts dealt with in the present communication do not conform with any certainty to one view or to the other. On the whole, however, they seem to point to the Lacertilian; since from that type the remaining schemes of encephalic arterial arrangement can be derived, while the extraordinary modification of the basilar artery in *Testudo*, found nowhere else, would seem for that very reason to be a divergence from the original condition.

2. On the Nomenclature of the Anthropoid Apes as proposed by the Hon. Walter Rothschild. By Sir H. H. JOHNSTON, G.C.M.G., K.C.B., F.Z.S.

[Received May 5, 1905.]

I should like to make a few remarks on the admirable paper written on this subject by Mr. Walter Rothschild, which has just appeared in the 'Proceedings' (1904, vol. ii. p. 413). Unfortunately, I did not know that this paper was going to be read in December 1904, or I should have endeavoured to be present. I am disposed in a general way to agree with Mr. Rothschild's classification of the great Apes of Africa. I have only one criticism to offer with respect to the nomenclature of the Chimpanzees. Since Mr. Rothschild has done so much to revise, revive, and establish the nomenclature of these Apes, I should like to see him introduce a more rational spelling into the third of his species of Chimpanzees—the Bald Chimpanzee, which he gives, following Du Chaillu, as *Simia koolookamba*. Du Chaillu was very inaccurate in his transcription of African words, and he used the cumbrous system of English transliteration which prevailed until the rational spelling was introduced thirty or forty years ago by various scientific societies and departments of the Government. *Koolookamba* is really two words, which are pronounced nkulu-nkamba. I think that this spelling might stand in preference to *Koolookamba* [*Simia nkulunkamba*].

A much more serious point, however, is the generic name which Mr. Rothschild gives to the Orangs—*Pongo*. Mr. Rothschild is undoubtedly right in reviving *Simia* as the most appropriate and the earliest name for the Chimpanzee genus, to which it was applied in the first instance by Linnæus. Linnæus evidently thought that the differences between the Chimpanzee and the Orang, which animal was later brought to his notice, were not more than specific, so that he included the Orang in the Chimpanzee genus. Much later, in 1799, Lacépède applied the generic name *Pongo* to the Orangs; and although in the same year the Orang genus was named *Satyrus*, Mr. Rothschild prefers *Pongo* to this very appropriate designation, and wishes to establish *Pongo* as the generic name for the Orangs. I would certainly protest against this. There is much to connect the Satyr of the Classical world and Mediæval mummeries with traditions of a red-haired man-of-

the-woods—the Orang—which had filtered to Europe through India and the Levant, and the Arab sea-borne trade from Sumatra; but *Pongo* is an African word originally applied to the Chimpanzee, and in all probability derived from the Bantu dialects of Angola, south of the Congo. The proper spelling of this word is Mpongo, and it is a root which, in varying forms, is found in a number of Bantu dialects and languages in Western and Equatorial Africa, and used to indicate either a chimpanzee or a big baboon*. I have not got access to various old books at the time of writing, but I think I am correct in saying that English and Dutch travellers on the West Coast of Africa in the 16th, 17th, and 18th centuries referred to the Chimpanzee as “Pongo.” I also fancy that the same allusion and the same name are made use of by Buffon. As in zoological nomenclature the preference is for the adoption of a Latin or Greek name, it is a pity to introduce into our lists a barbarous word in preference to one derived from either of the classical languages. But when in addition an *African* word is taken as the name of an *East Asiatic* genus, then the choice is singularly inappropriate.

* It may be of interest to add the names for “Chimpanzee” in a number of African languages, mostly collected by myself:—

LANGUAGE.	DISTRICT.	WORD FOR CHIMPANZEE.
<i>Tenne</i>	Sierra Leone	Ku-fuka (Ka- is <i>sing.</i> prefix).
<i>Vai</i>	Western Liberia	Ibulu.
<i>Busi</i>	North-western Liberia	Guru.
<i>Mandingo</i>	North of Sierra Leone, Liberia, and Ivory Coast.	Iburu.
<i>Kpvesi</i>	Central Liberia	Ibulu.
<i>Gora</i>	St. Paul's River, West Central Liberia.	Onyi.
<i>Basā and Dā</i>	Coast of Central Liberia	Ibē.
<i>Kru and Grebo</i>	Southern Liberia	Tuāwē
<i>Yoruba</i>	Interior of Lagos	Obō.
<i>Ijō</i> languages	Brass, Bonny, Niger Delta	Tele.
<i>Ibo</i>	Lower Niger	Ozodimba.
<i>Efik</i>	Old Calabar	Idiök.
<i>Umon, Ikun, and Akuna-kuna</i>	} Lower Cross River	Enōp or Enōwi.
<i>Nki</i>	Extreme Upper Cross River	Bōki.
<i>Mbudikun</i>	Sources of Cross River, N.E. of Cameroons.	Apū or Epfū.
<i>Barondo and Isubu</i>	North Cameroons Coast	Ewaka.
<i>Mpongwe</i>	Gaboon	Ntyege and Nchego; also Nkulu.
<i>Kongo</i>	Lower Congo and Congo Coast ...	Mpongi.
<i>Kimbundu</i>	Angola (south of Lower Congo) ...	Mpongo.
<i>Kiwemba [or Bemba]</i> ...	South-west of Tanganyika	Koroe.
<i>Ki-guha</i>	West Tanganyika	Tōlue.
<i>Kabwari</i>	North-west Tanganyika	Sōkō.
<i>Manyema</i>	West of Tanganyika and extreme Upper Congo.	Soko.
<i>Ruanda</i>	North of Tanganyika	Enjangwe.
<i>Kifipa</i>	East Coast, Tanganyika	Isike.
<i>Lu-ganda</i>	West and North Coast of Victoria Nyanza.	Edzike or Izike.

[*] The origin of the name “Pongo,” of Buffon and others.]

I do not suppose much deference will be shown to my own suggestions; but it seems to me that the best generic name for the Orangs would be *Satyrus*; or, if that is strongly objected to because it may be confused with the specific name of one or two Chimpanzees, then possibly *Pithecus*.

I cannot help thinking that in this case, as in many other instances, when we are settling for good and for all our biological nomenclature, we carry too far the passion for asserting the prior rights of the first invented name, which is occasionally a singularly inappropriate one.

I will conclude my paper with a few remarks on the definite knowledge of the different species of Anthropoid Apes from the dawn of zoological science in Greece to the end of the 18th Century of the present era, by which time European zoologists had begun to discriminate pretty clearly between the Gibbons, the Orang, and the Chimpanzee. Knowledge of the Gorilla of course was not clearly defined till about 1848 or even later. It is possible, however, that a living specimen of the Gorilla was brought over to Holland in the latter part of the 17th Century. A figure of this creature (which was a female) is given in Dr. Tyson's work on the Chimpanzee, published in London in 1699.

Aristotle, writing in about 330 B.C., divided the mammals that were nearest to man into three closely allied groups: the Pithekoï or Apes, the Keboi or Monkeys, and the Kunocephaloï or dog-faced Baboons. In the Latin translations of Aristotle these designations are rendered *Simia*, *Cebi*, and *Canicipes*. Aristotle's

LANGUAGE.	DISTRICT.	WORD FOR CHIMPANZEE.
<i>Nyoro</i> and <i>Hima</i> dialects.	Unyoro, Toro, Ankole, and south-west of Victoria Nyanza.	Isike, Yisiki, Echikuya, Empundu, Kitera.
<i>Konjo</i>	Mt. Ruwenzori	Ekitera.
<i>Lihuku</i>	Forest, north-west of Semliki River (Mboga Country).	Ngule.
<i>Kibiria</i>	Congo Forest between Semliki R. and Upper Congo (Aruwimi basin).	Kika.
<i>Mangala</i> and allied languages.	Upper Congo, between Aruwimi and confluence of Mubangi Welle, and between course of Congo and vicinity of Welle River.	(Mu) Kumbuso (Mu- is only the singular prefix).
<i>Lendu</i>	West of Albert Nyanza	Ngrrr (r's trilled).
<i>Bambute pygmies</i>	Semliki-Aruwimi Forest	U'u.
<i>Momfu</i>	North-east Borderlands (Congo-Nile water parting) of Congo Forest, west of Lendu.	Tato.
<i>Aluru</i>	North of Albert Nyanza	Bim.
<i>Madi</i>	(Western dialects of) West of Mountain Nile, north-east of Congo Forest.	Arugu.
<i>Makarka</i> (Nyamnyam).	Southern and Western parts of Bahr-el-Ghazal province of Egyptian Sudan.	Baham or Bamu; also Irangba and Nderuna.
<i>Mundu</i>	North-east of Makarka	Angó.
<i>Bongo</i>	North-west of Makarka	Dedda.

[Perhaps other travellers and philologists can fill up the gaps in this series of names.]

general description of the Pithekoi delineates very distinctly an Anthropoid Ape, and reads as though it was derived from a generalised knowledge of the Chimpanzee, a knowledge obtained no doubt from specimens which had been brought down the Nile from the Egyptian Sudan (in the southern parts of which the animal still exists) to Lower Egypt. A good summary of Aristotle's description of the Pithekoi is given in Dr. Tyson's celebrated book "On the Anatomy of a Pygmie, *sive Homo sylvestris*," which, as before stated, was published in 1699, and of which there are copies in two or three of the principal libraries of London.

I think I am correct in saying that in an Egyptian fresco or papyrus which is exhibited in the Egyptian collection of the Museum at Naples, a Chimpanzee is depicted amongst other strange animals brought to Egypt from the Sudan. I believe also there is a representation of the Chimpanzee on one of the Roman mosaics recently brought to light at or near Carthage, and now preserved in one of the Museums, either at Carthage or Tunis.

The Byzantine Greeks, who, after Alexander's conquests, extended their trade to India, and the Arabs of west, south, and east Arabia, who maintained commercial relations with Sumatra, the Malay Peninsula, North-west Borneo, and the ports of the Persian Gulf and the Red Sea, may have introduced some knowledge of the Orang utan to Constantinople, to Egypt, and to the Mediterranean world between 100 B.C. and the fall of the Byzantine Empire.

Sir Walter Scott in his novel 'Count Robert of Paris' introduced somewhat fantastically a captive Orang utan into the story. I am not aware what foundation he had for this incident; and I think it somewhat improbable that an Orang utan could at that period have survived the overland journey from the Persian Gulf to the Mediterranean, or the transit through Egypt.

Marco Polo, the Venetian, in 1296 or thereabouts, travelled overland from Asia Minor to China and the Malay Peninsula, and reached Sumatra and possibly Borneo, bringing back with him stories of man-like apes, some of which certainly referred to the Gibbons, while one or two may be attributed to the Orang utan.

Odoric, a friar of the Order of St. Francis, travelled overland from Constantinople to India during the first half of the 14th Century, and from India reached Sumatra by sea. He brought back distinct accounts of both Gibbons and Orangs.

Ibn Batuta, a Morocco Arab, also journeyed to those parts about the same time, and described the Orang utan in his records.

Friar Giovanni dei Marignolli, a Franciscan like Odoric, also travelled overland from France to China and thence to the Malay Archipelago during the first half of the 14th Century, and brought back from Sumatra, or more likely North Borneo, very distinct accounts of the Orang utan.

At the commencement of the 16th Century the Portuguese conquistadores reached Malacca and Sumatra in their ships, and

by 1521 had placed more or less roughly on the map all the big islands of the Malay Archipelago. They were followed a few years later by Spanish, Dutch, and French adventurers. During the 17th Century many British ships visited Sumatra and Borneo, and the Malay name *Orang utan* was in current use in scientific Europe during the second half of the 17th Century, having been originally definitely applied to the man-like apes of Sumatra and Borneo*.

But towards the close of the 15th Century the Portuguese had already become acquainted with the West Coast of Africa and the Chimpanzee. They first noticed this creature in the southern part of what is now the colony of Sierra Leone. They called it in their earlier writings "Selvage" (savage), and later "Barri." Later still they came to know more of the Chimpanzee in dealing with the Lower Congo and Northern Angola†. It there went under the name of Pongo, which as already explained is the Angola name Mpongo. Andrew Battel, of the 16th Century, was an Essex fisherman. Through being shipwrecked off Brazil he got conveyed into Portuguese captivity in Angola. Escaping, he travelled into the northern part of Angola towards the Congo. He returned to England and brought back with him stories of the "Pongos," which obviously referred to the Chimpanzee. The name "Chimpanzee" does not seem to have come into vogue till the latter part of the 18th Century, or to have been much used until the 19th Century. I have no certain clue as to its origin; but I have been told that it is a Loango word of which the root would be *-mpanzi* or *-mpangi* (possibly, therefore, cognate with the Congo name for Chimpanzee, *mpongi*), with the well-known Bantu prefix *chi* (*ki*) added. This prefix is sometimes an augmentative, so that *chimpanzi* or *chimpanzi* might merely mean a big ape.

At the close of the 18th Century, Buffon, Linnæus, Lacépède, and other zoologists had finally discriminated between the Gibbons, the *Orang utan*, and the African Chimpanzee; and to this list was added in the period between 1847 and 1860 the definitely established genus (afterwards species, then again genus) of the Gorilla. The discovery of the Gorilla was really due to the American Evangelical missionaries, who established themselves in the early part of the 19th Century in the Gaboon; but complete specimens of this Ape and a far more extended knowledge of it were brought to the civilised world by Du Chaillu. Stanley asserted the existence of the true Gorilla as far east as the forest between the Upper Congo and the Nile watershed; and this statement has seemingly been confirmed by the specimens received from that region by Dr. Matschie, and described and figured by Mr. Rothschild.

* Though often misapplied to the African Chimpanzee in the 17th and 18th Centuries by English and Dutch sea-captains, who, having first made acquaintance with the *Orang* in the Malay Archipelago, saw Chimpanzees at the West African ports on their return voyage.

† When I visited Angola in 1882 Chimpanzees were still found in forested regions inland south of the Congo and north of the Quanza River, especially in the old kingdom of Congo.



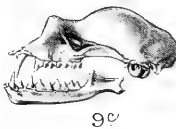
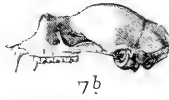

A. J. Engel Terzi, del.

Bale & Danielsson, L^{td}.

SKULLS OF RHINOLOPHI.

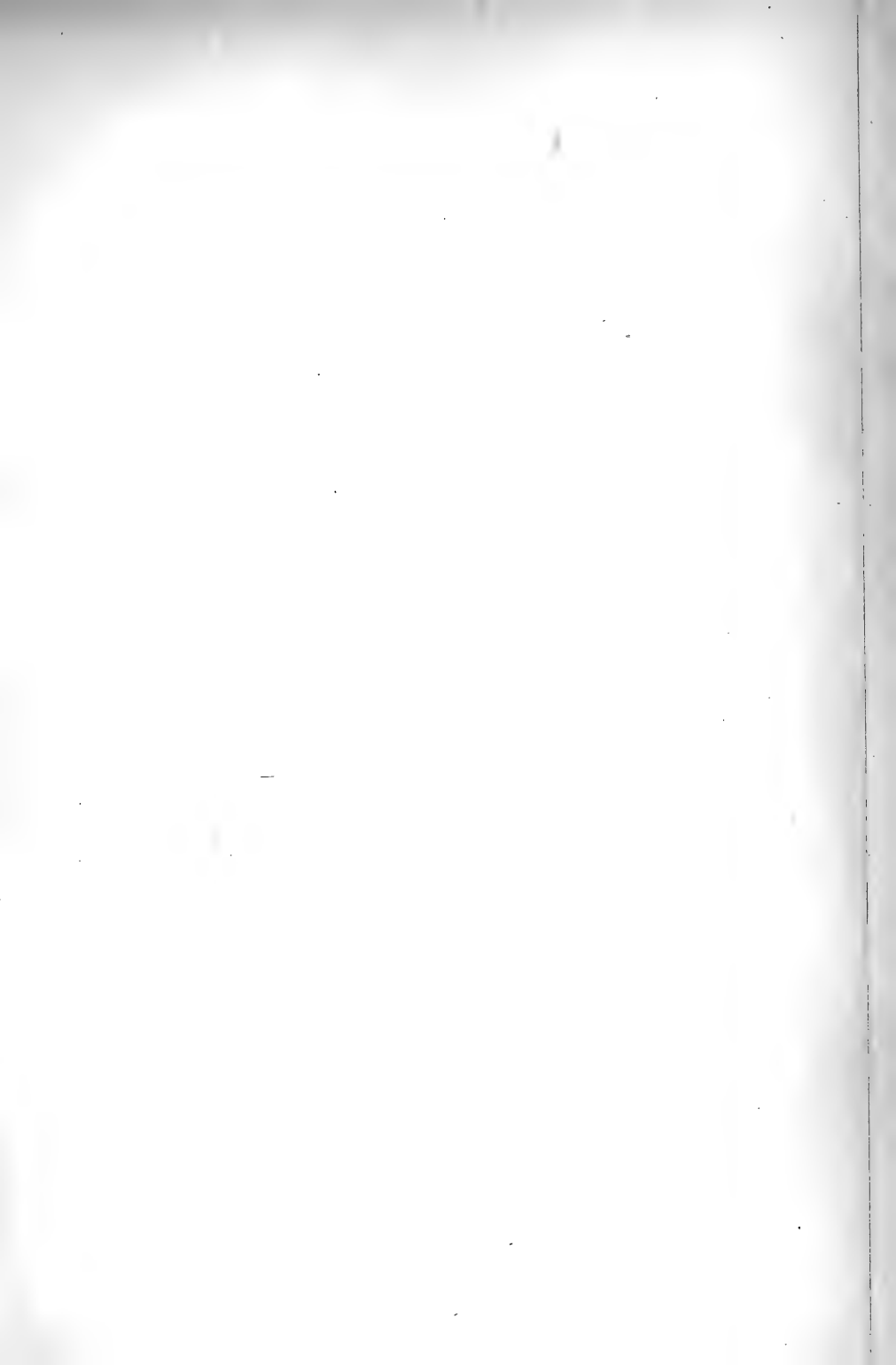



14 a



15



16 a



17 a



18 a



14 c



16 b



17 b



18 b



19 b



20 c



14 b

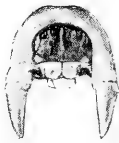

14 d



17 c



19 c



16 c



18 c



20 d



19 a



20 a



20 b

3. On some Bats of the Genus *Rhinolophus*, with Remarks on their Mutual Affinities, and Descriptions of Twenty-six new Forms. By KNUD ANDERSEN*.

[Received May 12, 1905.]

(Plates III. & IV.† and Text-figure 22.)

The present paper is, chiefly, an attempt to disentangle some of the more complicated groups of Eastern *Rhinolophi*, to make out the probable interrelations of the species, and to describe the many new, imperfectly known, or hitherto confused forms. I have appended some general remarks on the affinities of the Ethiopian and Western Palearctic species.

The material placed at my disposal has been more extensive than that of previous writers on these Bats, namely, Prof. Peters (1871) and Dr. Dobson (1878); and I have approached the subject from a different point of view, basing the diagnoses of the primary groups, and, where possible, of the species and subspecies too, not on external and dental characters alone, but also on important differences in the skulls. This may account, partly at least, for the essentially different conclusions on many points at which I have arrived. On the other hand, the following pages afford ample proof that my material has not been complete enough to enable me to venture an answer on all the difficult questions, taxonomic or phylogenetic, that occurred to me during my work. I shall feel satisfied if my paper is considered of some use as a basis for further investigations.

I owe my sincere thanks to Mr. Oldfield Thomas for entrusting me with a revision of these Bats, for giving me unlimited access to the recently acquired, still unregistered specimens in the British Museum, especially those of the large and important "Tomes Collection," and also for having favoured me with much valuable information during the progress of my work.

I also have to acknowledge the kind assistance of Mr. Gerrit S. Miller, Jr., who sent me for inspection almost all the Indo-Malayan *Rhinolophi* preserved in the United States National Museum, including many new and interesting forms, part of which will be dealt with below.

For the loan of specimens for comparison, or for information on examples preserved in Continental Museums, I am indebted to Geheimrath Prof. Dr. Ehlers, Göttingen; Prof. Matschie, Berlin; Prof. Dr. Kurt Lampert, Stuttgart; M. Ch. Mottaz, Geneva; M. A. Ménégau, Paris; and Prof. A. Cabrera Latorre, Madrid.

I. THE *RHINOLOPHUS SIMPLEX* GROUP.

Diagnosis. Basioccipital, between cochleæ, not unusually narrowed. Posterior connecting process low and rounded off (text-fig. 22 a, on p. 121).

* Communicated by OLDFIELD THOMAS, F.Z.S.

† For explanation of the Plates, see p. 145.

I include in this group 40 different forms (22 species), corresponding to *Rh. megaphyllus*, *affinis*, *capensis*, *clivusus*, and *ferrum-equinum* in Dobson's 'Catalogue of the Chiroptera in the British Museum.' Only the Austro-Malayan, Oriental, and Palearctic forms will be described below, and only the first species in some detail, the description of the other forms being, as a rule, confined to the points in which they differ from the fundamental type. The Ethiopian species will be briefly mentioned in the "General Remarks" on the group (p. 117).

1. RHINOLOPHUS SIMPLEX, sp. n. (Plate III. fig. 1.)

Diagnosis. Cranial character: supraorbital crests meeting at a point behind the middle of the orbit. External: sella distinctly constricted at middle. Forearm 44.2 mm.

Details. Nose-leaves large, as compared with those of the other Austro-Malayan species (*Rh. truncatus*, *nanus*). A supplementary leaflet distinctly visible in front of, and on the anterior part of the sides of, the horseshoe; a character common to all the members of the present group, but becoming gradually less pronounced in the more highly developed species (*affinis*, *ferrum-equinum*, and their allies); it seems to point back to the much more primitive genus *Hipposiderus*. Horseshoe so broad as to completely cover the upper lip; a slight indication of a tooth-like projection on either side of the median notch. Sella decidedly broader at base than at summit, and distinctly constricted at middle; summit rounded; height of sella, from angle between vertical portion and nasal lobe, about 4.8 mm., width at base 2.3, at constriction 1.9, at summit 1.8 mm.; front of sella densely covered with exceedingly short white hairs (scarcely observable without a lens). Posterior connecting process low and broadly rounded off. Lancet long, almost cuneate; length, from posterior transverse bridge, about 4.7 mm. Three mental grooves, as in all forms of this group, except the highest-differentiated species (*ferrum-equinum* and its nearest relations).

Ears, compared with those of the closely allied Austro-Malayan species, rather large, almost reaching the tip of the muzzle when laid forwards. Upper part of outer margin somewhat concave; tip blunt; no constriction below the tip.

Wing-structure very primitive: 4th and 5th metacarpals subequal in length (the 5th, if anything, a little shorter), and both of them but very slightly longer than 3rd; III.^{2*} less than 1½ the length of III.¹; IV.² and, especially, V.² very short, being only a trifle longer than IV.¹ and V.¹ This structure of the wing is characteristic of all the primitive members of this group (*simplex*, *megaphyllus*, *truncatus*, *nanus*, *celebensis*, *borneensis*, *malayanus*, *rouxi*, &c.); it is first in so highly-developed forms as *affinis* and its various modifications (*ferrum-equinum*, &c.) that we find an important progress: prolongation of III.²; shortening of the 3rd

* For brevity's sake I call the proximal phalanges of the 3rd, 4th, and 5th fingers III.¹, IV.¹, and V.¹, the distal phalanges of the same fingers III.², IV.², and V.²

metacarpal, as compared with the 4th and 5th; the 5th metacarpal decidedly longer than the 4th; &c.

Tail a little longer than the lower leg. Plagiopatagium inserted on tarsus.

Colour (of a spirit-specimen, unfaded). Fur of upper side a very dark shade of "drab," approaching "Prout's brown"; base of hairs rather more distinctly drab; under side somewhat darker than drab.

Skull. Four anterior nasal swellings and two posterior. The four anterior arranged in a transverse row, forming the upper and lateral borders of the nasal opening. Externally these anterior swellings are separated only by extremely faint linear depressions; internally by three bony lamellæ, also easily observable through the thin, transparent outer wall of the swellings. The posterior nasal swellings, situated immediately behind the anterior ones, at the front corner of the orbital cavity, are much lower, slightly concave at summit; three very faint lines divide them, rather indistinctly, into an upper, middle, and lower swelling.—The shape and arrangement of the nasal swellings, as here described, are, roughly speaking, the same in almost all the members of the *simplex*-group; there is some variation in the size of the swellings in the different species; but the more noteworthy deviations from the general scheme are two only: *Rh. malayanus* and *Rh. stheno*.

Postnasal depression triangular in shape, rather long; the supraorbital crests, which constitute the lateral border of this depression, meeting (and joining the sagittal crest) at a point more or less *behind* the middle of the orbital cavity. "Supraorbital length" of skull (*i. e.* distance between the point of junction of supraorbital crests and median anterior point of nasal swellings) greater than extreme width of nasal swellings.—The shape of this part of the skull, as here described, is characteristic of only the four most primitive members of the group (*simplex*, *megaphyllus*, *truncatus*, *nanus*).

Palatal bridge comparatively long (in antero-posterior direction); measured in the median line equal to about one-third the length of the upper tooth-row; median anterior point opposite the front of m^1 , median posterior point opposite the middle of m^2 .

Dentition. As a general guidance: in all existing species of the genus the upper p^3 * is completely lost; in all the more primitive

* I write the dental formula (excl. of incisors and canines) of a *Rhinolophus* with the most complete known dentition as follows: $\frac{p^2 \quad p^4 \quad m^1 \quad m^2 \quad m^3}{p_2 \quad p_3 \quad p_1 \quad m_1 \quad m_2 \quad m_3}$ (*cf.* Herluf Winge, "Jordfundne og nulevende Flagermus fra Lagoa Santa; med Udsigt over Flagermusenes indbyrdes Slægtskab"; E Museo Lundii, vol. ii. pt. 1 (1892), p. 56). As already mentioned by Winge, we have no *positive proof* whether the upper premolar lost in all known species is p^3 or p^2 . For two reasons I regard the former alternative to be the more probable:—(1) In all *Rhinolophi*, also the most primitive forms, the lower p_3 is *on the point of being reduced*, in the more highly-developed species pushed definitely out to the external side of the tooth-row, in the still higher forms completely lost; it is but reasonable to suppose that the premolar *quite lost* in the upper jaw of *all* species corresponds to the premolar which is *on the point of being lost* in the lower jaw of *all* species, in consonance with the general rule that the teeth of the upper jaw show a *more advanced stage* of evolution than those

species of the *simplex*-group also the lower p_3 is very much reduced in size and *on the point of* being driven out of the tooth-row, to the external side; in all the more primitive species of the group also the upper p^2 is reduced in size, but still, *invariably*, in the tooth-row.

The following remarks apply to *Rh. simplex* and *Rh. megaphyllus*, the dentition of these two species, the most primitive within the present group, being practically exactly alike:— p_3 very small, but decidedly less reduced than in the other species of the group. The position of this tooth, in relation to p_2 and p_1 , varies *individually* (in the same geographical race, and in examples from the same locality and of apparently the same age): completely in the tooth-row (one specimen), or slightly towards the external side (two), or half external (one), or almost quite external (one), or completely external (one). This "vacillation" in the position of p_3 is of some interest as being the first indication of a tendency towards driving this premolar out of the tooth-row, a tendency gradually increasing in a long series of more highly developed species, and culminating in the forms in which the tooth is quite lost, even in young individuals (*Rh. acrotis*).— p^2 is comparatively large, with a well-developed, pointed cusp. From its base to its tip this cusp is directed *obliquely inwards*, under an angle of about 25° to 45° with the vertical line; also in those species of the present group in which the cusp is so much reduced as to be scarcely perceptible without a lens, it is invariably pointing obliquely inwards, only to a still higher degree. The upper canine and p^1 always *widely* separated. In some individuals there is a very narrow interspace between p^2 and p^1 , on either side of the jaw, or on one side, no doubt a remnant of the place where p^3 , lost in all existing species, was situated (see footnote on p. 77).

*Measurements**. On p. 80.

of the lower jaw. (2) When the lower p_3 is external in position, or *even when it is completely lost*, we still, rather often, find p_2 and p_1 separated by a narrow interspace, reminiscent of the time when p_3 had its normal position in the tooth-row; if we can find, sometimes at least, a similar "atavism" in the upper jaw, our supposition will be strengthened; and such cases are, in fact, not very rare:—in some individuals, and just those of the most primitive species of the genus (*simplex*, *megaphyllus*, *borneensis*, *refulgens*, *philippinensis*), I find an arrangement of the upper teeth which can be graphically expressed as follows: cp pm¹ln²m³, i. e. the anterior of the upper premolars in contact with the canine, the posterior in contact with the first molar, but *between the two "p" still a narrow interspace*, apparently a remnant of the place where the lost premolar was situated; if so, however, the lost p is, of course, p^3 , those present p^2 and p^1 .

* Only the following measurements require some explanation:—*Ears*, length from base of inner margin to tip. *Forearm*, from posterior point of radius to front curve of carpus (wing bent), therefore somewhat greater than the length of radius measured on skeletons. *Metacarpals*, as far as possible the true length of the bones. *2nd phalanx*, always *exclusive of the cartilaginous "3rd phalanx"* (this restriction being of especial importance in measurements of the 3rd finger, the terminal cartilaginous rod of which is comparatively large). *Hind foot*, with claws. *Skull, total length*, to front of canines (not to front of premaxilla). *Width of brain-case*, above root of zygomata. *Supraorbital length*, distance between point of junction of supraorbital crests with sagittal crest and median anterior point of nasal swellings. *Mandible*, condylus to front of incisors. *Upper and lower teeth*, exclusive of incisors.

Type. ♀ ad. (in alcohol). Lombok, 2500 ft., June 1896. Collected by A. Everett, Esq. Brit. Mus. no. 97.4.18.4.

2. RHINOLOPHUS MEGAPHYLLUS Gray. (Plate III. fig. 2 a, b, c.)

Diagnosis. Allied to *Rh. simplex*, but considerably larger. Forearm 46–50 mm.

Details. This is a large continental representative of the *simplex*-type. The evidences of its close connection with the Lombok species are clear enough: the general shape of the facial portion of the skull; the wide interspace between the upper canine and p^4 ; the presence, individually at least, of an extremely narrow interspace between p^2 and p^4 ; the distinctly constricted sella; the strong development of the nose-leaves; the large ears. On the other hand, it has in several respects taken its own course of development: the sella is, also proportionately, broader than in *simplex*, the constriction at the middle is more abrupt; the nasal swellings are, also proportionately, considerably broader; the size of the animal is markedly increased: as regards this latter, *Rh. megaphyllus* bears quite the same relation to *Rh. simplex* as *Rh. rouxi* does to *Rh. borneensis*.

*Distribution**. Eastern Australia. Louisiade Archipelago.

Geographical races. There are two apparently well-marked forms of *Rh. megaphyllus*, differing in size and in geographical habitat.

2 a. RHINOLOPHUS MEGAPHYLLUS Gray, TYPICUS.

Rhinolophus megaphyllus J. E. Gray, P. Z. S. 1834, p. 52.

Rhinolophus megaphyllus (partim) Peters, MB. Akad. Berlin, 1871, p. 306 †; Dobson, Cat. Chir. Brit. Mus. (1878) p. 110.

Diagnosis. Larger: forearm 46.5–50 mm.

Sella. In one, out of eleven specimens, the summit of the sella is completely square-cut; in all the others (some of them from the same locality) it is broadly rounded off. Conf. with this *Rh. borneensis*.

Colour. (1) Dark phase (two skins, one adult and one full-grown, but young): Like *Rh. simplex*.

(2) Russet phase (one skin, full-grown individual, but young): Uniform "russet" above and below; base of hairs of upper side "clay."

Measurements. On p. 80.

Distribution. Eastern Australia: Queensland, New South Wales.

Technical name. The type of *Rh. megaphyllus* is in the British Museum.

* The information on the "distribution" of the species and subspecies reviewed in this paper is based *exclusively* on the material examined by myself.

† I am unacquainted with Peters's hypothetical *Rh. keyensis*, based on an example in the Leiden Museum, and characterised as "eine vielleicht nur etwas kleinere Varietät [of *megaphyllus*] oder Art" (*l. s. c.* p. 307). No further information has been published, and nine years later Peters records "*Rh. megaphyllus*" from the Key Islands without any reference to *Rh. keyensis* (*Ann. Mus. Civ. Genova*, xvi. (1880) p. 32). It is not very likely that the typical *Rh. megaphyllus* should occur in the Key Islands.

2 *b.* RHINOLOPHUS MEGAPHYLLUS MONACHUS, subsp. n.

Diagnosis. On an average smaller than the typical form: forearm 46 mm.

Details. Sella a trifle broader at base than in the typical form; summit completely square-cut; front face a little more distinctly haired. Length of forearm almost as in the smallest individuals of the typical form, but metacarpals distinctly shorter. Tail also comparatively somewhat shorter. Brain-case decidedly more slender. Tooth-rows somewhat shorter. In colour scarcely different from the dark phase of the typical form.

Measurements. Below.

Type. ♀ ad. (in alcohol). St. Aignan's Island (Misima), Louisiade Archipelago. Collected by Albert S. Meek, Esq. Brit. Mus. no. 98.4.1.1.

Measurements of Rh. simplex and megaphyllus.

	<i>Rh. simplex.</i>	<i>Rh. megaphyllus.</i>	
	♀ ad. Type.	f. <i>typica.</i> 11 specimens, 5 skulls.	<i>monachus.</i> ♀ ad. Type.
	mm.	Min. mm.	Max. mm.
Ears, length	18	18	19.5
" greatest breadth	13.5	13.5	15
Nose-leaves, total length	14.5	15	16.2
" breadth of horseshoe	8.5	8.8	9.8
Forearm	44.2	46.5	50
3rd metacarpal	31.8	33.8	36
III. ¹	13	13	14.6
III. ²	17.8	17.5	20
4th metacarpal	32	34.3	36.8
IV. ¹	9.2	9.8	11.2
IV. ²	11	11.5	13.3
5th metacarpal	31.8	34.3	36.5
V. ¹	10	10.4	12.7
V. ²	11.2	11.7	14
Tail	24.5	22.2	26.8
Lower leg	19.7	18.5	22
Foot	8.8	9	10.2
Skull, total length	18.7	19.9	20.5
" mastoid width	9	9.8	9.8
" width of brain-case	7.8	8.5	8.6
" zygomatic width	9.4	...	10
" supraorbital length	6	6	6.8
" width of nasal swellings	5.2	5.8	6
Mandible, length	12.8	13.3	14
Upper teeth	7.2	7.7	8.1
Lower teeth	7.8	8.2	8.7

3. RHINOLOPHUS TRUNCATUS Peters.

Rhinolophus truncatus Peters, MB. Akad. Berlin, 1871, p. 307.

Rhinolophus megaphyllus (non Gray), var. *a*, Dobson, Cat. Chir. Brit. Mus. (1878) p. 111.

Diagnosis. Allied to *Rh. simplex*. Sella more slightly constricted

at middle. Summit of sella square-cut, or even concave. Base of fur almost blackish. Forearm 44·7–46·8 mm.

Details. In this species the sella* is not of the shape characteristic of *Rh. simplex* and *megaphyllus*. It is narrower, not considerably broader at the base than at the summit, and the constriction at the middle is less distinct. This points decidedly away from *simplex*, and towards *nanus*, *celebensis*, and *borneensis*. The square-cut (or concave) summit of the sella seems to be a rather common feature in those forms of the present section of the group which are inhabitants of small islands (cf. *Rh. megaphyllus monachus*, *Rh. nanus*, *Rh. borneensis spadix*). Lancet long and cuneate. Wing-structure and proportionate length of tail as in *simplex*. Plagiopatagium inserted on tarsus.

Colour (six skins; adult individuals, but teeth quite, or almost, unworn). Very peculiar. General impression: a very dark brown. Details: hairs of upper side "broccoli-brown" at tip; below the tip, for a broad space, almost "clove-brown" (more exactly: an exceedingly dark shade of "hair-brown," very much approaching clove-brown); the extreme base of the hairs, immediately at the skin, again somewhat lighter. Individual hairs of the under side much of the same colour, but the tips more brightly broccoli-brown, giving the under side a somewhat lighter appearance. All the specimens are exactly alike in colour.

Skull. Essential characters as in *Rh. simplex*. Nasal swellings narrow.

Dentition. p_3 is, if anything, a little more reduced than in *simplex*. In two skulls I find it placed in the tooth-row, but slightly towards the external side; in a third, on the one side half external, on the other external; in a fourth, external on both sides, and the interspace between p_2 and p_1 therefore very narrow. p^2 is always in the tooth-row; its cusp rather well developed, though somewhat smaller than in *simplex*. No interspace between p^2 and p^4 .

Measurements. On p. 84.

Distribution. Batchian.

Technical name. One of the two typical specimens (in the Berlin Museum) was collected on Batchian by A. R. Wallace and forwarded to Prof. Peters by Tomes. The whole series in the British Museum is from the same island and the same collector, and four of the examples belong to the recently acquired Tomes Collection; they are therefore practically (though not technically) co-types.

Remarks. The dentition of *Rh. truncatus* proves it to be on a slightly higher level than *simplex*; the interspace between the upper canine and p^4 is a little narrower, p^2 a little more reduced. The vacillation in the position of p_3 gives evidence of the same tendency as in *simplex*: towards the more advanced members of the group. In the shape of the nose-leaves it has taken a course pointing towards *borneensis*. In its coloration it seems to stand alone.

* A good series of skins, but no spirit-specimens, are at my disposal. This description is from the *resoftened* nose-leaves of three examples.

4. RHINOLOPHUS NANUS, sp. n. (Plate III. fig. 3.)

Rhinolophus megaphyllus (non Gray), var. β (partim), Dobson, Cat. Chir. Brit. Mus. (1878) p. 111 (Goram).

Diagnosis. Essential cranial characters as in *Rh. truncatus*, but brain-case remarkably slender. Sella so slightly constricted as to be practically parallel-margined. Small: forearm 43.3 mm.

Details. This species marks a further step towards the *celebensis-borneensis* type. Externally *Rh. nanus* is exceedingly like these two species, but the skull is of the *simplex* type.

The sella (compared with that of the foregoing three species) is considerably reduced in breadth; its width at the base is but very little greater than at the summit; the constriction at the middle is much reduced (it requires some attention not to be overlooked); and the whole of the sella therefore might very well be called almost parallel-margined; summit completely square-cut (there will probably, in a large series, be some individual variation in this respect). The horseshoe, too, is a little narrower. Lancet almost cuneate, the lateral margins being but very slightly concave. The size of the ears, both length and breadth, is reduced; the tip slightly more attenuated (less blunt than in *Rh. simplex*). In the structure of the wings it stands exactly on the same level as the foregoing species.

Colour (one skin; adult; teeth almost quite unworn).—Fur of the upper side uniform dull "mars-brown"; base of hairs slightly lighter; under side very much of the same colour as the upper side, but with a slight tinge of "drab."

Skull. Postnasal depression and supraorbital crests as in *Rh. simplex*. Nasal swellings very narrow (4.9 mm.). Chief character (compared with the three foregoing species): the very narrow brain-case (7 mm.).

Dentition. p_3 quite external, and cingula of p_2 and p_4 in contact (a sufficiently large series will presumably show some vacillation in the position of p_3). p^2 in the tooth-row; its cusp very small.

Measurements. On p. 84.

Type. Ad. (skin). Goram Island. Collected by Dr. A. R. Wallace. Brit. Mus. no. 61.12.11.10.

Remarks. This species is readily distinguished from *Rh. celebensis* and *Rh. borneensis* by the different shape of the facial portion of the skull.

Dobson regarded the specimen here described, together with two others from N. Celebes (Menado), as a variety (" β ") of *Rh. megaphyllus*, characterised chiefly by having "the summit of the vertical process of the sella broadly rounded off, much broader than the base." But, firstly, it should be remembered that a sella, much broader at summit than at base, would be exactly the reverse of what is found in *megaphyllus*; it would even be unique in the whole genus. Secondly, on resoftening the nose-leaves I found the sella, in all the three specimens, quite of the same general shape as in *Rh. borneensis*, i. e. practically

parallel-margined. It would evidently have been much more to the point if Dobson had called these Bats *Rh. borneensis*, not *Rh. megaphyllus*. But *Rh. borneensis*, again, was confused with *Rh. minor*, which, however, not only is a distinct species, but belongs to a different group of the genus.

5. RHINOLOPHUS CELEBENSIS, sp. n. (Plate III. fig. 4 a, b.)

Rhinolophus megaphyllus (non Gray), var. β (partim), Dobson, Cat. Chir. Brit. Mus. (1878) p. 111 (Menado).

Diagnosis. Supraorbital crests meeting at a point more or less in front of the middle of the orbit. Nasal swellings narrow. Nose-leaves as in *Rh. nanus* and *Rh. borneensis*. Small: forearm 43-44.7 mm.

Details. In the foregoing species (*Rh. simplex*, *megaphyllus*, *truncatus*, *nanus*), all of which are Australian or Austro-Malayan, the supraorbital crests join the sagittal crest at a point more or less behind the middle of the orbit. In *Rh. celebensis*, as in all the other species of the present group, which are all Oriental, Palearctic, or Ethiopian, the supraorbital crests meet at a point more or less in front of the middle of the orbit. This makes a comparatively shorter postnasal depression, the supraorbital crests being the lateral borders of this depression. In this point therefore *Rh. celebensis* agrees with the *Western* forms of the group, differing from the *Eastern*.

The mechanical reason for this modification is evidently the following: a slight increase in the size of the temporal muscle has pushed the sagittal crest more forwards; this involves a shortening of the supraorbital crests; this again a reduction in the length of the postnasal depression.

The nasal swellings are narrow (4.8 mm.), as in the closely related *Eastern* forms (*nanus*, *truncatus*). In the more *Western Rh. borneensis* they are, at least somewhat, and as a rule considerably, broader. Compare figs. 4 and 5 on Pl. III.

It is worth noticing that the cranial characters of this species are, so to say, "in accordance with" its geographical habitat: Celebes is, geographically, intermediate between the Austro-Malayan and Indo-Malayan subregions, and in its more important cranial characters *Rh. celebensis* points partly westwards (shortening of supraorbital crests), partly eastwards (narrow nasal swellings).

The nose-leaves, ears, wings, and the general size are as in *Rh. nanus* and *Rh. borneensis*.

Colour. (1) Makassar specimen (φ ad.; in alcohol; unfaded; teeth unworn).—General impression of upper side: brown; the true colour is a deep brown shade of "drab"; base of hairs a little lighter than drab; under side drab with a tinge of "broccoli-brown."

(2) Menado specimens (two skins; ad.; teeth almost unworn).—Above uniform dull "mars-brown," base of hairs but

slightly lighter; colour of the fur of the under side very much as on the upper side.

The Makassar specimen seems to represent the true "dark phase"; the mars-brown tinge of the Menado skins may indicate a tendency towards a "russet phase." Similar differences in colour are very common in this section of the group.

Dentition. As in *Rh. nanus*.

Measurements. Below.

Type. ♀ ad. (in alcohol). Makassar, S. Celebes, November 1895. Collected by A. Everett, Esq. Brit. Mus. no. 97.1.3.19.

Distribution. Celebes: Makassar, Menado.

Measurements of Rh. truncatus, nanus, and celebensis.

	<i>Rh. truncatus.</i>		<i>Rh. nanus.</i>	<i>Rh. celebensis.</i>	
	6 specimens, 4 skulls.		Ad. Type.	3 specimens, 3 skulls.	
	Min. mm.	Max. mm.	mm.	Min. mm.	Max. mm.
Ears, length	16	...
" greatest breadth	12·5	...
Nose-leaves, total length	12·3	...
" breadth of horseshoe	8	...
Forearm	44·7	46·8	43·3	43	44·7
3rd metacarpal	31·2	32·3	30	30·5	31·4
III. ¹	13·2	14	11·2	12·2	13
III. ²	18·2	19·1	...	17·3	17·8
4th metacarpal	32	33·5	31·1	31·3	32
IV. ¹	9·8	10·6	8·8	9	9·7
IV. ²	11·2	12·5	...	10·8	11
5th metacarpal	31·7	33·2	31·1	31	32·5
V. ¹	10·7	11·7	9	9·5	10
V. ²	11·8	11·9	9·8	11	...
Tail	23	20	...
Lower leg	18·8	20	...	17·8	18·3
Foot	8·5	...
Skull, total length	18·1	...
" mastoid width	9·2	9	...
" width of brain-case	7	8	...
" zygomatic width	9	...
" supraorbital length	5·5	5·7	5·8	4·8	4·8
" width of nasal swellings	5·1	5·1	4·9	4·8	4·8
Mandible, length	12·8	13·1	13	12·2	12·7
Upper teeth	7·1	7·3	7·2	7	7·2
Lower teeth	7·8	7·9	7·8	7·4	7·8

6. RHINOLOPHUS BORNEENSIS Peters. (Plate III. fig. 5 a, b, c.)

Diagnosis. Similar to *Rh. celebensis*, but with broader nasal swellings. Small: forearm 41·2-46·3 mm.

Details. Sella so slightly constricted as to be almost parallel-margined from base to summit; in some individuals the constriction is completely obsolete; height of sella about 3 mm.;

width at base, at middle, and at summit: 2, 1·8, and 1·7 mm. Lancet almost cuneate, or the lateral margins but slightly concave, never abruptly narrowed at the middle (as in *Rh. rouxi*); length of lancet about 4·2 mm. Ears and wings quite as in *Rh. celebensis*. Plagiopatagium inserted on tarsus, or as much as 1·5 mm. above the tarsal joint.

Colour. There is an extreme dark phase and an extreme red phase, connected by several intermediate stages.

(1) Dark phase.—♀, Banguey Isl. (Brit. Mus.); two ♂, Pulo Sarutu (Un. St. Nat. Mus.); all of them *full-grown*, but with *unworn teeth*; distal epiphyses of metacarpals in two of them ossified, in one not completely so; in alcohol, unfaded. General impression of upper side: brown. The true colour is a deep brown shade of “drab”; base of hairs next to “broccoli-brown.” Under side between “wood-brown” and “broccoli-brown.” The individuals are not precisely, but almost, alike in tinge.

(2) Intermediate stage, nearer to “dark phase.”—♂ ad., ♀ ad., Labuan (B.M.); ♂ ad., N.W. Borneo (B.M.); teeth either *quite unworn*, or *almost unworn*; distal epiphyses of metacarpals ossified; in alcohol, unfaded. Upper side “russet,” base of hairs but slightly lighter. Under side “wood-brown.”

(3) Intermediate stage, nearer to “red phase.”—♀ ad., Sirhassen (U. N. S. M.); ♂ ad., ♀ ad., Karimata (U. N. S. M.); teeth either *quite unworn*, or very slightly worn; distal epiphyses of metacarpals ossified; in alcohol, unfaded. Much like the foregoing, but also the under side of the body “russet.”

(4) Extreme red phase.—♂ ad., Sirhassen (B.M.); *teeth unworn*; epiphyses ossified; in alcohol, unfaded. Much like the extreme red phase of *Rh. rouxi*: not far from “cadmium orange” above; “orange” beneath.

As proved by the above, these differences in colour are independent of the geographical habitat and of the sex of the individuals, seemingly also of the age. So far as the present material goes, the only “phase” in which a quite young, though full-grown, individual occurs (epiphyses not quite ossified) is the dark phase; but it may be accidental: the individual which represents the extreme red phase is, at all events, only a few months older (teeth unworn).

Skull. As in *Rh. celebensis*, but with broader nasal swellings (5·4 mm., on an average).

Dentition. p_3 almost always completely external, but in one skull (out of eleven) half in row. Cingula of p_2 and p_4 in contact (six), or very slightly separated (four), or distinctly separated (one). p^2 always in the tooth-row; cusp very small. In four individuals there is an extremely narrow interspace between p^2 and p^4 (the former place of p^3).

Distribution. N. Borneo; S. Natunas; Karimata Group.

Technical name. The type of *Rh. borneensis*, in the Berlin Museum, is from Labuan. There are two specimens from the

same island in the British Museum*. As, however, *Rh. borneensis* has for many years been completely confused not only with several more or less closely related species, but also with the widely different *Rh. minor*, the following remarks may not be out of place here :—

The salient point in the original description of *Rh. borneensis*, as given by Prof. Peters (*loc. infra cit.*), is this: "Sattel . . . an dem vordern obern Ende abgerundet, die hintere, zusammengedrückte Spitze [*i. e.* the posterior connecting process] kaum höher, abgerundet." I have emphasised the last three words, because they clearly prove that *Rh. borneensis* belongs to what here is called the *simplex* group (connecting process low and rounded off), and has nothing to do with *Rh. minor* or its allies (connecting process projecting and pointed). But ten years later (MB. Akad. Berlin, 1871, p. 306), Peters himself believed *Rh. borneensis* to be identical with *Rh. minor*, described by Horsfield so long ago as 1824. The reason was, beyond all doubt, this: to identify Horsfield's Bats without an examination of the types is, in most cases, impossible; and Peters had not seen the type of *Rh. minor* (then in the Indian Museum, London, now in the British Museum), but only the bad figure in the 'Researches in Java'; as, furthermore, the two species in many respects (size, wings, sella, ears, &c.) are, *externally*, puzzling alike, the mistake is easily explained. Thus, according to Peters, there were two small Indo-Malayan *Rhinolophi*: the one, with a low and rounded connecting process, he called *Rh. minor*, Horsf. (synonym: *Rh. borneensis*, Peters); the other, with a projecting and pointed connecting process, he identified with Temminck's *Rh. pusillus*, stated to be from Java. Under these circumstances, a quite reasonable conclusion: we had a name for either "species," and perfectly clear diagnoses.

Dobson, who examined the type of *Rh. minor*, states, quite correctly, that the connecting process is projecting and pointed; when, *nevertheless*, he put *Rh. borneensis* down in the list of "synonyms" to *Rh. minor*, he must have overlooked the most important point in Peters's description of *borneensis*, the shape of the connecting process. Dobson, therefore, called the small Indo-Malayan *Rhinolophus* with *pointed* process *Rh. minor* (synonym: *Rh. borneensis*): thus, the names were the same as employed by Peters, but the diagnosis exactly the reverse; Temminck's *Rh. pusillus* he identified with *Rh. hipposiderus* (sic); and as to the small Indo-Malayan *Rhinolophus* with *rounded* process (the true *borneensis*) he put it down under *Rh. affinis*, Horsf. (!), with which species he also united the very different *Rh. rouxi*, Temm., at the same time keeping a genuine *Rh. rouxi* separate as *Rh. petersi*. This accumulation of errors and wrong identifications

* On one point there is a discrepancy between Peters's description of *Rh. borneensis* and the series before me: according to Peters the length of the forearm is 37 mm.; in the smallest (adult) specimen I have seen, it measures 41·2 mm. I am informed by Prof. Matschie, who kindly re-examined the type for me, that Peters's statement must be a misprint or a slip of the pen; the forearm of the type specimen (a rather young, but apparently full-grown individual) measures 41 mm.

is the true reason of the exceedingly confused state in which this group of Bats has remained, making a safe determination of specimens procured almost impossible.

Geographical races. There seems to be two forms of *Rh. borneensis*, differing, slightly, in the size of the ears, and in geographical habitat.

6 a. RHINOLOPHUS BORNEENSIS Peters, TYPICUS.

Rhinolophus Borneensis Peters, MB. Akad. Berlin, June 25th, 1861, p. 709.

Rhinolophus minor (partim, nec Horsf.), Peters, MB. Akad. Berlin, 1871, p. 306; Dobson, Cat. Chir. Brit. Mus. (1878) p. 114.

Rhinolophus affinis (partim, nec Horsf.), Dobson, op. cit. (1878) p. 112.

Diagnosis. Ears slightly shorter: 16-17 mm., and narrower: 12.2-12.8 mm. Forearm 41.2-43.7 mm.

Details. In one specimen (from Banguay Isl.) the summit of the sella is completely square-cut; in the others (Labuan, N.W. Borneo) it is broadly rounded off. This is, no doubt, an individual variation, but, it would seem, of more frequent occurrence in individuals inhabiting smaller islands (cf. *Rh. megaphyllus monachus*, *Rh. nanus*, *Rh. truncatus*, *Rh. borneensis spadix*).

Measurements. On p. 88.

Distribution. N.W. Borneo; Labuan; Banguay.

6 b. RHINOLOPHUS BORNEENSIS SPADIX Miller.

Rhinolophus affinis rouxi (non Temm.) Thomas, Nov. Zool. i. (1894) p. 656.

Rhinolophus spadix Gerrit S. Miller, Jr., Proc. Wash. Ac. Sci. iii. (March 26th, 1901) p. 136.

Diagnosis. Ears slightly longer: 17-19.5 mm., and broader: 12.5-14.2 mm. Forearm 42.5-46.3 mm.

Details. In one specimen (Sirhassen Isl.) the summit of the sella is completely square-cut; in all the others (one of them from the same island) it is broadly rounded off.

Measurements. On p. 88.

Distribution. S. Natunas (Sirhassen); Karimata Group (Karimata and Pulo Sarutu).

Technical name. The type of "*Rh. spadix*," in the Washington Museum, is from Sirhassen. There is a specimen from the same island in the British Museum. I am indebted to Mr. Miller for the loan of a paratype, also from Sirhassen, and of the series from the Karimata Group, collected by Dr. Abbott.

Remarks. I should not have separated these two forms (if they be so) of *borneensis*, if the latter of them had not, accidentally*, got a name. There is no tangible difference in the skulls, not even

* When describing *Rh. spadix* as a new species, Mr. Miller compared it with *Rh. affinis*. He could not, very well, compare it with *Rh. borneensis*, which was regarded as identical with *Rh. minor*.

(as might perhaps be expected) in the measurements of them. It may well be that the few examples from N.W. Borneo, Labuan, and Banguay (four only) happen to be rather short-eared (and short-armed), and therefore do not show the true limits of individual variation in these respects. I prefer to keep them separate, provisionally at least, to call attention to the *possible* existence of two very slightly differing forms of the species.

7. RHINOLOPHUS VIRGO, sp. n.

Diagnosis. Similar to *borneensis*, but much smaller. Forearm 37·5–38·8 mm.

Details. This is decidedly the smallest species of the present group. The horseshoe is markedly narrower than in any other form of the *borneensis* type; the sella considerably smaller than in *borneensis*, but of the same shape; the ears much shorter and narrower.

Colour. Probably not far from being the same as in the dark phase of *borneensis* (the two specimens examined are evidently somewhat faded in alcohol).

Measurements of Rh. borneensis and virgo.

	<i>Rh. borneensis.</i>				<i>Rh. virgo.</i>	
	<i>f. typica.</i> 4 specimens, 4 skulls.		<i>spadir.</i> 6 specimens, 7 skulls.		2 specimens, 2 skulls.	
	Min.	Max.	Min.	Max.	Min.	Max.
	mm.	mm.	mm.	mm.	mm.	mm.
Ears, length	16	17·1	17·2	19·5	14·7	15·2
„ greatest breadth	12·2	12·8	12·5	14·2	10·7	10·8
Nose-leaves, total length	12·5	13·7	12·7	14·2	10·7	11·2
„ breadth of horseshoe	8	8·3	8	9	7·2	7·2
Forearm	41·2	43·7	42·5	46·3	37·5	38·8
3rd metacarpal	28·7	31·2	28·8	32·7	27·2	28·2
III. ¹	12·1	13·5	11·7	14·2	10·2	10·7
III. ²	16·2	18·7	16·6	19·9	15·2	15·2
4th metacarpal	29·7	32·2	30·7	34·5	28	28·6
IV. ¹	8·8	9·7	8·2	9·8	7·3	8·2
IV. ²	10	11·8	9·8	12	9	9
5th metacarpal	29·8	32·2	30·7	33·8	27	28·2
V. ¹	9·5	10·3	9	10·3	8·1	8·8
V. ²	10·2	11·8	9·8	12·2	8·2	8·3
Tail	18	19·2	18·3	21·5	17·9	20·2
Lower leg	17·8	19·2	17·2	19	14·2	15·2
Foot	8·8	9	8·5	9·1	7·2	8
Skull, total length	19·5	18·2	20	16·2	16·9
„ mastoid width	9·2	8·8	9·5	8	8·2
„ width of brain-case	8	7·8	8·2	7·1	7·7
„ zygomatic width	9·8	9	9·9	8·1	8·2
„ supraorbital length	5·1	5·2	5	5·2	4·7	5
„ width of nasal swellings	5·3	5·7	5·2	5·5	4·3	4·3
Mandible, length	12·2	13·1	12·2	13·7	10·8	11·5
Upper teeth	7	7·2	7	7·6	6·1	6·2
Lower teeth	7·5	7·8	7·4	8	6·5	6·8

Skull. As in *borneensis*, but considerably smaller; the nasal swellings are, also proportionately, narrower than in the Bornean species (perhaps as a consequence of the much smaller nose-leaves).

Dentition (two skulls). p_3 half in row (one skull), or external (the other). p_3 and p_4 in the former skull, of course, separated; in the latter almost in contact. p^2 in the tooth-row. Upper canine and p^1 widely separated.

Type. ♀ ad. (in alcohol). S. Camarinas, Luzon, Philippine Islands. Collected by L. M. McCormick, Esq. Un. St. Nat. Mus. no. 101966.

Remarks. This species is readily distinguished from any other form of the *simplex* group by its small size, narrow horseshoe, and short ears. The shape of the connecting process ought to prevent a confusion with the equally small species of the *minor* group, to which it, in other respects, bears a very striking *external* resemblance.

8. RHINOLOPHUS MALAYANUS Bonhote. (Plate III. fig. 6.)

Rhinolophus malayanus Bonhote, Fasc. Malayenses, Zool., i. (Oct. 1903) p. 15.

Diagnosis. Closely allied to *Rh. borneensis*, but median anterior nasal swellings somewhat more differentiated. Small: forearm 41.2–42.8 mm.

Details. Externally this Bat is exceedingly like *Rh. borneensis*, but the shape of the anterior nasal swellings is somewhat different. The colour, too, seems to be *constantly* different.

The sella is, in vertical direction, a trifle shorter, but the difference is scarcely appreciable without actual comparison with *borneensis*. The lateral margins of the sella are, practically, parallel from base to summit; an extremely faint constriction can be traced, at least under a lens; summit of sella rounded. Plagiopatagium inserted on tarsus, or very nearly so.

Colour. (1) Biserat specimens; two ♀ ad.; August and September; teeth slightly worn; in alcohol; unfaded.—Upper side a rather dark brown shade of “drab”; this colour is confined to the tips of the hairs; the much broader base of the hairs so light “ecru-drab” as to approach whitish; under side whitish “ecru-drab,” somewhat darker on the sides of the body.

(2) Laos specimen; ad.; teeth slightly worn; skin.—Very much lighter. Upper side bright “cinnamon,” base of fur “cream buff”; horseshoe patch* on back dark brown; under side buff.

* A dark-coloured patch on the upper side of the body, horseshoe-shaped, or like a V, the branches starting on each shoulder, convexity (or angle-point) directed backwards. It is curiously characteristic of many species of the families *Rhinolophidae* and *Phyllostomatidae*, but often (quite individually) more or less, or even completely, obliterated, especially, of course, when the fur also is dark-coloured. Being, as a rule, more common and more distinct in young or immature individuals, it is, probably, an inheritance from some remote ancestors of the two families. *Rhinolophidae* and *Phyllostomatidae* have, probably, had a common origin.

It looks like a dark and a light "phase." The dark phase differs from that of *Rh. borneensis*, chiefly, in having the under side of the body much lighter, in strong contrast to the colour of the upper side, and in having also the base of the hairs of the upper side much lighter. The light phase is, as will be seen from this description, totally different from the "cadmium orange" phase of *borneensis* (and more approaching the light phase of *Rh. affinis himalayanus*).

Skull. Essential characters as in *Rh. borneensis*, but the median anterior nasal swellings somewhat more distinctly marked off from the lateral anterior swellings.

Dentition. p_3 external; p_2 and p_4 almost in contact; p^2 in row, cusp extremely small.

Measurements. On p. 92.

Distribution. Biserat (Jalor, Malay Peninsula). Laos Mts. (Siam).

Technical name. The type is in the British Museum.

Remarks. From the Laos Mountains, Siam, I have seen one dried skin only (Tomes Collection); it looks like a light-coloured phase of *Rh. malayanus*; the nasal swellings of the (fragmentary) skull have the shape characteristic of this species. But fresh material from that region is desirable.

9. RHINOLOPHUS NEREIS, sp. n. (Plate III. fig. 7 a, b, c.)

"*Rhinolophus rouxii*?" (non Temm.) Gerrit S. Miller, Jr., Proc. Wash. Ac. Sci. ii. (Aug. 20th, 1900) p. 234.

Diagnosis. Allied to *Rh. borneensis*, and of about the same size, but with much larger skull and teeth. Lower leg considerably longer: 21 mm. Tail comparatively very short: 17 mm. Fore-arm about 45 mm.

Details. In addition to the above:—The second phalanx of the third finger is more than $1\frac{1}{2}$ the length of III.¹; this is the first time we have to note a decisive lengthening of III.²; in *Rh. borneensis*, as in all the foregoing species, III.² (always, in this paper, measured without the terminal cartilaginous rod) is invariably less than $1\frac{1}{2}$ the length of III.¹; compare with this *Rh. stheno*, *thomasi*, *affinis*, *ferrum-equinum*. IV.¹ is comparatively shorter than in *Rh. borneensis*, only about $\frac{1}{4}$ the length of the metacarpal of the same finger; compare with this *Rh. stheno*.

Colour. ♀ ad. (type); September; teeth almost quite unworn; first preserved in formalin, now in alcohol; probably unfaded.—"Mars-brown" above; base of hairs "ecru-drab"; of a peculiar yellowish "drab" beneath (? the yellow due to the influence of formalin).

Skull. Of the same general shape as in *Rh. borneensis*, but much larger, with considerably larger teeth, and therefore longer tooth-row; orbital constriction very narrow. The following measurements, in millimetres, will give a more precise idea of the differences (the ciphers in brackets are the measurements of eleven skulls of *Rh. borneensis*):—total length, inion to front

of canine 21·2 [18·2–20]; length of brain-case,inion to anterior point of proencephalon 13·7 [11·3–12·5]; width of brain-case above zygomata 9·5 [7·9–8·2]; zygomatic width 10·8 [9·9–9·9]; maxillar width, across antero-exterior corners of m^3 8·5 [6·8–7·2]; inter-orbital constriction 2·2 [2·4–2·8]; palatal bridge, median length 2·6 [1·8–2·3]; maxillar tooth-row 8·7 [7·7–6·6]; extreme width of m^1 2·2 [1·5–1·9].

Dentition. I have not seen the mandible of this Bat. p^2 in row; cusp almost imperceptible.

*Measurements**. On p. 92.

Type. ♀ ad. (in alcohol). Pulo Siantan, Anambas Group; September, 1899. Collected by Dr. W. L. Abbott. Un. St. Nat. Mus. no. 101714.

Remarks. As already pointed out above, the Bats of the *borneensis* type inhabiting the S. Natuna and Karimata groups, rather close to the north-western and western coasts of Borneo, are so extremely like the typical *borneensis* as to be, perhaps, scarcely separable. But *farther westwards*, on the much more isolated Anambas Islands, the *borneensis* type has developed into the present, peculiarly modified species. In the lengthening of III.², the shortening of IV.¹, and the shortening of the tail (compared with the tibia), *Rh. nereis* has taken the same course as the still more western *Rh. steno* (described below). But the shape of its skull sufficiently proves it to be an offshoot, not of that species, but of *Rh. borneensis*. Compare with this the "remarks" under *Rh. steno*.

10. RHINOLOPHUS STENO, sp. n. (Plate III. fig. 8, a, b.)

Diagnosis. Allied to *Rh. borneensis*, but anterior nasal swellings much more projecting. Lower leg long: 19·8–20·8 mm. Tail extremely short: 15·5–17·8 mm. Slightly larger than *borneensis*: forearm 45·2–48 mm.

Details. This is a third modification of the *borneensis* type, in several respects recalling *Rh. nereis*, in others quite peculiar. The shape of the facial portion of the skull is unique within the present group. As in *Rh. nereis*, III.² is lengthened, IV.¹ shortened; the tail is extremely short. The general size of the animal is slightly increased.

Plagiopatagium inserted 1–3 mm. above the ankle-joint.

Colour. ♂ ad., Penang; teeth unworn; skin.—General impression: reddish brown above; under side much lighter, contrasting with the upper side. "Mars-brown" above; base of hairs light "drab"; under side almost "broccoli-brown."—Three spirit-specimens (Selangor; teeth unworn) apparently agree in colour with the skin.

Skull (three individuals). Owing to the much more projecting anterior nasals wellings, the skull of *Rh. steno*, in side view, is strikingly different from that of *Rh. borneensis*. This peculiarity

* The tip of the ears and the posterior nose-leaf are damaged; forearms broken.

in its outline is produced, not by a heightening of the anterior swellings, but by a reduction of the posterior pair; these latter, which in all the allied species form a sort of transition between the anterior swellings and the adjacent part of the supra-orbital crests and interorbital constriction, are in *stheno* so much reduced as to leave the anterior swellings more isolated, *i. e.*, more *abruptly* projecting.

Dentition. p_3 external; p_2 and p_4 in contact; p^2 in row, cusp extremely small.

Measurements. Below.

Type. ♂ ad. (in alcohol). Selangor, Malay Peninsula. Presented by H. N. Ridley, Esq. Brit. Mus. no. 98.3.13.1.

Distribution. Selangor; Penang.

Remarks. *Rh. stheno* differs from *Rh. borneensis* in the series of characters pointed out above. From *Rh. nereis*, in the shape of the facial portion of the skull, the much slenderer brain-case, and the shorter tooth-rows. From *Rh. rouxi*, in the shape of the facial portion of the skull; the much shorter metacarpals (although the forearm is of the same length as in smaller individuals of *rouxi*); the long III.² (compared with III.¹); the short IV.¹

Measurements of Rhinolophus malayanus, nereis, and stheno.

	<i>Rh. malayanus.</i>		<i>Rh. nereis.</i>	<i>Rh. stheno.</i>	
	3 specimens, 2 skulls.		♀ ad. Type.	4 specimens, 3 skulls.	
	Min.	Max.		Min.	Max.
Ears, length	16·2	16·8	mm.	17	17·5
„ greatest breadth	12	12·5	13·7	13	13·2
Nose-leaves, total length	13·2	13·2	...	13·8	14·2
„ breadth of horseshoe ...	7·8	8	9	8	8·3
Forearm	41·2	42·8	♀ 45	45·2	48
3rd metacarpal	30	31	♀ 33·2	31·5	32·7
III. ¹	11·1	12	13·2	12·6	13
III. ²	15·3	16·8	21	20·1	21·7
4th metacarpal	30·2	31·5	33·7	33	33·8
IV. ¹	8·8	9·3	8·7	8·2	8·8
IV. ²	10	10·5	12·8	11	12·5
5th metacarpal	30	31·5	34	33·5	34·2
V. ¹	9·7	9·8	10·8	9	10·4
V. ²	9·7	10	10·2	10·5	11·5
Tail	19·2	20·5	17	15·5	17·8
Lower leg	16·8	17·8	21	19·8	20·8
Foot	7·8	...	9·3	8·5	9·2
Skull, total length	18·4	...	21·2	19·7	20·2
„ mastoid width	8·8	...	10·2	9·3	10
„ width of brain-case	8	...	9·5	8·5	8·7
„ zygomatic width	9·2	...	10·8	...	10·1
„ supraorbital length	5·1	5·2	5·6	5	5·1
„ width of nasal swellings	5·2	5·6	5·8	...	5·5
Mandible, length	12·1	12·7	...	13·2	...
Upper teeth	6·8	7	8·7	7·4	7·9
Lower teeth	7·3	7·5	...	8·1	8·4

(compared with the fourth metacarpal); the excessively short tail; and the smaller hind foot.

Phylogenetically, *Rh. stheno* is evidently more closely connected with *Rh. nereis* than with any other hitherto known Bat. To call the resemblance between these two species (in III.², IV.¹, the tail "convergence," would be a phrase only, not an explanation. There can scarcely be any doubt that the type of *Rhinolophus* to which the now existing *Rh. borneensis* belongs, sent off a branch *westwards*; a part of this branch, isolated on the Anambas Islands, developed into *Rh. nereis*; another part, in the Malay Peninsula, into *Rh. stheno* (cf. the diagram on p. 120).

11. RHINOLOPHUS ROUXI Temm. (Plate III. fig. 9 a, b, c, d.)

Diagnosis. Allied to *Rh. borneensis*, but larger, and with considerably longer metacarpals. Third metacarpal 34–38 mm. Forearm 46–51.5 mm.

Details. This is a large, continental representative of the *borneensis* type, characterised chiefly by the much longer metacarpals and the shape of the lancet. In general size, the continental *Rh. rouxi* bears the same relation to the insular *Rh. borneensis* as the continental *Rh. megaphyllus* does to the insular *Rh. simplex*.

The sella is practically parallel-margined from base to summit; not rarely some faint indication of a constriction at the middle can be traced; summit broadly rounded off. In *simplex* and its closest allies the lancet is long and quite (or almost) cuneate; in *borneensis* there is some tendency towards a slight emargination of the lateral margins of the lancet; this tendency has been carried almost to an extreme in *rouxi*: the lancet is *hastate*, i. e., abruptly narrowed in the middle, the tip well developed and slender (not abnormally shortened, as in *thomasi*); but still, individually (though, as it seems, rather rarely), in *rouxi*, the lancet is less abruptly narrowed, as an atavism towards a passed stage. The ears are as in *borneensis*.

Wing-structure almost on the *simplex-borneensis* stage, i. e., III.² almost always less than $1\frac{1}{2}$ the length of III.¹ The rare individual exception, that III.² is equal to (or a mere trifle more than) $1\frac{1}{2}$ the length of III.¹, is of some interest as foreshadowing the next important step to be taken in the series of evolution, viz., from *rouxi* to *affinis*, in which species III.² is *always considerably more* than $1\frac{1}{2}$ the length of III.¹

Plagiopatagium inserted on, or 1–4 mm. above, the tarsus, i. e., there is evidently some tendency to draw the insertion of this membrane *away* from the ankle-joint, a little higher up on the tibia; compare with this *Rh. affinis*. The proportionate length of the tail is as in *borneensis*.

Skull. The skull of *Rh. rouxi* is *larger* than that of *borneensis*, but I fail to find any appreciable difference in the shape—a strong evidence of the very close relationship between the two species. The individual variation in the size of the skull, in

rouxi, is rather considerable (as is also the variation in the external dimensions of this Bat); but among 18 skulls of the typical form of *rouxi*, from localities so many and so distant *inter se* as to represent practically the whole area covered by this form, I do not find any so small as the *largest* among 11 skulls of *borneensis* (and *b. spadix*); in so far there is no difficulty in discriminating them. The tooth-rows, too, in *rouxi*, are longer. As to the small S. Chinese race of *rouxi* (described below), the skull has the same length as the *largest* of *borneensis*, but the brain-case is decidedly broader, the zygomatic and maxillar width greater.

Dentition (19 skulls). p_3 , most often, quite external (12 skulls); not rarely half in row, or $\frac{3}{4}$ in row (6 skulls); in one *aged* individual (teeth much worn) p_3 is wanting, on both sides of the mandible, and the alveoli have disappeared. Cingula of p_2 and p_1 , most often, in contact or separated by a very narrow, sometimes almost hairfine, interspace (13 skulls); in the remaining (6) individuals, distinctly separated, but the width of the interspace is not always quite the same on both sides of the mandible.

The upper canine and p^1 are, with rare exceptions, distinctly separated, p^2 completely in the tooth-row (17 skulls, out of 19), as in all the foregoing species. The size of p^2 and, therefore, the width of the interspace between c and p^1 vary, however, to a certain extent; but in *no* instance is the width of the interspace as broad as (p^2 as well developed as) in *simplex*: this is a thing of the past. As to the remaining two skulls (Ceylon, Nepal), the interspace is very narrow, p^2 *half external*. This is the first time we have to note instances of p^2 not being *completely* in the tooth-row.

As a general conclusion:—(1) In *Rh. rouxi* p_3 has arrived so far on its way towards disappearance as to be, generally, external; but still, not rarely, the individual variation *falls back* to a former stage: p_3 partly in the tooth-row; and in some aged individuals the dentition (p_3 disappeared) *points forwards* to subsequent stages in the series of evolution: *Rh. ferrum-equinum* (p_3 rather often lost) and *Rh. acrotis* (p_3 always lost). (2) As to p^2 in *rouxi*, it is generally in the row, rarely half external; this latter, again, *points forwards* towards subsequent stages: *thomasi*, *ferrum-equinum*, and *acrotis* (p^2 always external, or lost).

Distribution. From S. China through the Himalayas to the Indian Peninsula and Ceylon.

Technical name. As *Rh. rouxi* has for many years been completely confused with *Rh. affinis*, some remarks are necessary to prove that the name *rouxi* belongs to the species here under consideration. The type locality of *Rh. rouxi* is "Calcutta"*; the types (in the Leiden Museum) were collected by the French naturalist, M. Roux. There is in the Tomes Collection (British Museum) a skin also collected by Roux. The essential points

* Temminck, *loc. infra cit.*, p. 30 c; Jentink, 'Catalogue systématique des Mammifères,' Mus. d'hist. nat. Pays-Bas, xii. (1888) p. 161 (under *Rh. affinis*).

in the original description as given by Temminck are the following:—

(1) In “taille, forme du corps, des oreilles et des follicules accessoires du nez” very much like Java specimens of *Rh. affinis* Horsf. It may be said so; the difference in the shape of the sella is not easily ascertained in dried skins.

(2) “Des proportions moins grandes,” as compared with *affinis*. As measurements Temminck gives:—Of *rouxi*: forearm “1 pouce 10 lignes” (49·5 mm.), expanse of wings “10 pouces.” Of *affinis*: forearm “1 pouce 10 lignes,” expanse “11 à 12 pouces.” 49·5 mm. is one of the commonest measurements of the forearm in the series before me. It looks a little contradictory that Temminck, having stated that *rouxi* is smaller than *affinis* (which is quite correct), gives precisely the same measurement of their forearms, though, at the same time, a considerably larger “expanse” of the latter species. But just that is the salient point. As a matter of fact, the two species *can* have the forearm of exactly the same length (very large *rouxi*, and small *affinis*); but also in that case, *the expanse of Rh. affinis is always markedly larger than that of Rh. rouxi*, for the obvious reason that in the former species the second phalanx of the third (longest) finger is always *absolutely* longer than in the latter.

(3) A red, a dark, and an intermediate phase of *rouxi* were known to Temminck. I have the same phases before me. That similar phases occur in *Rh. borneensis* has no bearing on the present technical question; *borneensis* lives far away from “Calcutta.” The “phases” of *Rh. affinis* are different.

(4) “Les molaires de la mâchoire supérieure sont en même nombre que dans l'*affinis*, celles de l'inférieure en compte cinq, ou une de moins, par le manque total de la petite dent dont l'*affinis* est pourvu, et qui forme la sixième molaire.” Since Temminck emphasises the “manque total” of p_3 , I suppose that he has not overlooked this small tooth, but has examined a (probably aged) individual in which it was wanting (*cf.* the specimen mentioned above). The word “sixième” is, of course, a lapsus for “cinquième” (Temminck counted the “molars” from behind forwards).

To sum up:—There can be no doubt that Temminck's *Rh. rouxi* is the Bat here under consideration, being a species (1) bearing much resemblance to *Rh. affinis*; (2) of almost the same size, but with a markedly smaller expanse of wings; (3) with a red, a dark, and an intermediate phase; and (4) inhabiting the Continent of India.

“*Rh. petersi*.”—The original description of *Rh. petersi* is meagre and vague; the figures of the head and nose-leaves published four years later are badly drawn; the type specimen (in the Calcutta Museum) has no indication of locality. This may sufficiently account for the fact that no technical name in the genus has been the source of more confusion. I therefore think it of some use to give a brief sketch of its rather complicated history in literature:—

(a) As to the identification of “*Rh. petersi*,” in the *original*

sense of the term*, there are only two alternatives: it is either *Rh. rouxi* or a species of the *Rh. acuminatus* section. I have not the slightest hesitation in referring the name as a synonym to the former species. As, however, Dobson himself later on applied the name to two Bats of the *acuminatus* section, it will only be necessary to give evidence, from his own description, that he was mistaken. The only important points in the description of "*Rh. petersi*" as given by Dobson in 1872 and 1876, *i. e.* at the time when he had access to the type specimen, are the following (the italics are mine)—(1) The nose-leaves are "as in *Rh. acuminatus*, except the upper border of the posterior connecting process, which is *much less acute*." This statement alone would be sufficient. In *acuminatus* the shape of the sella and lancet is very much as in *rouxi*, but the connecting process, both in *acuminatus* and in all its allies (*sumatranus*, *calypso*, *audax*), is *projecting* and *pointed*; there is, in this respect, no difference between the species of the *acuminatus* section, and there is also no appreciable individual variation. When, therefore, Dobson in this decisive point (the chief character of the whole group to which *acuminatus* belongs) declares his *Rh. petersi* to be very different from *acuminatus*, it may safely be said that it has nothing to do with that group. Dobson had evidently before him an example of *Rh. rouxi* with a *slightly raised* connecting process ("much less acute" than in *acuminatus*); such individuals are by no means rare; there are several in the British Museum, and the peculiarity is *purely* individual. Dobson found, quite naturally, that this peculiarity recalled that shape of the connecting process which had been described, one year earlier, by Peters in a species called by him *Rh. acuminatus* †; and, consequently, he compared it, in his paper, with this latter species, at the same time emphasising that there was a considerable difference. (2) The figure (side view) in Dobson's 'Monograph,' however bad it is, can scarcely represent the shape of the connecting process in *acuminatus*. Dobson has, no doubt, called the attention of his artist to the connecting process of the specimen to be figured as *Rh. petersi*, and the artist, in due obedience, has made his best to "emphasise" that point: this may account, I think, for the process being somewhat more exaggerated than in ordinary individuals of *rouxi*; but it is still not the process of an *acuminatus*. (3) The measurements of *petersi* are, without any exception, *perfectly* like those of several unquestionable specimens of *rouxi* measured by myself; there is not the slightest indication of a difference. (4) The type of *petersi* is from "India, precise locality unknown." The *acuminatus* section is distributed over Sumatra, Engano, Java, and Lombok. When Dobson wrote his 'Monograph,' there was not, in the Calcutta Museum, any specimen of any species of *Rhinolophus* from those islands; so that, if *Rh. petersi* were a member of the *acuminatus* section, the type, *without locality*, would have been

* Dobson, J. A. S. B. xli. pt. ii. (Dec. 22, 1872) p. 337; *id.*, Monogr. Asiat. Chir. (1876) p. 49, text-figs. *a*, *b*.

† Peters, MB. Akad. Berlin, 1871, p. 303.

the only *Rhinolophus* in the museum from any of those islands. This is, of course, not beyond the limits of possibility; but it is certainly much more likely that *Rh. petersi*, as also the vast majority of the Bats in the Calcutta Museum at Dobson's time, came from some part of the Indian Peninsula or the Himalayas, the habitat of *Rh. rouxi*, and far from the home of *Rh. acuminatus* and its allies.

To describe a new species which subsequently proves to be an old one is no rare occurrence, and, as a rule, it does no very serious harm. But the strong emphasising of a purely individual peculiarity, combined with the circumstance that the type had no "locality," caused in this case a series of confusions: *Rh. petersi* emerged, like a ghost, very unexpectedly at such different places as the Gold Coast, Sumatra, the Himalayas, and S. India. And, curiously enough, the author of the "species" inaugurated the mistakes. When he had returned to London and was working out his 'Catalogue,' Dobson had no longer access to the type of *Rh. petersi*; he had his own short description only, and perhaps some private note. It is quite evident that, in these circumstances and occupied with the study of many other Bats, he lost the precise idea of the type specimen; he only kept in his memory, as its most important character, its "projecting" connecting process. So it came that he referred a specimen labelled "Gold Coast," to *Rh. petersi**; for it is a genuine *acuminatus*, beyond all doubt from Java, and Dobson himself would scarcely have been able to tell why he called it *petersi* instead of *acuminatus*. Two years later, Dobson had for determination a collection of Bats belonging to the Göttingen Museum; among these he again believed he found a *Rh. petersi*†. I have had this example for inspection‡; it is neither "*Rh. petersi*" nor *Rh. acuminatus*, but *Rh. sumatranus*.

(b) In a paper on some Himalayan Bats, Capt. Hutton § records *Rh. petersi* from Masuri. All the Bats mentioned by Hutton were presented to the "Indian Museum," and are now in the British Museum. The two specimens labelled "*Rh. petersi*" are *Rh. monticola*, a species closely allied to *Rh. lepidus*||.

* Dobson, Cat. Chir. Brit. Mus. (1878) p. 114.

† Dobson, "On some new or rare Species of Chiroptera in the Collection of the Göttingen Museum," P. Z. S. 1880, p. 462.

‡ I am indebted to Geheimrat, Professor Dr. Ehlers, Göttingen, for the loan of this specimen.

§ Hutton, "On the Bats of the North-western Himalayas; with Notes and Corrections in Nomenclature by Prof. W. Peters," P. Z. S. 1872, p. 700.

|| As Hutton's article is one of the very few papers which give information respecting the habits of Himalayan Bats, and therefore has been frequently quoted by subsequent writers, I think it advisable to correct the following errors in the identifications of the four species of *Rhinolophus* dealt with in that paper:—" *Rh. affinis* " (p. 696) is *Rh. pearsoni*; " *Rh. rouxi* " (p. 697) is *Rh. affinis*; " *Rh. minor* " (p. 698) is *Rh. rouxi*; and, as pointed out above, " *Rh. petersi* " (p. 700) is *Rh. monticola*. Hutton's Bats were (as also stated in his paper) determined, not by himself, but by Prof. Peters in Berlin. But the mistakes are so strange that they cannot, certainly, be due to Prof. Peters; an extensive confusion of labels must have occurred (I can rather easily, from Peters's point of view, as laid down in his papers, guess the original arrangement of the labels), but the confusion had at all events taken place before the specimens were returned to Hutton.

(c) In Blanford's 'Fauna of British India' (*loc. infra cit.*) *Rh. petersi* is recorded from Masuri and from Nilghiri. The former statement is borrowed from Hutton's paper. The latter is based on an example collected by W. Davison in Coonoor, Nilghiri*. This specimen is now in the British Museum. It is a *Rh. rouxi*.

In short:—(1) For reasons given above I regard Dobson's *Rh. petersi* (1872 and 1876) as a synonym of *Rh. rouxi*; (2) Dobson's *Rh. petersi* (1878) is *Rh. acuminatus*; (3) Dobson's *Rh. petersi* (1880) is *Rh. sumatranus*; (4) Hutton's *Rh. petersi* is *Rh. monticola*; (5) Blanford's *Rh. petersi* is partly *Rh. monticola* (Masuri), partly *Rh. rouxi* (Nilghiri).

Geographical races. There are, at least, two forms of *Rh. rouxi*, differing in size and geographical habitat.

11 a. RHINOLOPHUS ROUXI SINICUS, subsp. n.

Diagnosis. Skull smaller, tooth-rows shorter. Forearm 46 mm.

Details. The general size is as in the very smallest examples I have seen of the typical form. Skull still a little smaller, with slenderer brain-case and shorter tooth-rows; nasal swellings, in front view, slightly lower. Colour as in the dark phase of Himalayan specimens of the typical form (see below).

Measurements. On p. 100.

Type. ♂ ad. (skin). Chin Tah, Anhwei, Lower Yangtse †. Presented by W. Styax, Esq. Brit. Mus. no. 99.3.1.6.

11 b. RHINOLOPHUS ROUXI Temm., TYPICUS.

Rhinolophus Rouxi Temminck, Mon. Mamm. ii. 8^e monogr. (1835) p. 30 b.

Rhinolophus rubidus, cinerascens, rammanika Kelaart, Prodr. Faunæ Zeylanicæ (1852), pp. 13, 14.

Rhinolophus Rouxi (partim) Peters, MB. Akad. Berlin, 1871, p. 308.

Rhinolophus petersii Dobson, J. A. S. B. xli. pt. ii. (1872) p. 337 (nec Dobson, 1878, 1880); Blanford, Fauna Brit. India, Mamm. pt. ii. (1891) p. 275 (partim).

Rhinolophus minor (non Horsf.) Hutton, P. Z. S. 1872, p. 698.

Rhinolophus affinis (partim, nec Horsf.) Dobson, Cat. Chir. Brit. Mus. (1878) p. 113.

Diagnosis. Skull larger, tooth-rows longer. Forearm 46–51.5 mm.

Colour.—(1) *Specimens from Nepal and Darjeeling.* (a) *Dark phase:* one ad.; Nepal; teeth unworn; skin:—Upper side "mars-brown"; horse-shoe patch on back distinguishable, though somewhat obliterated; base of hairs light "drab," almost "ecru-drab"; under side "drab," with a tinge of "russet"; sides of body somewhat darker. With this skin agree in colour another adult specimen from Nepal (teeth somewhat worn; skin) and a ♀ ad. from Darjeeling (in alcohol).

* Blanford, J. A. S. B. lvii. pt. ii. no. 3 (1888) p. 261.

† For the exact position of this locality, see 'Ibis,' 1899, p. 289.

(b) *Light phase*: one ad.; Darjeeling; teeth slightly worn; skin:—Above inclining to “clay”; a strongly marked, deep brown horse-shoe patch; base of hairs and fur of under side almost “cream-buff.”

(2) *Specimens from Ceylon and S. India*.—(a) *Dark phase*: three adult individuals; Ceylon; teeth rather slightly worn; skins:—Upper side a shade of brown, darker and duller than “mars-brown”; horse-shoe patch more or less effaced; base of hairs “drab,” with a tinge of “ecru-drab”; under side “wood-brown” or light “drab.”—This is Kelaart's *Rh. cinerascens*.

A skin (ad., January, teeth unworn) from Sirzi, Kanara, comes extremely near to the last-mentioned specimen, being only a little darker. A spirit-specimen from Nilghiri seems to be of very much the same colour.

(b) *Intermediate stage*: ♂ ad.; January; Sirzi, Kanara; teeth unworn. Upper side between “russet” and “mars-brown”; base of hairs “ecru-drab”; under side almost “clay.”—This is Kelaart's *Rh. rammanika*.

(c) *Red phase*: one ad.; Ceylon; teeth worn; skin:—Above light “hazel” with a tinge of “orange-rufous”; horse-shoe patch almost obliterated; base of hairs and under side of body light “orange-rufous.”—This is Kelaart's *Rh. rubidus*.

A skin (♂ ad., February, teeth unworn) from Jellapur, Kanara, represents the extreme of light colour: upper side next to “tawny-ochraceous”; base of hairs and fur of under side almost “orange-ochraceous.”

Conclusions:—The dark phase in specimens from the Himalayas (Nepal, Darjeeling) is of a richer brown, more tinged with russet, than in specimens from Ceylon and S. India (Kanara, Nilghiri). The light phase, in specimens from the Himalayas, seems to be more inclining to “clay”; in specimens from Ceylon and S. India more “hazel” or “tawny-ochraceous.” I do not think the series examined affords evidence conclusive enough to justify the separation of a Himalayan “race” and a southern (Ceylonese and S. Indian) “race.” In all the other characters (external, cranial, dental; variation in general size) there is no appreciable difference. If they were to be separated subspecifically, the southern form would have to stand as “*Rh. rouxi rubidus* Kelaart,” the Himalayan as “*Rh. rouxi typicus*.”

Measurements. On p. 100.

Distribution. Himalayas (Darjeeling, Nepal, Masuri). S. India (Nilghiri, Kanara) and Ceylon.

Remarks. Of the two forms here recognised, *Rh. rouxi sinicus* and *Rh. rouxi typicus*, the former, as coming nearest to *Rh. borneensis*, is no doubt the more primitive. The *rouxi*-type, therefore, has spread from an eastern point of the continent westwards, through the Himalayas, down the Indian Peninsula, to Ceylon.

12. RHINOLOPHUS THOMASI, sp. n. (Plate III. fig. 10.)

Rhinolophus affinis rouxi? (non Temm.), Thomas, Ann. Mus. Civ. Genova (2) x. (1892) p. 15, pl. xi. fig. 3.

Diagnosis. Allied to *Rh. rouxi*, but p² external to the tooth-row. Smaller than *rouxi*, with considerably shorter metacarpals, and the tip of the lancet excessively shortened. Third metacarpal 30.4–31 mm. Forearm 44.8–45.7 mm.

Details. While being similar to *Rh. rouxi* in the shape of the sella and the ears, and the proportionate length of the tail, *Rh. thomasi* differs, externally, from that species in the following particulars:—

The horse-shoe is considerably narrower; it is even narrower than in the smaller *borneensis* and in the much smaller *malayanus*. The tip of the lancet is exceedingly short, almost rudimentary; it is the hastate lancet of *rouxi* carried to an extreme.

The general size is smaller, as seen by the measurements of the forearm. But the metacarpals are proportionately *much* shorter, as short as in the much smaller *malayanus*. III.² is comparatively

Measurements of Rhinolophus rouxi and thomasi.

	<i>Rh. rouxi.</i>		<i>Rh. thomasi.</i>		
	<i>sinicus.</i> ♂ ad. Type.	<i>typicus.</i> 30 specimens, 18 skulls.	2 specimens, 1 skull.		
	mm.	Min. mm.	Max. mm.	Min. mm.	Max. mm.
Ears, length	16.6	19	16.8	16.8
" greatest breadth	13	15	12	12.2
Nose-leaves, total length	13.5	16.2	11.7	11.8
" breadth of horse-shoe	8	9.2	7.2	7.5
Forearm	46	46	51.5	44.8	45.7
3rd metacarpal	34	34	38	30.4	31
III. ¹	14.6	13.7	15.8	13	13.1
III. ²	20.8	18.5	23.5	20.2	20.2
4th metacarpal	34.7	34.5	38.9	31.3	31.9
IV. ¹	11.2	9.7	12	10	10.2
IV. ²	12.3	11.7	14.5	12.2	12.7
5th metacarpal	35.4	35.4	38.9	32.3	32.7
V. ¹	11.9	10.6	13.2	11	11.2
V. ²	11.2	11.2	13.8	9	9.7
Tail	21	21	26.5	19	19
Lower leg	19.8	19	23.5	18	18
Foot	9	11.2	8	8.8
Skull, total length	19.8	20.3	23	18.2	...
" mastoid width	9.5	9.7	10.8	9.2	...
" width of brain-case	8.7	8.7	9.8	8.7	...
" zygomatic width	10.3	10.4	11.8	10	...
" supraorbital length	4.8	4.8	5.8	4.4	...
" width of nasal swellings	5.8	5.5	5.9	5.3	...
Mandible, length	13.5	13	16.4	12.8	...
Upper teeth	7.7	8.2	9.2	7.1	...
Lower teeth	8.1	8.5	10.3	7.7	...

longer than in *rouxi*, *i. e.* more than $1\frac{1}{2}$ the length of III.¹ (*cf. nereis* and *stheno*). V.² is extremely short.

Colour. To judge from specimens preserved in alcohol, probably not far from being the same as in the dark phase of Nepal examples of *Rh. rouxi*.

Skull. The *essential* characters are as in *rouxi*, thus proving *Rh. thomasi* to be an offshoot from that type of Bat, not (as might very well be supposed, in view of the short metacarpals) from *borneensis*. The skull of *Rh. thomasi* agrees with that of *rouxi* in the broad brain-case; it differs from *rouxi* in the much smaller size. Compared with *borneensis*, the skull of *Rh. thomasi* is as small as in the smallest individuals I have seen of *borneensis* (even as small as in *malayanus*), but the brain-case is markedly broader, even broader than in the largest *borneensis*, and the supraorbital length is exceedingly short (*cf.* measurements, p. 100).

Dentition. p₃ external; p₂ and p₄ in contact; p² *external*. *Upper canine* and p¹ *in contact*. Both of the specimens examined are identical in dentition.

Measurements. On p. 100.

Type. ♀ ad. (in alcohol). Karin Hills, Burma, 1888. Collected by Signor Leonardo Fea. Presented by Marquis G. Doria. Brit. Mus. no. 90.4.7.10.

I venture to connect with this fine species the name of Mr. Oldfield Thomas, who already thirteen years ago (*l. s. c.*) pointed out that it could scarcely be identified with any hitherto known form, but refrained from describing it as new, owing to the general confused state of this group of Bats.

13. RHINOLOPHUS AFFINIS Horsf. (Plate III. figs. 11-13.)

Diagnosis. Sella pandurate. p² in the tooth-row. Forearm 50-56 mm.

Details. This species marks an important progress in development as compared with *Rh. rouxi*. It is the base of the *ferrum-equinum* section.

The chief modifications are four: in the shape of the sella; in the structure of the wings; in the size of the animal; in the shortening of the palatal bridge.

In the *borneensis-rouxi* type the sella is practically parallel-margined; in *affinis* it is pandurate, *i. e.* the lateral margins concave, as in *ferrum-equinum*, though generally to a slightly less degree. In *simplex* and its closest relations the lancet is almost cuneate; in *borneensis* there is a tendency towards emargination of the lateral margins; in *rouxi* this tendency is carried to an extreme; in *affinis* the lancet falls back to the former stage: it is almost cuneate.

Throughout the whole series of forms reviewed above, with the exception of the somewhat aberrant *Rh. nereis*, *stheno*, and *thomasi*, the wings have remained at the same primitive stage: no lengthening of the second phalanx of the third finger. In *affinis* this phalanx has considerably increased in length, being always more

than, and with very rare exceptions *considerably* more than, $1\frac{1}{2}$ the length of the first phalanx, a peculiarity which is preserved in the subsequent stage of evolution: *ferrum-equinum*. The aberrant species just alluded to, viz. *Rh. nereis*, *stheno*, and *thomasi*, are, from this point of view, of especial interest, as being Bats of the *rouxi* type which already show the wing-structure characteristic of the more highly developed *affinis*.

Rh. affinis is larger than *rouxi*; but small *affinis* have the same length of the forearm as very large *rouxi*. In such cases, *Rh. affinis*, provided the specimens examined are fresh or preserved in spirit, can, of course, easily be discriminated by the shape of the sella and the length of III.²; if preserved as dried skins (in which the shape of the sella is often difficult to recognise), still the latter character remains unchanged.

Colour. The many forms in which this species is differentiated seem to agree, rather closely, in colour:—

(1) Darker individuals: ♂ ad., Darjeeling (*Rh. a. himalayanus*); Oct. 22nd; teeth unworn; skin:—Upper side “mars-brown” with a rather strong hue of “drab”; no horse-shoe patch; base of hairs “ecru-drab”; under side “broccoli-brown.”

Still darker is a ♂ ad. from Lombok (*Rh. a. princeps*); teeth somewhat worn; in alcohol; unfaded:—“Prout’s brown” above, base of hairs “wood-brown”; under side almost “tawny-olive.”

(2) Light-coloured individuals: ♂ ad., Nanking (*Rh. a. himalayanus*); July 5th; teeth somewhat worn; skin:—Extremely light. Above light “clay,” almost “ochraceous-buff,” hinder back somewhat darker; a rather distinct, “mars-brown” horse-shoe patch; base of hairs “cream-buff”; under side very light, almost “cream-buff.”—A spirit specimen (♂ ad.) from the same locality (June 15th) is quite of the same colour.

Skull. The *essential* characters as in *rouxi*, proving that *Rh. affinis* originated from a Bat of that type. The skull is generally larger, and the gap in front between the maxillary bones wider. Chief character: the exceedingly short palatal bridge, as a rule only $\frac{1}{4}$ the length of the maxillar tooth-row, or *even less*; in *rouxi*, with very rare exceptions, decidedly more than $\frac{1}{4}$, sometimes almost $\frac{3}{4}$. The teeth, too, are slightly larger.

Dentition. p_3 external and extremely small; but, as a rare exception, this premolar may still, in this comparatively highly-developed species, show some tendency towards the tooth-row (one skull, out of 19), or be halfway in row (one). p_2 and p_4 generally quite, or almost, in contact (14 skulls); in the remaining somewhat more distinctly separated. p^2 always in the tooth-row, extremely small, and the interspace between the canine and p^4 rather narrow. In no less than five skulls there is an exceedingly narrow, in most cases almost hair-fine, interspace between p^2 and p^4 (the former place of p^3).

Distribution. From the N.W. Himalayas to S. China; through Indo-China, the Malay Peninsula, and N. Natunas, to Sumatra, Java, and Lombok.

Technical name. The type of *Rh. affinis* is in the British Museum. From the original description it would have been quite impossible to identify the species.

Remarks. Of all the races of *Rh. affinis*, the Himalayan form (*Rh. a. himalayanus*) is the most ordinary-looking: in the horse-shoe, the ears, the nasal swellings, the brain-case. There can hardly be any doubt that the *affinis* type originated in the Himalayas, and from there spread eastwards to S. China, south-eastwards through Indo-China, as far as Lombok.

Geographical races. There are, at least, seven forms of *Rh. affinis*, differing in certain cranial characters, in the size of the ears and horse-shoe, in the length of the tail and tibia, in general size, and in geographical habitat. Some of these forms may be called distinct species by other authors.

13 a. RHINOLOPHUS AFFINIS HIMALAYANUS, subsp. n. (Plate III. fig. 11 a, b.)

Rhinolophus affinis (partim) Dobson, Cat. Chir. Brit. Mus. (1878) p. 112.

Diagnosis *. External characters:—Size largest; ears small; horse-shoe narrow; tail short; lower leg short. Cranial: length of skull, width of brain-case, length of tooth-rows, moderate; nasal swellings narrow.

Type. ♀ ad. (in alcohol). Masuri. Collected and presented by Capt. Hutton. Brit. Mus. no. 79.11.21.148.

Distribution. Himalayas (Masuri, Nepal, Darjeeling); S. China (Nanking).

13 b. RHINOLOPHUS AFFINIS TENER, subsp. n. (Plate III. fig. 12.)

Diagnosis. External characters: Size small; ears small; horse-shoe broader; tail short; lower leg rather long. Cranial: skull short; nasal swellings and brain-case narrow; tooth-rows short.

Type. ♂ ad. (in alcohol). Pegu. Collected and presented by W. Theobald, Esq. Brit. Mus. no. 87.3.4.11.

13 c. RHINOLOPHUS AFFINIS MACRURUS, subsp. n.

Rhinolophus affinis Thomas, Ann. Mus. Civ. Genova (2) x. (1892) p. 922.

Diagnosis. External characters: Size moderate; ears larger; horse-shoe broader; tail long; lower leg longer. Cranial: length of skull, width of brain-case, length of tooth-rows, moderate; width of nasal swellings moderate.

Type. ♂ ad. (in alcohol). Taho, Karennee, Burma; Febr. 1888. Collected by Signor Leonardo Fea. Presented by Marquis G. Doria. Brit. Mus. no. 90.4.4.7.

* As the characters of the different forms of *Rh. affinis* are sufficiently clearly expressed in the table of measurements, p. 105, they will not be reviewed in detail, but only rendered in general terms, in the "diagnoses" of the subspecies.

13 d. RHINOLOPHUS AFFINIS SUPERANS, subsp. n.

Rhinolophus affinis (partim) Peters, MB. Akad. Berlin, 1871, p. 306; Dobson, l. s. c.

Diagnosis. External characters: As *macrurus*, but with short tail. Cranial: skull rather long; nasal swellings still broader than in *macrurus*; brain-case broad; tooth-rows rather long.

Type. ♀ ad. (in alcohol). Pahang, Malay Peninsula. Presented by the Selangor Museum. Brit. Mus. no. 0.7.3.2.

Distribution. Lower Siam (Trong); Malay Peninsula (Pahang); Sumatra.

Remarks. A specimen from Sumatra is in every respect, cranial, dental, and external, indistinguishable from those from Pahang and Trong (the latter sent for identification by the United States National Museum).

13 e. RHINOLOPHUS AFFINIS NESITES, subsp. n.

Rhinolophus affinis Gerrit S. Miller, Jr., Proc. Wash. Ac. Sci. iii. (1901) p. 135.

Diagnosis. External characters: As *superans*, but smaller, and with shorter tibia. Cranial characters unknown.

Type. ♀ ad. (in alcohol). Bunguran Isl., N. Natunas, Aug. 24th, 1900. Collected by Dr. W. L. Abbott. Un. St. Nat. Mus. no. 104753.

Remarks. This is evidently an offshoot of the Malacca form, *Rh. a. superans*, isolated on the outlying N. Natunas, and developed into a well-marked race (or species). It still shows some of the chief characters of *superans*: the large ears, broad horse-shoe, and short tail; but, to judge from the metacarpals (the forearms are broken), it is decidedly smaller, it would seem still a little smaller than *Rh. a. tener*, and the tibia is very short. The skull is so much damaged that I have only been able to examine the teeth and the lower jaw.

13 f. RHINOLOPHUS AFFINIS HORSF., TYPICUS.

Rhinolophus affinis Horsf., Zool. Res. Java (1824), pl. [7], figs. A, B.

Rhinolophus affinis (partim) Peters, l. s. c. (1871); Dobson, l. s. c. (1878).

I am unable to give a definite diagnosis of this, the "typical," form of *Rh. affinis*, having seen only one very old skin (the type) and a fragment of the skull, representing the facial portion and the tooth-rows. But these are sufficient to show, first of all, of course, the specific characters (pandurate sella, lengthened III.², dentition, &c.); secondly, that this form is quite different from any of its next neighbours, on Sumatra and the Malay Peninsula (*superans*), on the N. Natunas (*nesites*), or on Lombok (*princeps*). The horse-shoe seems, allowing for some shrinkage, to be quite as narrow as in *Rh. a. himalayanus*; the nasal swellings, too, are as narrow as in *himalayanus* and *tener*. But, although the

Measurements of *Rhinolophus* affinis and subspecies.

	<i>hinatalayanus</i> , 6 specimens, 7 skulls.		<i>tener.</i> ♀ ad. Type.		<i>macrurus</i> , 3 specimens, 3 skulls.		<i>supercus</i> , 5 specimens, 5 skulls.		<i>mesites</i> , ♀ ad. Type.		<i>typicus</i> , Ad. Type.		<i>princeps</i> , ♂ ad. Type.	
	Min.	Max.	mm.	Type.	Min.	Max.	mm.	Max.	mm.	Type.	mm.	Type.	mm.	Type.
Ears, length	17.2	18.5	18.8	mm.	20	20.7	20.2	20.5	20.2	21.3	mm.
" greatest breadth	13.8	14.5	14.3	...	15.2	15.8	14.8	15.7	14.2	16.9	...
Nose-leaves, total length	13.9	14	13.8	...	14.8	16.5	14.8	17	18.2	...
" breadth of horse-shoe	8	8.8	9.5	...	9	9.8	9.8	10	9.8	11.1	...
Forearm	52	56	50	...	51	53.8	51.2	53	51	52
3rd metacarpal	37.7	40	35.8	...	37.7	39	36	38.2	35.2	37.6	37.6
III ¹	15	16	14.3	...	14.8	16	14.6	15.2	14.3	15.5	15.5
III ²	26	30	25	...	24.8	26.5	23.8	26	24	24	24
4th metacarpal	38.8	41.2	37.1	...	38	40.7	36.8	38.8	36	37.5	39.5
IV ¹	10.4	11.2	10	...	10.3	12.2	10	10.9	10.2	10	10.5
IV ²	16	18	14.3	...	14.5	16.5	14	15.3	14.8	14.9	14.9
5th metacarpal	39.2	42.4	38	...	39.2	41.2	37.7	39.5	36.8	38.8	39.8
V ¹	12.3	13.8	11.8	...	12	13	11.2	11.9	11.5	11	11
V ²	12.1	14.1	13.3	...	13.5	14.8	12.2	13.5	12.2	13.1	13.1
Tail	21.8	25	23	...	26	29.3	21.5	25.2	22	21	21
Lower leg	22.8	23.8	24	...	23.9	25.4	25	25.8	22.8	26	26
Foot	11	12.8	12	...	11	12	11.1	12	10.2	12.4	12.4
Skull, total length	22.7	23.9	21.9	...	22.5	23.2	22.8	23.8	24.1	24.1
" mastoid width	10.2	10.9	10.5	11	10.9	11.2	11.2	11.2
" width of brain-case	9.2	10	9.3	...	9.3	9.8	9.8	10.2	10.5	10.5
" zygomatic width	11.1	11.8	10.8	...	11.2	11.6	11.3	12.1	12.1	12.1
" supraorbital length	5.2	5.5	5.2	...	5.2	5.9	5.7	6.2	5.2	5.9
" width of nasal swellings	5.6	6	5.7	...	5.8	6.2	6.2	6.7	5.8	6.8
Mandible, length	15.8	16.5	15.5	...	15.7	16.7	15.8	16.3	15.3	17.2	17.2
Upper teeth	9	9.4	8.7	...	8.8	9.2	9	9.7	9.7	9.9	9.9
Lower teeth	9.7	10.2	9.2	...	9.6	9.9	9.7	10.1	9.7	10.5	10.5

specimen is slightly smaller than the smallest example of *himalayanus* I have seen, the tibia is fully as long as (if anything, a trifle longer) than in the very largest of these latter. On the whole, I have but very little doubt that *Rh. a. typicus* will prove to be much more closely related to the Burmese and Himalayan forms than to any of the others. This would be an additional evidence of the *closer* connection between the fauna of Java and that of Indo-China and the Himalayas—closer than between Java and the geographically nearer Sumatra, Malacca, and Borneo.

Distribution. Java.

13 g. RHINOLOPHUS AFFINIS PRINCEPS, subsp. n. (Plate III. fig. 13.)

Diagnosis. External characters: General size moderate; tail short; but largest in the size of the horse-shoe and ears, and the length of the tibia. Skull, nasal swellings, tooth-rows: the extreme.

Type. ♂ ad. (in alcohol). Lombok, July 1896. Collected by A. Everett, Esq. Brit. Mus. no. 97.4.18.13.

Remarks. Placed side by side with *Rh. a. himalayanus*, this form is strikingly different; the horse-shoe is no less than $\frac{1}{4}$ broader than the *broadest* in *himalayanus*, and the skull is distinguishable at a glance by its excessive width and the very broad nasal swellings. But it must be remembered that *superans* leads, not up to, but decidedly *in the direction* of, *princeps*, and we do not yet know the extreme limits of individual variation, either in *superans* or in *princeps*.

When considering the geographical races* of *Rh. affinis* from a more general point of view—and excluding “*typicus*,” owing to the peculiar geological history of Java, as well as *nesites*, owing to its having, probably, been influenced by somewhat exceptional conditions, far away on the small isolated N. Natunas,—the following rule will be observed: the more southern or south-eastern the habitat, the longer the ears, the broader the horse-shoe, the longer the tibia, the larger the skull, the broader the nasal swellings, and the longer the tooth-rows.

14. RHINOLOPHUS FERRUM-EQUINUM Schreb. (Plate IV. figs. 14, 15.)

Diagnosis. Sella pandurate. p^2 completely external or wanting. Ears more than 20 mm. Width of horse-shoe less than 10 mm. Forearm 52.8–63 mm.†

Details. The *ferrum-equinum* type originated from a Bat in all

* I am unacquainted with Dobson's *Rh. andamanensis* (J. A. S. B. xli. pt. ii. (1872) p. 337). The only specimen known is in the Calcutta Museum. It seems to be a local representative of the *affinis* type.

† The first and second characters, combined, are sufficient to distinguish *ferrum-equinum* from all Oriental species of this group. The others are added to prevent confusion with those Ethiopian species of the present group which also have the sella pandurate and p^2 external or wanting (*clivus*, *darlingi*, *acrotis*; *augur* and *deckeni*).

essential points similar to *Rh. affinis*. It agrees with the now existing *affinis* in the pandurate sella and the prolongation of III.². But it is *considerably* higher-developed, chiefly in the following respects: (1) the dentition; (2) the wing-structure; (3) the length of the tail; (4) the beginning, or complete, reduction of the lateral mental grooves; (5) the general size.

The peculiar prolongation of the second phalanx of the third finger, described above under *Rh. affinis*, is preserved in *Rh. ferrum-equinum*: III.² is more than (or, extremely rarely, at least equal to) $1\frac{1}{2}$ the length of III.¹. Also IV.² is lengthened, *i. e.* more than $1\frac{1}{2}$ of IV.¹; it is an interesting fact that, in this particular point, *Rh. ferrum-equinum* (all races) agrees with *Rh. affinis himalayanus*, but not with any of the other races of *affinis*. Besides these two characters, which are simply inherited from an *affinis*-like ancestor, there is an important modification in another part of the wing, to which we have no parallel in any of the foregoing forms*, *viz. a change in the proportionate length of the third, fourth, and fifth metacarpals*, as shown in the subjoined table:—

	Forearm.	3rd metacarpal.	4th metacarpal.	5th metacarpal.
All the foregoing species (94 examples).....	1000	715	739	740
<i>Rh. ferrum-equinum</i> (all races; 121 examples).....	1000	644	724	743

This table shows:—(1) In all the foregoing 21 forms of this group the fourth metacarpal is but very little longer than the third (24 mm., for a supposed length of forearm of 1000 mm.), and the fifth metacarpal is practically of the same length as the fourth †. (2) In *ferrum-equinum* a considerable shortening of the third metacarpal has taken place; at the same time a much smaller reduction of the fourth metacarpal has occurred, so as to make the fifth metacarpal, slightly but *decidedly*, the longest of all.

The tail is proportionately longer than in the foregoing species, being, on an average, in the eastern races of *ferrum-equinum* (*nippon*, *tragatus*, *regulus*) exactly $1\frac{1}{3}$, in the typical form $1\frac{1}{2}$, the length of the lower leg, whereas *proximus*, in this point (as well as geographically), is intermediate between the eastern and western races ‡.

In all the foregoing forms, without exception, there are three

* But there is an exact parallel in an Ethiopian species, of the *affinis* type, *viz. Rh. darlingi* (see the "General Remarks," below, p. 118).

† It would only have made the table more complicated if I had given separate ciphers for all the foregoing species. The only difference (and an exceedingly small one) is that in *simplex*, *megaphyllus*, *truncatus*, *nanus*, *celebensis*, *borneensis*, *virgo*, and *malayanus* the fourth metacarpal is, almost always, a mere trifle longer than the fifth; in *nercis*, *stheno*, *rouxi*, *thomasi*, and *affinis* a mere trifle shorter than the fifth. However small this difference is, it is evidently the first faint trace of the modification definitely carried out in *ferrum-equinum*: the fourth metacarpal always shorter than the fifth.

‡ It is hardly necessary to say that a short tail cannot be a primitive character in the order Chiroptera, taken as a whole. But, for some reason or other, we find in the most primitive species of the genus *Rhinolophus* a very short tail; in the higher forms of the *present* group we see, again, a lengthening of the tail.

vertical grooves on the front of the lower lip. In the eastern races of *ferrum-equinum* (*nippon*, *tragatus*, *regulus*) sometimes exactly the same, but *very often* the lateral grooves are *more or less* reduced; in the western races (*proximus*, *typicus*, *obscurus*) they have, as a rule, almost or quite disappeared*.

As to the general size, the eastern races are, as it seems, always larger than any form of *affinis*; *proximus* and *typicus* at least on an average so; while *obscurus* is nearly of the same size as *affinis himalayanus*.

The remaining external characters need only a brief record:—

The supplementary leaflet is *slightly* more reduced than in *affinis*, and more closely united to the upper lip; this latter it is (more than the reduction) which makes it less distinctly visible. The posterior connecting process is more lengthened in antero-posterior direction, also a little more projecting, but quite rounded off at the summit. But, curiously enough, in one specimen (from Transcaspia) I find the process quite as in *affinis* (in all other specimens from W. Asia it is normal). The lancet has a marked tendency towards assuming a hastate shape, rather than a cuneate, the extreme tip being, generally, long and slender; but sometimes, and both in the eastern and western races (though more often in the former), individuals are found in which the lancet is almost cuneate, as in *affinis*.—These two individual variations are worth noticing, as, both of them, pointing back to *affinis*.

The ears are somewhat modified: more attenuated below the tip, and more pointed.

The plagiopatagium is inserted on the tarsus, on the base of the metatarsus, or about 1 mm. above the ankle-joint. But in one individual (from Cyprus) it is inserted no less than 6 mm. in front of the ankle-joint. It, again, recalls *Rh. affinis*.

Colour. A small series of skins from Tessin, Switzerland, affords some information as to the *difference in colour dependent on the age of the individuals*; all the specimens are of the same sex, from the same locality, and the same month:—

(1) Two full-grown, but *younger* individuals (females, December); distal epiphyses of metacarpals ossified, but teeth unworn; they are probably about six months old:—Upper side

* According to Blanford (J. A. S. B. lvii. pt. ii. no. 3 (1888) p. 263), *Rh. tragatus* Hodgs., regarded by him as a distinct species, and corresponding to what is here called the eastern races of *ferrum-equinum*, has three mental grooves, *ferrum-equinum* one only. If this were so, I should have no objection to separating *Rh. tragatus* specifically from *ferrum-equinum*. But there is, in this as in other respects, a complete intergradation. The details are these:—(1) "*Rh. tragatus*" (10 spirit-specimens): in three individuals (Kashmir, Almora, Darjeeling) the three grooves are perfectly distinct; in three (Masuri, Nepal) the lateral grooves are less distinct than the central one; in two (Nepal) they are so far on the way towards obliteration that it requires close examination to discover them; in the two remaining (Shanghai) they are still more reduced. (2) *Rh. ferrum-equinum* (*s. str.*): rather often traces of the lateral grooves are easily observable; a number of individuals before me, from various places in Europe and W. Asia, have either a slight depression or a short linear groove on either side of the central one; in a specimen from Tübingen (one instance only, among several) they are at least not *more* obliterated than in two "*tragatus*" from Nepal and two "*nippon*" from Shanghai.

greyish "drab," lighter on the head and neck; base of hairs "ecru-drab"; a strongly marked, dark brown horse-shoe patch; under side almost "ecru-drab" on throat and breast, very light "drab" on belly.

(2) One (female, December); teeth almost unworn; must be very nearly of the same age as (1):—Intermediate in colour between (1) and (3), but nearer to (3).

(3) Three *aged* individuals (females, December); teeth worn; two of them are at least $1\frac{1}{2}$ years old, the third (teeth very much worn) still older:—Upper side, a shade of brown which might be described as "maise-brown" with a pronounced tinge of "drab"; base of hairs light "ecru-drab"; scarcely any indication of a horse-shoe patch; under side light "wood-brown" with a tinge of "ecru-drab."

In a series from the Hautes-Pyrénées (January) I find the same differences in colour, but have not been able to verify the comparative age of the individuals by means of the skulls.

Three skins from Minorca (spring) are like the aged Swiss individuals or, if anything, a trifle lighter. The teeth are worn, showing the animals to be, probably, at least about two years old.

Skins of aged individuals from England are indistinguishable from Swiss specimens of a like age. A very young (not full-grown) example from Somerset is quite like the younger (greyish-drab) individuals from Switzerland.

As a general conclusion: young individuals are, broadly speaking, dark grey, old individuals brown; the colour of the young animal is retained, at least in some individuals, till December, beyond the time when the epiphyses of the metacarpals have become ossified. For those who have an opportunity to watch these Bats in the caves during the winter, it would be an object of some interest to ascertain how the colour-change is effected, by a moult or by a recolouring of the hairs.

Skull. The *essential* characters as in *Rh. affinis*, the *general shape* hardly different, but as a rule, of course, the skull is larger. The four anterior swellings are slightly more differentiated; the median ones almost circular in outline, the lateral ones oblong. Chief character: the much longer palatal bridge: very nearly $\frac{3}{4}$ the length of the maxillar tooth-row, a little more or less, but never so short as $\frac{1}{4}$ the tooth-row (as in *affinis*).

Dentition. p_3 external and exceedingly small, or, *very often, lost*, also in younger individuals. p_2 and p_1 in contact. p^2 *completely external*, extremely small, *not rarely lost*, also in younger individuals. Upper canine and p^1 not only in contact, but their *cingula*, as a rule, *considerably overlapping* each other (the cingula of p^4 being external to that of the canine).

Measurements. On p. 115.

Distribution. From S. China and Japan, through the Himalayas, the Mediterranean Subregion (exclusive of Egypt), and Central Europe to S. England.

Geographical races. There are, at least, six forms of *Rh. ferrum-*

equinum, three eastern (*nippon*, *tragatus*, *regulus*), and three western (*proximus*, the typical form, and *obscurus*). They are sufficiently differentiated to need technical names, but in no respect—in the external characters, in the skull, in the dentition—is there a sharp “hard-and-fast” line between them:—

In the extreme east (S. China and Japan) we find a Bat (*nippon*) of moderate size and with rather small teeth; the dentition, too, has remained on a rather primitive stage of development; but the horse-shoe and nasal swellings are very broad. Some of these peculiarities, viz. the broad horse-shoe and nasal swellings, are preserved in the Central Himalayan *tragatus*, but the general size of the animal is increased, the skull and teeth very large, the dentition more highly developed. This latter character reaches a climax in the next form, *regulus*, from the N.W. Himalayas, but at the same time the horse-shoe and nasal swellings are markedly narrower; in this respect *regulus* evidently shows tendencies towards the western races, as also might be expected from its habitat.—These three Bats constitute what I call the “eastern” races of *ferrum-equinum*. The geographical line separating them from the western races must be drawn somewhere between Masuri and Gilgit, at the border between the Oriental and Palæarctic Regions. East of that line the individuals are generally larger, with broader horse-shoe; the lateral mental grooves *not rarely* fully developed; the tail on an average only $1\frac{1}{3}$ the length of the lower leg.

Passing from Masuri (still *regulus*) to Gilgit, on the extreme north-western, “Palæarctic” side of the Himalayas, we find a form (*proximus*) with small and slender skull, narrower horse-shoe and nasal-swellings; which give it a decidedly “western” aspect, and contrast it with its eastern neighbour, *regulus*; but it has retained the somewhat shorter tail characteristic of the eastern races. The typical form has got rid also of this reminiscence, but, as a matter of fact, also in this race now and then, though rarely, individuals occur which “fall back” to the shorter-tailed eastern stage. The typical form leads to the generally smaller, extreme south-western race (*obscurus*: Spain, Algeria).

A closer study of these races, as compared with the Ethiopian *Rh. augur* and *Rh. deckeni*, will throw some light on the past history of the *ferrum-equinum* type (see the “General Remarks” on the *simplex* group, below, p. 118).

14 a. RHINOLOPHUS FERRUM-EQUINUM NIPPON Temm.

Rhinolophus nippon Temminck, Mon. Mamm. ii. 8^e monogr. (1835) p. 30 a; Temminck & Schlegel, Fauna Japonica (1842), p. 14, pl. iii. figs. 1, 2; Peters, MB. Akad. Berlin, 1871, p. 312.

Rhinolophus ferrum-equinum (partim) Dobson, Cat. Chir. Brit. Mus. (1878) p. 119.

Diagnosis. Size moderate, horse-shoe very broad. Skull small, but with rather broad nasal swellings; tooth-rows very short.

Details.—(1) Compared with *tragatus*: On an average (as a rule also absolutely) markedly smaller: forearm 57·2–59·3 mm. (*tragatus*: 59–63); but the horse-shoe is, nevertheless, of the same excessive breadth: 9–9·5 mm. (*tragatus*: 8·8–9·7). Skull considerably smaller and narrower, but (in conformance with the broad horse-shoe) with rather broad nasal swellings: comparatively as broad as in *tragatus*, but, owing to the smaller size of the skull, not absolutely so. Teeth markedly smaller, the tooth-rows shorter.

(2) Compared with *regulus*: Of approximately the same size (or *nippon* rather smaller), but horse-shoe considerably broader: 9–9·5 mm. (*regulus*: 8·2–8·8). Skull generally smaller and narrower, but nasal swellings, nevertheless, quite as broad as in *regulus* (comparatively, therefore, decidedly broader). Tooth-rows markedly shorter.

(3) Compared with the western races: The broad horse-shoe prevents it from being confused with any of the western forms.

Colour. As in adult individuals of *ferrum-equinum* from Europe*. No quite young specimens examined.

Dentition (5 skulls). In two skulls p_3 is present on both sides; in two (teeth unworn) on one side only; in one (teeth very slightly worn) lost, but the alveoli not quite obliterated. p^2 is present in all skulls examined. The cingula of the upper canine and p^4 not only less completely overlap than is generally the case in the other races, but in one skull the two teeth are very slightly, in one quite distinctly, separated. This dentition is decidedly more primitive than in the western neighbours of this race, *tragatus* and *regulus*.

Distribution.—S. China (Shanghai). Pt. Hamilton. Japan.

Remarks. I find the examples from Shanghai and Pt. Hamilton (S. of Korea) indistinguishable from those from Japan.

14 b. RHINOLOPHUS FERRUM-EQUINUM TRAGATUS Hodgs. (Plate IV. fig. 14 a, b, c, d.)

Rhinolophus tragatus Hodgson, J. A. S. B. iv. no. 48 (Dec. 1835) p. 699; Peters, MB. Akad. Berlin (1871), p. 312.

Rhinolophus ferrum-equinum (partim) Dobson, l. s. c.

Diagnosis. Size largest, horse-shoe very broad. Skull and tooth-rows: the extreme.

Details.—(1) Compared with *nippon*: see this form, *supra*.

(2) Compared with *regulus*: On an average larger, with markedly broader horse-shoe (but no sharp line of separation, the maxima

* According to Temminck the fur of *nippon* is "plus long, plus abondamment feutr , plus soyeux et moins lustr " than in *ferrum-equinum* from Europe, and the colours "diff rent  galement." In the length and abundance of the fur I am unable to find any tangible difference between *nippon*, *tragatus*, and *ferrum-equinum*. As to the colours (two well-preserved skins: Fuji and Nikko), it is quite the same as in darker individuals of *tragatus*, and this again as in fully adult individuals of the typical *ferrum-equinum*; laid side by side these Bats are indistinguishable in colour.

of *regulus*-being equal to minima of *tragatus*). Skull generally larger, and with broader nasal swellings.

(3) Compared with the western races: The large size, broad horse-shoe, shorter tail, large skull, broader nasal swellings, and longer tooth-rows prevent it, in most cases, from being confused with any of the western forms.

Dentition. In one only, out of six pairs of mandibles, p_3 is present on both sides; in two (teeth unworn, or very slightly worn) on one side (alveolus disappeared on the other side); in no less than three completely wanting, although the teeth are either quite or almost unworn. A similar high development of the upper teeth (eight skulls): p^2 present in five; completely wanting, and alveoli disappeared, in three (teeth unworn or slightly worn). Cingula of the upper canine and p^4 always overlapping. This is unquestionably a higher stage than in *nippon*.

Distribution. Darjeeling. Nepal.

Technical name. Hodgson's cotypes of *Rh. tragatus* (three examples; Nepal) are in the British Museum.

14c. RHINOLOPHUS FERRUM-EQUINUM REGULUS, subsp. n.

Rhinolophus ferrum-equinum Hutton, P. Z. S. 1872, p. 698.

Diagnosis. Size rather large, but width of horse-shoe moderate only. Skull large and broad, with long tooth-rows, but narrow nasal swellings.

Details. Compared with the western races: The large size, combined with the short tail, will, in most cases, make it readily distinguishable. The skull is, almost invariably, larger, the tooth-rows longer.

Dentition (4 skulls). In none of the skulls examined could I find any trace of the lower p_3 , although they all have the teeth unworn. In two skulls p^2 is present, in two completely wanting. Cingula of the upper canine and p^1 always overlapping. *This is the highest stage of dentition* in any race of *ferrum-equinum* (in the present group it is surpassed only by *Rh. acrotis*, but this species is an Ethiopian modification not of the *ferrum-equinum* type, but of the *affinis* type).

Type. ♂ ad. (in alcohol). Masuri. Collected and presented by Capt. Hutton. Brit. Mus. no. 79.11.21.153.

Distribution. Almora. Masuri.

14d. RHINOLOPHUS FERRUM-EQUINUM PROXIMUS, subsp. n. (Plate IV. fig. 15.)

Diagnosis. Size moderate, horse-shoe very narrow, tail short, Skull small and slender, with very narrow nasal swellings and short tooth-rows.

Details.—(1) Compared with the typical form: Although being of the same size as the larger and medium-sized individuals of the typical form, *proximus* has a very short tail; in so far, it might, very properly, be characterised as a "typical" *ferrum-equinum*

which has preserved the tail of the eastern races (*cf.* also its geographical habitat); the horse-shoe is remarkably narrow. The skull very small and slender; the nasal swellings narrow.

(2) Compared with *obscurus*: Larger, but *proportionately* with narrower horse-shoe. The skull is even smaller and more slender than in any individual of *obscurus* I have seen.

(3) Compared with the eastern races: The small size, combined with the very small horse-shoe, distinguishes it sufficiently. The skull is smaller and, especially, more slender, the nasal swellings narrower, than in any of the eastern forms.

Dentition (one skull). p_3 and p^2 present. Cingula of the upper canine and p^1 overlapping. This dentition is more in accordance with that of the typical *ferrum-equinum* than that of *regulus*, showing the "western" character of *proximus* (notwithstanding the short tail), a conclusion borne out by the general external aspect of this Bat, and the size of the skull and the tooth-rows.

Type. ♀ ad. (in alcohol). Gilgit. Presented by Dr. J. Scully. Brit. Mus. no. 81.3.1.10.

14 e. RHINOLOPHUS FERRUM-EQUINUM Schreb., TYPICUS.

Le fer-à-cheval Daubenton, Mém. Acad. Roy. Sci. Belg. 1759, pp. 377, 382, pl. 15. fig. 4.

Vespertilio Ferrum equinum (partim) Schreber, Säugthiere, i. (1775) pp. 174, 188, pl. 62 (the two upper figures).

Vespertilio equinus (partim) P. L. S. Müller, Natursyst., Suppl. (1776) p. 20.

Vespertilio Ungula (partim) Boddaert, Elenchus animalium, i. (1785) p. 71.

Vespertilio Ferrum equinum, a. *major* Gmelin, Linn. Syst. Nat. i. (1788) p. 50.

Vespertilio Hippocrepis (partim) Schrank, Fauna Boica, i. (1798) p. 64.

Rhinolophus uni-hastatus Geoffroy Saint-Hilaire, Descr. de l'Égypte, ii. (1812) p. 132; id., Ann. Mus. d'Hist. Nat. xx. (1813) p. 257, pl. 5.

Rhinolophus ferrum-equinum var. *germanicus* et var. *italicus* Koch, Jahrb. Ver. Naturk. Nassau, 1862-63, pp. 522, 523*.

Rhinolophus ferrum-equinum (partim) Peters, MB. Akad. Berlin, 1871, p. 310; Dobson, Cat. Chir. Brit. Mus. (1878) p. 119.

Rhinolophus libanoticus, *conchifer*, et *rufescens* "Ehrbg. et Lichtst. Mspt." Peters, loc. cit. (1871) (nomina nuda).

Diagnosis. Size moderate, horse-shoe rather narrow, tail long. Skull rather small and slender, with narrow nasal swellings and short tooth-rows.

* Koch's two "varieties" of *ferrum-equinum* must have been based on too small a material, or there must be some mistake in his statements. That individuals from S. Europe, *i. e.*, Europe S. of the Alps (his "var. *italicus*"), should, generally speaking, be larger than those from Europe N. of the Alps (his "var. *germanicus*"), is at all events not correct. The statement that var. *germanicus* is "über den Rücken mehr braungrau oder aschgrau gefärbt," whereas var. *italicus* "stets in das Rötliche neigt," raises the suspicion whether Koch has not compared immature individuals from Germany with fully adults from Italy.

Details.—(1) Compared with *obscurus*: the subjoined particulars will make the difference evident:—

59 specimens of the typical form have been examined from the following localities:—Transcaspia (1); Euphrates Valley (3); Syria (2); Galilee (2); Cyprus (2); N. Bulgaria (1); Transylvania (31); Hungary (1); Moravia (2); Dalmatia (2); Turin (1); Genoa (1); Sicily (2); Switzerland (Tessin and Geneva* 7); Tübingen (1).

Forearm, in these specimens, on an average 57·5 mm. In no less than 44, i. e. 75 per cent., the forearm measures 57 mm. or more (up to 60·3 mm.); in the remaining (and quite independent of the locality) less than 57 mm. (down to 53·5 mm.).

Of *obscurus* 31 specimens have been examined from:—Trobate, Hautes-Pyrénées (8); Cintra, Portugal (1); Madrid (3); Valencia † (12); Minorca (5); Algeria (2).

Forearm, in these specimens, on an average 55·5 mm. In no less than 25, i. e. 81 per cent., the forearm measures less than 57 mm. (down to 52·8 mm.); in the remaining between 57 and 58 mm. Although the series is smaller than that of the typical form, the facts here pointed out cannot be due to mere chance; the contrast is too well marked.

As a conclusion: in the typical form the forearm measures generally 57 mm. or more; in *obscurus* almost always less than 57 mm.; maximum of *obscurus* is but a trifle larger than the average size of the typical form.

(2) Compared with the eastern races: the proportionately longer tail prevents, in almost all cases, its confusion with any of these races. The skull is rather easily discriminated from that of *tragatus* and *regulus* (cf. measurements, p. 115), but I fail to find any point by which to distinguish it from the Japanese *nippon*.

British specimens. 13 specimens have been examined. *Forearm* on an average 55·4 mm., i. e., British specimens of *ferrum-equinum* are on an average of the same size as the extreme south-western (Spanish) race, *Rh. f. obscurus* ‡. Of the 13 specimens, 2 only have the forearm 57 mm. long or more (up to 58 mm., quite as in *obscurus*); all the others between 53·8 and 56·2 mm. These indications require, of course, verification by a much larger series §.

Dentition (11 skulls). In seven skulls p_3 is present on both sides (teeth in very different stages of wear); in one, on one side only (teeth worn); in three (teeth almost unworn, or much worn) completely wanting (no alveoli). p^2 is present in all the skulls examined, two of which are of very aged individuals. Cingula of the upper canine and p^4 generally more or less overlapping, but in two skulls separated by an extremely small interspace. This dentition is almost exactly as in *nippon*.

* For the loan of some Bats from the neighbourhood of Geneva I am indebted to M. Ch. Mottaz.

† A very elaborate table of measurements of fourteen Spanish specimens was kindly sent to me by Prof. A. Cabrera Latorre, Madrid. These are the only examples, dealt with in this paper, not examined by myself.

‡ Compare with this *Rh. hipposiderus minutus*, below, p. 142.

§ To keep the typical form uninfluenced by the smaller British individuals, I exclude these latter from the table of measurements on p. 115.

Measurements of Rhinolophus ferrum-equinum and subspecies.

	<i>nippon.</i> 7 specimens, 5 skulls.		<i>bragatus.</i> 5 specimens, 8 skulls.		<i>regulus.</i> 4 specimens, 4 skulls.		<i>procurvus.</i> 2 specimens, 1 skull.		<i>typicus.</i> 59 specimens, 11 skulls.		<i>obscurus.</i> 31 specimens, 4 skulls.	
	Min. mm.	Max. mm.	Min. mm.	Max. mm.	Min. mm.	Max. mm.	Min. mm.	Max. mm.	Min. mm.	Max. mm.	Min. mm.	Max. mm.
Ears, length	22.4	23.8	21.8	24.5	22	22.8	20.8	21.2	21	23.8	18	22
" greatest breadth	15.2	17	16.8	18.8	15.2	17.1	15	15.2	15	16.8	13	15
Nose-leaves, total length	15.2	15.8	16.2	17.8	15	15.7	14	14.5	14.5	16.8	13.7	15.5
" breadth of horse-shoe	9	9.5	8.8	9.7	8.2	8.8	7.7	8	7.8	8.8	7.7	8.5
Forearm	57.2	59.3	59	63	58.7	60	56.8	58	53.5	60.3	52.8	58
3rd metacarpal	37.2	38.8	37.2	40.3	37.3	38.2	36.2	37	34.8	40.2	34	38
III, ¹	19.3	21	20.5	23	19.3	21	19.1	20	18	20.2	15	19
III, ²	21	32	32	34.5	30.2	32	28.5	29.5	27.2	32.2	27.2	32
4th metacarpal	41.8	44	42	45.1	41.8	43.5	39.8	40.5	38	43.7	37	41.5
IV, ¹	11	12	11.6	13.8	11.2	13.2	10.7	11.7	10.3	12.5	10	11.7
IV, ²	18.2	19.5	20.2	22	18.7	20.2	18.5	19.5	17.2	20.2	16	20
5th metacarpal	43.1	45.3	43.5	47.3	42.2	44.5	40.8	41	39.4	44.7	38.5	42
V, ¹	13.7	14.5	14	15.8	13.2	14.7	13.1	13.1	12.5	15	12.2	14.5
V, ²	15.7	17.5	18	19	16.8	17	15.8	17	13.3	17	13.3	17
Tail	31	36.8	34.8	37.6	31.5	35	31.5	34	34	41	27	37
Lower leg	24.2	26.3	25.6	27.6	23.5	25.8	25.2	25.2	23.8	27.2	23	24.3
Foot	12.7	14.5	13	14.3	12.8	14.2	10.3	11.2	11	13.2
Skull, total length	22.9	23.7	24.9	25.7	23.7	24.7	22	...	22.7	23.8	22.3	23.2
" mastoid width	10.2	10.9	11	11.5	10.7	11.2	10.2	11	10	10.6
" zygomatic width	9.6	10	10.2	11	9.7	10.5	8.8	...	9.5	9.9	9	9.3
" supraorbital length	11.7	12.2	12.8	13.3	12.1	13	11.2	...	12.1	12.7	11.3	12.2
" width of nasal swellings	5.2	6	5.2	5.7	5.7	6	5.2	...	4.8	6	5	5.5
Mandible, length	6.3	6.8	6.7	7.2	6.1	6.7	6	...	6.2	6.7	6.2	6.5
Upper teeth	15.8	16.8	17.8	18	16.7	17.2	15.6	17	15.3	15.9
Lower teeth	8.3	9	9.3	9.9	9.2	9.7	8.8	...	8.5	9	8.5	8.7
	9.3	9.8	10.2	10.7	10.2	10.7	9.3	...	9.2	10	9.2	9.5

Distribution. From Transcaspia and the Euphrates Valley through Southern and Central Europe, exclusive of the Spanish Peninsula.

14 *f.* RHINOLOPHUS FERRUM-EQUINUM OBSCURUS Cabrera.

Rhinolophus ferrum-equinum obscurus Cabrera Latorre, Mem. Soc. Españ. Hist. Nat. ii. (1904) p. 257.

Diagnosis. Smaller than the typical form.

Details.—(1) Compared with the typical form: see above, p. 114.

(2) Compared with the Eastern races: the small size, combined with the narrow horse-shoe, make it readily distinguishable. The skull is apparently slightly smaller than in *nippon*.

Dentition (4 skulls). As in the typical form.

Distribution. Spanish Peninsula, with the Balearic Islands. Algeria*.

General Remarks on the Rhinolophus simplex Group.

The place of origin.—Of all the existing forms, the Australian *Rh. megaphyllus* is one of the most primitive in dentition. But it is very unlikely that the Australian Continent has been the place of origin of the group. *Rh. megaphyllus* is the only Australian species of the whole genus; this might suggest the assumption that it is an immigrant into the country, rather than an ancient inhabitant: secondly, Australia is the extreme eastern border for the group (as well as for the genus), no species being known from the islands to the east of the Continent; it would probably not be so, if Australia had been a centre of dispersal for the group: thirdly, *megaphyllus* has at least two characters which certainly are not primitive—the large nose-leaves, and (probably as a consequence of that) the rather broad nasal swellings: fourthly, *megaphyllus* looks extremely like an enlarged, continental representative of the Lombok species, *Rh. simplex* (just as *Rh. rouxi* is the larger, continental representative of *Rh. borneensis*). These arguments seem to support the conjecture that, not the Australian Continent, but the “Indo-Australian Transitional Tract,” now broken up into numerous larger and smaller islands, and still inhabited by such very primitive forms as *simplex*, *truncatus*, *nanus*, *celebensis*, and *borneensis*, has been the centre from which the group spread eastwards and westwards.

Differentiation †.—The ancestral species seems to have divided into two branches, an eastern and a western. In the eastern, more primitive branch the sagittal crest does not reach quite so far forwards as a point corresponding to the middle of the orbit; in the western the temporal fossa is comparatively a little wider, and the sagittal crest produced forwards more or less beyond that

* The type of *Rh. f. obscurus*, in the Madrid Museum, is from Valencia, Spain. As will be seen, I take the name in a wider sense. Valencia specimens were separated by Prof. Cabrera, as a distinct subspecies, mainly on account of a difference in the ratio between the length and breadth of the horse-shoe. In a large series of *ferrum-equinum* from Europe and W. Asia there is, however, no small, and quite individual, variation in this respect.

† Compare the diagram on p. 120.

point. The geographical line separating the two branches coincides with the line separating the "Austro-Malayan" from the "Indo-Malayan" subregion (Celebes being a part of the latter). The eastern branch is, as yet, represented by four known species—*Rh. simplex*, *megaphyllus*, *truncatus*, and *nanus*. The western by all the others.

The further evolution, from *borneensis* to *ferrum-equinum*, has been discussed above, and is summed up, in the briefest possible form, in the subjoined diagram (p. 120). But the sketch of this group would be deprived of some of its most instructive features if the Ethiopian species were left quite out of consideration. They belong to three closely related types:—

(1) *Ethiopian species of the borneensis-stheno-rouxi type*.—Far south in Africa, in Bechuanaland and Mashonaland, we find two small species, *Rh. denti* and *simulator*, described quite recently*. They are the Ethiopian representatives of the *borneensis* type: the same general shape of the skull; essentially the same dentition; the same parallel-margined sella, with a faint or almost imperceptible constriction at the middle; the same style of connecting process; the same proportionate length of the fourth and fifth metacarpals; even the same length of the tail, &c. But there are, in these species, three characters of especial interest, because they enable us to determine still more precisely their phylogenetic place: the nasal swellings (side view) are more projecting than in *borneensis*, but less than in *stheno*; III.² is lengthened, and IV.¹ somewhat shortened, as in this species,—proving that they have originated from a Bat which had already traversed a part of the distance separating *borneensis* and *stheno*. The dentition is on a slightly higher level than in *borneensis* and *stheno*, the only difference being that p², although still in the tooth-row (as in the Oriental species), shows a distinct tendency towards the external side.

In the extreme south of Africa (Cape Colony) we find a species, *Rh. capensis*, which, quite superficially, looks like an enlarged *Rh. simulator*. It is an African representative of *Rh. rouxi*: the skull is to such a degree that of *rouxi* that it would be hard to find any tangible difference, even the measurements being practically the same (on an average smaller than in *rouxi*); the nose-leaves (sella, process, lancet) are the same; proportionate length of fourth and fifth metacarpals, of tail and tibia, the same. But the dentition is somewhat more advanced: p² is generally external, but still, very often, a quite distinct interspace between the canine and p¹ indicates its former place; III.² is somewhat lengthened. In short: *Rh. capensis* is a "*Rh. rouxi*" which in the wing-structure has taken a course towards, in the dentition very slightly beyond, the *affinis*-stage.

(2) *Ethiopian species of the affinis-type*.—On the coasts of the Red Sea we find a species, *Rh. clivosus*, first made known by Cretzschmar from Mohila in Arabia; I have seen examples from

* Thomas, Ann. & Mag. Nat. Hist. (7) xiii. (1904) p. 386; Andersen, *op. cit.* (7) xiv. (1904) p. 384.

the African coast of the Gulf of Aden. *It is the closest existing relative of the Himalayan Rh. affinis*: the same shape of the skull; the same shape of the sella, of the connecting process, of the ears; the same structure of the wings (also the same lengthening of III.²); the same proportionate length of the tail. But it is more advanced in dentition: p_3 is not only external (as in *affinis*), but very often lost; p^2 , which in *affinis* is still in the tooth-row, is in *clivosus* external and very small. In short: *Rh. clivosus* is a "*Rh. affinis*" with *ferrum-equinum* dentition.

The *clivosus* type has found its way very far into the Ethiopian Region. *Rh. darlingi**, from Mazoe to Angola, is a modification of this type (as proved by the skull), differing from *clivosus* in the more pronouncedly pandurate sella, the much broader horse-shoe, the much smaller ears, and, by far the most interesting, in the shortening of the third metacarpal. This last peculiarity is the same as that pointed out above, under *Rh. ferrum-equinum*: in the wing-structure *Rh. darlingi* differs from *Rh. clivosus* quite in the same way as *Rh. ferrum-equinum* from *Rh. affinis*. It is a suggestive fact to find this peculiarity so exactly copied by the South-African species.

Rh. acrotis†, from Egypt and Erythrea, is, externally, very similar to *Rh. clivosus*; also the wing-structure is the same. But the tendency, in *clivosus*, towards an obliteration of p_3 and p^2 has been further developed by *acrotis*: it has completely lost both of these teeth, thus being, in this particular respect, the highest member of the whole group. *Rh. acrotis* is a "*Rh. affinis*" with a dentition still more advanced than in *ferrum-equinum regulus*.

(3) *Ethiopian species of the ferrum-equinum type*.—*Rh. augur*‡ is widely distributed, in several geographical races, over the southern part of the Ethiopian Region: the Orange River tract, Natal, the Lower Zambesi. *It is the closest existing relative of Rh. ferrum-equinum*; the skull, the nose-leaves, the wing-structure are the same; but the dentition is a trifle less advanced, and the ears are smaller.

We find the *ferrum-equinum* type also further northwards in Tropical Africa (Mombasa): *Rh. deckeni*; the skull and dentition, and all external characters of any importance, are as in *augur*; but the horse-shoe is broader.

The area occupied by these two Ethiopian representatives of the *ferrum-equinum* type extends, broadly speaking, from the Orange River to Mombasa. It is completely cut off from any other region inhabited by that type of Bat; it forms a large enclave bordered to the north and west by vast tracts where no representative of *ferrum-equinum* occurs; we must go so far away from South and Equatorial Africa as the Euphrates Valley, Syria, and Algeria before meeting with the closest relatives of those Ethiopian species. Thus the question suggests itself, by which way the *ferrum-equinum* type reached Tropical Africa, and why its range there is now so peculiarly insulate. When

* Andersen, Ann. & Mag. Nat. Hist. (7) xv. (1905) p. 70.

† Andersen, *op. cit.* (7) xiv. (1904) p. 454; (7) xv. (1905) p. 73.

‡ Andersen, *op. cit.* (7) xiv. (1904) p. 380.

trying to answer this question, the following facts must be borne in mind:—Firstly, that all palæontological evidence is wanting, which detracts from what we know about the affinities and distribution of the now existing representatives of these Bats. Secondly, that the *ferrum-equinum* type is unknown in Egypt, as well as in the whole region of the continent north of British East Africa, and that we have no reason, of any kind, to believe that it ever existed there. Thirdly, that we have to account not only for the distribution of *Rh. augur* and *deckeni* as compared with the other members of the same section of the genus, but also for the presence in Tropical Africa of representatives of the *borneensis* and *rouxi* types, and, be it noticed, representatives which, without exception, are *more highly differentiated* than their Oriental allies. These facts, so far as they go, seem to allow of no other satisfactory explanation than this: the immigration of these Bats, as of so many other Oriental types in the Ethiopian fauna, has taken place by way of the broad tract of land which, as commonly supposed, in a geologically late period connected Southern Asia with the African continent. In the case of the *ferrum-equinum* type this explanation would make it evident, why it, though vastly distributed in South and Equatorial Africa, is absent from the whole north of the continent with the exception of the extreme north-western (Mediterranean) coast-region, which it, no doubt, has reached from South-western Europe, since the Algerian race is subspecifically indistinguishable from the Spanish form (*Rh. f. obscurus*). In the case of the *borneensis* and *rouxi* types it would account for the fact that they are common to the Oriental and Ethiopian Regions, but absent from the whole of the Palæartic Region. And it would also account for the presence of the genus *Rhinolophus* in the Ethiopian Region, for, as I shall have to show later on in this paper, all the Ethiopian representatives of the genus are undoubtedly of Oriental origin.

Such being the case, I am able to draw up the following rough sketch of the history of *Rh. augur*, *deckeni*, and their Oriental and Palæartic relatives:—

The *ferrum-equinum* type has originated somewhere in South Asia; we find there the long series of more primitive forms which lead up to that type, whereas in the whole of the Ethiopian Region there is not any species with which it can be brought in genetic connection. The ancestral "*ferrum-equinum*," broke up into three branches: a south-western, a western, and an eastern. The south-western branch, which had spread directly from South Asia into the Ethiopian Region, was cut off from the main stem by the submergence of the connecting tract of land, and is now differentiated into two species—the southern *Rh. augur* and the northern *Rh. deckeni*. Both of them have retained at least two "ancient" characters: a slightly more primitive dentition (the upper canine and p^4 often more or less separated; p^2 sometimes half in row *) and a short tail. To the external difference

* 35 skulls of *Rh. augur* (all races) have been examined:—In 17 the upper canine and p^4 are more or less separated, in 7 in contact, in 11 more or less overlapping

between these two Ethiopian species, viz. a broad horse-shoe in *deckeni* and a narrow one in *augur*, we have a parallel in *ferrum-equinum*: a broad horse-shoe in *nippon* and *tragatus*, a narrow one in the other races. The western branch spread over South and Central Europe: the dentition slightly more advanced, the tail lengthened. The third branch is now represented by what I have called the Eastern races of *ferrum-equinum*; all of them have retained the short tail; *nippon* (which, so far as the dentition is concerned, has remained on a relatively less advanced stage) leads through *tragatus* to *regulus*, in which the dentition has reached the highest stage of development found in any race of *ferrum-equinum*.

According to this the mutual affinities of the species of the *simplex* group might be expressed as follows † (the Ethiopian species are marked with an asterisk):—

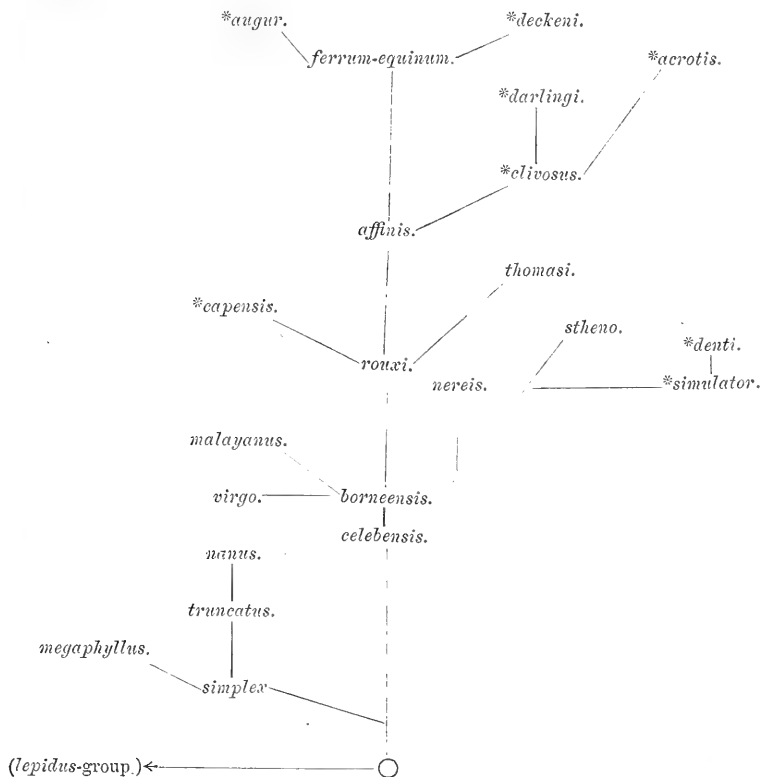

each other at base; in 4 p^2 is half in row. To this latter I find no parallel in any specimen of *ferrum-equinum* (all races) I have seen, and in 4 skulls only, out of 33, there is a more or less distinct remnant of the interspace between the canine and p^1 . Of *Rh. deckeni* I have seen one skull only; the dentition is as in many specimens of *Rh. augur*: c and p^1 separated, p^2 external.

† I give the diagram the form of a genealogical tree, only because it is convenient to

II. THE *RHINOLOPHUS LEPIDUS* GROUP.

Diagnosis. Basioccipital, between cochleæ, not unusually narrowed. Posterior connecting process projecting and pointed.

I include in this group:—(1) All the forms with projecting connecting process comprised by Dobson under the technical name "*Rh. minor*"; their close relationship is unquestionable; their differences will be pointed out below; (2) *Rh. acuminatus* and its allies, which are scarcely more than giant forms of the *lepidus*-type; (3) the *Rh. blasii* and (4) *Rh. eurysale* sections, peculiarly modified Ethiopian and W. Palearctic representatives of the *subbadius*-type. The two former sections only will be reviewed below; the two latter will be briefly mentioned in the "General Remarks" on the group (p. 135).

Text-fig. 22.

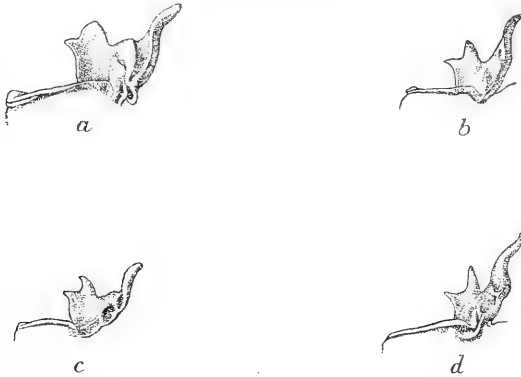

Side views of nose-leaves, showing the principal forms of the connecting process in the *Rh. simplex* group (a) and the *Rh. lepidus* group (b, c, d).

a. *Rh. borneensis typicus*; b. *Rh. cornutus pumilus*;
c. *Rh. monoceros*; d. *Rh. empusa*.

As this is a first attempt to disentangle the many different forms hitherto confounded with Horsfield's *Rh. minor*, the following preliminary remarks are necessary, as a general guidance:—

The first of the above-named sections (the "*lepidus*-section"), viz., all the *small* Oriental and E. Palearctic *Rhinolophi* which have the connecting process projecting and pointed, fall into three

show, at a glance, the probable interrelations of the species. As sufficiently emphasised in the foregoing pages, I am far from being of opinion that *ferrum-equinum* is derived from the *now-existing affinis* (or *capensis* from *rouvi*, or *stheo* from *borneensis*, &c.). But *ferrum-equinum* has originated from a Bat which had the more *essential* characters of *affinis* (besides several others, unknown to us). The technical names in the diagram are, in other words, to be taken, not in their strict specific sense, but as names of the *sections* ("types," "branches") of which the species, as we now see them, are the surviving representatives.

natural groups (sub-sections): the *lepidus*-type, the *minor*-type, and the *subbadius*-type.

I propose to characterise these types at once. It will enable me to confine the diagnoses of the various species to the points in which they differ from the subjoined general characteristic.

(1) The *lepidus*-type.—Chief characters: skull larger, width of brain-case about 7·7–7·8 mm.; connecting process (in side view) projecting as a small, erect triangle (not curved forwards as a sharply pointed “horn”).

Description, based on *Rh. lepidus* (Wynaad, Mysore, Indian Peninsula).—Supplementary leaflet as in *simplex* and its allies. Horse-shoe not completely covering the upper lip; a small tooth-like projection on either side of the median notch; front border sometimes, not always, slightly crenulate (individual variation). Sella decidedly broader at base than at summit, slightly, but quite distinctly, constricted at middle, narrow at summit: there is a tendency towards producing an almost subacute summit to the sella (compare with this the *borneensis*-type: sella broadly rounded off, or even truncated, at summit); height of sella 3·2 mm.; width at base, at constriction, and at summit: 2, 1·8, and 1·2 mm. Connecting process projecting as an acute, sometimes only subacute, triangle beyond the summit of the sella. Lancet strongly hastate, about 3 mm. long. Three mental grooves.

Ears much as in the *celebensis-borneensis* type, but somewhat more blunt-tipped.

Wing-structure quite primitive, *i. e.* no lengthening of III.², this phalanx being always less, and very often much less, than $1\frac{1}{2}$ the length of III.¹; no shortening of the third metacarpal; fourth metacarpal slightly the longest (individually it may fall short of the fifth by a fraction of a millimetre). This wing-structure is perfectly like that of *Rh. simplex* and its allies.

Tail slightly longer than (individually equal to, or a trifle shorter than) the lower leg. Plagiopatagium inserted on the ankle, slightly above or below.

Skull. General shape: the *simplex-borneensis* type, but *considerably smaller, with smaller teeth, and shorter tooth-rows.* The orbital cavities (the confluent orbital and temporal fossæ) are shorter and narrower than in *borneensis*, the zygomatic arches, therefore, less projecting laterally, making the zygomatic width of the skull, as a rule, only equal to, or even a trifle smaller than, the mastoid width. These peculiarities combined make, as a rule, the skulls of the species of the *lepidus*-type rather easily distinguishable from those of the *borneensis*-type.—Arrangement of the nasal swellings, essentially, as in *borneensis*. Palatal bridge, on an average, somewhat less than $\frac{1}{3}$, but more than $\frac{1}{4}$ the length of the maxillar tooth-row.

Dentition. Position of p_3 (in, or external to, the tooth-row) “vacillating.” p^2 invariably in the tooth-row. This dentition is precisely as in *simplex-borneensis*.

Species. *Rh. lepidus, monticola, refulgens.*

(2) The *minor*-type.—Chief characters: skull, also proportionately, very small; width of brain-case about 6·8–7·2 mm.; connecting process of the *lepidus*-type (text-fig. 22, *b*, p. 121).

Description, based on *Rh. cornutus pumilus* (Loo-choo Islands).—Nose-leaves as in the *lepidus*-type, but: sella narrower; height about 2·8 mm.; width at base, at constriction, and at summit: 1·7, 1·5, and 1·1 mm. Connecting process slightly higher, slightly more acute, but of the same general shape.

The other external characters as in the *lepidus*-type.

Skull. Considerably smaller; nasal swellings narrower. Teeth smaller.

Dentition. As in *lepidus*.

Species. *Rh. minor, cornutus, "minutus"* (Miller, nec Montagu), *gracilis*.

(3) The *subbadius*-type.—Chief character: connecting process long, slender, very sharply pointed, curved forwards, projecting like a small, curved "horn" (text-fig. 22, *c*, p. 121).

Nose-leaves, and other external characters, much as in *minor*, but connecting process as described above; lancet more or less approaching the shape of an equilateral triangle; length of sella about 2·4 mm.; width at base, at constriction, and at summit: 1·7, 1·3, and 0·9 mm.

Skull. To judge from fragments, and the skull of a quite young individual, much of the *minor*-type.

Dentition. As in *lepidus* and *minor*.

Species. *Rh. subbadius, monoceros*.

15. RHINOLOPHUS LEPIDUS Blyth.

Rhinolophus lepidus Blyth, J. A. S. B. xiii. pt. i. (June 1844) p. 486.

Rhinolophus minor (partim, nec Horsf.) Dobson, Cat. Chir. Brit. Mus. (1878) p. 114.

Diagnosis. Skull and external characters: *lepidus*-type. Larger: forearm 41·8–42 mm.

Details. This species differs from *Rh. monticola* in its broader nasal swellings, larger size, and considerably longer metacarpals.

Colour. Ad., skin: Ganges Valley; teeth almost unworn; two ♂ ad., in alcohol: Wynaad; teeth unworn. General colour above between "wood-brown" and "cinnamon," lighter on the anterior part of the back; base of hairs very light "ecru-drab"; under side "wood-brown" or tending to "ecru-drab."

Dentition (three skulls). p_3 external. p_2 and p_4 separated, or almost or quite in contact. p^2 in the tooth-row, with a well-developed cusp, pointing inwards.

Measurements. On p. 125.

Distribution. Indian Peninsula: Wynaad (Mysore); Ganges Valley.

Technical name. I identify this Bat with Blyth's *Rh. lepidus* (to which I find no reference in Dobson's 'Catalogue'), for the following reasons:—(1) *lepidus* belongs to this group of the genus,

as proved by Blyth's description of the connecting process, "still more developed [than in his *Rh. subbadius*] and obtusely angulated behind"; the words "still more developed" mean, evidently, "bigger," not extremely slender as in *subbadius*. (2) The types were "probably obtained in the vicinity of Calcutta"; one of the specimens in the British Museum is from the Ganges Valley, therefore in all probability from the very same locality as the types. (3) The colour, as described by Blyth, agrees very well with that of the specimens before me. (4) The forearm was stated to be "1 $\frac{5}{8}$ inches" (41.5 mm.); the longest finger "2 $\frac{1}{4}$ inches" (57.2 mm.); the tibia "above $\frac{5}{8}$ inch" (above 16 mm.); all these measurements are as in the British Museum examples: forearm 41.8-42 mm.; third finger 58.3-59.1 mm.; lower leg 16-17 mm. These facts leave no room for doubt as to the identification of *Rh. lepidus*.

16. RHINOLOPHUS MONTICOLA, sp. n.

Rhinolophus petersi (errore *) Hutton, P. Z. S. 1872, p. 700.

Rhinolophus minor (partim, nec Horsf.) Dobson, *ut supra*.

Rhinolophus subbadius (non Hodgs., nec Blyth) Scully, J. A. S. B. lvi. pt. ii. (1887) p. 244.

Diagnosis. Skull and external characters: *lepidus*-type. Smaller: forearm about 37.5 mm.

Details. This species differs from *Rh. lepidus* in its narrower nasal swellings, somewhat smaller size, and considerably shorter metacarpals. The horse-shoe seems to be narrower.

Colour. Unknown (faded in alcohol).

Skull. As in *Rh. lepidus*, but somewhat smaller, and with narrower nasal swellings.

Dentition (two skulls, one belonging to a quite young individual). p_3 in row (skull of an adult), or external (young). p_2 and p_4 well separated, or almost in contact. p^2 in row; a distinct cusp, pointing inwards.

Measurements. On p. 125.

Type. ♂ ad. (in alcohol). Masuri. Collected and presented by Capt. Hutton. Brit. Mus. no. 79.11.21.151.

17. RHINOLOPHUS REFULGENS, sp. n. (Plate IV. fig. 16 *a, b, c.*)

Diagnosis. Skull and external characters, essentially of the *lepidus*-type. But brain-case somewhat higher in front, making the anterior slope of the sagittal crest, towards the postnasal depression, somewhat more abrupt. Forearm 40.6-41.5 mm.

Details. Very nearly of the same size as *Rh. lepidus*, but metacarpals, also proportionately, somewhat shorter; tibia shorter. The horse-shoe is, if anything, slightly broader.

* There is no doubt that this is an accidental error. Prof. Peters (who determined Hutton's Bats) cannot, possibly, have identified the specimen here under consideration (forearm 37.5 mm.) with "*Rh. petersi*" (forearm of type 51 mm.). As already pointed out above (p. 97, footnote), the labels must have been confused; the name "*Rh. petersi*" was, probably, intended for Hutton's examples of *Rh. rouxi*.

Colour. ♀ ad., skin; Perak; March; teeth almost unworn. Very different from *Rh. lepidus*. General effect of the colour of the upper side: a dark shade of "Prout's brown" with a tinge of "hair-brown." On closer examination the fur of the upper side proves to be composed of two kinds of hair: longer, thinner, straight hairs, quite black; and somewhat shorter, crinkled hairs of a "hair-brown" colour; the mixture of the colours of these two kinds of hair produces the general effect. *Base of hairs of upper side not lighter coloured.* The fur of the upper side has a silvery reflection (iridescence). Under side between "broccoli-brown" and "hair-brown." A spirit-specimen from Selangor (♂ ad., apparently the same age) is of the same colour.

Skull. In addition to the characteristic in the diagnosis: the "maxillar width," across the antero-external corner of m^3 (a character subject to exceedingly small individual variation in the species of the *lepidus*-section) is somewhat larger, giving this part of the skull a somewhat broader aspect: 6.5-6.7 mm.; in *lepidus* 6.2 mm. Gap in front between the maxillary bones somewhat larger.

Dentition (two skulls). p_3 external. p_2 and p_1 almost or quite

Measurements of Rh. lepidus, monticola, and refulgens.

	<i>Rh. lepidus.</i>		<i>Rh. monticola.</i>	<i>Rh. refulgens.</i>	
	3 specimens, 3 skulls.		♂ ad. Type.	2 specimens, 2 skulls.	
	Min.	Max.		Min.	Max.
	mm.	mm.	mm.	mm.	mm.
Ears, length	15.2	15.6	...	15.7	...
„ greatest breadth.....	11.5	12.2	...	12	...
Nose-leaves, total length.....	11.5	12	...	12.1	...
„ breadth of horse-shoe	7	7.2	?	7.5	...
Forearm	41.8	42	37.5	40.6	41.5
3rd metacarpal.....	30.8	31.2	28.7	28.3	29.2
III. ¹	10.8	11.8	10.9	10.8	11.5
III. ²	15.8	16.1	14.2	14.2	15.3
4th metacarpal.....	31	31.2	28.8	29.2	30.2
IV. ¹	9	9.2	8.3	8.5	8.5
IV. ²	10	10.2	9.8	9.5	10
5th metacarpal.....	30.7	31.6	28	28.8	29.7
V. ¹	9.8	10	9.2	9	9
V. ²	9.8	9.8	9.8	10	10.2
Tail	17	18.3	...	16.7	19
Lower leg	16.6	17	15.3	15.9	16
Foot	8.3	8.7	7.7	8.3	...
Skull, total length	17.7	...	16.8	17.2	17.2
„ mastoid width	8.1	...	8.4
„ width of brain-case	7.7	...	7.7	...	7.8
„ zygomatic width	8.7	...	8.2	8.3	...
„ supraorbital length	4.5	5	4.4	4.8	5
„ width of nasal swellings..	5	5	4.5	4.8	4.8
Mandible	11.1	11.5	11	11.4	11.8
Upper teeth	6.6	6.7	6.3	6.3	6.8
Lower teeth	7	7	6.8	6.9	7.1

in contact. p^2 in row; a small cusp, pointing inwards. In one specimen there is an extremely narrow space between p^2 and p^4 (the former place of p^3).

Measurements. On p. 125.

Type. ♀ ad. (skin). Gunong Igar, Perak, 2000 ft.; March 1898. Presented by A. L. Butler, Esq. Brit. Mus. no. 98.11.29.2.

Distribution. Malay Peninsula: Perak; Selangor.

18. RHINOLOPHUS MINOR Horsf.

Rhinolophus minor Horsfield, Zool. Res. Java (1824), pl. [7], figs. C, D.

Rhinolophus pusillus Temminck, Mon. Mamm. ii. 8^e monogr. (1835) p. 36, pl. 29. fig. 8, pl. 32. figs. 22, 23; Peters, MB. Akad. Berlin, 1871, p. 309.

Rhinolophus brevatarsus Blyth, Cat. Mamm. Mus. Asiat. Soc. (1863) p. 24 (nomen nudum) ("vicinity of Darjeeling").

Rhinolophus minor (partim) Dobson, *ut supra*.

Diagnosis. Skull and external characters: *minor*-type. Ears, tail, and tibia shorter. Forearm 37–38 mm.

Details. This species differs from *Rh. cornutus* by the shorter ears, tail, and tibia (*cf.* measurements). The forearm is, at least on an average, shorter.

Colour. ♂ ad., skin; Darjeeling; November; teeth unworn. General effect of the colour of the upper side very much as in *Rh. refulgens*, though perhaps not quite as dark; *base of hairs light*, "ecru-drab"; under side "ecru-drab," darker on the hinder belly and flanks.

Dentition (three skulls). p_3 in row, almost in row, or external. p_2 and p_4 well separated, or almost in contact. p^2 in row; a small cusp, pointing inwards.

Measurements. On p. 128.

Distribution. Darjeeling. Siam. Java (*cf.* remarks below).

Technical name. Horsfield's type of *Rh. minor* is in the British Museum.

*Rh. pusillus**.—The figure of the head of *Rh. pusillus*, as given by Temminck, proves that he had before him one of the small species of what is here called the *lepidus* group (shape of connecting process, of sella, &c.). The only question is, therefore, to which species the name *pusillus* belongs. It would seem to be settled, beyond doubt, by Temminck's statement that the types were brought from Java. But Dobson, who examined these types in the Leiden Museum, gave the rather astounding information that they are "undoubtedly specimens of *Rh. hipposiderus*"!† There is only one answer: if so, an interchange of labels has

* Temminck, *ut supra*; Dobson, Cat. Chr. Brit. Mus. (1878) p. 117; id. Rep. Brit. Assoc. 1880, p. 175; Peters, MB. Akad. Berlin, 1880, p. 23.

† This is the source of the statement that *Rh. hipposiderus* should occur in Java; there is no other foundation. The range of *Rh. hipposiderus* has its extreme eastern limit in Gilgit (N.W. Himalayas); there is not a single reliable record of that Bat from the whole of the Oriental Region; and the species therefore cannot possibly turn up again in Java.

taken place in that Museum; for the Bat figured and described by Temminck as *pusillus* was certainly no *hipposiderus*; among all the small *Rhinolophi* existing it would be difficult to find a stronger contrast to *Rh. pusillus*, in the shape of the connecting process, than *Rh. hipposiderus*.

Remarks. From Java I have seen one old skin only (the type) and a fragment of the skull, representing the nasal swellings and the teeth. It is, of course, not sufficient to prove that the Java Bat is in all particulars identical with that from Darjeeling; but the nasal swellings, the teeth, the connecting process, the horse-shoe, as well as the measurements of the wings and tibia, are the same. If not identical, they are, at all events, extremely closely related.

19. RHINOLOPHUS CORNUTUS Temm.

Diagnosis. Skull and external characters essentially as in *Rh. minor*. Ears, tail, and tibia longer. Forearm 38·8–41 mm.

Details. Cf. *Rh. minor*.

Distribution. Loo-choo Islands, and Japan proper.

Geographical races. There are two races of *Rh. cornutus*, slightly differing in the general size, in the length of the tail and tibia, and in geographical habitat.

19a. RHINOLOPHUS CORNUTUS PUMILUS, subsp. n. (Plate IV. fig. 17 a, b, c.)

Rhinolophus minor (non Horsf.) Bonhote, Nov. Zool. ix. (1902) p. 626.

Diagnosis. On an average smaller: forearm 38·3–39·7 mm.

Details. See table of measurements, p. 128.

Colour. ♂ ad., ♀ ad., skins; March; teeth unworn. Fur strongly bicoloured, *i. e.* base of hairs strongly contrasting with the tip. *General effect* very much as in the adult *Rh. hipposiderus*. Upper side, anteriorly almost "broccoli-brown," posteriorly next to "Prout's brown"; base of hairs extremely light, almost white with a tinge of "ecru-drab." Under side "ecru-drab," darker on the flanks.

Skull. Quite of the *minor*-type. The teeth seem to be a mere trifle smaller.

Dentition (three individuals). p_3 external; p_2 and p_4 completely in contact. p^2 in row, but the space between the upper canine and p^4 narrower than in the *lepidus*-type and *Rh. minor*; cusp of p^2 so extremely minute as to be scarcely observable (teeth unworn), and the tooth itself a little reduced in size.

Type. ♀ ad. (in alcohol). Okinawa, Loo-choo Islands, March 16th, 1902. Presented by the Hon. N. C. Rothschild. Brit. Mus. no. 2.10.7.18.

Distribution. A skin (skull very incomplete) from Foo-chow (Swinhoe leg.; Tomes Collection) seems to be referable to this form.

19 b. RHINOLOPHUS CORNUTUS Temm., TYPICUS.

Rhinolophus cornutus Temminck, Monogr. Mamm. ii. 8^e monogr. (1835) p. 37; Temminck & Schlegel, Fauna Japonica, p. 14 (1842) pl. 3. figs. 3, 4; Peters, MB. Akad. Berlin, 1871, p. 309.

Rhinolophus minor (partim, nec Horsf.) Dobson, *ut supra*.

Diagnosis. On an average larger: forearm 39.2-41 mm.

Details. See table of measurements, below. To judge from three spirit-specimens, the plagiopatagium is inserted a little higher up on the tibia (1-3 mm. above the ankle) than in the foregoing forms of this group.

Colour. (1) Tsu-sima: ♂ ad., in alcohol, unfaded; September; teeth unworn. As *Rh. c. pumilus*. A young individual, from Tsu-sima, is still considerably darker.

(2) Japan proper: one skin, three spirit-specimens; teeth unworn. Very different; extremely like *Rh. lepidus*, if anything still a trifle lighter.

Skull. Quite of the *minor* type; measurements slightly larger.

Dentition (five skulls). p_3 almost in row (two), or external (three). p_2 and p_4 well separated (two), or almost in contact

Measurements of Rh. minor and cornutus.

	<i>Rh. minor.</i>		<i>Rh. cornutus.</i>			
	3 specimens, 3 skulls.		<i>pumilus.</i> 3 specimens, 2 skulls.		<i>f. typica.</i> 6 specimens, 5 skulls.	
	Min. mm.	Max. mm.	Min. mm.	Max. mm.	Min. mm.	Max. mm.
Ears, length	15	...	16	...	16	17.5
" greatest breadth	12.3	...	12	13
Nose-leaves, total length	11	...	11.2	12.5
" breadth of horse-shoe	? 7	...	6.2	...	6.4	6.7
Forearm	37	38	38.8	39.7	39.2	41
3rd metacarpal	26.8	27.5	27.7	28.7	28.2	29.8
III. ¹	10	10.8	10.7	11.4	11.1	11.6
III. ²	13	14.5	12.7	13.2	14	14.8
4th metacarpal	28.1	29	27.7	29.5	28.8	30.7
IV. ¹	7.8	8.5	8	8.7	8.5	9
IV. ²	9	9.8	8.7	9.2	9.9	10.3
5th metacarpal	26.8	28	27.7	29.5	29	30.9
V. ¹	8.8	9	9	9.5	9.1	9.7
V. ²	8.8	9.8	8.5	9.2	10.2	11.3
Tail	15.5	...	18	...	21	22
Lower leg	15.2	15.5	16.2	17.2	17.8	18.4
Foot	8	...	8.3	9
Skull, total length	15.7	16	16	17
" mastoid width	7.8	7.8	8	8.2
" width of brain-case	7	7.2	7	7.2
" zygomatic width	8	7.9	7.8	8
" supraorbital length	4	4.1	3.8	4	4.5	4.7
" width of nasal swellings	4	4.2	...	4.1	4	4.2
Mandible	10.4	10.4	10.2	10.4	10.5	11.2
Upper teeth	5.9	6	5.7	5.7	6	6.3
Lower teeth	6.2	6.3	6	6.1	6.2	6.8

(three); in none, completely in contact. p^2 in row; a well-developed cusp, pointing inwards. Upper canine and p^4 widely separated; in one skull there is a small interspace between p^2 and p^4 (the former place of p^3).

Distribution. Japan proper.

Remarks. In general size, as well as in the skull and dentition, the Tsu-sima Bat agrees with the typical form; but the colour is that of *Rh. c. pumilus**.

20. RHINOLOPHUS GRACILIS, sp. n. (Plate IV. fig. 18 a, b, c.)

Rhinolophus minor (partim, nec Horsf.) Dobson, *ut supra*.

Diagnosis. Skull: the *minor*-type. Sella parallel-margined; tail extremely short. Very small: forearm 36.2 mm.

Details. This is an aberrant species of the *minor*-type. The connecting process is quite of the same shape as in the foregoing species (very different from that of *subbadius*). But the sella is parallel-margined, as broad at the summit as at the base; by means of a lens (probably not without) an exceedingly faint trace of a constriction can be observed; the summit of the sella is broadly rounded off, as in *borneensis*, not with a tendency towards a subacute shape, as in the foregoing forms of this group; length of sella 2.8 mm.; width at base 1.8 mm., at summit 1.7 mm. The lancet is, considering the small size of the Bat, remarkably long (4 mm.), with the lateral margins almost straightly converging towards the tip; it recalls the lancet of *Rh. midas* and *hipposiderus* (with which species *Rh. gracilis* has no very close affinity).

The tail is extremely short (13.5 mm.), shorter than the lower leg. Plagiopatagium inserted a trifle above the ankle.

The colour (a little faded in alcohol) has probably been rather like that of *Rh. lepidus*.

Skull. Quite of the *minor*-type.

Dentition (one skull). p_3 external. p_2 and p_4 distinctly separated. p^2 in row; cusp extremely minute (unworn).

Measurements. On p. 132.

Type. ♀ ad. (in alcohol). Malabar Coast. Purchased. Brit. Mus. no. 73.4.16.2.

21. RHINOLOPHUS SUBBADIUS Blyth.

Rhinolophus subbadius Blyth, J. A. S. B. xiii. pt. i. no. 150 (June 1844) p. 486.

Rhinolophus garöensis Dobson, J. A. S. B. xli. pt. ii. no. 4 (Dec. 22, 1872) p. 337; id., Mon. Asiat. Chir. (1876) p. 48, text-figs. a-c; id., Cat. Chir. Brit. Mus. (1878) p. 115.

* I have examined a paratype of Gerrit S. Miller's *Rh. minutus* (Proc. Wash. Acad. Sci. 1900, p. 235), the type of which is from the Anambas Islands. It is an offshoot of the *minor*-type, but undoubtedly a distinct species, differing from *Rh. minor* (from Darjeeling) in having the brain-case decidedly higher in front, giving the skull, in side view, a very characteristic outline. The name "*minutus*" is, however, preoccupied by Montagu's "*Vespertilio minutus*," which is the British form of *Rh. hipposiderus*. Mr. Miller will rename the Anambas species.

Diagnosis. *Subbadius*-type (cf. p. 123). The smallest species in the genus: forearm 34.2 mm.

Details. The very characteristic shape of the connecting process, formed as a long, sharply pointed, slightly curved "horn," prevents the confusion of this (and the next-following) species with any of the foregoing forms. Also the shape of the lancet is peculiar: short, broad, almost as an equilateral triangle; but I doubt that this character, in a large series, will prove to be quite as safe a guide for the discrimination of the species as the shape of the connecting process; there is, in all species of *Rhinolophus*, a little more individual variation in the lancet than in other parts of the nose-leaves. The sella is, essentially, of the *minor*-type (not as in *gracilis*), much broader at base than at summit; below the constriction the margins are almost parallel, above the constriction slightly converging; *the summit somewhat more subacute** than in any of the foregoing species; tip of sella bent forwards.

Plagiopatagium inserted a trifle above the ankle.

The colour (a little faded) is probably not very different from that of *Rh. lepidus*.

Skull. Unknown. I have seen a small fragment only; it seems to be of the *minor*-type.

Dentition (one example). p_3 external. p_2 and p_4 in contact. p^2 in row; cusp small, but distinct.

Measurements. On p. 132.

Distribution. Nepal (type locality). Garo Hills †. (The only example of this species in the British Museum is without exact indication of locality.)

Technical name. Hodgson's "*Vespertilio subbadia*" (J. A. S. B. x. pt. ii. (Nov. 1841) p. 908), from the "Central Region of the Himalayas," is a nomen nudum (no word of description). The head of this Bat is figured in his unpublished drawings (pl. 8. fig. 3); it is not a *Rhinolophus*, but a *Hipposiderus*, probably *H. bicolor* or an allied form.

* I emphasise this peculiarity (and, on the whole, enter into a detailed description of the sella), because it is this "pattern" of sella which has been carried to an extreme in some of the Ethiopian and W. Palearctic representatives of the *subbadius*-type (*Rh. empusa* and *blasii*); cf. the "General Remarks," pp. 136-37).

† In Dobson's 'Monograph' and 'Catalogue' (l. s. c.) *Rh. garoënsis* (= *subbadius*) is recorded from Masuri. The species is very likely to occur there, only it must be said that till now there is no proof. Its alleged occurrence in Masuri can be traced back to two examples in the British Museum (Capt. Hutton) identified by Dobson with *Rh. garoënsis*. They are, however, *Rh. monticola*, differing in all important points (process, lancet, size) from his own original description of *garoënsis*. Quite as in the case of *Rh. petersi*: as Dobson had no longer access to the type, he lost the precise idea of it. Still later (Rep. Brit. Assoc. 1880, pp. 175-76) he gave up the separation of *Rh. garoënsis* as a distinct species, and then we arrive at the stage when all small Indian and E. Palearctic *Rhinolophi* with a projecting process were called *Rh. minor*, irrespective of differences in the skull, the process, the sella, lancet, general size, and geographical habitat. What led Dobson to this conclusion was the fact that the position of the lower p_3 varies in individuals from the same locality (which, however, also is the case in all the more primitive species of the *simplex* group, as high up in the series as *Rh. affinis*), and he was quite right in arguing that, from an exclusively *taxonomic* point of view, this character had no value; but he overlooked the other and more important characters by which the members of his composite species differ from each other.

Blyth's *Rh. subbadius* (1844) from Nepal, erroneously believed by himself to be the same as Hodgson's *V. subbadia*, is a genuine *Rhinolophus*. The following analysis of the original description will make it evident that it is the species here under consideration : (1) The connecting process is stated to be "conspicuously developed, and pointed"; one of the chief characters of *subbadius*. (2) The lancet is but "slightly emarginated towards the point"; also one of its principal characters; for the salient point in the sentence is the word "slightly," as proved by a comparison with the immediately subsequent description of *lepidus*, in which the lancet is called "considerably emarginated towards the tip." (3) Forearm " $1\frac{3}{8}$ inches" (34.8 mm.); third finger " $1\frac{7}{8}$ inches" (47.6 mm.); these measurements, as being smaller than in any other species, and like those of the individual before me (forearm 34.2, third finger 46.4 mm.), settle the identification beyond all doubt.

Rh. garoënsis.—Dobson's *Rh. garoënsis* (1872) is evidently the same species as Blyth's *Rh. subbadius** (to which there is no reference in Dobson's 'Monograph' or 'Catalogue'). The two authors emphasise the same points:—(1) The connecting process is described by Dobson as "forming an acutely pointed elevation." (2) The lancet is a "broad, triangular, pointed process," or, as he says in his 'Monograph,' "almost an equilateral triangle"; both of these features are the same as already pointed out by Blyth. (3) The Bat is said to be "probably the smallest known species of the genus," the forearm measuring only 1.3 in. (33 mm.). (4) Width of horse-shoe 0.2 in. (5.1 mm.); a very narrow horse-shoe is also characteristic of the species (5.5 mm., as measured by myself). In the type of *garoënsis* p_3 is, according to Dobson, in the tooth-row; this is of no importance for the identification; the position of this tooth is "vacillating" in the whole *lepidus* section.

22. RHINOLOPHUS MONOCEROS, sp. n.

Diagnosis. *Subbadius*-type. Larger: forearm, in a *not full-grown* example, 38.2 mm.

Details. Connecting process (text-fig. 22 *c*, on p. 121) and lancet as in *subbadius*. Horse-shoe markedly broader. General size considerably larger. Tail proportionately longer.

The type, and only specimen known to me, is not full-grown (supraorbital crests still separated posteriorly; no saggital crest; metacarpals far from having acquired their full length). In the table p. 132 I give only those measurements which may be of some use for comparison with *Rh. subbadius*.

Dentition. p_3 external. p_2 and p_1 in contact. p^2 in row; cusp very minute.

Type. ♀ juv. (in alcohol). Baksa, Formosa; June 5th, 1893. Collected by Mr. P. A. Holst. Presented by Henry Seebohm, Esq. Brit. Mus. no. 94.2.4.1.

* This view was held by the late Dr. Blanford, who, however, put the names down as synonyms of *Rh. minor* (J. A. S. B. lvii. pt. ii. no. 3 (1888) p. 262; Fauna Brit. Ind., Mamm. pt. ii. (1891) p. 277).

Measurements of Rh. gracilis, subbadius, and monoceros.

	<i>Rh. gracilis.</i>	<i>Rh. subbadius.</i>	<i>Rh. monoceros.</i>
	♀ ad. Type.	♂ ad.	♀ juv. Type.
	mm.	mm.	mm.
Ears, length	15·7	14·5	...
„ greatest breadth.....	11	11·2	...
Nose-leaves, total length.....	11·2	10	...
„ breadth of horse-shoe ...	6·2	5·5	6·5
Forearm.....	36·2	34·2	38·2
3rd metacarpal	25	24·8	...
III. ¹	9·7	9·8	11·2
III. ²	12	11·8	...
4th metacarpal.....	26·5	25	...
IV. ¹	7·7	7·2	8·8
IV. ²	8·8	8·7	...
5th metacarpal.....	26·5	25	...
V. ¹	8·3	7·8	9·2
V. ²	9·2	8·7	...
Tail	13·5	14	17·8
Lower leg	14·8	14·3	16·5
Foot	8	7·8	...
Skull, total length	15·7
„ mastoid width	7·7
„ width of brain-case	7
„ zygomatic width	7·7
„ supraorbital length	4·2
„ width of nasal swellings	4·2	4	...
Mandible, length	10	10·2	...
Upper teeth	6	6	...
Lower teeth	6·3	6·2	...

23. RHINOLOPHUS ACUMINATUS Peters.

Diagnosis. Connecting process of the *lepidus*-type. Sella parallel-margined. Forearm 47–51 mm.

Details. This species, together with *Rh. sumatranus* and *calypso* described below, form a small, well-marked section of the *lepidus* group, which might conveniently be termed the *acuminatus* section, confined to Java, Lombok, Sumatra, and Engano, and differing from all the foregoing species:—(1) in being very much larger; *Rh. lepidus* is in size like a *Rh. hipposiderus*; *Rh. sumatranus* like a small *Rh. ferrum-equinum*; (2) in being a trifle more advanced in dentition: there seems to be no “vacillation” in the position of p_3 .

Sella in *Rh. acuminatus* practically parallel-margined; on very close examination an extremely faint indication of an expansion below the middle can be traced. Lancet strongly hastate.

The rest of the nose-leaves, the mental grooves, the ears, the wing-structure, the length of the tail, and the insertion of the plagiopatagium (on the ankle, or slightly above or below) as in *Rh. lepidus*.

Skull. Very much larger than in *lepidus*. There is no essential difference in the shape*.

Dentition (two skulls). p_3 external. p_2 and p_4 quite, or almost, in contact. p^2 in row; a minute cusp, pointing inwards.

Measurements. On p. 134.

Geographical races. There are two forms of *Rh. acuminatus*, differing in size and in geographical habitat.

23 a. RHINOLOPHUS ACUMINATUS Peters, TYPICUS.

Rhinolophus acuminatus Peters, MB. Akad. Berlin, 1871, p. 308; Dobson, Cat. Chir. Brit. Mus. (1878) p. 113.
Rhinolophus petersi (partim, nec Dobson 1872 et 1880) Dobson, op. cit. (1878) p. 114.

Diagnosis. Larger: forearm 50·5–51 mm.

Colour.—(1) Dark phase: ♂ ad., skin; teeth unworn. As *Rh. refulgens*.

(2) Russet phase: ♀ ad., in alcohol, unfaded; teeth unworn. "Cinnamon-rufous" above; base of hairs of the same colour; under side lighter.

Distribution. Java.

23 b. RHINOLOPHUS ACUMINATUS AUDAX, subsp. n.

Diagnosis. Smaller: forearm 47–49·5 mm.

Colour. Two adult females, in alcohol, unfaded; teeth unworn, or worn. As *Rh. refulgens*.

Type. ♀ ad. (in alcohol). Lombok. Collected by A. Everett, Esq. Brit. Mus. no. 97.4.18.16.

Remarks. This form ought perhaps to be separated specifically from *Rh. acuminatus*. The mandible is markedly shorter, the teeth a trifle smaller, the nasal swellings slightly narrower, the geographical habitat quite isolated from that of *Rh. acuminatus*. But the Bali form, still unknown, may perhaps connect them together.

24. RHINOLOPHUS SUMATRANUS, sp. n.

Rhinolophus petersi (non Dobson 1872 et 1878) Dobson, P. Z. S. 1880, p. 462 (specimen examined).

Diagnosis. *Acuminatus* section, but sella very distinctly expanded below the middle. Width of horse-shoe 8·3 mm. Forearm 51–51·2 mm.

Details. Chief characters:—(1) compared with *acuminatus*: the very different shape of the sella, as described above; width at base, at expansion, and at summit: 2, 2·4, and 1·7 mm.; (2) compared with *calypso*: the much narrower horse-shoe.

Colour. ♂ ad., in alcohol, unfaded; teeth unworn. Upper

* The skull of the species of the *acuminatus* section is much like that of *Rh. rouxi*. It can, however, always be discriminated by the broader nasal swellings. The mandible is, proportionately, longer.

side darker than "mars-brown," lighter than "burnt-umber"; base of hairs scarcely differing in colour; under side "russet." This looks like an intermediate stage between a "dark phase" and a "russet phase." A second specimen (Göttingen Museum) is, however, quite of the same colour.

Skull. As in *Rh. acuminatus*.

Dentition (one skull). p_3 external. p_2 and p_4 quite in contact. p^2 in row; a minute cusp, pointing inwards. The interspace between the upper canine and p^4 is narrower than in *acuminatus*.

Measurements. Below.

Type. ♂ ad. (in alcohol). Lower Langkat, Sumatra; 1898. Presented by Herr Gustav Schneider. Brit. Mus. no. 4.4.1.1.

25. RHINOLOPHUS CALYPSO, sp. n. (Plate IV. fig. 19 a, b, c.)

Rhinolophus affinis (non Horsf.) Thomas, Ann. Mus. Civ. Genova (2) xiv. (1894) p. 108.

Diagnosis. Similar to *Rh. sumatranus*, but horse-shoe much broader: 10.2 mm.; ears longer and much broader. Forearm 52-52.3 mm.

Measurements of Rh. acuminatus, sumatranus, and calypso.

	<i>Rh. acuminatus.</i>				<i>Rh. sumatranus.</i>		<i>Rh. calypso.</i>	
	<i>f. typica.</i> 2 specimens, 1 skull.		<i>audax.</i> 2 specimens, 1 skull.		2 specimens, 1 skull.		2 specimens, 1 skull.	
	Min.	Max.	Min.	Max.	Min.	Max.	Min.	Max.
Ears, length	18.5	...	18	19	18.7	19	19.5	21.5
„ greatest breadth	14	...	14	14.5	14.3	14.3	16.3	16.8
Nose-leaves, total length	14	...	14	14.8	14	16	16	16.8
„ breadth of horse-shoe	8.2	...	8.1	8.2	8.2	8.3	10.2	10.2
Forearm	50.5	51	47	49.5	51	51.2	52	52.3
3rd metacarpal	35.8	36.5	33.7	35.2	35.2	36.8	37	38.3
III. ¹	16.2	16.2	15	15	15.2	16.3	15	15.8
III. ²	19.8	20.7	17.5	20	20	21	20.9	21.5
4th metacarpal	37.4	38.7	35.1	38.3	37.2	38	38.2	39.3
IV. ¹	11.2	11.8	9.7	10.5	11	11.7	10.3	10.8
IV. ²	13	...	12	13	13	13.6	12.8	13.8
5th metacarpal	37.7	38.7	36	38.8	37.5	38.3	38.2	39.3
V. ¹	12.6	12.8	11.5	11.8	12.2	12.7	11.8	11.8
V. ²	13.6	...	13	13.5	13.7	14.6	12.8	13.8
Tail	25	...	21.7	23.5	25.2	26.5	24.7	26.5
Lower leg	22.2	23	21	21.7	22.5	22.5	22.5	23.2
Foot	11.8	...	10.8	11	10.8	11	10.3	11
Skull, total length	21.2	21.6
„ mastoid width	10	10.2
„ width of brain-case	9.3	9.2
„ zygomatic width	11.4	11.2	10.9
„ supraorbital length	5	5.3	5	5.4
„ width of nasal swellings	6.2	6	6.2	6.3
Mandible, length	16	14.8	15.8	15.2
Upper teeth	8.8	8.2	8.8	8.7
Lower teeth	9.5	9	9.6	9.2

Colour. ♂ ad. and ♀ ad., in alcohol, unfaded; teeth unworn. As *Rh. refulgens*.

Skull. As in *Rh. sumatranus*, but maxillar width, across the antero-external corners of m^3 , narrower (8.1 mm., as against 8.6 in *Rh. sumatranus*).

Dentition. Essentially as in *Rh. sumatranus*, but the interspace between the upper canine and p^1 broader; p_2 and p_4 not quite in contact.

Type. ♂ ad. (in alcohol). Kifa Juc, Engano. Collected by Dr. E. Modigliani. Presented by Marquis G. Doria. Brit. Mus. no. 94.1.7.3.

General Remarks on the Rhinolophus lepidus Group.

The ancestral species.—The ancestors of the *simplex* and *lepidus* groups were very closely related. The latter had a projecting connecting process, a slightly smaller skull and teeth. But the general *shape of the skull*, the *dentition*, the nose-leaves, apart from the process and a very slight difference in the shape of the sella, the ears, the *wing-structure*, the length of the tail, and, we might even say, probably the size, were either identical or extremely similar in both of these extinct Bats.

The place of origin.—There can scarcely be any doubt that the *lepidus* group originated much farther westwards than the *simplex* group. If we regard Japan as a continental group of islands, and put aside Java, on account of its peculiar geological history, we still find, not only the most primitive, but in fact *all* the species of the *lepidus* section on the Continent. It is only the *acuminatus* section which has spread over the adjacent larger islands, one of which (Sumatra) has comparatively recently been continental, while another (Java), probably in a more remote period, seems to have been connected with some part or other of Indo-China; and only one form, still so closely related to the Java species as hardly to be specifically different, has found its way so far eastwards as Lombok. The hypothesis, therefore, cannot be called unfounded, that *of the two ancestral species, the ancient "simplex" and the ancient "lepidus," the former was Eastern in range (Austro-Indo-Malayan), the latter Western (Oriental).*

*Differentiation**.—From a systematic point of view I found it convenient to divide the *lepidus* section into three "types"; I think that, phylogenetically speaking, there are two only: the *lepidus* and the *minor* type. The former, as coming nearest to *simplex* in the proportionate size of the skull and teeth, is, probably, the more primitive; it is now distributed over the Indian Peninsula (*lepidus*), the Himalayas (*monticola*), and Malacca (*refulgens*). The latter, the *minor*-type, has spread from the Himalayas (*minor*) eastwards through S. China to Japan (*cornutus*); it is represented on the now quite isolated Anambas Islands (" *minutus*"); its occurrence in Java is not surprising, considering

* Compare the diagram on p. 138.

the faunistic affinities of that island; and it has established itself on the western coast of the Indian Peninsula (*gracilis*). I have but very little doubt that now, when attention has been called to the differences of all these forms of the *minor*-type, it will be found also in other parts of the Indian Peninsula.

If any inference can be drawn from fragments of a skull and the external characters, the *subbadius*-type would appear to be an offshoot of the *minor*-type: already in *minor* and *cornutus* the process is a little sharper-pointed than in *lepidus*; in *subbadius* and *monoceros* this tendency is carried much further.

The skull of the species of the *acuminatus* section (Java-Lombok, Sumatra-Engano) is of the *lepidus*-type; the process too; the colour remarkably like that of *refulgens*. This leads me to suppose that *acuminatus* and its allies (*sumatranus*, *calypso*) are scarcely more than giant representatives of the *lepidus*-type.

It is the *subbadius*-type which, from a zoogeographical point of view, is by far the most interesting: it has spread southwards over a vast part of the Ethiopian Region, and westwards over the Mediterranean countries:—

(1) The *empusa*-type.—*Rh. empusa** and *blasii* have progressed further on the way already indicated by *Rh. subbadius*. They have the small skull and the small teeth characteristic of *minor-subbadius*; in the shape of the skull there is no essential difference; *the dentition is identically the same*; the process is that of a *subbadius*; *the sella is deltoid*, that is: the tendency, in the *subbadius*-sella (as emphasised above), towards assuming a subacute summit has been further developed; and we still see *the constriction at the middle of the sella*. But *empusa* and *blasii* are (as always the Ethiopian and W. Palearctic species) in several points more highly developed: III.² is lengthened (about, or more than, $1\frac{1}{2}$ the length of III.¹); also IV.² is very much longer (not far from twice the length of IV.¹). *Rh. empusa* is, however, an inhabitant of Nyasaland, far S. of the Equator, *Rh. blasii* of the Mediterranean Subregion; thus, the two extremely closely allied species are now separated by an enormous tract, where no relative appears to occur. As we now know that they are descendants of the Oriental *subbadius*-type, the explanation seems to be quite clear: one branch spread southwestwards, into the Ethiopian Region, and developed into *Rh. empusa* (slightly more primitive dentition; shorter ears, broader horse-shoe); another westwards into the Mediterranean countries, *Rh. blasii*. There is an instructive fact connected with these two Bats: I believe them to be comparatively recent intruders into their areas; *Rh. empusa* is known from one specimen only, from the very East of Tropical Africa; *Rh. blasii* is much more common in the Eastern Mediterranean tract, and still it does not seem to have reached Spain †.

* Andersen, Ann. & Mag. Nat. Hist. (7) xiv. (1904) p. 378 (there is a misprint on p. 380: the length of the mandible is 12·1, not 13·1 mm.).

† Not recorded in Cabrera Latorre's "Quirópteros de España," Mem. Soc. Españ. Hist. Nat. ii. (1904). I am also not satisfied that there is any reliable record from the African coast of the Mediterranean.

(2) The *landeri-euryale* type.—The Ethiopian *Rh. landeri* (Fernando Po, Gaboon), *Rh. lobatus* (Lower Zambesi to Mombasa), and *Rh. dobsoni** (Kordofan) have the small skull and the small teeth characteristic of *minor-subbadius*; the same shape of the skull; the same dentition (no vacillation in the position of p_3); the process is that of a *subbadius*. In so far there is no difference at all between this section and the former (*empusa-blasii*). But in the shape of the sella and in a certain peculiarity in the wing-structure they have taken a course of their own:—We have seen, in the *simplex* group, a progressive development from a sella constricted at the middle, through a parallel-margined stage, to a pandurate sella; we have seen in the *lepidus* group, too, the constricted sella (*minor*) modified into the parallel-margined (*gracilis*); the Ethiopian species here under consideration represent the third and final stage, the pandurate sella. In addition to this: in all of them IV.¹ is peculiarly shortened: less than (extremely rarely, as a slight individual atavism, equal to) half the length of IV.². As in *Rh. empusa* and *blasii*, III.² is lengthened.

Rh. euryale, from the Mediterranean Subregion, is so extremely closely allied to the above-named Ethiopian species that it shares with them all essential characters (even the highly peculiar shortening of IV.¹), with one exception: it has retained the parallel-margined sella.

Summary.—When discussing the affinities of the Ethiopian species of the *Rh. simplex* group (above, pp. 117–20), I arrived at the conclusion that they are undoubtedly derived from Oriental types, and that, most probably, the ancestral species have spread directly from South Asia into the Ethiopian Region. As will be observed from this, a study of the Ethiopian representatives of the *Rh. lepidus* group leads to quite the same result: they have their closest known allies in the Oriental Region, but they are, without exception, considerably more highly developed than any of their Oriental relatives. Bats of the *subbadius*-type have evidently spread from some part of South Asia southwestwards into the Ethiopian Region (*empusa*; *landeri*, *lobatus*, *dobsoni*), and westwards over the Mediterranean countries (*blasii*; *euryale*). Of all the species of the *Rh. lepidus* group only one has found its way to Lower Egypt, *Rh. euryale*. It is a species exclusively Mediterranean in range, and unusually liable to differentiation into slightly differing local forms †. Its presence in Lower Egypt is easily explained by invasion from the adjacent Asiatic coast of the Mediterranean, where it is very common (specimens from Lower Egypt are indistinguishable from the Palestine form, *Rh. e. judaicus*) ‡.

* Thomas, Ann. & Mag. Nat. Hist. (7) xiv. (1904) p. 156.

† Andersen and Matschie, "Ueber einige geographische Formen der Untergattung *Euryalus*" (SB. Ges. naturf. Fr. Berlin, 1904, pp. 71–83).

‡ Although it is beyond the strict limits of the present paper, I propose to insert a few words on the remaining Ethiopian species of the genus:—The *athlops* section (*Rh. athlops*, *hildebrandti*, and *fumigatus*) are very closely related to the Himalayan *Rh. macrotis*, but much more highly developed in the dentition, the wing-

The probable affinities and phylogeny of the principal forms of the *Rh. lepidus* group are expressed in the subjoined diagram (Ethiopian types marked with an asterisk):—

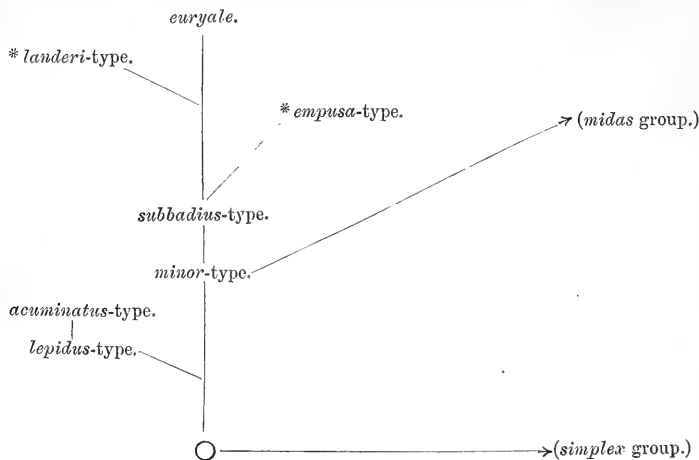

III. THE *RHINOLOPHUS MIDAS* GROUP.

Diagnosis. Cochleæ large, making the basioccipital, between them, extremely narrow (linear). Posterior connecting process very low and rounded off.

26. *RHINOLOPHUS MIDAS*, sp. n. (Plate IV. fig. 20 *a*, *b*, *c*, *d*.)

Diagnosis. Sella almost deltoid, summit rounded. Forearm 37.7 mm.

Details. Horse-shoe as broad as the upper lip; no "tooth" on the sides of the median notch; no crenulation of the border. Lateral margins of sella converging from base to tip; breadth at base (2.3 mm.) much more than half the vertical height of the sella (3.5 mm.); a very slight (rather easily overlooked) constriction at the middle; summit rounded (breadth 1.6 mm.). Connecting process very low, and broadly rounded off. Lancet long (4 mm.) and cuneate. One mental groove only.

Ears a little longer than in *minor*, outer margin immediately below the tip somewhat more emarginate; tip more distinctly pointed.

Wing-structure, compared with that of *minor*, considerably

structure, and the mental grooves (Andersen, Ann. & Mag. Nat. Hist. (7) xvi. Sept. 1905, pp. 291-92). *Rh. macclaudi* is an Ethiopian representative of the *Rh. philippinensis* group, but on a considerably higher stage of development in the same respects as the species just named (*Id.*, tom. cit. Aug. 1905, pp. 254-55).

This completes the account, showing that all the Ethiopian *Rhinolophi*, without exception, are of Oriental origin.

modified, chiefly in two respects:—(1) *the third metacarpal is shortened*; but at the same time the fourth metacarpal has remained the longest (as in all primitive species of *Rhinolophus*); (2) III.², IV.², and V.², that is all the distal phalanges, are lengthened. Compare the table of measurements of *Rh. midas* and *hipposiderus* on the one side, with those of *minor*, *lepidus*, and all their allies on the other (see p. 143).

Tail rather long, $1\frac{1}{2}$ the length of the leg. Plagiopatagium inserted on the ankle-joint.

Colour (somewhat faded in alcohol) probably as light as in *Rh. blasii*.

Skull. In all species of *Rhinolophus* the cochleæ are large, making a narrow basioccipital (compare the genus *Hipposiderus*); but in *Rh. midas* and *hipposiderus* the peculiarity is carried to an extreme: *the cochleæ are so much increased in size as to reduce the basioccipital to a linear bridge of bone*; in some individuals (of *Rh. hipposiderus*) the cochleæ are almost in contact. This character alone makes the skull of these two species easily distinguishable, at a glance. But in every other respect, in the shape, the size, and the teeth, the skull is so exceedingly like that of *Rh. minor*, that there can scarcely be any doubt as to the very close relationship of the *minor* and *midas* types.

Dentition. On the *minor* stage:— p_3 external. A very narrow interspace between p_2 and p_4 . p^2 quite in row; a small cusp, pointing inwards. Upper canine and p^4 well separated.

Type. ♀ ad. (in alcohol). Jask, Persian Gulf. Presented by A. Butcher, Esq. Brit. Mus. no. 94.11.16.1.

Remarks. The discovery of this highly interesting species seems to remove all doubt as to the close affinities of *minor* and *hipposiderus*. The sella of *midas* is intermediate between that of *minor* and *hipposiderus*; it recalls that of *empusa* and *blasii*, which also are modifications of the *minor*-type; to the peculiarly long and cuneate lancet we have a parallel in one of the modifications of the *minor*-type described in this paper, viz. *Rh. gracilis*. The geographical habitat of *midas* is, too, rather intermediate between the Oriental *minor* and the W. Palearctic *hipposiderus*.

Rh. midas is, of course, readily distinguishable from *Rh. hipposiderus* by the shape of the sella. In the width of the brain-case, as well as in external dimensions, it is like the *southern*, more primitive form of *hipposiderus* (*Rh. h. minimus*).

27. RHINOLOPHUS HIPPOSIDERUS Bechst.

Diagnosis. Sella cuneate; summit pointed. Forearm 34·7–41·7 mm.

Details. Breadth of sella at base never more, but generally less, than half its vertical height.

Colour. (1) Younger, but quite full-grown individuals; skins; Cyprus, S. Carpathians, Switzerland. Very nearly "mouse-grey" above; horse-shoe patch faintly, or not at all, indicated; base

of hairs of the upper side and the whole of the under side "drab-grey."

(2) Aged individuals; skins; Cyprus, Malta, Balearic Islands, Switzerland, Germany. Much browner. General colour above brownish "drab," with some individual variation in the shade of the colour: sometimes almost "wood-brown" (lightest extreme), sometimes with a tinge of "Prout's brown" (darkest extreme); horse-shoe patch indicated, or quite obliterated; base of hairs "ecru-drab"; under side "ecru-drab," sometimes with a tendency towards "drab-grey."

Skull. As in *Rh. midas*.

Dentition. As in *minor* and *midas*. In the series of skulls examined (20; of all races) there is, of course, some variation in the position of p_3 ; the general rule is: p_3 external, p_2 and p_4 almost or quite in contact; one extreme: p_3 almost in row (one skull), and p_2 and p_4 , therefore, well separated; the other extreme: p_3 not only external, but hair-fine (four skulls; teeth unworn), or disappeared and the alveoli obliterated (two skulls; teeth unworn).

Distribution. From Gilgit to Ireland; from the Baltic to Sennar.

Geographical races. The series examined—95 examples, from almost the whole area occupied by the species—enables me to recognise three races of *Rh. hipposiderus*. The first two of these would probably be called distinct species by other zoologists.

27 a. RHINOLOPHUS HIPPOSIDERUS MINIMUS Heugl.

Rhinolophus minimus Heuglin, N. Act. Acad. Cæs. Leop.-Car. xxix. (1861) p. 6.

Rhinolophus hipposiderus minimus Andersen, Ann. & Mag. Nat. Hist. (7) xiv. (1904) p. 455.

Diagnosis. Small: forearm 34·7–38 mm.

Details. As lately pointed out by me elsewhere (*l. s. c.*), v. Heuglin's *Rh. minimus*, first described from Keren in Erythrea (type in the Stuttgart Museum), is a well-marked geographical race of *Rh. hipposiderus*, differing from the Central European form by its considerably smaller size. At the same time I mentioned that the British Museum possesses an example from Sennar indistinguishable from the type specimen of *minimus*. A subsequent examination of the whole series of *Rh. hipposiderus* preserved in the British Museum has revealed the rather surprising fact that *Rh. h. minimus* is by no means confined to Keren and Sennar, but generally distributed over the Mediterranean Subregion.

It differs from the Central European form in being in every respect smaller; in some respects, as it seems, absolutely smaller, in others at least on an average. I find the length of the forearm to be the best means for a ready discrimination: in *minimus*, 34·7–38 mm.; in the typical form, 39–41·7 mm. For other details, cf. the measurements on p. 143.

The skull is markedly smaller, the nasal swellings a trifle narrower, the teeth slightly smaller.

Distribution. 32 specimens examined. As it is of some interest to have the range of this hitherto overlooked form exactly determined, I subjoin a list of the localities from which I have seen examples, together with measurements of the forearm; it might perhaps lead to further investigation:—

Keren (1, the type*): forearm 36·3. Sennar (1): 36·5. Cyprus (6): 34·7–37·7. Smyrna (1): 37·5. Malta (8): 36–37. Middle Italy (Ostia 2): 35·7–36·8. Corsica (1): 37·7. Haute Savoie and Geneva (2): 37·7–38. Balearic Islands (7): 36·2–37·6. Seville † (1): 37·7. Morocco (Tangiers 1): 37·7. Portugal (Cintra 1): 36·2.

Summary of Distribution:—The Mediterranean Subregion, southeasterly to Sennar and Keren. Be it noted: there is no record from Egypt (and, very likely, it does not occur there: cf. remarks on p. 143).

Remarks. In the whole series of *Rh. hipposiderus* examined (apart from the British specimens, of course) I have not found any individual which I could not easily refer either to the southern or the northern form. I have some reason to believe that in certain border districts (e. g. S. W. Switzerland; perhaps also Cyprus) the two forms occur together, perhaps side by side, but intermediate examples I have never seen. They will probably be found.

27 b. RHINOLOPHUS HIPPOSIDERUS Bechst., TYPICUS.

Vespertilio Ferrum equinum (partim) Schreber, Säugthiere, i. (1775) pp. 174, 188, pl. 62 (lower fig. only).

Vespertilio equinus (partim) P. L. S. Müller, Natursyst., Suppl. (1776) p. 20.

Vespertilio Ferrum equinum, β . minor, Gmelin, Linn. Syst. Nat. i. (1788) p. 50.

Vespertilio Hippocrepis (partim) Schrank, Fauna Boica, i. (1798) p. 64.

Vespertilio Hipposideros Bechstein, in Pennant's Allg. Uebers. vierfüß. Thiere, ii. (1800) p. 629, footnote (compare also pp. 615 and 736).

Vespertilio hippocrepis Hermann, Obs. Zool. (1804) p. 18.

Rhinolophus bi-hastatus Geoffroy St.-Hilaire, Descr. de l'Égypte, ii. (1812) p. 132; id., Ann. Mus. d'Hist. Nat. xx. (1813) p. 259, pl. 5.

* For the loan of this specimen I am indebted to Prof. Dr. Kurt Lampert, Director of the Royal Natural History Cabinet, Stuttgart. The type is a young, but apparently fullgrown, individual. All other examples of *hipposiderus*, of all races, of which I give the measurements, are fully adult (distal epiphyses of metacarpals ossified).

† As I have seen only one example from Spain, I may mention that of the whole series examined by Cabrera Latorre, for his "Quirópteros de España," no Spanish specimen had the forearm more than 37·5 mm. (Mem. Soc. Españ. Hist. Nat. ii. (1904) p. 252). I am unacquainted with the *Rh. phasma* (allied to *hipposiderus*) described by Cabrera in the same paper.

Rhinolophus Hipposideros var. *typus*, *alpinus*, et *pallidus* (partim) Koch, Jahrb. Ver. Naturk. Nassau (1862-63) pp. 530-31*.

Rhinolophus hipposideros (partim) Peters, MB. Akad. Berlin, 1871, p. 310; Dobson, Cat. Chir. Brit. Mus. (1878) p. 117.

Rhinolophus bihastatus var. *Kisnyiresiensis* Daday, Orvos-Term. Értés. x. pt. 3 (1885) p. 274.

Rhinolophus hipposideros var. *troglophilus* Daday, Magy. tud. Akad. Ertekez. xvi. pt. 7 (1886) p. 8, figs. 1, 2.

Rhinolophus eurjale helvetica Bretscher, Vierteljahrsschr. naturf. Ges. Zürich, xlix. (1904) p. 256 †.

Diagnosis. Large: forearm 39-41·7 mm.

Distribution. 33 specimens have been examined, from the following localities:—

Gilgit (1): forearm 39·8. Urmi, N.W. Persia (1): 39·8. Van, Armenia (2): 39·2-39·3. Cyprus (1): 39·6 ‡. N. Bulgaria (1): 39. Roumania (13): 39-41·2. Transsylvania (2): 40-41. S. Carpathians (1): 39·3. Hungary (1): 41·7. Schlangenbad (2): 40-40·1. Strassbourg (3): 39-40·1. Thurgau and Vallais (5): 40·2-41·7.

Summary of Distribution:—From the extreme N.W. Himalayas, through N.W. Persia and Armenia, over the whole of Central Europe N. of the Balkans and the Alps.

27c. RHINOLOPHUS HIPPOSIDERUS MINUTUS Montagu.

Vespertilio minutus Montagu, Trans. Linn. Soc. ix. (1808) p. 162, pl. 18. figs. 7-8.

Diagnosis. Forearm 36·3-39 mm.

Details. English and Irish individuals of *Rh. hipposiderus* differ from the Central European form in being on an average (and nearly always also *absolutely*) smaller. The length of the forearm varies, in 30 adult specimens from England, Wales and Ireland, between 36·3 and 39 mm., the average being 37·6. In other words: *the average size of the British race is considerably below the minimum of the typical form, and almost exactly like maximum of Rh. h. minimus.*

Distribution. England, Wales, Ireland §.

Technical name. Till the close of the 18th century, the two Bats now called *Rh. ferrum-equinum* and *Rh. hipposiderus* were

* Koch's "varieties" are scarcely determinable, his descriptions being utterly vague and based upon such characters as are subject to individual variation or dependent on age: var. *typus* and *alpinus* belong, probably, to the Central European form; var. *pallidus* seems to be a mixture of this and the southern race.

† A glance at the measurements in Bretscher's paper is sufficient to show that what he takes to be "eine ausgesprochene Lokalform" of *Rh. eurjale* is an ordinary, typical *Rh. hipposiderus*!

‡ I ought perhaps to mention that this example, the only *typical hipposiderus* I have seen from Cyprus, is a dealer's specimen; a Cyprus series collected and presented by Miss Dorothy M. A. Bate (cf. P. Z. S. 1903, ii. p. 342) are unquestionably of the Mediterranean form.

§ For details, cf. J. E. Kellsall, "The Distribution in Great Britain of the Lesser Horse-shoe Bat," The Zoologist, xlv. (1887) p. 89.

regarded as a large and a small variety of one species. In 1808, Montagu pointed out some of their distinctive characters, and proposed for the smaller species the name *Vespertilio minutus*, being evidently unaware that the two Bats had already twice been specifically separated—by Bechstein in 1800, and by Hermann in 1804. Montagu's name, as being antedated by "*hipposiderus*," was soon almost completely forgotten (it is not recorded in Dobson's Catalogue). The original description of *V. minutus* being, however, based on English specimens, the name is now available for the British race of *hipposiderus*.

Remarks. We are now able to form a much clearer idea of the past history of *Rh. hipposiderus*. It originated from a Bat allied to *Rh. minor*, somewhere in Asia, most probably near the western border of (if not within) what is now called the Oriental Region. From there it spread southwestwards into Africa, westwards through the Mediterranean countries to Central Europe and the British Islands. There is, to my knowledge, no record of *Rh. hipposiderus* from Egypt; if this is evidence that it does not occur, and has not occurred, there, it is at the same time a

Measurements of Rh. midas and hipposiderus.

	<i>Rh. midas.</i>	<i>Rh. hipposiderus.</i>					
	♂ ad. Type.	<i>minimus.</i> 32 specimens, 12 skulls.		<i>f. typica.</i> 33 specimens, 6 skulls.		<i>minutus.</i> 30 specimens, 2 skulls.	
	mm.	Min.	Max.	Min.	Max.	Min.	Max.
Ears, length	17	14	16	15	16.5	14.2	15.5
„ greatest breadth	13	10	12	11.3	12.8	11.1	11.8
Nose-leaves, total length	12.8	10.6	12	11.2	12.9	10	11.8
„ breadth of horse-shoe	7.3	6	6.8	6.5	7	6	6.7
Forearm	37.7	34.7	38	39	41.7	36.3	39
3rd metacarpal	24.2	22.2	25.7	24.8	27.3	22.8	24.9
III. ¹	11.8	11	12.8	12.7	14.2	11.6	13.2
III. ²	18.8	15.7	19	17.7	19.7	16.3	18.7
4th metacarpal	27	25	29.2	28	30.2	25.7	29.1
IV. ¹	7.1	5.8	7.8	7	8	6.7	8
IV. ²	12	10.9	13.2	12	14.1	11.7	13.2
5th metacarpal	25.8	23.5	27.7	27.2	29.7	24.7	28.2
V. ¹	8.9	7.9	9.2	9.1	10.5	7.2	9.8
V. ²	12.2	11.2	13.8	12.8	14.3	12.5	14.3
Tail	24.5	23.5	27.7	26.2	30.3	23.5	27
Lower leg	16.2	16	17.8	17.8	19.9	16.3	18.5
Foot	7.6	7.2	7.8	7.5	8.5	7.5	8.7
Skull, total length	15.9	14.5	15.5	16	16.2	16	16
„ mastoid width	7.4	7.2	7.7	7.7	7.8	7.8	7.8
„ width of brain-case	6.4	6.1	6.5	6.8	6.8	6.8	6.8
„ zygomatic width	7.6	7.2	7.9	7.8	8	8	8
„ maxillary width	5.8	5.2	5.3	5.3	5.5	5.6	5.7
„ supraorbital length	4.5	4	4.5	4.2	5	4.3	4.4
„ width of nasal swellings	4.2	3.7	3.8	3.9	4	4	4
Mandible, length	10.8	9.5	10	10	10.2	...	10.2
Upper teeth	5.8	5.2	5.4	5.4	5.7	5.7	5.7
Lower teeth	6.2	5.6	5.8	5.8	6	5.9	6

proof that it did not reach Erythrea and Sennar from the Mediterranean, by way of the Nile Valley, but *via* the formerly existing, broad land-connection between S.W. Asia and N.E. Africa. The individuals which established themselves in Central Europe, N. of the Balkans and the Alps, gradually making their way as far north as the Baltic, developed into a distinct, larger race (*Rh. h. typicus*). The British colony, originally the extreme western offshoot of the larger form, but soon cut off from communication with the Continental main stem, also developed into a distinct race (*Rh. h. minutus*); it got the not unusual stamp of an island form: the smaller size; and so it came to occupy, *seemingly*, but neither phylogenetically nor geographically, a somewhat intermediate position between the northern and southern races of *hipposiderus*, between its immediate and its more remote progenitors.

It is worth noticing that *Rh. hipposiderus* is distributed over the whole of England, occurring also in several places in Ireland, whereas *Rh. ferrum-equinum* is confined to the extreme south of England, apparently not farther north than Essex, Gloucester, and Pembroke, and has never reached Ireland. It may indicate that of these two comparatively recent immigrants into the British Islands, *Rh. hipposiderus* was the earlier comer. This assumption seems strengthened by another fact. On the Continent *Rh. hipposiderus* goes farther northwards and considerably higher up on the mountains than *ferrum-equinum*. It is but reasonable to suppose that the more hardy species was also the first to make its way to England.

IV. SUMMARY.

1. A progressive evolution is pointed out from the Austro-Malayan *Rh. simplex*, through a long series of Oriental forms, to the Western Palearctic *Rh. ferrum-equinum* (pp. 76-120; *résumé* pp. 116-120).

2. A similar chain from the Oriental *Rh. lepidus* to the Western Palearctic *Rh. blasii* and *Rh. euryale* (pp. 123-138; *résumé* pp. 135-138).

3. The Western Palearctic *Rh. hipposiderus* has no closer known relative than *Rh. midas* from the coast of the Persian Gulf, which again can be traced back to the Oriental *Rh. minor* (pp. 138-144).

4. All the Ethiopian representatives of the genus *Rhinolophus* are of Oriental origin (pp. 117-120, 136-138).

5. The following 26 forms (14 species and 12 subspecies) are described as new, all of them Austro-Malayan, Oriental, or Asiatic-Palearctic:—*Rh. simplex*, p. 76; *megaphyllus monachus*, p. 80; *navus*, p. 82; *celebensis*, p. 83; *virgo*, p. 88; *neréis*, p. 90; *sthenos*, p. 91; *rouxi sinicus*, p. 98; *thomasi*, p. 100; *affinis himalayanus*, p. 103; *a. tener*, p. 103; *a. macrurus*, p. 103; *a. superans*, p. 104; *a. nesites*, p. 104; *a. princeps*, p. 106; *ferrum-*

equinum regulus, p. 112; *f. proximus*, p. 112; *monticola*, p. 124; *refulgens*, p. 124; *cornutus pumilus*, p. 127; *gracilis*, p. 129; *monoceros*, p. 131; *acuminatus audax*, p. 133; *sumatranus*, p. 133; *calypso*, p. 134; *midas*, p. 138.

6. The following 10 forms, hitherto usually regarded as identical with other species, are shown to be distinct species or subspecies:—*Rh. truncatus* Peters, p. 80; *borneensis* Peters, p. 84; *rouxi* Temm., p. 93; (*ferrum-equinum*) *nippon* Temm., p. 110; (*f.*) *tragatus* Hodgs., p. 111; *lepidus* Blyth, p. 123; *cornutus* Temm., p. 127; *subbadius* Blyth, p. 129; (*hipposiderus*) *minimus* Heugl., p. 140; (*h.*) *minutus* Mont., p. 142.

7. The following names, hitherto usually regarded as indicative of distinct species, are referred to the lists of synonyms:—*Rh. petersi* Dobson, p. 95; *garoënsis* Dobson, p. 131.

EXPLANATION OF THE PLATES.

PLATE III.

Rhinolophus simplex group; skulls; front views $\frac{2}{3}$, all other figures $\frac{1}{3}$.

- Fig. 1. *Rh. simplex* (p. 76); Lombok; type of the species. Front view.
 2 a, b, c. *Rh. megaphyllus f. typica* (p. 79); Cooktown; B.M. no. 3.8.3.3. Upper, lateral, and front views.
 3. *Rh. nanus* (p. 82); Goram; type. Front view.
 4 a, b. *Rh. celebensis* (p. 83); Makassar; type. Upper and front views.
 5 a, b, c. *Rh. borneensis f. typica* (p. 84); Labuan; topotype; B.M. no. 65.5.9.15. Upper, lateral, and front views.
 6. *Rh. malayanus* (p. 89); Biserat; topotype; B.M. no. 3.2.6.84. Front view.
 7 a, b, c. *Rh. nereis* (p. 90); Siantan, Anambas; type. Upper, lateral, and front views.
 8 a, b. *Rh. stheno* (p. 91); Selangor; topotype; B.M. no. 98.3.13.2. Lateral and front views.
 9 a, b, c, d. *Rh. rouxi f. typica* (p. 93); Ceylon. Upper, lower, lateral, and front views.
 10. *Rh. thomasi* (p. 100); Taho, Karin Hills; topotype; B.M. no. 90.4.7.9. Upper view.
 11 a, b. *Rh. affinis himalayanus* (p. 103); Nepal. Lower and front views.
 12. *Rh. a. tener* (p. 103); Pegu; type. Upper view.
 13. *Rh. a. princeps* (p. 106); Lombok; type. Upper view.

PLATE IV.

Rhinolophus simplex, *lepidus*, and *midas* groups; skulls; front views $\frac{2}{3}$, all other figures $\frac{1}{3}$.

- Fig. 14 a, b, c, d. *Rh. ferrum-equinum tragatus* (p. 111); Nepal; one of the cotypes. Upper, lower, lateral, and front views.
 15. *Rh. f. proximus* (p. 112); Gilgit; type. Upper view.
 16 a, b, c. *Rh. refulgens* (p. 124); Perak; type. Upper, lateral, and front views.
 17 a, b, c. *Rh. cornutus pumilus* (p. 127); Loo-choo Isl.; topotype; B.M. no. 2.10.7.2. Upper, lateral, and front views.
 18 a, b, c. *Rh. gracilis* (p. 129); Malabar coast; type. Upper, lateral, and front views.
 19 a, b, c. *Rh. calypso* (p. 134); Engano; type. Upper, lateral, and front views.
 20 a, b, c, d. *Rh. midas* (p. 138); Jask, Persia; type. Upper, lower, lateral, and front views.

4. On Stridulating Hemiptera of the Subfamily *Halyinae*, with Descriptions of new Genera and new Species. By Dr. E. BERGROTH, C.M.Z.S., Tammerfors, Finland.

[Received April 1, 1905.]

In his paper "Zur Kenntniss der Stridulationsorgane bei den Rhynchoten," Handlirsch* has described three different kinds of stridulatory organs in the Rhynchota: the prosternal furrow of the Reduviidæ; the strigose ventral patches of the Division Tetyraria of the Scutelleridæ; and the, at that time, still incompletely known stridulating apparatus of the Corixidæ, of which Kirkaldy† has since given us a complete description and a probably correct interpretation. There is, however, one group of Rhynchota in which these organs have remained unknown to Handlirsch and all other zoologists, except the distinguished systematist Stål, who knew them without recognising their function. In his important paper "Bidrag till Hemiptervernas systematik"‡ he states that the Pentatomid genera *Platycoris*, *Niarius*, *Alphenor*, and *Oncocoris* have the following character in common: "segmentis ventris secundo et tertio latera versus vitta longitudinali nonnihil curvata, opaca, vix elevata, transversim densissime subtilissimeque strigosa, instructis." Although *Gilippus* is described in the same paper, Stål seems to have overlooked the fact that this genus possesses the same structure, and in the systematic arrangement he places *Oncocoris* far apart from the other genera above mentioned. In a subsequent memoir§ he ascribes the same character to *Mecidea*, the species of which are mostly African, though it is also represented in India and the temperate parts of America. In a third work||, finally, he gives "ventre antierius vitta laterali transversim strigosa vel rugosa instructo" to a group of genera comprising *Mecidea* Dall., *Platycoris* Guér., *Niarius* Stål, *Oncocoris* Mayr, *Gilippus* Stål, *Alphenor* Stål, and *Caridophthalmus* Assm. (*Allocotus* Mayr, præocc.). Mayr¶ has also seen these organs in his *Oncocoris punctatus*, but simply mentions them as a "schwache Erhöhung," without having observed that they are strigose. That they were not quite unknown to Dallas and Walker, will be shown below. Distant** has lately removed *Mecidea* from the Halyinæ, placing it together with a part of the genus *Niphe* Stål (*Aenaria* Dist. nec Stål) in a division which he names Mecidaria, without mentioning the transversely striolated ventral patches of *Mecidea* at all. This is, however, no systematic improvement, these two genera scarcely having anything in common except the

* Ann. Naturhist. Hofmus. Wien, xv. (1900) pp. 127-141.

† Entomologist, 1901, p. 9; Journ. Quekett Micr. Club, (2) viii. pp. 33-46 (1901).

‡ Öfv. Vet.-Ak. Förh. 1867, pp. 491-560.

§ Enum. Hem. ii. p. 17 (1872).

|| Enum. Hem. v. p. 34 (1876).

¶ Reise d. Novara, Hem. p. 46 (1866).

** Rhynch. Brit. India, i. p. 140 (1902).

more or less "elongated body." Berg* has described two new genera from the southern parts of South America, *Proczelicus* and *Lobepomis*, which he says are allied to the genera *Amaurochrous* Stål and *Oncocoris* Mayr; but judging from the descriptions it seems very doubtful whether they belong here, the more so as *Amaurochrous* does not appertain to the Halyinæ at all. Distant † has also described an African genus, *Crollius*, which he places near *Platycoris*, but as nothing is said in the description as to the presence or absence of the strigose ventral patches, its position is uncertain. It is said to have the "rostrum about reaching the anterior coxæ"; if this be correct, it scarcely belongs to the Halyinæ. Besides the seven genera referred to this group by Stål, there is one described genus which appertains to the same group, viz. *Commisus* Stål. Stål overlooked the striolated ventral patches of this genus and therefore incorrectly placed it among the Pentatominae s. str., near *Chalcocoris* Dall. For this division of the Halyinæ I propose the name *Platycoraria*; all its genera, except *Mecidea*, are Australian, two of them (*Oncocoris* and *Caridophthalmus*) extending to the Austro-Malayan region (New Britain, New Guinea, Timor, Flores, Ceram).

As Stål ‡ calls the strigose ventral patches of the Tetyraria "*macule stridulatoriæ*," but only speaks of "*vittæ strigose*" in the *Platycoraria*, it is evident that he did not recognise their true nature in the latter division. A close examination of the ventral patches of the *Platycoraria* shows, however, that they are perfectly homologous to the strigose areas of the Tetyraria. As described by Handlirsch, the stridulatory organs of the Tetyraria are made up of two different parts—(1) the passive element, consisting of the strigose ventral patches; and (2) the active element, consisting of a series of minute wart-shaped tubercles, bearing a subapical tooth or bristle and placed on the inner side of the tibia. The ventral patches are straight and situate on each side of the median line of the fourth and fifth segments, sometimes extending to the third or sixth segment; they converge behind and the striæ are arranged longitudinally, being nearly parallel to the axis of the body. When the insect bends the tibia against the femur and again stretches it, the spinous tubercles of the tibia pass across the strigose surface of the venter, thus enabling the insect, by rapidly repeating these movements, to produce an audible sound. In the *Platycoraria* both the active and the passive parts of the stridulatory organ show the same structure as in the Tetyraria, but the ventral patches are usually comma-shaped, a little elevated and placed near the base of the venter, beginning with a rather broad base at the anterior margin of the second segment and proceeding, gradually tapering and curved inwardly, to the posterior margin of the third (rarely second) segment, where they end not far from the median line. The

* An. Soc. Cient. Arg. xxxii. pp. 234 & 236 (1891).

† Ann. & Mag. Nat. Hist. (7) vii. p. 21 (1901).

‡ Enum. Hem. iii. p. 3 (1873).

patches are transversely strigose in the basal part, but the striae gradually become more oblique and are often practically longitudinal at the narrow end. From the position of the patches it is clear that the tibiae cannot come in contact with them, and the active part of the stridulatory organ must be sought for elsewhere. I have found it on the inner side of the hind femur, where it consists of a number of very small spinous knobs arranged either in a single regular row or in two or three irregular ones. They are visible under a common pocket-lens, but under a compound microscope they present exactly the same structure as the tibial spinules of the *Tetyraria*. I propose to call them "*spicula stridulatoria*." The movements of the femur exactly correspond to the different direction of the striae of the ventral patches, these striae being always crossed at a right angle by the "*spicula*." By rubbing the inner side of the femur over the ventral patch I have experimentally produced a stridulating noise. Stål seems to have observed the "*spicula stridulatoria*" in *Platycoris* and *Niarius*, for in his above-quoted paper of 1867 he says they have the "femoribus posticis intus granulatis." In his larger work of 1876 he has omitted to mention it.

In his revision of the Hemiptera Heteroptera of the British Museum, Distant was apparently not satisfied with the state in which he left the genus *Dictyotus*. He says* : "*Dictyotus* requires revision; all the species which Dallas included in his genus do not appear to be congeneric." Without having seen Dallas's types I had myself, in determining some species of this genus, come to the same conclusion. In some of his specific descriptions Dallas speaks of "a curved raised line on each side of the second and third segments" of the venter. Walker has also described his *Mormidea detersa* as having the "abdomen beneath with a short curved smooth line on each side near the base." I therefore suspected that these particular species belong to the genus *Oncocoris*, and this supposition has proved to be correct, my friend Mr. Distant having at my request kindly re-examined the types of the British authors previously referred by him to *Dictyotus*. It is therefore necessary to give a complete revised list of the species of *Oncocoris*, which follows here, and which is essentially founded upon the communications received from Mr. Distant.

ONCOCORIS Mayr.

Verh. zool.-bot. Ges. Wien, xvi. p. 362 (1866); Reise d.
Novara, Hem. p. 44 (1866).

Dictyotus Dall. List Hem. Brit. Mus. i. p. 139 (pro parte).
Tarba Walk. Cat. Het. Hem. Brit. Mus. i. p. 236 (1867).

1. *ONCOCORIS APICALIS* Dall. West Australia.
Dictyotus apicalis Dall. List, i. p. 141 (1851).

* Ann. & Mag. Nat. Hist. (7) v. p. 388 (1900).

2. ONCOCORIS CŒLEBS Fabr. Australia*.
Cimex cœlebs Fabr. Ent. Syst. iv. p. 111 (1794).
Oncocoris cœlebs Stål, Hem. Fabr. i. p. 23.
3. ONCOCORIS CONFINIS Dall. Australia.
Dictyotus confinis Dall. List, i. p. 143.
4. ONCOCORIS DETERSUS Walk. Ceram.
Mormidea detersa Walk. Cat. iii. p. 554 (1868).
Dictyotus detersus Dist. Ann. & Mag. Nat. Hist. (7) v. p. 388
(1900).
5. ONCOCORIS DIMIDIATUS Mont. Victoria.
O. dimidiatus Mont. Bull. Soc. Sc. Bucarest, xii. p. 291
(1903).
6. ONCOCORIS DISCOIDEUS Dall. North Australia.
Dictyotus discoideus Dall. List, i. p. 144.
7. ONCOCORIS FAVILLACEUS Walk. North Australia.
Tarba favillacea Walk. Cat. i. p. 237.
Dictyotus favillaceus Dist. Ann. & Mag. Nat. Hist. (7) iv.
p. 434 (1899).
8. ONCOCORIS GENICULATUS Dall. South Australia.
Dictyotus geniculatus Dall. List, i. p. 142; Dist. l. c.
Dictyotus lineatus Walk. Cat. i. p. 181.
9. ONCOCORIS INSULANUS Bergr. New Britain.
O. insulanus Bergr. Rev. d'Ent. x. p. 202 (1891).
10. ONCOCORIS LETHIERRYI Mont. Australia.
O. lethierryi Mont. Bull. Soc. Sc. Bucarest, xii. p. 294 (1903).
11. ONCOCORIS MODESTUS Horv. New South Wales.
O. modestus Horv. Term. Füz. xxv. p. 601 (1902).
12. ONCOCORIS OVALIS Bergr., *infra*, p. 153. Queensland.
13. ONCOCORIS PUNCTATUS Mayr. New South Wales.
O. punctatus Mayr, Verh. zool.-bot. Ges. Wien, xvi. p. 362
(1866); Reise d. Novara, Hem. p. 46, tab. i. fig. 6.
14. ONCOCORIS SEMIMARGINATUS Westw. West Australia.
Pentatoma semimarginata Westw. Cat. Hem. Coll. Hope, i.
p. 42 (1837).
Dictyotus semimarginatus Dist. P. Z. S. 1900, p. 810.
15. ONCOCORIS SIMILIS Dall. Tasmania.
Dictyotus similis Dall. List, i. p. 143; Dist. Ann. & Mag. Nat.
Hist. (7) iv. p. 434 (1899).
Pentatoma truncatula Walk. Cat. ii. p. 311 (1867).

* Fabricius gives no nearer habitat; I possess examples of the species from Queensland.

16. *ONCOCORIS SUBSIMILIS* Mont. Victoria.
O. subsimilis Mont. Bull. Soc. Sc. Bucarest, xii. p. 293 (1903).
17. *ONCOCORIS TRANSVERSUS* Carp. Murray Isl.
Dictyotus transversus Carp. Proc. Roy. Dublin Soc. vii.
 p. 138, pl. xii. f. 1 (1891).
18. *ONCOCORIS TRUNCATELLUS* Walk. Australia.
Eysarcoris truncatellus Walk. Cat. iii. p. 558.
Dictyotus truncatellus Dist. Ann. & Mag. Nat. Hist. (7) iv.
 p. 434 (1899).
19. *ONCOCORIS VENTRALIS* Walk. North Australia.
Mormidea ventralis Walk. Cat. iii. p. 555.
Dictyotus ventralis Dist. Ann. & Mag. Nat. Hist. (7) iv.
 p. 434 (1899).

The species of *Oncocoris* are very similar in *facies* to those of *Dictyotus*, but, apart from the stridulatory patches, are easily distinguished by having the antenniferous tubercles visible from above and the metasternal orifice prolonged in a keel.

Before proceeding to describe some new forms of this group, I may remark that in *Oncocoris* and *Commius* the "*spicula stridulatoria*" are arranged in a single straight row, whilst in *Platycoris* and *Niarius* they are placed in two or three irregular rows. The other described genera of the group are unknown to me.

NIARIUS TRYONI, sp. n.

Ovatus, opacus, niger, subtiliter sat dense punctulatus, supra callulis minutis flavidis conspersus, vitta superiore posteriore et margine angusto laterali capitis, basi hujus subtus, basi articuli primi, tertii quartique antennarum, rostro (articulo ultimo excepto), limbo laterali prothoracis et partis basalis corii, epipleuris, macula prope angulos basales et apice scutelli, macula oblonga laterali intus rotundata segmentorum abdominalium, acetabulis pedibusque (annulo antecapicali femorum excepto) flavo-ochraceis, ventre medio impunctato, dilute piceo, nitido. Articulus primus antennarum apicem capitis haud attingens, secundus duobus ultimis unitis aequilongus, tertius et quartus subaeque longi. Pronotum lateribus leviter sinuatum. Scutellum apice impunctatum. Hemelytra apicem abdominis attingentia, corio basin segmenti sexti connexivi superante. Segmentum genitale maris medio segmentis tribus praecedentibus unitis subaequilongum. (Pedes postici desunt.)

Long. ♂ 10 mm.

Queensland.

Allied to *N. illuminatus* Dist., but in Distant's species the

head, pronotum, and scutellum seem to be differently sculptured, and there is no annulation to the femora.

LEVENNA, gen. nov.

Caput longitudine latius, leviter convexum, apice rotundatum, marginibus anguste reflexis, ante oculos magnos globosos sinuatis, tylo et jugis æque longis, illo postice elevato, his antice valde approximatis, ocellis majusculis, in linea inter marginem posticum oculorum ducta positis, a linea media capitis quam ab oculis saltem duplo et dimidio longius distantibus, bucculis humilibus, rectis; rostro coxas posticas attingente, articulo secundo duobus apicalibus unitis brevior, tertio quarto longiore, tuberculis antenniferis e supero distinguendis, extus spinula porrecta armatis; antennis quadri-articulatis, articulo primo apicem capitis paulum superante, secundo longissimo. Pronotum medio capite parum longius, marginibus lateralibus anticis acutis, leviter explanatis et reflexis, angulis lateralibus haud prominulis, anguste rotundatis, angulis basalibus latissime rotundatis, margine basali recto. Scutellum pone medium leviter sinuatum. Mesosternum carinatum. Orificia metasternalia in rugam mediocrem continuata. Hemelytra apicem abdominis longe superantia, corio apicem abdominis subattingente (♂) vel hoc paullo brevior (♀), margine apicali levissime sinuato, angulo apicali acuto, membrana venis circiter sex instructa, exterioribus tribus furcatis et pone medium vena transversa conjunctis. Alæ apicem abdominis superantes, sed hemelytris paullo breviores. Abdomen hemelytris haud vel vix latius, subtus utrinque prope basin vitta stridulatoria curvata usque ad apicem segmenti tertii pertracta instructum, segmentis quinque primis ventralibus in mare medio valde retractis, quam lateribus fere triplo brevioribus, segmento sexto hujus sexus permagno, precedentibus unitis medio longiore, angulis apicalibus hujus segmenti in mare latissime rotundatis, fere deletis, margine apicali recto, in femina obtusiusculis, margine apicali late arcuato-sinuato, segmento genitali maris latissimo, angulis apicalibus productis, margine basali sub segmento sexto ventrali suboculto, medio processu liguliformi verticaliter recurvo instructo. Pedes longiusculi, femoribus posticis intus spiculis stridulatoriis uniseriatis instructis; tibiis omnibus femoribus subæquilongis, superne sulcatis; tarsis triarticulatis, articulo primo tarsorum posticorum incrassato.

This remarkable genus is to be placed near *Commius* Stål, but is at once distinguished by the four-jointed antennæ, the very long hemelytra, and the enormously developed sixth ventral and genital segments in the male. The considerable length of the hemelytra is probably due to the necessity for preserving the inner parts of the very wide and open male genital segment from injury.

LEVENNA SALAX, sp. n.

Supra niger, sat dense et fortiter punctatus, linea longitudinali media plus minusve distincta verticis, vitta vel linea longitudinali media interdum medio late interrupta pronoti hujusque limbo laterali ab angulis apicalibus ultra medium interdumque etiam margine postico, macula parva ad angulos basales, maculis duabus mediis magnitudine variabilibus fasciaque subapicali scutelli, fascia corii ab angulo apicali interno ad marginem costalem ducta ibique dilatata segmentisque connexi basi flavis, remote fusco-punctatis, venis membrane praesertim apice saepe pallescentibus. Alae fusco-violaceae. Caput subtus cum rostro et antennis violaceo-nigrum, bucculis saepeque macula utrinque adjacente flavidis. Pectus violaceo-nigrum, limbo laterali prosterni ab apice ultra medium, carina media et margine laterali mesosterni ac limbo postico metasterni, interdum etiam acetabulis omnibus et prosterno medio, flavis. Abdomen subtus flavo-testaceum, disco medio interdum rufopiceotincto vel segmento sexto medio macula fusca notato, limbo laterali ventris violaceo, macula quadrata ad angulos basales segmentorum flavida cum disco ventris interdum confluyente signato. Pedes nigro- vel fusco-violacei, femoribus posterioribus interdum basin versus flavescentibus. Caput subtus et pectus remote punctulata, articulo secundo antennarum tertio fere dimidio vel saltem tertia parte longiore, tertio et quarto subaeque longis. Pronotum longitudine media fere duplo et dimidio latius, marginibus lateralibus rectis. Abdomen subtus impunctatum, appendicibus duabus internis (lateralibus, Sharp) segmenti genitalis maris longe subulatis.

Long. ♂ 6-7.6 mm., cum membr. 8-9.6 mm. ♀ 7.8 mm., cum membr. 9.8 mm.

Queensland; South Australia (Yorketown).

COMMUS MINOR, sp. n.

Flavus, capite (exceptis basi subtus, macula triangulari ab hac ad tubercula antennifera ducta bucculisque), maculis duabus magnis transversis triangularibus anticis pronoti, macula magna basali triangulari scutelli medium hujus attingente maculaque ejusdem angusta elongata marginali pone medium, meso- et metasterno medio (carina illius excepta), macula magna pleurarum, maculis quinque ventralibus, una utrinque sublaterali segmenti quarti et quinti et una magna media segmenti sexti, maculaque transversa segmenti genitalis maris violascenti- vel viridi-aeneis, maculis duabus magnis basalibus basi contiguis pronoti fuscis, hemelytris subpurpureo-fuscis, opacis, levissime aenescentibus, corio fascia flava inter angulum apicalem internum et marginem costalem ornato; antennis, rostro pedibusque castaneis, his aenescentibus. Caput vertice medio et pone juga remote subtilissime punctulatum, jugis oblique strigosis, articulo secundo antennarum primo plus

quam dimidio longiore, tertio secundo tertia parte longiore (ceteri desunt). Pronotum medio capiti subæquilonquum, remotissime et subtilissime punctulatum, marginibus lateralibus anticis subrectis. Scutellum remotissime et subtilissime, pone medium latera versus fortius punctulatum. Hemelytra apicem abdominis attingentia, clavo et corio remote subtiliter punctulatis, margine apicali hujus exterius levissime sinuato. Pectus remote punctulatum, pleuris medio lævibus. Abdomen impunctatum, segmento sexto ventrali maris medio segmentis tribus antecedentibus unitis æquilongo, segmento genitali maris margine apicali segmenti ultimi ventralis paullo latiore, appendicibus internis (lateralibus, Sharp) falciformibus, dilute piceis (in elegante longioribus, nigris).

Long. ♂ 9 mm.

Queensland.

Much smaller than *C. elegans* Don. and differently coloured, with the pronotum much shorter, the hemelytra also shorter, the apical margin of the corium much less sinuate near the apical angle, and the genital segment of the male much broader.

ONCOCORIS OVALIS, sp. n.

Ovalis, livido-testaceus, modice dense sat fortiter nigricanti-punctatus, ventre medio remote punctato, limbo laterali prosterni et ventris impunctato, articulo ultimo rostri, vitta angusta sublaterali paullo curvata dimidii antici pleurarum, macula oblongula ante angulos posticos prosterni, mesosterno medio (carina excepta), macula magna transversa basali ventris, macula media segmenti ejus sexti maculaque parva ad angulum basalem et apicalem segmentorum connexivi et ventris nigrinis. Caput pronoto medio subæquilonquum, tylo et jugis eque longis, rostro coxas posticas superante; (antennæ desunt). Pronotum longitudine media duplo et dimidio latius, marginibus lateralibus subrectis, angulis lateralibus levissime eminulis, obtusis. Scutellum maculis quinque minutis basalibus et summo apice impunctatum. Hemelytra apicem abdominis superantia, corio areolis aliquot impunctatis prædito, membrana fusca, venis albo-cinerascentibus. Abdomen hemelytris subæquatum. Pedes maculis punctiformibus nigrinis conspersi, femoribus posticis medium segmenti sexti ventris parvum superantibus, spiculis stridulatoriis fusco-ferrugineis.

Long. ♀ 8 mm.

Queensland.

EURYNNANNUS, gen. nov.

Corpus parvum, late breviter rotundato-ovale. Caput planiusculum, dimidio basali partis anteocularis antrorsum admodum angustato, lateribus obtusissimis, convexis, in tuberculis antennifera continuo transeuntibus, dimidio ejus apicali parallelo, apice late rotundato et medio levissime inciso, lateribus acutis, jugis tylo longioribus et ante hunc contiguis,

oculis minutis, brevissime stylatis, ocellis perminutis, ab oculis ac linea media capitis subæque longe distantibus, mox pone lineam inter marginem posteriorem oculorum fictam positus, vertice oculo circiter septuplo latiore, tuberculis antenniferis e supero distinguendis, antrorsum convergentibus, apice extus spinuloso-productis; antennis ab oculis et ab apice capitis subæque longe insertis, quinque-articulatis, articulo primo apicem capitis haud attingente, bucculis humilibus, rectis; rostro coxas posticas paulum superante, articulo secundo apicalibus duobus subæquilongis unitis paullo breviora. Pronotum medio capiti subæquilongum, marginibus lateralibus anticis leviter rotundatis, antice leviter sinuatis, margine postico rotundato, angulis lateralibus vix eminulis, obtusis. Scutellum subæque longum ac latum, parte apicali latiuscula, frenis medium scutelli paulum superantibus. Sterna medio sulcata; orificia in rugam longiusculam oblique antrorsum producta. Hemelytra apicem abdominis paulum superantia, margine apicali corii levissime sinuato, membrana paucinervi. Abdomen hemelytris parum latius, subtus prope basin utrinque vitta stridulatoria curvata ad apicem segmenti tertii extensa instructum. Pedes mediocres, femoribus posticis intus spiculis stridulatoriis uniseriatis instructis, tibiis femoribus subæquilongis, supra sulcatis, tarsis triarticulatis.

Easily distinguished from *Oncocoris* by the structure of the head, the very small substylated eyes, and the short and broad body.

EURYNANNUS LIPPUS, sp. n.

Ochraceus, opacus, sat dense ferrugineo-punctatus (disco ventris tamen remotissime punctato), ubique maculis minutis nigris remotissime adpersus, macula parva nigra ad angulos basales et apicales segmentorum abdominalium notatus. Caput longitudine paullo latius, rostro apice nigro; antennis ochraceis, articulo tertio apice et duobus ultimis totis dilute ferrugineis, articulo secundo primo duplo longiore, tertio primo dimidio longiore, quarto secundo subæquilongo, quinto quarto æquilongo vel paullo longiore. Pronotum capite duplo latius. Scutellum mox pone medium levissime sinuatum. Membrana cinerea, maculis minutis nigris remote dispersa. Abdomen (♂) dorso apice arcuato-sinuatum, segmento ventrali sexto apice medio subrecto, latera versus levissime sinuato, medio segmento quinto duplo longiore, segmento genitali perpendiculari, ultra segmentum ultimum abdominale haud producto. Pedes maculis punctiformibus nigris remotissime conspersi, femoribus posticis apicem abdominis attingentibus, spiculis stridulatoriis ferrugineis.

Long. ♂ 5.6 mm., lat. 4.3 mm.

Queensland.

5. On the Anatomy of Limicoline Birds ; with special Reference to the Correlation of Modifications. By P. CHALMERS MITCHELL, M.A., D.Sc. (Oxon.), Secretary to the Society.

[Received May 16, 1905.]

(Text-figures 23-28.)

In this memoir I use the term Limicolæ in the sense of Gadow (3) as a major subdivision of the Order Charadriiformes. I have dissected examples of the following forms, and where, in this paper, I refer to family-characters, I must be understood as limiting my remarks to the birds I have myself dissected, unless I definitely state otherwise:—

Suborder LIMICOLÆ.

Family Charadriidæ	<i>Charadrius plumialis.</i> <i>Himantopus nigricollis.</i> <i>Vanellus vulgaris.</i> <i>Gallinago caelestis.</i> <i>Rhynchœa capensis.</i> <i>Scolopax rusticola.</i>
Chionidæ.....	<i>Chionis alba.</i>
Glareolidæ	<i>Glareola pratincola.</i>
Thinocoridæ	<i>Thinocorus</i> species ?
Ædicnemidæ	<i>Ædicnemus scolopax.</i>
Parridæ	<i>Hydrophasianus chirurgus.</i>

The greater part of the actual dissection was completed in 1902, in continuation of my work on Gruiform Birds (7); pressure of other duties has made it impossible to finish it sooner. I am indebted to the facilities afforded by this Society in the prosectorium at the Gardens for the material, and to my friend Mr. F. E. Beddard, F.R.S., the Society's Prosector, for much kindly interest.

DIASTATAXY IN THE LIMICOLÆ.

In the arrangement of the feathers on the wing, all Limicoline birds are closely similar. They are diastataxic in the most typical form. The condition in *Chionis alba* (text-fig. 23, p. 156) may serve as an example. Along the edge of the ulna, from the wrist towards the elbow, the great quills with their associated coverts are arranged in an orderly series, but after four of these rows, each headed by a quill, there is a row from which the quill is missing, forming the diastataxic gap (text-fig. 23, *x*, p. 156). The carpal remex and covert are present (C.R., C.C.), the covert, in most cases (although not in *Chionis*), being conspicuously larger than the remex. These two feathers lie closer to the most proximal primary-

quill than to the most distal secondary-quill in most Limicolæ, but the position varies, and that shown in the diagram is more primitive. As evidence of their association with the secondary series, there is to be taken into account first the fact that the covert crosses the remex as in the secondary rows, not lying distal to it as in the primaries, and, secondly, that a plica (*pl.*), to which I have called attention in other groups (4 and 5), unites the carpal remex with the most distal secondary remex.

Text-fig. 23.

Wing-structure of *Chionis alba*.

Diagram of the distal secondary quills and coverts, showing the *diastataxic* arrangement.

S. First secondary. P. First primary. x. Diastataxic gap. C.R. Carpal remex. C.C. Carpal covert. Pl. Plica, binding carpal covert to first secondary.

The condition of the wing in the Limicolæ is similar to that found in the greater number of the Columbæ, but whereas in some Columbæ (4) the eutaxic condition is found—or, as I have tried to show, has been attained,—it has not been attained by any of the Limicolæ. In the Gruiformes, a somewhat incoherent group certainly closely related to the Charadriiformes, both conditions of the wing are present (7).

GUT-PATTERNS IN THE LIMICOLÆ.

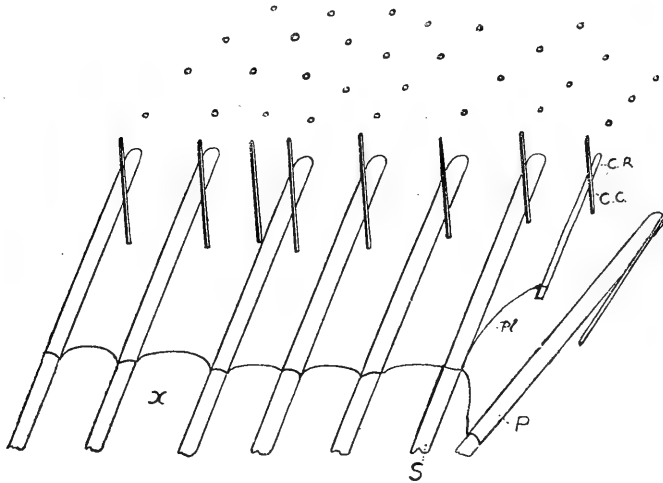
I have already shown (6) that the pattern of the gut in Limicolæ is of considerable interest. It displays a configuration which differs from the pattern which is arche-centric for all birds in a fashion similar to the divergence shown by the Gruiform birds,

and notably different from that of the Columbæ, or, indeed, of any other group except the Lari. The duodenal loop is simple and definite (text-figs. 24 and 25, A-B); the portion of Meckel's tract proximal to Meckel's diverticulum (Div.) tends to be enlarged in such a way that the diverticulum is not at the apex of a loop as in Columbæ or Passeres, but on the distal limb of a loop, which is short in the forms which are less specialised in this respect, such as the Chionidæ, Glareolidæ, Thinocoridæ, Œdicnemidæ, and the simpler Charadriidæ (such as *Numenius* and *Vanellus*),

Text-fig. 24.

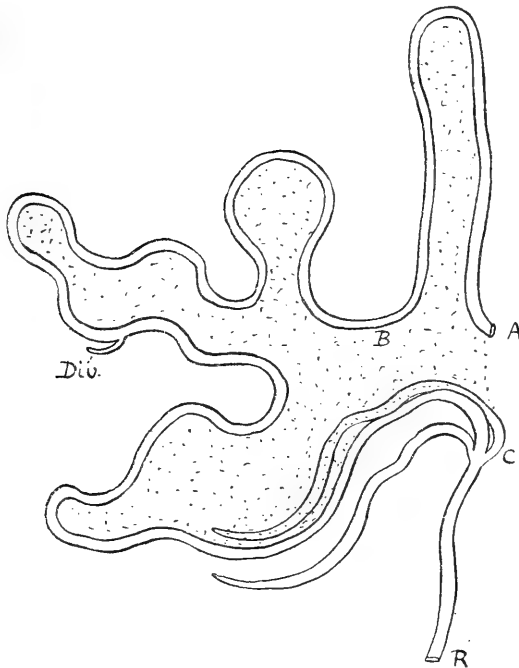
Diagram of intestinal pattern of *Rhynchœa capensis*.

A. Cut proximal end of duodenal loop. B. Distal end of duodenal loop.
Div. Meckel's diverticulum. C. Origin of cæca. R. Cut end of rectum at cloaca.

but which in other Charadriidæ and Parridæ (such as *Scolopax*, *Himantopus*, and *Hydrophasianus*) is elongated and spirally twisted. The portion of Meckel's tract between this and the duodenal loop is ill-defined in the simpler forms, but in others tends to be thrown into a definite narrow loop. The portion posterior to the diverticulum is in close relation to the colic cæca, which are long in the simpler forms (text-fig. 24, C.), but become

almost atrophied in the more specialised types of gut-pattern—as, for instance, in *Hydrophasianus* (text-fig. 25, C.).

With regard to these two features of their structure, the conditions of which in Birds generally are pretty well known, the position of the *Limicolæ* is easy to define. In wing-structure they are diastataxic, like all but the most specialised *Columbæ*, and like many of the *Gruiformes*. In the gut-pattern they are not much modified from the arche-centric condition, but the modification is definite, characteristic, and progressive, and, in its simpler form,

Text-fig. 25.

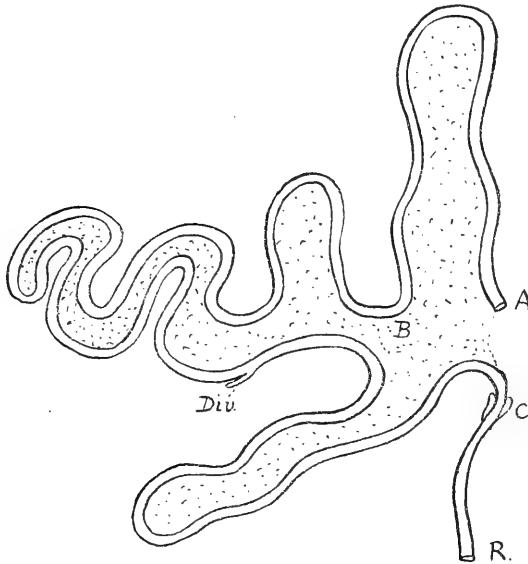

Diagram of intestinal pattern of *Hydrophasianus chirurgus*.

Lettering as in text-fig. 24.

similar to that shown by the *Gruiformes*. In the more specialised types the elongation and spiral twisting of a portion of Meckel's diverticulum brings about a superficial resemblance with the arrangement in the long-gutted *Columbæ* and *Passeres*, but the morphological condition is different, as a different portion of the intestinal tract is affected. I shall now endeavour to set out the chief modifications in muscular anatomy that I have found to be of interest in these birds.

MUSCULAR ANATOMY.

Latissimus dorsi anterior et posterior.—The anterior division in all these birds is a broad flat muscular strap, without any peculiarities.

Its insertion is muscular, and just below that of the posterior division (text-fig. 26, L.A. and 3). The posterior division is absent in *Scolopax*, present in the others, and its proximal edge touches the distal edge of the anterior division in *Ædicnemus* (text-fig. 26, L.P. and 4) and *Hydrophasianus*, but not in the others. In *Hydrophasianus* and *Ædicnemus* the two muscles are almost continuous, although they cross before insertion, at which point they are closely in contact; whilst in the others the tendon of the posterior division is separated by a short gap from the muscular and more distal insertion to the humerus of the anterior division; this tendon is always in close association with the humeral anchor of the anconæus.

Text-fig. 26.

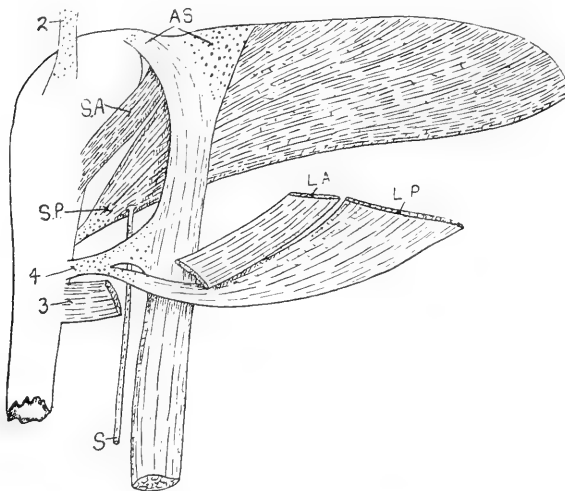

Shoulder-muscles of *Ædicnemus scolopax*.
Left shoulder; external view.

2. Tendon of supra-coracoideus. A.S. Anconæus scapularis, the reference lines pointing respectively to the humeral origin and the scapular anchor. S.A. Scapuli-humeralis anterior. S.P. Scapuli-humeralis posterior. S. Expansor secundariorum. L.A. Latissimus dorsi anterior. L.P. Latissimus dorsi posterior. 3. Insertion of lat. dors. ant. 4. Common insertion of lat. dors. post. and humeral anchor of ancon. scapularis.

The posterior division, where present, tends to spread backwards to reach the ilium and part of the ribs. In *Chionis* its origin is limited to the vertical anterior edge of the ilium, whilst the gap between it and the anterior muscle is wider than in any of the other birds.

The arche-centric, or most generalised, condition of these muscles in Birds appears to be the existence of an anterior and posterior division, fairly well separated at their origins and close together

at their insertions. Any well-marked deviation from this condition may be regarded as derivative. I have shown that in the more specialised Columbidae the posterior division of the muscle tends to disappear (4); in the Kingfishers the anterior division similarly is in progressive diminution (5); in most of the Gruiform birds the anterior division is less strongly marked, whilst the posterior division tends to increase greatly in size and strength, whilst in the Crane and Bustard it is the posterior division which disappears (7). In the Limicoline birds generally the anterior division remains in the primitive condition, whilst the posterior tends to enlarge as it does in the Rails, the enlargement being specially a backward and downward extension of the origin. On the other hand, in the Woodcock, as an exception, there is a disappearance of the posterior division.

Latissimus dorsi metapatagialis.—This muscle is probably present in all these birds, but it is very slightly developed and apt to be removed in the process of skinning.

Rhomboides superficialis et profundus.—Of these two muscles, the superficial is phylogenetically older. In all these birds it is the thinner of the two muscles, but is longer, being longest in *Ædicnemus* and *Chionis*, whilst it shows a general tendency to die away posteriorly. In *Chionis* it is nearly divided into a proximal and distal portion by a thin central area, a secondary cleavage which is well marked in the deep muscle of the eutaxic Kingfishers.

The deep muscle in *Hydrophasianus* is almost of the same length as the superficial muscle and it is difficult to separate the two. In the others it is well separated by its greater thickness and by the slope of its fibres upwards and forwards from the scapula to the vertebræ. Its origin begins at the extreme posterior end of the scapula and extends forwards under the origin of the superficial muscle, but never reaching so far forwards.

In the condition of these muscles, then, the Limicolæ are fairly homogeneous; the older superficial muscle is well developed, extending in front of the deep muscle, but, except in *Scolopax*, leaving a portion of it exposed behind. The deep muscle has made comparatively little progress in forward extension along the line of the scapula and clavicle.

Biceps brachialis.—This muscle displays in *Ædicnemus* the condition normal in the majority of birds; it arises by a narrow tendon from the acrocoracoid, and by a broad tendon from the proximal end of the humerus; the rounded belly runs down the arm and ends in a forked tendon, the thicker fork being inserted to the radius, the thinner to the ulna. No doubt, fleshy origins must have preceded tendinous origins, and there is considerable variation as to the relative size of the two origins and insertions in different birds; but the *Ædicnemus* condition is a fairly central one, and it is interesting to notice that in this respect *Ædicnemus* stands apart from other Limicoline birds and might be associated with many other groups. In *Hydrophasianus* there is a comparatively slight deviation from the normal, consisting in the complete disappearance

of the humeral head. This has already been noted by Fürbringer and Beddard (1 and 2), and the latter author states that he found a similar reduction in *Rhynchæa*. In the example of *Rhynchæa* that I dissected, however, I found a very different condition, the well-marked occurrence of a peculiar Limicoline deviation which occurs in a more or less modified form in all the other birds which form the subject of this paper.

The Limicoline peculiarity of the biceps brachialis is well marked in *Chionis* (see text-fig. 27). The main mass of the

Text-fig. 27.

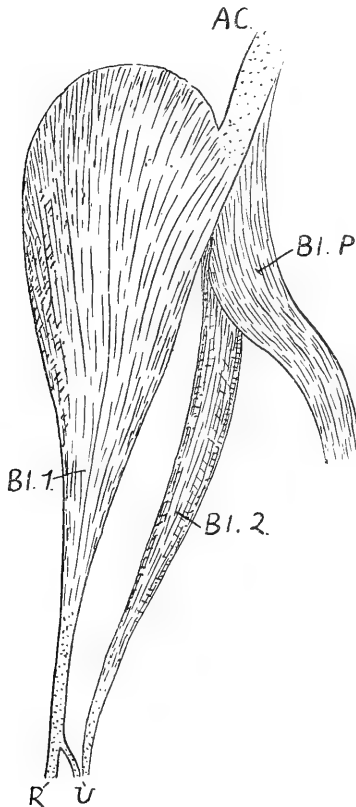
Biceps of *Chionis alba*.

AC. Coracoid head. BLP. Biceps patagialis. BI. 1. Chief portion of biceps.
BI. 2. Accessory biceps. R. Radial insertion. U. Ulnar insertions.

muscle arises by a tendon from the acrocoracoid (AC.) and by a large and fleshy head from the humerus (BI. 1); this tapers towards the lower end of the humerus and then divides into a

large tendon inserted to the radius (R.) and a very small tendon to the ulna (U.). There is also a second belly, smaller and rounder, arising almost wholly from the coracoid tendon of origin (BI. 2), and towards the lower end of the humerus passing into a round tendon which is inserted to the ulna only (U.), distal to the insertion of the ulnar branch of the tendinous fork of Biceps 1. This doubled condition of the biceps is practically repeated in *Scolopax*, except that Bi. 1 appears to supply only the tendon to the radius, and the same state of affairs is present in *Gallinago*, *Charadrius*, *Himantopus*, *Vanellus*, and *Rhynchæa*. It occurs also in *Glareola* and in *Thinocorus*, but in the latter the humeral head is degenerate although present.

This complication of the biceps shows a link between the Charadriidæ, through *Chionis*, with a more exaggerated peculiarity in some of the Gulls. The condition in *Scolopax* differs from that in *Chionis* practically only in the tendon of Bi. 1 in the latter being forked so as to be inserted both to the radius and ulna. If we suppose this fork in *Chionis* to be split up into the body of the muscle so as to separate the portion of the belly arising from the acroracoid tendon from the portion coming from the humerus, the Gull condition would be reached. In *Larus*, for instance, the tendon of origin arising from the acroracoid divides into two fleshy bellies, the one representing Bi. 2 in text-fig. and running to the ulna, the other, fused with Bi. 1 in the figure, running independently to the radius. As there is very strong evidence of other kinds for supposing that the Gulls are modified from a Charadriiform stock, it would seem natural to suppose that here we have to deal with a case of progressive complexity, starting from the *Scolopax* condition and leading through *Chionis* to the Gull condition. But it is important to remember that, in cases of muscles and tendons of birds, the general morphological course is from the more complex to the simpler, and, to my mind, it is more probable that the *Scolopax* and general Limicoline condition is a simplification from the Gull condition, *Chionis* showing how the simplification may have come about.

Deltoidis patagialis.—This muscle is of moderate width in all these birds, and gives off the *longus* and *brevis* tendons from its relatively broad distal extremity, with not more than the slightest indication of division into peaks for the different tendons, and so far remaining in a primitive or arche-centric condition. With regard to the tendons, *Ædicnemus* displays a condition markedly different from that found in all the others. The *longus* tendon is simple and slender; it has an anchor to the humerus, and, after being joined by the biceps slip, gives off one or two very weak slips of fascia to the patagium, and then takes the usual course towards the wrist. The *brevis* tendon is simple, flat, and well marked; it runs an undivided course towards the elbow, parallel with the biceps, and, close to its insertion, broadens out into a fan-shaped termination, which displays in a reduced condition the three slips named respectively α , β , γ by Fürbringer. In all the

other birds on my list the condition is much more complex, but as the complexity is similar in all, it is unnecessary to add to the figures given on plate xxi. of Fürbringer's great monograph (2). The *longus* tendon has an anchor to the humerus in all: it is broad and partly doubled in *Chionis*, *Scolopax*, *Vanellus*, and *Himantopus*; it is single in *Glareola*, *Thinocorus*, *Hydrophasianus*, *Charadrius*, *Rhynchæa*, and *Gallinago*, although in these a greater width in the elastic portion shows a tendency to duplication. In all, from just below the middle of its course, it sends a tendinous anchor inwards and downwards to join with the α portion of the *brevis* tendon; the width of this anchor and the exact point and mode of junction with the *brevis* tendon differ, but the details do not appear sufficiently important for individual description. The *brevis* tendon is doubled in all, the duplication being complete from origin to insertion. A well-defined tendon nearest to the biceps runs towards the elbow, where it is practically free from the second portion of the *brevis*; its extremity corresponds with γ of Fürbringer and it occasionally turns in towards the elbow, or may run a straight course towards the ulnar margin of the arm. The second division of the *brevis* is stronger and wider; it runs parallel with the latter, and nearer the *longus* tendon. At its distal extremity it divides into two well-marked slips—the proximal, being the β of Fürbringer and spreading out into a fan running towards the ulnar margin of the arm, whilst the more distal, the α of Fürbringer, receives the anchor from the *longus*.

Pectoralis propatagialis.—This slip is present in all the birds on my list. Leaving the pectoralis major it joins the deltoideus patagialis before the muscular part of that muscle has given off the *longus* and *brevis* tendons, but its fibres run towards the *longus* rather than to the *brevis*. It is weakest in *Glareola* and *Thinocorus*.

Biceps patagialis.—This muscular slip, to the presence or absence of which Garrod attached so much importance, is present in all these birds and joins the *longus*. It is much weaker in *Glareola* and *Hydrophasianus*, where it is little more than a tendon. In *Ædicnemus* it sends a slip to the patagium, recalling the arrangement which I have described in *Heliornis* (7, text-fig. 78, p. 640). Its length varies, it being much longest in *Himantopus*, where its distal end nearly reaches the radial margin of the arm—an extremely specialised condition. Where the biceps is double, the origin of the biceps patagialis is sometimes from both portions (text-fig. 27, BI. P. p. 161), but in other cases it comes from the acrocoracoid head only, and in others again from the humeral head.

The condition of these alar muscles and tendons is of considerable interest. The first salient point is that *Ædicnemus* stands markedly apart from the others, showing in these structures, as in the biceps, an arrangement much more resembling that found in the Gruiformes, and, indeed, in many other birds, than the typical Limicoline condition. On the other hand, just as the complexity of the biceps in the Limicolæ recalls the similar

complexity in Gulls, so Gulls exhibit the doubling of the brevis tendon and the anchor from the longus to Fürbringer's α , which are the conspicuous features of the Limicoline alar complex. The general trend of change in the formation of the alar tendons seems to have been, first, the formation of distinct tendons from a series of scattered fasciæ and cutaneous slips, and next a reduction of the complex tendons to a more and more simple form. The most ready interpretation of the facts appears to me to be that in the ancestors of the Laridæ and Limicolæ a complex and specialised alar series of tendons had been elaborated; this condition has been retained by the Gulls and by most of the Limicolous birds, whereas in the Gruiformes and in *Ædicnemus* it has more or less completely disappeared, leaving traces such as the separation of the distal fan of the brevis into the small divisions which can be recognised as the α , β , γ of Fürbringer.

Deltoides major et minor.—In all these birds both muscles are present and display little divergence. The *minor* is extremely small in *Chionis*, *Gallinago*, and *Hydrophasianus*; in the others it is normal. The *major* is a muscle which in many birds displays a progressive tendency to creep down the humerus. It is shortest in *Hydrophasianus*, not reaching more than three-eighths of the proximal end of the humerus, and is without the usual scapular anchor. In *Gallinago* it reaches rather less than halfway down the humerus, in *Thinocorus* rather more; in the others nearly an exact half, the scapular anchor being well marked in all but *Hydrophasianus*.

Scapulo-humerales anterior et posterior (text-fig. 26, p. 159).—The posterior muscle (S.P.) is present in all these birds and is large and important, converging from an extensive origin occupying the greater part of the scapula to a rounded tendon inserted to the median process of the humerus. The anterior muscle (S.A.) is small and occupies the usual position across the angle between the scapula and the humerus. It is normal in *Ædicnemus* and *Hydrophasianus*, very small, merely a few fibres, in *Glareola* and *Thinocorus*. In *Charadrius* it is small but quite distinct, whilst in *Himantopus* it is represented by a narrow band of fibres. In *Chionis*, *Vanellus*, *Rhynchæa*, *Gallinago*, and *Scelopax* it is absent.

There seems little doubt but that the normal, or archcentric, condition in Birds is for both divisions of the muscle to be present, whilst the anterior division is frequently absent. The Limicolæ obviously form a group with a marked tendency to the disappearance of this muscle, but there is no special correlation between specialisation in other directions and the degree of reduction of the muscle.

Expansor secundariorum.—The specialised division of the anconeus to which Garrod gave the name of "expansor secundariorum" is a muscle in obvious course of disappearance in this group. It is present in a well-marked condition in *Ædicnemus* (text-fig. 26, S., p. 159) and *Hydrophasianus*. Its

proximal portion is well marked in *Scolopax*, *Himantopus*, *Gallinago*, *Rhynchaea*, *Vanellus*, *Charadrius*, *Thinocorus*, and *Glareola*, but it disappears before reaching the elbow. It is absent in *Chionis*.

Ilio-tibialis internus seu sartorius.—This muscle is practically identical in all the birds on my list. It arises from the anterior edge and a narrow portion of the anterior dorsal extremity of the ilium, and has the usual insertion to the fasciæ over the knee-capsule. In most cases, it shows little sign of fusion with the anterior edge of the ilio-tibialis.

Ilio-tibialis.—In all these birds this muscle is large, the post-acetabular portion having a strong fleshy origin, whereas the anterior portion is more membranous.

Ilio-trochanterici posterior, anterior et medius.—These muscles are all present in typical form in these birds, except that in *Thinocorus*, *Ædicnemus*, and *Hydrophasianus* the anterior and medius are nearly fused, showing only a trace of separation at their tendon of insertion to the femur.

Ilio-trochantericus externus.—This variable muscle is present in all these birds, but is extremely small in *Thinocorus*.

Ambiens.—This important muscle is present in all the birds on my list, and, in the normal fashion, ends in a tendon which passes through the capsule of the knee-joint and is reinforced (except in *Chionis*) by a ligament from the head of the fibula, finally forming one of the heads of origin of the muscle complex which gives rise to the perforated flexors of the second, third, and fourth digits.

Femori-tibiales seu Cruræus and Vastus.—These muscles are alike in all the birds on my list, corresponding almost exactly with the condition I found in Gruiform birds (7), with the exception that in *Thinocorus* the femoro-tibialis externus is not developed as a separate slip.

Caud-ilio-femoralis (Femoro-caudal and accessory F.-c.) (text-fig. 28, p. 166).—The condition of these muscles, to which the researches of Garrod, Forbes, and Beddard have given special importance, differs in *Ædicnemus* from that found in the others. In *Ædicnemus*, as in *Otis* and many Gruiform birds, the portion with a caudal origin ("femoro-caudal" of Garrod) is totally absent; the portion arising from the ilium ("accessory femoro-caudal" of Garrod) is present and has the usual relations, but displays a considerable tendinous area in the middle of its muscular belly—an obvious sign of degeneration, to which I have already called attention (7).

The condition in *Chionis* (text-fig. 28, p. 166) is more generalised. Both muscles are present, the caudal portion (CAUD. IL. F. 2) displaying a fairly large rounded belly, which tapers to the tendon of origin which is inserted to the femur just distad of the insertion of the iliac portion. The iliac portion (CAUD. IL. F. 1) has a fan-shaped origin from the ilium, displaying on its proximal border a well-marked area of tendinous degeneration (X), and is

inserted to the femur along a narrow vertical line. In *Vanellus* the caudal portion is very large, whilst the accessory portion is present, but minute and with a tendinous degeneration similar to that just described. In *Thinocorus*, *Hydrophasianus*, and *Rhynchaea* both portions are present and large. In *Glareola*, *Charadrius*, and *Himantopus* the caudal portion is large, and the iliac is extremely minute, represented by not more than a few fibres. In *Gallinago* and *Scolopax* the caudal portion is of moderate size, the iliac portion completely absent.

Text-fig. 28.

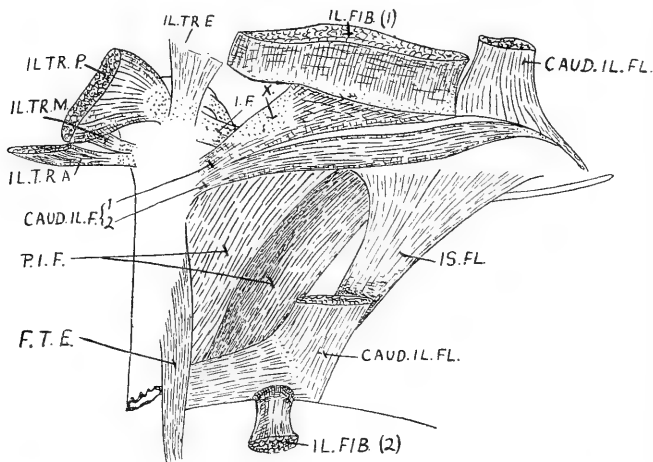
Thigh-muscles of *Chionis alba*. Right thigh, external view.

IL.T.R.E., P., M., A. Ilio-trochanterici externus, posterior, medius et anterior. IL.FIB. (1). Origin of ilio-fibularis seu biceps, cut and reflected. IL.FIB. (2). Insertion of biceps, cut and reflected. I.F. Ischio-femoralis, seu obduator externus. CAUD.I.L.F. 1, 2. Insertions of caudilio-femoralis (accessory femoro-caudal (1) and femoro-caudal (2)). CAUD.I.L.F.L. Caudilio-flexorius, cut, and origin reflected. IS.FL. Ischio-flexorius. P.I.F. Pubischio-femorales, seu adductores longus et magnus. The tendinous areas are dotted. X. Tendinous area on accessory femoro-caudal. F.T.E. Femoro-tibialis externus.

Edicnemus in this respect, as in others, shows its wide divergence from the typical Limicoline condition. Of the others, *Thinocorus*, *Hydrophasianus*, and *Rhynchaea* show what is probably the archcentric or generalised condition for birds, the presence of both muscles in a well-marked form. The remaining birds of the list show that the tendency of modification in the group is for the disappearance of the iliac portion (the "accessory" of Garrod); and complete disappearance has been reached by *Gallinago* and *Scolopax*, two birds in other respects relatively highly specialised.

Caudilio-flexorius (*Semitendinosus* and *Accessory semitendinosus*), *Ischio-flexorius* (text-fig. 28).—In all these birds the three

muscles are present, and, save that in *Hydrophasianus* and *Himantopus* the semitendinosus and its accessory or femoral head were very small, the conditions I did not find to differ from the generalised state found in Gruiform birds.

Insertions of *Caud-ilio-flexorius*, *Ischio-flexorius*, and middle or posterior femoral head of *Gastrocnemius*.—In a former communication to this Society (7) I described the differences that exist amongst Gruiform birds in this respect, and I grouped these divergences round four central types. The conditions in the Limicolæ are more uniform, and may be explained by comparison with the figure of the *Otis* type (7, text-fig. 83, p. 651). In all the birds the internal adductor muscle (*Pub-ischio-femoralis internus*) sends a strong slip to the middle head (internal femoral) of the gastrocnemius, or may be actually fused with it. The internal femoral head of the gastrocnemius at its insertion to the femur is parallel with and distad of the accessory or femoral attachment of the caud-ilio-flexorius; in *Vanellus* and *Himantopus* the edges of the two are in close contact, although they are not actually fused as in the Rallidæ. In all the other birds on my list they are quite as in *Otis*. From the raphe between the accessory and main portion of the caud-ilio-flexorius a strong fibrous band runs downwards fusing with the middle head of the gastrocnemius, whilst another band from the same point of origin runs across to be inserted into the tibia, under the tibial portion of the gastrocnemius, generally in association with the similar insertion of the ischio-flexorius.

Gastrocnemius, external femoral head.—This is double in *Vanellus*, *Himantopus*, and *Charadrius*, single in all the others. The two heads unite before the muscle joins with the conjoined tibial and inner femoral portions. This recalls the similar doubling in *Cariama*, the three heads in *Otis* and *Eurypyga*, and the enormous undivided head in *Heliornis*. I have not information as to the occurrence of a similar variation of the external head of the gastrocnemius in other groups.

Ilio-fibularis (text-fig. 28, IL.FIB. (1) & (2)).—This muscle, with its sling and connections, exhibits practically identical conditions, and these not differing from the state in the Gruiformes generally in all the birds on my list. The fleshy origin is unusually large.

Pub-ischio-femorales (adductors).—These are both present in all the birds on the list. As I have mentioned above, the internal adductor has usually a strong connection with the middle head of the gastrocnemius. It is wider than the external adductor and shows traces of tendinous degeneration.

Tibialis anticus and Soleus.—These are present and normal in all the birds on the list, the tibialis anticus passing through a ligamentous ridge.

Extensor digitorum communis.—This has the normal arrangement and relations in all. Its tendon of insertion breaks up into two central slips for digit 3 and a single lateral slip at each

side for digits 2 and 4 respectively, except in *Glareola* and *Thinocorus*, where it is a fan-shaped slip of fasciæ common to the three digits, with the slightest trace of specialisation into tendons on the edges of the fan.

Peroneus superficialis (with slip to perforated tendon of digit 3), *Peroneus profundus*.—These muscles are present, with one exception, in the normal or archcentric condition in all the birds on the list. The exception is the *peroneus profundus* in *Ædicnemus*, in which bird it is practically absent, the absence being another point in which *Ædicnemus* differs from the Limicolæ and recalls many of the Gruiformes, such as *Otis*.

Flexores perforantes et perforati.—These muscles and tendons, including the slip connecting the tendon of digit 3 with the corresponding tendon of the perforated flexor, all present a practically identical condition, which does not differ in any important respect from the condition in the majority of the Gruiformes.

Flexores perforati.—These muscles in all the birds on my list have the usual inter-relations and divide into tendons for the three digits in customary fashion. The muscular mass has three heads: of these I have already described the ambiens head, which is similar throughout, except that there is no accessory ligament from the head of the fibula in *Chionis*. The external head is fleshy in *Himantopus*; it is small and tendinous in *Chionis*, *Glareola*, *Thinocorus*, *Hydrophasianus*, *Charadrius*, *Rhynchæa*, and *Gallinago*. It is absent in *Ædicnemus* and *Scolopax*.

Flexor profundus and Flexor longus hallucis.—In my communication on the Gruiform birds I described various ways in which the tendons of these two muscles (which are similar in their origin in all the birds on my list) are united with one another and distributed to the toes. I suggested that probably the most primitive condition was such as is to be found in *Eurypyga* (7, text-fig. 85, VII), where the longus hallucis sends a slip to the hallux, and distad of this blends so completely with the profundus tendon that each tendon supplies each of the three digits. The condition in *Chionis* resembles this closely, except that, as in *Rhinchetus*, the hallucis tendon, after giving off its slip to the toe, is not so markedly spread out for the other toes. *Ædicnemus* shows a state practically identical with that of *Otis*; there is no great toe, and therefore no slip to it; the spreading out of the junction of the hallucis tendon with the profundus tendon has become obliterated.

In *Hydrophasianus* the condition is exactly as in *Eurypyga*, except that, although there is a long great toe, there is no slip to it. In *Rhynchæa* the condition is also the primitive one, except that the slip to the great toe comes off a considerable distance above the branching of the conjoined main tendons for the three other digits. In *Scolopax* the condition is similar to that in *Rhynchæa*, but although there is a small great toe there is no slip to it, and the long junction of the two tendons is ossified.

Glareola and *Thinocorus* are like *Scolopax*, but have a slip to the great toe. *Vanellus* and *Gallinago* are exactly like *Scolopax*; *Charadrius* and *Himantopus* are also identical with it, except that there is no great toe.

The conditions of these tendons in Limicolæ are similar and much alike, being not far removed from the condition that I take to be archecentric or primitive for Birds. But in the group there is a tendency to lose or reduce the great toe, and that loss or reduction has produced modifications which are similar in character and very easy to derive from the primitive type.

SUMMARY.

With the exception of *Ædicnemus*, the Limicoline birds examined, so far as relates to the characters dealt with, show a definite and coherent series of modifications. The group is moving, or has moved, along the same anatomical lines. The limits of its variations overlap in a special way the variations displayed by Gulls, and in a general way those exhibited by Gruiform birds.

REFERENCES.

- (1) BEDDARD, F. E.—The Structure and Classification of Birds. 1898.
- (2) FÜRBRINGER, M.—Untersuchungen zur Morphologie und Systematik der Vögel. 1888.
- (3) GADOW, H.—“Aves” in Bronn’s Thierreich.
- (4) MITCHELL, P. CHALMERS.—“Quintocubitalism in the Wing of Birds.” Journ. Linn. Soc., Zool. vol. xxvii. p. 237.
- (5) MITCHELL, P. CHALMERS.—“Anatomy of Kingfishers.” The Ibis, 1901, p. 97.
- (6) MITCHELL, P. CHALMERS.—“On the Intestinal Tract of Birds.” Trans. Linn. Soc. ser. 2, Zool. vol. viii. p. 173.
- (7) MITCHELL, P. CHALMERS.—“On the Anatomy of Gruiform Birds.” Proc. Zool. Soc. Lond. 1901, vol. ii. p. 629.

6. Observations upon a Female Specimen of the Hainan Gibbon (*Hylobates hainanus*), now living in the Society’s Gardens. By R. I. POCK, F.L.S., F.Z.S., Superintendent of the Gardens.

[Received May 16, 1905.]

(Plate V.*)

Age at Maturity.

On Jan. 26, 1904, the Society received on deposit a female specimen of the Hainan Gibbon, the property of Mr. E. H. de

* For explanation of the Plate, see p. 180.

St. Croix, who procured her in the island of Hainan on July 11th, 1897. She had thus been in captivity nearly six years and seven months. On the testimony of natives, her owner believed her to be about six weeks old at the time of capture; but since, as he affirms, she was already weaned and capable of fending for herself in the matter of food, it is probable that she was very much older than was supposed. On the assumption that she was at least six months old, it may be inferred that the beginning of 1897 was the approximate date of her birth.

Menstruation set in at the end of the first week of December 1903; and taking this as the sign of maturity, coupled with the fact that she has not increased appreciably in size since her arrival in the Gardens, it may be assumed that she became adult when about seven years old. And in view of the close affinity between the various species of Gibbons and the subequality in size of full-grown individuals, it may be further inferred that about seven years are required on an average for these animals to reach maturity*.

Menstruation.

Very little appears to be known about the menstruation of Gibbons. In Chimpanzees, according to Dr. Keith (P. Z. S. 1899, p. 297), the discharge is sanguineous in colour, profuse, monthly in occurrence, and three days in duration. In our Hainan Gibbon it is also sanguineous, stains the floor of the cage, and, according to her keeper, Mansbridge, who also looked after the Society's historic Chimpanzee "Sally," is about the same in quantity relatively to the size of the animals as in that ape. The pudendal organs are always conspicuous by reason of their turgescence, and no very conspicuous change in their condition precedes the menstrual discharge. In this particular the Gibbon differs markedly from certain Cercopithecidæ (such as Baboons, Macaques, and Mangabeys), and also, to judge from published and verbal accounts, considerably, though to a lesser degree, from Chimpanzees. With the help of Mansbridge and Robertson, the two keepers of our Anthropoid Apes, I recorded the dates of the appearance of the discharge during the autumn, winter, and spring. The first noted was from Sept. 12 to 14, the second from Oct. 14 to 16, and the third from Nov. 19 to 21. During December the animal had a severe illness, beginning with an influenza cold and ending with diarrhœa, which was accompanied by extreme wasting and weakness. This illness extended over the time for menstruation, which did not appear in December. In January also there was no sign of it observable, although by the middle of that month she had apparently recovered her normal health. It is probable, I think, that the cessation for these two midwinter months was due to the illness. But it is by no means impossible that cessation during that time of the year is normal. The question can only be

* Perhaps the Siamang (*Symphalangus*), which exceeds the other Gibbons in dimensions and differs from them in other respects, will be found to be an exception.

decided by observing what happens in the ensuing winter, should the animal still be in the Gardens. Menstruation reappeared on Feb. 6 to 8, and has continued at tolerably regular monthly intervals since. Hence it may, I think, be laid down as an established fact that in Gibbons the interval between the menstrual discharges is a little over the calendar month and that the discharge continues for from two to three days.

Determination of the Sex.

When Mr. de St. Croix brought the specimen to the Gardens he informed me that she was a castrated male; and in support of his opinion drew my attention to the large size of the clitoris, which he most naturally mistook for the penis. The naked and turgid labia of the vulva he regarded as the unhealed wound caused by castration; and the menstrual discharge which first appeared in December of 1903, when the Ape was on her way to England, he attributed to normal bleeding induced by enforced sitting on the hard floor of her travelling-box. He also told me that it is commonly believed in Hainan that female specimens of the Gibbon are never brought to the coast and are practically unobtainable.

There can be no doubt that this belief, coupled with the peniform clitoris of the Gibbon, misled Mr. de St. Croix as to the true sex of his animal, the castration of which, he admitted, he had not himself witnessed. And it seems probable that the belief itself is traceable to repeated mistakes on the part of Europeans in determining females as castrated males on account of the unusual length of the clitoris in these Apes as compared with the same organ in the Monkeys of the Old World generally. In this connection it is interesting to recall the fact that Dr. Harlan*, after dissection of the generative organs, described his specimen of *Hylobates concolor* as "an hermaphrodite Orang Outan." It appears to me, however, that Lesson's criticism of this opinion was perfectly justifiable and his decision that the specimen was an immature female undoubtedly correct. Pousargues, also, who evidently did not know Lesson's paper, came independently to the same conclusion, and stated that in the type of *Hylobates nasutus*, a young female, the clitoris was well developed and grooved below; and that the animal resembled in every particular, so far as the generative organs were concerned, the Gibbon determined as an hermaphrodite by Harlan. And since Harlan and two other doctors, presumably acquainted with human anatomy, who assisted at the dissection, were deceived as to the true sex of the specimen, in spite of the best possible opportunities for investigation, it is no wonder that the Europeans living in Hainan fall into a similar mistake.

So far as can be seen, the clitoris of our Hainan Gibbon is like that of the specimen figured and described by Harlan, which resembled the penis of a Primate in a state of hypospadias. A

* For Bibliography, see *infra* pp. 174-175.

comparatively slight structural modification would convert such an organ into a closed tube for the passage of the urine—a fact perhaps of some significance in connection with the low position of the Gibbons in the Anthropomorphous series, seeing that in the Lemurs, the lowest of existing Primates, the clitoris is traversed by the urethral canal.

Change of Colour.

I am informed by Mr. de St. Croix that the young of both sexes of this species are alleged by the natives to be lighter-coloured at birth and for a short time afterwards than their parents. His animal, when first purchased, was a dark smoky grey, which, however, soon turned to black; and perfectly black she remained all the years she was in his possession. But within a few weeks of being brought to the Gardens she began to go grey, Mr. de St. Croix himself noticing a decided alteration in this respect when he visited her on March 8th, about six weeks after her arrival in London. During the spring and early summer the greyness progressed rapidly, but not quite uniformly all over the body. In midsummer, according to my notes, the head was black with a grey band extending on each side from the eyebrow over the ear; the beard was whitish and the nape of the neck blackish; the greater part of the body was blackish grey, with a considerable quantity of blacker hair on the sides of the belly close to the thigh and a broad triangular black patch, narrower posteriorly, extending from the collar-bones on to the fore part of the belly and bordered on each side by a grey area paler in tone than the back; the thigh and upper arm were paler than the distal portion of the limbs. By this time she was not recognisable as the animal that reached the Gardens in January. Still the greyness continued to spread, the black pigment died out from the areas mentioned above, lasting longest upon the chest and the crown of the head. At this period she presented a decided similarity to the left-hand figure on the plate depicting *H. pileatus* Gray (P. Z. S. 1861, p. 136, pl. xxi.), although the black pectoral area was smaller and the patch on the crown less sharply defined at the edges. In the early autumn she was a stone or silvery grey practically all over except for a black median band, fading away laterally and posteriorly, down the middle line of the head.

At the present time (May 1905) she is brownish grey or silvery grey in colour, the tint varying according to the light. The black cap is still retained as a patch broadest and blackest between the ears, fading into brown upon the forehead and narrowing towards the nape of the neck. The hair on the chest has grown pale and thin, showing the blackish-grey tint of the underlying skin as a dark triangular shield. On the penultimate phalanges of the hands and feet the blackness of the hairs persists. The long hairs on the brows are also black.

It is known that in some species of Gibbons, e. g. *H. leuciscus*, according to Mr. Hose, the individual variation in colour is considerable, like unto that which obtains indeed in some Squirrels and Lemurs. But, so far as I am aware, it was not previously known that a given individual after reaching maturity may change in colour in the way exemplified by Mr. de St. Croix's specimen. This change may be compared to that which takes place in the hair of the human head concomitantly as a rule with senescence or to that exhibited by some specimens of the Arctic Fox upon the approach of winter*. It is not accompanied by any replacement of coat, nor is it directly attributable to any change in the environment or to external agencies. The cause, whatever it may be, lies within the organism itself; it is constitutional or subjective, and as such may be distinguished by the term "canescence," from the decoloration or fading which is caused by exposure to sunlight or other bleaching agencies.

In the case of the Hainan Gibbon it is important to note the coincidence between the appearance of menstruation and that of the colour-change. The former phenomenon began in December 1903, the latter about February 1904.

Of the two specimens of this species in the British Museum (both of which are jet-black), one is only about two-thirds grown; the other, the type, as Mr. Oldfield Thomas states, not quite adult; and since Mr. de St. Croix's specimen is, on the contrary, full-grown, it might be inferred that it is characteristic of the species to change from black to grey upon reaching maturity. This, however, is not the case; for Mr. de St. Croix informs me that he was acquainted in the island of Hainan with another specimen, alleged to be a male, which was jet-black, like his own before coming to the Zoological Gardens, and had been in captivity sufficiently long to justify the belief that it was about twelve years old when he last saw it.

Is the canescence, then, a matter of sex and exhibited only by mature females? The balance of evidence seems to be on the whole in favour of an affirmative reply to this question. For, apart from the change here recorded of the only adult female known, it must be remembered that Mr. Swinhoe, in his published account of all the information respecting the Hainan Gibbon he was able to gather, quotes from the Chinese gazetteer of the Kiung Shan district of the island a passage stating that the male is black and the female white (P. Z. S. 1870, p. 244, &c.).

* There are two Arctic Foxes living in the Zoological Gardens at the present time. One remains dark-coated throughout the year; the other turns snow-white towards the winter. In both the winter coat, whether "white" or "blue," is replaced in the summer by a darkish brown clothing of new hair, which is at its best in August, but becomes paler and loses to a large extent its richness of tint as it grows. In neither is there an autumn moult comparable in extent to that of the spring; and there is no doubt that in the animal which turns white the metamorphosis is effected by the destruction of the pigment in the hairs themselves. This bears out Major Barrett-Hamilton's statement as to what occurs in the Arctic Hare.

The Name of the Species.

The correct name for this species is still unsettled. The specimen now living in the Gardens is specifically identical with the type of *H. hainanus* Thos., and with the specimen previously exhibited in the Menagerie* and now in the British Museum, with both of which I have compared it. According to Matschie †, however, *hainanus* is a synonym of *concolor* Harlan ‡. This opinion was based apparently upon the similarity in colour between the types of *concolor* and *hainanus*; but it unfortunately involves the assumption that the locality given for *concolor*, namely Borneo, is erroneous. It is also objectionable on the grounds that the hair of *concolor* was described as "thick, woolly, and frizzled." The last two epithets are in no sense applicable to the hair of either of the three specimens of *hainanus*, comprising young and adult animals, available for examination. In these the hair, although thick, is smooth, depressed, relatively coarse, and quite unlike the hair of a young specimen of *H. lar* from Pahang, now in the Gardens, which is essentially rough and woolly; and also equally unlike that of examples of *H. agilis* in the British Museum, which is beautifully silky and woolly. Furthermore, Trouessart § adopts for the species the name *harlani*, unlawfully proposed by Lesson || as a substitute for *concolor* Harl., alleging that *concolor* was first applied by Harlan in 1825 to a young specimen of *H. (Symphalangus) syndactylus*. *Concolor*, therefore, falls as a synonym of *syndactylus*, and *harlani* comes in for the species described by Harlan in 1827, which Trouessart follows Matschie in identifying with *hainanus*. Trouessart, however, gives no reference to Harlan's paper of 1825, and since I have failed to find it in the Royal Society's Catalogue, and there is no suggestion in Harlan's paper of 1827 (contained in a volume dated 1825), or in Lesson's almost contemporaneous criticism of it, that the name *concolor* had been previously published, I must conclude that Trouessart has fallen into some error. But in any case, since the specimen described by Harlan in 1827 as *concolor* and renamed *harlani* by Lesson in the same year and erroneously quoted as *niger* by Ogilby (P. Z. S. 1840, p. 20) was definitely stated to have come from Borneo and to have had thick woolly frizzled hair, and since it is only known to have resembled the type of *hainanus* in the matter of coloration, an admittedly variable feature in the genus and one in which it also resembles *H. syndactylus* ¶, it is, in my opinion, premature to state without qualification that *hainanus* is a synonym of *concolor*.

* Sclater, P. Z. S. 1892, p. 541.

† SB. Ges. nat. Freunde Berlin, 1893, p. 211.

‡ Jr. Acad. Sci. Philad. v. pt. 2, p. 231 (1827).

§ Cat. Mamm. Suppl. 1904, p. 6.

|| Bull. Sci. Nat. xiii. p. 111 (1827).

¶ Since Harlan states (*loc. cit.* p. 231) that *concolor* differs from *H. syndactylus* and other species in being of a universal black colour, it is assumable that he did not know *H. syndactylus*. I do not, however, suggest that *concolor* is a synonym of *syndactylus*, because Harlan states that his specimen had no guttural sacs.

Again, Pousargues* believed *hainanus* to be established upon a specimen of the same species as the type of *H. nasutus*, from Tonkin. This belief was also based upon resemblance in colour. Nothing else is known of the characters of *nasutus* except the alleged presence of a "fine and delicate little nose," whence the name was derived. But since *hainanus* is not distinguishable from other Gibbons by the fineness and delicacy of its nose, judgment on the synonymy suggested by Pousargues must be suspended until the type of *nasutus* has been re-examined and described. Trouessart, who may have seen the type, gives *nasutus* the rank of a subspecies of the Hainan form.

No further justification need, I think, be sought for retaining the name *hainanus* for the subject-matter of these remarks.

Description of the Species.

Face, ears, palms of hands, soles of feet, and skin black, the face with a slightly brownish tinge; iris and exposed portion of eyeball blackish. Colour of hair either uniformly black, with shining tips, or grey, the roots of the hair being tinged with fawn or washed-out brown, their exposed portion shining with silver-grey lustre in reflected light, but of a more stone-grey in direct light. During the change from black to grey, the coloration is a mixture of the two, the black or the grey predominating according to the nearness of the time of observation to the incipience or completion of the change.

On the crown of the head a median longitudinal black patch with ill-defined edges and extending posteriorly as a narrow evanescent stripe persists. A few scanty hairs upon the penultimate phalanx of the fingers and toes and the long hair on the brow also remain black. The hair on the body and limbs is longish, soft, and thick, but depressed and smooth. It is not woolly in the sense that the hair of our young Lar Gibbon is woolly, *i. e.* much resembling a Sheep's fleece; nor does it exhibit the fine and silky wooliness of the skin of *H. agilis* in the British Museum. On the forehead and crown of the head the hair is shorter, fine, and close, and in the living specimen grows somewhat *à la Pompadour*, being erect on the crown and almost porrect on the forehead, so that the head has the appearance of being very much higher than in our living example of the Hoolock (*H. hoolock*) and in adult skins of *H. lar*, *H. pileatus*, and *H. leuciscus* in the British Museum, in which the hair lies smoothly backwards. The difference may be briefly expressed by saying that in our Hainan Gibbon the hair looks as if it had been brushed up, whereas in the others it looks as if it had been

* Bull. Mus. Paris, 1900, p. 272. Pousargues gave A. Milne-Edwards the credit of naming *nasutus*. Milne-Edwards, however, published no description of the species when the name was quoted (Le Naturaliste, 1884, p. 497). Hence it seems that Kunckel d'Herculeis, who first associated the name with definite characters, must be regarded as the author (Science et Nat. ii. no. 33, p. 86, 1884).

brushed down. In the two skins of *H. hainanus* in the British Museum, however, the hair on the crown is not so markedly up-standing, nor so long, as in the living example. On the cheeks the direction of the hairs is, generally speaking, upwards. On the upper surface or back of the hand and on the corresponding surface of the forearm the points of the hairs lie towards the ulnar side of the limb, assuming a more and more elbowward direction as that joint is approached. On the palmar and radial side of the forearm, on the contrary, the hairs point for the most part towards the wrist. The palmar surface, however, is marked by a crest formed by the meeting of the two opposing streams of hair, the crest extending obliquely from the radial side of the elbow to the ulnar side of the wrist, the hairs on the ulnar side of it being directed proximally, those on the radial side distally. On the body the hairs lie backwards, except on the belly, where they incline towards the middle line and form a median longitudinal crest where the two streams meet. This is the area against which the inner sides of the thighs are pressed when the Gibbon is in a sitting posture. On the outer side of the thigh the direction of the hair is upwards (proximad) and backwards, below the knee it is downwards (distad).

Additional Notes.

The voice of our Hainan Gibbon is quite different from that of the Hoolock. It is a high-pitched trill all on the same note, and shriller even than the high note of the Hoolock's cry. It consists of from about three to six distinct cries repeated in very rapid succession, suggesting almost production by vibration of the tongue, although, as a matter of fact, I believe the lips alone are instrumental in producing the effect. There is then a momentary pause, after which the cry is repeated. It may perhaps be represented in the following way:—hōō hōō hōō hōō—hōō hōō hōō—hōō hōō hōō hōō hōō hōō—&c. The Hoolock, on the contrary, cries as follows:—hāh, hōō, hāh, hōō, hāh, hāh, hōō, hāh. The "hōō" is on a lower note than the "hāh," with which the cry frequently ends.

The ordinary expression of anger or remonstrance in the Hainan Gibbon is a prolonged and guttural grunt, which is repeated rapidly and often, and frequently interspersed with a kind of warble when the excitement rises.

Both the Hoolock and the Lar Gibbon in the Gardens drink habitually by dipping the back of the hand and knuckles into the dish and licking the water off. They do not scoop it up, in the strict sense of the word, at all. Hence Col. Tickell's generalisation to the effect that in its habit of scooping up water in its hands the Lar Gibbon differs from the Hoolock, which applies its lips directly to the fluid, is contradicted on both counts by our specimens of these species. The Hainan Gibbon, on the contrary, almost invariably drinks direct with her mouth, only very rarely using her left hand for the purpose. It is possible she may have

abandoned the habit of employing the hand at the time when an injury deprived her of the use of her right arm. And since the left is frequently occupied in supporting herself upon the bars or perches in the cage, she has no hand available for the purpose of drinking without quitting her hold.

This method of hand-drinking, probably common to all Gibbons, may have arisen in connection with their arboreal life. To avoid descending to the ground, they would naturally lick the rain-drops off the leaves near by, and their great stretch of arm would enable them to wipe the water off foliage hanging beyond reach of the mouth, the hairy back of the hand being clearly more fitted for the purpose than the smooth palm. In connection with this habit, it is interesting to recall the story told by Duvaucel of female Gibbons carrying their young to the waterside and washing their faces with their hands. This alleged proceeding, presumably witnessed in the jungle, can hardly, I think, be accepted without confirmation, on account of the absence of any obvious reason for the ablutions. If the young Gibbons of which the tale is told were hanging, as is their wont, to the breasts of the mothers, the action of hand-drinking by the latter might very easily be mistaken at a distance for the face-washing.

Amongst "quadrumanous" Primates the Gibbons have no equals in proficiency in the use of the arms for arboreal and the legs for terrestrial progression. Moreover, within the limits of the entire order, they are only surpassed in bipedal activity by the specialised biped Man.

Although able to stand and walk to a very limited extent, Monkeys are essentially quadrupedal and employ their arms and legs to an approximately equal extent in traversing the level ground, scaling rocks, or climbing trees. Generally speaking, the most active climbers are long non-prehensile tailed species, such as the Mangabeys*, in which the tail acts as a balancer, like the pole of a tight-rope dancer. Monkeys of this kind leap with great precision and strength, and pass with speed from branch to branch in virtue of the great propelling power in their hind-quarters. They are specialised for that manner of progression, which only differs in degree of perfection from that of other Monkeys and Lemurs as a whole. The method, however, is entirely distinct from that practised by the Gibbons, which swing from branch to branch, with the legs tucked up out of harm's way against the body, the motor power lying exclusively in the arms. Both groups have been specialised for arboreal progression, but along totally different lines; and it is as difficult to believe that the Gibbons, expert gymnasts though they be, have been derived from active long-tailed climbers, like the Mangabeys or Langurs for instance, as it is to believe that the tail-swimming Cetaceans have been derived from forms like the flipper-swimming Seals.

* I have never yet seen the Baboon or Macaque that could catch a Mangabey single-handed, given equal conditions as to health and age, in a large-sized cage.

This conclusion respecting the descent of the Gibbons may be inferred from their habits alone, quite apart from structure.

If the Anthropoid Apes be ranged in series according to proficiency in bipedal locomotion, the order will be (1) Gibbons, (2) Gorillas, (3) Chimpanzees, (4) Orangs. Gibbons not only stand erect and habitually walk without putting the hands to the ground; they can even run with astonishing speed, a speed indeed comparable to that of Man, allowance being made for difference in size. Like Man they race away when scared; and, unlike the other Anthropoid Apes, they do not use their arms as crutches. Sometimes also, but rarely, they leap over the ground with both feet together*.

Gorillas can stand and walk upright, but not with the ease of Gibbons, and it may be doubted if they ever run erect or leap, *i. e.* progress with both feet off the ground at one time; and they probably never run from danger, standing upright, as Man and Gibbons do. Their usual walk is quadrupedal.

Chimpanzees, too, are essentially quadrupedal; and under ordinary conditions, and when in perfect health, almost always get over the ground on "all fours," like a Baboon or Rhesus. In this respect, indeed, they more resemble the Cercopithecoïd Monkeys than does any other Anthropoid Ape; and they are able to cover the ground with much greater speed than either Gorillas or Orang-Utans; but I am unable to say if their quadrupedal method is so fast as the bipedal method of Gibbons. Like Baboons, they can stand erect and walk to a certain extent, but not with the facility of Gorillas.

The gait of young Orang-Utans may be described as a clumsy quadrupedal shuffle. I never saw one stand unsupported by the arms. Weakness of leg and weight of body make exclusively bipedal action, if not an impossibility, at least so great an effort that it may be doubted if it is ever resorted to. Their whole organisation suggests unfitness for terrestrial locomotion.

Thus, if the Apes be classified according to their quadrupedal activity on the ground, they will stand:—(1) Chimpanzees, (2) Gorillas, (3) Orangs, (4) Gibbons.

It is interesting to compare this series with one based upon dexterity in climbing and addiction to arboreal life. It is: (1) Gibbons, (2) Orangs, (3) Chimpanzees, (4) Gorillas. The Gibbons stand quite alone both in method and expertness; the others differ *inter se* merely in degree.

The foregoing results may be briefly summarised as follows:—The Gibbons are the most expert climbers and bipedal walkers, the least expert quadrupedal walkers. The Orangs rank second in climbing, third in quadrupedal and fourth and last in bipedal activity. The Gorillas take fourth place in climbing, second in bipedal and second in quadrupedal activity. The Chimpanzees

* These and the following statements and reflections are based upon my own observations of the Anthropoid Apes that have come under my notice in the Society's Gardens.

stand third in climbing, third in bipedal and first in quadrupedal powers.

Since, therefore, the action of Monkeys, whether Cercopithecidae, Cebidae, or Hapalidae, and of Lemurs is essentially quadrupedal, the fore and hind limbs being used to an approximately equal extent, both in terrestrial and arboreal locomotion, it may be inferred that the Chimpanzees have departed least in these respects from the primitive Primate stock; the Gorillas a little more in the line of bipedal erection and, concomitantly, loss of climbing power; the Orangs still more in the direction of loss of terrestrial activity and increase of arboreal expertness; the Gibbons most of all in the line of bipedal activity, dexterity in hand-climbing, and loss of quadrupedal power.

This serial arrangement of the Apes is the exact opposite of the one prevalent in text-books, where the order adopted is based upon structure with Man placed first as the standard for comparison. It suggests that for the origin of Gibbons we must look not to forms resembling any known Cercopithecoid type, but to forms which had already acquired the Simiine or Anthropomorphine characteristics and had either lost or never learnt the method and skill in climbing found in the former group. They may have started from a type somewhat on a level with the Chimpanzees with respect to terrestrial and arboreal activity; and to swing with greater facility from tree to tree and to obviate the risk of injury in case of a fall, it is highly probable that they have become dwarfed in stature and grown lighter in build. Their muscularity and length of arm, slightness of body and strength of leg, all factors of importance in enabling them to traverse the jungle and, in case of a miss or a breaking branch, to drop lightly to the ground and run to the nearest tree for safety, were probably perfected concomitantly. That Gibbons are able to drop with safety a considerable distance is substantiated by the fact that Mr. de St. Croix has seen his specimen come to the ground without injury from a height of about 20 feet. When leaping to the ground Gibbons swiftly draw up the knees as the feet touch, exactly as a man does under similar circumstances, to break the shock.

Another interesting feature connected with the habits of the Anthropoid Apes is the size of their ears. I have already suggested that the difference in size between the ears of the Orang and those of the Chimpanzee may be connected with the difference of habits of the two animals. The Orang lives a more arboreal and therefore a safer life than the Chimpanzee, which requires quick hearing to enable it to escape to the trees when feeding on the ground*. Gibbons also, which have relatively large ears, need auditory acuteness for the same purpose as Chimpanzees. This explanation, however, is not complete and appears at first sight to be contradicted by the case of the Gorillas, which have small ears

* 'Nature,' Oct. 11th, p. 585 (1900).

and yet are less arboreal in habit than other Anthropoids. It must be remembered, however, that they are far more capable of self-defence and much less liable to attack and therefore need less keenness of ear as an aid in avoiding enemies. In this connection it is important to note that of the two Apes inhabiting W. Africa, namely the Chimpanzee and the Gorilla, and of the two inhabiting the East Indies, namely, the Orang and the Gibbon, the larger and stronger has in each case small insignificant ears and the smaller and weaker large ears.

EXPLANATION OF PLATE V.

Hainan Gibbon (*Hylobates hainanus*), from the female specimen now living in the Society's Menagerie. The lower figure, taken from an obscure photograph by Mr. W. P. Dando, F.Z.S., represents the Ape when she first came to the Gardens. The upper figure, modified from a photograph of another Gibbon, shows her as she has been since the change of colour took place.

June 6, 1905.

DR. HENRY WOODWARD, F.R.S., Vice-President,
in the Chair.

The Secretary read the following report on the additions that had been made to the Society's Menagerie in May 1905:—

The registered additions to the Society's Menagerie during the month of May were 367 in number. Of these 174 were acquired by presentation and 27 by purchase, 129 were received on deposit, 25 by exchange, and 12 were born in the Gardens. The total number of departures during the same period, by death and removals, was 185.

Amongst the additions special attention may be directed to:—

A Crowned Duiker (*Cephalophus coronatus*) from West Africa: deposited on May 1st.

A Maxwell's Duiker (*Cephalophus maxwelli*) from W. Africa: presented by Lieut.-Col. Bartlett, R.A.M.C., on May 16th.

A Nepalese Hornbill (*Aceros nepalensis*) from the Himalayas: received in exchange on May 18th.

Two Sulphur-breasted Toucans (*Rhamphastos carinatus*): purchased on May 13th and May 23rd respectively.

Mr. Oldfield Thomas, F.R.S., exhibited a specimen of a Bushbuck which had been obtained by Mr. C. W. Haywood in British East Africa and which appeared to represent a new species of the group. It was described as follows:—

TRAGELAPHUS HAYWOODI Thos.*

Thos. Abstr. P. Z. S. No. 21, p. 9, June 13, 1905.

A large heavily-built member of the group of small species without a definite short-haired collar. Under surface darker than upper.

Fur comparatively coarse and long throughout, the hairs of the back 35-40 mm. in length. General colour very dark, the nape black; the fore-quarters blackish brown (near "seal-brown"), passing into dark reddish brown ("vandyke-brown") on the middle back and deeper rufous (dark "tawny") on the rump. Sides gradually darkening downwards to the wholly black belly. Dorsal crest black as far as the withers, then whitish mixed with some black hairs. Three inconspicuous transverse whitish stripes on each side. No longitudinal bands, but a few white spots on the sides of the rump. Shoulders and proximal part of limbs deep black, succeeded by tawny below. (Feet unfortunately lost in the type.) Top of muzzle nearly black, with prominent interorbital whitish streaks nearly touching each other in the middle line. Forehead and crown deep ferruginous. Cheeks tawny ochraceous. Two white spots on each side behind and below the eyes. Ears thinly haired, dull tawny brown with blackish edges; hairs of inner surface white. Chin and interramia white and a large throat-spot duller white; between this and the white chest-band the throat was glossy blackish, mixed with some tawny hairs. White axillary and inguinal patches present. Tail dark tawny, white below.

Skull very large and heavy for one of the smaller members of the genus, much larger than in *T. scriptus* or *sylvaticus*. Median palatal notch rather farther forward than the lateral ones. Palatal foramina comparatively long.

Horns also very powerful, thick and strongly ridged, much finer than those of any of the allied forms.

Skull dimensions of type:—

Greatest length 265 mm.; basal length 247; greatest breadth 112; muzzle to orbit 134; muzzle to front of p³ 77; length of palatal foramina 36. Length of upper tooth-series 72, of three upper premolars 31.

Horns: length in straight line 400; on anterior ridge 470; greatest basal diameter 59; basal circumference 171.

Hab. Nyeri, Kenya District, British East Africa. Altitude 6000 feet.

Type. Full-grown male. B.M. No. 5.5.16.3. Collected and presented by C. W. Haywood, Esq.

Mr. Oscar Neumann † had sorted the smaller species of *Tragelaphus* into two groups, characterised by the presence or absence of the peculiar collar of short hairs which had been so

* [The complete account of the new species described in this communication appears here; but since the name and preliminary diagnosis were published in the 'Abstract,' the species is distinguished by the name being underlined.—EDITOR.]

† SB. Ges. nat. Fr. Berl. 1902, p. 98.

often noticed in Bushbucks, and which was evidently of definite systematic value. But, as Dr. Einar Lönnberg had shown*, several of Mr. Neumann's allocations were incorrect—certainly the Cape *sylvaticus* had a short-haired collar, and fell into the *scriptus* group, while the Nilotic *bor* had a well-haired neck.

Mr. Neumann had also stated that the forms with well-haired necks known to him did not have a darker underside, but since his paper was written Lönnberg's *knutsoni* and the present animal had both proved to present the combination of a hairy neck and a black belly. This combination therefore distinguished *haywoodi* from any of Mr. Neumann's species, while from the Cameroon *knutsoni* it was separated by its whitish dorsal crest, less numerous spotting, and other detailed characteristics.

In company with this handsome animal, which Mr. Thomas had much pleasure in naming after its discoverer, Mr. Haywood had sent home to the National Museum two immature skins, with skeletons, of the recently described Forest-Pig (*Hylocheerus meinertzhageni*). It was hoped that an adult specimen suitable for mounting would soon be obtained, and this Mr. Thomas looked forward to exhibiting to the Society in due course.

Mr. Oldfield Thomas also exhibited a series of Mammals and Birds from Japan as the first-fruits of an exploration of the islands of Eastern Asia conducted for the furtherance of science by the President, the Duke of Bedford, K.G., in order to show his Grace's sympathy with the technical side of the Society's work. The specimens obtained during this exploration would be laid before the Society from time to time, and papers would be read on them by various specialists, after which his Grace proposed to present them to the National Museum.

Mr. Thomas commented on the immense value such a systematic exploration would be to science if it were carried on for some time, and instanced the revolution in our knowledge of the mammals of South Africa—a region supposed to be well-known—which had been effected by the similar exploration conducted by Mr. C. D. Rudd.

The Japanese collection had been made by Mr. Malcolm P. Anderson, who had already proved his powers both during the Stone Expedition to Alaska and by the collections he had made in California.

Of the specimens now laid before the meeting Mr. Thomas drew attention to a fine Marten, which appeared to be different from the ordinary Japanese Marten (*Mustela melampus*) and which, as the first new mammal discovered on the expedition, he proposed to name in honour of the President :—

* Arkiv för Zoologi, Stockholm, ii. 15 (905).

MUSTELA MELAMPUS BEDFORDI Thos.*

Thos. Abstr. P. Z. S. No. 21, p. 10, June 13, 1905.

Size as in true *melampus*, or slightly larger. General colour above, in winter pelage, near "isabella," but rather darker and with an olivaceous tone, nearer to the yellowish brown of *M. m. tsuensis* † than to the golden yellow of *melampus*. Wool-hairs of back brown at base, then dark yellowish. Long hairs brown. Muzzle dark chocolate-brown, passing backwards, on the crown, into silvery greyish. Ears whitish both externally and internally. Nape more yellow than back. Sides of neck brilliantly yellow ("deep chrome"), sharply contrasted with the upper colour along a line halfway up the neck, and in continuation with the deep orange ochraceous of the chest-patch. Lips pale brown, lighter than the top of the muzzle; sharply defined from the whitish interramia, which in turn passes without line of demarcation into the orange of the throat and chest. Belly brown, not unlike back, the throat-patch extending to the sternum and continued in some specimens as an irregular line of spots to the inguinal region. Limbs deep brownish black from halfway down the forearms and on the hind feet. Tail pale brown for the greater part of its length, the underfur dull yellowish as on the body; tip sharply contrasted yellowish or cream-colour, forming a conspicuous terminal tuft.

Skull as in *tsuensis*, slightly larger than in *melampus* so far as material for comparison existed.

Dimensions of the type, measured in the flesh:—Head and body 425 mm.; tail 220; hind foot 87; ear 40.

Skull—greatest length 84; basal length 75; zygomatic breadth 48; interorbital breadth 20; mastoid breadth 37.5; palatal length 42; length of upper p' on outer edge 9.5.

Hab. Washikaguchi, Nara District, E. of Osaka, Southern Central Hondo, Japan.

Type. Adult male. B.M. No. 5.5.30.3. Original number 123. Collected 13 January 1905 by Malcolm P. Anderson, and presented by the Duke of Bedford. Four specimens.

This very handsome Marten is conspicuously different from the yellowish *M. melampus*, and is curiously more similar in general colour to the *M. m. tsuensis* of the Tsu-shima Islands. From both, however, it is readily distinguished by its brilliant yellowish throat and neck patches and its contrasted tail-tip.

Mr. R. I. Pocock, F.L.S., the Superintendent of the Gardens, exhibited a female specimen of the Jamaican Scorpion, *Centrurus*

* [The complete account of the new species described in this communication appears here; but since the name and preliminary diagnosis were published in the 'Abstract,' the species is distinguished by the name being underlined.—ЕДИТОР.]

† Thos. Ann. Mag. N. H. (6) xix. p. 161 (1897).

insulanus, carrying its young on its back. The specimen had been presented to the Society by Mr. Henry Munt, F.Z.S.

Dr. P. Chalmers Mitchell, the Secretary to the Society, read a paper, illustrated by lantern-slides, entitled "On the Intestinal Tract of Mammals."

This paper will be published entire in the 'Transactions.'

The following papers were read:—

1. Rough Notes on the Natural History of the Country West of Lake Victoria Nyanza. By Lt.-Col. C. DELMÉ-RADCLIFFE, M.V.O., F.Z.S.

[Received June 6, 1905.]

These notes contain the general results of my observations on the Natural History of the region traversed by the Anglo-German Boundary Commission in the years 1902-4. Memoirs dealing more exactly with the collections that were made have already appeared in the 'Proceedings' of the Zoological Society (P. Z. S. 1904, vol. i. pp. 371, 459) and 'The Ibis' (1905, p. 199.).

MAMMALS.

Beginning with the larger mammals in the country under discussion, it may be stated that Elephants appear periodically in the swamps and forest near the mouth of the Kagera River on the northern side. These elephants stray in this direction, probably, at a time when it is dry in the interior. They come, no doubt, from the herds in northern Ankole and Toru. At no other point were traces of elephants seen except one single track going from north to south from the Koki hills towards the Busenya forest. In the west, a few elephants were noticed near the shores of Lake Albert Edward, also probably stragglers from the herds further north. There was no evidence of elephants crossing from south to north, or *vice versá*, along the 1st parallel south latitude.

It may perhaps be assumed that the herds of elephants reported by E. S. Grogan and other travellers in the Mfumbiro district belong to the forest-regions of the west. The herds of elephants on the east of Lake Albert Edward and Ruwenzori probably do not wander into the Congo forests. It has been noticed that the elephants to the west of the great line indicated by Lake Tanganyika, Lake Kivu, Lake Albert Edward, Lake Albert, &c., and the Nile differ in many particulars from those lying to the east of this line. At the same time, it must be remembered that large herds of elephants are in the habit of crossing the Nile to

the north of Lake Albert, and there seems no reason why they should not extend their wanderings into the Congo forests, although so far observation tends to show that these herds find their way back again, as a rule, to the countries east of the Nile.

Hippopotami are not very numerous in the Victoria Nyanza near the mouth of the Kagera. The locality does not seem very well suited to them. In the Kagera River itself there are more, and parts of the river are infested by a number of very savage brutes that make navigation in canoes or small boats extremely dangerous. Lt. Weiss, of the German Commission, was repeatedly attacked when in a very large canoe. He was almost upset—a man was dragged out by the arm, but escaped. Finally his crew refused to go on and ran away with their paddles. The actual number of hippopotami cannot be considered large in comparison with the huge herds in the Nile north of Lake Albert. Probably in the great swamps of the Kagera, considerably to the south of the area traversed by the Boundary Commission, the hippopotami are much more numerous. The specimens secured in the Kagera were decidedly inferior in size and in development of ivory to those of the Nile.

Rhinoceroses are extremely numerous on the right bank of the Kagera, especially in Karagwe. The number of these animals is quite remarkable, and, according to accounts received, they are to be met with in even greater numbers a little further south. It is a curious fact that no rhinoceroses are to be found on the left bank of the Kagera. All those seen belonged to the common black African type. Stories were current of the existence of the White Rhinoceros on the right bank of the Kagera, but these rumours require confirmation. The rhinoceroses appear to have no hesitation in frequenting the extremely steep and difficult hills of Karagwe. Their tracks and signs were seen up and down hills and on ridges which appeared more adapted to the habits of klipspringers or goats than of such bulky animals as rhinoceroses.

In the virgin forest west of the lake near the mouth of the Kagera, in the swampy and open forest east of Koki, and in the Busenyi forest west of the Gambaizi group of hills, several herds of Buffaloes are to be found. These buffaloes are of a very interesting, new, large variety. They are, perhaps, the largest buffaloes in existence. In all, in the district referred to, there may be 400 or 500 buffaloes, and as their numbers are not likely to be interfered with, except by men armed with rifles, they may be considered to be firmly established again after the devastation caused by the great cattle-plague of some ten years back.

In Bukanga the buffaloes wander in search of young grass, after the fires, as far as the hills of Ankole and Koki, from the forests which form their strongholds. There is one disadvantage, however, connected with the presence of the Buffaloes, of the Eland, and perhaps of other Antelopes. This is the tsetse-fly, and it is to be feared that as long as large herds of buffaloes and the greater antelopes exist, so long will the tsetse-fly make it

impossible for domestic cattle and horses to live in the same part of the country. I myself lost an Arab horse I had had for six years in Africa and was very fond of. He was bitten by tsetse-fly in Bukanga.

Eland were met with at two points in Bukanga—near the Nyakafunzo swamp, and in the districts known as Mpororo and Rushenyi. In Bukanga there were herds amounting to, perhaps, 200 animals, and the uninhabited country surrounding the Nyakafunzo swamp seemed admirably suited to their needs. They were considerably preyed upon, unfortunately, by natives, who organised hunting-parties into this district both from the British and the German side. Still more unfortunately, the natives are sometimes armed with rifles. The result could be seen in many wounded animals observed from time to time, and in dead bodies found with bullets in them. Lions also take toll of the elands, but the natural decrease due to this cause is nothing compared to the damage inflicted by natives with firearms. Further west a herd of considerably over 300 elands was seen, and this, probably, is only an outlier of still greater herds in the open country further south. It seems, therefore, that this country is abundantly supplied at present with representatives of this magnificent antelope, which, I believe, might be made of great economic value. The meat is equal to the best English beef, and a bull eland weighs about 17 cwt.

Zebras occurred coincidentally with the Eland in Bukanga, and they number, perhaps, 400 individuals. In Rushenyi another very large herd of zebras was seen; and it may be remarked that in the Rushenyi herd a single zebra was seen almost entirely pure white in colour, a few stripes only appeared on the neck and hind-quarters. Another small herd of zebras, amounting, perhaps, to 150 individuals, was seen in the plains in southern Ruampara, on the left bank of the Kagera, just north of the point where the river turns from the south to east.

Roan Antelope were encountered, a few at a time, in Bukanga, in the narrow valley of the Kagera, and in south-west Ruampara north of the bend of the Kagera just referred to. They were occasionally met with in Rushenyi and Mpororo, and appeared more numerous in Karagwe, where for some reason there appeared to be no Eland, no Zebras, and no Damaliscus. These last were the common hartebeeste throughout the area west of the lake. In Bukanga, Damaliscus were very numerous. The number in this part may be estimated at 1000 individuals. No other variety of hartebeeste made its appearance: 200 or 300 individuals were found with the herd of zebras in south-western Ruampara, and in Rushenyi and Mpororo the Damaliscus hartebeestes are very numerous.

The Nile Valley variety of Water-buck (*Kobus defassa*) is common in Bukanga, and may be met with in herds up to a dozen or fifteen individuals. They also appear fairly plentiful throughout the valley of the Kagera and in western Ruampara, but

apparently not further west. These water-buck have fine heads, as a rule considerably larger than *K. ellipsiprymnus* in East Africa, although the heads are not nearly so big as are found in the Semliki Valley.

In the swamps near the mouth of the Kagera, on the shores of the lake, and on the islands of the Sesse group, *Limnotragus spekei* was fairly common. This animal, owing to its nocturnal and swamp-loving habits, is of course seen extremely rarely, but it is frequently hunted by natives with nets and packs of dogs. The horns are often to be met with in possession of natives. There is at present a doubt whether more than one species of this antelope is not found in the same district.

In Bukanga, especially about the Nyakafunzo swamp and to the south of it, large herds of Mpala (*Epyceros melampus*) may be met with. These beautiful antelopes are to be seen in herds of 200 or 300, and in the district referred to perhaps 1500 individuals exist at the present time. They were met with at no other point throughout the country traversed.

Very common, although occurring only in ones and twos at a time, was a species of Reed-Buck (*Cervicapra?* sp.). This antelope was chiefly confined to the low-lying grassy country in Bukanga, along the banks of the Kagera, and in Ruampara.

Another very common antelope was the Oribi (*Ourebia montana*). This little antelope appeared almost everywhere on the low ground in the mountains, except in the highly cultivated parts of Ankole and the mountains in the west. In general, it may be said that no antelopes or game animals of any description were seen in the Ruchigga mountains and their northern and eastern extensions. Bush-buck and Harnessed Antelope were seen at rare intervals in the valley of the Kagera. The latter appeared occasionally at the edges of the dense forests near the mouth of the Kagera, and in one or two places in the narrow valley of the Kagera between the mountains.

Bush-buck were occasionally seen in the Koki hills and the mountains of Ruampara, where the deep gullies choked with vegetation afforded them shelter, and the open grassy hillsides excellent feeding-grounds.

On the steep hills of Ankole and Karagwe, Klipspringers were common wherever the ground suited them. The form in this country shows some differences when compared with the klipspringers of other parts of Africa, and may prove to be an intermediate variety.

Of Monkeys, *Colobus guereza* was seen in the forests near the lake. The common grey African monkey was also observed in many places, and an interesting species, *Cercocebus aterrimus*, was also seen in the dense forests near the lake and in the dense forests round Minziro. The last-named monkey looks almost black and is very shy. Its cry is very loud and peculiar, reminding one slightly of the cry of the Chimpanzee. Baboons are common, especially in the mountains in Ankole and Karagwe.

Wart-Hogs (*Phacochoerus ethiopicus*) were occasionally to be met with all along the valley of the Kagera, though nowhere very numerous. Aardvark were present, though of course never seen unless dug for. Their holes, however, were found in all directions in the low-lying country, and they are probably fairly common.

Of beasts of prey Lions are fairly common in Bukanga, in the neighbourhood of the Nyakafunzo swamp. They also appear in western Ruampara and in Rushenyi and Mpororo. In general terms, it may be said that they are to be found wherever large herds of zebras and antelopes exist. In Bukanga, however, it appears that they have taken to man-eating fairly extensively. The natives in this part of the world have a wholesome dread of them, and during the short time the Boundary Commission was at work in Bukanga repeated instances occurred of lions attacking human beings.

Leopards are also found throughout the whole area under discussion except the extreme western portion. Although they live principally on the small antelopes, monkeys, guinea-fowl, &c., they also take toll of the natives' goats, &c., and thus become sometimes a great nuisance. At Mulema camp, for instance, a leopard took goats from one hut or the other almost every night for a month, and when Captain Laughlin, Dr. Bagshawe, and Mr. Doggett endeavoured to kill him at the natives' request, he wounded, more or less seriously, no less than thirteen men before being finally despatched. Cheetahs apparently do not exist in this part of the country west of the lake. Serval Cats were occasionally met with, and a smaller grey, rather long-tailed Wild Cat. Hyænas appeared occasionally, but may be said to be rare. They were of the usual spotted variety.

Otters are common in the lake. Two forms were met with, one very large, the other smaller. These two are stated also to be common in Lake Kivu.

Among smaller mammals, interesting species were a *Pæcilogale doggetti*, an extremely handsome, large, striped Stoat; *Tatera fallax*; *Procavia bettoni*: these three being new species. Another extremely interesting animal was *Herpestes galera robustus*, a fish-eating Mongoose.

In all about 180 specimens of mammals were collected, and a large number have been described in the 'Proceedings' of the Zoological Society of London, the most interesting being the new Buffalo (*Bubalus caffer radcliffei*), *Pæcilogale doggetti*, *Tatera fallax* and *Procavia bettoni*. There is no doubt that a scientific investigation would disclose a much larger number of small mammals than were secured for the collections of the Boundary Commission. All the region west of the lake abounds with species of great scientific interest, the interest increasing the further west one goes, and it is a matter for the greatest regret that a collection could not be made in the neighbourhood of the Mfumbiro Mountains.

BIRDS.

Lake Victoria is a disappointing sheet of water in bird-life as in fishes. Birds are of course present, but not in the vast numbers so extended a sheet of water in the heart of Africa might lead a naturalist to expect. The reason is probably to be found in the fact that the food-supply in the lake is very deficient for birds and fishes alike—for many species of birds in consequence of the poverty in fish.

The White-headed Fish-Eagle (*Haliaeetus albicilla*) is fairly common all round the lake-shore and up the Kagera River. This bird is invariably found in pairs, and appears to divide the districts into beats, each containing its pair of fish-eagles in possession. Their cheerful squalling, as described by Sir Harry Johnston, is one of the most familiar sounds near African river and lake.

An Osprey may also occasionally be seen on Lake Victoria seizing fish on the surface of the water in a manner peculiar to its kind

A species of *Plotus* is fairly common, and may be seen in small congregations at certain points where the ambatch or rocks afford a convenient spot for perching and hanging their wings out to dry.

With them may also be seen the large Cormorants, which here and there form communities numbering several hundreds. The northern end of the island Usuwgwe and the small rocky Mwasambwa Islands and Dumo Point are favourite haunts of all these birds.

A large Gull, resembling the black-backed gull at home when on wing, is also not uncommon close in-shore and especially in the rivers.

The Pied Kingfisher is fairly common inland. The two varieties of brilliant-hued Kingfishers appear to forsake their occupation of fishing to devote themselves entirely to the capture of insects.

Hérons are fairly plentiful in the swamps and at the edge of the lake. The most conspicuous amongst these is the Goliath Heron, a bird whose immense span of wing can be fully appreciated when, disturbed by a canoe, he flaps slowly across the Kagera River. The common Grey Heron is also a familiar sight, and at times flocks of the White Egret. Night-Hérons are fairly common along the Kagera River.

In the lake, Egyptian Geese and Spur-winged Geese may be seen in small numbers; Pigmy Geese are not uncommon near the lake-shore, where the open reeds afford them shelter.

Yellow-billed Ducks are perhaps the commonest of the ducks on Lake Victoria. Throughout the course of the Kagera River no ducks and geese were observed until reaching the Rufua River, and especially the Karengé Lake. The latter seems a favourite haunt of wild-fowl, and for this region of Africa is very well supplied with water-birds of all descriptions.

Huge flocks of Pelicans are to be seen, and large numbers of Pochards and Yellow-billed Duck; also Egyptian Geese.

A few Pin-tailed Ducks were also seen, but no Mallard at any time.

Teal are not uncommon; and in the Rufusa Stream and the swampy streams draining the Karenga Lake the Snipe were fairly numerous in December and January.

Along the lake-shore, especially among the ambatch trees, were vast communities of Weaver-birds. No less than seventeen forms are represented in the collection of these, many belonging to the brilliant species found inland.

Ibises are not uncommon near the water. The Glossy Ibis is a common bird, and most travellers are familiar with its exasperating cry when disturbed. The Sacred Ibis, on the other hand, is much shyer, and confined to larger and remote sheets of water.

Crowned Cranes are common, especially in the west.

Bustards are not uncommon, especially in the open cattle-country in the west, about December. Denham's Bustard, the large red-necked species, was frequently seen.

Pigeons are not often seen, but the Doves in places were very numerous indeed, especially in Bukanga.

Parrots were scarce, except the one small species collected. Grey Parrots, so common in Uganda, were never seen near the Kagera.

Birds of Prey were represented by the Bateleur Eagle and another species which was frequently observed pursuing guinea-fowl.

Vultures were rarely seen except in Bukanga, where the lions provided them with frequent meals.

It is worth noting that in April a migration of Hobbies appears to pass through the country. Enormous numbers of this handsome little falcon were seen at the same time busily engaged in pursuing locusts, large clouds of which appear to make their appearance at the same time.

In the neighbourhood of the lake Hornbills of two species are common, and Touracoes of two species make their appearance in the dense forests.

An interesting bird was the Honey-guide, which in Bukanga and the narrow valley of the Kagera River very frequently provided us with honey by leading to the nests of wild bees.

Goatsuckers are common, and in March, April, and May the pennant-winged species became very conspicuous, as when the long feathers are developed the bird has the appearance, when on the wing, of a toy Japanese kite.

Three species of Bee-eaters were seen, but the Roseate Bee-eater of East Africa and the Nile countries did not make an appearance.

The birds belonging to the scrub and open forest country, the Barbets, Woodpeckers, Pittas, Swallows, Flycatchers, Thrushes, Shrikes, Tits, and Finches, were never to be seen in large numbers, though appearing in isolated parties sufficiently often to preserve the district from the appearance of lifelessness, which is a disappointing feature in other parts.

The Larks and Pipits were, on the whole, very scarce. An extremely handsome Glossy Starling was a very conspicuous bird, which seemed to like the neighbourhood of camps. The White-necked Crow and the fine Razor-billed Raven were especially common in the west; and it was in the cattle country and on the Ruchigga Mountains that the Tick-birds (*Buphaga*) were observed, although some were seen following large herds of elands in Bukanga and Mpororo, and the rhinoceros in Karagwe.

Perhaps the most noticeable feature in the bird-life was the extraordinary number of Francolins of every species to be seen in Bukanga. Every valley and almost every patch of dry grass appeared to contain a large number of these birds. In the evenings, when the grass had been burnt in patches, numbers of Francolins could be observed feeding in the open like pheasants outside a cover in September at home. It would have been easy to have shot forty or fifty brace a-day if time and cartridges had been available.

2. The Distribution of Mexican Amphibians and Reptiles.

By HANS GADOW, F.R.S., F.Z.S.

[Received May 17, 1905.]

(Text-figures 29–32.)

CONTENTS.

Introduction, p. 191.		
List of Species collected by H. G., p. 193.		
Physical Features of the Localities, p. 196.		
Review of the Distribution of Cæcilia, p. 199.		
—, " " Urodela, p. 200.	Summary, p. 204.	
—, " " Anura, p. 205.	" p. 208.	
—, " " Crocodilia, p. 209.	" p. 209.	
—, " " Chelonia, p. 209.	" p. 210.	
—, " " Lacertilia, p. 211.	" p. 220.	
—, " " Ophidia, p. 222.	" p. 226.	
Distribution according to Altitude, p. 227.		
List of Species occurring in High Altitudes, p. 232.		
General Conclusions:—Evolution of Middle America, p. 234.		
Immigration and Spreading, p. 238.		
Northern and Southern Immigrants, p. 241.		

INTRODUCTION.

These investigations are based upon a considerable material which it is convenient to enumerate:—

1. The volume on Reptilia and Batrachia, by Dr. Günther, of the 'Biologia Centrali-Americana,' with its thousands of references to localities.

2. Cope's posthumous work, 'The Crocodilia, Lizards, and Snakes of North America,' Rep. U.S. National Museum for 1898.

3. Boulenger's Catalogue, with the lists of ever-increasing additions, of the Collection in the British Museum of Natural History.

4. Collections made by Dr. Meek during his ichthyological

tours through many States of Mexico. These, and others, I have been able to examine owing to the courtesy of the officials of the Field Columbia Museum, Chicago. Dr. Meek has, moreover, given me much verbal information about the physical aspects of the places visited by him.

5. There is a fair number of native specimens in the Governmental Museums and other Institutions of various towns in Mexico; for instance, in Mexico City, Orizaba, and Oaxaca, but the labels vouchsafe at best no further trustworthy information than "Mexico" or "La República."

6. Lastly, the material which I have collected myself, or noted down, during two journeys in Mexico, notably in the Valley of Mexico, the States of Vera Cruz, Oaxaca, Guerrero, Morelos, and Puebla, and in the neighbourhood of Zapotlan s. Guzman in Jalisco, especially the Nevado de Colima. The features of the Central and Northern plateau, except the vicinity of El Paso, I know only from several rapid transits, quite enough, however, to gather the main aspects of this enormous stretch of country. Moreover, here Dr. Meek's information has been especially welcome. Valuable for comparison, but of too short a time for serious collecting, were a few days passed in New Mexico, the Grand Cañon of Arizona, the Californian Desert, and the neighbourhood of San Francisco.

A few words are necessary as to the way in which I have marshalled the thousands of data. The reputed localities were marked down on an outlined map of the Republic, a separate map for each species. In this way alone generalisations could be formed, often at a glance, concerning the distribution of the species and genera. Many localities, at first suspicious, revealed themselves as very doubtful or as obviously erroneous on further reference to the original papers.

It was also found that the number of different localities is astonishingly small, less than 100, although they now cover a fair portion of the whole country. With the exception of 20, all these localities lie south of the line Guadalajara, Guanajuato, Tampico. The whole State of Michoacan and the western half of Guerrero are still an almost absolute terra incognita, but to judge from what I have found in Middle Guerrero and what is known from Colima, the fauna seems to be rather continuous. However, the basin of the Lower Balsas and thence to Colima will in all probability yield much of interest to whoever will brave these inhospitable and positively unknown regions.

Both Godman (introduction to the volume on Rhopalocera) and Günther, in their statistical tables, have divided Mexico simply into Northern and Southern by an absolutely arbitrary line which runs from Mazatlan to Tampico right across the country! They have done this in spite of their correct statements about the main physical features of Mexico, the unmistakable continuation of North American forms over the Plateau, and the extension of

Southern or Central American forms northwards into the Pacific and the Atlantic borderlands embracing this Plateau. The two columns in these tables are of no use, they are even misleading. Günther has properly taken off Yucatan as a separate district. Cope's division (*op. cit.* p. 1206) into a Sonoran, Austroriparian,

Text-fig. 29.



Map of Mexico.

and Toltecan subregion of Blanford's Medi-Columbian region, and the Atlantic+Pacific Tierra Caliente as belonging to the Neotropical region, is excellent when taken broadly; but his subdivision of the Toltecan into an Oriental, Central, and Occidental province is a failure.

List of Species collected by myself during the months of June to October 1902 and during 1904.

<i>Dermophis mexicanus.</i>	San Juan Evangelista.
<i>Amblystoma tigrinum.</i>	Lake Xochimilco.
" <i>altamirani.</i>	Dos Rios. Contreras, Sierra de Ajusco.
<i>Thorius pennatulus.</i>	Citlaltepeli, 9000'; Cerro de S. Felipe, Oaxaca, 8250'.
<i>Spelerpes orizabensis.</i>	Citlaltepeli, 8000-12,500'.
" <i>leprosus.</i>	" 8000-11,500'.
" <i>chiropterus.</i>	" 9000-10,000'.
" <i>variegatus.</i>	Orizaba, Presidio S. of Cordoba, Tetela, S. Juan Evangelista.
" <i>belli.</i>	Omitlente.
<i>Batrachoseps attenuatus.</i>	Nevado de Colima, 7000'.
<i>Scaphiopus dugesi.</i>	Totolapan, S. Oaxaca.
<i>Rhinophrynus dorsalis.</i>	Presidio; Agua fria.

- Bufo valliceps.*
 " *marinus.*
 " *marmoratus.*
 " *intermedius.*
Hyla baudini.
 " *eximia.*
 " *staufferi.*
 " *copei.*
Phyllomedusa dacnicolor.
Hylodes rhodopis.
 " *beata.*
Eupemphix gadovii.
Leptodactylus albilabris.
 " *caliginosus.*
- Borborocates mexicanus.*
Syrhophus verruculatus.
Paludicola mexicana.
Eugystoma ustum.
Rana montezumae.
 " *halecina.*
 " *palmipes.*
- Crocodylus americanus.*
Caiman sclerops.
Cinosternum integrum.
 " *effeldti.*
 " *leucostomum.*
 " *pennsylvanicum.*
- Dermatemys mawi.*
Nicoria rubida.
Chrysemys grayi.
 " *ornata.*
- Chelone viridis.*
- Sphaerodactylus glaucus.*
Phyllodactylus tuberculosus.
- Coleonyx elegans.*
Holbrookia texana.
Uta elegans.
 " *bicarinata.*
 " *irregularis.*
Phrynosoma asio.
 " *modestum.*
Sceloporus torquatus.
 " *spinosus.*
 " *acanthinus.*
 " *formosus.*
 " *pyrrhocephalus.*
 " *aeneus.*
- Orizaba, Presidio, Motzorongo, Tetela, Agua fria.
 Tetela, San Mateo del Mar, Tehuantepec; Iguala,
 Tierra Colorada; San Luis Allende.
 Salina Cruz; Cocoyul, Tierra Colorada, Cajones
 3000', Chilpancingo, Rio Balsas, Iguala.
 Tetela, Totolapan, Oaxaca; Omilteme, Chilpancingo,
 Presidio, Motzorongo, La Raya; Tierra Colorada,
 San Luis Allende.
 Tacubaya near M. C., Buena Vista.
 Motzorongo.
 Chilpancingo, Mazatlan, Cajones.
 Rio Balsas; San Luis Allende.
 Citlaltepēt, 8000-12,500'; Motzorongo, Agua fria;
 Nevado de Colima, 8000'.
 La Perla, North of Orizaba.
 San Mateo del Mar.
 Agua fria, Salina Cruz, Cocoyul.
 S. Juan Evangelista; S. Mateo del Mar, Salina
 Cruz, Tequesixtlan; Cocoyul, Pacific Camp, San
 Luis, Tierra Colorada.
 Omilteme, 7500'; Nevado de Colima, 8000'.
 Buena Vista, S. Guerrero.
 Chilpancingo.
 Presidio and Motzorongo.
 Xochimilco, Chalco, Zapotlan.
 Mexico, Orizaba, Motzorongo, La Raya, Agua fria,
 Salina Cruz, Tequesixtlan, near Totolapan;
 Cajones, Buena Vista, Tierra Colorada, Limon;
 Omilteme.
 Motzorongo, Tequesixtlan; Cuernavaca.
- La Raya, Agua fria, Rio Balsas, Pacific Camp.
 Agua fria.
 San Mateo del Mar; S. Dionisio, Zapotlan.
 San Mateo.
 San Luis Allende.
- Tetela.
 Tetela, Agua fria, San Mateo del Mar.
 San Mateo.
 San Mateo.
- San Mateo; Pacific Camp.
- Salina Cruz.
 Totolapan; Pacific Camp, San Luis, Tierra
 Colorada.
 Cocoyul.
 Juarez, El Paso.
 Juarez; San Marcial, N.M.; Grand Canyon, Arizona.
 Salina Cruz, Tequesixtlan, San Bartolo, Totolapan,
 Rio Balsas, Iguala, Mesquititlan, Chilpancingo,
 Tierra Colorada, Cocoyul.
 Cocoyul, San Luis Allende.
 Salina Cruz, Tequesixtlan; Rio Balsas.
 Juarez, El Paso; San Marcial, N.M.
 Xochimilco; Chilpancingo; Zapotlan, Nevado de
 Colima.
 Totolapan.
 Cuernavaca, Iguala, Rio Balsas, Tierra Colorada,
 Ayutla.
 Oaxaca, Cerro S. Felipe, 6000'; Omilteme.
 Oaxaca; Chilpancingo; Nevado de Colima, 7000-
 6000'.
 Iguala, Rio Balsas.
 Citlaltepēt, up to 13,700'; Contreras.

<i>Sceloporus scalaris.</i>	Contreras.
„ <i>variabilis.</i>	Chilpancingo, Tierra Colorada, Rio Balsas. Orizaba, La Perla; Mexico, Presidio, Motzorongo, La Raya, Tetela, Agua fria. Chilpancingo; Nevado de Colima, 7000-6000'.
„ <i>siniferus.</i>	San Mateo del Mar, Tequesixtlan, San Carlos Yautepec. From Pacific Camp to S. Luis, Tierra Colorada, Buena Vista, up to southern slope of Los Cajones.
„ <i>melanorhinus.</i>	Tierra Colorada, Cocoyul, San Luis.
„ <i>microlepidotus.</i>	Citlaltepctl, up to 13,500'. Xochimilco, Contreras. Iguala; Omilteme, Nevado de Colima.
„ <i>gadoviae.</i>	Mesquititlan between Mescala and Chilpancingo. Motzorongo.
<i>Corythophanes hernandezii.</i>	Motzorongo, Agua fria, Huile; Tequesixtlan Tierra Colorada, Ayutla.
<i>Basiliscus vittatus.</i>	Tetela, Agua fria; Tequesixtlan, Totolapan. Tetela, Agua fria; Tequesixtlan; Cuernavaca, Iguala, Tehuantepec, Salina Cruz, San Mateo. Rio Balsas, Tierra Colorado, Cocoyul, Pacific Camp.
„ <i>quinquecarinata.</i>	Salina Cruz, Tequesixtlan.
<i>Ameiva undulata.</i>	Presidio, Agua fria; Cocoyul forest; North and South below Los Cajones.
<i>Cnemidophorus gularis.</i>	Puente de Ixtla. Rio Balsas. Chilpancingo. Cuernavaca.
„ <i>mexicanus.</i>	Oaxaca.
„ <i>bocourti.</i>	Oaxaca.
„ <i>deppci.</i>	San Juan Evangelista. Tehuantepec; Salina Cruz; Tequesixtlan; Totolapan; San Carlos. Rio Balsas. Tierra Colorada; Cocoyul; Pacific Camp; San Luis Allende. Ayutla.
„ <i>striatus.</i>	Salina Cruz; Totolapan; Tierra Colorada; Ayutla; San Luis; Cocoyul.
„ <i>guttatus.</i>	Agua fria.
<i>Anolis sallei.</i>	La Perla near Orizaba.
„ <i>tropidonotus.</i>	Motzorongo, La Raya.
„ <i>nebulosus.</i>	Cuernavaca. Tierra Colorada; Cocoyul, San Luis Allende, El Coquillo; Nevado de Colima up to 7000'.
„ <i>gadovii.</i>	Tierra Colorada.
„ <i>liogaster.</i>	Omilteme, 7600'.
<i>Gerrhonotus gramineus.</i>	Citlaltepctl, 8000-9000'.
„ <i>antauges.</i>	„ 12,000'.
„ <i>deppci.</i>	„ 8000-10,000'.
„ <i>imbricatus.</i>	„ 8000-10,000'; La Perla; near Mexico, 7800'; Nevado de Colima up to 11,000'.
„ <i>liocephalus.</i>	Omilteme, 8000'.
<i>Eumeces fuscirostris.</i>	Nevado de Colima.
„ <i>lynce.</i>	„ Omilteme 8000'.
<i>Mabuia agilis.</i>	Salina Cruz, Tequesixtlan; Tierra Colorada, Cum- bre del Coquillo, Buena Vista, Cocoyul.
<i>Lygosoma laterale.</i>	La Perla.
<i>Anelytropsis papillosus.</i>	Motzorongo.
<i>Chirotcs canaliculatus.</i>	Rio Balsas.
<i>Glauconia albifrons.</i>	La Raya; Chilpancingo.
„ <i>dulcis.</i>	Rio Balsas; Chilpancingo.
<i>Boa imperator.</i>	Motzorongo. North of Rio Balsas; Coquillo.
<i>Tropidonotus melanogaster.</i>	Xochimilco. Nevado de Colima.
„ <i>scaliger.</i>	Xochimilco.
„ <i>ordinatus,</i>	
var. <i>equus.</i>	Xochimilco. San Mateo del Mar.
var. <i>marcianus.</i>	Rincon, N.M.
„ <i>scalaris.</i>	Citlaltepctl, 8000-12,000'.
„ <i>chrysocephalus.</i>	Omilteme.

<i>Contia nasus.</i>	Contreras.
<i>Zamenis mentovarius.</i>	San Mateo, Tequesixtlan.
" <i>mexicanus.</i>	Rio Balsas, Cocoyul.
" <i>pulcherrimus.</i>	Salina Cruz.
" <i>lineatus.</i>	Iguala.
<i>Coluber corais.</i>	La Raya; Tequesixtlan; Ayutla.
<i>Coronella micropholis</i> , var. B.	Chilpancingo, San Luis Allende.
<i>Urotheca elapoides.</i>	La Raya.
<i>Drymobius margaritiferus.</i>	Motzorongo, Agua fria, San Juan Evangelista.
" <i>boddaerti.</i>	Motzorongo, La Raya.
<i>Leptophis mexicana.</i>	Motzorongo, La Raya.
" <i>diplotropis.</i>	San Mateo del Mar.
<i>Rhadinea decorata.</i>	Presidio.
" <i>clavata.</i>	Tetela.
" <i>vittata.</i>	La Raya, Salina Cruz, Tequesixtlan, Totolapan ; Omilteme, Chilpancingo.
<i>Streptophorus atratus.</i>	Presidio, Motzorongo, La Raya.
<i>Geophis semidoliatus.</i>	Orizaba.
<i>Geagras redimitus.</i>	San Mateo del Mar.
<i>Trimorphodon upsilon.</i>	Cuernavaca, Rio Balsas.
" <i>biscutatus.</i>	Tierra Colorada.
<i>Himantodes cenchoa.</i>	La Raya.
<i>Leptodira personata.</i>	Rio Balsas, Ayutla.
" <i>albofusca.</i>	Cocoyul, San Luis ; Nevado de Colina.
" <i>guilleni.</i>	Rio Balsas.
<i>Conophis vittata.</i>	Salina Cruz, Tequesixtlan.
<i>Homaloceranium minutum.</i>	Tezonapan, N. of Ayutla.
<i>Manolepis putnami.</i>	Los Cajones.
<i>Petalognathus nebulatus.</i>	La Raya.
<i>Dryophis acuminatus.</i>	Motzorongo.
<i>Elaps fulvius.</i>	La Raya, San Juan Evangelista.
<i>Lachesis lanceolatus.</i>	Motzorongo, La Raya.
" <i>atrox.</i>	Motzorongo.
<i>Crotalus terrificus.</i>	Tequesixtlan.
" <i>triseriatus.</i>	Citlaltepctl, 9000-12,500' ; Nevado de Colima.

PHYSICAL FEATURES.

A list of the names of the localities where collections have been made should be supplemented by a *short description of the chief physical features*; without these it is of no more use than the bare mentioning of the name of the political country. The "altitude" is supposed to be all-sufficient; but this is a great mistake, since it conveys nothing without further information. For instance, 2000 feet on the Atlantic slope means typical tropical hot-country vegetation, while on the Pacific side (*e. g.* Oaxaca and Guerrero) the same elevation implies pine- and oak-forests, with a character devoid of tropical fauna and flora. Mexicans divide their country into the Tierra Caliente, Templada, and Fria, with a hot, temperate, and cool climate respectively; the Tierra Templada corresponding on an average with an elevation of 3000 to 5000 feet. But the natives of the State of Vera Cruz draw the imaginary line at a level very different from that used by the citizens of Puebla. Chilpancingo, 4100 feet, in Guerrero, has a much cooler climate, with nothing tropical about its vegetation, than Oaxaca, 5060 feet, or even Orizaba at 4027 feet, which is in many respects subtropical.

Valley of Mexico, 7600 feet. Alluvial; swampy meadows to west and south. Lake Texcoco brackish. Lakes Chalco and

Xochimilco freshwater, surrounded by meadows, wooded hills with streams.

Sierra de Ajusco, volcanic, well-wooded mountains. Contreras, 8090'; Dos Rios, 8800', pines. Orizaba, 4027'; on the east side of the slope of the plateau; valley with streams, pastures, and rich vegetation, on alluvial and hard-limestone terrain. Thence gradual ascent to the volcano Citlaltepétl; dense mixed forest, oak, arbutus, and pines, about 9000'; giving way entirely to pines. Tree-line about 13,500'; then tussocks of grass. Snow-line about 14,500'.

Cordoba, 2700'. Dense tropical vegetation. Thence southwards, through limestone terrain, along the foot of the slopes, which are covered up to the edge with luxurious forests; eastwards bordered by savannahs. Permanent rivers with high banks; lagoons in the forests and savannahs.

Motzorongo, Presidio, and La Raya, about 1500', in forest land.

Tetela, about 900', near the edge of the savannah.

Agua fria, 100-200'; lagoons, swamps, and low forest; flat country, subject to inundations. The Rio Papaloapan, with its many tributaries, carries an enormous volume of thick, yellow water; much of the lower basin is for months under water, only island-like parts standing out, used as refuges, although by no means sanctuaries, by the game and other creatures.

Then follows low, undulating, rolling, cattle-grazing land, with sandy subsoil.

San Juan Evangelista, 100'. Tropical river-bed through savannahs, bordered by dense lowland forest.

Isthmus of Tehuantepec. Eastern slope, dense humid evergreen forest; on the ridge, less than 1000', open country with temporary stagnant lagoons; on the western slope prevails the dry Pacific type without continuous forests, but with more scattered patches of mostly deciduous trees.

Tehuantepec, 120'. Sandy, varied terrain.

San Mateo del Mar. Sandy, lagoons connected with the sea. Flat, scanty vegetation except in occasional swamps or near the lagoons, some of which are fringed with dense low brushwood and small trees.

Salina Cruz. Porphyritic terrain; hilly, steep coast-range, varied by promontories and fresh- and salt-water lagoons.

From Salina Cruz and Tehuantepec northwestwards to Oaxaca.

The coast-range, averaging 2000-3000 feet, is covered with pines down to 2000 feet. Tequesitlan, 560', in a river-valley, shut off by the coast-range; varied, rather low vegetation, volcanic alluvial. Thence through mountainous country, across parallel ridges. Hills at first with tropical vegetation; oak-forests from 3000' upwards, then pines prevailing, but nowhere continuous forests. General character of the country dry, most of the smaller rivers run dry except in the rainy season. An intricate system of

hills, deep gorges with sandy river-beds and patches of xerophile vegetation, especially cactus.

San Bartolo, 2800'; San Carlos, 2460', in more open country. Totolapan, 2800', in broad, sandy river-valley. Thence steep ascent on to the plateau, the edge of which is 5300'. Looking back, southwards, over the many ridges of mountains and hills, the Tierra Caliente appears to be densely covered with wood, while towards the north stretches the flat, almost treeless Southern Plateau, here and there with outcropping low ridges which are barren when of volcanic, wooded when of Palæozoic formation.

San Dionisio and Tlacolula, 5160'; Oaxaca, 5060'. The Palæozoic terrain stretches from Oaxaca westwards. There is the forest-clad Cerro de San Felipe, 9000 feet high, with semialpine meadows on its slopes.

From Cuernavaca southwards to the coast.

Cuernavaca, 5000'. Fertile valleys of volcanic and limestone terrain, with little streams. Shut off from the Valley of Mexico by the high, volcanic, densely wooded Sierra de Ajusco, &c., averaging 10,000 feet.

Puente de Ixtla to Tetecala. Pleasant, fertile, varied open country; limestone terrain, in which are the huge Caves of Cacahuimilpa.

Iguala, 2400', in a wide plain, surrounded by limestone hills, with scanty vegetation.

Rio Balsas Station, 1500'; in the valley of the Balsas or Mescala River. Very mountainous; tropical vegetation. High and low forest, interspersed with much brushwood. The river, during the rainy season, brings down floods of yellow or brown water with rather little sand, but much comminuted vegetable matter. The bed is rocky, limestone, the banks mostly steep, but there are many sandy shelves above the high-water mark. Mescala, 1700'.

The Balsas basin is bordered on the southern side by a long and high range of mountains, parallel with the Pacific coast, attaining heights of 10,000 feet, densely wooded, intersected by very deep, steep, and long gorges, and the river-beds are the only available roads; here and there these river-beds broaden out into meadows.

Mesquititlan, 2800'. Narrow, luxuriant gorges.

Zumpango, 3400'. Open, sandy, meadows.

Chilpancingo, 4100'. In a windswept, shallow depression of Cretaceous terrain, surrounded by sparsely wooded hills, and meadows on the top of the ridge.

To the west, in the mountains the hamlet of Omilteme, 7100', luxurious forests; at first oak, dwarf palms and pines; then oak, pine, and arbutus; then oak and pine; and lastly pines up to the highest summits, forming dense high forests, with the most luxurious underwood in the gorges, especially within the cloudbelt.

Mazatlan, 4200'. Meadows and fields.

Cumbre de los Cajones; the pass at 3500' over a ridge which, on the south flank of the main range, marks the beginning of volcanic terrain. Oak and pines and columnar cactus.

Buena Vista, 2300'. Wide meadows, with pools in the rainy season; low hills with oak and pines.

Typical Tierra Caliente, with an essentially tropical aspect of flora and fauna, begins on the southern slopes of the main ridge, coinciding with what is officially and locally known as La Costa. Its upper limit may be put at not higher than 1000 feet. In the depressions between the successive parallel ranges of hills the type is absolutely tropical and southern, but the country loses this character at once on the ridges which rise higher than 1500 feet.

Tierra Colorada, 990'; river valley, volcanic. Andesite overlaid with red rubble.

Valley of the Omitlan River, 500'. Limestone, densest vegetation on the slope which culminates in a ridge of 1600', called El Cumbre de Coquillo.

Coquillo to Chacalapan, about 700'; tropical life.—From here, across several smoothed down ridges and to the coast, the subsoil consists of gneiss and granite in rapid decomposition, fairly well wooded in clumps or large patches, often interrupted by meadows and natural stretches of pasture. Numerous small rivers, carrying much sand, but nearly always with clear water, but most of them are liable to run dry in the winter. Near the granite-bound coast are numerous lagoons, mostly of fresh water, and there is a broad belt of almost impenetrable high forest, which in many places touches the sea. The mangrove-swamps of course are permanent, but during the rainy season many parts of these forests are inundated.

Limon, 1800'. Open, dry grass country.

Teconapan, 1500'. Broad meadows.

Ayutla, 1200'. Permanent river; rich vegetation.

Cocoyul, 160'. Near the coast forest.

Pacific Camp. Near the shore, 99° W., 16° 36' N. Close to the forest; large lagoons and swamps; granitic rocks and mangroves.

San Luis Allende, 930'. Broad river-valley, with well-wooded hills which are covered with various kinds of oak, and from 1900' upwards chiefly with pines.

Nearly the whole Coastal District is, during and after the rainy season, covered with a dense mass of tall herbs, which between the trees especially take the place of underwood.

CÆCILLÆ.

Dermophis mexicanus.—This is the only Cæcilian which extends into the Mexican Tierra Caliente. Previously known to range from "Tehuantepec" to Panama, I found it in the low woods near San Juan Evangelista. The American ancestral home of this circum-tropical family is South America, and none are known to occur on the Antilles or on the Galapagos. It is therefore

interesting that these burrowing, slowly moving worm-like creatures have managed to travel over at least 1500 miles of ground, covered with humus, since the close of the Miocene epoch, *i. e.* since the separation of the Antilles (*cf.* p. 237). A not unreasonable computation of one million years carries us back into the Miocene epoch. The rate of spreading could in this case have been extremely slow, only about one mile in 700 years, and this works out at three yards a year. Of course this is mere speculation, but it may be as well to give even such an imaginary instance of slow spreading. The fact remains that *Dermophis* has done it, and whether we double or treble the rate of progress, or increase the time two- or three-fold, the result remains within very reasonable possibility.

URODELA.

The *Amblystomatinae* are a pre-eminently Eastern Palearctic group; only two out of eight genera occur in North America: *Dicamptodon ensatus* in California, and *Amblystoma*, with some 16 species, on the North-American Continent, and one, *A. persimile* in Siam. In Mexico only two species occur.

Amblystoma tigrinum, the larval form of which, when permanent, is the famous Axolotl. This species has an enormous range, from the State of New York to Dakota and Colorado, whence, apparently now with wide gaps between, it extends through Mexico, as far south as the valley of Mexico City. But its distribution in Mexico is, at least now, restricted to the western Sierra Madre and the southern part of the Mexican plateau.

Well-ascertained localities of this species are the following:— West of Chihuahua Town; West of the town of Durango; Cumbre de los Arrastrados in Jalisco; somewhere N.W. of Guadalajara; district of Autlan in Jalisco; Lake Patzcuaro in Michoacan, Valley of Mexico, notably Lakes Xochimilco and Zumpango (but not Lake Texcoco, to which alone Weismann's dismal dream to account for the permanent Axolotl stage could apply!). Possibly there are *Amblystoma*, either metamorphosing or as Axolotls, in or near some of the other lakes of Michoacan and Jalisco, but they have as yet not been recorded from Lake Chapala; and I found none in the Lakes of Zapotlan; nor were such creatures, or even the name Axolotl, known to the natives.

A. altamirani.—This species, which metamorphoses regularly into a gill-less Newt, is known only from the streams of the mountains which border the western and south-western side of the Valley of Mexico. It was discovered in the Montes de las Cruces, about 15 miles to the west of Mexico City, at an altitude of 8800 feet. In 1902 I found it also above Contreras, in the Sierra de Ajusco, some 12 miles south-southwest of the city, at an altitude from 8500 feet upwards to 8800 feet. Further up the rivulets are apparently too small. I stated in 'Nature,' Feb. 5, 1903, that searching in the streams only a little above the City of Mexico,

which lies at an altitude of about 7600 feet, was fruitless. In the month of September 1904, however, when we revisited this district, I was able to ascertain that these Newts live regularly in the stream below Contreras (altitude 8090 feet) down to about 7900 feet, where the stream leaves the hills, and runs, still swiftly, in its stony bed through the Pedregal, or recent field of lava, then through rich evergreen meadows into Lake Xochimilco. Moreover, I can now add with certainty that *A. altamirani* is absolutely aquatic throughout its life. The natives (millers, field-labourers, and boys) knew the creatures well. They called them "axolotes sordos" (deaf, having no ears), and described them as *axolotes sin aletas* (without winglets, meaning gills); when I searched for them on land, on the bordering meadows, under stones, or amongst the trees, the people laughed at my ignorance of expecting to find "fishes" on dry land. There are no fishes in that stream. But this, their "fish," they pronounced as no good, because these axolotes de cerro (Mountain Axolotl) are not eaten like the "axolotes del lago."

During our last visit the mountain-streams were transformed into turbid roaring torrents, and it was only at a few spots that the Newts were visible, generally in some stiller water, in the shelter of some great boulder. There they stood, or rather were lying, on little patches of sandy bottom, the larvæ working their gills vigorously, the adult motionless except for the undulating tail, and never rising to the surface to breathe. They were all extremely shy, quickly hiding beneath or between the stones.

In the Montes de las Cruces, close to the railway-station Dos Rios, the streams form here and there little swamps or ditches, with much watercress in the slowly-flowing water; there we found plenty of larvæ; the adult only in the running water. Not one of these mountain-streams runs dry.

The lungs are well developed.

The only specimen, a larva 100 mm. long, which I succeeded in bringing home alive in 1902, metamorphosed within 8 weeks, losing the fins and gills, and closing the gill-openings completely, but it died before losing the yellow and black piebald coloration.

The distribution of *Amblystoma* in Mexico coincides absolutely with the large central and western portion of the country, which has been covered with volcanic masses, repeatedly or successively, since the Eocene epoch; and the last outburst, which produced the Pedregal near Mexico, is known to have occurred after this part of the country was already inhabited by man. It was impossible for Amphibia to live on such a terrain until it was weathered enough to sustain a permanent and moisture-loving vegetation. In fact every locality where *A. tigrinum* is known to occur is on the Quaternary, mostly sandy, patches formed by the disintegrating debris of the volcanic masses; or it is found in the lakes, all of which are partially filled-up mountain valleys.

We have to conclude that the *Amblystomas* are recent immigrants from the North. Where they have met such lakes,

these have become, or are becoming, too attractive for them, with the result that *A. tigrinum* has sunk, or is sinking, into a more or less perennibranchiate state, the Axolotl. Typical Axolotl are those of Lake Xochimilco, the condition of which I have described in 'Nature,' Feb. 5, 1903, and Lake Patzcuaro, which, with its rushes, weeds, and other abundance of vegetation, is very similar to the Mexican lake. Sexually ripe Axolotl are also known from Jalisco mountain tarns or lakes, and lastly from St. Mary's Lake, Estes Park, Colorado. It is therefore the combination of certain favourable circumstances (permanence of water, abundance of food, shelter, equable temperature) which produces the "Axolotl." Whoever has seen the very different conditions prevailing in Lake Zumpango, to the north of Mexico City, will easily credit Velasco's statement that *A. tigrinum* metamorphoses into the normal gill-less Newt, as it does in the United States, and probably in various other parts of Mexico.

All the more interesting is the fact that the other species, *A. altamirani*, the only one which lives in the streams of recent volcanic mountains, has been modified into a gill-less but permanently aquatic form.

DESMOGNATHINÆ.—The three species of *Desmognathus* inhabit the Eastern United States.

Typhlotriton speleus is restricted to subterranean caves in Missouri. *Thorius pennatulus*, the only remaining member of this small group, and its sole representative in Mexico, points therefore unmistakably to the Eastern half of North America as the original home of the group, not of *Thorius* itself.

This tiny Newt, less than two inches in length and thinner than a match, with weak limbs and reduced digits, shows a peculiar dimorphism of the size of the nostrils. They are very large and open in the males, much smaller in the females. The lungs are quite aborted as in *Desmognathus* and *Speleerpes*.

Thorius has a very limited distribution. It was discovered on the south-western slope of the Pic of Orizaba. I found *Thorius* in abundance on the south slope, 9000–10,000 feet, in high, mixed forest, either on the ground beneath flat pieces of fallen bark, or on decaying logs of pine between the bark and the wood amongst the "worm-meal" of boring beetles and maggots. Again I met them under exactly the same conditions on the Cerro de San Felipe, 8250 feet, near Oaxaca. These are the only two localities so far as we know at present. It is doubtful whether their distribution is now continuous; the watershed between the Atlantic and Pacific, to the west of a line drawn from Orizaba to Oaxaca, averages about 8000 feet in height, and it is well-wooded, but there are several deep transverse depressions in it.

PLETHODONTINÆ.—This group, consisting of 5 genera with about 40 species, is entirely American, with the sole exception of *Speleerpes fuscus* in Europe.

Spelerpes.—This large genus, composed of about 20 species, ranges from Massachusetts into North-western South America. At least 10 species live in Mexico, 9 of them south of a line drawn from Guadalajara to Tuxpan on the Atlantic; some of them extend into Guatemala and Costa Rica. *S. yucatanicus* in Yucatan. A few occur as far south as Peru; one, *S. infuscatus*, inhabits Hayti, and *S. fuscus* lives in Sardinia and Northern Italy.

The distribution of the Mexican species is important. The Aztec name is "Tlaconéto" = little land creature.

S. cephalicus, described by Cope from "North-eastern Mexico." No *Spelerpes* seem to occur in Texas; the nearest American species, *S. multiplicatus*, lives in Arkansas; *S. orizabensis* and *S. lineolus*, the latter with tiny, reduced limbs, are known only from the mountain of Orizaba, *S. orizabensis* ranging between 8000 to 12,000 feet.

S. leprosus, of which *gibbicaudus* Blatchley is a not unfrequent individual variation, is common in the mixed and pine forests of the mountain of Orizaba, up to 12,000 feet. It has also been recorded from the north slope of Popocatepetl, 9000 feet, and from the mountains of Jalapa.

S. morio from "Jalapa," and from Tlalpam, which lies between Mexico City and Lake Xochimilco, in flat, sandy, moist terrain, with meadows and willows. It appears again far in the south, in Guatemala and Costa Rica.

S. chiropterus. Mountain of Orizaba, from the town, 4000 feet up to near 10,000 feet; "Jalapa," and Cuernavaca which has an elevation of 5000 feet. "Vera Cruz" must be left as a doubtful locality.

S. rufescens is recorded from "Orizaba," Cordoba, Vera Cruz, Tehuantepec, Chiapas, and Tabasco; all in the Tierra Caliente, except the first locality.

S. variegatus ranges from the Valley of Mexico, Orizaba (from 9000 feet downwards), Jalapa, Cordoba, right through the forest of the Tierra Caliente and through the whole of Central America to Costa Rica. I found it on Orizaba mountain, as well as at San Juan Evangelista, which lies scarcely higher than 100 feet above the sea, in the same ground with *Dermophis*.

S. unifornis, with reduced limbs like *S. lineolus*, described from Costa Rica, elevation of 5000 feet, is said also to have come from "Vera Cruz."

Lastly, *S. belli*: mountains of Jalapa, Orizaba, Mexico, Zacualtipan, Guanajuato, Guadalajara, Sierra de Nayarit; and at Omilteme, west of Chilpancingo. This species alone has found its way across the plateau, following the belt of alluvial deposits described elsewhere (p. 237). With the exception of this transverse belt, the distribution of Mexican Newts coincides closely with the broad band of Cretaceous limestone which extends from Nuevo Leon to the Isthmus, with intricate but almost continuous patches verging from Cordoba and Orizaba south-westwards to Chilpancingo. This limestone terrain was the only one available

for Newts during most of the Tertiary period: on the west the plateau suffering from the volcanic revolutions; on the east the sea still covering the present Atlantic Tierra Caliente. The Cretaceous parts formed so many oases where alone Newts could exist or survive. Later, when the volcanic ranges, even the volcanoes themselves, became covered with forests, the Newts spread onto them, just as they have spread into the moist hotlands of the State of Vera Cruz. It may appear strange that the limestone should have been the means of their preservation, considering that lime-water is, as a rule, not favourable to their development; but here comes in the significant fact that most, if not all, the Mexican *Spelerpes* are viviparous, unless they deposit their eggs, like *Batrachoseps*, in hollow trees. Some of them, for instance *S. orizabensis*, lead a partially arboreal life. We found many on the pine-trees of Citlaltepétl, favourite hunting and hiding places being the epiphytic plants, especially the large Tillandsias, Orchids, and Philodendron in the hot country forests. The humus and moisture collecting in these growths, often many feet above the ground, swarm with insect life and with little Scolopendras, which seem to be the staple food of these *Spelerpes*.

The apparent absence of Newts on the Northern plateau is most likely due to the dearth of permanent moisture, long-continued periods of drought, and dust. A more difficult question is the apparent absence of Newts on the terrain of gneiss and granite which covers so large a portion of Southern Guerrero and Oaxaca, and on the well-wooded mountains of the Sierra Madre. For months have we searched Guerrero during the rainy season (there are thousands of places which, if they were on the Eastern slope, would yield an abundance of Newts), but it was in vain. A few specimens of *S. belli*, from the mountain forest of Omilteme, are the only exception.

Batrachoseps.—*B. scutatus* ranges from Illinois to Rhode Island and to the Gulf of Mexico; the other species live in the Pacific States, from California to Oregon. Quite unexpected was therefore the occurrence of the Californian *B. attenuatus* on the Nevado de Colima. I found a single, young specimen on the northern slope, at about 7000 feet elevation, in the stump of a decayed pine-tree. There are some patches of granite and of limestone in that district, but then comes an unbroken stretch of originally volcanic formation, for about 200 miles, until the gneiss is reached to the north-east of Mazatlan. We cannot well imagine that this species is an ancient survival; it must be a comparatively recent immigrant from the north-west, from California. Probably it occurs all through the slopes of the western Sierra Madre, which is mostly clad with pine-forests.

Résumé of the Distribution of Mexican Urodela.

All the American Urodela are of Nearctic origin, with their earliest centre in Old Sonoraland. At least the Amblysto-

matinae point to the long-continued land-connection with Eastern Asia. A later centre of dispersal lies in the Eastern half of North America, the old Appalachia, the Alleghany mountains, &c., whence Urodeles have spread, as *Plethodontinae* and *Desmognathinae*, over most of the Eastern and Southern States, also into and through Mexico's eastern half. This spreading dates back to Miocene times, witness the existence of *Spelerpes* in Hayti, while others have reached even South America, and, lastly, the occurrence of a *Plethodon* somewhere in the La Plata basin. Much later immigrants, directly from the old north-western home, are *Amblystoma* and *Batrachoseps*: *A. tigrinum* and *B. attenuatus* being identical species in the States and in Mexico, only *A. altamirani* being a new modification; while *Spelerpes* has developed many species, different in the north, centre, south, and in Hayti.

ANURA.

PELOBATIDÆ.—*Scaphiopus*, the Spadefoot, closely allied to the European *Pelobates*, is the only American genus of this family, with about 7 or 8 species, two of which are restricted to the United States. The zone of sandy terrain of Texas, New Mexico, and California is richest in Spadefeet, whence they have extended over the Mexican plateau down to the Pacific and Atlantic coasts. *S. dugesi* s. *hammondi* has the widest distribution: from Missouri and California through New Mexico and Texas, the mountains west of Chihuahua, in Guanajuato, and again on the southern slope of Oaxaca, where I found it at Totolapan, its most southern locality. The retiring habits of the Spadefoot no doubt account for the few scattered records. The well-wooded mountain-ranges which form the south-eastern, southern, and western borders of the Mexican plateau are a natural obstacle to a further southward spreading of this genus.

BUFONIDÆ.—Central America and Mexico are one of the centres of Bufonidæ. Concerning Mexicans, they can be grouped as follows:—

1. Indigenous: *Rhinophryne dorsalis*, the only species of the genus, a toad specialised as an eater of Termites; it is restricted to the moist Atlantic Tierra Caliente, from Tuxpan, north of Vera Cruz, through the Isthmus to Campeche and Guatemala. The light-coloured spots on the bluish-slaty black skin are either yellow or orange to red, varying in individuals from the same locality. They are very sluggish, rather nocturnal, and retire beneath a rotten stump or into a small self-dug hole in the moist humus. Aztec name "Póche."

2. Southerners: *Engystomops*, the few species of which range from Venezuela and Ecuador northwards, but only *E. pustulosus* reaches the Isthmus of Tehuantepec.

Several of the 13 species of *Bufo* found in Mexico are southern forms: in their spread northwards they either stop short at the

Isthmus, *B. coccifer* and *B. sternosignatus*; or they extend into the Atlantic hot-lands, *canaliferus*; or along the Western Sierra Madre into Jalisco, *intermedius*, with *marmoreus* peculiar to South-western Mexico; or they go as typical hot-country Toads into both the eastern and western Tierra Caliente, *marinus*, *valliceps* on the Atlantic side from Nicaragua to Texas, not on the plateau, but recorded from Jalisco and Presidio near Mazatlan; lastly, *B. simus* from Panama on to and over most of the Mexican plateau.

3. Northerners, chiefly at home in the South-western United States and in the northern half of Mexico, eventually extending south over the Central plateau: *B. punctatus*, *debilis*, *compactilis*.

Of the Bufonidæ which are found in the Greater Antilles all are now separate, insular species, except *B. marinus*, which has probably been introduced.

HYLIDÆ.—The creative centre of this family is decidedly South America. Every one of the 14 genera of Hylidæ is found in America, and it is only by the large genus *Hyla* (incl. the slightly modified *Hylella*) that this family has attained its world-wide range with the remarkable exception of the whole Paleø-tropical region. From North-western South America they have spread through Central America into the Antilles (about 7 or 8 species, mostly peculiar), and through Mexico into North America.

Concerning Mexico they fall into the following groups:—

1. Genera peculiar to Mexico: *Pternohyla*, *P. fodiens* of Presidio near Mazatlan; *Tripriion*, *T. petasatus* of Yucatan; but *Diaglena jordani* of Ecuador and *Corythomantis greeningi* of Brazil point to the south as the old centre of these peculiar Mexicans.

2. Genera with preponderating numbers of species in Central and South America, while comparatively few have reached, or have been developed in, Mexico: *Phyllomedusa* with only *P. dacnicolor* on the Pacific side, *Agalychnis callidryas* and *Nototrema oviferum* in the Atlantic Tierra Caliente.

P. dacnicolor is saturated green, often with the same white temporary patches or spots as happen so frequently in the Australian *Hyla cærulea*. They were pairing at Rio Balsas in the month of June. During the nightly thunderstorms the males kept up an incessant noise like the snarling bark of little dogs. The couples were sitting in low shrubs or amongst herbs, a foot above the ground, overhanging little ditches which led into a dirty stagnant pool. During the daytime the ditches were absolutely dry. The eggs are very small, very numerous, and of a light grass-green colour.

3. *Hyla*. About 15 species are recorded from Mexico, to which no less than 11 seem to be peculiar, but at least 8 of these have hitherto been found in single localities only. Our knowledge of the distribution of Tree-frogs is still very defective. Most of them inhabit the forest-regions of the Atlantic slope. They are dis-

covered and caught by mere accident. For instance, I found one single specimen of *H. staufferi* at Motzorongo, a species until then known only from Guatemala. *H. boucourti* of the same country has been recorded once from Tepic, none from the enormous intervening stretch. *H. miotympanum* seems to range from the Isthmus through the mountainous parts of Vera Cruz, going up towards Puebla. *H. venulosa* is an eastern form, from South America to Tampico, decidedly Atlantic, but once recorded from near Mazatlan. *H. baudini*, the commonest Tree-frog, ranges from Ecuador right through Central America, and then spreads east and west through the hot countries of Mexico, absolutely avoiding the plateau, but reaching Texas.

On July 4, 1902, when the rains were very irregular, we found *H. baudini* spawning, south of Cordoba. On a piece of inundated woodland meadow, about the size of a suburban lawn, were 45,000 frogs at a low computation, two-thirds of them in amplexus, the other males making a deafening din. Next day the pool was dried up completely, the grass glazed with the spawn, and there was not a single frog to be heard or seen in the neighbourhood.

H. copei, known as "Sapo blanco" or white toad, is a hill form. Known already from Texas, Chihuahua, Guanajuato, and Jalisco, I found it plentiful on the whitish calcareous terrain south of Chilpancingo, not in the trees but sometimes on rather barren and dry fields. Decidedly typical of the western and southern plateau and its Pacific slope, and very abundant, is *H. eximia*.

Result.—Mexico has many Hylidæ in common with Central and even South America; but the majority are now peculiar to Mexico, and only two, *H. copei* and *H. baudini*, extend northwards into Texas.

CYSTIGNATHIDÆ, like the Hylidæ, of decidedly South-American origin. Of the 15 or 16 genera of this family only *Leptodactylus**, *Pabudicola*, *Syrrophopus*, *Hylodes**, and *Borborocates* occur also in Mexico, altogether with some 23 species. Those marked* are also Antillean. Not one reaches the United States; in fact the most northern record is made by *H. calcitrans* at Zacatecas. *B. mexicanus* is peculiar to the Central plateau and the high mountains of Jalisco, Colima, and Guerrero. Of the 9 or 10 species of *Hylodes* 6 are restricted to Mexico, but their recorded localities are still too few and scattered. The same applies to the six species of *Syrrophopus*; the others range far south to Nicaragua and Costa Rica: *H. palmatus* is Pacific, *H. melanostictus* Atlantic Mexican; *H. rhodopsis* on either side. The last is the commonest species and seems to be an instance of a southerner which, although not going on to the plateau itself, ascends the high mountains on its eastern, southern, and western borders, *e. g.* Citlaltepétl up to 10,000 feet, Cerro de Oaxaca, Nevado de Colima; it also inhabits the hot lowlands of Agua fria in the State of Vera Cruz. Mostly of dark brown and reddish tints and living on or near the ground; however, some specimens in the epiphytic Tillandsias, or on green

shrubs at the edge of a forest, were quite green, but they soon changed to reddish yellow and ultimately assumed the normal reddish colour.

Of the 5 species of *Leptodactylus*, 3 are too little known. *L. microtis* from "Guanajuato" would be the only instance of the occurrence of a *Leptodactylus* on the plateau instead of in the lowlands. Only two species have a wide distribution: *L. albilabris* of South Guerrero, Oaxaca, and of Vera Cruz, also Antillean; *L. caliginosus* from Paraguay northwards, in Mexico in the Pacific Tierra Caliente as far as Mazatlan.

ENGYSTOMATIDÆ, with an obviously South-American centre of dispersal; not Antillean. The small genus *Engystoma* reaches through Mexico into the South-eastern United States (*E. ustum*).

RANIDÆ.—This family is essentially Palæo-tropical. Scarcely more than a dozen species, all belonging to *Rana*, occur in North America, only 6 in Mexico, and fewer still further south, in the north-western portion of South America. There, however, the Ranidæ have found a new congenial home, which has stimulated them into the development of 5 new genera, with about one dozen species, all arboreal, besides *Dendrobates*. The Ranidæ have not found their way into the Antilles.

Of the six Mexican species, *R. forreri* is restricted to the district between Durango and Mazatlan; *R. pustulosa* to same district and Western Jalisco; *R. omiltemana* to Guerrero mountains: these three are peculiar to Mexico. *R. halerina* is the common river-frog of the country, both in the hot parts and on the plateau, extending from the United States through the whole of Mexico down to Costa Rica. *R. palmipes* ranges from southern tropical Mexico to South America. Lastly, *R. montezuma*, the largest of all, is a lake-dweller, e. g. lakes of Jalisco, near Mexico City, Tehuantepec, extending south into Tabasco and Guatemala.

Résumé of the Distribution of Mexican Anura.

We can easily distinguish between northern and southern immigrants.

1. Northern, decidedly of Neartic origin. *Scaphiopus*, scarcely reaching the Isthmus of Tehuantepec; and a few *Rana*, all water-frogs. Both genera are comparatively recent immigrants, non-Antillean, although *Rana* extends through and beyond Central America.

2. Southern, of obvious South-American origin.—*a.* With related, or identical, species in the Greater Antilles. *Cystignathidæ*, not reaching the United States. *Hylidæ* and *Bufo*nidæ, each, especially the Hylidæ, with genera peculiar to Mexico, indicating ancient residence.—*b.* Non-Antillean, a few *Engystomatine*, scattered through Mexico.

CROCODILIA.

Crocodylus americanus is the commonest tropical American Crocodile, from Florida to Northern South America. In Mexico it is strictly confined to the Tierra Caliente, with Mazatlan as its north-western limit. It ascends the Rio Balsas at least up to Mescala, but this is not much more than 1700 feet above sea-level. Common in the lagoons on the coast of Guerrero and Oaxaca, except where it has recently been well-nigh exterminated by American skin-hunters. More exist in the river-systems of the State of Vera Cruz, ascending occasionally up to Motzorongo, *i. e.* 1500 feet. During the rainy season they often forsake the then turbid rivers, and roam at night through the forests in search of lagoons.

C. moreleti inhabits the Tierra Caliente from Tampico to Honduras.

Caiman sclerops s. punctulatus has its centre in South America. In America it occurs only in the Atlantic hot-lands. I met with very large specimens (length of skull 20 inches) at Agua fria in the same lagoons and rivers as the Crocodile. Whilst the latter, anyhow not averse to brackish water, inhabits the Greater Antilles, the Caiman has found its way only into Trinidad and, if report is true, to Martinique. The Alligator of the southern United States does not seem to cross the Rio Grande.

CHELONIA.

It seems almost incredible that *Chelydra* has never been recorded from Mexico, considering the wide range of *Ch. serpentina* in the United States and the existence of the other species, *Ch. rossignoni*, from Guatemala to Ecuador. The Papaloapan and S. Juan Rivers of the State of Vera Cruz are certainly large enough, with pools and backwaters, but I could not ascertain the presence of a large, snappy species.

DERMATEMYDIDÆ.—The few species of this family are peculiar to Central America. *Dermatemys mawii* extends from Honduras into Yucatan and Vera Cruz; it occurs, for instance, in the pools of the forests and savannahs near Tetela, where it is known as the "Tortuga blanca." *Stawrotypus* seems to have a similar range: *S. triporcatus* going up to Vera Cruz; *S. biporcatus* only up to the Isthmus.

CINOSTERNIDÆ, with the sole genus *Cinosternum*. About 10 species in North and Central America, one extending to Guiana. Well represented in Mexico by 6 species. Of these, *C. pennsylvanicum*, previously recorded from the Valley of Mexico, was found by myself in South Guerrero, at San Luis Allende. *C. hirtipes* ranges from Arizona and New Mexico along the Pacific side into Jalisco, and includes the Tres Marias Islands.

C. sonoriense in Sonora. *C. integrum* (a variety of *C. scorpioides*) is likewise Pacific, from Jalisco, *e. g.* Lake Chapala, to which I can now add Zapotlan and the small rivers on the plateau south of Oaxaca and the swamps of San Mateo near Tehuantepec. *C. leucostomum* extends from New Orleans along the Atlantic side of Mexico through and beyond Central America. *C. effeldti* is known from the State of Vera Cruz, San Mateo del Mar, and Guatemala.

TESTUDINIDÆ.—*Cistudo* with two species in North America and one in Yucatan, strictly terrestrial. *C. mexicana* of Texas and New Mexico, *e. g.* San Marcial. How far it extends into Mexico is not known; Tampico is quite possible, but I very much doubt "Mexico City" and neighbourhood.

Nicoria rutila I have met in swampy bush-land of the State of Vera Cruz and near Tehuantepec, and this seems to be its range; allied species occur in Central America.

Chrysemys extends from Canada to Argentina, but with a preponderance of northern forms. In Mexico restricted to the hot countries, and even there common only about the Isthmus, whence *C. grayi*=*umbra* and *C. incisa* go further south. *C. ornata*, from Panama to Tehuantepec, has been found by Forrer also near Mazatlan, with *C. pulcherrima*. I do not know of a single locality for *Chrysemys* on the plateau, or to the east of it, except for *C. mobiliensis*, which goes from Texas into the lowland of Nuevo Leon.

This scarcity of Water-Tortoises in Mexico is rather puzzling. On the plateau *Cinosternum* alone is found, and these thick-shelled box-like creatures are, moreover, the only kind which can withstand the buffeting to which they are subjected in the torrents into which the rivers of the slopes of the plateau are converted in the rainy season. The Tortoises hide then under the boulders in the stream. *Chrysemys* shuns such waters, and neither it nor *Cinosternum* occurs in those rivers which carry much sand.

Chelone viridis was laying during July and August on the coast of Guerrero and Oaxaca.

Résumé of the Distribution of Mexican Chelonia.

The Cinosternidæ, taken with the closely-allied Dermatemydidæ and Chelydridæ, are autochthonous Americans; the first a Sonoran, the second obviously a southern group so far as the present distribution is concerned. Both Chelydrids and Dermatemyds are known from the Cretaceous of North America. The three together may well be regarded as originally northern and ancient. The same applies to the Testudinidæ, the only family which has, recently, sent a United States *Chrysemys* into the Antilles and a South American into the Windward Islands. The Testudinidæ, plentiful in North America, scarce in Central, and with still fewer species in South America, have clearly come from the

Northern continent. The earliest, probably all of the genus *Testudo*, have been found in the mid-Eocene of Wyoming and New Mexico; since Oligocene in Europe, still later in India. With this remote occurrence in ancient Sonoraland I couple the most important fact of the Galapagos Tortoises. They are a strong indication of the former, let us say Oligocene, extension of land considerably to the west and south of the present Central America. We shall find this idea supported by Iguanidæ. Now North America possesses but the single *T. polyphemus* in the South-eastern States, and South America has only *T. tabulata*. Something has gone wrong with this genus, which has flourished in the Miocene of Dakota, Nebraska, and Oregon, as has been the case with so many mammals which started and flourished in the States and are now restricted to the Old World.

LACERTILIA.

GECKONIDÆ.—The distribution of American Geckos is almost entirely tropical. The greatest number and diversity of species occur in the Antilles, in Northern South America and the adjoining Central America, whence few have spread into the warmer parts of Mexico, avoiding the plateau. North America has received only *Sphaerodactylus notatus* from the Antilles through the Bahamas into Florida, and *Phyllodactylus tuberculosus* into California; this species is the commonest Gecko in Mexico, ranging strictly along the Pacific slope to the Isthmus of Tehuantepec and thence to Nicaragua. *Sphaerodactylus* sends only three species into Mexico: *S. glaucus* to Salina Cruz and into the State of Vera Cruz; the Central American *S. torquatus* and the Antillean *S. anthracinus* are recorded from the same State, and *S. torquatus* has been described from Mazatlan. *Gymnodactylus sumichrasti* reaches the Isthmus, and *Thecadactylus rapicauda*, of Yucatan, Antilles, and southwards, is said by Cope to have been recorded from Guadalajara, a very doubtful locality.

Phyllodactylus tuberculosus is common in the villages of Southern Oaxaca and Guerrero, where it is known as "Pata de bueye," *i. e.* ox-foot, because of its peculiar digits. The general name for Geckos is "Salamanqueza" or "Salamanqueza," which name, however, also applies to the slippery *Mabuia* and *Eumeces*. I found the same Gecko on the trees of dense forests near the coast of Guerrero. *Sphaerodactylus glaucus* is typically xerophile. As in Spain and Portugal, all Geckos are considered extremely poisonous.

EUBLEPHARIDÆ.—This small and very scattered family (in West Africa, Somaliland, India, Transcaspia, and Persia) is represented by three species in Mexico, a few others occurring in Panama and Ecuador. *Eublepharis variegatus* is the northern offshoot, from El Paso to the Gila River and California, probably also in Sinaloa. *E. fasciatus* is known from Ventanas, north-west of Mazatlan. These are apparently typically xerophile, like the

two Asiatics of the same genus. But *Coleonyx elegans* is distinctly a forest form. I found it a few miles from the coast of Guerrero in a moist patch of thick lowland forest on the ground under stones and rotten stumps. A typical Central American, ranging through the Pacific and Atlantic Tierra Caliente of Mexico, from which country it had hitherto been recorded only by Sumichrast from near Orizaba; extending south to Costa Rica.

IGUANIDÆ †.—It is not profitable to speculate upon the original home of this family. The overwhelming majority of genera and species is American, from Mexico to Brazil. It is well known that the Galapagos possess the semimarine *Amblyrhynchus* and *Conolophus*, that a few species occur in Madagascar, and *Brachylophus fasciatus* in the Viti and Tonga Islands; further, that an Iguanid allied to the genus *Iguana* existed in the Eocene or Oligocene of Europe, and that therefore attempts have been made to explain the present scattered distribution of the family by a formerly subuniversal range; in other words, they are a very ancient group.

Concerning America, it is significant that only a few species of *Sceloporus* and *Phrynosoma* extend into the United States, although far northwards. Of the large genus *Anolis*, only *A. carolinensis* enters Texas to Carolina, but it is also found in Cuba.

Mexico itself, Central America, and the Antilles are rich in genera and species. These Iguanidæ can be divided into two groups:—

A Sonoran set, comprising genera which are essentially xerophile and humivagous, with depressed bodies and short tails. None of these reaches far into Central America, and none has entered the Antilles. *Crotaphytus*, *Holbrookia*, *Uta*, *Phrynosoma*, *Sceloporus*, which, in the order mentioned, extend from California and Arizona southwards, with decidedly Pacific or Western predilection; only a few *Sceloporus*, those which have spread into the Atlantic Tierra Caliente, continue further into Central America. Nearly all these southern *Sceloporus* are fitted for arboreal life, less depressed in body, and suited to a moist climate, be this hot or cool. They lead thereby to the second set, which are essentially arboreal, mostly inhabitants of forests or of rocky bush-land; all southerners, with their centre in Central and South America, extending into the Mexican Tierra Caliente, with prevalence on the Atlantic side, and two* have allied genera or species in the Antilles: *Anolis**, *Iguana**, *Basiliscus*, *Læmanctus*, *Corythophanes*, and *Ctenosaura*.

Of course there are transitional forms, for instance the genus

† Iguana, or Guana, is a native word applied to the Iguana; but where this does not occur, the name is given to *Ctenosaura*, for instance at Cuernavaca. The Zapotec name of *Ctenosaura* is Tilcampo; *Basiliscus* and *Corythophanes* are called Teteréte. At Rio Balsas, scaly lizards, e. g. *Sceloporus*, are distinguished as Chintéte.

Ctenosaura, and we will not discuss the question which of the two groups is the more primitive; apparently the latter, but this can be contested.

Crotaphytus, a typical old Northern Sonoran genus with several species in Western United States. *C. wislizeni* ranging from Oregon and Nevada into Sonora and Chihuahua; *C. collaris* also into Nuevo Leon.

Holbrookia, from Texas and California into the dry parts of Northern Mexico. *H. maculata* into North Sonora, *H. texana* to Monterey and Lerdo near Torreon. I found it running about swiftly on the almost barren shaly ground near El Paso. *H. propinqua* from Texas to Presidio near Mazatlan.

Uta, with most species in South-western United States and in Lower California. *U. elegans* from Utah to Texas and Sonora; *U. stansburiana* from Utah to Torreon. *U. lateralis* from Presidio and Tres Marias Islands and *U. bicarinata* are Mexican, from Presidio to Tehuantepec, and everywhere between these places. Otherwise strictly confined to the western side of the plateau and the coast, it has entered the plateau at Cuernavaca and Puebla. I have almost invariably found it on the stems and branches of low trees, upon which they flatten themselves like arboreal *Sceloporus*; rather remarkable, since the other species are so decidedly dwellers on the sandy or stony ground. Very important is the occurrence of a species, *U. auriculata*, on the Revilla Gigedo Islands, 280 miles south of Cape Lucas, Lower California, and nearly 350 miles from the coast of Jalisco. This genus is typically Sonoran, with its centre around the Gulf of California.

Phrynosomā, "Animal rey," or "Camaleón," or "Escorpión." The original centre of this genus is undoubtedly Sonoraland, whence it extends now over most of the Central, South-western, and Western States of North America and over the whole of Mexico as far as Guatemala. *Ph. cornutum*, *modestum*, and *orbiculare* are, in Mexico, scattered over the plateau. *Ph. asio* is the most southern and at the same time the largest and most handsome species, ranging from Colima to Guatemala. Stejneger and Cope have already remarked on the "metachrosis" of *Ph. douglasi*. I have found *Ph. modestum* near El Paso of exactly the same delicate French-grey colour as the little slabs of Cretaceous limestone with which the hills are strewn; the same species at San Marcial and at Rincon in Mexico, on the red and sandy volcanic rubble of that hilly desert region, were of the same pronounced red tint. Examination with a magnifying-glass showed the spirit-specimens to be covered with the iron-stained red sand, but those which I have brought home alive show this same red colour also to be that of their genuine skin.

Sceloporus may well be called the most characteristic genus of Mexican Lizards. Of the 34 species recognised by Boulenger, 28 occur in Mexico, between El Paso and Tehuantepec. Only 4 live in the United States, and only 3 or 4 are found south of

the Isthmus of Tehuantepec, and are restricted to Central America.

Some species have a very wide, others a very limited distribution. The majority combine humivagous with climbing habits, and show great adaptiveness to the nature of their surroundings; for instance, *S. scalaris* and *S. ceneus* do not climb the trees beneath which they live, but prefer the grassy ground, and they are equally at home in the moist, clouded pine-forests and on the more barren, grassy and lava-strewn slopes up to the snow-line. *S. variabilis* prefers the wooded lowlands of the Atlantic side, and likewise does not climb, loving the banks of rivulets and well-herbed ravines. Others, e. g. *S. torquatus*, are found only on rocks, stone walls, and buildings; they are swift. Some—and these are the most depressed in body—are rather sluggish, e. g. *S. spinosus*, and spend most of their time on the ground between spiny growth of hedges and low trees, which they ascend a little way, in short rapid jerks, when alarmed. Lastly, *S. microlepidotus* is truly arboreal, ascending the trees in the morning, with the sun, right into the green tops, where they hunt for insects. This species has the greatest possible altitudinal range; from the hot country of Southern Oaxaca, only a few hundred feet above the level of the sea, to the upper tree-line of Citlalpetl, about 13,500 feet elevation.

Many species are viviparous. According to my own observations, the following: *acanthinus*, *ceneus*, *formosus*, *microlepidotus*, *scalaris*—all gravid in the months of July to September.

Iguana rhinolophus is interesting for various reasons. It is the largest Lizard in Mexico, attaining a total length of about 5 feet. Always arboreal and aquatic and truly tropical, it occurs in the whole of Central America, but in Mexico, north of the Isthmus, only in the States of Vera Cruz and Southern Oaxaca, everywhere strictly below the Plateau, and on the Pacific side it has been recorded only from Manzanillo near Colima and near Mazatlan; undoubtedly also near San Blas and in the lower reaches of the Balsas, but this information I have only from hearsay. I never found it in Guerrero. The creature requires permanent, rather sluggish rivers, or deep pools in the savannahs. They climb about in the trees, eating the succulent leaves, which they bolt without much chewing, for instance those of the guava tree. Favourite places for resting are the branches which overhang the water, into which they plump with a loud splash, sinking at once and remaining at the bottom for many minutes. Whilst the adult are dusky, the young are grass-green and are frequently found in the tall grass at the edge of a pool. They at once take to the water and swim to the bottom, with their legs laid back and propelling themselves, like newts, by rapid undulating motions of the tail. The eggs are buried in the soft soil, among the roots of a tree, always near the water, in the month of May; by the end of July they are already hatched. They are known as Guanans or Iguanas.

Ctenosaura acanthura is a common Lizard of the hot and warm

countries, from Yucatan to Tampico and on the Pacific side as far as Southern California. It does not take to the water, preferring rocky bush-land or savannahs. According to the locality, it makes its home in a hollow tree, in the roof of a house, or on the ground, where, among rocks or trees, it digs out a permanent burrow, heaping up the soil above and around it. This "Iguana," or "Tilcampo" of the Zapotecs, is very fierce, bites, and lashes out furiously with its tail. Its food is varied, from all kinds of lizards, snakes, and insects to grass and flowers; in turn the Tilcampo itself is much prized as an article of food, and in the markets fetches more than two fowls.

The young are entirely vivid green; in their second and third years the back and sides develop blackish patches upon the green ground, and in this stage they are often very beautiful. With approaching maturity the green colour disappears, being encoached upon and then entirely suppressed by the spreading black and brown pigment. But in certain localities, where these lizards live amongst luscious growth of evergreen trees, many individuals retain their green livery throughout life. I caught a young Tilcampo, which belonged to a green family, as shown by the parents, at San Juan Evangelista, on the eastern side of the Isthmus, where the green colour was normal; within less than 18 months my captive had lost all the green, and had assumed the dusky brownish and patchy garb.

Ctenosaura quinquecarinata.—This much smaller, brownish-yellow species is not arboreal, ranging from Honduras into the southern hot parts of Oaxaca. It becomes very tame, takes a varied diet, and defends itself in its burrow by sideward strokes of its spiny tail, much like the Indian *Uromastix*, which it greatly resembles in habits and outward appearance.

Basiliscus vittatus.—Closely allied to the Central American *B. americanus*, ranges from Ecuador into the Tierra Caliente of Mexico, where it is, however, restricted to the southern part, not going further north than Cordoba. Until I found it at Tequesitlan and Tierra Colorada in the centre of Guerrero, it was not known from the Pacific side. The locality "Orizaba" in the 'Biol. Centr.-Am.' is erroneous; Sumichrast states clearly, and correctly, that this species extends only up to 3300 feet. The "Pasarios," its universal Spanish name, lives always on the banks of rivers or pools. I generally found them busy on the ground close to the water's edge, or upon a low overhanging branch. On the slightest alarm, they plunge or rush into the water, rapidly running over the surface in a slightly erect position, splashing the water with their long-toed hind limbs and the long wriggling tail, whilst the arms are adpressed to the body. They do not dive; arrived on the other side, they climb up the bank and hide in the tangled vegetation. The usual statement that they propel themselves by rapid strokes of the fore-limbs is erroneous, and the notion that the high dorsal and caudal crests, which adorn the male only, serve as a sail is a fable.

Corythophanes hernandezii, "Teteréte."—From Chiapas and

Yucatan to the State of Vera Cruz, absolutely confined to the Atlantic Tierra Caliente, in forest-land; arboreal, or rather amongst shrub-like trees, the brown bark of which this curious-looking gentle lizard looks to for protection. It feeds upon insects.

Laemanectus.—The two Mexican species are excessively rare, perhaps because they live higher up in the trees, where it is then next to impossible to discover them. *L. serratus* is known from Campeche and the States of Vera Cruz and Oaxaca without localities. *L. longipes*, hitherto known from Jalapa only; all the more remarkable is the solitary specimen which I found amongst a collection sent to the Field Columbian Museum from the State of Colima.

Anolis, with at least a dozen species in the Eastern or Western Tierra Caliente. *A. nebulosus* has the widest range in Mexico, from Tehuantepec to Jalapa, and to Ventanas on the west; I found it not only on the coast of Guerrero, but also on the Nevado de Colima, up to at least 7600 feet, together with *A. liogaster*. *A. gadovii* at Tierra Colorada, in bush-land. The *Anolis* seem to spend most of their time on the lower branches of shrubs and trees or amongst the rank herbaceous vegetation, waiting for insects, and trusting to not being seen when basking. Especially when they have become excited by being pursued, the males stretch out their mostly beautifully-coloured gular sac. None of the Mexican species which I have observed displays any marked change of colour like the *A. carolinensis*, the "Chameleon" of the Americans.

TEJIDE* are clearly a Neotropical family, with several dozen genera in South America. Of all these, only *Ameiva* and the closely-allied *Cnemidophorus* extend through and beyond Central America: *Ameiva* into the Eastern and Western hot-lands of Mexico and into the Antilles; *Cnemidophorus* through Mexico into the United States, where *C. sexlineatus* has spread over nearly the whole Union. This genus is entirely terrestrial, preferring sandy districts with bush-land; only *C. guttatus* is a typical inhabitant of the lowland forests of Vera Cruz. The Mexican species avoid the high plateau, 5000 feet being about the upper limit. The only exception is made by *C. gularis*, which has been credibly recorded from Guanajuato, and of which I have examined specimens collected by Dr. Meek close to the town of Puebla, which lies at an altitude of more than 7600 feet, higher than the Valley of Mexico, where *Cnemidophorus* does not occur.

Concerning distribution and variation, cf. my paper, "Evolution of the Colour-pattern and Orthogenetic Variation in certain Mexican Species of Lizards, with adaptation to their surroundings," Proc. Roy. Soc. vol. lxxii. p. 109 (1903).

Ameiva undulata, the only species in Mexico, is an inhabitant

* From the Aztec "teco-ixin," i. e. Rock-lizard, the name of *Sceloporus torquatus*, misspelt and misapplied. The Zapotecs and Mazatecs call *Cnemidophorus* and *Ameiva* Zumbichi and Cachumbo.

of the hot, well-wooded parts of Guerrero, Oaxaca, and Vera Cruz, whence it extends far into Central America. It is far less quick than *Cnemidophorus*, and I have found it invariably in the vicinity of water.

ANGUIDÆ.—*Anguis*, with its sole species *fragilis*, and two species of *Ophisaurus* s. *Pseudopus* (Morocco to Burma) are the only members of this family which are not American, and even the third species of *Ophisaurus*, *O. ventralis*, lives in the United States. The countries now richest in Anguidæ are Mexico, Central America, and the Antilles; a few extend into South, and a few, *Gerrhonotus* with the *Ophisaurus*, into North America, where the latter is widely distributed (also recorded from Jalapa).

Diploglossus is peculiar to the mountainous regions of Mexico; *D. steindachneri* from Orizaba, Jalapa, and Guatemala. The related genus *Celestus* in Antilles and Central America.

Gerrhonotus is the main genus, eight species of which occur in Mexico, entirely in mountainous districts or on the plateau; they are consequently absent in the hot lowland forests, and references to Vera Cruz and Tehuantepec do not apply to such towns but to unknown places in the state or district.

G. cæruleus has the widest range, from British Columbia and Colorado along the Pacific side of Mexico to Costa Rica. Most of the species live on the ground, in the oak- and pine-forests, preferring clearly a moist and by no means warm climate. *G. antavages* ascends Citlaltepētēl to an altitude of more than 12,000 feet, in the pine-forests, or in the grass near little streams, and higher up amongst the tussocks of grass, basking on the top of such a tussock and making its home among the roots or in the mass of last year's rotting blades. In such a place they disappear easily, although they are not quick. The same applies to *G. imbricatus*. *G. gramineus*, delicately light green above and yellow below, is arboreal, ascending the highest trees in search of insects and making its lair in hollow trees of oak, pines, and arbutus. They all are viviparous, live on insects and worms, and lose their shyness a few hours after having been caught and handled.

XENOSAURIDÆ.—*Xenosaurus grandis* alone is recorded only from the mountains near Orizaba, Cordoba, and Oaxaca.

HELODERMATIDÆ.—The sole genus *Heloderma*, unless we include *Lanthanotus* of Borneo. *H. suspectum* of Arizona and New Mexico, and *H. horridum* of Mexico. The notion that *Heloderma* is a dweller on arid mountains is quite erroneous. It is restricted to hot lowlands with sandy ground. Most of Arizona is high and dry tableland, and there is quite a trade in "Gila monsters," but, so far as I could find out, they all came from such terribly hot and low sandy places as Yuma, on the lower reaches of the Gila river, and from similar localities in Sonora. *H. horridum* is

stated by Günther to have probably a wide distribution in Mexico. The fact is that it has hitherto been recorded only from the following localities:—near Tehuantepec, and near Presidio by Forrer; and in the museum at Mexico is a specimen from Apatzingan in Michoacan. It is very local. In Guerrero and Oaxaca, Colima and Jalisco everybody speaks of the “Escorpión.” “He is unkillable unless you crush him with a big stone. When at last secured in a cleft stick, his poison dropping to the ground causes all vegetation to wither for yards around. There are two kinds in Guerrero, one brown, the other black and yellow; nocturnal, hidden in the daytime beneath the stump of a tree or under a boulder; æstivating during the dry season.” Hundreds of times have I offered much money, even for being taken to its lair, but all in vain. The only place where I personally know it to occur is Juchitan, not far to the north-east of Tehuantepec; in the museum at Oaxaca is a stuffed specimen, a monster about $2\frac{1}{2}$ feet in length. At last I thought I had run the beast down, when at Zapotlan in Jalisco. The poison, the sluggish fierceness, difficulty in killing it, all this sounded favourable. We found the Escorpión, but it was the harmless, gentle *Gerrhonotus*, which for some unaccountable reason is feared as very poisonous! The Zapotecan name of *Heloderma* is “Talachini”; the Aztecs called it “Acaltepeon.” Hernandez states that “it is found in Cuernavaca and other hot districts.” But it does not occur anywhere near the State of Morelos, unless the huge figure of a lizard carved out of a rock near Cuernavaca is evidence!

The last three families taken together form a very ancient group, which seems to have its original centre in the old Sonoraland, or let us say in the old Sonoran + Central American + Antillean landmass. The absence of Anguidæ in Eastern Asia suggests the spread from North America into Europe and Asia across the polar region, unless we prefer the problematic bridge across the Northern Atlantic from the Antilles (which possess their own genus *Celestus* with several species) towards the Mediterranean.

SCINCIDÆ.—Of this large and almost cosmopolitan family America possesses the smallest number, and it is significant that the number of forms decreases from North to South. Mexico has about 10 species. They may perhaps be divided into a Northern lot, *Eumeces*, which ranges from the middle of North America over the Mexican plateau and its bordering mountains; and into a Southern set, *Mabuia* and *Lygosoma* s. *Mocoa*, which love the hot country, extending far into tropical South America, with species in the Antilles, in Mexico restricted to the Southern States east and west.

Mabuia agilis is fond of basking on shrubs and it even climbs trees, hiding under the bark. Like *Lygosoma laterale* it hunts in the dusk. *Eumeces*, of which I have observed only *lynxe* and *fuscirostris*, prefer mountain forests, where they live on the

ground, basking on the fallen leaves, between which, and in the soft humus, they wriggle away with perplexing agility.

ANELYTROPSIDÆ, an artificial assembly of a few degraded Scincoids in Madagascar, Tropical Africa, and *Anelytropsis papillosus* in Mexico. Of this only the two type specimens, described by Cope, "from near Jalapa," were known, until I found another in the humus of a dense forest near Motzorongó, south of Córdoba.

XANTUSIIDÆ.—The range of *Xantusia* extends from the desert tracts of Nevada, California with its impressive Mojave desert, into Lower California. There is little doubt that some species of *Xantusia* will be found in the desert-like country between Chihuahua and New Mexico, which has all the characteristic features of the home of *Xantusia*, not the least being the Yucca-trees, the bunches of spiky leaves of which give them shelter. The only other Mexican, *Lepidophyma flavomaculatum*, ranges from Panama to the Isthmus of Tehuantepec. The few other members of the family are likewise Central American, and one is found in the Antilles. This little strictly American family shows consequently division into a Northern or Sonoran, and a Southern or Central American Antillean group.

ANIELLIDÆ, with *Aniella pulchra* in California, and *A. texana*, of which the only specimen known came from El Paso.

AMPHISBÆENIDÆ.—The distribution of numerous Amphisbænidæ throughout Africa and several Mediterranean countries, as well as in South and Central America, Mexico, Lower California, Florida, and the Greater Antilles, seems to favour a former transatlantic connection.

Curiously enough, Mexico possesses only one genus, but this is the most interesting of all:—

Chirotos.—Discovered many years ago somewhere in Mexico, *Chirotos* s. *Bipes canaliculatus* remained almost mythical. Then Dugès received a single specimen from near Tecpan in Southern Guerrero, which he named *Hemichirotos tridactylus*. Next, some twenty years ago, the creature was discovered in Lower California in considerable numbers, they are Cope's *Euchirotos biporus*. I myself found *Chirotos* at last on the banks of the Balsas River, in the centre of Guerrero. It lives there in the fields of alluvial sand, well out of reach of possible floods. Our only chance of getting these pink, worm-like creatures was the offering of rewards to the Indians who were ploughing the fields of young Indian corn in the month of July. They live at a depth of at least one foot, burrowing little tunnels which lead a long way in any direction in the moist sand, but in the drier parts collapse at once behind the digging animal. When kept in a tin with sand, they dug into it with their heads first and then with their mole-like hands. They never appeared on the surface. Like

the Portuguese *Blanus cinereus* they soon became flabby from evaporation, but they soon swelled up again when the sand was moistened.

To split these creatures into three genera is ridiculous. But it is very interesting that the specimens from the only three localities known differ in the number of femoral pores, the length of the tail, and in the reduction of the number of the fingers and claws.

C. canaliculatus.—Fifth finger very small, clawless; three pores on either side in front of the enlarged preanal scales; tail twice as long as the head. Nasal plates widely separated.

Specimen in Berlin Museum.....	Right hand	1. 2. 3. 4. 0;	Left	1. 2. 3. 4. 0.
British Museum I.	" "	1. 2. 3. 4. 0;	" "	1. 2. 3. 4. 0.
" " II.	" "	1. 2. 3. 4. 0;	" "	1. 2. 3. 4. 0.
Río Balsas I.	" "	1. 2. 3. 4. 0;	" "	1. 2. 3. 4. 5.
" " II.	" "	1. 2. 3. 4. 5;	" "	1. 2. 3. 4. 5.
" " III.	" "	1. 2. 3. 4. 5;	" "	1. 2. 3. 4. 5.

(Fifth finger on both hands well-developed in Balsas II. and III.)

C. biporus (*Euchirotes biporus* Cope).—13 specimens in Smithsonian Institute, from La Paz in Lower California; said also to be common at Cape Lucas.

According to Cope, with tail twice as long as the head, five digits all clawed, with only one pore on either side, nasal plates nearly in contact in front.

C. tridactylus (*Hemichirotes tridactylus* Dugès). One specimen from Tecpan, near Acapulco. Tail slightly longer than the head; only three digits, all with claws; a pair of pores on either side; nasal plates widely separated.

It is remarkable that *Chirotes*, the least reduced member of the family, is the only Mexican representative of this presumably ancient group. *Rhineura* of Florida has been found in the Oligocene of South Dakota, whereby the former range is extended considerably to the north. It is very difficult to imagine how *Chirotes*, a helpless digger, without any chance of travelling, bound to sandy soil, has managed to survive, unless we assume that it is really a coast-form. Living in dunes, as it does at Cape Lucas, Lower California, it may have ascended the Basin of the Balsas, which river, from its mouth far into Guerrero, is bordered by many sand-covered ledges.

The arenicolous *Chirotes* has retained its fore-limbs, which, although short, are rather well-developed, while those genera which live in humus and rich soil have lost the limbs as usual.

The natives had no proper name for these little creatures, but described them as "culebritas con manitas."

Résumé of the Distribution of Mexican Lacertilia.

Geckonidae.—Chiefly Antilles, North-western South America and adjoining Central America.

Eublepharidae.—North-western Mexico and Mexican Tierra Caliente.

Iguanidæ :

1. Xerophile, humivagous; Sonoran, non-Antillean.
2. Arboreal; Central and South American and Antillean.

Tejidæ.—Neotropical, with *Ameiva* into Tierra Caliente and Antilles, *Cnemidophorus* far into United States.

Anguidæ.—Mexican, Central American and Antillean, reaching far North and South.

Xenosauridæ. }
Helodermatidæ. } Mexican, non-Antillean.

Scincidæ :

1. Northern America and plateau of Mexico, non-Antillean.
2. Central American into Mexico and Antilles.

Xantusiidæ :

1. Sonoran, non-Antillean.
2. Central American and Antillean.

Amphisbænidæ.—Mexico, Central America, and Antilles; formerly much farther north in the United States; extending far into South America.

These statements are intended, in their reduced form, to indicate the probable centres of dispersal of the various families. It is important that of these 10 families no less than 7 have representatives in the Greater Antilles, and that these Insular members belong, in not a few cases, to Insular, peculiar genera, e.g. *Cyclura* and *Metopoceros* of the Iguanidæ, *Celestus* of the Anguidæ, *Cricosaura* s. *Cricolepis* of the Xantusiidæ; and it is also worth noting that *Amphisbæna* itself occurs in Puerto Rico, on the Virginia Islands, and South and Central America, but not in Mexico. *Xenosaurus* and *Heloderma*, each the sole member of a family, are restricted to Mexico in a slightly wider sense. Most of the Anguidæ and Iguanidæ, and all the Xantusiidæ, are centred in tropical and semitropical America. We may fairly conclude that at least the Amphisbænidæ, Anguidæ, Iguanidæ, Xantusiidæ, are very old inhabitants of the ancient Sonoran-Central American and Antillean mass of land. Of these families the Amphisbænidæ may well be autochthonous. The Tejidæ alone are unmistakable Southern immigrants from an original centre, probably Brazilian, not N.W. South America; otherwise it would not be obvious why only so few Tejidæ have extended beyond the present South-American continent. They (*Anolis* and *Ameiva*) were the latest immigrants into the Central Land Complex just before the Antillean separation, after which these genera and *Cnemidophorus* could continue their continental progress northwards.

It is suggestive that so many of these families fall into a north-western, typically Sonoran and Pacific, xerophile, and a southern, more Atlantic group with predominant hygrophile characters; the Antillean forms naturally siding with the latter. The Mexican plateau, instead of connecting, rather severs these two, mainly ecological groups, the connection passing round to the south of the plateau. It must remain a moot question which of the

two groups is the older. Not unlikely both are, in America, the divergent result of more generalised features; the one with the desert, the other with the typical forest as the leading motive, or rather the ultimate theme or goal for adaptation. We do not know the physical features of ancient Sonoraland. There need have been no deserts or semiarid tracts and rather barren plateaus. The "petrified forest" of Arizona; the fact that many of the present desert-like stretches from Northern Mexico, through New Mexico to Utah and beyond, are the basins of former lakes (many of them still rapidly receding); nay, even the prehistoric towns in the now inhospitable parts of Arizona and New Mexico—all these circumstances indicate that much of Old Sonoraland is still further tending towards the formation of deserts, just as clearly as enormous parts of Central Asia.

Sonoraland had originally a much wider extent. It is obvious that the Tres Marias Islands were part of Tepic; there is also little doubt that the peninsula of Lower California was continued to the Revilla Gigedo Islands. That was at an epoch when the Gulf of California did not yet exist, the peninsula as such dating from the end of the Miocene.

OPHIDIA.

TYPHLOPIDÆ.—Only two species are known from Mexico. *Typhlops tenuis* from the State of Vera Cruz, ranging south to Guatemala; and *Anomalepis mexicana* from Nuevo Leon. The present centre of this family is South and Central America, whence they have extended into the Antilles (Puerto Rico).

GLAUCONIDÆ.—*Glauconia*, the main genus, ranges from New Mexico, Texas, and Florida, far into South America, whence only the Lesser Antilles have been entered. Mexican localities are still very scattered. The northern species, e. g. *G. humilis*, ranges over the plateau and the Pacific slope; *G. dulcis* from New Mexico to Chilpancingo; while *G. albifrons* is a Central American, entering the Eastern and Western States of Mexico but avoiding the plateau.

BOIDÆ.—In Mexico only the Pythonine *Loxocemus bicolor*, recorded from Colima, Tehuantepec, and Guatemala; and the *Boa imperator* (incl. *mexicana*), "Masacoatl," which ranges from Ecuador through Central America into the Mexican Pacific and Atlantic Tierra Caliente, keeping strictly to the forest and bush lands. The Boiæ continue northwards as the arenicolous *Lichanura* of Lower California and of similar hot desert-like districts of Arizona; and the likewise arenicolous *Charina*, which extends from California to Washington. Another set of Boas, typical dwellers of luxurious tropical countries, occurs in the Antilles; all these, *Epicrates*, *Corallus*, and *Ungalia*, have allied species in Central and South America.

Consequently this archaic family is clearly divided into a

Pacific, terrestrial xerophile, and a more Atlantic and southern rather hygrophile stock. The former is almost typically Sonoran, except that it does not enter the plateau. Since *Charina* shows that it can endure a cold climate, the absence of similar forms on the Mexican plateau may possibly date back to the barrier of volcanic terrain.

COLUBRIDÆ.—Of the bewildering number of these snakes in Mexico only those have been selected for discussion which seem to yield some tangible results, while such as are too widely scattered or rather imperfectly known in their distribution have been mostly left out.

C. AGLYPHÆ.—*Tropidonotus*, decidedly a Nearctic genus, extending through the whole of Mexico, with greatly diminishing numbers of species into Central, but not into South America or into the Antilles. *T. ordinatus* (incl. varieties) is the commonest species in the whole of Mexico. *T. validus* is a western form, from Utah to Colima. *T. sipedon* s. *fasciatus* is eastern, from east of the Rocky Mountains to Costa Rica. Others are confined to the southern half of Mexico.

Ischnognathus is Nearctic, extending over the plateau, re-occurring in Guatemala.

Contia, clearly Nearctic, through Mexico, with preference for the plateau and its western slope, into South America.

Ficimia is Sonoran, scattered through Mexico.

Zamenis.—Sonoran. Of the 9 American species, 8 occur in Mexico, 3 of which are confined to the southern half or extend into Central America, but not into the Antilles. *Z. constrictor*, widely spread over the States, enters North Mexico. *Z. ornatus*, *semilineatus*, and *tenuatus* are typical of New Mexico, Arizona to Sinaloa, continuing as *Z. mentovarius* as a western form from Sinaloa, Colima, S. Oaxaca to Guatemala. *Z. grahami* is a central and eastern form from the Southern States right over the plateau and the East to Tehuantepec. *Z. pulcherrimus* is southern, from Salina Cruz to West Nicaragua; lastly, *Z. mexicanus* has been recorded from Colima, Central and South Guerrero, Guana-juato, and from Cape Corrientes in Jalisco*.

Coluber with *Spilotes* and *Pityophis* are clearly Nearctic, with some species in almost every State of Mexico; none is Antillean, although some extend far into South America. *C. corais*, the most powerful Colubrine Snake of Mexico, inhabits the warm and hot countries, with the wide range from the South-eastern States of North America to Brazil.

Coronella.—Nearctic. *C. regalis* from Kansas, over the plateau to Mexico City; *C. lævis* in Nuevo Leon; *C. annulata* = *micropholis* from Texas to Para, in Mexico certainly all over the

* Bocourt (Mission Scient. Mex.) states emphatically "au cap Corrientes sur le Pacifique"; it is therefore rather perplexing that Günther (Biol. Centrali-Americ.) adds "Cuba, Mus. Paris," as a locality of this species. There happens to be a Cape Corrientes at the western end of Cuba.

southern half; coloured and behaving exactly like *Elaps*, it is often mistaken for a true "Coralillo."

Urotheca, *Dromicus*, *Drymobius*, and *Leptophis* are mainly Central and South American with species in the Antilles, extending northwards into the Atlantic and Pacific Tierra Caliente, on the east side even into Texas. *Drymobius margaritiferus* is the commonest tree-snake. *D. boddaerti* ranges from South America, Trinidad and S. Vincent, and on the Pacific side it has been brought from Tres Marias Islands.

Rhadinea is South and Central American, going into Mexico east and west and onto the slopes of the Southern plateau. *Urotheca* likewise Central and South American and Cuban; *U. elapoides* from Costa Rica along the Atlantic side to Orizaba.

Streptophorus typically Central American, extending into the Atlantic Tierra Caliente. *S. diadematus* from Tabasco through Oaxaca to Jalapa and Orizaba. *S. atratus* from Ecuador and Venezuela to Jalapa. None is Antillean.

Hypsiglena torquata from Venezuela to California, in Mexico on the plateau and the Pacific side.

Atractes, *Tropidodipsas*, *Dirosema*, and *Geophis* are Southern genera, extending into the Atlantic and Pacific Tierra Caliente, the last genus with more western range. *G. (Geagras) ridimita* I have found in the sand-dunes of the lagoons near Tehuantepec.

OPISTHOGLYPHA.—*Trimorphodon*, a Mexican genus with western preference. *T. upsilon* extending northwards into Arizona, southwards to Panama; *T. biscutatus* distinctly Pacific from Mazatlan to Panama; *T. tau* on the Isthmus of Tehuantepec.

Himantodes, a typical Neotropical forest genus, of which *H. cenchoa* has spread into the Atlantic, *H. gemmistrata* and *H. tenuissima* into the Pacific Tierra Caliente. Cope's statement that *H. gemmistrata* has been found at Toluca seems to be erroneous.

These Tree-snakes are called "Súchil" in Oaxaca and on the Isthmus, are feared as poisonous, and are said to attain a very great length. Every snake, when in motion, appears to be much longer than it is, and these active creatures gliding rapidly through the dense canopy of a tropical forest seem indeed to give one the impression of prodigious length. Another name for Tree-snakes is "Bejuquillo," in allusion to lianas, which are called bejuco.

Leptodira, Neotropical, into the eastern and western Tierra Caliente, remaining outside the plateau, although *L. albofusca*, which extends to Para and Ecuador, ascends outlying mountains, like the Nevado de Colima, up to 7000 feet. *L. septentrionalis*, as the most northern offshoot, occurs in Texas and New Mexico.

Oxyrhopus, essentially South and Central American; *O. cloelia* and *O. plumbeus* stop at the Isthmus of Tehuantepec; *O. petiolaris* goes into Guerrero. This genus is of special interest since it contains the only Opisthoglyph which has reached the Antilles, but only the Lesser.

Erythrolamprus and *Oxybelis* are likewise South and Central American genera, entering the Tierra Caliente; e. g. *O. acuminatus* from South America to Motzorongo in Vera Cruz, and through Guerrero to Mazatlan; it is also on the Tres Marias Islands. *E. fissidens* extends from Costa Rica along the Atlantic side of Mexico to Tamaulipas and thence into Texas.

Conophis, South and Central American, with *C. vittatus* on the Isthmus and in Guerrero.

Scolecophis.—The few species live in rather high altitudes. *S. emula* in the mountains of Chihuahua; *S. michoacensis*; *S. atrocinctus* at Toluca (*vide* Cope) and in Guatemala.

Homalocranium, with two dozen species, mostly in South and Central America, whence 8 Mexicans, chiefly on either side of the plateau, and north-eastwards, through Nuevo Leon into Texas.

These last two genera are not arboreal.

Stenorhina degenhardti from Ecuador into the Atlantic hot country.

Manolepis putnami, hitherto known only from Jalisco, e. g. Cumbre de los Arrastrados, 8000 feet; I have found it on the Cumbre de los Cajones, south of Chilpancingo, in pine and oak forest, altitude 3000 feet.

Petalognathus nebulatus. Of this South and Central American species I found one specimen in the forest of La Raya, south of Cordoba.

AMBLYCEPHALIDÆ.—With a few forms in South-eastern Asia, but many in South and Central America. Of the 20 species of *Leptognathus*, only *L. elegans* reaches the Isthmus of Tehuantepec.

ELAPINÆ.—Of the many species of the Neotropical genus *Elaps* only 2 or 3 occur in Mexico. The commonest, *E. fulvius*, ranges from South Brazil far into the Eastern United States. In Mexico it seems to live in the whole southern half, including the plateau, e. g. Mexico and Guanajuato; it is curious that it has not yet been recorded from anywhere north of a line drawn from Mazatlan to Guanajuato and Tuxpan, but Cope mentions *E. euryxanthus* of Arizona from "Chihuahua" and "Sonora." *E. elegans* seems to range from Guatemala into the Atlantic Tierra Caliente near Jalapa. No Elapine snakes occur in the Antilles. These "Coralillos," although well-known to be poisonous, are not feared because they do not bite unless handled clumsily; when they bite they do not strike, but chew deliberately like our European *Coronella*. Although occasionally found basking, they lead a very retired life, preferring vegetation, hiding under rotten stumps, with a predilection for ants' nests. They are practically nocturnal like nearly all the non-poisonous snakes which possess the same beautiful coloration; the combination of black and red rings has a most effacing effect in the dusk.

VIPERIDÆ.—CROTALINÆ, taken together, occur all over Mexico, as is to be expected of a group which ranges from Massachusetts and British Columbia to Argentina, but they fall into two lots:—

I. Northerners, with their archaic centre in Sonoraland. *Ancistrodon* is chiefly Nearctic; but of the terrestrial forms *A. bilineatus* extends along the Pacific side of Mexico, including Tres Marias Islands, to Yucatan and Guatemala. Of *Sistrurus*, east of the Rocky Mountains, *S. ravus* has been described by Cope from Vera Cruz. *Crotalus*, the main genus, radiates out from the tablelands of Arizona; *C. terrificus* (*horridus* of some authors) is the only species which extends right through Mexico to the Isthmus, and thence right into Argentina, avoiding, however, the moist and wooded Tierra Caliente. It is the only Rattlesnake in South America. *C. triseriatus* is confined to Mexico's mountains, ranging from the Nevado de Colima right across to Citlaltepētē, where I have found it at an altitude of 12,500 feet.

II. Southerners.—*Lachesis*, an essentially Neotropical genus, a few species of which extend into the Eastern and Western States below the plateau. *L. lansbergi* has the widest distribution, and it is the only Pit-viper which has entered the Lesser Antilles, the larger and older islands being free from poisonous snakes.

The Rattlers, or “Viboras de cascabel,” are not much feared, being “manzitos” (rather tame), meaning sluggish and not inclined to strike unless provoked; moreover, they always try to give fair warning with the rattle, which they sound only when coiled up and prepared to strike, but not when crawling away as they generally attempt doing. The *Lachesis lanceolatus*, the “Fer de lance” of Martinique, &c., “Rabo de hueso” or Bone-tail of the Mexicans, on account of the curiously coloured and spike-like tip of the tail, behaves quite differently. It is very quick, highly irascible, and even known to make for its pursuer, therefore much dreaded. In fact the few cases of snake-bite which I could ascertain, mostly fatal, were due to this species.

Résumé of the Distribution of Ophidia.

Typhlopidae.—Central and South American, Atlantic Mexican and Antillean*.

Glauconiida.—Remnants of Sonoran to Neotropical distribution; they may reasonably be expected to be found in the Antilles.

Boidae.

1. Xerophile Sonoran, not Antillean.
2. Hygrophile Central South American, Mexican Tierra Caliente, and Antillean.

* For the present purpose only those Snakes are considered Antillean which occur in the Greater Antilles. The Lesser Antilles, entirely volcanic and of much younger date, have received the *Lachesis*, *Oxyrhopus*, and *Glauconia* directly from the opposite part of Venezuela.

Aglyphous Colubrineæ.—Obviously with an archaic Nearctic centre. There is a gradual change from North to South.

1. Northerners which send a few species only into Central and still fewer into South America*, while none reaches the Antilles: *Tropidonotus*, *Ischnognathus*, *Contia**, *Ficimia*, *Coluber*, *Spilotes*, *Pituophis*, *Coronella**. Here also *Zamenis*.
2. Central Americans, from the Mexican Tierra Caliente into South America and into the Antilles** : *Urotheca***, *Dromicus***, *Drymobius***, *Leptophis***, *Rhadinea*, *Streptophorus*.
3. Essentially Southerners with their present centre in South America, extending northwards into Mexico, but not into the Antilles: e. g. *Atractes*, *Tropidodipsas*, *Dirosema*, *Geophis*; *Xenodon*.

Opisthoglyphous Colubrineæ.—Essentially South and Central American, with many mostly arboreal forms in the hot countries of Mexico, whilst a few terrestrials extend also over the plateau and into the neighbouring United States. None Antillean.

Elapineæ.—Neotropical, non-Antillean; but a few species of *Elaps* range through Mexico, and one far into the United States.

Crotalineæ.

1. Nearctic, especially Sonoran, xerophile, non-Antillean. Only one of them extending far into South America.
2. Neotropical, northwards into the Mexican Tierra Caliente, and into the Lesser Antilles.

All this means that the Greater Antilles possess only the ancient *Typhlopidae* and perhaps *Glauconiidae* and have received those Boas and *Aglyphous Colubrineæ* which have near relations in Central and North-western South America, whilst *Crotalineæ*, *Elapineæ*, and *Opisthoglyphæ* are excluded. Further, this indicates that all these latter groups are post-Antillean, that they have extended southwards after the Antillean separation, have developed into the present tropical genera and species in Central and South America, and have then, eventually, most recently extended northwards into or even beyond Mexico, just as some obviously Nearctic species are still extending southwards.

DISTRIBUTION OF MEXICAN SPECIES ACCORDING TO ALTITUDE.

Our knowledge of the fauna of North-western, Northern, and North-eastern Mexico is too imperfect. The calculations are therefore restricted to those parts of Mexico which lie within the following lines: Mazatlan—Guanajuato—Mizantla, north of Jalapa in the State of Vera Cruz; and Coatzacoalcos, across the

Isthmus to San Mateo del Mar near Tehuantepec. These lines enclose all the most varied and characteristic physical features: the highest mountains, part of the Central high plateau with gradual slopes into the lowlands, abrupt boundaries, the hot lowlands, the principal rivers, lakes, swamps, forests, and savannahs; Central or inland, Atlantic and Pacific climate.

All the species, with available records, were sorted into six groups:—Those which occur only in the cold and cool regions; those which are found in these and in the temperate zones; in the cool, temperate, and hot zones; temperate zone only; temperate and hot; and, lastly, hot or tropical only.

Of course the lines of demarcation are quite arbitrary, but the 132 species collected by myself, represented by about 1000 specimens, with my knowledge of the country, gave me a lead. Hot-lands extend from the sea-level to about 3000 feet, the temperate zone to 5000 or 6000 according to the district. Everything beyond 7000 feet can safely be considered within the cool zone, and all stations above 9000 feet are decidedly cold. Lastly, there is some safety in numbers.

I. My own Collections : 131 species employed.

Climate.	No. of species.	Per cent	
1. Cold or cool only.....	22	17	} within cool zone 38 sp. = 30 per cent.
2. Cold and temperate....	6	5	
3. Cold to hot	13	10	
4. Temperate only	12	9	} within temperate zone 42 = 32 per cent.
5. Temperate and hot ...	11	9	
6. Hot only	67	51	} within hot zone 91 = 70 per cent. (groups 6 + 5 + 3).
	<u>131</u>	<u>101</u>	

II. My own and previous Collections and records : 247 species, then rounded up to 250.

Climate.	No. of species.	Per cent.	
1. Cold or cool only.....	42	17	} within cool zone 86 sp. = 34 per cent.
2. Cold and temperate....	20	8	
3. Cold to hot	24	9.6	
4. Temperate only	15	6	} within temperate zone 99 = 40 per cent.
5. Temperate and hot... ..	40	16	
6. Hot only	109	43.6	} within hot zone 173 = 69 per cent. (groups 6 + 5 + 3).
	<u>250</u>	<u>100.2</u>	

These two calculations agree remarkably well: species restricted to cool regions 17 per cent. in both cases; species occurring within the cool regions 30 or 34 per cent. respectively; and species





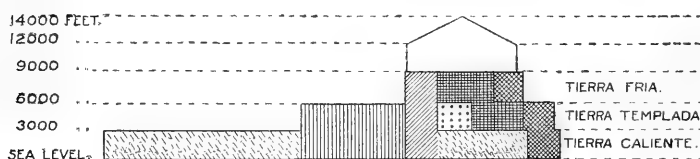

recorded from the hot-lands 70 or 69 per cent. ! I have left the two lists as they are, for fear that a revision would not be free from bias and might thus prove too much*.

Fairly established is the fact that the Tierra Fria is inhabited by about 34 per cent., one third of the total number of species, of which one half, *i. e.* 17 per cent., are restricted to the cool and cold zone.

Equally safe is the conclusion that in the Tierra Caliente occur 69 or 70 per cent., about 50 of which (51 or 43) are restricted to it. This shows the richness of tropical life, especially if we consider the small extent of the hot-lands in Mexico in comparison with the rest of the country.

Text-fig. 30.

Diagram of the distribution of 250 Mexican species according to *Altitude*.

		Per cent.
Southern or hot-country species.	{ 	Restricted to the Tierra Caliente 44
	{ 	Ascending into temperate zone 16
	{ 	Ascending into cool zone 5
	{ 	Species restricted to the temperate zone ... 6
Northern or cool-country species.	{ 	Restricted to cool and cold zone..... 17
	{ 	Descending into temperate zone..... 8
	{ 	Descending into hot zone 4
		100

Further, the whole fauna is practically composed of these two groups, whilst the species restricted to the temperate zone form a very small minority, 6 per cent., at the utmost 10 per cent. if we allow for the difficulty of classifying.

This shows that the original stocks were either cool or tropical,

* Probably all the numbers of species, as put down for the six groups, have been understated, but this would not much alter the proportions. For instance, on p. 228, the species given as occurring in cool to hot zones amount to about 24, but even half a dozen more might be added according to the interpretation of such records as "Amula" and "Omiteme," which may mean anything from 5000 to 8000 feet.

in other words either Northerners, as natives of Old Sonoraland, dwellers of mountains and high plateaus, or Southerners, which were and are mostly tropical species. The temperate zone is in the present case rather no-man's-land than the happy medium favourable to the majority.

The configuration of the whole country lends every support to this result; broadly speaking, a high, mountainous plateau, abruptly falling off into tropical lowlands.

The species which have such a considerable range of altitude that they occur in the cool, temperate and hot zones, are of further interest. The same kind which is bound to hibernate on the high mountains is active throughout the year in the moist and hot lands, and possibly there are some which also aestivate during prolonged drought. The species can be grouped as follows:—

I. Undoubted Northerners, or originally at home in a cool climate, as indicated by their main distribution, or by that of allied species of the same genus. These have *descended* into the hot lands.

Scaphiopus dugesi.

Rana halecina.

„ *montezumæ.*

Sceloporus scalaris.

„ *microlepidotus.*

Uta bicarinata.

Gerrhonotus ceruleus.

Tropidonotus melanogaster.

„ *ordinatus.*

„ *validus.*

Coluber triaspis.

Crotalus horridus.

Cinosternum pennsylvanicum.

II. Essentially hot-country species which have *ascended*; and it is remarkable that most of these are not found on the plateau proper, although they ascend the surrounding mountains, up to an altitude equal to or surpassing that of the plateau. This fact seems to indicate that the respective species are still continuing their upward spreading, or that they have conquered these mountains comparatively recently. This fits well with the suggestion expressed on p. 244 that the Southern or tropical fauna of Mexico represents for the greater part the most recent immigrants. The Sierra Madre del Sur affords a good illustration. It is separated from the plateau by the depression of the basin of the Rio Balsas. Tropical species coming from the south can surge up to the Sierra, and they have ascended its higher mountains (*e. g.* those of Omilteme, Amula, Cerro de S. Felipe near Oaxaca), and the backbone itself is of no mean height; but then comes the descent into the hot basin, then again the ascent of the plateau. A tropical species, which has succeeded in acclimatising itself to life on the Sierra, will have to “undo” this hardening, become tropical again, and lastly once more ascend and accommodate itself to a cool climate. Of course all this can be done, but it takes time. The same applies to the fauna of the rather isolated Volcan and Nevado de Colima. The ranges of mountains which border

the great plateau are rather abrupt and in many parts are even higher than the plateau itself, so that to gain the latter would imply a descent. There are, as mentioned elsewhere, p. 240, regions which offer a gradual, easy entry, and they have facilitated the exchange of many species, but not of all, and of course not in other districts.

Species found in the hot country and on high mountains; those excluded from the plateau are marked * :—

* <i>Hylodes rhodopis.</i>	* <i>Leptodira albofusca.</i>
* <i>Auolis nebulosus.</i>	* <i>Xenodon rhabdocephalus</i> (?).
* <i>Zamenis mentovarius.</i>	<i>Geophis chalybea.</i>
* <i>Rhadinea vittata.</i>	<i>Trimorphodon upsilon.</i>
* <i>Leptophis mexicana.</i>	<i>Elaps fulvius.</i>
* " <i>diplotropis.</i>	

III. Lastly there are some species which are difficult to group, whether they have descended or ascended. For instance, most kinds of *Hylodes* live rather high up; they want permanent moisture, and this *H. rhodopis* gets on the high mountains and in the hot forests of the Atlantic side; only a very few returns have been made from the truly temperate zone, and it is not known from the plateau.

<i>Hyla eximia.</i>	* <i>Sceloporus formosus.</i>
* <i>Bufo intermedius.</i>	* " <i>acanthinus.</i>
* <i>Hylodes palmatus.</i>	" <i>spinus</i> (?).
<i>Sceloporus variabilis.</i>	<i>Coronella micropholis.</i>

The list (*infra*, pp. 232–233) contains 70 species, of which 8 (*Diploglossus*, *Xenosaurus*, 1 *Zamenis*, 3 *Leptophis*, 1 *Drymobius*, and 1 *Sceloporus*) may be deducted as probably not ascending beyond 6000 feet. The remaining 62 species, out of a probable total of 250 for Mexico from between the Isthmus of Tehuantepec and the line Mizantla to Mazatlan, represent about 25 per cent. Of these, again, 30–32 (13 per cent.) seem to be restricted to levels above 7000 feet. These have been marked with an asterisk (*). If we add to them the following 10 species, which seem to be restricted to the high plateau, 6000–8000 feet :—

<i>Spelerpes morio</i> (also from	<i>Tropidonotus variabilis,</i>
" Jálapa"),	" <i>scaliger,</i>
<i>Scaphiopus multiplicatus,</i>	<i>Homalocranium bocourti,</i>
<i>Bufo compactus,</i>	<i>Crotalus miliaris,</i>
<i>Hyla miotympanum</i> (?),	" <i>salvini,</i>
<i>Phrynosoma orbiculare,</i>	

we get a total of about 42 species, equalling 17 per cent., as restricted to the cold and cool zones (*cf.* p. 228).

List of Species recorded from Mexican Mountains within the Cool Zone.
 [The Plateau, e. g. Valley of Mexico, Puebla and Zacatecas, is not included.]

	Citlaltepetl.	Cerro de S. Felipe, near Oaxaca.	Amula, Sierra Madre del Sur, between Oaxaca and Chilpancingo.	Omitlame, Sierra Madre, West of Chilpancingo.	Nevado de Colima.	Cumbre de los Arrastrados.	Sierra de Ajusco, near Mexico.
<i>Thorius pennatulus</i>	9000	8000	*	7200
<i>Spelerpes orizabensis</i>	8000-12,500	8500
— <i>leprosus</i>	8000-12,500	7900-8800
— <i>chiropterus</i>	9000-10,000
— <i>belli</i>
<i>Batrachoseps attenuatus</i>	*	7100	6600-8900
<i>Amblystoma tigrinum</i>
— <i>altamirani</i>
<i>Bufo intermedium</i>	7100	6270-8250
— <i>sinus</i>
<i>Hylaetes rhodopis</i>	8000-12,000	8000	*
— <i>palmatus</i>
<i>Syrrihopus omiltemanus</i>	*
<i>Borhoroceates mexicanus</i>	*	7100
<i>Tomonodactylus amule</i>
<i>Hyla eximia</i>	Sierra de Cavatlan, 8000	8000
<i>Rana halszcinai</i>	7100
— <i>omiltemana</i>	*	5000-7200
<i>Sceloporus torquatus</i>	7000	*	4400-8500
— <i>bulleri</i>	3450-8500
— <i>garronei</i>	7300
— <i>acanthinus</i>	8000	7000	*	8500
— <i>asper</i>	7200
— <i>formosus</i>	8000	8000*	7200-11,000*	8000*
— <i>microlepidotus</i>	13,000	8000	7800-8500	8500*
— <i>heterolepis</i>	8900	*	8500*
— <i>ameus</i>	8500-13,500
— <i>scularis</i>	10,000-14,000	7000	*	8900	8500*
— <i>variabilis</i>	*
— <i>siniferus</i>	?

GENERAL CONCLUSIONS.

1. *Evolution of Middle America.*

We have seen in the review of the Amphibian and Reptilian fauna of Mexico that it is composed of Northern and Southern immigrants; that a considerable number of the northern group can claim to be old, autochthonous Nearctics; that some families, genera, or species have also representatives in the Antilles, and that most of these forms point unmistakably to Central America, or even further south, as their original home; lastly, that but few Antilleans belong to a northern stock.

The explanation lies in the geological history of this part of the world. I restrict myself on purpose to this part, lest such an inquiry should lead to a discussion of the whole globe since the first dawn of Amphibian life in some Palæozoic country.

Our present task limits itself to the Tertiary period. It is doubtful whether any of the genera in question are older than the Eocene, but not a few can be proved to have existed in our region in the mid-Miocene epoch; and it is surprising that they should date so far back. Lastly, there was no Central America in the Cretaceous period.

The building up of Mexico and neighbouring countries seems to have taken place as follows, so far as I can gather from the writings of A. Agassiz, Suess, Lapparent, R. T. Hill, J. W. Spencer, J. W. Gregory, C. Sapper, and José G. Aguilera*.

The accompanying consecutive series of maps illustrate my abstract conclusions, and only in this abstracted sense can claim originality.

Mexico came into existence during the Lower Cretaceous epoch. To a nucleus of land, Sierra Nevada and California, were added the Rocky Mountains and the bulk of the Mexican Plateau. This large complex I call the *Old Sonoraland*. It is important to remember that it was separated, during the Upper Cretaceous epoch, by a broad belt of sea from the eastern and northern parts of North America. A third mass of land existed as Brazilialand. In the meantime appeared Antillean lands, and, possibly in sympathy with the east to west trending mountains of Honduras

* SUSS.—*Das Antlitz der Erde*. DE LAPPARENT.—*Traité de Géologie*.

R. T. HILL.—“The Geology and Physical Geography of Jamaica: Study of a type of Antillean development.” *Bull. Mus. Comp. Zool. Harvard*, xxiv. (1899) pp. 1-226. See also other papers in same *Bulletin*, xvi. (1895), and in *Amer. Journ. Sci.* vol. xlviii. (1894).

J. W. SPENCER.—“Reconstruction of the Antillean Continent.” *Bull. Geol. Soc. America*, vol. vi. 1895; and *Geol. Mag.* 1894, pp. 448-451.

A. AGASSIZ.—*Reports of the Results of Dredging* by the ‘Blake.’ *Mem. Mus. Comp. Zool.* x. (1883) no. 1, p. 79.

J. W. GREGORY.—“Contributions to the Palæontology and Physical Geography of the West Indies.” *Quart. Journ. Geol. Soc.* vol. li. (1895) pp. 255-312.

J. G. AGUILERA.—“*Bosquejo Geológico de Mexico*.” *Instituto Geológ. de Mexico*, pt. 4 (1895) pp. 1-270, with maps.

C. SAPPER.—“*Sobre la Geografía física y la geología de la península de Yucatan*.” *Inst. Geol. Mexico*, pt. 3 (1896).

and Guatemala, also the Mexican Sierra Madre del Sur. These parts were in time annexed by Sonoraland.

By the late Eocene, conditions were so far consolidated that there existed the present North American Continent, eastern and

Text-fig. 31.

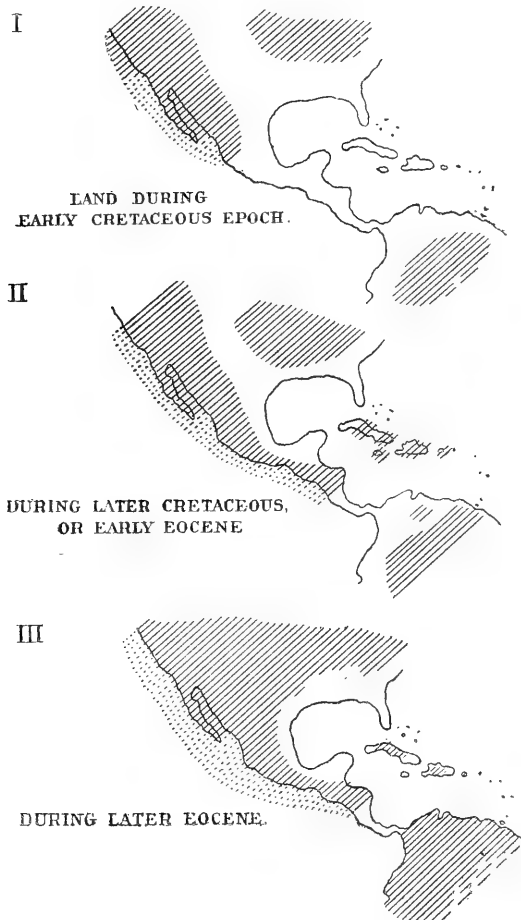

Diagrams to illustrate the contours of Mexico at different geological ages.

western halves joined, and the latter extending southwards as the present Mexico and part of Central America. Brazilia had grown into South America, but the two continents were still separated, the Atlantic and Pacific communicating across the present Isthmus of Panama and probably further north.

Late Eocene, or early Oligocene, times mark a period of considerable local subsidence which drowned the Antillean land, or islands, except their summits. Late Oligocene, or early Miocene, mark a period of considerable elevation with most important

Text-fig. 32.

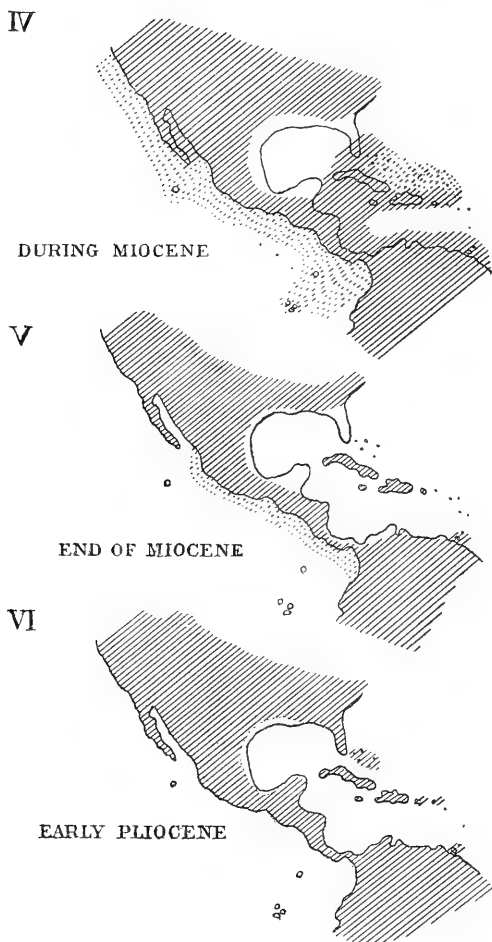

Diagrams to illustrate the contours of Mexico at different geological ages.

results:—Establishment of the continuity of North and Central with South America, and a continuous mass of land from Central America, north and eastwards, comprising the Greater Antilles and the southern end of Florida. For this Central Land (Antilles + Central America proper, and adjoining parts of South

America, viz. Colombia and Venezuela) I use the name of *Great Antillia*, the term *Antillia* having already been used by others. The present Gulf of Mexico remained below the sea, and was larger than it is now, covering the Atlantic Tierra Caliente of Mexico, Yucatan, and, according to Hill, the main part of Florida. If correct, the latter point is important.

It seems also probable that the Mexican-Central American land, during the Miocene epoch, extended considerably further westwards than the present Pacific coast, taking in with almost certainty the Revilla Gigedo Islands.

Late Miocene, or early Pliocene, comprise a time of subsidence, resulting in the present features. Severance of the Antilles into the present islands, which since have undergone comparatively unimportant changes of shape and extent; separation of Florida. Lower California became a peninsula, owing to the formation of the Gulf of California. The Revilla Gigedo Islands, still later the Tres Marias, are remnants of the subsiding land. Yucatan appears at the beginning of the Pliocene epoch*. The Isthmus of Panama is limited to its present narrow dimensions.

A few words remain to be said about the volcanic activity and other changes affecting the configuration of the Mexican Plateau. A tremendous dislocation, at the latest in Eocene times, produced the Eastern Sierra Madre, composed entirely of Cretaceous limestones, raised up high, forming the elevated eastern rim of the plateau, and falling off abruptly towards the Atlantic lowlands.

In the Eocene epoch began also the enormous outburst of volcanism, raising the Western Sierra Madre, piling up gigantic masses of igneous rocks, mostly andesite, and lavas, which continued to spread over a vast part of the country during most of the Miocene epoch, and, more locally, even in historic times. Most of the plateau is now covered with the Quaternary debris, sand, &c., which overlie the eruptive masses and the older calcareous or limestone formations. These accumulations of more or less sandy soil form plains, mostly treeless. They are of great extent, in the northern half, from Texas to Zacatecas. In the middle, say from Guadalajara to Puebla, exist a great number of smaller plains or "valles," that is to say fertile plains, interrupted or partly surrounded by the outcropping hills of volcanic formation, and they contain a fair number of lakes. In the south of Mexico, in the States of Oaxaca and Guerrero, such plains are rare or absent. Trees are scarce or absent on the plateau; it is an idle fable that it was well-wooded in historic times. The bordering high Sierras and their slopes are well-wooded, densest on the moist, Atlantic side. The eastern, southern, and western Tierra Caliente is covered with luxurious growth, either forming continuous forests or showing the features of savannahs.

The plateau is dry, verging towards prolonged droughts, interrupted by few, occasionally torrential, rains. The Atlantic

* See footnote to p. 242.

hot-lands and the eastern slopes of the States of Vera Cruz and Chiapas are very wet, with a very long and abundant rainy season, interrupted by a short dry time in the winter. The Pacific side is much drier; the actual amount of annual rainfall is considerably less and the dry winter period is much longer.

The plateau rises from less than 1000 feet near Laredo, and 3800 at El Paso, gradually to about 6000 at Aguas Calientes and Querétaro, and above 7000 at Mexico City and Puebla. The highest masses of mountains, bordering the plateau, lie in the south-east, south and west, culminating in the snow-capped peaks of Citlaltepétl or Volcan de Orizaba, Popocatepetl, Nevado de Toluca, and Nevado de Colima.

2. *Immigration and Spreading.*

Obviously these physical conditions influence the fauna now; what they were like in bygone ages we can only surmise. Ranges of mountains are by no means always barriers; on the contrary, they help the dispersal along the lines of their long axes. Regions covered by the sea are of course not available. The same applies to districts which are subject to volcanic eruptions. This is very important for Mexico. Not only the Western Sierra Madre with its continuations to Colima and thence towards Puebla, but also almost the whole of the plateau became covered with eruptive masses, and, considering the immense extent of this terrain, a long time must have elapsed before it became available for plants and animals. We may well ask, what remained of the country as suitable for life. Of course, probably, there were archaic tracts standing out, not affected by these revolutions, but these gneisses, schists, and granites form scattered enclaves. I think it was the Pacific strip—Sonora, Sinaloa, Tepic, and part of Jalisco—which was not affected; in fact, the Pacific slopes, together with the land which has since sunk below the Gulf of California. On the eastern side, part of the plateau did not suffer from eruptions, but the land was still narrowed; there was no Atlantic lowland, this being during the whole Miocene epoch, and even later, still below the sea. Consequently we have as available land the western strip as the least altered remnant of Old Sonoraland, and the present eastern limestone belt, beginning with a broad basis in Texas, and extending through Coahuila and Nuevo Leon southwards, narrowing down towards Oaxaca. These were the two belts of land available for spreading southwards. Obviously the Pacific belt is the older of the two, the north-east of Mexico, with Texas, being late Cretaceous terrain. Once arrived in the south of the plateau, there was the essentially granitic, gneissic, and older Cretaceous terrain of Guerrero and Oaxaca, not so much overlaid by volcanic masses. Thence the Great Antillia afforded easy access into the present Antilles. But it was a long way round from the North. The spreading from South America into this same Antillia was easier in this respect.

Later immigrants from the North into Mexico are those of the

plateau, which by climate and every other physical feature is a direct continuation of the more northern countries. Hence the imperceptible change from Arizona, New Mexico, and Texas southwards. The political frontier between Mexico and the United States is no boundary whatever for our purposes.

For northern animals and plants the drier climate, not so much the annual mean temperature, of the plateau suggests this as a natural limit, but not a few northern forms, even the same species, have adapted themselves to life in the hot lowlands and have extended their range far south, even into South America. With the original natives of the latter continent, conditions are different. They could spread easily through Central America, but arrived in South Mexico the wedge of the plateau divides them into an Atlantic and a Pacific mass. They can go a long way north, and are still in *Tierra Caliente*, like the countries whence they came. But a sifting takes place. The Atlantic lowlands are hot and moist, whilst the Pacific slopes and much narrower lowlands are hot and rather dry, the dryness increasing rapidly towards the north. To people such divergent countries implies a severe sifting of the immigrants, or the necessity of changing, by adaptation to, or by, the new surroundings.

This is well illustrated by the gradual change, from species to species, of essentially northern into slightly less northern, into almost tropical forms of the same genus; or, since a genus is in most cases an imaginary abstract, of the same group of closely allied creatures. Still further south that particular genus comes in most cases to an end. There may be a species or two which form outposts, straggling on, perhaps in actual process of successful adaptation; however, after all the genus has found its limit. But it is there not met by the outposts of the southerners; they in their turn stand much further north. If it were otherwise, there would be a real boundary line, with a kind of neutral zone between North and South, and this neutral zone should contain comparatively few species and genera. Emphatically this is not the case. The two faunas overlap broadly; they commingle, except on the plateau, which seems to be a much more effective barrier to the southerners than is the descent from the plateau into the hot lowlands to the northern creatures. It seems to be easier for xerophile northern genera, and even species, to go south and to adapt themselves to life in a more equably hot and decidedly moister country with luxurious vegetation, than for hygrophile southerners to do the reverse.

Be it noted, however, that this applies only to those terrestrial northerners which can adapt themselves to arboreal life; rattlesnakes cannot do it. Speaking broadly, xerophiles are essentially humivagous; hygrophiles either live on the ground which is rich in humus, grass, or herbaceous tangle and underwood, or they are arboreal.

A favourite way of adaptation is arboreal life, whereby the xerophiles escape inundations, accumulation of humus, debris,

and the gloom of the underwood. In a desert or semidesert the amount and character of the scarce and precarious vegetation remain practically stable; not so in the Pacific lowlands. During the rainy season grows up a dense mass of herbaceous plants covering the ground with a tangle of weeds, tall *Salvias* and Composites, stinging herbs and spiny creepers; all this disappears, is burnt up, scattered during the dry season, and for months the ground may be bare, whilst many of the trees are leafless. In this Pacific type of Tierra Caliente we have periodical extremes. Different again is the moist Atlantic Tierra Caliente, and also the ranges of mountain forests of the Southern and South-eastern Tierra Templada. There are no extremes; the very opposite to arid tracts; there is plenty of high and low vegetation all the year round.

The important factor is not the temperature, nor the altitude as such, but the amount, or rather the distribution, of annual moisture. Temperature: more than the northern half of the Mexican plateau belongs to one of the hottest regions of the world, the centre of heat being the State of Sonora. From May to July the mean temperature for Sonora is $36^{\circ}\text{C.} = 96.8^{\circ}\text{F.}$; for the rest of the northern plateau $30^{\circ}\text{C.} = 86^{\circ}\text{F.}$, which is *more* than the summer average of South Mexico and Central America. But in the winter the North averages $16^{\circ}\text{C.} = 60.8^{\circ}\text{F.}$, while the Tierra Caliente enjoys 25°C. In short, the Hot-land temperature averages from 25° to $28^{\circ}\text{C.} = 75^{\circ}$ to 82°E. ; the Northern plateau from 60° to 96°F. , with additional extremes from frost and snow to unbearable broiling heat and drought.

The overlapping, mentioned above, is much more generic than specific. There are, indeed, very few species which, although having a wide geographical range, are well established in stations of decidedly very different physical aspect. For instance, species on the higher mountains, or plateaux, and also in the Tierra Caliente: see p. 231. But of all these only very few, e. g. *Hylodes rhodopis*, *Sceloporus scalaris*, a Rattlesnake, and *Tropidonotus ordinatus*, can, in their indifference to physical conditions, be compared with the Puma, the Armadillo, Opossum, the Raven, and Turkey-Buzzard.

Some species, natives of the plateau, descend from it down to the neighbouring coast (*Bufo simus*, *Hypsiglena torquata*, *Zamenis grahami*); others ascend from the hot countries on to the plateau, especially from the west by way of Guadaluajara, and thence to Guanajuato and further east, the means being the alluvial plains spoken of before; or the ascent can be traced through the Balsas depression towards Iguala and Cuernavaca; another opportunity seems to lead from the east side to Zacualtipan in the State of Hidalgo. Such ascending species are *Bufo marinus*, *B. valliceps*, *Hyla miotympanum*, *Engystoma ustum*, *Phyllodactylus tuberculatus*, *Uta bicarinata*, *Zamenis mexicana*.

To another category belong those species which have a wide, but very scattered, discontinuous distribution, especially those

which, like most *Gerrhonotus*, are now restricted to the higher mountains.

Lastly, a considerable number of Southern species ascend from the hot lowlands high up onto mountains which rise isolated, or which fringe the plateau.

Of course it is difficult, perhaps premature, to generalise in this respect, and sharp lines cannot be drawn between these categories. Not the least cause is the vagueness or doubtful nature of many of the reported localities. For instance, Cope had various correspondents in Mexico, and some of the alleged localities are quite impossible. Peters had a good correspondent resident in Puebla City, but the specimens which now figure as "Puebla" came from anywhere in that State, which has the most perplexing, intricate boundaries, and contains altitudes from 3500 to less than 100 metres! "Vera Cruz" is another snare to the unwary. Others have bought specimens, even collections, in Mexico City. I myself found in a shop at Orizaba several large glass vessels full of well-preserved snakes for sale, but I left them alone since nobody knew where they came from. Sumichrast lived for many years in Tehuantepec and he travelled widely, all over the Isthmus and beyond. The town is situated on a plain, about 100 feet above the not distant sea; within a few hours' ride are mountains, covered with pines, well above the Tierra Caliente, as typical of which every specimen labelled "Tehuantepec" is put down.

I shall not, at least in this paper, go into the detail of the generic overlapping, a very important question. Suffice it to say, that in many cases the species of a genus are so distributed that some are decidedly northern, living on the plateau, typical inhabitants of the Tierra Fria; another species lives in the adjoining Tierra Templada, more often on the western than on the eastern slopes and descending more or less far into the lowlands; while a third kind is confined to the typical tropical Tierra Caliente. Such cases are clearly illustrative of the evolution of species due to the prevailing physical conditions, especially when none of these species has a wide geographical range.

Are we justified in calling a certain species ancient because it has a wide continuous range? For instance, *Tropidonotus ordinatus*, *Crotalus terrificus*. It is rather doubtful, because these creatures are so indifferent to climatic conditions. With more right we consider those as ancient which have to be very particular about their terrain, and which are now scattered, without the least chance of communication—as, for instance, *Thorius*, *Chirotos*, *Heloderma*, and other slow, or digging, creatures.

3. Northern and Southern Immigration.

In the following table the Mexican Amphibia and Reptiles are divided into a Northern or Nearctic and a Southern or Neotropical mass, according to their presumable ancestral home or centre of

NEARCTIC, extending into:

NEOTROPICAL.

Not beyond Mexico. Central America. Antilles.

Pelobatidæ _____		
Ranidæ _____	----->	
Desmognathinæ _____		
Amblystomatinae _____		
Plethodontinæ _____	-----*	----->
Heloderma _____		
Xenosaurus _____		
Xantusiidæ: a. Sonoran _____		
b. Southern _____	-----*	
Anguidæ _____	-----*	----->
Amphisbænidæ _____	-----*	----->
Iguanidæ: a. Xerophile _____		
b. Hygrophile _____	-----*	----->
Glauconiidæ _____		
Boidæ _____	-----*	
Crotalinæ _____		
Colubrinæ Aglypha _____	-----*	
_____	-----	} Colubrinæ } Opisthoglypha.
_____	-----	
_____	-----	Elapinae.
_____	-----*	Typhlopidae.
_____	-----*	Tejidae.
_____	-----*	Geckonidae.
_____	-----	Engystomatidae.
_____	-----*	Cystignathidae.
_____	-----*	Hylidae.
_____	-----*	Bufo nidae.
Chelonia: Testudinidæ _____	-----	
Cinosternidæ _____	-----	
Dermatemydidae _____	-----	

dispersal so far as America is concerned. Those which have sent forms into the Greater Antilles are also indicated.

The Greater Antilles have received their fauna* from Nearctic

* Gregory thinks it is "almost certain" that Yucatan was connected with Cuba. Other zoogeographers have likewise assumed this connection, and it looks very plausible on the map. If it ever existed, it must have been very transitory. Amphibia

and from Neotropical groups, of both Amphibia and Reptilia, but no northern group has contributed, unless it had spread well into Central or even into South America (witness the Plethodontæ, Anguidæ, Amphisbænidæ, Scincidæ, Xantusiidæ, Aglyphous Colubrinæ, Iguanidæ).

All these Nearctic, or Old-Sonoran, groups must have been there in Miocene times. The same age must be assigned to the northern immigrants—the Cystignathidæ, Hylidæ, Bufonidæ, Tejidæ, Typhlopidae.

On the other hand, the following must be considered as decidedly post-Miocene so far as their existence in the present Central America is concerned: from the North the Pelobatidæ, Desmognathinæ, and Amblystomatinae, none of which extend southwards, beyond Mexico proper; from the South the Engystomatinae, Opisthoglypha, Elapinae, none or few of which go beyond Mexico into the United States. Lastly, the latest arrivals in South America are the Crotalinae, of which only *Lachesis lancecolatus* has entered the Lesser Antilles.

Ancient Sonorans are *Heterodermæ* and *Chirotes*.

The Testudinidæ are also Old Sonorans. Still with fair numbers in Mexico, but ever decreasing southwards through Central into South America. *Testudo* has arrived in Central and South America too late for the Antilles, but in time for the Galapagos. This indicates that the Caribbean Sea and Gulf of Mexico connection was established before the disappearance of the western extent of Central American land. It is another hint that the Isthmus of Panama is but the last vestige of a former much broader land-connection between the two Continents.

Concerning the Colubrine Snakes, they remind us in their dispersal southwards of the Iguanidæ, Anguidæ, and Boiidæ. They have gone in detachments. The earliest migrants, when arrived in South America, have developed there, and since, into Opisthoglypha and the Aglypha part 3; and these are now surging back, northwards, post-Antillean. A second lot are the Aglypha part 2, many of which have entered the Antilles. Lastly, the last detachment of northerners passing through Mexico and Central America, too late for the Antilles, but still continuing their southward migration.

If I am right in the conclusion that American Colubrinæ gave rise to Opisthoglypha in South America, it follows that Opisthoglypha are not a natural group, those of the Old World, chiefly palæotropical, being an instance of collateral development, convergent, homoplastic, or whatever term may be preferred.

and Reptiles do not support it; on the contrary, their present distribution is opposed to it.

About 70 species are known from Yucatan. Its fauna is essentially that of the Atlantic Tierra Caliente; it differs from that of the Antilles apparently by the absence of Xantusiidæ, Glauconiidæ, and Anguidæ. On the other hand, it is inconceivable why Tortoises, Pit-vipers, Opisthoglypha, and *Cnemidophorus*, all of which are plentiful in Yucatan, should not have crossed over into Cuba if a direct land-bridge had been available.

Unless this conclusion be accepted, we have to resort to violent interpretations. Either complete extinction all over North America, a measure which receives no support from actual distribution; or we must be prepared to assign to the *Opisthoglypha* a Cretaceous age, as a family not descended from North-American *Colubrinæ*; or, lastly, if we should insist upon the *Opisthoglypha* as a natural group, the only explanation would be a land-connection across the Equatorial Atlantic, which with shifting modifications is supposed to have existed from Lower or Mid-Cretaceous into at least the Oligocene epoch.

This bridging of the Atlantic is somewhat problematic. For our purposes we can discard the Cretaceous Brazil-Africa connection. Of more concern to periarctic distribution is the Europe-Greenland-North America continuity, which is supposed to have persisted well into the Tertiary period. But there was a third, more direct bridge, although one of a curious and mysterious structure, which by its several advocates is dimly described as composed of a shallow sea interspersed with many islands; or as a solid land-belt; or, lastly, as a long archipelago with a continuous coast. This mysterious structure is supposed to account for the unmistakable similarity between the now extinct Antillean and Mediterranean coral-fauna, Old-World and Antillean land-mollusca, &c. Obviously the corals require sea, the mollusca land. The apparent contradiction may be solved by the suggestion that there existed between Central America and the Mediterranean a sea (part of the Tethys of Suess and Ortmann, later their "Great Mediterranean"), shallow during the Oligocene epoch, studded with islands, bordered by continuous land in the South (Brazilia to West Africa, or later between N. South America and West Africa, part of the Mesozonia of Ortmann) and in the North (Western Europe to Appalachia). Subsequently the Tethys increased to a big "bay" in Mid-Atlantic, this bay extending, spreading south and north, drowning first the southern land-belt, driving the northern land farther and farther north, with the ultimate result of a junction of the South with the North Atlantic; in other words, establishment of the whole Atlantic.

Now these land-bridges, provided they existed long enough and at the right time and place, the Southern until at least the beginning of the Eocene, the Northern at least through the Oligocene epoch, would explain many a puzzle in geographical distribution; for instance, that of the *Aglossa*, *Boas*, *Podocnemis*, *Amphisbænidae*, *Solenodon*. The Northern bridge would throw light upon the *Anguidæ* and upon *Spelerpes*, a large American genus with a solitary species in Sardinia and Italy.

But this is at present a land of dreams. With more claim to reality, we can conclude that *Central America, although genetically part of the North-American continent, has received its dominant, most characteristic fauna from South America*, and this southern fauna has surged northwards chiefly to the east and west of the Mexican plateau.



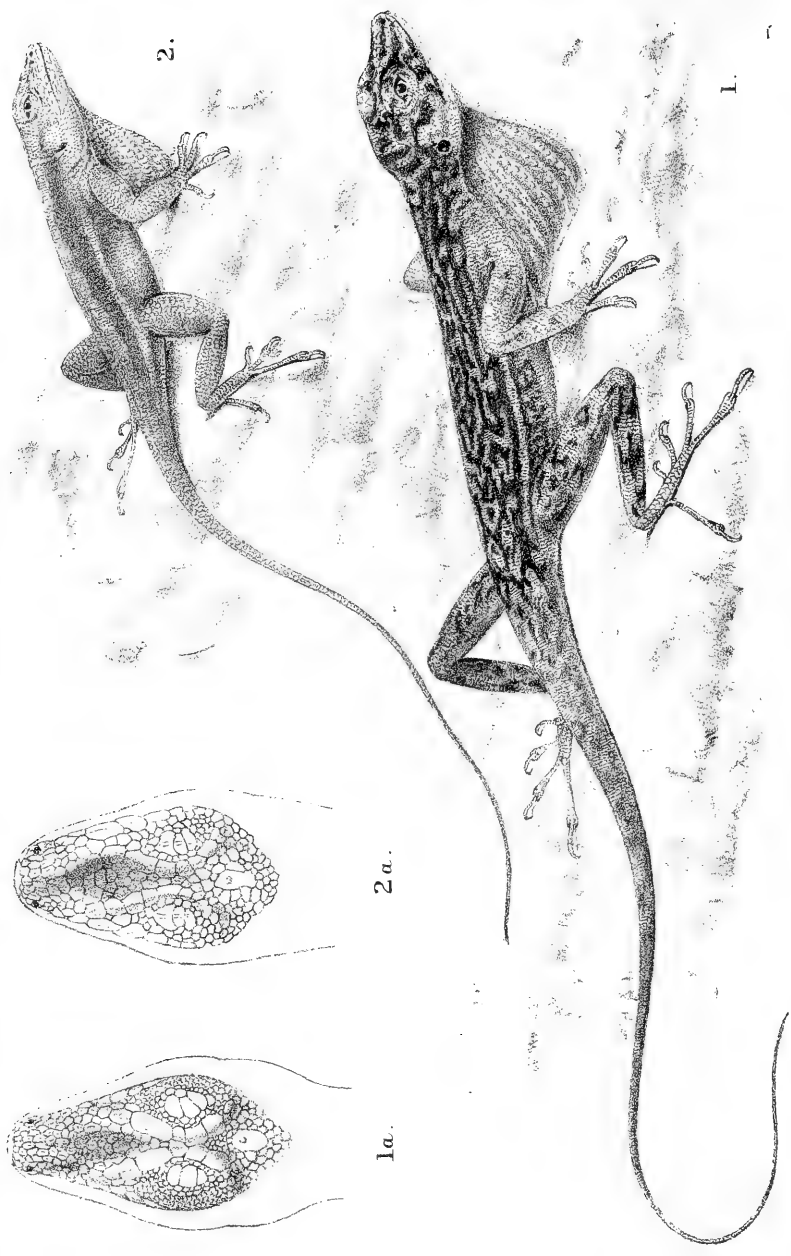

J. Green del. et lith.

1. ANOLIS GADOVII. 2. ANOLIS LIOASTER.

Bale & Danielsson Lith. Imp.

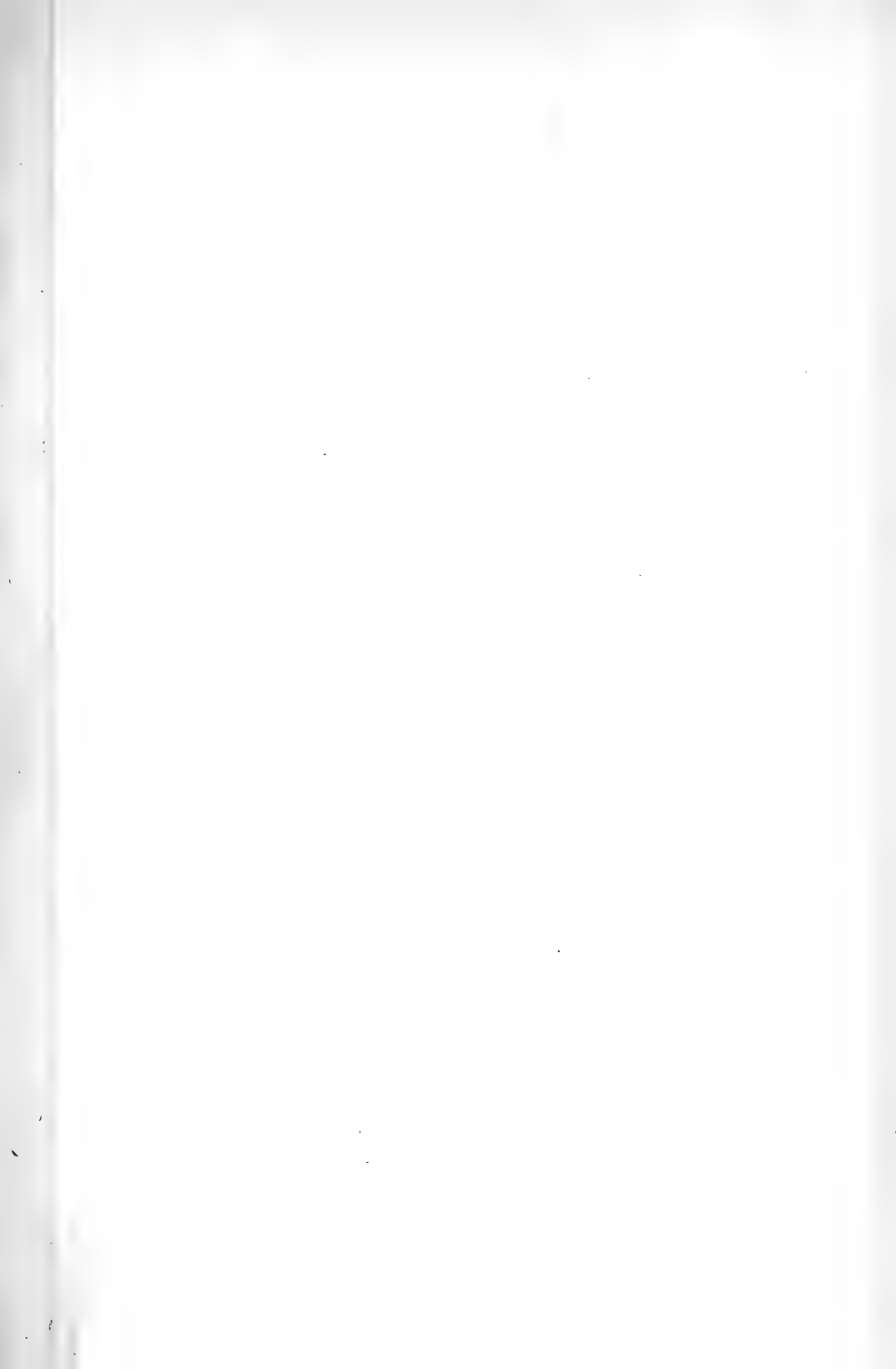

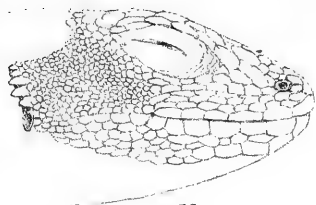

1b.



2.

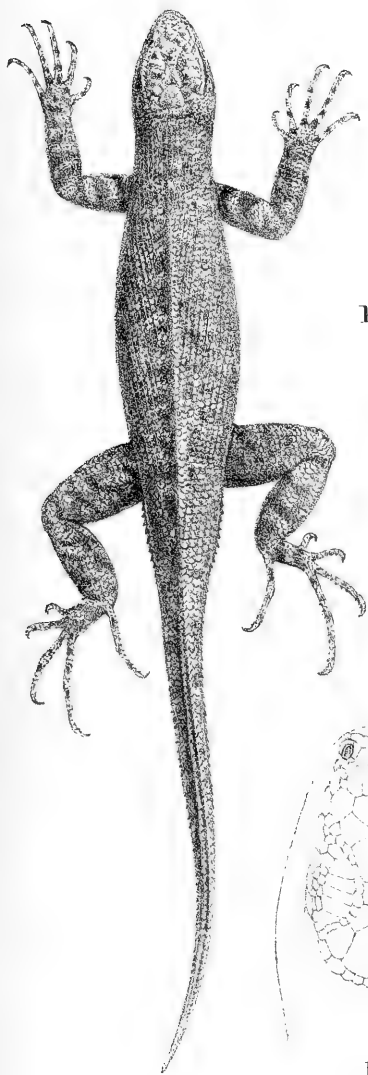

1.

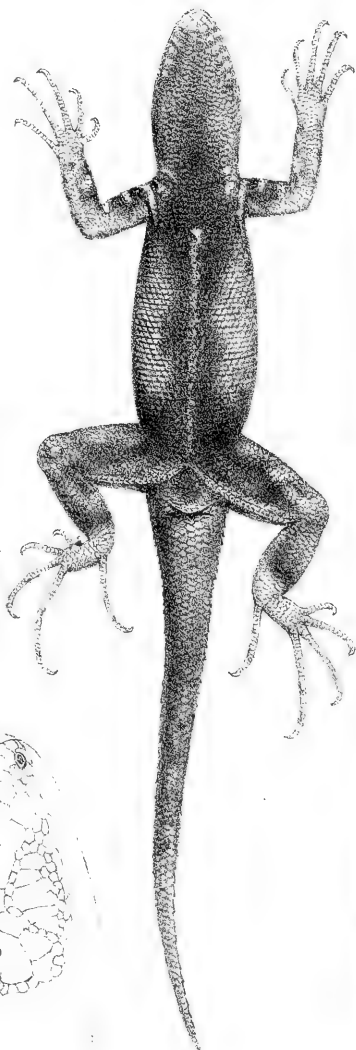

1a.

3. Descriptions of new Reptiles discovered in Mexico by
Dr. H. Gadow, F.R.S. By G. A. BOULENGER, F.R.S.,
V.P.Z.S.

[Received May 17, 1905.]

(Plates VI. & VII.*)

ANOLIS GADOVII. (Plate VI. fig. 1.)

Head once and two-thirds as long as broad, slightly longer than the tibia; forehead concave; frontal ridges distinct, divergent; upper head-scales rugose, not keeled; scales on frontal ridges and supraorbital semicircles large, the latter in contact on the interorbital region; three large supraoculars, forming together a disk separated from the supraorbital semicircle by two series of small scales; occipital large, a little larger than the ear-opening, separated from the supraorbital semicircles by two series of small scales; canthal scales four, loreal rows six; six or seven upper labials to below centre of eye; ear-opening large, vertically oval. Gular appendage very large, extending far back on the breast; gular scales smooth. Body compressed; no dorso-nuchal fold. Dorsal scales small, smooth or faintly keeled, irregular, juxtaposed; lateral scales minute, granular; ventral scales larger than dorsals, smooth, juxtaposed. The adpressed hind limb reaches the eye; tibia as long as the distance between the end of the snout and the ear; digits moderately dilated; 20 lamellæ under phalanges II and III of the fourth toe. Tail feebly compressed, not crested, once and three-fourths length of head and body. No enlarged postanal scales. Greyish above, with black wavy and vermicular lines; two parallel black lines on each side from shoulder to hip; belly white; gular appendage bright red.

Total length	225 millim.	Fore limb.....	37 millim.
Head	20 "	Hind limb ...	63 "
Width of head ...	12 "	Tail	145 "
Body	60 "		

This very distinct and handsomely marked *Anolis* is represented by a single male specimen, from Tierra Colorada, South Guerrero.

ANOLIS LIOGASTER. (Plate VI. fig. 2.)

Head once and a half as long as broad, longer than the tibia; forehead deeply concave; frontal ridges strong, short, divergent; upper head-scales smooth or feebly keeled; scales of the frontal ridges and supraorbital semicircles large, the latter in contact on the interorbital region or separated by one series of small scales; three large, smooth or faintly keeled, transverse supraocular scales forming a single longitudinal series, in contact with the supraorbitals or separated from them by one series of small scales; occipital larger than the ear-opening, separated from the supraorbitals by one or two series of scales; canthus rostralis sharp; canthal scales

* For explanation of the Plates, see p 247.

three; loreal rows five; six upper labials to below the centre of the eye; ear-opening rather small, vertically oval. Gular appendage very large, extending far back on the breast, in the male, absent in the female; gular scales feebly keeled. Body feebly compressed; no dorso-nuchal fold. Dorsal scales subrhomboidal, subimbricate, strongly keeled, passing gradually into the minute, granular scales of the sides; ventrals much larger than dorsals, rounded, imbricate, smooth. The adpressed hind limb reaches the eye or a little beyond; digits moderately dilated; 16 lamellæ under phalanges II and III of the fourth toe. Tail scarcely compressed, twice as long as head and body. Male with enlarged postanal scales. Reddish brown above, with a paler broad vertebral stripe, widening on the nape; this stripe edged with dark brown in the female; lower parts golden, the gular appendage bright red.

Total length	150 millim.	Fore limb.....	23 millim.
Head	16 "	Hind limb ...	37 "
Width of head ...	10 "	Tail	100 "
Body.....	34 "		

Two specimens, male and female, from Omilteme, Guerrero, 7600 ft.

The male is remarkable in the absence of the inner digit on the four limbs.

Allied to *A. nebulosus* Wiegmann. Distinguished principally by the smooth ventral scales.

SCELOPORUS GADOVLÆ. (Plate VII. fig. 1.)

Head-shields smooth; frontal transversely divided, separated from the interparietal by a pair of frontoparietals; interparietal as long as broad; parietals small, one pair on each side; two canthal scales; five or six large transverse supraoculars, bordered inwards by one series of scales, outwards by one or two; five long pointed scales form a strong denticulation in front of the ear. Dorsal scales larger than ventrals, strongly keeled, pointed or shortly mucronate, forming oblique series converging towards the median line, passing gradually into the smaller scales of the sides; 73 to 77 scales between the interparietal shield and the base of the tail; 19 or 20 scales, taken in the middle of the back, correspond to the length of the shielded part of the head. Ventral scales small, smooth, bicuspid. 75 to 80 scales round the middle of the body. The adpressed hind limb reaches the ear; tibia as long as the distance between the end of the snout and the ear; the distance between the base of the fifth toe and the extremity of the fourth exceeds the distance between the end of the snout and the posterior border of the ear. 28 to 33 femoral pores on each side, the two series narrowly separated on the præanal region. Tail compressed; caudal scales a little larger than dorsals, strongly keeled, the two median upper series more strongly mucronate and forming a pair of serrated ridges. Male with slightly enlarged postanal scales. Greyish olive above, reddish on the sides, dotted with bluish

green; limbs with rather indistinct dark bars; throat and belly dark blue; a narrow whitish median ventral streak.

Total length	147 millim.	Fore limb.....	32 millim.
Head.....	15 "	Hind limb ...	45 "
Width of head ...	11 "	Tail	80 "
Body.....	52 "		

Two male specimens from a ravine near Mesquititlan, north of Chilpancingo, Guerrero.

This very remarkable species, which I take the liberty of naming after Mrs. Gadow, agrees with *S. pyrrocephalus* Cope, in its distinctly compressed tail, but differs from it in having much smaller scales and more numerous femoral pores. No species of *Sceloporus* was hitherto known to have more than 25 femoral pores on each side.

LEPTODIRA GUILLENI. (Plate VII. fig. 2.)

Rostral twice and a half as broad as deep, scarcely visible from above; internasals a little longer than broad, little shorter than the prefrontals; frontal once and two-thirds as long as broad, a little longer than its distance from the end of the snout, a little shorter than the parietals; loreal as long as deep; one præocular, well separated from the frontal; two postoculars; a subocular below the præocular and another below the postoculars; temporals 1 + 2; eight upper labials, fourth and fifth entering the eye; five lower labials in contact with the anterior chin-shields, which are much shorter than the posterior. Scales in 23 rows. Ventrals 189; anal divided; subcaudals 71. Above with eleven dark brown areas separated by narrow greyish-white bands; snout, interocular region, and temples brown, back of head and nape bright red with a dark brown median line; a light, dark-edged streak along the upper lip; lower parts white, the ventrals with a brown spot on each side; subcaudals brown, edged with whitish.

Total length 530 millim.; tail 110.

A single female specimen from the Rio Balsas, Guerrero.

This species which, on the whole, is intermediate between *L. nigrofasciata* Gthr. and *L. personata* Cope, is named after Señor Don Manuel Guillen, Governor of the State of Guerrero, in recognition of valuable assistance rendered to Dr. Gadow.

EXPLANATION OF THE PLATES.

PLATE VI.

Fig. 1. *Anolis gadovii*, sp. n., p. 245.

1 a. " " Upper view of head, $\times 2$.

2. " *tiogaster*, sp. n., p. 245.

2 a. " " Upper view of head, $\times 2\frac{1}{2}$.

PLATE VII.

Fig. 1. *Sceloporus gadoviae*, sp. n., p. 246. Upper and lower views.

1 a. " " Upper view of head, $\times 2\frac{1}{2}$.

1 b. " " Side view of head, $\times 2\frac{1}{2}$.

2. *Leptodira guilleni*, sp. n., p. 247. Upper and side views of head and anterior part of body.

4. On a Collection of Batrachians and Reptiles made in South Africa by Mr. C. H. B. Grant, and presented to the British Museum by Mr. C. D. Rudd. By G. A. BOULENGER, F.R.S., V.P.Z.S.

[Received May 29, 1905.]

The collections made within the last two years in South Africa by Mr. C. H. B. Grant and presented to the British Museum by Mr. C. D. Rudd, the Mammals of which have already afforded matter for two papers by Messrs. O. Thomas and H. Schwann, published in these 'Proceedings,' included a good series of Batrachians and Reptiles, a list of which is here given. No new species were discovered, but the series is interesting for the sake of the localities, our knowledge of the exact distribution of these animals in South Africa being still very imperfect.

A list of the localities is here given:—

- I. Cape.
Durban Road, near Cape Town. This "Durban" is a town about 15 miles N.E. of Cape Town.
- II. British Namaqualand.
Port Nolloth, at mouth of Orange River.
Klipfontein, a station on the railway between Port Nolloth and O'okiep, 54 miles from Port Nolloth. Altitude 3104 ft.
- III. Zululand.
Hluhluwe Stream, flows west into False Bay.
Umfolosi Station, on the railway, about 5 miles north of Umfolosi River.
Eshowe, about 30 miles inland from Coast and Umhalazi River. Altitude 1800 ft.
Ngoye Hills, 15 miles E. of Eshowe, and 8 miles inland from Coast. Altitude 600–1000 ft.
Sibudeni, about 60 miles inland from coast, at source of Umhlatuzi River. Altitude 3500–5500 ft.
Jususie River, close to Sibudeni.
- IV. Transvaal.
Wakkerstroom, on the Natal border and at southern end of Drakenberg Range.
Zuurbron, 20 miles East of Wakkerstroom.

BATRACHIA.

AGLOSSA.

1. XENOPUS LÆVIS Daud.

Durban Road, Umfolosi Station, Wakkerstroom,
The largest specimen (♀) measures 100 millim. from snout to vent.

In the present uncertainty as to the distinction of species in this genus, the distribution of *X. levis* is difficult to trace. This species appears to be found all over South Africa where there is water, and it extends as far north as Angola to the West and Abyssinia to the East, the British Museum possessing specimens, which I cannot separate from the typical form, from Lake Mweru, Uganda, and Senafé.

Angola specimens (*X. petersii* Bocage), which have been referred either to *X. levis* or to *X. muelleri* by Günther, by Peters, and by myself, cannot be separated, by any character that I can detect, from *X. levis*. I have examined eight specimens, one from Benguella, received from Prof. Barboza du Bocage himself, five from Pongo Andongo, obtained by Dr. Ansorge, and two from Dr. Welwitsch's Angola collection. Bocage gives the length of the Angola specimens as not exceeding 65 millim. from snout to vent, but one of Welwitsch's specimens measures 80.

In the typical *X. levis* from South Africa the subocular tentacle measures less than one-third the diameter of the eye, and is sometimes reduced to a mere tubercle, the inner metatarsal tubercle is very blunt and feebly prominent, never conical, and vomerine teeth are constantly absent.

The true *X. muelleri*, as described and figured by Peters in his 'Reise nach Mossambique,' vol. iii. (1882), has the tentacle more than half as long as the eye, the metatarsal tubercle more prominent, more conical than in *X. levis*, and vomerine teeth, first noticed by Tornier, are often present. In addition to Mozambique, whence it was first described, this species is found in Nyasaland and on Zanzibar and the opposite coast.

To distinguish between *X. muelleri* and *X. levis* is, however, not so easy as one might at first think, for the British Museum has received from Mr. C. S. Betton three specimens from hot springs near Lake Nakuro, British East Africa, which agree with the former in the prominent, conical metatarsal tubercle, and with the latter in the short tentacle and the absence of vomerine teeth.

X. clivii described from Erythræa by Peracca, and obtained in numerous examples at Addis Ababa and Ashoofi, Abyssinia, by Mr. E. Degen, agrees with *X. levis* in the proportions, in the short tentacle, and in the absence of vomerine teeth, but is easily distinguished by the inner metatarsal tubercle being armed with a black claw, as in *X. calcaratus*, which inhabits Liberia, Lagos, Nigeria, Cameroon, the Gaboon, and the Congo. In the males of *X. clivii* the brown nuptial asperities, instead of being restricted to the inner side of the fore limbs, as in *X. levis*, extend as a large patch on each side of the breast.

Two specimens from "West Africa," collected by Mr. Fraser, therefore probably from Nigeria or Fernando Po, which have been referred by Dr. Günther and by myself to *X. muelleri* in the British Museum Catalogue, agree with that species in the size of the eye, the length of the tentacle, and the presence of vomerine

teeth (five in number)*, with *X. clivii* and *X. calcaratus* in the presence of a metatarsal "claw." These specimens, the larger of which measures only 39 millim., no doubt indicate a distinct species, for which I propose the name *X. fraseri*.

PHANEROGLOSSA.

2. BUFO REGULARIS Reuss.

Umfolosi Station, Hluhluwe Stream, Ngoye Hills, Wakkerstroom.

3. BUFO GRANTI Blgr.

Durban Road, Klipfontein.

Since this species was described, in 1903, from numerous specimens obtained by Mr. Grant at Deelfontein, it has been rediscovered at Matjesfontein by Dr. W. F. Purcell, of the South African Museum. The male specimen which the British Museum has received from that institution measures 60 millim. from snout to vent and strikingly resembles a *Bufo viridis*. The interorbital space is as broad as the upper eyelid, the tympanum measures three-fifths the diameter of the eye, the first finger extends a little beyond the second, the tibio-tarsal articulation reaches the tympanum, and the subarticular tubercles under the toes are all single. The single male specimen found by Mr. Grant in a garden on Durban Road, near Cape Town, agrees very closely with the Matjesfontein Toad, but some of the subarticular tubercles under the toes are double. Another male, from Klipfontein, also has double subarticular tubercles.

4. BUFO ANGUSTICEPS A. Smith.

Durban Road.

Several specimens, the largest measuring 46 millim. from snout to vent. The first finger never extends beyond the second, the fold along the inner side of the tarsus is more or less distinct, and the subarticular tubercles of the toes are usually single, although there are occasionally two between the last phalanges of the fourth toe.

Bufo dombensis, from Dombe, Benguella, described by Barboza du Bocage in 1895 as a close ally of *B. angusticeps*, is more nearly related to Smith's *Bufo vertebralis*, which, following Günther, I have erroneously regarded as the young of *B. carens*. The examination of a small Toad found at Vrededorf Road, Orange River Colony, by Major Barrett-Hamilton, and of which four specimens have been presented by him to the British Museum, has convinced me of my error. The breeding male, with large gular vocal sac, measures only 27 millim. from snout to vent, the female 35. In these specimens, the tympanum is close to the eye,

* The vomer is single in *X. laevis*, *muelleri*, and *clivii*, absent in *X. calcaratus*, *Hymenochirus*, and *Pipa*.

and may measure three-fourths its diameter; the parotoids are flat and very indistinct, broken up into several glands; the subarticular tubercles are double, and there is no trace of a tarsal fold. The limbs are shorter than in *B. carens* and the white rhomboidal spot on the vertebral line, which does not exist in *B. carens*, appears to be constant; black spots are always present on the belly.

5. *RANA DELALANDII* D. & B.

Durban Road.

6. *RANA FUSCIGULA* D. & B.

Klipfontein.

7. *RANA ANGOLENSIS* Bocage.

Eshowe, Sibudeni, Wakkerstroom.

The vocal sacs of the males form longitudinal folds on the sides of the throat.

8. *RANA MASCARENIENSIS* D. & B.

Sibudeni.

This species had not previously been recorded from South Africa. In the five specimens from Sibudeni the tibio-tarsal articulation reaches beyond the tip of the snout; a light vertebral stripe and a light line along the tibia are present.

9. *RANA GRAYI* A. Smith.

Durban Road, Klipfontein, Sibudeni, Ngoye Hills.

10. *RANA FASCIATA* Tsch.

Sibudeni.

The longitudinal folds and the dark stripes on the back are absent in the single specimen.

11. *PHRYNOBATRACHUS NATALENSIS* A. Smith.

Sibudeni.

12. *ARTHROLEPTIS WAHLBERGII* A. Smith.

Sibudeni and Hluhluwe Stream. The British Museum has also received a specimen from Pietermaritzburg, through Mr. Quekett.

REPTILIA.

CHELONIA.

1. *STERNOTLHERUS SINUATUS* A. Smith.

Umfulosi Station.

A single half-grown specimen, the shell measuring 110 millim. As pointed out by me in 1896*, this species is very variable and

* Ann. Mus. Genova, (2) xvii. p. 15.

to distinguish it from *S. nigricans* is not without difficulties. In this specimen the cusps in the upper jaw are absent, the posterior border of the carapace is very distinctly serrated, the intergular shield is twice as long as broad, the length of the outer border of the pectoral shield slightly exceeds that of the humeral, and the suture between the abdominal shields is shorter than the front lobe of the plastron. Head pale brown above, with black vermiculations, white beneath, with blackish spots; plastron yellowish brown, bordered with black.

2. *CINIXYS BELLIANA* Gray.

Umfolosi Station.

This species had not previously been recorded from South Africa. In the specimens collected by Mr. Grant the shields of the carapace are marked with black radiating streaks.

3. *HOMOPUS SIGNATUS* Walb.

Klipfontein.

LACERTILIA.

4. *LYGODACTYLUS CAPENSIS* A. Smith.

Ngoye Hills.

5. *PACHYDACTYLUS BIBRONII* A. Smith.

Klipfontein.

6. *PACHYDACTYLUS MARIQUENSIS* A. Smith.

Klipfontein.

7. *AGAMA BRACHYURA* Blgr.

Klipfontein and Port Nolloth.

This species was established on a single female specimen labelled "Cape of Good Hope," from Sir A. Smith's collection. I have since examined four specimens collected at Deelfontein by Mr. Seimund, and presented to the British Museum by Col. Sloggett, and these, together with the six collected by Mr. Grant in British Namaqualand, enable me to give a revised description of this near ally of *Agama hispida*.

Head convex, subcordiform, as long as broad. Nostril not tubular, lateral, pierced just below the canthus rostralis in a convex nasal. Scales on anterior part of head smooth or rugose, sometimes feebly keeled, often trihedral on middle of snout, on back of head more or less strongly keeled, some erect and spinose; occipital enlarged; head about the ears and neck with short erect spines. Body strongly depressed, covered with irregular, imbricate, strongly keeled scales intermixed with strongly enlarged, trihedral, spinose ones; a small nuchal crest, sometimes continued along the body; ventral scales smooth or very feebly

keeled. Limbs moderate, with scales very unequal in size; hind limb reaching between the shoulder and the ear; tibia as long as the skull to occiput; fingers short, third longest; third and fourth toes equal, or fourth very slightly the longer, fifth not extending as far as first. Tail shorter or a little longer than head and body, cylindrical or slightly compressed, covered with strongly keeled scales. Male without gular pouch, with a single row of anal pores. Olive-brown or reddish brown above, with dark brown or blackish spots, the principal of which form a double series along the back, each pair separated on the vertebral line by a square or X -shaped or N -shaped yellowish marking; lower parts whitish or greyish, with a wide-marked grey or blackish network, which may disappear in adult males; the latter always have a bluish throat.

	♂. millim.	♀. millim.
Total length	235	160
Head	29	22
Width of head	28	22
Body	81	63
Fore limb	53	40
Hind limb	72	54
Tail	125	75

A. brachyura differs from *A. hispida* principally in the fourth toe not being shorter than the third and in the absence of strong keels on the ventral scales.

8. AGAMA ARMATA Peters.

Hluhluwe Stream.

9. AGAMA ATRA Daud.

Klipfontein.

Both *A. micropholis* Matschie (Zool. Jahrb., Syst. v. 1890, p. 607), and *A. microterolepis* Blgr. (Ann. & Mag. N. H. [6] xvii. 1896, p. 22), from the Transvaal, must be added to the synonymy of this species.

10. ZONURUS POLYZONUS A. Smith.

Port Nolloth, Klipfontein.

11. PSEUDOCORDYLUS MICROLEPIDOTUS Cuv.

Wakkerstroom.

12. CHAMESAURA ANGUINA L.

Umfolosi Station.

13. VARANUS ALBIGULARIS Daud.

Umfolosi Station.

14. *VARANUS NILOTICUS* L.

Ngoye Hills, Sibudeni, Jususie Valley.

15. *NUCRAS TESSELLATA* A. Smith.

Klipfontein.

16. *NUCRAS DELALANDII* M.-Edw.

Sibudeni.

17. *ICHNOTROPIS CAPENSIS* A. Smith.

Umfolosi Station.

The parietal shields sometimes form a short suture separating the interparietal from the occipital. The scales on the preanal region are much smaller in females than in males.

18. *SCAPTIRA KNOXII* M.-Edw.

Port Nolloth.

19. *SCAPTIRA CTENODACTYLA* A. Smith.

Port Nolloth.

The femoral pores may number as many as 36 on each side.

20. *MABUIA TRIVITTATA* Cuv.

Wakkerstroom.

21. *MABUIA VARIA* Peters.

Klipfontein, Umfolosi Station.

22. *MABUIA STRIATA* Peters.

Hluhluwe Stream, Umfolosi Station, Sibudeni, Ngoye Hills, Zuurbron, Wakkerstroom.

23. *MABUIA SULCATA* Peters.

Klipfontein.

24. *SCELOTES BIPES* L.

Durban Road.

25. *ACONTIAS LINEATUS* Peters.

Port Nolloth, Klipfontein.

RHIPTOGLOSSA.

26. *CHAMELEON QUILENSIS* Bocage.

Jususie Valley.

27. *CHAMELEON VENTRALIS* Gray.

Port Nolloth.

OPHIDIA.

28. *PYTHON SEBÆ* Gm.
Umfolosi Station.
29. *ABLABOPHIS RUFULUS* Licht.
Sibudeni.
30. *PSEUDASPIS CANA* L.
Wakkerstroom.
31. *DASYPELTIS SCABRA* L.
Ngoye Hills.
Uniform brown (var. *palmarum* Leach). 23 scales across the body. Ventrals 218; caudals 75.
32. *AMPLORHINUS MULTIMACULATUS* A. Smith.
Wakkerstroom.
Uniform green, without spots, as in the specimens presented by Dr. Quain and mentioned in the British Museum Catalogue (iii. p. 125). Ventrals 138; caudals 76.
33. *TRIMERORHINUS RHOMBEATUS* L.
Durban Road, Wakkerstroom, Klipfontein.
34. *PSAMMOPHIS SIBILANS* L.
Umfolosi Station.
The single specimen falls under Division F of the British Museum Catalogue (iii. p. 163). Ventrals 165; caudals 97.
35. *DISPHOLIDUS TYPUS* A. Smith.
Sibudeni.
Green, the scales edged with black (Division D of British Museum Catalogue, iii. p. 189). Scales in 19 rows. Ventrals 174; caudals 119.
36. *ASPIDELAPS LUBRICUS* Laur.
Klipfontein.
37. *DENDRASPIS ANGUSTICEPS* A. Smith.
Ngoye Hills.
38. *BITIS ARIETANS* MEY.
Umfolosi Station, Hluhluwe Stream.
39. *BITIS CORNUTA* Daud.
Port Nolloth, Klipfontein.
40. *BITIS CAUDALIS* A. Smith.
Port Nolloth.

5. Some Notes upon the Anatomy of the Yellow-throated Lizard, *Gerrhosaurus flavigularis*. By F. E. BEDDARD, F.R.S., Prosector to the Society.

[Received May 17, 1905.]

(Text-figures 33-38.)

Apart from osteology* and a few scattered notes, which will be referred to in the course of the present communication, there does not appear to be a great deal known about the internal structure of *Gerrhosaurus*. Inasmuch as this Lizard is regarded, from the point of view of external characters and osteology, as being exactly intermediate between the Lacertidæ and Scincidæ †, it seemed to me interesting to attempt a criticism or confirmation of this view, while recording any new facts which an investigation of *Gerrhosaurus flavigularis* might bring to light.

Jugal Ligament.

Many, but not all, of the Lacertilia possess, as is well known, a jugal ligament, which Huxley compared to the bony lower temporal arcade of *Hatteria*. The exact relationships of this ligament have not, I believe, been described in some of the Lizards in which I shall now proceed to detail the arrangement.

It is possible to recognise several stages in the conditions of the jugal ligament, which may represent evolutionary stages, though it is, of course, not implied that the genera to be mentioned are genetically connected in the order named.

In *Iguana tuberculata* the ligament as a distinct structure is totally absent. On cutting through the skin covering the "cheek," the muscles and bones of this region of the skull are at once arrived at. It appeared to me, however, that the subcutaneous connective tissue, which is dense and white in most parts of the body, was rather denser and whiter in the region where the jugal ligament would be were it present. It is possible, in fact, that in this lizard an early stage is met with—that the ligament is not yet differentiated from the general connective tissue of the skin. On the other hand, it cannot be denied that the same fact may be explained on the theory that the ligament has disappeared. In any case, *Gerrhosaurus* offers an intermediate condition. In this reptile the ligament in question is anchored firmly to the quadrate behind, but in front it is not attached to the jugal bone but to one of the bony scales which cover the face in this region. That is to say, the ligament has not as yet completely detached itself from the skin. So, at any rate, the facts seem to indicate. It is important to notice in connection with the main object of the present communication, viz., to attempt to fix the systematic

* Siebenrock, Ann. k. nat. Hofmus. Wien, vii. 1892.

† Boulenger, Cat. of Lizards.

position of *Gerrhosaurus*, that this lizard agrees absolutely and in every detail, so far as the jugal ligament is concerned, with the skink *Eumeces*.

The final stage in the arrangement of the jugal ligament is shown in *Physignathus*. In this lizard the ligament is attached firmly to the bones at either extremity, and has entirely lost its presumably original connection with the skin. Moreover, in the last-named lizard, the ligament is divisible into two regions. There is, first of all, a stronger narrow ligament which occupies exactly the position of the bony quadrato-jugal bar in *Hatteria*, and above this and in part overlapped by it is a thinner but still stout sheet of ligament which entirely fills up the temporal vacuity.

This state of affairs does not exist at all in *Gerrhosaurus* and *Eumeces*. It is distinctly suggestive of the complete obliteration of the lower temporal vacuity in certain Vertebrates.

In view of the fact that bones in some cases can be shown to degenerate into ligaments, it is not certain that the stages sketched out above may not be read in the inverse order. For example, the lower part of the fibula is ligamentous in Birds; but it is not to be assumed that here there is anything but a degeneration of the bone into ligament. The facts which have been detailed above concerning certain Lizards do not, however, appear to me to point to a reduction from a state of affairs such as is found in *Hatteria*. If we were only acquainted with the condition observable in *Physignathus* and *Iguana*, such a view might indeed be held. The bone, it would be urged, has degenerated into ligament in the one case, and has finally disappeared in the other. But the conditions to be seen in *Gerrhosaurus* and in *Eumeces* would seem to negative such a supposition.

Peritoneal Folds and Cœlom.

Although the suspension of the alimentary tract and the other viscera contained in the cœlom is broadly like that of many other Lacertilia, there are some differences of detail which require attention.

In the female example the line of attachment of the oviducal membrane, which diverges laterally on each side, marks off sharply the posterior pigmented area of the cœlomic membrane from the anterior non-pigmented or less pigmented area. This is quite a common and well-known arrangement among the Lacertilia. The reason why I bring the matter forward here, is that *Gerrhosaurus* differs from *Eumeces*, where there is no such differentiation of pigmented and non-pigmented areas*, and because the pig-

* This is not, however, a distinctive mark of difference from the Scincidæ and of likeness to *Lacerta*. *Lacerta* shows this sharp demarcation; but there are varying degrees among the Scincidæ. In *Eumeces* there is hardly any pigmentation; in *Tiliqua scincoides* there is a moderate amount, but evenly spread through the body-cavity (in a male). In *Macroscoincus cocteauii* (female), however, the oviducal membrane marks off two areas; but the posterior area is not so deeply pigmented as in *Gerrhosaurus*.

mented area in the male *Gerrhosaurus* is distinctly greater than in the female example of that lizard, and there is no conspicuous fold of membrane continued forward from the gonad duct to serve as a demarcation between the two areas in the latter.

The *suspensory ligaments of the liver* offer, as is well known, characteristic differences of arrangement in various Lacertilia. In both examples of *Gerrhosaurus* the falciform ligament of the liver is double posteriorly for about the last $\frac{1}{4}$ of the total length of the liver. This double region of the umbilical or falciform ligament is a tent-like structure; that is, the two separate membranes converge ventrally to be inserted in common on to the ventral median line of the parietes. A partial duplication of the umbilical ligament of this kind is not uncommon in the Lacertilia. It occurs, for example, in *Lacerta ocellata*. The double condition of the umbilical ligament in the Scincidae, originally discovered by John Hunter* and subsequently more fully dealt with by myself† and Prof. Cope‡, seems to be merely an exaggeration of this, the union of the two, posteriorly separate, umbilical ligaments being deferred until at or near the anterior extremity of the liver. Furthermore, all of the members of the family Scincidae are not thus characterised; for in *Macroscincus cocteauii* the arrangement of the umbilical ligament is much like that of *Gerrhosaurus*. In the question of affinity, therefore, the disposition of these mesenteries is not decisive. There are, however, one or two other points to be noted. In the first place, in *Eumeces algeriensis* both the umbilical ligaments are thickly invaded by muscular tissue, especially the left-hand ligament. This is also noticeable in *Macroscincus*, though to a much less extent; and it will be remembered that *Macroscincus cocteauii* is a much larger lizard than is *Eumeces algeriensis*, so that size in this case has nothing to do with the development of thickness and muscularity in the umbilical ligaments. It is plainly therefore of importance to note that in *Gerrhosaurus* these ligaments are not obviously muscular at all.

In the accompanying figures (text-figs. 33, 34) of the ventral surface of the liver in *Gerrhosaurus* two other facts may be pointed out. In the first place, there are traces of a membrane which runs obliquely forward and ends in a notch in the left border of the liver. As this white seam (*b* in text-figs. 33, 34) is much better developed in one example than in the other, I take it to represent a rudimentary structure, and it may represent the original course of the umbilical vein and thus correspond to a similar trace which Hochstetter has lately described § in the Blind Worm (*Anguis fragilis*).

* Essays and Observations, revised by Richard Owen, London, 1861, vol. ii. p. 369. "The liver [of *Tiliqua*] is attached forwards by two membranes, one to each lobe, which unite at top."

† P. Z. S. 1888, p. 98.

‡ Proc. Acad. Sci. Philadelphia, 1896, p. 308.

§ Morph. Jahrb. xix. Taf. xvi. fig. 18; but the course of the seam is different in the two cases.

The second point concerns the relationship of the two umbilical ligaments to veins entering the liver. A dissection of both specimens of *Gerrhosaurus* shows that the anterior abdominal vein enters the liver in the region of the left umbilical ligament (*c* in text-figs. 33, 34), and that the epigastric vein is similarly connected with the right umbilical ligament. Precisely the same relationship holds for *Macrosцинus cocteani*. Inasmuch as the anterior abdominal vein joins the portal vein, the latter might

Text-fig. 33.

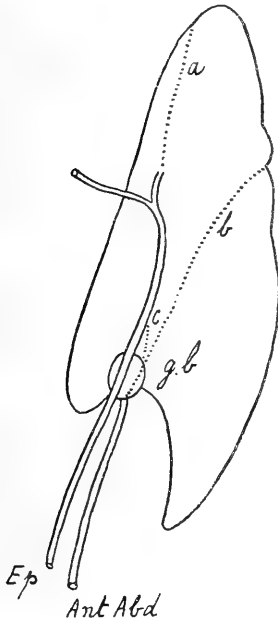

Text-fig. 34.

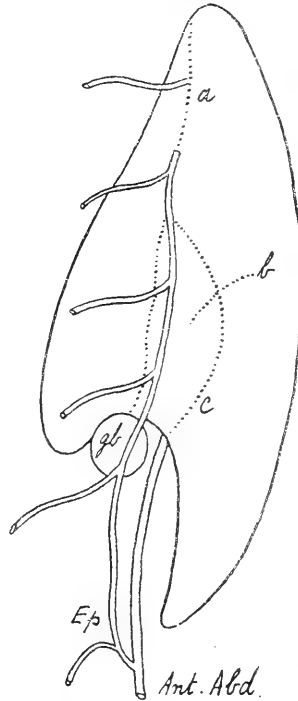
Text-fig. 33.—Liver of *Gerrhosaurus flavigularis*, ventral aspect.

a. Attachment of umbilical ligament; *b.* Seam indicating course of embryonic umbilical vein (?); *c.* Left half of umbilical ligament; *Ant. Abd.* Anterior abdominal vein; *Ep.* Epigastric vein; *g.b.* Gall-bladder.

Text-fig. 34.—Liver of a second example of *Gerrhosaurus flavigularis*, ventral aspect. Lettering as in text-fig. 33.

be regarded as fixing this point were it not for the conditions observable in *Macrosцинus cocteani*. In that lizard the portal vein, immediately in front of the region where it has, as have the portal veins of other lizards, a spiral twist, divides into two branches, which enter the liver in a line with each part of the divided umbilical ligament. As to the relationship between the divided

umbilical ligaments and blood-vessels, it is noteworthy that in *Eumeces algeriensis* two hepatic arteries are associated each with one of the two umbilical ligaments of that lizard.

Gastrosplenic Omentum.—This mesentery is very conspicuous in *Gerrhosaurus*. It stands out as a free fold with the following relations:—It arises from the stomach close to the pylorus and passes obliquely downwards supporting the posterior extremity of the spleen, the rest of which lies upon the mesogastrium; it is finally attached to the median dorsal line of the body-wall on a level with the left ovary.

This arrangement is practically repeated in *Macrosцинus*, where, however, owing to the position of the viscera, the omentum is shorter, but very strong and fibrous. Moreover the spleen does not even reach, let alone hang over, the edge, as is the case with *Gerrhosaurus*. In *Eumeces*, however, the gastrosplenic omentum is identical in its relations with that of *Gerrhosaurus*, save that it is a little less pronounced as a free fold. I am not describing here a state of affairs which is merely Lacertilian; for in *Tupinambis* the course and relations of the apparently homologous fold are different and do not involve the spleen.

Hepato-pulmonary Ligaments.—*Gerrhosaurus* agrees with the majority of Lizards in that the right lung is suspended by two mesenteries, viz., the hepato-pulmonary and dorsal pulmonary. It is noteworthy that the latter mesentery in the case of both lungs extends to the very tip of the organ; whereas in *Eumeces* the mesenteries in question do not reach the extremity of the lungs. This is not, however, a characteristic of the Skinks as opposed to *Gerrhosaurus*, for in *Tiliqua* the membrane is co-extensive with each lung as in *Gerrhosaurus*. Mr. Butler* observes that "certain Scincoid lizards are as to the relations of their right lungs and liver intermediate between the Teiidae and other Lizards." My own knowledge of the family Scincoidæ enables me to confirm Mr. Butler; but his accurate statement requires expansion †. In *Eumeces*, *Macrosцинus*, and *Tiliqua* there is, in fact, attached to the right lung a pulmo-hepatic ligament which is not so extensive as in, e. g., *Gerrhosaurus*.

In *Macrosцинus cocteaui* this membrane extends rather more than halfway down the lung and ends off upon the dorsal pulmonary ligament, necessarily running in this region in a direction nearly at right angles to the longitudinal axis of the lung. Whereas in *Gerrhosaurus flavigularis* the two pulmonary membranes join behind the right lung ‡, in both specimens which I examined.

The fact that there is no ligamentous interval between the

* "On the Subdivision of the Body-cavity in Snakes," P. Z. S. 1892, p. 481.

† And has also been expanded by Hochstetter quoted below.

‡ Hochstetter (Morph. Jahrb. xxvii. p. 292) figures the same membranes in some other Skinks, where they appear to agree with those of the forms studied by myself. He says, however, of *Gerrhosaurus madagascariensis* that the "caudal end of the right lung commences to be isolated from the ligamentum hepato-cavo-pulmonale." It is not so in *G. flavigularis*.

prolonged right lobe of the liver and the gonad, both male and female, does not bear upon the question of the affinities of *Gerrhosaurus*. For among the Skinks these organs may be in contact or separated by a ligamentous interval.

Muscular fibres in Mesenteries.—As is the case with other Saurians, *Gerrhosaurus* has bands of unstriped muscle in several of the mesenteries. The most important of these is a bundle of muscular fibres which accompanies the anterior abdominal vein (text-fig. 35, *m*) and runs into the gastro-hepatic ligament. It is a thick bundle of fibres, but after traversing the gastro-hepatic ligament for about half its extent it fans out into a fine bundle, the individual fibres of which hardly reach the stomach. This bundle is represented in many lizards. But the conditions observable in *Gerrhosaurus* throw no light upon the affinities of

Text fig. 35.

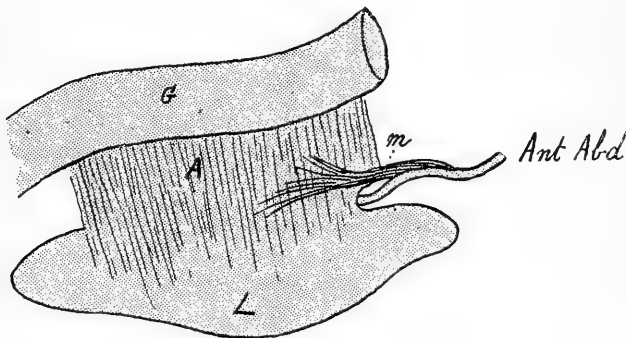

Gastro-hepatic ligament of *Gerrhosaurus flavigularis*, showing course of muscular bundle.

A. Gastro-hepatic ligament; *Ant. Abd.* Anterior abdominal vein; G. Stomach; L. Left lobe of liver; *m*. Muscular band.

that lizard. For though it differs from the arrangement found in the Scincidæ, it shows no likeness to what is found in *Lacerta ocellata*. In *Eumeces*, *Macroscincus*, and *Lacerta ocellata* the bundle of fibres is continued without fanning out to the stomach, where it forms a close investment of that organ for the greater part of its extent in *Macroscincus*. Inasmuch as both specimens of *Gerrhosaurus* were identical in the characters of this muscle, it may, I think, be assumed that its condition is typical of the species.

Pancreas.—The pancreas of *Gerrhosaurus* (text-fig. 36, p. 262) differs from that of *Lacerta ocellata* in the comparative stoutness of the branch which goes to the spleen. It is, in fact, like Leydig's figure of the pancreas of *Lacerta agilis*, expanding when it reaches the spleen. The pancreas of *Gerrhosaurus* furthermore differs from that of *Lacerta* (at any rate *ocellata*) in that there is a

patch of the gland on the dorsal side of the pyloric angle from which the splenic limb arises, and which is continuous beneath the end of the stomach with the main body of the pancreas. In *Lacerta ocellata* the splenic limb arises from the main lobe of the pancreas further towards the gall-bladder. In these points the

Text-fig. 36.

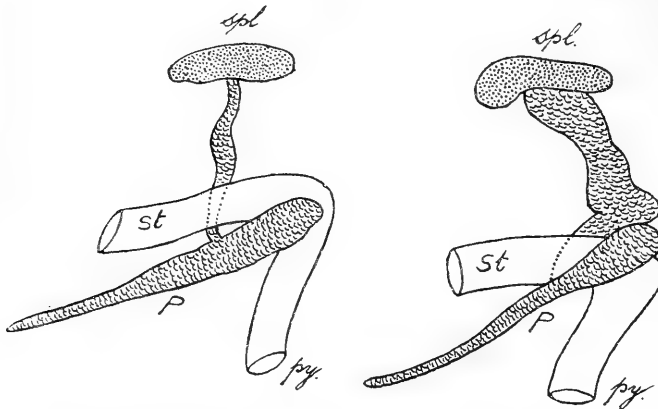

Pancreas of *Lacerta ocellata* (left-hand figure) and of *Gerrhosaurus flavigularis* (right-hand figure).

P. Pancreas; *py.* Commencement of intestine; *spl.* Spleen; *St.* Stomach.

pancreas of *Gerrhosaurus* agrees with that of the Skinks, in which, however, there is a tendency towards an enlargement of the dorsal lobe of the pancreas and a disappearance of the splenic lobe. I could not detect the latter in *Macrosclincus*, and it was very thin in *Tiliqua*.

Arterial System.

As one of the two specimens of *Gerrhosaurus flavigularis* which I have dissected was successfully injected, I am able to give some account of the arterial system, dealing particularly with those points which vary among the families of *Lacertilia*. The heart has the usual, but not universal, tag tying the apex of the ventricle to the pericardium. The pericardium extends forward beyond the trifurcation of the arteria innominata.

A pair of arteries exist of very fair size, running one on each side of the trachea in the position occupied by the carotids in many Vertebrates, and they are like them quite close to the trachea. These arteries have, however, nothing whatever to do with the carotids. They are branches of the pulmonary arteries (*P*, text-fig. 37), and the existence of these arteries in what appears to be an unexpected place is possibly indicative of a former forward extension of lung-tissue.

The branches of the carotid arch differ slightly from those of

some other Lizards, though they agree, as might be expected, in their main features. The first branch given off is a hyoid (*hy*, text-fig. 37), which supplies the hyoid region generally; I have not followed its branches minutely. In this region the carotid is in close contact with the systemic arch. Further dorsally they part company, and, shortly after this separation has occurred, the

Text-fig. 37.

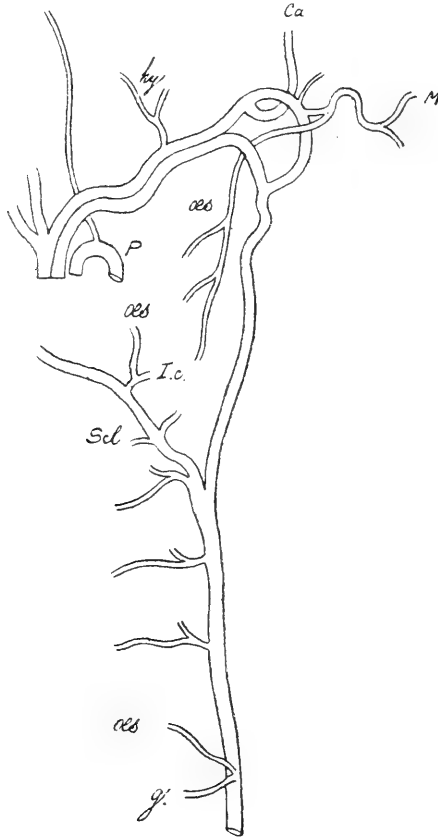
Aortic arches and first part of dorsal aorta of *Gerrhosaurus flavigularis*.

Ca. Carotid; *g.* Gastric; *I.c.* Vertebral artery; *hy.* Hyoid artery; *M.* Muscular twig; *oes.* Esophageal branches; *P.* Pulmonary arch; *Scl.* Subclavian.

main trunk of the carotid arises. The trunks are here so twisted that the carotid stem is given off posteriorly and dives under the carotid arch to reappear on its anterior face. The rest of the carotid arch is to be regarded as ductus Botalli. From this section arise two arteries: the first is a small muscular twig; the

second is an important trunk which divides into two branches. One of these supplies the muscles of the shoulder-region (*M*); the

Text-fig. 38.

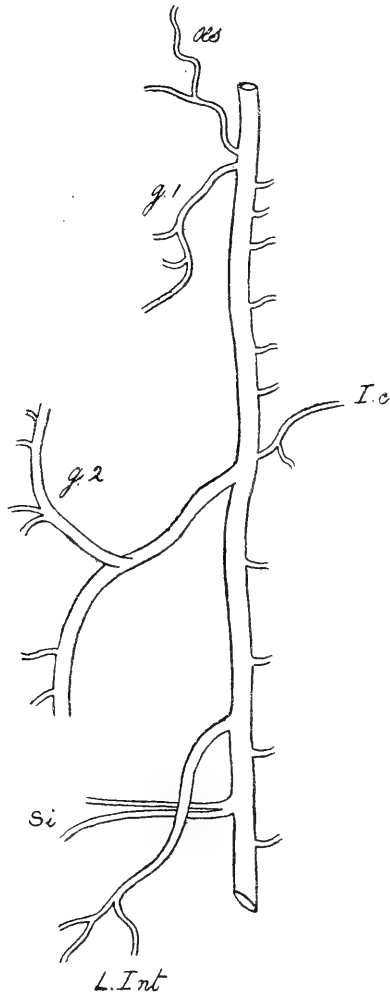

Abdominal region of aorta of *Gerrhosaurus flavigularis*.

*g*¹, *g*². Gastric arteries; *I.c*. Intercostals; *L.Int*. Artery of large intestine;
æs. Oesophageal artery; *Si*. Artery of small intestine.

other has a recurrent course and dives through the ring formed by the carotid and systemic arches to supply the oesophagus (*æs*).

The left systemic arch gives off no branches at all that I could discover.

From the *right systemic arch* (which joins the left at about the commencement of the lung) the two *subclavians* (text-fig. 37, *Sol.*, p. 263) are given off, nearly, if not exactly, opposite to each other. In front of this arises the *vertebral artery* (*I.c.*), which gives off an œsophageal branch before plunging into the thickness of the parietes. Behind the vertebral artery commences the series of intercostals. The first *intercostal artery* arises just before the junction of the two aortæ. It gives off a branch to the œsophagus. The next two intercostals have also œsophageal branches; but it is to be noted that in all these the right intercostal alone has this œsophageal branch. The left has none. The remaining intercostals have no œsophageal or gastric branches. Their arrangement is peculiar and agrees with that of the Skinks; it differs from that of some other Lizards.

In *Tropidurus hispidus*, for example, the regularly paired intercostals emerge from the dorsal aorta close to the articulation of successive vertebræ, and plunge at once into the thickness of the parietes.

In *Gerrhosaurus* the intercostal arteries emerge from the aorta at about the middle of each vertebra. In many cases, and the arrangement is roughly alternating, the intercostal of one or both sides divides at once into two branches; one of these plunges at once into the thickness of the parietes. The other passes obliquely forwards and runs superficially in close relation to a rib. This, however, only occurs in the thoracic region, not in the lumbar.

Precisely the same disposition of vessels is found in *Eumeces* and some other Skinks, and the fact is a bond of union between the Gerrhosauridæ and Scincidæ.

The next artery to arise from the aorta is a gastro-œsophageal (text-fig. 37, *œs, g*, p. 263, and text-fig. 38, *œs, g¹*, p. 264), which divides at once into a thin forwardly directed œsophageal, and a stout backwardly directed gastric. Between this and the large gastric artery (text-fig. 38, *g²*) are 6 pairs of intercostals. Two pairs intervene between this artery and that of the large intestine, and one pair between the latter and the artery of the small intestine.

The ovarian and oviducal arteries present some features which are worthy of note. There are three pairs of oviducal arteries which are not symmetrical. The first of these is really mainly an ovarian artery, which gives off a thin and slender oviducal branch running along the anterior section of the oviduct. The two remaining oviducal arteries arise in common with an intercostal. They lie in front of the rectal artery.

Venous System.

Although the venous system of neither of the examples at my disposal was injected, most of the veins were beautifully displayed by their own turgescence.

There are many differences in detail between the venous system of this lizard and that of other genera.

Vena cava posterior.—It is interesting to note that *Gerrhosaurus* agrees with *Tiliqua* in that the left vena cava posterior is very much thinner than the stout right vein. This is another of those numerous though individually perhaps small points of likeness between the genus whose anatomy is dealt with in the present communication and the Scincidae. As in *Tiliqua* also*, the left cava or vena renalis revehens lies to the left side of the mesorectum and the right vein to the right side of that mesentery. The left vena revehens is large where it receives the three or four veins arranged in a fan-like fashion from the left ovary; behind this point it dwindles immediately but can be easily traced to the kidney, where it becomes enlarged at its junction with the right vena renalis revehens.

The left vena renalis revehens receives two intercostal veins before the ovarian veins join it, and on the right side also I observed two intercostals. I could only observe one, and that a slender, oviducal vein joining the left vena renalis revehens. I feel convinced, however, that no veins from the oviducts join the afferent renal veins, as is often the case in Lizards. The reason for this in the present species may be that the kidneys are unusually far back.

Afferent Renal Veins.—The caudal vein reaches the kidneys as an undivided vein. It runs between them and receives a cloacal vein before dividing. Immediately after division each half receives another cloacal vein. The cloacal artery runs exactly at the point of division between the two afferent renals. At about the end of the first third of the kidney each renal afferent vein turns at right angles and runs superficially over the kidney, giving off a large branch to the kidney itself at about the middle of the transverse diameter of that organ. There is no sign of any forward continuation of the renal afferent vein beyond the anterior border of the kidney such as occurs in *Chameleon* and *Pygopus* †.

Where the renal afferent vein reaches the border of the hind leg it receives three veins, two from the hind limb and one from the median dorsal parietes. It there runs directly forwards parallel with the kidney, and on a level with the anterior end of that gland receives the femoral vein, and a small parietal on the opposite side which crosses the epigastric artery. The vein then continues its straight course forward, and before bending inwards and downwards to follow closely the inner margin of the fat-body gives off a short forwardly directed branch, which appears to me to be the equivalent of the lateral abdominal vein of other Lizards. Its shortness in *Gerrhosaurus* contrasts with its length in *Tiliqua*.

Hepatic Portal Veins.—The mode of entrance of the conjoined intestinal portal and anterior abdominal and of the epigastric vein

* See Beddard, P. Z. S. 1904, vol. i. p. 445, fig. 93.

† See P. Z. S. 1904, vol. ii. p. 15, fig. 4.

has already been noted. The epigastric springs from the anterior abdominal some way behind the liver (text-fig. 34, *Ep.*, p. 259), and running along the umbilical ligament disappears in the substance of the liver some way behind the anterior end. It is reinforced by the usual branches from the median ventral parietes. These vary in number in what appears to me to be a remarkable way. In one specimen repeated examination has only enabled me to ascertain the presence of a single *ventral parieto-hepatic* vessel, which joins the epigastric at about the middle of the liver. In a second specimen, on the other hand, there were four of these ventral parieto-hepatic vessels (*cf.* text-figs. 33 and 34, p. 259). I am disposed to think that the fluctuation in number of these blood-vessels is related to fluctuation in the number and size of the dorsal parieto-hepatic veins. These differed in the two specimens which I have dissected, though not quite to so great an extent as the ventral parieto-hepatic veins. In the specimen with but one ventral parieto-hepatic vein, the *dorsal parieto-hepatic* veins were as follows:—a large vein accompanies the anterior edge of a fold of membrane which in this, as in many lizards, runs obliquely and binds the end of the right lobe of the liver to the parietes. This vein runs superficially for a short distance anteriorly alongside the aorta on the right side, and is clearly a fragment of the right posterior cardinal. It reaches the parietes on a level with and outside of one intercostal artery and disappears from view to the inside of the next intercostal artery in front; it resembles a large superficially running intercostal vein. Besides this there are three other dorsal parieto-hepatic veins lying behind it. In the second specimen, with numerous ventral parieto-hepatic veins, I could find only three dorsal ones; and the first of these was by no means so large as in the first described individual.

I could find only one *gastro-hepatic portal*, which was anterior in position.

6. On two Points in the Anatomy of the Lacertilian Brain.

By F. E. BEDDARD, F.R.S., Prosector to the Society.

[Received May 17, 1905.]

(Text-figures 39 & 40.)

(1) *Note on the Cerebellum in Varanus exanthematicus.*

In the account of the Lacertilia in Bronn's 'Thierreichs' * the following statement is made concerning the cerebellum of *Varanus*:—"Das Cerebellum oder das Hinterhirn ist gewöhnlich ein unpaarer, dünner, steil und hoch aufsteigender Körper, der seitlich mit der Medulla oblongata fest zusammenhängt. Bei

* Bd. vi. p. 714.

manchen Gattungen, z. B., bei *Varanus*, *Iguana*, ist es nach den Angaben von Stannius zwar dünn, aber schildförmig, vorne concav, hinten convex und zeigt Andeutungen einer Sonderung in eine mittlere und zwei seitliche Erhabenheiten, durch sehr schwache Vorragungen, zwischen denen Spuren von Furchen liegen."

It seems plain from the above account that the cerebellum of *Varanus* is considered to be like that of *Iguana*, and, presumably, of other Lacertilia.

In one of the most recent works dealing with the brain of the Sauropsida, the Catalogue of the Museum of the College of Surgeons*, there is a description of the brain of *Varanus* and some incidental references to the brain in the Lacertilia. Of the brain of *Varanus* it is remarked that "the cerebellum is of moderate dimensions and has the plate-like form usual among Reptiles." Elsewhere (p. 110) it is said that "the reptilian brain is narrow . . . and, except in swimming forms, with insignificant cerebellum." I have examined this specimen myself and agree with the description. None of these statements, as I think, does justice to the cerebellum of *Varanus exanthematicus*, which is not at all like that of *Iguana*, has not a plate-like form, and is not insignificant—comparatively speaking, at any rate.

The accompanying figure shows the characteristics of the

Text-fig. 39.

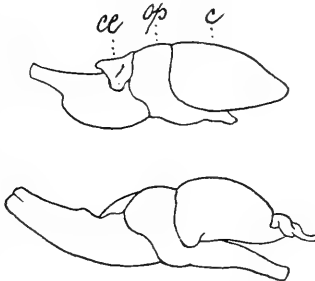

Text-fig. 39.—Lateral view of brain of *Varanus exanthematicus* (upper figure) and of *Tupinambis nigropunctatus* (lower figure).

Text-fig. 40.

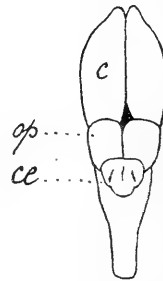

Text-fig. 40.—Dorsal view of brain of *Varanus exanthematicus*.
c. Cerebrum; ce. Cerebellum; op. Optic lobes.

cerebellum of the Teguxin Lizard (text-fig. 39), which appears to me to be quite typical of the Lacertilia and to bear out the above quoted statements. It is a plate-like disc convex posteriorly, which as it were lies up against the optic lobes and is propped up

* Descriptive and Illustrated Catalogue of the Physiological Series contained in the Museum of the Royal College of Surgeons of England, vol. ii. p. 113 (2nd ed.).

by them. It is faintly grooved in the middle line and laterally on each side is a flattened process extending backward rather beyond the rest of the cerebellum. Its insignificant proportions are shown by the fact that the transverse (antero-posterior) diameter of this thin plate is 2 mm., while the corresponding measurement of the optic lobe is 8 mm.

As will be seen from text-figs. 39, 40 (p. 268), the cerebellum of *Varanus exanthematicus* is a much more important structure. Not only the actual but the relative size of the cerebellum is greater. The corresponding measurements to those given above for *Tupinambis* are for *Varanus*—diameter of cerebellum 4.5 mm., diameter of optic lobes 4.5 mm. They are thus equal.

The difference in dimensions between the cerebella of the two *Lacertilia* is due to the exaggeration in *Varanus* of the boss-like eminence upon the cerebellum of *Tupinambis* and *Iguana*. Not only is the cerebellum of *Varanus exanthematicus* much greater in bulk than that of *Tupinambis* or *Iguana*, but it is more complicated in structure owing to furrows.

The dorsal furrow, continuous with that dividing from each other the corpora bigemina, is more deeply marked in *Varanus* and more definitely circumscribed than in *Tupinambis*; in *Iguana* I did not find any traces of it. In the second place, the cerebellum of *Varanus exanthematicus* has an equally deeply marked lateral furrow, which runs obliquely upwards and forwards. Thirdly, the lateral process of the cerebellum is much more sharply marked off from the cerebellum itself than in *Tupinambis*, and runs downwards rather than backwards, thus distinctly suggesting the flocculus in the cerebellum of the higher forms. It is, indeed, not at all unlike the cerebellar flocculus in Alligator.

It is plain therefore that the cerebellum of this Lizard is not "a mere transverse plate," but an organ of some dimensions, and, indeed, not very far, in point of relative size, from that of the *Crocodylia*.

A large cerebellum has been associated in reptiles with the swimming habit. And it is true that the Monitor Lizards are often largely aquatic in habit. Curiously enough, however, the present species, with its large cerebellum, is stated by Dr. Günther* not to take to the water.

More likely, as it appears to me, is this advance in structural complexity of the brain to be associated with the not only isolated but high position which the Monitors occupy among the *Lacertilia*.

(2) *On the Cerebral Hemispheres in Tropidurus hispidus.*

I imagine that I am right in believing that the brain of this Iguanoid Lizard has not up to the present been submitted to anatomical examination. I am able, therefore, to add a fact of

* "On the Anatomy of *Regenia ocellata*," P. Z. S. 1861, p. 60.

some little interest to what is already known about the Lacertilian brain, as a result of the examination of two brains of this Lizard. In the Lacertilian brain generally, so far as my own knowledge and the inspection of published figures* enable me to state, the optic lobes lie behind the cerebral hemispheres, the furrow between them being practically vertical; there is, in fact, no trace of an overlap of the corpora bigemina by the hemispheres. In the *Chelonia*, on the other hand, it has been recognised that some forms show an overlap of the corpora bigemina by the cerebral hemispheres.

I have found this lobe very obvious in a brain of the large *Testudo vicina*, the vascular system of which I have recently described †. The overlap, however, is lateral and not dorsal. It is quite different with *Tropidurus*. There is a very distinct overlap of the corpora bigemina by the hemispheres dorsally. The corpora bigemina are thus partly hidden when the entire brain is viewed on the dorsal aspect.

A comparison of the measurements of the brain in this species and in *Iguana tuberculata* seems to throw some light upon the causation of this overgrowth of the cerebral hemispheres over the corpora bigemina dorsally.

The following are the measurements to which I desire to refer:—

	<i>Iguana.</i> <i>Tropidurus.</i>	
	mm.	mm.
Length of brain to end of cerebellum ...	16	11
Length of cerebral hemispheres	9	6
Breadth of cerebral hemispheres	11·5	6·5

It will be observed, from a comparison of these figures, that the proportions between the total length of the brain in the two Lizards, and both the breadth and length of the cerebral hemispheres, are about equal. It therefore results that the overlap of the hemispheres in *Tropidurus* is rendered necessary by the skull formation and consequent lack of room for increased lateral growth of the hemispheres. By growing over the corpora bigemina, the hemispheres have been able to attain to the proper size necessary to the equilibrium of their possessor.

These considerations may be regarded, perhaps, as discounting the morphological importance of the partial covering over of the corpora bigemina by an extension backwards of the cerebral hemispheres.

Nevertheless, it is impossible to overlook the fact that there is an approximation in the brain of this Lizard, to whatever cause it may be due, to those of higher Vertebrates.

* See Bronn's Klassen u. Ordnungen des Thierreichs, Bd. vi., and Meyer, Zeitschr. wiss. Zool., Bd. lv. (1893).

† *Suprà*, p. 67.

7. On new Coleoptera from South Africa collected by Dr. H. Brauns and others—*Serricornia*, *Endomychida*, *Erotylidæ*. By H. S. GORHAM, F.Z.S.

[Received May 19, 1905.]

This paper is a sequel to those published by me in the 'Annals and Magazine of Natural History' for 1900–1901. The material dealt with is similar in character to that contained in the collections sent to me by Mr. G. A. K. Marshall, but is without Coccinellidæ or Languriidæ. The publication of the paper has unfortunately been much delayed, owing to domestic reasons.

The Cleridæ are particularly well represented and indicate a very rich fauna in this subfamily as well as in the Melyridæ. *Hedybius* represents the European *Malachius*, and is evidently (with its allied genera) as rich in species.

TELEPHORIDÆ.

TELEPHORUS VIRIDESCENS Fab.

Telephorus viridescens Fab. Syst. Eleuth. i. p. 295 (*Cantharis*).

Hab. Willowmore, Uitenhage, Cape Colony (*Brauns*).

In the Munich Catalogue this species is given as a synonym of *Cantharis smaragdulus* Fab. Spec. Ins. p. 259, a Brazilian insect; but Fabr. *loc. cit.* gives "Cap bon. spei" as the locality of the *Cantharis viridescens*, with which my specimens agree very well.

TELEPHORUS INCISUS Wied. Zool. Mag. ii. p. 71.

Hab. Algoa Bay, Cape Colony (*Brauns*). 2 examples.

Smaller than *T. viridescens*, with a thoracic vitta from the front to the hind margin and without spots on the sides or at the base; elytra less green, of a dull grey-black.

TELEPHORUS ZONATUS Gemm. Cat. Col. p. 1674.

Telephorus vitticollis Bohem. Ins. Caffr. i. 2, p. 453, nec Ménétr. Cat. Rais. p. 162.

Hab. Algoa Bay, Cape Colony (*Brauns*). 1 example.

Described by Bohem. *loc. cit.* from "Limpopo" R., Caffraria.

TELEPHORUS BIVITTATUS Fab.

Nec *T. bivittatus* Mars.

Hab. Algoa Bay, Cape Colony (*Brauns*). 1 example.

TELEPHORUS NIGRINUS Bohem. Ins. Caffr. i. 2, p. 457 (*Cantharis*)?

Hab. Algoa Bay, Cape Colony (*Brauns*). 2 examples.

In one of the two examples sent the thorax is nearly twice as long as long in the other example (which, from the length of its antennæ, appears to be a male) it is quadrate. This seems to me to agree with the insect described by me (Ann. & Mag. N. H. 1901,

vii. p. 351) as *T. teter* from Natal. From so few examples it is impossible to say whether these two pertain to one or two species; or what is the sex of the specimen with transverse thorax, which is also more shining and has shorter antennæ. I incline to the belief that they represent two species, the latter being referable to *C. nigrina* Bohem.

CLERIDÆ.

EUCYMATODERA Schenkling.

Eucymatodera Schenkling, Ann. Mus. Civ. Genova, 1899, p. 333; Genera Ins. fasc. xiii. p. 19 (1903).

EUCYMATODERA CINGULATA Klug, Cler. p. 273 (*Tillus cingulatus*).
Hab. Algoa Bay.

EUCYMATODERA HOTTENTOTA Knw. Ann. Soc. Ent. Belg. p. 463 (1893); Schenk. *l. c.* p. 20.

Hab. Willowmore, Cape Colony (*Brauns*).

CYLIDRUS Lat.

Cylidrus Schenk. Genera Ins. fasc. xiii. p. 5.

CYLIDRUS BALTEATUS Klug, Cler. p. 263.

Hab. Bothaville, Orange R. State (*Brauns*).

I had not seen this from S. Africa before.

GYPONYX Gorham.

Gyponyx Gorham, Ann. Mus. Civ. Gen. 1883, p. 604; Schenk. *l. c.* p. 45.

GYPONYX CHINENSIS Fab.

Gyponyx marmoratus Klug, Cler. p. 308 (*Clerus*), notâ p. 379.

Hab. Bothaville, Orange R. State (*Brauns*).

GYPONYX RETROCINCTUS Chev. Rev. Mag. Zool. p. 283 (1874).

Hab. Sunday River, Cape Colony (*Brauns*).

GYPONYX ALGOENSIS, sp. n.

Oblongus, subparallelus, piceo-brunneus, nitidus; elytris basi dilutioribus, ultra medium fascia undulata et apice albis. Capite crebre prothorace parce punctatis, hoc pernitido, antice tenuiter constricto, postice coarctato; antennis et palpis rufopiceis; elytris usque ad fasciam grosse seriatim punctatis, inde ad apicem fere levibus; pedibus piceis, tarsis dilutioribus, metasterno punctato. Long. 11-14 millim.

Hab. Algoa Bay (*H. Brauns*).

The general colour of this species is dark pitchy brown, the antennæ, palpi, tarsi, and the base of the elytra nearly as far as the white fascia are rufopiceous, the elytra are blackish in an

indefinite way just before the very definite white fascia; this is narrowly interrupted at the suture; the apex is white, but with a fine blackish margin; the space between the fascia and the apex is very obsoletely punctured, as is the fascia, almost smooth externally. The eyes, head, legs, and body generally are clothed with long but fine hairs.

One example of this insect received long ago from Dr. Baden is in my collection, but had, unfortunately, no precise locality. It is the larger specimen.

GYPONYX BRAUNSI, sp. n.

Elongatus, nigro-piceus; ore, antennis palpisque, thoracis margine antico, corpore subtus, pedibus (geniculis tibiisque exceptis) dilutioribus, rufo-piceis. Elytris basi indeterminate, fascia mediana (in marginem latissima postice bidentata) maculaque apicali obliqua testaceis. Thorace elongato, antice tenuiter, ad basin fortius constricto; elytris ad basin punctato-lineatis, seriebus vix ad medium vectis, externe deficientibus. Long. 13 millim.

Hab. Willowmore, Cape Colony (*Brauns*).

This species differs from any other known to me by its elongate thorax and its comparatively smooth and shining appearance, and also by the clear and distinct coloration and pattern of the elytra. The colour of the body, with the exception of the head and thorax, of the tips of the femora, and bases of the tibiæ, is a bright rusty red. The elytra have an oblique broad fascia, much indented, running backwards from below the callus to the suture, of a pitchy colour; a much broader patch before the apex of a lighter pitchy brown, deeply indented twice on its upper edge, and once on its lower edge, so that it is narrowest in the middle. The lines of punctures scarcely pass the first brown fascia, only four or five punctures being on the yellow median wide patch. The thorax is nearly twice as long as wide, its front margin is rufous, the sides very little widened, not deeply constricted in front, the base coarctate and margined, the punctuation close and fine, the disk a little flat. I have at present only seen the example described, which I have pleasure in naming after its captor, Dr. H. Brauns.

GRAPTOCLERUS GORH.

Graptoclerus Gorh. Ann. & Mag. N. Hist. ser. 7, vii. p. 351 (1901); Schenk. *l. c.* p. 48, nota.

GRAPTOCLERUS QUADRIPUNCTATUS Gorh. *l. c.* p. 353.

Hab. Grahamstown, Cape Colony (*Dunkerbosh, Dr. Penther*). Described by me from Natal. 1 example.

TARSOSTENUS SPINOLA.

TARSOSTENUS UNIVITTATUS ROSSI.

Hab. Willowmore (*Brauns*).

DOZOCOLLETUS Chevz.

Dozocolletus Schenk. *l. c.* p. 38.

Pezoporus Klug, *Clerii*, p. 311.

DOZOCOLLETUS BRUNNEUS Hintz, *Deuts. ent. Zeit.* 1902, p. 397 ?

Hab. Willowmore, Algoa Bay (*Brauns*). Bothaville, Orange R. Colony.

I have not seen Hintz's description, but I have little doubt that the insect taken in some numbers by Dr. Brauns is to be referred to it. This species has a large head, the thorax as wide in front as the head, the head and thorax deep pitchy brown, the elytra, legs, and body light brown, the punctuation and striæ are obsolete.

DOZOCOLLETUS SORDIDUS, sp. n.

Saturate brunneus; antennis palpisque rufo-brunneis, illis quam caput et thorax brevioribus, articulis quarto ad octavum quadratis, tribus ultimis transversis, apice compresso; capite prothoraceque creberrime confluentem, elytris fortiter striatopunctatis, femoribus clavatis. Long. 5 millim.

Hab. Algoa Bay (*Brauns*).

Smaller than the species which I have assumed to be *D. brunneus* Hintz, and especially to be distinguished from it by the shorter antennæ, which have much shorter joints; the second and third joints are a little longer than wide; the fourth to the eighth are about as long as wide, while the last three joints form a compact club and are transverse. The eyes are more prominent than in *D. brunneus*, the femora are strongly clavate. The thorax is as wide as the head in front, much narrowed to its base, obconic; the elytra small in proportion, elongate-ovate.

THRIOCERA Gorham.

Thriocera Gorham, *Trans. Ent. Soc. Lond.* 1878, p. 156; Schenk. *l. c.* p. 117.

THRIOCERA PECTORALIS Klug, *Clerii*, p. 348.

α. Elytris unicoloribus fascia mediana plicata.

Hab. Algoa Bay, Port Elizabeth (*Brauns*).

β. Elytris basi rufis.

Hab. Algoa Bay, Port Elizabeth (*Brauns*).

THRIOCERA BICINCTELLA, sp. n.

Nigra, nitida, tenuiter pubescens; antennis, palpis pedibusque rufo-brunneis, illis basi dilutioribus; prothorace brevi, antice tenuiter constricto, postice coarctato, lateribus rotundatis, disco inaequali impresso; elytris sublevibus, fasciis duabus elevatis, eburatis, ad suturam interruptis, anteriore (juxta callum) intus abbreviatis. Long. 5 millim.

Hab. Algoa Bay (*Brauns*).

Var., *capite, antennis, palpis, elytris usque ad fasciam posteriorem, corpore subtus cum pedibus rufo-ferrugineis.*

Hab. Port Elizabeth, Cape Colony (*Brauns*).

Antennæ as in *T. pectoralis*, but less robust, the two basal joints stout, the intermediate joints longer than wide, the three apical forming a lax club. The thorax is notably shorter than in *T. pectoralis* and of a different form, being much more narrowed towards the base; its disk is also roughly punctured and uneven, finely pubescent with long hairs, but neither it nor the elytra are so thickly pubescent as in *T. pectoralis*. The elytra are black, or, as in the variety, red to the second fascia. The fasciæ are raised and ivory-white, not clothed with silky-white hairs (as they are in *T. pectoralis*), but clear shining white; the anterior one is shortened, so as to leave a space at the suture equal to its own length, nor does it reach the margin.

There are two examples of the type form and two of the variety.

NOTOSTENUS Spinola.

Notostenus Schenk. *l. c.* p. 114.

NOTOSTENUS VIRIDIS Thun. Nov. Ins. vol. i. p. 9 (1784).

Hab. Algoa Bay (*Brauns*).

MELYRIDÆ.

ANTHOCOMUS Erichs.

ANTHOCOMUS CORIACEUS, sp. n.

Breviter oblongus, niger, obscure subviridescens, longe pubescens; capite prothoraceque nitidis, hoc profunde parce punctatus; elytris coriaceis; antennis (apice exceptis), tibiis tarsisque ferrugineis. Long. 4 millim.

Hab. Bothaville, Orange R. Colony (*Brauns*).

Black, densely clothed with long black pubescence. Head and thorax shining, the former very closely and finely, the latter very sparsely punctured. Clothed all over with long fine hairs. The mouth, palpi, antennæ (excepting the extreme tip), the tibiæ, and tarsi are ferruginous red. The elytra are little shining, coriaceous, tubercles obscurely in rows and but little elevated, being rather uniform all over their surface. There is a slight greenish, but hardly perceptible, tint over the whole upper surface; the body beneath is quite black. As there are only two specimens, and I cannot distinguish the sexes, it is impossible to say if this is a true *Anthocomus*. The lamellæ of the tarsi are about as long as the claws.

HEDYBIUS Erichson.

HEDYBIUS SCULPTICEPS, sp. n.

Nigro-subcæruleus; capite (basi excepta), antennis (articulis extus et apicem versus nigro notatis), prothoracis margine, pedibus

anticiis et intermediis (externe nigris) testaceis; elytris cæruleis, purpureo vel violaceo micantibus. Long. 5·5–6·5 millim. ♂ ♀.
 Mas, *capitis basi profunde excavato-eroso, erosione ima tota nigra; fronte elevata, in medio profunde sulcata. Antennis acute serratis, articulo quinto triangulari apice nigro.*

Femina, *antennis brevioribus, leviter serratis.*

Hab. Willowmore, Cape Colony (*Brauns*).

The head in the male is deeply excavated; the surrounding parts are yellow and elevated, but very differently from either of the *Hedybii* described by me in the 'Annals and Mag.' for Jan. 1900*. The deep notch in the front part of this elevated edge of the crater is of itself sufficient to prevent its being confused with them. The base of the crater in the male and the base of the head in the female are black. The antennæ are more acutely serrate than in any other species I have seen. They vary in the degree to which they are marked with black. Their second joint is very short, the third as long as the basal, the fourth and fifth triangular, the last in the male always black in its apical half and more acutely produced inwards; the following joints are longer, acutely serrate, and more or less dark, in the females I have seen always dark.

The thorax is of the same shape as in *H. amoenus*, *H. anceps*, &c., but the disk is nearly all suffused with blue-black, two dark points project on the base, and it is sometimes indented on each side in front.

The scutellum is black; the elytra are blue and often have a beautiful metallic-violet reflection, they are finely coriaceous. The legs are yellow but tinged with black, and the hind pair are altogether dark, in which respect this insect also differs from any of the *Hedybii* of this group described.

Three males and two females of this species were sent me by Dr. H. Brauns.

HEDYBIUS QUADRICORNIS, sp. n.

Oblongus, nigro-cæruleus; capite, prothorace pedibusque sanguineis; scutello et elytris viridibus, sericeo-pubescentibus; antennis rufis, articulis singulis (maris) nigro-notatis, femine articulis basi tribus rufis usque ad apicem infuscatis. Long. 4–4·5 millim. ♂ ♀.

Mas, *capite excavato-eroso, erosionis margine basali in cornu duplici quasi elevato, cornu anteriore apice ciliato, posteriore hamato apice nigro, supra oculos tuberculato.*

Femina, *fronte deplanata, basin versus nigrescente.*

Hab. Willowmore, Cape Colony (*Brauns*).

Head, thorax, base of the antennæ, margins and apex of the abdomen yellow; the scutellum and elytra are bluish green. The upper side is finely clothed with a pruinose silky pubescence, long hairs are absent.

The head in the female and the front of the thorax in the male

* Ann. & Mag. N. H. ser. 7, v. p. 81 (1900).

are sometimes faintly suffused, and the hind tarsi are blackish. The body beneath is bluish. The extraordinary structure of the head in the male is alone sufficient to distinguish this insect from any species described; it resembles in colour and size an insect sent by Mr. G. A. K. Marshall from Salisbury, and which I doubtfully referred to *H. varicornis* Bohem., but as the latter specimen was a male I am certain that it does not belong to the species I now describe.

Obs.—Boheman does not in describing *H. superciliosus* give the diagnosis of the male head, but I have no doubt from his remarks it is a male he describes. His express assertion, repeated, that the scutellum is yellow precludes any of the specimens I have yet received from being referred to this species. A considerable series of this insect has been obtained by Dr. Brauns; four males and four females are before me.

HEDYBIUS AMENUS Gorh. Distant's Nat. in Transvaal, p. 197; Ann. & Mag. N. H. ser. 7, v. p. 80 (1900).

Hab. Bothaville, Orange R. Colony (*Brauns*).

One male and three females, in all respects agreeing with the types. They are interesting as corroborating the differences pointed out before and as being found in quite a new locality.

PHILHEDONUS Gorham.

Philhedonus Gorham, Ann. & Mag. N. H. ser. 7, v. p. 82 (1900).

PHILHEDONUS SERICEUS, sp. n.

Nigro-ceruleus, pube brevi sericea vestitus; prothorace rufo, fere glabro, macula nigra in margine antico haud bene discretata; elytris creberrime subtiliter punctatis, pube brevi pruinosis; scutello, pedibus et corpore infra nigro-ceruleis. Long. 5 millim. ♀?

Hab. Bothaville, Orange R. Colony (*Brauns*).

This *Philhedonus* differs from the insect described by me as *P. coronatus* by its smaller size, by the wholly black antennæ, and by the labrum not being red; the thorax is also differently marked, the single black spot is placed upon the front margin, and is wedge-shaped, pointing backwards. The head is blue-black and shining, not punctured, very sparingly golden pubescent; antennæ, mouth, and palpi black, the former short and feebly serrate. The thorax is wider than long, the sides and base finely margined, the anterior margin raised, but only very finely so.

The elytra are wide, and are widest a little before the apex, deep blue with a silky and shining pubescence; the punctuation is fine, close, and confluent. They do not cover the apex of the abdomen. The body and legs are entirely blue-black; the vesicles, which can be protruded from the sides (and are so in the specimens sent), are blood-red. The pygidial segments beyond the elytra show a green tinge. The examples, two in number, are both, I think, females.

PHILHEDONUS RUGULOSUS, sp. n.

Niger, nitidus, pube erecta nigra vestitus; prothorace rufo, plaga magna discoidali marginem basalem haud attingente nigra, parcius irregulariter punctato; elytris saturate caeruleis, ruguloso-coriaceis; scutello nigro; corpore infra cum pedibus nigris; antennis nigris, acute serratis. Long. 5.5 millim. ♀.
Mas, antennis longioribus, acute serratis, capite intra oculos inaequaliter impresso.

Femina, antennis brevioribus, minus acute serratis, fronte plana.
Hab. Willowmore, Cape Colony (*Brauns*).

Rather like *P. sericeus*. Head, mouth, antennae, palpi, legs, and body beneath black. The head is uneven and impressed between the eyes, the base is nearly smooth and shining; the antennae have the first three joints testaceous beneath, from the fourth to the tenth the joints are longer than wide, acutely produced at their inner apices. The thorax has a large black and square patch on the disk and front margin; this is somewhat produced behind, but does not reach the hind margin; the disk is smooth in front, but punctured and rugose at the sides. The form is like that of *P. sericeus*, transverse, rounded at the sides and base, without angles; finely margined, and a little elevated in front. The disk and the elytra are clothed with long upright black hairs. The elytra are of a deep violaceous or indigo-blue, uniformly rugulose; the rugosities are tuberculous. They are widest a little before their apices, the apex broadly rounded. In addition to the black erect hairs there is a white, shining, pruinose pubescence, arranged in fasciae (but not very evidently so).

The legs and underside are wholly jet-black.

The male has the head unevenly impressed between the eyes, the antennae more acutely serrate, and of course the front tarsi four-jointed. The elytra cover the abdomen in all of the four specimens before me; in the female the segments of the abdomen when distended appear narrowly margined with red.

HEDONISTES, gen. nov.

Labrum corneum.

Tarsi antici quinque-articulati; caput maris eroso-excisum, feminae fronte plana; antennae maris articulo basali quinto et sexto ampliatis, septimo ad undecimum simplicibus; feminae articulis omnibus simplicibus.

Hab. Africam meridionalem.

A genus recalling by the curious sexual characters of the antennae in the male the genera *Laius* from Australia and *Collops* from the New World, and by its excavated and cornuted head in the male the genus *Hedybius*, with which it might have been associated; but I think although the enlarged fifth and sixth joints of the antennae are only a sexual character, it is one so similar to what is found in *Laius* and *Collops* that it will be well to keep insects of this family possessing it in a separate

genus. M. Fairmaire has described some species as to be attributed to *Laius*, from Madagascar, Nossi Bé. I have not seen them, but I suspect it will be found that there are such radical differences as to preclude such an association; and he does not mention enlarged joints. *Laius*, it may be observed, was founded upon a female example from Australia, and ought strictly to be suppressed for Westwood's name *Megadeuterus*, which at least expresses the fact that the second joint of the antennæ is enlarged in the male sex. That he included other insects in his genus is no reason for suppressing the name, but only for confining it to the type, and to such as can be associated with it.

HEDONISTES LÆTUS, sp. n.

Brevis, niger, pube brevi cinerea erecta vestitus, valde punctatus; elytris subquadratis, grosse et confluentur punctatis, fascia lata, ad marginem latissima, apiceque lete sanguineis; epistomate, labro ad apicem et antennarum basi rufis. Long. 4.5-5 millim. ♂ ♀.

Mas, capite eroso-excavato, ad antennarum basin utrinque carinato elevato, basi triangulariter elevato, elevatione in medio sulcata, antice ciliata, bicirrosa; antennarum articulis basali quinto et sexto ampliatis.

Femina, fronte plana, antennis simplicibus.

Hab. Willowmore, Cape Colony (*Brauns*).

Head and thorax black, thickly and the latter rather coarsely punctured; the antennæ have four joints at the base red, the rest black, the apical joint is elongate, the intermediate joints in the male are longer than wide, in the female about as long as wide, not serrate but rather triangular. The thorax is shining, not wider than the head, and much narrower than the elytra at the base, somewhat cordate, with the margins a little reflexed. The elytra are blue-black, with a fascia which is interrupted at the suture, but very broad on the margin, of a fine blood-red, and their apex is rather broadly margined with the same colour; the basal side of the fascia is produced along the margin so as to surround the shoulder; their surface is uniformly, coarsely, and in places confluent punctured, honeycombed. The legs are black.

Eight examples, consisting equally of each sex, were sent me by Dr. H. Brauns, by whom they were obtained at Willowmore in Cape Colony.

EROTYLIDÆ.

AMBLYSCELIS ILEMORRHOUS Gorb. Ann. Soc. Ent. Belg. 1885, p. 326; Ann. & Mag. N. H. ser. 7, v. p. 90 (1900).

Hab. Bothaville, Orange R. Colony.

Excepting that the brownish-yellow colour is more diffused in two examples from Bothaville, so that one is wholly brown with darker striæ, and the other has a not very well-defined yellow vitta, formed by the humeral spot extending to meet the apical

yellow, there is no difference in these examples and those from Natal.

ENDOMYCHIDÆ.

ÆDIARTHURUS Gerst.

Ædiarthrus Gerst. Mon. Endom. p. 344.

ÆDIARTHURUS ALGOENSIS, sp. n.

Æ. natalensi similis et affinis. Ferrugineus, antennis, palpis pedibusque nigris, tibiis rectis. Long. 4.5 millim. ♂.

Mas, antennarum articulo nono ampliato.

Hab. Algoa Bay (*Brauns*). 1 example.

Rather larger than *Æ. natalensis*, and differing from it in having the antennæ wholly black, with all the joints rather longer and more stoutly built; the ninth joint is triangularly enlarged, as in other species of this genus, in the males; the two terminal joints are formed quite as in *Æ. natalensis*, but are larger.

The legs are black and have their tibiæ straight, which alone is sufficient to distinguish this species from *Æ. natalensis*. For some general remarks on the genus I must refer to Ann. & Mag. N. H. ser. 7, vii. p. 402 (1901).

LYCOPERDINA SERICEA Gerst. Mon. Endom. p. 218?

Hab. Algoa Bay, Cape Colony (*Brauns*).

There is a single specimen of a very small *Lycoperdina* in Dr. Brauns' collection which I refer to this species with some little doubt.

8. On the Fœtus and Placenta of the Spiny Mouse (*Acomys cahirinus*). By RICHARD ASSHETON, M.A., F.Z.S., Lecturer in Biology in the Medical School of Guy's Hospital, University of London.

[Received May 23, 1905.]

(Text-figures 41-45.)

I received from Mr. F. E. Beddard, F.R.S., Prosector to the Zoological Gardens, London, a bottle containing the fœtus and uterus from an individual of the Spiny Mouse (*Acomys cahirinus*). The exact age of the fœtus was not known, but the figure (text-fig. 41) given here shows that it was well advanced.

In the bottle were three objects—namely, the fœtus and placenta (as shown in text-fig. 41), the uterus with Fallopian tubes and ovaries, and a third object which was a partially absorbed fœtus and placenta.

The uterus is bicornuate; each horn measures about 18-20 mm., and passes gradually into the Fallopian tube, a short, coiled tube lying alongside the ovary (4 mm. × 2 mm.).

Each horn had been opened. Opposite the slit on the meso-metric side a swelling marked the place of attachment of the fully formed placenta and fœtus in the one case, and of the absorbed specimen in the other.

The fœtus appeared devoid of amnion and was chiefly remarkable for the long hairs or spines which rise from the dorsal walls of the nostrils and point backwards over the head. The pits from which these hairs arise are plainly visible (text-fig. 41).

Text-fig. 41.



The fœtus of *Acomys cahirinus*, together with the placenta separated from the walls of the uterus. The sac-like folds attached to the discoid placenta are the yolk-sac and amnion membranes. An epitrichium is seen closely applied to the body of the fœtus. $\times 3$.

A thin membrane could be seen covering certain parts of the embryo, the face, neck, and wrist, and it could be detected by careful search over other parts. This membrane covered the finer hairs, but was perforated by the stout bristles, and is probably of the nature of an epitrichium.

The fœtus was attached by a long cord to the placenta, which had been separated from the uterus.

The placenta was discoidal in shape, but with a longer diameter of 12 mm. and a shorter of 9.5 mm. In thickness it was about 3 mm. The embryonic surface was concave, the ab-embryonic surface convex (text-fig. 42).

Attached to the proximal (fœtal) surface of the placenta was a wide sac through which the cord passed to the centre of the placenta.

At the point where the cord appears to penetrate the sac there

was a crumpled mass of membranes, consisting of the yolk-sac and amnion, which had been detached from the fœtus during the act of preservation.

Description of the Placenta.

The proximal wall of the yolk-sac, which lies up against the face of the placenta, is extremely vascular and covered with an epithelium of large columnar cells. Moreover, this epithelium is much folded; and the blood-vessels lie in the folds, and so approach closely the surface of the placenta (text-fig. 42). The yolk-sac wall is firmly attached to the placenta over the peripheral area.

Text-fig. 42.



The placenta of *Acomys* with the proximal wall of the yolk-sac attached showing the radiating vessels of yolk-sac circulation which are covered with a thick epithelium. $\times 3$.

This attachment of the yolk-sac to the placenta is not so intimate as it is in the common rat, in which animal the yolk-sac forms villi or at least folds which become embedded in the tissues of the allantoic placenta, but remain quite easily distinguishable therefrom (*cf.* Robinson, A., "The Nutritive Importance of the Yolk-sac," *Journ. Anat. & Phys.* vol. xxvi. p. 308 (1892); Duval, M., "Le placenta des Rongeurs," *Journ. Anat. et Phys.* 1889-1892). In *Acomys* the yolk-sac is much folded, but the folds do not become involved in the placental tissues (text-fig. 45, HH).

The placenta itself, which we may regard as being nearly full term, shows only a small area of actual vascular attachment to the wall of the uterus (text-figs. 41, 42). Here it is rough, and marked by open blood-sinuses and shreds of tissue. Passing outwards and extending nearly to the rim, there is a layer of rather darkly staining material showing no particular structure

and containing dead nuclei, which I must regard as cell-detritus. This layer probably lay against, and was no doubt more or less attached to, the uterine wall (text-fig. 45, D).

Text-fig. 43.

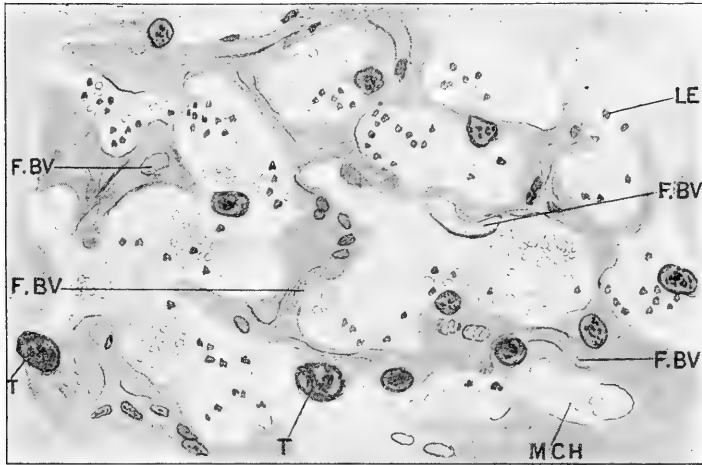

A section of a portion of the placenta of *Acomys* taken vertically near the centre of the organ, where the fetal capillaries are forming a network round about the channels containing maternal blood.

F.BV. Fetal capillary. LE. Maternal leucocyte. MCH. Maternal blood in channels excavated in the trophoblast of the foetus. T. Trophoblast nuclei. $\times 480$.

From this point and passing over the edge of the placenta, and covering the free surface of the foetal side of the placenta, a flattened attenuated epithelium can be distinguished (text-fig. 45, H, p. 285). This becomes thicker and more cubical as it nears the point at which the yolk-sac wall is connected with the placenta, and here it passes into the decidedly cubical or columnar epithelium of the yolk-sac. This layer continued in the other direction would pass at some period into the distal wall of the yolk-sac, though whether this distal wall exists at the period under examination I cannot say.

The rough surface of vascular attachment, so far as I can judge from the general character of the cells, is composed entirely of maternal tissue. This tissue is of that kind so frequently found where trophoblastic ingrowth is about to take place, and had been named by Hubrecht trophospongia (text-fig. 44, p. 284).

Text-fig. 45 is a diagrammatic representation of a section passing through the centre of the placenta. The placenta, as

stated above, had been separated from the wall of the uterus, so although shown *in situ* in the figure it must be understood that the two parts were not together in my specimen. The line S marks the boundary between the two.

On the outside I have drawn in outline the muscle coats (M) of the wall of the uterus.

Within this, and seen only near the centre, is the trophospongial tissue alluded to above (TS), while towards the peripheral parts the thin layer of detritus can be seen at D, composed probably of both maternal and fetal tissues.

Text-fig. 44.

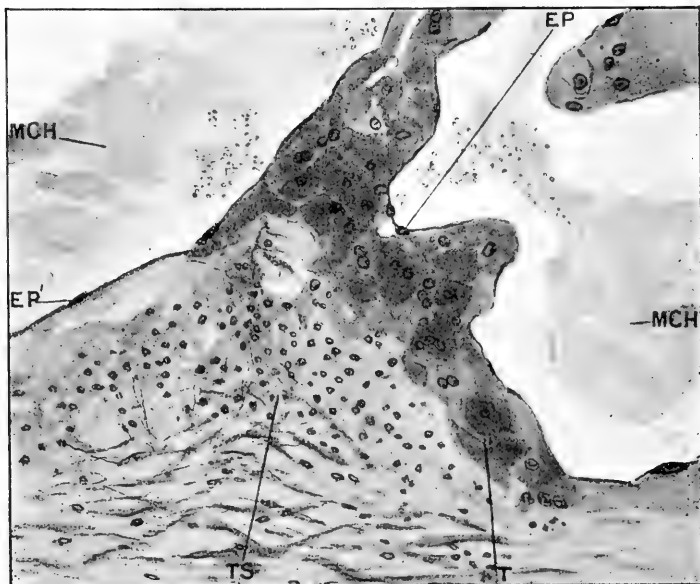

A section through the junction between trophoblast and trophospongia of *Acomys*.

T. Trophoblast. TS. Trophospongia. EP. Pseudoepithelium of trophoblast.
EP'. Pseudoepithelium of trophospongia. MCH. Maternal blood.

Everything within this line formed by the detritus layer on the outside and the trophospongial layer at the centre is probably fetal in origin, except the maternal blood, which is extravasated and flowing in channels excavated in the fetal trophoblast. It must of course be remembered that this description is an interpretation of a single stage based upon the known facts in closely allied forms (ref. Duval, Robinson, Jenkinson), and not upon the study of the actual development in this genus.

The advancing edge of the trophoblast is sharply defined from the maternal tissue (text-fig. 44, T). The trophoblast is composed of a compact mass of cells with large nuclei and generally fairly well-marked cell-boundaries. It has, in fact, the character more of a cytrophoblast than a plasmodi-trophoblast (text-fig. 44). The nuclei tend to arrange themselves in pairs.

Text-fig. 45.

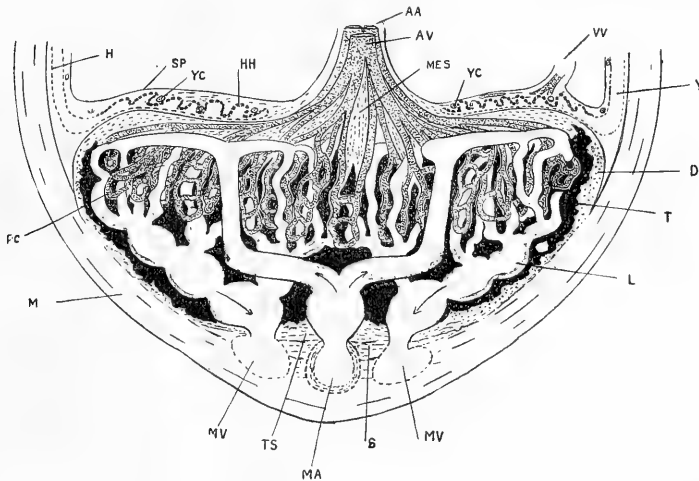

A diagram of a section taken through the centre of the placenta of *Acomys*. The maternal channels are not much exaggerated in size, but the foetal capillaries are considerably magnified. The trophoblast layer in the region of the foetal capillaries is not nearly so much attenuated as it should be.

The foetal vessels are dotted, the channels containing maternal blood are white. The deep black is trophoblast.

AA. Allantoic artery. AV. Allantoic vein. D. Layer of cell-detritus probably foetal as well as maternal. FC. Foetal capillary. H. Hypoblast of the parietal wall of the yolk-sac. HH. Hypoblast of the proximal wall of the yolk-sac, very much folded. L. Lacunæ in trophoblast containing maternal blood. M. Muscle-coat of uterus. MA. Maternal artery. MES. Mesoblast of foetus. MV. Maternal vein. S. Line along which the placenta had been detached from the uterus. SP. Splanchnopleur layer of mesoblast. T. Trophoblast. TS. Trophospongia. VV. Approximate portion of the main vitelline vessels. Y. Cavity of the yolk-sac. YC. Blood-vessels of the yolk-sac circulation.

This trophoblastic tissue, which in the figure (text-fig. 45) is shown as a thick black mass (T), is honeycombed by channels containing maternal blood (L), which channels become more broken and more numerous nearer to the foetal surface, and the trophoblast consequently more attenuated. I think there are possibly other cavities in the trophoblast-cells which are not blood-spaces.

This mass of tissue formed entirely of trophoblast and maternal

blood makes up nearly half the thickness of the placenta, and contains no fetal mesoblast or blood.

The half of the placenta towards the foetal surface is made up of trophoblast (much attenuated) forming channels filled with maternal blood, which take a more or less sinuous course, and a network of fine foetal capillaries, with also the larger vessels and larger main maternal channels. This is shown diagrammatically in text-fig. 45, FC, p. 285).

Text-fig. 43 (p. 283) is a drawing of an actual section of a piece of this region near the maternal surface. The great bulk is made up of the channels (MCH) excavated in the trophoblast containing maternal blood. There are many leucocytes (LE). The walls of these channels are thin, though the large trophoblastic nuclei (T) are very conspicuous. The foetal capillaries are seen at F.BV.

Nearer to the foetal surface the maternal channels become finer and the foetal capillaries perhaps rather more numerous. At places where the main foetal arteries penetrate the tissues of the placenta, a considerable quantity of foetal mesoblast tissue accompanies them.

There are a few spherical masses of tissue within this region, which are not vascular, nor do they seem to be trophoblastic. They resemble in some respects Duval's "îlots vésiculeux," which, according to him, are pieces of the maternal sub-mucosa which have become enveloped by the advancing trophoblast layer.

The main features of the vascular systems are fairly easily determinable.

In this specimen the whole of the maternal arterial blood-supply arises from a single artery in the centre (MA), which opens into the large afferent channel which lies partly in the trophospongial tissue and partly in the trophoblast.

This, like the other main channels, is lined by a flattened epithelium-like layer, which is probably a pseudo-epithelium of trophoblastic origin where the wall is trophoblast, and trophospongial origin where the wall is trophospongia.

Duval has described the growth inwards along the maternal vessels of trophoblast cells to form a pseudo-epithelium. This is denied by Jenkinson*, who derives the pseudo-epithelium from the simple flattening of the adjacent cells. This is not a question which can be decided by reference to a single stage; but I may say that there is nothing in this specimen which supports in any way Duval's account in the mouse.

The afferent channel divides into two main branches, which diverge and then penetrate straight to the foetal surface of the placenta. Here they break up into channels, which take a rather more sinuous course back again to the middle of the thickness of the placenta, where they collect into a number of efferent channels lying near the surface of the trophoblast and ultimately into two

* Jenkinson, J. W., "Observations on the Histology and Physiology of the Placenta of the Mouse," Tijdschr. d. Ned. Dierk. Vereen. Dl. vii. 1902.

large efferent vessels which presumably debouch into two maternal veins (MV).

These large efferent maternal vessels are more peripheral in position than the afferent courses.

The foetal blood-supply is less easily followed. The allantoic arteries, on reaching the surface of the placenta, radiate and subdivide and give off branches which pass into the placenta at intervals over the more central part of the surface. These pass (as regards the main stream) straight through the foetal half of the placenta, but give off at frequent intervals small capillaries, which take a more sinuous and radial course, anastomosing, forming network, and collecting together again into veins, which I believe to run parallel with the arteries of the villus.

A considerable amount of connective tissue accompanies these villi for the first part of their ingress into the placenta.

Comparison with other Placentas.

The placenta is clearly of the type which I have described elsewhere as cumulate as contrasted with the plicate type characteristic of such groups as the Ungulates.

The general shape, the arrangement of the membranes and their character, resemble, according to the interpretation placed upon them above, the condition that pertains in *Mus musculus*, and, rather less closely, that of *Mus decumanus*.

Jenkinson has recently given an account of the development of the placenta of the Mouse, which differs in several important particulars from that of Duval, which, until that time, had been generally accepted.

Jenkinson agrees with Duval as regards the general arrangement of membranes and in the main features of the development.

He differs, however, in respect to the vascular system, and my account given above is in complete agreement with Jenkinson. I see also nothing to suggest the appearance of an ingrowth of the trophoblast into the maternal blood-vessels, and growth along the inside as described by Duval ("plasmode endovasculaire").

Another point of disagreement is with reference to the glycogenous tissue. Duval takes but little notice of this and does not seem to have found the maternal glycogenous mass, which, according to Jenkinson, degenerates, and the space occupied by it becomes subsequently filled with a second glycogenous tissue which is of foetal (trophoblastic) origin.

This is a matter of very considerable interest. It is not to be expected that an isolated case in an allied genus can afford any conclusive evidence.

Unfortunately the method of preservation (corrosive sublimate) is not suitable to the study of glycogen.

Tested with iodine I find no trace of glycogen, but there are certain spaces in the trophoblast cells alluded to in the foregoing

which may possibly have contained glycogen—so my evidence on this point is negative.

Along the line which marks the internal limit of the foetal mesoblast (that is to say, the limit of the capillary system of the foetal villi) a deposit of brown pigment occurs. This appears to be deposited in the walls of the capillaries, by the endothelium. It occurs nowhere else. Treated with the ferrocyanide test, it shows no trace of blue colour.

In the detritus in the layer D (text-fig. 45, p. 285) there are indications of the presence of free iron.

Summary.

To recapitulate my interpretation of the single specimen I possess. The placenta of *Acomys cahirinus* is a compound structure of maternal and foetal tissues in which, excepting the blood, the foetal tissue largely preponderates.

On the maternal side is a central area of attachment through which the maternal blood gains access to the placenta. Here a thin layer of maternal connective tissue surrounds the main afferent and efferent maternal blood-channels.

Within this region comes a thick layer of tissue probably of foetal origin (the trophoblast, the cells of which are large, stain deeply, and have large nuclei), containing intercellular spaces, which are continuous with the expanded maternal vessels just named. These spaces are lined by an endothelium, as to the origin of which I can give no account. There is no foetal blood in this part of the placenta.

These two regions, of which the latter is by far the larger, make up nearly one half of the whole placenta.

The rest (that is, all towards the foetus) is composed of channels probably excavated in the trophoblast of the foetus and containing maternal blood interlacing with much branched tufts of foetal capillaries containing foetal blood. These foetal capillaries are in parts thickly covered with foetal mesoblastic tissue, but more often are separated from the maternal blood by their own endothelium and a single layer of trophoblast only.

The maternal afferent channels penetrate to the foetal surface before undergoing much subdivision and are more central in position.

The foetal afferent vessels tend to penetrate the deeper layers, but given to break up nearer to the surface of approach than is the case with the maternal afferent vessels.

There is no such intimate connection between the yolk-sac and allantoic placenta as there is in the Rat,

9. Remarks on the supposed Clavicle of the Sauropodous Dinosaur *Diplodocus*. By FRANCIS, BARON NOPCSA, Ph.D.*

[Received June 6, 1905.]

(Text-figures 46-49.)

It is still uncertain whether the extinct Dinosauria possessed clavicles.

Considering the close relationship existing between these reptiles, the Rhynchocephalians, Parasuchians, and Birds—this last relationship being shown by the continuous tendency of Dinosaurs to specialize on most different occasions in bird-like manner—one is at first naturally induced to believe that in Dinosaurs clavicles were present; but, as a matter of fact, bone after bone supposed to represent this element has had to be removed from this position.

Hitherto only the family Ornithopodidæ is known to possess, in addition to scapula and coracoid, a curious further element in the shoulder-girdle, which was called clavícula, but may quite as well form only a part of the sternum (this double element being in one case united in the middle by bony matter). No other Saurischian or Orthopodous Dinosaur shows a clavicular ossification. It is true that in the Sauropoda, besides scapula and coracoid, one or two flat bones are always present in the scapular region of the body: these, however, do not represent claviculæ, but may with certainty be determined as ossifications of the sternum. The discovery, therefore, of what may be called a supernumerary bone besides the sternal plates in two of the several *Diplodocus* skeletons known to science proves to be of quite exceptional interest.

Hatcher, in his important Monographs of the *Diplodocus* skeletons Nos. 84 and 662 of the Carnegie Museum, describes this element as follows:—"Throughout the greater portion of its length it is circular in cross-section, it is bifid at one extremity and slightly expanded at the other. It is strongly curved, especially toward the bifid extremity. It is asymmetrical." In a more complete specimen (No. 662) than the former (84) it is "somewhat expanded and spatulate; the flattened extremity presents a slightly rugose surface, as though it had been imbedded in cartilaginous or muscular tissue, and this together with the bifid nature of the other extremity has suggested the possibility that the bone might be an os penis." After the description of this bone, however, its asymmetry is regarded by this eminent palæontologist as a weighty argument against its being an os penis, and therefore its identification with the clavícula is advocated.

* Communicated by Dr. A. SMITH WOODWARD, F.R.S., F.Z.S.

According to the figures given by Hatcher and reproduced here (text-figs. 46 & 47) the bone in question seems to present a great deal of what might be termed individual variation.

Text-fig. 46.

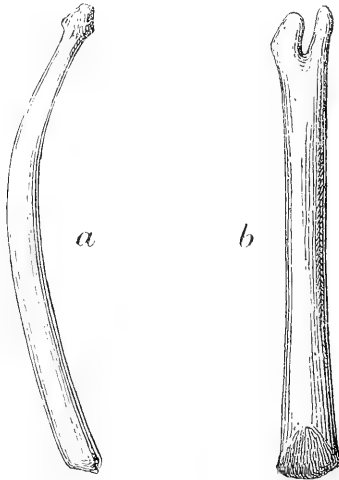
Supposed clavicle of *Diplodocus*, No. 84.

Text-fig. 47.

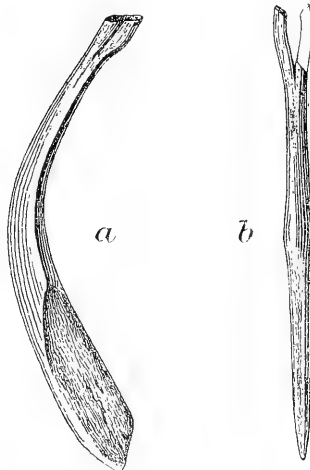
Same bone of *Diplodocus*, No. 662.

It seems to fit fairly well into the shoulder-girdle, but still

there are several points to be brought forward against the theory of its clavicular nature.

Firstly, it must be remembered that in one case this problematical bone, like the greater part of the skeleton, was displaced and that in the second skeleton, as pointed out by Dr. Holland, the femur bears tooth-marks of carnivorous Dinosaurs. In consequence of this the relative position of the bone cannot prove anything for or against its being an os penis; for the penis would be one of the first parts of the body to become displaced by decomposition and the first part that would be torn away if carnivorous animals were gnawing at the dead body.

Text-fig. 48.

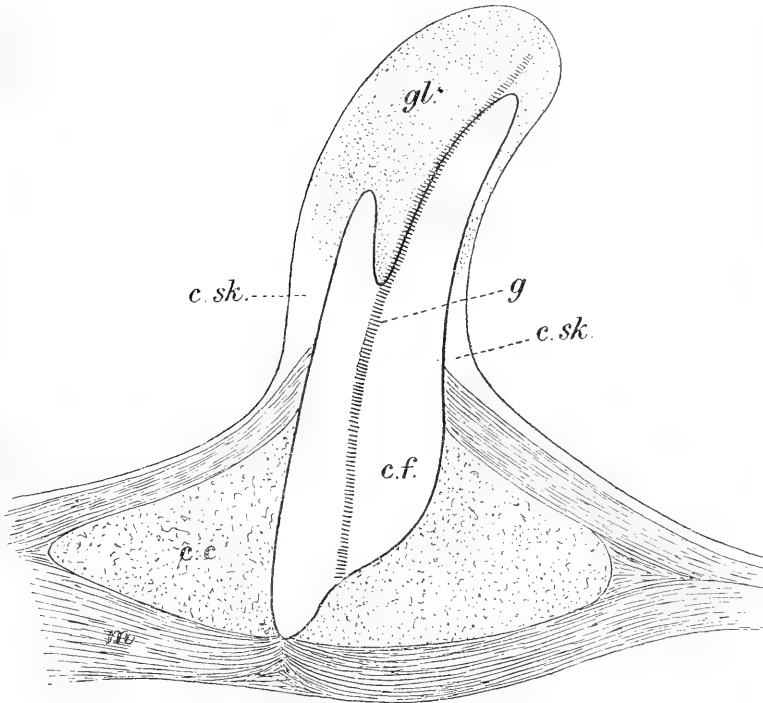

Diagram of penis of *Struthio*.

Explanation of letters:—*c.c.*, corpus cavernosum; *c.f.*, corpus fibrosum; *c.sk.*, coarse skin; *g.*, gutter; *gl.*, glans-like part; *m.*, muscles.

Secondly, in each of the two pretty complete skeletons that comprised this bone, only one example was present, and this one appeared to belong to the same side of the body. In other specimens of *Diplodocus* the element was altogether wanting.

This highly remarkable coincidence suggests the probability that the bone in question represents an asymmetrical but nevertheless unpaired organ.

So far as I am aware there is no known reptile, living or extinct, in which the clavicle is bifurcated at one end. Moreover, in most terrestrial and aquatic reptiles, when clavicles are present there is also an interclavicle, which has never been found in Sauropoda. It must also be remembered that these large herbivorous Dinosaurs were probably descended from the carnivorous Theropoda, which are always destitute of a clavicular arch.

Text-fig. 49.

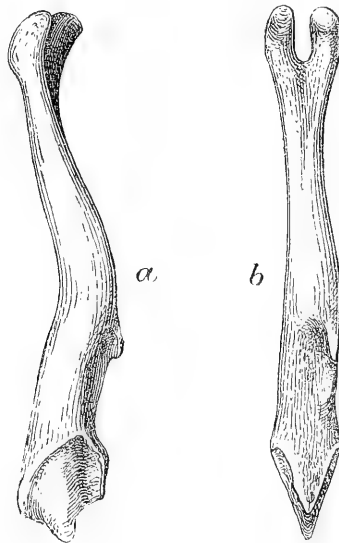

Os penis of European Otter.

I am therefore of opinion that the problematical bone of *Diplodocus* in question cannot be a clavicle, and it is necessary to consider Hatcher's alternative suggestion that it is an os penis.

The fact that existing birds and reptiles are destitute of an os penis does not necessarily imply that gigantic reptiles like *Diplodocus* similarly lacked the bone. Among Mammalia it is well known that the element occurs only sporadically, being present, for instance, in the Anthropoid Apes and absent in Man.

Among the living reptiles we know two types of genital organs. The Squamata show what may be called a bifid penis, while the Crocodylia and Chelonia have the penis simple exteriorly, with a corpus fibrosum and frequently even a glans penis well developed.

In *Chelonia* the penis sometimes exhibits internally a partially bifid structure.

For the purpose of this paper the penis of birds is of quite exceptional interest. In its origin it is not only traceable to the Crocodylian type, but shows a very great amount of asymmetry, and besides in the *Ratitæ* a distal bifurcation of the corpus fibrosum (text-fig. 48, p. 291). In *Struthio* the distal part of the penis is changed into a glans-like organ, while in *Rhea* the corpus fibrosum consists of an exceedingly hard and nearly cartilaginous substance.

A bifurcation like that observable in the problematical bone of *Diplodocus* is also frequently to be met with at the distal end of the mammalian os penis, which is often asymmetrical. The os penis of mammals always shows quite remarkable variability. For comparison with the bone of *Diplodocus*, side and hind views of the os penis of the European Otter (*Lutra lutra*) are given (in text-fig. 49, p. 292), and one can see at a glance the well-rounded, smooth, condyle-like, distal ends, the proximal rugosities, and the lateral impressions for the attachment of the corpus fibrosum. In other mammals the corpus fibrosum is not attached laterally to the ossified element, but ends in a deep pit situated at the proximal end of the latter.

We have therefore to consider the following propositions:—

(1) That among the Mammalia it is the corpus fibrosum with which the os penis comes in close contact, forming the anterior prolongation into the glans penis, that the os penis ossifies from fibrous matter; that a corpus fibrosum is also present among Reptilia, and that therefore an os penis in Dinosaurs can only have originated from the corpus fibrosum.

(2) That in *Rhea* the corpus fibrosum is quite as hard as cartilage, and differs from this only by not possessing cartilage-cells.

(3) That in Sauropsida a glans is frequently present.

(4) That it is quite a common thing to find bird-like characters in various parts of the Dinosaurian skeleton.

(5) That among the birds the *Ratites* show the most primitive and still the best-developed male genital organ.

(6) That the shape and variation of the problematical bone in *Diplodocus* are well in accord with its being an os penis, while they militate against its determination as clavicular.

(7) Lastly, that this so-called clavicle when present is always found only as an unpaired organ showing the same direction of curvature.

Hence I am of opinion that it is at present advisable to remove the subject of this paper from the shoulder-girdle and determine it as the ossified axis of the penis.

Further evidence and, especially, further discoveries are naturally necessary before so delicate a question can be regarded as definitely settled; but since Hatcher's single argument against the bone in question being an os penis (namely, its asymmetry) breaks down on reference to *Struthio* or even to *Lutra*, the balance of the argument is at present in favour of this newer interpretation.

The existence of clavicles in Dinosauria must therefore still be considered doubtful.

In conclusion, I wish to express my thanks to Mr. Boulenger, Dr. Forsyth Major, Mr. Pycraft, and Dr. A. S. Woodward at the British Museum, and to Professor Stewart and Mr. R. H. Burne at the Royal College of Surgeons, for their kind help in studying so intricate a question.

Literature.

- GADOW & SELENKA.—Birds: Bronn's Klassen und Ordnungen d. Thierreiches, vol. vi. part iv.
- GILBER.—“Das Os priapi der Säugethiere.” Gegenbauer's Morphologisches Jahrbuch, 1891.
- HATCHER.—“*Diplodocus carnegii*.” Memoirs of Carnegie Museum, Pittsburg, vol. i.
- . “Osteology of *Haplocanthosaurus*, with Appendix on *Diplodocus*.” *Loc. cit.* vol. ii.
- [NORCSA.]—Critical Review of Hatcher's Paper on *Haplocanthosaurus*. Keilhack's Geologisches Centralblatt, 1904.
- WEBER.—Die Säugethiere. Leipzig, 1903.
- WIEDERSHEIM.—Lehrbuch der vergleichenden Anatomie d. Wirbelthiere. Leipzig, 1902.
-

CONTENTS (*continued*).

May 16, 1905 (*continued*).

	Page
5. On the Anatomy of Limicoline Birds; with special Reference to the Correlation of Modifications. By P. CHALMERS MITCHELL, M.A., D.Sc. (Oxon.), Secretary to the Society	155
6. Observations upon a Female Specimen of the Hainan Gibbon (<i>Hylobates hainanus</i>), now living in the Society's Gardens. By R. I. Pocock, F.L.S., F.Z.S., Superintendent of the Gardens. (Plate V.)	169

June 6, 1905.

The Secretary: Report on the Additions to the Society's Menagerie during the month of May 1905	180
Mr. Oldfield Thomas, F.R.S. Description of a new Bush-buck (<i>Tragelaphus haywoodi</i>) from British East Africa	180
Mr. Oldfield Thomas, F.R.S. Exhibition of specimens of Mammals and Birds from Japan and description of a new Marten (<i>Mustela melampus bedfordi</i>)	182
Mr. R. I. Pocock, F.L.S. Exhibition of a Jamaican Scorpion (<i>Centruurus insulanus</i>) carrying young on its back	183
Dr. P. Chalmers Mitchell: Notice of a memoir entitled "On the Intestinal Tract of Mammals"	184
1. Rough Notes on the Natural History of the Country West of the Victoria Nyanza. By Lt.-Col. C. DELMÉ-RADCLIFFE, M.V.O., F.Z.S.	184
2. The Distribution of Mexican Amphibians and Reptiles. By HANS GADOW, F.R.S., F.Z.S.	191
3. Descriptions of new Reptiles discovered in Mexico by Dr. H. Gadow, F.R.S. By G. A. BOULENGER, F.R.S., V.P.Z.S. (Plates VI. & VII.)	245
4. On a Collection of Batrachians and Reptiles made in South Africa by Mr. C. H. B. Grant, and presented to the British Museum by Mr. C. D. Rudd. By G. A. BOULENGER, F.R.S., V.P.Z.S.	248
5. Some Notes upon the Anatomy of the Yellow-throated Lizard, <i>Gerrhosaurus flavigularis</i> . By F. E. BEDDARD, F.R.S., Prosector to the Society	256
6. On two Points in the Anatomy of the Lacertilian Brain. By F. E. BEDDARD, F.R.S., Prosector to the Society	267
7. On new Coleoptera from South Africa collected by Dr. H. Brauns and others— <i>Serricornia</i> , <i>Endomychidae</i> , <i>Erotylidae</i> . By H. S. GORHAM, F.Z.S.	271
8. On the Fœtus and Placenta of the Spiny Mouse (<i>Acomys cahirinus</i>). By RICHARD ASSHETON, M.A., F.Z.S., Lecturer in Biology in the Medical School of Guy's Hospital, University of London	280
9. Remarks on the supposed Clavicle of the Sauropodous Dinosaur <i>Diplodocus</i> . By FRANCIS, BARON NOPCSA, Ph.D.	289

LIST OF PLATES.

1905.—VOL. II.

PART I.

Plate	Page
I. <i>Clathrina contorta</i>	3
II. Osteology of the Eurylæmidæ	30
III. } Skulls of <i>Rhinolophi</i>	75
IV. }	
V. <i>Hylobates hainanus</i>	169
VI. 1. <i>Anolis gadovii</i> . 2. <i>Anolis bogaster</i>	245
VII. 1. <i>Sceloporus gadoviae</i> . 2. <i>Leptodira guilleni</i>	

NOTICE.

The 'Proceedings' for the year are issued in *four* parts, forming two volumes, as follows:—

VOL. I.

- Part I. containing papers read in January and February, in June.
II. " " " " " March and April, in August.

VOL. II.

- Part I. containing papers read in May and June, in October.
II. " " " " " November and December, in April.

'Proceedings,' 1905, Vol. I. Part II., was published on August 10th, 1905.

The Abstracts of the papers read at the Scientific Meetings in May and June are contained in this Part.



PROCEEDINGS

OF THE

GENERAL MEETINGS FOR SCIENTIFIC BUSINESS

OF THE

ZOOLOGICAL SOCIETY

OF LONDON.

1905, vol. II.

PART II.

CONTAINING PAPERS READ IN
NOVEMBER AND DECEMBER.

APRIL 1906.

PRINTED FOR THE SOCIETY,
SOLD AT THEIR HOUSE IN HANOVER SQUARE.

LONDON:
MESSRS. LONGMANS, GREEN, AND CO.,
PATERNOSTER-ROW.

[*Price Twelve Shillings.*]



LIST OF CONTENTS

1905.—VOL. II.

PART II.

November 14, 1905.

	Page
The Secretary. Report on the Additions to the Society's Menagerie during the months of June, July, August, September, and October 1905	295
Col. W. H. Broun. Exhibition of mounted heads of a White Waterbuck and two Rhinoceroses	296
The Hon. Walter Rothschild, F.Z.S. Exhibition of specimens of a rare Marsupial (<i>Dactylopsila palpator</i>)	297
The Hon. Walter Rothschild, F.Z.S. Exhibition of two tusks from Abyssinia	297
Mr. A. S. Hirst, F.Z.S. Exhibition of microscopic preparations of a new Hæmosporidian (<i>Halteridium crumenium</i>)	297
Dr. Walter Kidd, F.Z.S. Exhibition of lantern-slides illustrating the Papillary Ridges in Mammals	297
Dr. P. L. Selater, F.R.S. Letter from Mr. W. Rodier on the Rabbit-pest in Australia ..	298
Mr. Henry Scherren, F.Z.S. Exhibition of lantern-slides of, and remarks upon, old pictures of Anthropoid Apes	298
1. On a Collection of Mammals brought home by the Tibet Frontier Commission. By J. LEWIS BONHOTE, M.A., F.L.S., F.Z.S.	302
2. Notes on the Geographical Distribution of the Okapi. By Dr. EINAR LÖNNBERG, C.M.Z.S.	309
3. Notes on the Goral found in Burma. By Major G. H. EVANS	311
4. On the Mammals of Crete. By DOROTHEA M. A. BATE	315

November 28, 1905.

Mr. J. T. Cunningham, M.A., F.Z.S. Exhibition of photographs of, and remarks upon, a horse bearing horn-like structures	323
Mr. Frank Slade, F.Z.S. Exhibition of photographs of a Sea-Anemone in the process of division	324
Mr. Douglas English. Exhibition of an albino Field-Vole	324
Mr. G. A. Boulenger, F.R.S. Exhibition of, and remarks upon, a melanistic specimen of the Wall-Lizard	324
Capt. Albert Pam, F.Z.S. Remarks upon a living specimen of the Violet-cheeked Humming-bird	324
Mr. W. R. Ogilvie-Grant, F.Z.S. Exhibition of a series of bird-skins from Japan.....	324
1. Colour Evolution in Guereza Monkeys. By R. LYDEKKER	325
2. The White-maned Serow. By R. LYDEKKER. (Plate VIII.)	329
3. The Duke of Bedford's Zoological Exploration in Eastern Asia.—I. List of Mammals obtained by Mr. M. P. Anderson in Japan. By OLDFIELD THOMAS, F.R.S. (Plate IX.)	331
4. A Revision of the Fishes of the Family <i>Galaxiidae</i> . By C. TATE REGAN, B.A., F.Z.S. (Plates X.—XIII.)	363
5. The Mammalian Fauna of China.—Part I. <i>Murine</i> . By J. LEWIS BONHOTE, M.A., F.L.S.	384
6. Descriptions of new Species of Phytophagous Coleoptera of the Genera <i>Homophata</i> , <i>Asphara</i> , and <i>Oedionychis</i> . By MARTIN JACOBY, F.E.S. (Plates XIV. & XV.) ..	398, 591
7. Some Additions to the Knowledge of the Anatomy, principally of the Vascular System, of <i>Hatteria</i> , <i>Crocodylus</i> , and certain <i>Iacertilia</i> . By FRANK E. BEDDARD, M.A., F.R.S., Prosector to the Society	461

Contents continued on page 3 of Wrapper.

November 14, 1905.

G. A. BOULENGER, Esq., F.R.S., Vice-President,
in the Chair.

The Secretary read the following reports on the additions that had been made to the Society's Menagerie during the months of June, July, August, September, and October, 1905 :—

The number of registered additions to the Society's Menagerie during the month of June was 321. Of these 57 were acquired by presentation, 53 by birth, 14 by purchase, 195 were received on deposit and 2 in exchange. The number of departures during the same period, by death and removals, was 178.

Among the additions special attention may be called to :—

1. An Orang-utan (*Simia satyrus*) from Deli, Sumatra, presented by Dr. J. C. Graham on June 25th.

2. A Wolf's Monkey (*Cercopithecus wolffi*) from the Congo, deposited on June 26th.

3. Eleven Kiwis (*Apteryx mantelli*) from the North Island, New Zealand, seven being presented by the Government of New Zealand and Mr. H. C. Wilkie, F.Z.S., on June 26th, and four by the Earl of Ranfurly, H.M.Z.S., on the same date. The Society is specially indebted to Mr. H. C. Wilkie, in whose care these Kiwis were successfully brought from New Zealand.

The number of registered additions to the Society's Menagerie during the month of July was 274. Of these 96 were acquired by presentation and 17 by purchase, 92 were received on deposit, 1 by exchange, and 68 were bred in the Menagerie. The number of departures during the same period, by death and removals, was 184.

Among the additions special attention may be called to :

1. A female Leopard (*Felis pardus*) from near Hong Kong, presented by Mr. J. A. Bullin on July 26th.

2. Three Californian Sea-Lions (*Otaria gillespii*) from Santa Barbara, purchased on July 11th.

3. A White-tailed Gnu (*Connochates gnu*) born in the Menagerie on July 25th.

4. A male Somali Ostrich (*Struthio molybdophanes*) from Somaliland, purchased on July 14th.

5. A Collection of Birds from British Guiana, including examples of five species new to the Collection, presented by Mr. E. W. Harper, F.Z.S., on July 31st.

The number of registered additions to the Society's Menagerie during the month of August was 348. Of these 108 were acquired by presentation and 37 by purchase, 66 were born in the Gardens, 103 were received on deposit and 34 by exchange. The number of departures during the same period, by death and removals, was 255.

Among the additions special attention may be called to:—

1. A Silky Marmoset (*Hapale chrysoleucos*) from Brazil, deposited on Aug. 30th.
2. A pair of West-African Marsh-Bucks (*Limnotragus gratus*) from the Congo, purchased on Aug. 31st.
3. A Spot-billed Toucanet (*Selenidera maculirostris*) from Santos, purchased on Aug. 19th.
4. A Black-and-White Cobra (*Naja melanoleuca*) from West Africa, deposited on Aug. 31st.

The number of registered additions to the Society's Menagerie during the month of September was 313. Of these 106 were acquired by presentation, 26 by purchase, 124 were received on deposit, 15 by exchange, and 42 were bred in the Gardens. The number of departures during the same period, by death and removals, was 245.

Among the additions special attention may be called to:—

1. A male Orang-utan (*Simia satyrus*) from Sumatra, presented by Mr. H. N. Ridley on Sept. 7th.
2. Five Talpoin Guenons (*Cercopithecus talapoin*) from Ubanghi, Upper Congo, deposited on Sept. 19th & 21st.
3. A Jaguarondi (*Felis jaguarondi*) from S. America, purchased on Sept. 11th.
4. A Binturong (*Arctictis binturong*) from Singapore, presented by Mr. H. N. Ridley on Sept. 7th.
5. A White-tailed Sea-Eagle (*Haliaëtus albicilla*) from the Arctic, presented by the Duke of Orleans, F.Z.S., on Sept. 30th.
6. A Knob-nosed Lizard (*Lyriocephalus scutatus*) from Ceylon, presented by Mr. E. Ernest Green, F.E.S., on Sept. 26th.

The registered additions to the Society's Menagerie during the month of October were 232 in number. Of these 74 were acquired by presentation and 79 by purchase, 3 were born in the Gardens, 53 were received on deposit and 23 in exchange. The total number of departures during the same period, by death and removals, was 216.

Among the additions special attention may be called to:—

1. A White Oryx (*Oryx leucoryx*) from Arabia, presented by Col. R. J. Scallon, C.B., D.S.O., on Oct. 30th.
2. A Cave-Rat (*Thryonomys swinderianus*), a Bouvier's Owl (*Scotopelia bowvieri*) (new to the Collection), and a Beautiful Wood-Hawk (*Dryotriorchis spectabilis*), from Lagos, presented by Dr. W. F. Macfarlane, F.Z.S., on Oct. 13th.
3. Three Antillean Boas (*Boa divini-loqua*) from St. Lucia, West Indies, presented by the Hon. E. G. Bennett, K.C., on Oct. 28th.

Col. W. H. Brown exhibited a mounted head and skin of a White Waterbuck (*Kobus ellipsiprymnus*) and two mounted heads

of *Rhinoceros* (*Rhinoceros bicornis*), and made the following remarks:—

“The White Waterbuck was shot in July 1904 on the right bank of the Guaso Nyiro river, about 20 miles west of the Lorian Swamp, British East Africa, lat. 1° N., alt. above sea 1000 feet. A white doe was alone with the buck. The ordinary Waterbuck seen there were all examples of *Kobus ellipsiprymnus*. The eyes of this buck were of the normal colour, not pink.

“Of the two Rhinoceroses, one was a female and carried two normal and two rudimentary horns. She was shot in August 1904, in dense covert, west of the Jambeni Mountains north-east of Mount Kenia, at an elevation of 4150 feet above the sea. It was not seen till after death what an interesting animal she was. One of the rudimentary horns was between the ears and the other about 4 inches further back.

“The other individual was a male, and was shot in September 1904 north of Aberdare range, British East Africa; height above sea 9600 feet. The anterior horn showed abnormal growth due either to an old injury or excessive wearing away of the outer surface from the tip downwards.”

The Hon. Walter Rothschild, F.Z.S., exhibited specimens of a very rare and interesting Marsupial, hitherto unique, in the Paris Museum, viz. *Dactylopsila palpator* Milne-Edw., which differed from *D. trivirgata* in possessing an extremely thin, prolonged, second finger.

Mr. Rothschild also exhibited two tusks which had been obtained by Baron Maurice de Rothschild during his recent expedition to Abyssinia. They were so unlike the normal tusks of any known animal, that Mr. Rothschild was of opinion that they might belong to some new form.

Mr. A. S. Hirst, F.Z.S., exhibited microscopic preparations of a new Hæmosporidian from the blood of an African Stork (*Leptoptilus crumeniferus*). He pointed out that this parasite belonged to the genus *Halteridium*, but differed from *H. danilewskyi* in its greater size (stade moyen 7–10 μ), and also in its method of sporulation, in which the merozoites were more numerous, smaller, and arranged in a ball-like rounded mass. The name *Halteridium crumenium* was proposed for the new species.

Dr. Walter Kidd, F.Z.S., read a paper, illustrated by lantern-slides, “On the Papillary Ridges in Mammals, chiefly Primates.” The arrangements of the ridges on the hand and foot of 24 species were shown and described, and their functions discussed. Arguments were brought forward to show that their primary function was to increase the delicacy of the sense of touch.

Dr. P. L. Selater, F.R.S., read a letter addressed to him by Mr. William Rodier, dated Tambua Station, Cobar, New South Wales, June 29th, 1905, in which it was stated that Mr. Rodier's plan for combating the Rabbit-pest ('Nature,' March 21st, 1889) was still proving a "wonderful success." As there had been some good rains in the district the feed at Tambua was "splendid, right up to the boundary netting-fence," but on the other side there was "absolute starvation," owing to the great numbers of rabbits. This summer, in Mr. Rodier's opinion, would see the surrounding district quite "eaten out" by the rabbits, which were there in millions, but were easily kept down at Tambua by his plan.

Mr. Rodier's plan, which was very simple, might be shortly described as follows:—Ferrets and nets are employed to catch the rabbits alive in the usual way, but while all the females captured are destroyed, the males are turned out uninjured. The results are that the male rabbits, so soon as they begin to predominate in numbers, persecute the females with their attentions and prevent them from breeding. They also kill the young rabbits, and, as Mr. Rodier declares, "worry the remaining does to death."

Mr. Henry Scherren, F.Z.S., exhibited two lantern-slides of old pictures of Anthropoid Apes, and made the following remarks on the *Satyros indicus* of Tulp (text-fig. 50):—

There appeared to be in Dapper ('Beschreibung von Afrika,' Amsterdam, 1670, p. 393) an early reference to a Gorilla. No figure was given, but the description, though of course inexact, seemed to fit the Gorilla better than the Chimpanzee, especially with regard to erect progression*, the folk-story of carrying off and ravishing women, and the supposed human origin. The passage is as follows:—

"Hier [Quoja, north of Fernando Po] wird auch ein Tier gefunden, welches die Einwohner *Quojas-Morrou* oder *Worou* und die Portugallier *Salvage* dass ist ein Waldmann nennen. Es hat einen grossen Kopf, dicken Leib, fleischichte Arme, damit es in Ringen sehr stark ist, aber ganz keinen Schwantz; und gehet zuweilen mit ausgerecktem gerade Leibe auf den Hinterfüssen allein wie die Affen zuweilen auf allen vieren längst der Erde. Die Schwartzen sagen dass es von Menschen entsprossen; aber durch das wilde Leben im Busche zum halben unvernünftigen Tiere sei worden. Diese Tiere leben vom wilde Honige und die Früchten in den Büschen: auch fechten sie fort und fort mit einander. Ja, sie dürfen nicht allein die Frauen ergreifen und nohtzüchtigen, sondern auch die gewafnete Männer selbst anfallen."

In December 1904 the Hon. Walter Rothschild, M.P., laid before the Society a valuable paper, entitled "Notes on Anthropoid Apes" †, and exhibited what was undoubtedly the finest

* R. I. Pocock, P. Z. S. 1905, vol. ii. p. 178.

† P. Z. S. 1904, vol. ii. pp. 413-440.

collection of mounted specimens, skeletons, and skulls ever brought together. In his paper Mr. Rothschild spoke of the *Satyros indicus* Tulp., and identified it with *Simia satyrus* Linn., claiming that the latter name must now be applied to a Chimpanzee—to quote his exact words, “the famous ‘Tschego’ proves to be the veritable *Simia satyrus*.”

Text-fig. 50.

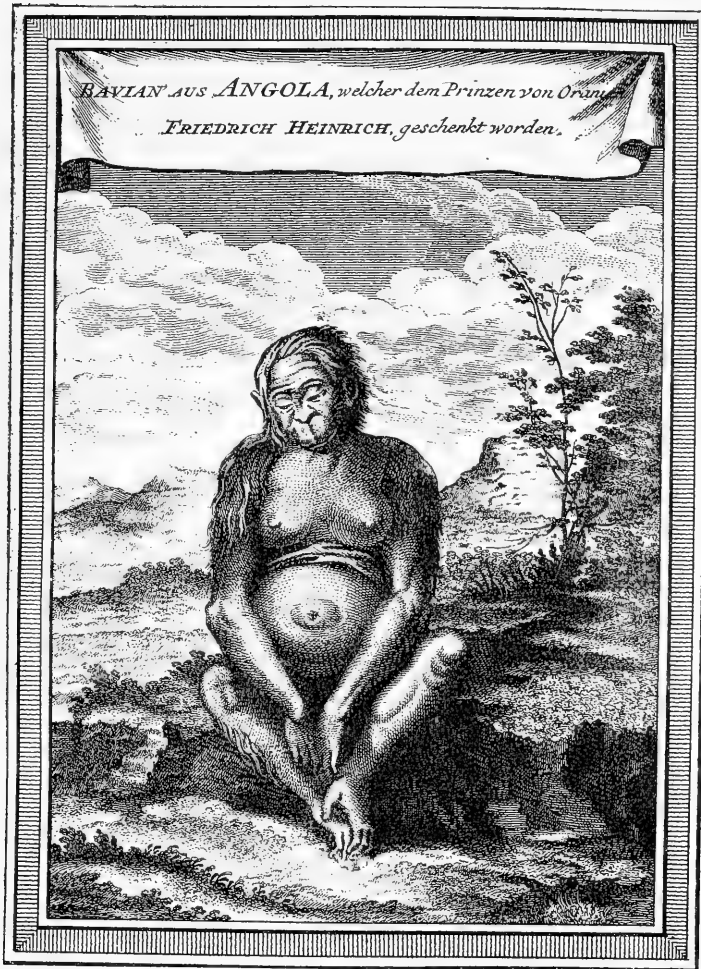

The *Satyros indicus* of Tulpius.

Mr. Scherren then quoted the following description by Tulpius

of the anthropoid presented at the end of the seventeenth century to Prince Frederick Henry of Orange:—

“Quamvis extra forum medicum, attexam tamen huic telæ Satyrum Indicum; nostrâ memoriâ ex Angolâ delatum: et Frederico Henrico Arausionensium Principi, dono datum. Erat autem hic Satyrus quadrupes: sed ab humana specie, quam præ se fert, vocatur Indis orang-outang: sive homo sylvestris, uti Africanis quoias morrou. Exprimens longitudine puerum trimum, ut crassitie sexennem.

“Corpore erat nec obeso nec gracili, sed quadrato habilissimo tamen, ac perniciosissimo. Artubus verò tam strictis et musculis adeò vastis: ut quidvis & auderet et posset. Anterius undique glaber: at ponè hirsutus, ac nigris crinibus obsitus. Facies mentiebatur hominem: sed nares sinæ, & aduncæ, rugosam, et edentulam anum.

“Aures verò nihil discrepare, ab humanâ formâ. Uti neque pectus; ornatum utrimque mamma prætumida (erat enim sexus fœminî) venter habebat umbilicum profundiorē; et artus, cum superiores, tum inferiores tam exactam cum homine similitudinem, ut vix ovum ovo videris similis.

“Nec cubito defuit requisita commissura: nec manibus digitorum ordo: neque pollicis figura humana: vel cruribus suræ, vel pedi calcis fulerum. Quæ concinna, ac decens membrorum forma, in caussâ fuit, quod multoties incederet erectus: neque attolleret minus gravate quam transferret facilè, qualecunque gravissimi oneris pondus.

“Bibiturus prehendebat canthari ansam, manu alterâ; alteram vero vasis fundo supponens, abstergebat deinde madorem labiis relictum, non minùs adpositè ac si delicatissimum vidisses aulicum. Quam eandem dexteritatem observabat utique cubitum iturus. Inclinans quippe caput in pulvinar, & corpus stragulis convenienter operiens, velabat se haud àliter, ac si vel mollissimus illic decubisset homo.

“Quin imo narravit aliquando affini nostro, Samueli Blomartio, Rex Sambacensis, Satyros hosce, præsertim mares, in Insulâ Borneo, tantam habere animi confidentiam, & tam validam musculorum compagem: ut non semel impetum fecerint, in viros armatos, nedum in imbellem, fœminarem, puellarumve sexum.

“Quarum interdum tam ardenti flagrant desiderio: ut raptas non semel constuprârint. Summè quippe in Venerem sunt proclives (quod ipsis, cum libidinis veterum Satyris commune) immo interdum adeo protervi ac salaces: ut mulieres Indicæ propterea vitent cane pejus et angue saltus ac lustra, in quibus delitescunt impudica hæc animalia.”

Mr. Scherren called attention to the discrepancy between the Linnæan diagnosis of *Simia satyrus* and the description of Tulpius with respect to form and size. Linnæus wrote: “Magnitudine pueri sexennis,” which differed widely from the words of Tulpius: “Exprimens longitudine puerum trimum, ut crassitie sexennem.” It was also suggested that the expression “corpore quadrato” suited a Gorilla rather than a Chimpanzee, and confirmation was

sought in the pictures by Wolf of Wombwell's Gorilla (from a daguerreotype) and a Chimpanzee from life which hung in the meeting-room. Sir Harry Johnston * had seen a reproduction of Tulpius's figure in Tyson's work on the Chimpanzee (London,

Text-fig. 51.

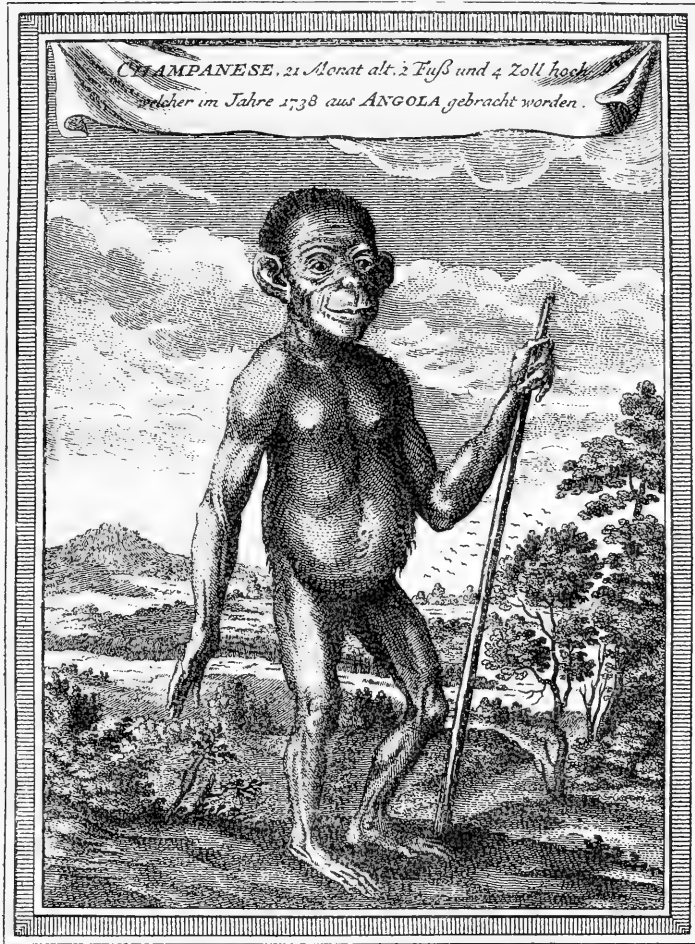

Early figure of Chimpanzee, from Astley's 'Travels.'

1699), and was struck by its resemblance to a Gorilla. Another picture (text-fig. 51) (with label, of which the following is a translation :—“ Chimpanzee, 21 months old, brought from Angola,

* P. Z. S. 1905, vol. ii. p. 72.

in 1738, 2 ft. 4 in. high") was thrown on the screen to prove that as early as 1746 the *Satyrops indicus* was recognised as differing from the Chimpanzee. This picture was said to have been taken from life.

It was usually said that the existence of an African anthropoid other than the Chimpanzee was not known till about the middle of the last century. This was not the opinion of J. E. Gray; for at a scientific meeting of this Society*, in calling attention to Wombwell's Gorilla, he alluded, but without quotation, to Bowdich's 'Mission to Ashantee' (London, 1819), where the "African Orang (*Pithecus Troglodites*)" was compared with the Gēna.

The following papers were read:—

1. On a Collection of Mammals brought home by the Tibet Frontier Commission. By J. LEWIS BONHOTE, M.A., F.L.S., F.Z.S.†

[Received August 9, 1905.]

(Text-figures 52 & 53.)

The collection‡ of mammals brought home by the Tibet Mission, and collected by Capt. H. J. Walton of the Indian Medical Service, although not large in numbers contains several specimens of great interest, and there can be no doubt but that the region is full of mammalian treasures, only waiting time and opportunity for their discovery.

Of the eight species of which examples were brought back, two, *Microtus waltoni* and *Cricetulus lama*, are new to science, while the large red Fox of the country is sufficiently distinct to be entitled to subspecific rank. In addition to these, I have been enabled for the first time to examine the skull of another Fox, *Vulpes ferrilatus*, described 63 years ago, but of which the skull-characters have hitherto remained entirely unknown. This skull shows features of great peculiarity, and proves the validity of *ferrilatus* as a species, a matter hitherto considered doubtful by some writers.

In addition to the specimens collected by Capt. Walton, the British Museum is indebted to Col. Waddell for two or three skins, an account of which has also been incorporated in this paper.

FELIS MANUL Pall.

Felis manul Pall. Reise Russ. Reichs, iii p. 692 (1776); Blanf. Faun. Br. Ind., Mamm. p. 83 (1891).

* P. Z. S. 1861, p. 278.

† [The complete account of the new forms described in this communication appears here; but since the names and preliminary diagnoses were published in the 'Abstract,' the former are distinguished by being underlined.—EDITOR.]

‡ A sketch-map giving all the localities in which this collection was procured is published in 'The Ibis' (1905, p. 57, pl. ii.).

a. ♂. Yamdok Lake, alt. 15,000', 28th Sept., 1904.

This specimen, the only one procured, was brought home by Col. Waddell.

VULPES VULPES WADDELLI.

Vulpes vulpes waddelli Bonhote, Abstr. P. Z. S. No. 22, p. 14, Nov. 21, 1905.

a. Khamba Jong, alt. 16,400', 8th Oct., 1903.

b. Phari Jong, Upper Chumbi Valley, 11th Jan., 1904 (*coll. Waddell*).

General colour above reddish fulvous, the median dorsal area from the occiput to the root of the tail being bright red, shading to pale buff on the flanks and hindquarters. The head rufous; the ears moderately large and pointed, being clothed with long white hairs on the inside and short black ones externally. Feet rufous along their margins and white or grey in the centre. Tail long, woolly, and very bushy, tipped with white; each hair being pale fulvous at its base, with a long, black, terminal portion. Underparts pure white.

The *skull* does not show any special characters by which it may be distinguished from that of the typical form. It is stout and well built, being short and broad in the muzzle and rather swollen in front of the orbits, but otherwise it shows no features of note.

Dimensions of type (in flesh). Head and body 25 in.; tail 16 in.; hind foot 6 in. Height at shoulder 14.75 in. Weight 8 lbs.

Skull. Greatest length 145 mm.; zygomatic breadth 72; width in line with ant. root of pm. 4, 37.5. (Further skull-dimensions are given under the next species.)

Habitat. Khamba Jong, Tibet, alt. 16,400'.

Type. B.M. 5.4.6.1. Collected 8th October, 1903, by Capt. Walton.

This race may be readily distinguished from *V. v. flavescens* by its much brighter coloration throughout, and especially by the deep red median dorsal area. In the true *flavescens* the back is much more uniform in colour, the median dorsal area being but very slightly darker than the surrounding parts and of a more brownish yellow, the red tint being entirely lacking.

The local name is "Wamo."

VULPES FERRILATUS (Hodgs.).

Vulpes ferrilatus Hodgs. J. A. S. B. xi. p. 278, pl.; *Blanford, Fauna Br. Ind., Mamm. p. 155 (1891); Mivart, Mon. Can. p. 121 (1890).*

a. Karo-La Pass, alt. 16,600', 30 miles E. of Gyangtse.

The only specimen procured is a typical example of *V. ferrilatus*, but in very bad fur. This species may always be recognised by the underfur, which, besides being close and woolly, is fulvous to the base. The peculiar and woolly character of the fur throughout is quite sufficient to distinguish it from all other species.

Capt. Walton writes :—"The small fox does not, I feel pretty sure, occur near Khamba Jong, all the foxes seen there being of the large species (*V. v. waddelli*, ante). I saw other foxes almost certainly of this species between Karo-La and the neighbourhood of the Yam Dok Cho (Lake Palti)."

Accompanying the skin is a very fine adult skull (text-fig. 52), which, so far as I am aware, has never before been described. This skull is quite unlike that of any other species of Fox, and is characterised by the extreme slenderness and elongation of the muzzle and the great length of the upper canines. The brain-case

Text-fig. 52.

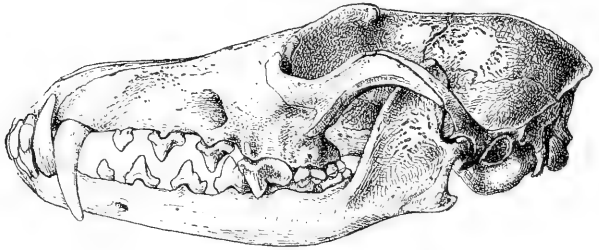

A

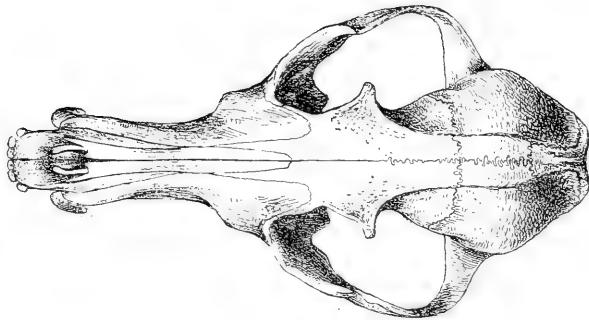

B

A, lateral, and B, upper view of the skull of *Vulpes ferrilatus*. $\frac{1}{2}$ nat. size.

and zygomata, on the other hand, do not show any signs of lateral compression or elongation, but are fairly normal in their dimensions and breadth. The supraorbital processes are stout and well developed, and the brain-case gradually widens out from immediately behind these processes and reaches its greatest breadth in line with the posterior roots of the zygomata. On the under side we may note the narrowness of the soft palate and the tendency of the pterygoids to approach each other posteriorly. The bullæ are more elongated and less rounded than usual. The dentition, which

is normal, except for the great length of the canines already noted, calls for but little comment. The spaces between the premolars are large in correlation with the length of the muzzle, and the first upper molar is relatively small.

Dimensions :—

	<i>V. ferrilatus.</i> mm.	<i>V. v. waddelli.</i> mm.
Greatest length	155	145
Basal length	138	130
Palatal length	78	71
Length from post. end of palate to basioccipital	60	59
Length from last incisor to ant. root of 1st premolar (alveoli)	19	16
Length of premolar series	48	39
Breadth of brain-case immediately behind supraorbitals	26	23
Greatest breadth of brain-case.....	50.5	49
Zygomatic breadth	84	72
Breadth of muzzle at ant. root of 2nd premolar	19	23
Length of upper canine along its anterior margin.....	29	20

This comparison of dimensions will show more clearly than any description the main features in which this skull differs from that of the more typical "*Vulpes*"; and in spite of the doubt of Mivart* there can be no question that *ferrilatus* not only is a good species, but is more differentiated than any other species in the region.

The only other skull of *ferrilatus* known is a very young one collected by Mr. Hodgson; it is, however, too young to show any of the specific characters enumerated above.

PUTORIUS ALPINUS (Gebler).

Mustela alpina Gebler, Mém. Soc. Imp. Nat. Moscou, vi. p. 213 (1823).

Putorius alpinus Blanford, Faun. Br. Ind., Mamm. p. 168 (1891).

a. ♂ ad. (in spirit). Gyantse, alt. 12,900', 1904.

b. ♂. Khamba Jong, alt. 15,500', 11th Sept., 1904.

CRICETULUS LAMA.

Cricetulus lama Bonhote, Abstr. P. Z. S. No. 22, p. 14, Nov. 21, 1905.

a. ♂ ad. Lhasa (skinned from spirit).

b. ♂ ad. Lhasa (in spirit).

The *Cricetulus* referred to † as "the little white mouse" is

* *Loc. cit. ante.* † Percival Landon: Tibet, App. by H. J. Walton (1905).

represented in the collection by two spirit-specimens, one of which has since been skinned. It appears, although closely related to *Cricetulus phæus*, to have been hitherto undescribed.

Size about that of *C. phæus*. General colour above pale fulvous grey, greyer than in *C. phæus*.

Each hair is slate-grey at its base, fulvous for about $\frac{1}{3}$ of its distal end and with a black tip. Over the head and fore part of the body the fulvous portion of each hair is the more conspicuous. but on the hinder part of the back the dark tips predominate and a faint dark median dorsal line may be traced. The underparts are pure white, the hairs being slate-grey at their base. The line of demarcation between the upper and under parts, although abrupt, is very uneven in outline. The feet are but scantily clothed with hair and are white. The tail is moderately long and stout, well clothed with dark brown hairs above and white hairs below; the tip is white.

The whiskers are for the most part black with a white tip, some shorter ones, however, being entirely white.

The skull resembles somewhat closely that of *C. phæus*, but is slightly larger and the brain-case more inflated and rounder. The chief points of difference, when viewed from below, are the greater width of the basioccipital and the much flatter and smaller bullæ in the new species. Above there is a slight, although very constant, difference in the hinder margin of the parietals, which are practically straight in outline; whereas in *C. phæus* there is a sharp turn backwards when about two-thirds of their length from the middle line.

Dimensions (of type when in spirit). Head and body 87 mm.; tail 40; hind foot 17; ear 16.

Skull. Greatest length 28.5 mm.; basal length 24; palatal length from hensenion 12; interorbital breadth 5; greatest breadth of brain-case 12.5; width of basioccipital at anterior end of auditory bullæ 3.

Habitat. Lhasa, Tibet.

Type. B.M. 5.4.6.4. Collected at Lhasa, Tibet, by Capt. H. J. Walton, I.M.S.

The darker colour of the hinder part of the back combined with the general much greyer coloration, and in addition the somewhat longer and stouter tail, form characters by which this species may be distinguished from *C. phæus*. The animal, according to Capt. Walton, was extremely common, and was swarming in one of the shrines of the Jo Khang Cathedral at Lhasa.

MICROTUS (PHAIOMYS) WALTONI.

Microtus (Phaiomys) waltoni Bonhote, Abstr. P. Z. S. No. 22, p. 14, Nov. 21, 1905.

a. ♀ ad. Lhasa, Tibet.

Slightly smaller in size than *Ph. blythi*, to which it is by skull-

characters closely allied, though widely differing in colour. General appearance above fulvous grey, slightly greyer over the anterior part of the body; below very pale buff. Each hair is slate-grey from its base and for the greater part of its length, with a fulvous subterminal portion and dark tip. On either side, between the limbs, the dark tips are absent, leaving a clear fulvous patch. Interspersed in the fur are a few thin black bristles. The feet are whitish, both palms and soles are 5-tuberculate. The tail is bicolor. The ears small and sparsely covered with hairs similar in colour to those on the rest of the body. Mammæ eight in number, four pectoral and four inguinal.

Skull. The dental characters are practically identical with those of *Ph. blythi*. The skull itself is very similar in general outline, but slightly smaller; this is especially noticeable in the bulle,

Text-fig. 53.

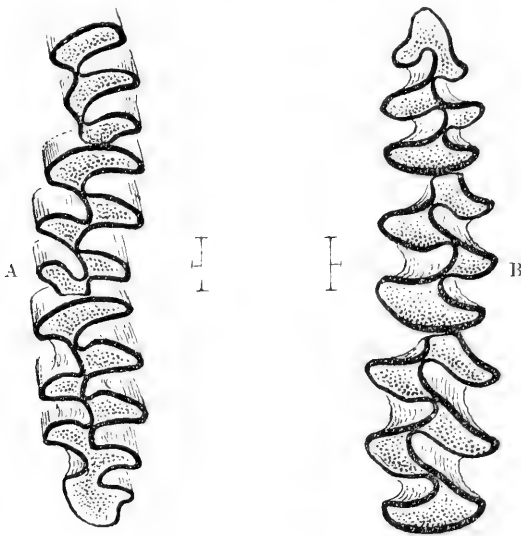
A, upper, and B, lower right molar series of *Microtus waltoni*.

which do not stand out so prominently from the rest of the cranium.

Dimensions of type (from spirit). Head and body 98 mm.; tail 30; hind foot 17; ear 10.5.

Skull. Greatest length 28 mm.; basilar length 24.5; zygomatic breadth 16.5; interorbital breadth 4; length of nasals 7; diastema 8.2; palatal length 15; length of molar series (text-fig. 53) (alveoli) 7.

Habitat. Lhasa, Tibet.

Type. B.M. 5.4.6.5. ♀ ad. Collected by Capt. H. J. Walton, I.M.S.

This interesting species cannot well be confused with any other,

as the skull-characters clearly prove it to belong to the subgenus *Phaiomys*, and its colour is quite unlike any of the other species of that group.

LEPUS OIOSTOLUS Hodgs.

Lepus oiostolus Hodgson, J. A. S. B. ix. p. 1186 (1840); Blandford, Faun. Br. Ind., Mamm. p. 452 (1891).

a. Khamba Jong, Oct. 1903.

Apparently the common Hare of Tibet, two more skins having been brought home by Col. Waddell. Capt. Walton states that this hare, which, as a rule, avoids cultivated land and frequents bare and rocky hillsides, was very common at Khamba Jong and also at Tuna at the head of the Chumbi Valley. It was, however, much scarcer, although still occurring, between Gyantse and Lhasa.

OCHOTONA CURZONÆ (Hodgs.).

Lagomys curzonæ Hodgs. (nec Stoliczka) J. A. S. B. xxvi. p. 207 (1858); Blandford, Faun. Br. Ind., Mamm. p. 457 (1891); Bonhote, P. Z. S. 1904, vol. ii. p. 214.

a. ♀. Yamdok Lake, 14,800', 29th Sept., 1904.

b, c. No particulars.

d. Ad. in spirit. Tuna.

The specimen from the Yamdok Lake had evidently just assumed its new winter pelage, the other two skins being in old and worn fur. Tuna, where the spirit-specimen was procured, is only a few miles north of the Chumbi Valley, the type locality of the species.

Capt. Walton writes of this species:—"They are exceedingly common at Khamba Jong, Tuna, and in all the open bare country from Tuna to Gyantse, as well as between Gyantse and Lhasa. They, however, become less common as one approaches Lhasa, probably because the country is more cultivated. They avoid cultivated fields for the most part, and were always commonest in bare sandy country. They do not hibernate at all, and on any sunny day in the middle of winter they might be seen sunning themselves at the entrance to their burrows. I dug up a few burrows during the winter. The tunnel runs more or less vertically downwards for 1 or 2 feet and then somewhat horizontally for 4 to 6 feet. The passage is dilated at irregular intervals in some two or three places. At these spots and at the end of the burrow, which is also dilated, there is a certain amount of coarse grass collected to form a kind of nest. The ground in many places is honeycombed with these burrows, which sometimes communicate with one another close to the mouth, but as a rule they are quite distinct. I never heard the animal utter a cry of any sort."

2. Notes on the Geographical Distribution of the Okapi.

By Dr. EINAR LÖNNBERG, C.M.Z.S.

[Received August 28, 1905.]

I have had the pleasure recently of meeting my compatriot Lieutenant Karl Eriksson, who delivered to Sir Harry Johnston the first skull and skin of the Okapi. I took this opportunity of asking Lieutenant Eriksson about the distribution of this remarkable animal, and his reply was that he believed it to be distributed practically over the whole of the "equatorial forest" of the Congo Free State. He showed me on the map of the Congo basin appended to Mr. Boulenger's work, 'Les Poissons du Bassin du Congo'*, the approximate limits of this area of distribution. If we begin at the River Ubangi in the west about midway between Mobena and Jmese, from there the limit extends north-east towards Businga at the River Likame or somewhat north of that place, and then more east to the River Uele just before it joins the River Ubangi. From that place and eastward the River Uele is the northern limit to a point about midway between Amadi and Suruaugo. From there it turns south-east, passing somewhat east of Mawambi, and continuing to a point a little west of Karimi. Not much south of this, the most eastern point of the great forest, the boundary-line turns westward again and crosses the great Congo River at Ponthierville, and continues westward a little south of Tschuapa River, but bends by-and-by a little north, so that it passes on the northern side of Bolondo towards Coquilhatville. It is evident that this is only a rough outline of the area of distribution of the Okapi, but it may hold good in a general way.

Outside this boundary-line there are many forest-clad areas, but they are not extensive, and Lieutenant Eriksson does not believe that they are inhabited by the Okapi. It is an inhabitant of the great forest, but does not live everywhere in it. Its regular pasture-grounds are open glades in the forest, where rivulets with shallow water expand and produce a rich growth of grass. This grass and the leaves of the bushes and undergrowth under the trees, which are especially luxuriant in such places, may form the principal food of the Okapi. Although a shallow sheet of water expands over the very flat ground to greater or less extent in these glades, there are no swamps. The soil is hard and firm †, which explains the shape of the hoofs of the animal. Lieutenant Eriksson has not seen the Okapi in a living state in its natural surroundings, as probably no white man ever has or is likely to do. But he has, while on his marches during the night,

* Bruxelles, 1901.

† Because gravel or hard red earth lies quite near the surface.

many a time heard it run away when he passed such glades as described above.

The Okapi is extremely wary and shy, and nocturnal in its habits. It lives singly or perhaps in pairs, never in herds. The negroes know very little about it, and, as a rule, it is only the Wambutti-dwarfs who are able to kill it. These dwarfs are perhaps the most perfect of all hunting tribes and steal up near the animals, slaying them with spears.

How little the negroes (not counting the dwarfs) know about the Okapi, may be concluded from the following ridiculous tale told and believed by them. They have observed that the Okapi is very cleanly, and even during the rainy season, when almost all other animals are more or less dirty, its skin is just as clean as ever. The negroes say then that the Okapi climbs up in the trees (!) to keep itself clean and to avoid the dirty muddy soil.

I have used the name Okapi as that is the one known to the zoological world, and has become the *nomen triviale* of this interesting mammal. Lieutenant Eriksson informs me, however, that it was only a mere chance that it happened so. Okâpi (with long-drawn â) is only used by the Wambobba tribe for signifying this animal. The Wambobba language is hardly spoken by more than 300 persons, but it was Wambutti-dwarfs, living in harmony with Wambobbas and speaking their language*, that brought the first remains of the Okâpi, hence the name. (The first complete specimens were procured by another tribe of Wambuttis belonging to Wabira negroes, which use another name mentioned below.) But it is still worse, because the word "Okâpi" means simply in the Wambobba language "donkey" or "ass." Strictly speaking, therefore, the latinised "*Okapia*," which became the second and permanent scientific generic name of this mammal, is not much better with regard to its original meaning than the first generic term "*Equus*," applied before anything but a piece of skin was known.

The name by which the Okapi is known in most of the Congo languages is "Dumba."

I am glad to be able to add that the Okapi is protected by law, so that it is forbidden to kill it without special permission. The Wambutti-dwarfs and the leopards do not, however, respect any laws, and therein lies the danger for the existence of this animal.

Lieutenant Eriksson has also told me that in the great forest a kind of black wild hog is to be found, which may be the recently described *Hylochaerus meinertzhageni*. These hogs are called by the negroes "n'gulube bibi," which means "black hog," whilst "n'gulube" = hog is the name of the common Red River-Hog (*Potamochoerus porcus*).

* The Wambuttis always use the language of those negro tribes with which they live in symbiosis, and from which they obtain vegetables for meat and honey from the forest.

3. Notes on the Goral found in Burma.

By Major G. H. EVANS*.

[Received September 2, 1905.]

The Himalayan range in Assam gives off a succession of spurs southward to form a tract of mountainous and, in many parts, almost impassable country extending into Arakan and Burma, and inhabited by numerous wild tribes. That portion of this tract lying between Assam and Manipur to the north, Chittagong and Tipperah on the west, Arakan on the south, and Burma on the east, is now known as the Chin-Lushai Hills. These so-called hills vary in their altitude from 1000 to 10,000 feet.

I was employed in what was known as the Southern Chin Hills from November till June 1889-90, and during my stay visited several Chin villages. Like many others who have visited these people, I came to the conclusion that Chins generally, and their chiefs in particular, have one hobby at least, viz., collecting skulls. Outside and inside the villages, skulls were to be seen stuck on posts or kept in the houses. The finest collection I met with was in the house of a Bounghé chief, whose tribe is thus called by the Burmans, from the method in which they dress their long hair. The whole hair is done up in a large knot placed well forward on the top of the head, almost on the forehead, and round this ball of hair is wound, round and round, usually a white turban with a blue stripe through the centre. In the chief's house was a collection of skulls, excellent as regards the number and variety. The heads ranged from those of elephants to palm-civets, and I doubt if there are many museums which could excel the collection of monkey skulls, at least numerically. The chief enjoyed the reputation of having been a mighty Nimrod in his youth, and I was informed that he had shot practically every head in the collection. I noticed one splendid gaur skull, three or four fine mythun or gayal, several sambar and serow, also some small heads which I concluded must be goral. Game throughout the hills was scarce, a matter not to be wondered at, inasmuch as every Chin had a gun of some sort, and in addition was always trapping and snaring. I was assured that the Goral heads had been obtained in the hills, but that now the animals were very scarce. I had no opportunity of verifying at this time the presence of Goral in these hills, and any attempt to do so would have been a matter of considerable risk owing to the most unfriendly attitude of the people. Many months later I happened to be in a Burmese village some hundred miles distant, but on the confines of the South Chin Hills, and there discovered in a house the skull of a Goral identical with those above mentioned. On enquiry from the Burmans I learned that it had been obtained from some Chinbóks, another tribe of Chins near Lounghé in the Yaw country. As

* Communicated by R. LYDEKKER, F.Z.S.

the Burmans dare not venture into Chin-land, they could afford no definite information beyond that the Chins had told them that there were several of these animals on a certain high mountain now known as Mount Victoria. Since then several Goral have been shot there by policemen on outpost and others.

During the season of 1896-97 I visited the Arakan Hill-tracts, which are merely a southern continuation of the Chin Hills into the Akyab district of Arakan. Here again I came on a skull and a skin (the latter in a very bad state of preservation) of this Goral. This animal, from the horns evidently a female, was shot in the hills at a place not very far distant, and local informants said that there were a fair number. Being unable to visit the place at that time, I told a friend of the ground, and asked him to find out if what I had heard was correct. He did so, and came across some six animals, of which he shot a couple. One of these, owing to the ground, it was impossible to recover. I sent a skull for identification, and was informed that it was a Himalayan Goral. I was unacquainted with the Indian Goral, but from the descriptions in books I was not quite satisfied that it was the same animal. Later on, while after Serow in the Shan range of hills to the east of the Irrawaddy, I was much surprised again to run across these animals. I was still more convinced that the beast was not the same as the Indian Goral, so much so, that I asked a friend to shoot an Indian Goral and send me a head and skin, which he very kindly did. On comparison my suspicions were confirmed. I was then most desirous to procure a specimen for the British Museum, but luck was against me, as it was a long time before I ran across them again.

The following are the chief characteristics of these Goral :—

General form.—Goat-like with sturdy limbs. Horns are present in both sexes : those of the female are shorter, thinner, and not so rough as those of the male. They are generally almost parallel, *i. e.* only slightly divergent, and have a slightly backward curve. The coat is moderately long, close, and the hair rather coarse ; there is generally a well-marked underfur. The mammae are four in number.

General colour.—A dark, more or less rat-grey, with an admixture of longish, dark, rufous-tipped hairs running through the coat, but mostly on back and upper surface of body. In an old buck the back, haunches, and upper portions of sides were dark pepper-and-salt or grizzled grey. In a young specimen the colour was generally lighter. There is no distinct dorsal stripe : in a young animal a very faint but distinct brownish line was traceable, extending from the nape to the dock, and in the skin of a female also, when held in a good light, a darker brownish median line could be discerned. The colour fades gradually on the side to a dirty reddish white under the abdomen. The colour about the back of the neck is a lighter grey than that of the body, and the hair is longer. A distinct crest of longer hair of a blackish-brown colour extends from between horns to behind the

ears. The hair surrounding base of horns is also long and of a rufous tint.

The face is ruddy brown, passing into grey on the cheeks, and to a fainter and almost whitish colour around the eyes and lips. The throat is a yellowish white. The hair on the outer surface of the ears is rufous; whitish on the inner surface. The muffle is black in colour and naked. The tail is black or brownish black, and has a tuft of long hair of varying length. The colour of the iris is reddish brown.

The Limbs: Fore legs.—Outer aspect a dark brown or yellowish red to just above the knees, and this colour is continued on the posterior aspect of lower limb to hoofs. The anterior aspect from below the knees, or in some cases just above the knees, is a yellowish white.

Hind legs.—Outer aspect of thigh brownish, the posterior aspect of the hocks dark brown, continuing down posterior aspect of lower limb. The anterior aspect below the hocks is a dirty white.

Horns.—Short, black in colour, conical, irregularly ringed, especially at the base in males. The annular markings extend for about three quarters of the total length on the posterior aspect of the horn; they appear to be rubbed off in front. The horns are set close, and in some cases are almost parallel. For the first inch or so from the base they are straight, then curved slightly backwards, and are slightly divergent towards the tips.

Measurements of Horns.

	1.	2.	3.	4.	5.
	inches.	inches.	inches.	inches.	inches.
Right horn	5	4	3 $\frac{1}{4}$	3 $\frac{1}{2}$	4 $\frac{1}{2}$
Left horn	4 $\frac{7}{8}$	4	3 $\frac{1}{8}$	3 $\frac{5}{8}$	3 (broken)
Girth.....	2 $\frac{3}{4}$	2 $\frac{1}{2}$	2	2 $\frac{1}{2}$	2 $\frac{1}{2}$
Between horn-cores ...	$\frac{3}{4}$	$\frac{3}{4}$	$\frac{7}{8}$	$\frac{3}{4}$...
Between points	2 $\frac{1}{4}$	1 $\frac{7}{8}$	2 $\frac{1}{4}$	2	...

Dimensions.

	♂. inches.	♀. inches.
Height at shoulder	25 to 27	25 to 27
Girth behind shoulder	29 $\frac{1}{2}$	27
Length from nose to tail	50 $\frac{1}{2}$	50
Tail: average of five specimens.....	4 $\frac{1}{2}$	
Tuft: average of five specimens	2 $\frac{3}{4}$	
Length of ears.....	3 $\frac{1}{2}$ to 4 $\frac{1}{2}$	
Length of head	10 $\frac{3}{8}$	10
Breadth across orbits	4	3 $\frac{1}{4}$ to 3 $\frac{3}{4}$
Length of horns	5	4 $\frac{1}{2}$
Girth of horns.....	2 $\frac{1}{2}$ to 2 $\frac{3}{4}$	2
	22*	

Distribution.—So far as is at present known to me, in the localities noted, and at elevations above 3500 feet. These Goral appear to be rather localised, and I should say are uncommon. It is reasonable to expect, however, that when a more intimate knowledge of the higher ranges is gained, the distribution of these animals may be found to be more extensive.

These Goral, I believe, extend into Siam and are to be found in suitable places on the Siamese side of the Thaungyin River, and also occur, but are more scarce, about the hills at the headwaters of the Me-Ping.

Habits.—As has been recorded in the case of the Indian form, these Goral live in parties of four, six, or even a dozen. They inhabit very steep ground and the more precipitous it is the better they seem to like it. They are never to be found at any distance from rugged, rocky ground, even though there may be forest near by. The only time they may be found away from dangerous ground is during the early hours of the morning and late in the evening, when they graze on the grassy patches close by. No doubt when the sky is overcast, as is the case during the rains, or in the cold weather when there is a heavy mist, they feed much later. Apparently they are inclined to remain always about any favourite locality. Their sight seems to be extraordinarily good, and they appear to rely more on this sense than on smell or hearing. The day is usually passed lying on inaccessible ledges of rock about precipices.

If a Goral is startled it jumps up and makes a short sharp hissing or sneezing noise, very often repeated at short intervals. It may be a note of alarm or a call to its mates, for as sure as one calls, if there are any others about (and this is generally the case), it is immediately answered. In Burma, at least, these Goats are not easily followed, unless by expert cragsmen; and in this category I do not include myself.

Goral, when standing about these crags, afford fairly easy shots with high-velocity rifles, but the recovery of a carcass is, as a rule, by no means an easy matter. The shikaris and followers are generally anything but keen on a trip down one of these precipices, and I for one do not blame them. Though they may be adepts in woodcraft, they cannot be anything like the cragsmen (hill-shikaris) met with in the Himalayas. Goral-flesh is not at all bad. From December till May is the best season to hunt these animals, and morning and evening is the best time to find them, as they are then grazing or lying down in places more accessible.

I sent specimens of the skin &c. of this Goral to Mr. Lydekker, by whom the animal has been named after myself, *Urotragus evansi*.

I have to thank Captains Blakeway and Wood, R.E., and Mr. W. B. Tydd, of the Burma Civil Service, for their kindness in helping me in this matter.

Rangoon, 1st June, 1905.

4. On the Mammals of Crete. By DOROTHEA M. A. BATE*.

[Received September 6, 1905.]

The following list of the wild mammals known to inhabit Crete is based on a small collection made in the island during a stay of four and a half months in the earlier part of last year (1904). This includes only sixteen species, but it is quite possible that a species of *Crocidura* may have to be added to the number, for remains of a Shrew were found in more than one Pleistocene cave-deposit in the western part of the island, and it is not unlikely that it may yet survive. It is probable that a Roedeer still existed in the island during the earliest historical times. Four species seem to be here recorded for the first time from this locality; these are *Rhinolophus ferrum-equinum*, *R. hipposideros*, *Micromys sylvaticus hayi*, and *Acomys dimidiatus minois*.

In his work on Crete † published in 1869, M. V. Raulin gives a list of thirteen species, amongst which is included the Polecat as well as the Beech-Marten and Weasel; however, no specimens appear to have been obtained, so that their occurrence may have been admitted on insufficient evidence or as the result of some confusion with regard to the other members of the group. Admiral Spratt ‡, in describing the country between Eremopoli and Palaikastro, mentions that Foxes occur there; but this was doubtless a slip, for elsewhere (vol. ii. p. 157), in reference to the safety of the flocks of sheep, he says that "Crete has no wild animals but badger and weasels or martens." Dr. Lorenz-Liburnau has written at some length on the Wild Goat of Crete; and in 1903 Major Barrett-Hamilton described the Hare, and noticed the Badger and Beech-Marten, at the same time remarking on the paleness of the specimens from this locality. The same may be said of the Cretan Hedgehog and Rabbit, but is not the case with the Weasel and Spiny Mouse, which are both richly coloured forms.

Crete has, in all probability, been isolated as an island for a considerable period, therefore it is not surprising to find that there are a number of localised forms amongst the Mammalia. Admiral Spratt, whose valuable researches were carried on in so many parts of the Mediterranean, was of opinion § that Crete was connected in earlier times with Europe (including Asia Minor), and not with the north coast of Africa as tradition would have us suppose ||. Suess ¶ would also seem to link this island rather with the northern than the southern boundaries of the Mediterranean. The mammalian fauna, as well as the recent land-

* Communicated by OLDFIELD THOMAS, F.Z.S.

† Description Physique de l'Île de Crète, 2 vols., Paris, 1869.

‡ Travels and Researches in Crete, 2 vols., London, 1865 (vol. i. p. 205).

§ *Op. cit.* vol. ii. pp. 408-10.|| *Ibid.* pp. 278-9.

¶ La Face de la Terre, vol. ii. p. 713.

shells, of the island shows a decided preponderance of European types; the only suggestion of a North-African relationship being found in the Wild Cat and perhaps the Spiny Mouse.

I should like to take this opportunity to express my thanks to Mr. Oldfield Thomas, who has again most courteously given me every facility for working out my collection in his department of the British Museum (Natural History).

List of Species.

1. RHINOLOPHUS FERRUM-EQUINUM Schreb.

In the latter part of March three large Horseshoe Bats were secured in a cave close to the sea, on the north-west coast of the island.

2. RHINOLOPHUS HIPPOSIDEROS Bechst.

Only one specimen of this Bat was obtained, from a cave in the hills south of Khania. Neither this nor the above mentioned species appears to have been previously recorded from Crete.

3. MYOTIS MYOTIS (Bechst.).

When visiting the extraordinary underground quarry known as the Labyrinth, near Haghia Dekka in the south of the island, one of the galleries was found to be tenanted by hundreds of Bats belonging to this species. They were hanging from the roof in large clusters and became very noisy when approached. Four specimens were preserved, and these appear to be somewhat smaller than examples from the Continent. These underground galleries have evidently been inhabited by this species of Bat for many hundreds of years; their occurrence in the "Labyrinth" was noticed by Tournefort as early as about 1700*.

4. MINIOPTERUS SCHREIBERSI (Natt.).

Two examples of this species were also procured, and several others observed, in the so-called Labyrinth. These, however, occurred singly, and in galleries other than those occupied by *Myotis myotis*.

5. ERINACEUS EUROPÆUS NESIOTES, subsp. n.

On comparing the three specimens obtained of the Cretan Hedgehog, these were found to differ from all the forms of *E. europæus* represented in the British Museum collection; therefore this island race may be given subspecific rank.

In external characters it seems to most closely resemble *E. e. italicus* Barr.-Ham. †, from which it may be distinguished by its slightly smaller size, dingy appearance, and the lighter

* See Raulin, *op. cit.* vol. ii. p. 1033.

† Anu. Mag. Nat. Hist. ser. 7, vol. v. April 1900, p. 364.

colour of the fur. In one specimen (No. 17) this is almost pure white except on the face, hands, and feet. The spines are shorter and more slender, whilst both the short and long hair of the underparts is much scantier.

The following measurements (in millims.) were taken in the flesh :—

	Head and body.	Tail.	Hind foot.	Ear.	Basal length of skull.
No. 9 (♂) (type)	208	29	40	29	51·5
No. 17 (♀)	34	37	28·5	48
No. 8 (♀)	204	...	38	26·5	50·5

The skull differs from that of *E. e. italicus*, and resembles that of *E. e. roumanicus* Barr.-Ham.* in having the frontal processes of the premaxillæ squared posteriorly, and further these only extend backward for less than half the length of the nasals.

In Crete, Hedgehogs are common in the low country, but were not met with in the hills. In captivity they will eat oats freely as well as a more natural diet of eggs &c.

6. FELIS OCREATA† AGRIUS‡, subsp. n.

This species is the chief exception to the general European appearance of the mammalian fauna of the island, being unmistakably African in type and belonging to the *Felis ocreata* group. The two specimens obtained were bought, at different times, in the bazaar at Khandia, and therefore are unaccompanied by any measurements taken in the flesh, though they appear to have been large and robust. In one of these, No. 35, the type, which is in summer coat, the average length of fur on the back is about 32 mm., while in the other, No. 36, evidently a winter specimen, the fur is much thicker and longer, averaging 45 mm. in length on the back, and there is at the same time a corresponding difference in the intensity of the markings of the dorsal region.

The Cretan race may be distinguished from specimens from Abyssinia, the type locality, and Egypt, by their much more distinctly marked stripes, both longitudinal and transverse, and by the greater number of rings, or half-rings, on the tail, which is short. As Mr. de Winton has mentioned§, these markings of the dorsal region are more distinct in short-coated specimens; and on comparing them it is found that even the long-haired Cretan skin is more strongly marked than short-haired ones from Abyssinia and Egypt in the British Museum collection. The same holds good in the case of a short-haired specimen from Machakos (B.M. 92.12.3.2.), which otherwise somewhat closely resembles the skin in winter pelage from Crete. It may also be mentioned that some specimens from Abyssinia show a

* *Op. cit.* p. 365.

† For use of this specific name see Mr. H. Schwann, "On *Felis ocreata* and its Subspecies," *Ann. Mag. Nat. Hist.* ser. 7, vol. xiii. June 1904, pp. 421-2.

‡ From *ἀγρεὺς*, a hunter.

§ Zoology of Egypt (Anderson), London, 1902, p. 173.

tendency towards a sandy colouring; this is especially noticeable in a skin from Zoulla (B.M. 69.10.24.9.), in which the transverse dorsal bars are much broken up, causing a somewhat "spotty" appearance.

In the specimens from Crete the proximal portion of the fur is decidedly dark over almost the entire body; this feature is hardly noticeable in those from Abyssinia, and is not so strongly marked in the examples examined from Egypt. The increased richness in colour of the Cretan race is no doubt chiefly due to climatic influences: a still further divergence in this particular direction is exemplified by the wild cat, *F. o. sarda* Lataste, from the more westerly island of Sardinia.

Hybrids between *F. o. agrius* and the domestic cat of the island appear to be not uncommon, and this can easily be accounted for by the fact that formerly small villages were often totally deserted for a considerable time, or possibly entirely, during the insurrections which occur so frequently in Crete, when the cats, as well as the villagers, are forced to take to a life in the hills. Skins of these hybrids, which are generally of large size like the true wild race, may often be seen hanging up in the bazaars at Khania and Candia.

F. o. agrius was recorded by Raulin* as *F. catus*.

7. MELES MELES MEDITERRANEUS Barr.-Ham. †

Only two immature specimens of this Badger were obtained; these came from an earth in a rocky mound, on the crown of which is perched one of the several monasteries of the Lasseth Plain.

The local name for the Badger is "Arkalos" (ἄρκαλος); it is plentiful in the island, and is killed in some numbers by the natives, the richer of whom use the skins for saddle-cloths and for making into purses &c.

8. MUSTELA FOINA BUNITES‡, subsp. n.

Five skins of the Cretan Beech-Marten were obtained, and have been carefully compared with those of *M. f. leucolachnea* Blanf., from Turkestan, with which two specimens from Crete, already in the British Museum collection, were formerly identified§. However, the examples from these two localities are found to differ considerably and to be easily distinguishable; therefore it is proposed that the island form be known by the above-given subspecific name.

In length and woolliness of coat *M. f. bunites* is intermediate between the typical *M. foina* and *M. f. leucolachnea*, though in general appearance it most closely resembles the latter. From this it differs in its much duller and more uniform colouring,

* *Op. cit.* vol. ii. p. 1033.

† *Ann. Mag. Nat. Hist.* ser. 7, vol. iv. pp. 363-4.

‡ From βουνιτης, a dweller on hills.

§ *Ann. Mag. Nat. Hist.* ser. 7, vol. iv. Nov. 1899, p. 313.

which is partly caused by the slighter contrast between the upper and under fur and by the lack of any gloss on the brown hairs, particularly on the paws and tail. The tail is very much less bushy and the fur shorter, in one specimen having an average length on the back of 25-26 mm., while in a skin from Vernoe, Turkestan (B.M. 83.4.21.2.), it is about 43 mm. The size and shape of the throat-patch seem to be even more variable in the Cretan race than it is in others; in one example of the former (No. 31) it is represented by only a few white hairs on either side of the throat close to the fore legs. The following measurements of the type (No. 34) were taken in the flesh:—

Head and body 403 mm., tail 255, hind foot 79, ear 39. The basal length of the skull is 75 mm., and the zygomatic breadth 58 mm.

It is perhaps worth noting that *M. f. bunites* also has much closer and shorter fur and a less bushy tail than the type of *M. f. mediterranea* Barr.-Ham.*, from Andalucia, from which it further differs in colour.

The Beech-Marten is common in the island, both in the low ground and in the hills, where it is known to occur at Katharo, between 3000 and 4000 feet, though probably its range extends to a much greater height than this. It is killed in some numbers by the peasants, who bring the skins to the larger port-towns on the north coast, whence they are exported, chiefly to Trieste.

The Cretans call this Marten “Zouridha” (ζουρίδα), by which name it is also known in the neighbouring island of Karpathos†.

9. *PUTORIUS NIVALIS GALINTHIAS*, subsp. n.

Only two specimens, without skulls or measurements taken in the flesh, were obtained of this Weasel, which is of large size. These I have been unable to identify with any one of the several races of *Putorius nivalis* represented in the collection of the British Museum. Therefore it seems necessary to regard it as a local form, which I propose to name after the mythological character changed into a weasel by the Moeræ and Ilithyïæ at the time of the birth of Herakles‡.

It was somewhat unexpected to find that, among all the material which I have been able to examine, this island race most closely resembles in general appearance the type (the only specimen in the British Museum collection) of *P. n. atlas* Barr.-Ham.§, from the Atlas Mountains, Morocco. Also there seems to be no appreciable difference in size between these two subspecies, which are amongst the largest of those belonging to the group of Weasels in which the colours of the upper and under surfaces are sharply divided.

* Ann. Mag. Nat. Hist. ser. 7, vol. i. June 1898, p. 442.

† “Karpathos.” Etude géologique &c. Prof. C. de Stefani, Dr. C. I. Forsyth Major, and W. Barbey. Lausanne, 1895, p. 70.

‡ *Ibid.* p. 65.

§ Ann. Mag. Nat. Hist. ser. 7, vol. xiii. April 1904, p. 323.

Considering the great distance by which the habitats of these two forms are separated, and that a number of other races occupy the intervening and neighbouring countries, the only plausible explanation of such a remarkable likeness seems to be that in this we have a striking case of similar characteristics independently acquired. This does not seem so improbable when it is remembered that among the Weasels variation acts only within very narrow limits; the chief points in which differences occur being in size, in the line of separation between the two colours, and in the presence and amount of white on the upper surfaces of the paws. In connection with the Cretan form it may be suggested that its large size is, at any rate partly, due to prolonged isolation in a locality where food is plentiful and competition not keen, owing to the absence of Stoats in the island.

P. n. galinthias may be distinguished from *P. n. atlas* by its richer colouring and in having only a scarcely perceptible "pencil" of darker hairs at the tip of the tail, which in one of the dried specimens measures 89 mm. exclusive of the terminal hairs. *P. n. sicule* Barr.-Ham.*, although differing from these species in size and colouring, agrees with them not only in the well-defined line of separation of the colours along the flanks, but also in having white on the upper surfaces of the hind as well as the fore paws.

The colour of the under side in one of the skins from Crete (No. 33, ♂) is dirty white; while in the larger of the two (No. 15), the type, probably an old male, this colour is washed with buffish yellow. The "white" extends in a narrow line along the upper lips to the base of the nose.

This Weasel is common and frequently abroad in the daytime, when it may be seen running along the loosely-built stone dykes which are a noticeable feature of many parts of the country, being built for the purpose of ridding the ground of some of the overwhelming number of stones with which it is cumbered. It probably feeds largely on the lizards of various kinds that abound in the island: one day in an olive-grove at Phaestos a weasel was seen to spring out of some thick undergrowth at the edge of a stream and seize a large green lizard (*Lacerta viridis major* Blgr.), which, on becoming aware of my presence, it hurriedly carried off in its mouth.

It is known to the natives by different names in different parts of the island: in the west it is called "Kalajannou," in the east "Sinteknaria" (συντεκνάρια †), and in the Lasseth Mountains a modification of the former term which I neglected to make a note of at the time.

10. *MUS RATTUS* Linn.

This Rat is found in the port-towns on the northern coast, but

* Ann. Mag. Nat. Hist. ser. 7, vol. v. Jan. 1900, p. 46.

† "κάλοσυντεκνάρια," according to Dr. Forsyth Major, *op. cit.* p. 63.

no specimens were obtained in the country, although traps were frequently set for them in several localities. It is probably owing to the occurrence in considerable numbers of a weasel that this rat has not spread and increased in the interior of the island as it has already done in Cyprus.

11. *MUS MUSCULUS* Linn.

This species like the last does not, so far as I am aware, occur beyond the limits of the larger towns. In connection with the restricted range of this Mouse, it is interesting to note that a form of *Micromys sylvaticus* is abundant in the island.

12. *MICROMYS SYLVATICUS* HAYI (Waterh.).

Of all the subspecies of *M. sylvaticus* recognised by Major Barrett-Hamilton in his paper published in 1900*, the specimens from Crete seem to agree most closely with *M. s. hayi*, though they are, if anything, slightly smaller. In colouring they cannot be distinguished from the darker examples of a series from Cintia, Portugal, in the British Museum collection. None of the Cretan skins shows any sign of a band of colour across the white of the throat. The following are the maximum and minimum measurements of the six specimens preserved:—

Head and body 80–88 mm., tail 86–89·5, hind foot 21–22, ear 16–17; total length of skull 25–26.

This Mouse, which appears not to have been previously recorded from Crete, is plentiful in the island and easily trapped. Two specimens, one of which (No. 11) is very dark, were caught not far from Khania in rocky ground close to some patches of cultivated land; the remaining four are from Katharo, a small valley in the Lassethé Mountains nearly 4000 feet above sea-level.

13. *ACOMYS DIMIDIATUS* MINOÛS †, subsp. n.

The Cretan Spiny Mouse, a richly coloured form with fairly large ears and tail equalling or exceeding in length the head and body, is evidently closely allied to *A. dimidiatus*. It may be distinguished from examples of this species in the British Museum collection from the vicinity of Aden, and one (somewhat faded) from Sinai, the typical locality, by the very restricted area occupied by the spines, which are exceptionally fine and have an average length of about 10·5 mm. Further, these are pigmented for a greater distance from the tip (about 4·5 mm.), which gives the spinous region a more richly coloured appearance owing to the proximal and semi-transparent portions of the spines not showing on the surface. The colours of the upper and under surfaces do not intergrade, the line of separation along the flanks being very sharply defined.

* "On *Mus sylvaticus* and its Allies," P. Z. S. 1900, p. 387.

† "Minoüs" was employed by the early poets as equivalent to Cretan.

The following measurements (in millimetres) of the three specimens preserved were taken in the flesh :—

	Head and body.	Tail.	Hind foot.	Ear.	Skull.	
					Extreme length.	Zygomatic breadth.
No. 3 (♀)	93	...	18·5	19	30	15
No. 12 (♂)	112	...	19	18	...	15
No. 16 (♀, type of subspecies.) }	94	113	18	19·5	...	15·5

The threespecimens obtained were trapped in the same locality—in rocky ground close to cultivated land between Khania and Suda. It was not known to any of the natives questioned on the subject. This discovery of an *Acomys* in Crete is interesting, being an extension, in a somewhat unexpected direction, of the recorded range of the genus.

14. *LEPUS EUROPÆUS CRETICUS* BARR.-HAM.

This Hare was described in 1903 by Major Barrett-Hamilton* but as no measurements accompanied the four skins received by him, the following dimensions of a single example (a ♂), taken in the flesh, may be of interest :—

Head and body 514 mm., hind foot 123, ear 102. The basal length of the skull is 71 mm.

Hares are found all over the island, even near the summit of Mount Ida, which attains a height of over 8000 feet, where Admiral Spratt mentions † having disturbed a number out of their “forms” in the open snow. The same author remarks that those seen on Mount Ida “seemed to be a smaller species than the Hare of the lowlands.” Unfortunately no specimens were obtained from this locality, so that this observation still awaits confirmation.

Of late a close season has been instituted in the island, and the Hare is among the number of species so protected. It was recorded by Raulin ‡ under the name of *L. timidus*.

15. *ORYCTOLAGUS CUNICULUS CNOSSIUS* §, subsp. n.

This Rabbit is paler and decidedly more uniformly grey in colour than the typical form; this lightness is partly caused by the paleness of the reddish area on the back of the neck, which more or less affects the greater part of the dorsal region, and further by the absence of a markedly dark ring between the smoky grey of the proximal portion of the hairs and the sub-terminal light band.

In the one specimen preserved (a ♀), which lived for some months in the Zoological Society's Gardens, the hind paws are

* Ann. Mag. Nat. Hist. ser. 7, vol. xi, Jan. 1903, p. 126.

† *Op. cit.* vol. i. p. 13.

‡ *Op. cit.*

§ “Cnossius” was employed by the early poets as equivalent to Cretan

almost entirely white, and its dimensions, taken in the flesh, are as follows:—

Head and body 341 mm., tail 65, hind foot 82, ear 70; weight 2 lbs. $\frac{3}{4}$ oz. The skull's greatest length 75 mm., basal length 57·5.

It seems curious that this Rabbit does not occur on the mainland of Crete, and I have found no record of its having done so formerly. Raulin wrote* of it as being very plentiful in the small islands off the coast, and a man who brought me three from Dhia, off Candia, said that it is still found there in considerable numbers.

16. CAPRA ÆGAGRUS CRETENSIS Lorenz-Liburnau †.

The Cretan Wild Goat has been known from very early times, and has doubtless acquired an added interest on account of the legend of Zeus' upbringing on Mount Ida by the goat Amalthea. It is still found in the three main mountain masses of the island—the Aspro Vouno, Mount Ida, and the Lassethe Mountains. One skin, that of a ♂, was forwarded to me in the spring of the present year (1905), it having been obtained during the winter in the Sphakia district. The horns indicate an animal of eight years old, and measure 605 mm. along the front curve, while the circumference at the base is 175 mm. The greatest length of horn given by Dr. Lorenz-Liburnau ‡ for this subspecies is 81 cm. (810 mm.), this being in a seven-year old specimen preserved in the Vienna Museum.

November 28, 1905.

Dr. HENRY WOODWARD, F.R.S., Vice-President, in the Chair.

Mr. J. T. Cunningham, M.A., F.Z.S., exhibited some photographs of a Horse bearing structures that he interpreted as incipient horns, and made the following remarks:—

The peculiarity of the horse represented in these photographs was described by Dr. G. W. Eustace, of Arundel, before the Linnean Society in 1903. The horse, the name of which is "Domain," was then in the stables of Mr. Alfred Day at 'The Hermitage' near Arundel, and was still there when, by the kindness of Mr. Day, these photographs were taken for me in October last. A few other similar cases have been recorded, but the pedigree of Domain contains no individuals which are known to have possessed the peculiarity, and it appears therefore to be a new variation, not a result of reversion or heredity.

Dr. Eustace's paper was illustrated by plaster casts of the forehead of Domain which are now in the Natural History Museum, and Dr. Ridewood has presented to the Museum the frontal

* *Op. cit.* vol. i. p. 253.

† 'Die Wildziegen der Griechischen Inseln &c.,' 1889.

‡ *Op. cit.* p. 24.

portion of the skull from another case whose history is unknown. 'Domain' was stated to be five years old in 1903, so that he was seven years of age when the photographs were taken.

The horns are about $\frac{3}{4}$ inch in length, the left slightly larger than the right. There can be no doubt that they are outgrowths of the frontal bone. They are covered by normal skin and hair.

Mr. Frank Slade, F.Z.S., showed three photographs of the Sea-Anemone (*Anemonia sulcata*), which had been taken from life in the Horniman Museum at Forest Hill, in the process of division. The first photograph showed the Anemone at rest after having made the initial tear in the body-wall. The second showed the animal, two days later, straining to increase the tear, whilst the third, taken after an interval of sixteen days, showed the division completed.

Mr. Douglas English exhibited and made remarks upon a living albino Field-Vole (*Microtus agrestis*) which had been captured last July in Wales.

Mr. G. A. Boulenger, F.R.S., exhibited a living Lizard, *Lacerta muralis*, from Brozzi, province Florence, which he had received from Dr. A. Banchi, through the mediation of Dr. J. de Bedriaga, C.M.Z.S. The lizard belonged to the typical form of the Wall-Lizard, but was remarkable for its black coloration, above and below. Melanistic forms of the Wall-Lizard were well known on small islands in the Mediterranean, but, so far as Mr. Boulenger was aware, no black specimen had ever been recorded from the mainland. The scales across the body numbered 58 and the lamellar scales under the fourth toe 25 in the specimen exhibited; these two numbers being sufficient to distinguish the Brozzi lizard from the melanistic insulars previously described.

Capt. Albert Pam, F.Z.S., made some remarks on a living specimen of the Violet-cheeked Humming-bird (*Petasophora iolota*) which he had recently brought home from Venezuela and presented to the Society's Menagerie. He also gave a general account of the habits of these birds, as observed by him, in a wild and captive state, and notes on their management and feeding while in confinement.

Mr. W. R. Ogilvie-Grant, F.Z.S., sent for exhibition a named set of the Birds collected in Japan by Mr. M. P. Anderson in connection with the Duke of Bedford's Exploration in Eastern Asia. No new species were discovered, but several of the specimens were of special interest as illustrating stages of plumage not represented in the British Museum.

The following papers were read :—

1. Colour Evolution in Guereza Monkeys.

By R. LYDEKKER.

[Received November 7, 1905.]

(Text-figures 54–58.)

An interesting example of the progressive evolution of specialised features in colouring (if we may thus term combinations of black and white) is afforded by the black and black-and-white African long-haired monkeys included in the genus *Colobus*, and which may be collectively designated Guerezas, although the name “guereza” refers properly only to the north-east African representative of the group.

Beginning at one end of the series, we have the Black Guereza (*Colobus satanas*), of West Africa, which, as shown in text-fig. 54,

Text-fig. 54.

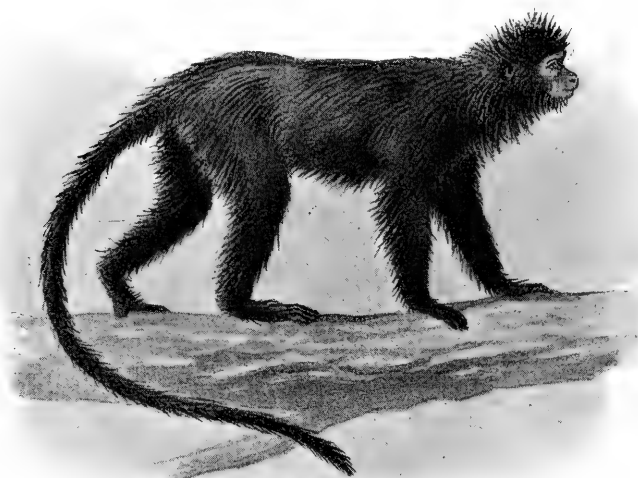

Black Guereza (*Colobus satanas*).

is wholly black with tufts of long hair on each side of the face and throat, a pointed crest on the crown of the head, and the long tail short-haired from base to tip. Following on this we may take a variety of the Mantled Guereza from East Central Africa which I have recently described as *Colobus palliatus cottoni*, in which the face-tufts, chin, and narrow pendent tufts of long hair on the shoulders are white, while the terminal half of the tail is grey with a white tip, which shows a slight tendency to

expand into a brush. A further development is exhibited by the typical form of *Colobus palliatus* (text-fig. 55), from British East Africa and the neighbouring districts, in which the two lateral white face-tufts are connected by a white band across the brow, while the shoulder-tufts are of considerably larger size, a small whitish patch beneath the tail occupies the perineal region, and the tail has its terminal third whitish, the middle third grey, and the remainder black. A nearly allied type is found in the form of the Mountain Guereza (*C. ruwenzorii*), of the Ruwenzori district, in which the white perineal patch has assumed much larger proportions, although the extreme tip of the tail is alone greyish; the latter feature placing the species, so far as the colouring of this appendage is concerned, next to the Black Guereza.

Text-fig. 55.

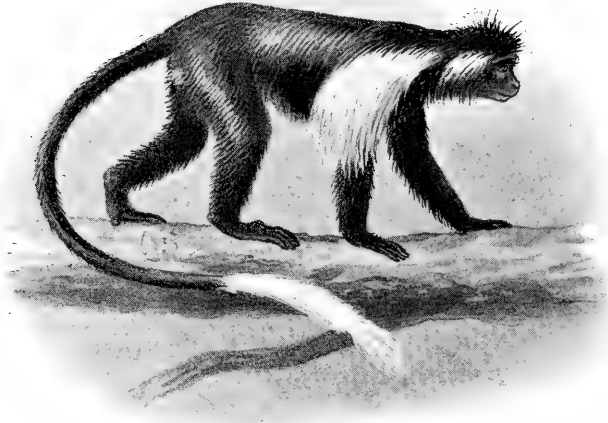
Mantled Guereza (*Colobus palliatus*).

From the three foregoing black-and-white forms there is an easy transition to Sharpe's Guereza (*C. sharpei*), of Nyasaland, in which, as shown in text-fig. 56, p. 327, the white brow-band, face-, throat-, and shoulder-tufts have become very long and pronounced, the hairs of the last hanging down the outer side of the fore-limbs. Moreover, the white terminal third of the tail has developed a distinct tuft, not dissimilar in relative size and form to that of a lion's tail. A step still further in advance is taken by the typical Guereza (*C. guereza*) of Abyssinia and North-east Africa generally. In this handsome monkey the white shoulder-tufts extend backwards to form a long mantle, falling down each side of the body

Text-fig. 56.



Sharpe's Guereza (*Colobus sharpei*).

Text-fig. 57.



White-tailed Guereza (*Colobus caudatus*).

and uniting on the lower part of the back. The culmination of this type of coloration is formed by the White-tailed Guereza (*C. caudatus*, or *albocaudatus* as it ought to have been called) of the Kilimanjaro district and other parts of Eastern Africa. Here, as we see from text-fig. 57, the beautiful pendent white mantle has become still longer, and the tail, which is wholly white except for a very small length at the root, is clothed with long pendent hair comparable to the "flag" of a setter; the cheek- and throat-tufts, however, have been completely lost, so that the head is wholly short-haired, with the face and throat white.

The difference between the species last-named and the Black Guereza in the matter of colouring is enormous, and yet the transition from the one to the other in this respect is almost complete. In the case of the white-tailed species the excessive

Text-fig. 58.

White-thighed Guereza (*Colobus vellerosus*).

length of the white hair forming the mantle and the tail-fringe appears to have been evolved in order to render the creature as inconspicuous as possible amid the long pendent greyish-white lichens which clothe the branches of the trees of an East African forest. The evolution of such a type is, of course, easy to comprehend; but, as in so many other cases, the difficulty comes in with regard to the purpose of the coloration in the intermediate types connecting this species with the Black Guereza. What purpose do these incipient attempts at the development of a pied coat serve?

The line of evolution culminating in the white-tailed species by no means, however, brings us to the end of the modifications in the colour and local development of the hair in this group of monkeys,

for the West African White-thighed Guereza (*C. vellerosus*), text-fig. 58, appears to exhibit a kind of retrograde development in these respects. The body, for instance, has entirely lost the mantle of long white hair and the tail its white "flag," while the white of the perineal patch has spread on to the hinder and outer sides of the thighs. In this case we find, indeed, a practical reversion to the type of the Black Guereza, with the exception that the band on the forehead, the sides of the face and throat, the thighs, and almost the whole of the tail have become white, while the long hair has entirely disappeared from the face.

That the colouring and special development of the long hair in the White-tailed Guereza form a protective modification, there seems to be little doubt. Whether, however, the colour-phases and hair-growth in the other forms are of a protective nature, or are merely due to what is commonly called sexual selection, must be left for those to decide who have the opportunity of seeing these beautiful monkeys in their native haunts.

2. The White-maned Serow. By R. LYDEKKER.

[Received November 11, 1905.]

(Plate VIII.*)

In 1888 the very appropriate name of *Nemorhædus argyrochaetes* was bestowed by the Rev. Père Heude † on a large and strikingly coloured species of Serow inhabiting the mountains of Central China in the neighbourhood of Che-kiang in the Upper Yang-tse-kiang district. Later, a fuller notice, with a figure of the skull, was given by the same writer ‡; while in 1890 Dr. A. Henry § contributed a note on skins of the species which had come under his notice while in China. Hitherto, however, so far as I am aware, no coloured figure of the entire animal has appeared; and since the colouring is of a very remarkable and striking type, somewhat different from that of the ordinary Serow, I think the opportunity ought to be taken of remedying this deficiency.

This opportunity has been afforded by the recent addition to the Collection of the British (Natural History) Museum of a mounted male specimen of this Serow and of the Tibetan Takin (*Budorcas taxicolor tibetana*). They were acquired by Rowland Ward, Ltd., from a French dealer, by whom they were stated to have come from Tibet; but I should think that Sze-chuen, or thereabouts, is more probably their place of origin, unless, indeed, the Serow was procured still farther east. The two are, I believe, the first representatives of their respective kinds ever received in England, and it is quite probable that in the case of the Serow this statement may be extended to European museums in general.

* For explanation of the Plate, see p. 331.

† Mém. Hist. Nat. Emp. Chinois, vol. ii. p. 4, note (1888).

‡ T. c. p. 228, pl. xxxi. (1890).

§ Proc. Zool. Soc. London, 1890, p. 93.

In his note of 1890, Dr. Henry described the White-maned Serow as being as tall as a cow, and employed by the natives of Central China for riding and as a beast of burden. This, I think, is somewhat exaggerating matters (unless a very small breed of cattle is referred to), and a good-sized donkey would seem to be a better standard of comparison. Although, from the circumstance that the skull still retains the last two premolars, and therefore indicates an animal not yet fully mature, it is possible that the specimen in the Museum does not quite represent the full height attained by the species, yet it certainly cannot fall very short of this, and, as mounted, the skin indicates an animal only about three inches taller than the ordinary Himalayan or (as it may well be called) Black-maned Serow.

The general build and type of coloration approximate to those of the last-named animal, although in two respects there are marked peculiarities in the matter of colouring. The horns are small and very thickly ringed for more than half their length, differing, I think, in these respects to some extent from those of the Himalayan animal, although, on account of the immaturity of the Museum specimen, I cannot be confident on these points. The ears certainly appear to be larger, but here again it is difficult to say that there may not have been shrinkage in the mounting of the Himalayan specimens.

The general colour of the upper-parts is mingled black and white, but the face and outer surface of the ears are blackish brown, with an admixture of chestnut hairs on the upper part of the forehead and the sides of the upper lips. The insides of the ears and part of the muzzle are white, but the white area on the latter is of much smaller extent than in the Himalayan species, being confined to the margins of the upper lips, although wider on the lower lips, whence it extends as a streak on the sides of the jaws. A large patch on the throat, another on the chest, and the whole mane are dirty white. On the other hand, the lower portion of the buttocks, the whole hind limb (except a light streak inside), and the middle third of the tail are bright mahogany or ferruginous red. The fore legs from the knees downwards, and to some extent on their inner and outer sides above the latter, are of a lighter and more chestnut-red.

The upward extension of the red of the legs and its deeper tone are features of this species as contrasted with the Himalayan and Sumatran Serows, which are best regarded as varieties of one species, the latter distinguished by the legs being chestnut in place of wholly white. It appears, however, that in some cases the Sumatran Serow has the mane white, as in the present animal.

The prevalence of bright red, reddish yellow, and yellow in the colouring of mammals of the West Tibetan province, as exemplified by *Rhinopithecus roxellance*, *Budorcas taxicolor tibetana*, and the present species, is very remarkable, and stands in need of explanation.

The skull belonging to the same individual as the skin is in a

somewhat damaged condition, having a large portion of the parieto-frontal region cut away, and also lacking the nasal and premaxillary bones; it still, however, serves as a basis of comparison between the present species and *N. bubalinus*. The third and fourth milk-molars are still retained, the second premolar is just piercing the gum, and the third molar has its summits slightly abraded by wear. The animal may therefore be considered to have been sub-adult at the time of its death, and may perhaps have not quite attained its full stature.

As it is, the skull is fully as large as that of an aged individual of *N. bubalinus*, but appears to have been of a relatively broader, deeper, and shorter type, although from its imperfection I cannot be sure on all these points. The palate is, however, evidently wider, the interval between the bases of the second molar being about a quarter of an inch more than in the Himalayan species. The basioccipital and basisphenoidal rostrum is also markedly wider and more tapering, with less prominence of the anterior tubercles for muscular attachment, which are, however, much larger.

Perhaps the most important distinctive feature of the skull of the white-maned species is the much greater backward extent of the nasals on to the frontal region, in consequence of which the fronto-nasal suture is situated only a short distance in front of the vertical line formed by the anterior border of the orbit, instead of very considerably in advance of the same. The pit for the face-gland also occupies nearly the whole extent of the lachrymal bone, instead of leaving a large flat surface along the upper border of the same. The palatine bones likewise extend much further forward on the palate, so that the palato-maxillary foramina are situated on the line of the hinder lobe of the first molar instead of opposite the cleft between the two lobes of the second tooth of the same series.

EXPLANATION OF PLATE VIII.

The White-maned Serow (*Nemorhædus argyrochætes*), from the specimen in the British Museum.

3. The Duke of Bedford's Zoological Exploration in Eastern Asia.—I. List of Mammals obtained by Mr. M. P. Anderson in Japan. By OLDFIELD THOMAS, F.R.S.*

[Received October 9, 1905.]

(Plate IX.†)

As I announced at the last Meeting of the Society, our President, His Grace the Duke of Bedford, K.G., has consented, in order to

* [The complete account of the new species described in this communication appears here; but as the names and preliminary diagnoses were published in the 'Abstract,' such species are distinguished here by the name being underlined.—
EDITOR.]

† For explanation of the Plate, see p. 363.

further the cause of zoological exploration, to bear the cost of a collector working systematically through the islands of the Far East, and I now have to give an account of the Mammals obtained by that collector—Mr. Malcolm P. Anderson—in Japan, where he has begun his labours.

The selection of Japan for the first field of Mr. Anderson's work was almost a necessity, for practically nothing has been done with regard to the Mammalogy of that country since the time of Siebold and Burger, whose collections resulted in Temminck's great work of 1842-45, while authentic modern specimens of the species then described were necessary before any further progress could be made. It is true that, by the liberality of the Leyden Museum, typical specimens of most of Temminck's species were distributed to many European museums, our own National Museum receiving a very complete set, but these specimens, 60 to 70 years old, are all naturally much deteriorated by exposure to light, while scarcely any of them have any more exact locality recorded than "Japan."

Under these circumstances no words can express the value of the fine series of specimens obtained by Mr. Anderson, who has proved himself a most successful collector, and one well able to do full justice to the liberality of our President. The specimens, which are of all classes, after being exhibited before the Society, are to be transferred by His Grace to our National Museum, where they will be most gratefully appreciated.

Mr. Anderson landed at Yokohama in July 1904, and began collecting at once in Hondo (Central and North), and made two trips to Hokkaido in September and November.

Later he went to the two large southern islands, Shikoku in March 1905, and Kiushiu in April and May, the specimens from this latter being particularly valuable, as the Dutch Factory, from which the Leyden Museum obtained its materials, was situated at Nagasaki, at the south-eastern corner of the island.

Lastly, Mr. Anderson visited the Oki group of islands, to the north of Southern Hondo, and Tanegashima, south of Kiushiu, while his brother, Mr. Robert Anderson, went to Yakushima, still further south. The specimens from these separate island collections I have included in an Appendix to the paper.

In all, the mammals referred to in the present communication number about 600 examples, belonging to 50 species and sub-species. Of these I have found it necessary to give new names to twelve, besides describing one new Shrew discovered by Mr. Hawker in 1903. The fine new Marten, *Mustela melampus bedfordi*, now figured, but described last session, is also to be credited to Mr. Anderson's collection.

As yet I am chary of making any general conclusions about the mammal-fauna of Japan. It is, however, evident from this collection that there is little faunistic difference between Shikoku, Kiushiu, and the main southern portion of Hondo, but that a number of species do not extend into the north of Hondo, where

such species as occur are sometimes subspecifically different from those of the south. Hokkaido, of course, is very different from Hondo, and the occurrence there of such typically Japanese species as *Micromys speciosus* and *geisha* is somewhat unexpected; possibly they are comparatively recent introductions, even though in each case subspecifically separable from their Hondo relatives.

The following is a list of the species obtained in each of the four islands referred to:—

Hokkaido :

- Sciurus vulgaris orientis.*
Mus norvegicus.
Micromys speciosus ainu, geisha hokkaidi.
Evotomys mikado, bedfordiæ.
Lepus timidus ainu.

Hondo :

- Pipistrellus abramus.*
Sorex shinto, hawkeri.
Crocidura dsinezumi chisai.
Chimarrogale platycephala.
Mogera wogura.
Urotrichus talpoides pilirostris.
Canis hodophylax.
Nyctereutes viverrinus.
Mustela melampus bedfordi.
Putorius itatsi.
Petaurista leucogenys.
Sciuropterus momonga amygdali.
Sciurus lis.
Mus tanezumi, molossinus.
Micromys speciosus, geisha.
Microtus montebelli.
Evotomys (Craseomys) andersoni.
 ,, (Phaulomys) smithii.
Lepus brachyurus.
Sus leucomystax.
Nemorhædus crispus.
Cervus sika.

Shikoku :

- Macacus fuscatus.*
Crocidura dsinezumi.
Mogera wogura kobæ.
Urotrichus talpoides.
Putorius itatsi.
Meles anakuma.
Micromys speciosus, geisha, minutus japonicus.
Evotomys (Phaulomys) smithii.
Lepus brachyurus.

Kiushiu :

Rhinolophus ferrum-equinum nippon.
Myotis macrodactylus, nattereri hombinus.
Miniopterus schreibersi japonice.
Crocidura cærulea, dsi-nezumi.
Urotrichus talpoides.
Mustela melampus.
Putorius itatsi.
Meles anakuma.
Petaurista leucogenys.
Micromys speciosus, geisha, minutus japonicus.
Microtus montebelli.
Evotomys (Phaulomys) smithii.
Lepus brachyurus.

In order to focus so far as possible the existing information about the mammals of Japan, I have prepared the following *résumé* of the literature, which, apart from Temminck's fine work, is of a very fragmentary character.

1824. Siebold, G. T. de. *Spicilegia Faun. Japon.*, in *Dissertatio Hist. Nat. Japon.* p. 13.

Description of "*Myoxus lineatus*"—a *Tamias*, from Hokkaido.

- 1842-45. Temminck, C. J. *Mammalia of P. F. de Siebold's 'Fauna Japonica,'* pp. 1-60, pls. i.-xxx.

A complete account of the Fauna, as known from the collections sent by Messrs. Siebold, Burger, and other Dutch naturalists to the Leyden Museum.

One of the finest and most complete faunistic works ever published. Up to 1904, that is, for more than sixty years, the only valid species added to those contained in it were *Microtus montebelli* M.-Edw., *Murina hilgendorfi* Peters, and *Talpa mizura* Günth.

The following species are first described in this great work :—*Macacus fuscatus* (under the name of *Inuus speciosus*), *Pteropus dasymallus*, *Rhinolophus nippon* and *cornutus*, *Pterygistes molossus*, *Myotis macrodactylus*, *Pipistrellus abramus* and *akakomuli*, *Talpa wogura*, *Urotrichus talpoides*, *Chimarrogale platycephala*, *Crocidura dsi-nezumi* and *umbrina*, *Meles anakuma*, *Mustela melampus* and *brachyura*, *Putorius itatsi*, *Nyctereutes viverrinus*, *Lepus brachyurus*, *Sciurus lis*, *Pteromys leucogenys*, *Sciuropterus momonga*, *Mus erythronotus*, *argenteus*, *molossinus*, *tanezumi*, and *speciosus*, *Glirulus japonicus*, *Cervus sika*, *Nemorhædus crispus*, and *Sus leucomystax*.

1857. Schlegel, H.

Ursus japonicus, sp. n. Handl. Beoefening der Dierkunde, i. p. 42; Sclater, P. Z. S. 1862, p. 261; Günther, P. Z. S. 1880, p. 442.

The *U. torquatus* of the 'Fauna Japonica.'

1862. Gray, J. E.
Leopardus japonensis, sp. n. P. Z. S. 1862, p. 262, pl. xxxiii.
Based on a tanned Leopard-skin without exact locality.
1865. Gray, J. E.
Martes japonica, sp. n. P. Z. S. 1865, p. 104; Cat. Carn.
B.M. p. 82 (1869).
No doubt the summer form of *Mustela melampus*.
1867. Gray, J. E.
Lutronectes whiteleyi, g. & sp. nov. P. Z. S. 1867, p. 181;
Cat. Carn. B.M. p. 107 (1869).
Based on young specimens of the Japanese Otter.
1868. Gray, J. E.
Vulpes japonicus, sp. n. P. Z. S. 1868, p. 517; Cat. Carn.
B.M. p. 204 (1869).
"Japan."
1874. Milne-Edwards, A. Recherches Mammifères. Texte, p. 285.
Description of *Microtus montebelli*, from Fusi-yama.
1875. Von Martens, E. Die Preussische Expedition nach Ost-
Asien. Zoologische Abtheilung. I. Pt. 1, pp. 75 & 362.
General account of Japanese mammal-fauna, and list of
species obtained. (Determinations by W. Peters.)
1875. Rein, J. J. Notizen über die Verbreitung einiger Säuge-
thiere auf Nippon. Zool. Gart. xvi. 1875, p. 55.
Notes on habits, native names, and distribution of thirteen of
the better-known species. In the same author's 'Japan,' 1881,
i. p. 201, these notes are incorporated in a general popular account
of the fauna.
1880. Günther, A. Notes on some Japanese Mammalia. P. Z. S.
1880, p. 440.
Notes on *Urotrichus talpoides* (with description of *Neurotrichus*
g. n. for the American *U. gibbsi*), *Talpa mizura*, sp. n., *Ursus*
arctos, *U. japonicus*, and *Calorhinus ursinus*.
The new Mole, *Talpa mizura*, has not since been obtained.
It is closely allied to the European *T. europaea*.
1880. Peters, W. Ueber die von Hrn. Dr. F. Hilgendorf in
Japan gesammelten Chiropteren. MB. Ak. Berl. 1880,
p. 23.
Records of 7 species, and description of *Murina hilgendorfi*
from Yedo, near Tokyo.
1880. Thomas, O. On the *Myoxus elegans* of Temminck. P. Z. S.
1880, p. 40.
See below, under *Glirulus japonicus*.

1882. Doederlein, L. Ueber einige Japanische Säugethiere. MT. Deutsch. Ges. Ostasiens, vol. iii. Heft 25, p. 210.
 (1) Existence of Fox in Shikoku. (2) A Changing Hare (" *Lepus variabilis* ") in Japan. (3) On a small musky-smelling rodent (more likely a Shrew).
1886. True, F. W. Description of a new genus and species of Mole (*Dymecodon pilirostris*) from Japan. Pr. U.S. Nat. Mus. 1886, p. 97.
 From Yenoshima, near Tokyo.
 This Mole is probably an immature *Urotrichus talpoides*.
1900. Barrett-Hamilton, G. E. H.
Lepus timidus ainu, subsp. n. P. Z. S. 1900, p. 90.
 From Hokkaido.
1904. Sasaki, C. A new Field-Mouse in Japan. Bull. Coll. Agric. Tokyo, vi. p. 51.
 Description of *Arvicola hatanedzumi* (= *Microtus montebelli*), from Tokyo.
1904. Beard, J. C.
Nyctereutes albus, sp. n. Scientific American, 1904, p. 237.
 Based on a white specimen in the New York Zoological Park, said to be from Hokkaido.
1905. Thomas, O. On some new Japanese Mammals presented to the British Museum by Mr. R. Gordon Smith. Ann. & Mag. N. H. (7) xvi. p. 487.
 Descriptions of *Mogera wogura kobecæ*, *Petaurista leucogenys nikkonis*, *oreas*, and *tosæ*, *Micromys geisha*, and *Evotomys (Phaulomys, subg. n.) smithii*.
1905. Thomas, O. Exhibition of Mammals from Japan. Abstr. P. Z. S. 1905, p. 9; P. Z. S. 1905, ii. p. 183.
 Description of *Mustela melampus bedfordi*.

1. MACACUS FUSCATUS Bly.

Macacus fuscatus Bly. J. A. S. B. xlv. extra number, p. 6 (1875).
 ♂. 304. ♀. 303, 323. Jinrio, Tokushima Ken, Shikoku. 500'.

This is the *Inuus speciosus* of the 'Fauna Japonica,' nec F. Cuv.
 "Numbers of monkeys live in the forest surrounding certain large temples at a distance from Jinrio. I did not see them, but sent my servant in search of them, and through him secured these specimens. They are considered difficult to hunt, for they hide themselves very effectually in the high Cryptomeria trees. It is said that with the help of a dog they can easily be shot, as the monkey pays little heed to the man and his whole attention is absorbed in exhibiting his anger towards the barking dog. The flesh is commonly eaten by the natives, but on trying it I did not like it."—*M. P. A.*

2. RHINOLOPHUS FERRUM-EQUINUM NIPPON Temm.

♂. 485. Tano, Miyasaki Ken, Kiushiu.

3. PIPISTRELLUS ABRAMUS Temm.

♂. 6. Takayu, near Yonezawa, Uzeu, N. Central Hondo.

Dr. Jentink* has shown that Temminck's *Vespertilio akokomuli* is the same species as his *V. abranus*. The type locality of both is Nagasaki, Kiushiu.

"Caught, with the two succeeding species, in caves near the village."—*M. P. A.*

4. MYOTIS (LEUCONOE) MACRODACTYLUS Temm.

♂. 490, 500. ♀. 493, 494, 515, 516, 517. Tano, Miyasaki Ken, Kiushiu. 500'.

Dimensions of an adult male:—

Forearm 36 mm.

Head and body 44; tail 35; ear 14.5.

These specimens agree absolutely with Temminck's description, and there can be no doubt that they belong to his species, in spite of Peters's assertion † that *macrodactylus* resembled very closely the European *M. capaccinii*, to which these examples bear no resemblance whatever. Indeed, so great is the discrepancy, that I am tempted to suppose that Peters did not really see the specimens described by Temminck at all. *M. macrodactylus* in fact is more closely allied to *M. daubentonii*.

5. MYOTIS NATTERERI BOMBINUS, subsp. n.

♀. 486, 487, 488, 489, 492. Tano, Miyasaki Ken, Kiushiu. 500'.

Similar in essential respects to the European *M. nattereri*, which it evidently represents in Japan. But the ear appears to be rather longer (judging from skins only), the tragus narrower and more boldly curved outwards, the skull is more abruptly and considerably inflated in the frontal region, and the colour is not quite the same.

In true *M. nattereri* the colour is paler and more uniform than in the other small European species of *Myotis*, this being apparently due to the fact that the pale brown ends to the hairs are longer and therefore hide the blackish-grey of their bases. In *bombinus*, however, the coloration is more normal, a darker variegated brown, the blackish-grey bases of the hairs showing through. In a similar way below, the light ends to the hairs are shorter and less prominently white.

Dimensions of the type:—

Forearm 40 mm.

Head and body 52; tail 44; ear 17.

* Notes Leyd. Mus. ii. p. 37 (1879).

† MB. Ak. Berl. 1866, p. 681. Dobson, on this statement, actually synonymised *macrodactylus* with *capaccinii*.

Skull—greatest length 15·5; basal length in middle line 11·8; front of canine to back of m^3 5·9.

Type. Old female. B. M. No. 6.1.4.14. Original number 487. Collected 30 April, 1905.

It is a matter of interest to find in the Far East this representative of *M. nattereri*, which has hitherto only been known from Europe. It is probable, also, that Mr. Miller's *M. thysanodes* is the corresponding Bat in the N. American fauna.

6. *MINIOPTERUS SCHREIBERSI* JAPONÆ, subsp. n.

♂. 501, 502, 503, 505, 510, 511, 512, 513, 514. ♀. 495, 496, 497, 504, 507, 508, 518, 519, 520, 521. And two in alcohol. Tano, Miyasaki Ken, Kiushiu. Alt. 500 feet.

Size rather large, uniformly larger than in the Liu-Kiu form, *M. fuscus* Bonh.*

Colour of back between "seal-brown" and dark "Prout's brown"; head and nape rather greyer, though the difference is perhaps due rather to the ends of the hairs being more glossy and so catching the light, than to any essential difference in colour. Under surface like the head.

Dimensions of the type:—

Forearm 47 mm. (range from 46 to 48).

Head and body 57; tail 53; ear 12.

Skull—greatest length 16, median basal length 12; front of canine to back of m^3 6·4.

Type. Adult male. B.M. No. 6.1.4.22. Original number 512. Collected 3 May, 1905.

As was to be expected, the Japanese *Miniopterus* is clearly different from the pale European one, nor does any form quite agreeing with it appear to have been described. Bonhote's *M. fuscus* from the Liu-Kiu Is. is similar in colour (or slightly darker), but is uniformly smaller, the forearm rarely reaching 44 mm. Seven additional examples of *fuscus* recently received from Mr. A. Owston confirm the characters derived from the three originally examined by Mr. Bonhote.

The fine series obtained by Mr. Anderson is remarkably uniform both in colour and size.

This Bat is of course the "*Vespertilio blepotis*" of the 'Fauna Japonica'; but that species was primarily described on examples from Java.

7. *SOREX SHINTO* Thos.

Sorex shinto Thos. Abstr. P. Z. S. No. 23, p. 19, Dec. 5, 1905.

♂. 47. Makado, near Nohechi, Aomori Ken, N. Hondo. Alt. 400 ft.

A small species with a long tail.

Size as in *S. macropygmaeus* Miller, though tail much longer. Fur of back slightly over 3 mm. in length. General colour above

* Nov. Zool. ix. p. 626 (1902).

uniform brown (between "seal-brown" and "Prout's brown"), quite similar in tone from head to rump. Sides not presenting a contrasted light area, being scarcely lighter than the back, and passing gradually without line of demarcation into the drab-washed belly. Chin and throat slightly more greyish. Hands and feet glossy brown, the hairs at the tips of the digits silvery. Tail long, nearly as long as the head and body, well-haired throughout, slightly pencilled at tip, blackish brown above, dull whitish below.

Skull conspicuously larger than that of *S. minutus*, but of the same light and delicate build. Upper unicuspid subequal in transverse section, the last one not smaller than the rest or out of series. All the teeth liberally tipped with brown.

Dimensions of the type, measured in the flesh :—

Head and body 50 mm. ; tail 49 ; hind foot 11·5 ; ear 7.

Skull—greatest length 17·5 ; basal length 15 ; breadth of brain-case 8·5 ; length of upper tooth-series 7·6.

Hab. as above.

Type. Adult male. B.M. No. 6.1.4.30. Original number 47. Collected 28 September, 1904.

This small Shrew belongs to the genus *Sorex*, which had not hitherto been recorded from Japan. It appears to be a member of the *S. minutus* group, but may be readily distinguished by its size and unusually long tail. A second specimen of it is in the Museum collection, obtained by Mr. Alan Owston near Tokyo.

[*SOREX HAWKERI*, sp. n.

♂. Inukawa, Yedo, Hondo.

Size very small, about as in *S. minutus*. Fur, in summer, about 3 mm. long on the back. General colour of the dorsal area brown, near "Prout's brown" but considerably paler. Sides distinctly different from back, greyish broccoli-brown ; belly like sides, but paler. Upper surface of hands and feet pale drab. Tail short, much shorter than head and body, well-haired and pencilled, pale broccoli-brown above, rather lighter below.

Skull crushed in the single specimen, but apparently even smaller than that of *S. minutus*, as indicated by the short tooth-row. Anterior incisor large, not very deeply notched. Five upper unicuspid broad, closely packed, in even slightly decreasing sequence to the penultimate, the fifth again slightly larger than the fourth, in the tooth-row, clearly visible from without. Brown on teeth about as in *S. minutus*.

Dimensions of the type :—

Head and body (measured in skin) 55 mm. ; tail (measured in flesh) 30 ; hind foot 9.

Skull—tip of anterior incisor to that of large premolar 2·8 ; to back of m² 5·2.

Type. Male. B.M. No. 3.9.10.1. Collected 7 June, 1903, and presented by R. McD. Hawker, Esq.

Although not collected by Mr. Anderson, I take this opportunity to describe a tiny Shrew obtained in Japan by Mr. Hawker. It

has no alliance with any of the European types of Shrews, but would seem to have relatives among some of the short-tailed Arctic American forms, with which it will no doubt prove to be linked by allied species from the East Siberian mainland.]

8. *CROCIDURA CÆRULEA* Kerr.

4 in alcohol. Nagasaki; in houses.

9. *CROCIDURA* (Cr.) *DSI-NEZUMI* Temm.

♂. 263, 275, 293. Jinrio, Tokushima Ken, Shikoku. 500'.

♀. 321. Tanano, Tokushima Ken, Shikoku. 250'.

♂. 420, 423. ♀. 446. Takamori, Kumamoto Ken, Kiushiu. 1850'.

♂. 463. Kawachi, Miyasaki Ken, Kiushiu. 1500'.

Flesh-measurements of an adult male from Shikoku:—Head and body 67 mm.; tail 46; hind foot 13·5; ear 9.

These specimens from the two southern islands are all of a uniform brownish grey, very like the colour of the European *C. russula*, of which this is evidently the Japanese representative. The type locality is presumably Kiushiu.

But the corresponding Shrew found by Mr. Anderson in the north of Hondo is not quite the same, and may be regarded as a different subspecies.

10. *CROCIDURA DSI-NEZUMI CHISAI**, subsp. n.

♂. 51. ♀. 48. Tsunagi, near Morioka, N. Hondo.

♀. 93. Morioka, N. Hondo.

Similar to *dsi-nezumi* in size, but tail rather and hind feet decidedly shorter. General colour much darker, near "seal-brown," but browner and less purple. Under surface "mouse-grey." Tail uniformly dark brown.

Skull rather narrower, less broadly flattened than in *dsi-nezumi*.

Measurements (in mm.) of three specimens in the flesh:—

51. (Type.) Head and body 68; tail 43; hind foot 12.

48. " " 69; " 37; " 11.

93. " " 66; " 38; " 11.

Skull of type—Greatest length 18, basal length 15·4; greatest breadth 8·5; length of upper tooth-series 7·5.

Type. Adult male. B.M. No. 6.1.4.43. Original number 51. Collected 3 October, 1904.

Temminck's "*Sorex umbrinus*" would appear to be similar to this Shrew in colour and size, but is distinguished by its very long tail, 54 mm. in length.

11. *CHIMARROGALE PLATYCEPHALA* Temm.

♀. 168. Tajima, E. coast of Izu Peninsula, S.E. Hondo.

Flesh measurements:—Head and body 112 mm.; tail 90; hind foot 25·5; ear 9.

* Chisai=small.

12. *MOGERA WOGURA* Temm.

♂. 56. Tsunagi, near Morioka, Iwate Ken, N. Hondo.

Flesh measurements:—Head and body 108 mm.; tail 20; hind foot 16·5.

13. *MOGERA WOGURA KOBÆ* Thos.

♂. 336. Ochi, Kochi Ken, Shikoku.

Flesh measurements:—Head and body 160 mm.; tail 25; hind foot 21.

No specimens intermediate in size between these large Moles and the true *wogura* have as yet turned up. Possibly the two forms ought to be regarded as specifically distinct.

14. *UROTRICHUS TALPOIDES* Temm.

♂. 397, 398, 406, 429, 444. ♀. 385, 396, 422, 430, 435. Takamori, Kumamoto Ken, Kiushiu. 1800'.

♂. 471, 472, 476. ♀. 447, 473, 474. Kawachi, Miyasaki Ken, Kiushiu. 1500'.

♂. 274, 290. ♀. 288, 289, 310. Jinrio, Tokushima Ken, Shikoku. 500'.

♀. 314. Fukuhara, Tokushima Ken, Shikoku. 750'.

♀. 324. Ikeda, Tokushima Ken, Shikoku.

♂. 339, 357. ♀. 337, 338, 342, 343, 358. Ochi, Kochi Ken, Shikoku. 1300'.

♀. 329. Sakawa, Kochi Ken, Shikoku.

♂. 370, 378, 379, 380. ♀. 371, 377. Kuma, Ehime Ken, Shikoku. 1200'.

Specimens from Kiushiu may be regarded as typical *talpoides*, for that island is the first locality mentioned in Temminck's original account, besides being that which contains Nagasaki, where the factory of the early Dutch traders was situated.

A pair of well-grown Kiushiu specimens measure (in mm.) as follows:—

♀. Head and body 99; tail 34; hind foot 16.

♂. " " 102; " 34; " 16.

The Shikoku specimens appear to be quite similar to those from Kiushiu. A pair measure:—

♂. Head and body 96; tail 32; hind foot 15·5.

♀. " " 95; " 33; " 15·5.

The general colour of the Kiushiu and Shikoku specimens is a brown, between vandyke and seal-brown, much browner than in those from Northern and Central Hondo.

"These animals are undoubtedly partly herbivorous; for examination of many stomachs showed them to be frequently filled with vegetable matter, probably some root. Remains of earthworms are also frequently found. I catch as many specimens in traps baited with wheat or rice as in those baited with flesh. At all times of the year they come frequently above ground, especially in grassy places.

"Not uncommon; usually found in the embankments that bound the terraced paddy-fields. Often accepting bait of rice or wheat. The stomach contents of those examined was largely of a vegetable character, not mixed with earth as when earthworms are the chief food."—*M. P. A.*

This observation about the food of *Urotrichus* is of remarkable interest, as it is quite opposed to the general rule in the Talpidae. I can find no previous statement on the subject, either as regards this genus or its American ally *Neurotrichus*.

15. *UROTRICHUS TALPOIDES PILIROSTRIS* True.

Dymecodon pilirostris True, P. U.S. Nat. Mus. 1886, p. 97 (juv.).

♂. 53, 61, 62, 65, 73, 74, 75. ♀. 55. Tsunagi, near Morioka, Iwate Ken, N. Hondo.

♂. 94, 95. Morioka, Iwate Ken, N. Hondo.

♂. 142, 144, 145, 162. ♀. 143, 152, 161. Nakaomi, near Ohito, Izu, S.E. Hondo. 400'.

These specimens, from Hondo, are all of a "slate-black" (grey no. 2), with a slight tinge of "mouse-grey," and are without the distinctly brown tone of the typical *talpoides* of Kiushiu and Shikoku. They are also very slightly smaller, with shorter tails and shorter hind feet.

The following are the measurements (in mm.) of a pair from Izu, near the typical locality of "*Dymecodon pilirostris*":—

♂. Head and body 92; tail 30; hind foot 14.5.

♀. " " 90; " " 26; " " 14.5.

A study of Mr. True's description of the genus *Dymecodon* convinced me that his specimen was a young *Urotrichus*, and this suggestion has been confirmed by Mr. Gerrit Miller, who tells me that the type, now in the U.S. National Museum, "is young, with the milk-dentition still in place."

But Mr. Miller goes on to state that the molars of *pilirostris* are smaller than those of *talpoides*, and that there are other slight cranial differences, although, owing to the youth of the specimen, he cannot express an opinion as to their value. "My surmise would be that *Dymecodon* is the same as *Urotrichus*, but that the species *pilirostris* is quite distinct from the ordinary animal."

On geographical grounds, however, it appears to me so unlikely that there should be a different species of *Urotrichus* at Yeno-shima, a place in the Bay of Tokyo quite close to Misaki, where we know the ordinary form occurs, and not far from the Izu peninsula, that I do not at present feel justified in giving the Hondo subspecies any other name than *pilirostris*.

16. *CANIS HODOPHYLAX* Temm.

♂. 255. Washikaguchi, Nara Ken, Hondo.

"The Wolf was purchased in the flesh, and I can learn but little about it. It is rare, some say almost extinct. Japanese name 'Okami' or 'Aamainu.'"—*M. P. A.*

17. NYCTEREUTES VIVERLINUS Temm.

♂. 251. Washikaguchi, Nara Ken, Hondo.

"Japanese name 'Tanuki.'"—*M. P. A.*

18. MUSTELA MELAMPUS Temm.

♀. Takamori, Kumamoto Ken, Kiushiu.

The beautiful golden yellow of this fresh specimen shows a striking contrast to the dark general colour of the Hondo subspecies.

19. MUSTELA MELAMPUS BEDFORDI Thos. (Plate IX.)

Mustela melampus bedfordi Thos. Abstr. P. Z. S. No. 21, p. 10, June 13, 1905; P. Z. S. 1905, ii. p. 183.

♂. 213, 254. ♀. 217, 232. Washikaguchi, Nara Ken, east of Hiogo, Southern Hondo.

This handsome form of the Japanese Marten, the first new mammal obtained by Mr. Anderson, has already been described, and a figure of it is now given to show its striking colour-contrasts. It will no doubt prove to be the form found all over Southern Hondo, the true yellow *melampus* being a native of Kiushiu.

I am informed that the two forms of the Japanese Marten are well known to the furriers, through whose hands many thousands of skins pass every year.

"The Marten may be regarded as common in Nara Ken. Besides the specimens sent, I saw three other individuals which were shown me by peasants. It lives in the more remote parts of the forest, where its burrows are to be found beside rocks or stumps. Native name 'Teng.'"—*M. P. A.*

20. PUTORIUS ITATSI Temm.

♂. 185, 186. Tsushima, Aichi Ken, Hondo.

♂. 224, 225, 226, 227, 233, 245. Washikaguchi, Nara Ken, Hondo.

♂. 281, 319. ♀. 308. Jinrio, Tokushima Ken, Shikoku. 500'.

♂. 427, 442. ♀. 405. Takamori, Kumamoto Ken, Kiushiu. 1850'.

♂. 466. Kawachi, Miyasaki Ken, Kiushiu. 1500'.

The Japanese Mink is evidently very common in Southern Hondo and Shikoku, as every collector sends a number of specimens. But in Northern Hondo Mr. Anderson does not seem to have met with it. In Hokkaido it is probably replaced by some representative of the *P. ermineus* group.

"These animals infested the houses of the neighbourhood, presumably for the purpose of catching rats. All the specimens secured were trapped near houses."—*M. P. A.*

21. MELES ANAKUMA Temm.

♂. 312, 313. ♀. 295. Jinrio, Tokushima Ken, Shikoku. 500'.

♂. 403, 404. Takamori, Kumamoto, Kiushiu.

"Not uncommon. The peasants secure them by smoking them out of their holes."—*M. P. A.*

22. PETAURISTA LEUCOGENYS Temm.

♂. 231, 234, 240. ♀. 253. Washikaguchi, Nara Ken, Hondo.

♂. 477. ♀. 479, 480, 481. Mitai, Miyasaki, Kiushiu.

The specimens from Kiushiu are nearly topotypical, but are less similar to the Nagasaki skin which I provisionally took as typical when recently writing on the subject, than to the form from Shikoku which I described as *P. l. tosa**. Further material from different localities will be needed before the races of this interesting and variable animal can be satisfactorily understood.

"The large Flying Squirrel is well-known in this region (Washikaguchi), and is probably as plentiful as anywhere in Japan. It is found in the large Cryptomerias and other trees which grow about some of the temples and shrines and are never cut. The specimens were all purchased from peasants, who brought them to me. The people say that this animal possesses great control over its 'flight,' being able to turn almost at right angles while in mid-air. Japanese literary 'Musasabi,' but called 'Bandari' in this locality."—*M. P. A.*

"At Mitai, Kiushiu, they lived in numbers in a grove of Cryptomerias surrounding a temple. On the evening of April 21 they appeared about 7.30, when darkness was coming on. The first I saw alighted noiselessly on a trunk near me and immediately ascended rapidly among the branches. Another I saw 'fly' from near the top of a Cryptomeria, make almost a half-circle past a cluster of trees, and alight some 40 ft. from the ground on another Cryptomeria. The 'flight' is swift, but we had time to notice that the tail is held nearly straight out behind."—*M. P. A.*

23. SCIUROPTERUS MOMONGA AMYGDALI †, subsp. n.

♂. 257, 259. ♀. 258, 260, 261, 262. Washikaguchi, Nara Ken, Southern Central Hondo.

The Flying Squirrel received by the British Museum in 1844 from the agent of the Leyden Museum as representing Temminck's "*Pteromys momonga*" is so much smaller than these examples that there is no doubt that the two should bear different names. But it is probable that both are included in Temminck's description, in which case one or other of them must be selected as typical of his species. I would therefore propose to select the smaller one, of which he figured the skull, even though he himself

* Ann. Mag. N. H. (7) xv. p. 488 (1905).

† Dr. Rein states that the Japanese name for this animal, Momodori, means "peach-bird."

believed that it was "semi-adulte." This course, besides making the figure fix the type, has the advantage of giving at least one of the two forms an exact typical locality, whereas if the name *momonga* were applied to the large form and a new name given to the small one, the typical locality of neither would be definable. We may thus treat the British Museum 1844 specimen as a co-type, as it was one of those on which the description was based and agrees absolutely with the typical figure. This specimen, far from being "semi-adulte," is absolutely full-grown; its teeth showing more evidence of wear than is the case with any of Mr. Anderson's examples.

The new subspecies may be briefly described as similar to true *momonga*, but conspicuously larger and with a much longer tail. The co-type above referred to has a skull measuring 36×20 mm., Temminck's figure is 35.5×21.5 ; while the smallest of the Nara skulls is 41×23.5 . The hind foot of *momonga* is just 30 mm., that of *amygdali* 37-38.

In colour there is probably little difference, but direct comparison is not possible, as the co-type of *momonga* is in the brown summer pelage. The new form, in its winter pelage (January), has its dorsal hairs blackish slaty, washed terminally with isabella, tending sometimes towards buffy. Cheeks and under surface white, the hairs slaty basally. Under side of membranes irregularly washed with pale fawn. Upper surface of hands and feet grizzled black and fawn, a prominent tuft of longer hairs at the end of each hind toe clear isabella. Tail subdued wood-brown, washed above and below with black.

Skull larger and heavier in every way than that of true *momonga*.

Dimensions of the type, measured in the flesh:—

Head and body 166 mm.; tail 139; hind foot 38; ear 25.

Skull—greatest length 42.2; basilar length 31.5; greatest breadth 26; length of nasals 13.6; breadth of brain-case 19; palatilar length 17.7; palatal foramina 4.3; length of upper tooth-series, exclusive of p^3 , 6.8,

Type. Adult male. B.M. No. 6.1.4.122. Original number 257. Killed 27 January, 1905.

It is probable that the smaller form, to which I restrict the name *momonga*, will prove to be an inhabitant of one of the southern islands, while the larger one is no doubt spread widely over Hondo.

"Brought to me by a servant after my departure from Washikaguchi. They were taken near the top of a rather high mountain, in a forest of *Chamaecyparis*. Regarded by the peasants as the young of the Petaurista, and therefore called 'Bandari.'"—*M. P. A.*

24. *SCIURUS VULGARIS ORIENTIS*, subsp. n.

♂. 98, 102. ♀. 103. Aoyama, Hokkaido.

♂. 125, 127, 136. ♀. 126, 128, 131, 132, 133, 138. Noboribetsu, near Moruran, Hokkaido.

♂. 9, 11, 12, 13. ♀. 8, 14, 15, 16, 17, 18, 19, 20. Jozankei, ear Sapporo, Hokkaido.

The Noboribetsu and Aoyama specimens are in the winter, and the Jozankei specimens in the summer pelage.

In Major Barrett-Hamilton's paper* on the subspecies of *Sciurus vulgaris*, those from the Far East, from Korea and Hokkaido, are assigned to *S. v. calotus* Hodgs. †, whose typical locality is the high region of Central Asia. But the valuable series obtained by Mr. Anderson indicates that they are sufficiently different to have a subspecific name of their own. For while the type of *calotus* and other specimens from the Altai are, in winter pelage, a clear deep grey above without rufous suffusion, the whole of the Hokkaido examples are strongly suffused along the head, dorsal area, and base of the tail with a colour between "Mars-brown" and "vinaceous-cinnamon" of Ridgway, though paler than either. Sides clearer and more silvery grey, especially on two patches on each side, behind the shoulders and in front of the hips. Throat, chest, and belly pure sharply defined white, the hairs white to their roots. Ear-tufts, hands, and feet blackish, more or less speckled with fulvous. Tail broadly washed with black, the basal part of the hairs more or less greyish or fulvous.

In summer pelage the ground-colour (apart from melanism) is dull reddish brown, with dark red ears and feet, and perhaps sometimes a more or less red-washed tail. But every specimen is to a certain degree affected with melanism, and the only one that has the body, ears, feet, and proximal half of tail red, also has the terminal half of the latter organ blackish, as the whole of it is in the majority of specimens.

Dimensions of the type, measured in the flesh:—

Head and body 244 mm.; tail 175; hind foot (s. u.) 60; ear 34.

Skull—greatest length 54; basilar length 43.

Hab. Hokkaido. Type from Aoyama.

Type. Adult male in winter pelage ‡. B.M. No. 6.1.4.128. Original number 98. Collected 9 November, 1904.

Two specimens from Söul, Korea, presented by Mr. C. W. Campbell, and killed in January 1889, appear to be quite similar to the Hokkaido Squirrel.

This Eastern form of *S. vulgaris* is no doubt most closely related to *S. v. calotus*, but may be distinguished by the rufous suffusion along its dorsal area. This produces, at least in the winter coat, a considerable resemblance to the Scandinavian Squirrel, but from that animal it is readily distinguished by its dark ear-tufts and feet, and by the sharp definition and complete whiteness of the colour of the under surface.

This Squirrel is of course the *Sciurus varius* of the 'Fauna

* P. Z. S. 1899, p. 3.

† *Mastela* (?) *calotus* Hodgs. Calc. Journ. N. H. ii. p. 221 (1842).

‡ The hands and feet of the type have some of the red of the summer coat still on them, and this specimen is not, as I at first thought, an exception to the rule that the Hokkaido Squirrel has dark feet in the winter pelage.

Japonica,' but that name, first used by Pallas for the Siberian Squirrel, was rendered invalid by its previous use by Kerr, as shown in Major Barrett-Hamilton's paper.

25. *SCIURUS LIS* Temm.

♀. 7. Takayu, near Yonezawa, Uzeu, Northern-Central Hondo, 3000'. 13 August.

♀. 208. Nara, east of Hiogo, Hondo.

♂. 242. ♀. 249, 250. Washikaguchi, Nara Ken, Hondo.

The Uzeu specimen is in the red-footed summer pelage, without ear-tufts; the others are in the grey winter coat. By some curious error, Temminck has described the former pelage as that of winter, and the latter of summer, but even with only undated specimens available, it is difficult to understand how such a mistake could have been made, as the difference in the quality of the fur is very considerable.

Mr. Anderson did not send any true Squirrels from Kiushiu or Shikoku, but he tells me that they do occur there, though rare and local.

Mr. Gordon Smith's collection contains examples of *Sciurus lis* from Shimosa, Misaki, and the Hiogo Hills, all in Southern Hondo.

"These Squirrels were shot in the groves of pine-trees along the tops of ridges above the village. We found them scarce in the neighbourhood, the three secured being the only ones seen. Native name 'Kinezumi.'"—*M. P. A.*

[*GLIRULUS* (g. n.) *JAPONICUS* Schinz.

Myoxus elegans Temm. 1844.

Although not included among Mr. Anderson's captures, the Japanese Dormouse needs a few remarks on its systematic position and nomenclature, which may conveniently be made here.

Firstly in regard to its specific name. Temminck unfortunately gave it a title which was preoccupied (*Graphiurus elegans* Ogilby, 1838*; *Myoxus elegans* Wagn. 1843), and it was therefore renamed first, in 1845, by Schinz, who called it *javanicus*, and then in 1882, on the ground that *javanicus* was invalid owing to its incorrectness, by myself, with the name of *lasiotis*.

But the plea of incorrectness is no longer admitted, and we are therefore forced to take Schinz's name. We may, however, look upon it as a misprint for *japonicus*, and amend it accordingly, for the statement "Habitat in Japonia" clearly shows that Schinz did not suppose it came from Java, and the accidental alteration of two letters only would make the difference. This course has been already taken by Wallace†, and is, I think, the best way out of the difficulty.

With regard to the generic position of this Dormouse, I think it

* References to all the names here mentioned are given in Reuven's, 'Myoxidæ: p. 66 (1890).

† 'Island Life,' 2nd edition, p. 395 (1892).

cannot be assigned to any of the existing groups and must have a special name of its own. It is no doubt most nearly allied to *Eliomys* (*Dryomys*, subg. n.) *nitidulus** Pall., but may be readily distinguished by the rather more complicated pattern of its teeth, its small bullæ, the absence of the angular foramen in its mandible, and its peculiar and characteristic colour-pattern. These characters are all brought out in Reuven's descriptions and figures, and do not need further reference here.]

26. *MUS NORVEGICUS* Erxl.

- ♂. 21. Jozankei, Sapporo, Hokkaido.
 ♂. 96, 97. Shinshinotsu, Sapporo, Hokkaido.
 ♀. 99. Aoyama, Hokkaido.

"Caught in forest; extremely abundant."

27. *MUS TANEZUMI* Temm.

- ♀. 42. Makado, near Nohechi, Aomori Ken, N. Hondo. 400'.
 ♂. 5. Takayu, near Yonezawa, Uzeu, Hondo. 3000'.

This is the Japanese representative of the Chinese *Mus losea* Swinh.

28. *MUS MOLOSSINUS* Temm.

- ♀. 66. Tsunagi, near Morioka, Iwate Ken, N. Hondo.
 ♀. 482. Tano, Miyasaki Ken, Kiushiu. 500'.
 "Contained 6 embryos 17 mm. in length."

No. 66 has all the appearance of a wild-living individual, not that of a house-mouse, and its proportions approximate to those of the European *Mus spicilegus*. Head and body 92 mm.; tail 55; hind foot 15.

29. *MICROMYS SPECIOSUS* Temm.

- ♂. 28, 30, 33, 34, 36. ♀. 29, 37, 40, 41. Makado, near Nohechi, Aomori Ken, N. Hondo.
 ♂. 52, 54, 60, 63, 77, 78. ♀. 49, 59, 79, 82, 83. Tsunagi, N. Hondo.
 ♂. 165, 174, 176, 177. ♀. 172, 173. Tajima, Izu, S.E. Hondo.
 ♂. 139, 153, 156, 164. ♀. 141, 150, 154, 157. Nakaomi, Izu, S.E. Hondo.
 ♂. 276, 278, 279, 285, 302. ♀. 264, 265, 266, 272, 277, 280, 284. Jinrio, Tokushima Ken, Shikoku. 500'.
 ♂. 330. ♀. 331, 332. Sakawa, Kochi Ken, Shikoku.
 ♂. 334, 335, 344. ♀. 340, 341, 353, 356, 369. Ochi, Kochi Ken, Shikoku. 200'–1000'.
 ♂. 326, 327. ♀. 328. Ikeda, Tokushima Ken, Shikoku.
 ♀. 317, 318. Fukuhara, Tokushima Ken, Shikoku. 750'.

* Better known as *dryas* Schr. The peculiarities of this species, which, while essentially an *Eliomys*, shows certain leanings towards *Glis*, demand a special sub-generic name. *Elius* Schulze is not available, being a synonym of *Glis*.

♂. 373, 374. ♀. 375, 376. Kuma, Ehime Ken, Shikoku. 1200'.

♂. 459, 460, 461. ♀. 452. Kawachi, Miyasaki Ken, Kiu-shiu. 1500'.

♂. 390, 391, 402, 411, 412, 425, 436, 437. ♀. 393, 418, 419, 426, 433. Takamori, Kumamoto Ken, Kiu-shiu. 1850'.

♂. 483, 498, 499. ♀. 484, 491. Tano, Miyasaki Ken, Kiu-shiu. 500'.

“Common everywhere.”

Even with this fine series, combined with that sent by Mr. Gordon Smith, I am unable to trace completely the relation of the presence of spines in the fur to season and sex. Many specimens of each sex are spinous, many spineless, and in a general way it is clear that spines are a character of summer, while they are rarely or never present in the winter pelage. Two examples, however, killed in the middle of December have spines, and one from Shikoku, killed in February, so that there are evidently exceptions to the general rule.

Young specimens, before the development of the rufous colour, are always spineless.

The mammary formula in this species is 2—2=8.

It appears probable that Temminck's *Mus argenteus*, also described in the 'Fauna Japonica,' was based on small spineless specimens of *M. speciosus*.

The following are the dimensions (in mm.) of a pair from the Izu peninsula:—

♂. Head and body 128; tail 112; hind foot 24; ear 16.

♀. " " 115; " 105; " 24; " 15.

30. MICROMYS SPECIOSUS AINU, subsp. n.

♂. 10. Jozankei, near Sapporo, Hokkaido.

♀. 26. Shinshinotsu, near Sapporo, Hokkaido.

♀. 108, 117. Aoyama, Hokkaido.

As in true *speciosus*, but with rather longer feet and longer skull.

General characters as in the *M. speciosus* of Hondo, with the same dark fulvous colour blackened along the dorsal area and the same whitish underside. Fur similarly either spinous or spineless. Hands and feet greyish white. Feet longer and heavier than in true *speciosus*.

Skull rather narrower and more elongate than in true *speciosus*; palatal foramina longer.

Dimensions of the type, measured in the flesh:—

Head and body 118 mm.; tail 107; hind foot 27·5; ear 15.

Skull—greatest length 31; basilar length 25; nasals 12·2; interorbital breadth 4·8; breadth of brain-case 12·8; palatilar length 14·4; diastema 9·5; palatal foramina 5·8; length of upper molar series 4·2.

Hab. Hokkaido. Type from Aoyama.

Type. Female. B.M. No. 6.1.4.219. Original no. 117. Collected 15 November, 1904.

Of the large series of *M. speciosus* from Hondo, enumerated just previously, only one has a hind foot as much as 25.5 mm. in length, the majority of the adults ranging from 23 to 25. And of those from Shikoku and Kiushiu one only has 25.5, and one 26. On the other hand, the four from Hokkaido are all measured as 26 or over, and in addition their skulls are rather more elongate, especially in the muzzle, than those of the more southern form.

Under these circumstances, in view of the general difference between the faunas of Hondo and Hokkaido, I have thought it advisable to give the form from the latter island a special subspecific name, like as it is to its ally in all other respects.

31. MICROMYS GEISHA THOS.

Ann. Mag. N. H. (7) xv. p. 491 (1905).

♂. 32, 35. ♀. 31. Makado, N. Hondo.

♂. 50, 57, 58, 64, 67, 68. ♀. 69, 70, 71, 72. Tsunagi, Iwah Ken, N. Hondo.

♀. 1, 2, 4. Takayu, Uzeu, Hondo.

♂. 166, 169, 178, 179. ♀. 167, 170, 171. Tajima, Izu, S.E. Hondo.

♂. 140, 147, 155. ♀. 148, 149, 158, 163. Nakoma, Izu, S.E. Hondo.

♂. 268, 292, 309. ♀. 273, 299, 300, 301. Jinrio, Tokushima Ken, Shikoku. 500'.

♂. 351, 363, 364, 365, 366. ♀. 352, 354, 362, 368. Ochi, Kochi Ken, Shikoku. 1500'–2100'.

♂. 381. ♀. 372. Kuma, Ehime Ken, Shikoku.

♂. 394, 401, 416. ♀. 409, 410, 417. Takamori, Kumamoto Ken, Kiushiu. 1800'.

♂. 453. ♀. 451, 454. Kawachi, Miyasaki Ken, Kiushiu. 1500'.

Two specimens of this pretty little species were obtained by Mr. H. Pryer in the Yokohama region in 1888, but it was only when Mr. Gordon Smith's collection was being worked out that it was recognised as new. It would appear to be generally distributed over Hondo, Shikoku, and Kiushiu, and is represented in Hokkaido by a short-eared subspecies.

Its mammary formula, as previously stated with doubt, is 2—2=8.

The following are the flesh measurements (in mm.) of a pair from the Izu peninsula:—

♂. Head and body 94; tail 99; hind foot 20; ear 14.

♀. " " 94; " 94; " 18; " 14.

32. MICROMYS GEISHA HOKKAIDI, subsp. n.

♂. 100, 110, 111, 112, 118. ♀. 109, 119, 120. Aoyama, Hokkaido.

♂. 122, 123, 124, 130, 134, 137. ♀. 135. Noboribetsu, near Moruran, Hokkaido.

“Common in bamboo-grass.”

Similar to true *M. geisha* in all respects except that the general colour averages slightly paler (nearly as pale as “isabella,” but of a more rufous brown), and the ears are decidedly shorter.

Dimensions of the type, measured in the flesh:—

Head and body 90 mm.; tail 95; hind foot 19; ear 12.5.

Skull—greatest length 23.5; basilar length 18; palatilar length 10; palatal foramina 5; length of upper molar series 3.6.

Hab. Hokkaido; type from Noboribetsu.

Type. Adult male. B.M. No. 6.1.4.269. Original number 123. Collected 21 November, 1904.

The ear-measurement of *M. geisha* was given in the original description as 12.5 mm., but this was taken on a poorly-made skin, and it is evidently below the correct dimensions. For of nine adult Izu examples seven have been measured by Mr. Anderson as 14 mm., and two as 13.5, while of thirteen adult Hokkaido skins two have this measurement 12, two 12.5, eight 13, and one 13.5. Little as this difference sounds in figures it is easily recognisable by eye.

The occurrence in Hokkaido of representatives of *Micromys speciosus* and *geisha* shows that there is a genuine Japanese element in the fauna of that island, mixed with the boreal non-Japanese fauna indicated among others by the occurrence of *Sciurus vulgaris* instead of *lis*, and *Lepus timidus* instead of *brachyurus*.

33. MICROMYS MINUTUS JAPONICUS, subsp. n.

♂. 286. Jinrio, Tokushima Ken, Shikoku. 500'.

♂. 322. Tanano, Tokushima Ken, Shikoku. 250'.

♀. 462. Kawachi, Miyasaki Ken, Kiushiu. 1500'.

General colour above dusky sepia, the rump only rufous, as in the Eastern forms of *minutus*; belly sharply contrasted white, though with slaty bases to the hairs, as in the European races. One old specimen, however, is more or less rufous over the whole of the upper surface; but this would seem to be an exception.

Skull apparently thicker and heavier than in the other races, with an unusually large brain-case and short muzzle, but material is lacking for a satisfactory comparison with the Eastern forms *pygmaeus* and *ussuricus* *. Molars decidedly larger than in *ussuricus*, which has the tooth-row only 2.8 mm. in length.

Dimensions of the type, measured in skin:—

Head and body 66 mm.; tail 61; hind foot 14.5.

Skull—basilar length 13.7; interorbital breadth 3.4; breadth of brain-case 9.3; palatilar length 8; diastema 4.5; palatal foramina 3; length of upper molar series 3.1.

* The type of *ussuricus* has a hind foot 14 mm. in length, not 12 as given in the original description.

Dimensions of one of Mr. Anderson's specimens, measured in the flesh:—

Head and body 59 mm.; tail 55; hind foot 15; ear 7.

Hab. Southern Hondo, and the islands of Shikoku and Kiushiu. Type from Tosa, Kochi Ken, Shikoku.

Type. Adult male. B.M. No. 5.3.3.44. Collected 15 February, 1904, by R. Gordon Smith, Esq.

The occurrence of the Harvest-Mouse in Japan was recorded by Temminck.

34. *MICROTUS MONTEBELLI* M.-Edw.

Arvicola montebelli M.-Edw. Rech. Mamm. p. 285 (1874). (Fusiyama.)

Arvicola hatanedzumi Sasaki, Bull. Tokyo Coll. Agric. vi. p. 51 (1904). (Tokyo.)

♂. 39. ♀. 38, 43, 45, 46. Makado, near Nohechi, Aomori Ken, N. Hondo.

♂. 80, 84, 85, 86. ♀. 81, 87, 88, 89, 90, 91, 92. Morioka, Iwate Ken, N. Hondo.

♂. 151. ♀. 159. Nakaomi, nr. Ohito, Izu, S.E. Hondo.

♀. 464, 467. Kawachi, Miyasaki Ken, Kiushiu. 1500'.

The British Museum owes to the kindness of Prof. Sasaki representative examples of the Vole described by him as *Arvicola hatanedzumi*, and with these Mr. Anderson's specimens entirely agree. But Prof. Sasaki's name is unfortunately antedated by that given by Milne-Edwards in 1874, the type of which latter is in the Paris Museum.

This type was carefully examined by Mr. Gerrit Miller during his recent visit to Europe, and on his later studying in London the specimens of "*hatanedzumi*" from Tokyo, and a series from Misaki sent home by Mr. Gordon Smith, he came to the conclusion that all belonged to one species, a conclusion from which I see no reason to differ.

One (No. 80) of the twenty-three specimens has a supplementary *agrestis*-like lobe on m², but does not differ from the rest in any other respect.

This Vole is evidently rare in Shikoku and Kiushiu, for Mr. Anderson obtained no example of it in the former island and only two in the latter.

35. *EVOTOMYS MIKADO* Thos.

Evotomys mikado Thos. Abstr. P. Z. S. No. 23, p. 19, Dec. 5, 1905.

♂. 121. Noboribetsu, near Moruran, Hokkaido.

♀. 107. Aoyama, Hokkaido. 400'. *Type.*

"Under moss-grown log in forest of alders and birches."

A true *Evotomys* of medium size, similar in general appearance to Danish examples of *E. glareolus*.

Rufous dorsal area covering the whole top of the head and breadth of the back fairly well defined laterally, especially on the

fore-quarters; its colour rather redder than in *E. glareolus*, approaching "hazel" of Ridgway. Sides greyer. Belly washed with pale buff, not sharply defined laterally. Ears bright rufous. Upper surface of hands and feet pale brownish white. Tail of medium length, well-haired and tufted, dark brown above, dull white below, the terminal tuft black above, whitish below.

Skull rather flatter than in *E. glareolus*, with a low weak muzzle and the frontal outline not so convex. Palatal foramina longer. Choanæ broad and low, their structure as usual.

Molars with the same essential pattern as in *E. glareolus*, but they are peculiarly compressed from before backwards, so as to be unusually broad in proportion to their length, this proportion also being shown in the individual cement-spaces, which are broad transversely, short antero-posteriorly, and with their lateral angles (especially the outer above and the inner below) very sharp.

Dimensions of the type, measured in the flesh:—

Head and body 104 mm.; tail 34; hind foot 17; ear 11·5.

Skull—tip of nasals to back of frontals 15·5; nasals 6·7 × 2·9; height of muzzle behind incisors 3·5; interorbital breadth 3·8; palatilar length 10·4; diastema 7; palatal foramina 5; length of upper molar series (crowns) 4·7.

Type. Adult female. B.M. No. 6.1.4.296. Original number 107. Collected 13 November, 1904.

The occurrence of a typical *Evotomys* in Hokkaido was quite to be expected from the general character of the fauna of that island.

36. *EVOTOMYS (CRASEOMYS) BEDFORDIÆ* THOS.

Evotomys bedfordiæ Thos. Abstr. P. Z. S. No. 23, p. 18, Dec. 5, 1905.

♂. 22, 23, 24. ♀. 25, 27. Shinshinotsu, near Sapporo, Hokkaido. Below 100'.

♂. 101, 104, 106, 113, 114, 115, 116. ♀. 105. Aoyama, Hokkaido. 200'.

"On plains covered with tall grass and scattered alders."

"In bamboo-grass."

Size about as in the Scandinavian *E. (C.) rufocanus* Sund. Fur as in that species, long and loose; hairs of back about 10 mm. in length. General colour less contrasted red and grey than in *rufocanus*, the back darker chestnut, more *E. glareolus*-like, and the sides darker and less sharply contrasted grey. Under surface dull greyish washed with buffy. Crown rufous-chestnut, like the back. Ears inconspicuously reddish. Cheeks like sides. Upper surface of hands and feet dull greyish, the fingers whiter. A prominent glandular patch present in the male on each flank in front of the hip, rather further back than in *E. rufocanus*. Tail considerably longer than in *rufocanus*, less thickly haired, the rings of scales not hidden; brown above, dull white below.

Skull apparently very much as in *E. rufocanus*. It may be

noted that in not one of the specimens are the two bridges over the lateral grooves on the posterior palate complete, while they appear to be always complete in true *Evotomys*.

Teeth broad and powerful, their pattern much as in *E. rufocanus*; last segment of m^3 simple, with scarcely any trace of a postero-internal re-entrant angle.

Dimensions of the type, measured in the flesh:—

Head and body 119 mm.; tail 47; hind foot (s. u.) 20; ear 15.

Skull—greatest length 27·8; basilar length 24; zygomatic breadth 16; length of nasals 8; interorbital breadth 3·7; diastema 7·9; palatilar length 13; palatal foramina 5·7; length of upper molar series 6·4; breadth of front lamina of m^2 1·3.

Hab. Hokkaido. Type from Shinshinotsu.

Type. Adult male. B.M. No. 6.1.4.298. Original number 23. Collected 10 September, 1904.

I have named this handsome Vole after Her Grace the Duchess of Bedford, whose interest in zoology is not less than that of her husband.

E. bedfordiae agrees with the Scandinavian *E. rufocanus*, the type of the subgenus *Craseomys*, in all essential particulars, but may be readily distinguished by its more *glareolus*-like colour, less contrasted back and sides, and longer, less hairy tail.

E. (C.) latastei Allen, from Kamtchatka, is a considerably smaller animal.

An example of this species was obtained by the late Dr. John Anderson in Hokkaido in 1885, and presented by him to the British Museum, but has not hitherto been identified.

37. *EVOTOMYS (CRASEOMYS) ANDERSONI* THOS.

Evotomys andersoni Thos. Abstr. P. Z. S. No. 23, p. 18, Dec. 5, 1905.

♂. 76. Tsunagi, near Morioka, Iwate Ken, N. Hondo. (*Type*.)

♂. 44. Makado, near Nohechi, Aomori Ken, extreme North Hondo.

Very like *E. (Craseomys) bedfordiae* externally, but with longer tail, and the teeth much less powerful.

General external appearance almost exactly the same as in *E. bedfordiae*, the fur of the same long loose texture, and the colour similarly dark lined chestnut passing gradually into greyish on the sides, without the marked contrast found in *E. rufocanus*. Under surface rather darker buff than in *E. bedfordiae*. Feet rather shorter than in the allied species; tail longer, its dark upper less contrasted with its pale lower surface.

Skull of the same general shape as in *E. bedfordiae*, and with the same long parallel-sided interorbital region, but more lightly built throughout. Palatal foramina shorter. Hinder edge of palate with the bridges over the lateral grooves complete.

Teeth conspicuously lighter and weaker than in *E. bedfordiae*, the incisors and all the molars much narrower. Pattern in a

general way similar, but the broad bold outlines of *E. bedfordiæ* are replaced by a weaker and more rounded pattern, more like that of ordinary *Evotomys*, to which this species shows some approximation. But the teeth are rootless, and with m^2 and m_3 encapsuled as in *Craseomys*. Posterior section of m^3 more complicated than in *bedfordiæ*, forming an inturned C, there being three re-entrant angles on each side of this tooth, the last at least half as deep as the two anterior ones. In *E. bedfordiæ* and *E. rufocanus* there is scarcely any trace of a third concavity on either side, while the two anterior re-entrant angles are exceedingly deep and bold.

Dimensions of the type, measured in the flesh :—

Head and body 120 mm.; tail 54; hind foot (s. u.) 18·5; ear 13.

Skull—greatest length 26·6; basilar length 22·7; zygomatic breadth 15; length of nasals 7·8; interorbital breadth 3·3; diastema 7; palatilar length 12·2; palatal foramina 5; length of upper molar series 5·1; breadth of front lamina of m^2 0·9.

Hab. Northern Hondo. Type from near Morioka.

Type. Adult male. B.M. No. 6.1.4.307. Original number 76. Collected 10 October, 1904.

The second specimen (No. 44) is younger and therefore more greyish brown in colour, and its teeth are more angular than those of No. 76. But I do not think that there is any doubt as to its belonging to the same species as the type.

I have named this interesting Vole in honour of Mr. Anderson, its discoverer, who has so far carried out the Duke of Bedford's exploration with conspicuous success.

38. EVOTOMYS (PHAULOMYS) SMITHII THOS.

Evotomys (Phaulomys) smithii Thos. Ann. Mag. N. H. (7) xv. p. 493 (1905).

♂. 146. ♀. 160. Nakaomi, nr. Ohito, Izu Peninsula, S.E. Hondo. 400'.

♂. 345, 346, 347, 348, 359, 360. ♀. 333, 349, 350, 361, 362. Ochi, Kochi Ken, Shikoku. 1400'.

♂. 267, 270, 271, 296, 297, 311. ♀. 287, 291, 298. Jinrio, Takushima Ken, Shikoku. 500'.

♂. 382, 383, 384. Kuma, Ehime Ken, Shikoku. 1200'.

♂. 315. ♀. 316. Fukuhara, Tokushima Ken, Shikoku. 750'.

♂. 325. Ikeda, Tokushima Ken, Shikoku.

♀. 320. Yanainidane, Tokushima Ken, Shikoku. 1600'.

♂. 387, 388, 399, 407, 414, 424, 431, 445. ♀. 386, 389, 400, 415, 439, 440, 441. Takamori, Kumamoto Ken, Kiushiu.

♂. 465. ♀. 448, 449, 450, 455, 457, 468, 469, 470. Kawachi, Miyasaki Ken, Kiushiu. 1500'.

♂. 478. Mitai, Miyasaki Ken. 1000'.

This fine series, numbering 53 examples, of the new form of Red-backed Vole discovered by Mr. Gordon Smith, adds considerably to our knowledge of its variation and distribution. It

would seem to be widely spread over Southern Hondo, S. of 35° N., and to be common in both Shikoku and Kiushiu, its distribution thus corresponding with that of so many Japanese animals. There does not appear to be any tangible difference between the specimens from the Izu Peninsula, from the type locality, Kobe, or from the two southern islands, Shikoku and Kiushiu. In each place, however, there seems a good deal of variability, both in colour, which ranges from a light russet-brown to a dark "vandyke-brown," and in tooth-pattern.

In the latter respect the following description applies to the majority of the specimens, the type being among the minority; but there is every gradation between the two.

M³ with the first outer and inner re-entrant angles subequal, the latter being much deeper in the type; second and third spaces partially, and in some cases fully, separated, not continuous as in the type; fourth space not always separated off from the posterior C; head and tail of the C strongly developed, with a deep re-entrant angle between them, as deep as the one before the head, the third internal projecting angle of the tooth; there are, therefore, three subequal internal re-entrant angles, while in the type there are two deep ones only (the second deeper than is shown in my figure and running more directly backwards), the third being represented by a quite inconspicuous concavity. Similarly on the outer side of the tooth the third concavity is usually far more marked than in the type. As a result of these variations in the depths of the re-entrant angles, the whole tooth appears more bilaterally symmetrical than in the figured specimen. Below, the spaces of m₁ are usually less uniformly coalesced with each other, and the slight antero-internal concavity of the front trefoil is often developed into a well-defined re-entrant angle, so that there are four inner re-entrant angles to the tooth instead of three.

The measurements (in mm.) in the flesh of two Kiushiu adults are as follows:—

♂. Head and body 100; tail 50; hind foot 17·5; ear 11.

♀. " " 103; " 49; " 18·0; " 12.

With regard to the number of the mammae, there appear to be only 6, two inguinal pairs and a posterior pectoral pair, no trace of an anterior pectoral pair being discoverable. But the examination has only been made on skins, none of them killed in the breeding-season, and must therefore not be looked on as final.

"Lives both in forest and on grassy hill-sides."—*M. P. A.*

39. *LEPUS TIMIDUS* AINU BARR.-HAM.*

♂. 129. Noboribetsu, near Moruran, Hokkaido.

In the white winter pelage.

Dimensions in the flesh:—

Head and body 510 mm.; tail 35; hind foot 142; ear 65.

* P. Z. S. 1900, p. 90.

40. *LEPUS BRACHYURUS* Temm.

♂. 3. Takaya, near Yonezawa, Uzeu, Hondo.

♂. 175. Tajinia, Izu Peninsula, S.E. Hondo.

♂. 180. Ohito, Izu Peninsula. 100'.

♂. 235, 242. ♀. 239, 244. Washikaguchi, Nara Ken, Hondo.

♂. 282, 305. ♀. 283, 306, 307. Jinrio, Tokushima Ken, Shikoku.

♂. 421. ♀. 413. Takamori, Kumamoto Ken, Kiushiu.

Dimensions of an adult female in the flesh:—

Head and body 505 mm.; tail 40; hind foot 135; ear 78.

“Very common; called ‘Usangi’ by the Japanese.”—*M. P. A.*41. *PENTALAGUS FURNESSI* Stone.

♂. 600. Oshima, Okinawa, Liu-Kiu Is.

This specimen of the interesting Liu-Kiu Hare was presented to Mr. Anderson by Mr. Alan Owston, of Yokohama. It agrees with the type in the possession of only five upper cheek-teeth.

Another specimen is now living in the Duke of Bedford's menagerie at Woburn.

42. *SUS LEUCOMYSTAX* Temm.

♀. 252. Washikaguchi, Nara Ken, Hondo.

“The Wild Boar is very common, some 500 being killed yearly in Nara Ken alone. Japanese name ‘Inoshishi.’”—*M. P. A.*

43. *NEMORHEDUS CRISPUS* Temm.

♂. 229. ♀. 230. Washikaguchi, Nara Ken, Hondo.

“The Goat-Antelope is exceedingly rare in Nara Ken, and probably everywhere, for this is but the second place where I have heard of its existence. I was told that 5 to 7 are killed yearly in Nara Ken. It inhabits dense forested heights, and when pursued seeks the rockiest and most precipitous places where it can find cover. Japanese name ‘Niku.’”—*M. P. A.*

44. *CERVUS SIKA* Temm.

♀. 228. Washikaguchi, Nara Ken, Hondo.

“Common, many hundreds being killed yearly by the natives. Native name ‘Shika.’”—*M. P. A.*

APPENDIX.

On Collections from the Islands of Oki, Yakushima, and Tanegashima.

I. OKI ISLANDS.

These islands lie about 50 miles out at sea, north of Matsuye, towards the western end of South-west Hondo. Mr. Anderson says:—“Dogo Island, the largest of the group, is a heavily-wooded,

mountainous island, rising in places to over 2000 feet. Only the broadest valleys are cultivated, and the hill-sides near the sea. The mountains are steep, but not usually rocky. With few exceptions dense forest clothes all the mountain-sides and tops. It consists of oaks, elms ('zelkova'), chestnuts, camelias, pines, firs, and cryptomerias.

"The island is well watered. We had frequent heavy rains during our stay, which was from June 28 to July 12. The prevailing temperature at the little interior hamlet where we stayed was 74° F. at noon. The nights were slightly cooler."

Of the geology Mr. Robert Anderson says: "Dogo seems to be founded on a formation of very old gneiss of sedimentary origin, which is concealed over much of the surface by recent volcanic rocks and local Tertiary deposits."

31 specimens were obtained in Dogo, belonging to the following six species. Several show some slight modification as compared with their Hondo allies.

1. *MOGERA WOGURA KOBÆ*, Thos.

♂. 586, 587, 596, 602. ♀. 582, 585, 588, 589, 590, 594, 595, 597, 601, 605, 607, 610. Dogo Island. 100'.

These specimens are in no way distinguishable from the large Mole of S.W. Hondo.

Their skulls, without exception, are all within the narrow limits of 38 to 40 mm. in total length.

2. *UROTRICHUS TALPOIDES* Temm.

♂. 591. Dogo Island. 100'.

3. *CROCIDURA DSI-NEZUMI* Temm.

♂. 599. Dogo Island. 100'.

4. *MICROMYS SPECIOSUS NAVIGATOR**, subsp. n.

♂. 583, 592, 593, 603. ♀. 580, 584. Interior of Dogo Island.

General characters as in Japanese *speciosus*, though the colour is a little duller than the average and the feet are more brownish grey, not so distinctly white. Tail markedly shorter than in any specimens from elsewhere.

Skull as in true *speciosus*.

The following are the dimensions (in mm.) of four well-grown specimens:—

♂	Head and body	112;	tail	87;	hind foot	24·5;	ear	16.	
♂	"	"	120;	"	88;	"	25;	"	16·5.
♂	(Type)	"	"	104;	"	79;	"	25;	"	15.
♀	"	"	104;	"	87;	"	24·5;	"	15.

Skull of type—greatest length 29 mm.; basilar length 23; length of upper molar series 4·2.

* Oki=out in the sea, out in the offspring.

Type. Young adult male. B.M. No. 6.1.4.378. Original number 583. Collected 30 June, 1905.

This insular form of the common Japanese Field-Mouse is readily recognisable by its much shorter tail, this organ in true *speciosus* being rarely less than 100 mm. in length.

5. *MICROMYS GEISHA CELATUS*, subsp. n.

♂. 598, 611. ♀. 581, 606. Interior of Dogo Island. 100'.

Average size distinctly smaller than in mainland *geisha*, and the tail proportionally short. Fur fine and close; hairs of back about 6-7 mm. in length. Colour as in true *geisha*.

Dimensions (in mm.) of three specimens, measured in the flesh:—

♂ (Type) Head and body 80; tail 80; hind foot 19; ear 15.

♂ " " 77; " 83; " 19; " 14.

♀ " " 78; " 74; " 19; " 13.

Skull of type—greatest length 24 mm., length of upper molar series 3.6.

Type. Male. B.M. No. 6.1.4.385. Original number 611 Collected 10 July, 1905.

These insular examples of the common *geisha*-mouse are 5-15 mm. less in the head and body measurement, and 5-20 less in the tail, than specimens from the mainland, but are like the latter in all other respects.

6. *LEPUS BRACHYURUS OKIENSIS*, subsp. n.

♂. 609 (*yg.*). ♀. 604, 608 (*yg.*). Dogo Island. 100'.

Size and other essential characters as in true *brachyurus*, but the colour heavily blackened throughout, more or less melanistic. Of the type, the only adult, the general colour above is uniform bistre-brown, the ordinary subterminal buffy rings on the hairs being either absent or much reduced. Central area of face and crown similar to back, as are the cheeks; a lighter line running from the whiskers past the eyes to the ears. Nape brown. Ears with the proectote* deep black, inconspicuously fringed with buffy; metentote blackish proximally, brownish buffy terminally, outer fringe narrow, dull buffy, inconspicuous; metectote brown proximally, the terminal half-inch black. Sides little lighter than back. Interramia dull whitish, reduced in size by the extension of the black chin-patch. Collar deep bistre-brown. Belly dull whitish. Limbs coloured like back, the long hairs of the feet

* Every mammalogist in describing specimens has felt the need for names to characterise the different parts of the ear when folded, as in repose. The anterior third and posterior two-thirds of the outer surface, and the same of the inner, make four areas always distinguished from each other by colour or degree of hairiness, and constantly have to be described. If, therefore, the whole outer surface of the ear be called the ectote, we may call its anterior part the proectote and the posterior the metectote. Similarly the inner surface would be the entote, its anterior part the proentote and the posterior part the metentote. In ordinary specimens, with the ears folded back, it is the proectote and the metentote which are visible and characteristically coloured, while the metectote and proentote are commonly more or less naked and colourless.

smoky blackish. Tail black above, very slightly more greyish below.

Skull as in true *brachyurus*.

Dimensions of the type, measured in the flesh :—

Head and body 506 mm. ; tail 54 ; hind foot 138 ; ear 78.

Type. Adult female. B.M. No. 6.1.4.389. Original number 604. Collected 7 July, 1905.

This Hare affords an instance of the blackening so often found in insular forms. No doubt it is a kind of melanism, but the indications given by three specimens, even though they differ in degree, that the darkening is not spasmodic or individual, renders it necessary to recognise the animal by a subspecific name*.

II. YAKUSHIMA.

Yakushima was not visited by Mr. Malcolm Anderson, but by his brother, Mr. Robert V. Anderson, who had been helping him in his collecting work in Kiushiu, Shikoku, and the Oki Islands. The following is an extract from the admirable notes on the island he has given me :—

“Yakushima lies some forty miles south of the southernmost headland of Kiushiu, a few miles south-west of Tanegashima, and between 30° 15' and 30° 25' N. lat. It is one of the Osumi group of small islands which are the most northerly of the Liu-Kiu curve. It is extremely mountainous in character, the only approximation to the level being along the coast whence a gentle incline slopes to the steep hills a quarter of a mile to a mile away. The island is seen from the sea as a mass of densely-forested high mountains with straight low coast-line, several ridges that inclose basins culminating centrally in Miyanouradake at an altitude of more than six thousand five hundred feet. The island is circular, with a diameter of about fifteen miles. The sides of the hills usually slope at an angle of forty-five degrees, except here and there where great cliffs of granite make a break in the forest.

“The climate is very wet, and the island abounds in streams and mountain-torrents. Light snow sometimes falls, even in summer, on the highest peaks.

“There are no rabbits or martens in Yakushima, but, according to native reports, weasels are common.”—*R. V. A.*

Although he heard of them from the natives, Mr. Anderson was not able to obtain any specimens of the Yakushima monkey, weasel, or deer ; but it fortunately happens that a collection of Mammals has just been acquired by the Museum from Mr. Alan Owston, which contains examples of the first and third, besides a weasel from Tanegashima, and I therefore record them here, so as to complete the list of the Mammals known to exist in the island.

* Mr. Anderson has since written to me expressing his conviction that the Oki Hare is constantly different from that from Hondo.

1. *MACACUS FUSCATUS*, Bly.

♂. Owston Collection. Nos. 1, 3, 4. ♀. 2, 5.

These specimens are dark in colour, but not darker than some of the Shikoku examples.

2. *MOGERA WOGURA KANAI*, subsp. n.

♂. 560, 561, 564, 566, 569, 571, 573, 574. ♀. 562, 563. Miyanoura, Yakushima. Sea-level.

Two specimens in the Owston Collection.

A small insular form, rather larger than the typical *wogura* of Yokohama, far smaller than the large *kobeae* of S.W. Hondo, Shikoku, and the Oki Islands. Colour rather dark, tending towards slaty; not so brown as in *kobeae*.

Dimensions of the type, measured in the flesh:—

Head and body 138 mm.; tail 14; hind foot 19.

Skull—greatest length 35; basal length 30.3; greatest breadth 16.6; front of upper canine to back of m³ 12.8.

Lengths of six other skulls, all male—36.2, 36.5, 35.1, 34.9, 36.5, 35.4.

Type. Old male. B.M. No. 6.1.4.394. Original number 569. Collected 13 June, 1905.

The recurrence of a small Mole at the south-west corner of the Japanese Islands, separated from the other small one of N.E. Hondo by the large *kobeae*, renders it a difficult matter to know how best to name the different forms. But as in my paper describing *kobeae* the original *wogura* is allocated to the Yokohama animal, it seems better to maintain that reference in the absence of direct evidence to show that *wogura* was given to the small Mole now described.

The extreme uniformity in the size of the specimens is very noteworthy.

At the instance of Mr. Robert Anderson I have used for this Mole the name of Mr. K. Kanai, a native Japanese helper, to whom he and his brother were much indebted for assistance.

Mr. Anderson states that the Mole is exceedingly common in Yakushima, where the damp climate no doubt produces a plentiful crop of earthworms.

3. *CROCIDURA DSI-NEZUMI UMBRINA* Temm. (?).

♀. 547. Miyanoura. 40'.

“Caught in forest of large trees and bamboo undergrowth.”—*R. V. A.*

This Shrew is rather darker and longer-tailed than the ordinary Japanese *C. dsi-nezumi*, and may represent the form described by Temminck as *Sorex umbrinus*.

4. *MUS MOLOSSINUS* Temm.

♂. Miyanoura, Yakushima. 500'.

5. *MICROMYS SPECIOSUS* Temm.

♂. 556. ♀. 545. Miyanoura, Yakushima. Sea-level to 400'. These specimens are rather more heavily blackened on the back than average mainland examples.

6. *MICROMYS GEISHA* YAKUI, subsp. n.

♂. 549, 551, 552. ♀. 548, 550. Mountains of Central Yakushima. 3500'.

Size and length of tail about as in typical *geisha*, but the feet unusually long and heavy. Colour rather darker and fur longer (hairs of back 7-8 mm.).

Dimensions (in mm.) of three specimens, taken in the flesh:—

♂	Head and body	88;	tail	101;	hind foot	21	;	ear	15.
♀	(Type)	„	„	86;	„	96;	„	20.5;	„	14.
♀	„	„	84;	„	96;	„	20	;	„ 13.5.

Skull of type—greatest length 25; length of upper molar series 4.

Type. Female. B.M. No. 6.1.4.407. Original number 548. Collected 7 June, 1905.

The long and rather dark fur of the Yakushima *geisha* is probably due to the extreme dampness of the island, where the rain is heavy and continuous.

These Mice were obtained during a trip Mr. Anderson made up to the mountainous centre of the island, part of the way down into the basin which succeeds the highest ridge to be seen from the sea. They appeared to be abundant in the forest.

7. *CERVUS SIKA* Temm.

♂. Owston Coll. No. 1. Yakushima.

III. TANEGASHIMA.

“Tanegashima lies between Yakushima and the mainland of Kiushiu, from which it is distant about 20 miles. It is comparatively flat, the highest ridge attaining about 1200 feet. It is cultivated except on the central hills, which are covered partly with forest, partly with grass.

“Monkeys, weasels, deer, and boars were reported to us by the natives. No hares exist here.”—*M. P. A.*

Mr. Anderson only succeeded in obtaining examples of the two usual species of *Micromys*. A weasel from Tanegashima is in the Owston Collection.

1. *PUTORIUS TRAIISI* Temm.

♀. Owston Coll. No. 1. Tanegashima.

2. *MICROMYS SPECIOSUS* Temm.

♂. 522, 524. ♀. 523, 525. Northern Tanegashima. Sea-level.

♂. 527, 528, 537, 538, 539. ♀. 526, 529, 531, 532, 533, 534, 540. Central Tanegashima. 300'

♂. 542. ♀. 543, 544. Nishinoomote, Tanegashima. 150'.

3. MICROMYS GEISHA THOS.

♂. 536. ♀. 535, 539, 541. Central Tanegashima. 300'.

These specimens are intermediate, as should be the case, between the long-footed *yakui* and the ordinary *geisha* of Japan. Three of the specimens are measured as having the hind foot 19.5 mm.

EXPLANATION OF PLATE IX.

Mustela melampus bedfordi, p. 343.

4. A Revision of the Fishes of the Family *Galaxiidae*.

By C. TATE REGAN, B.A., F.Z.S.

[Received October 26, 1905.]

(Plates X.-XIII.)*

The Galaxiidae are a family of Teleostean Fishes which are placed by Boulenger in the Haplomi, a suborder defined by the abdominal ventral fins, the persistent pneumatic duct, and the absence of a mesocoracoid element in the pectoral arch.

They may be thus defined:—

Maxillary behind the præmaxillary and toothless, but to a certain extent bordering the mouth. Parietals in contact, separating the frontals from the supraoccipital; orbitosphenoid, basisphenoid, and opisthotic wanting; pro-otics not forming a roof for the eye-muscle canal, which is confluent with the cranial cavity; mesethmoid small, unpaired. Ribs attached to autogenous parapophyses; epipleurals and epineurals present. Post-temporal simple, attached to the epiotic; pectoral pterygoids normal, 4 in number. 5 to 11 branchiostegals; gill-membranes free from the isthmus; pseudobranchiæ present; four gills, a slit behind the fourth. Body naked. No adipose fin. Pectorals placed low; ventrals, if present, with 6 or 7 rays. Air-bladder present. Ova falling into the abdominal cavity before extrusion.

The closely allied Haplochitonidae differ in the greater development of the præmaxillaries, the presence of a roof for the eye-muscle canal, formed by the pro-otics, and in having an adipose fin.

The Esocidae of the Northern Hemisphere resemble the Galaxiidae and Haplochitonidae of the Southern in the primitive structure of the vertebral column, also in the shape of the cranium, the orbitosphenoid wanting and the opisthotic very small or absent. However, the presence of well-developed paired ethmoids and the separation of the parietals by the supraoccipital are cranial differences of considerable importance.

* For explanation of the Plates, see p. 383.

So long as they were supposed to be a fresh-water group, the geographical distribution of the Galaxiidae was considered to be of considerable interest, occurring as they do in the Southern half of Australia, Tasmania, New Zealand and the neighbouring islands, Chile, Patagonia and the Falkland Islands, and at the Cape of Good Hope.

The occurrence of *Galaxias maculatus* in the sea has been recorded by Valenciennes and by Philippi, off the Falklands and off the coast of Chile respectively. The observations of Johnston in Tasmania and of Hutton and Clarke in New Zealand are to the effect that *Galaxias attenuatus* descends to the sea periodically to spawn. Mr. Rupert Vallentin has seen shoals of little fishes, which I identify with the *Galaxias gracillimus* of Canestrini, in the sea at the Falkland Islands. Recently *Galaxias brevipinnis* has also been found to be marine, *G. bollansi*, described by Hutton from the Auckland Islands, proving to be identical with this species.

The Galaxiidae present many analogies to the Salmonidae of the Northern Hemisphere, both being circumpolar groups of marine origin which are establishing themselves in fresh-water. In both families we meet with non-migratory forms which appear to have finally left the sea and with others which return to the sea periodically; but whilst the migratory Salmonidae are anadromous, the migratory Galaxiidae, on the contrary, are catadromous.

The enormous range of variation in the fresh-water Salmonidae renders the delimitation of species a matter of great difficulty, and so it is with the Galaxiidae, with the similar result that a large number of nominal or insufficiently defined species have been described.

In some species numerous small blackish spots on the body and fins, due to the presence of parasitic organisms, are almost always present, and have been mistaken for colour-markings characteristic of the species (e. g. *G. lynx* and *G. olidus*).

The burrowing-habits of a species of *Galaxias* have been recorded by T. S. Hall (Vict. Nat. xviii. 1900, p. 65), who states that, according to the observations of Mr. Russell Ritchie of Launceston, in Tasmania *Galaxias* have been dug up in moist peaty soil, and swim when placed in water. As many as twelve at a time have been dug up in one place and lived in water in a pickle-jar for various periods up to three days. The loss of the ventral fins and the small eyes of the New Zealand *Neochanna apoda*, which burrows in damp clay, show its special adaptation to similar habits.

The material on which the present revision is based consists of the specimens in the British Museum, including all the types described by Richardson and by Günther, as well as a series of specimens from Tasmania, sent by Mr. R. W. Johnston in 1880, representing the species described by him, and typical examples of *G. nigothoruk* Lucas and *G. bollansi* Hutton. A large series of specimens has been received from the Australian Museum, including the types of *G. occidentalis*, *G. waterhousei*, and *G. kayi*.

The author has also been permitted to examine the types of *G. scriba* and *G. ornatus*, preserved in the Paris Museum, and those of *G. attenuatus*, *G. maculatus*, and *G. alpinus*, in the Museum of the University of Cambridge.

The author wishes to gratefully express his thanks to the Director of the Australian Museum, to Mr. E. R. Waite, to Professor L. Vaillant and to Dr. S. F. Harmer. Also to Mr. J. A. Wolffsohn, who has kindly sent him a copy of Philippi's paper describing the Chilian species.

27 species may be regarded as well established, but this number will doubtless soon be augmented. Two genera may be recognised, *Galaxias* and *Neochanna*.

GALAXIAS.

Galaxias Cuv. Règne Anim. ii. p. 183 (1817); Cuv. & Val. Hist. Nat. Poiss. xviii. p. 340 (1846); Günth. Cat. Fish. vi. p. 208 (1866).

Mesites (non Geoffr.) Jenyns, Voy. Beagle, Fish. p. 118 (1842).

Austrocobitis Ogilby, Proc. Linn. Soc. N.S. Wales, xxiv. 1899, p. 158.

Body more or less elongate. Teeth conical, pointed, in a single series in the jaws and on the inner edge of each entopterygoid, and in a double series on the tongue. Eyes small or moderate, with a free circular lid. Dorsal fin more or less posterior in position, with 9 to 15 rays; anal opposite or posterior to the dorsal, with 10 to 19 rays. Ventral fins present, with 6 or 7 rays.

Vertebrae 53 to 64 in number (53 in *G. olidus*, 56 in *G. platei*, 60 to 61 in *G. findlayi*, 61 in *G. fasciatus*, 62 in *G. attenuatus* and *G. maculatus*, 64 in *G. brevipinnis*).

Synopsis of the Species.

- | | |
|--|-------------------------|
| I. South African. (Ventrals 6-rayed; dorsal and anal fins each with 9 to 12 rays; cleft of mouth rather small.) | |
| Caudal truncate-rounded | 1. <i>zebratus</i> . |
| Caudal emarginate | 2. <i>punctifer</i> . |
| II. South American. | |
| A. 6 or 7 branchiostegals; caudal emarginate; origin of anal opposite or slightly posterior to that of the dorsal. | |
| 1. Origin of ventral equidistant from tip of snout and base of caudal or nearer the former. | |
| Length of head 5 (young) to 6½ (adult) in the length of the fish. | 3. <i>attenuatus</i> . |
| Length of head 7 to 7½ (young) in the length of the fish | 4. <i>gracillimus</i> . |
| 2. Origin of ventral nearer to base of caudal than to tip of snout. | |
| Maxillary extending to below anterior margin of eye or slightly beyond | 5. <i>maculatus</i> . |
| Maxillary extending to below anterior ⅓ of eye | 6. <i>alpinus</i> . |
| B. 8 or 9 branchiostegals; caudal truncate; origin of anal posterior to that of the dorsal. | |
| Origin of ventral considerably nearer to base of caudal than to tip of snout..... | 7. <i>platei</i> . |
| Origin of ventral slightly nearer to tip of snout than to base of caudal | 8. <i>smithii</i> . |

III. New Zealand and neighbouring islands.

A. Anal fin, when laid back, not reaching the procurrent caudal rays.

1. 6 or 7 branchiostegals; 9 to 11 gill-rakers on the lower part of the anterior arch.

Pectoral extending less than $\frac{1}{2}$ of the distance from its base to the base of ventral; anal with 12 to 15 branched rays 3. *attenuatus*.
 Pectoral extending more than $\frac{1}{2}$ of the distance from its base to the base of ventral; anal with 10 to 12 branched rays 9. *huttoni*.

2. 8 or 9 branchiostegals; 12 to 14 gill-rakers on the lower part of the anterior arch 10. *lynx*.

B. Anal fin, when laid back, extending to the procurrent caudal rays but not to the base of the caudal; 7 to 9 gill-rakers on the lower part of the anterior arch 11. *brevipinnis*.

C. Anal fin, when laid back, extending to or beyond the base of caudal; 10 or 11 gill-rakers on the lower part of the anterior arch.

Length of head 4-5 in the length of the fish (in specimens of 82-215 mm.) 12. *fasciatus*.
 Length of head $3\frac{2}{3}$ - $3\frac{1}{2}$ in the length of the fish (in specimens of 163-205 mm.) 13. *alepidotus*.

IV. Australian and Tasmanian.

A. Ventrals 7-rayed.

1. Origin of anal opposite to that of the dorsal.

Anal with 12-15 branched rays 3. *attenuatus*.
 Anal with 10 branched rays 14. *occidentalis*.

2. Origin of anal posterior to that of the dorsal, below or in advance of the middle of the dorsal.

a. Origin of ventrals equidistant from tip of snout and base of caudal.

Lower jaw projecting; pectoral extending less than $\frac{1}{2}$ of the distance from its base to the base of ventral 15. *waitii*.

Lower jaw shorter than the upper (in the adult); pectoral extending $\frac{1}{2}$ - $\frac{2}{3}$ of the distance from its base to the base of ventral 16. *weedoni*.

b. Origin of ventrals nearer to base of caudal than to tip of snout; jaws equal anteriorly.

a. Pectoral extending much less than $\frac{1}{2}$ of the distance from its base to the base of ventral 17. *rostratus*.

β . Pectoral extending about $\frac{1}{2}$ of the distance from its base to the base of ventral.

* Maxillary extending to below anterior $\frac{1}{4}$ or anterior $\frac{1}{3}$ of eye.

Length of head $4\frac{2}{3}$ - $4\frac{1}{3}$ in the length of the fish 18. *truttaceus*.
 Length of head 4 in the length of the fish 19. *auratus*.

** Maxillary extending to, or nearly to, below middle of eye.

Anal, when laid back, extending to the base of caudal 20. *coxi*.
 Anal, when laid back, not extending to the base of caudal 21. *affinis*.

3. Origin of anal posterior to the middle of dorsal.

a. Pectoral extending less than $\frac{1}{2}$ of the distance from its base to the base of ventral.

a. Lower jaw slightly projecting 22. *ornatus*.

β . Jaws equal anteriorly or the lower somewhat the shorter.

Caudal peduncle $1\frac{1}{2}$ - $1\frac{1}{3}$ as long as deep 23. *olidus*.
 Caudal peduncle $1\frac{1}{2}$ -2 as long as deep 24. *findlayi*.

b. Pectoral extending more than $\frac{1}{2}$ of the distance from its base to the base of ventral 25. *schomburgkii*.

B. Ventrals 6-rayed 26. *dissimilis*.

1. GALAXIAS ZEBRATUS.

Cobitis zebratus Casteln. Poiss. Afrique Austr. p. 56 (1861).

Galaxias capensis Steind. Sitzb. Ak. Wien, ciii. 1894, p. 460, pl. iii. fig. 2.

Teeth in the jaws subequal, without distinct enlarged canines. Depth of body $5-5\frac{1}{2}$ in the length, length of head $4-4\frac{1}{4}$. Snout a little shorter than eye, the diameter of which is about 4 in the length of head, interorbital width nearly 3. Jaws equal anteriorly; maxillary extending to below anterior $\frac{1}{4}$ of eye. 8 gill-rakers on the lower part of the anterior arch. Dorsal III 7-8; distance from origin of dorsal to base of caudal $2\frac{1}{2}-2\frac{2}{3}$ in the length of the fish. Anal III-IV 8, commencing below the middle or anterior part of the dorsal. Pectoral extending $\frac{1}{2}-\frac{2}{3}$ of the distance from its base to the base of ventral. Ventrals 6-rayed, originating at a point nearly equidistant from tip of snout and base of caudal, extending $\frac{1}{2}-\frac{2}{3}$ of the distance from their base to the origin of anal. Caudal subtruncate. Caudal peduncle twice as long as deep. Irregular dark cross-bars on the back and sides of the body; head and body covered with small dark dots.

Cape of Good Hope.

1. (54 mm.)
2-6. (35-55 mm.)

—
Near Cape Town.

Sir. A. Smith.
Prof. M. Weber.

2. GALAXIAS PUNCTIFER. (Plate X. fig. 3.)

Cobitis punctifer Casteln. Poiss. Afrique Austr. p. 56 (1861).

Teeth in the jaws subequal, without distinct enlarged canines. Depth of body about $5\frac{1}{2}$ in the length, length of head $4\frac{1}{5}-4\frac{1}{3}$. Snout shorter than eye, the diameter of which is $3-3\frac{1}{2}$ in the length of head, interorbital width $2\frac{2}{3}-3\frac{1}{4}$. Jaws equal anteriorly; maxillary extending to below anterior margin of eye or slightly beyond. 8 or 9 gill-rakers on the lower part of the anterior arch. Dorsal III-IV 7-8; distance from origin of dorsal to base of caudal $2\frac{1}{2}-2\frac{2}{3}$ in the length of the fish. Anal III-IV 6-8, commencing below the middle or posterior part of the dorsal. Pectoral extending $\frac{1}{2}$ the distance from its base to the base of ventral. Ventrals 6-rayed, originating at a point nearer to tip of snout than to base of caudal, extending $\frac{1}{2}-\frac{2}{3}$ of the distance from their base to the origin of anal. Caudal slightly emarginate. Caudal peduncle $2\frac{1}{2}-3$ as long as deep. A series of obscure dark bars or blotches on the upper part of the sides; head and body covered with small dark dots.

Cape of Good Hope.

This species is distinguished from *G. zebratus* by the shorter head, smaller mouth, more slender caudal peduncle, &c., but especially by the different shape of the caudal fin.

1-2. (47 and 54 mm.)
3-12. (27-30 mm.)

Near Cape Town.
Durban Rd., Cape Town.

S. African Mus.
C. D. Rudd, Esq.

3. GALAXIAS ATTENUATUS. (Plates XII. fig. 1, and XIII. fig. 2.)

Mesites attenuatus Jenyns, Zool. 'Beagle,' Fish. p. 121, pl. xxii. fig. 5 (1842).

Galaxias truttaceus (non Cuv.) Valenc. in Cuv. Règne Anim., Poiss. pl. xcvi. fig. 2 (1829).

Galaxias scriba Cuv. & Val. Hist. Nat. Poiss. xviii. p. 347 (1846); Richards. Zool. 'Erebus' & 'Terror,' Fish. p. 66 (1848); Günth. Cat. Fish. vi. p. 212 (1866).

Galaxias attenuatus Cuv. & Val. t. c. p. 348; Günth. t. c. p. 210; Hutton, Fish. N. Zeal. p. 60, pl. x. fig. 96 (1872); Klunz. Sitzb. Ak. Wien, lxxx. 1879, p. 412; Macleay, Proc. Linn. Soc. N. S. Wales, vi. 1881, p. 230; Johnston, Proc. Roy. Soc. Tasmania, 1882, p. 130; Hutton, Trans. New Zealand Inst. xxviii. 1896, p. 317; Ogilby, Proc. Linn. Soc. N. S. Wales, xxi. 1896, p. 71; Clarke, Trans. New Zealand Inst. xxxi. 1899, p. 78.

Galaxias maculatus (non Jenyns) Richards. t. c. p. 75, pl. xliii. figs. 14-17.

Galaxias minutus Philippi, Arch. f. Nat. 1858, vol. xxiv. i. p. 309.

Galaxias krefftii Günth. t. c. p. 211.

Galaxias punctatus Günth. t. c. p. 212.

Galaxias waterhousei Krefft, Proc. Zool. Soc. 1867, p. 943; Klunz. l. c.

Galaxias cylindricus Casteln. Proc. Roy. Soc. Victoria, i. 1872, p. 177; Macleay, t. c. p. 235.

Galaxias delicatulus Casteln. t. c. p. 178; Macleay, l. c.

Galaxias campbelli Sauv. Bull. Soc. Philom. (7) iv. 1880, p. 229.

Galaxias nebulosa Macleay, t. c. p. 234.

Galaxias alpinus (part.), Smitt, Bih. Svenska Ak. xxvi. iv. No. 13, p. 21, pl. ii. figs. 9-12 (1901).

Teeth in the jaws subequal, without distinct enlarged canines. Depth of body $5\frac{1}{2}$ -10 in the length, length of head 5-6 $\frac{1}{2}$. Snout a little longer than eye (in the adult), the diameter of which is 3 (young)-5 in the length of head, interorbital width $2\frac{1}{4}$ -2 $\frac{2}{3}$. Jaws equal anteriorly; maxillary extending about to the vertical from anterior margin of eye or a little beyond. 6 or 7 branchiostegals. 9-11 gill-rakers on the lower part of the anterior arch. Dorsal 10-13 (III-IV 7-9); distance from origin of dorsal to base of caudal $3\frac{3}{4}$ (young)-4 $\frac{1}{2}$ in the length of the fish. Anal 16-19 (III-V 12-15), commencing below the origin of dorsal. Pectoral extending from less than $\frac{1}{3}$ to more than $\frac{2}{5}$ of the distance from its base to the base of ventral. Ventrals 7-rayed, originating at a point about equidistant from tip of snout and base of caudal or from base or anterior part of pectoral and origin of anal, extending less than $\frac{1}{2}$ of the distance from their base to the origin of anal. Caudal slightly emarginate. Caudal peduncle $1\frac{1}{3}$ -2 as long as deep. Golden or orange; upper parts of head and body finely punctulated with blackish and spotted or marbled with dark purplish; fins immaculate.

South Australia, Victoria, New South Wales, Tasmania, New

Zealand and neighbouring islands, Falkland Is., Tierra del Fuego, Patagonia, and Chile.

With the type of the species, which I have been enabled to examine through the courtesy of Dr. S. F. Harmer, I have compared the types of *G. scriba*, for permission to examine which I am indebted to Prof. L. Vaillant, of *G. waterhousei*, kindly lent by the Director of the Australian Museum, and of *G. krefftii* and *G. punctatus*, preserved in the British Museum.

The varying size of the eye in preserved specimens is sometimes due to the method of preservation; often the eye tends to protrude and the circular fold surrounding it is stretched or broken, thus apparently increasing the size of the eye. In the type of *G. scriba*, which measures only 74 mm. in total length, the eye is slightly more than $\frac{1}{3}$ the length of head.

1.	(130 mm.)	} types of	{ Murray R.	A. Lloyd, Esq.
2-4.	(70-90 mm.)			{ Sydney.
5.	(170 mm.)	type of <i>G.</i>	Eastern Creek.	
		<i>punctatus</i> .		
6-8.	(80-95 mm.)		Australia.	G. Krefft, Esq.
9.	(105 mm.)		Moorabool R.	Mr. E. Degen.
10-19.	(75-135 mm.)		Tasmania.	J. B. Jukes, Esq.
20.	(90 mm.)		Tasmania.	R. W. Johnston, Esq.
21.	(170 mm.)		Tasmania.	Sir. J. Richardson.
22-23.	(78 and 110 mm.)		? New South Wales.	G. Krefft, Esq.
24-26.	(65-135 mm.)		New Zealand.	Otago Mus.
27-33.	(90-120 mm.)		New Zealand.	New Zealand Inst.
34-35.	(85 and 110 mm.)		Falkland Islands.	Sir J. Richardson.
36.	(60 mm.)		Tierra del Fuego.	Marquis G. Doria.
37-44.	(55-60 mm.)		Magellan.	Dr. Coppinger.
45-50.	(63-80 mm.)		? Peru.	Royal Coll. Surgeons.

The New Zealand race may usually be distinguished by the following characters:—Head moderate ($5\frac{1}{2}$ – $6\frac{1}{2}$ in the length in specimens of 65–135 mm.); eye rather large ($3\frac{1}{4}$ – $4\frac{1}{2}$ in the length of head); ventrals nearly always nearer to tip of snout than to base of caudal; dorsal and anal fins almost triangular in shape, the rays decreasing from the first branched ray, which is the largest, to the last, which is very short, the free edge of the fin being straight; caudal distinctly emarginate.

The Australian race often shows a slightly longer head (5–6 in the length in specimens of 70–170 mm.) and a slightly larger eye; the ventrals are sometimes equidistant from tip of snout and base of caudal, sometimes a little nearer to one or the other; the dorsal and anal fins are often more rounded than in the New Zealand form, the anterior branched rays being longer and decreasing in length less rapidly, the last ray also being longer; the caudal is usually not quite so distinctly emarginate.

The South American race seems perhaps to differ from the New Zealand one in having a slightly smaller head ($5\frac{1}{2}$ – $6\frac{1}{2}$ in the length in specimens of 55–110 mm.) and a smaller eye ($3\frac{1}{2}$ – $4\frac{2}{3}$ in the length of head).

Galaxias versicolor Casteln. (Proc. Zool. Soc. Victoria, i. 1872, p. 176) is probably allied to *G. attenuatus*, agreeing in the small head ($5\frac{8}{10}$ in the total length), small mouth (the maxillary just

reaching the vertical from the anterior margin of the eye), and in having the dorsal and anal opposite one another and the caudal emarginate. It appears to differ in the deeper body (depth $4\frac{2}{3}$ in the total length) and the fewer fin-rays (Dorsal 9, Anal 12). It is described from a specimen of 140 mm. from a marsh near St. Kilda, Victoria.

4. GALAXIAS GRACILLIMUS.

Mesites gracillimus Canestrini, Arch. Zool. Anat. Fisiol. iii. 1864, p. 100, pl. iv. fig. 2.

Galaxias gracillimus Günth. Cat. Fish. vi. p. 213 (1866).

Galaxias maculatus (non Jenyns) Smitt, Bih. Svenska Ak. xxvi. iv. No. 13, p. 21, pl. ii. figs. 5-8 (1901).

Teeth apparently as in *G. attenuatus*. Depth of body 10-12 in the length, length of head $7-7\frac{1}{2}$. Snout a little shorter than eye, the diameter of which is $3\frac{1}{4}-3\frac{1}{2}$ in the length of head and less than the interorbital width. Jaws equal anteriorly; maxillary extending nearly to the vertical from the anterior margin of eye. 5 or 6 branchiostegals. 9 or 10 gill-rakers on the lower part of the anterior arch. Dorsal 11-12 (III-IV 8-9); distance from origin of dorsal to base of caudal about $3\frac{3}{4}$ in the length of the fish. Anal 16-17 (III-IV 13-14), commencing below the origin of dorsal, when laid back not extending to the caudal. Pectoral extending about $\frac{2}{3}$ of the distance from its base to the base of ventral. Ventrals 7-rayed, originating at a point nearer to tip of snout than to base of caudal, and nearer to origin of anal than to base of pectoral, extending about $\frac{2}{3}$ of the distance from their base to the origin of anal. Caudal slightly emarginate. Caudal peduncle $2\frac{1}{2}$ as long as deep. Some small blackish spots on the head and on the upper part of the body; a line of black dots along the middle of the side and one at the base of each of the unpaired fins.

Chile; Falkland Is.

1-4. (53-55 mm.)

Falkland Is.

R. Vallentin, Esq.

Possibly this species may be based on a larval form of *G. attenuatus*, but if so it is remarkable that it has been recorded only from South America and that larval forms of other species have not been described.

5. GALAXIAS MACULATUS.

Mesites maculatus Jenyns, Zool. 'Beagle,' Fish. p. 119, pl. xxii. fig. 4 (1842).

Galaxias maculatus Cuv. & Val. Hist. Nat. Poiss. xviii. p. 355 (1846); Günth. Cat. Fish. vi. p. 212 (1866).

Galaxias punctulatus Philippi, Arch. f. Nat. 1858, vol. xxiv. i. p. 310.

Galaxias coppingeri Günth. Proc. Zool. Soc. 1881, p. 21.

Galaxias alpinus (non Jenyns) Smitt, Bih. Svenska Ak. xxiv. iv. No. 5, p. 56, pl. v. fig. 40 (1899).

Teeth in the jaws subequal, without distinct enlarged canines. Depth of body 6-8 in the length, length of head $4\frac{1}{2}-5\frac{3}{4}$. Snout

nearly as long as eye, the diameter of which is $3\frac{1}{2}$ – $4\frac{1}{3}$ in the length of head, interorbital width $2\frac{3}{5}$ –3. Jaws equal anteriorly; maxillary extending to below anterior margin of eye or slightly beyond. 6 or 7 branchiostegals. 9–12 gill-rakers on the lower part of the anterior arch. Dorsal III–IV 8; distance from origin of dorsal to base of caudal $3\frac{3}{4}$ – $4\frac{1}{4}$ in the length of the fish. Anal IV V 11–14, commencing below the origin of dorsal, when laid back not reaching the caudal. Pectoral extending from less than $\frac{2}{5}$ to $\frac{1}{3}$ of the distance from its base to the base of ventral. Ventrals 7-rayed, originating at a point a little nearer to base of caudal than to tip of snout or equidistant from middle of pectoral and origin of anal, extending from a little less than $\frac{2}{5}$ to nearly $\frac{3}{5}$ of the distance from their base to the origin of anal. Caudal slightly emarginate. Caudal peduncle $1\frac{1}{2}$ –2 as long as deep. Olivaceous, covered with numerous irregular blackish spots; fins immaculate.

Patagonia; Tierra del Fuego; Falkland Islands.

1. (73 mm.) type of <i>G. coppingeri</i> .	Alert Bay.	Dr. Coppinger.
2-3. (76 and 83 mm.)	Orange Bay.	Paris Mus.
4-8. (82-93 mm.)	Falkland Is.	Commander Knocker.
9-11. (65-75 mm.)	Falkland Is.	R. Vallengin, Esq.
12-21. (70-120 mm.)	Estero de Penco.	Mons. F. Lataste.

6. GALAXIAS ALPINUS.

Mesites alpinus Jenyns, Zool. 'Beagle,' Fish. p. 121 (1842).

Galaxias alpinus Cuv. & Val. Hist. Nat. Poiss. xviii. p. 356 (1846); Günth. Cat. Fish. vi. p. 212 (1866).

Teeth in the jaws subequal, without distinct enlarged canines. Depth of body about 7 in the length, length of head $4\frac{1}{5}$ – $4\frac{2}{5}$. Snout shorter than eye, the diameter of which is 3 – $3\frac{1}{4}$ in the length of head and equal to the interorbital width. Lower jaw slightly projecting; maxillary extending to below anterior $\frac{1}{3}$ of eye. 6 branchiostegals. 12 gill-rakers on the lower part of the anterior arch. Dorsal III 8–9; distance from origin of dorsal to base of caudal $3\frac{3}{4}$ – $3\frac{7}{8}$ in the length of the fish. Anal IV 12–13, commencing below or slightly behind the origin of dorsal, when laid back not reaching the caudal. Pectoral extending $\frac{1}{2}$ or nearly $\frac{1}{2}$ of the distance from its base to the base of ventral. Ventrals 7-rayed, originating at a point equidistant from middle or posterior part of eye and base of caudal or from middle of pectoral and origin of anal, extending $\frac{3}{5}$ – $\frac{2}{3}$ of the distance from their base to the origin of anal. Caudal apparently slightly emarginate. Caudal peduncle twice as long as deep. Head and body with small blackish dots, which are especially developed to form a mid-dorsal longitudinal band.

Alpine lakes of Hardy Peninsula, Tierra del Fuego.

1. (52 mm.) one of the types of the species. Cambridge Univ. Mus.

Through the kindness of Dr. S. F. Harmer, F.R.S., I have been enabled to examine the types of the species, two specimens which measure 52 and 62 mm. respectively in total length, and to retain one of these for the British Museum Collection.

7. GALAXIAS PLATEI.

Galaxias platei Steind. Zool. Jahrb. Suppl. iv. 1897, p. 329, pl. xx. fig. 13.

Galaxias alpinus, (part.) Smitt, Bih. Svenska Ak. xxvi. iv. No. 13, p. 9, pl. iii. (1901).

Teeth in the jaws subequal, without distinct enlarged canines. Depth of body 5-6 in the length, length of head $4\frac{1}{4}$ - $4\frac{3}{4}$. Snout longer than eye, the diameter of which is $5\frac{1}{2}$ - $7\frac{1}{2}$ in the length of head, interorbital width $2\frac{1}{2}$ - $2\frac{2}{3}$. Jaws equal anteriorly; maxillary extending to below the middle of eye. 8 or 9 branchiostegals. 11-13 gill-rakers on the lower part of the anterior arch. Dorsal IV 8; distance from origin of dorsal to base of caudal $3\frac{1}{2}$ - $3\frac{3}{4}$ in the length of the fish. Anal IV-V 10-11, commencing below the anterior part or middle of the dorsal, when laid back extending to the procurent rays or base of caudal. Pectoral extending $\frac{2}{5}$ - $\frac{1}{2}$ of the distance from its base to the base of ventral. Ventrals 7-rayed, originating at a point equidistant from cheek or præoperculum and base of caudal or from middle or extremity of pectoral and origin of anal, extending $\frac{3}{5}$ - $\frac{2}{3}$ of the distance from their base to the origin of anal. Caudal truncate. Caudal peduncle as long or a little longer than deep. Head, body, and fins covered with numerous irregular dark spots.

Patagonia.

1. (195 mm.)	Rio Chico.	Marquis G. Doria.
2-5. (260 and 300 mm.)	Magellan.	Mons. F. Lataste.

The two large fishes, undoubtedly belonging to one species, from a lake in the province of Punta Arenas, Chile, described by Philippi (Verh. Deust. Wiss. Ver. Sant. Chile, iii. 1895, p. 19) under the names of *Galaxias grandis* and *G. delfini*, agree with *G. platei* in the form and proportions of head and body, size of the eye, shape of the caudal, length of pectoral and ventral and size of the dorsal fin, and also in coloration. The unpaired fins are torn in the type of *G. grandis*, a fish of 330 mm., and the number of fin-rays in *G. delfini* is given as Dorsal 8, Anal 18. If it were not for this, I should have no hesitation in regarding this species and *G. platei* as the same.

8. GALAXIAS SMITHII, sp. n.

Lower jaw with distinct lateral canines. Depth of body $6\frac{1}{2}$ in the length, length of head $5\frac{1}{2}$. Snout slightly longer than eye, the diameter of which is $4\frac{1}{4}$ in the length of head, interorbital width $2\frac{2}{3}$. Jaws equal anteriorly; maxillary extending nearly to below middle of eye. 8 branchiostegals. 10 gill-rakers on the lower part of the anterior arch. Dorsal III-IV 9; distance from origin of dorsal to base of caudal $3\frac{3}{5}$ in the length of the fish. Anal IV 10, commencing below the anterior part of the dorsal, when laid back not extending to the caudal. Pectoral extending more than $\frac{1}{2}$ of the distance from its base to the base of ventral. Ventrals 7-rayed, originating at a point slightly

nearer to tip of snout than to base of caudal or equidistant from base of pectoral and origin of anal, extending nearly $\frac{3}{5}$ of the distance from their base to the origin of anal. Caudal truncate. Caudal peduncle $1\frac{2}{5}$ as long as deep. Greyish, with traces of darker vertical stripes; a dark bar above the pectoral.

Falkland Islands.

1. (110 mm.) type of the species. Falkland Is. Sir A. Smith.

9. *GALAXIAS HUTTONI*, sp. n. (Plate X. fig. 2.)

Teeth apparently as in *G. attenuatus*. Depth of body about 7 in the length, length of head nearly 5. Snout a little shorter than eye, the diameter of which is $3-3\frac{1}{2}$ in the length of head, interorbital width about $2\frac{1}{2}$. Jaws equal anteriorly; maxillary extending to below anterior $\frac{1}{4}$ or anterior $\frac{1}{5}$ of eye. 7 branchiostegals. 9 gill-rakers on the lower part of anterior arch. Dorsal III-IV 7-8; distance from origin of dorsal to base of caudal $3\frac{1}{2}-3\frac{3}{4}$ in the length of the fish. Anal IV-V 10-12, commencing below the origin or anterior part of dorsal, when laid back not extending to the caudal. Pectoral extending from more than $\frac{1}{2}$ to $\frac{2}{3}$ of the distance from its base to the base of ventral. Ventrals 7-rayed, originating at a point equidistant from tip of snout and base of caudal, or nearer the former, or equidistant from base of pectoral and origin of anal, extending from more than $\frac{1}{2}$ to $\frac{2}{3}$ of the distance from their base to the origin of anal. Caudal emarginate. Caudal peduncle $1\frac{2}{3}-2$ as long as deep. Yellowish with brown cross-bars; fins pale.

Lake Rainiera, New Zealand.

- 1-7. (39-45 mm.) types of the species. Lake Rainiera. Prof. F. W. Hutton.

Perhaps as closely allied to *G. lynx* as to *G. attenuatus*.

10. *GALAXIAS LYNX*. (Plate X. fig. 4.)

Galaxias olidus (non Günth.) Hutton, Trans. N. Zealand Inst. v. 1872, p. 270, and Fishes of N. Zeal. Suppl. p. 11 (1873).

Galaxias lynx Hutton, Trans. N. Zealand Inst. xxviii. 1896, p. 317.

Lower jaw with distinct lateral canines. Depth of body 6-7 in the length, length of head $4\frac{1}{3}-4\frac{2}{3}$. Snout nearly as long as or longer than eye, the diameter of which is $3\frac{1}{2}-5$ in the length of head, interorbital width $2\frac{3}{4}-3$. Jaws equal anteriorly or the lower slightly projecting; maxillary extending to below middle of eye, in the adult. 8 or 9 branchiostegals. 12-14 gill-rakers on the lower part of the anterior arch. Dorsal IV 8; distance from origin of dorsal to base of caudal $3\frac{1}{2}-3\frac{2}{3}$ in the length of the fish. Anal V 10-11, commencing below the anterior part of the dorsal, when laid back not nearly extending to the caudal. Pectoral extending $\frac{1}{2}$ or nearly $\frac{1}{2}$ of the distance from its base to the base of ventral. Ventrals 7-rayed, originating at a point about equidistant from eye and base of caudal or from middle or posterior part of pectoral and origin of anal, extending $\frac{2}{5}-\frac{2}{3}$ of the distance from their base to

the origin of anal. Caudal truncate or slightly emarginate. Caudal peduncle nearly twice as long as deep. Traces of irregular dark cross-bars in the young.

Lakes Coleridge and Wakatipu, New Zealand.

1-3. (58-83 mm.)	Lake Coleridge.	Canterbury Mus.
4. (170 mm.)	Lake Wakatipu.	Otago Mus.

11. GALAXIAS BREVIPINNIS*.

Galaxias brevipinnis Günth. Cat. Fish. vi. p. 213 (1866); Hutton, Fish. N. Zeal. p. 59 (1872), and Trans. N. Zealand Inst. xxviii. 1896, p. 317.

Galaxias grandis Haast, Trans. N. Zealand Inst. v. 1872, p. 278.

Galaxias robinsoni Clarke, Trans. N. Zealand. Inst. xxxi. 1899, p. 89, pl. v.

Galaxias bollansi Hutton, Trans. N. Zealand Inst. xxxiv. 1902, p. 198.

Lower jaw with distinct lateral canines. Depth of body $4\frac{2}{3}$ - $6\frac{2}{3}$ in the length, length of head $4\frac{2}{3}$ - $5\frac{1}{4}$. Snout as long as or longer than eye, the diameter of which is 4-6 in the length of head, interorbital width 2- $2\frac{1}{3}$. Jaws equal anteriorly or the lower a little shorter than the upper; maxillary extending to below middle of eye or a little beyond. 7 branchiostegals. 7-9 gill-rakers on the lower part of the anterior arch. Dorsal IV 8-9; distance from origin of dorsal to base of caudal $3\frac{2}{3}$ -4 in the length of the fish. Anal IV-V 9-10, commencing below the middle of the dorsal, when laid back extending to the procurvent caudal rays. Pectoral extending from $\frac{2}{3}$ to more than $\frac{1}{2}$ of the distance from its base to the base of ventral. Ventrals 7-rayed, originating at a point about equidistant from angle of mouth and base of caudal or from middle of pectoral and origin of anal, extending $\frac{1}{2}$ - $\frac{2}{3}$ of the distance from their base to the origin of anal. Caudal truncate or slightly emarginate. Caudal peduncle $1\frac{1}{3}$ - $1\frac{2}{3}$ as long as deep. Head, body, and fins with dark brown spots, marblings, or reticulations.

New Zealand and neighbouring islands.

1-3. (133-153 mm.) types of the species.	New Zealand.	Capt. Stokes.
4. Skeleton.	New Zealand.	Dr. Günther.
5. (210 mm.)	North Island, N.Z.	H. K. Nicholl, Esq.
6. (158 mm.)	Dunedin, N.Z.	Otago Mus.
7-11. (73-115 mm.)		Wellington Mus.
12. (105 mm.) type of <i>G. bollansi</i> .	Auckland Is.	Prof. F. W. Hutton.

12. GALAXIAS FASCIATUS.

Galaxias fasciatus Gray, Zool. Misc. p. 73 (1831), and in Dieffenb. New Zealand, ii. p. 221 (1842); Cuv. & Val. Hist. Nat. Poiss. xviii. p. 350 (1847); Richards, Zool. 'Erebus' & 'Terror,' Fish. p. 77 (1848); Günth. Cat. Fish. vi. p. 209 (1866); Hutton, Fish. N. Zeal. p. 59, pl. x. fig. 94 (1872), and Trans. N. Zealand Inst. xxviii. 1896, p. 317; Clarke, ib. xxxi. 1899, p. 90, pl. v.

* An excellent figure of this species is given in the 'Cambridge Natural History,' vol. vii. p. 607.

Galaxias brocchus Richards. t. c. p. 76, pl. xliii. figs. 8-13.

Galaxias reticulatus Richards. l. c. pl. xlii. figs. 7-12.

Galaxias postvectis Clarke, t. c. p. 88, pl. v.

Lower jaw with distinct lateral canines. Depth of body 4-5½ in the length, length of head 4-5. Snout as long as or a little longer than eye, the diameter of which is 4-5 in the length of head, interorbital width 1¾-2½. Jaws equal anteriorly; maxillary extending to below posterior part of eye. 8 or 9 branchiostegals. 10 or 11 gill-rakers on the lower part of the anterior arch. Dorsal IV 7-9; distance from origin of dorsal to base of caudal 3¼-4½ in the length of the fish. Anal IV-V 10-11, commencing below or a little behind the origin of dorsal, when laid back extending to or a little beyond the base of the caudal. Pectoral extending from more than ½ to nearly ⅔ of the distance from its base to the base of ventral. Ventrals 7-rayed, originating at a point equidistant from snout or eye and base of caudal or from anterior part or middle of pectoral and origin of anal, extending ⅔-¾ of the distance from their base to the origin of anal. Caudal truncate. Caudal peduncle from ¾ to as long as deep. Brownish, with narrow light vertical stripes, which may be undulating or irregular or may form reticulations; often a light vertical bar above the base of pectoral, succeeded by a dark purplish blotch.

New Zealand and neighbouring islands.

1-3. (82-210 mm.) types of the species.	New Zealand.	Dr. Dieffenbach.
4. (145 mm.)	New Zealand.	Dr. Sinclair.
5. (215 mm.) type of <i>G. brocchus</i> .	Auckland Islands.	Sir J. Richardson.
6-8. (140-170 mm.) types of <i>G. reticulatus</i> .	Auckland Islands.	Sir J. Richardson.
9-10. (150-185 mm.)	New Zealand.	Capt. Stokes.
11. (115 mm.)	Porirua.	Wellington Mus.
12. (205 mm.)	Chatham Islands.	Prof. F. W. Hutton.

A large female specimen, ready to spawn, measuring 265 mm. in total length, has not been included in the above diagnosis. The depth of the body is ⅔ of its length, the caudal peduncle is ⅔ as long as deep, the maxillary does not extend beyond the middle of the eye, the origin of the anal fin is only a little in advance of the middle of the dorsal. These peculiarities appear due partly to the condition of the fish, partly to individual variation.

13. GALAXIAS ALEPIDOTUS.

Esox alepidotus Forster, Descript. Anim. p. 142 (1844); Schneider in Bloch's System. Ichthyol. p. 395 (1801).

Galaxias alepidotus Cuv. Règne Anim. ii. p. 283 (1829); Richards. in Dieffenb. New Zealand, Appendix, p. 219 (1842), and Zool. 'Erebus' & 'Terror,' Fish. p. 77 (1848); Günth. Cat. Fish. vi. p. 208 (1866); Hutton, Fish. N. Zeal. p. 58 (1872), and Trans. N. Zealand Inst. xxviii. 1896, p. 317.

Galaxias forsteri Cuv. & Val. xviii. p. 351 (1847).

Galaxias kokopu Clarke, Trans. N. Zealand Inst. xxxi. 1899, p. 88, pl. iv.

Lower jaw with distinct lateral canines. Depth of body $4-4\frac{1}{2}$ in the length, length of head $3\frac{3}{5}-3\frac{4}{5}$. Snout a little longer than eye, the diameter of which is 5 in the length of head, interorbital width $2\frac{1}{4}-2\frac{1}{5}$. Jaws equal anteriorly; maxillary usually extending beyond middle of eye. 8 or 9 branchiostegals. 10 or 11 gill-rakers on the lower part of the anterior arch. Dorsal IV 9-10; distance from origin of dorsal to base of caudal $4-4\frac{1}{2}$ in the length of the fish. Anal IV-V 10-11, commencing below or a little behind the origin of dorsal, when laid back extending beyond the base of caudal. Pectoral extending $\frac{3}{5}-\frac{2}{3}$ of the distance from its base to the base of ventral. Ventrals 7-rayed, originating at a point equidistant from cheek or posterior margin of eye and base of caudal or from middle of pectoral and origin of anal, extending $\frac{2}{3}-\frac{4}{5}$ of the distance from their base to the origin of anal. Caudal truncate. Caudal peduncle nearly $\frac{3}{4}$ as long as deep. Brownish, with rather large rounded, oblong or crescentic, light yellowish spots; fins dusky.

New Zealand.

1-3. (163-205 mm.)
4. (196 mm.)

New Zealand.
Thomson Sound, Otago.

Capt. Stokes.
Otago Mus.

14. GALAXIAS OCCIDENTALIS. (Plate XI. fig. 4.)

Galaxias occidentalis Ogilby, Proc. Linn. Soc. N. S. Wales, xxiv. 1899, p. 157.

Teeth in the jaws subequal, without distinct lateral canines. Depth of body $5\frac{2}{3}$ in the length, length of head $5\frac{1}{3}$. Snout a little longer than eye, the diameter of which is $4\frac{1}{2}$ in the length of head, interorbital width $2\frac{2}{5}$. Lower jaw projecting; maxillary extending to below anterior $\frac{1}{3}$ of eye. 6 or 7 branchiostegals. 10 gill-rakers on the lower part of the anterior arch. Dorsal 10 (III 7); distance from origin of dorsal to base of caudal $4\frac{1}{5}$ in the length of the fish. Anal 15 (V 10), commencing below the origin of dorsal, when laid back not nearly extending to the procurvent caudal rays. Pectoral extending a little more than $\frac{1}{3}$ of the distance from its base to the base of ventral. Ventrals 7-rayed, originating at a point equidistant from tip of snout and base of caudal or a little nearer to origin of anal than to base of pectoral, extending a little more than $\frac{1}{3}$ of the distance from their base to the origin of anal. Caudal slightly emarginate. Caudal peduncle $1\frac{1}{2}$ as long as deep. Yellowish, with narrow dark cross-bars on the sides of the body; a pair of dark blotches on the basal part of the caudal.

Western Australia.

1. (155 mm.) one of the types.

W. Australia.

Australian Mus.

15. GALAXIAS WAITII, sp. n. (Plate XI. fig. 2.)

Teeth in the jaws subequal, without distinct lateral canines. Depth of body $6\frac{1}{2}-6\frac{3}{4}$ in the length, length of head $4\frac{2}{3}-4\frac{4}{5}$. Snout

longer than eye, the diameter of which is $5-5\frac{1}{3}$ in the length of head, interorbital width $2\frac{1}{2}-2\frac{3}{4}$. Lower jaw slightly or distinctly projecting; maxillary extending to below anterior $\frac{1}{4}$ of eye. 6 or 7 branchiostegals. 11 or 12 gill-rakers on the lower part of the anterior arch. Dorsal 11-13 (IV-V 7-8); distance from origin of dorsal to base of caudal $3\frac{1}{5}-4\frac{1}{5}$ in the length of the fish. Anal 13-14 (IV 9-10), commencing below or somewhat in advance of the middle of dorsal, when laid back extending nearly to the procurent caudal rays. Pectoral extending a little more than $\frac{2}{5}$ of the distance from its base to the base of the ventral. Ventrals 7-rayed, originating at a point equidistant from tip of snout and base of caudal or from base of pectoral and origin of anal, extending $\frac{1}{3}-\frac{2}{5}$ of the distance from their base to the origin of anal. Caudal slightly emarginate. Caudal peduncle $1\frac{1}{2}-1\frac{2}{3}$ as long as deep. Brownish (in spirit); caudal fin with a more or less distinct pair of dark stripes running from the base to the posterior angles of the fin.

Gulpa Creek, New South Wales.

1-4. (110-125 mm.) types of the species.

Australian Museum.

16. *GALAXIAS WEEDONI*. (Plate XI. fig. 1.)

Galaxias weedoni Johnston, Proc. Roy. Soc. Tasmania, 1881, p. 131 (1882).

Galaxias atkinsonii Johnston, l. c.

Lower jaw with the lateral teeth slightly or distinctly enlarged and canine-like. Depth of body $5-6\frac{1}{2}$ in the length, length of head 5. Snout slightly longer than eye, the diameter of which is $4\frac{1}{2}-4\frac{2}{3}$ in the length of head, interorbital width $2\frac{1}{3}-2\frac{2}{5}$. Lower jaw slightly shorter than the upper; maxillary extending to below the middle of eye. 9 branchiostegals; 9 gill-rakers on the lower part of the anterior arch. Dorsal 11-12 (IV 7-8); distance from origin of dorsal to base of caudal $3\frac{2}{3}-3\frac{3}{4}$ in the length of the fish. Anal 14 (IV-V 9-10), commencing below or in advance of the middle of dorsal, when laid back nearly reaching the procurent caudal rays. Pectoral extending $\frac{1}{2}-\frac{2}{3}$ of the distance from its base to the base of ventral. Ventrals 7-rayed, originating at a point equidistant from tip of snout and base of caudal or from base of pectoral and origin of anal, extending $\frac{1}{3}-\frac{2}{3}$ of the distance from their base to the origin of anal. Caudal slightly emarginate. Caudal peduncle $1\frac{1}{3}$ as long as deep. Brownish, with dark brown spots and vertical bars; a dark bar above the base of pectoral; fins with a few dark spots.

Tasmania.

1. (110 mm.)

Tasmania.

R. W. Johnston, Esq.

2-3. (100 and 105 mm.)

Australian Mus.

The first specimen was received from Mr. Johnston in 1880, and it appears to correspond to his *Galaxias weedoni* from the River Mersey.

Five small specimens (50-68 mm.) from Lake Laura, received

from Prof. W. B.^s Spencer, agree very well with Johnston's description of *Galaxias atkinsonii* from the River Pieman. They differ from the adult fish in the more slender body (depth 6-8 in the length, caudal peduncle $1\frac{2}{5}$ - $1\frac{3}{4}$ as long as deep), the smaller mouth with the jaws equal anteriorly, and the less distinct markings.

17. GALAXIAS ROSTRATUS.

Galaxias rostratus Klunz. Arch. f. Nat. 1872, p. 41.

Depth of body $8\frac{1}{2}$ in the total length, length of head $5\frac{1}{2}$. Snout $1\frac{1}{2}$ as long as eye, the diameter of which is $4\frac{1}{2}$ in the length of head and $1\frac{1}{2}$ in the interorbital width. Jaws equal anteriorly; maxillary extending to below middle of eye. 6 branchiostegals. Dorsal 11. Anal 14, commencing a little behind the origin of the dorsal. Pectoral extending much less than $\frac{1}{2}$ of the distance from its base to the base of ventral. Ventrals 7-rayed, originating at a point equidistant from anterior margin of eye and base of caudal. A dark spot on the base of the caudal fin.

Mersey River.

Total length 130 mm.

Evidently allied to *G. occidentalis* and *G. waitii*

18. GALAXIAS TRUTTACEUS. (Plate XIII. fig. 4.)

Galaxias truttaceus Cuv. Règne Anim. ii. p. 283 (1817); Cuv. & Val. Hist. Nat. Poiss. xviii. p. 344, pl. 543 (1846); Richards. Zool. 'Erebus' & 'Terror,' Fish. p. 75, pl. xlii. figs. 1-6; Günth. Cat. Fish. vi. p. 209 (1866); Macleay, Proc. Linn. Soc. N.S. Wales, vi. 1881, p. 229; Johnston, Proc. Roy. Soc. Tasmania, 1882, p. 130.

Galaxias ocellatus McCoy, Intern. Exhib. Ess. p. 14 (1866); Casteln. Proc. Zool. Soc. Victoria, i. 1872, p. 175; Macleay, t. c. p. 235.

Lower jaw with the lateral teeth more or less distinctly enlarged and canine-like. Depth of body 5-6 in the length, length of head $4\frac{2}{3}$ - $4\frac{4}{5}$. Snout as long as or slightly longer than eye, the diameter of which is 4- $4\frac{2}{3}$ in the length of head, interorbital width $2\frac{1}{4}$. Jaws equal anteriorly; maxillary extending to below anterior $\frac{1}{4}$ or anterior $\frac{1}{3}$ of eye. 7-9 branchiostegals. 8 or 9 gill-rakers on the lower part of the anterior arch. Dorsal 10-12 (III-IV 7-8); distance from origin of dorsal to base of caudal $3\frac{3}{5}$ - $3\frac{3}{4}$ in the length of the fish. Anal 14-16 (IV-V 10-12), commencing below the anterior $\frac{1}{4}$ of the dorsal, when laid back usually reaching the procurvent caudal rays. Pectoral extending $\frac{1}{2}$ the distance from its base to the base of ventral. Ventrals 7-rayed, originating at a point equidistant from eye and base of caudal, extending $\frac{2}{3}$ of the distance from their base to the origin of anal. Caudal emarginate. Caudal peduncle a little longer than deep. Olivaceous, with purplish ocellated spots; upper lip dark; an oblique dark stripe running back from below the eye;

sometimes 2 or 3 dark vertical bars above the base of the pectoral; dorsal, anal, and ventral fins sometimes blackish at the tip.

Tasmania; Victoria.

A. *Forma typica*, with 2 or 3 dark vertical bars above the pectoral and with the dorsal, anal, and ventral fins blackish at the tip.

1. (105 mm.)	Tasmania.	Sir J. Richardson.
2-6. (90-130 mm.)	Tasmania.	Haslar Coll.
7-8. (110-160 mm.)	Tasmania.	J. Gould, Esq.
9-11. (107-118 mm.)	Tasmania.	R. W. Johnston, Esq.

B. Variety without bars above the pectoral, with fins uniformly pale.

1-2. (112 and 128 mm.)	Moorabool R., Victoria.	Mr. E. Degen.
------------------------	-------------------------	---------------

According to Johnston (*l. c.*) there are Tasmanian varieties of this species without bars above the pectoral.

19. GALAXIAS AURATUS. (Plate XIII. fig. 1.)

Galaxias auratus Johnston, Proc. Roy. Soc. Tasmania, 1881, p. 131 (1882).

Lower jaw with the lateral teeth somewhat enlarged. Depth of body about 5 in the length, length of head about 4. Snout scarcely longer than eye, the diameter of which is $4\frac{1}{3}$ in the length of head, interorbital width $2\frac{3}{5}$. Jaws equal anteriorly; maxillary extending to below anterior $\frac{1}{4}$ of eye. 7-9 branchiostegals. 10 gill-rakers on the lower part of the anterior arch. Dorsal IV 8; distance from origin of dorsal to base of caudal $3\frac{2}{3}$ in the length of the fish. Anal IV 10, commencing below the middle of the dorsal, when laid back extending to the procurent caudal rays. Pectoral extending $\frac{1}{2}$ the distance from its base to the base of ventral. Ventrals 7-rayed, originating at a point equidistant from posterior margin of præoperculum and base of caudal, extending nearly to the vent. Caudal emarginate. Caudal peduncle as long as deep. Reddish above, golden on the sides and beneath; upper part of head and body with numerous rather large purplish spots; fins pale, the dorsal, anal, and ventrals with the free edge blackish.

Neighbourhood of the Great Lake, Tasmania.

The description above is based on a single specimen measuring 125 mm. in total length, received from Mr. R. W. Johnston in 1880. The species is said by him to be confined to the neighbourhood of the Great Lake, at an altitude of about 4000 feet, and to attain a larger size than any other member of the genus. He gives the following measurements of a large specimen:—Total length $9\frac{2}{3}$ inches; length, without caudal, $8\frac{1}{2}$ inches; length of head [*i. e.* including opercular flap] $2\frac{1}{2}$ inches; depth of body nearly 2 inches; length of snout $\frac{3}{4}$ inch; interorbital width 1 inch.

The species is especially distinguished from the allied *G. truttaceus* by the larger head and the more posterior position of the ventrals.

20. GALAXIAS COXII. (Plate XII. fig. 2.)

Galaxias coxii Macleay, Proc. Linn. Soc. N. S. Wales, v. 1880, p. 45.

Galaxias nigothoruk Lucas, Proc. Roy. Soc. Victoria, (2) iv. 1892, p. 28.

Lower jaw with distinct lateral canines. Depth of body 5-6 in the length, length of head $4\frac{1}{2}$ -5. Snout as long as or a little longer than eye, the diameter of which is 4-5 in the length of head, interorbital width $2-2\frac{1}{3}$. Jaws equal anteriorly; maxillary extending nearly to below middle of eye. 7 or 8 branchiostegals. 8-9 gill-rakers on the lower part of the anterior arch. Dorsal IV 7-9; distance from origin of dorsal to base of caudal $3\frac{3}{4}$ -4 in the length of the fish. Anal IV-V 8-10, commencing below or in advance of the middle of dorsal, when laid back extending to the base of caudal. Pectoral extending about $\frac{1}{2}$ of the distance from its base to the base of ventral. Ventrals 7-rayed, originating at a point equidistant from eye and base of caudal or from middle of pectoral and origin of anal, extending more than $\frac{1}{2}$ of the distance from their base to the origin of anal. Caudal slightly emarginate. Caudal peduncle as long as or a little longer than deep. Brownish, with numerous small dark spots or vertical streaks; a more or less distinct dark vertical bar above the base of pectoral; fins usually dusky.

Victoria; New South Wales.

- | | | |
|-----------------------------|---------------------------|-----------------|
| 1. (95 mm.) one of the type | Nigothoruk, Victoria. | Prof. A. Dendy. |
| | of <i>G. nigothoruk</i> . | |
| 2-6. (145-180 mm.) | | Australian Mus. |

The specimens received from the Australian Museum, without name and without locality, evidently correspond to Macleay's *Galaxias coxii*, from Mt. Wilson, New South Wales, and may probably be regarded as the types of that species.

21. GALAXIAS AFFINIS, sp. n. (Plate X. fig. 1.)

Lower jaw with distinct lateral canines. Depth of body 6-7 in the length, length of head $4\frac{1}{2}$ - $4\frac{3}{4}$. Snout longer than eye, the diameter of which is $4\frac{2}{3}$ - $5\frac{1}{2}$ in the length of head, interorbital width $2\frac{1}{3}$ - $2\frac{2}{3}$. Jaws equal anteriorly; maxillary extending to below middle of eye. 8 or 9 branchiostegals. 8 or 9 gill-rakers in the lower part of the anterior arch. Dorsal IV 6-8; distance from origin of dorsal to base of caudal $3\frac{2}{5}$ - $3\frac{1}{4}$ in the length of the fish. Anal IV-V 8-9, commencing below the middle of dorsal, when laid back not reaching the caudal. Pectoral extending nearly $\frac{1}{2}$ of the distance from its base to the base of ventral. Ventrals 7-rayed, originating at a point about equidistant from eye and base of caudal or from anterior part of pectoral and origin of anal, extending $\frac{1}{2}$ or nearly $\frac{1}{2}$ of the distance from their base to the origin of anal. Caudal slightly emarginate. Caudal peduncle $1\frac{1}{3}$ - $1\frac{1}{2}$ as long as deep. Brownish, with numerous small dark spots; a dark vertical bar above the base of pectoral; fins dusky.

Tasmania.

This species is very closely allied to *G. cowii*, but is distinguished by the smaller eye, the somewhat shorter ventrals, less deep anal, and more slender caudal peduncle.

1-4. (120-150 mm.) types of the species.	Lake St. Clair.	Prof. W. B. Spencer.
5-6. (73 and 78 mm.)	Tasmania.	Australian Mus.

22. GALAXIAS ORNATUS.

Galaxias ornatus Casteln. Proc. Zool. Soc. Victoria, ii. 1873, p. 153; Macleay, Proc. Linn. Soc. N. S. Wales, vi. 1881, p. 237.

Depth of body about 6 in the length, length of head $5\frac{2}{3}$. Snout a little longer than eye, the diameter of which is 5 in the length of head, interorbital width $2\frac{1}{4}$. Lower jaw slightly projecting; maxillary extending to below anterior $\frac{1}{3}$ of eye. 8 gill-rakers on the lower part of the anterior arch. Dorsal III 8; distance from origin of dorsal to base of caudal $3\frac{1}{3}$ in the length of the fish. Anal III 9, commencing slightly in advance of the posterior end of the base of dorsal, when laid back not extending to the caudal. Pectoral extending $\frac{2}{5}$ of the distance from its base to the base of ventral. Ventrals 7-rayed, originating at a point nearly equidistant from tip of snout and base of caudal, extending $\frac{2}{5}$ of the distance from their base to the origin of anal. Caudal emarginate. Caudal peduncle $1\frac{2}{3}$ as long as deep. Body with numerous irregular dark vertical stripes; fins immaculate.

Victoria.

The typical example, from Cardinia Creek, measures 105 mm. in total length; I have been permitted to examine it by the courtesy of Prof. L. Vaillant.

23. GALAXIAS OLIDUS. (Plate XI. fig. 3.)

Galaxias olidus Günth. Cat. Fish. vi. p. 209 (1866).

Galaxias kayi Ramsay & Ogilby, Proc. Linn. Soc. N. S. Wales, (2) i. 1886, p. 6.

Teeth in the jaws subequal, without distinct lateral canines. Depth of body $4-6\frac{1}{2}$ in the length, length of head $5-5\frac{2}{3}$. Snout as long as or slightly longer than eye, the diameter of which is $4-4\frac{3}{4}$ in the length of head, interorbital width $2\frac{1}{6}-2\frac{1}{3}$. Jaws equal anteriorly; maxillary extending to below middle of eye. 7 or 8 branchiostegals. 7 or 8 gill-rakers on the lower part of the anterior arch. Dorsal 10-12 (III-IV 7-9); distance from origin of dorsal to base of caudal $3\frac{1}{3}-3\frac{2}{3}$ in the length of the fish. Anal 11-13 (IV 7-9), commencing behind the middle of the dorsal, when laid back nearly reaching the procurvent caudal rays. Pectoral extending from $\frac{1}{3}$ to a little more than $\frac{2}{5}$ of the distance from its base to the base of ventral. Ventrals 7-rayed, originating at a point equidistant from eye and base of caudal or from middle or posterior part of pectoral and origin of anal, extending $\frac{2}{5}-\frac{1}{2}$ of the distance from their base to the origin of anal. Caudal slightly

emarginate. Caudal peduncle $1\frac{1}{3}$ - $1\frac{1}{2}$ as long as deep. Dark spots or undulating vertical stripes on the sides of the body.

South Australia.

1-2.	(100 and 110 mm.) types of the species.		G. Krefft, Esq.
3.	(112 mm.) one of the types of <i>G. kayi</i> .	Fifth Creek.	Australian Mus.
4-5.	(75 and 84 mm.)	Adelaide.	"
6.	(74 mm.)	S. Australia.	"

24. GALAXIAS FINDLAYI. (Plate XIII, fig. 3.)

Galaxias findlayi Macleay, Proc. Linn. Soc. N. S. Wales, vii. 1882, p. 107; Ogilby, Proc. Linn. Soc. N. S. Wales, xxi. 1896, p. 66.

Teeth in the jaws subequal, without distinct lateral canines. Depth of body $5\frac{1}{2}$ - $7\frac{1}{2}$ in the length, length of head $4\frac{2}{3}$ - $5\frac{2}{3}$. Snout as long as or longer than eye, the diameter of which is 4-5 in the length of head, interorbital width $2\frac{1}{4}$ - $2\frac{1}{2}$. Jaws equal anteriorly or the lower somewhat the shorter; maxillary extending to below anterior $\frac{1}{3}$ of eye or beyond. 8 to 10 branchiostegals. 7 to 9 gill-rakers on the lower part of the anterior arch. Dorsal 11-13 (III-IV 7-9); distance from origin of dorsal to base of caudal $3\frac{1}{4}$ - $3\frac{3}{4}$ in the length of the fish. Anal 13-14 (III-V 8-10), commencing below the posterior $\frac{1}{2}$ of the dorsal, when laid back not extending to the caudal. Pectoral extending $\frac{2}{5}$ of the distance from its base to the base of ventral. Ventrals 7-rayed, originating at a point equidistant from eye or cheek and base of caudal or from posterior part of pectoral and origin of anal, extending $\frac{1}{2}$ the distance from their base to the origin of anal. Caudal slightly emarginate. Caudal peduncle $1\frac{1}{2}$ -2 as long as deep. Sides of body with dark spots, blotches, or vertical bars.

Victoria; New South Wales.

1-2.	(75 and 78 mm.)	Mt. Kosciusko.	J. Douglas Ogilby, Esq.
3-7.	(40-80 mm.)	Australian Alps.	Australian Mus.
8-9.	(81 and 83 mm.)	Richmond R.	"
10-11.	(42 and 57 mm.)	Colo Vale.	"
12-13.	(66 and 68 mm.)	—	"

Galaxias planiceps and *G. bong-bong* Macleay, Proc. Linn. Soc. N. S. Wales, vi. 1881, p. 233, respectively from Bathurst and from Moss Vale and Bong-Bong, are probably not distinct from this species.

25. GALAXIAS SCHOMBURGKII.

Galaxias schomburgkii Peters, Monatsb. Ak. Berlin, 1868, p. 455.

Depth of body $6\frac{1}{2}$ in the total length, length of head $5\frac{1}{2}$. Eye occupying the second fourth of the length of the head. Dorsal 9. Anal 10, commencing scarcely before the posterior end of the dorsal. Pectoral extending more than $\frac{1}{2}$ of the distance from its base to the base of ventral.

Adelaide.

Total length 50 mm.

Probably allied to *G. olidus*.

26. GALAXIAS DISSIMILIS, sp. n.

Teeth in the jaws subequal, without distinct lateral canines. Depth of body 6 in the length, length of head $3\frac{1}{2}$. Snout much longer than eye, the diameter of which is 5 in the length of head, interorbital width $3\frac{1}{2}$. Jaws equal anteriorly; maxillary extending to below anterior $\frac{1}{4}$ of eye. 8 or 9 branchiostegals. 13 gill-rakers on the lower part of the anterior arch. Dorsal 13; distance from origin of dorsal to base of caudal $2\frac{1}{3}$ in the length of the fish; length of base of dorsal equal to its distance from the caudal. Anal 9, commencing below the last 2 or 3 rays of dorsal, when laid back not reaching the caudal. Pectoral extending $\frac{2}{3}$ of the distance from its base to the base of ventral. Ventrals 6-rayed, commencing below the origin of dorsal, extending nearly to the origin of anal. Caudal slightly emarginate. Caudal peduncle $1\frac{2}{5}$ as long as deep. Uniform brownish (in spirit).

? New South Wales.

1. (75 mm.) type of the species.

Australian Mus.

NEOCHANNA.

Neochanna Günth. Ann. Mag. Nat. Hist. (3) xx. 1867, p. 305.

Differs from *Galaxias* in having no ventral fins, the teeth in the jaws obtuse and somewhat compressed, and the palate toothless. 54 vertebræ.

A single species from New Zealand.

NEOCHANNA APODA.

Neochanna apoda Günth. t. c. p. 306, pl. vii.; Hutton, Fish. N. Zeal. p. 61, pl. x. fig. 97 (1872).

Depth of body 7-8 in the length, length of head $5-5\frac{3}{4}$. Diameter of eye 6-8 in the length of head, interorbital width $2\frac{1}{2}-2\frac{4}{5}$. Jaws equal anteriorly; maxillary extending to below the eye. 7 branchiostegals. 8 gill-rakers on the lower part of the anterior arch. Dorsal 16-19; distance from origin of dorsal to base of caudal $3\frac{2}{5}-3\frac{4}{5}$ in the length of the fish. Anal 16-19, opposite to the dorsal and similar to it, both fins subcontinuous with the caudal. Pectoral about $\frac{2}{3}$ the length of head. Caudal rounded. Yellowish, marbled or barred with dark brown; fins sometimes with small dark spots.

New Zealand.

- | | | |
|-----------------------------------|--------------|----------------|
| 1. (135 mm.) type of the species. | New Zealand. | Sir G. Grey. |
| 2. (114 mm.) | Hokitika. | Otago Mus. |
| 3-6. (67-88 mm.) | " | E. Hill, Esq. |
| 7. Skeleton. | " | " |
| 8. (127 mm.) | — | Sir D. Cooper. |

EXPLANATION OF THE PLATES.

PLATE X.

- Fig. 1. *Galaxias affinis*, p. 380.
 2. " *huttoni* ($\times 2$), p. 373.
 3. " *punctifer* ($\times 1\frac{1}{2}$), p. 367.
 4. " *lyna*, p. 373.

PLATE XI.

- Fig. 1. *Galaxias weedoni*, p. 377.
 2. " *waitii*, p. 376.
 3. " *olidus* (type of *G. kayi*), p. 381.
 4. " *occidentalis*, p. 376.

PLATE XII.

- Fig. 1. *Galaxias attenuatus* (type of *G. punctatus*), p. 368.
 2. " *coyii*, p. 380.

PLATE XIII.

- Fig. 1. *Galaxias auratus*, p. 379.
 2. " *attenuatus* (type of *G. krefftii*), p. 368.
 3. " *findlayi*, p. 382.
 4. " *truttaceus*, var., p. 378.

5. The Mammalian Fauna of China.—Part I. *Murinae*.

By J. LEWIS BONHOTE, M.A., F.L.S.*

[Received October 28, 1905.]

The object of a proposed series of papers, of which this is the first, is to bring up to date our existing knowledge of the Mammalian Fauna of China, at present scattered throughout various papers, which, except Mons. Milne-Edwards's 'Recherches Mammifères,' are short.

The material used has been chiefly that contained in the British Museum, which, apart from a portion of Swinhoe's collection, contains large collections made by Messrs. Styan, Rickett, and La Touche, as well as several smaller collections, amongst which we may mention a small consignment very carefully collected by Mr. E. B. Howell.

I have to thank the late Dr. E. Oustalet for his kind courtesy and the facilities afforded me for a careful examination of Père David's types in the Paris Museum.

Many imperfections due to lack of specimens and exact data are bound to occur, but it is hoped that these papers may prove useful as a foundation on which future workers may build, and with this object in view the synonymy throughout has been made as full and accurate as possible.

List of Chinese *Murinae*.

1. *Mus edwardsi* Thos.
2. *Mus coxingi* Swinh.
3. *Mus confucianus* A. M.-E.
4. *Mus huang*, sp. n.
5. *Mus ling*, sp. n.
6. *Mus latouchei* Thos.
7. *Mus flavipectus* A. M.-Edw.

* [The complete account of the new species described in this communication appears here; but since the names and preliminary diagnoses were published in the 'Abstract,' the species is distinguished by the name being underlined.—EDITOR.]

8. *Mus losea* Swinh.
9. *Mus griseipectus* A. M.-E.
10. *Mus norvegicus* Erxl.
11. *Mus humiliatus* A. M.-E.
12. *Mus musculus* Linn.
13. *Micromys sylvaticus chevrieri* A. M.-E.
14. *Micromys sylvaticus draco* Barr.-Hamilton.
15. *Micromys minutus pygmaeus* A. M.-E.
16. *Micromys agrarius manchuricus* Thos.
17. *Micromys agrarius ningpoensis* Swinh.

MUS EDWARDSI Thos.

Mus edwardsi Thos. P. Z. S. 1882, p. 587, pl. xlv.; Thos. P. Z. S. 1898, p. 773; Bonh. Fasc. Malayenses, Zool. vol. i. pp. 33 & 36 (1903).

This species was originally described from four examples sent to Paris by Père David. The type is in the B.M. 82.6.16.1, the other three examples being in Paris and dated October 1872. This is a very large Rat belonging to the *jerdoni* group, of which it is typical of the subgroup bearing its name. The British Museum now possesses a fine series of these Rats from Kuatun in N.W. Fokien. They seem to be very uniform and show remarkably little variation.

The general colour is yellowish grey, some specimens being much yellower than others. Each hair is slate-grey at its base and fulvous for the distal half, and interspersed among these hairs are long slender spines with dark tips as well as long black bristles. On the flanks, owing to the absence of the black bristles, the fulvous colour of the fur proper is more visible.

The under parts are pure white. The tail is equal in length to the head and body, markedly bicolor, and covered with short hairs, while the last two or three inches are pure white. The feet are uniform dark brown with white margins and toes. Whiskers very long and entirely black with the exception of a few shorter white ones.

The *skull* partakes of the usual characters associated with the *jerdoni* group, *e. g.*, long, narrow, flat, and with small bullæ. The supraorbital ridges are well defined over the orbits and slightly flattened so as to produce a comparatively broad upper surface; they end somewhat abruptly about halfway across the parietals. Below, owing to the smallness of the bullæ, the basioccipital presents a broad surface and the external condyles are well developed.

The dimensions (as given by Thomas and rendered into millimetres) are as follows:—Head and body 300; tail 289; hind foot 57; ear 24.

Skull. Greatest breadth 57 mm.; basilar length 44; palatal length 24.5; diastema 15; incisive foramina 10; length of nasals 22.5; zygomatic breadth 26; interorbital breadth 9.5; breadth of brain-case 22; length of molar series (alveoli) 11.

Habitat. Only recorded from W. and N.W. Fokien.

The first specimens of these Rats were all obtained high up on the mountains among rocky ground, in the crevices of which it lives. Beyond this, nothing is known of its habits. It has only been taken in W. and N.W. Fokien.

MUS COXINGI Swinhoe.

Mus coninga Swinhoe, P. Z. S. 1864, pp. 185, 382.

Mus coxinga Swinhoe, P. Z. S. 1870, p. 637; Thos. Ann. Mus. Gen. 1892, p. 939 (footnote).

Mus coxingi Swinhoe, Bonh. Fasc. Malay., Zool. vol. i. pp. 33 & 36 (1903).

Mus coninga (under which name it was originally described by Swinhoe) is undoubtedly a Rat of the *jerdoni* type (*rajah* subgroup), and *not* the *jerdoni* subgroup as noted by me. The typical form, as described by Swinhoe, has the upper parts reddish brown, sprinkled with stiff black bristles, especially on the back, where the fur is also often a little darker. Under parts pure white; feet white; tail bicolor, white at the tip.

The skulls at my disposal are too fragmentary to allow of a description.

Dimensions (from skin). Head and body 208 mm.; tail 180; hind foot 36.

Skull. Palatal length 19 mm.; diastema 11; incisive foramina 7; length of nasals 17; interorbital breadth 6.5; length of molar series (alveoli) 8 mm.

Habitat. Formosa.

Swinhoe noted many varieties of this species as occurring in Formosa; these doubtless represent forms belonging to the different subgroups of the *jerdoni* group, but unfortunately the only specimens I have been able to examine are a portion of Swinhoe's series of which the skulls are all defective. It is therefore impossible to distinguish any of these varieties by name; but the true *coxingi* may be distinguished by its white feet, the white tip to its tail, and the fact that the fur is thickly beset with spines.

MUS CONFUCIANUS A. M.-E.

Mus confucianus A. M.-Edwards, Nouv. Arch. du Mus. vii. p. 93 (1871); id. Rech. Mamm. p. 286, pl. xli. fig. 2 (1874); Thos. P. Z. S. 1898, p. 773 (partim); Bonh. Fasc. Malay., Zool. vol. i. p. 33.

General colour above dark brown (clay, Ridgw.), shading to pale buff or yellowish on the flanks. Fur slate-grey at the base with pale fulvous tip, interspersed amongst which are long black bristles. The pale tips predominate over the black so as to give the animal the appearance noted above. Occasionally these bristles are semi-spinous, and in one or two examples the fur is exceedingly harsh and spiny; but as a rule it is quite soft to the

touch, as stated by M. Milne-Edwards in the original description. Under parts pure milk-white, sharply contrasted with that of the upper parts. Feet whitish, but the colour of the upper parts runs down the centre of their upper surface to a varying extent. Tail moderately long and bicoloured, clothed with short hairs; its terminal portion is usually, but not invariably white. The skull is that of a typical *Mus* of the *jerdoni* group, being long and narrow, somewhat flattened and with small bullæ.

Dimensions (in flesh). Head and body 164 mm.; tail 192; hind foot 39; ear 18.

Skull (average dimensions). Greatest length 36 mm.; basilar length 27.5; palatal length 15; diastema 9.75; incisive foramina 6.6; length of nasals 13.6; zygomatic breadth 16; inter-orbital breadth 6; greatest breadth of brain-case 14; length of molar series (alveoli) 6.

Habitat. The type was received from Père David from the mountains of Moupin, in the province of Szechuen, W. China. There are also specimens in the Museum from E. Kiangsi, from Kuatun and Ching Fen Ling in N.W. Fokien, and from Nankin, all forming a very uniform series showing hardly any variation.

It is as a rule generally found in the mountainous country, occasionally entering the houses in winter; and it may be easily recognised, for its dull brown colour and *pure white* under parts, sharply divided from the colour of the back, form a combination of characters found in no other Rat from that part of the world.

Some of the spiny individuals very closely resemble *Mus niveiventris* from the Himalayas, of which it is probably the Chinese representative.

MUS HUANG.

Mus confucianus A. M.-E., O. Thos. P. Z. S. 1898, p. 773 (partim).

Mus huang Bonh. Abstr. P. Z. S. No. 23, p. 19, Dec. 5, 1905.

Size as in the last-mentioned species. General colour rufous (ochraceous-rufous, Ridgw.), darker along the dorsal area. The underfur is slate-coloured at its base with a rufous tip, thickly intermixed, especially on the back, with black bristles or spines. On the flanks the bristles become much less numerous and many of them have rufous tips. The colour of the head resembles that of the upper parts. The feet are whitish, with the rufous colour running down the centre of their upper surface. Under parts pure white, the line of demarcation being sharply defined. Tail rather longer than the head and body, clothed with short hairs and bicoloration. Ears moderately long and sparsely covered with very close, short, dark brown hairs.

The *skull* very closely resembles that of *M. confucianus* in size and general appearance, but may be recognised by the supra-orbital ridges being continued right across to the posterior margin of the parietal.

Dimensions (of type from skin). Head and body 155 mm.; tail 188; hind foot 30; ear (approx.) 16.

Skull (of type). Greatest length 37 mm.; basilar length 27; palatal length 15; diastema 9·5; incisive foramina 7; length of nasals 14; interorbital breadth 6; greatest breadth of brain-case 14; length of molar series (alveoli) 6.

Type. B.M. 89.11.1.16. ♂ ad. Collected on the 24th April, 1898, at Kuatun, N.W. Fokien, by Mr. J. D. La Touche.

Habitat. Kuatun. The Museum also contains a specimen indistinguishable from the type from the Ngau-tchi-lea Mts., Hainan.

This species is evidently the representative of the true *Mus jerdoni*, although it is more spiny than the other members of that subgroup hitherto described. Its nearest ally is *Mus rapit*, mihi, from Borneo, to which it bears a very close resemblance. From *Mus confucianus* it may be easily distinguished by its bright coloration, the absence of any white tip to the tail, and also the very much shorter hairs with which the tail is clothed.

I have called this species from its Chinese name "Huang mao shū," meaning yellow-haired rat.

MUS LING.

Mus confucianus A. M.-E., O. Thos. P.Z.S. 1898, p. 773 (partim).

Mus ling Bonh. Abstr. P. Z. S. No. 23, p. 19, Dec. 5, 1905.

Size smaller and paler, otherwise closely resembling *Mus huang*. The amount of spininess varies considerably, some individuals being very thickly beset, while in others the fur is uniformly soft. The tail is covered with short hairs and bicoloured as the *Mus huang*, but in the young and in some adult individuals we find a tendency to a unicolorous tail. The general colour is fulvous (ochraceous-buff, Ridgw.).

Skull. Except for its smaller size, the skull does not differ markedly from that of *Mus huang*. The ridges referred to in that species may be traced as far back as the posterior margin of the parietal, but are not so strongly marked. Several skulls, however, are intermediate in size between those of this species and those of *Mus huang*, but this Rat may in all cases be distinguished externally by its paler colour and shorter tail; while in no case does any single measurement overlap that of the smallest *M. huang*.

Dimensions (of type from skin). Head and body 132 mm.; tail 157; hind foot 27; ear 15.

Skull (of type). Greatest length 33 mm.; basilar length 25; palatal length 14; diastema 8·5; incisive foramina 5·5; length of nasals 12; zygomatic breadth 14; interorbital breadth 5·5; greatest breadth of brain-case 14; length of molar series (alveoli) 5·5.

Type. B.M. 98.3.7.8. Collected by Mr. C. B. Rickett in December 1897, at Ching Fen Ling, N.W. Fokien.

Habitat. Ching Fen Ling, N.W. Fokien; it also occurs at Kuatun in the same province.

This species is the representative of the *cremoriventer* subgroup.

In external appearance it resembles *Mus cremoriventer* Mill. very closely; the bicoloured tail, however, serves as an easily distinguishable feature, but that it is very nearly related is shown by the tendency in the young and even some adults to the unicolorous tail. The immature pelage is, as a rule, soft and destitute of bristles, and resembles in colour true *M. confucianus*.

This species seems to be most abundant at Ching Fen Ling, but it also occurs at Kuatun.

MUS LATOUCHEI THOS.

Mus latouchei Thos. Ann. & Mag. N. H. ser. 6, vol. xx, p. 113 (1897); id. P. Z. S. 1898, p. 772; Bonh. Fasc. Malay., Zoology, vol. i, p. 34 (1903).

General colour of the upper parts clear grizzled grey. Fur light at its base, with a greyish-brown subterminal portion and white tip, thickly intermixed with soft spines similar in colour but lacking the white tip. Under parts pure white, the hairs being white to their bases. Hands and feet white along their margins and on the digits, brownish in the centre. Tail dark, covered with short hairs, white at the tip in some individuals. Ears large, rounded and almost naked.

The skull most nearly resembles that of *Mus bowersi*, from which it differs, according to Mr. Thomas, in having the line of the fronto-premaxillary and fronto-nasal suture running straight from side to side, instead of being bowed backwards, and the supra-orbital rims more developed. The incisors are broad and pale yellow.

Dimensions (of type from skin). Head and body 310 mm.; tail 290; hind foot 60.

Skull. Greatest length 58 mm.; basilar length 48; palatilar length 28; diastema 17; length of incisive foramina 11; length of nasals 23.5; interorbital breadth 8; breadth of brain-case 22; length of molar series 10.

Habitat. The type came from Kuatun, as do all the series of specimens that have hitherto been obtained, although Mr. Thomas mentions a specimen in the Paris Museum from Père David. It is evidently a scarce Rat, and little seems to be known of its habits, but according to Mr. La Touche it inhabits the forest country. Its uniform grizzled-grey colour and large size are sufficient to distinguish it from all other Chinese rats.

MUS FLAVIPECTUS A. M.-E.

Mus — ? Swinhoe, P. Z. S. 1864, p. 382. no. 26.

Mus canna Swinhoe, P. Z. S. 1870, p. 636.

Mus alexandrinus Geoffr., Swinhoe, P. Z. S. 1870, p. 635.

Mus flavipectus A. M.-E. Nouv. Arch. du Mus. vol. vii, p. 93 (1871); id. Rech. Mamm. p. 289, pl. 42, fig. 1 (1874); Bonh. Fasc. Malay., Zoology, vol. i, pp. 35 & 37.

Mus ouangthomæ A. M.-E. Nouv. Arch. du Mus. vol. vii, p. 93 (1871); id. Rech. Mamm. p. 290, pl. 40, fig. 3 (1874).

Mus plumbeus A. M.-E. Rech. Mamm. p. 138, pl. 43. fig. 2 (1874).

Mus rattus flavipectus A. M.-E., Thos. P. Z. S. 1898, p. 772.

This species is the representative of the *rufescens*-group of *Mus rattus*, which inhabits China. It is of moderate size, having the tail rather shorter than the head and body. Fur soft and destitute of spines. General colour above uniform yellowish brown, slightly lighter on the flanks. Hairs slate-coloured at their base, with ochreous tips, and intermixed among these are pure black hairs of a finer texture. Under parts varying from dirty yellowish to yellowish-white, often, but not invariably, showing traces of a white mark on the breast. The hind feet are whitish and the hands dark brown margined with white. Tail unicoloured and covered with hairs.

Skull. The skull is that of a fairly typical *Mus rufescens*, and, except in its slightly smaller size, is indistinguishable from the Indian form*.

Dimensions. Head and body 200 mm.; tail 160; hind foot 31; ear 18.

Skull †. Greatest length 41 mm.; basilar length 36·5; palatilar length 20; diastema 11·5; length of incisive foramina 8; length of nasals 15; zygomatic breadth 20; interorbital breadth 6; breadth of brain-case 15·5; length of molar series 7.

Habitat. The type of this species came from Moupin in W. Szechuen, but it also occurs at Kuatun in N.W. Fokien, Kiou Kiang in Kiangsi, and Foochow, so that it is probably widely distributed throughout the country. It also occurs in Formosa.

This and *Mus griseipectus* are the common Rats of China. The difference in the colour of the under parts, as denoted in their specific names, will form to some extent a distinguishing character, although the under parts in *flavipectus* often become very light, and in old specimens of *griseipectus* may show a yellowish tinge. However, I am inclined to think this character unreliable, and a much better test is the greater size of *griseipectus*, as shown by the length of the hind foot and skull-measurements. In *griseipectus*, moreover, the tail, although it can hardly be called "bicolor," is distinctly lighter on its under surface, and this seems to be the only reliable external characteristic at all ages.

In the description of *M. flavipectus* in the Rech. Mamm., M. Milne-Edwards adds a footnote to say that *M. germaini* from Pulo Condor closely resembles this species, especially in its coloration. Although approximately correct, it may be well to notice that *M. germaini* may be distinguished by its size, which

* For careful figure of the skull of *M. rufescens*, see paper by the author, Fasc. Malayenses, Zoology, vol. i. pl. iv. fig. 3 (1903).

† The measurements, which are the same as those taken in my former paper, are now called after Mr. O. Thomas's scheme for cranial measurements, published Proc. Biol. Soc. Wash. vol. xviii. p. 191 (1905), the alterations (in name only) being basilar and palatilar for basal and palatal.

is greater than that of *M. griseipectus*. The ears are longer, and the colour of the under parts, which is white, differs from that of both *M. flavipectus* and *M. griseipectus* by the fact that the hairs are white to their bases and not slate-coloured.

When working out Père David's collection from Moupin, M. Milne-Edwards described a species under the name of *M. ouangthomæ*, stating that it was distinguished by a pure white cross on the breast. It was described from a single specimen, which, by the kindness of Dr. Oustalet, I had the privilege of examining when in Paris, and I am of opinion that it is merely a $\frac{3}{4}$ -grown example of this species. The white cross is not so conspicuous as one would be led to infer from the description, and is merely a well-marked development of the white breast-mark which is found in many individuals of otherwise typical *flavipectus*.

Another species from the collection of Père David was described by M. Milne-Edwards under the name *M. plumbeus*, and figured in the Rech. Mamm. This specimen I have also had an opportunity of examining, and the coloration depicted in the plate is much too blue. There is a specimen in the British Museum which agrees tolerably well with the description and type of *M. plumbeus*, but on examination of the skull it proves to be a very young individual, probably belonging to *M. flavipectus*.

The latter is the only specimen I have seen that shows white incisors, a characteristic of *M. plumbeus*. Under these circumstances, and as the skull of the type of *M. plumbeus* cannot be examined, as it has not been removed from the skin, we must, in the absence of further evidence, consider *plumbeus* as founded on an immature *flavipectus*.

MUS LOSEA Swinhoe.

Mus flavescens Elliot, Swinhoe, P. Z. S. 1864, p. 186.

Mus rufescens Gray, Swinhoe, P. Z. S. 1870, p. 636.

Mus losea Swinhoe, P. Z. S. 1870, p. 637.

This species may best be described as a small form of *M. flavipectus*, to which it closely approaches in coloration. The under parts are, however, as a rule greyer. The tail is unicoloured and very finely annulated (the annuli being 14 to the cm. as against 12 in *flavipectus*), and covered with minute and almost invisible setæ.

The ear is elongated, being longer by 2 mm. than immature *flavipectus* of the same size.

The skull, except in being $\frac{4}{5}$ the size, is otherwise indistinguishable.

Dimensions (from skin). Head and body 150 mm.; tail 123; ear 18; hind foot 26.

Skull. Greatest length 32 mm.; basilar length 26; palatilar length 15; diastema 8; incisive foramina 6.5; length of nasals 12; zygomatic breadth 15; interorbital breadth 5; length of molar series 6.5; breadth of brain-case 14.

Habitat. This species was originally described from Tamsuy in Formosa. But there is also a specimen collected by Mr. Swinhoe at Amoy, and other specimens in the Museum from W. Fokien.

This is undoubtedly a small form of *M. flavipectus*, distinguishable, apart from its size, by the more elongated ear and finer annulations to the tail.

It is possible that the original *losea* from Formosa may prove to be different from the form inhabiting the mainland; and this is the more likely, as in the paper describing the original *losea* Mr. Swinhoe referred to the specimen from Amoy as *Mus rufescens*. For the present, however, owing to lack of material, I have no alternative but to consider them all as *losea*.

MUS GRISEIPECTUS A. M.-E.

Mus indicus Geoffr., Swinhoe, P. Z. S. 1870, p. 635.

Mus griseipectus A. M.-E. Nouv. Arch. Mus. 1871, p. 93; id. Rech. Mamm. p. 290, pl. 42. fig. 2 (1874).

Similar to *M. flavipectus*, but slightly larger. Tail about equal in length to the head and body. Fur soft and destitute of spines. General colour above yellowish brown; fur slate-grey at base, with yellowish tips, and thickly interspersed among these are longer thin black hairs, which predominate along the median dorsal area. Upper surfaces of the feet and hands white. Under parts white or greyish, the fur being dark at its base as in the upper parts.

Skull. The skull, except in being slightly larger, closely resembles that of *M. flavipectus*, and calls for no special comment.

Dimensions. Head and body 196 mm.; tail 160; hind foot 33; ear 22.

Skull. Greatest length 45 mm.; basilar length 36; palatilar length 22; diastema 13; length of incisive foramina 8; length of nasals 17; zygomatic breadth 21.5; interorbital breadth 7; breadth of brain-case 18; length of molar series 8.

Habitat. Sze-chuen (type-locality); also found in W. Fokien.

There is but little further to add with regard to this species. It is most likely to be confused with *M. flavipectus*, but the characters distinguishing it from that species have already been given. There is, however, another small character which it may be as well to notice. In *M. flavipectus* the hands on their upper surfaces are brown margined with white, while in all the specimens of *griseipectus* that I have examined the upper surfaces of the hands are uniformly white.

MUS NORVEGICUS ERXL.

Mus decumanus Pall., Swinhoe, P. Z. S. 1864, pp. 186, 382; id. op. cit. 1870, pp. 233, 635.

Mus humiliatus A. M.-E., Thos. P. Z. S. 1898, p. 772 (partim).

The common Norway Rat occurs not infrequently in China, as shown by several examples in the British Museum. Apart from the skull-characters, which are quite distinctive, it may be recognised from *griseipectus*, which it resembles most closely externally, by its larger size (hind foot 36 mm.) and stouter tail.

MUS HUMILIATUS (A. M.-E.).

Mus humiliatus A. M.-E., Ann. Sci. Nat. vii. p. 375 (1867); id. Rech. Mamm. p. 137, pl. 41. fig. 1 (1874); Rhoads, Proc. Acad. Nat. Sci. Philad. 1898, p. 121; Thos. P. Z. S. 1898, p. 772.

Another member of the *Mus rattus* group but smaller. General colour above yellowish-brown. Fur slate at its base, but yellowish brown (cinnamon, Ridgw.) for the greater part of its length, becoming paler on the flanks; intermixed with the fur are a few long soft black hairs, but they are so scattered as to have but little effect on the general colour. The hands and feet are white, and the under parts uniform grey. The tail is short, tapering, and bicoloured, well clothed with short hairs that are brown on the upper and white on the lower surface. The ears small and rounded and covered with fine hairs.

The skull differs from that of *M. griseipectus* in being broader and shorter. The supraorbital ridges are not so well marked and do not run back so far, disappearing about halfway across the parietals.

Dimensions (taken in flesh: Nankin*). Head and body 145 mm.; tail 115; hind foot 30; ear 16.5.

Skull (of co-type). Greatest length 35 mm.; basilar length 29; palatilar length 17; diastema 7; length of incisive foramina 6; length of nasals 12; zygomatic breadth 18; interorbital breadth 6; breadth of brain-case 15; length of molar series 7.

Habitat. Pekin and neighbourhood (type); Nankin and W. Fokien.

The chief distinctive feature of this Rat is its light colour, caused by the almost entire absence of the longer black hairs found in so many species, and besides this its smaller size and short tail form a combination of characters enabling it to be easily recognised. It is apparently a scarce animal, as only one specimen has reached the British Museum during the last 23 years, and it is entirely absent from the collections of Messrs. Styan, Rickett, and La Touche. Mr. Howell has, however, just sent over a small collection, which contains a mature female, from the city of Nankin, this specimen agreeing closely in all respects with the type.

A specimen received originally from the Paris Museum as belonging to this species, and collected by Père David in W. Fokien, is undoubtedly *Mus norvegicus*, and it was this example that led Mr. Thomas to suggest *Mus humiliatus* as the possible wild stock of *Mus norvegicus*.

* The skull-measurements of this specimen practically coincide with those of the co-type.

Key to the larger Chinese Species of Mus.

(Hind-foot measurement of the smallest, 26 mm.).

- A. Colour of under parts sharply divided from that of upper parts.
- a.* Size large. Hind foot 57 mm. *M. edwardsi.*
- b.* Smaller. Hind foot not exceeding 36 mm.
- a*₁. Feet white *M. coxingi.*
- b*₁. Feet coloured.
- a*₂. General colour dull brown (clay, Ridgw.). Hind foot 39 mm. *M. confucianus.*
- b*₂. General colour brighter (ochraceous rufous, R.). Hind foot 30 mm. *M. hung.*
- Smaller and paler. Hind foot 27 mm. *M. ling.*
- B. Colour of under parts not sharply divided from that of upper parts.
- a.* Tail bicolor. Hands white.
- a*₁. Tail clothed with minute setæ. Hind foot 33 mm.... *M. griseipectus.*
- b*₁. Tail clothed with hairs.
- a*₂. Large. Hind foot 36 mm..... *M. norvegicus.*
- b*₂. Smaller. Hind foot 30 mm. *M. humilatus.*
- b.* Tail unicoloured. Hands brown with white margins.
- a*₁. Fur of under parts with slate-coloured bases.
- a*₂. Size large. Hind foot 31 mm..... *M. flavipectus.*
- b*₂. Smaller. Hind foot 26 mm..... *M. losea.*
- b*₁. Fur of under parts white throughout. Hind foot 60 mm..... *M. latouchei.*

MUS MUSCULUS L.

Mus musculus L., Swinhoe, P. Z. S. 1864, p. 382, and 1870, p. 637.

The common House-Mouse does not seem to be very abundant in China, though there are several specimens in the Museum from widely separated localities in that country.

A description of so well known a species would be superfluous, and there is no other mouse with which it could well be confused.

Dimensions (from spirit-specimen). Head and body 77 mm.; tail 80; hind foot 17.

MICROMYS Dehne.

Micromys (type of genus *Micromys agilis*, Dehne, Hoflössnitz, 1841), revived by O. Thomas, Ann. Mag. N. H. ser. 7, vol. xv. p. 491 (May 1905).

Mr. Thomas has used *Micromys* as the generic name of several species of the smaller mice hitherto included under the universal genus "*Mus*." The Chinese forms belonging to it are:—

- Mus sylvaticus chevrieri.*
 ,, ,, *draco.*
Mus minutus pygmaeus.
Mus agrarius manchuricus.
 ,, ,, *ningpoensis.*

The distinctive character of this genus is that the posterior

laminae of the first and second upper molars have each an additional internal cusp beyond the number present in *Mus*, so that, counting along the inner side of the tooth-row, there are three cusps on both the first and second molars.

MICROMYS SYLVATICUS CHEVRIERI (A. M.-E.).

Mus chevrieri A. Milne-Edwards, Rech. Mamm. p. 288, pl. xl. fig. 2 (1874); E. Büchner, Mamm. Przewalski, p. 92 (1889).

Mus sylvaticus chevrieri (A. M.-E.), Barrett-Hamilton, P. Z. S. 1900, p. 418.

Major Barrett-Hamilton, in the paper noticed above, restricts the name *chevrieri* to that form of *Micromys sylvaticus* represented by the typical series from Moupin in Tibet.

The general colour is pale fawn, grizzled with brownish on the back. The under parts and feet are pure white. Tail about equal in length to the head and body, bicoloured and scantily clothed with hair.

Dimensions. Head and body 100 mm.; tail 90; hind foot 21.5 mm.

Habitat. Moupin, Tibet. A single specimen in the British Museum from S. Shensi is probably referable to this species.

So little is known of this species that it is impossible to add anything in reference to its habits, &c.

MICROMYS SYLVATICUS DRACO (B.-H.).

Mus chevrieri A. M.-E., Thos. P. Z. S. 1898, p. 773.

Mus —, sp. no. 27, Swinhoe, P. Z. S. 1864, p. 382.

Mus sylvaticus draco Barrett-Hamilton, P. Z. S. 1900, p. 418.

Mus badius Blyth, Swinhoe, P. Z. S. 1870, p. 233.

This form of *Mus sylvaticus* described by Major Barrett-Hamilton may be distinguished from *Micromys chevrieri* by its duller colour and its slightly smaller size. The general colour is pale fulvous (hair-brown, Ridgw.), darker along the median dorsal area owing to many of the hairs having black tips. Feet and under parts pure white. Tail well clothed with short hair, dark above and light below. The bases of the hairs on all parts of the body are slate-coloured.

According to the original describer, the skull is "narrower and slightly smaller than that of the adult of the subspecies *intermedius* (of Britain and portions of Western Europe), and having the anterior portions of the frontals more attenuated and the nasal region proportionately more slender than in the latter subspecies."

Dimensions. Head and body 91 mm.; tail 95; hind foot 20.

Skull. Greatest length 26 mm.; basilar length 21; palatilar length 11; diastema 7; length of incisive foramina 5; length of nasals 10; interorbital breadth 5; breadth of brain-case 11; length of molar series 4.

Habitat. Kuatun, N.W. Fokien.

The typical series, all from Kuatun, are the only ones at present known.

MICROMYS MINUTUS PYGMÆUS (A. M.-E.).

Mus pygmæus A. M.-Edw. Rech. Mamm. p. 291, pl. xliii. fig. 1 (1874); Thos. P. Z. S. 1898, p. 775.

Mus minutus pygmæus B.-Hamilton, Ann. & Mag. N. H. ser. 7, vol. iii. p. 343 (1899).

This is the Chinese representative of our European Harvest-Mouse, from which it differs in its rather longer tail and darker colour. The general colour above is of a uniform olive-brown, rather more rufous on the hind-quarters. The under parts are greyish white. Hands and feet scantily clothed with brownish hair. Tail equal in length or longer than the head and body, clothed with minute and almost invisible setæ.

The skull, which is typical of the genus, has a moderately broad brain-case, but is rather short in the muzzle. The bullæ are large for the size of the skull, and project sharply downwards, compressing the basioccipital at its anterior portion.

Dimensions of a dried skin from Kuatun. Head and body 58 mm.; tail 61; hind foot 14*.

Skull. Greatest length 19 mm.; basilar length 17; palatilar length 8; diastema 5; length of incisive foramina 3.6; length of nasals 6; interorbital breadth 3.7; breadth of brain-case 9; length of molar series 3.8.

Habitat. Sze-chuen. Specimens in the British Museum from Kuatun and Shanghai.

Nothing further is known of the distribution or habits of this species. The Japanese Harvest-Mouse recently described by Mr. Thomas is more rufous and resembles the European one more closely than the Chinese.

MICROMYS AGRARIUS MANCHURICUS (Thos.).

Mus agrarius mantchuricus Thos. P. Z. S. 1898, p. 774.

This is the Northern Chinese form of *Mus agrarius*, from typical examples of which it differs only to a slight extent. It is slightly larger and more rufous in its general tone of colour. The dark median dorsal stripe is black and very clear cut, and starting from the crown reaches to the root of the tail. Under parts grey with a tinge of rufous along the middle line. Tail dark brown above, lighter below, well covered with short hairs.

The *skull* does not materially differ from that of *M. agrarius typicus*.

Dimensions (of type after Thos.). Head and body 116 mm.; tail 78; hind foot 19; ear 14.

* The measurements of the type as given by M. M.-Edwards are: head and body 73, tail 53, ear 5, hind foot 18; but on the discrepancies between the tail and hind-foot measurements see O. Thomas, *loc. cit. supra*.

Skull. Greatest length 27 mm.; palatilar length 12; diastema 8; length of incisive foramina 6; length of nasals 10; interorbital breadth 4; breadth of brain-case 11; length of molar series (alveoli) 4.

Habitat. The type comes from near the Korean border of Manchuria. The British Museum contains a further specimen from S. Shensi procured by Père David, which has been referred to this race.

MICROMYS AGRARIUS NINGPOENSIS Swinh.

Mus ningpoensis Swinh. P. Z. S. 1870, p. 637 et 1872, p. 818.

Mus harti Thos. P. Z. S. 1898, p. 774.

Very similar to *M. a. manchuricus*, but lacking the rufous tinge on the back, which in the present species is replaced by fulvous. General colour above fulvous throughout, uniformly grizzled with black. In some cases a well-defined dark stripe is apparent down the back, and in most specimens a trace of a dark stripe is discernible. Under parts white, sharply defined from the colour of the upper parts. Tail brown above, lighter below, and covered with short hairs.

The *skull* does not appreciably differ from that of *M. agrarius typicus*.

Dimensions (of type converted from inches given in Swinhoe's description). Head and body 81 mm.; tail 68; hind foot (measured from type) 20.

Another example, ♂ (in flesh, coll. E. B. Howell, no. 69). Head and body 111 mm.; tail 78; hind foot 20; ear 14.

Skull. Greatest length 26 mm.; basilar length 21.5; palatilar length 11; diastema 7; length of incisive foramina 5; length of nasals 10; zygomatic breadth 12; interorbital breadth 4.7; breadth of brain-case 11.5; length of molar series 4.

Type. Collected by Mr. Swinhoe. Now in the Berlin Museum.

Habitat. Ningpo. The British Museum contains specimens also from Nankin, Hanchow, and Kuantun.

I have had to sink, under Swinhoe's name, Mr. Thomas's *Mus harti*, as there can be no doubt as to its identity with *ningpoensis*. Since the description of *Mus harti* was written, a fine series has been received from the neighbourhood of Nankin, collected by Mr. Howell. It appears that although the dorsal stripe is as a rule faint and indistinct, it is in some cases deep black and very well marked, while in other individuals no trace of it can be found.

Herr Matschie (*in litt.*) states that in the type of *ningpoensis* there is no trace of the dorsal stripe, and the same is the case with the type of *M. harti*.

Little is known of its habits; Mr. Howell seems to have trapped most of his specimens on open ground in the vicinity of water.

6. Descriptions of new Species of Phytophagous Coleoptera
of the Genera *Homophæta*, *Asphæra*, and *Oedionychis*.
By MARTIN JACOBY, F.E.S.

[Received May 13, 1905.]

(Plates XIV. & XV.)*

In the 'Proceedings' for 1894 (p. 609) I have given the descriptions of many species belonging to the group of bladder-clawed *Halticinae*, which until then were simply Catalogue names as published by Clark. The number of further species which I have received since enables me to publish here a considerable addition to my former paper; where Clark's names have been retained for the same species I have stated this, but by far the greater portion of my species were not known to Clark. The genera *Oedionychis* and *Asphæra* as at present understood almost rival in species the Galerucid genus *Diabrotica*, and it is frequently very doubtful to which of the two genera a species should be referred. Von Harold has tried to point out the differences between *Oedionychis*, *Asphæra*, and the allied genera (Coleopterol. Hefte, xv. p. 91), and lays the principal stress on the more or less elongate first joint of the posterior tarsi in *Asphæra* in contradistinction to the corresponding very short joint in *Oedionychis*, which in most cases holds good, but in many instances there are intermediate degrees as well as in the more or less inflated claws, so that it is uncertain to which genus these species should be referred; these are, however, rather exceptional, and v. Harold's definition must be accepted for want of a better one. All the species described here are contained in my collection.

HOMOPHÆTA CLAVAREAUI, sp. n.

Black, a frontal spot and the clypeus flavous; thorax fulvous, impunctate; elytra nearly impunctate, fulvous, a broad transverse band at the base and another narrower one below the middle, black.

Length 9 millim.

Head black, very shining, with some punctures near the eyes the latter widely separated, with a flavous transverse spot at the intermediate space, frontal elevations narrow, likewise flavous as well as the clypeus; antennæ extending beyond the middle of the elytra, black, the first joint fulvous below, third and fourth joints equal; thorax twice as broad as long, the sides feebly rounded, with narrow thickened margins, the anterior angles strongly produced and thickened, the surface fulvous, impunctate, rather convex; scutellum black; elytra with narrow, reflexed margins, microscopically finely punctured, fulvous, with a rather broad basal band occupying about one-fourth of the length of the elytra, its posterior edge oblique, widest at the suture, another narrower

* For explanation of the Plates, see p. 460.

punctate, frontal elevations broad, feebly raised, clypeus broad and thick; eyes widely separated, not very prominent; antennæ long and slender, black, third and following joints very elongate, nearly equal; thorax about twice as broad as long, the sides widened, the lateral margins strongly rounded, the anterior angles strongly produced and pointed, the surface impunctate, the lateral sulci broad but shallow, testaceous, the middle of the disc black; scutellum black; elytra with strongly reflexed lateral margins, the posterior portion convex and widened, the surface impunctate, testaceous; posterior femora less thickened than usual, the metatarsus very elongate; claw-joint scarcely, if at all, swollen; prosternum very narrow.

Hab. Bogota.

This *Asphæra* differs in more than one respect from the other members of the genus: the slender antennæ, widened sides of the thorax, and the but moderately thickened posterior femora are not found in any other species, to my knowledge, and agree rather with the genus *Aspicela*, but the perfectly normal shape of the mesosternum prevents the insect from being included in that genus. I know of only a single specimen.

ASPHERA HILARIS, sp. n.

Entirely pale testaceous; eyes rather large, antennæ pale fulvous or testaceous, thorax with gradually flattened sides, elytra not perceptibly punctured, metatarsus of the posterior legs elongate, claws swollen.

Length 7-8 millim.

Head impunctate, testaceous, shining; the eyes proportionately closely approached and rather large; antennæ extending to the middle of the elytra, obscure fulvous; thorax with feebly rounded sides, slightly narrowed anteriorly, the anterior margin concave, anterior angles thickened but only very slightly produced, the sides gradually flattened, the disc impunctate; elytra with a very shallow depression below the base, with broadly reflexed lateral margins, the surface entirely impunctate, shining; under side coloured as the upper surface, legs slightly darker; the metatarsus of the posterior legs nearly as long as the following joints together, claw-joints distinctly swollen.

Hab. Espirito Santo, Brazil.

An apparently rather common species of unicolorous appearance, which may be known by the gradually flattened sides of the thorax and the more than usually thickened claws; the elongate metatarsus shows, however, the species to belong to *Asphæra*. *A. pallida* Jac. is a much larger and broader species, with a black head.

ASPHERA ALBIFRONS, sp. n.

Testaceous, the antennæ black (apical three joints sometimes pale), the breast piceous, the head whitish-testaceous, thorax with the anterior and posterior margins black at the middle, elytra finely punctured.

Length 7 millim.

Head entirely impunctate, very light testaceous; eyes well separated, moderately large, frontal elevations narrowly transverse; antennæ slender, black, the apical two joints sometimes pale, the third and fourth equal; thorax with broadly rounded and flattened sides, the sulci strongly marked, the disc impunctate, testaceous, with the anterior and posterior margins black at the middle, the anterior angles not mucronate but slightly produced; scutellum more or less fuscous; elytra rather convex, very closely and finely punctured; the breast, tibiæ, and tarsi more or less piceous; the metatarsus distinctly elongate, the claw-joint strongly swollen.

Hab. Bolivia.

This species may easily be mistaken for one of the varieties of *Oedionychis albipennis* Jac., but it is of a more convex shape, the eyes are much more widely separated, the intermediate space is very light-coloured and entirely impunctate, and the metatarsus of the posterior legs is distinctly more elongate.

ASPLERA TARSATA, sp. n. (Plate XIV. fig. 10.)

Head, antennæ, and thorax, under side and legs black; thorax with broadly flattened sides, impunctate; elytra obscure testaceous, finely and closely punctured; metatarsus of the posterior legs elongate and slender, claw-joint strongly swollen.

Length 8 millim.

Head impunctate, black, frontal tubercles very strongly developed, trigonate, carina convex; antennæ black, the lower three joints shining, the others pubescent, the intermediate joints slightly widened, third and fourth joints equal; thorax with strongly rounded and broadly flattened sides, anterior margins blunt and slightly produced outwards, more or less testaceous, the rest of the surface black; scutellum black; elytra convex, widened towards the middle, with broadly reflexed margins, the base without depression, closely, finely, but distinctly granulate-punctate; under side and legs black.

Hab. Peru.

The more than usual elongate and slender metatarsus and the strongly swollen claw-joint and system of coloration well distinguish this species, of which I possess a single specimen.

ASPLERA NASALIS, sp. n.

Black, the head and the sides of the thorax anteriorly pale testaceous, the anterior angles mucronate; elytra testaceous, finely and closely punctured; carina of the head very broad.

Length $7\frac{1}{2}$ millim.

Head pale testaceous, shining, impunctate; eyes widely separated, frontal elevations broadly oblique, carina very broad and convex; antennæ long and slender, black, third and fourth joints very elongate, equal; thorax more than twice as broad as long, the sides broadly flattened and rounded, the anterior angles mucro-

nate, the surface impunctate, more or less black, the anterior angles broadly testaceous; scutellum black; elytra testaceous, finely and closely punctured; under side and legs black; the metatarsus as long as the following two joints together, claw-joint strongly inflated.

Hab. Peru.

Very closely allied in coloration to *A. tarsata*; but the head pale, the antennæ slender, without widened and pubescent joints, and the metatarsus much shorter. Of this species I possess three specimens. The species is also closely allied to *A. albifrons*, but is much larger, and the anterior angles of the thorax are mucronate, the under side and legs are black. From both species the broad and blunt carina will distinguish the present one; it is more pronounced than in any other species I am acquainted with.

ASPHERA AMABILIS, sp. n.

Black; thorax short, transverse, impunctate; elytra testaceous, extremely finely and closely punctured, the apical margins black.

Var. Elytra unicolorous testaceous.

Length 5 millim.

Of posteriorly slightly widened shape; the head black, shining, impunctate, the vertex sometimes marked with a testaceous spot, deeply transversely grooved between the eyes, the latter large; palpi testaceous; antennæ black, the third and fourth joints equal; thorax short and transverse, the lateral margins rounded, the sides broadly flattened, this portion well separated from the disc, the latter impunctate, black, shining, the anterior angles produced outwards into a small tooth; scutellum broad, black; elytra slightly wider at the base than the thorax, convex, gradually widened posteriorly and without basal depression, testaceous, extremely closely and finely punctured, the extreme apical margins black; under side and legs black, the metatarsus of the posterior legs as long as the following two joints together, claw-joint rather strongly swollen.

Hab. Peru.

The black head and thorax and the proportionately short shape of the latter well distinguish this species, of which I possess three specimens, two of which have the apex of the elytra black to a small extent and the vertex marked by a small testaceous spot; in the other specimen the spot and the black apex of the elytra are absent.

Elytra with metallic transverse bands.

ASPHERA CARILLOENSIS, sp. n.

Testaceous; the head, breast, and the legs black; antennæ long, fulvous; thorax impunctate, anterior angles bluntly produced; elytra nearly white, impunctate, a transverse band at the base and another narrower one, slightly oblique, metallic dark blue, both bands abbreviated at the sides.

Length 6 millim.

Head impunctate, black; eyes distant, frontal elevations oblique, rather broad; clypeus very narrow, strongly thickened, carina very convex; antennæ long and slender, fulvous, third and following joints slender, equal or nearly so; thorax about twice as broad as long, the lateral margins feebly rounded, the anterior angles bluntly produced, the lateral sulci deep and broad, the surface impunctate, pale flavous; scutellum triangular, black; elytra with narrow but strongly reflexed lateral margins, yellowish-white, with two transverse blue bands not extending to the lateral margins, the first extending to about one-third of the length of the elytra, with its posterior edge nearly straight, the second band below the middle, of only half the width and of obliquely downward direction; breast and legs black, abdomen testaceous; metatarsus elongate, claw-joint very moderately swollen.

Hab. Carillo, Costa Rica.

The black head, fulvous antennæ, and the shape of the elytral bands principally distinguish this *Asphæra*; the elytra have the basal portion rather distinctly raised, but the intrahumeral depression is but moderately deep. I have three exactly similar specimens before me.

From *A. nigrofasciata* Jac., likewise from Costa Rica, the present species may be separated by the fulvous colour of the antennæ, the blue, not black, elytral bands, the much more narrow, reflexed margins of the elytra, and the rather smaller general size and more widened shape.

ASPLERA ZONULATA, sp. n. (Plate XIV. fig. 7.)

Black below, antennæ and legs more or less piceous, above flavous; thorax impunctate, the anterior angles produced; elytra very finely punctured, with four metallic green transverse bands, much widened towards the suture, which is likewise metallic green.

Length 7 millim.

Of medially widened shape; the head more or less piceous at the vertex, the lower portion fulvous; eyes moderately large, with a few punctures near their inner margins; clypeus in shape of a transverse ridge; antennæ nearly black, the third joint smaller than the fourth; thorax with strongly rounded lateral margins, the anterior angles produced into a small tooth, the sides broadly and deeply sulcate, the surface impunctate, flavous, obsolete transversely grooved near the base; scutellum black; elytra convex, broadly margined, widest at the middle, very finely punctured throughout, flavous, with four bright green metallic bands, not extending to the margins—of these, the one at the base is the widest and has its posterior margin obliquely rounded, it extends as far as the shoulders, the second band at the middle is connected with the first along the suture by a rather broad stripe of green, its ends are greatly narrowed, the third band below the middle is of similar shape, but the fourth near the apex is of a shorter and

broader form, the suture connects all these lower bands by a narrow metallic green stripe; metatarsus elongate, claw-joint strongly swollen.

Hab. Peru.

Different in the number and shape of its elytral bands from any other species; two exactly similar specimens are contained in my collection.

ASPHERA VERNALIS, sp. n.

Piceous, the lower part of the face and the thorax flavous, sides of the latter broadly flattened, disc impunctate; elytra flavous or pale fulvous, with two transverse violaceous bands, one at the base, the other below the middle, not extending to the sides or apex.

Length 6-6½ millim.

Head with a few punctures near the eyes; the vertex nearly black, the frontal tubercles and the clypeus flavous; antennæ piceous or black, the lower three joints obscure fulvous; thorax slightly narrowed anteriorly, the sides with a rather broad flattened margin, the anterior angles dentiform, the disc impunctate, yellowish-white; scutellum black; elytra impunctate, flavous, the basal transverse blue or violaceous band nearly extending to the middle, the lower band of equal width, not extending to the apex, both bands are limited laterally by the broadly reflexed lateral margins, the flavous band which separates the darker ones at the middle is of about half the width (in a longitudinal sense) than the blue bands; breast and legs piceous, the base of the femora rather lighter; abdomen flavous; claw-joint scarcely thickened.

Hab. Br. Guiana.

This is another species with transverse blue bands of which so many are known, yet there is none which agrees entirely with the present one. *A. cecula* Illig. is described as over 4½ lines in length, the thorax as having the sides obsoletely flattened, while in this species it is very distinctly marked; the colour of the head is given as testaceous and the median pale band as broad, while in *A. vernalis* this band is of only half the width of that of the dark bands. These remarks also apply to *A. ornata* Illig. *A. curialis* Erichs. has the posterior band much narrower and the pale division broader; in *A. limitata* Har. the posterior blue band is still narrower, and there are other differences besides.

ASPHERA SEPARATA, sp. n.

Black; thorax fulvous, impunctate; elytra pale testaceous, impunctate, a broad transverse band at the base, not extending to the lateral margins, and another band at the apex, dark violaceous.

Length 6 millim.

Head black, shining, impunctate; eyes large, elongate, frontal elevations very broad but feebly raised, clypeus with an acute central ridge; antennæ black, the third and fourth joints equal,

intermediate joint slightly widened; thorax with nearly straight sides, slightly narrowed anteriorly, anterior angles thickened and produced into a short point, the sides flattened but gradually so, without deep accompanying groove, the disc impunctate, fulvous or flavous, anterior margin rather deeply concave; scutellum black; elytra gradually and slightly widened posteriorly, with a short but rather deep sutural depression below the base, impunctate, pale testaceous, with two metallic dark purplish bands, the first subquadrate at the base, nearly extending to the middle but not to the lateral margins, its posterior edge straight, the posterior angles rounded, the second band occupies the entire apex and has its anterior angles rounded, these bands are separated by the testaceous ground-colour in shape of a transverse band of nearly similar size as the dark ones; under side and legs black, apex of abdomen flavous; claw-joint not strongly thickened.

Hab. Peru.

Principally distinguished by the position and shape of the posterior band in connection with the flattened sides of the thorax.

ASPILERA GLABRIPENNIS, sp. n.

Obscure testaceous; the thorax with gradually flattened sides, impunctate; elytra impunctate, with a metallic bright green subquadrate spot at the base and another one near the apex; posterior femora with the apex black.

Length 7-10 millim.

Of elongate and flattened shape, of a rather dirty testaceous; the head finely punctured at the sides as well as the space in front of the eyes, the frontal elevations broad, clypeus rather strongly raised; antennæ long and slender, obscure testaceous, the terminal joints very elongate; thorax with gradually flattened sides, narrowed anteriorly, the anterior margin deeply concave, the sides nearly straight, anterior angles in shape of a small tooth, the surface impunctate; scutellum testaceous; elytra entirely impunctate, with two brilliant metallic green bands or patches, the first at the base, not extending to the sutural or lateral margin and downwards to about one-third the length of the elytra, the other band of more rounded shape near the apex, not extending to either margin; below finely pubescent; the apex of the posterior femora black; claw-joint moderately swollen.

Hab. Marcapata, Peru.

I would have referred this species to *A. chapuisi* Har., but the author gives the colour as rufo-testaceous and the elytra as finely punctured, but even with a strong lens I cannot discover any punctuation.

ASPILERA FUNEREA, sp. n.

Black; thorax whitish or obscure testaceous, the flattened sides well separated; elytra very minutely punctured, coloured like the thorax, a broad transverse band at the base and another still

broader band below the middle and interrupted at the outer portion, obscure brownish-æneous.

Length 6-7 millim.

Head sparingly punctured at the vertex, the latter piceous or blackish; eyes very large, each as broad as the dividing space; antennæ long and slender, black, the lower joints sometimes testaceous at the base, very elongate with the exception of the second one; thorax with flattened and well-separated sides, the anterior margin but little concave, the angles produced outwards into a truncate tooth, the surface impunctate, pale testaceous; scutellum broad, black; elytra with distinct basal depression, very finely punctured, with narrow reflexed lateral margins, pale testaceous or whitish, with two broad dark brown bands with greenish gloss, the first at the base, not extending to the lateral margins, the other band of much longer shape, not extending to the sides or apex of the elytra, at its outer edge it is semidivided by a narrow stripe of the ground-colour; under side piceous or black; metatarsus as long as the following two joints together, claw-joint distinctly swollen.

Hab. Peru.

There are two specimens of this species before me, which is well distinguished by the produced, truncate, anterior thoracic angles and the markings of the elytra; the ground-colour of the latter is in one specimen of a pinkish-white tint, in the other obscure testaceous, the dark bands are divided at the middle by the narrow transverse stripe of the ground-colour.

ASPILERA BREVICOLLIS, sp. n.

Piceous, legs black, the head and antennæ fulvous; thorax scarcely twice as broad as long, flavous, impunctate; elytra impunctate, flavous, a broad transverse band at the base and a transverse spot below the middle metallic green.

Length 7 millim.

Head impunctate, fulvous; frontal elevations broad, divided by a deep groove and bounded behind by a narrow, more shallow sulcus; clypeus strongly raised in shape of a broad triangular ridge; eyes widely separated; antennæ extending to the middle of the elytra, dark fulvous, the third joint shorter than the fourth; thorax scarcely twice as broad as long, the sides obliquely narrowed anteriorly, the lateral sulci rather narrow, the anterior angles thickened and strongly produced, the surface impunctate, flavous; scutellum black; elytra slightly widened towards the middle, distinctly depressed below the base, flavous, with two bright metallic-green transverse bands, the first at the base extending downwards to about one-third the length of the elytra, the other in shape of a large slightly oblique spot, below the middle, neither of the bands extending to the lateral margins; breast and abdomen piceous, legs black; metatarsus elongate, claw-joint but slightly swollen.

Hab. Peru.

The comparatively small width of the thorax and the widely separated elytral green bands, in connection with the fulvous head and antennæ, distinguish this species, which is evidently closely allied to *A. oblecta* Baly; but the head has no punctures nor hairs, the thorax is certainly not "more than twice as broad as long," and the elytra are not furnished with hairs at the apical margins.

ASPHERA DIMIDIATICORNIS, sp. n.

Flavous, head piceous, the intermediate joints of the antennæ black; thorax flavous, impunctate; elytra not perceptibly punctured, pale flavous, a transverse band at the base and a broader one below the middle metallic green; legs fulvous.

Length 6 millim.

Head impunctate, the vertex piceous; frontal elevations strongly raised, pyriform; clypeus flavous, semicircular, with an acute central ridge; eyes very large, the diameter of each larger than the dividing space; antennæ long and slender, the lower and the apical three joints fulvous, the rest black, third and fourth joints very elongate, equal, apical joints shorter; thorax twice as broad as long, slightly narrowed anteriorly, the anterior angles pointed but not produced, lateral margins evenly rounded, preceded by a broad sulcation, the surface impunctate, flavous; scutellum fulvous; elytra widened at the middle, yellowish-white, with two broad transverse metallic-green bands, not extending to the lateral margins, the first extending from the base to nearly the middle, the second immediately below the latter and abbreviated at some distance from the apex, both bands are of nearly subquadrate shape; the breast and the legs pale fulvous, abdomen flavous, the tarsi obscure piceous; the metatarsus moderately elongate, claw-joint strongly swollen.

Hab. Ecuador.

Distinguished by the colour of the head and the antennæ, the large eyes and broad elytral bands, pale legs, &c.

ASPHERA DEJEANI, sp. n.

Black; thorax impunctate, testaceous, the entire disc black; elytra impunctate, testaceous, a broad band at the base and another below the middle, not extending to the lateral margins, metallic blue; claw-joint scarcely swollen.

Length 8 millim.

Head with some punctures near the eyes, black, frontal elevations strongly raised, narrow and transverse; antennæ extending beyond the middle of the elytra, black, all the joints elongate and slender, the third and fourth equal; thorax twice as broad as long, the lateral margins scarcely rounded, the anterior angles more than usually produced and pointed (in one specimen to a much smaller extent), anterior margin concave, the sides broadly but not deeply sulcate, testaceous as well as the extreme base, the rest of the surface occupied by a transverse black band; scutellum black;

elytra with the basal portion rather convex, impunctate, metallic blue, the lateral margins and a rather narrow transverse band at the middle testaceous, epipleuræ of the latter colour; below and the legs black; metatarsus rather elongate, claw-joint scarcely swollen.

Hab. Peru.

The black band of the thorax and the strongly dentate and produced anterior angles of the latter, together with the nearly simple claw-joint, principally characterise this species.

Elytra metallic, with flavous margins.

ASPHERA ALBICINCTA, sp. n. (Plate XIV. fig. 4.)

Black, thorax pale flavous, impunctate; elytra metallic blue, the disc foveolate and rugose, the lateral margins yellowish-white; abdomen flavous.

Length 9-10 millim.

Of ovately-elongate shape, rounded below the middle; the head black, with some few punctures near the eyes, longitudinally grooved between the latter; antennæ extending to the middle of the elytra, black, the third, fourth, and fifth joints equal, the following ones shorter; thorax with gradually flattened sides, the anterior margin deeply concave, anterior angles slightly produced into a small tooth, thickened, the disc entirely impunctate, pale yellowish; scutellum black; elytra bright metallic blue or purplish, variolose-punctate, the interstices strongly wrinkled or rugose, the lateral margins to the apex whitish; breast and legs black; metatarsus elongate, claw-joint slightly swollen; abdomen flavous.

Hab. Peru.

Of the same coloration as *Asphæra* (*Aspicela*) *albomarginata* Latr., and of nearly similar sculpturing, but a true *Asphæra* (like the last-named species) on account of the metasternum not being truncate anteriorly; in Latreille's insect the thorax is margined with black and the elytral foveæ are larger and less numerous.

Elytra variously coloured, with transverse pale bands or with spots.

ASPHERA BISBIPLAGIATA, sp. n.

Obscure fulvous or fuscous, the head and the antennæ black; thorax yellowish white; elytra impunctate, each with two white bands, one transversely shaped at the middle, the other more rounded near the apex.

Length 7 millim.

Head with some deep punctures near the eyes, the vertex nearly black, the frontal elevations bounded behind by a very deep transverse groove; base of the antennæ flavous, the basal two joints piceous, the others black; thorax with the anterior margin straight, the sides not flattened, but the lateral margins gradually

and very strongly thickened at the anterior angles, the latter produced but not dentiform, the surface impunctate, nearly white; scutellum dark brown; elytra of the same colour or dark fuscous, shining, impunctate, each with two white markings, the first at the middle in shape of a transverse band not quite extending to either margin, the second of rounded shape, near the apex; the breast piceous; the legs dark fulvous; the abdomen testaceous or flavous; claw-joint rather strongly swollen; prosternum very narrow and parallel.

Hab. Colombia.

In some specimens the ground-colour of the elytra is much paler. The absence of a thoracic flattening of the sides and the position and colour of the elytral markings distinguish this species.

ASPHERA BIPLAGIATA, sp. n.

Black, thorax and the femora flavous; elytra nearly impunctate, the lateral margins, a large discoidal patch, and the apex flavous; apex of the posterior femora black.

Length 5-6 millim.

Head black, with one or two punctures near the eyes; antennæ black, the lower two joints flavous below, third and following joints nearly equal; thorax nearly twice as broad as long, the sides rounded anteriorly, with a broad flattened sulcus, the anterior angles thickened but not produced, the surface impunctate, flavous; scutellum black; elytra impunctate; under side, the apex of the posterior femora, and the tibiæ and tarsi black, rest of the femora flavous.

Hab. Brazil.

This *Asphæra* resembles almost exactly *A. episcopalis* Ill. in the elytral pattern, which consists of a transverse black band at the base and another near the apex connected by a very narrow sutural stripe, the disc in shape of a large oval patch and the apex as well as the lateral margins being flavous. The differences which separate this species are: the entirely black head, without the whitish frontal tubercles; the anterior angles of the thorax, which are not produced; the position of the posterior elytral band, which is placed much lower down than in the above-named species; and the colour of the legs. I have received several specimens from the La Plata Museum without a special locality.

ASPHERA ERICHSONI, sp. n.

Black; thorax testaceous, the sides straight, the surface impunctate; elytra nearly black, the lateral margins and an extremely narrow transverse straight band at the middle flavous.

Length 6 millim.

Head with a few punctures above the eyes, black, the frontal elevations very broad and flat, scarcely raised, the base of the antennæ flavous; the antennæ very long and slender, black, the fourth joint longer than the third; thorax only about one-

half broader than long, slightly narrowed anteriorly, the sides nearly straight, with an extremely narrow thickened margin, only obsoletely flattened in front of it, the anterior angles slightly mucronate, the surface entirely impunctate, pale flavous or testaceous; scutellum black; elytra not perceptibly punctured, black, very shining, nearly parallel, the lateral margins narrowly and an equally narrow transverse band at the middle, flavous; under side and legs black; the metatarsus elongate, the claw-joint but slightly swollen.

Hab. Peru.

The comparatively long thorax, the nearly straight and but slightly flattened sides, in connection with the very narrow and straight elytral pale band at the middle, well distinguish this species from others similarly marked.

ASPLERA MACULICOLLIS, sp. n.

Black, the antennæ obscure fulvous; thorax pale testaceous with a transverse piceous band, the sides straight; elytra entirely impunctate, metallic green, the lateral margins and a transverse narrow band at the middle flavous; claw-joint distinctly swollen.

Length 5 millim.

Smaller than the preceding species; the elytra more widened at the middle, with a broader lateral reflexed margin; the head with a single puncture close to the eyes, black at the vertex, the lower portion stained with flavous, the frontal elevations broad, trigonate, divided by a deep narrow groove; clypeus strongly raised; antennæ dark fulvous, the third and fourth joints very elongate, the following joints shorter; thorax with nearly straight lateral margins, the sides flattened, the anterior angles mucronate; the disc impunctate, whitish, with a narrow transverse piceous band; scutellum black; elytra with broad flattened lateral margins, impunctate, metallic green, the flattened sides and a transverse narrow band at the middle pale yellowish; below and the legs black; metatarsus elongate; claw-joint distinctly thickened.

Hab. Peru, Marcapata.

Separated by the sculpture and colouring of the head and that of the antennæ, the thoracic transverse band, and colour of the elytra. The general size is smaller than that of the allied species. *A. nobilitata* Fab. is of different coloration, although the elytral pattern is similar and the claw-joint is scarcely swollen. *A. discofasciata* Baly is another closely allied species, but has differently coloured antennæ, rounded sides of the thorax, finely punctured elytra, and their transverse band broad, not narrow.

ASPLERA APICALIS, sp. n.

Black or piceous, the basal joints of the antennæ and the clypeus flavous; thorax impunctate, fulvous or flavous; elytra greenish-eneous or purplish, impunctate, the lateral margins, a transverse band at the middle, a spot near the scutellum,

another one below the middle, and a short oblique stripe near the apex flavous.

Var. *a*. The elytral transverse band and the spots absent.

Var. *b*. Elytra as in the type, but the spots absent.

Var. *c*. The transverse band indicated by a sutural and lateral spot; the other spots wanting.

Var. *d*. Like var. *c*, but the apical stripe as well as the spots wanting.

Length 7 millim.

Head entirely impunctate, with the exception of one or two punctures near the eyes, the frontal elevations broadly transverse; clypeus flavous, with an acutely raised central ridge; antennæ dark fulvous, extending slightly below the middle of the elytra, the third and fourth joints equal; thorax strongly transverse, the lateral margins rounded, the anterior angles thickened but not dentiform, the sides with a longitudinal groove, flattened, the surface impunctate, fulvous or flavous, posterior margin nearly straight; scutellum black; elytra impunctate, but the paler markings with minute fuscous spots, the ground-colour metallic greenish cupreous, the lateral margins, elytral epipleuræ, a narrow transverse band at the middle, a small spot near the scutellum, another below the middle near the suture, and a short oblique streak near the apex at the sides flavous; under side piceous; the anterior legs more or less pale, the metatarsus of the posterior legs as long as the following two joints; claws rather strongly swollen.

Hab. Peru, Prov. Huallaga; also Bolivia.

The type of this species, from which I have drawn the above description, is not difficult to distinguish from others, on account of the elytral markings, and is principally separated by the sub-apical short flavous streak which is connected with the similarly coloured lateral stripe. Some of the varieties, however, are without this mark, and consequently resemble several other similarly coloured species; there is, however, nearly always the indication of the transverse band in shape of a small flavous sutural spot at the middle and a corresponding one opposite at the margins; the thorax has the sides well defined by a deep longitudinal groove, and the claw-joint is more strongly swollen than in many other species of the genus.

Of var. *d* two specimens are before me. In these the elytral spots and band are absent, but, as usual, the sutural remnant of the band is present, and instead of the subapical short streak there is a widening of the flavous lateral margin at the corresponding place, thus indicating the typical mark. *Oedionychis dipus* Ill. is of exactly similar coloration, but is a true *Oedionychis* with a short posterior metatarsus.

ASPHERA ELEGANTULA, sp. n. (Plate XIV. fig. 6.)

Black; clypeus and the thorax flavous, the latter impunctate; elytra bright metallic blue, impunctate; a narrow transverse band

at the middle and another near the apex, as well as the lateral margins, flavous.

Length 8-9 millim.

Head black, shining, with a few deep punctures near the eyes; the latter large, widely separated; clypeus acutely triangularly raised, flavous; labrum black, with a row of punctures; antennæ long and slender, black; thorax short and strongly transverse, the sides feebly rounded anteriorly, straight at the base, the anterior angles thickened and produced, the sides broadly flattened, with a thickened margin, the flat portion well defined from the convex surface, the latter impunctate, obsoletely transversely depressed or grooved near the base; scutellum broad, black; elytra with a distinct depression below the base, not perceptibly punctured, bright metallic blue; the lateral margins, the epipleuræ, and two narrow transverse bands flavous—of these the first is placed at the middle and extends quite to the suture, the second one is situated very near the apex, not quite extending to the suture and of slightly upward direction; metatarsus elongate, claw-joint moderately thickened; the anterior femora more or less stained with flavous at the extreme base.

Hab. Peru, Prov. Huallaga (*G. A. Baer*).

Of this handsome species I have received several specimens from M. Clavareau, of Brussels. I know no other species with similar shaped and same number of bands.

Elytra blue.

ASPHLERA TIBIALIS, sp. n.

Pale flavous, the head, antennæ, tibiæ, and tarsi black; thorax impunctate; elytra metallic blue, impunctate.

Length 7 millim.

Head entirely impunctate, black; clypeus acutely raised, triangular, slightly stained with flavous, palpi robust; antennæ extending below the middle of the elytra, black, third joint slightly shorter than the fourth; thorax with the sides gradually flattened, with narrow thickened margins, the anterior angles thickened but not dentiform and scarcely produced, the disc impunctate, flavous; scutellum black; elytra with a shallow transverse depression below the base, entirely impunctate, dark metallic blue, below flavous; the tibiæ and tarsi black, extreme base of the posterior tibiæ flavous; claw-joint moderately thickened.

Hab. Amazons,

Of this species, distinguished by its system of coloration, five specimens are contained in my collection.

Elytra with longitudinal fulvous bands.

ASPHLERA FERRUGINEO-VITTATA, sp. n.

Elongate, subparallel, testaceous; thorax with strongly rounded and broadly flattened sides, impunctate; elytra with a narrow

sutural and an equally narrow discoidal longitudinal band, ferruginous.

Length 6 millim.

Head impunctate or with a few fine punctures; eyes large, the diameter of each as wide as the intermediate space, frontal elevations subquadrate, carina short and blunt; antennæ scarcely extending to the middle of the elytra, pale fulvous, basal joint robust and elongate, third joint slightly shorter than fourth, terminal joints shorter than the intermediate ones; thorax short, the sides broadly sulcate, anterior angles with a short tooth, the disc impunctate, with an obsolete transverse sulcus near the base; elytra nearly parallel, somewhat flattened, finely and closely punctured, testaceous, the suture very narrowly ferruginous; a similar, slightly and inwardly curved band extends from the shoulders to near the apex; metatarsus as long as the following two joints together, claw-joint strongly swollen; prosternum linear.

Hab. Bolivia.

The elytral dark bands are very narrow and of equal width and the discoidal one is of slightly curved shape. The species, on account of the distinctly elongate metatarsus of the posterior legs, cannot be mistaken for a similarly coloured species of *Oedionychis*.

Elytra otherwise marked.

ASPHERA LACERATA, sp. n.

Elongate and parallel, black; thorax dark fulvous, impunctate, the anterior angles produced and blunt; elytra finely rugose anteriorly, impunctate, black, a round patch at the base, a small one at the shoulders, a transverse subdivided patch at the middle, and another at the apex, testaceous.

Length 9 millim.

Head black, impunctate, the frontal elevations broad and flat; clypeus in shape of a strongly raised triangular ridge; eyes widely separated; antennæ black, long, the third and following joints equal; thorax transversely subquadrate, convex, of equal width, the lateral margins nearly straight, accompanied by very deep and narrow sulci, the anterior angles blunt and produced forwards, the disc impunctate, dark fulvous; scutellum black; elytra with narrow but deeply reflexed lateral margins, furnished with fine rugosities anteriorly but without punctuation, each elytron with four testaceous or pale flavous patches, which are separated by narrow transverse black bands before and below the middle, at the latter place the band sends off a spur towards the suture, thereby subdividing the preceding flavous portion; all the margins of the elytra as well as a humeral stripe and the epipleuræ are likewise black; of the same colour are the under side and the legs.

Hab. Peru.

I have only a single specimen of this somewhat peculiar species before me; whether the fine elytral rugosities to be seen at the

anterior portion of the elytra are normal or accidental, I am unable to say. The design of the elytra resembles that of *Homophœta 8-guttata* Fab., but in that insect the vertex of the head has the characteristic white or flavous patch and the clypeus is of similar coloration; the elytra are smooth, and the intermediate flavous patch is never subdivided; in the Peru species the metatarsus is moderately elongate and the claw-joint rather strongly swollen.

ASPHÆRA NITIDISSIMA, sp. n. (Plate XIV. fig. 5.)

Broadly ovate, black; clypeus fulvous; thorax strongly transverse, fulvous, anterior angles toothed; elytra strongly convex, minutely punctured, bright metallic green, the lateral and apical margins and a narrow transverse band at the middle flavous or fulvous.

Length 10 millim.

Head impunctate, blackish; frontal elevations transverse, bounded by a deep groove behind; clypeus fulvous, acutely carinate at the middle; diameter of each eye of less width than the dividing space; antennæ long and slender, extending below the middle of the elytra, black, the third joint shorter than the fourth; thorax more than twice as broad as long, the lateral margins strongly rounded, deeply and broadly sulcate, the anterior angles strongly produced into a blunt tooth, the disc impunctate, fulvous, sometimes marked with two small fulvous spots; scutellum black; elytra broad, convex and widened posteriorly, deeply sulcate within the shoulders and with another shallow depression below the base, very minutely punctured, very bright metallic green, this colour divided at the middle by a narrow transverse fulvous band which joins the similarly coloured lateral margins; under side and legs black; the metatarsus of the posterior legs as long as the following two joints together; claw-joint strongly swollen.

Hab. Pachitea, Peru.

Larger and more broadly ovate than the other similarly coloured species of the genus; the antennæ slender and proportionately long; the thorax strongly toothed; the metatarsus somewhat intermediate between that of *Oedionychis* and the present genus as a rule, but as long as the following two joints together.

ASPHÆRA VIRIDICOLLIS, sp. n.

Black; thorax bright green, impunctate, the sides gradually flattened; elytra black or æneous, deeply foveolate, the lateral and apical margins green.

Length 7 millim.

Of medially slightly widened shape; the head black, impunctate, frontal elevations broad and convex; clypeus triangularly widened, not ridge-shaped; antennæ black, the third and fourth joints equal; thorax not more than twice as broad as long, rather widened at the sides, the lateral margins feebly rounded, anterior margin concave, its angles moderately produced, not toothed, the

disc impunctate, gradually flattened at the sides, bright green, shining; scutellum black, trigonate; elytra broadly margined, with elongate deep foveæ, placed in about six longitudinal rows, the interstices strongly reticulate and confluent, the lateral margins rather broadly green, furnished with single hairs near the apex, rest of the surface shining black or bronze; under side and legs black; metatarsus elongate; claw-joint but slightly swollen.

Hab. Ecuador.

At once distinguished from *A. inæqualis* Erichs. by the green thorax and sides of the elytra and by the entirely black breast and abdomen. I know of no similarly coloured species.

ASPLERA TESSELLATA, sp. n. (Plate XIV. fig. 8.)

Black, head spotted with flavous; thorax impunctate, flavous, with a transverse black band; elytra extremely minutely punctured, flavous, two elongate spots at the base, a narrow transverse band below the middle, and a spot near the apex black.

Length 8 millim.

Head impunctate, black, the eyes surrounded by a flavous band, frontal elevations narrow, strongly raised, lower portion of face pale fulvous, labrum piceous; antennæ black, rather short, the basal joint fulvous below, third and fourth joints equal; thorax twice as broad as long, slightly arched, the sides flattened, with a narrow thickened margin which gradually widens anteriorly, the angles strongly thickened and produced, the disc impunctate, flavous, with a transverse black band, the anterior edge of which is concave and irregular in outline; scutellum black; elytra extremely minutely and closely punctured, flavous, the base with two elongate black spots, a short transverse black band placed much below the middle and another triangular spot near the apex complete the design of each elytron; under side and legs black; metatarsus of the posterior legs as long as the following two joints together, claw-joint strongly swollen.

Hab. Brazil.

I know only a single specimen of this well-marked and distinct species, without precise locality.

ASPLERA VARIEGATA, sp. n.

Black; the clypeus, thorax, and abdomen flavous; elytra metallic green or obscure purplish, impunctate; a round spot near the scutellum, a transverse band near the apex, and the lateral margins flavous.

Var. *a.* Elytra with a narrow transverse band at the middle and another one near the apex, as well as the lateral margins, flavous, the basal spot absent.

Var. *b.* Elytra with a single band near the apex and the margins flavous.

Length 7-7½ millim.

Head impunctate, the vertex black, the clypeus flavous, frontal

elevations rather broad and flat, transverse; clypeus in shape of an acutely raised triangular ridge; antennæ rather long and slender, black, the third and fourth joints equal; thorax about twice and a half broader than long, flavous, the lateral margins straight at the base, feebly rounded anteriorly, narrowly thickened, the anterior angles produced forwards and strongly thickened, the sides deeply sulcate, the disc impunctate, obsoletely transversely sulcate near the base; scutellum black; elytra with the basal portion rather strongly raised, impunctate, flavous, marked with bands of metallic green or purplish in various ways; the breast and legs black, the base of the femora more or less and the abdomen flavous.

Hab. Peru.

This is evidently a most variable species as regards coloration, but I have little doubt that all the forms represent but one species, as not the slightest structural difference seems to be present. In one form the elytra (if the testaceous colour is taken for that of the ground, which is justified by the similarly coloured epipleuræ) have the anterior two-thirds occupied by a metallic band, including a flavous spot near the scutellum and another narrow transverse band near the apex extending upwards along the suture, the lateral and apical margins remaining flavous; in var. *a* the metallic colour is interrupted by a narrow transverse band at the middle and another below the latter near the apex; in var. *b* there is only a single rather broad band near the apex and connected with the flavous lateral margins; the abdomen in all these forms remains flavous; the metatarsus of the posterior legs is as long as the following two joints together, and the claw-joint is strongly swollen.

A. variegata resembles a great deal *A. apicalis*, but is always larger, and the apical elytral flavous band is not placed so near the apex as in the last-named species, and the antennæ are black and the abdomen flavous.

ASPHERA BASIMACULATA, sp. n.

Oblong, nearly parallel, testaceous, the intermediate joints of the antennæ piceous; eyes rather closely approached; sides of thorax nearly straight, impunctate; elytra impunctate, each with two elongate short stripes at the base and a small spot (sometimes absent) near the apex.

Length 4 millim.

Head impunctate, frontal elevations subquadrate, eyes large and rather closely approached; antennæ slender, extending to the middle of the elytra, the lower four and the apical three joints testaceous, the others black or piceous, basal joint thickened and elongate, third and fourth equal, terminal joints shorter; thorax scarcely twice as broad as long, gradually narrowed anteriorly, the lateral margins straight, anterior angles pointed in shape of a small tooth, the sides strongly flattened, the disc impunctate, basal margin somewhat thickened and accompanied

by a more or less distinct sulcus; scutellum broad, testaceous; elytra nearly parallel, minutely punctured, testaceous, each elytron with two short black stripes, one placed on the shoulders, the other near the scutellum, occupying about a fifth of the length of the elytra, near the apex at the sides is another small piceous or black spot which is sometimes obsolete or wanting; metatarsus of the posterior legs rather elongate.

Hab. Peru: Prov. Huallaga, Rio Mixiollo (*Baer*).

ASPHERA DIVISA, sp. n. (Plate XIV. fig. 9.)

Fulvous, the antennæ, the breast, and the abdomen black; head, thorax, and elytra impunctate, the last fulvous, their apical half metallic purplish-violaceous.

Length 8 millim.

Head with a single deep puncture and a few finer punctures near the eyes, fulvous; frontal elevations very broad and wide; clypeus acutely raised; labrum black; elytra long and slender, black, the basal joint fulvous; thorax narrowed anteriorly, the sides gradually flattened, the anterior angles produced into a short tooth, the disc entirely impunctate, fulvous; elytra widened towards the middle, with broad reflexed margins, the anterior half fulvous, the other portion metallic violaceous or purplish, the anterior edge of this colour rounded at the sides, also extending to the epipleuræ; breast, abdomen, the anterior and intermediate tibiæ and tarsi and the posterior legs black, the femora of the anterior and intermediate legs fulvous; claw-joint but slightly swollen.

Hab. Marcapata, Peru.

The purplish colour of the posterior portion of the elytra sometimes extends rather higher upwards than the middle; I know of no other similarly marked species of *Asphæra*.

ASPHERA FUSCOFASCIATA, sp. n.

Head, the antennæ, the underside, and legs obscure piceous; thorax yellowish white, with five obsolete fuscous spots; elytra impunctate, pale yellowish, with four transverse fuscous bands, the first divided into two spots.

Length 8-9 millim.

Head impunctate, piceous, the clypeus flavous; antennæ with the lower seven joints piceous or dark fulvous (the others wanting), the third joint slightly shorter than the fourth; thorax without a distinct flattening of the sides, but with the lateral margins thickened as well as the anterior angles which are produced forward, the surface impunctate, nearly white, the disc with five obsolete, more or less confluent fuscous spots, of which the three at the middle are better defined and placed triangularly; scutellum fuscous; elytra entirely impunctate, of yellowish-white ground-colour, with four transverse fuscous bands, one at the base and separated into two spots, the second near the middle, the third below the latter, and the fourth at the apex, all these bands are

surrounded and separated by very narrow spaces or bands of the ground-colour; under side and legs pale piceous; claw-joint moderately swollen.

Hab. Bolivia; also Brazil.

Of this species I have seen a great many specimens of most variable coloration, some of which have the elytral bands very dark in regard to the basal and subapical ones, and the intermediate bands pale or absent altogether and entire or divided into two spots as described here. It is possible that the species is identical with *A. albida* Schauf.

Genus OEDIONYCHIS.

Elytra entirely pale-coloured or nearly so.

OEDIONYCHIS ROTUNDICOLLIS, sp. n.

Broadly ovate, subdepressed, pale testaceous; antennæ and the posterior femora obscure piceous; sides of thorax strongly rounded, broadly flattened, impunctate; elytra extremely minutely punctured.

Length 8 millim.

Head impunctate, frontal elevations transverse; antennæ pale piceous, the third joint slightly shorter than the fourth and following joints; thorax about twice and a half broader than long, the sides strongly rounded and broadly flattened, the anterior angles strongly pointed but scarcely dentiform, the surface impunctate; elytra broadly ovate, the margins narrowly reflexed, the base with a very shallow depression, the surface scarcely perceptibly punctured; posterior femora pale piceous.

Hab. Espírito Santo, Brazil.

The sides of the thorax in this species are more rounded than in any of the unicolorous members of the genus with which I am acquainted; the elytra are likewise of more broadly rounded shape than usual.

OEDIONYCHIS PARAGUAYENSIS, sp. n.

Short and convex, testaceous; apical joints of the antennæ black; thorax densely and strongly punctured, the sides not deeply flattened; elytra punctured like the thorax.

Length 7 millim.

Head somewhat closely punctured, frontal elevations oblique, carina short and broad; antennæ scarcely extending to the middle of the elytra, the lower three joints testaceous, the others black, third and following joints nearly equal, rather elongate; thorax twice as broad as long, the lateral margins feebly but evenly rounded, the anterior angles produced outwards into a small tooth, the surface rugosely and rather strongly punctured, the sides gradually and rather shallowly flattened; scutellum black; elytra rather strongly convex below the middle, sculptured like the thorax; legs short and robust.

Hab. Paraguay.

Of this species, very well distinguished by the almost rugose entire upper surface, I know of only a single specimen.

OEDIONYCHIS NIGROSUTURALIS, sp. n.

Black; thorax finely and sparingly punctured, testaceous; elytra strongly convex, closely and strongly punctured, testaceous, the extreme sutural margins black; abdomen fulvous.

Length 9 millim.

Head entirely black, with a few punctures near the eyes; clypeus strongly convex between the antennæ, the latter short, not extending to the middle of the elytra, black, the lower two joints obscurely stained with piceous, third joint distinctly shorter than the fourth; thorax rather more than twice as broad as long, the lateral margins strongly rounded, anterior angles not produced but thickened, sides deeply but narrowly sulcate, the disc very sparingly and finely punctured, testaceous; scutellum black; elytra rather strongly convex below the middle (when viewed sideways), with very narrow, thickened, reflexed margins, very closely and comparatively strongly punctured, the suture very narrowly black; breast and legs black; abdomen fulvous.

Hab. Brazil.

I know of only a single, apparently female specimen of this species, which is distinguished by the strongly punctured, convex elytra and black suture, as well as by the colour of the head and under side.

OEDIONYCHIS PICIFRONS, sp. n. (Clark Catal.).

Testaceous, the vertex of the head and the antennæ pale piceous; thorax impunctate; elytra very finely and closely punctured; posterior femora pale fulvous.

Length $6\frac{1}{2}$ millim.

Of somewhat flattened, oblong shape, the head impunctate, the vertex very pale piceous, frontal elevations strongly raised, trigonate; clypeus triangularly carinate; eyes large, widely separated; antennæ extending to the middle of the elytra, pale piceous, third and fourth joints equal; thorax with the sides rather strongly rounded and broadly flattened, the anterior angles thickened but only slightly produced, the surface impunctate; scutellum pale piceous; elytra slightly widened towards the middle, narrowly margined, extremely finely and rather closely punctured, the shoulders very prominent and deeply longitudinally sulcate within, the depressions more strongly punctured, pale testaceous; under side and legs coloured like the upper surface, the posterior femora pale fulvous or piceous.

Hab. Brazil.

Of more oblong shape, less broadly rounded than most of the unicolorous species, very pale testaceous, with the exception of the head, antennæ, and the posterior femora; the sides of the thorax rather strongly rounded, the shoulders very prominent.

OEDIONYCHIS MILLEPORA, sp. n.

Under side and legs dark brown; the head black at the vertex, testaceous lower down; antennæ (the basal joints excepted) black; thorax testaceous, impunctate; scutellum black; elytra testaceous, closely and finely punctured.

Length 4-4½ millim.

Head rather strongly punctured at the sides of the vertex, the latter bluish-black; clypeus testaceous, strongly carinate at the middle, the anterior portion forming a transverse ridge; antennæ black, the lower three joints more or less stained with flavous, third and fourth joints equal, terminal joints rather short and stout; thorax short and transverse, nearly similar to that of *O. obscuripennis* Jac., with a narrow transverse sulcus each side of the basal margin, the disc impunctate; scutellum black; elytra of the same shape and punctuation as in *O. obscuripennis*; prosternum very narrow and elongate, also carinate, fulvous; under side and legs piceous.

Hab. Colombia; also Mexico.

The testaceous colour of the anterior portion of the head, the distinctly punctured vertex, and the colour of the antennæ and under side separate this species from the preceding one, and the partly testaceous head from *O. obscuripennis*.

OEDIONYCHIS DISTINCTA, sp. n.

Convex, widened posteriorly, testaceous; terminal joints of antennæ black; thorax with strongly rounded and deeply sulcate sides, impunctate; elytra deeply, closely and strongly punctured, more finely and closely so towards the apex.

Length 8 millim.

Head with a few deep punctures at the vertex, deeply and broadly sulcate between the eyes, the latter widely separated, frontal tubercles rather obsolete; carina broad anteriorly; clypeus perpendicularly deflexed, bounded by an acute ridge above; antennæ robust, black, the lower four joints testaceous, third joint shorter than the fourth, the following joints also less elongate than the fourth one; thorax not more than twice as broad as long, rather wider at the sides (longitudinally), the latter strongly rounded, with broadly flattened sulci, the anterior angles slightly mucronate, the anterior margin deeply concave at the middle, the disc impunctate; elytra strongly widened at the middle and convex, the reflexed margins not very broad, the surface deeply and closely punctured anteriorly, intermixed with some smaller punctures, the posterior portion extremely closely and more finely punctured; metatarsus of hind legs very short; claw-joint very strongly inflated.

Hab. Colombia.

More strongly punctured and convex than most of the allied species, the thorax of characteristic shape, and the antennæ with pale basal joints.

OEDIONYCHIS APICICORNIS, sp. n.

Elongate, nearly parallel, testaceous; antennæ black, the basal joint testaceous, the apical one fulvous; thorax impunctate, the sides rounded, the anterior angles scarcely mucronate; elytra extremely minutely punctured.

Length 5 millim.

Head impunctate, the eyes very large, frontal elevations broad, not strongly raised; clypeus deeply deflexed, not prominent; antennæ not quite extending to the middle of the elytra, black, the basal joint testaceous, the last one fulvous, third joint shorter than the fourth; thorax twice as broad as long, of even width, the lateral margins moderately strongly rounded, the anterior angles scarcely produced or mucronate, the sides deeply sulcate, the surface impunctate; scutellum testaceous; elytra slightly widened towards the middle, narrowly margined, extremely minutely and closely punctured; metatarsus short; claw-joint strongly swollen.

Hab. Bolivia.

Closely allied to *O. pallescens* but larger and the antennæ and legs of different coloration. *O. pauperæ* Illig. is described as being only 3 millim. in length and with an elongate first joint of the posterior tarsi, which show that the species is an *Asphæra*.

OEDIONYCHIS SORDIDA, sp. n.

Black, the head strongly punctured; thorax flavous, with rounded sides and mucronate anterior angles, impunctate; elytra finely punctured, flavous, the basal portion obscure fulvous; scutellum black.

Length $7\frac{1}{2}$ millim.

Broadly elongate, nearly parallel; the head bluish black, strongly and closely punctured, deeply transversely depressed between the eyes, the latter widely separated; antennæ rather short, black, the lower three joints shining, the rest pubescent, basal joint short and thick, third and fourth joints subequal, the last of wider shape, the following joints rather robust, cylindrical, slightly shorter; thorax twice as broad as long, of equal width, the sides deeply sulcate, the lateral margins rounded, the anterior margin produced outwards in shape of a small tooth, the surface flavous, impunctate; scutellum black; elytra slightly wider at the base than the thorax, with narrow reflexed margins, nearly parallel, finely but distinctly and very closely punctured; under side and legs black; prosternum longitudinally carinate.

Hab. Santa Catharina, Brazil.

There are two specimens of this insect before me, which, although they show some differences, I must refer to the same species. In one the head has only a few punctures and the extreme basal margin of the elytra is stained with black, the colour of the elytra is also entirely pale fulvous; but in structure the two specimens agree entirely. The species is closely allied to

O. navicularis, but is of more elongate and less convex shape and is much larger; the thorax is longer and less transverse.

OEDIONYCHIS ECUADORIENSIS, sp. n.

Broadly ovate, the head, antennæ, and the under side black; thorax flavous, impunctate; elytra obscure pale fulvous with slight purplish shade, extremely finely punctured.

Length 8 millim.

Head with a few fine punctures near the eyes, finely granulate, black, the frontal elevations pyriform, divided by a deep groove; clypeus flavous; eyes very large, but not closely approached; antennæ black, the basal three joints more or less testaceous above, third joint slightly shorter than the fourth; thorax with strongly rounded and broadly flattened sides, the anterior angles acute but scarcely produced, the disc rather convex, flavous, impunctate; scutellum triangular, fulvous; elytra widened towards the middle, with broadly reflexed margins, the latter pale; the disc obscure fulvous with a slight purplish tint, very finely and closely punctured; under side and legs black or piceous; metatarsus very short, claw-joint strongly swollen.

Hab. Ecuador.

This is a species of peculiarly dull appearance, unless this is caused by discoloration. The two specimens before me are, however, entirely similar in this respect, the shape is rather broadly ovate, and the elytral margins are proportionately broad.

OEDIONYCHIS RHODINA, sp. n.

Oblong, nearly parallel, black; thorax rather short, testaceous, impunctate, the sides gradually flattened; elytra without prominent shoulders, testaceous, impunctate.

Length 7-7½ millim.

Head impunctate, black; frontal tubercles broad, ill-defined; eyes widely separated, with a few punctures placed between them; clypeus very short, strongly deflexed; antennæ not extending to the middle of the elytra, black, the third and following joints equal, terminal joints elongate; thorax rather short, the sides rounded anteriorly, the anterior margin concave, anterior angles produced into a short, blunt tooth, the disc impunctate, shining, testaceous, the sides flattened, but this portion limited within by a shallow sulcus only; scutellum more or less piceous at the base; elytra slightly wider at the base than the thorax, rather elongate, feebly widened only towards the middle, the shoulders but slightly prominent and bounded within by a shallow depression only, the surface nearly impunctate; below and the legs black.

Hab. Espirito Santo, Brazil.

A rather larger species, and principally differing in the less strongly flattened sides of the thorax, the oblong shape of the elytra and their less prominent shoulders and almost impunctate surface.

OEDIONYCHIS PALLESCENS, sp. n.

Pale flavous, the antennæ (the basal joints excepted), the knees, and the anterior and intermediate tibiæ and tarsi black; thorax impunctate; elytra exceedingly minutely punctured.

Length 4-4½ millim.

Head impunctate, deeply grooved between the eyes, the latter very large but well separated, frontal elevations transverse, strongly raised, carina linear, palpi flavous; antennæ extending to the middle of the elytra, black, the lower three joints flavous, third joint very slightly shorter than the fourth; thorax one half broader than long, slightly narrowed anteriorly, the sides narrowly flattened, the lateral margins rounded, anterior angles produced into a small tooth, the disc impunctate; elytra slightly widened towards the middle, narrowly margined, the base not depressed, the surface very minutely and closely punctured; the knees, the anterior and intermediate tibiæ and tarsi black (but not always); the rest of the legs and the under side flavous, the posterior femora sometimes with a piceous spot near the apex.

Hab. Peru.

Principally distinguished by the colour of the legs and its small size.

OEDIONYCHIS INCONSPICUA, sp. n.

Testaceous, the intermediate joints of the antennæ black; eyes closely approached; thorax impunctate; elytra finely and closely punctured.

Length 5 millim.

Head impunctate, deeply grooved between the eyes, the latter very large, each broader than the space dividing them; clypeus short and thick; antennæ not extending to the middle of the elytra, black, the lower three and the apical two joints testaceous, third and fourth joints equal; thorax twice as broad as long, the sides rounded, broadly flattened, the anterior angles slightly produced but blunt, the surface impunctate; elytra rather convex, nearly parallel, extremely minutely punctured; below and the legs testaceous, the breast more or less pale piceous; first joint of the posterior tarsi as long as the following two joints together, claws strongly swollen.

Hab. Amazons.

Larger than *O. pallescens*; the antennæ of different colour, the eyes larger and more closely approached, the metatarsus of the posterior legs rather longer than usual, but not so pronounced as in *Asphaera*, and the thorax typical of the genus. There are four specimens before me.

OEDIONYCHIS HERBACEA, sp. n.

Black, head finely punctured; thorax testaceous, the sides strongly rounded, finely wrinkled; elytra convex, testaceous, strongly and closely punctured, the extreme basal and sutural margins black; abdomen testaceous.

Length 8 millim.

Of strongly convex, posteriorly widened shape, the head distinctly punctured at the vertex and near the eyes, black, the middle of the base with a short longitudinal groove, frontal tubercles narrow and transverse: antennæ black, not extending to the middle of the elytra, the lower three joints testaceous below, short, the third joint slightly shorter than the fourth; thorax strongly transverse, the lateral margins strongly rounded, the anterior angles thickened but not dentiform, the sides rather broadly flattened, the disc minutely aciculate and extremely finely punctured; scutellum black; elytra strongly convex, rather suddenly deflexed below the middle, closely, evenly and strongly punctured, the sides below the shoulders somewhat flattened, the margins only slightly thickened, not reflexed, the extreme basal and sutural margins black; abdomen obscure testaceous; rest of the under surface and the legs black.

Hab. São Paulo, Brazil.

Amongst the nearly unicolorous species the present one is well distinguished by the shape and sculpture of the thorax and elytra and by the coloration. *O. balyi* Cl. has a differently shaped thorax and finely wrinkled elytra.

OEDIONYCHIS NIGROTIBIALIS, sp. n.

Head pale fulvous, the antennæ, the anterior and intermediate tibiæ, and the tarsi black; thorax flavous; elytra fulvous, nearly impunctate; under side and legs testaceous.

Length 6 millim.

Oblong-ovate; the head pale fulvous, with a few punctures near the eyes; labrum piceous; antennæ black, the third and fourth joints equal, terminal joints shorter and thicker; thorax rather strongly convex, the sides rounded and broadly flattened, the anterior angles thickened, slightly truncate, not produced, the surface very shining, impunctate, flavous; scutellum black; elytra dark fulvous, impunctate, with the exception of a short double row of punctures below the shoulders; below pale fulvous, the anterior and intermediate tibiæ and all the tarsi black, posterior tibiæ fulvous.

Hab. St. Catharina, Brazil.

Of rather convex and oval shape, and distinguished by the flavous thorax and the colour of the legs.

OEDIONYCHIS CONSIMILIS, sp. n. (Clark Catal.).

Black, the clypeus testaceous; thorax with broadly flattened sides, impunctate, testaceous; scutellum black; elytra very finely, partly obsoletely punctured, testaceous.

Length 8 millim.

Of posteriorly slightly widened shape; the head black, with a few punctures placed in a row in front of the eyes; clypeus testaceous, the carina very prominent; antennæ black, the lower two

joints more or less flavous below, the third joint distinctly shorter than the fourth; thorax with the sides broadly flattened, the anterior angles pointed but not produced, the disc impunctate, testaceous, the lateral margins feebly rounded anteriorly; scutellum black; elytra convex, without basal depressions, with narrow reflexed margins, closely and very finely punctured, testaceous; under side and legs black, the abdomen more or less flavous at each side.

Hab. Peru.

Very closely allied to *O. plebeja* Klug, but in that species the head is punctured at the vertex and the eyes are margined with testaceous, the elytra are more strongly punctured, and the "habitat" of the species is Brazil. I have preserved Clark's catalogue name for the present species, of which specimens are also contained in the British Museum. *O. obscuripennis* Jac., also from Peru, is likewise very closely allied, but is a smaller insect, of different shape, with the anterior angles of the thorax mucronate and a much more flattened carina of the clypeus.

OEDIONYCHIS NIGRIMANA, sp. n.

Black; thorax short and strongly transverse, impunctate; elytra finely punctured, pale greyish-testaceous.

Length 5 millim.

Of medially gradually widened shape, moderately convex; the head entirely impunctate, black, the frontal elevations transverse, contiguous, carina acute, convex; antennæ black, the third and fourth joints equal (the rest wanting); thorax short, of equal width, more than twice as broad as long, the lateral margins rounded, the sides broadly flattened, the anterior angles neither thickened nor produced, the surface impunctate, black, very shining; scutellum black; elytra gradually widened towards the middle, finely and closely punctured, pale greyish-testaceous, below and the legs black; metatarsus moderately short, claw-joint very strongly inflated; prosternum proportionately broad.

Hab. Peru.

Of similar coloration to *O. turpis* Jac., but much smaller, the head and thorax entirely black and the elytra without apical black spot.

OEDIONYCHIS ALBIPENNIS Jac.

Since this species was described (P. Z. S. 1894, p. 609) I have received a good many more specimens from the Amazon regions, which prove that the insect is extremely variable in regard to size as well as to coloration. The type was described from nearly unicolorous specimens; those now before me show the following elytral markings:—

- a. Two spots at the basal margin; a longitudinal streak near the side, very broad at its commencement, strongly pointed at the apex.

- b. The basal spots absent; each elytron with a narrow, oblique band from the middle of the base to the lateral margin below the middle.
- c. The extreme basal margin, connected with a narrow sub-lateral longitudinal stripe, black.
- d. Elytra with two basal small spots and another at the middle.

In all these forms the anterior and posterior margins of the thorax are more or less black, and frequently this colour occupies the entire middle of the disc, leaving only the sides testaceous; the eyes are closely approached, and the head at the vertex is generally finely punctured and wrinkled, but sometimes impunctate; the metatarsus of the hind legs is scarcely typical of *Oedionychis*, being rather more elongate, but not to such an extent as to include the species in *Asphæra*. The form with three black spots can scarcely be distinguished from *O. humeralis* Fab., but in that species all the specimens I have seen have a unicolorous testaceous thorax, without any markings, and no black basal elytral margin. All the specimens before me (16) come from the Amazon regions.

Elytra pale, with spots and bands combined.

OEDIONYCHIS PARALLINA, sp. n.

Head and breast black; thorax testaceous, impunctate; elytra extremely minutely punctured, flavous, two spots at the base, two others below the middle, and a transverse band at the latter place black; legs testaceous, apex of the posterior femora black.

Length 6-7 millim.

Of posteriorly slightly widened shape, rather flattened; the head black, the vertex minutely granulate and punctured, frontal elevations very broad, trigonate, eyes extremely large, carina acute; palpi flavous; antennæ rather robust, the basal four and the apical three joints flavous, the rest black, third and following joints nearly equal; thorax more than twice as broad as long, the sides gradually but broadly flattened, the posterior margin straight, the anterior angles not produced, the disc impunctate, testaceous; scutellum black; elytra extremely minutely and closely, almost confluent punctured, testaceous, the shoulders with an elongate black spot, another round spot near the scutellum; a transverse narrow band at the middle and two spots near the apex, placed transversely, likewise black; breast black; abdomen and legs testaceous, the posterior femora black at the apex.

Hab. Brazil.

Easily known by the pattern of the elytra and system of coloration. The male insect is of considerably smaller size and much narrower.

OEDIONYCHIS COLOMBIANA, sp. n.

Piceous, above testaceous, the apical joints of the antennæ and

the breast piceous; thorax impunctate; elytra subdepressed, extremely closely and finely punctured, the basal margin, a narrow transverse band below the middle, and two spots near the scutellum dark brown.

Length 7 millim.

Head impunctate, testaceous, the frontal elevations rather feeble; eyes large, the intermediate space not wider than the width of each eye; antennæ with the basal three or four joints and the apical one testaceous, the rest blackish; thorax short and transverse, the sides broadly flattened, the anterior angles dentiform; the disc impunctate, testaceous, feebly transversely sulcate near the base; scutellum testaceous; elytra widened towards the apex, rather flat, extremely finely and closely punctured, testaceous, the extreme basal margin, a small spot near the scutellum, and a narrow transverse, slightly convex band, immediately below the middle, piceous or dark fulvous; legs testaceous; breast and abdomen piceous.

Hab. Pichinché, Colombia (*Rosenberg*).

Of this species I have five exactly similar specimens before me. The design of the elytra differs from that of any other species I am acquainted with except *O. tenuicincta* Jac., which is a differently shaped insect, with a different thorax, very narrow elytral bands, and of black colour. This species is also known from Mexico.

OEDIONYCHIS DIVERSA, sp. n.

Testaceous, the apical joints of the antennæ (except the last) and the breast black; thorax impunctate; elytra elongate, finely punctured, each with two spots at the base, one at the middle, and a transverse band near the apex, black.

Var. The apical band divided into two spots.

Length 5 millim.

Head impunctate, deeply foveolate between the eyes, the latter very large; antennæ with the lower five and the apical joint testaceous, the others black, third and fourth joints equal, elongate, the terminal joints rather shorter; thorax about twice and a half broader than long, the sides broadly flattened, the lateral margins strongly rounded anteriorly, the anterior angles thickened but not produced, the surface impunctate, rather convex; scutellum black; elytra elongate, nearly parallel, very minutely punctured, testaceous, a small spot on the shoulders, another near the scutellum, a third at the middle, and a transverse band near the apex, not quite extending to either margin, black; legs and abdomen testaceous, breast black.

Hab. St. Catharina, Rio Janeiro, Brazil.

A somewhat elongate species, principally distinguished from those with similar elytral spots by the additional black subapical band and the black breast, colour of the antennæ, &c.

OEDIONYCHIS BISBINOTATA, sp. n. (Plate XV. fig. 8.)

Flavous, the apical joints of the antennæ black; thorax im-

punctate, with two small black spots; elytra minutely punctured at the base only, a spot on the shoulders, another near the scutellum, and the posterior half black.

Var. The thoracic and elytral spots absent.

Length 6 millim.

Head impunctate, flavous; eyes large, each as broad as the intermediate space, frontal elevations transverse; antennæ with the lower joints flavous, the terminal ones more or less black; thorax twice as broad as long, the sides rounded, narrowed in front and broadly flattened, anterior angles pointed, slightly produced, the surface impunctate, flavous, with two small black spots near the base; elytra nearly impunctate, except near the base, where there are a few minute punctures, flavous, a spot near the scutellum and one on the shoulders, as well as almost the whole posterior portion, black, but this colour not quite extending to the apex; under side and legs flavous; prosternum convex between the coxæ; metatarsus very short, claw-joint strongly swollen.

Hab. Peru.

Of this species I possess two specimens, in one of which some obsolete additional thoracic spots are present and the elytral ones absent, the shape of the posterior black portion is regular; in the other the anterior edge is deeply sinuate, but other differences I cannot find.

OEDIONYCHIS VARIATA, sp. n.

Obscure piceous below, above testaceous; thorax impunctate: elytra subdepressed, extremely minutely punctured, the basal margin, a spot on the shoulders, another oblique spot near the scutellum, a transverse narrow band at the middle, and another spot near the apex, black.

Length 7 millim.

Head impunctate, the frontal elevations feebly raised, carina short and convex; antennæ fulvous, the third joint shorter than the fourth (♀) or equal (♂); thorax with broadly flattened sides, the lateral margins nearly straight, obliquely narrowed anteriorly, the disc rather flat, impunctate, testaceous, the anterior angles in shape of a small tooth; elytra evenly rounded and widened at the middle, broadly margined, scarcely perceptibly punctured, testaceous, the extreme basal margin, connected with an elongate spot which covers the shoulders, an oblique comma-like spot near the scutellum, a narrow transverse band (somewhat angulate near the lateral margin) at the middle, and another transverse spot near the apex, black; below and the legs testaceous.

Hab. Bolivia.

Well distinguished by the shape and the position of the elytral spots.

OEDIONYCHIS INGRATA, sp. n.

Testaceous, the apical joints of the antennæ piceous; thorax

impunctate, the anterior angles not produced; elytra finely punctured anteriorly, a sutural pear-shaped spot below the scutellum and a transverse band below the middle bluish-black; breast black.

Length 5 millim.

Head impunctate, deeply foveolate between the eyes, the latter rather closely approached; antennæ with the lower four joints fulvous, the rest piceous, the joints comparatively short; thorax about twice as broad as long, the sides feebly rounded and narrowed anteriorly, the anterior angles thickened and not produced, the sides broadly flattened, the disc impunctate; scutellum black; elytra very finely punctured, except near the base and within the humeral depression, where the punctuation is stronger, the ground-colour testaceous, a sutural spot below the scutellum and an irregular narrow transverse band below the middle bluish-black, sometimes piceous; the breast black, the abdomen and legs testaceous.

Hab. Espirito Santo, Brazil.

Two exactly similarly coloured specimens of this species are before me; the design of the elytra differs from that of any other *Oedionychis*, and the general size of the insect is comparatively small.

OEDIONYCHIS VENEZUELENSIS, sp. n.

Flavous, the apical joints of the antennæ piceous; head with two black bands; thorax fulvous, impunctate; elytra extremely minutely punctured, with a spot at the shoulders, another near the scutellum, a transverse band before and another below the middle, black.

Length 6 millim.

Of somewhat flattened, posteriorly slightly widened shape; the head with a few punctures near the eyes, the latter very large, the diameter of each distinctly wider than the intermediate space; the vertex flavous, with a black stripe at each side, the space between the antennæ strongly convex in shape of a ridge, black; the palpi flavous; antennæ slender, the lower three joints flavous, the others blackish, third joint slightly shorter than the fourth; thorax not more than twice as broad as long, the sides nearly straight and slightly narrowed anteriorly, broadly flattened, the anterior angles thickened but scarcely produced, the disc impunctate, fulvous, the flattened portion flavous, the base with an obsolete transverse sulcus; scutellum flavous; elytra scarcely perceptibly punctured, flavous, the shoulders with a short, thick black spot, another one of more elongate shape is placed near the scutellum, a transverse, medially constricted black band is situated before and a second one below the middle; the under side and legs are flavous; metatarsus and claw-joint typical.

Hab. Venezuela.

Differs in the coloration of the head and the position of the elytral markings from any other species.

OEDIONYCHIS CENTROMACULATA, sp. n. (Plate XV. fig. 2.)

Testaceous or fulvous; antennæ (the apical joints excepted) black; thorax impunctate; elytra minutely punctured, a transverse band at the base, another below the middle, obscure fulvous, the intermediate space with four small black spots.

Length 6-7 millim.

Head impunctate, with a deep fovea between the eyes, the latter large, closely approached; antennæ black, the lower three or four and the apical two joints fulvous, third and fourth joints equal, the following joints rather shorter; thorax with rather strongly rounded sides, the latter broadly flattened, anterior angles mucronate, the disc impunctate, obscure fulvous; elytra widened at the middle, distinctly margined, extremely finely punctured at the base, fulvous, this colour divided at the middle by a narrow testaceous transverse band in which four black spots are placed transversely; under side and legs testaceous; prosternum in the male strongly convex anteriorly.

Hab. St. Catharina, Brazil.

Quite distinct in its system of coloration from any other species. Two specimens are before me.

OEDIONYCHIS ARCUATOFASCIATA, sp. n. (Plate XV. fig. 7.)

Ovate, subdepressed, greenish testaceous; thorax impunctate, with rounded sides; elytra scarcely perceptibly punctured, the basal margin, a narrow semicircular band at the base, a spot at the lateral and another near the sutural margins below the middle, black.

Length 5 millim.

Head impunctate, eyes large, frontal tubercles subquadrate, short, carina acute; antennæ extending to the middle of the elytra, testaceous, the third and fourth joints equal, terminal joint rather more robust; thorax quite twice as broad as long, of equal width, the sides moderately rounded, the lateral sulci deep, rather narrow, the base with another obsolete transverse groove, the surface impunctate; scutellum black; elytra widened towards the middle, rather flattened, pale greenish testaceous, with a few minute punctures (only visible under a strong lens), the extreme basal margin as far as the shoulders and a transverse semicircular narrow band below the base black; this band extends upwards along the suture to the scutellum, it is suddenly constricted at its middle and does not extend to the lateral margins, near the latter is another black spot, below the middle and a little lower a second one is placed near the suture; under side and legs testaceous.

Hab. Chilpancingo, Mexico.

I formerly looked upon this species as a variety of *O. 13-maculata* Jac., but a further careful examination has convinced me that it really represents another form, as the colour of the antennæ, shape and number of the elytral spots are different and exactly similar in the two specimens before me; this species is also of a less rounded and smaller shape.

Elytra blue or black, without markings.

OEDIONYCHIS SUBCOSTATA, sp. n.

Metallic blue, the head and thorax reddish-fulvous, the latter finely punctate; elytra dark blue, rather opaque, closely and strongly rugose-punctate, with a single, very obsolete costa near the sides.

Length 7 millim.

Head impunctate, reddish-fulvous; frontal elevations strongly raised, transverse, carina linear, very convex; antennæ with the lower two joints fulvous, the following four black, the rest wanting, third joint shorter than the fourth; thorax transversely convex, about twice as broad as long, the sides broadly flattened, rounded in front, the anterior angles produced outwards into a small tooth, the disc with a rather distinct transverse groove near the base, minutely punctured when seen under a strong lens; scutellum black; elytra dark blue, rugosely punctured throughout, a slightly raised narrow line extends from within the shoulders to below the middle; under side and legs dark metallic blue, smooth and shining.

Hab. Brazil.

OEDIONYCHIS MOTSCHULSKYI, sp. n.

Head at the vertex, the antennæ (the apical joints excepted), the under side, and the tibiæ and tarsi black; thorax and femora flavous; elytra metallic violaceous, finely and closely punctured.

Length 5 millim.

Head entirely impunctate, black, shining; the eyes widely separated; frontal elevations transverse, very strongly raised; clypeus triangular, flavous as well as the labrum; antennæ slender, extending to the middle of the elytra, black, the apical three joints fulvous, third and fourth joints equal; thorax nearly three times broader than long, flavous, the sides rounded, deeply sulcate, the anterior angles very slightly produced outwards into a blunt tooth, the surface entirely impunctate, obsolete transversely sulcate near the base; scutellum black; elytra with a feeble impression below the base, convex, nearly parallel, very narrowly margined, finely and very closely punctured, metallic violaceous blue; legs flavous, the breast, abdomen, the apex of the posterior femora, and the tibiæ and tarsi black.

Hab. Peru.

The colour of the head, antennæ, and legs, and the rather narrow parallel shape of this species separate it from those of nearly similar coloration.

OEDIONYCHIS INDIGOSOMA, sp. n.

Head and thorax fulvous, nearly impunctate; elytra dark blue, closely and strongly semirugose punctate; below and the legs bluish black.

Length 7 millim.

Head fulvous, impunctate, eyes widely separated; antennæ black, the basal two joints obscure fulvous, terminal joints shortened, third and fourth equal; thorax twice as broad as long, the sides rounded anteriorly, the middle of the disc rather convex, the anterior angles produced outwards into a small tooth, the sides broadly flattened and subrugose, the surface impunctate, obsolete transversely sulcate near the base; scutellum black; elytra not perceptibly depressed below the base, dark blue, not very shining, closely and distinctly rugose punctate throughout; below and the legs bluish black; prosternum comparatively broad, flavous.

Hab. Petropolis, Brazil.

A well-distinguished species on account of the colour and sculpture of the elytra.

Elytra dark, with flavous spots, patches, or bands.

OEDIONYCHIS INTERSIGNATA, sp. n. (Clark Catal.).

Black, thorax flavous; elytra closely and strongly punctured, violaceous or blue, a transverse band or broad patch at the middle, the apex and the lateral margins (partly) flavous.

Length 7 millim.

Head piceous or black, impunctate, eyes very large, as wide as the intraocular space, frontal elevations strongly raised, pyriform, carina acute; antennæ black, the lower three joints fulvous below, third and fourth joints equal; thorax quite twice as broad as long, the sides rounded, broadly flattened within, the anterior angles in shape of a very small tooth, the surface impunctate, flavous; scutellum black; elytra strongly and closely punctured, blue, violaceous or purplish, with a transverse flavous patch at the middle and a smaller one at the apex, the lateral margins anteriorly and posteriorly likewise flavous as well as the elytral epipleuræ; underside and legs black.

Hab. Espirito Santo, Brazil.

A rather variable species as regards the flavous markings of the elytra, but distinguished by the comparatively strong punctation; the central flavous band scarcely extends to the suture, nor does the apical one, but both unite with the flavous lateral margins.

OEDIONYCHIS RUSTICA, sp. n.

Testaceous, the intermediate joints of the antennæ black; thorax impunctate; elytra extremely closely and finely punctured, a transverse band at the base, another of oblique shape near the apex, and the intermediate portion of the suture fulvous, more or less edged with piceous.

Length 5 millim.

Head impunctate, eyes very large and rather closely approached; frontal elevations broad, subquadrate, divided by a narrow groove; antennæ extending beyond the middle of the elytra, the five lower and the terminal two joints fulvous, the others blackish; thorax

short and transverse, the sides rounded and broadly flattened, the anterior angles acute but not dentiform, the surface entirely impunctate, testaceous; scutellum piceous; elytra with broadly flattened margins, slightly widened at the middle, finely and closely punctured, testaceous, with two broad fulvous transverse bands—one at the base, deeply concave at its lower margin and connected by a sutural stripe with the second band near the apex of obliquely subquadrate shape, both bands are interrupted at some distance from the lateral margins and are more or less distinctly edged with piceous, the basal margin especially so; under side and legs testaceous.

Hab. Argentine R. and Brazil.

Not unlike *O. pustulata* Jac. in coloration, but the antennæ differently coloured, the thorax without a fulvous spot, and the elytral bands of different shape.

OEDIONYCHIS CATHARINÆ, sp. n.

Dark fulvous below, antennæ black; thorax flavous, impunctate; head and scutellum dark fulvous; elytra rather strongly and closely punctured, dark fulvous, a large discoidal ovate patch on each, flavous.

Length 6 millim.

Of rather elongate and parallel shape; the head impunctate, fulvous, deeply grooved between the eyes, the latter large, frontal elevations broad, transverse; carina blunt and thick; antennæ robust, black, third joint distinctly shorter than the fourth; thorax strongly transverse, the lateral margins distinctly rounded, the anterior angles but slightly produced outwards, scarcely toothed, lateral sulci broad and deep, the surface impunctate, flavous; elytra with narrow reflexed margins, fulvous, distinctly punctured, the disc occupied by a large flavous ovate patch, with its narrowest portion near the suture; under side and legs dark fulvous, the tibiæ and tarsi blackish; metatarsus very short, claw-joint strongly inflated.

Hab. St. Catharina, Brazil.

Of somewhat similar coloration to *O. 4-pustulata* Jac. from the same locality, but the thorax without fulvous spot, the antennæ entirely black, with more elongate joints, and the whole apex of the elytra fulvous; the thoracic sulci in the present species also are wider and deeper.

OEDIONYCHIS OCELLATA, sp. n. (Plate XV. fig. 10.)

Black, thorax testaceous, with three black spots; elytra closely and strongly punctured, each elytron with six small flavous spots (1.2.2.1).

Length 5 millim.

Head not perceptibly punctured, the middle black, the sides and the anterior portion testaceous, frontal tubercles short and broad, strongly raised, carina broad; antennæ rather short and robust, black, the lower three joints more or less flavous, third joint more

slender and slightly longer than the fourth, the following joints thickened; thorax strongly transverse, the sides rounded, broadly flattened, anterior angles mucronate. the surface with a few minute punctures, testaceous, with three small black spots placed transversely; scutellum black; elytra with strongly but narrowly reflexed margins, rather strongly and very closely punctured, with a very feeble depression below the base, black, each elytron with six round flavous spots—of these, one is placed at the middle, just below the basal margin, two at the middle, placed transversely, two immediately below, and one at the apex; under side and legs black.

Hab. Paraguay.

A rather small and well-marked species, of which I possess a single specimen only.

Elytra with elongate spots or longitudinal black or flavous bands.

OEDIONYCHIS HUMBOLDTI, sp. n.

Testaceous, the head and the breast black, sides of the thorax straight, the latter impunctate; elytra closely and finely punctured, two elongate spots at the base and two below the middle of each elytron black.

Length 6 millim.

Head black or nearly so, impunctate, the frontal elevations broad, trigonate, clypeus perpendicularly deflexed; antennæ robust, fulvous, the third joint smaller than the fourth; thorax narrowed in front, one-half broader than long, the sides straight, broadly flattened, the anterior angles produced into a small tooth, the surface impunctate, testaceous; scutellum testaceous; elytra nearly parallel, closely and distinctly, although finely punctured, testaceous, each elytron with two more or less elongate black spots at the base and two others below the middle—of the basal spots, one is placed on the shoulders and extends nearly down to the middle, the other shorter one is placed near the suture; the posterior spots are almost joined, the outer one being of more elongate shape than the inner; under side and legs testaceous, breast black.

Hab. Bolivia.

This *Oedionychis* is well distinguished by the straight lateral margins of the thorax, which are obliquely narrowed anteriorly, and by the four elytral spots. In one specimen the latter are represented by short and narrow stripes.

OEDIONYCHIS WATERHOUSEI (MS. Clark), sp. n.

Black, the clypeus flavous; head strongly punctured; thorax flavous, impunctate; elytra finely and closely punctured, bluish black, the lateral margins narrowly and a broad discoidal band, joined at the apex to the margin, flavous.

Length 6 millim.

Head piceous or black, the vertex coarsely punctured, the clypeus flavous; antennæ black, the third and fourth joints very nearly equal; thorax strongly transverse, the sides strongly but not broadly flattened, the lateral margins rounded in front, anterior angles dentiform, the surface impunctate, flavous, with a very obsolete transverse sulcus near the base; scutellum black; elytra finely and closely punctured, bluish black, the discoidal flavous stripe of double the width of the similarly coloured lateral margins and connected with the latter at the apex; under side and legs black; elytral epipleuræ with a very narrow inner dark margin.

Hab. Brazil.

This banded species is more nearly allied to *O. figurata* Chev. than to any other, and may be known by the dark head, antennæ, and legs, the broad discoidal elytral flavous stripe, which has somewhat irregular outlines, and by the inner dark margin of the elytral epipleuræ. The species, if these details be kept in view, cannot be mistaken for any of those of which v. Harold has given an analytical table (Berlin. ent. Zeitschr. 1881).

OEDIONYCHIS EXCLAMATIONIS, sp. n. (Plate XV. fig. 3.)

Testaceous, the intermediate joints of the antennæ black; thorax impunctate; elytra minutely punctured, two elongate spots at the base and a longitudinal stripe at the sides, strongly thickened at the upper end, black.

Length 7 millim.

Head impunctate; the eyes large, each as wide as the intervening space; carina short and convex, narrow; antennæ testaceous, the sixth to the ninth joints blackish, third smaller than the fourth joint; thorax more than twice as broad as long, the sides strongly rounded and broadly flattened, the anterior angles produced into a small tooth, the surface impunctate; elytra not wider at the base than the thorax, with narrow reflexed lateral margins, extremely finely and closely punctured, testaceous, the base with two black longitudinal short stripes, the sides near the margins with another longer narrow black stripe, which ends anteriorly rather abruptly in a club or knob directed towards the suture; under side and legs testaceous.

Hab. Brazil.

I know of only a single specimen of this rather peculiarly marked species, the exact locality of which is unknown to me.

OEDIONYCHIS INTERRUPTO-VITTATA, sp. n. (Plate XV. fig. 6.)

Testaceous, the head and the intermediate joints of the antennæ black; thorax impunctate, the anterior angles mucronate; elytra finely punctured, testaceous, each elytron with two more or less interrupted longitudinal black stripes; the breast black.

Length 6 millim.

Of flattened shape; the head impunctate, black, deeply foveolate between the eyes, the latter large, their diameter as wide as the

dividing space; labrum fulvous; antennæ with the lower four and the apical three joints fulvous, the others black, third and following joints nearly equal, elongate; thorax with strongly rounded and flattened sides, the anterior angles mucronate and produced forward, the disc impunctate, testaceous, obsoletely transversely grooved near the base; elytra finely and closely punctured, rather flattened, narrowly marginate, each elytron with two narrow longitudinal stripes—one near the suture, the other near the lateral margins, below the middle both, or one, of the stripes are interrupted, so that only one or two elongate spots remain near the apex; under side and legs testaceous, the breast black.

Hab. St. Catharina, Brazil.

In one of the specimens the inner black elytral stripe only is interrupted; in the other this is the case with both stripes, there is also an indication of another stripe in shape of a minute spot between the others, placed at the middle. Amongst the species with elytral longitudinal bands the present one is well distinguished by the colour of the head, antennæ, and the shape of the elytral stripes, which resemble signs of exclamation.

Elytra pale, with transverse black or blue bands or spots.

OEDIONYCHIS BISTRIFASCIATA, sp. n.

Black or piceous, antennæ dark fulvous, clypeus flavous; thorax impunctate, flavous; elytra finely and closely punctured, flavous, each with three transverse dark blue bands, the first subquadrate and emarginate or subdivided at the base.

Length $5\frac{1}{2}$ millim.

Of rather elongate shape; the head bluish black, with some strong punctures near the eyes; clypeus and labrum flavous, the eyes likewise margined more or less with the same colour; antennæ extending to nearly the middle of the elytra, dark fulvous, the basal two joints more or less stained with black above, third and fourth joints equal, terminal joints slightly thickened; thorax rather more than twice as broad as long, the sides strongly but not very broadly flattened, the lateral margins rounded anteriorly, anterior angles produced into a short blunt tooth, the surface impunctate or with a few very minute punctures, obsoletely transversely grooved near the base, flavous; scutellum black; elytra finely and closely but distinctly punctured, with three transverse blue or purplish bands—the first at the base the largest, of subquadrate shape, its basal margin with a narrow incision, the second band immediately below the middle, half the width of the first band, the third near the apex, short and of subquadrate shape, none of these bands extends to either margin; below and the legs black or piceous.

Hab. Peru.

In one of the specimens before me the basal band is also rather deeply emarginate near the suture at the sides as well as at the base.

OEDIONYCHIS INFORMIS (MS. Clark), sp. n.

Testaceous, the head, breast, and abdomen (partly) black; thorax impunctate, scutellum black; elytra minutely punctured each with three transverse black bands; legs testaceous, the apex of the posterior femora and the base of the tibiæ black.

Length 6 millim.

Head narrow, dark piceous, impunctate, eyes large; two basal joints of the antennæ testaceous, the others wanting; thorax with the lateral margins strongly rounded, the sides very broadly flattened, anterior angles not produced into a tooth, the disc impunctate, testaceous; scutellum black; elytra with rather broadly reflexed lateral margins, extremely finely and closely punctured, testaceous, with three transverse black short bands abbreviated at each end, the basal one in shape of a large subquadrate patch placed on the shoulders, the second one, the narrowest, placed at the middle, and the third near the apex; under side black, the last three abdominal segments and the legs testaceous, the extreme apex of the posterior femora and the base of their tibiæ black.

Hab. Rio de Janeiro.

OEDIONYCHIS GRAYI, sp. n.

Dark fulvous below; clypeus and thorax flavous, base of the head black, anterior angles of thorax mucronate, the latter impunctate; elytra very finely and closely punctured, flavous, a broad transverse band at the base and another below the middle, not extending to the margins, dark violaceous, posterior edge of the second band rounded.

Length $6\frac{1}{2}$ millim.

Head impunctate, the vertex black, frontal tubercles narrowly transverse, flavous, as well as the clypeus, labrum, and the palpi; antennæ short, not extending to the middle of the elytra, dark fulvous, the basal joint thick, subcylindrical, widened at the apex, the third joint twice as long as the second but shorter than the fourth joint, the following joints about as long as the third; thorax narrowed anteriorly, about twice and a half broader than long, the sides nearly straight, the lateral sulci not deeply separated from the disc, anterior angles mucronate, the surface convex, impunctate, flavous; scutellum blackish; elytra rounded and widened towards the middle, narrowly margined, the shoulders with a short, moderately deep impression within, the surface finely but distinctly and very closely punctured, the dark bands very wide, the dividing spaces narrow, the lateral margins likewise narrowly flavous, the posterior band rounded at its apical margin, leaving the suture for a little way upwards and the apex of the elytra somewhat more broadly flavous; under side and legs fulvous.

Hab. Amazons (*Bates*).

The single specimen contained in my collection was obtained by Bates, but bears no special locality. The species differs from

O. cardinalis in the coloration of the head and the antennæ, in the scarcely rounded sides of the thorax, and in the shape of the posterior elytral band. The same differences separate the species from others nearly similarly marked.

This is one of the most difficult sections of the genus, as the amount of variation in regard to the elytral bands, their shape and size, can only be ascertained where sufficient material is at hand; neither coloration nor sculpture can always be relied upon in these insects.

OEDIONYCHIS ARCUATA, sp. n.

Black, the head bluish; clypeus flavous; thorax impunctate, flavous; elytra closely and distinctly punctured, flavous, a broad transverse band at the base, a transverse large spot below the middle, and the apex metallic blue.

Length 6 millim.

Head bluish black, strongly punctured at the sides above the eyes, frontal elevations broadly transverse; clypeus flavous; antennæ black, third joint scarcely shorter than the fourth, terminal joints rather robust and short; thorax more than twice as broad as long, the sides with a deep but not very broad sulcus, anterior angles strongly thickened but scarcely produced, the lateral margins rounded anteriorly, straight at the base, the disc very finely punctured when seen under a strong lens, flavous, the base with a very obsolete transverse sulcus; scutellum black; elytra with very narrow reflexed lateral margins, not depressed below the base, very closely and more or less strongly punctured, the anterior half of their length occupied by a transverse blue band not extending to the lateral margins, its posterior edge concave, immediately below the middle is another large transverse band which has its anterior margin convex and the posterior one rounded, the extreme apex of each elytron is likewise metallic blue; under side and legs black.

Hab. Colombia.

Evidently closely allied to *O. labiata* Schauf., but the fourth joint of the antennæ in that species is described as the longest; the elytra are described as nearly smooth, and the first transverse band as being interrupted at the suture; the same is the case with the second band, which is said to be composed of two spots.

OEDIONYCHIS BIPARTITA, sp. n.

Broadly ovate, convex, black, the clypeus and the thorax fulvous, the latter very minutely punctured, the angles mucronate; elytra extremely closely and finely punctured, flavous, a transverse band at the base, another one at the middle, and a third near the apex, bright metallic green.

Length 7-8 millim.

Head black, impunctate, diameter of each eye about as wide as the dividing space, clypeus fulvous, frontal elevations narrowly

transverse; antennæ long and slender, black, the lower three joints more or less piceous below, third joint shorter than the fourth, intermediate joints slightly widened; thorax more than twice as broad as long, the sides strongly rounded and deeply sulcate, anterior angles distinctly produced into a tooth, the disc fulvous, minutely punctured when seen under a very strong lens; scutellum black, broad; elytra widened towards the middle, testaceous, with three metallic green transverse bands which do not extend to the lateral margins; of these bands, which are all connected with each other at the suture, the first is of somewhat irregular shape and does not extend to a third of the length of the elytra, its posterior edge is irregularly serrate, the second band at the middle is broader (in a longitudinal sense) and of more regular shape, the third band is again narrow and more or less curved and does not extend to the apex, which remains of the ground-colour; below and the legs black, metatarsus of the posterior legs shorter than the following two joints together, claw-joint strongly swollen.

Hab. Pachitea, Peru.

A handsome species, distinguished by the three bright metallic green elytral bands.

OEDIONYCHIS ILLUSTRIS, sp. n. (Dej. i. litt.) (Plate XV. fig. 11.)

Testaceous, the legs dark fulvous; thorax short, impunctate; elytra convex, scarcely perceptibly punctured, a broad transverse band at the base, another below the middle, not extending to the suture, and the apex purplish violaceous.

Length 8 millim.

Head impunctate, the vertex obscure purplish, the rest of the face testaceous; clypeus strongly raised in shape of a triangular ridge; eyes large; antennæ piceous, the basal joint testaceous below, third joint shorter than the fourth; thorax short and transverse, the sides broadly flattened, the anterior angles produced but scarcely dentiform, the surface impunctate, testaceous; scutellum black; elytra widened towards the middle and convex, extremely minutely punctured, flavous, with two transverse broad purplish bands—the first at the base, not quite extending to the middle nor to the lateral margins, the second, in shape of a transversely subquadrate band, not extending to either margin, another triangular spot occupies the apex; all these bands are separated by nearly equal narrow spaces of the flavous ground-colour, but the basal band extends across the suture; under side and the base of the anterior and intermediate femora testaceous, the rest of the legs and the posterior femora dark fulvous.

Hab. Cayenne.

A species of broadly ovate shape and resembling in its markings *O. biteniata* Baly, but in that species the second elytral band extends to the suture, all are of much more narrow shape, and dull blue instead of metallic purple.

OEDIONYCHIS ILLIGERI, sp. n.

Piceous; thorax flavous, anterior angles not mucronate; elytra closely punctured, flavous, a transverse band at the base, emarginate within the shoulders, a narrower band below the middle, and a triangular spot near the apex, dark fulvous or piceous.

Var. The posterior elytral markings joined.

Length 5-6 millim.

Of short and ovately rounded shape; the head with some deep punctures near the eyes, the vertex piceous, clypeus flavous, eyes well separated, frontal tubercles oblique, rather short; antennæ short, fulvous or black, the third, fourth, and fifth joints equal; thorax strongly transverse, more than twice as broad as long, the sides broadly sulcate, rounded in front, the anterior angles not mucronate but thickened, the surface impunctate, flavous; elytra finely and closely punctured, with three transverse dark fulvous bands—the first at the base, nearly extending to the middle and notched at its anterior margin within the shoulders, the second narrower band below the middle and immediately followed by a triangular spot; neither of the bands extends to the lateral or sutural margins, and they are sometimes tinged with an æneous gloss; metatarsus very short, claw-joint strongly swollen.

Hab. Trinidad.

I possess four specimens of this species, which is of rather small size, and may be known by the shape of the anterior elytral band, which in all cases is notched at the base, and by the position of the posterior bands, which sometimes form but a single broad one.

OEDIONYCHIS DISSEPTA Erichs.

This is evidently a very variable species in size as well as in the markings of the elytra. Erichson has described two varieties, but I have before me others. In the type the elytra have a broad transverse, nearly black band at the base and another one near the apex; this latter band is often reduced to an oval spot, or may be absent altogether; in another form which I received from Marcapata, Peru, together with typical specimens, the thorax has two blackish spots at the middle; then there is a third variety, in which the bands are very much broader and only separated by a very narrow transverse flavous band at the middle. No other structural differences are visible, in spite of a very careful examination, nor do the male genitalia of these varieties show any difference whatever. In all the specimens the clypeus, thorax, and the lateral elytral margins remain flavous, the punctation is extremely fine, the sides of the thorax are nearly straight and are produced anteriorly into a small tooth. *O. signifera* Baly and *O. 5-maculata* Jac., likewise from Peru and Bolivia, seem to be nothing but other varieties in which the elytral markings are reduced to spots; they cannot otherwise be

distinguished. M. Clavareau, of Brussels, has sent me specimens obtained in the Province Huallaga, Peru, which again differ in having the elytral band of a golden coppery tint and fulvous head and antennæ. I am, however, unable to see anything more in these differences than one of colour.

OEDIONYCHIS IMPERIALIS, sp. n.

Pale piceous below, the head, antennæ, and thorax pale fulvous; elytra very closely and finely punctured, purplish-violaceous, the lateral and apical margins and a narrow transverse band at the middle flavous.

Length 9 millim.

Head flavous, impunctate; the frontal elevations broad, contiguous; clypeus strongly raised into a triangular ridge, the anterior edge of which is very prominent; antennæ pale fulvous, the third joint one-half shorter than the fourth (the terminal two joints wanting); thorax more than twice as broad as long, the lateral margins strongly rounded anteriorly, the anterior angles thickened but not dentiform, the sides broadly flattened, the surface minutely and rather closely punctured, pale flavous; scutellum obscure fulvous; elytra widened towards the middle, convex, with narrow reflexed lateral margins, the shoulders prominent, the surface extremely closely and finely punctured throughout, purplish violaceous, a narrow straight transverse band at the middle and the lateral and apical margins (the latter slightly more widely so) flavous; under side and legs pale piceous.

Hab. Yurimaguas, Peru.

This species differs from *O. steinheili* Jac. (Proc. Zool. Soc. 1880, p. 179) in the pale-coloured antennæ, in the differently shaped anterior angles of the thorax, and in the narrow and straight, flavous band of the elytra; the larger size and colour of the elytra separate the species from other nearly similarly marked species, as well as from *O. bifasciata* Baly, which has also differently coloured antennæ and a black apex to the posterior femora.

OEDIONYCHIS OCCIPITALIS, sp. n.

Testaceous, the base of the head and the terminal joints of the antennæ black; thorax impunctate; elytra microscopically punctured, testaceous, a transverse band at the base connected at the suture with another broad band below the middle, black; the breast, abdomen, and the posterior tibiæ more or less piceous or black.

Var. *a.* The elytral bands not connected at the suture.

Var. *b.* Elytra with a spot near the scutellum and an elongate larger spot below the middle, black.

Var. *c.* Elytra entirely testaceous.

Length 4-5 millim.

Head impunctate, black at the vertex, the lower portion testaceous, frontal elevations broad, eyes large; antennæ slender, the lower four or five joints testaceous, the others piceous, third

and fourth joints equal; thorax scarcely more than twice as broad as long, the sides with well-marked flattened margins, feebly rounded, anterior angles not produced, the surface impunctate, testaceous; scutellum piceous; elytra visibly punctured only when seen under a very strong lens, with narrow flattened margins, testaceous, with two transverse nearly black bands, the first at the base, of somewhat triangular shape, and connected at the suture with another broader band below the middle, not extending to the apex, neither of the bands extends quite to the lateral margins; breast and abdomen black, legs testaceous.

Hab. Bolivia.

A small and very variable species, in which the nearly black vertex of the head seems to be the only constant character so far as coloration is concerned. The description is based on a specimen in which the elytral bands are mostly developed; the elytra in this form may be described as black, with the lateral and apical margins, as well as a slightly oblique transverse band at the middle, testaceous, this band not extending to the suture; in this specimen the posterior tibiæ and tarsi are black. In the var. *a* the dark bands are smaller and disconnected, and the posterior one is in shape of an oblong patch on each elytron; in var. *b* there is only a black spot near the scutellum and an elongate larger one placed near the suture below the middle; while in var. *c* the elytra are entirely unspotted. In all these forms, however, the base of the head and the underside remain black.

OEDIONYCHIS ÆNEA, sp. n. (Clark, MS.).

Fulvous; thorax flavous, the sides broadly sulcate; elytra very convex and strongly widened at the middle, minutely punctured, a transverse band at the base and another one, narrowed at the suture and not extending to either margin, violaceous blue.

Length 8 millim.

Head fulvous, impunctate, frontal elevations narrow and transverse, carina acute, eyes not closely approached; antennæ with the third joint much shorter than the fourth, fulvous (the other joints wanting); thorax more than twice as broad as long, the sides strongly rounded and broadly sulcate, the anterior angles slightly mucronate and strongly thickened, posterior margin sinuate at each side, the disc impunctate, flavous; scutellum fusco-violaceous; elytra strongly widened and convex, flavous, with a broad transverse band at the base not extending to the lateral margins, of violaceous-blue colour, but more or less dark fulvous when viewed sideways, another band, rather suddenly widened at its outer end, is placed below the middle but does not extend to either margin; the flavous portion separating these bands is of about the same width as the bands themselves; breast and the femora dark fulvous, tibiæ and tarsi flavous; metatarsus very short, claw-joint strongly swollen.

Hab. Ega, Amazon (*Bates*).

The description of this species is based on a specimen named

by Clark, and formerly in the Baly collection. The colour of the elytral bands, their shape, and the more than usually convex and widened general shape of the insect, distinguish this species. Whether *O. jaculus* Illig. is identical with this or some other similarly marked species I am unable to say, but Illiger's description of the shape of the elytral bands does not agree with that of the insect before me.

OEDIONYCHIS REGINA, sp. n. (Plate XIV. fig. 12.)

Large and broad, black, the last two joints of the antennæ pale yellow; thorax impunctate, flavous, with a large black transverse band; elytra strongly and very closely punctured, metallic dark green; the lateral margins and a transverse band below the middle testaceous.

Length 10 millim.

Head bluish-black, impunctate, except near the eyes, the latter with a flavous spot near the inner margins, widely separated; antennæ slender, black, the last two joints pale flavous, third joint slightly shorter than the fourth; thorax rather more than twice as broad as long, the sides broadly flattened, evenly rounded, the anterior angles thickened, very slightly produced outwards, the disc impunctate, black, the lateral and basal margins flavous; scutellum black; elytra widened below the middle, closely and strongly rugose-punctate, metallic green, the lateral margins narrowly and a slightly wider transverse band, immediately below the middle, testaceous; under side and legs black.

Hab. Espirito Santo, Brazil.

The black thoracic band which extends to the anterior margin, the colour of the antennæ, and the strongly punctured elytra well distinguish this species from any other.

OEDIONYCHIS DIFFICILIS, sp. n. (Clark, MS.).

Black, thorax flavous, impunctate; elytra convex, widened posteriorly, closely and finely punctured, flavous, a broad transverse band at the base and another band below the middle, with the lateral and posterior margins rounded, metallic blue, both bands not extending to the margins.

Length 6-9 millim.

Head impunctate, black, two or three deep punctures are placed near the eyes, frontal tubercles trigonate, nearly connected; antennæ rather long, black, the base at their insertion flavous, third and fourth joints nearly equal; thorax twice as broad as long, the sides rounded anteriorly, the anterior angles produced into a small tooth, the disc impunctate, flavous or fulvous; scutellum black; elytra widened towards the middle, convex, finely and closely punctured, flavous, with two transverse dark blue bands—the first at the base, of regular shape, with its posterior edge straight and not quite extending to the middle, the second band below the latter, its anterior margin straight, but the lateral and apical margins rounded, the last-named some-

times slightly concave near the suture, both bands do not quite extend to the lateral margins of the elytra; under side and legs black, the apex of the abdomen sometimes more or less fulvous; prosternum longitudinally carinate at the middle.

Hab. Peru.

The characteristic feature of this species, by which it may be principally distinguished from the many similarly coloured ones, is the shape of the elytral blue posterior band, of which the posterior edge is broadly rounded instead of straight; the flavous band which separates the blue ones at the middle is generally, but not always, of about the same width as that of the basal dark band, sometimes broader. *O. alacris* Erich. and *O. prompta* Erich. are described with black not blue bands, and the former with the head rufous, the other with a broad median flavous band; other details are not given. The eight specimens before me show no variation of any importance, but I may add that the posterior elytral band is in all cases broader (in a longitudinal sense) than the anterior one.

OEDIONYCHIS COLOMBIANA, sp. n.

Black, the clypeus and the thorax flavous, the latter impunctate; elytra with a few punctures near the base, flavous, a broad band at the base, another at the middle, and the extreme apex metallic blue; abdomen fulvous.

Length 7 millim.

Head bluish black, impunctate, frontal elevations small, transverse, clypeus flavous, carina short and thick; antennæ with the lower and the terminal three joints dark fulvous, the intermediate ones piceous, third joint much shorter than the fourth; thorax impunctate, flavous, the sides deeply sulcate, especially so near the anterior angles which are thickened but not produced, near the base is a very shallow transverse sulcation; scutellum black; elytra extremely finely punctured, with some more distinct punctures near the suture and within the shoulders, flavous, a broad transverse band at the base, not extending downwards to the middle nor to the lateral margins, another band immediately below the middle but of more rounded shape, and the extreme apex metallic blue; breast and legs black, the abdomen and the tarsi more or less fulvous.

Hab. Colombia. (Collection H. Clavareau and my own.)

Closely allied to *O. bipunctata* Chev. (*insularis* Jac.), but the head impunctate, the frontal elevations black, not flavous, and the elytra extremely finely punctured, the posterior band broader, not in shape of a round spot.

OEDIONYCHIS SUCCINCTA, sp. n.

Black, antennæ fulvous; thorax flavous, with an æneous short band at the middle of the anterior margin; elytra flavous, a broad transverse band at the base and another below the middle black, nearly impunctate.

Length $6\frac{1}{2}$ millim.

Head impunctate, the vertex black, the clypeus flavous, frontal elevations scarcely indicated, eyes widely separated, labrum and palpi flavous; antennæ fulvous, the first joint piceous above, third joint shorter than the fourth; thorax strongly transverse, the sides strongly rounded, the anterior angles very prominent and pointed, the lateral sulci narrow, somewhat interrupted anteriorly, not well separated from the discoidal portion, the surface impunctate, flavous, with a transverse short black band at the middle of the anterior margin; elytra with narrowly reflexed margins, extremely minutely punctured when seen under a strong lens, flavous, with two broad transverse black bands, one at the base, the other below the middle, the latter band shorter than the basal one (in a longitudinal sense), neither band extends to the lateral margins and the flavous space separating them is narrow and perfectly regular in shape; below and the legs black.

Hab. Bolivia.

The thoracic spot or band placed at the middle of the anterior margin and the regular shape and black colour of the elytral bands distinguish this species, of which I know only a single specimen.

OEDIONYCHUS WEISEI, sp. n.

Flavous, the base of the head, the antennæ, and the breast and legs black; thorax impunctate; elytra finely and closely punctured, the basal margin and a transverse narrow band below the middle dark metallic blue.

Length 8 millim.

Head with a few fine punctures, black, the clypeus flavous; eyes large, the diameter of each as wide as the intermediate space; frontal elevations oblique, strongly raised, bounded by a deep fovea behind; antennæ scarcely extending to the middle of the elytra, black, the third and fourth joints equal; thorax twice as broad as long, somewhat narrowed anteriorly, the lateral margins strongly rounded, the anterior angles distinctly produced into a tooth, the sides deeply sulcate, the surface impunctate, except when seen under a very strong lens, when some minute punctures are visible, flavous; scutellum black; elytra convex, elongate, but slightly widened at the middle, very finely and closely punctured, the extreme base as far as the shoulders and a narrow band below the middle, not quite extending to the lateral margins, violaceous blue; below and the legs black, abdomen fulvous.

Hab. Colombia.

Much larger than *O. colombiana*; the bands of the elytra blue, the spot near the scutellum absent, and the thorax of entirely different shape; the legs black.

OEDIONYCHUS SELECTA, sp. n.

Pale fulvous; elytra extremely minutely and closely punctured,

a broad transverse band at the base and another below the middle, connected at the suture, metallic green.

Length 9 millim.

Head fulvous, with a few punctures near the eyes, the clypeus with a strongly raised, central carina, eyes large; antennæ long and slender, third joint shorter than the fourth; thorax more than twice as broad as long, the sides strongly rounded, broadly flattened; the disc very convex, very minutely punctured when seen under a strong lens, fulvous; scutellum broad, fulvous; elytra convex, scarcely widened at the middle, with a shallow transverse depression below the base, extremely finely punctured, the punctures of different sizes, with two very broad, transverse, metallic green bands, the first at the base not extending to the margins but nearly to the middle, the second band immediately below the latter, of nearly the same width and not extending to the apex; these bands are therefore separated by a narrow transverse and straight band of the ground-colour which does not quite extend to the suture and rounded at its inner termination; under side and legs fulvous.

Hab. Amazons.

Of more parallel shape than *O. aenea*, and distinguished from that and other similarly marked species by the bright metallic-green bands of the elytra, separated at the middle by a straight narrow fulvous band which does not extend quite to the suture; in *O. bipartita*, which has similarly coloured metallic bands, these are divided *before* and *below* the middle.

ODIONYCHIS CARDINALIS, sp. n. (Clark, MS.).

Piceous, head and thorax flavous, the latter narrowed in front; elytra microscopically punctured, flavous, a broad transverse band at the base and another of more rounded shape below the middle, violaceous blue.

Length 10 millim.

The principal differences which separate this species from many similarly coloured forms are to be found in the large general size, anteriorly narrowed thorax, and the shape of the elytral bands; the eyes are well separated, and the head is sparingly and finely punctured; the frontal elevations and the carina are proportionately broad; the antennæ have very slender and elongate joints, the lower three are fulvous, the rest black (in the British Museum specimen, named by Clark, the antennæ are entirely fulvous). The thorax is less transverse than in many other species, distinctly narrowed anteriorly, with strongly rounded sides, the anterior angles are blunt above, but have a short projection below the margin in front of the eyes; the lateral sulci are rather broad and shallow; the scutellum is flavous; the punctuation of the elytra can only be seen with a very strong lens; of the blue elytral bands, the first extends nearly to the middle and has its posterior margin straight or nearly so, in the second band the anterior and posterior margins are rounded, so that the

flavous portion separating both bands is slightly widened at the suture, the extreme lateral margins and a small triangular space at the apex are of the ground-colour; the under side and legs are dark fulvous or piceous, and the posterior femora have the apex broadly stained with blackish. *O. steinheili* Jac. is a much broader insect with a differently shaped thorax.

Hab. Amazons.

OEDIONYCHIS FULVOTIBIALIS, sp. n.

Obscure piceous below, the clypeus, antennæ, and the tibiæ more or less fulvous; thorax flavous, impunctate; elytra closely and finely punctured, metallic greenish, the lateral margins and a narrow transverse band at the middle flavous.

Length $5\frac{1}{2}$ millim.

Head at the vertex and the frontal elevations greenish, impunctate, a narrow space round the eyes and the clypeus and labrum flavous, frontal elevations subquadrate; eyes large, with a rather deep, punctured sulcus near the inner margins; carina short and blunt; antennæ fulvous, the third joint slightly shorter than the fourth; thorax strongly transverse, the lateral margins straight at the base, rounded in front, the sides deeply flattened, anterior angles not prominent but thickened, the disc impunctate, flavous; scutellum black; elytra slightly widened at the middle, very finely punctured except within the shoulders, where there is a short row of deeper punctures, the lateral margins and a narrow transverse band at the middle flavous, rest of the surface metallic dark green, this colour forming two subquadrate patches on each elytron which extend across the suture; below and the legs piceous, the apex of the posterior femora and the tibiæ and tarsi more or less fulvous; the metatarsus very short.

Hab. Bolivia.

A rather small species, and at once distinguished by the colour of the antennæ and tibiæ.

Elytra with longitudinal bands.

OEDIONYCHIS VITTATIPENNIS, sp. n.

Broad and elongate, flavous; apical joints of the antennæ black; thorax strongly transverse, impunctate; elytra very finely and extremely closely punctured, flavous, the suture, a subsutural and a submarginal longitudinal stripe, connected at the apex, ferrugineous.

Length 10 millim.

Head impunctate, flavous, eyes large, frontal elevations strongly raised, trigonate; antennæ filiform and slender, black, the lower three or four joints testaceous, third and fourth joints equal; thorax twice as broad as long, the sides rounded, broadly flattened, the anterior angles produced into a small tooth, the surface impunctate, flavous; elytra with very close and fine but distinct punctuation, the suture very narrowly and two longitudinal broader stripes, of which one is placed near the suture,

the other near the margin, reddish-fulvous, these stripes are united at the apex but do not extend to that portion of the elytra; under side and legs pale flavous.

Hab. Brazil.

Of this large species three specimens are contained in my collection. Amongst the longitudinally banded species described by von Harold in the *Berl. ent. Zeit.* 1881, there is none which can be compared in size with this species, and all similarly coloured forms have but one elytral stripe instead of two. *O. tenuolata* Har. has the eyes widely separated, a small thorax, and narrow elytral epipleuræ, and is much smaller.

OEDIONYCHIS ADJUNCTA, sp. n. (Plate XV. fig. 12.)

Black; thorax impunctate, the margins flavous; elytra impunctate, a subsutural vitta, the lateral margins, and a short transverse band near the apex, connecting the stripes, flavous.

Length $5\frac{1}{2}$ millim.

Head broad, black, closely and strongly punctured in front of the eyes, the latter small, very widely separated; antennæ very short, the joints moniliform; thorax twice as broad as long, the lateral margins strongly thickened, narrowly sulcate in front, the anterior angles thickened, slightly produced, the disc impunctate, black, all the margins narrowly flavous; scutellum black; elytra without any perceptible punctuation, black, with the lateral margins and a narrow longitudinal stripe at the disc flavous; this stripe extends from the middle of the base to the apex and approaches slightly the suture below the middle, near the apex it is connected with the flavous margin by another oblique transverse thin stripe; below and the legs black.

Hab. Bolivia.

Amongst the species with pale longitudinal stripes, the present one seems most nearly allied to *O. haagi* Har. in colour and pattern, but differs in the entirely impunctate thorax and elytra.

OEDIONYCHIS DONCKIERI, sp. n.

Elongate and parallel, the head fulvous; antennæ and breast more or less black; thorax flavous, impunctate; elytra finely punctured, obscure flavous, a sutural and a discoidal longitudinal band black; legs dark fulvous.

Length 7 millim.

Head rugosely punctured above the eyes, fulvous; frontal elevations strongly raised, broadly trigonate; clypeus short and broadly convex between the antennæ; the latter robust, extending to the middle of the elytra, black, the basal two joints piceous, third and fourth equal, the terminal joints more elongate; thorax rather more than twice as broad as long, not or scarcely narrowed in front, the sides rounded, with a well-marked sulcus, the anterior angles acute but not produced, the disc transversely grooved near the base, impunctate, flavous, rather opaque

scutellum black; elytra of elongate shape, minutely and obsoletely punctured, flavous; the suture and a discoidal longitudinal stripe, both abbreviated near the apex, black; under side obscure blackish, the legs dark fulvous, the tibiæ rather darker, prosternum pale.

Hab. Tasco, Mexico.

Of this species, one of the most elongated of the genus, I received a single specimen from M. Donckier of Paris; the elytral sutural stripe is of narrower shape than the discoidal one.

Elytra blue or black, with flavous lateral and apical margins.

OEDIONYCHIS CINCTIPENNIS, sp. n.

The head, breast, and legs black; thorax fulvous, impunctate; elytra convex, widened posteriorly, metallic blue, closely and distinctly punctured, the lateral and apical margins fulvous; abdomen partly flavous.

Length 7 millim.

Strongly convex and widened posteriorly; the head black with bluish gloss, with a few punctures near the eyes; antennæ black, the lower three joints fulvous below, third and fourth joints equal; thorax with the lateral margins strongly rounded anteriorly, the sides broadly flattened, the disc convex, impunctate, fulvous; scutellum black; elytra widened below the middle, with a short but deep depression within the shoulders, very closely and rather strongly punctured, metallic blue, the lateral margins narrowly and the apex rather more broadly so, fulvous; under side and legs black, the sides of the abdomen more or less fulvous or flavous.

Hab. Peru.

From other similarly coloured species, the present one is distinguished by the posteriorly widened shape and the distinct and close punctuation of the elytra; the latter have in some specimens a very small fulvous spot placed near the suture at the middle, the fulvous margin widens slightly and gradually near the apex, the latter part is also entire, not serrulate as in *O. sagulata* Erichs.

OEDIONYCHIS PALLIDICINCTA, sp. n.

Obscure piceous below, the thorax and legs flavous; tibiæ and tarsi and the apex of the posterior femora black; thorax impunctate; elytra black, entirely impunctate, the extreme lateral and the apical margins more broadly, flavous.

Length $5\frac{1}{2}$ millim.

Of rather flattened shape; the head nearly black, impunctate, deeply transversely grooved between the eyes, the latter very large, frontal elevations broad, transverse; antennæ rather robust, black, the lower two joints and the last one fulvous, third and fourth joints equal; thorax twice as broad as long, the sides rather rounded, deeply sulcate, with strongly reflexed and thickened margins, the anterior angles not produced, the surface

impunctate, flavous; scutellum black; elytra shining, black or nearly so, impunctate, the extreme lateral margins and epipleuræ and the apex more broadly flavous; femora flavous; the under side, tibiæ and tarsi piceous, the apex of the posterior femora black.

Hab. Espirito Santo, Brazil.

A rather small species, not difficult to distinguish, of which I possess two specimens.

OEDIONYCHIS SEMIFOVEOLATA, sp. n. (Plate XV. fig. 5.)

Black, the thorax and abdomen flavous; elytra dark purplish, the disc with longitudinal rows of elongate foveæ, the sides narrowly and the apex broadly flavous.

Length 9 millim.

Head black, impunctate, frontal elevations rather broad; carina acute, black, clypeus flavous at the sides; antennæ black, the basal joint flavous below, third joint shorter than the fourth; thorax more than twice as broad as long, narrowed anteriorly, the sides rounded, with a broad, flattened margin, the anterior angles produced into a tooth, the surface convex, impunctate; scutellum black; elytra dark metallic purplish, margined at the sides and apex with flavous, at the first named place narrowly so, at the latter suddenly widened into a broad band the anterior edge of which is quite straight, the disc impressed with distant, elongate and partly round greenish foveæ, which are placed in rows, interstices entirely impunctate; under side and legs black, abdomen flavous.

Hab. Venezuela.

Closely allied to *O. porosa* Baly, but the elytra of different sculpture, the foveæ isolated and placed in rows, and the abdomen flavous. A single specimen is contained in my collection.

In Duvivier's Catalogue *O. porosa* Baly is given as a synonym of *O. variolosa* Harold, but this requires confirmation, since the size of Baly's species is from $3\frac{1}{2}$ –4 millim., while Harold gives 11 millim as the length; Duvivier, moreover, has only given a short diagnosis, which in these closely allied and numerous groups of insects is quite useless.

OEDIONYCHIS PRETIOSA Baly.

The locality of this species as given by the author is *Brazil*, not *Siam* as stated in Duvivier's Catalogue, 1885.

OEDIONYCHIS CUBANA Harold.

Coleopter. Hefte, xiii. p. 90: Cuba.

This species is not mentioned in any of the Catalogues.

OEDIONYCHIS FLAVOMARGINATA, sp. n. (Plate XV. fig. 9.)

Black, thorax impunctate, the sides broadly flavous; elytra convex, finely and closely punctured, black, the lateral margins narrowly and the apex more broadly flavous.

Length 6–7 millim.

Head with some punctures at the vertex, black, the eyes more or less margined with flavous within and with some distinct punctures; antennæ not extending to the middle of the elytra, black, third and fourth joints equal; thorax scarcely twice as broad as long, the lateral margins straight at the base, rounded in front, the anterior angles produced into a tooth, the sides broadly flattened, flavous, the middle of the disc in shape of an anteriorly narrowed broad band, black, impunctate; elytra rather broad, very closely and finely but distinctly punctured, black, the lateral margins narrowly flavous, this colour widened at the apex into a spot which does not quite extend to the suture; under side and legs black or piceous.

Hab. Espírito Santo, Brazil.

Distinct in its coloration from any other species of the genus known to me; two specimens are before me.

Elytra pale, with small black spots.

OEDIONYCHIS BIPUNCTULATA, sp. n.

Testaceous above, the under side and legs darker; thorax impunctate, with broadly flattened sides; scutellum piceous; elytra very finely and closely punctured, each with a small black spot below the middle.

Length 6 millim.

Vertex of the head stained with piceous, with a central groove and bilobed in front, frontal tubercles short and broad; clypeus convex; antennæ with the lower three joints flavous, the following four black, the rest wanting; thorax strongly transverse, of very even width, the sides straight at the base, rounded anteriorly, broadly flattened, anterior angles thickened, oblique but scarcely produced outwards, the disc impunctate, testaceous, obsoletely depressed in front of the scutellum, the latter triangular, nearly black; elytra strongly convex, nearly parallel, with a short row of deeper punctures within the shoulders, the rest very finely and closely punctured, below the middle a small black spot is placed, halfway between the lateral and sutural margins; under side and femora fulvous; prosternum narrowly elongate, rather convex.

Hab. Prov. Tucuman, Argentine Rep. (*C. Bruch*).

In the markings of the elytra and general coloration this species resembles *O. complanata* Suff., from Cuba, but the latter is smaller, much more depressed in shape, and has impunctate elytra.

OEDIONYCHIS TRILOBA, sp. n.

Elongate, testaceous; head and thorax impunctate, the latter with two trilobed black spots; elytra not perceptibly punctured, each elytron with three black spots, two at the base and one at the middle, the extreme sutural margins from the middle to the apex black.

Length 6 millim.

Head impunctate, frontal elevations broad, well marked, carina very convex and prominent, eyes very large; thorax twice as broad as long, the sides broadly flattened, the lateral margins rather rounded near the base, gradually narrowed anteriorly, anterior angles produced into a small tooth, the surface impunctate, with a transverse depression at the sides near the base, testaceous, the sides with a trilobate black spot, the middle lobe pointed upwards; elytra nearly parallel, with a feeble depression below the base, impunctate, a round black spot on the shoulders, another near the scutellum, and a third spot of transverse shape at the middle, as well as the sutural margins from below the base to the apex, black; under side and legs testaceous.

Hab. Peru.

I know only a single specimen of this species and am not aware therefore if the markings of the elytra are subject to variation, which is probably the case. The species has the frontal carina, however, much more strongly raised than most of its allies, the elytral spots are comparatively large and deep black; this and the similarly coloured suture will assist in the recognition of the species.

OEDIONYCHIS BASINOTATA, sp. n. (Plate XV. fig. 4.)

Piceous, the base of the head and a transverse band at the thorax bluish-black; elytra strongly and closely punctured, with four black spots, placed obliquely at the base in a semicrescent.

Length 6 millim.

Head strongly punctured near the eyes, fulvous, the vertex bluish-black, frontal elevations robust, oblique, carina short and broad; eyes large, each as broad as the dividing space; antennæ scarcely extending to the middle of the elytra, black, the lower three joints more or less flavous below, third joint thinner but as long as the fourth; thorax twice as broad as long, the lateral margins straight at the base, rounded anteriorly, the anterior angles produced into a strong tooth, the sides deeply sulcate and flattened, surface with a few minute punctures, the entire disc bluish-black, the margins fulvous; scutellum black; elytra not depressed below the base and scarcely so within the shoulders, closely and strongly punctured, each with two bluish-black spots at the base placed transversely, the outer one transverse, the inner of more elongate shape; below and the legs nearly black; metasternum raised anteriorly.

Hab. Paraguay.

This beetle differs in the markings of the elytra from any other described species.

OEDIONYCHIS MACULATISSIMA, sp. n.

Ovate, convex, dark fulvous below, vertex of head piceous; antennæ and thorax fulvous, the latter with two transverse, black spots; elytra rather strongly punctured, pale fulvous, with ten spots each (3.3.2.2).

Var. Thorax without spots; elytra greenish-black, the sides and apex rather broadly fulvous.

Length 6 millim.

Of rather short, broadly ovate and convex shape, the head with a few punctures near the eyes, the latter large, each as wide as the intermediate space, the vertex piceous, lower portion fulvous, frontal tubercles narrowly transverse; antennæ extending to the middle of the elytra, fulvous, the third and fourth joints very nearly equal, following joints rather stout and not longer than the fourth; thorax more than twice as broad as long, of equal width, the sides rounded anteriorly, straight at the base, anterior angles prominent with a small tooth, lateral sulci deep and broad, the surface impunctate, fulvous, with a short transverse black band or spot at each side; elytra narrowly margined, rather strongly punctured, fulvous, each with ten black spots, of which three are placed transversely at the base, three below these before the middle, two larger ones nearly connected below the middle, and two others well separated near the apex, there is also another obscure spot placed at the apex on the suture; under side and legs dark fulvous; metatarsus of posterior legs very short, claw-joint strongly swollen.

Hab. Bolivia.

I cannot identify this species with *O. fenestrata* Har., to which it is no doubt closely allied. Von Harold, who gives no details in regard to the shape of the thorax, describes his species as having black antennæ and under side, as well as similarly coloured legs and the elytra with 9 spots only; the thorax also is said to have a single band, not two spots, and the third joint of the antennæ to be distinctly shorter than the fourth: none of these details applies to the present insect. The variety, which at first sight entirely differs in coloration, agrees in every structural detail and also in the colour of the antennæ and under side; there is also a widening of the fulvous band at the sides corresponding with the fulvous space which separates the spots as in the type, and the greenish-black colour likewise is the same in the spotted form, although which of the two may be looked upon as the type is optional.

OEDIONYCHIS DUODECIMNOTATA (Clark, MS.), sp. n. (Plate XIV. fig. 11.)

Testaceous, the terminal joints of the antennæ black; the head and thorax with two black spots, closely punctured; elytra very closely and strongly punctured, the basal margin and five spots on each elytron black; under side black, legs testaceous.

Length 10 millim.

Head with a few deep punctures, flavous, shining, the vertex with two black spots, frontal tubercles bounded behind by a deep groove, labrum black; antennæ slender, testaceous, the terminal six joints black; thorax with strongly produced anterior angles, the lateral margins feebly rounded, the disc broadly flattened at the sides, closely and distinctly punctured, testaceous, with a large black spot at each side; scutellum black; elytra very broad and

rather flattened, evenly, closely, and strongly punctured, the basal margin very narrowly and five spots on each elytron black: of these, one of transverse shape is placed before the middle, two obliquely below the middle, and two others near the apical margin; breast and abdomen black, the last segment and the legs testaceous, the posterior femora with a black spot at the apex.

Hab. Brazil.

Allied to *O. nigromaculata* Sturm, but differing in the black basal elytral margin and the different position of the spots, also in the colour of the antennæ.

OEDIONYCHIS PERSIMILIS, sp. n.

Elongate, testaceous; thorax impunctate, the anterior angles mucronate; scutellum black; elytra not perceptibly punctured, with five black small spots on each (1.2.1.1).

Length 6 millim.

Head impunctate, the eyes rather widely separated, frontal tubercles broadly subquadrate, carina short and rather blunt; antennæ scarcely reaching to the middle of the elytra, testaceous, the third and following joints nearly equal; thorax more than twice as broad as long, the sides rounded, the anterior angles slightly produced outwards into a small tooth, the lateral sulci deep, the surface impunctate, obsoletely depressed in front of the scutellum, the latter black; elytra obscure testaceous, each with five small black spots, of which one is placed on the shoulders, two before the middle obliquely, the inner one near the suture, the fourth spot below the middle near the lateral margin, and the fifth below the sutural spot at some distance from the apex; under side and legs testaceous, the posterior femora with a black spot at the upper edge.

Hab. Chilpancingo, Mexico.

Of more elongate shape than *O. 13-maculata*, and with five spots on each elytron, the spots small and placed rather differently. Both specimens before me are of a very dull obscure testaceous colour in regard to the elytra, but this may be due to discoloration. *O. atroguttata* Jac., from the same locality, is a closely allied species, but it differs in the shape of the thorax, as well as in the position of the elytral basal spots and their number.

OEDIONYCHIS SUBDILATATA, sp. n.

Ovate, medially widened, black; head and antennæ piceous; thorax pale testaceous or whitish, narrowed anteriorly, impunctate; elytra broadly margined, impunctate, testaceous, an obscure transverse band at the base, with two black spots and another below the middle with another larger spot, obscure fulvous.

Length 6-7 millim.

Head impunctate, the vertex black or piceous, frontal elevations narrowly transverse, eyes rather large; antennæ piceous or dark fulvous, the third and fourth joints equal; thorax with distinctly rounded sides, gradually narrowed anteriorly, the angles rather

strongly produced, the sides broadly sulcate, the surface impunctate, whitish-testaceous; scutellum black; elytra widened towards the middle, rather broadly margined, especially so at their greatest width, not perceptibly punctured, with two broad, transverse, sometimes very obscure dark bands—one at the base, containing two black spots, of which one is placed on the shoulders, the other near the scutellum, the second band below the middle, thin which a single larger subtriangular black spot is placed; der side and legs black; metatarsus of the posterior legs rather shorter than the following two joints together; claw-joint strongly swollen.

Hab. Bolivia.

The ground-colour of the elytra is but little lighter than the bands, except when these are well marked: in this case there is only the single spot visible near the scutellum—that is, in a specimen before me; in the others the black spots are well marked, but the bands are obscure.

OEDIONYCHIS ATROPUNCTATA, sp. n.

Testaceous, the breast more or less black; thorax impunctate, the sides broadly flattened; elytra finely and closely punctured, each with five black spots (2.1.2).

Length 5-6 millim.

Head impunctate, with a deep triangular fovea between the eyes, the latter large, rather closely approached; frontal elevations contiguous, distinct; antennæ flavous, the 6th, 7th, and 8th joints more or less piceous, 3rd and 4th joints equal; thorax with broadly flattened sides, the lateral margins rather evenly rounded, the posterior angles produced into a small tooth, the surface impunctate; elytra with rather broadly flattened margins, finely but distinctly and closely punctured; a spot on the shoulders, one near the scutellum, a third at the middle, and two others placed transversely near the apex, black; under side (the black breast excepted) and the legs testaceous; last abdominal segment of the male rather deeply sinuate at each side.

Hab. Brazil.

The number and position of the elytral spots distinguish this species, of which I received a specimen from Mr. C. Bruch, of the La Plata Museum; two others I subsequently obtained from M. Clavareau, who likewise got them from the same gentleman, without indication of a more exact locality.

OEDIONYCHIS ARGENTINENSIS, sp. n.

Black; above testaceous, the apical joints of the antennæ fuscous, the knees and the tarsi black; thorax impunctate; elytra finely punctured, somewhat flattened, each elytron with six small black spots (2.2.2) placed transversely, the last two pairs oblique.

Length $4\frac{1}{2}$ -5 millim.

Head entirely impunctate, broad, the eyes small and round; frontal elevations strongly raised, subquadrate; labrum piceous; antennæ long and slender, the lower four joints pale, the others piceous, third and fourth joints elongate, equal, terminal joints shorter, robust and thickened; thorax about twice as broad as long, the sides broadly flattened, posterior margin perfectly straight, the surface impunctate, testaceous; elytra finely and closely punctured—of the spots, two are placed transversely at the base, one on the shoulders, the other near the scutellum, two at the middle, with the outer one lower than the other, and two of exactly similar position near the apex; breast and abdomen, as well as the knees of all the legs and the tarsi, black; claws strongly swollen.

Hab. Buenos Ayres.

This is another of the small black-spotted species, of which I received two specimens from Mr. C. Bruch, of the La Plata Museum; the position and number of the spots and the colour of the legs separate the species from *O. atropunctata* and others.

OEDIONYCHIS NIGROPUNCTATA, sp. n.

Black, the sides of the thorax broadly testaceous, the surface impunctate; elytra extremely minutely punctured, testaceous, the sutural margins, three small spots at the base, a spot near the suture at the middle, and another below the latter, of each elytron black.

Length 7 millim.

Of posteriorly slightly widened shape; the head with a few punctures at the vertex, the latter black; the space in front of the eyes testaceous, these widely separated; frontal elevations indistinct; clypeus triangularly pointed between the antennæ; labrum obscure testaceous; antennæ extending just below the base of the elytra, black, the third joint slightly shorter than the fourth, this and the following joints robust and proportionately short, subquadrate cylindrical; thorax twice as broad as long, the lateral margins strongly rounded, the anterior angles produced forwards, the sides broadly sulcate, the disc impunctate, black, in shape of a transverse irregular band, the sides broadly testaceous; scutellum black; elytra extremely minutely and closely punctured, testaceous, with three small black spots placed on the basal margin (one at the shoulders and two at the middle) and another larger subsutural spot immediately before, as well as a smaller one below, the middle of each elytron; besides these spots, the disc is stained with irregular fuscous patches, which are specially pronounced near the suture; under side and legs black.

Hab. Bolivia.

A rather peculiarly marked species, of which I know only a single specimen. The elytral fuscous patches are probably due to discoloration.

OEDIONYCHIS TORQUATA, sp. n.

Testaceous, the terminal joints of the antennæ and the breast piceous; head strongly punctured; thorax impunctate; elytra distinctly punctured, with three small black spots, two at the base and one at the middle of each elytron.

Length 6 millim.

Rather flattened above, the head very strongly and deeply punctured; frontal elevations transverse, strongly raised, nearly contiguous; carina short and rather broad; antennæ testaceous, the terminal joints more or less piceous, third and fourth joints equal, apical joints shorter; thorax twice as broad as long, the sides rounded and broadly flattened, anterior angles not produced outwards, the surface impunctate, obsoletely transversely grooved at each side near the base; elytra slightly widened towards the middle, very closely and distinctly punctured at the base, rather more finely so below the middle, the spots placed as in *O. humeralis* Fab., one at the shoulders, one near the scutellum, and the third of oblique shape at the middle; the breast nearly black; legs testaceous, as well as the abdomen.

Hab. Brazil.

I must separate this species from *O. humeralis* Fab., *O. 4-punctata* Schauf., and several others with nearly similar elytral markings, on account of the strongly punctured head and the black breast; the eyes are moderately large and widely separated.

OEDIONYCHIS DECORA, sp. n.

Narrow and subdepressed, testaceous; antennæ black, the basal and the terminal three joints pale; thorax impunctate, the anterior and posterior margins fuscous at the middle; elytra nearly impunctate, each with two basal elongate spots, a transverse band at the middle, and another spot near the apex, fuscous.

Length 5-6 millim.

Head impunctate, testaceous or pale fuscous; eyes very large; frontal tubercles trigonate, nearly joined; antennæ scarcely extending to the middle of the elytra, black, the basal joint testaceous, the terminal three joints obscure flavous, third and following joints equal; thorax flattened, rather more than twice as broad as long, the sides rounded, broadly flattened, the base (in one specimen) with an obsolete transverse groove, the disc impunctate, testaceous, the anterior and posterior margins fuscous at the middle, anterior angles acute but scarcely produced; elytra not perceptibly punctured, testaceous, with four fuscous or piceous marks—an elongate one on the humeral callus, a rounded spot near the scutellum, a short transverse band at the middle, and another larger rounded spot near the apex; under side and legs testaceous.

Hab. Amazons; also Peru.

I may add that the suture of the elytra is sometimes also narrowly marked with fuscous, and that the central band has a short and narrow stripe attached to its outer end, pointing downwards.

Elytra otherwise marked.

OEDIONYCHIS BICOLORATA, sp. n.

Testaceous; the head, antennæ, breast, and the legs black; thorax impunctate, the anterior angles produced; elytra extremely minutely punctured, the anterior two-thirds metallic greenish-eneous, the rest testaceous.

Length 7 millim.

Head with some fine punctures at the vertex, the frontal elevations pyriform; clypeus flavous, strongly transversely raised; antennæ black, the basal joint elongate, strongly widened anteriorly, third joint shorter than the fourth; thorax rather strongly narrowed anteriorly, the sides nearly straight, the anterior angles much produced and pointed, the sides broadly flattened, the surface impunctate, testaceous; scutellum black; elytra very feebly depressed below the base, very minutely and closely punctured, the anterior portion to below the middle metallic greenish, this colour not quite extending to the lateral margins and divided by a straight line from the apical testaceous portion; the breast and legs black; the abdomen testaceous.

Hab. Baños, Ecuador.

This is a peculiarly marked species, of which I know only a single specimen. The thorax has the sides less rounded than is usually the case and the angles much produced; these differences distinguish the species from *O. bolivianus* Jac., previously described, which must find its place in *Asphaera*, as the metatarsus of the hind legs is decidedly elongate; otherwise the coloration of the elytra nearly resembles that of the present species, except that the metallic colour of the latter occupies only the anterior half of the elytra.

OEDIONYCHIS NIGROBASALIS, sp. n.

Testaceous, the intermediate joints of the antennæ black; thorax impunctate; elytra very finely punctured, a transverse band at the base and another one near the apex fulvous, the extreme basal margin black.

Length 7-8 millim.

Head impunctate, testaceous or pale fulvous; eyes very large, rather closely approached; antennæ with the four basal and the two apical joints testaceous, the others black, third and fourth joints equal; thorax with very broadly flattened sides, the lateral margins rounded, the anterior angles produced outwards into a small tooth, the surface entirely impunctate, testaceous; scutellum blackish at the base; elytra testaceous, with a transverse fulvous band at the base; this band is concave at its posterior edge and extends generally downwards in a narrow stripe along the suture, where it is connected with another broad transverse band near the apex, neither of them extends to the lateral margins, and the posterior band is sometimes reduced to a round spot;

under side and legs testaceous; the extreme basal margin of the elytra black.

Hab. Rio Janeiro.

This species is principally distinguished by the narrow black base of the elytra, which extends to the shoulders and limits the fulvous band anteriorly. The colour of the antennæ will further assist in the recognition of the insect.

OEDIONYCHIS PROMINULA, sp. n. (Plate XV. fig. 1.)

Ovately widened posteriorly, black, the apical two joints of the antennæ fulvous; thorax impunctate, narrowed anteriorly; elytra finely punctured, pale fulvous, the apical third portion black.

Length 6 millim.

Head impunctate, with the exception of a single puncture near the eyes, black; the eyes are very large and prominent; frontal elevations strongly raised, rather broad; antennæ long and slender, black, the apical two joints fulvous, third joint shorter than the fourth; thorax twice as broad as long, the lateral margins rounded, the anterior angles thickened and produced into a small tooth, the sides broadly sulcate, the sulcus connected at the base with another shallow transverse groove extending across the disc and close to the basal margin, the rest of the surface impunctate, black, very shining; scutellum black; elytra widened towards the middle, rather broadly margined, minutely and closely punctured, the anterior two-thirds flavous, the rest black; under side and legs black; metatarsus short, claw-joint strongly swollen; prosternum deeply longitudinally sulcate.

Hab. Peru.

Distinguished by the black head, thorax, and under side, and the short and posteriorly rather widened shape of the elytra.

EXPLANATION OF THE PLATES.

PLATE XIV.

- | | |
|---|--|
| <p>Fig. 1. <i>Homophæta angustolineata</i>,
p. 591.</p> <p>2. <i>H. peruviana</i>, p. 399.</p> <p>3. <i>H. argus</i>, p. 591.</p> <p>4. <i>Asphæra albicincta</i>, p. 409.</p> <p>5. <i>A. nitidissima</i>, p. 415.</p> <p>6. <i>A. elegantula</i>, p. 412.</p> | <p>Fig. 7. <i>Asphæra zonulata</i>, p. 404.</p> <p>8. <i>A. tessellata</i>, p. 416.</p> <p>9. <i>A. divisa</i>, p. 418.</p> <p>10. <i>A. tarsata</i>, p. 402.</p> <p>11. <i>Oedionychis duodecimnotata</i>,
p. 454.</p> <p>12. <i>O. regina</i>, p. 444.</p> |
|---|--|

PLATE XV.

- | | |
|---|--|
| <p>Fig. 1. <i>Oedionychis prominula</i>, p. 460.</p> <p>2. <i>O. centromaculata</i>, p. 431.</p> <p>3. <i>O. exclamationis</i>, p. 436.</p> <p>4. <i>O. basinotata</i>, p. 453.</p> <p>5. <i>O. semifoveolata</i>, p. 451.</p> <p>6. <i>O. interrupto-vittata</i>, p. 436.</p> <p>7. <i>O. arcuatofasciata</i>, p. 431.</p> | <p>Fig. 8. <i>Oedionychis bisbinotata</i>,
p. 428.</p> <p>9. <i>O. flavomarginata</i>, p. 451.</p> <p>10. <i>O. ocellata</i>, p. 434.</p> <p>11. <i>O. illustris</i>, p. 440.</p> <p>12. <i>O. adjuncta</i>, p. 449.</p> |
|---|--|

7. Some Additions to the Knowledge of the Anatomy, principally of the Vascular System, of *Hatteria*, *Crocodylus*, and certain Lacertilia. By FRANK E. BEDDARD, M.A., F.R.S., Prosector to the Society.

[Received June 5, 1905.]

(Text-figures 59-69.)

- (1) On some Points in the Vascular System of *Hatteria*, p. 461.
 (2) Notes on certain Veins in the Crocodile, p. 466.
 (3) Notes on the Vascular System of *Ophisaurus*, p. 468.
 (4) On the Anatomy of *Amphisbæna brasiliiana*, particularly of the Vascular System and the Mesenteries, p. 479.

(1) *On some Points in the Vascular System of Hatteria.*

It is a noteworthy fact that, apart from the absence of a copulatory organ, hardly anyone has attempted to utilise the disposition of the internal viscera of *Hatteria* in order to show its primitive, or at any rate isolated, position in the series with regard to other Sauropsida. So far as I am aware, the only internal feature in which *Hatteria* has been alleged to be primitive is in the equal development of the internal surface of the lungs from end to end, there being no trace in this Sauropsidan of the partly or wholly anangious region at the caudal extremity of the lung found in Lizards*, and, of course, especially in Snakes. On the other hand, Osawa† has lately used the internal viscera to emphasise the likeness between *Hatteria* and the Lacertilia, especially even the Agamid Lacertilia. It is, in fact, agreed on all hands that the viscera of this reptile are not widely different from those of Lizards. The absence of a penis could hardly be alleged to be primitive; it would rather seem to be a specialisation.

The vascular system of this reptile does not appear to me to have been much investigated. Osawa, in his otherwise exhaustive survey of the structure of *Hatteria*, has nothing to say of the blood-vessels. Hochstetter‡, however, has given some details concerning the intestinal arteries, quoting an earlier paper by Klaatch§. In the long bibliography given by Messrs. Howes and Swinnerton||, which includes references to papers dealing with "soft parts," as well as with skeleton, I can find no memoir quoted which refers to the vascular system. I am able therefore, as I hope, to add something to our knowledge of this system of organs in *Hatteria*, and to furnish additional evidence towards the settlement of the much-vexed question of the place of *Hatteria* in the system.

* Milano, Zool. Jahrbücher (Abth. f. Anat.), vii. p. 545.

† Arch. f. mikr. Anat. Bd. xlix. p. 113.

‡ Morph. Jahrb. vol. xxvi. p. 217, pl. v. fig. 1.

§ *Ibid.* vol. xviii.

|| Trans. Zool. Soc. vol. xvi. p. 1.

Arterial System.—The arrangement of the aortic arches is precisely like that of the Lacertilia. It is not so different from that of *Lacerta*, *Iguana*, &c. as is the arrangement found in *Varanus*. The carotid arch gives off the usual three branches before joining posteriorly the aortic arch. The third branch, that to the muscles of the shoulder, arises just before the carotid arch joins the aorta.

As to the systemic (aortic) arch (see text-fig. 59), it is interesting to note that on both sides this arch gives off an œsophageal artery; frequently, as is well known, the right arch alone gives off such a branch. Just at the meeting of the two aortæ the subclavians arise. A careful dissection shows (see text-fig. 59, *Scl.*) that both subclavians arise close to each other—and one a little in advance of the other—from the right aortic arch only just before it joins the left. Each subclavian gives off immediately after its origin a forwardly directed vertebral artery, which plunges at once into the parietes. Immediately after the junction of the two aortæ arises the first pair of intercostals. Between this pair and the next arises a gastro-œsophageal artery. This artery is separated from the gastric by three pairs of intercostals, and five pairs of intercostals lie between the gastric and the superior mesenteric artery. The intestinal arteries I need not refer to, as they have been already treated of by Hochstetter*.

It may be mentioned that, as in some other Lizards (e. g. *Gerrhosaurus* †), the pulmonary arch gives off on each side a branch which runs along the windpipe and sends off branches to the thyroid.

Venous System.—There is no question that, apart from details, the venous system of *Hatteria* is distinctly Lacertilian. Nor do the differences which it shows from Lacertilia tend to prove a nearer resemblance to the Chelonia or to the Crocodilia. On the other hand, I believe it possible to detect likenesses to the Ophidia. This, however, in my opinion, does not argue a special affinity between *Hatteria* and the Ophidia, but the antiquity of the *Hatteria* type, which palæontology, as is well known, has proved.

The Lacertilia are distinguished by the double vena cava posterior, which is double, that is to say, as far forward as the gonads, from which point onwards there is but a single trunk formed by the fusion of the two trunks. As a rule, also, there is an asymmetry between the two venæ cavæ, or efferent renals, as they are commonly termed. When there is this difference, the right vessel is of greater calibre than the left. In *Hatteria* we meet with the same conditions, and here the left vena cava is of distinctly less calibre than the right. The two vessels, moreover,

* Morph. Jahrb. vol. xxvi. p. 217.

† Beddard, "Anatomy of *Gerrhosaurus*," P. Z. S. 1905, vol. ii. p. 263, text-fig. 37, P.

Text-fig. 59.

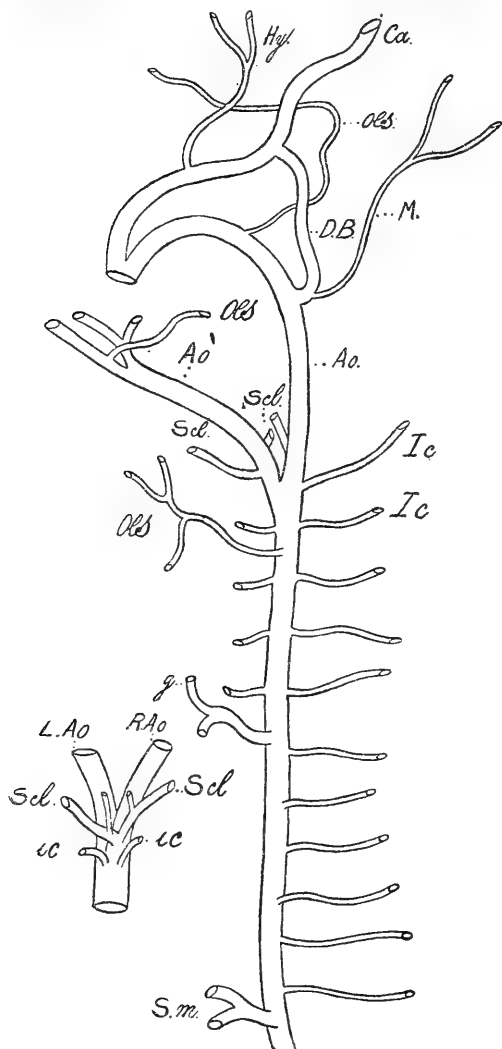
Principal arteries of *Hatteria*.

The left-hand figure represents more in detail the origin of the subclavians viewed from the dorsal aspect.

Ao., *Ao.* Right and left aorta; *Ca.* Carotid; *D.B.* Ductus botalli; *g.* Gastric; *Hy.* Hyoid; *Ic.* Intercostals; *L.Ao.*, *R.Ao.* Right and left aorta; *M.* Muscular branch; *oes.* Oesophageal; *Scl.* Subclavians; *S.m.* Superior mesenteric.

as is also often the case with the Lacertilia, are separated by the dorsal mesentery.

The afferent renals are, as is the case with Lizards, derived from two sources: the caudal vein divides into the two veins of Jacobson and there is also a system of vessels derived from the hind limbs and from the parieties in that neighbourhood. I traced the veins of Jacobson for some way into the substance of the kidney. It appeared to me that they did not directly join the anterior abdominal vein; and in any case it seems clear that instead of there being a branch superficial to the kidney which joins the ischiadic afferent renal system as in other Lizards (for instance, in *Lacerta*, as figured by Hochstetter*), there is at most a branch which effects such a union running within the substance of the kidney. I am inclined even to think that the union is indirect. But in either case there is obviously an approach to the condition observable in non-Boine Snakes, where the anterior abdominal vein is independent of the caudal vein. It will be noted, moreover, that the condition observable in the kidney-region of *Hatteria* is quite remote from that to be noted in the Varanidæ and in the Crocodilia, where the ischiadic, or both the ischiadic and caudal, veins are directly continuous with the anterior abdominal vein or veins, and merely send branches to the kidney. The afferent renal system of *Hatteria* is, as it were, an exaggeration of the typical Lacertilian type.

It is more particularly the anterior abdominal vein which appears to me to show these Ophidian characters, partly matched, however, as I shall indicate later, in a legless Lizard, *Pygopus lepidopus*. In Lacertilia, at least as a rule, the conjoined anterior abdominal and portal veins enter the left lobe of the liver at or quite close to its posterior border.

In Snakes, on the other hand, there is, at least in some cases, a different arrangement. In *Eryx*, for instance†, the portal runs along the side of the liver to its anterior end, giving off branches at intervals to the liver-substance. In *Hatteria* also (see text-fig. 60) this is precisely what happens. The anterior abdominal vein, reinforced by the portal, runs in the membrane which connects the stomach with the left lobe of the liver, giving off branches at intervals to the liver-substance and receiving at intervals branches from the stomach. Towards the anterior end of the liver the conjoined porto-abdominal trunk finally disappears in the liver.

The details of the branching described here in general terms can be understood by a reference to the figure (text-fig. 60). *Pygopus*‡ shows an intermediate state of affairs. The main branch of the conjoined portal and anterior abdominal veins enters the liver near to its posterior extremity, as in Lacertilia

* Morph. Jahrb. vol. xix. pl. xvi. fig. 12.

† "Notes upon the Anatomy of certain Snakes of the Family Boidæ," P. Z. S. 1904, vol. ii. p. 113.

‡ P. Z. S. 1904, vol. ii. p. 17.

generally. A thin branch, however, passing forward along the

Text-fig. 60.

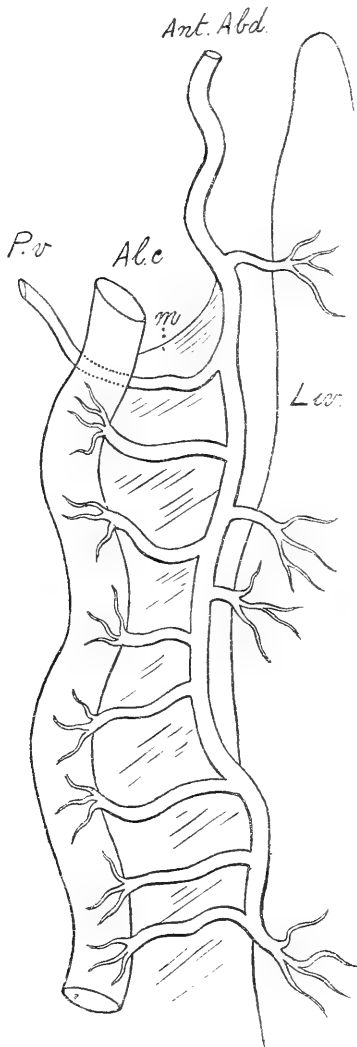
Anterior abdominal and portal veins of *Hatteria*.

Al.c. Stomach; *Ant. Abd.* Anterior abdominal; *Liv.* Liver; *m.* Gastro-hepatic ligament; *P.v.* Portal vein.

stomach, transmits branches to the anterior section of the liver.

This appears to me to be a reminiscence or a prophecy of the forwardly extended portal of *Hatteria*.

The anterior abdominal vein gives off on each side before the union of its two roots a well-developed lateral abdominal vein, so common a feature in the Lacertilia.

It is a noteworthy fact that some of the venous trunks within the liver appear upon the surface of that organ instead of being entirely concealed within its substance. Almost the whole of the vena cava is thus exposed and a considerable section of the hepatic vein.

Another difference from the conditions usually, if not always, to be observed among the Lacertilia is the total absence of dorsal parieto-hepatic veins. This might at first appear to be a point of likeness to the Crocodilia, among which the absence of these veins has been asserted.

(2) *Notes on certain Veins in the Crocodile.*

Parieto-hepatic veins in Crocodilus acutus.—As there appears to be a considerable conflict of opinion as to these veins in the Crocodilia, coupled no doubt with actual differences in different genera, it is perhaps worth while to record the condition of the parieto-hepatic veins in *Crocodilus acutus*.

Contrary to what is to be met with in many Lizards and Snakes*, this Crocodile has three sets of parieto-hepatic vessels, viz. ventral, dorsal, and lateral. The two former alone exist in the Squamata, so far as we know at present.

The dorsal parieto-hepatics exist on both sides of the vertebral column. On the left side they are most extensive and have the following arrangement:—There are five trunks which correspond to as many ribs. The three anterior of these, of which the second and third are the stoutest, combine to form a common trunk, which enters the liver (naturally the left lobe) near its posterior extremity. These vessels, where they emerge from the parietes, receive, each one of them, an intercostal. The last of these three vessels (*i. e.*, that which is most remote from the heart) gives off two branches. One of these seems to be of some morphological importance; the other appears to be less important. The latter is a branch which joins the last intercostal, which takes a share in this section of the hepatic portal system. The vessel in question runs along the “diaphragm,” and, receiving the branch already referred to, enters the liver independently of the main dorsal parieto-hepatic trunk. The branch which I regard as of some little morphological importance arises from the bend of the third of the first three affluents of the dorsal parieto-hepatic; it receives an intercostal and then perforates the dorsal mesentery and joins the system of parieto-hepatic vessels of the right side. I regard this vessel as of importance because it seems to represent a corre-

* In all snakes, so far as my own experience goes.

sponding vessel in *Tiliqua**, which arises on the left side of the vertebral column and joins the right parieto-hepatic. In the Lacertilia generally the dorsal parieto-hepatic veins are on the right side only; and if there are such vessels on the left they either join the right-hand vein before entering the liver, as in *Tiliqua*, or, as in *Iguana*† and *Anguis*‡, supply the gastric and œsophageal networks and thus reach the liver indirectly. It may be said, therefore, so far as present knowledge allows the statement, that the Crocodilia differ from the Lacertilia in having a left as well as a right dorsal parieto-hepatic, entering the liver independently into both right and left lobes.

On the right-hand side of the body the single dorsal hepatoparietal trunk is composed of three stout affluents, of which the two posterior are joined by a cross anastomosis. The anterior vessel is continued forwards superficially and joins, or nearly joins, the right azygos. I may remark that on the left side the gaps between the several superficially running sections of the azygos are more pronounced.

Finally, the venous system of the liver in *Crocodilus acutus* receives another affluent, which is not, as I believe, represented in the Lacertilia. This is a vein which arises from the parietes on the right side, in a position intermediate between the dorsal and ventral parieto-hepatics. This single vein arises from a longitudinally running trunk in the parietes which corresponds, as I think, to the lateral abdominal vein; it passes straight to the liver, which it does not, however, enter independently, but in common with the dorsal parieto-hepatic.

The above-given facts are, as has been already mentioned, not in entire accord with previous statements.

Hochstetter observes § “Eine vena hepatica advehens vertebralis [= my right dorsal parieto-hepatic] wie bei *Lacerta* und anderen nicht vorkommt.” But his observation refers to *Alligator lucius*. Jacquart||, who previously studied the venous system of the same species (“Caïman à museau de Brochet”), makes no particular mention of the vessels which I describe here in *Crocodilus acutus*. He refers to what is possibly the right dorsal parieto-hepatic (figured in fig. 1, pl. iii. 20 d, of his memoir) merely as “une petite veine qui contourne le bord tranchant du lobe droit du foie”; and the vein in question may be really a branch of the ventral parieto-hepatic system. For the possibly corresponding vein of the left side (figured by Jacquart in fig. 1, pl. iii. 41, of his memoir) no special reference is made in the text.

Rathke¶, however, under the name of “vena epigastrica

* Beddard, “Contributions to the Anatomy of the Lacertilia: Pt. I.,” P. Z. S. 1904, vol. i. p. 445.

† Id. *ibid.* p. 440.

‡ Morph. JB. xix. p. 478.

§ Morph. JB. vol. xix. p. 473.

|| Ann. Sci. Nat. (4) ix. 1858, p. 129 &c.

¶ ‘Untersuchungen über die Entwicklung und der Körperbau der Krokodile’ (Braunschweig, 1866), p. 256. The same name is also applied to the abdominal veins; but, I presume, in error for “externæ.”

interna," does describe such vessels as I have dealt with above; but his descriptions do not tally exactly with the facts which I have observed, and it is not clear to what species or even to what genus his observations refer.

There are also *ventral parieto-hepatic* veins connected with the epigastric vein, which are but slightly dealt with by Rathke* and not figured by Jacquart †. These are most conspicuous in the case of the right lobe of the liver. They are partly directly connected with the right epigastric vein and partly enter the ventral parietes separately. There are three of these vessels, which arise from a slender superficial vein running along the ventral surface of the liver and continuous with the anterior abdominal vein posteriorly. The first of these ventral parieto-hepatic veins (*i. e.*, that nearest to the breast) divides into three branches, of which one joins the epigastric and the others plunge into the ventral parietes separately. The second vein is at about the middle of the liver and joins the epigastric. The third is really given off from the anterior abdominal before it enters the liver and joins the epigastric.

On the left side there is only one of these veins corresponding in position to the stronger and middle one of the three on the right side.

(3) *Notes on the Vascular System of Ophisaurus.*

The most recent memoir known to me which deals with the blood-vessels of *Ophisaurus apus* (*Pseudopus pallasii*) is by Prof. Hochstetter ‡, whose notes refer entirely to the venous system of that Saurian. Some earlier works upon comparative anatomy, such as those of Siebold and Stannius §, contain various facts relating to the blood-vessels. But I find that the recorded knowledge of the course of the arteries and veins in this Lizard is practically confined to Rathke's extensive memoir || and to Hochstetter, and does not enable us to draw up anything like a complete account of the vascular system. I have therefore thought it desirable to utilise a thoroughly injected example of this Lizard, which was treated immediately after death, for the purpose of a further contribution to the knowledge of the vascular system in Lizards, which matter has been for some time occupying my attention.

The origin of the several *aortic trunks* from the ventricle is as in other Lacertilia and a detailed description of the same is therefore unnecessary here. The *carotids* show certain peculiarities which are worth noting. The carotid artery arises from the carotid arch just where it turns over to join the systemic arch of its own side in a fashion which does not appear to

* *Loc. cit.*

† *Loc. cit.*

‡ "Venensystem der Amnioten," *Morph. Jahrb.* xix. 1893, p. 475.

§ *Handbuch der Zoologie*, 2 Theil, Amphibien (Berlin, 1856), p. 225.

|| "Die Aortenwurzeln der Saurier," *Denkschr. Akad. Wien*, xiii. (1857).

characterise other Lizards. As will be seen from the drawing (text-fig. 61), the artery is not merely a branch of the arch, but between the two is an abbreviated rete mirabile. The carotid, in fact, arises by three or four mouths, which at once unite to form the single vessel. This is not shown in a lateral view of the neck-arteries given by Rathke.

One cannot but compare this with the carotid "gland" of the Frog.

Precisely the same mode of origin was shown on both sides of the body, so that we have evidently not to do with an asymmetrical anomaly.

Text-fig. 61.

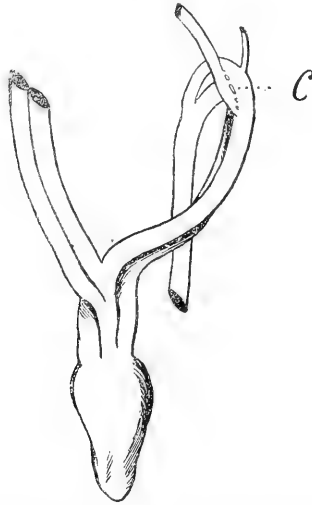

Heart and aortic trunks of *Ophisaurus*, to illustrate mode of origin of carotid (*c*).

Branches of Carotid.—Before the origin of the carotid artery, the carotid arch, as in other Lacertilia, gives off branches, which differ in detail from these other forms. The first to be given off is a branch to the thyroid on the right side; I did not notice a corresponding branch on the left side, and, as will be seen shortly, the right half of that gland receives its blood-supply from another source. The next trunk divides into three principal branches, of which the first supplies the sternal musculature and the adjoining parts, the next is a slender artery which runs under the skin and above the musculature, ramifying out beneath the scales. The third branch goes to the hyoid region.

The right aorta gives off the *subclavian* vessels before joining the left aorta. My observations upon these arteries agree with those of Rathke. They arise by a common stem from that aorta, which,

after giving off at any rate one intercostal twig, divides into two slender trunks diverging right and left. Each of these separates from itself immediately after its own origin a vessel which rapidly plunges into the thickness of the body-wall in the middle line, and which represents on either side the anterior vertebral arteries of other Lizards. In spite of the limbless character of this *Ophisaurus*, the subclavians are still more distinctly recognisable as such than they are in *Amphisbæna*.

The left aorta gives off several vessels to the œsophagus before joining the right aorta, but no intercostals. On the other hand, the right aorta gives off several intercostals before joining the left. Rathke mentions œsophageal arteries as arising from the right aorta.

The carotid artery does not pass up the neck alongside of the trachea. But the windpipe is, as in other Lacertilia, accompanied by an artery. This artery, however, in *Ophisaurus* is only to be seen on the right side of the trachea; on the left there is at most a rudiment of the same. It gives off branches to the thyroid which correspond to those given off on the left side by the carotid arch before it gives off the carotid artery. This tracheal artery arises, as do the corresponding pair in *Hatteria*, &c., from the pulmonary artery. In *Ophisaurus* it is accompanied by a vein of larger calibre than itself, which runs up the neck in close contact with it and again only on the right side. On the left I could discover no traces of a corresponding vein. This vein joins the anterior cava. The asymmetry in this part of the arterial system is noteworthy, for the reason that it is the only part of the arterial system which shows, in correspondence with the snake-like habit of body, any traces of an asymmetry.

The dorsal aorta gives off ventrally a regular paired series of intercostals, which fail apparently nowhere and are even and regularly paired throughout.

Œsophageal and Gastric Arteries.—A striking feature of this Lizard as compared with many is the very large number of trunks arising from the aorta which supply the œsophagus and stomach. There are two or three œsophageal vessels arising from the left aorta before it joins the right. After the junction there are seven small arteries still supplying the œsophagus. Of these, which are not mentioned by Rathke, the first four arise from the aorta itself. After these come three trunks, which arise not from the actual aortic trunk but from the intercostal vessel of the left side. All of the œsophageal arteries are very small and at the same time very convoluted in their course. Following them are five gastric trunks, which are all of greater calibre than the œsophageal vessels. The last three of these are particularly important. A considerable gap separates these gastric vessels from the three chief arteries which end upon the walls of the intestinal canal. Hochstetter has figured three variations in point of origin of these three arteries. In the individual dissected by myself I found one of these three arrangements to

exist, and that was—first the *arteria cœcalis*, second the *arteria cœliaca*, and then, of course, the mesenteric. The cœliac artery is limited to the stomach, liver, pancreas, and spleen. The small branch to the spleen arises on the right side of the mesentery. It is

Text-fig. 62.

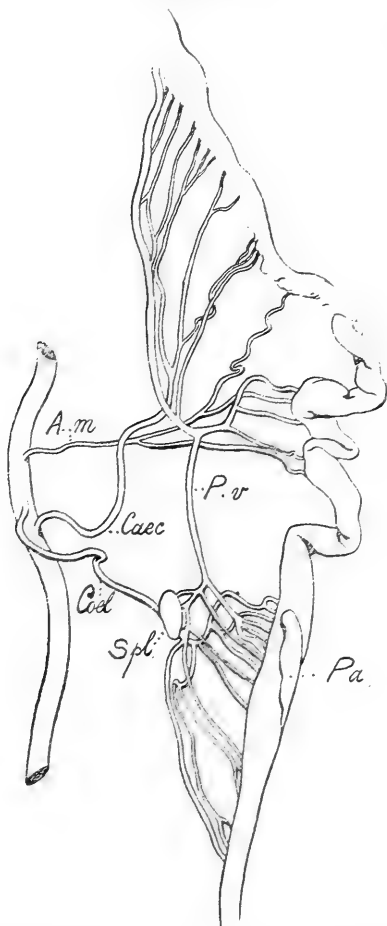
Intestinal arteries and portal of *Ophisaurus*, from left side.

A.m., Mesenteric artery; *Caec.*, Cæcal artery; *Coel.*, Cœliac artery; *Spl.*, Spleen;
Pa., Pancreas; *P.v.*, Portal vein.

thus not seen exactly in the accompanying drawing (text-fig. 62), which represents the arteries and veins seen from the left aspect of the suspensory membrane of the alimentary canal. It is to be

noticed that all three of the important gastro-intestinal arteries in this Lizard arise from the aorta at the same plane exactly. One is not more to the right or left of the median ventral line of the aorta than the others. The hepatic artery accompanies the conjoined abdominal and portal veins in entering the liver. That organ is also supplied by several small branches (see text-fig. 64, p. 475), which naturally owe their blood to the anterior gastric arteries already mentioned, inasmuch as they accompany the gastric veins, which, as is stated below, pour their contents into the anterior region of the liver. I did not detect any further arterial blood-supply of the liver than from the two sources referred to.

Renal Arteries.—These arteries (text-fig. 63, p. 473) are very numerous and show a great regularity, not only in their mode of origin, but in their segmental relations. I counted six separate renal arteries on the right side and seven on the left; and in addition to these the iliac trunks, which also give off the epigastric arteries, send a branch to the kidneys posteriorly. The renal arteries are accurately paired, save that one artery is missing on the right side. That they are otherwise accurately paired is connected with the fact that they all arise in common with the intercostal arteries. Each artery runs over the kidney for some distance before opening into it rather laterally and of course dorsally.

Anterior Abdominal Vein.—This vein is typically Lacertilian in origin and distribution. There are nevertheless two or three facts concerning its branches to which it will be necessary to call attention.

The vein arises as usual by two roots from the caudal vein. On each side before they unite into the single vein each half gives off two small veins side by side to the posterior part of the kidney posterior in position to the parieto-renal afferent veins mentioned below. After the origin of these a larger vein is given off which runs along the body-wall dorso-ventrally and on the outer side of the kidney. This vein dies away anteriorly before the anterior end of the kidney. It is, as I think, the lateral abdominal vein of other Lacertilia. The anterior abdominal vein runs along the mid-ventral line of the body and is supported by a fold of peritoneum, the continuation backwards of the falciform ligament, and thus the equivalent of the primitive ventral mesentery. The vein joins the portal before entering the liver close to the gall-bladder.

Hepatic Portal System.—The intestinal portal vein posteriorly frees itself from the large intestine, along which it runs in close apposition, at the junction of the small and large intestines. Henceforth it lies at some distance from the intestine in the mesentery. It is noteworthy that this main portal trunk lies on the left side of the dorsal mesentery, so that it lies superficially to the arteries when this mesentery is viewed from the left side. The vein, moreover, contrasts with the arteries over which it runs

by its straight as opposed to their highly sinuous course. This applies also to the affluents of the portal, which, so far as concerns the small intestine, are five in number.

Text-fig. 63.

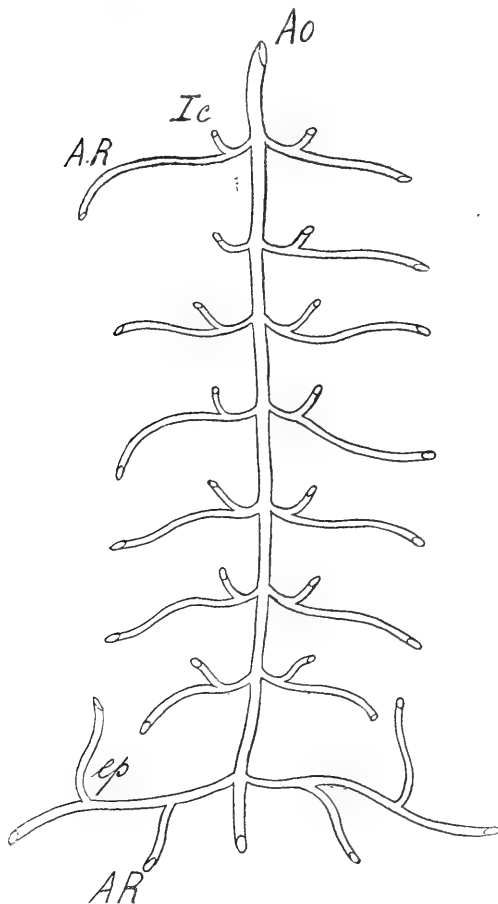
Renal arteries of *Ophisaurus*.

Ao. Aorta; *A.R.* First and last renal arteries; *ep.* Epigastric; *Ic.* Intercostal.

The gastric affluents of the portal trunk arise from both sides of the stomach. On the right side is a vein which runs forward along the stomach to nearly its anterior end, but stops a little before a region of the stomach the veins of which instead of joining the main portal system open independently into the liver; the arrangement of these veins will be considered presently. At

the posterior end of the stomach this portal affluent joins the main portal trunk in the immediate neighbourhood of the junction of the latter with the anterior abdominal vein.

On the left side is a corresponding vein which takes up blood from the spleen as it passes that viscus.

The liver anteriorly is supplied (see text-fig. 64, p. 475) with a series of some five gastro-hepatic veins, which run across from the stomach to the liver, where they are collected into a longitudinal vein before opening directly into the liver. This forwardly directed vessel is not, however, a direct prolongation of the conjoined portal and anterior abdominal as in *Hatteria**. This vein also receives the dorsal parieto-hepatic affluents of the hepatic portal system, which will be dealt with immediately. Accompanying each gastro-hepatic vein is an artery, which arteries I have already described above. The close association of gastro-hepatic veins and supplementary hepatic arteries is very reminiscent of what is to be found among Snakes, and very unlike the prevailing arrangement among Lacertilia. It is doubtless to be correlated with the great length of the liver in *Ophisaurus* and Snakes.

The *dorsal parieto-hepatic veins* are particularly well developed in this Lizard as compared with many other genera. And, furthermore, they differ from those of many other Lacertilia in being mainly developed upon the left instead of upon the right side. There is, in fact, only one of these veins upon the right side. On the left, on the contrary, three or four veins arise from a varied number of intercostal spaces. The most posterior of these runs along the vertebral column for a distance of seven vertebræ, receiving a branch corresponding to each intercostal space. The vertebral affluents of the hepatic portal system which arise in front of this have not so long a course along the vertebral column by far. They emerge from the parietes and at once pass downwards to the portal system. These dorsal parieto-hepatic veins join the longitudinal vein already described, which runs along the dorsal edge of the liver anteriorly and which also receives the gastro-hepatic vessels. The fact that this system is almost entirely developed on the left side is to be compared with the parallel fact that the only one of two *azygos* veins to be retained in *Ophisaurus* is also the left-hand vein.

Epigastric System of Veins.—The smaller veins which run in the umbilical (falciform) ligament and pour their contents into the liver have a somewhat different arrangement from that found in certain other Lizards. The system, instead of consisting of one continuous vein running in the falciform ligament in close apposition to the ventral body-wall in the median line with branches to the liver-substance, consists of two separate veins of considerable size. The anterior of these enters the liver far forwards. It is formed of two veins which unite just before their conjoined entry into the liver, of which the anteriorly

* Above, p. 464, I offer some remarks upon this extension forwards of the portal vein, also on p. 484 of the present communication.

running one is much the shorter; the posteriorly running vein extends back to nearly the end of the liver, but sends no branches into that organ; nor is it continuous, so far as I could make out,

Text-fig. 64.

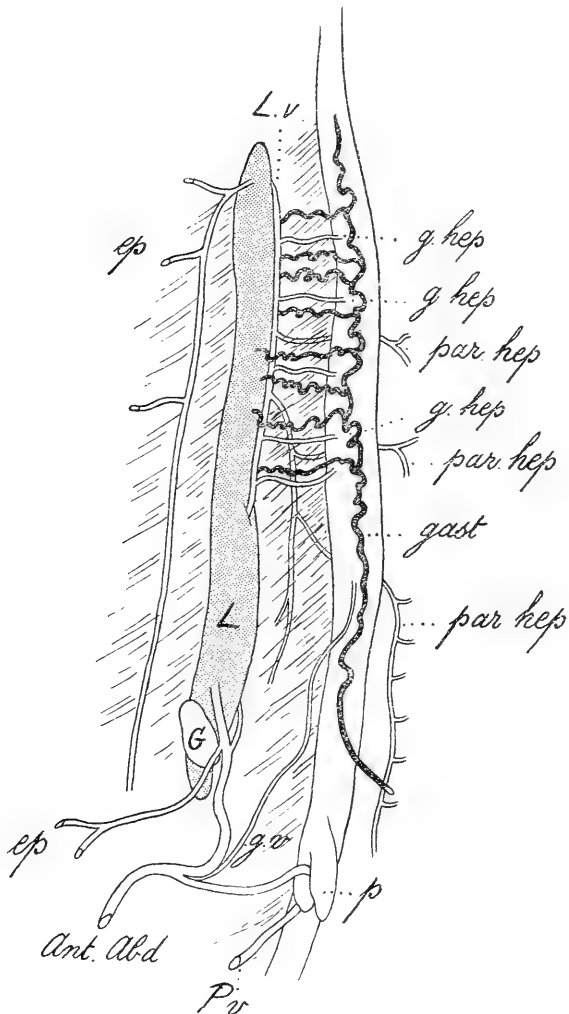
Hepatic portal system of *Ophisaurus*.

Ant. Abd. Anterior abdominal; *ep.* Epigastric veins; *G.* Gall-bladder; *g.v.* Gastric vein; *g.hep.* Gastro-hepatic veins; *gast.* Gastric artery; *L.v.* Lateral vein on liver receiving gastro-hepaties; *L.* Liver; *p.* Pancreas; *par.hep.* Parieto-hepatic veins; *P.v.* Portal vein.

with a second epigastric vein, which, running parallel to and above the anterior abdominal, enters the shelter of the liver at its end close to the anterior abdominal and joins that vein under the lower surface of the right lobe before it loses itself in the substance of the liver. The disposition of these veins will be obvious from an inspection of text-fig. 64.

Renal Portal Veins.—In addition to the veins from the tail which bring blood to the kidneys, these glands are also supplied with blood from the parietes in their immediate neighbourhood. A series of vessels (see text-fig. 65) arises from the body-walls and plunges into the substance of the kidney on either side. These vessels were for the most part partly injected in the specimen at my disposal and can therefore be accurately mapped. The peritoneum in this region of the body as elsewhere is densely pigmented. But the difficulty of seeing through it is removed by the fact that it is very loosely attached to the parietes and to the kidneys, which lie, of course, behind it. When it is carefully removed the veins in question are very plainly exposed. They arise from the parietes very laterally—that is, not at all close to the median dorsal line, whence such vessels ordinarily arise in Lizards. Originally they appear to have been accurately segmental, one arising from each segment as denoted by a rib. In point of fact, however, the vessels belonging to two or to three ribs occasionally unite before opening into the kidney. It is also to be noted that the veins in question pour their contents into the kidney at different levels. Some vessels enter the kidney along its outer edge, while others plunge into its substance more dorsally. This arrangement is roughly alternate. There were six of these vessels to each kidney, but their distribution was not exactly the same on both sides of the body. These vessels do not appear to be referred to by Hochstetter, though he mentions them in *Anguis fragilis*. I have noticed them in other Lizards, where possibly they are represented by the veins from the hind limbs. In any case they are very conspicuous and impossible to miss in *Ophisaurus*, and their arrangement is somewhat different from that which characterises *Anguis*.

It is furthermore to be noted that those veins which enter the kidney more dorsally join in each case one of another series of afferent renals. I counted three of these on the right side, which emerge from the parietes very close to the dorsal middle line. They are rather stouter vessels, and run over the dorsal surface of the kidney nearly to the outer edge of that gland before plunging into its substance. All these parieto-renal vessels become lost in the substance of the kidney. There is no superficially running trunk continuous with the caudal vein posteriorly into which they open. Nor can they be traced into direct and superficial connection with the efferent renal veins.

Supra-renal Portal Veins.—These important veins are naturally referred to by Hochstetter, who has done so much towards the elucidation of this as of other venous systems in the Lacertilia. I

shall, however, describe the conditions observed by me in a male *Ophisaurus* (Hochstetter also examined a male) as an indication of the variability of this region of the venous system. Each

Text-fig. 65.

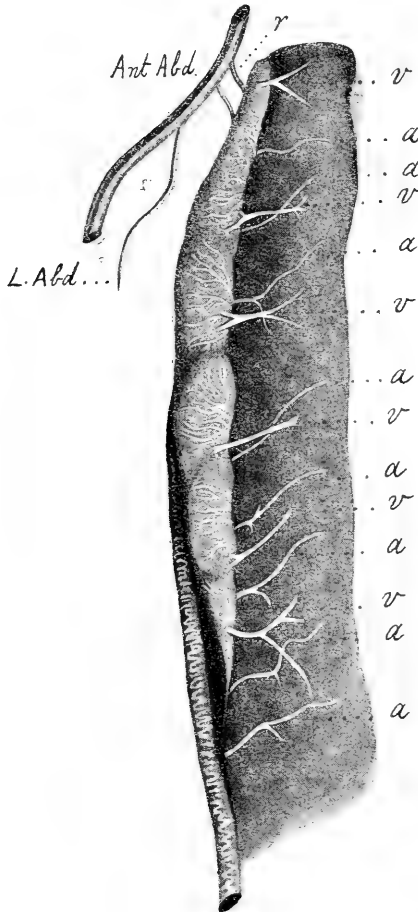
Renal veins of *Ophisaurus*.

a. Intercostal arteries; *Ant. Abd.* Anterior abdominal vein; *L. Abd.* Lateral abdominal vein; *r.* Afferent renals; *v.* Veins running from parietes to the kidney.

supra-renal body has two series of affluent supra-renals, as has *Iguana**. There is an outer series springing from the lateral

* Beddard, "On the Venous System in certain Lizards," P. Z. S. 1904, vol. i. p. 443.

parietes in line with the afferent renal veins that have just been described, and an inner series emerging from the body-wall close to the median dorsal line. Of the latter I observed only one vessel on each side of the body. Of the former there were two on the left side and one on the right. They collected blood, however, from more than one intercostal space. On the left side a blood-vessel belonging to the same series runs from the parietes to the sperm-duct some way behind the testis and supra-renal. I did not observe one of these vessels on the right side.

Résumé.

It may be useful to state briefly the main facts in the circulatory system of this Lizard for purposes of an easier comparison with other forms.

Arterial System.

(1) The *origin of the carotids* from the carotid arch suggests the carotid "gland" of the Frog, inasmuch as the carotid trunk arises by several mouths from the carotid arch as it bends round to join the systemic arch.

(2) As in some other Lizards, the *pulmonary artery* gives off a *branch running along the trachea* and supplying the thyroid body. This exists only on the right side. The artery is relatively small.

(3) The *subclavians* are two slender vessels arising by a common trunk from the right aorta and give off two vertebrales, one arising from each.

(4) The *intercostals* are quite *regularly paired*, and nowhere deficient or asymmetrical. They commence upon the right aorta before it joins the left.

(5) The *left aorta* gives off several *oesophageal branches*.

(6) There are *seven oesophageal arteries* arising from the common aorta, of which the last three arise from the intercostal of the left side.

(7) There are *five gastric arteries* anterior to the cœliac.

(8) The *liver* is supplied with arterial blood from *two sources*. First by the usual Lacertilian *hepatic artery*, which is a branch of the cœliac; and secondly by a number of *small trunks accompanying the gastro-hepatic vessels* and arising from the *gastric arteries*.

(9) The relative positions of the cœliac, superior mesenteric, and cæcal arteries (as has been shown by Rathke and Hochstetter) differ.

(10) The *renal arteries* are *six or seven* in number, arising *in common with the intercostals* and nearly *regularly paired*. The iliac arteries also give off a branch to the kidneys.

Venous System.

(1) The *anterior vena cava* of the right side receives a *branch*

which runs along the trachea parallel with a tracheal artery referred to. This vein does not exist on the opposite side.

(2) The *azygos vein* is developed on the *left side* of the body only.

(3) There is an unusual series of *vestiges of the posterior cardinals*, which, like the anterior vestige of the same, the *azygos*, are upon the left side of the body, and, with the exception of a small twig, not upon the right side. The veins form the dorsal parieto-hepatics, and *pour their contents into a common trunk which runs below the liver only in its anterior region, and which receives also branches from the first half of the stomach.*

(4) The *anterior abdominal vein* receives the portal just before its entrance into the liver, along which it is not prolonged, and just after the entrance of the portal the posterior part of the epigastric vein. The anterior region of the epigastric vein is either separate from the posterior part or joined by the minutest twig; it pours its blood into the liver near to its anterior end.

(5) There are *gastro-hepatic vessels* to the number of *four or five in the anterior region of the stomach and liver* only. The blood from the posterior region of the stomach is chiefly collected into a vessel which runs back along the stomach and joins the combined portal and anterior abdominal.

(6) The *supra-renal portal system* consists of *two series of vessels*, of which one series, consisting of one or more twigs, arises from the parietes laterally; the other series, consisting of one vessel only, arises from the parietes close to the dorsal middle line. Veins also emerge from the parietes and run to the sperm-duct.

(7) The *kidneys receive blood from the parietes* in their neighbourhood by a series of *about six veins to each kidney* arranged metamerically, and corresponding in point of emergence from the parietes with the more laterally placed supra-renal portals.

The two halves of the *anterior abdominal*, before they join, also *give off two twigs to the kidney* on each side

(8) A *lateral abdominal vein* is present, which runs along the kidney on the outer side, but dies away before reaching its anterior end.

(4) *On the Anatomy of Amphisbæna brasiliæna, particularly of the Vascular System and the Mesenteries.*

Though a good deal of information concerning the anatomy of this genus of Lacertilia is already contained in zoological literature*, there remain certain matters which have not been exhaustively studied, either in the species (*Amphisbæna brasiliæna*) with which I deal in the communication now submitted to the Society or in other species. I have therefore, in continuation of a series of dissections of the Lacertilia, some of the results of which

* The principal anatomical memoirs dealing with the viscera are by v. Bedriaga (Arch. f. Naturg. 1884), Smalian (Zeitschr. wiss. Zool. 1885), and Butler (P. Z. S. 1895). In none of these is *A. brasiliæna* dealt with.

have been published by the Society*, attempted to fill in some of the lacunæ in our knowledge of an undoubtedly interesting genus of Lacertilia, the systematic position of which within the order cannot certainly at present be regarded as conclusively decided †.

Mesenteries and Veins of the Liver.—The hepatic ligaments are quite typically Lacertilian, though presenting apparent differences from those of other Lacertilia, which are due simply to the snake-like form of *Amphisbæna* and the correspondingly snake-like form of the liver. In my example of *Amphisbæna brasiliæna*, measuring 15 inches in total length, the liver is 107 mm. or nearly $4\frac{1}{2}$ inches. The smaller left lobe, which extends neither so far forward nor so far backward as the right lobe ‡, is only 73 mm. long. It may be noticed in passing that the liver shows several rather obliquely placed transverse fissures, a state of affairs which is known to exist in burrowing, and also in marine, snakes and in the burrowing Cæcilians. The transverse lobation of the liver is not, however, a very marked phenomenon in this Lizard and might easily be, as it has been by some at any rate §, overlooked.

The *umbilical ligament* is, as in other Lizards, attached along the whole length of the liver from beginning to end. It does not, however, end with the liver, but is prolonged further, in fact to the very end of the abdominal cavity. This fact has been noted by Butler ||, whose remarks, in so far as they bear upon the matter under consideration, are as follows:—"In many Lizards these fat-bodies, pushing the peritoneum before them, bulge into the body-cavity; and, lying on the course of the large vessel, ventral to the . . . bladder . . . and the alimentary canal, into the ventral ligament of which they in some forms (*Amphisbænidae*) obviously extend," &c. Posteriorly, however, in the present species the umbilical ligament is not attached to the gut. It leaves the liver for the stomach at the gall-bladder and ceases to be attached to the stomach on a level with the posterior extremity of the right lobe of the liver. The ligament is single throughout.

The liver is attached dorsally by membranes which find their homologues in other Lacertilia and are indeed but little altered from the arrangements found generally. There are two of these membranes. The left-hand one attaches the left lobe of the liver to the stomach, and the right-hand membrane is the "Hohlvene-gekröse" of Hochstetter, which attaches the vena cava to the dorsal parietes posteriorly and is continued on to the gonad, and which anteriorly has somewhat varying relations among the Lacertilia to the stomach and the parietes. In *Amphisbæna* this mesentery does not reach the dorsal body-wall independently

* P. Z. S. 1904, 1905.

† For a *résumé* of opinion, see Fürbringer, "Beitrag z. Systematik und Genealogie der Reptilien," Jen. Zeitschr. xxxiv. 1900, p. 616.

‡ It thus differs from *A. cinerea* as figured by v. Bedriaga, Arch. Naturg. p. 481 1884, pl. iv. fig. 2.

§ *E. g.* by Cuvier, 'Leçons d'Anat. Comp.' ed. 2, vol. iv. part ii. (1835).

|| "On the Relations of the Fat-Bodies of the Sauropsida," P. Z. S. 1889, p. 603.

of the stomach, to which it is attached. This disposition is possibly due to the absence of a left lung and its accompanying pulmo-hepatic ligament, which in forms where it does occur comes into relation with the right hepato-gastric ligament. At a distance of rather more than 40 mm. from the anterior end of the liver the two dorsal hepatic ligaments unite to form a single membrane, which extends forward for the remainder of the course of the liver. It is at least common, if not the rule, among the Lacertilia, for these two membranes to unite anteriorly. So that the conditions obtaining in *Amphisbæna* are merely an exaggeration of those to be seen elsewhere, and due to the elongation of the liver. I shall recur to this anatomical relationship of the membranes in considering the blood-vessels which run in them.

Text-fig. 66.

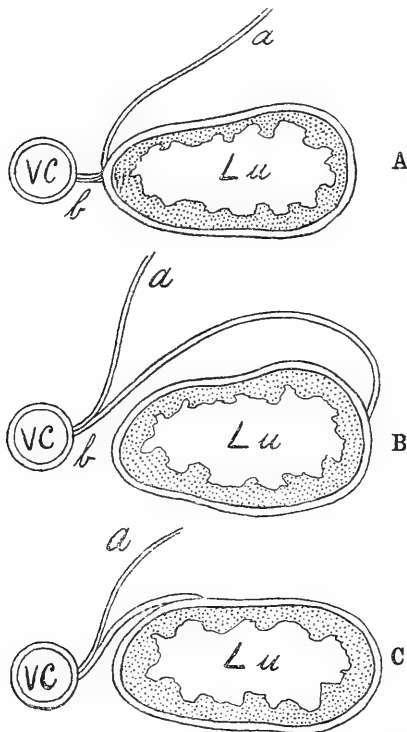

Membranes uniting vena cava and left lung in *Amphisbæna brasiliiana*.

a. Umbilical ligament; *b.* Pulmo-hepatic ligament; *Lu.* Lung; *v.c.* Vena cava.

The liver is also attached to adjacent viscera by a lateral mesentery upon the left side of the body, and uniting the liver with

the fully developed left lung (the only lung, as Mr. G. W. Butler has correctly asserted, which exists in *Amphisbæna*). The pulmo-hepatic ligament in question is attached to the outer border of the lung, where it is first visible (text-fig. 66, **B**) at some little distance from the commencement of the lung, but at a greater distance from the termination posteriorly of that viscus. It is seen to be covered by the umbilical ligament when the reptile is dissected so as to leave the umbilical ligament on the left side; it is furthermore attached at first to that ligament, and has therefore a common attachment with it to the liver. Further forward (text-fig. 66, **C**) the course of the attachment of the pulmo-hepatic ligament gradually moves over the lung obliquely until it comes to lie upon its inner border, *i. e.* that nearest to the liver, or rather by this time the vena cava, for the liver-substance ends anteriorly a good way behind the heart. At the same time the umbilical ligament moves obliquely in the line of its attachment in the opposite direction, so that ultimately (text-fig. 66, **A**) the inner edge of the lung is tied to the opposite edge of the vena cava by a short mesentery which is formed by the fused pulmo-hepatic and umbilical ligaments, while the inner edge of the lung is attached to the median parietes by a ligament which is presumably umbilical ligament only. These relations will be understood by an inspection of the accompanying figures (text-fig. 66), which represent a series of diagrammatic transverse sections through the region of the liver and lung which are dealt with here. These attachments between the liver and lung are not peculiar to *Amphisbæna*, as I believe; but they are specially obvious in that Lizard on account of the elongation of the organs concerned. The only other ligament in this region of the body which remains to be noticed is the pulmo-gastric, which attaches the lung to the stomach. It extends along the whole lung, and is continued beyond it as a fold upon the stomach, extending back as far as the spleen.

Amphisbæna agrees with other Lizards in the possession of a parieto-hepatic system of veins, which seem, however, to be limited to the dorsal body-wall. I could at least observe no such veins in the umbilical ligament belonging to the ventral epigastric system. Of the former there are, as Mr. G. W. Butler has correctly pointed out*, five veins distributed along the course of the liver, and not limited, as they so often are, to the right lobe where it is free from the left. These veins (text-fig. 67) are large and for the most part bifurcate with a long course between the point of emergence from the body-wall and of entrance into the liver. They run, of course, in the right hepato-dorsal mesentery. The large number of these veins is not an important character, for in *Scincus officinalis* I find as many as six. It is their extension along the whole length of the liver which is worthy of note, and is a likeness to the conditions which obtain in the Ophidia.

* P. Z. S. 1895, p. 699, footnote.

Text-fig. 67.

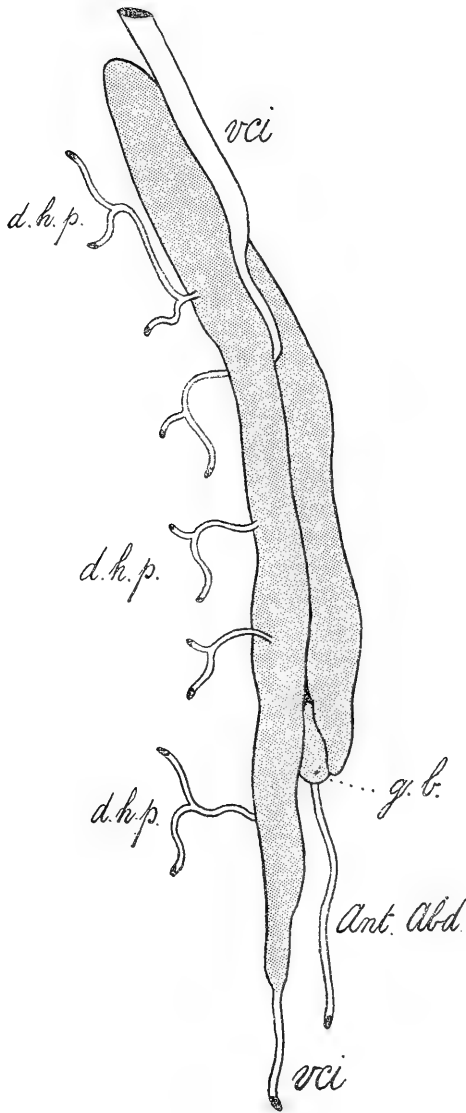
Liver of *Amphisbæna brasiliæna*, ventral view.

Ant. Abd. Anterior abdominal vein; *d.h.p.* Dorsal parieto-hepatic vein;
g.b. Gall-bladder; *vci.* Vena cava posterior.

Between the liver and the stomach runs a forward extension of the portal vein, which dies away anteriorly but nearly reaches the forward extremity of the liver. At first the dorsal parieto-hepatic vessels, where the right lobe of the liver is prolonged beyond the gall-bladder, open directly into the intra-hepatic venous system. But further forward, where the two lobes of the liver come into continuity and the two dorsal hepatic ligaments fuse, the parieto-hepatic portal veins open into (or at least very close to) the forward extension of the portal vein already referred to. It is only in this region that gastro-hepatic vessels occur. The left gastro-hepatic ligament carries no gastro-hepatic vessels, that I could see, in that part where it is free from the right ligament. The vessels, in fact, are first visible about 40 mm. from the anterior end of the liver. They open into the longitudinal portal vessel like the dorsal parieto-hepatic veins.

It is important to notice the likeness which the arrangement of these veins in *Amphisbæna* bears to the similar arrangement of the same veins in Snakes on the one hand and in *Hatteria* on the other. In *Lacertilia*, as a rule, the gastro-hepatic veins bringing blood from the stomach and œsophagus to the liver enter the latter organ separately, or at most one or two blend together before opening into the blood-sinuses of the liver. In *Hatteria*, as I have already pointed out*, there is a collecting-vein, which is a prolongation forward of the portal vein, that is the conjoined portal and anterior abdominal, which runs in the gastro-hepatic ligament on the left side of the body and receives on the one hand veins from the stomach, while on the other side it gives off veins to the liver. There is, however, in *Hatteria*, no further resemblance to the conditions which obtain in *Amphisbæna*. In Snakes there is the further likeness in that, while there is the same forward prolongation of the portal vein forwards between the liver and the stomach, this vein not only receives branches from the stomach which it transmits to the liver from the opposite side, but it is also in connection with the venous system of the body-wall by means of the dorsal parieto-hepatic veins, which thus come, as in *Amphisbæna*, into close relations with the gastro-hepatic veins.

The important point of likeness between all three types is, as it appears to me, the extension forwards of the portal up to or nearly up to the anterior extremity of the liver. The close association in Snakes and in *Amphisbæna* of the dorsal parieto-hepatic vessels with branches from the stomach to the liver seems to me to be dependent merely upon the narrow form of the body and of the liver, and the consequent necessity of packing everything in a narrow space. As it is so markedly the rule for the portal to enter the liver at its hinder border in the *Lacertilia*, these two divergences from that normal condition cannot but attract attention, especially as they show a likeness to the admittedly nearly

* Above, p. 464.

related Ophidia. A likeness between *Hatteria* and the Ophidia fits in well with the view that *Hatteria*, though unquestionably an ancient form, is nevertheless to be placed closer to the Squamata than to any other group of Reptiles. The Amphisbæenids undoubtedly differ much from other Lacertilia, not only in structures related to their apodous condition and snake-like habit, but in various features which have at least no obvious connection with their mode of life. There are no clear indications of their relationship to other Lacertilia*. It may be that the fact dealt with above is of some suggestiveness as a clue to the position of this group, which, judging from its distribution and great modification, would not seem to be a modern type of Lacertilian.

Other Veins.—It has been recorded by v. Bedriaga that the posterior *vena cava* of *Amphisbæna* shows no divergences from the Lacertilian type. The left *vena renalis revehens* turns abruptly to the right at about the middle of the testis, where it receives the left spermatic vein, and from the right *vena renalis revehens* where the latter receives the right spermatic vein. In its course the *vena renalis revehens* of the right side (no doubt of the left also, though I have not positively ascertained the fact) appears to receive several veins from the parietes. These, however, really open into a vein to be described later.

Supra-renal portal veins exist. There were two on the left side and two on the right. On the right side, where circumstances allowed a more careful study, these veins were seen to open into a vein running along the *vas deferens* as figured by Hochstetter † for *Lacerta viridis*. But in *Amphisbæna* this vein runs back to the kidney and receives in its course between the testis and the kidney four veins from the parietes springing close to the dorsal line. In continuation of this series three veins open into each kidney.

This vein is shown in the accompanying figure (text-fig. 68, p. 486). It is clearly the equivalent of the *vena deferentialis* figured and described by Hochstetter in *Varamus* ‡. He does not, however, mention branches to it from the parietes, such as occur in *Amphisbæna*. Considering this latter fact and the relations of the vein to the *vas deferens* (Wolffian duct), I imagine that it is to be regarded as a persistent, though small, posterior cardinal vein.

V. Bedriaga, in his illustration § of the viscera and vascular canals in *Amphisbæna cinerea*, shows veins from the parietes opening into the *vena renalis revehens* of the left side. But this illustration refers to a female example, in which the vein which I have just described may not exist. Moreover, veins running along the oviducal membrane and opening into the kidney-system, such as exist in other Lizards, are obviously not the homologues

* They are, as it appears to me, rightly regarded by Fürbringer as a suborder equivalent to Lacertilia vera, Chamaeleonta, &c.

† Morph. JB. xix. Taf. xvi. fig. 13.

‡ Loc. cit. p. 465, Taf. xvi. fig. 17, v.d.

§ Arch. f. Naturg. Bd. 1. 1884, pl. iv. fig. 2, vv.

of this *vena deferentialis*, or posterior cardinal as I prefer to call it.

Text-fig. 68.

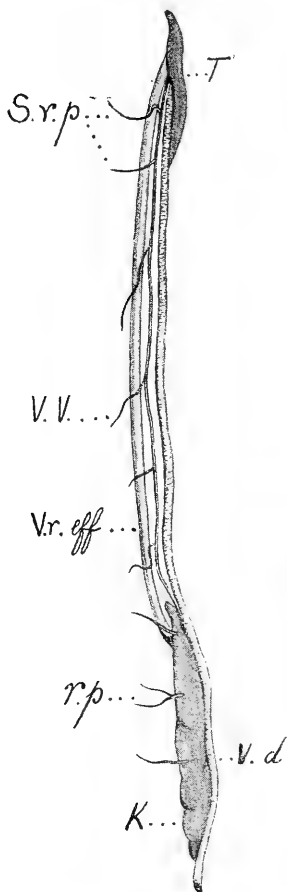

Text-fig. 69.

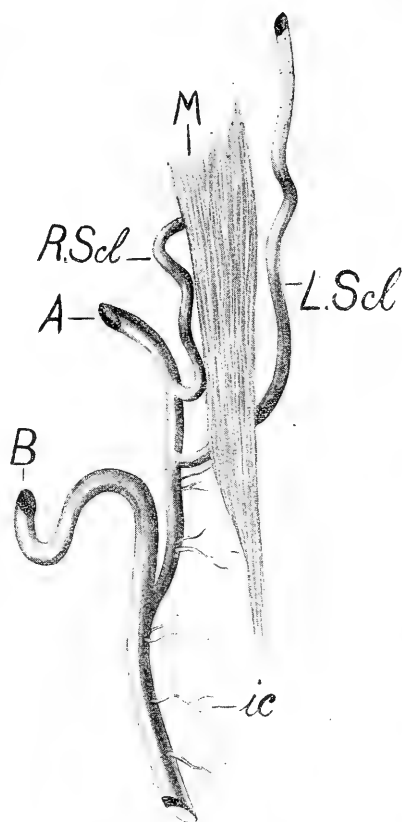
Text-fig. 68.—Kidney, testis, and intervening veins of *Amphibæna brasiliæna*.

K. Kidney; *r.p.* Veins from the parietes to the kidney; *S.r.p.* Suprarenal portals opening into a cardinal; *T.* Testis; *V.d.* Vas deferens; *Vr. eff.* Renal efferent vein; *V.V.* Parietal veins opening into cardinal.

Text-fig. 69.—Origin of subclavian in *Amphibæna brasiliæna*.

A & *B.* Aortic arches; *ic.* Intercostals; *L.Scl.* & *R.Scl.* Left and right subclavian
M. Muscle referred to in text.

Arterial System *.—As is well known, the carotids in *Amphis-*

* The arteries of *Amphibæna* (but not of the present species) are dealt with by Rathke, v. Bedriaga, and Smailian (*Zeitschr. wiss. Zool.* 1885), the last of whom does not give many details.

bæna are not joined by ductus Botalli to the systemic arch. The left systemic arch in *A. brasiliæna* is considerably larger than the right.

The left anterior vertebral artery is not exposed for the whole of its course within the body-cavity. Shortly after its origin from the right aortic arch, and while its course is still oblique and towards the left side of the body, it is covered by a muscular layer, which is a continuation of the thick muscle covering the vertebral centra in the cervical region, and forming a soft cushion for the œsophagus to rest upon, and corresponding, I presume, to the longus colli. This muscle (see text-fig. 69, p. 486), after crossing the left anterior vertebral artery as already mentioned, becomes more and more slender and disappears. It is important to note that it is not symmetrical, and that no corresponding slip covers the right anterior vertebral artery. This curvature of one artery at least by a muscular slip seems to me to have a bearing upon the homology of the arteries.

The origin of these arteries from the right aortic arch, and the fact that one springs from the aortic stem in front of the other, is a distinct point of likeness to the subclavians of other Lizards, which give off an anteriorly running vertebral. The loss of the fore limbs and the increased importance of the neck for burrowing purposes might account for the disappearance of the main subclavian stem and the increase of its vertebral branch. The burrowing of the artery in question beneath the musculature to which I have referred is found in the case of the subclavian of *Tiliqua**.

There are three very slender *œsophageal arteries* arising from the aorta. They are followed by three gastric arteries, of which the last lies a little way behind the gall-bladder. The mesenteric arteries have been shown by Rathke † to differ considerably among the Amphisbænidae. In the species examined by me there is a cœliac artery followed by a common mesenteric; the intestine is also supplied by a posterior mesenteric which arises from the aorta among the renal arteries.

The *spermatic arteries* arise just after the arteria mesenterica communis; the right is slightly in advance of the left. They both arise in common with an intercostal. On the left side an additional spermatic artery arises very close behind the main one.

Behind the spermatic arteries a number of fine arteries supply the vas deferens. Of these I counted six on the left side, and there are about as many on the right. As a rule (five on the left side), these arteries arose directly from the aorta and independently of the intercostal arteries.

The *renal arteries* differ in number on the two sides of the body. I counted four on the left and five on the right side.

* Beddard, P. Z. S. 1904, i. p. 465.

† Abh. Ak. Wiss. München, ix. (1863). See also Hochstetter, Morph. Jahrb. xxvi. (1898).

They very largely arise in common with intercostals. They do not, however, show the continuous symmetry and regularity that is shown by the renal arteries in *Ophisaurus*. In *Amphisbæna cinerea*, v. Bedriaga states the presence of 5-7 pairs of renal arteries, of which the first pair are much the largest and are traceable for a long distance along the outer border of each kidney.

The *intercostal arteries* in *Amphisbæna* are upon the Lacertilian plan, and not upon that shown in the Ophidia in spite of the length of the body. They are paired equisized arteries*, each artery of a pair close together in their origin from the ventral surface of the dorsal aorta. Though these pairs are regular and repeated with no variation from segment to segment, there are nevertheless occasional, but very occasional, indications of a divergence in the direction of the arrangement so characteristic of the Ophidia other than the Boidæ. In one case, on the left side of the body, a single intercostal artery bifurcated immediately after its origin from the aorta and supplied two intercostal regions, one in front and one behind. In another case an intercostal was wanting on the left side, but a branch from the right corresponding intercostal was seen to pass under the vertebra and to supply the left side of the body. Very generally the intercostals branch before becoming lost to sight within the muscles of the dorsal parietes. There are two divisions which burrow, and a trunk which runs superficially outwards between the ribs. This superficial trunk is to be seen in other Lacertilia, particularly among the Scincidæ. No intercostals arise from the left aortic arch, which is, indeed, free from branches of any kind. Three pairs arise from the right aortic arch.

Lungs.—The trachea and lungs of the present species differ very considerably from those of *Amphisbæna fuliginosa*, described and figured by Wiedersheim†. That author figures the lung as extending considerably anteriorly to the heart, and the trachea opens into it by a series of short branches of its lower surface. The arrangement, in fact, is obviously suggestive of the "tracheal lung" of certain Snakes, and especially of the genus *Ophiophagus*, where, as I myself have recently described, the trachea opens by a series of orifices into the pre-cardiac portion of the lung‡. An almost exactly similar specialisation in a Snake, or rather in many Snakes and in a snake-like Lizard, is very remarkable. It seems possible, in view of the fact that the tracheal lung exists in Snakes of quite different families, and that it also exists in *Amphisbæna fuliginosa*§, that this state of affairs is primitive and is to be referred to an Amphibian ancestor in which the lung, as in the Frog &c., opens at once into the pharynx without the intermediation of any length of trachea.

* V. Bedriaga, however, figures the first few intercostals as arising in an irregular and therefore snake-like fashion.

† Vergl. Anat. Wirbelth. 2nd ed. 1886, p. 558.

‡ P. Z. S. 1903, vol. ii. p. 322.

§ Smalian, however (*Zeitschr. wiss. Zool.* 1885), does not find this arrangement.

In any case the tracheal lung does not exist in *Amphisbæna brasiliæna*. The trachea opens into the lung some way behind the heart, and is only continued into the lung for a very short way. The short portion of the trachea which lies within the lung shows an irregularity in the cartilaginous rings, which are no longer uniform hoops. The rudimentary right lung is exactly half an inch long, and, like the long left lung, extends for a short way in front of the entrance of the trachea. The left lung reaches down the body as far as the end of the liver. Of the lung of *Amphisbæna* (presumably the species *fuliginosa*) Dr. Wiedersehheim writes in the same work (referred to in footnote): "Die Lunge, deren interessantes Verhalten zur Trachea ich früher schon erwähnt habe, ist insofern höher entwickelt als diejenige der Lacertilier, als es kein einheitliches centrales Lumen mehr besitzt, sondern von einem feinen Bälkchennetz durchflochten ist." The lung, in fact, of that species would appear to resemble that of higher Reptiles, such as the Crocodilia. In *Amphisbæna brasiliæna* there is nothing of the kind to be seen. The lung is a simple sac as in Lizards generally. It has not, indeed, even traces of a more complex structure, such as are to be found in many Lacertilia. The walls show the usual honeycomb appearance, and they are fairly thick, which would seem to allow of a considerable inflation of the lung. These important differences between two species placed in the same genus would seem to suggest that the genera of Amphisbænidæ need revision. They are remarkably analogous, as I have observed, to the differences which distinguish the Hamadryad Snake from the Cobra; and these two are by many authorities confounded in one genus*.

December 12, 1905.

HOWARD SAUNDERS, Esq., Vice-President, in the Chair.

The Secretary read the following report on the additions that had been made to the Society's Menagerie in November 1905:—

The number of registered additions to the Society's Menagerie during the month of November was 147, of which 64 were by presentation, 24 by birth, 9 by purchase, 35 were received on deposit and 15 in exchange. The number of departures during the same period, by death and removals, was 166.

Amongst the additions attention may be called to:—

An Abyssinian Guereza (*Colobus abyssinicus matschiei*) and a White-tailed Mongoose (*Herpestes albicauda*) from the Upper Nile, presented by Mr. J. J. Harrison, on Nov. 3rd.

A Water-Chevrotain (*Dorcatherium aquaticum*) from Liberia,

* See Beddard, "On the Trachea &c. of the Hamadryad," P. Z. S. 1903, vol. ii. p. 319.

presented by Sir Harry Johnston, G.C.M.G., K.C.B., on Nov. 25th.

A Capybara (*Hydrochoerus capybara*), a Violet-eared Humming-bird (*Petasophora iolata*), two Purple Sugar-birds (*Cæreba cærulea*), two Spotted Emerald Tanagers (*Calliste guttata*), and a Red-billed Toucan (*Rhamphastos erythrorhynchus*), from Carácas, Venezuela, presented by Capt. Albert Pam, F.Z.S., on Nov. 25th.

The Secretary exhibited a coloured print, published by R. Ackermann in July 1812, of Polito's Royal Menagerie at Exeter 'Change, London. Mr. Polito died in 1814, and the Menagerie was taken over by his chief assistant Mr. Cross, a relative of the well-known Liverpool naturalist. The Exeter 'Change Menagerie became famous in 1827, because of the death of an Elephant which became infuriated and had to be killed. The Secretary was indebted to Mr. Howard Saunders, V.P.Z.S., for calling his attention to a long account of this occurrence published in Hone's 'Every-Day Book' for 1827.

Mr. A. H. Cocks, F.Z.S., exhibited twelve enlarged photographs of Whales taken by him at the Finwhaling Factories in East Finmarken in 1883-89. The species represented were *Megaptera longimana*, *Balænoptera sibbaldii*, *B. musculus*, and *B. borealis*.

Mr. Geo. P. Mudge, F.Z.S., exhibited an abnormal Dogfish (*Scyllium canicula*) in which the proximal limb of the siphonal stomach was everted into the pharynx, where it took the form of a flattened spatulate-shaped sac. Within the sac (which was lined with cœlomic epithelium) there were contained the distal loop of the stomach, the spleen and pancreas. That it was a permanent condition, formed in the course of development, he believed to be shown by the great length of the lienogastric artery and by the presence of a peculiar triangular-shaped invaginated sac, supplied by this artery, and infolded from the dorsal surface of the everted loop of the stomach at its anterior end.

Mr. Mudge also exhibited an Earthworm (*Allolobophora* sp.?) with a bifid posterior extremity. It was found at Bradfield, Manningtree, in Essex, and was sent to Mr. Cole, the honorary curator of the Essex Field-Club Museum, who was kind enough to lend it to Mr. Mudge for description. The worm was normal to about the 56th segment, or to rather more than one-half its length, when it divided into two nearly symmetrical branches; the right branch at its origin was just a trifle larger than the left, but otherwise the two were equal.

A distinct anal aperture was present at the posterior extremity of each branch, and indicated that the intestine was branched in

a corresponding way. The dorsal (supra-intestinal) blood-vessel could be distinctly seen through the body-wall, and it branched in the same fashion as the body. Each branch bore its own four rows of setæ.

Mr. H. B. Fantham, B.Sc., F.Z.S., exhibited and made the following remarks upon microscopic preparations of a new Hæmosporidian parasite belonging to the genus *Piroplasma*, from the blood of the white rat:—The parasite is endoglobular and the trophozoites are ovoid (0.5 to 1.5 μ in diameter) or pear-shaped (2 to 3 μ long and 1 to 1.5 μ broad), and usually uninucleate. A single pear-shaped trophozoite often occurs alone in a blood-corpuscle of the host. Some amœboid forms were seen in the spleen. Schizogony takes place inside the red blood-corpuses by simple fission. Double infection of a blood-corpuscle may occur, while free ovoid forms of the parasite have also been seen. For this new species of *Piroplasma* in the white rat, the name *Piroplasma muris* is proposed. The parasites are not numerous in the peripheral circulation of the host, but occur in greater numbers in the spleen, liver, and bone-marrow.

Some of the pathological effects (piroplasmosis) in the white rat, due to this parasite, were anæmia, biliary fever, alopecia, emaciation, ulcers on the ears and tail, enlarged spleen, &c., and proved fatal.

The genus *Piroplasma* is of great interest, as species of it give rise in various mammals to serious diseases, usually of the nature of biliary fever. *P. bigeminum* is the pathogenic agent of Texas Fever (Redwater) in cattle; *P. canis* of malignant jaundice in dogs; *P. equi* of biliary fever in horses; and *P. ovis* of similar diseases in sheep. Piroplasmosis may also occur in the human subject, e.g. *P. hominis* is found in the blood of persons suffering from Spotted or Tick Fever in the Rocky Mountains; while the Leishman-Donovan bodies found in cases of "Kala-azar" and Delhi boil in India are referred by Laveran and Mesnil to this genus, as *P. donovani*. A *Piroplasma* has also been stated to have been found in the blood of certain lizards in India, though details have not yet been published. The symptoms in the white rat seem to exhibit a combination of those enumerated in other mammalian hosts.

Piroplasmosis is usually disseminated by ticks; but no ticks have yet been found on infected white rats. Perhaps the intermediate host in this case is a louse or a flea. No flagellates were found in citrate cultures of the blood of infected white rats, though Capt. Rogers, I.M.S., has obtained flagellates from cultures of *P. donovani*.

Mr. Oldfield Thomas, F.R.S., F.Z.S., exhibited the tail-vertebræ of a Dormouse of the genus *Eliomys* recently received by the British Museum from Central Asia, and stated that it appeared to represent a case of regeneration similar to what occurred in

the tails of Lizards. Any form of regeneration of osseous parts had been hitherto quite unknown among Mammals*.

The external tail of this Dormouse was about 5 cm. in length, and was thickened, fat, and club-shaped terminally, where its hairs, 9 or 10 mm. long on its basal portion, lengthened to 25–28 mm. It formed therefore a sort of bushy club, quite different to the simple distichous tail of a normal specimen. A similar tail had been described in a Liberian Dormouse (*Claviglis crassicaudatus* Jent.†), but the bones had not been examined.

On extracting the bones of the tail, they proved to be of an appearance so closely similar to that found in cases of regeneration in Lizards, that Mr. Thomas had no doubt whatever that they were of the same nature, and search for further examples fully confirmed this opinion.

For, firstly, among the collections of the British Museum there was found an example of a small *Graphiurus* from Fernando Po with a similar club-shaped, bushy tail, always hitherto looked upon as accidentally broken, and this on being opened proved also to contain a long regenerated terminal "style," as shown in fig. 71.

But this specimen, like that from Central Asia, was open to the objection that being a single individual from an out of the way locality, it might conceivably represent a normal specific variation, and not a case of regeneration.

Happily, however, further search had resulted in the discovery of four specimens of a species of *Graphiurus* from the Cameroons, sent by Mr. G. L. Bates, one of which had a club-shaped tail, with a styliform bony appendix, while the other three had normal Dormouse tails. This series thus put beyond cavil the inference already arrived at as to the abnormal character of the specimen exhibited.

Text-fig. 70 shows the tail-vertebræ and regenerated appendix of the Central-Asian *Eliomys*, now exhibited. The caudal column consisted of 11 normal vertebræ, while the proximal end of the 12th was also normal. But distally this vertebra thinned out into a long slender style, its total length being 15 mm. and its diameter (after the basal 2 mm.) rather less than 1 mm. At its tip there was a constriction succeeded by a small thickened knob. The preceding vertebra measured 6·2 × 1·8.

Text-fig. 71 shows the tail of the Fernando Po *Graphiurus*. Here, owing to the original breaking having occurred nearer the body, there appeared to be only about six normal vertebræ preceding the elongated terminal one. This latter was 11 mm. in length, and instead of the knob at the end it had a slightly crooked point. The drawing would show the position of the point relative to the general body of the tail.

On breaking the terminal spike across, its section proved to be

* "In the Mammals neither the legs nor the tail nor the jaws regenerate, although several of the internal organs . . . have extensive powers of regeneration."—Morgan, T. H., 'Regeneration,' p. 97 (1903).

† Notes Leyd. Mus. x. p. 41 (1887).

similar to that in Lizards, there being a central tube filled with soft or cartilaginous matter, and surrounded by a cylindrical bony envelope, of similar appearance and texture to the true caudal vertebræ. A proper microscopic examination and report would, it was hoped, be made by Dr. Ridewood.

In the third specimen from the French Congo the tail had been broken at about a third of its length, and the regenerated terminal vertebra, with its spike, measured 15 mm. in length.

Text-fig. 70.

Text-fig. 70.—Tail-vertebræ and regenerated appendix of a species of Central Asian *Eliomys*.

Text-fig. 71.

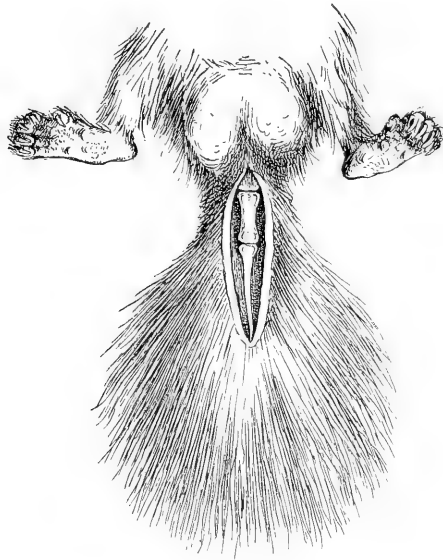
Text-fig. 71.—Tail of a species of *Graphiurus* from Fernando Po showing regenerated appendix.

It seemed clear from these specimens, from the type of *Claviglis crassicaudatus*, as described by Dr. Jentink, and from the appearance presented by certain other skins of *Graphiurus* in the Museum Collection, that in the not uncommon event of losing part of their tail, Dormice—perhaps of all species—were able to supply the place of the lost part by swelling up what remained into a club-shaped organ, clothed externally with abnormally long hairs, and supported internally by an elongated rod of bone growing out of the vertebra in which the break had occurred.

Such a regeneration would be of essential value to the animal, for, in climbing, the tail was used as a balancer, and, if broken off

short, its balancing functions might be restored by the increase in its thickness and length.

Dr. W. G. Ridewood, F.Z.S., exhibited microscopic sections of the skeletal tube found in the restored tail of one of the Dormice (*Graphiurus*) exhibited by Mr. Thomas. He showed that the wall was made up of close-set lamellæ, producing in a transverse section a fine concentric striation. Lacunæ with numerous branching canaliculi were disposed regularly in relation with the concentric striations, and the general effect was that presented by a transverse section of the humerus or femur of a Frog. Internally to the bony layers and contiguous with the central jelly was a moderately thick layer, which was clear, homogeneous, and highly refractive.

Dr. Ridewood also exhibited, by way of contrast, slides of the skeleton of the restored tail of an Iguana Lizard, the skeletal tube in this case being composed of calcified fibro-cartilage and not of bone.

The following papers were read:—

1. On the Habits and Reactions of Crabs bearing Actinians in their Claws. By J. E. DUERDEN, Ph.D., A.R.C.Sc. (Lond.), Professor of Zoology, Rhodes University College, Grahamstown, Cape Colony*.

[Received November 29, 1905.]

(Text-figures 72-76.)

Prof. K. Möbius, in 1880 ('Beiträge zur Meeresfauna der Insel Mauritius und der Seychelles'), described the crab *Melia tessellata* (Latr.) as having the remarkable habit of holding a living actinian in each claw †. The polyps are carried about in front of the crab, held in a kind of defensive attitude, and it is assumed that the actinians, by means of their stinging-threads, may be of service to the crab as aggressive and protective agents and assist it in securing its food; while, on the other hand, the movements of the crab may serve the actinians by bringing them into the neighbourhood of more prey.

The fact of one animal making direct use of an altogether different type of animal whereby to obtain its food, employing it as if it were a weapon or implement, would appear to be unique among the lower animals, and involves questions as to the mutual relationships of the two, the reactions of one towards the other,

* Communicated by Prof. HICKSON, F.R.S., F.Z.S.

† The account is given in a footnote (p. 174) to Dr. F. Richter's Report of the Crustacea of the Mauritius and the Seychelles Islands, the crab with an actinian in each claw being depicted on plate xvi. fig. 19.

the manner in which the combination is brought about, and the peculiarities which each may exhibit in correlation with the commensal habit.

The note by Möbius is as follows:—"I have collected about 50 male and female examples of *Melia tessellata*, all holding in each claw an *Actinia prehensa* [text-fig. 72]. The hooks on the inner border of claws are bent in a peculiar manner, so as to hold fast the actinian. I have never been able to withdraw the actinian from the crab without injury. If the pieces of the actinian which had been thus withdrawn were allowed to remain in the vessel along with the *Melia tessellata*, the latter again seized them in a short time. If the actinians were cut into pieces they were again found in a few hours in the claws of the crabs.

Text-fig. 72.

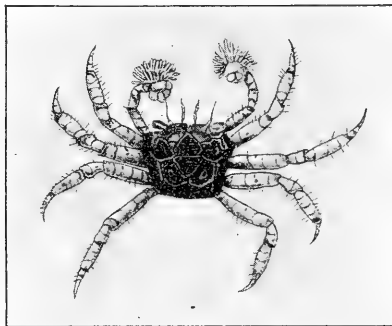

Melia tessellata from Mauritius, holding an actinian in each claw (Richter).

"It is very evident that the actinians by means of the threads of their stinging-cells are able to assist the crab in securing its prey, for which the actinian has the advantage of being carried from one place to another, and by this means is brought into touch with more animals which serve them as food. We have here a very interesting case of commensalism."

Nothing further seems to have been contributed to this peculiar relationship between crab and actinian until Mr. J. Stanley Gardiner's expedition to the Maldives Islands. In the account of the marine crustaceans of this expedition, Mr. L. A. Borradaile ('The Fauna and Geography of the Maldivian and Laccadive Archipelagoes,' vol. i. pt. 3, p. 250) writes of *Melia tessellata* (text-fig. 73, p. 496) as follows:—"The crab, which lives, like *Trapezia*, among the living branches of coral stocks, holding on by its long slender legs, has for some time been known to be in the habit of carrying in each chela a small sea-anemone. The object of this habit is not known, but it is certainly a voluntary act on

the part of the crab, for the actinian is not attached, but held between the fingers of the *Melia*, and, if it be taken away, will be again seized. Usually there is an anemone in each hand, but sometimes one or both hands are empty. The actinians, which

Text-fig. 73.



- a.* *Melia tessellata* from the Maldive and Laccadive Archipelagoes, bearing in each claw a sea-anemone; the crab is represented holding on to a living coral stock.
b. The "hand" holding an anemone. Both enlarged. (After Borradaile.)

are grasped firmly round the middle below the tentacles, may be useful, by means of their stinging-cells, either for defence or to 'fish' for food with, or perhaps for both purposes. The chelipeds

are slender and feeble—ill-suited for defence, but at the same time mobile and well adapted to wield the anemones they carry; and, if the crab be threatened, it will stretch out its arms towards the aggressor, as though it would ward him off with the disagreeable obstacles it thus presents to his attack. Certainly the fingers cannot be used to take food unless the anemone be first dropped; but, on the other hand, the tentacles of the latter are directed outwards, away from the mouth of the crab. The third maxillipeds are mobile, with the proximal joints rather slender and the last three stout, and are fringed with long hairs. Possibly they are used to catch small organisms for food in much the same way as those of the China Crabs (*Porcellanidæ*), which part with their chelipeds so readily when they are attacked, since they do not use them for taking food.

“In any case we seem to have here an interesting example of the use of an implement by an animal which, however intelligent, has at least a very differently organised nervous system from the Vertebrata. It should be noted that the case is different from that of a Spider-crab, which sticks pieces of seaweed on its back and enjoys passively the concealment gotten thereby. For the *Melia* carries the anemone in its cheliped—the chief grasping-organ of the animal, corresponding to the hand of a primate or the trunk of an elephant—and, whatever its use, it cannot be a means of passive concealment, to which its size is wholly inadequate.”

These two accounts leave much to be desired ere we can be said to have a complete acquaintance with the living relationships between *Melia* and its associated actinians, and their peculiarities of habits and reactions.

A short time ago Miss M. J. Rathburn, of the United States National Museum, forwarded me for identification the actinians held in the claws of a specimen of *Melia*. The crab had been collected at Hilo Bay, Hawaiian Islands, by Prof. Henshaw, and the actinian proved to belong to a species of *Bunodeopsis*, a genus well known as occurring in the Mediterranean and the West Indies. During a recent visit by the author to the Hawaiian Islands, under the auspices of the Carnegie Institution, for the purpose of studying the living corals, an effort was also made to procure other specimens of *Melia* and its commensal actinians. On the second day's collecting over the reef-flats at Waikiki Beach, near Honolulu, a single crab carrying actinians (text-fig. 74, p. 498) was obtained, and another a few days later. During all the subsequent collecting, extending over three months, at various points of the islands, no other *Melias* were seen, so that evidently the species is not so common in Hawaiian waters as in the regions visited by Möbius and Borradaile.

Both specimens of *Melia* were found on the dead under surface of coral blocks, not wandering among the branches of the living coral as in Borradaile's experience. Further, Prof. Henshaw, who has on rare occasions collected the crab at Hilo Bay, also

found them on the under surface of blocks of coral. When kept in the laboratory they would sometimes come from under the corals and wander over the living polyps.

The following observations were made upon the two specimens of *Melia*, and a few notes are added upon an example of *Polydectus*—another crab obtained which likewise bears actinians in its claws.

The first *Melia* collected carried a *Bunodeopsis* in each claw. One of the actinians was fully grown, while the other was a mere fragment having two or three large tentacles and several imperfect members. The polyps were held across the column, the tentacular disc directed upwards and the aboral disc downwards; so that when at rest the crab presented the appearance depicted in fig. 74, where, however, the tentacles have been increased to their usual number. Usually the crab travelled with its claws extended a little forwards, sometimes waving them and the actinians from side to side.

Text-fig. 74.

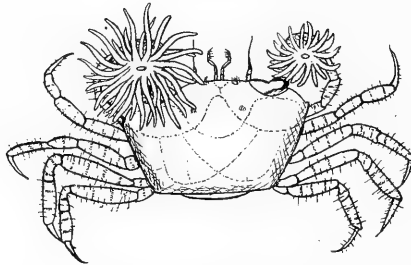

Melia tessellata from the Hawaiian Islands, bearing an expanded actinian in each claw. When food is placed on the disc of the actinians, the first ambulatory limbs of the crab reach over and abstract it and pass it to the crab's mouth.

The actinians were grasped rather loosely, the claws of the crab being about halfway open, and with a little care it was possible to free them, though sometimes the minute spines on the inner side of the claws (text-fig. 75, p. 500) would penetrate and tear the polypal wall as described by Möbius. The claws seemed very feeble and during the operation remained open, making none of the attempts to close and grasp objects, such as one usually experiences when experimenting with crabs. The imperfect polyp was torn during its removal, a minute fragment being left on the chela; but the larger piece quickly recovered from its injuries and expanded its tentacles to their full degree.

The second *Melia* held two small sagartiids, these actinians being of an altogether different type from the *Bunodeopsis*. Both polyps were of about the same size, and were likewise held across the middle of the column in a partly expanded condition. The fact that the two specimens of *Melia* held different forms of

actinians at once makes it certain that the commensalism is not restricted to a single species of actinian, as might have been supposed; moreover, the experiments given below prove that the individual crab will seize whichever of the two forms is presented to it. It may be, however, that the commensalism is limited to these two forms of actinians, *Bunodeopsis* and *Sagartia*. The figure of the actinian which Borradaile gives, reproduced on p. 496 (text-fig. 73), closely recalls the sagartiids found on the Hawaiian crabs, though he writes me that it is to be regarded as only a conventional representation. Richter's figure (p. 495, text-fig. 72) is clearly intended for a *Bunodeopsis*, and there is no reason to suppose that the form is different from the Hawaiian species.

Experiments were first conducted to determine the responses of *Melia* toward different actinians. The first crab was deprived of both its bunodeopsids and then placed in a dish in which were the two sagartiids removed from the claws of the second crab, the polyps lying free upon the bottom of the dish, not fixed by their base. The crab walked about for some time, showing no response whatever which would indicate that it was aware of the presence of the actinians; many a time it would pass in close proximity to them without any recognition signs. Happening in its wanderings to touch one of the sagartiids, it stopped immediately, moved its claws around as if examining the polyp, and then grasped it at an oblique angle and carried it away. After the crab had moved about for some time longer, with one claw occupied and the other vacant, the second sagartiid was intentionally placed so as to touch the unoccupied chela, when it was likewise examined, seized upon, and carried off.

Thus the crab which originally held two bunodeopsids had now provided itself with two sagartiids; hence the species of actinian as regards *Bunodeopsis* and *Sagartia* are interchangeable.

One of the sagartiids was now released and placed in the dish along with its original crab having both chelipeds vacant, the bunodeopsid fragment being also introduced. After a short time the *Sagartia* was seized, and later the small fragment of *Bunodeopsis*. The first *Melia* was also placed in a dish along with its own *Bunodeopsis* and a *Sagartia*, and after a time these were likewise appropriated. Thus each crab was again provided with two actinians but of different species, the one a bunodeopsid and the other a sagartiid. In all the experiments the crabs appeared to seize either one or the other species with equal readiness. Experiments as to the behaviour of the crabs towards other species of actinians were very desirable, but at the time no other forms were available.

The crabs exercised what must unquestionably be considered an intelligent selection, as far as regards the desirability or otherwise of an actinian already held by them. A *Melia* carrying a small fragment of a *Bunodeopsis* in one claw and a perfect *Sagartia* in the other was placed in a dish containing the full-

grown *Bunodeopsis* fixed by its base. While walking about, the crab accidentally came into contact with the large *Bunodeopsis* and stopped as if to examine it; then by means of one of its first ambulatory limbs it began working around the base of the polyp, and after a few minutes detached it. At the same time it moved the claw holding the fragment of *Bunodeopsis* towards its mouth as if to ingest the polyp, but the fragment was merely liberated and left free in the dish, and the empty claw then seized upon the larger *Bunodeopsis* which it had previously dislodged from its substratum. The *Melia* had now a perfect bunodeopsid and a sagartiid. At a later stage the large *Bunodeopsis* was removed and the previously discarded fragment introduced into the dish, when after a time the latter was appropriated.

The fragment of *Bunodeopsis* and also a *Sagartia* were again placed in a dish containing a *Melia* with both its claws unoccupied. These were taken up as soon as the crab came into contact with them, and a second perfect sagartiid was then placed in the dish. The crab with both its claws occupied came into contact with the third actinian, remained near it for some time, and then pushed it away. On returning fifteen minutes later, however, it was found that the fragment of *Bunodeopsis* had disappeared, and its place was occupied by the sagartiid; the *Melia* had detached the bunodeopsid fragment and had taken up the sagartiid in its place. There appeared to be evidence that the crab will tear a single actinian in two in order to provide each claw with a polyp.

METHOD OF HOLDING AND SEIZING THE ACTINIANS.

Usually the actinians were held so loosely within the chelipeds of the crab that the column was but slightly constricted. As mentioned by Möbius, the joints of the chelæ are provided with very

Text-fig. 75.

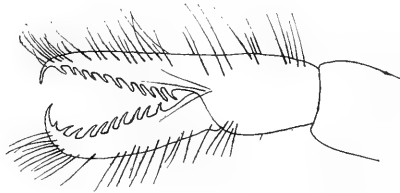

Claw of *Melia tessellata* showing the two rows of spines. Much enlarged.

minute spines, and these no doubt assist in maintaining the polyp in position (text-fig. 75). Occasionally the body of the polyp was held in such a manner that the column was not altogether within the claws, and the wall would then be constricted and indented by the tips of the claws. In preserved specimens the polypal tissues

are sometimes thus deeply constricted and indented, and in one instance the body of the polyp was actually pierced by the two sharp points of the claws coming together. In such cases, it is conceivable that the crab when placed in preservative fluid had closed its chelæ more firmly than usual. Under ordinary circumstances, the actinians do not seem to be in any way injured by the crab. Indeed, the polyps show no signs of their peculiar position being even one of irritation; shortly after seizure they expand to their full degree and remained in this condition, the tentacles outstretched and overhanging.

Numerous observations with the crabs deprived of the polyps lead one to suppose that the actinians are encountered only in a haphazard manner, and also that the crab makes no response to their presence until it comes into actual contact with them. When the crabs with their claws unoccupied were placed in vessels along with free polyps, they would remain still or wander around in an apparently aimless manner, even coming close to the polyps without showing any signs of recognition. When, however, the chelipeds happened to touch a polyp the crab would at once stop, move its chelæ around the polyp for a few seconds, and then open the claws and seize hold of it in almost any position, not necessarily across the column.

In their natural condition, most actinians are firmly adherent by a broad base to some substratum from which they are with difficulty dislodged; and *à priori* it is not manifest how the crabs are able to detach and carry away a polyp thus firmly fixed. Faurot*, who has studied the habits of various Hermit Crabs (*Pagurus*) and their commensal actinians, *Sagartia parasitica* and *Adamsia palliata*, finds that when a Hermit Crab attempts to remove a fixed actinian it seizes it with its maxillipeds and ambulatory limbs, and moves these about as if resisting the escape of some prey. These movements being continued bring about the retraction of the polyp, and in the end the detachment of its pedal disc from the surface of the glass or stone. *Bunodeopsis* and *sagartiids* have each adherent bases, and experiments were made to determine the manner in which they are loosened by the crustacean. After removal from the chelæ the *sagartiids* failed to fix themselves, but remained lying free on their sides; the large *Bunodeopsis*, on the other hand, readily fixed itself to the bottom of the glass vessel, to such a degree that it was not detached by a strong stream of water from a pipette. A *Melia* with empty claws was then introduced into the vessel. In time the crab came into touch with the fixed actinian and began, as usual, to pass its chelæ around it, but without effecting its dislodgment. Then the right member of the first pair of ambulatory appendages was brought forward, and its sharp end was applied between the polypal base and the surface of the glass, exactly in the manner one would apply one's finger in attempting to

* Faurot, L.: "Études sur l'anatomie, l'histologie et le développement des Actinies," Arch de Zool. Exp. et Gén. 3 ser. vol. iii. p. 152.

carefully separate an actinian from its attachment (text-fig. 76). The crab moved round the actinian, inserting the tip of its limb at intervals, until in the end the polyp was dislodged, when it was seized and borne away.

Text-fig. 76.

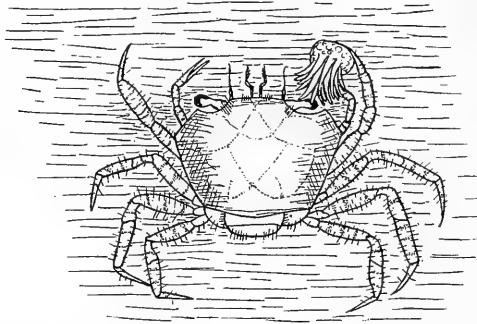

Melia tessellata dislodging a fixed actinian by means of its first ambulatory limb.

The crab *Melia* has thus the remarkable power of being able to detach a sea-anemone fixed to a substratum, proceeding in absolutely the same way as would a collector in endeavouring to secure the same kind of animal. Manifestly it is only by some such method that the actinian can be freed without injury, as the chelæ, along with the other appendages, are almost useless as grasping-organs. In other instances where crabs mask themselves by hydroid, sponge, or algal growths, the fragments are simply torn away by the chelipeds, but the dislodgment of an entire actinian without injury and without the use of the claws is an operation much more complex in character, whether we regard it as an instinctive or an intelligent act.

When first grasped by the crabs the sea-anemones were not necessarily held in the most favourable position, that is, across the middle of the column with the disc directed upwards; at the beginning the chelæ seized them in almost any fashion, so that the disc and tentacles were directed at an angle. In one instance, an actinian which had been thus grasped in an irregular manner was turned towards the maxillipeds and there held in position by the first ambulatory limbs; the chela was then freed from the actinian, cleansed thoroughly, and finally seized the actinian so that it was held across the middle with the disc directed upwards. There seems some evidence also that the actinians themselves institute righting reactions, such as they carry out under more natural conditions; so that, although at first grasped in any position, they are ultimately held across the middle with the

oral disc and tentacles turned upwards, this being the usual relationship when first captured.

Whenever an actinian was removed from the claw of a crab, certain cleansing-operations on the part of the latter invariably took place. Ordinarily the claws have particles of débris adhering to the hairs with which they are provided, as well as to the general surface of the skeleton, the amount being undoubtedly increased by the presence of mucus from the actinian. On the chelipeds becoming unoccupied they were turned towards the mouth, and the masticatory appendages, which are richly provided with bristles and spines, at once began a series of scraping or combing movements over them. So effective were these, that within a short time the claws were altogether cleansed of any adhering foreign particles and presented a much fresher appearance.

REACTIONS.

Under ordinary circumstances the crab when at rest holds its two chelipeds bent towards itself, and the actinians are inclined upwards and outwards with the tentacles fully expanded, thus masking to a certain extent the anterior part of the crab. When walking the chelipeds are held more forwards, and the actinians are then presented in what can be best described as a threatening attitude. It would be impossible for any animal of moderate size to molest the crab in front without touching the polyps. Sometimes the claws are held downwards so that the polyps touch the bottom of the vessel, and on being dragged over it the mucus with which the body is covered leads to the adherence of débris.

If any part of the crab be touched in front, the reflexes are such that the chelipeds are at once extended in the direction whence the stimulus proceeds, the polyps being thereby raised and presented in a defensive attitude. Likewise when irritated from the side, both chelæ are turned laterally, the polyps again being directed towards the region whence the stimulus comes. Similarly, if touched on the upper surface of the carapace or posterior part of the body, the actinians are turned upwards and backwards: in fact, by varying the part stimulated, the chelipeds can be made to turn through about two-thirds of a circle in a vertical direction, and in addition they can perform complex lateral movements. In every case, it may be said that the responses of the crab are of such a nature that the claws bearing the actinians are turned towards the part irritated, thereby placing the polyps in a position most favourable for defence or offence. The reflexes are usually rapid and continue for some time, first in one direction and then in another, according to the region irritated. At the same time the crab generally moves away from the stimulus, backwards or forwards, though the claw reaction, the striking out, always occurs as a preliminary measure: retreat on molestation is by no means so readily resorted to as in most crabs.

It is of much importance to find that exactly the same responses

to stimuli take place in a *Melia* deprived of its actinians as when they are present, but the empty chelipeds make no attempt whatever to grasp the source of irritation as in ordinary crabs. The movable joint (dactylopodite) remains partly open, to about the same degree as when holding an actinian, and its use as an organ for direct protection or attack seems to have altogether disappeared.

The responses of the chelipeds are manifestly so many instinctive reflexes on the part of the crab, directed towards the region whence the irritation comes, and are carried out independently of the presence or absence of the actinians. When the latter are in position, the reactions may be assumed to be aggressive or protective in their nature; while when taking place in the absence of the polyps they are of no protective value, as the claws are useless for grasping or seizing.

Compared with most crabs, it would seem that there is in *Melia* a marked increase in the power of directive response on the part of the chelipeds, accompanied by a loss of activity on the part of the movable joint which ordinarily serves for aggressive purposes; moreover, the chelipeds as a whole are greatly reduced in size.

FEEDING REACTIONS.

Under ordinary circumstances, the *Melias* were often seen transferring towards their mouth the débris occurring on the bottom of vessels or other objects over which they passed. This they accomplished by means of the maxillipeds, with the assistance of the first, second, and even third pair of ambulatory limbs, the first ambulatory pair being the most active. The débris was seized by the maxillipeds, and the nutritive particles were ingested, and the non-nutritive rejected and wafted away posteriorly. The chelipeds, whether empty or holding actinians, took no part whatever in the feeding processes. Even fragments of meat given directly to the crab were treated in the same manner; their passage to the masticatory appendages was effected by the first ambulatory limbs, always without the assistance of the chelipeds.

As the actinians were dragged about from place to place, débris readily adhered to them by means of the viscid slime with which they were covered, and very frequently the first ambulatory limbs were applied to the polypal walls, and the latter were thoroughly cleansed from any adhering particles. The operation was carried out much in the same way as that by which the crab cleansed its own limbs. During the process the actinians were brought close to the mouth, and the débris removed was easily transferred thereto by the appendages. Some of the particles were nutritive, and there is no question that the crab will frequently secure food material thus mechanically adhering to the walls of the polyp. No instance was observed where the crab applied its appendages to the general body-surface of the polyps except when foreign particles were adherent. During the cleansing treatment the

actinians remained altogether passive without even retracting; sometimes the points of the maxillipeds would penetrate the delicate flesh of the polyps and be freed only after a struggle.

By far the most unique and remarkable reactions were those observed when the actinians were supplied with food. When shreds of meat were placed on the disc of the polyp, the latter responded in the usual manner of actinians by bending its tentacles towards the disc and partly closing over the food. If the pieces were too large to be wholly covered and readily ingested, the crab seemed to be soon aware of their presence, and would then bring forward the hook of one of the first ambulatory limbs and apply it to the oral disc from time to time until all the fragments of food were removed and transferred to its own mouth. Thus the freshly broken chela of a small *Alpheus* was placed upon the oral disc of the actinian so carefully as not to touch any part of the *Melia*. Immediately the polypal tentacles closed over it preparatory to ingestion, but before the process was accomplished the first ambulatory limb of the crab reached over among the tentacles and dragged away the fragments to its own mouth.

If the fragment were sufficiently small as to rest wholly on the disc of the polyp, and the latter quickly opened its mouth to swallow it, the *Melia* might then exhibit no responses and the actinian appropriated the food. But in very few instances in a number of feeding experiments were the ingestion reactions of the actinian sufficiently rapid as to wholly indraw the food before the crab would extend an ambulatory limb and vigorously abstract it. In some instances the fragments were already partly swallowed by the polyp when the crab, receiving some stimulus, would extend an ambulatory limb to the polypal disc, and actually abstract the food from the stomodæum of the actinian and transfer it to its own mouth.

The feeding experiments were sufficient to demonstrate beyond all question that Melia actually takes away and appropriates to itself the food procured by the actinian. In the language applied to human actions, it can be truly said that the crab robs the actinian of its food, though no one would think of introducing ethical considerations into the act, even if consciousness could be established.

What are the means by which the crab is made aware of the presence of food-material on the disc of the actinian, or, rather, what determines the very definite responses of the chelipeds towards the disc of the actinians? It is certainly not a tactile reaction, for the responses took place when the food-particles could not possibly have come into contact with the crab or any of its tactile organs. It may have been that the movements of the polyp during ingestion produced some stimulus which was transmitted through the chelipeds, but ordinary stimulation of the actinian by mechanical means failed to call forth any responses on the part of the crab. It is most probable that the reaction is

a result of stimulation by the meat juices emanating from the food on the disc. Fragments of meat or meat extract diffused around the anterior part of the crab called forth vigorous movements of the mouth-appendages and first pair of walking-legs, though directed towards no very definite end; but when the extract was applied towards one side or the other, there was a decided movement of the appendages in that direction. Similarly, juices emanating from the food on the polypal disc may be assumed to serve as the stimuli by which the reflexes are brought about, the source of the stimulation and direction of response being determined from the direction in which the juices reach the crab.

When non-nutritive particles, such as fragments of shell or grains of sand, were placed upon the polypal disc they produced no movements on the part of the actinian; likewise there was no response from the crustacean. Also in other cases substances which called forth no responses on the part of the actinian failed to bring about reactions from the crab. A small spider fallen into the water, and thereby drowned, was given the actinian. The tentacles closed over it momentarily, then withdrew, leaving the spider exposed on the disc. In this case the crab made no attempt to abstract the spider from the polyp, and after a time it was rejected by the latter. Fragments of bread and small pieces of paper placed on the polypal disc called forth no response from the actinian nor any from the crab. In fact, throughout the observations the actinians and crabs responded or remained indifferent to the same substances; in each case ingestion reflexes took place only towards nutritive substances from which stimulative juices might be supposed to emanate, while there was indifference or rejection towards what might be supposed to be non-nutritive substances. Where the food supplied was so small in bulk that the polyp ingested it without any attempt at abstraction on the part of the crab, we may assume that the nutritive juices were so weak that they failed to reach the sensory organs of the crab, and thereby failed to stimulate it to activity.

POLYDECTUS.

While searching among the blocks of coral rock for further examples of *Melia*, a single specimen of *Polydectus cupilifera* (Latr.) was secured, also bearing an actinian in each claw. Both in its form and behaviour the new crab presented a great contrast with *Melia*. The former is very hairy, sluggish, and irresponsive, while the latter is active and most readily responds to stimuli of all kinds.

The actinians held by *Polydectus* were small specimens of a species of *Phellia*, which occurs in abundance on the under surface of rocks and stones all round the Hawaiian Islands. Externally the polyps are characterised by having a thick cuticle over the greater part of the column, a circular area at the apex (the

capitulum) alone being naked. In aquaria they are very inactive and do not readily expand.

Polydectus was under observation for only two or three days, and during most of that time it remained quiescent, hidden under fragments of coral. It allowed itself to be pushed over the floor of the vessel, making only a feeble attempt to escape, and showed little or no activity with its chelipeds. If irritated, the chelæ were not directed against the source of the stimulus as in the case of *Melia*. When the actinians were gently removed from the claws and after a time again presented, the crab made no immediate attempt to seize them. On the whole *Polydectus* proved itself to be a most unsuitable crab for experimental studies.

INTERDEPENDENCE OF CRAB AND ACTINIAN.

Enquiry may now be made as to how far the crab and its actinians are interdependent. Can the crabs maintain their existence deprived of the actinians, and can the latter exist separated from their captors? Although a careful search was made during three months' collecting, no free independent examples of either *Sargartia* or *Bunodeopsis*, the actinians commensal with *Melia*, were met with, and neither Möbius nor Borradaile speaks of finding such. There seems no reason, however, why the actinians should not be able to live separated from the crustaceans. Compared with closely allied species elsewhere, they present no modifications whatever which indicate a correlation with the commensal habit. So far as the actinians are concerned, their presence in the claws of the crab seems of the most incidental character, and it can scarcely be doubted that ordinarily they are fixed isolated species, and may yet be found as such either in the Hawaiian Islands or elsewhere. As regards *Polydectus* and its associate *Phellia*, the latter certainly exists independently of any commensalism, for all round the Hawaiian Islands specimens of the sea-anemone are very numerous, attached to the under surface of stones and coral blocks. These places also constitute the habitat of the crab. In the case of the actinians *Sargartia* and *Adamsia*, commensal with hermit crabs, Faurot has shown experimentally that the polyps do not live long when separated from their host; but the relationship on the part of the actinian is here much closer than in the polyps simply held by *Melia* and *Polydectus*. In *Sargartia palliata*, at any rate, the commensalism is correlated with a permanent modification of form.

The genus *Bunodeopsis* occurs also in the West Indian and Mediterranean seas, where it lives in shallow water loosely adherent to the leaves of the marine phanerogams *Thalassia* and *Ruppia*. In these regions, however, it is never found associated with crabs; indeed, the genus *Melia* is absent from the Atlantic. A careful comparison of the external characters and internal anatomy of the Hawaiian and West Indian species of *Buno-*

deopsis shows no important differences, and they may have to be regarded as one and the same species. Hence the commensal habit may be regarded as not essential to the life of *Bunodeopsis*, and the same can also be said of the *Sagartia* and *Phellia*.

Of all actinians, members of the genus *Bunodeopsis* would appear to be the best adapted for the rôle of commensalism. They are active polyps with long tentacles which are usually expanded to their full extent, and in the absence of a sphincter muscle the column is incapable of overfolding the tentacles. The tentacles are provided with nematocysts of several sizes, and very large stinging-cells occur in the spheroidal outgrowths on the column; and, lastly, the polyps are easily detached from any substratum to which they may be adherent. Were the commensalism of *Melia* restricted to *Bunodeopsis*, its suitability for such a relationship is so pronounced as to suggest more than a haphazard selection on the part of the crab. But when we consider that the same crab will also take up a *Sagartia*, it must be admitted that the wisdom of its selection is not so manifest; for this form retracts readily on slight irritation, does not re-expand so freely as *Bunodeopsis*, and is usually very firmly attached to its substratum. *Phellia*, so far as observations upon its activities in aquaria go, seems even less desirable than *Sagartia* for the cœnobiotic habit.

As regards the dependence of the crabs upon the actinians, the case seems much clearer. Owing to the absence of the usual junctions of the claws, the commensal habit would appear to be necessary to the existence of *Melia*. The claws, when deprived of the anemones, showed no power to grasp or seize other objects, not even when food was presented to them. The maxillipeds and ambulatory limbs transferred to the mouth any nutritive objects offered, but from their non-chelate character these appendages can be of little use in seizing or holding prey or warding off enemies. There is no question that the procuring of food by the crab itself would be very precarious were it not for the assistance of the actinians. Moreover, wherever met with, throughout its wide distribution, the crab is found to bear actinians. According to the observations of Möbius, all the specimens of *Melia* collected by him possessed polyps, though in Borradaile's experience they were sometimes absent from both claws, or from only one. It is to be expected that the crabs will occasionally lose their polyps, especially during ecdysis, and conceivably they may wander about for a time without meeting with others.

If we attempt to estimate the advantages of the commensalism to the two organisms concerned, it must be admitted that the result seems to be entirely one-sided, and in favour of the crustacean. The experiments show that the reflexes of the crab are of such a nature as to result in the removal of any food or prey which the actinian may secure. The tentacles of the polyp move about freely and seize and retain organisms coming within their

reach, passing them towards the middle of the disc, from which, however, they are abstracted by the ambulatory limbs of the crab. Enemies to the crab, too large to be held by the tentacles of the polyps, may nevertheless be warned off by the stinging-cells of the anemone emitted on irritation. A careful consideration of all the circumstances justifies the view that the crab will secure much of its food through the activity of the anemones, and, further, that the latter will exercise a protective influence upon the crab against larger enemies. The advantages to the actinian appear largely negative. As Möbius suggests, the movements of the crab will serve to bring the actinian into the neighbourhood of more prey, but its chances of ultimately appropriating to itself much of this seem very small. The feeding experiments demonstrated very clearly that it is only rarely that the actinians succeed in ingesting their food ere it is withdrawn by the crab. In the case of the actinians *Sagartia* and *Adamsia*, commensal with hermit crabs, it is usually considered that the polyps secure fragments of the food torn up by the masticatory appendages and slipping away, but it is not likely that this occurs with *Melia*. Independently of the actinians, the crab can only obtain such food as may be lying upon the sea-floor and incidentally come upon the maxillipeds and the ambulatory limbs.

The acquisition of such a peculiar commensal habit on the part of two wholly distinct types of crabs, *Melia* and *Polydectus*, correlated, in the case of the former at least, with a diminutive size and partial loss of activity on the part of the chelipeds, does not admit of ready explanation. Among the activities of other crustacea there appear to be no examples which help us to understand how such behaviour and structural peculiarities have become established—no simpler or intermediate stages which suggest the lines along which the evolution has taken place. In the well-known instances of masking-crabs (*Stenorhynchus*, *Dromia*) we have the tearing away of suitable objects, such as zoophytes, algae, and sponges, which are then affixed to the shell; but the instinctive processes involved therein are less complex than in the cases under consideration. In the latter the ordinary aggressive and tearing functions of the chelipeds are replaced by those of merely holding a living example of another group of organisms. Even the seizure by a crab of an anemone and the affixation of it upon a gastropod shell, as in the well-known hermit crabs *Pagurus*, and the actinians *Sagartia parasitica* and *Adamsia palliata*, involves much less of a departure from the usual activities of crustacea.

As in so many morphological and physiological phenomena in nature where intermediate stages are not forthcoming, it is difficult to see how such an instinct could have been acquired or evolved by slow degrees. For instance, while holding the actinians the crab could not at the same time employ its claws for the usual purpose of seizing and conveying food to its mouth. One is constrained to think of mutation as a possible explanation

of commensalism of such a nature, to conceive that a similar instinct has appeared suddenly in the case of two distinct species of crab, and its possession proved favourable to the survival of the individuals. Such an explanation may suffice until it can be put to experimental test, or until extended observations on the activities and structure of animals render the theory of mutation as plausible in the animal kingdom as from De Vries's work it is among plants.

SUMMARY.

1. The commensalism between the crab *Melia tessellata* and actinian polyps is not restricted to a single species of actinians. Of two crabs captured, one carried a *Bunodeopsis* in each claw and the other a *Sagartia*.

2. As regards the same crab the two actinian species are interchangeable, and the crabs will dislodge a small polyp of one species to take up a larger polyp of another (intelligent selection).

3. Apparently the crab is not aware of the presence of an actinian until it comes into tactile connection with it. Dislodgment of a fixed actinian is brought about by the insertion of the first ambulatory limb between the polypal base and the substratum.

4. The crab travels with the actinians expanded and directed forwards, sometimes waving them from side to side. When irritated it responds by moving its chelipeds towards the source of irritation, thereby placing the actinians in what may be considered as the most favourable aggressive or defensive attitudes. The crab reacts in the same manner, whether carrying the actinians or deprived of them.

5. Food given the polyps is abstracted by the crab by means of its first pair of walking-limbs, the stimulus to activity being derived from the diffusion of the meat juices.

6. In correlation with the commensal habits the crabs have no direct use of the chelipeds as aggressive or defensive organs, or for grasping objects other than the actinians, and the functions of the first ambulatory appendages are partly modified.

7. The commensal actinians present no structural or physiological modification compared with closely allied free species elsewhere.

8. The cœnobiotic habit seems to be necessary for the existence of *Melia*, though not for that of the actinians.

9. A second species of crab, *Polydectus cupilifera*, also bears an actinian, *Phellia*, in its chelipeds; specimens of the actinian are also found adherent to stones and coral rock in the natural habitat of the crabs. Thus in all probability a similar commensal habit has been acquired independently by two wholly distinct forms of crabs.

10. The advantages of the commensalism to the crab are (1) that

it secures most of its food from the activity of the anemones in capturing small organisms, these being afterwards abstracted by the crab; (2) a possible protective influence against enemies by the ejection of stinging-cysts as a result of the irritation of the polypal tentacles. The only possible advantage to the anemone would seem to be that of being carried about by the crab, whereby it may be brought into contact with more prey, against which is the disadvantage of having much of its food abstracted by the crab.

2. Notes on a Collection of Snakes from Japan and the Loo Choo Islands. By Captain F. WALL, C.M.Z.S., Indian Medical Service.

[Received August 28, 1905.]

I am indebted to Mr. Alan Owston, of Yokohama, for the opportunity of examining a large number of Snakes collected by him in Japan and the Loo Choo Islands. Of a total of 513 specimens, 461 are Land Snakes; and the special interest of the collection lies in the extensive and representative area in which the specimens have been captured, for besides a large number obtained from Japan itself and many from all the important islands of the Loo Choo Group, examples have been obtained from the two islands, Tanega and Yaku, interposed between Japan and the Northern Loo Choos. They are distributed as follows:—

Japanese.	{	YEZO.		
		1. <i>Ancistrodon blomhoffii</i> .	(1)	1
		HONDO.		
		1. <i>Tropidonotus vibakari</i> .	(14)	} 165
		2. " <i>tigrinus</i> .	(53)	
		3. <i>Dinodon japonicus</i> .	(1)	
		4. <i>Coluber conspicillatus</i> .	(18)	
		5. " <i>climacophorus</i> .	(11)	
		6. " <i>quadrivirgatus</i> .	(30)	
		7. <i>Ancistrodon blomhoffii</i> .	(38)	
		TANEGA ISLAND.		
		1. <i>Tropidonotus tigrinus</i> .	(1)	} 3
		2. <i>Coluber conspicillatus</i> .	(1)	
		3. <i>Ancistrodon blomhoffii</i> .	(1)	
		YAKU ISLAND.		
1. <i>Tropidonotus tigrinus</i> .	(2)	} 6		
2. <i>Coluber quadrivirgatus</i> .	(2)			
3. <i>Ancistrodon blomhoffii</i> .	(1)			
4. <i>Lachesis okinavensis</i> .	(1)			

	AMAMI.		
North Loo Choos.	1.	<i>Tropidonotus pryeri.</i>	(3)
	2.	<i>Dinodon semicarinatus.</i>	(3)
	3.	<i>Ablabes semicarinatus.</i>	(3)
	4.	<i>Hemibungarus japonicus.</i>	(4)
	5.	<i>Lachesis okinavensis.</i>	(3)
	6.	" <i>flavoviridis.</i>	(21)
			} 37
	OKINAWA.		
North Loo Choos.	1.	<i>Tropidonotus pryeri.</i>	(54)
	2.	<i>Dinodon semicarinatus.</i>	(19)
	3.	<i>Ablabes semicarinatus.</i>	(131)
	4.	<i>Hemibungarus japonicus.</i>	(6)
	5.	<i>Lachesis okinavensis.</i>	(4)
	6.	" <i>flavoviridis.</i>	(20)
			} 234
	MIYAKO.		
South Loo Choos.	1.	<i>Dinodon rufozonatus.</i>	(2)
	2.	<i>Lachesis mucrosquamatus.</i>	(3)
			} 5
	ISHIGAKI.		
South Loo Choos.	1.	<i>Dinodon rufozonatus.</i>	(2)
	2.	<i>Coluber schmackeri.</i>	(1)
			} 3
	IRIOMOTE.		
South Loo Choos.	1.	<i>Tropidonotus pryeri.</i>	(1)
	2.	<i>Dinodon rufozonatus.</i>	(4)
	3.	<i>Ablabes herminæ.</i>	(1)
	4.	<i>Lachesis mucrosquamatus.</i>	(1)
			} 7
		Land Snakes	461
		Sea Snakes	52
		Total	513

Hitherto the Snakes from the Loo Choo Archipelago have been simply labelled "Loo Choos," with no special reference, except in a few instances, to the particular islands from which they were obtained (*vide* Boulenger, Cat. Snakes Brit. Mus. vols. i.-iii.). Thanks to the careful and methodical way in which Mr. Owston has labelled his specimens, more than a usual interest attaches to his collection, for it shows that the distribution of the species in this region is restricted to very definite zoological areas. Three such may be recognised by a glance at the above-given list:— (1) The Japanese area, with which the islands of Tanega and Yaku must be included. It will be noticed that all the species from these two islands belong to the Japanese Snake fauna except *Lachesis okinavensis*, a single specimen of which, curiously enough, was collected in Yaku. (2) The North Loo Chooan area, comprising the islands Amami and Okinawa. The six species collected

in this area are peculiar to it, except *Lachesis okinavensis*, which encroaches upon the Japanese area on Yaku, and *Tropidonotus pryeri*, which extends further south into the next division. (3) The South Loo Chooan area, comprising the islands of Miyako, Iriomote, and Ishigaki. Only 15 specimens were collected in this area, including 5 species. Two of these extend to Formosa, viz., *Lachesis mucrosquamatus* and *Dinodon rufozonatus*; one is common to the whole Loo Chooan area, viz. *Tropidonotus pryeri*; and the remaining two hitherto have only been obtained from this area, viz. *Coluber schmackeri* and *Ablabes herminæ*.

Group I. JAPANESE SNAKES.

Family COLUBRIDÆ. Subfamily COLUBRINÆ.

1. *TROPIDONOTUS VIBAKARI*.—The 14 specimens were all obtained from Japan (Hondo)*. The supralabials were eight with the fourth and fifth only touching the eye in three specimens, and eight with the third, fourth, and fifth touching the eye on one side in one specimen. The anterior chin-shields touched five infralabials in one specimen. One example captured in July contained five eggs, the largest measuring $1\frac{3}{20}'' \times \frac{8}{20}''$.

2. *TROPIDONOTUS TIGRINUS*.—Of 56 specimens, 53 were collected in Japan (Hondo), two in Yaku, and one in Tanega. The supralabials were eight with the fourth and fifth touching the eye in two, the postoculars two on one side in one. The loreal was confluent with the postnasal on both sides in three, and on one side in one. A toad had been ingested in two examples.

3. *DINODON JAPONICUS*.—A single normal specimen was obtained from Yamanashi (Hondo). The ventrals were 202 and the sub-caudals 74.

4. *COLUBER CONSPICILLATUS*.—Of 19 specimens, 18 were from Japan (Hondo) and one from Tanega Island. The temporals were two in one Hondo specimen, and the scales 23 in another Hondo specimen in the middle of the body. Ventrals and sub-caudals were as follows in five specimens:—209+71, 203+64, 214+71, 217+66, 221+69 (the fourteenth and fifteenth sub-caudals entire). The Hondo adult examples, with one exception, were uniform brown with each scale outlined darker; the belly rose or cherry-coloured, with a double series of large, rectangular, black, median spots frequently confluent across the belly; two

* Boulenger, *op. cit.* vol. i. p. 221, mentions Formosa as a habitat for this species. If this is correct, it is a very singular circumstance. There are no other instances of Japanese species occurring in Formosa, except *Dinodon rufozonatus* and *Ancistrodon blomhoffii*. The existence of both in Formosa is easily understood, since they are common snakes on the Chinese mainland, and the Formosan Snake fauna is composed almost entirely of Chinese species. In the case of *Tropidonotus vibakari*, however, it is significant that it has not been recorded from China (except Manchuria) and it does not occur in the Loo Choos. I am prompted to regard this record as an error.

chevrons on the head, the anterior converging in front of the eyes, divergent behind to form postocular streaks, the posterior converging on the frontal, both often obscure or almost obliterated. In one the belly was sparsely spotted and in another was whitish and unspotted. The young were pinkish-brown or dove-coloured with small black dorsal spots, with an inclination to a transverse distribution; the belly whitish chequered black. One Hondo adult specimen had preserved the peculiar colouring and dorsal spots of the young, but the belly was rosy, as is usual in adults. In this specimen the scales in mid-body counted 23. The example obtained in Tanega Island was a very distinct colour-variety, singularly resembling a *Dinodon japonicus* at first sight. It was light brown with well-defined black bars, as wide as the intervals. A series of large spots in the flanks alternated with the dorsal bars. The usual head-marks were present and the belly was chequered black and white.

5. COLUBER CLIMACOPHORUS.—All the eleven specimens were obtained from Japan (Hondo). In four specimens the scales were 25 in mid-body, in all the rest 23. The subocular was absent in one. Temporals three in one. Postoculars three on one side in two. Anterior chins touched four infralabials in two. One captured on 6th July contained 14 eggs with no trace of embryo, the largest of which measured $2'' \times 1\frac{3}{20}''$.

6. COLUBER QUADRIVIRGATUS.—Of 32 examples, 30 were collected in Japan (Hondo) and two in the Island of Yaku. In one Hondo specimen the supralabials were nine with the fifth and sixth touching the eye on one side. Postoculars three on one side in one specimen. Nearly all belonged to Boulenger's Variety A*. The young were lighter in colour, with well-marked spots or cross-bars, but the longitudinal stripes faint or absent. One of the Yaku specimens belonged to Variety B, and the other was intermediate between A and B.

Family VIPERIDÆ. Subfamily CROTALINÆ.

7. ANCISTRODON BLOMHOFFII.—Of 41 specimens, 39 were from Japan (Hondo 38, Yezo 1), one from Tanega Island, and one from Yaku Island †. In only one Hondo specimen were the scales 23 in the middle of the body, but this number was present in both the specimens from Tanega and Yaku. The ventrals and subcaudals in the Yaku example were 143 + 53, and in the Tanega example the ventrals were 142. One had eaten a frog. One captured on the 27th June contained three immature eggs with no trace of embryo.

* *Op. cit.* vol. ii. p. 60.

† It is doubtful whether the specimen in the British Museum labelled Okinawa (Boulenger, *op. cit.* vol. iii. p. 526) is correctly recorded. It appears to be the only specimen reported from the Loo Choo Group of islands, where it is singularly out of place. Tsu Sima is an island in the Corean Strait, and not in the Loo Choos as stated by Boulenger on the same page.

Groups 2 and 3. LOO CHOO SNAKES.

Family COLUBRIDÆ. Subfamily COLUBRINÆ.

1. *TROPIDONOTUS PRYERII*.—Of 58 specimens, 54 were obtained from Okinawa, three from Amami, and one from Iriomote. There were two postoculars on one side in one specimen. Four contained eggs with no trace of embryos.

1 killed 20th April had 3 eggs, largest $1\frac{17}{20}'' \times 1\frac{10}{20}''$.
 1 " " " " 5 " " about $1''$ long.
 1 " 22nd " " 3 " " $1\frac{11}{20}''$ long.
 1 " 8th May " 6 " " $\frac{19}{20}''$.

The size of the eggs first alluded to is very remarkable considering the size of the species. The mother measured 2 feet $7\frac{1}{2}$ inches, tail slightly docked.

2. *DINODON RUFOZONATUS*.—Of eight specimens two were from Miyako, two from Ishigaki, four from Iriomote. The two specimens from Miyako were peculiar in colour, being of a much lighter brown than usual. Each had 21 whitish, dark-margined dorsal bars. The ventrals were 182 and 189.

3. *DINODON SEMICARINATUS*.—Of 22 specimens, 19 were from Okinawa and three from Amami. The supralabials in one were eight with the fourth and fifth only touching the eye. One had swallowed a fledgling, and another a lizard.

4. *COLUBER SCHMACKERI*.—A single specimen, much mutilated and of large size, was obtained from Ishigaki. The supralabials were nine on the right side with the fifth and sixth touching the eye, ten on the left side with the sixth and seventh touching the eye. The loreal was more than twice as long as high. The upper of two præoculars nearly touched the frontal.

5. *ABLABES SEMICARINATUS*.—Of 134 specimens, 131 were from Okinawa and three from Amami*.

6. *ABLABES HERMINÆ*.—The single specimen was from Iriomote. It was an aberrant example in that the scales number 19 in mid-body. Anteriorly and posteriorly the normal 17 scales were present. Ventrals 159 and subcaudals 60.

7. *HEMIBUNGARUS JAPONICUS*.—Of ten examples, six were from Okinawa and four from Amami†. Those from Okinawa were all alike in having five longitudinal black dorsal lines broader than the pink intervals. There were 9–12 narrow black annuli round the body and 1–2 (2 usually) on the tail. The ventrals and subcaudals

* There seems but little doubt that Japan has been incorrectly included as a habitat for this species and for *Hemibungarus japonicus*. Boulenger is clearly of this opinion (*vide op. cit.* vol. iii. p. 395 footnote). These species were originally described and figured by Günther (*Ann. & Mag. Nat. Hist.* (4) i. 1868, pp. 418 & 428) from one specimen of each reported to have come from Nagasaki. Thirty-seven years have now elapsed without either being rediscovered in Japan.

† See footnote to *Ablabes semicarinatus*.

are 204+28, 183+28, 194+30, 202+?, 197+27, 129+29. Two specimens from Amami agreed in having three longitudinal dorsal, black lines, narrower than the pink intervals. One of these had indications of another line in the flanks on each side. One had 12 and the other 14 black annuli. Both were peculiar in that the last ventral was divided, a condition which obtains in no other specimen, and this may constitute a separate species. The ventrals and subcaudals were 208+29 and 198+28. The remaining two specimens from Amami were pale pink with a single, narrow, vertebral black line. One had 15 and the other 13 black annuli, and the ventrals and subcaudals were 215+28 and 214+30. One of the Okinawa examples had swallowed a lizard measuring $4\frac{1}{2}$ inches. The snake was 1 foot $7\frac{1}{2}$ inches in length, and the lizard occupied a position entirely posterior to the tenth inch in the snake's length. The stomach was therefore placed unusually far back in this species, and I have noticed a similar peculiarity in an allied snake, *Bungarus candidus*, in India.

Family VIPERIDÆ. Subfamily CROTALINÆ.

8. LACHESIS OKINAVENSIS.—Of eight specimens four were from Okinawa, three from Amami, and one from Yaku. The scales were 23 in mid-body in all except one specimen, where they were 24. The subocular was broken up in two specimens. The ventrals and subcaudals were 131+44, 134+46, 127+42, 128+46, 128+46, and 129+42. One had swallowed a small shrew-like animal.

9. LACHESIS FLAVOVIRIDIS.—Of 41 specimens, 21 were from Amami and 20 from Okinawa. The ventrals were 232 in one specimen, 234 in another. The scales were 40 in mid-body in one specimen. Many were quite young, hatchlings apparently; six such varied in length from 1 foot $6\frac{1}{2}$ inches to 1 foot $9\frac{3}{4}$ inches. One had swallowed a rat. The fang of one large specimen was $\frac{12''}{20}$ measured straight.

10. LACHESIS MUCROSQUAMATUS.—Of four specimens, three were from Miyako and one from Iriomote. I have no hesitation in considering these specimens as belonging to this species, though it extends the habitat considerably. They agreed with the specimens I have examined in the British Museum Collection. A pair of internasals was present. Two to four rows of temporals were smooth. The scales were 23 in mid-body in two specimens, 24 in another, and 25 in the fourth. The ventrals and subcaudals were 186+66, 190?+77, and 185+72.

SEA SNAKES.

Family COLUBRIDÆ. Subfamily HYDROPHIINÆ.

1. HYDRUS PLATURUS.—One specimen of Boulenger's Variety E (*op. cit.* vol. iii. p. 268) was from Okinose Sagami (Hondo).
2. HYDROPHIS MELANOCEPHALUS.—Of three examples two were

from Ishigaki and one from Iriomote. The scales behind the neck were 24 in one specimen, round mid-body 29 in one specimen and 33 in the others. The ventrals were 336, 316, and 332.

3. *DISTIRA ORNATA*.—The three specimens were all from Okinawa. The scales behind the neck were 29, 32, and 33; mid-body 35, 37, and 38. Ventrals 271, 268, and 251.

4. *AIPYSURUS ANNULATUS*.—All the six examples were from Okinawa. Four had a sharp spine on the rostral which was absent on the other two. The præfrontals were very irregular. There were four in three specimens, two in one specimen, and three (2 right, 1 left) in two specimens. In all one or both parietals were split by a suture behind. The scales were 17 in mid-body when the vertebral row was enlarged, which was usually the case, though often to a variable degree. In two specimens the scales were 19, the vertebrales being divided into three rows subequal to the other dorsals. Ventrals numbered 138 to 143.

5. *PLATURUS LATICAUDATUS*.—The two specimens were from Okinawa. The ventrals were 243 in one specimen; the last was divided in both specimens.

6. *PLATURUS SCHISTORHYNCHUS*.—Of 37 specimens, 29 were from Miyako, 6 from Okinawa, and 2 from Amami.

All the specimens were preserved in formalin.

3. Description d'un Ophidien nouveau du Mexique (*Morenoa orizabensis*, g. et sp. nn.). Par ALFRED DUGÈS, M.D., C.M.Z.S.

[Received July 7, 1905.]

(Text-figure 77.)

Ce Colubride (Sous-fam. *Colubrinæ*) ne m'est connu que par deux exemplaires provenant d'Orizaba (État de Vera-Cruz) d'où me l'a envoyé le Prof. Aniceto Moreno pour le déterminer. Ne le trouvant décrit dans aucun des ouvrages que j'ai pu consulter, j'ai du lui donner un nom générique et spécifique nouveau et je le dédie à mon ami M. Moreno.

Ses rapports les plus intimes sont avec le g. *Ablabes*, tel que l'a compris Boulenger (Catal. Snakes of Brit. Mus. 1894); mais il en diffère assez pour l'en séparer, comme le prouve sa description.

Les vertèbres dorsales postérieures manquent d'hypapophyses. La dentition est isodonte: il m'a semblé qu'il y avait une douzaine de dents au maxillaire supérieur, mais je n'ai pu m'en assurer exactement pour ne pas trop mutiler l'exemplaire que je pouvais examiner. L'aspect général est celui d'une *Coronella*.

Caractères.—La rostrale se replie un peu sur le museau. Les internasales sont un peu plus petites que les préfrontales; celles-ci

se rabattent de chaque côté jusqu'au contact de la frénale. La frontale égale à peu près la distance qui la sépare du bout du museau ; elle est plus étroite en arrière qu'en avant. Les sur-oculaires, subtriangulaires, séparent la frontale de la préoculaire. Pariétales à bords externes un peu excavés, et plus étroites à leur extrémité postérieure. Nasale double. Frénale un peu plus longue que haute. Une seule grande préoculaire. Deux post-oculaires. Temporales 2+2, celles du second rang atteignant l'extrémité des pariétales ; sur un exemplaire la temporale inférieure du premier rang à gauche est divisée près de la post-oculaire inférieure. Rostrale plus large que haute. Huit sus-labiales, les quatrième et cinquième sous l'œil ; la sixième, triangulaire, ne touche pas la première temporale inférieure. Deux générales longues, suivies de deux petites séparées par une écaille. Huit labiales inférieures. La mandibule est un peu plus courte que le museau.—Dix-neuf rangs d'écailles lisses, rhomboïdales, sans pores. Anale simple. Gastrostèges 198. Urostèges doubles 85. Queue terminée par une petite pointe cornée

Text-fig. 77.

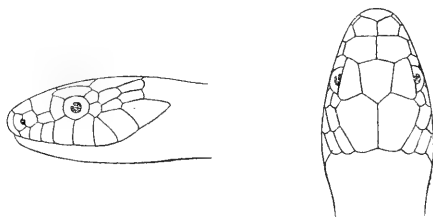
Tête de *Morenoa orizabensis*, en dessus et de profil.

Dimensions :—

	m.
Corps avec la tête ...	0·41
Queue	0·08
	<hr/>
Total	0·49

Le corps est un peu comprimé.

Coloration.—Parties supérieures brun-gris clair ; les écailles sont toutes bordées de noir. Des barres transversales brun-foncé se détachent sur le fond et sont plus nettes dans le tiers postérieur du corps. Une tache noire oblique se voit de chaque côté en arrière de la tête, distante de l'angle de la bouche comme celle-ci l'est du museau ; plus loin sur les flancs il y en a quelques autres moins visibles. Le dessus de la tête est d'un brun fauve uniforme ; le dessous est blanc ; il y a une bordure noire sur 4 des labiales supérieures. Le dessous du corps est blanchâtre avec des lignes noires transversales qui descendent des flancs.—Sur un exemplaire les pariétales portent une ligne anguleuse un peu plus foncée, mais très peu distincte.

Guanajuato, le 20 Juin 1905.

4. On a Collection of Mammals from Persia and Armenia
presented to the British Museum by Col. A. C. Bailward.
By OLDFIELD THOMAS, F.R.S., F.Z.S.*

[Received October 27, 1905.]

(Plate XVI.†)

The National Museum owes to Col. A. C. Bailward a most interesting collection of small mammals from Persia and Armenia, obtained during the past summer on his way home from India to England. Before starting he applied to the Society's Secretary for advice on the subject, and Dr. Mitchell suggested his taking with him someone trained to collect mammals and birds. By good fortune Mr. R. B. Woosnam, one of our ablest collectors, who had already done good work in South Africa, was able to go with Col. Bailward, and the specimens now described were all trapped and skinned by him.

Considering that the expedition was primarily a shooting-trip, that it never stayed more than a day or two in any place, and that the party rode something like 20 or 30 miles every day, the number of mammals obtained—about 70—is a credit to Mr. Woosnam, who also collected about 380 birds.

About 31 species are represented in the Mammal collection, of which I have described five as new. Of these by far the most interesting is the beautiful large-eared mouse described as *Calomyscus bailwardi*, which forms a new genus entirely unlike anything hitherto known from the Old World, but allied to the North-American *Peromyscus*.

Col. Bailward's party entered Persia at the head of the Persian Gulf, beginning work at Ahwaz, on the Karun River. From there they travelled north-eastward across the Bachtari mountains to Isfahan, and it was in this region that the majority of the novelties were obtained. From Isfahan they went westwards to Kermanshah, and thence by way of Lake Van, Erzeroum, and Baibort to Trebizond.

While the Armenian specimens obtained during the trip are most valuable, their interest is dwarfed by that of the series from Persia, for from the region travelled by Col. Bailward the only mammals that have ever been collected were those obtained in 1870–72 by the late Dr. W. T. Blanford, and described in his work on Eastern Persia ‡, the few collected and described by de Filippi §, and a small series obtained in 1902 by Mr. H. F. Witherby. From the character of the present collection it is

* [The complete account of the new species described in this communication appears here; but since the names and preliminary diagnoses were published in the 'Abstract,' such species are distinguished by the name being underlined.—EDITOR.]

† For explanation of the Plate, see p. 527.

‡ 'Eastern Persia,' Zoology and Geology (1876).

§ 'Viaggio in Persia,' p. 342 (1865).

evident that much remains to be done in this area, and I would draw the attention of other Indian sportsmen to Col. Bailward's success, with the hope that when coming home to England they may follow his admirable example in working Persia by the way.

1. *VESPERTILIO* sp., near *V. serotinus*.

♀. 27. Mala-i-Mir, 70 mi. N.E. of Ahwaz. 4300'.

This Bat, of which Mr. Witherby also obtained examples near Telespid, is a pale form of the Serotine group, but I cannot at present determine its exact relationship to *V. turcomanus* Eversm. and *V. mirza* Fil. One thing is clear, however, that *V. shiraziensis*, described in 1871 by Dobson, but afterwards referred by him, in company with *turcomanus* and *mirza*, to *V. serotinus*, is a perfectly distinct species, readily distinguishable by its much greater size.

2. *VESPERTILIO MATSCHIEI* PELLUCENS, subsp. n.

♂. 14, 15, 16, 17, 19. Ahwaz, Karun R., S.W. Persia. 220'.
"Common in the town."

Closely similar to the species recently described as *V. matschiei**, from Aden, but slightly larger, and markedly paler in colour, the upper surface uniformly pale buffy, very slightly darker than Ridgway's "cream-buff," which the under surface just matches. Ears and membranes pale brownish, the hinder edges of the wings white, and the posterior third of the interfemoral transparent white or colourless. In true *matschiei* the membranes are dark opaque brown throughout.

Dimensions of the type:—

Forearm 35·7 mm.

Head and body (in flesh) 45; tail 43; ear 13.

Skull, greatest length 13·2.

Hab. as above.

Type. Male. B.M. No. 5.10.4.4. Original number 16. Collected 28 Mar., 1905.

This beautiful little Bat is readily distinguishable from all others by its uniform pale colour, the hairs being pale to their roots. In the pale form of *Pipistrellus kuhlii*, found in company with it, the bases of the hairs are dark, even though the tips are light. The peculiar translucent character of the posterior third of the interfemoral is also very unusual.

3. *PIPISTRELLUS KUHLI* Natt.

♂. 2, 5, 18, 20, 21. Ahwaz, Karun R. 220'.

♀. 11. Dizful, near Ahwaz.

These specimens vary a good deal in colour, some being nearly as light as the darker examples of the last species. But the darkest are far lighter than South European specimens, and no doubt

* Thos. Ann. Mag. N. H. (7) xvi. p. 573 (1905).

they represent a valid lighter-coloured Eastern subspecies, for which there appear to be several names available.

"Shot close to the town of Ahwaz—their fur matches the soil in colour."—*R. B. W.*

4. *PIPISTRELLUS ALADDIN* THOS.

Abstr. P. Z. S. No. 24, p. 23, Dec. 19, 1905.

♂. 41. Derbent, 50 mi. W. of Isfahan. 6500'. B.M. No. 5.10.4.13. *Type.*

A very small species. The minute upper premolar in the tooth-row.

Size about as in *P. nanus* and *mimus*. Ears of medium size; inner margin slightly convex, outer margin with a well-marked concavity in its middle third; antitragal notch shallow, the outer basal lobe low, buried in the fur. Tragus of medium length, rather broad, its broadest point just above its inner base; inner margin slightly concave; outer basal lobe rounded. Wings to the base of the toe.

General colour above "wood-brown," the hidden basal halves of the hairs blackish. Under surface similar, but rather lighter. Ears and wing-membranes blackish grey, the hinder edge of the wing from the tip of the fifth finger backwards prominently white, as in *P. kuhlii*.

Skull small, delicate; much as in *P. nanus*. Outer upper incisors about equalling the well-marked secondary cusp of the inner. Large premolar well separated from the canine, the small premolar standing in the tooth-row, wholly visible from without.

Dimensions of the type:—

Forearm 31 mm.

Head and body (in flesh) 41; tail 35; ear 10.

Skull—greatest length 11.3; basal length in middle line 8.7; breadth of brain-case 6.1; palatal length 4; combined length of large upper premolar and two molars 2.8; lower tooth-row from front of canine 4.2.

Hab. and *Type* as above.

This little Bat is perhaps a representative of the Indian *P. mimus* Wrought*, with which it agrees in size and certain other characters. But it is much lighter in colour, the extreme tips of the dorsal hairs in that animal being alone pale brown, the rest being blackish, and the small upper premolar does not stand so well in the tooth-row, although more so than in most species of the genus. *P. nanus* again is a dark-coloured bat, as dark as a European Pipistrelle.

5. *MYOTIS MYOTIS OMARI*, subsp. n.

♂. 42, 43. Derbent, 50 mi. W. of Isfahan. 6500'.

(♀. No. 13. Near Telespid, S.W. Persia. H. F. Witherby.

Essential characters as in true *myotis*, the ears apparently

* Journ. Bombay Nat. Hist. Soc. 1899, p. 722.

nearly or quite as long as usual, not shortened as in the N. Indian *blythi*. But the colour is very different, being that characteristic of specimens from desert-regions. General colour above uniform pale "wood-brown," the basal halves of the hairs smoky brown, succeeded by a broad ring of glossy whitish sandy and a fine pale brown point. Under surface broadly washed with "cream-buff." Membranes and ears also much paler brown than in *myotis*.

Teeth rather smaller than those of true *myotis*, larger than those of *blythi*.

Measurements of the type:—

Forearm 60 mm.

Head and body (in flesh) 75; tail 61; ear 26.

Skull—greatest length 22·2; breadth of brain-case 9·9; upper tooth-row from front of canine 9·5; front of lower canine to back of m_3 10·1.

Hab. Persia; type from Derbend. Alt. 6500'.

Type. Adult male. B.M. No. 5.10.4.14. Original number 42. Collected 14 May, 1905.

It is quite natural to find a desert-coloured form of the common *M. myotis* inhabiting Persia. Mr. Witherby's specimen is very similar to the two presented by Col. Bailward.

Mr. Miller has shown* that the Indian *Vespertilio blythi* Tomes is definably different from the European *M. myotis*, to which Dobson had assigned it. I may further note that Dobson's *V. africanus* † is clearly the same as *M. blythi*, the collection from which the type came having been wrongly labelled as from the Gaboon, when it really was from N. India. Dobson's mistake was therefore quite excusable.

6. NEOMYS FODIENS Schr.

♂. 53. 25 miles N. of Erzeroum. 7000'.

"Caught by a brook in the mountains. Was swimming and diving with two others."—*R. B. W.*

7. ERINACEUS EUROPEUS L.

56. ♀. Tortoum R., N. of Erzeroum. 4000'.

Probably belonging to the form recognised by Barrett-Hamilton as *E. e. concolor* Mart.

8. CANIS AUREUS L.

♂. 12. Shus, near Dizful, Arabistan.

9. VULPES VULPES FLAVESCENS Gray.

♂. 7. Bunde Kil, Karun R.; 250'.

10. PUTORIUS NIVALIS L.

♂. 61. Baibort. 7000'.

* P. Biol. Soc. Wash. xiii. p. 155 (1900).

† Cat. Chir. B.M. p. 310.

11. MELLIVORA INDICA Kerr.

♀. 24. Ram Hormuz, E. of Ahwaz.

12. CITELLUS XANTHOPRYMNUS Benn.

♂. 60. Baibort, between Erzeroum and Trebizond.

In the fulvous summer pelage. Those obtained by Mr. Danford in Central Asia Minor are in the grey winter coat.

13. CITELLUS CONCOLOR Geoff.

♀. 47. Bast-Kala, near Lake Van. 7200'.

♂. 52. ♀. 48, 49. Lake Van. 5500'.

"Very plentiful on open sandy ground; to be seen about all day."—*R. B. W.*

14. TATERA TENIURA Wagn.

♂. 8, 9, 10. Bunde-Kil, Karun R. 250'.

♀. 13. Shus, near Dizful. 500'.

♂. 23. Ram-Hormuz, 60 mi. E. of Ahwaz. 500'.

♀. 28. Mala-i-Mir, 70 mi. N.E. of Ahwaz. 3300'.

Whether this species grades into the Indian *T. indica* remains to be seen when more material is available.

15. MERIONES PERSICUS Blanf.

♀. 26. Mala-i-Mir, 70 mi. N.E. of Ahwaz, S.W. Persia.

♂. 36. Dopulan, 120 mi. N.E. of Ahwaz.

No. 26 agrees very well with a co-type, a female, in the British Museum from Kohrud, but 36 has longer ears and smaller bullæ. As its locality, however, is intermediate between those of 26 and the type, I presume the differences are either individual or sexual.

I am glad to be able to come at last to a definite conclusion about the generic position of this animal, the teeth of the co-type being so worn down that it was impossible till now to decide whether it was a *Meriones* or a *Gerbillus*. The new specimens show clearly that its teeth are those characteristic of the former genus.

16. MERIONES ERYTHRURUS Gray.

♂. 1, 3, 22. Ahwaz, Karun R. 220'.

This Gerbille, which I provisionally refer to the Afghan species, is also nearly related to *M. meridianus* Pall.

"Plentiful all along the flat coast plain from Bushire to the Karun River. Nocturnal."—*R. B. W.*

17-18. MUS—MUSCULUS group.

♀. 29. Deh-i-Diz, 90 mi. N.E. of Ahwaz. 5500'.

♀. 31. Bachtyari Mts., 100 mi. N.E. of Ahwaz. 5800'.

♀. 37. Bagh-i-Badaran, 30 mi. S. of Isfahan. 8000'.

♀. 45. Sakiz, 100 mi. N. of Kumanshah. 5000'.

♂. 55. Tortoum R., N. of Erzeroum. 4000'.

When the difficult *Mus musculus* group comes to be worked out these specimens will be of the greatest value, but they cannot well be determined at present. No. 55 is a typical dark long-tailed house-mouse; the others are pale desert forms.

19. *MICROMYS MYSTACINUS* Danf. & Alst.

♂. 64, 65, 66. ♀. 67. Sumela, 30 mi. S. of Trebizond. 1500'.

"Trapped on hill-side below the fir-woods."—*R. B. W.*

20. *MICROMYS SYLVATICUS ARIANUS* Blanf.

♂. 30, 34. ♀. 32. Bachtari Mts., 100 mi. N.E. of Ahwaz. 5800'.

These specimens are coloured very like the South Persian *M. s. witherbyi* Thos., but have the larger teeth of *arianus*.

21. *CALOMYSCUS BAILWARDI* Thos. (Plate XVI.)

Abstr. P. Z. S. No. 24, p. 23, Dec. 19, 1905.

25. ♂. Mala-i-Mir, 70 mi. N.E. of Ahwaz. 4300'. 10 April, 1905. B.M. No. 5.10.4.68. *Type*.

CALOMYSCUS.

A member of the *Cricetinae*, or biserial-toothed Muridæ, of which the only recent Old World* members hitherto known have been the *Cricetus* group and the South African *Mystromys*. Most nearly allied to the N. American *Peromyscus*, with which it shares the possession of only five cusps on the anterior upper molars.

External form as in *Peromyscus*, but the tail bushy terminally, as in many Gerbilles, to which the pallid colour also gives a resemblance. Ears large. Fur soft. Feet of normal length and structure; soles naked except just under the heels; sole-pads six, the posterior one far back, separated from the others. Tail long, pencilled, the single specimen with a peculiar double tuft of white hairs at a point two-thirds along it, which may indicate the presence of a special gland, or, more probably, be merely due to an accidental injury.

Skull, as compared with that of *Peromyscus*, low, flat, and rounded, the shape of the brain-case recalling that of a dormouse. Bullæ low, little developed. Palatal foramina comparatively small. Coronoid process of mandible long, considerably overtopping the condyle. Incisors smooth. Molars brachyodont, thin, pattern very similar to that found in *Peromyscus*, but even more simple; the cusps low, and the valleys between them shallow, and without any trace of supplementary intermediate ridges. First upper molar with only five cusps and without any trace of that duplication of the anterior cusp so characteristic of *Cricetus* and its allies.

* Madagascar excepted.

Type:—

CALOMYSCUS BAILWARDI.

A beautiful Gerbille-coloured, long-eared, tufted-tailed mouse of about the size of *Mus musculus*.

Fur soft and fine, hairs of back about 7 mm. in length.

General colour above a beautiful "pinkish buff," darkened on the back by the tips of the hairs being black, clear and rich along the flanks and down the outer sides of the legs to the ankles. Whole of under surface pure sharply contrasted white, which ascends rather high up on the cheeks, nearly to the eyes, covers the whole of the fore limbs, ascending almost to the shoulder, and the inner side of the hind limbs. Head buffy, slightly paler than back. Ears very large, practically naked, pale brown, their few fine scattered hairs white; a small white patch above the base of their anterior margin. Upper surface of hands and feet pure white. Fifth hind toe long, reaching to the middle of the terminal phalanx of the fourth. Tail long, well haired, the hairs lengthening terminally into a pencil; pure white below, above whitish proximally, darkening terminally to blackish.

Skull with the nasal region long and narrow. Interorbital space broad, smooth, slightly convex, its edges scarcely marked, no ridges developed on the parietals. Anterior plate of zygomata not projected forwards. Palatal foramina ending half their own length in front of the molars.

Dimensions of the type (measured in the flesh):—

Head and body 78 mm.; tail 87; hind foot 20·5; ear 21·5.

Skull—greatest length 26; basilar length 19·2; greatest breadth 13·8; nasals 10·1 × 3·2; interorbital breadth 4·4; brain-case breadth 12; interparietal 3·1 × 8·7; palatilar length 10·5; diastema 6·9; palatal foramina 4·5 × 1·8; length of upper molar series 3·3.

Hab. and *Type* as above.

"Trapped among barren rocks on mountain-side above the Mala-i-Mir marsh."—*R. B. W.*

The discovery of this beautiful animal is of extreme interest, as it belongs to a group hitherto believed to be exclusively American and Malagasy, with the exception of *Cricetus* and *Mystromys*. This group of biserial-toothed Muridæ is apparently a very primitive one*, and was no doubt spread widely over the Old World as well as the New before the triserial *Murinae* were developed and beat it in the struggle for existence throughout the Eastern Hemisphere. But they penetrated neither to Madagascar nor America, in which countries the Muridæ are all of the biserial group. Now in *Calomyscus* we have another Cricetine

* Several fossil members of this group, Eocene and Miocene, are known, and are all referred by paleontologists to *Cricetodon* Lartet, but if still existing they would apparently represent quite a number of what mammalogists now call genera. I am indebted to Dr. Forsyth Major for showing me a series of representative specimens of the fossil forms.

Mouse preserved in the mountains of Persia, closely allied to the N. American *Peromyscus*, and widely different from any of the Asiatic Muridæ hitherto known.

I have named this striking novelty in honour of Col. Bailward, to whose generosity the Museum is indebted for the interesting collection of which it forms a part.

22. *CRICETULUS PHÆUS* Pall.

♂. 46. Sakiz, N.W. of Karmanshah. 5000'.

♀. 54. Tortoum R., 60 mi. N. of Erzeroum. 4000'.

♂. 58. Baibort, Choruk River, between Erzeroum and Trebizond. 5500'.

"Trapped among the corn-lands."—*R. B. W.*

23. *MICROTUS NIVALIS* Mart.

♂. 62. 25 miles N. of Baibort. 7000'.

24–27. *MICROTUS* spp.

♂. 40. Derbend, 60 mi. W. of Isfahan. 6500'.

♀. 44. Diwan-Déré, 150 mi. N.W. of Kermanshah. 6500'.

♀. 57. Arab-Keni, 60 mi. N. of Erzeroum. 9000'.

♀. 59. Baibort. 5000'.

♀. 63. 70 mi. N. of Baibort. 7000'.

These five Voles belong to at least four species.

28. *ELLOBIUS LUTESCENS* Thos.

♂. 51. Lake Van. 5000'.

Topotype. Quite similar to the original specimens.

29. *ELLOBIUS WOOSNAMI* Thos.

Abstr. P. Z. S. No. 24, p. 23, Dec. 19, 1905.

♂. 38. ♀. 39. Dumbeneh, 50 miles N. of Isfahan. 7000'.

Colour much as in *E. lutescens*. Teeth of much simpler pattern.

Fur soft and loose in texture; hairs of back about 9 mm. in length. General colour above dull greyish buffy, the hairs slaty grey, with dull buffy tips. Sides paler greyish, not more strongly buffy as is the case in *E. talpinus*. Head blackish above, contrasting markedly with the general colour, much more so than in *E. lutescens*. Under surface similar to sides, the tips of the hairs very pale buffy.

Skull rather more heavily built than in *E. lutescens*. Zygomata not so expanded vertically in the centre as in *lutescens* and *fuscocapillus*, its greatest vertical breadth 3 mm. or less.

Teeth of a more simple type than those of *E. lutescens* and *fuscocapillus*, and nearly corresponding with those of fig. 6 of Büchner's plate* of *Ellobius* teeth. The last upper molar with

* Mamm. Przewalsk. pl. xv. (1889).

one simple deep reentrant angle on each side, the projecting angles bordering them in front and behind nearly equally salient; no trace of the secondary antero-external reentrant angle, which in *E. lutescens* tends to divide into two the large antero-external projecting angle; posterior lobe diminished or absent. Last lower molar with the anterior external reentrant angle about half the depth of the posterior one; in *fuscocapillus* it is quite as deep as the posterior one, while in *talpinus* it is almost non-existent.

Dimensions of the type (measured in the flesh):—

Head and body 112 mm.; tail 16; hind foot 23.

Skull—greatest length 32; basilar length 29·2; zygomatic breadth 24; nasals 8·8 × 3·5; palatilar length 19; diastema 12·5; length of upper molar series (alveoli) 7·4.

Hab. as above.

Type. Female. B.M. No. 5.10.4.65. Original number 39. Collected 9 May, 1905.

“Trapped in corn-land in broad valley, near a stream. Plentiful.”—*R. B. W.*

In colour this *Ellobius* has a close resemblance to the *E. lutescens* of Lake Van, but its teeth are of much simpler pattern, more approaching those of *E. talpinus*.

30. ALLACTAGA WILLIAMSII Thos.

♂. 50. Lake Van.

A topotype of this beautiful Jerboa, which was described in 1897 from specimens presented to the British Museum by Col. W. H. Williams, R.A.

31. LEPUS CRASPEDOTIS Blanf.

♂. 4. Karun R., N. of Ahwaz. 250'.

♀. 6. Bunde Kil, Karun R. 250'.

This appears to be the lowland coast representative of the ordinary plateau Hare of Persia and Afghanistan, to which the name of *L. tibetanus* should probably be applied.

It is distinguished by its shorter fur, which is silvery whitish at base, with a broad black subterminal ring. In the highland forms the part below the black ring is slaty basally, with a creamy terminal half.

The type was described from Pishin, S.W. Baluchistan, about 100 miles from the coast.

EXPLANATION OF PLATE XVI.

Calomyscus bailwardi; natural size: p. 524.

5. On the Colour-Variation of the Beetle *Gonioctena variabilis*. By L. DONCASTER, M.A., F.Z.S.

[Received July 7, 1905.]

In 1895 (P. Z. S. 1895, p. 850) an account was given by Mr. Bateson of the colour-variation of *Gonioctena variabilis*, a Chrysomelid beetle. His material was collected almost entirely at Granada in the months of March and April; and he found that although the insect is extraordinarily variable, yet when a large collection is made the beetles could be classified into two chief groups with very few intermediates between them. The ground-colour of the elytra varies from a brilliant red through orange and buff to a greyish green; and although the intermediate colours (orange and buff) are comparatively rare, no sharp line between the red and green can be drawn. There is also a great diversity in the markings: some individuals, chiefly those with red elytra, have two black spots on each elytron (spotted type), others (almost exclusively greens) are without these spots but have rows of minute black dots (striped form), and a third class has both spots and stripes. A large series of figures is given in the paper referred to. Bateson further found that the spots and stripes have a definite relation to the sculpturing of the elytra; the spots having their centres on certain of the longitudinal rows of punctulations, while the stripes lie between them. The spotted or striped type may be associated with either the red or green colour, but Bateson observed that almost invariably the spotted elytra were associated with black pigmentation of the ventral surface of the abdomen, and that specimens with no spots had no black pigment in this position. The colour of the underside therefore provided a means of dividing a population into two classes with exceedingly few intermediates; some had dark undersides and spotted elytra (with or without stripes in addition), the remainder had light undersides and were without spots. When classified in this way, it is found that most of the dark-spotted specimens have red or reddish elytra, and most of the unspotted light are green; and further, that about 80 per cent. of the first class are males, and about 70 per cent. of the second class females. The males are easily distinguished from the females by the presence of a small rounded depression in the last uncovered abdominal plate; this is absent in the female.

In addition to the variations mentioned, there may be more or less suffusion of the elytra with black pigment, until a totally black form is reached. The specimens in which this melanic variation is not very pronounced show that they belong to the class which is both spotted and striped; it occurs much more frequently in red than in green individuals.

The case is of peculiar interest not only on account of the great variability in a single species, but especially because of the rather close correlation between the two chief colour-types and the two sexes. Bateson found that on the hills behind the Alhambra at Granada 80 per cent. of the males were spotted and dark below, and over 70 per cent. of the females unspotted and light. In the Darro valley, perhaps a couple of miles away, only 62 per cent. of the males were dark, and 85 per cent. of the females were light; *i. e.* there was a much higher proportion of light specimens in each sex. On the other hand, at Castillejo, near Toledo, rather early in the season, of 75 specimens all were dark and spotted, all but one being males. There was therefore some indication that the proportions vary with the locality, or possibly with the season; and it seemed important to determine whether the correlation between variation and sex was a genuine and permanent phenomenon, or was more or less accidental, depending on the local and seasonal conditions at Granada. I therefore took the opportunity, during a visit to Southern Spain this spring (1905), of collecting *Gonioctena* in various localities, in the hope of settling this question.

I found that *Spartium retama*, upon which the beetle lives, grew abundantly in most of the hilly uncultivated districts I visited, except in the neighbourhood of Gibraltar, where I imagine that the rainfall is too great, and in the desert to the east of the Sierra Nevada, which is almost wholly without vegetation. Almost everywhere where I found the *Spartium* I found also *Gonioctena*, but never saw it on any other plant. Where the beetles were abundant they were beaten into a net, but when they were scarce it was necessary to search carefully for them and catch each one separately. This probably leads to a slight excess of reds in my samples, since they are much more conspicuous; but when this method was adopted the bushes were searched very thoroughly, and I believe that the error may safely be disregarded. On one occasion one method was used in a particular locality, and two days later the other was tried in the same place; and the difference in the proportions of red and greens was not more than about 3 per cent., which might easily have been due to chance in a comparatively small sample.

I collected the beetles at Ronda, Granada, and in two or three localities in the neighbourhood of Malaga; those at Ronda were obtained on March 23-24, at Granada March 25 and 28, and collections were made at Malaga at the beginning of April and again towards the end of the month. It will be most convenient to describe the Granada collection first. On the hills behind the Alhambra, between the Genil and Darro valleys, *Gonioctena* was exceedingly abundant, and I collected altogether 1382 specimens, 978 males and 404 females (Table I.). In the distribution of the different varieties they agree remarkably closely with those obtained by Bateson ten years ago in the same place. Bateson

found that of the males 81 per cent. were spotted with dark undersides, 19 per cent. striped only with light undersides. I found rather over 83 per cent. spotted and dark, 16 per cent. striped and light, and about 0.5 per cent. with intermediate undersides. Of the females, I found 27.5 per cent. with dark undersides, the same proportion as was observed by Bateson. The occurrence of the different varieties is in every way in close agreement with that found by Bateson; and it may be concluded that their distribution at that season has not changed appreciably in ten years. I did not collect in the Darro valley from which Bateson's second sample was obtained, but I found that on the lower slope of the hill towards the Genil valley the proportions did not differ from those on the top. On the Darro slope of the hill, which is very steep and faces north, the beetle did not occur, although *Spartium* was abundant.

At Granada a considerable proportion of the beetles were *in cop.*, and I collected 119 couples and recorded the characters of each as they were gathered. Care was taken to see that they were really paired, and since 71 pairs remained coupled after they were dead in the killing-bottle, there can be little doubt that all or nearly all were really *in cop.* Table II. gives an analysis of these. Of the 119 pairs, there were 22, or over 18 per cent., in which both male and female were striped green with light undersides. Taking pairing at random among the general population the expectation would be 10.5 per cent. But the proportion of males of this type which were paired is considerably higher than in the general population (29 out of 119 or 24.4 per cent.); so that random mating out of those paired would give 17 per cent. of such pairs, which does not differ greatly from the 18 per cent. observed. Similarly there were 25 pairs (21 per cent.) in which both male and female were red with dark undersides. The expected number on random mating among the whole population is 15.2 per cent., on random mating among those actually found paired about 17 per cent. The numbers observed are of course much too small to give reliable conclusions, but they indicate that of the males of the green striped form, and females of the red spotted form, a slightly higher proportion is found paired than in the general population, and that there is possibly a very small tendency towards selective mating between individuals of the same colour type.

At Ronda *Spartium* bushes were very scarce, and upon many there were no beetles, so that altogether only 106 individuals were obtained, 80 of which were males, 26 females. Although these numbers are small, they indicate that the population differs considerably from that of Granada (Table III.). Of the males 60 (75 per cent.) were spotted and dark underneath, 9 were green, striped and light, one red, spotted and striped, light, and 10 red, spotted and striped, with intermediate undersides. At Granada only 6 intermediates occurred in 1382 specimens; while

at Ronda over 12 per cent. of the males, and one female out of 26, were classed as such. The females also differed greatly from the Granada population: out of 26 only 10 were green striped with light undersides, one was red, spotted and striped and intermediate, and 15 were spotted and dark below. Even this small collection indicates that the proportion in which the different forms occur varies widely according to locality, as was suggested by Bateson's collections in two areas very near together at Granada, and the entirely different type which he found at Castillejo.

The only other collections which I was able to make came from localities in the neighbourhood of Malaga, and these differ very greatly not only from those of Granada and Ronda, but from one another. In the first few days of April I collected on the hills round El Palo, a village on the coast some three miles east of Malaga. *Spartium* bushes were not very abundant and the collection is not large. All the beetles were obtained in an area not more than two miles in length, extending from near the sea to less than a mile inland, and nearly all were found at heights from 20 to perhaps 200 feet above the sea. In some places higher up the hills, *Spartium* was common but the beetles exceedingly scarce. A summary of this collection is given in Table IV *a*, and it is seen that out of 173 males 141 (81.5 per cent.) were of the green striped form with light undersides, the remainder being mostly red, spotted with no stripes, and dark below. Of 204 females 187 (91.6 per cent.) were green, striped and light underneath, so that the percentage of this form does not differ greatly from that found among the males. It is important to notice that two of the males and one female included in this class were pure green with no spots or stripes. It is also noticeable that in this locality the females were more numerous than males.

During the same days I made collections in two localities to the north of Malaga. One of these was at a place some three miles up the main road, perhaps 500 feet above the sea. Here I obtained 322 males and 197 females (Table V *a*). Of the males with light undersides, 98 were green striped (9 of them having also spots), 3 red striped, 18 red spotted and striped, and one pure green, giving 120 or about 37 per cent. of light undersides. There were 16 with intermediate undersides, and the remainder were red spotted and dark underneath, mostly without stripes. Among 197 females, 52 (about 26 per cent.) were light underneath, all being green, and there were only two with intermediate undersides. At this place, therefore, the proportions of the different colours were entirely different from those of Palo, although the two places are not more than 5 miles apart; and the percentage of light undersides was actually lower in the females than in the males.

I also made a very small collection on some bushes growing in

the river-bed about two miles above Malaga, *i. e.* about a mile from the place just mentioned, but only a few feet above sea-level. There were just 25 males and 39 females (Table VI *a*), but they are of interest partly on account of the preponderance of females, and partly because the proportions closely resemble those shown in Table V., although the beetles were obtained from near sea-level, *i. e.* at the same kind of altitude as those from Palo. In this collection there were no plain greens.

On April 7 collecting was interrupted for nearly three weeks, but on April 25 and 27 I was able in the short time at my disposal to obtain 23 males and 33 females at Palo (Table IV *b*). These numbers are too small to make possible a close comparison with the earlier gathering, but they are of importance from the fact that 12 of the males and 14 of the females were of the pure green type, usually with a yellowish tinge and nearly always brighter in colour than the green striped form. At the beginning of the month only 3 specimens of this type occurred in a collection of 377.

On the 26th I visited the bushes up the river-bed and gathered 23 males and 31 females (Table VI *b*), which included 4 males and 9 females of the pure green type, the proportions among the remainder being similar to those found on April 6. And on the 28th I obtained 40 males and 47 females from the road to the north (Table V *b*), and here again the plain green type was frequent, while three weeks before it had been almost absent.

When I first arrived at Malaga I found that a beetle larva was common on the *Spartium*, and a couple which I kept alive both hatched to the pure green form of *Gonioctena*. It occurred to me that the green type might develop black pigment later, but several which I kept alive for a week showed no change of colour. Finally, when I was about to return to England, I gathered a quantity of larvæ in the hope of bringing them back alive; some of these came from Palo, where the predominant type was green, others from the north road locality, where the majority were red. The greater part died on the voyage, but I reared to maturity three of the Palo batch and eleven from the north road, and every one of these was plain green. There were 4 males and 10 females.

I thought at Malaga that possibly the plain green type belonged to another species; and I attempted to find out whether it ever paired with the other forms, but was not successful. Very few, however, were pairing at that time, so no importance can be attached to the fact that I never found the two types paired together.

On my return to England, Dr. Sharp very kindly examined some specimens of the green form and compared them with the spotted red, and reported that he believed they belonged to the same species. It must be concluded that as the season advances a new type begins to appear, and, judging by the fact that all the

larvæ which hatched yielded this form, it probably replaces the other varieties altogether.

A possible explanation of the meaning of this seasonal change occurred to me, when I noticed that the plain green form only appeared when the bushes began to come into bloom. Bateson has pointed out how close a resemblance the green striped form has to the grey-green of the *Spartium* twigs, and suggested that the resemblance might be regarded as protective. So also the red spotted type has a marked general similarity to the common *Coccinella septempunctata* which frequently occurred on the *Spartium*; so that the red type of coloration may perhaps be considered as mimicry of a species protected by its unpleasant odour. But more close than either of these is the resemblance of the plain green type to the flowers of the *Spartium*. The flowers are very small and grow in clusters; the petals are yellow, but are partly covered by the bright green calyx. When a bush is in full bloom the plain green type of beetle becomes almost invisible; its thorax is yellow corresponding with the yellow petals, and its elytra have nearly the same colour as the calyx. The general resemblance is so close that the beetles are very hard to see when the bush is in bloom, although when they are found on a plant which has not come into flower they are nearly as conspicuous as the red type.

My observations, taken as a whole, lead me to the conclusion that the correlation between the two main forms of *Gonioctena* and the two sexes, which Bateson observed at Granada, is a special phenomenon depending partly on locality and partly on season. At Ronda the correlation was much less conspicuous, and at Malaga it did not exist. Further, it appears that the frequency of the different varieties depends largely on season, but my observations did not extend over a long enough period to work this out thoroughly. At the higher, and presumably more backward, localities the males were more numerous than the females, and the red spotted type was most abundant; this was most conspicuously the case in Bateson's collections from Castillejo. Near sea-level there was an excess of females, and at Palo this was associated with a predominance of green. Finally, as the season advanced and the *Spartium* came into bloom, a pure green type appeared; and from the fact that no other form hatched from the larvæ which I collected, it seems probable that in the summer this is the predominant type of both sexes.

In conclusion, I wish to acknowledge my indebtedness to my brother for much valuable help in collecting the beetles.

[In the tables reference is made to the figures given by Bateson,
P. Z. S. 1895, plate xlvii.]

TABLE I.—Collection made at Granada, March 25–28.

Description.	Males.		Females.	
	Col-lected.	Per-cent.	Col-lected.	Per-cent.
A. Dark undersides.				
Red, spotted (Bateson's figs. 1, 2, 3, 14, 19)	674	69	50	11
Green, spotted (B., figs. 4, 5, 6, 13)	34	3·5	23	6
Red, spotted and striped (B., figs. 7, 8, 30)	77	8	17	4
Melanic reds (B., figs. 10, 11, 12)	28	3	19	5
Green, spotted and striped (B., figs. 27, 28)	4	0·5	6	1·5
Total dark undersides	817	84	115	27·5
B. Intermediate undersides.				
Red, spotted and striped	2	0·5	1	
Red, spotted	1			
Green, spotted and striped	2			
Total intermediate	5	0·5	1	
C. Light undersides.				
Green, striped (Bateson's figs. 22, 23)	149	16	274	68
Green, spotted and striped (B., figs. 25, 27, 28)	7		14	3·5
Total light undersides	156	16	288	71·5
TOTAL	978	100·5	404	99

TABLE II.—Couples recorded at Granada, March 28.

Description.	Total recorded as gathered.	Remained coupled after death.	Description.	Total recorded as gathered.	Remained coupled after death.
red, spotted, dark	17	10	green, spotted, dark ...	3	2
red, spotted	6	2	green, striped, light ...		
red, melanic			green, striped, light ...	3	1
red, spotted, dark	4	3	red, spotted, dark (one melanic) ...		
green, spotted, dark ...			green, striped, light ...	4	3
red, spotted (one melanic) ...	58	40	green, spotted, dark ...		
green, striped, light ...			green, striped, light ...	22	9
red, melanic					
red, spotted & striped }	2	1			
			TOTAL	119	71

TABLE III.—Collection made at Ronda, March 23 and 24.

Description.	<i>Males.</i>		<i>Females.</i>	
	Collected.	Per cent.	Collected.	Per cent.
A. Dark undersides.				
Red, spotted (Bateson's figs. 1, 2, 19)	46	...	12	
Red, spotted and striped (B., figs. 7, 8, 16)	11	...	1	
Green, spotted (B., figs. 4, 5, 28)	3	...	2	
Total dark undersides	60	75	15	58
B. Intermediate undersides.				
Red, spotted and striped (B., figs. 7, 16, 30) ...	10	12·5	1	4
C. Light undersides.				
Red, spotted and striped (B., fig. 7)	1	...		
Green, spotted and striped (B., figs. 27, 28)	2	...	4	
Green, striped (B., figs. 22, 23)	7	...	6	
Total light undersides	10	12·5	10	39

TABLE IV.—Collections made at Malaga (El Palo).

IV *a* on April 1, 2, 4, 7. IV *b* on April 25 and 27.IV *a*.IV *b*.

Description.	<i>Males.</i>		<i>Females.</i>		<i>Males.</i>		<i>Females.</i>	
	Collected.	Per cent.	Collected.	Per cent.	Collected.	Per cent.	Collected.	Per cent.
Red, spotted, dark	25	...	9	...	1	...	2	
Red, spotted and striped, dark	7	...	5	1	
Total dark	32	18·5	14	7	1	4	3	9
Red, spotted and striped, intermediate	2	1				
Green, spotted and striped, light	1					
Green, striped, light	139	80·5	187	91·5	10	43	16	48
Plain green, light	2	1	1	0·5	12	52	14	42
Total light	141	81·5	189	92	22	95	30	90
TOTAL	173	100	205	100	23	99	33	99

TABLE V.—Collection made 3 miles north of Malaga.

V *a* on April 3 and 5. V *b* on April 28.V *a*.V *b*.

Description.	Males.		Females.		Males.		Females.	
	Collected.	Per cent.	Collected.	Per cent.	Collected.	Per cent.	Collected.	Per cent.
A. Dark undersides.								
Plain red	1
Red, spotted (Bateson's figs. 1, 2, 3)...	166	...	114	...	17	...	15	...
Red, spotted and striped (B. figs. 7, 8)	19	...	27	...	2	...	8	...
Red, melanic (B., figs 9, 10, 11)	2
Total dark	186	58	143	72.5	19	48	23	49
B. Intermediate undersides.								
Red, spotted and striped (Bateson's figs. 7, 19, 30)	16	5	2	1				
C. Light undersides.								
Red, spotted and striped (Bateson's figs. 7, 19, 30)	18	2	5		
Red, striped (B., figs. 20, 21)	3							
Green, spotted and striped (Bateson's figs. 27, 28)	9	...	1	...				
Green, striped (B., figs. 22, 23)	89	...	50	...	12	...	12	...
Plain green	1	...	1	...	7	...	12	...
Total light	120	37	52	26.5	21	52	24	51
TOTAL	322	100	197	100	40	100	47	100

TABLE VI.—Collection made in river-bed, 2 miles above Malaga.

VI *a* on April 6. VI *b* on April 26.VI *a*.VI *b*.

Description.	Males.		Females.		Males.		Females.	
	Collected.	Per cent.	Collected.	Per cent.	Collected.	Per cent.	Collected.	Per cent.
Red, spotted, dark	16	...	29	...	11	...	6	...
Red, spotted and striped, dark	6	...	2	...	8	...
Total dark	16	64	35	90	13	56	14	45
Red, spotted and striped, intermediate	2	8	1	4	1	3
Green, striped, light	7	28	4	10	5	23	7	23
Plain green, light	4	17	9	29
Total light	7	28	4	10	9	40	16	52
TOTAL	25	100	39	100	23	100	31	100

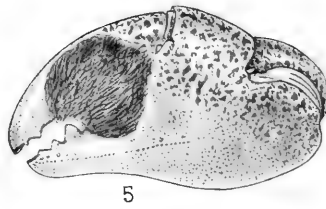
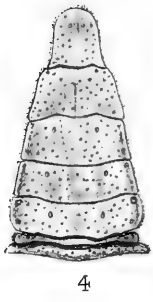
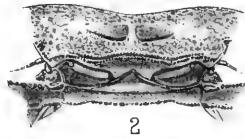
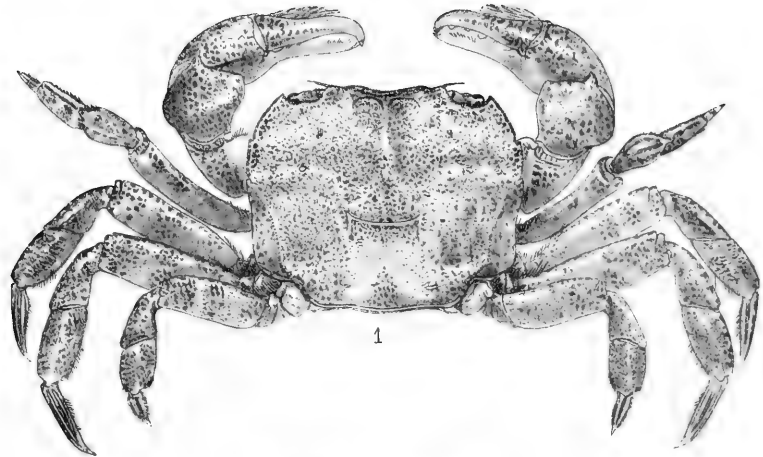

J.G.de Man.del.

Bale & Danielsson Lit. Photogravure.

I-5. PTYCHOGNATHUS PUSILLUS.
6. P. BARBATUS.

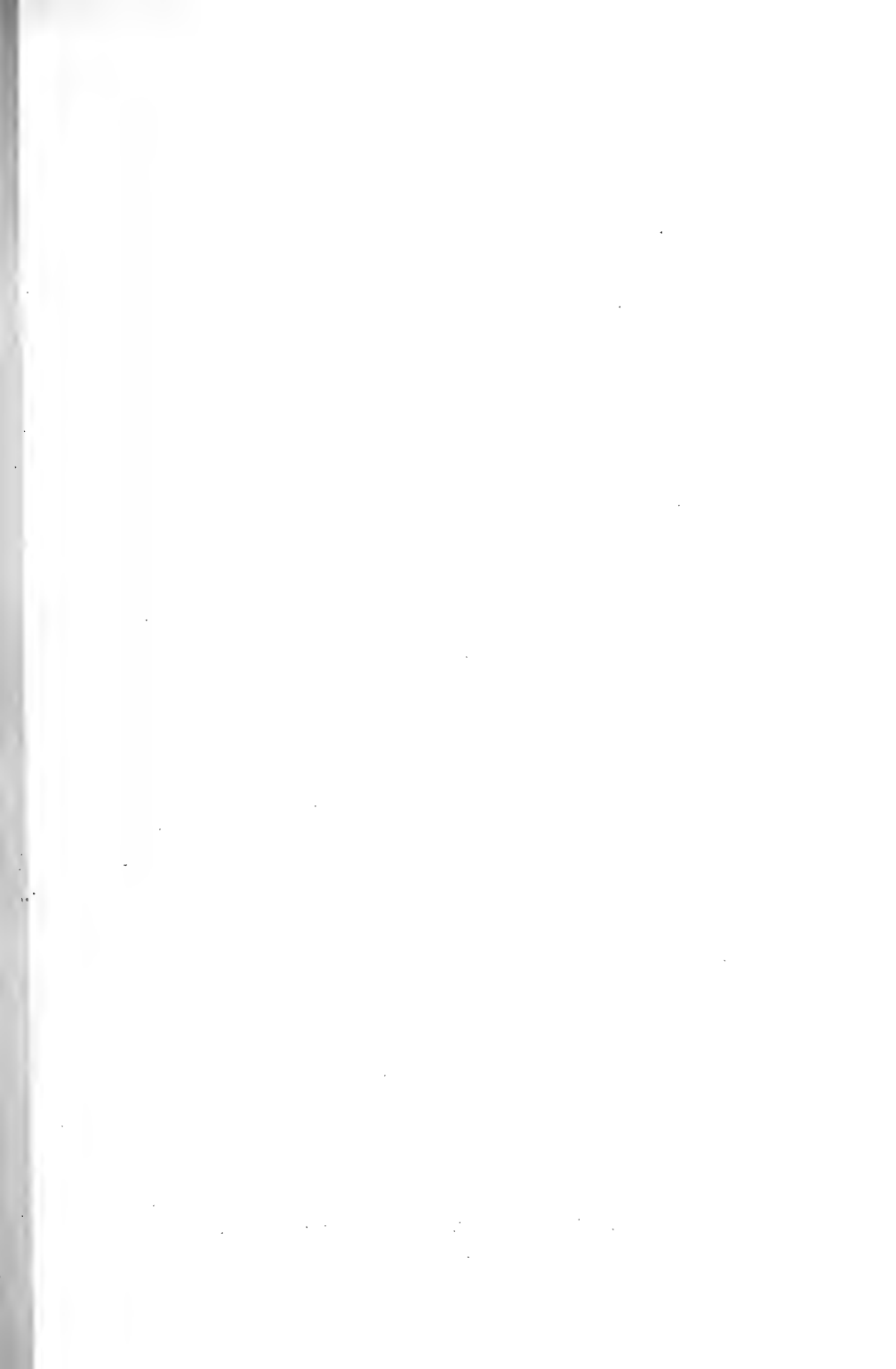

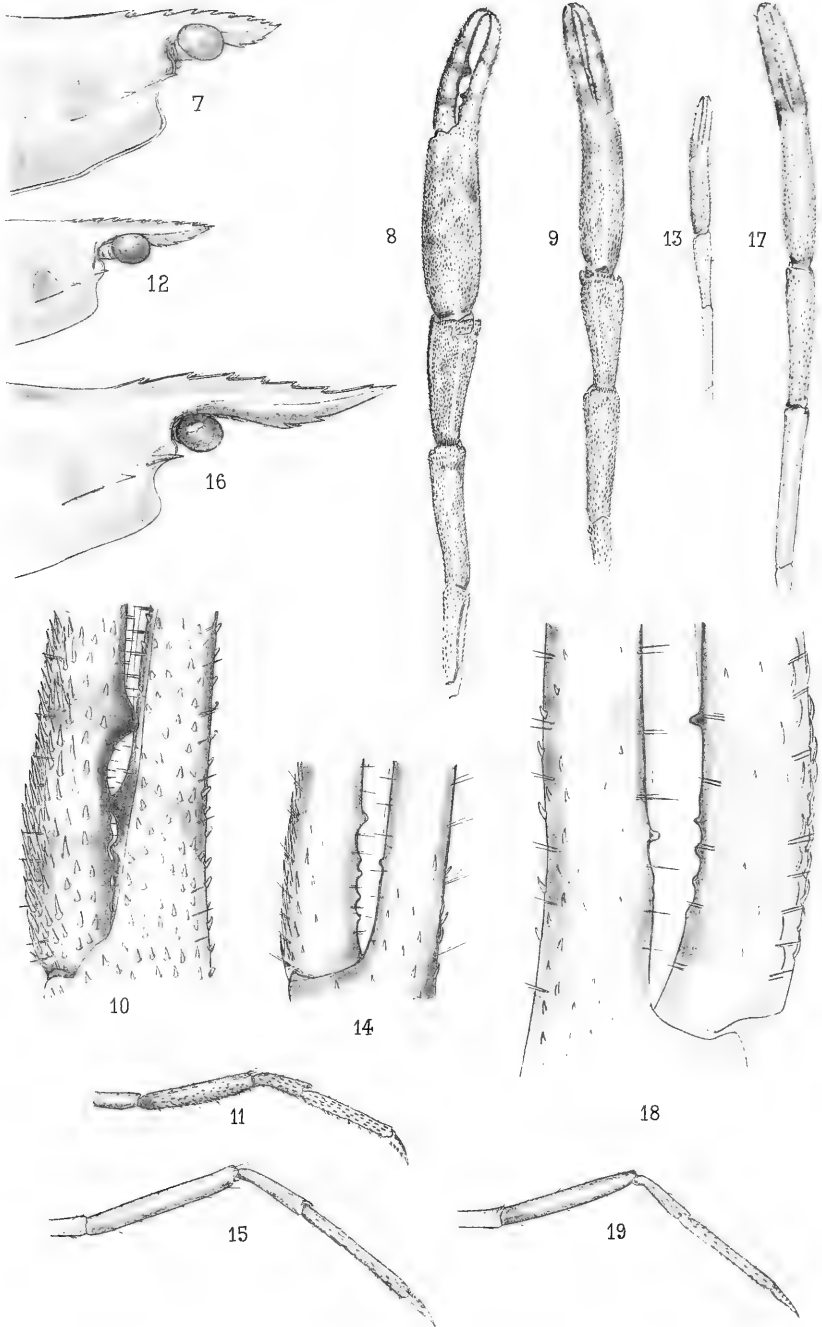

J. G. de Man. del.

Bale & Danielsson Lith. Photographure.

7-15, PALÆMON (EUPALÆMON) LAR. VAR.
16-19, P. (EUPALÆMON) LAR.

6. On Species of Crustacea of the Genera *Ptychognathus* Stimps. and *Palæmon* Fabr. from Christmas Island.
By Dr. J. G. DE MAN, of Ierseke, Holland.

[Received October 20, 1905.]

(Plates XVII. & XVIII.*)

The Crabs and Prawns described in this paper were sent me for examination by Dr. W. T. Calman, of the British Museum. They were collected by Dr. R. Hanitsch, of the Raffles Museum, Singapore, who wrote to Dr. C. W. Andrews regarding them: "The Prawn and the Crab were obtained from a small, artificial freshwater pool, on Christmas Island, above the waterfall, which probably did not exist in your time [*i. e.* when Dr. Andrews was on the island in 1897-1898]." Dr. Andrews adds that at the time of his stay on the island the stream in question was a very small thread of water, trickling down the precipitous hill through thick bush, without pools of any size or depth, and that he carefully explored it for Crustacea without finding any. Of course it is just possible that they may have existed in some pools not visited by him.

PTYCHOGNATHUS PUSILLUS Heller. (Plate XVII. figs. 1-5.)

Ptychognathus pusillus Heller, Crustaceen der Novara Reise, 1865, p. 60.

Ptychognathus pusillus de Man, in Zoolog. Jahrb. (Spengel), vol. ix. 1895, Abth. f. Syst. p. 99, Taf. 28, fig. 22.

One male and one female without eggs from a freshwater pool on Christmas Island.

Ptychognathus pusillus Heller was founded, forty years ago, on a single female specimen collected by the 'Novara' Expedition on the Nicobar Islands; Heller did not figure his species. A new, detailed description, illustrated by several figures, of this type-specimen, preserved in the Museum of Vienna, appeared in 1895 in my paper on the Decapod Crustacea gathered by Captain Storm in the Indian Archipelago: I suggested in this description that *Ptychognathus pusillus* should be regarded either as a distinct species, the male of which was still unknown, or as a young individual of another known species, perhaps *Ptych. pilipes* A. M.-Edw., from Celebes, or *Ptych. intermedius* de M., from the Moluccas (*l. c.* p. 100). *Ptychognathus pusillus*, however, apparently a rare freshwater crab, has not been met with during the long period of forty years, and its rediscovery on Christmas Island is therefore particularly interesting, especially because not only the female was found, but also the male, which hitherto was unknown. The two specimens prove that *Ptych. pusillus* Heller is a "good species," different from all its congeners.

* For explanation of the Plates, see p. 550.

The female from Christmas Island is of a somewhat larger size than Heller's type specimen; the measurements are the same, except that the greatest width of the carapace of the female from Christmas Island is a little larger in proportion both to the length of the carapace and to the distance between the external orbital angles. The exognath of the external maxillipedes, though still less broad than the ischium-joint, appears broader in proportion to this joint than in Heller's younger type specimen, and the chelæ are comparatively larger. The tips of both fingers carry some stiffish hairs on their outer surface close to the horny border; these hairs are more numerous on the tip of the fixed finger. In the Vienna type specimen these hairs were, no doubt, worn off. The dactylus carries 6 or 7, acute, conical teeth, and the fixed finger 4 or 5, which are a little larger. These slight differences are caused by the larger size of this specimen, which, for the rest, fully agrees with Heller's type. The male is larger than the female and more than once and a half as large as Heller's type specimen; regarding the proportion of the measurements of the carapace, the male agrees with the female from Christmas Island. The cephalothorax also fully agrees in its other characters with my description of 1895, except as regards the outer footjaws. I suggested in that paper that, in the male, the exognath should be as broad as or perhaps even a little broader than the ischium-joint; this supposition is now confirmed by the male from Christmas Island. In this male, indeed, the exognath (Pl. XVII. fig. 3) appears *a little broader* than the ischium, the proportion between them being as 11:10; the exognath is distinctly convex longitudinally and also a little transversely. The merus-joint fully agrees with that of the type specimen, its antero-lateral angle being rounded, whereas the external margin, so far as it is contiguous to the exognath, appears very slightly concave; the outer half appears, under a lens, finely granulate. The exognath is somewhat punctate, except on the inner border and posteriorly, as is also the endognath, except in the middle, and short stiff setæ are inserted on the puncta. The abdomen (fig. 4) resembles that of *Ptych. polleni* de M. from Madagascar (de Man, l. c. Taf. 28. fig. 20 b), as is proved by the figure and the measurements. Sternum and abdomen are punctate; the 3rd, 4th, and 5th segments of the abdomen, counting from the base, carry, moreover, each a larger pit on their antero-lateral angle and another on the anterior half at either side of the middle line.

The chelipedes are equal (fig. 1). The punctate, anterior surface of the ischium carries one or two short, stiff setæ. The upper border of the merus is hairy on its proximal half, the obtuse anterior border is granular and a little pubescent proximally. The upper surface of the carpus is closely, but finely punctate, the rest smooth, but it appears finely granular under a lens in the female; the internal angle is obtuse, though not rounded. The chelæ (fig. 5) resemble *closely* those of *Ptych. barbatus*, not only as regards their general shape but also because

the fingers are provided, *each*, exactly as in that species, *with a tuft of hair*; the chelæ also much resemble those of *Ptych. pilipes* A. M.-Edw. from the Philippine Islands, but here the tufts of hair are wanting. Measured horizontally, the chelæ appear just as long as the distance between the antero-lateral angles of the carapace; the palm is a little shorter than the fingers and, at their articulation, a little higher than long. The convex, outer surface of the palm, under a lens, appears very finely, but closely, punctate, though smooth to the naked eye; both the upper and the lower borders are rounded. The somewhat curved, tapering dactylus carries 7 or 8 small teeth, which are rather obtuse, except two or three near the tip; the immobile finger has 5 or 6 more conical teeth, which are larger than those of the dactylus, especially two or three in the middle. The fingers are finely and closely punctate, just like the palm; on the middle of the outer surface of the fixed finger the puncta are arranged in a longitudinal row that extends from the tip almost to the middle of the palm; a few larger, impressed puncta occur on the distal half of the index just above that row. As in *Ptych. barbatus*, each finger carries a *close tuft of brown woolly hairs* on the proximal half of its outer surface; the tuft of the dactylus does not extend on to the upper border of the finger, and that of the fixed finger reaches only halfway between the teeth and the lower border. The tips of the fingers have horny margins: on the outer side of the tip of the fixed finger, close to and parallel with the horny edge, are seen a few short, stiffish setæ, though much less numerous than in the female; on the tip of the dactylus they are perhaps worn off. The inner surface of the chelæ (palm and fingers) is smooth and glabrous.

The ambulatory legs are hairy on the upper side of their basal joints, and a few stiff setæ occur on the lower surface of ischium and merus on either side of the articulation between these joints; the posterior border of the last two joints is also setose, and rows of short setæ occur on the lower side of the propodites of the 1st and 2nd pair. For the rest, the upper and the lower borders of these legs are *glabrous, devoid of the long hairs* that are characteristic of *Ptych. pilipes* A. M.-Edw. The meropodites appear under a strong lens very finely granular, except those of the last pair, which are almost smooth and only punctate; the puncta are small and numerous, but three or four larger puncta in a longitudinal row are found on the middle of the meropodites of the last pair. Just as in *Ptych. barbatus* A. M.-Edw., there is *no subterminal spine* on the anterior border of the meropodites. The following joints are also punctate, and the dactyli are ridged longitudinally both on the upper and lower sides.

On a yellow ground-colour the upper surface of carapace and legs is marked with innumerable, small, irregular spots of a dark purple colour, which on the epigastric and protogastric regions are almost confluent.

Among the twelve species of *Ptychognathus*, certainly *Ptych.*

barbatus A. M.-Edw. *, a marine crab from New Caledonia, which has also been observed on the shores of Atjeh, Penang, and of the islands between Japan and Formosa, is the most closely related form. As regards the proportion between the length of the carapace and the greatest width of it in adult specimens, both species fully agree with one another, but in young individuals the carapace of *barbatus* is slightly broader in proportion to its length than that of *pusillus* (de Man, *l. c.* p. 104). At all ages, however, both in the male and in the female, the cephalothorax of *barbatus* is anteriorly distinctly broader in proportion to its length, as is proved by comparing the measurements of the length of the carapace and of the distance between the extraorbital angles; the extraorbital teeth run therefore more obliquely with regard to the median line of the carapace in *Ptych. pusillus* than in *Ptych. barbatus* (figs. 1 and 6). In proportion to the greatest width of the carapace the front appears a little broader in *barbatus*; it has the same form in both species, but the granulated line that runs immediately behind the frontal margin is, in the middle line of the carapace, contiguous to that margin in *barbatus*, whereas in Heller's species (fig. 2) both lines are distant from one another in the middle. In *Ptych. barbatus* the epigastric lobes are situated farther from the frontal border than in *pusillus* (figs. 1 and 6). In *Ptych. barbatus* the 2nd and the 3rd antero-lateral teeth of the carapace are more salient and the incisions are deeper than in *pusillus*; near the antero-lateral teeth the carapace of *pusillus* is somewhat granulated, but in *barbatus* not.

The exognath of the external maxillipedes of the adult male of *Ptych. barbatus* is one-third broader than the ischium, and in the adult female it is just as broad or even very slightly broader than the ischium; in the adult male of *pusillus* the exognath appears a little less broad in proportion to the ischium, and in the female the ischium is decidedly broader than the exognath.

The slight differences exhibited by the legs are of little importance. But for a few hairs on the outer side of the tip of the fixed finger in the female, the extremities of the fingers of *barbatus* are glabrous. *Ptych. barbatus* is smaller than *pusillus* and the habitat is different, the former being probably a marine species, the latter a freshwater one.

An adult female of *Pseudograpsus barbatus* Rumph from the River Wukur, on the island of Flores, is lying before me (*vide* de Man, in Max Weber's 'Decapoden des Indischen Archipels,' 1892, p. 317); it will be useful to indicate the differences between this specimen and the female of *Ptych. pusillus* Heller, since they much resemble each other. Both species, of course, differ at first sight by their external maxillipedes; the rounded antero-external angle of the merus-joint is less strongly produced in *Pseudograpsus barbatus* than in Heller's species, and the exognath

* *Ptych. barbatus* is also described in Prof. Alcock's work: "Materials for a Carcinological Fauna of India.—No. 6. The Brachyura Catometopa or Grapsoida," Journ. Asiatic Soc. Bengal, lxi. (2) no. 3, 1900, p. 406.

of the former is, in the middle, only *half as broad* as the ischium, whereas it narrows more anteriorly. The epistome has a different form: in *Ptych. pusillus* it is barely broader laterally than in the middle, but in *Pseudogr. barbatus* the posterior margin is strongly arcuate, so that the epistome appears much broader laterally than in the middle. The legs are much alike in both species, but in *Pseudogr. barbatus* the last three joints of the ambulatory legs are much more tomentose. *Pseudogr. barbatus* finally attains a larger size.

Measurements of the two specimens of *Ptych. pusillus* Heller from Christmas Island, in millimetres.

	♂.	♀.
Distance between the antero-lateral angles of the carapace	13·5	10·5
Distance between the second teeth	17·5	13·25
Distance between the third teeth, <i>i. e.</i> the greatest breadth of the carapace	18	13·75
Breadth of the carapace at the posterior end of the lateral margins	17	13
Length of the carapace, in the middle line ...	14·5	11·5
Breadth of the frontal border	7·2	5·5
Breadth of the posterior border of the carapace	7·5	6
Breadth, in the middle, of the ischium-joint of the external maxillipedes	2	1·5
Breadth, in the middle, of the exognath	2·2	1·3
Horizontal length of the chelæ	13·5	6·5
" " " palm	6	3
Height of the palm, at the articulation of the fingers	7·75	3·3
Length of the antepenultimate joint of the abdomen, measured in the middle	2·1	
Length of the penultimate joint.....	2·1	
Breadth of the posterior border of this joint...	4·12	
" " anterior " " " ...	2·7	
Length of the terminal joint	2·6	

REVISION OF THE GENUS *PTYCHOGNATHUS* STIMPS.

The genus *Ptychognathus*, created by Stimpson in 1858 (Proc. Acad. Nat. Sci. Philadelphia, p. 104), and identical with the genus *Gnathograpsus* A. M.-Edw. 1868, is, at the present time, September 1905, represented by the following twelve species:—

1. *Ptychognathus glaber* Stimps. 1858. ♂.
2. " *pusillus* Heller 1865. ♂ ♀.
3. " *riedelii* A. M.-Edw. 1868. ♂ ♀.
- 3 *a.* " " var. *pilosa* de M. 1892. ♂.
4. " *pilipes* A. M.-Edw. 1868. ♂.
5. " *barbatus* A. M.-Edw. 1872. ♂ ♀.

- 6. *Ptychognathus intermedius* de M. 1879. ♂.
- 7. " *dentatus* de M. 1892. ♂ ♀.
- 8. " *spinicarpus* Ortm. 1894. ♂.
- 9. " *polleni* de M. 1895. ♂.
- 10. " *affinis* de M. 1895. ♂.
- 11. " *onyx* Alcock 1900. ♂.
- 12. " *andamanicus* Alcock 1900. ♀.

Of all these species the male is known, except of *Ptych. andamanicus* Alcock, which is, however, probably identical with *Ptych. riedelii* A. M.-Edw.; of five species only has the female been observed.

According to their outer appearance and physiognomy these 12 species may be divided into three natural sections. The first section represented by five species, viz. *Ptych. dentatus*, *spinicarpus*, *polleni*, *affinis*, and *onyx*, of which *Ptych. dentatus* is the typical form, is distinguished by the following characters:—The carapace is hardly broader than long, the regions usually quite distinct, as also the epigastric lobes. The three teeth of the antero-lateral margins are sharp and salient. Front prominent, laminar, straight, or nearly straight. Inner angle of the carpus of the chelipedes produced, in the male, to form a more or less long spine, except in *Ptych. dentatus*, in which the inner angle is acute, but not spiniform. Chelæ glabrous on their outer surface, except in *Ptych. onyx*, in which there is a tuft of hair in the finger-cleft and extending along the fixed finger. Ambulatory legs hairy, the anterior border of the merus with a subterminal spine.

The second section is composed of *Ptych. glaber*, *riedelii*, with its variety *pilosa*, and *Ptych. andamanicus*; *Ptych. riedelii* may be regarded as the type. The carapace of *Ptych. riedelii* and *andamanicus* is hardly broader than long, that of *glaber*, however, is distinctly broader than long. The upper surface is quite flat, much depressed, the regions are not or hardly indicated, and the epigastric lobes are wanting. There are two teeth behind the extraorbital angle, as in the two other sections, or one (*glaber*); the teeth are small, not very acute or distinct. Front prominent, laminar, slightly sinuous, furrowed transversely. Inner angle of the carpus of the chelipedes obtuse, rounded, or (in *Ptych. andamanicus*) pronounced, though not spiniform. A brush of stiffish hair at the tip of the fixed finger on its outer surface, except in *Ptych. glaber*; chelæ for the rest glabrous, except in *Ptych. riedelii* var. *pilosa*. Ambulatory legs hairy; subterminal tooth on the anterior border of the merus inconspicuous or blunt.

The third section is represented by four species, viz. *Ptych. pusillus*, *pilipes*, *barbatus*, and *intermedius*, of which *pusillus* may be regarded as the type. The carapace is decidedly broader than long, flat, though not much depressed. Regions more or less distinct, as also the epigastric lobes. Front not prominent, distinctly sinuous, and transversely ridged. The three antero-lateral teeth are not very conspicuous. Inner angle of the carpus

of the chelipedes obtuse, or little pronounced, never spiniform. Fingers, in the male, with a tuft of hair on their outer surface, proximally (*barbatus*, *pusillus*), or glabrous; in the latter case the palm is either smooth on its outer side (*pilipes*), or granulated (*intermedius*). Ambulatory legs more or less hairy, no sub-terminal spine on the anterior border of the meropodites.

Artificial key to the males of the Indo-Pacific species of the genus *Ptychognathus* Stimps.*

- | | |
|---|--|
| 1. Fingers glabrous on their outer side (proximally †) | 2. |
| 1. Both fingers, or one of them, with a tuft of hair on their outer surface, proximally | 3. |
| 2. Exognath of external maxillipedes, in the adult male, twice or more than twice as broad as the ischium ‡ | 4. |
| 2. Exognath less than twice as broad as the ischium | 5. |
| 4. Inner surface of the chelæ glabrous | 6. |
| 4. Inner surface of the palm with a tuft of hair; carpus with a small, acute tooth at the inner angle; second and third antero-lateral teeth of the carapace sharp, salient; epigastric lobes distinct | <i>dentatus</i> . |
| 6. Inner angle of the carpus obtuse or pronounced, but not spiniform; a brush of stiffish hair at the tip of the fixed finger on its outer surface; second and third antero-lateral teeth of the quite flat, much depressed carapace not salient, inconspicuous | { <i>riedelii</i> .
<i>andamanicus</i> §. |
| 6. Inner angle of the carpus produced to form a long spine; no brush of stiffish hair at the tip of the fixed finger on its outer surface; second and third antero-lateral teeth of the flat, though not particularly depressed carapace salient, sharp ... | <i>spinicarpus</i> . |
| 5. Two teeth behind the extraorbital angle | 7. |
| 5. One single, small tooth behind the extraorbital angle; inner angle of the carpus rounded; outer surface of the chelæ smooth; ambulatory legs with long hairs on both margins .. | <i>glaber</i> . |
| 7. Outer surface of the chelæ smooth, towards the base of the immobile finger | 8. |
| 7. Outer surface of the chelæ distinctly granulated; antero-lateral teeth of the carapace as little prominent as in <i>Ptych. riedelii</i> , general shape of the carapace as in <i>Ptych. pilipes</i> , and ambulatory legs, as in that species, very hairy | <i>intermedius</i> . |
| 8. Inner angle of the carpus produced to form a short, sharp spine | 9. |
| 8. Inner angle of the carpus obtuse; distance between the extra-orbital angles much shorter than the length of the carapace; epigastric lobes distinct; ambulatory legs very hairy | <i>pilipes</i> . |
| 9. Distance between the extraorbital angles much shorter than the length of the carapace; epigastric lobes distinct | <i>polleni</i> . |

* *Ptych. andamanicus* Alcock is included in this key, though only the female is known, because this species is probably identical with *riedelii*, or in any case most closely related.

† The word "proximally" is added, because in *Ptych. riedelii* and *andamanicus* there is a small tuft of hair at the distal end of the immobile finger, externally.

‡ Only the young female of *andamanicus* is known. In it the breadth of the exognath is nearly twice that of the ischium; we may therefore conclude that in the adult male the exognath will be twice or more than twice as broad as the ischium, because, as a rule, the exognath is, in this genus, less broad in the female than in the male.

§ These two species are probably identical. The carpus of the chelipedes of *riedelii* has a tuft of hair on its outer angle, both in the male and in the female; in Alcock's description of *andamanicus* this character has not been mentioned. *Ptych. riedelii* has also been observed at Atjeh.

9. Distance between the extraorbital angles as long as the length of the carapace; no epigastric lobes *affinis.*
10.
3. Both fingers with a tuft of hair proximally 10.
3. A tuft of hair in the finger-cleft and extending along the fixed finger; carapace hardly broader than long, depressed; teeth of the antero-lateral border sharp and salient; inner angle of the wrist produced to form a long spine *onyx.*
10. Exognath of external maxillipedes, in the adult male, more than twice as broad as the ischium; epigastric lobes wanting; a brush of stiffish hair at the tip of the fixed finger externally { *riedelii.*
var. *pilosa.*
10. Exognath, in the adult male, not once and a half as broad as the ischium 11.
11. Upper surface of the carapace granulated near the antero-lateral margins; second and third antero-lateral teeth of the carapace not salient; epigastric lobes distinct; granulated ridge behind the frontal border distinctly separated from it in the middle *pusillus.*
11. Upper surface of the carapace, which is broader anteriorly than that of *pusillus*, not granulated near the antero-lateral margins; second and third antero-lateral teeth more salient than those of *pusillus*; epigastric lobes distinct; granulated ridge behind the frontal margin contiguous to it in the middle line *barbatus.*

Artificial key to the known females of the species of
Ptychognathus.

1. Carapace hardly broader than long, front prominent, nearly straight 2.
1. Carapace decidedly broader than long, front little prominent and distinctly sinuous 3.
2. Regions of the flat, though not particularly depressed carapace and epigastric lobes distinct; antero-lateral teeth of the carapace sharp and salient *dentatus.*
2. Regions of the much depressed and quite flat carapace hardly indicated; no epigastric lobes { *riedelii.*
andamanicus.
3. Upper surface of the carapace granulated near the antero-lateral margins; ridge behind the frontal margin distinctly separated from it in the middle; exognath of external maxillipedes distinctly less broad than the ischium *pusillus.*
3. Upper surface of the carapace, which is anteriorly broader than that of *pusillus*, not granulated near the antero-lateral margins; ridge behind the frontal margin contiguous to it in the middle; exognath of outer footjaws just as broad or very slightly broader than the ischium *barbatus.*

PALEMÓN (EUPALEMÓN) LAR Fabr. var. ? (Plate XVIII. figs. 7-19.)

One male and one female without eggs from a freshwater pool, Christmas Island.

During the two or three last decennaries several carcinologists have regarded a more or less large number of described species of the subgenus *Eupalemón* as synonyms or, at the utmost, as individual or local varieties of *Palemón* (*Eupalemón*) lar Fabr. (confer: de Man, in 'Notes from the Leyden Museum,' 1879, pp. 168-173; Ortmann, in 'Zoolog. Jahrbücher (Spengel),' v. Abth. f. Syst. 1890, p. 724; Coutière, in 'Annales Sciences Naturelles,' Zool. 8^{me} série, t. xii. 1900, p. 292, and other papers of the same authors). Several specimens of *Pal. lar* Fabr. from

different localities of the Indian Archipelago, described, in 1892, in my paper on the Decapod Crustacea collected by Prof. Max Weber, are lying before me, as also are specimens from my own collection. When the young male from the River Palopo on the island of Celebes (de Man, in Max Weber, Zool. Ergebnisse, ii. 1892, p. 447) is compared with the male from Christmas Island, a doubt occurs to me whether we are right in considering these two Prawns as belonging to one and the same species. The male from the River Palopo (Pl. XVIII. figs. 16-19) is certainly a typical example of *Pal. lar* Fabr., but in the male from Christmas Island, the size of which is even a little smaller, *all the legs have a much stouter shape*, and there are no doubt still other differences. Specimens of *Eupalæmon*, presenting the same characters as this male from Christmas Island, have formerly been referred by me, and no doubt also by other authors (because this form is probably also widely distributed throughout the Indian Archipelago), to the "well-known" *Pal. lar* Fabr.; but it appears to be a question *whether this form may still be regarded as a variety or not*. I do not venture to decide this question at present, because the specimens are apparently young, but I wish to draw the attention of carcinologists to it, confining myself at present to describing the specimens from Christmas Island accurately.

These Prawns are, no doubt, young; the male is 62 mm. long from the tip of the rostrum to the end of the telson, the female 43 mm. The carapace of both is *smooth*. The lanceolate rostrum (Pl. XVIII. fig. 7) of the male is rather short, shorter than the peduncles of the internal antennæ, *reaching but a little beyond the penultimate joint of these peduncles*. The upper border, slightly arcuate above the eyes, is somewhat directed downward, though the acute tip extends horizontally forward; it carries eight equidistant teeth, that reach to the tip. *The first two teeth stand on the carapace*, the third just before the frontal margin, above the insertion of the eye-peduncles, and these teeth diminish a little in length from the second, that is the longest, to the last one. The distal half of the lower border carries *three* equidistant teeth that are smaller than those of the upper border, and the first of which is situated just below the antepenultimate tooth of the upper border; the acute tip of the 3rd is a little farther from the extremity of the rostrum than from the tip of the 2nd tooth. At the level of the 1st tooth of the lower margin the rostrum is *just as broad above as below the lateral carina*, and the height of the rostrum at its base is a *little larger* than its breadth below that carina. Hepatic and antennal spines as in typical specimens of *Pal. lar*. Of the two pairs of spinules on the upper surface of the telson, the anterior is inserted on the middle, the posterior midway between the anterior pair and the tip of the telson. The telson ends posteriorly in a sharp tooth; the inner of the two spines on either side projects half its length beyond the median tooth, whereas the outer spinule, barely half as long as the inner, reaches not so far backward as the median

tooth. The short flagellum of the internal antennæ, which is just as long as their peduncle, is serrulate internally, and coalesced for a very short distance, *i. e.* for $\frac{1}{9}$ of its length, with the outer flagellum.

The legs of the first pair reach with their chelæ beyond the antennal scales; the chela is *a little more than half as long* as the carpus.

The legs of the 2nd pair (figs. 8 and 9) are *unequal*, the left being a little larger than the other. The left leg (fig. 8), which is somewhat shorter than the body, projects more than half the carpus beyond the antennal scales. The cylindrical merus, that slightly thickens distally, is four times as long as thick. The carpus, which is *a little shorter* than the merus, has a *rather stout*, conical shape; it thickens considerably towards the distal end, appearing here *more than twice as thick* as at its base, when looked at from above, and its width at the distal end measures *two-fifths* of its length. The chela is somewhat longer than merus and carpus taken together. The palm is *nearly once and a half as long as the carpus*, and *one-fourth longer* than the fingers, which are a little curved inward, so that the inner border of the chela appears somewhat concave; the palm, *distinctly broader* than the carpus, is *somewhat broader than thick*, though but very little, the breadth in the middle being in proportion to its thickness as 15 : 13, so that it appears almost cylindrical. About at one-third of its length from the articulation the immobile finger is armed with a conical tooth (fig. 10), half as high as the finger is broad at this place; behind it is seen a smaller rounded tooth and, between the latter and the articulation, four or five extremely small and low rounded teeth. The dactylus appears, at its base, a little broader than the fixed finger (fig. 8), and is armed, just in the middle, with a slightly curved, conical tooth, which is *a little larger* than the foremost tooth of the index; opposite to it on the fixed finger is a small notch (fig. 10), that fits the tooth. Between this tooth and the articulation there are still five or six, *much smaller*, obtuse, somewhat unequal teeth. The tapering fingers therefore do not shut close together; between the foremost teeth and the tip the cutting-edge is sharp. The joints of this leg are everywhere covered *with innumerable minute, sharp spinules*, except on the usual, naked lines; these spinules are more crowded and a little larger on the outer and on the inner border of the palm and near the finger-cleft on the upper surface, whereas they are less numerous on the rest of the upper and on the lower surfaces. They are few in number on both sides of the fixed finger; on the outer margin of this finger they are also few in number, but larger than on the inner border of the palm. The outer side of the dactylus is thickly beset with slenderer, larger spinules, the sharp tip of which is curved upward, whereas the inner part of the upper and lower surface is nearly smooth. A few microscopical hairs occur on the outer and inner borders of the chela and of the other joints.

The right leg (fig. 9) resembles the one described (confer the measurements), but the palm is *a little less broad* than the distal end of the carpus, and the crowded spinules on the inner border of the palm are decidedly larger than those on the outer border. The toothing of the fingers is also different, the teeth being *much smaller*. The fixed finger carries a minute, conical tooth at one-third of its length from the articulation, and a smaller one behind it; at two-fifths of its length from the articulation the dactylus carries a similar, small, acute tooth, and between it and the articulation four much smaller teeth, also sharp. The palm of both legs is somewhat marbled by darker flecks; the fingers are bluish on their lower side with yellow tips, whereas their pale yellow upper surface is marked with three or four blue bands.

The three following legs are also of *a stouter shape* than in the typical specimens of *Pal. lar*. The 3rd pair reach to the end of the antennal scales, the 4th are a little shorter, and the 5th pair reach to the distal third part of the scales. The breadth of the meropodites of the 3rd pair (Pl. XVIII. fig. 11) is little more than $\frac{1}{6}$ of their length, and that of the propodites little more than $\frac{1}{5}$ of the length of these joints. The basal joints and the meropodites are smooth above, but their lower surface is beset with small spinules, a few of which occur also on their outer surface. The carpopodites are on all sides covered with similar spinules, and the propodites are still *more spinulose*; the spinules show here a tendency to be arranged in *longitudinal rows*. The lower border of the propodites carries *a row of larger spines*, 9 or 10 on the propodites of the 3rd legs, which are 0.36-0.4 mm. long; on the propodites of the 5th pair these larger spines of the lower border are 14 or 15 in number and become distally a little longer, so that the last one near the articulation of the dactylus is 0.55 mm. long. The dactylopodites of the 3rd pair (fig. 11) measure somewhat more than one-third, the shorter dactyli of the 5th one-fourth of their propodites. The ambulatory legs are a little hairy, especially the carpo- and propodites; the hairs, however, are *short and fine*. A tuft of hairs occurs at the distal end of the upper border of the propodites, and those of the 5th pair carry, moreover, a brush of hairs at the far end of the lower border.

The rostrum of the female (Pl. XVIII. fig. 12) is slightly inclined downward and reaches to the distal end of the peduncles of the internal antennae. The upper border carries 9 teeth, the 3rd of which is situated not before, but just above the frontal margin, two standing also on the carapace; the teeth, which reach to the tip, are a little unequal, the 2nd and the 6th being longer than the rest, and the foremost tooth is smaller than the preceding. The lower edge carries 3 smaller teeth, the tip of the 3rd tooth, which is situated just below the middle of the penultimate tooth of the upper border, is once and a half as far distant from the extremity of the rostrum as from the tip of the 2nd tooth of the lower border.

As regards the two spines on the carapace and the telson, the female agrees with the male. The short flagellum of the internal antennæ, when put back, reaches to the 1st tooth of the upper border of the rostrum.

The legs of the 1st pair agree also with those of the male; the chela extends beyond the antennal scales and is distinctly more than half as long as the carpus.

The legs of the 2nd pair are subequal, the left (Pl. XVIII. fig. 13) being very little larger than the right. They show a *less stout shape* than those of the male, as is proved by the measurements. For example, the width of the distal end of the carpus is but *one-fourth* of its length, and the palm is also less broad in proportion to its length. The dactylus carries one small obtuse tooth at the end of the sharp cutting-edge (fig. 14), at one-third of the length of the finger from the articulation, and four smaller teeth, also obtuse, posterior to it; the fixed finger carries one single tooth at the end of the cutting-edge. These legs are also covered with small, slender spinules; those on the inner margin of the palm are more prominent than on the outer and more numerous than on the upper and lower surfaces. The ambulatory legs (fig. 15) are also *slenderer* than in the much larger male.

When, however, the legs of the 2nd pair are compared with a female from Kadjang of the same size which belongs to the typical form (de Man, *l. c.* 1892, p. 449), then they appear in the female from Christmas Island distinctly *stouter*, especially the carpus.

The male from the River Palopo (p. 545) is 75 mm. long. The rostrum (Pl. XVIII. fig. 16) reaches to the extremity of the antennal scales. The upper border, which is slightly arcuate above the eyes, carries 7 teeth; the 2nd tooth, situated above the frontal border, is a little longer than the four following, which are subequal; the foremost tooth is longer than the preceding and almost twice as far distant from the penultimate tooth as from the slightly upturned tip. The two teeth of the lower margin are situated below the 5th and the 6th of the upper border. The chelæ of the 1st pair are barely half as long as the carpus. There is but one leg of the 2nd pair (fig. 17); this leg has a *much slenderer* shape than those of the male from Christmas Island (confer the measurements). The carpus is, at the distal end, comparatively only *half as thick* as in that specimen. The ambulatory legs (fig. 19) are also *much slenderer* than in the male from Christmas Island.

I do not wish to go further into this question, but, at first sight at least, it appears probable that under the name of *Pal. lar* Fabr. two different species are confounded. The following may, however, be added.

Specimens lying before me from a river near Mbawa in the island of Flores (de Man, *l. c.* 1892, p. 449) belong certainly to the same form as the male from Christmas Island. A male 71 mm. long fully agrees with it, as regards the shape and the characters of the rostrum and of the ambulatory legs (the 2nd

Reunion, ought to be regarded as a, probably local, variety of *Pal. lar* Fabr.

The male from Christmas Island bears a *close* resemblance, indeed, to *Pal. altifrons* Hend. from British India (Delhi, River Jumna, Lahore), described and figured in Trans. Linnæan Soc., 2nd ser. Zool. vol. v. 1893, p. 444, pl. 40. figs. 4-6. The carapace of *Pal. altifrons* is, however, slightly *scabriculate* anteriorly, and the rostrum appears *considerably higher* above the lateral carina than below it and than in the specimens from Christmas Island; the carpus of the 2nd legs, finally, has also a less stout shape.

EXPLANATION OF THE PLATES.

PLATE XVII.

- Fig. 1. *Ptychognathus pusillus* Heller, male from Christmas Island, $\times 2$. Fig. 2. Front, epistome &c., viewed from before, $\times 3$. Fig. 3. External maxillipede of the right side, $\times 3$. Fig. 4. Abdomen, $\times 3$. Fig. 5. Chela viewed from the outer side, $\times 3$.
6. *Ptychognathus barbatus* A. M.-Edw., male from Atjeh, the cephalothorax of which is 10.2 mm. broad; anterior half of the upper surface, $\times 3$.

PLATE XVIII.

- Fig. 7. *Palæmon (Eupalæmon) lar* Fabr. var. ? rostrum of the male from Christmas Island, $\times 2$. Fig. 8, left, fig. 9, right leg of the 2nd pair of the male, $\times 2$. Fig. 10. Toothing of the fingers of the left leg, $\times 8$. Fig. 11. Leg of the 3rd pair of the male, $\times 2$. Fig. 12. Rostrum of the female from Christmas Island, $\times 2$. Fig. 13. Left leg of the 2nd pair of this female, $\times 2$. Fig. 14. Toothing of same leg, $\times 17$. Fig. 15. Leg of the 3rd pair of the female, $\times 4$.
16. *Palæmon (Eupalæmon) lar* Fabr., rostrum of the male from the River Palopo, Celebes, $\times 2$. Fig. 17. Leg of the 2nd pair of the male, $\times 2$. Fig. 18. Toothing of the fingers of same leg, $\times 17$ (the dactylus is a little loose). Fig. 19. Leg of the 3rd pair, $\times 2$.

7. Note on Heredity in Pigeons.

By RICHARD STAPLES-BROWNE, F.Z.S.

[Received November 8, 1905.]

I. THE WEBBED FOOT.

I received in 1902 a Pigeon with webbed feet, and, thinking it would be interesting to investigate the inheritance of this character, I made the following experiments with it.

There is no established strain of web-footed Pigeons, but specimens so webbed are occasionally met with among domestic birds. The character has been found in the Dove-cot Pigeon and Working Homer, also in the Show Homer, Dragon, Magpie, Tippler, Tumbler, Jacobin, and Pouter. I have myself bred birds in the F. 4 generation of a cross between a Barb and a Fantail, which showed this character to a considerable extent.

So far as I can at present judge from specimens recorded by breeders, the most common type is a web between two digits

only on each foot, and it is more usual to find the development of the web nearly symmetrical in the two feet.

It sometimes occurs between digits ii. and iii. sometimes between iii. and iv., and sometimes between all three.

The instances in which it reaches the bases of the claws between all the digits on both feet are rarer. It has occurred on one foot only.

Though this character has been observed to occur in the offspring of normal-footed parents, I have never heard of an instance in which all the young so bred were webbed. It has been found in a pigeon bred from parents of two different strains, and I have also heard of cases in which it occurred from time to time in the same strain, birds showing the character having been discarded.

The general result of the experiments is that the inheritance of the webbed foot is Mendelian.

It is recessive to the normal foot.

The character is not a thoroughly satisfactory one to work with, as it is liable to considerable fluctuation in extent.

Extracted recessives, though all show webbing, have this character in various degrees; in some it reached only to the first interphalangeal joint of the second and third digits, or to the second joint of the fourth digit.

On examining the normal population I find that birds occasionally, though rarely, occur with webs as extensive as this.

In the families here recorded I took the first interphalangeal joint of the second and third digits and the second joint of the fourth digit as a minimum, and counted as "webbed" all birds with a web reaching this minimum in the case of at least two adjoining digits: all birds with less webbing than this being given as normal.

If a much greater series of numbers could be investigated, undoubtedly there would be overlapping between the two classes of normal and webbed birds.

On the other hand, the evidence, so far as it goes, does not indicate that the degree of webbing in the parents closely limits the amount in the offspring, for moderately webbed birds have given birds more webbed, and fully webbed birds have given offspring less webbed (see exp. 13 and 14).

I hope later to make further experiments with the lower states of this condition.

Web-footed ♂ used in Experiments.

The Pigeon which I used in the following experiments somewhat resembled an Antwerp in appearance, but was of no distinct variety. The web extended to the base of the claws in both feet, but the digits were rather closely webbed together except iii. and iv. of the right foot, where the web was sufficiently loose to allow the usual spread of the foot. The bird was of the

ordinary blue colour found in *Columba livia*. The feathers on the back of the head were perfectly smooth (*cf.* Nun Pigeon).

It was bred by Mr. Doggett, of Cambridge, in 1896, from a pair of birds with perfectly normal feet. The parents produced several offspring showing webbing in varying degrees. Three of these birds were exhibited by Mr. Bateson at the Zoological Society, and are described in the 'Proceedings' for Dec. 15th, 1896, p. 989. (The bird used is No. 3 in that description.)

It was also described and the right foot figured by Mr. Tegetmeier in 'The Field' of Sept. 12th, 1896.

It appears that some of these birds were bred together and produced, among others, a bird with completely webbed feet, the web being sufficiently loose to allow the normal spread of the foot between every digit. This bird was exhibited by Mr. E. S. Montagu at a meeting of the British Ornithologists' Club on Jan. 22nd, 1902. It is described in the report of the meeting (Bull. B. O. C. xii. p. 41), and again in 'The Field' of Feb. 1st, 1902 (vol. xcix. p. 177).

"Nun" Pigeon ♀ used in Experiments.

The Nun is an old established strain of Pigeons, originally a variety of Tumbler. The feet are normal and free from feathering. It exhibits a tuft of reversed feathers standing up at the back of the head forming the "shell." It is slightly larger than the peak found in the Turbit and some similar varieties.

Crosses between the Web-footed Pigeon and the Nun Pigeon.

The experiments were begun in 1902. The original cross was made between one pair of birds only, viz., those described above. The subsequent experiments consisted of breeding from the birds produced by the first cross.

The results of the experiments, so far as they concern the two principal characters of web-foot and "shell," are given in Table I.

The table is arranged in a similar manner to that used by Bateson and Punnett in the description of their experiments with Poultry in the second report to the Evolution Committee of the Royal Society. The ordinary Mendelian terms are used:—

D and R being the original dominants and recessives;

DR is the first hybrid generation or F. 1;

$\frac{DR}{2}$ the heterozygote dominant in F. 2;

$\frac{DD}{2}$ the homozygote dominant in F. 2; and

$\frac{R}{2}$ the extracted recessive.

The same terms over 3 apply to similar forms in F. 3.

The asterisk shows that the bird is bred from a DR × R mating, and not from a DR × DR.

TABLE I.

Exp. No.	♀.	Origin from Exp.	Feet.	"Shell."	Also used in Exp.	♂.	Origin from Exp.	Feet.	"Shell."	Also used in Exp.	Nature of Mating.	Feet.		Nature of Mating.	"Shell."	
												Normal.	Webbed.		Present.	Absent.
1902.	1	—	N	P	—	Web	Doggett	W	A	2 & 5	D × R	6	0	R × D	0	6
1903.	2	1	N	A	—	Web	Doggett	W	A	1 & 5	DR × R	5	4	DR × D	0	8
	3	1	N	A	6 & 11	41	1	N	A	6 & 12	DR × DR	11	0	DR × DR	2	7
	4	1	N	A	5	42	1	N	A	—	DR × DR	9	3	DR × DR	3	6
1904.	5	1	N	A	4	Web	Doggett	W	A	1 & 2	DR × R	4	5	DR × D	0	9
	6	1	N	A	3 & 11	41	1	N	A	3 & 12	DR × DR	12	0	DR × DR	1	10
repetition of 3	7	2	W	A	—	58	2	W	A	—	$\frac{R^*}{2} \times \frac{R^*}{2}$	0	5	[DR × DR]	1	1
	8	2	W	A	—	19	2	W	A	14	$\frac{R^*}{2} \times \frac{R^*}{2}$	0	6	[—]	0	5
	9	4	N	P	—	24	3	N	P	—	[—]	7	0	$\frac{R}{2} \times \frac{R}{2}$	7	0
	10	3	N	P	—	38	3	N	A	—	[—]	8	0	$\frac{R \times DR}{2}$	5	2
1905.	11	1	N	A	3 & 6	20	8	W	A	13	$\frac{R^*}{3}$	3	4	[—]	0	5
	12	5	W	A	13	41	1	N	A	3 & 6	$\frac{R^*}{2} \times DR$	3	2	[—]	0	2
	13	5	W	A	12	20	8	W	A	11	$\frac{R^*}{2} \times \frac{R^*}{3}$	0	3	[—]	—	—
	14	8	W	A	—	19	2	W	A	8	$\frac{R^*}{3} \times \frac{R^*}{2}$	0	5	[—]	0	5

Feet.—W = Webbed feet. N = Normal feet. "Shell."—P = Presence of "shell." A = Absence of "shell."

A discrepancy will be noticed between the numbers of birds illustrating the foot character and those which show presence or absence of "shell" in the same experiment. This is accounted for by the fact that it is possible to recognise the webbed or normal foot on hatching, or even in birds found dead in the egg-shell if sufficiently incubated, whereas the presence or absence of the "shell" can only be ascertained when the feathering of the young birds is fairly advanced.

It was noticed that many of the young birds which were webbed were extremely weakly in the nest, and several of them died at a very early age. Of the three extracted web-footed birds bred in Exp. 4 from the DR \times DR mating, not one was reared. The extracted webbed birds whose purity was tested were all bred from the DR \times R matings.

Discussion of Results.

Foot character.—It will be seen from the foregoing table that the feet of the F. 1 generation, of which six birds were bred, were all normal, the web character behaving as a recessive. Two pairs of F. 1 were mated, and in experiment 4 the webbed foot reappears in three birds out of the twelve, this being the exact proportion expected on the Mendelian hypothesis.

From the other pair (Exp. No. 3), however, *no recessives appeared*, and the mating was repeated in 1904, as Exp. 6, with the same result. During the two years that these birds were mated together 29 eggs were laid and 23 birds produced, all showing the normal foot character. The absence of webbed birds in this family was quite contrary to expectation, for 5 or 6 recessives were to be expected. In order to test the matter further, in 1905 the two F. 1 birds in question were mated to extracted recessives, and, as will be seen on referring to experiments 11 and 12, webbed and normal offspring were then obtained in approximately equal numbers in accordance with Mendelian expectations.

The absence of recessives in the 23 birds in F. 2, bred in experiments 3 and 6, is very remarkable. Whether it arose from any definite disturbing cause, or was merely a chance aberration, cannot be asserted. The behaviour of the same birds when mated to pure R clearly proves that their gametic production was then normal.

In the matings of DR's both with the original recessive web and with the extracted recessives the results are simple. It will be noticed that in experiments 2, 5, 11, and 12 fifteen webbed and fifteen normal birds were produced, the Mendelian expectation of such a mating being equality.

It being impossible to test the purity of webs bred by the DR \times DR matings, as the birds died in the nest, the extracted recessives from the DR \times R matings were used, and experiments 7, 8, 13, and 14 show the results. Nineteen birds were raised in these four experiments, all having the feet webbed.

TABLE II.

Exp. No.	Bird's No.	LEFT FOOT.	RIGHT FOOT.
2 ...	58.	D ii φ 2 — D iii φ 2, — D iv normal.	D iii — D iv normal.
	19.	iii φ 2, — iv φ 4.	iii — iv φ 4.
4 ...	30.	iii φ 3, — iv normal.	iii φ 3(½) — iv φ 2.
	31.	iii φ 3, — iv φ 3.	iii φ 2, — iv φ 3.
	(1.)	iii φ 3, — iv φ 4.	iii φ 2, — iv φ 2.
	(3.)	iii φ 2(½) — iv normal.	iii φ 1 — iv φ 2.
	(5.)	iii φ 3, — iv φ 4.	iii φ 1 — iv φ 2.
5 ...	23.	iii φ 2, — iv φ 2.	iii φ 1 — iv φ 2.
	45.	iii φ 2, — iv φ 4.	iii φ 1 — iv φ 2.
	88.	iii φ 3, — iv φ 3.	iii φ 1 — iv φ 2.
	109.	iii φ 3, — iv φ 4.	iii φ 3 — iv φ 4.
	110.	iii φ 3, — iv φ 2.	iii φ 3 — iv φ 4.
7 ...	7.	iii φ 2(½) — iv φ 2.	iii φ 1 — iv φ 2.
	(8.)	iii φ 2(½) — iv φ 3.	iii φ 1 — iv normal.
	(9.)	iii φ 3, — iv φ 4.	iii φ 2 — iv φ 4.
	(10.)	iii φ 2(½), — iv φ 2.	iii φ 3 — iv normal.
8 ...	20.	iii φ 3, — iv φ 4.	iii φ 3 — iv φ 4.
	41.	iii φ 2, — iv φ 2.	iii φ 1 — iv φ 4.
	42.	iii φ 3(½), — iv φ 4.	iii φ 3 — iv φ 2(½).
	60.	iii φ 3(½), — iv normal.	iii φ 1 — iv φ 3.
	85.	iii φ 3, — iv normal.	iii φ 1 — iv φ 2.
11 ...	(11.)	iii φ 3(½), — iv normal.	iii φ 2 — iv normal.
	40.	iii φ 1, — iv φ 3.	iii — iv normal.
	41.	iii φ 2, — iv φ 4.	iii φ 1 — iv φ 2(½).
	(16.)	iii φ 3, — iv φ 4.	iii φ 3 — iv φ 4.
	(17.)	iii φ 3, — iv φ 2.	iii φ 1 — iv φ 2.
12 ...	(14.)	iii φ 2(½) — iv φ 2.	iii φ 3(½) — iv φ 4.
	(15.)	iii φ 2, — iv φ 4.	iii — iv normal.
	(18.)	iii φ 3, — iv φ 4.	iii φ 3 — iv φ 4.
13 ...	(19.)	iii φ 1, — iv normal.	iii φ 1 — iv φ 2.
	(20.)	iii φ 2, — iv φ 4.	iii φ 2 — iv φ 4.
14 ...	510.	iii φ 3(½), — iv normal.	iii — iv normal.
	511.	iii φ 3(½), — iv normal.	iii — iv normal.
	539.	iii φ 1, — iv normal.	iii — iv normal.
	540.	iii φ 2(½) — iv normal.	iii — iv normal.
	560.	iii φ 3(½) — iv φ 2.	iii — iv normal.

Variation in the Amount of Webbing.

I have stated that the webbed foot is subject to considerable fluctuation, both when the character is observed to occur in normal strains and when it appears as an extracted recessive in these experiments.

Table II. is arranged to show the approximate stretch of the web in the case of each bird recorded in the experiments. The observations were made by bending the foot and noting to which part of each digit the web was attached. In the table D stands for the digit, and ϕ for the phalanx. Unless otherwise stated, it should be understood that the web is attached to the distal end of the phalanx in question; but if a fraction is inserted after the number of the phalanx, then the web is attached halfway or three-quarters of the way up that phalanx. No very accurate means of measurement were applicable, and the estimations should be taken as approximate only.

The experiment numbers refer to Table I.

Brackets are placed round the number of a bird to signify that the bird died either in the egg-shell or very soon after hatching.

In all 37 web-footed Pigeons have been raised in the experiments, but upon such small numbers discussion of the relationship of the several graduations is impossible.

It may, however, be noted that some extremely small webs were raised in experiments 7 and 8, although the birds were bred from parents both showing the web character in a higher degree. Experiments 13 and 14 have already been discussed.

II. THE SHELL.

It will be seen from Table I. that this character behaves as a simple recessive throughout the experiments with the webbed strain (but *v. infra*).

In experiments 3, 4, and 6, out of the 29 birds bred, 6 show the "shell" in F. 2, a sufficiently close result.

The extracted recessives bred true, as shown in Exp. 9.

In Exp. 10 the number of recessives (5 : 2) is too high for a DR \times R mating, which should have given equality, but the total is very small.

Further Experiments with "Shell."

The same Nun female which was used in the foregoing experiments was also mated to a Barb male.

There is no need to give here a description of the Barb beyond the statement that the feathers on the head are always smooth and no crest or "shell" is ever found.

The results of the mating of Barb σ and Nun ϕ are recorded in Table III.

TABLE III.

EXP. No.	♀.			Also used in Exp.	♂.			Nature of Mating.	"Shell."		
	Origin.	"Shell."			Origin.	"Shell."			Present.	Absent.	
1901. a ...	Nun	—	P	{ 1 & γ	Barb	—	A	γ	R×D	2	2
1902. β ...	8	α	P	—	54	α	A	—	(♀ DR×DR)	2	1
1903. γ ...	Nun	—	P	{ 1 & α	Barb	—	A	α	R×D	0	8
1904. δ ...	1	γ	A	—	3	γ	A	—	DR×DR	1	10

P = Presence of "shell."
A = Absence of "shell."

It will be noticed that as a result of the mating of Nun ♀ × Barb ♂ in Exp. α, a mixed generation was obtained as regards "shell" in F. 1. The two birds in which the "shell" was absent were ♂, the two in which it was present were ♀. It was thus impossible to test the "shelled" birds by mating together, and little or no clue is obtained as to their gametic constitution by Exp. β, as the numbers are so small. It may, however, be recorded that both the "shelled" females and one of the smooth-headed males were mated subsequently to smooth-headed birds which were crosses in F. 1 between a Barb and a Fantail. From these matings:

Barb Nun ♀ 8 (shell) × Barb Fantail ♂ gave 8 young.
Barb Nun ♀ 18 (shell) × Barb Fantail ♂ gave 5 young.
Barb Nun ♂ 54 (no shell) × Barb Fantail ♀ gave 6 young.

Of these 19 birds so produced, none had "shells."

In view of these results, which indicate that "shell" is a recessive character, the appearance of "shells" in the two females mentioned above is paradoxical. It is likely that this is some failure of dominance and that the birds were gametically DR's. A similar irregularity is recorded in the Report to the Evolution Committee of the Royal Society, ii. p. 114, as regards extra toe in fowls, which, though generally dominant, is sometimes recessive.

It was found inconvenient to follow up the experiment at the

time, but in 1903 the mating α was repeated in the experiment γ , in which the *identical birds* used in α were again mated together. In this experiment a uniform generation was obtained. A pair of birds bred in this F. 1 generation were mated together and the result is recorded in exp. δ .

The total results of the mating of Barb and Nun are:—

(Exp. α , γ) F. 1: shell present 2; shell absent 10.

(Exp. β , δ) F. 2: shell present 3; shell absent 11.

I can also mention here that two birds which were crosses, in the F. 1 generation, between a Nun and a Fantail, kindly sent to me by Miss Thiselton-Dyer, showed no trace of "shell." These birds were not bred from.

The experiments here recorded form part of a larger investigation into heredity in Pigeons still in progress, which has been subsidised by the Government Grant Committee of the Royal Society.

I am indebted to Mr. J. Lewis Bonhote for raising and recording birds bred in Exp. 14, also to Mr. R. J. Elwell for raising birds in Exps. 9 and 12.

I have also to thank Mr. Bateson, who has most kindly supervised all the experiments.

8. On a new Species of Worm of the Genus *Pontodrilus* from the Shores of the Red Sea. By FRANK E. BEDDARD, M.A., F.R.S., Prosector to the Society.

[Received October 5, 1905.]

(Text-figures 78 & 79.)

The specimens of *Pontodrilus* upon which the following description is based were kindly placed in my hands by Mr. Cyril Crossland, F.Z.S. They were collected by that gentleman "in clean shell and coral sand on the shores of an islet in Khor Dongola, on the Soudan coast." Mr. Crossland further informed me that the worms "live about the highest level at which the sand is kept wet by the sea. As there is practically no rainfall the water in which they live is undiluted by rain almost always. A species of *Nereis* and some Crustacea share this habitat." There is thus no doubt about the purely marine surroundings of this *Pontodrilus*, which so far agrees with the majority of the species of the genus.

The general aspect of the worms was like that of the other species of *Pontodrilus* with which I am acquainted.

The length of the largest and fully mature example was 102 mm., the size being thus about the average size of the species of this genus.

The *prostomium* was frequently difficult to define accurately, owing, of course, to a protrusion of the buccal cavity. In three specimens, where its characters were very plain, I observed two conditions. In two individuals the prostomium was continued over the first segment of the body by grooves extending over about half that segment; in the other there was no such extension backwards of the prostomium. As both of these specimens were immature, I have no positive reason for asserting that they are not different species. But existing knowledge of this genus does not favour the supposition that two species live in common in one limited area. I should prefer, therefore, in the meantime to regard the character of the prostomium as variable in this particular. The prevalent arrangement in the genus is an epilobic or (as I prefer to call it) epicheilous prostomium. But one species, *P. insularis*, is reported to have no process of the prostomium, and also a variety of the type form *P. matsushimensis** described by Dr. Michaelsen. But in this case the variety does not occur in the same locality as the type.

The *setæ*, as is usual or universal (?), in the genus, are paired, and the two setæ of the ventral pair close together than those of the lateral pair. On the xviiith segment, which bears, as in other species, the male pores, the most ventral seta of each ventral couple is present, but I did not detect the more dorsal seta of the couple.

The *clitellum* in this genus usually embraces segments xiii-xvii. In the present species it very distinctly extends over the xviiith and to the very end of that segment. This is the first external feature which has led me to distinguish the present species as new and undescribed.

The *genital papillæ* confirm by their arrangement this point of view. It is true that I have examined only one fully mature worm and that the papillæ are known to vary † among mature specimens. I find, however, that in no species already known is there a close approximation to the conditions which obtain in the species of *Pontodrilus* which forms the subject of the present communication. For in the present species the genital papillæ are very distinctly paired structures, and not single and median. Moreover, they lie in front of the male pores, and there are no papillæ following the male pores which are so prevalent in the genus *Pontodrilus*. The paired papillæ lie between segments xiii/xiv and xiv/xv. They correspond in position to the ventral setæ. The anterior pair are decidedly larger than the posterior pair. These papillæ are very flat and hardly, if at all, project beyond the adjacent surface of the body. The appearance when seen through a hand-lens is shown in the figure (text-fig. 78, p. 560). The centre of each papilla is opaque, white, and either somewhat kidney-shaped (anterior papillæ) or more rounded (posterior papillæ). This is surrounded

* Michaelsen, Zool. Jahrb. Syst. Abth. xii. p. 220.

† E. g. *P. laccadicensis*, see Beddard in 'Fauna of Maldives and Laccadive Arch.' vol. i. pt. 4.

by a clear ring, and this again by a broader and opaque, white, halo.

The *male pores* are very conspicuous upon the xviiith segment, and, as in other species of *Pontodrilus*, the area upon which they open is depressed in a sucker-like fashion. Each depression is divided into two by a transverse raised fold. The actual pore seems to correspond in position to the outer of the ventral seta couple. Although the external characters are sufficient to define the present as a new species of *Pontodrilus*, in the existing state of knowledge of that genus it may be useful to give particulars of certain internal organs which are known to vary from species to species.

Text-fig. 78.

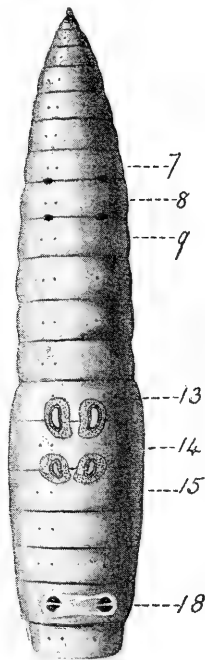
Text-fig. 78.—Ventral view of *Pontodrilus crosslandi*, sp. n.

Some of the segments are numbered 7, 8, 9, &c.

Text-fig. 79.

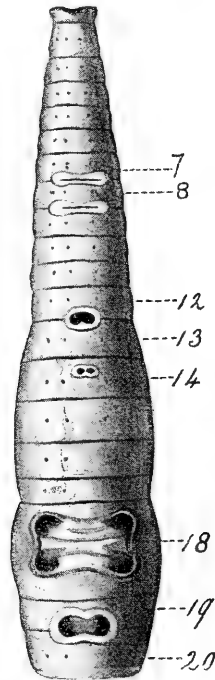
Text-fig. 79.—Ventral view of *Pontodrilus laccadivensis* F. E. B.

Some of the segments are numbered 7, 8, &c.

The *gizzard* is not at all prominent.

The anterior intersegmental *septa* are as usual much thickened. The last of these thickened *septa* divides segments xiii./xiv.; but

this septum is not quite so strongly developed as those which lie in front. The last *hearts* lie in segment xiii. The *nephridia* are obvious in segment xv.

The *spermathecae*, which open in line with the male pores, *i. e.* with seta *b* of Michaelsen's scheme*, have a single diverticulum of about half the length of the pouch itself. Their pores are situated between segments vii./viii. and viii./ix.

The *spermiducal glands*, like those of some, but not every, species of the genus, possess a distinct duct separable from the glandular and also tubular region by a constriction and by its nacreous appearance due to the strong muscular coat. The glandular part is fully six times as long as the muscular duct. The duct in the fully mature is curved into a horseshoe-shape. It is of uniform thickness throughout, and does not increase in diameter towards the external pore.

For the purposes of an easier comparison with other species I append a definition of this new *Pontodrilus*, which I propose to name after Mr. Crossland.

Pontodrilus crosslandi, sp. n. (Text-fig. 78.)

Length about 100 mm. *Prostomium* *epicheilous* ($\frac{1}{3}$ - $\frac{1}{2}$). *Setae* paired rather distant; distance a-b less than c-d. *Clitellum* xiii.-xviii. *Male pores* (on xviii.) and *spermathecal pores* (vii./viii., viii./ix.) in line with seta *b*. *Papillae* paired on intersegmental areas xiii./xiv., xiv./xv. *Last thickened intersegmental septum* xiii./xiv. *Last hearts* in xiii. *Spermathecae* with single diverticulum half the length of the pouch. *Spermiducal glands* with distinct muscular duct.—*Hab.* Shores of Khor Dongola, Red Sea.

In view of the cutting of the Suez Canal and the alleged and consequent migration of the Mediterranean fauna eastwards and of eastern additions to the same †, it is important to note that the species *Pontodrilus crosslandi* is by no means a variant of, or most nearly related to, the Mediterranean *P. littoralis*. It comes nearest, as I am inclined to think, to *P. laccadivensis* and *P. matsushimensis* var. *chathamiana* by reason of its anteclitellian papillae, unknown in other species. It lacks the papillae following the male pores, which are so general in *Pontodrilus*.

To emphasise the likenesses and also the differences between *P. crosslandi* and *P. laccadivensis* I add a figure of the latter (text-fig. 79, p. 560) for purposes of comparison. This species has not yet been figured, though its essential characters have been described ‡.

* Oligochæta, in 'Das Tierreich,' 10 Lief. (Berlin, 1900).

† E. A. Smith in P. Z. S. 1891, p. 396.

‡ Beddard in 'The Fauna and Geography of the Maldive and Laccadive Archipelagoes,' vol. iv. pt. iv. p. 374.

9. On a new Enchytræid Worm (*Henlea lefroyi*, sp. n.) from India destructive to the Eggs of a Locust (*Acridium* sp.).
By FRANK E. BEDDARD, M.A., F.R.S., Prosector to the Society.

[Received October 5, 1905.]

Dr. S. F. Harmer, F.R.S., of King's College, Cambridge, was so good as to forward to me recently a tube of small white worms for identification and study. These had been sent to him from India by Mr. H. Maxwell Lefroy, Entomologist to the Government of India, who discovered that they attacked and destroyed the eggs of a locust belonging to the genus *Acridium* when the ground in which those eggs were deposited is moist.

Dr. Harmer directed my attention to the fact that they were Oligochaetous worms; they prove to be a species of the family Enchytræidæ, and were in a good state of preservation for microscopical examination. The family, as is well known, occurs in damp earth as well as in water; it is not so purely aquatic as are some of the families of the "Microdrili."

The species appears to be new, and presents a certain number of characters which in combination render its inclusion in any already defined genus difficult. I shall, however, describe its characters before proceeding to discuss its systematic position.

The species is small, 3-4 mm. in length and, as already mentioned, white. The *setæ* are curved and of the usual Enchytræid form; they are, however, rather few in number in each bundle, though present upon all the segments of the body, with the exception of the first and apparently the twelfth (in the mature worm with a clitellum). The lateral bundles possess *two* *setæ* apiece, and the ventral bundles *three*; very occasionally I observed three *setæ* in a dorsal bundle. This arrangement extends from end to end of the body.

The *number of segments* in a large specimen is 27.

I could detect no *dorsal pores*.

The *clitellum* and other external characters call for no remark.

The *alimentary canal* shows certain characters which assist in the placing of the species. Peptonephridia are present and of very small length, though I am unable to give any details concerning them. The *oesophagus* appears to pass without any break into the intestine; I can find no demarcation between these two sections of the gut. Behind the clitellum the gut is of course much wider than it is in front of that region of the body. Furthermore, I can discover no *cæca* or pouches of any description appended to the gut. It is a simple tube without outgrowths. The *septal glands* of this species extend back as far as the sixth segment, in which the last pair occur; in front of this pair and in segments iv. and v. are equally prominent pairs of *septal glands*.

The *dorsal blood-vessel* is anteclitellian in origin and does not seem to be connected at its point of origin with any dorsal diverticulum of the gut such as exists in *Buchholtzia*. It arises in the xith segment. I could see no "heart body."

The exact origin of the dorsal vessel is rather difficult to locate exactly in this very minute Enchytræid. I fix the xith segment as the point of emergence from the intestinal plexus, since the vessel is very much broader here than in the dorsal region of the blood-plexus posteriorly* and stands out more from the walls of the gut. The vessel is, in fact, in this segment quite twice the width that it is anteriorly to the point in question. Commonly, for example in *Henlea nasuta*, the dorsal vessel is much wider at its emergence from the intestinal plexus than it is anteriorly.

This is confirmed by an examination of a series of transverse sections, from which it was evident that the dorsal vessel stood away from the walls of the intestine in the anterior part of the clitellum; it was indistinguishable posteriorly.

Concerning the *reproductive organs*, it may be observed, in the first instance, that the position of the various ducts and pouches is perfectly normal. The external orifices of the atria are very conspicuous upon the ventral surface of the twelfth segment, in line or nearly so with the ventral setæ of that segment. These setæ are, however, absent, and there are no penial setæ of any kind. The testes and the ovaries occupy their usual segments, *i. e.* xi. and xii. Concerning the exact form of the sperm-duct funnel I am unable to give details; but I have identified them and satisfied myself that they are of the usual Enchytræid pattern.

The spermathecae offer characters of obvious systematic use. They open on the one hand into the œsophagus in the fifth segment, and on the other by a muscular duct on to the line dividing segments iv. and v. I could not find any diverticula. There are but a single pair of spermathecae.

In the above description I have only been able to dwell upon a certain number of facts which are of systematic importance in the group. Of importance in determining the genus are: (1) the presence of four bundles of curved setæ on all the segments of the body, save the first and the twelfth; (2) intraclitellian origin of dorsal vessel; (3) absence of any diverticula to œsophagus; (4) simplicity of spermathecae and their communication with œsophagus.

Of the thirteen genera allowed by Michaelsen †, 9, viz., *Achaeta*, *Michaelsena*, *Mesenchytræus*, *Chirodrilus*, *Buchholtzia*, *Enchytræus*, *Stercutus*, *Marionina*, and *Lumbricillus*, are excluded by these characters. Though I did not find any dorsal pores, it is clear

* It must be borne in mind that Pierantoni ("Studi anatomici su *Michaelsena macrochaeta* Pierant.," *Mitth. Zool. St. Neapel*, xvi. 1903, p. 409) traces a distinct dorsal vessel in the intestinal plexus posteriorly to the region where the former is said to commence. But this does not affect the point of emergence.

† Oligochaeta, in 'Das Thierreich' (Berlin, 1900).

that the present species cannot be safely referred to the genus *Fridericia*, which is so distinctly characterised by the peculiar paired character of its setæ. There remains only *Henlea* and *Bryodrilus*, from which, however, the species described in the present paper differs in several points. With genera described more recently than those included in Michaelsen's comprehensive work just quoted, e. g. *Hydrenchytræus**, I cannot identify this semiparasitic Enchytræid from India.

It is true that four species, viz., *Marionina glandulosa*, *Enchytræus minimus*, *E. parvulus*†, and *E. turicensis*, possess, as does the species dealt with here, two setæ in each lateral, and three in each ventral, bundle; but I do not regard those European species as identical with the present Indian form.

In the meantime I place the species in the genus *Henlea*, where the characteristic glandular pouches of the gut are occasionally absent (e. g. *Henlea dicksoni*), in default of living material and a more exhaustive examination. I propose to name it after Mr. Lefroy, who first directed attention to the species.

10. On new and rare British Mites of the Family *Oribatidæ*.

By CECIL WARBURTON, M.A., F.Z.S., and NIGEL D. F. PEARCE, M.A.

[Received November 21, 1905.]

(Plates XIX. & XX. ‡)

Since the publication of Mr. A. D. Michael's Monograph on British Oribatidæ in 1888, only a single new species, so far as we are aware, has been described from these islands. This was a *Lohmannia* taken in Ireland by Prof. Carpenter and described by Berlese in 'Redia,' vol. ii. fasc. i. (1904, Aug. 18), as *L. insignis*. Curiously enough this mite was in our hands while the Italian arachnologist was describing it, and narrowly escaped another specific name.

No doubt the workers in this particular group have been few, but it is a striking testimony to the thoroughness of Mr. Michael's work that so long an interval should have elapsed without substantial addition to the British list of Oribatidæ, for the study of which his labours have so admirably paved the way.

For two years we have searched pretty thoroughly the neighbourhood of Cambridge, and especially of Grantchester, and have examined moss from many other localities, and we have hitherto met with 82 of the species described in the Monograph, and the seven forms, new, we believe, to science, of which the diagnoses are given below.

* Bretcher, Rev. Zool. Suisse, ix, p. 208.

† This worm is described by Friend (Irish Nat. xi. 1902, p. 110), though not sufficiently to permit of any certainty.

‡ For explanation of the Plates, see p. 569.

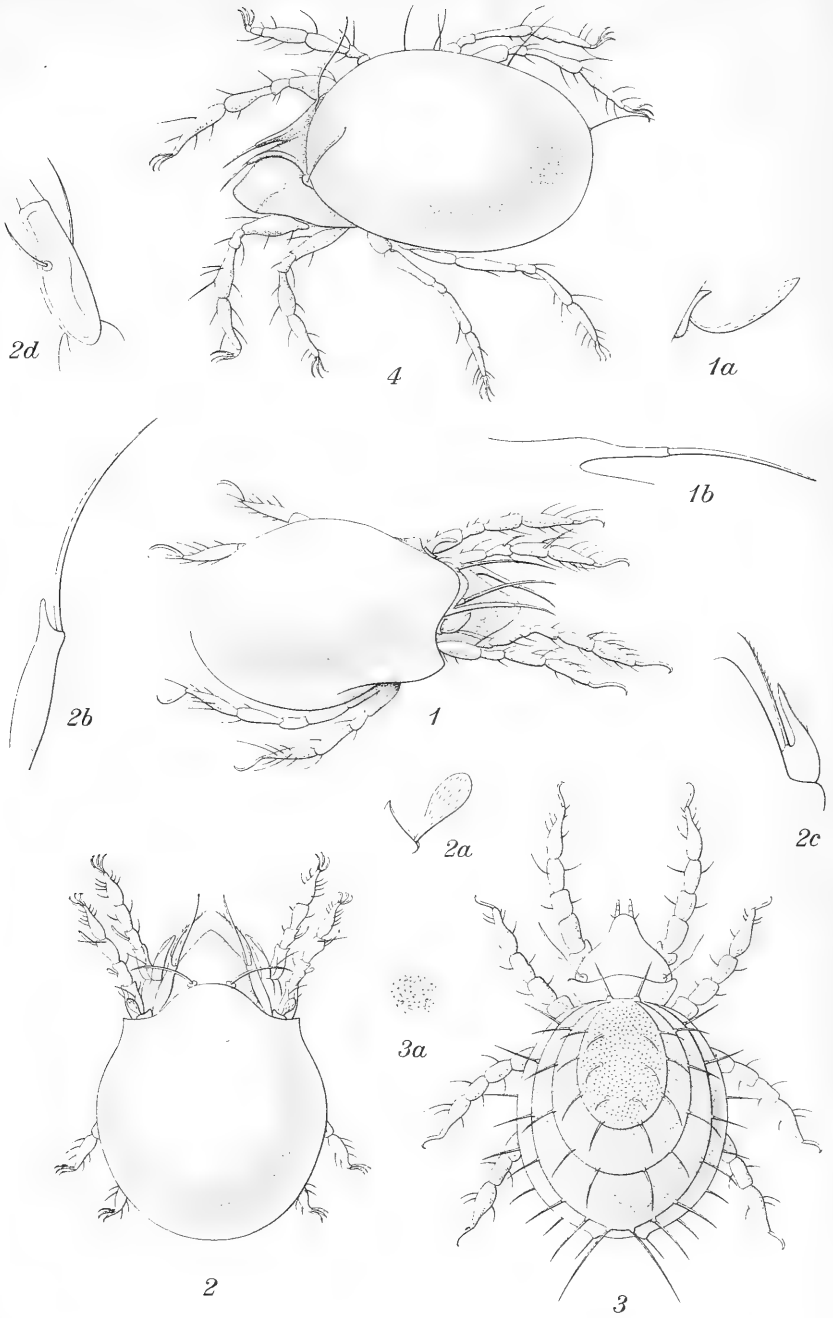

E. Wilson, Cambridge.

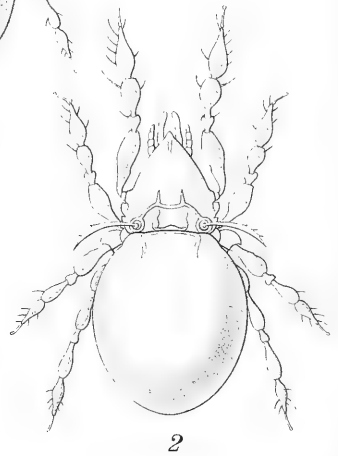
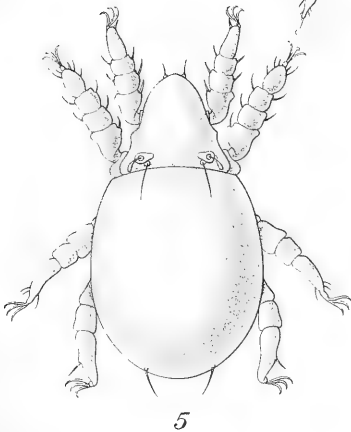
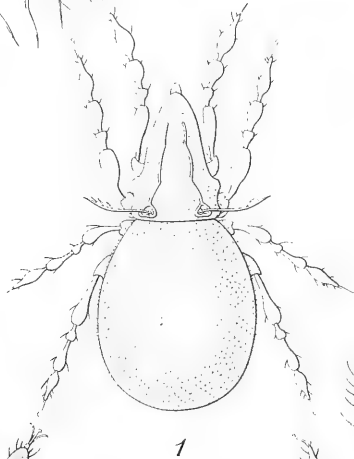
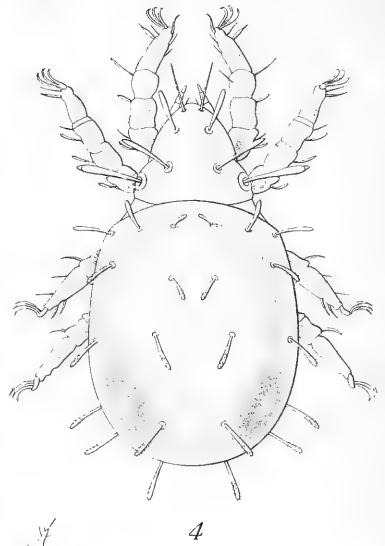
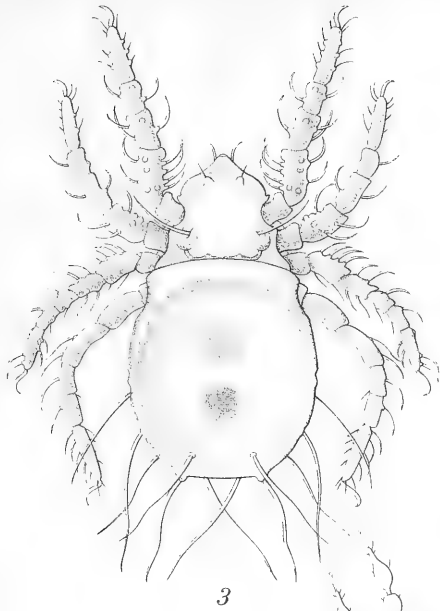



Fam. ORIBATIDÆ.

Subfam. ORIBATINÆ.

Gen. ORIBATA Latreille.

ORIBATA FURCATA, sp. nov. (Plate XIX. fig. 1.)

Adult. Length 500 μ . Colour dark brown, nearly black. Surface polished. Lamellæ, blades on edge with very long cylindrical cusps, the whole extremity of the cusp being occupied by the base of the long lamellar hair. Translamella an inverted V. Interlamellar hairs present.

Pseudostigmatic organs long, sub-clavate, directed forwards and upwards.

Pteromorphæ small. Claws monodactyle. Genital and anal orifices moderately far apart, shaped like the keystone of an arch; the anal considerably the larger.

Nymph and larva unknown.

Two specimens found in moss from Austwick Bog, Yorkshire, in May 1904.

There is no danger of confusing this very distinct species with either of the other two known British monodactyle Oribatas, *O. fusigera* and *O. parmellie*. The first is very minute, while the second has hairs on the notogaster, and short clavate pseudo-stigmatic organs.

ORIBATA OMISSA, sp. nov. (Plate XIX. fig. 2.)

Adult. Length 700 μ . Colour dark brown. Surface highly polished and shining. Body distinctly broadest in the middle. Lamellæ, blades on edge, with a long sharp-pointed cusp standing free, the lamellar hairs springing from the inner angle of the cusps. No translamella. Claws tridactyle. Not rare in moss, at Cambridge.

Nymph and larva unknown.

We think it likely that this species has hitherto been overlooked on account of its resemblance to the common and extremely variable species *O. lapidaria*, and in spite of the different facies, due chiefly to its barrel-shaped body and polished surface (destitute of a light spot), there seemed to be few clear distinctive characters. The absence of any trace of a translamella, and the sharp-pointed cusps, are, however, good characteristics. Though occurring in the same neighbourhood their habitat is different, *O. omissa* being exclusively found in moss, nor have we met with any intermediate forms.

ORIBATA RUBENS C. L. Koch.

This very distinct species occurred in *Sphagnum* from heath-pools at Bournemouth in October 1905. It is about 500 μ in length, chestnut-coloured, and with very long legs. It is now for the first time recorded as British.

Subfam. SERRARIINÆ.

Gen. SERRARIUS Michael.

SERRARIUS MICROCEPHALUS Nicolet.

This interesting species, which Mr. Michael in his 'British Oribatidæ' describes as occurring rarely at Epping Forest, the Land's End, and Swanage, was found in abundance in the autumn of 1904 in the moss of an osier-bed at Grantchester, Cambridge, and several specimens of the nymph, hitherto unknown, were discovered. This is a remarkable creature, entirely unlike the imago, and has the habit of carrying on its back the cast larval and nymphal notogastral skins (Plate XIX. fig. 3). As each of these skins bears round its edge eighteen conspicuous spines, proceeding from short apophyses, the fully-grown nymph has a remarkably spiny appearance. The colour is pale yellow and the surface finely punctate.

In 1879 Kramer (in the Archiv f. Nat., Jahrg. 45, Bd. i. p. 16) described a new species of mite which he named *Gustavia sol*, which, so far as we have been able to ascertain, only Oudemans has suspected of belonging to the Oribatidæ. He states that it is probably the nymph of a *Serrarius*. A glance at Kramer's figure at once makes it perfectly clear that he was dealing with a *Serrarius* nymph, and he even gives a drawing of the mandible, perfectly characteristic in shape, but lacking the serration, which is always difficult to see. He mentions no locality, and attributes to the animal a size much too large (1.2 mm.) for either of the known European species of *Serrarius*. Possibly the length given is intended to include the legs. In any case, *Gustavia sol* Kramer can now be stated to be a nymph of *Serrarius*, as Oudemans suspected.

Subfam. NOTASPIDINÆ.

Gen. LIACARUS Michael.

LIACARUS BICORNIS, sp. nov. (Plate XIX. fig. 4.)

Adult. Length 600 μ . Colour red-brown. Surface highly polished. Lamellæ, large blades on edge, near together and sub-parallel, but slightly converging anteriorly. Very long free-projecting cusps, from the extremities of which proceed the long lamellar hairs. Translamella and interlamellar hairs wanting.

Pseudostigmatic organs long, filiform, curved upwards and slightly outwards.

Abdomen very globular, with rather prominent shoulders, and with a few longish hairs.

The coxa of the 4th leg is almost as long as the femur, and is produced anteriorly in a pointed blade.

Three specimens were found in moss from Austwick in May 1904, and one from moss from the river-bank near Ely, in July 1905.

Nymph and larva unknown.

The appearance of the living mite strongly recalled *Serrarius microcephalus*, but its chelate mandibles remove it from that genus. It also bears some superficial resemblance to *Notaspis bipilis*.

Gen. NOTASPIS Warren.

NOTASPIS MACULOSA, sp. nov. (Plate XX. fig. 1.)

Adult. Length 520 μ . Colour light brown. Surface spotted, the spots being in the epiostracum and easily rubbed off. Cephalothorax very long and pointed, nearly $\frac{2}{3}$ the length of the abdomen. Lamellæ, long ridges, arising near the pseudostigmata, converging at first, and then extending parallel for $\frac{3}{4}$ the length of the rostrum. Pseudostigmatic organs long and slender, very coarsely pectinated on their anterior border. Claws monodactyle. Abdomen long oval, somewhat truncated at each end. Legs long and slender, with globular joints.

Nymph and larva unknown.

Three specimens were taken in moss from Nine Wells, Cambridge, in May 1905.

The nearest allies of this fine species are among the minute forms of which *N. splendens* is the type. Like them, it has a peculiar habit of shaking its beaded legs as it runs. Its large size, spotted surface, and pectinate pseudostigmatic organs render its identification easy.

NOTASPIS SCULPTILIS, sp. nov. (Plate XX. fig. 2.)

Adult. Length 330 μ . This mite has a close general resemblance to *N. splendens*, but, on careful examination, may easily be distinguished from that species by the peculiar design of the ridges on the vertex and notogaster. These are best understood from the figure, but may be described thus:—

The lamellæ arise from the pseudostigmata, converge sharply, and then continue forward and parallel. At the extreme point of convergence there is a faint translamella, and from its extremities ridges proceed backwards. On the notogaster there is a well-marked transverse ridge close to its anterior border; the ends of this ridge curve abruptly backwards, approach slightly, and then separate again.

Pseudostigmatic organs long, rough and hairy.

Nymph and larva unknown.

Ten or twelve specimens were found in wet *Sphagnum* sent by Miss Heath, of Crayford, from the Devil's Punchbowl, Hindhead, in June 1905.

This species seems to be allied to *Eremaeus novus* Oudemans.

Subfam. NOTHRINÆ.

Gen. NOTHRUS C. L. Koch.

NOTHRUS CRINITUS, sp. nov. (Plate XX. fig. 3.)

Length 900 μ . Colour dark brown. Integument more fully chitinised than is usual in this genus.

Claws monodactyle. Pseudostigmatic organs long and filiform.

Nymph and larva unknown.

This fine species is closely allied to *N. targionii* Berlese, but may be distinguished from it by the *much longer, wavy, unpectinated hairs on the notogaster*. The apophyses from which these hairs spring are very small, while in *N. targionii* they are exceedingly conspicuous.

A single example was sent by Mr. W. Evans, taken at Loch Gally, Fife, in May 1905. Another specimen was found by us in *Sphagnum* from Blairgowrie, Perthshire, in November 1905.

This species, even more strongly than *N. targionii*, recalls *Hermannia bistriata*, and in these three forms the two genera approach one another very closely.

NOTHRUS TECTORUM Berlese. (Plate XX. fig. 4.) (*Hypothonius tectorum* Berlese, Acari Myriapoda et Scorpiones etc., fasc. 78, no. 8, 1896.)

This species, which we at first regarded as new to science and which may be easily recognised from the figure (Pl. XX. fig. 4), is no doubt identical with the *Hypothonius tectorum* of Berlese. That arachnologist has, we believe, been misled by an apparent segmentation artificially produced by slight pressure in mounting. We have examined many living specimens, and specimens mounted without pressure, and these present no trace of segmentation; but we find that a transverse furrow (varying slightly in position and width) is readily produced in the soft integument when the cover-slip is allowed to press somewhat heavily upon it. The species must therefore be removed to the genus *Nothrus*, to which it undoubtably belongs.

Not rare in moss from walls and house-roofs at Grantchester, Cambridge.

NOTHRUS CRASSUS, sp. nov. (Plate XX. fig. 5.)

Length 500 μ . Colour light yellow-brown. Integument smooth and very imperfectly chitinised. Claws tridactyle. Pseudostigmata fairly large but not very projecting. Pseudostigmatic organs spindle-shaped, often directed backwards, and rather large. Genital and anal plates large and close together.

An aquatic or amphibious species occurring in *Sphagnum* in heath-pools near Bournemouth, in company with *N. glaber* and *N. monodactylus*.

Of the not very well-defined genus *Nothrus* the five species *tectorum*, *tardus*, *glaber*, *monodactylus*, and *crassus* form a compact group, agreeing in the rounded form of the abdomen and in their very slight degree of chitinisation. *Tectorum* and *tardus* are terrestrial species, while the other three always occur in or near water, and in *glaber* and *monodactylus* the pseudostigmatic organs are absent.

NOTHRUS ANAUNIENSIS Canestrini & Fanzago.

There has always been some uncertainty with regard to this species, which very closely resembles *N. sylvestris*. On looking over our British specimens of supposed *sylvestris*, however, we find some which agree precisely with the description of *anauniensis*, being tridactyle and having the abdomen rounded posteriorly, with short spatulate hairs of about equal length.

This species is therefore for the first time recorded here as British. The diagnosis is complicated by the fact that we find some specimens of undoubted *sylvestris* which are didactyle, but in no case have we come across a tridactyle specimen of the form characterised by the more truncated abdomen and filiform hairs of unequal length. The two species are, no doubt, closely allied, but there appear to us good grounds for regarding them as distinct.

EXPLANATION OF THE PLATES.

PLATE XIX.

- Fig. 1. *Oribata furcata*, p. 565. 1 *a*, pseudostigmatic organ; 1 *b*, lamella.
 2. *Oribata omissa*, p. 565. 2 *a*, pseudostigmatic organ; 2 *b*, lamella; 2 *c*, tectipedium; 2 *d*, femur of 1st leg.
 3. *Serrarius microcephalus*, nymph, p. 566. 3 *a*, markings on notogaster more highly magnified.
 4. *Liacarus bicornis*, p. 566.

PLATE XX.

- Fig. 1. *Notaspis maculosa*, p. 567.
 2. *Notaspis sculptilis*, p. 567.
 3. *Nothrus crinitus*, p. 567.
 4. *Nothrus tectorum*, p. 568.
 5. *Nothrus crassus*, p. 568.

11. On some South Australian Spiders of the Family
Lycosidæ. By H. R. HOGG, M.A., F.Z.S.

[Received October 17, 1905.]

(Text-figures 80-89.)

The Spiders described in the present paper are from the Collection of the S. Australian Museum, Adelaide. I am indebted for the loan of them to the kindness of its Director, Prof. E. C. Stirling, F.R.S. They were collected, however, chiefly from the north side of the River Murray in New South Wales.

This important group of roving Spiders ranges in great numbers over every part of the known world, and the main features of the type species, *L. tarentula* Rossi of the type genus *Lycosa* Latreille, are so closely reproduced, even to the pattern on the back of the abdomen, in the most widely separated countries (in Australia with *L. obscura*, *L. godeffroyi* L. Koch, *L. hasseltii* L. Koch, etc.), that all attempts to divide them into subsidiary genera, until we reach a few less numerous and quite outlying forms, have proved unsatisfactory. Consequently many earlier genera,

such as *Pirata* Sund., *Trochosa* C. Koch, *Arotosa* C. Koch, *Tarentula* C. Koch, *Potamia* C. Koch, &c., have been abandoned by later writers.

M. Simon (Hist. Nat. des Araign. vol. ii, pp. 317 *et seqq.*, 1898) separates the main group into those species following *Lycosa* Latreille, but further divides it into a number of sub-types and those following *Pardosa* C. Koch. The former comprises species which have the front aspect of the cephalothorax moderately sloping at the sides and a lip longer than broad; the latter those with the front aspect squarer with more perpendicular sides, the lip broader than, or at least as broad as, long, and having as a subsidiary character the tarsal joint of the fourth pair of legs longer than the patella *cum* tibia of the same.

Some years ago, following these lines, I constituted a new genus, which I called *Venator* (Proc. Royal Soc. Victoria, vol. xiii, pt. 1, 1900), for some species with a more extremely widened type of frontal aspect, but with the lip clearly broader than long and the tarsal joint of iv. not so long as tibia *cum* patella iv.

However, the more specimens I examine the more the only tangible characteristics show themselves to be interchanged, and I look on these two genera as no more distinctly definable than M. Simon's above mentioned other varieties of *Lycosa* (*loc. cit.* pp. 346-349).

M. Simon further makes a division between those species with two teeth on the inner margin of the falx-sheath and those with three.

The bulk of the Australian species have three, but (in Horn Exped. part ii. p. 349, 1896) I described *L. cowlei* which had five large equal-sized teeth on same, and no other specially marked characteristic distinguishing it from the rest of the genus.

Out of about 60 specimens in the present collection there are 12 species of *Lycosa*, of which no fewer than 9 are new, and one new *Dolomedes*. These I have described below.

Synopsis of Species.

- In all.* Three large equal sized-teeth on inner margin of falx-sheath. Front row of eyes shorter than middle row.
- a.* Eyes of front row of equal width.
Under side of abdomen wholly black. Clypeus wider than the diameter of eyes of front row *L. tasmanica*, sp. nov.
- b.* Diameter of median eyes of front row larger than laterals.
*a*¹. Clypeus wider than the diameter of the front median eyes.
*a*². No distinguishable pattern on under side of abdomen. Abdomen underneath pale yellow-brown. Tibial joint of palp longer than patellar. Cephalothorax equal in length to patella *cum* tibia iv. *L. arenaris*, sp. nov.
- b*². A shield-shaped or triangular field on under side of abdomen.
*a*³. A fawn-coloured shield on a dark brown ground. Cephalothorax shorter than patella *cum* tibia iv. *L. molyneuxi*, sp. nov.
- b*³. A black shield on yellow-brown ground. Median eyes of front row barely their diameter from eyes of second row *L. stirlingæ*, sp. nov.

- b*¹. Clypeus not wider than the diameter of the front median eyes.
- a*⁴. Abdomen underneath wholly brown or black.
- a*⁵. Black underneath; a dark pattern on buff ground on upper side. Median and marginal stripes on cephalothorax *L. obscura* L. Koch.
- b*⁵. Brown underneath.
- a*⁶. Dull dingy brown underneath, yellow-brown above; pale median and marginal stripes on cephalothorax *L. gilberta*, sp. nov.
- b*⁶. Bright chocolate-brown underneath, with large buff spot on upper side at base. Legs brown from base to middle of patella, remainder buff *L. bicolor*, sp. nov.
- b*⁴. A triangular shield pattern underneath abdomen on creamy-yellow ground.
- a*⁷. No pale median or marginal stripes on cephalothorax.
- a*⁸. Shield brown.
- a*⁹. Shield long and narrow, pale chestnut. Clypeus as broad as front median eyes *L. castanea*, sp. nov.
- b*⁹. Shield broad oval, dark brown edged with yellow stripes. Clypeus three-fourths the diameter of front median eyes *L. errans*, sp. nov.
- b*⁸. Shield black.
- a*¹⁰. Shield reaching only about halfway to spinnerets. Eyes of second row less than half their diameter apart *L. laeta* ? L. K.
- b*¹⁰. Shield reaching nearly to spinnerets. Eyes of second row four-fifths of their diameter apart *L. phyllis*, sp. nov.
- b*⁷. Pale median and marginal stripes on cephalothorax.
A dark brown nearly black shield halfway to spinnerets. Clypeus only slightly narrower than front median eyes *L. clara* ? L. K.

LYCOSA TASMANICA, sp. nov. (Text-fig. 80, p. 572.)

Cephalothorax dark brown, with narrow paler marginal and side stripes and only faint median stripe. The mandibles are black-brown, with yellow-brown hair on upper and outer portions. Lip, maxillæ, sternum, and coxæ black-brown, with dark brown hair. The upper side of the abdomen has a dark brown bell-shaped pattern at the base marked out with yellow-brown streaks on chocolate-brown ground. The posterior half is dark brown, with faint traces of paler transverse stripes. There is a rather pale stripe down each side separating the back colour from the wholly black-brown field on the under side. The legs and palpi are chocolate-brown all over, except the under side of the femora which are paler yellowish grey.

The *cephalothorax* is of the broad frontal type, being three-fifths of its greatest breadth at the base of the mandibles, and one-fourth of the same only in height from the mandibles to the level of the rear row of eyes.

The front row of *eyes* appears slightly procurved, the side eyes being as broad as the median eyes, but oval. The latter are half their diameters apart and rather less from the side eyes. The clypeus is wider than the median eyes. The latter are their

diameter from those of the second row, one of which, in this specimen, is abnormally small. They are yellow on wide black rings, and apparently two-thirds of their normal diameter apart, and one-eighth of their length wider than the front row.

The *mandibles* are as long as the front of the cephalothorax, and half their length in breadth.

There are three large teeth on the inner margin of the falx-sheath and one large tooth between two smaller at irregular intervals on the outer.

Text-fig. 80.

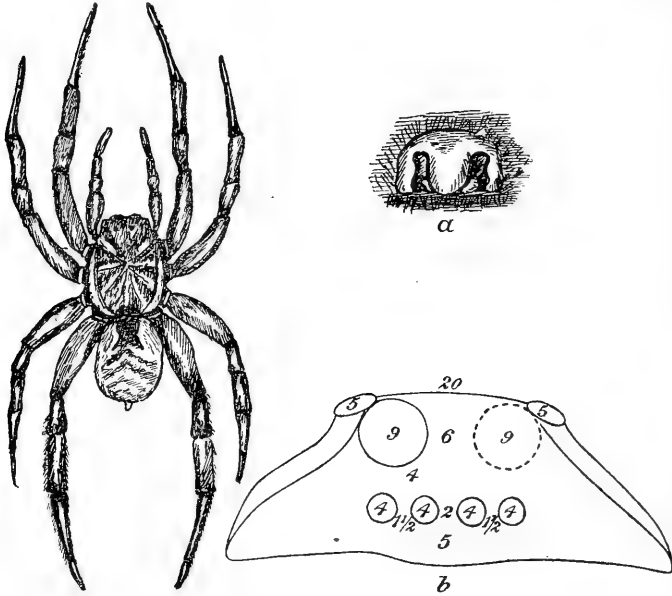
*Lycosa tasmanica.*

a, epigyne; *b*, eyes from front*.

The *lip* and *maxillæ* are covered with rough upstanding bristly hair. The former is broader than long, slightly incurved in front and less than one-half the length of the *maxillæ*. The *sternum* is a broad oval; the hair on this and the *coxæ* thick, but shorter and less erect.

The *palpi* are longer than the cephalothorax, and the *legs* have two spines above on *tibiæ* iii. and iv., none on *tibiæ* i. and ii.

The hair on the *abdomen* is coarse and thickly laid. The epigyne is arched but broader than long, the median ridge being a broad flat plate falling from above.

* The measurements given for the eyes are, in all cases, in tenths of a millimetre.

Measurements in millimetres.

	Long.	Broad.				
Cephalothorax ...	13	$\left\{ \begin{array}{l} 6 \text{ in front.} \\ 10 \end{array} \right.$				
Abdomen	$11\frac{1}{2}$		9			
Mandibles	6					
		Trochanter	Patella	Metatarsus		
		Coxa. & femur.	& tibia.	& tarsus.		
Legs	1.	5	11	$11\frac{1}{2}$	11 =	$38\frac{1}{2}$
	2.	$4\frac{1}{2}$	$10\frac{1}{2}$	11	$10\frac{1}{2}$ =	$36\frac{1}{2}$
	3.	$4\frac{1}{2}$	10	9	10 =	$33\frac{1}{2}$
	4.	5	12	$12\frac{1}{2}$	14 =	$43\frac{1}{2}$
Palpi.....		$2\frac{1}{2}$	6	5	4 =	$17\frac{1}{2}$

One female sent by Mr. Dove from Table Cape, Tasmania.

It may be worth noting that this Tasmanian species conforms to the type of three species of my *Venator* class from Macedon, 40 miles north of Port Phillip Bay, Victoria. It was at Macedon that I discovered a species of *Peripatus* new to Victoria, which subsequently turned out to be the normal Tasmanian species.

LYCOSA PHYLLIS, sp. n. (Text-fig. 81, p. 574.)

Cephalothorax dark brown, with chestnut-brown downlying hair. No distinctly marked median or marginal stripes, but the hair is rather thicker there. The side streaks nearly bare, showing the under surface.

Mandibles black-brown, covered all over with thick matted buff-coloured hair.

Lip, maxillæ, sternum, and coxæ dark reddish-brown with brown hairs, the sternum thickly matted.

The abdomen on the upper side has a dark brown hair-pattern of usual type on paler ground. Angular transverse stripes, six or seven in number, with pale spots at each end. The sides pale yellow-brown; on the under side a broad shield-shape black-brown field extends from the genital fovea nearly to the spinnerets, where the buff ground of the sides comes across. Anteriorly of the genital fovea clearly paler than the field, but still dark brown. Spinnerets dark brown.

The legs and palpi are of a medium yellow-brown; the under side of the femora more red-brown.

The cephalic fovea is short and shallow.

The eyes of the front row are one-half the diameter of the median apart, and the same distance from the margin of the clypeus and those of the second row. The laterals are three-fourths the diameter of the median; whole row slightly procurved.

The eyes of the second row are distant from one another four-fifths of their diameter, which is $2\frac{1}{2}$ times that of the front median.

The mandibles are longer than the front patella. There are

three large teeth on the inner edge of the falx-sheath, and a thick fringe on the outer, which hides the teeth if any.

The *lip* is broader than long, slightly hollowed and bevelled in front, constricted at base, and reaches to less than half the height of the maxillæ through beginning below them.

The epigyne is longer than broad and narrowest anteriorly.

There are two spines above on tibiæ iii. and iv., none on tibiæ i. and ii.

The metatarsus of the fourth pair of legs is shorter than the patella *cum* tibia of same.

Text-fig. 81.

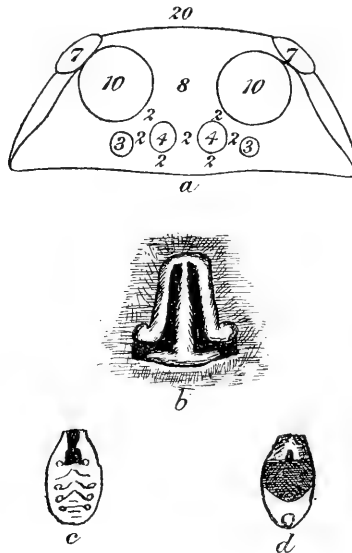

Lycosa phyllis.

a, eyes from front; *b*, epigyne; *c*, upper, and *d*, lower sides of abdomen.

Measurements in millimetres.

		Long.	Broad.			
Cephalothorax ...		11	} 5 in front. 7			
Abdomen		12		7		
Mandibles		4½				
Legs				Pat. & tib.	Metat. & tars.	
	1.	Coxa. 3½	Tr. & fem. 9½	9	8½	= 30½
	2.	3	8½	8½	8½	= 28½
	3.	3	8	8	9	= 28
	4.	3½	10	10	13	= 36½
Palpi.....	2	4½	4		(8½ & 4½)	= 13½

Two females from the Gilbert River, Riverina, sent by Mr. A. Molyneux. One female from Kangaroo Island (A. Zietz), paler and rather smaller.

LYCOSA MOLYNEUXI, sp. nov. (Text-fig. 82.)

The cephalothorax is red-brown, with pale to darker yellow-brown downlying hair intermixed with dark brown upstanding hair; a paler marginal and median stripe with side-streaks the same.

Text-fig. 82.

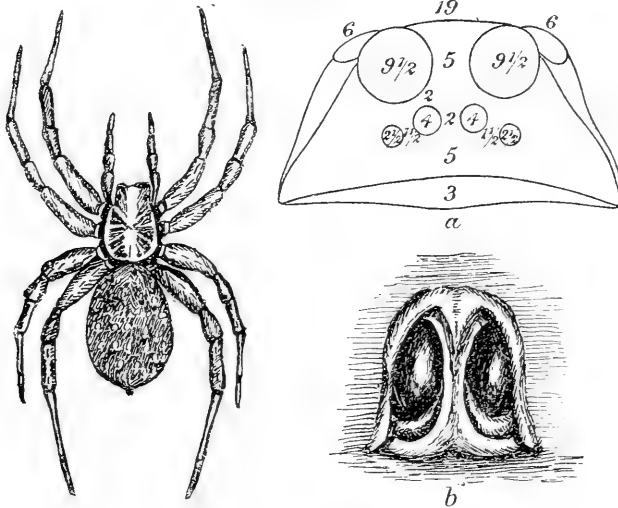

Lycosa molyneuxi.

a, eyes from front; *b*, epigyne.

The mandibles are black-brown, with yellow-brown hair except on the lower inner edges of the falx, which are bare. The lip, maxillæ, sternum, and coxæ are reddish-brown with yellow-brown hair. The legs and palpi yellow-brown; the under side of the femoral joints much paler than above.

The abdomen is yellow-brown above, with a small darker patch at the base and two pairs of darker spots near the middle. The sides are pale. The under side of the abdomen is a bright rich brown anteriorly, with two broad stripes of the same curving inwards and joining in front of the spinnerets, which are of the same colour. The space enclosed from the genital fovea to the point of juncture is of a pale buff.

The *cephalothorax* is rather narrow in front and shorter than patella *cum* tibia iv.

The *eyes* of the front row are clearly procurved. The side eyes not quite $\frac{2}{3}$ the diameter of the median, having their centres on a level with the lower part of the latter. The median pair are half their diameter apart, the same distance from the eyes of the second row and slightly less from their own laterals. The clypeus is broad, the distance to the root of the mandibles being twice the diameter of the front median, but a transverse edge marking runs across at more than half the distance away from the eyes; the whole distance is of the same colour and covered with hair.

The eyes of the second row are rather more than half their diameter apart, their total width being $1\frac{1}{3}$ of that of the front row. Those of the third row are three times their diameter apart and $\frac{2}{3}$ the diameter of those of the second row.

The *mandibles* are $\frac{1}{3}$ longer than the front patellæ, are thickly covered with downlying matted hair, interspersed with upstanding bristles; on the inner edge of the falx-sheath are three equally large teeth, and on the outer edge one similar sized large tooth between two smaller ones.

The *lip* is straight across the front, but the edge slightly hollowed and bevelled forward; it widens towards the base, where it narrows somewhat suddenly. It is clearly less than half the length of the maxillæ, which are broadest $\frac{2}{3}$ of the distance from the base; rounded in front and on the outside, and narrowed considerably at the basal end.

The *sternum* is broadly ovate, almost pointed at the base, thickly covered with short coarse hair.

The *abdomen* is a long oval, thickly covered with short fine downlying hair.

The spinnerets are rather prominent, covered with thick coarse hair.

The epigyne is only slightly longer than broad and not much narrower anteriorly than at its base; the median longitudinal ridge broadens out considerably from the basal to the anterior end.

The *legs* are moderately long and stout, thickly covered with short downlying hair and upstanding bristles. There are two median spines on the upper sides of tibiæ iii. and iv., none on the same of tibiæ i. and ii.

The *palpi* are clearly longer than the cephalothorax.

In colouring, pattern, and size, this spider is very like *L. leuckartii* Thor. from Peak Downs, Queensland, as described by L. Koch, but differs in having the pattern of the under side of the abdomen bright brown instead of black-brown. The clypeus is much wider, instead of slightly only, than the front median eyes, which are rather wider apart than they are from the side eyes instead of equidistant. The palpi are longer instead of shorter than the cephalothorax, and the lip less instead of more than half the length of the maxillæ. The epigynal ridge of *leuckartii* is drawn by L. Koch widest in the middle, while here it certainly widens from the middle anteriorly.

Measurements in millimetres.

		Long.	Broad.			
Cephalothorax ...	10	} $4\frac{1}{2}$ in front. 8				
Abdomen	$16\frac{1}{2}$				11	
Mandibles	5					
		Coxa.	Tr. & fem.	Pat. & tib.	Metat. & tars.	
Legs	1.	$4\frac{1}{2}$	$9\frac{1}{2}$	$10\frac{1}{2}$	$9\frac{1}{2}$	= 34
	2.	4	9	$9\frac{1}{2}$	$9\frac{1}{2}$	= 32
	3.	4	$8\frac{1}{2}$	$8\frac{1}{2}$	$9\frac{1}{2}$	= $30\frac{1}{2}$
	4.	$4\frac{1}{2}$	$9\frac{1}{2}$	11	14	= 39
Palpi.....	2	5	$4\frac{1}{2}$	3		= $14\frac{1}{2}$

One female seen by Mr. A. Molyneux from the Gilbert River, Riverina, and I have named it after the sender.

LYCOSA CASTANEA, sp. nov. (Text-fig. 83.)

Female. Cephalothorax and mandibles pale yellow-brown, with pale yellowish-grey hair, without distinct marginal, median, or side

Text-fig. 83.

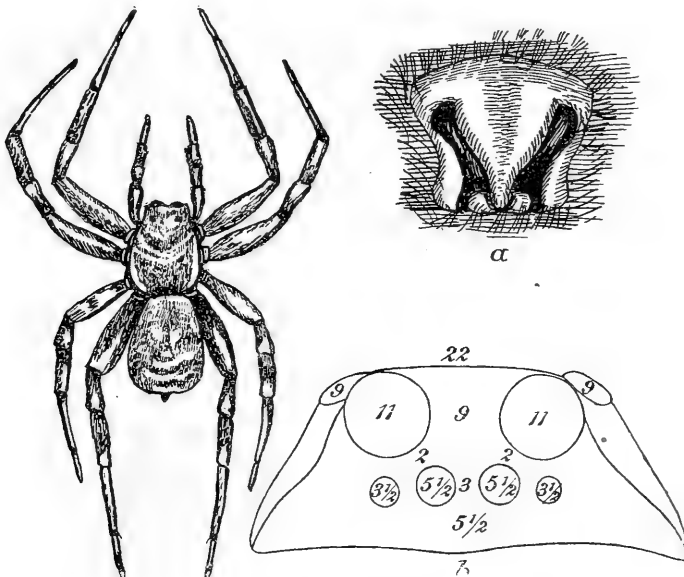

Lycosa castanea.

a, epigyne; b, eyes from front.

stripes. Lip, maxillæ, and coxæ bright yellow-brown. The abdomen above bright chestnut-brown ground with pale creamy-

yellow transverse stripes; underneath, a chestnut triangular shield, broadest at base and narrowing to spinnerets, which lie at its apex; sides pale creamy-yellow.

Legs and palpi bright chestnut all over, except the under side of the femora, which are of a pale cream-colour.

The *cephalothorax* is rather broad, being four-fifths of its length at its greatest breadth, and in front one-half of its length. The mandibles are also half the length of the cephalothorax and proportionately stout. There are three large teeth of equal size on the inner edge of the falx-sheath, and one as large between two small on the outer edge.

The front row of *eyes* is straight, the median being $1\frac{1}{2}$ times as far apart as they are from the laterals. Their diameters are in the same proportion.

The *clypeus* is as broad as the front middle eyes; the latter are half their diameter from those of the second row, which are slightly less than their diameter apart and twice that of the front median.

The *lip* is broader than long, straight in front, and less than half the length of the maxillæ.

The *abdomen* is a broad oval, thickly covered above and below with short smooth downlying hair.

The epigyne is of a trapezoidal outline, broader than long, with the broadest part anteriorly, where also the middle ridge is very broad, tapering to where it springs from a base of the usual type.

The *legs* are long and powerful; and the palpi (from the trochanter) longer than the cephalothorax.

There is one spine above on tibia i., two on tibiæ ii., iii., and iv.

Measurements in millimetres.

		Long.	Broad.			
Cephalothorax ...		12	6 in front. $9\frac{1}{2}$			
Abdomen		13		10		
Mandibles		6				
		Coxa.	Tr. & fem.	Pat. & tib.	Metat. & tars.	
Legs	1.	5	12	$12\frac{1}{2}$	12	= $41\frac{1}{2}$
	2.	$4\frac{1}{2}$	11	$11\frac{1}{2}$	12	= 39
	3.	$4\frac{1}{2}$	10	$10\frac{1}{2}$	12	= 37
	4.	5	12	$12\frac{1}{2}$	16	= $45\frac{1}{2}$
Palpi.....		$2\frac{1}{2}$	5	$5\frac{1}{2}$	$3\frac{1}{2}$	= $16\frac{1}{2}$

In measurements and pattern of epigyne and other points this species differs but slightly from *L. errans*, sp. nov. The coloration of the latter is, however, much darker. Its large second row eyes are only $\frac{2}{3}$ of their diameter apart, and the median ridge of the epigyne in the female is broader anteriorly, and the base of same reaches to $\frac{1}{3}$ of the length. The clypeus

also is not so wide as the front median eyes, instead of equal. It has no spines on tibia i. or ii. above, and lip only as broad as long instead of broader.

One female (without locality) sent from Adelaide, S.A.

LYCOSA ERRANS, sp. nov. (Text-fig. 84.)

The cephalothorax is red-brown, with yellow-brown downlying hair; mandibles black-brown, with rather brighter coloured hair. Lip, maxillæ, sternum, and coxæ dark chocolate-brown. The abdomen above dark brown, rather thick coarse hair, with four pale spots at the base and transverse stripes of bright pale buff from middle to posterior end; on the underside a broad dark brown field reaching from base nearly to the spinnerets; the sides light yellow-brown.

Text-fig. 84.

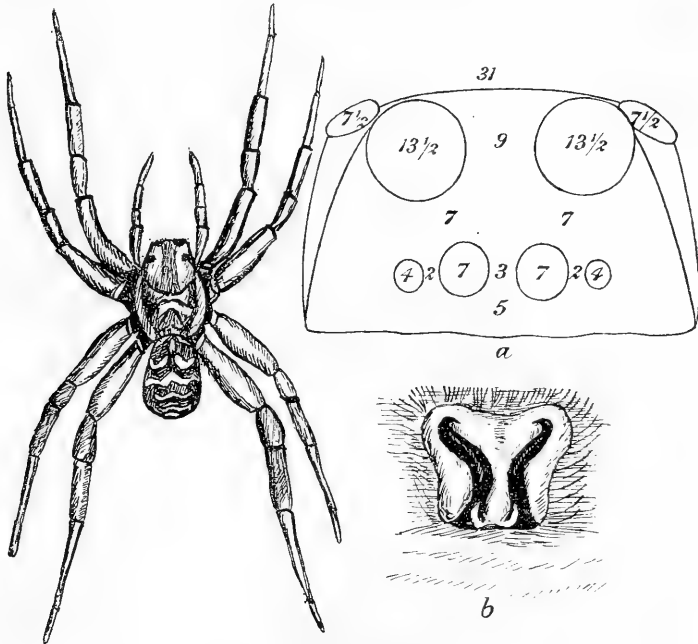

Lycosa errans.

a, eyes from front; b, epigyne.

The legs are yellowish-brown, the patellæ and tibiæ darkest, and the underside of the femora almost silver-grey.

The cephalothorax is broad, being four-fifths its length in the broadest part and two-fifths in front, and not so long as patella cum tibia iv.

The *eyes* of the front row are in a straight line, the laterals half their diameter from the median, which are $1\frac{1}{2}$ that distance apart, their diameter being rather more than twice the same. The clypeus is less than their diameter by one-third. They are half their diameter from the eyes of the second row, whose diameter is twice that of the front median, and this is $1\frac{1}{2}$ times their distance apart.

The *mandibles* are long and stout. There are three large teeth on inner margin of falx-sheath, one large between two small on the outer.

The *lip* is as broad as long, straight in front, and less than half as long as the maxillæ.

The *abdomen* is a broad oval. In the female the epigyne is of a trapezoidal outline, broadest anteriorly, where it is broader than its length. The base of the median ridge reaches $\frac{1}{3}$ of the whole length, and is narrowest in the middle, the ridge being broader anteriorly than the base.

The *legs* are long and stout. There are no spines above on tibiæ i. and ii.; two each on tibiæ iii. and iv. The *palpi* (from trochanter) are longer than the cephalothorax.

Measurements in millimetres.

	Long.	Broad.			
Cephalothorax ...	13	5 in front. 10			
Abdomen	$10\frac{1}{2}$		8		
Mandibles	6				
	Coxa.	Tr. & fem.	Pat. & tib.	Metat. & tars.	
Legs	1. $4\frac{3}{4}$	12	$12\frac{1}{2}$	12	= $41\frac{1}{4}$
	2. $4\frac{1}{4}$	11	$11\frac{1}{2}$	$11\frac{1}{2}$	= $38\frac{1}{4}$
	3. $4\frac{1}{4}$	$10\frac{1}{2}$	11	13	= $38\frac{3}{4}$
	4. $4\frac{3}{4}$	12	$13\frac{1}{2}$	$16\frac{1}{2}$	= $46\frac{3}{4}$
				($11\frac{1}{2}$ & $4\frac{1}{2}$)	
Palpi.....	$2\frac{3}{4}$	$6\frac{1}{4}$	$5\frac{1}{4}$	$4\frac{1}{4}$	= $18\frac{1}{2}$

One female, without locality or collector.

LYCOSA BICOLOR, sp. nov. (Text-fig. 85.)

Cephalothorax bright yellow-brown (buff) all over, no side or median streaks. Mandibles, with hair of the same buff colour, dark brown underneath: fangs dark red-brown. Lip and maxillæ dark olive-brown with dark brown hair. Coxæ dark olive-brown. Sternum black-brown. Abdomen rich chocolate-brown on upper and under sides, with a bright buff field on upper side anteriorly, reaching to the middle of the back where it ends in a point. It is half as broad as long in the female, but in the male, which is young, a narrow stripe only.

Legs deep chocolate-brown from coxæ to near the anterior end of the patella, which is buff. Tibia, tarsus, and metatarsus buff

on both upper and under sides. Palpi: femur dark brown, other joints buff.

The *cephalothorax* is square in front, the greatest breadth two-thirds its length, covered with thickly matted coarse hair. The front row of *eyes* is procurved, median pair larger than laterals. Clypeus rather narrower than front median, which are only half that distance from the second row eyes.

The two middle row eyes are more than $2\frac{1}{2}$ times the diameter of the front median and $\frac{2}{3}$ of their diameter apart. The eyes of the third row are 3 times their diameter apart, and half that distance from the eyes of the second row.

There are three large teeth on the under side of the falx-sheath, one large between two smaller on upper side of same.

Text-fig. 85.

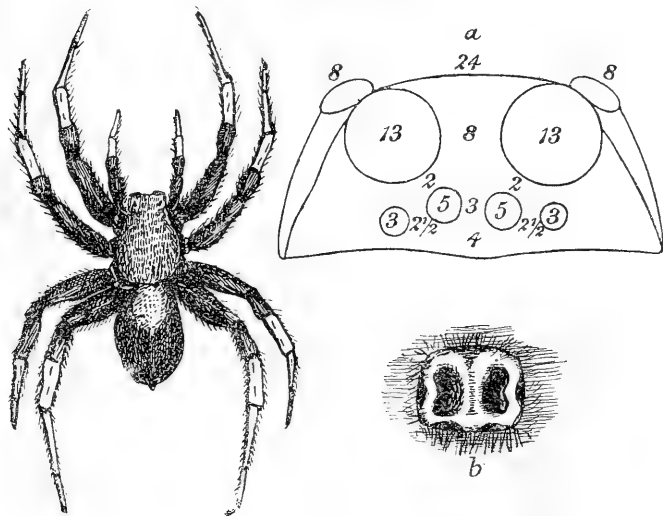
*Lycosa bicolor.*

a, eyes from front; *b*, epigyne.

The *lip* is slightly broader than long and less than one-half the length of the maxillæ.

The oval *sternum* is three-fourths as broad as long.

There are no spines above on *tibiæ* i. and ii. of female. One short one in male. On *tibiæ* iii. and iv. above there are two in both male and female.

In the female the outline of the *epigyne* is oblong, rounded at the corners, one and a half times wider than long. The median ridge is narrowest in the middle, widening out at each end.

The palps of the male specimen wanted a moult of development.

The measurements of the female (in millimetres) are as follows:—

		Long.	Broad.			
Cephalothorax ...	12		5 in front.			
Abdomen	12½		8½			
Mandibles	6		9			
			longer than pat. i.			
		Coxa.	Tr. & fem.	Pat. & tib.	Metat. & tars.	
Legs	1.	4½	10	10	10	= 34½
	2.	4	9½	9½	9½	= 32½
	3.	4	9½	9	9½	= 32
	4.	4½	10	11	13½	= 39
Palpi.....		2½	5	5	3½	= 16

One male (undeveloped).

Two females. The locality is not given.

LYCOSA GILBERTA, sp. nov. (Text-fig. 86.)

Cephalothorax brown with yellow-grey hair; a paler yellow-

Text-fig. 86.

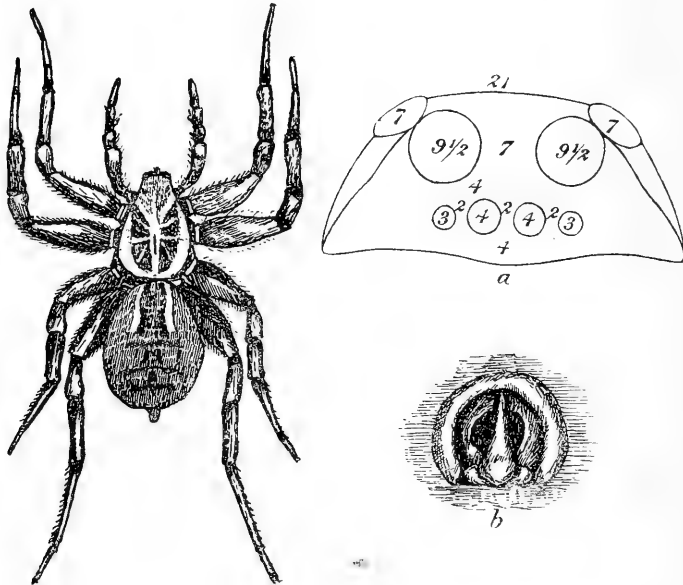

Lycosa gilberta.

a, eyes from front; b, epigyne.

grey median, marginal, and four side-streaks on each side, the latter backed by darker brown. Mandibles black-brown with thick

yellow decumbent hair and long erect brown bristles. Lip, maxillæ, and sternum dark red-brown, with dark yellow-brown hair. Coxæ with rather browner hair.

The abdomen above is yellow or grey-brown, almost orange on the sides in some specimens, in others paler yellow-brown. The whole of the under side from base to spinnerets of a dull dingy brown, about the same colour as the coxæ. Legs and palpi red-brown, with pale yellow-grey hair somewhat darker underneath.

The *cephalothorax* is as long as patella *cum* tibia iv.; as broad as femur i. It is slightly wider in front than one-half the greatest breadth.

There are three large teeth of equal size on the lower edge of the falx-sheath, and one large tooth between two small teeth, the lower of which is a little distance off, on the upper side.

The front row of *eyes* is straight along the lower edge, the larger median being $1\frac{1}{2}$ times the diameter of the laterals; they are one-half the diameter of the larger apart. The clypeus is as broad as the median front eyes, and they are the same distance from the pair of the second row. The latter are $\frac{2}{3}$ of their diameter apart, and the row is one-third longer than the front row.

The *lip* is broader than long, and barely half as long as the maxillæ.

There are two spines above on tibiæ iii. and iv., none on i. and ii.

There are five females from the Gilbert River, Riverina, all fully developed. Two large and three smaller vary considerably in size, but I can discover no structural differences between them.

The epigyne is of a horseshoe-shape, slightly broader than long. The median ridge broad at the base, and tapers to a narrow ridge anteriorly.

Measurements in millimetres

(of a large and small specimen respectively).

		Long.		Broad.			
Cephalothorax ...		14		$\left\{ \begin{array}{l} 5\frac{1}{2} \text{ in front.} \\ 10 \end{array} \right.$			
Abdomen		$17\frac{1}{2}$			13		
Mandibles		$6\frac{1}{2}$					
					Pat. &	Metat.	
		Coxa.	Tr. & fem.	tib.	& tars.	=	
Legs	1.	6	12	13	12	=	43
	2.	5	$11\frac{1}{2}$	12	12	=	$40\frac{1}{2}$
	3.	5	11	11	12	=	39
	4.	6	14	14	17	=	51
Palpi.....		$2\frac{1}{4}$	$6\frac{1}{4}$	5	4	=	$17\frac{1}{2}$
		Long.		Broad.			
Cephalothorax ...		11		$\left\{ \begin{array}{l} 4 \\ 7\frac{1}{2} \end{array} \right.$			
Abdomen		13			9		
Mandibles		$4\frac{1}{2}$					

		Coxa.	Tr. & fem.	Pat. & tib.	Metat. & tars.		
Legs	1.	4	9	10	9	=	32
	2.	3½	8½	9	9	=	30
	3.	3½	8	8	9½	=	29
	4.	4	10	10	14	=	38

LYCOSA STIRLINGÆ, sp. nov. (Text-fig. 87.)

Female. Cephalothorax brown, with paler median, side, and marginal stripes. Mandibles black-brown, with red-brown hair. Lip, maxillæ, and sternum red-brown, with dark red-brown hair. Coxæ dark red-brown, with paler yellow-brown hair at anterior ends.

The abdomen above is black-brown, with dark red-brown hair and with just a faint pattern. Underneath bright red-brown, with black shield broadest at the genital fold and tapering to the spinnerets.

Legs and palpi yellow-brown all over, lighter on the under sides.

In the *male* the stripes on the cephalothorax are more silvery, and the hair on the coxæ and legs generally paler yellow-brown.

The *cephalothorax* is of the high narrow type, the clypeus being more than twice as wide as the front median eyes.

The front row of *eyes* is slightly procurved, the median eyes slightly less than their diameter apart and the same distance from those of the second row. The laterals have their diameter slightly smaller than that of the median, and are $\frac{2}{3}$ of it from the median.

The eyes of the second row are twice the diameter of the front median apart, and their diameter slightly more.

The eyes of the third row are four times their diameter apart.

In the *male* the front row of eyes is rather more procurved than in the *female*, and the eyes of the second row just their diameter apart.

The *mandibles* are longer than the width of the cephalothorax in front. They have three large equal teeth on the lower edge of the falx-sheath and one large between two small on the upper edge.

The *lip* is as broad as long and less than half the height of the maxillæ.

The *sternum* is of a broad shield-shape, thickly covered with coarse flatly placed hairs.

The *legs* are thickly covered with short flatly placed hairs, there are no bare long streaks, and a fair number of erect bristles. On the upper side of the tibial joint the *female* has two spines on the 3rd and 4th pairs. In the *male* two on all the tibiæ.

The tibial joint of the *palpi* is longer than the patella.

In the *female* the epigyne is narrowest anteriorly, and is $2\frac{1}{2}$ times as long as it is broad at the base. The median ridge is broadest at the base and tapers anteriorly. Outside the epigyne proper, on each side of the base, is a darkened oval hollow, with its longer diameter lying longitudinally.

This species in many points resembles *L. ramosa* L. K., described from an immature female, but besides being larger has no rings

Text-fig. 87.

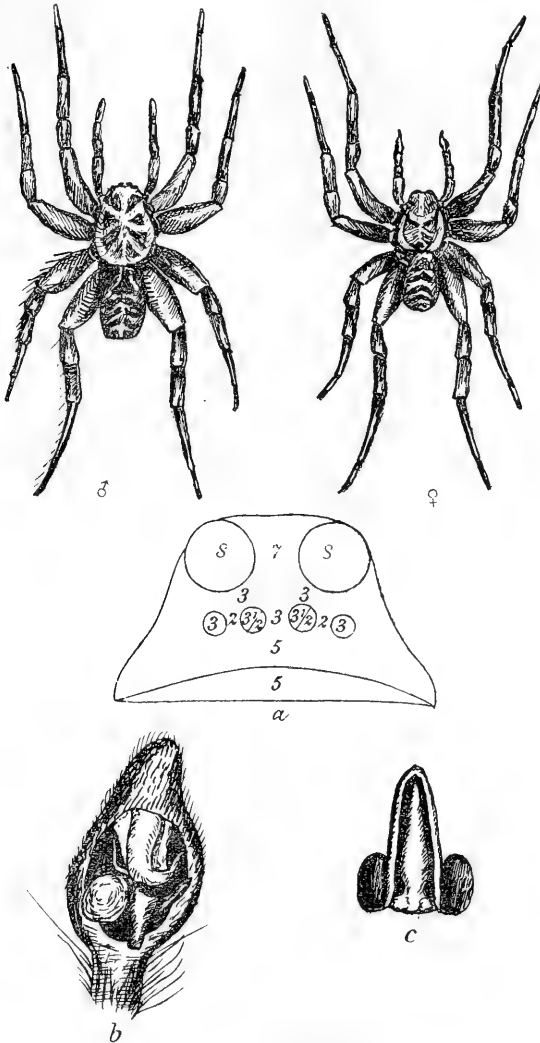

Lycosa stirlingæ, ♂ & ♀.

a, eyes from front of female; *b*, male palp; *c*, epigyne.

on the legs. The front row of eyes is shorter than the second instead of being equal, and the median eyes of the front row are

only one instead of two diameters from those of the second row; also the tibial joint of the palpi is longer than the patellar joint instead of equal to it.

Measurements in millimetres.—Female.

	Long.	Broad.				
Cephalothorax ...	11	$\left\{ \begin{array}{l} 4\frac{1}{2} \text{ in front.} \\ 8 \\ 6 \end{array} \right.$				
Abdomen	9					
Mandibles	$5\frac{1}{2}$	much longer than front patella.				
	Coxa.	Tr. & fem.	Pat. & tib.	Metat. & tars.		
Legs	1.	4	$9\frac{1}{2}$	$9\frac{1}{2}$	$9\frac{1}{2}$	= $32\frac{1}{2}$
	2.	$3\frac{1}{2}$	9	9	9	= $30\frac{1}{2}$
	3.	$3\frac{1}{2}$	$8\frac{1}{2}$	$8\frac{1}{2}$	8	= $28\frac{1}{2}$
	4.	4	10	10	$12\frac{1}{2}$	= $36\frac{1}{2}$
Palpi.....	2	5	$4\frac{1}{2}$	3		= $14\frac{1}{2}$

Male.

	Long.	Broad.				
Cephalothorax ...	8	$\left\{ \begin{array}{l} 3\frac{1}{2} \\ 6 \\ 5 \end{array} \right.$				
Abdomen	8					
Mandibles	4					
	Coxa.	Tr. & fem.	Pat. & tib.	Metat. & tars.		
Legs	1.	$3\frac{1}{2}$	9	10	11	= $33\frac{1}{2}$
	2.	3	8	9	$10\frac{1}{2}$	= $30\frac{1}{2}$
	3.	3	$9\frac{1}{2}$	7	10	= $29\frac{1}{2}$
	4.	$3\frac{1}{2}$	$9\frac{1}{2}$	$9\frac{1}{2}$	13	= $35\frac{1}{2}$
Palpi.....	2	4	3		$2\frac{1}{2}$	= $11\frac{1}{2}$

One male and one female from Gilbert River, Riverina, collected by Mr. A. Molyneux.

LYCOSA ARENARIS, sp. nov. (Text-fig. 88.)

Cephalothorax yellow-brown; hairs red, black, and white mixed over cephalic part, behind this a white patch extending to middle of rear slope, and less distinctly pale round the margin. Mandibles dark brown, with erect brown and decumbent greyish-yellow hairs. Lip, maxillæ, and sternum yellow-brown, with pale greyish-yellow hair. Coxæ yellow-brown.

Abdomen dull grey-brown, irregularly spotted with small patches of white hairs, the underside dingy brown, the centre area rather paler than the sides.

The *legs* and *palpi* yellow, brown decumbent hairs and darker brown erect bristles, with a ring of paler yellow round femur, middle of tibia, and metatarsal joints.

The front of the *cephalothorax* is high and narrow, with a clypeus twice the width of the front middle eyes. The front row of *eyes*

is straight, the median larger than the laterals, all equidistant, less than half the diameter of the median from one another. From the second row to front median equals the diameter of the front laterals. The eyes of the second row are rather more than half their diameter apart, which is twice that of the front median; they are three diameters away from the rear row.

On the lower margin of the falcx-sheath are three large teeth.

The *mandibles* are longer than the front of the cephalothorax.

The *lip* is as broad as long and half the length of the *maxillæ*.

The *sternum* is a broad oval, pointed posteriorly and thickly covered with coarse hair. The *coxae* have only short fine hairs lightly spread.

Text-fig. 88.

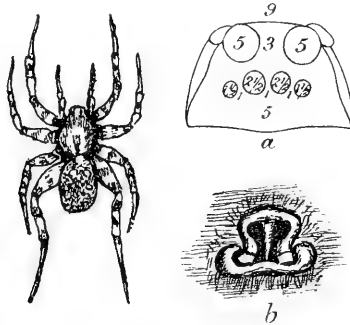
*Lycosa arenaris.*

a, eyes from front; *b*, epigyne.

The *abdomen* is oval, rather pointed posteriorly. The epigyne of the female broader than long, with a narrow middle ridge and the basal part curling round outside the horseshoe-shaped middle.

The *legs* are rather fine. There are two spines above on tibiae iii. and iv., none on the first or second pairs. On the under side the spines are long and stout.

The tibial joint of the *palpi* is longer than the *patella*.

Measurements in millimetres.

	Long.	Broad.			
Cephalothorax ...	6	$\left\{ \begin{array}{l} 2\frac{1}{2} \text{ in front.} \\ 4\frac{1}{2} \\ 4\frac{1}{2} \end{array} \right.$			
Abdomen	$7\frac{1}{2}$		$4\frac{1}{2}$		
Mandibles	3				
	Coxa.	Tr. & fem.	Pat. & tib.	Metat. & tars.	
Legs	1.	$2\frac{1}{2}$	5	$5\frac{1}{2}$	5 = 18
	2.	2	$4\frac{1}{2}$	5	= $16\frac{1}{2}$
	3.	2	$4\frac{1}{2}$	$5\frac{1}{2}$	= $16\frac{1}{2}$
	4.	$2\frac{1}{2}$	6	8	= $22\frac{1}{2}$
Palpi.....	$1\frac{1}{4}$	3	$2\frac{1}{4}$	$1\frac{3}{4}$	= $8\frac{1}{4}$

Two females brought by the Horn Expedition from the MacDonnell Ranges.

This species rather closely resembles L. Koch's *L. crispipes* from Rockhampton, though larger. It is more faintly marked on the cephalothorax, and is without the pattern on the back of the abdomen. The lower edge of the front row of eyes is straight instead of procurved, and the epigyne is broader at the base, which curls round instead of ending at the base of the horseshoe parts.

In this species the cephalothorax is as long as patella cum tibia iv. L. Koch says that in *L. crispipes* it is longer than tibia iv.

Dolomedes habilis, sp. nov. (Text-fig. 89.)

Cephalothorax chocolate-brown, with a narrow pale yellow-brown stripe reaching from the second row of eyes to the rear slope, and a similar stripe on each side of the cephalothorax at about one-third of the distance from the margin to the middle line.

Text-fig. 89.

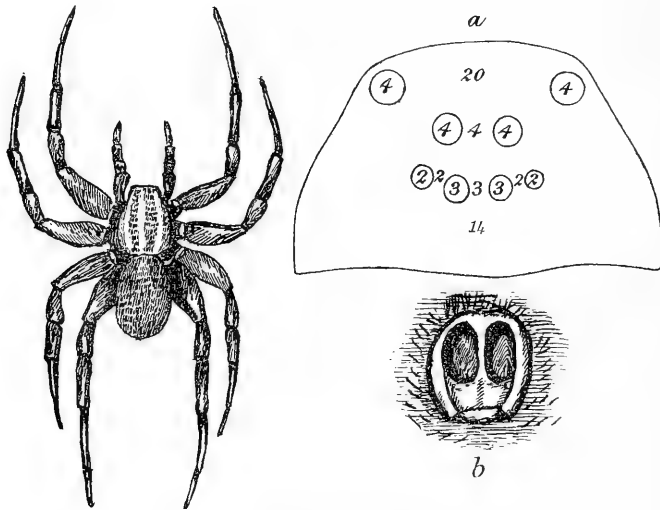

Dolomedes habilis.

a, eyes from front; b, epigyne.

The mandibles are black-brown, thickly covered with long yellow-brown hair. The lip and maxillæ yellow-brown; sternum rather more yellow. Legs and palpi yellow-brown all over, brighter underneath. The abdomen is yellow-brown, of the same shade as the upper side of the legs. The sides paler yellow-brown in the front half, merging into the same colour as that of the back towards the rear, the paler part being divided from the back by a

bright yellow-brown stripe of the same colour as on the cephalothorax. The under side of the abdomen is yellow-brown, with a faint shield-pattern marked out by paler side-lines and two similarly coloured parallel lines inside.

The *cephalothorax* is moderately high in front, being two-thirds as high as broad in that part and rather more than half as broad as in its widest part; the median line slightly slopes upwards as far as the rear end of the longitudinal fovea, whence it falls steeply down.

The front row of *eyes* is recurved or straight along the upper edge, the median pair being their diameter apart; the laterals are two-thirds the diameter of the median and the same distance away from them. The clypeus is twice as broad as one median and lateral eye with the space between them. The eyes of the second row are a diameter apart, larger than the front median and their diameter from them. The eyes of the third row are as large as the second, on rather large prominences, and 5 diameters apart.

The *mandibles* are as long as the width in front of the cephalothorax, and have one small and three large teeth on the inner margin of the falx-sheath, with one large between two small on the outer.

The *lip* is slightly broader than long, straight in front and half the length of the *maxille*.

The *sternum* is nearly round, and thickly covered with short downy hair.

The *abdomen* is ovate, straight in front, with four prominent muscle-spots in the anterior half above, with short decumbent hair. The epigyne of the female is oval, the inside oval hollows being in the anterior part of the arch.

The *palpi* are longer than the cephalothorax, and the tibial joint is longer than the patella.

The *legs* are covered with smooth decumbent hair, and there is a not very thick scopula on the tarsus and metatarsus of all legs.

Measurements in millimetres.

		Long.	Broad.		
Cephalothorax ...		9½	{ 4½ in front. 8 7		
Abdomen		11			
Mandibles		4½		= longer than front patella.	
				Pat. & tib.	Metat. & tars.
Legs	1.	4	9½	11	10½ = 35
	2.	3½	9	10½	10 = 33
	3.	3½	9	10	9½ = 32
	4.	4	9½	11½	13 = 38
				(4 & 7½)	
Palpi.....	2	4½		4½	3 = 14
				(2 & 2½)	

This species is rather close to L. Koch's *D. instabilis*, from Mudgee, not very far north of Gilbert River; but differs in having scopulæ on the tarsus and metatarsus of each pair of legs, and the first pair of legs longer than the second pair, instead of equal in length. The clypeus, though very wide, is not so wide as the front row of eyes, thus differing from the condition described by L. Koch for his species. There is no scolloped pattern on the back of the abdomen, and no paler coloured spots at the root of the spines on the legs.

There are two females sent by Mr. A. Molyneux from the Gilbert River.

LYCOSA OBSCURA L. Koch, 1877.

Die Arachn. Austr. vol. ii. p. 954.

Gilbert River, Riverina, N. S. Wales (*Molyneux*); Kangaroo Island, S. Austr. (*Tepper*); Onkaparinga, S. Austr. (*Tepper*). 15 males, 22 females.

Previously described from Bowen, Queensland, and Sydney.

LYCOSA LETA? L. Koch, 1877.

Op. cit. vol. ii. p. 944.

One female. Kangaroo Island (*Tepper*).

According to L. Koch, *L. leta* has the palpal tibia longer than patella of same; in this specimen the two joints are of equal length.

Previously described from Rockhampton, Queensland, and Palm Creek, Central Australia.

LYCOSA CLARA? L. Koch, 1877.

Op. cit. vol. ii. p. 912.

Four females. Goolwa (*A. Zietz*).

In *L. clara*, according to Koch, the cephalothorax is equal to patella *cum* tibia iv., in these specimens it is slightly longer.

Previously described from Bowen, Queensland, and Macedon, Victoria.

The following descriptions of two new species of Coleoptera of the genus *Homophæta* were inadvertently omitted from Mr. Martin Jacoby's paper *supra* page 399:—

HOMOPHÆTA ARGUS, sp. n. (Plate XIV. fig. 3.)

Flavous, the antennæ, knees, tibiæ, and tarsi black; thorax with a transverse black band; elytra not perceptibly punctured, each elytron with five round pale spots surrounded by a black ring.

Length 6–7 millim.

Var. Thorax without the black band.

Head impunctate, the middle portion and the clypeus yellowish white, the vertex and the labrum black; antennæ extending beyond the base of the elytra, black, the joints rather short and robust, third and fourth equal. Thorax strongly transverse, the sides rounded, the anterior angles strongly thickened and produced, the surface impunctate, with a transverse narrow black band not extending to either margin. Scutellum black or piceous. Elytra flavous, each elytron with five round pale spots, each spot surrounded by a black ring, and as follows—one at the base near the scutellum, one at the middle near the lateral margin, a third below the middle near the suture, and the others near the apex and joined together transversely; apex of the femora, the tibiæ and tarsi black.

Hab. São Paulo, Brazil, also Bolivia.

This species must not be confounded with *H. annulata* Illig., which it resembles somewhat in number and position of the elytral spots; but these in the present species are of different shape, round instead of transverse, always margined with black, and the subapical spots joined at their inner margins. In Gemminger's Catalogue the name of *Argus* Chev. i. litt. is given once as a synonym of *H. annularis* Ill. and again as *Oedionych. 10-guttata* Fab., but the species has evidently never been described. *H. 4-notata* Illig. is a variety of *H. æquinoctialis* Fab. None of these species has a black banded thorax like the present typical form.

HOMOPHÆTA ANGUSTOLINEATA, sp. n. (Plate XIV. fig. 1.)

Below and the legs fulvous, above bright flavous, entirely impunctate, antennæ dark fulvous, scutellum black; elytra with the extreme margins, a ring-shaped band at the sides and another transverse band near the apex, violaceous black or æneous.

Length $6\frac{1}{2}$ –7 millim.

Head entirely flavous; antennæ robust, entirely dark fulvous. Thorax transverse, the anterior angles prominent and thickened. Elytra shining; bright yellow, narrowly margined with purplish or violaceous, with a narrow transversely rounded similarly coloured band near the middle, nearly extending to the suture,

and an equally narrow transverse band below the middle, extending to either margin.

Hab. Bolivia, Peru.

Closely allied to some of the varieties of the widely distributed *H. æquinoctialis* Linn., but evidently quite distinct, as I have many specimens before me which show no variations. The species is larger and of more elongate shape, the small flavous spot in front of the humeral callus in *H. æquinoctialis* is absent, the dark elytral markings are linear and of different shape and entirely separated, not confluent, and the antennæ are more robust and, like the legs, of a dark fulvous colour.

INDEX.

- Ablabes, 517.
 hermineæ, 512, 513,
 515.
 semicarinatus, 512,
 515.
 Ablabophis
 rufulus, 255.
 Aceros
 nepalensis, 180.
 Achæta, 563.
 Acomyx
 cahirinus, 280-288.
 dimidiatus, 321.
 — *minois*, 315, 321.
 Acontias
 lineatus, 254.
 Acridium
 sp., 562.
 Actinia
 prehensa, 495.
 Adamsia, 507, 509.
 palliatæ, 501, 509.
 Aenaria, 146.
 Æpyceros
 melampus, 187.
 Agalychnis
 callidryas, 206.
 Agama
 armata, 253.
 atra, 253.
 brachyura, 252.
 hispida, 252, 253.
 micropholis, 253.
 microterolepis, 253.
 Aipysurus
 annulatus, 517.
 Allactaga
 williamsi, 527.
 Alligator
 lucius, 467.
 Alloctotus, 146.
 Allolobophora
 sp., 490.
 Alphæus, 505.
 Alphenor, 146.
 Amaurochrous, 147.
 Amblyrhynchus, 212.
 Amblyscelis, 279.
 hæmorrhous, 279.
 Amblysomus
 chrysellus, 58.
 corriæ, 57.
 hottentottus, 57, 58.
 iris, 57.
 obtusirostris, 58.
 Amblystoma, 200, 205.
 altamirani, 193, 200,
 201, 202, 232.
 persimile, 200.
 tigrinum, 193, 200, 201,
 202, 232.
 Aneiva, 216, 221.
 undulata, 195, 216.
 Amphisbæna, 470, 480,
 481, 482, 484, 485,
 486, 488.
 brasilitana, 461, 479,
 480, 481, 483, 486,
 487, 489.
 cinerea, 480, 485, 488.
 fuliginosa, 488, 489.
 Amplorhinus
 multimaculatus, 255.
 Ancistrodron, 226.
 bilineatus, 226.
 blomhoffii, 511, 513,
 514.
 Anelytropis
 papillosus, 195, 219.
 Anemonia
 sulcata, 324.
 Anguis, 467.
 fragilis, 217, 258, 476.
 Aniella
 pulchra, 219.
 texana, 219.
 Anolis, 216, 221.
 carolinensis, 212, 216.
 Anolis
 gadovii, 195, 216, 233,
 245, 247.
 liogaster, 195, 216, 245,
 247.
 nebulosus, 195, 216,
 231, 233, 246.
 sallei, 195.
 tropidonotus, 195.
 Anomalepis
 mexicana, 222.
 Anthocomus, 275.
 coriaceus, 275.
 Anthropithecus
 trogodytes, 57.
 Apteryx
 mantelli, 295.
 Arctietis
 binturong, 26, 296.
 Arctosa, 570.
 Arthroleptis
 wahlbergii, 251.
 Arvicola
 hatanedzumi, 336, 352.
 montebelli, 352.
 Ascaltis
 cerebrum, 17.
 contorta, 6, 17.
 gegenbaueri, 17.
 Ascandra
 angulata, 20.
 contorta, 3, 5, 6, 12, 15,
 16, 17, 18.
 densa, 10.
 parus, 10.
 Ascetta
 spinosa, 3, 5, 12, 13,
 14, 16, 17, 18, 19, 20.
 Asplæra, 398.
 æmula, 405.
 albicincta, 409, 460.
 albifrons, 401, 403.
 amabilis, 403.
 apicalis, 411, 417.

- Asphæra**
basimaculata, 417.
biplagiata, 410.
bisbiplagiata, 409.
brevicollis, 407.
carilloensis, 403.
chapuisi, 406.
curialis, 405.
dejeani, 408.
dimidiaticornis, 408.
discicollis, 400.
discofasciata, 411.
divisa, 418, 460.
elegantula, 412, 460.
episcopalis, 410.
erichsoni, 410.
femorata, 400.
ferrugineo-vittata, 413.
funerea, 406.
fuscofasciata, 418.
glabripennis, 406.
hilaris, 401.
inæqualis, 416.
lacerata, 414.
limitata, 405.
maculicollis, 411.
nasalis, 402.
nigrofasciata, 404.
nitidissima, 415, 460.
nobilitata, 411.
oblecta, 408.
ornata, 405.
pallida, 401.
separata, 405.
tarsata, 402, 403, 460.
tessellata, 416, 460.
tibialis, 413.
unicolor, 399.
variegata, 416, 417.
vernalis, 405.
viridicollis, 415.
zonulata, 404, 460,
 (Aspicela) *albomarginata*, 409.
Aspicela, 401.
Aspidelaps
lubricus, 255.
Atractes, 224, 227.
Austrocobitis, 365.
Balænoptera
borealis, 490.
musculus, 490.
sibbaldii, 490.
Basiliscus, 212.
americanus, 215.
vittatus, 195, 215.
Batrachoseps, 204.
attenuatus, 193, 204,
 205, 232.
Batrachoseps
scutatus, 204.
Bipes
canaliculatus, 219.
Bitis
arietans, 255.
caudalis, 255.
cornuta, 255.
Blanus
cinereus, 220.
Boa
divinilogua, 296.
imperator, 195, 222.
mexicana, 222.
Borborocœtes, 207.
mexicanus, 194, 207,
 232.
Brachylophus
fasciatus, 212.
Bryodrilus, 564.
Bubalus
caffer radcliffæi, 189.
Buchholtzia, 563.
Budorcas
tawicolor tibetana, 329,
 330.
Bufo, 205.
angusticeps, 250.
canaliferus, 206.
carens, 250, 251.
coccifer, 206.
compactilis, 206.
compactus, 231.
debilis, 206.
dombensis, 250.
granti, 250.
intermedius, 194, 231,
 232.
marinus, 194, 206, 240.
marmoreus, 194, 206.
punctatus, 206.
regularis, 250.
simus, 206, 232, 240.
sternosignatus, 206.
valliceps, 194, 206,
 240.
vertebralis, 250.
viridis, 250.
Bungarus
candidus, 516.
Bunodeopsis, 498, 499,
 500, 501, 507, 508,
 510.
Buphaga, 191.
Caiman
punctulatus, 209.
sclerops, 194.
Calliste
guttata, 490.
Calomyscus, 524, 525.
bailwardi, 519, 524,
 525, 527.
Calorhamphus, 42.
Calorhinus
ursinus, 335.
Calyptomena, 31, 32, 33,
 34, 35, 36, 37, 38,
 39, 44, 45, 47, 48,
 50, 51, 52, 56.
viridis, 56.
Canis
auveus, 522.
hodophylax, 333, 342.
Cantharis
nigrina, 272.
smaragdulus, 271.
viridescens, 271.
Capra
agagrus cretensis,
 323.
Cariama, 167.
Caridophthalmus, 146,
 147.
Celestus, 217, 218, 221.
Centrurus
insulanus, 184.
Cephalophus
coronatus, 180.
maxwelli, 180.
Cercocebus
aterrimus, 187.
Cercopithecus
talapoin, 296.
wolfi, 295.
Cervicapra
 sp., 187.
Cervus
claphus, 1.
sika, 333, 334, 357.
Chalcocoris, 147.
Chamæleon, 266.
quilensis, 254.
ventralis, 254.
Chamæsauro
anguina, 253.
Charadrius, 162, 163, 164,
 165, 166, 167, 168,
 169.
pluvialis, 155.
Charina, 222, 223.
Chasmorhynchus, 32, 33,
 35, 37, 38, 47, 48.
Chelone
viridis, 194, 210.
Chelydra
rossignoni, 209.
serpentina, 209.
Chimarrogale
platycephala, 333, 334,
 340.

- Chinchilla, 28.
 Chionis, 159, 160, 161,
 162, 163, 164, 165,
 168.
alba, 155, 156, 161,
 166.
 Chirodrilus, 563.
 Chirotos, 220, 241, 243.
biporus, 220.
canaliculatus, 195, 219,
 220.
tridactylus, 220.
 Chrysemys, 210.
grayi, 194, 210.
incisa, 210.
mobilienis, 210.
ornata, 194, 210.
pulcherrima, 210.
umbra, 210.
 Cimex
cælebs, 149.
 Cinixys
belliana, 252.
 Cinosternum, 209, 210.
effeldti, 194, 210.
hirtipes, 209.
integrum, 194, 210.
leucostomum, 194,
 210.
pennsylvanicum, 194,
 209, 230.
scorpioides, 210.
sonoriense, 210.
 Cistudo, 210.
mexicana, 210.
 Citellus
concolor, 523.
xanthopyrinus, 523.
 Clathrina
contorta, 3-20.
coriacea, 15, 16.
lacunosa, 20.
reticulum, 14.
spinosa, 18.
 Claviglis
crassicaudatus, 492,
 493.
 Cliona
celata, 14.
 Cnemidophorus, 216,
 221, 243.
bocourti, 195.
depei, 195.
gularis, 195, 216.
guttatus, 195, 216.
mexicanus, 195.
sexlineatus, 216.
striatus, 195.
 Cobitis
capensis, 367.
punctifer, 367.
 Coccinella
septempunctata, 533.
 Cœreba
cærulea, 490.
 Coleonyx
elegans, 194, 212.
 Collops, 278.
 Colobus
abyssinicus matschiei,
 489.
albicaudatus, 328.
caudatus, 327, 328.
guereza, 187, 326.
*palliatu*s, 326.
 — *cottoni*, 326.
ruwenzorii, 326.
satanas, 325.
sharpai, 326, 327.
vellerosus, 328, 329.
 Coluber, 223, 227.
chlorosoma, 233.
climacophorus, 511,
 514.
conspicillatus, 511, 513.
corais, 196, 223.
quadrivirgatus, 511,
 514.
schmackeri, 512, 513,
 515.
triaspis, 230.
 Columba
livia, 552.
 Commius, 147, 150, 151.
elegans, 153.
minor, 152.
 Connochaetes
gnu, 295.
 Conolophus, 212.
 Conopbis, 225.
vittata, 196, 225.
 Contia, 223, 227.
nasus, 196, 233.
 Corallus, 222.
 Coronella, 223, 225, 227,
 517.
annulata, 223.
lævis, 223.
micropholis, 196, 223,
 231.
regalis, 223.
 Corvus, 32, 34, 35, 39.
corax, 54.
frugilegus, 42.
 Corydon, 33, 34, 36, 37,
 38, 39, 44, 45, 46, 48,
 50, 51, 56.
 Corythomantis
greeningi, 206.
 Corythophanes, 212.
hernandezii, 195, 215.
 Cricetodon, 524.
 Cricetulus
lama, 302, 305.
phæus, 306, 526.
 Cricetus, 524, 525.
 Crocidura, 315.
cærulea, 334, 340.
dsi-nezumii, 333, 334,
 340, 358, 361.
 — *chisai*, 333, 340:
 — *umbrina*, 361.
russula, 340.
umbrina, 334.
 Crocodilus, 461.
acutus, 466, 467.
americanus, 194, 209.
moreletii, 209.
 Crollius, 147.
 Crotalus, 226.
horridus, 226, 230.
miliarius, 231.
salvini, 231.
terrificus, 231, 233,
 241.
triseriatus, 231, 233.
 Crotaphytus, 212, 213.
collaris, 213.
wislizeni, 213.
 Ctenosaura, 212, 213.
acanthura, 195, 214.
quinquecarinata, 195,
 215.
 Cyldiris, 272.
balteatus, 272.
 Cymbirhynchus, 34, 36,
 37, 38, 39, 44, 45, 46,
 48, 56.
 Cynictis
levallanti, 26.
 Dactylopsila
palpator, 297.
trivirgata, 297.
 Dasypeltis
scabra, 255.
 — *palmarum*, 255.
 Dendraspis
angusticeps, 255.
 Dendrobates, 208.
 Dermatemys
mawi, 194, 209.
 Dermophis, 200, 203.
mexicanus, 193, 199.
 Desmognathus, 202.
 Diabrotica, 398.
 Diaglena
jordani, 206.
 Dicamptodon
ensatus, 200.
 Dichoceros
bicornis, 57.

- Dictyotus, 148, 150.
 apicalis, 148.
 confinis, 149.
 detersus, 149.
 discoideus, 149.
 favillaceus, 149.
 geniculatus, 149.
 lineatus, 149.
 semimarginatus, 149.
 similis, 149.
 transversus, 150.
 truncatellus, 150.
 ventralis, 150.
 Dinodon
 japonicus, 511, 513,
 514.
 rufozonatus, 512, 513,
 515.
 semicarينات, 512, 515.
 Diplodocus, 289-294.
 carnegii, 294.
 Diploglossus, 217, 231.
 steindachneri, 217, 233.
 Dirosema, 224, 227.
 Dispholidus
 typus, 255.
 Distira
 ornata, 517.
 Dolomedes
 habilis, 588.
 instabilis, 590.
 Dorcatherium
 aquaticum, 489.
 Dozocolletus, 274.
 brunneus, 274.
 sordidus, 274.
 Dromia, 509.
 Dromicus, 224, 227.
 laureatus, 233.
 Drymobius, 224, 227,
 231.
 boddaerti, 196, 224.
 margaritiferus, 196,
 224, 233.
 Dryomys, subg. n., 348.
 Dryophis
 acuminatus, 196.
 Dryotriorchis
 spectabilis, 296.
 Dymecodon
 pilirostris, 336, 342.
 Elaps, 225, 227.
 elegans, 225.
 euryxanthus, 225.
 fulvius, 196, 225, 231.
 Eliomys, 491, 493.
 dryas, 348.
 (*Dryomys*) *nitidulus*,
 348.
 Elius, 348.
 Ellobius
 fuscocapillus, 526, 527.
 lutescens, 526, 527.
 talpinus, 526, 527.
 woosnami, 526.
 Enchytraeus, 563.
 minimus, 564.
 parvulus, 564.
 turicensis, 564.
 Engystoma, 208.
 ustum, 194, 208, 240.
 Engystomops, 205.
 pustulosus, 205.
 Epicrates, 222.
 Eremaeus
 novus, 567.
 Erinaceus
 europaeus, 522.
 — *concolor*, 522.
 — *italicus*, 316, 317.
 — *nestotes*, 316.
 — *roumanicus*, 317.
 Erythrolamprus, 225.
 fissidens, 225.
 Eryx, 464.
 Esox
 alepidotus, 375.
 Eublepharis
 fasciatus, 211.
 variegatus, 211.
 Euchirotes
 biporus, 219, 220.
 Eucymatodera, 272.
 cingulata, 272.
 hottentota, 272.
 Eumeces, 218, 257, 260,
 261, 265.
 algeriensis, 61, 62, 258,
 260.
 brevirostris, 233.
 fuscirostris, 195, 218.
 lynx, 195, 218, 233.
 Eupemphix
 gadovii, 194.
 Eurylamus, 34, 36, 39,
 42, 56.
 ochromelas, 40, 41, 42,
 52, 54.
 Euryannus, gen. nov.,
 153.
 lippus, 154.
 Eurypyga, 167, 168.
 Eurystomus, 35, 36, 37,
 49.
 Evotomys
 andersoni, 354.
 bedfordiae, 333, 353,
 354, 355.
 glareolus, 352, 353.
 mikado, 333, 352.
 Evotomys
 rufocanus, 353, 354,
 355.
 (Crasomys) *andersoni*,
 333, 354.
 (—) *bedfordiae*, 353,
 354.
 (—) *latastei*, 354.
 (—) *rufocanus*, 353,
 354.
 (Phaulomys) *smithii*,
 333, 334, 336, 355.
 Eysarcoris
 truncatellus, 150.
 Felis
 catus, 318.
 jaguarondi, 296.
 manul, 302.
 ocreata, 317.
 — *agrius*, 317, 318.
 — *sarda*, 318.
 pardus, 295.
 Ficimia, 223, 227.
 Fridericia, 564.
 Galaxias
 affinis, 366, 380, 383.
 alepidotus, 366, 375.
 alpinus, 365, 368, 370,
 371, 372.
 atkinsonii, 377.
 attenuatus, 364, 365,
 366, 368, 369, 370,
 373, 384.
 auratus, 366, 379.
 bollansi, 364, 374.
 bong-bong, 382.
 brevipinnis, 364, 365,
 366, 374.
 brochus, 375.
 campbelli, 368.
 capensis, 367.
 coppingeri, 370, 371.
 coxi, 366, 380.
 cylindricus, 368.
 delfini, 372.
 delicatulus, 368.
 dissimilis, 366, 383.
 fasciatus, 365, 366,
 374.
 findlayi, 365, 366, 382,
 384.
 forsleri, 375.
 gracillimus, 364, 365,
 370.
 grandis, 372, 374.
 huttoni, 366, 373, 383.
 kayi, 364, 381, 382,
 384.

Galaxias

- kokopu*, 376.
kreffii, 368, 369, 384.
lynx, 364, 366, 373, 383.
maculatus, 364, 365, 368, 370.
minutus, 368.
nebulosa, 368.
nigohoruk, 364, 380.
occidentalis, 364, 366, 376, 378, 384.
ocellatus, 378.
olidus, 364, 365, 366, 373, 381, 382, 384.
ornatus, 365, 366, 381.
planiceps, 382.
platei, 365, 372.
postvectis, 375.
punctatus, 368, 369.
punctifer, 365, 367, 383.
punctulatus, 370.
reticulatus, 375.
robinsoni, 374.
rostratus, 366, 378.
schomburgkii, 366, 382.
seriba, 365, 368, 369.
smithii, 365, 372.
truttaceus, 366, 368, 378, 379, 384.
versicolor, 369.
waitii, 366, 376, 378, 384.
waterhousei, 364, 368, 369.
weedoni, 366, 377, 384.
zebratus, 365, 367.
- Galictis, 24, 25, 29.
barbara, 26, 27.
- Gallinago, 162, 163, 164, 165, 166, 168, 169.
cælestis, 155.
- Geagras
redimitus, 196, 224.
- Geophis, 224, 227.
chalysa, 231.
mæsta, 233.
omiltemana, 233.
semidoliatus, 196.
- Gerrhonotus, 217, 218, 241.
antagues, 195, 217, 233.
cæruleus, 217, 230.
deppei, 195, 233.
gramineus, 195, 217, 233.

Gerrhonotus

- imbricatus*, 195, 217, 233.
liocephalus, 195, 233.
- Gerrhosaurus, 61, 462.
flavigularis, 62, 256-267.
madagascariensis, 260.
- Gilippus, 146.
- Giraffa
camelopardalis peralta, 57.
- Glareola, 162, 163, 164, 165, 166, 168, 169.
pratincola, 155.
- Glaucania, 222, 226.
albifrons, 195, 222.
dulcis, 195, 222.
humilis, 222.
- Glirulus, gen. nov., 347.
japonicus, 334, 335, 347.
- Glis, 348.
- Gonioctena, 529, 532, 533.
variabilis, 528.
- Graphiurus, 492, 493, 494.
- Graptoclerus, 273.
quadripunctatus, 273.
- Gustavia
sol, 566.
- Gymnodactylus
sumichrasti, 211.
- Gyponyx, 272.
algoensis, 272.
braunsi, 273.
chinensis, 272.
marmoratus, 272.
retrocinctus, 272.
- Haliaëtus
albicilla, 189, 296.
- Halteridium
crumenium, 297.
danilewskyi, 297.
- Hapale
chrysoleucos, 296.
- Haplocanthosaurus, 294.
- Hateria, 69, 256, 257, 461, 462, 463, 464, 465, 466, 470, 474, 484, 485.
- Hedonistes, gen. nov., 278.
lætus, 279.
- Hedybius, 271, 275.
amænus, 276, 277.
anceps, 276.
quadricornis, 276.
sculpticeps, 275.

Hedybius

- superciliuosus*, 277.
varicornis, 277.
- Helictis
personata, 21-29.
subavantiaca, 21, 24, 27.
- Heliornis, 163, 167.
- Heloderma, 221, 241, 242, 243.
horridum, 217.
suspectum, 217.
- Hemibungarus
japonicus, 512, 515.
- Hemichirotes
tridactylus, 219, 220.
- Henlea
dicksoni, 564.
lefroji, 562.
nasuta, 563.
- Hermannia
bistriata, 568.
- Herpestes
albicauda, 489.
galera robustus, 188.
- Himantodes, 224.
cenchoa, 196, 224.
gemmistriata, 224.
tenuissima, 224.
- Himantopus, 157, 162, 163, 164, 165, 166, 167, 168, 169.
nigricollis, 155.
- Hipposiderus
bicolor, 130.
- Holbrookia, 212, 213.
maculata, 213.
propinqua, 213.
texana, 194, 213.
- Homalocranium, 225.
atrocinctum, 233.
bocourti, 231.
miniatum, 196.
- Homo
sylvestris, 73.
- Homophœta, 398.
æquinoctialis, 591.
angustolineata, 460, 591.
annulata, 591.
arqus, 460, 591.
boliviana, 399.
clavareauxi, 398.
10-guttata, 591.
peruviana, 399, 460.
4-notata, 591.
- Homopus
signatus, 252.
- Hydrechytæus, 564.
- Hydrochœrus
capybara, 490.

- Hydrophasianus, 157,
 158, 159, 160, 163,
 164, 165, 166, 167,
 168.
chirurgus, 155, 158.
 Hydrophis
 melanocephalus, 516.
 Hydrus
 platurus, 516.
 Hyla, 206.
 baudini, 194, 207.
 boucourti, 207.
 cærulea, 206.
 copei, 194, 207.
 eximia, 194, 207, 231,
 232.
 miotympanum, 207,
 231, 240.
 staufferi, 194, 207.
 venulosa, 207.
 Hylella, 206.
 Hylobates
 agilis, 174, 175.
 concolor, 171, 174.
 hainanus, 169, 174,
 175, 176, 180.
 harlani, 174.
 hoolock, 175.
 lar, 174, 175.
 leuciscus, 173, 175.
 nasutus, 171, 175.
 niger, 174.
 pileatus, 172, 175.
 syndactylus, 174.
 (*Symphalangus*) *syn-*
 dactylus, 174.
 Hylocherus
 meinertzhageni, 182,
 310.
 Hylodes, 207.
 beatæ, 194.
 calcitrans, 207.
 melanostictus, 207.
 palmatas, 207, 231,
 232.
 rhodopis, 194, 207, 231,
 232, 240.
 Hymenochirus, 250.
 Hypochothius
 ictorum, 568.
 Hypsiglena
 torquata, 224, 240.
 Ichnotropis
 capensis, 254.
 Iguana, 59, 60, 61, 212,
 257, 268, 269, 270,
 462, 467, 477.
 rhinolophus, 195.
 tuberculata, 60, 256,
 270.
 Inuus
 speciosus, 334, 336.
 Irrisor, 52.
 Ischnognathus, 223, 227.
 copei, 233.
 Kobus
 defassa, 186.
 ellipsiprymnus, 187,
 296, 297.
 Lacerta, 257, 261, 462,
 464.
 agilis, 261.
 muralis, 324.
 ocellata, 258, 261, 262.
 viridis, 485.
 — *major*, 320.
 Lachesis, 226.
 atrox, 196.
 flavoviridis, 512, 516.
 lancoletus, 196, 226,
 243.
 lansbergi, 226.
 microsquamatus, 512,
 513, 516.
 okinavensis, 511, 512,
 513, 516.
 undulatus, 233.
 Læmanctus, 212.
 longipes, 216.
 servatus, 216.
 Lagomys
 curzonæ, 308.
 Laius, 278.
 Lama
 huanacos, 57.
 Lankesterella
 ranorum, 58.
 tritonis, 58.
 Lanthanotus, 217.
 Larus, 162.
 Leopardus
 japonicus, 335.
 Lepidophyma
 flavomaculatum, 219.
 Leptodactylus, 207, 208.
 albilabris, 194, 208.
 caliginosus, 194, 208.
 microtis, 208.
 Leptodira, 224.
 albofusca, 196, 224,
 231, 233.
 guilleni, 196, 247.
 nigrofasciata, 247.
 personata, 196, 247.
 septentrionalis, 224.
 Leptognathus
 elegans, 225.
 Leptophis, 224, 227, 231.
 bilineatus, 233.
 diplotropis, 196, 231,
 233.
 mevicana, 196, 231,
 232.
 prestans, 233.
 Leptoptilus
 crunciferus, 297.
 Lepus
 brachyurus, 333, 334,
 351, 357, 359, 360.
 — *okiensis*, 359.
 craspedotis, 527.
 europæus creticus, 322.
 oiostolus, 308.
 tibetanus, 527.
 timidus, 322, 351.
 — *ainu*, 333, 336,
 356.
 variabilis, 336.
 Leucosolenia
 botryoides, 4.
 cerebrum, 6.
 complicata, 4, 5, 8, 10,
 15, 16, 18.
 contorta, 3, 4, 5, 6, 8,
 10, 11, 12, 13, 14, 15,
 16, 17, 18, 19.
 coriacea, 4, 5, 6.
 reticulatum, 6.
 spinosa, 18.
 variabilis, 5, 15, 16.
 (*Leuciria*) *contorta*, 17.
 (*Nardoia*) *contorta*, 17.
 Levenna, gen. nov., 151.
 salax, 152.
 Liacarus
 bicornis, 566, 569.
 Lichanura, 222.
 Limnotragus
 gratus, 296.
 spekei, 187.
 Lipaugus
 cineraceus, 53.
 Lobopomis, 147.
 Lohmannia
 insignis, 564.
 Loxocemus
 bicolor, 222.
 Lumbriellus, 563.
 Lutra
 lutra, 293.
 Lutronectes
 whiteleyi, 335.
 Lycoperdina
 sericca, 280.
 Lycosa
 arenaris, 570.
 bicolor, 571, 580, 581.
 castanea, 571, 577.

- Lycosa**
clara, 571, 590.
cowlei, 570.
crispipes, 588.
errans, 571, 578, 579.
gilberta, 571, 582.
godeffroyi, 569.
hasseltii, 569.
hispanica, 3.
leia, 571, 590.
leuckartii, 576.
molynceuxi, 570, 575.
obscura, 569, 571, 590.
phyllis, 571, 573, 574.
stirlingæ, 570, 584, 585.
tarentula, 569.
tasmanica, 570, 571, 572.
- Lygodactylus**
capensis, 252.
- Lygosoma**, 218.
laterale, 195, 218.
- Lyriocephalus**
scutatus, 296.
- Mabuia**, 218.
agilis, 195, 218.
striata, 254.
sulcata, 254.
trivittata, 254.
varia, 254.
- Macacus**
fuscatus, 333, 334, 361.
- Macrosincus**, 260, 261, 262.
cocteau, 257, 258, 259, 260.
- Manolepis**
putnami, 196, 225, 233.
- Marionina**, 563.
glandulosa, 564.
- Martes**
japonica, 335.
- Mecidea**, 146, 147.
- Megadenterus**, 279.
- Megaptera**
longimana, 490.
- Meles**
anakuma, 333, 334, 336, 344.
meles mediterraneus, 318.
- Melia**, 496, 497, 498, 499, 500, 501, 504, 505, 506, 507, 508, 509, 510.
tessellata, 494, 495, 496, 498, 500, 502, 510.
- Mellivora**
indica, 523.
- Menura**, 32, 34, 35.
- Meriones**
erythrurus, 523.
meridianus, 523.
persicus, 523.
- Mesenchytraus**, 563.
- Mesites**, 365.
alpinus, 371.
attenuatus, 368.
gracillimus, 370.
maculatus, 370.
- Michaelsena**, 563.
macrochaeta, 563.
- Micromys**
agilis, 394.
agrarius manchuricus, 385, 396, 397.
— *ningpoensis*, 385, 397.
— *typicus*, 397.
chevrieri, 395.
geisha, 333, 334, 336, 350, 351, 359, 362, 363.
— *celatus*, 359.
— *hokkaida*, 333, 350.
— *yakui*, 362.
intermedius, 395.
minutus, 351.
— *japonicus*, 333, 334, 351.
— *pygmæus*, 385, 396.
mystacinus, 524.
pygmæus, 351.
speciosus, 333, 334, 348, 349, 350, 351, 358, 362.
— *ainu*, 333, 349.
— *navigator*, 358.
sylvaticus, 320, 395.
— *arianus*, 524.
— *chevrieri*, 385, 395.
— *draco*, 385, 395.
— *hayi*, 315, 320.
— *witherbyi*, 524.
ussuricus, 351.
yakui, 363.
- Microtus**
spp., 526.
agrestis, 324.
montebelli, 333, 334, 335, 336, 352.
nivalis, 526.
(Phaiomys) *waltoni*, 302, 306, 307.
- Miniopterus**
fuscus, 338.
schreibersi, 316.
— *japonica*, 334, 338.
- Mococa**, 218.
- Mogera**
kobæa, 336, 361.
wogura, 333, 336, 341, 361.
— *kanai*, 361.
— *kobæa*, 333, 341, 358.
- Molge**
cristata, 58.
- Morenou**, gen. nov., 517, 518.
orizabensis, 517, 518.
- Mormidea**
deversa, 148, 149.
ventralis, 150.
- Murina**
hilgendorfi, 334, 335.
- Mus**
agrarius manchuricus, 394, 396, 397.
— *ningpoensis*, 394.
— *typicus*, 396.
alexandrinus, 389.
argenteus, 334, 349.
badius, 395.
bowersi, 389.
canna, 389.
chevrieri, 395.
confucianus, 384, 386, 387, 388, 389, 394.
coninga, 386.
coxingi, 384, 386, 394.
cremoriventer, 388.
decumanus, 287, 392.
edwardsi, 384, 385, 394.
erythronotus, 334.
flavipectus, 384, 389, 390, 391, 392, 394.
germaini, 390.
griseipectus, 385, 390, 391, 392, 393, 394.
harti, 397.
huang, 384, 387, 388, 394.
humiliatus, 385, 392, 393, 394.
indicus, 392.
intermedius, 395.
jerdoni, 385, 386, 387, 388.
latouchi, 384, 389, 394.
ling, 384, 388, 394.
losea, 348, 385, 391, 392, 394.
minutus pygmæus, 394, 396.
molossinus, 333, 334, 348, 361.

Mus

- musculus*, 287, 321, 385, 394, 523, 524, 525.
ningpoensis, 397.
niveiventer, 387.
norvegicus, 333, 348, 385, 392, 393, 394.
ouangthomæ, 389, 391.
plumbeus, 390, 391.
pygmæus, 396.
rapii, 388.
rattus, 320, 390, 393.
 — *flavipectus*, 390.
rufescens, 390, 391, 392.
speciosus, 334.
spicilegus, 348.
syloaticus, 321, 395.
 — *chevrieri*, 394, 395.
 — *draco*, 394, 395.
tanzunni, 333, 334, 348.
- Mustela**
alpina, 305.
brachyura, 334.
calotus, 346.
foina, 318.
 — *bunites*, 318, 319.
 — *leucolachnea*, 318.
 — *mediterraneus*, 319.
melampus, 182, 183, 334, 335, 343.
 — *bedfordi*, 183, 332, 333, 336, 343, 363.
 — *tsuensis*, 183.
- Myotis**
blythi, 522.
capaccinii, 337.
daubentoni, 337.
macrodactylus, 334, 337.
myotis, 316, 521, 522.
 — *omari*, 521.
nattereri, 337, 338.
 — *bombinus*, 334, 337.
thysanodes, 338.
- Myoxus**
elegans, 335, 347.
javanicus, 347.
lineatus, 334.
- Mystromys**, 524, 525.
- Naia**
melanoleuca, 296.
- Nardoia**
spongiosa, 17.
- Nemorhædus**
argyrochætes, 329, 331.
bubalinus, 331.
crispus, 333, 334, 357.
- Neochanna**, 365, 383
apoda, 361, 383.
- Neomys**
fodiens, 522.
- Neurotrichus**, 335, 342.
- Niarius**, 146, 148, 150.
illuminatus, 150.
tryoni, 150.
- Nicoria**
rubida, 194.
rutila, 210.
- Niphe**, 146.
- Notaspis**
bipilis, 567.
maculosa, 567, 569.
sculptilis, 567, 569.
splendens, 567.
- Nothrus**
anauniensis, 569.
crassus, 568, 569.
crinitus, 567, 569.
glaber, 568.
monodactylus, 568.
sylvestris, 569.
tardus, 568.
tergionii, 568.
tectorum, 568, 569.
- Nototenus**, 275.
viridis, 275.
- Nototrema**
oviferum, 206.
- Nucras**
delalandii, 254.
tessellata, 254.
- Numenius**, 157.
- Nyctereutes**
albus, 336.
viverrinus, 333, 334, 343.
- Ochotona**
curzonæ, 308.
- Ediarthrus**, 280.
angolensis, 280.
natalensis, 280.
- Edienemus**, 159, 160, 162, 163, 164, 165, 166, 168, 169.
scolopax, 155, 159.
- Oedionychis**, 398, 414, 415, 419.
adjuncta, 449, 460.
ænea, 443, 447.
alacris, 445.
albipennis, 419, 426.
apicicornis, 422.
arcuata, 439.
arcuatofasciata, 431, 460.
argentinensis, 456.

Oedionychis

- atroguttata*, 455.
atropunctata, 456, 457.
balyi, 425.
basinotata, 453, 460.
bicolorata, 459.
bifasciata, 442.
bipartita, 439, 447.
bipunctata, 445.
bipunctulata, 452.
bisbinotata, 428, 460.
bistri-fasciata, 437.
biteniata, 440.
bolivianus, 459.
cardinalis, 439, 447.
catharinæ, 434.
centromaculata, 431, 460.
cinctipennis, 450.
colombiana, 427, 445, 446.
complanata, 452.
constititilis, 425.
cubana, 451.
decora, 458.
difficilis, 444.
dipus, 419.
disepta, 441.
distincta, 421.
diversa, 428.
donckieri, 449.
duodecimnotata, 454, 460.
ecuadoriensis, 423.
exlanationis, 436, 460.
fenestrata, 454.
figurata, 437.
flavomarginata, 451, 460.
fulvotibialis, 448.
grayi, 438.
haagi, 449.
herbacea, 424.
humboldti, 435.
humeralis, 427, 458.
illigeri, 441.
illustris, 440, 460.
imperialis, 442.
inconspicua, 424.
indigosoma, 432.
informis, 438.
ingrata, 429.
insularis, 445.
interrupto-vittata, 436, 460.
interstignata, 433.
jaculus, 444.
labiata, 439.
maculatissima, 453.
millepora, 421.

- Oedionychis**
motschulskyi, 432.
nigrimana, 426.
nigrobasis, 459.
nigromaculata, 455.
nigropunctata, 457.
nigrosuturalis, 420.
nigrotibialis, 425.
niwivivialis, 423.
obscuripennis, 421, 426.
occipitalis, 442.
ocellata, 434, 460.
pallescens, 422, 424.
pallidicincta, 450.
paraguayensis, 419.
parvialina, 427.
paupera, 422.
persimilis, 455.
picifrons, 420.
plebeja, 426.
porosa, 451.
pretiosa, 451.
prominula, 460.
promita, 445.
pustulata, 434.
4-punctata, 458.
4-pustulata, 434.
5-maculata, 441.
regina, 444, 460.
rhodina, 423.
rotundicollis, 419.
rustica, 433.
saginata, 450.
selecta, 446.
semifoveolata, 451, 460.
signifera, 441.
servida, 422.
steinheili, 442, 448.
subcostata, 432.
subdilata, 455.
succincta, 445.
teviolata, 449.
tenuicincta, 428.
torquata, 458.
13-maculata, 431.
triloba, 452.
turpis, 426.
variata, 429.
variolosa, 451.
venezuelensis, 430.
vittatipennis, 448.
waterhousei, 435.
weisei, 446.
- Okapia**, 410.
- Oncocoris**, 146, 147, 148.
apicalis, 148.
caelebs, 149.
confinis, 149.
detersus, 149.
dimidiatus, 149.
discoideus, 149.
- Oncocoris**
favillaceus, 149.
geniculatus, 149.
insulanus, 149.
lethierryi, 149.
modestus, 149.
ovalis, 149, 153.
punctatus, 146, 149.
semimarginatus, 149.
similis, 149.
subsimilis, 150.
transversus, 150.
truncatellus, 150.
ventralis, 150.
- Ophiophagus**, 488.
- Ophisaurus**, 217, 461, 468, 469, 470, 471, 473, 474, 475, 476, 477, 488.
apus, 468.
ventralis, 217.
- Oribata**
furcata, 565, 569.
fusigera, 565.
lapidaria, 565.
omissa, 565, 569.
parnelliae, 565.
rubens, 565.
- Oryctolagus**
cuniculus clossius, 322.
- Oryx**
leucoryx, 296.
- Otaria**
gillespiei, 295.
- Otis**, 165, 167, 168.
- Ourebia**
montana, 187.
- Oxybelis**, 225.
acuminatus, 225.
- Oxyrhopus**, 224, 226.
cloelia, 224.
petiolaris, 224.
plumbeus, 224.
- Pachydactylus**
bibronii, 252.
mariguensis, 252.
- Pagurus**, 501, 509.
- Palæmon**
altifrons, 550.
lar, 544, 545, 547, 548, 550.
 — *spectabilis*, 549.
reuniannensis, 549.
 (Eupalæmon) *lar*, 544, 550.
- Paludicola**, 207.
mexicana, 194.
- Paradisea**, 54.
- Pardosa**, 570.
- Pentalagus**
burnessi, 357.
- Pentatoma**
semimarginata, 149.
truncatula, 149.
- Peromyscus**, 519, 524, 526.
- Petalognathus**
nebulatus, 196, 225.
- Petasophora**
iolota, 324, 490.
- Petaurista**
leucogenys, 333, 334, 336, 344.
 — *tosa*, 344.
nikkonis, 336.
oreas, 336.
tosa, 336.
- Pezoporus**, 274.
- Phacochærus**
athropicus, 188.
- Phaiomys**
blythi, 306, 307.
- Phellia**, 506, 507, 508, 510.
- Philledonus**, 277.
coronatus, 277.
regulosus, 278.
sericeus, 277.
- Phrynobatrachus**
natalensis, 251.
- Phrynosoma**, 212, 213.
asio, 194, 213.
cornutum, 213.
douglasi, 213.
modestum, 194, 213.
orbiculare, 213, 231.
taurus, 233.
- Phyllodactylus**
tuberculatus, 194, 211, 240.
- Phyllomedusa**, 206.
durocolor, 194, 206.
- Physignathus**, 257.
- Pipa**, 250.
- Pipistrellus**
abramus, 333, 334, 337.
akakomuli, 334.
aladdin, 521.
kuhli, 520, 521.
mimus, 521.
nanus, 521.
- Pirata**, 570.
- Piroplasma**
bigeminum, 491.
cantis, 491.
donovani, 491.
equi, 491.
hominis, 491.
ovis, 491.

- Pithecius, 72.
troglodites, 302.
 Pituophis, 223, 227.
 Platurus
laticaudatus, 517.
schistorhynchus, 517.
 Platycoris, 146, 147, 148,
 150.
 Plethodon, 205.
 Plotus
 sp., 189.
 Podargus, 35, 36.
 Podocnemis, 244.
 Pœcilogale
doggetti, 188.
 Polydectes, 498, 506,
 507, 509.
cupilifera, 506, 510.
 Pongo, 70, 71.
 Pontodrilus, 558.
crosslandi, 560, 561.
insularis, 559.
laccadivensis, 559, 560,
 561.
littoralis, 561.
matsushimensis, 559.
 — *chathamiana*, 561.
 Potamia, 570.
 Potamochoerus
porcus, 310.
 Procavia
bettoni, 188.
 Procias, 31.
 Procellicus, 147.
 Psammophis
sibilans, 255.
 Pseudaspis
cana, 255.
 Pseudocordylus
microlepidotus, 253.
 Pseudopus, 217.
pallasii, 468.
 Pternohyla
fodiens, 206.
 Pteromys
leucogenys, 334.
mononga, 344, 345.
 Pteropus
dasygnathus, 334.
 Pterygistes
molossus, 334.
 Ptychognathus
affinis, 542, 544.
andamanicus, 542, 543,
 544.
barbatus, 538, 539,
 540, 541, 543, 544,
 550.
dentatus, 542, 543,
 544.
glaber, 541, 542, 543.
- Ptychognathus
intermedius, 537, 542,
 543.
onyx, 542, 544.
pilipes, 537, 539, 541,
 542, 543.
polleni, 538, 542, 543.
pusillus, 537, 540, 541,
 542, 543, 544, 550.
reidellii, 541, 542, 543,
 544.
 — *pilosa*, 541, 542,
 544.
spiniarpus, 542, 543.
 Putorius
alpinus, 305.
ermineus, 343.
itatsi, 333, 334, 343.
nivalis, 319, 522.
 — *atlas*, 319, 320.
 — *galinthias*, 319,
 320.
 — *sicula*, 320.
 Pygopus, 266.
lepidopus, 464.
 Python, 59, 65, 67.
molurus, 64, 65.
sebae, 255.
- Rana, 208.
angolensis, 251.
delalandii, 251.
fasciata, 251.
ferreri, 208.
fuscigula, 251.
grayi, 251.
halecina, 194, 208, 230,
 232.
mascarenensis, 251.
montezumae, 194, 208,
 230.
omiltemana, 208, 232.
palmyrae, 194, 208.
pustulosa, 208.
- Regenia
ocellata, 269.
 Rhadinea, 224, 227.
clavata, 196.
decorata, 196.
vittata, 196, 231, 233.
- Rhampastos
carinatus, 180.
crythrorhynchus, 490.
- Rhea, 293.
- Rhineura, 220.
- Rhinoceros
bicornis, 297.
- Rhinochetus, 168.
- Rhinolophus
acrotis, 78, 94, 106, 112,
 118, 120.
- Rhinolophus
acuminatus, 96, 97, 98,
 121, 132, 133, 134,
 135, 136, 138.
 — *audax*, 133, 134,
 145.
 — *typicus*, 133, 134.
aethiops, 137.
affinis, 76, 86, 87, 90,
 93, 94, 95, 97, 98,
 101, 102, 103, 104,
 105, 106, 107, 108,
 109, 112, 117, 118,
 120, 121, 130, 134.
 — *himalayanus*, 90,
 102, 103, 104, 105,
 106, 107, 108, 144,
 145.
 — *macrurus*, 103, 105,
 144.
 — *nesites*, 104, 105, 144.
 — *princeps*, 102, 105,
 106, 144, 145.
 — *rouxi*, 87, 100.
 — *superans*, 104, 105,
 144.
 — *tener*, 103, 104, 105,
 144, 145.
 — *typicus*, 104, 105,
 106.
andamanensis, 106.
audax, 96.
angur, 106, 110, 118,
 119, 120.
bi-hastatus, 141.
 — *kisinyresiensis*, 142.
blasii, 121, 130, 136,
 137, 139, 144.
borneensis, 76, 78, 79,
 81, 82, 83, 84, 85,
 86, 87, 88, 89, 90,
 91, 92, 93, 94, 95,
 99, 100, 101, 102,
 107, 116, 117, 119,
 120, 121, 122, 145.
 — *spadix*, 81, 87, 88,
 94.
 — *typicus*, 87, 88, 121,
 145.
brevitarsus, 126.
calypso, 96, 132, 133,
 134, 136, 145.
capensis, 76, 117, 120,
 121.
celebensis, 76, 81, 82,
 83, 84, 85, 107, 116,
 120, 122, 144, 145.
cinerascens, 98, 99.
clivus, 76, 106, 117,
 118, 120.
conchifer, 113.

Rhinolophus

- cornutus*, 123, 126, 127,
128, 135, 136, 145,
334.
— *pumilus*, 121, 123,
127, 128, 129, 145.
— *typicus*, 128.
darlingi, 106, 107, 118,
120.
deckeni, 106, 110, 118,
119, 120.
denti, 117, 120.
dobsoni, 137.
empusa, 121, 130, 136,
137, 138, 139.
curviale, 121, 137, 138,
142, 144.
— *helvetica*, 142.
— *judaicus*, 137.
ferrum-equinum, 76, 90,
94, 101, 106, 107,
108, 109, 110, 111,
112, 113, 114, 115,
116, 117, 118, 119,
120, 121, 132, 142,
144, 315, 316.
— *germanicus*, 113.
— *italicus*, 113.
— *nippon*, 110, 115,
145, 334, 337.
— *obscurus*, 114, 115,
116, 119.
— *proximus*, 112, 115,
145.
— *regulus*, 112, 115,
118, 145.
— *fragatus*, 111, 115,
145.
— *typicus*, 113, 115.
fumigatus, 137.
garoënsis, 129, 133,
131, 145.
gracilis, 129, 130, 132,
136, 137, 139, 145.
hildebrandti, 137.
himalayanus, 104, 106.
hipposiderus, 86, 126,
127, 129, 132, 139,
140, 141, 142, 143,
144, 145, 315, 316.
— *alpinus*, 142.
— *minimus*, 139, 140,
143, 145.
— *minutus*, 114, 142,
143, 144, 145.
— *pallidus*, 142.
— *trogophilus*, 142.
— *typicus*, 141, 143, 144.
— *typus*, 142.
keyensis, 79.
landeri, 137, 138.

Rhinolophus

- lepidus*, 97, 120, 121,
122, 123, 124, 125,
126, 127, 128, 129,
130, 131, 132, 133,
135, 136, 137, 138,
139, 144, 145.
libanoticus, 113.
lobatus, 137.
maclaudi, 138.
macrotis, 137.
macrurus, 104.
malayanus, 76, 77, 89,
90, 92, 100, 101,
107, 120, 145.
megaphyllus, 76, 77,
78, 79, 80, 81, 82,
83, 93, 107, 116,
117, 120.
— *monachus*, 80, 81,
87, 144.
— *typicus*, 79, 145.
midas, 129, 138, 139,
140, 143, 144, 145.
minimus, 140.
minor, 83, 86, 87, 89,
97, 98, 121, 122,
123, 124, 126, 127,
128, 129, 130, 131,
135, 136, 137, 138,
139, 140, 143, 144.
minutus, 123, 129, 135.
monoceros, 121, 123,
131, 132, 136, 145.
monticola, 97, 98, 122,
123, 124, 125, 130,
135, 145.
nanus, 76, 77, 81, 82,
83, 84, 87, 107, 116,
117, 120, 144, 145.
nereis, 90, 91, 92, 93,
101, 102, 107, 120,
144, 145.
nesites, 104, 106.
nippon, 107, 108, 110,
111, 112, 114, 116,
120, 334.
obscurus, 108, 110, 113,
114.
pearsoni, 97.
petersi, 86, 95, 96, 97,
98, 124, 130, 133, 145.
phasma, 141.
philippinensis, 78, 138.
princeps, 104, 106.
proximus, 107, 108,
110, 112, 113.
pusillus, 86, 126, 127.
rammanika, 98, 99.
refulgens, 122, 124, 125,
133, 135, 136, 145.

Rhinolophus

- regulus*, 107, 108, 110,
111, 112, 114, 120.
rouxi, 79, 85, 86, 90,
92, 93, 94, 95, 96,
97, 98, 99, 100, 101,
102, 107, 117, 119,
120, 121, 124, 133,
145.
— *rubidus*, 99.
— *sinicus*, 98, 99, 144.
— *typicus*, 98, 99, 145.
rubidus, 98, 99.
rufescens, 113.
simplex, 76, 77, 78, 79,
80, 81, 82, 83, 86,
89, 93, 94, 116, 117,
120, 121, 122, 135,
137, 138, 144, 145.
simulator, 117, 120.
spadix, 87.
stheno, 77, 90, 91, 92,
93, 101, 102, 107,
117, 120, 121, 144,
145.
subbadius, 121, 122,
123, 124, 129, 130,
131, 132, 136, 137,
138.
sumatranus, 97, 98,
132, 133, 134, 135,
136, 145.
superans, 104, 106.
tener, 104.
thomasi, 90, 93, 94,
100, 101, 102, 107,
120, 144, 145.
tragatus, 107, 108, 110,
111, 112, 114, 120.
truncatus, 76, 77, 80,
81, 82, 83, 84, 87,
107, 116, 117, 120,
145.
typicus, 108.
uni-hastatus, 113.
virgo, 88, 107, 120,
144.
Rhinophryne dorsalis, 193, 205.
Rhinopithecus roxellana, 330.
Rhynchæa, 161, 162, 163,
164, 165, 166, 168.
capensis, 155, 157.
Ruppicola, 52, 55.
Ruppia, 507.
Sagartia, 499, 500, 507,
508, 509, 510.
palliata, 507.
parasitica, 501, 509.

- Satyrus, 70, 72.
indicus, 298, 299,
 302.
- Scaphiopus, 205, 208.
digesi, 193, 230.
hammondi, 205.
multiplicatus, 231.
- Scaptira
ctenodactyla, 254.
knoxii, 254.
- Sceloporus, 212, 213,
 231.
acanthinus, 194, 214,
 231, 232.
æneus, 194, 214, 232.
asper, 232.
bulleri, 232.
formosus, 194, 214,
 231, 232.
gadoviae, 195, 246,
 247.
heterolepis, 232.
melanorhinus, 195.
microlepidotus, 195,
 214, 230, 232.
pyrrhocephalus, 194,
 247.
scalaris, 195, 214, 230,
 232, 240.
siniferus, 195, 232.
spinosus, 194, 214,
 231.
torquatus, 194, 214,
 216, 232.
variabilis, 195, 214,
 231, 232.
yarrovi, 232.
- Scelotes
bipes, 254.
- Scincus
officinalis, 482.
- Sciuopterus
monga, 334.
 — *amygdali*, 333,
 344.
- Sciurus
lis, 333, 334, 347.
varius, 346.
vulgaris, 346, 351.
 — *calotus*, 346.
 — *orientis*, 333, 345.
- Scolecophis
amule, 225.
atrocinctus, 225.
michoacensis, 225.
- Scolopax, 157, 159, 162,
 163, 164, 165, 166,
 168, 169.
rusticola, 155.
- Scotopelia
bouvieri, 296.
- Scyllium
canicula, 490.
- Selenidera
maculirostris, 296.
- Serrarius
microcephalus, 566, 567,
 569.
- Simia, 70.
koolookamba, 70.
nkulunkamba, 70.
satyrus, 295, 296, 299,
 300.
- Sistrurus, 226.
ravus, 226.
- Solenodon, 244.
- Sorex
hawkeri, 333, 339.
macropygmaeus, 338.
minutus, 339.
shinto, 333, 338.
umbrinus, 340, 361.
- Spelerpes, 202, 203, 205,
 244.
belli, 193, 203, 204,
 232.
cephalicus, 203.
chiropterus, 193, 203,
 232.
fuscus, 202, 203.
gibbicaudus, 203.
infuscatus, 203.
leprosus, 193, 203,
 232.
lineolus, 203.
morio, 203, 231.
multiplicatus, 203.
orizabensis, 193, 203,
 204, 232.
rufescens, 203.
uniformis, 203.
variegatus, 193, 203.
yucatanicus, 203.
- Sphaerodactylus, 211.
anthracinus, 211.
glaucus, 194, 211.
notatus, 211.
torquatus, 211.
- Spilotes, 223, 227.
- Spongia
botryoides, 4.
complicata, 4.
- Staurotypus
biporcatus, 209.
triporcatus, 209.
- Stenorhina
dagenhardti, 225.
- Stenorhynchus, 509.
- Stercutus, 563.
- Sternotherus
nigricans, 252.
sinuatus, 251.
- Streptophorus, 224,
 227.
atratus, 196.
diadematus, 224.
- Struthio, 291, 393.
molybdophanes, 295.
- Sturnus, 54.
- Suricata
tetradactyla, 28, 29.
- Sus
leucomystax, 333, 334,
 357.
- Sycon
 sp., 15.
- Symphalangus, 170.
- Syrrhopus, 207.
omiltemanus, 232.
verruculatus, 194.
- Talpa
europæa, 335.
mizura, 334, 335.
wogura, 334.
- Tarba, 148.
favillacea, 149.
- Tarentula, 570.
- Tarsostenus, 273.
univittatus, 273.
- Tatera
fallax, 188.
teniura, 523.
- Telephorus
bivittatus, 271.
incisus, 271.
nigrinus, 271.
teret, 272.
viridescens, 271.
vitticollis, 271.
zonatus, 271.
- Testudo, 69, 211, 243.
græca, 60.
polyphemus, 211.
tabulata, 211.
vicina, 59, 67, 68,
 270.
- Thalassia, 507.
- Thecadactylus
rapicauda, 211.
- Thinocorus, 162, 163,
 164, 165, 166, 168,
 169.
 sp., 155.
- Thorius, 202, 241.
pennatulus, 193, 202,
 232.
- Thricera, 274.
bicinctella, 274.
pectoralis, 274, 275.
- Thryonomys
swinderianus, 296.

- Tiliqua, 257, 258, 260,
 262, 266, 467, 487.
scincoides, 257.
- Tityra, 37.
- Toluca
lineata, 233.
- Tomodactylus
annulæ, 232.
- Tragelaphus
bor, 182.
haywoodi, 181.
knutsoni, 182.
scriptus, 181.
sylvaticus, 181.
- Trapezia, 495.
- Trimerorhinus
rhombeatus, 255.
- Trimorphodon, 224.
biscutatus, 196, 224.
tau, 224.
upsilon, 196, 224, 231,
 233.
- Tripurion
petasatus, 206.
- Triton
eristatus, 58.
- Trochosa, 570.
- Tropicodipsas, 224,
 227.
- Tropidonotus, 223, 227.
chrysocephalus, 195,
 233.
fasciatus, 223.
godmani, 233.
melanogaster, 195, 230,
 233.
natrrix, 60.
ordinatus, 195, 223,
 230, 233, 240, 241.
 — *equus*, 195.
 — *marcianus*, 195.
pryeri, 512, 513, 515.
scalaris, 195, 233.
scaliger, 195, 231.
scapdon, 223.
tigrinus, 511, 513.
validus, 223, 230.
variabilis, 231.
vibakari, 511, 513.
- Tropidurus
hispidus, 61, 265,
 269.
- Tupinambis, 268, 269.
nigropunctatus, 62, 65,
 268.
- Typhlops
tenuis, 222.
- Typhlotriton
spelæus, 202.
- Ungalia, 222.
- Upupa, 52.
- Urotheca, 224, 227.
elapoides, 196, 224.
- Urotragus
evansi, 314.
- Urotrichus
gibbsi, 335.
talpoides, 333, 334, 335,
 336, 341, 358.
 — *pilirostris*, 333, 342.
- Ursus
arctos, 335.
japonicus, 334, 335.
torquatus, 334.
- Uta, 212, 213.
auriculata, 213.
bicarinata, 194, 213,
 230, 240.
elegans, 194, 213.
irregularis, 194.
lateralis, 213.
stansburiana, 213.
- Vanellus, 157, 162, 163,
 164, 165, 166, 167.
vulgaris, 155.
- Varanus, 61, 462, 485.
albigularis, 253.
evanthematicus, 59, 267,
 268, 269.
griseus, 59.
niloticus, 254.
- Venator, 570.
- Vespertilio
 sp., 520.
abramus, 337.
africanus, 522.
akokomuli, 337.
blepotis, 338.
blythi, 522.
equinus, 113, 141.
ferrum-equinum, 113,
 141.
- Vespertilio
ferrum-equinum major,
 113.
 — *minor*, 141.
hippocrepis, 113, 141.
hipposideros, 141.
nutschiei, 520.
 — *pellucens*, 520.
minutus, 129.
mirza, 520.
serotinus, 520.
shiraziensis, 520.
subbadia, 130, 131.
turcomanus, 520.
- Vulpes
ferrilatus, 302, 303,
 304, 305.
flavescens, 303.
japonicus, 335.
vulpes flavescens, 303,
 522.
 — *waddelli*, 303, 304,
 305.
- Xantusia, 219.
- Xenodon, 227.
rhabdolephalus, 231,
 233.
- Xenopus
calcaratus, 249, 250.
clivii, 249, 250.
fraseri, 250.
lævis, 248, 249, 250.
muelleri, 249, 250.
petersii, 249.
- Xenosaurus, 221, 231, 242.
grandis, 217, 233.
- Zamenis, 223, 227, 231.
constrictor, 223.
grahami, 223, 233, 240.
lineatus, 196.
- Zentodarius, 196, 223,
 231, 233.
- mexicanus*, 196, 223,
 240.
ornatus, 223.
pulcherrimus, 196, 223.
scmilineatus, 223.
teuatus, 223.
- Zonurus
polyzonus, 253.

THE END.

ABSTRACT OF THE PROCEEDINGS
OF THE
ZOOLOGICAL SOCIETY OF LONDON.*

May 2nd, 1905.

Dr. W. T. BLANFORD, C.I.E., F.R.S., Vice-President,
in the Chair.

The SECRETARY exhibited three large photographs, presented to the Society by Mr. Howard B. Turner, of Hippopotanuses swimming in a river in their native haunts.

Mr. R. E. HOLDING exhibited and made remarks on a series of antlers, of the first year, of the Roebuck, Red-Deer, Fallow-Deer, and Wapiti.

Mr. R. I. POCOCK, F.Z.S., exhibited and made remarks on a specimen of the Spanish Tarantula, *Lycosa hispanica*, that had died in the Society's Gardens.

Mr. W. BATESON, F.R.S., exhibited a series of specimens of domestic chicks to illustrate peculiarities in the hereditary transmission of white plumage.

Mr. GEORGE R. ALFORD communicated a paper by Prof. E. A. MINCHIN entitled "On *Leucosolenia contorta* (Bowerbank), *Ascandra contorta* Haeckel, and *Ascetta spinosa* Lendenfeld." The author pointed out that the nomenclature of the Calcarea Homocœla was in a more tangled state than that of any other group of the animal kingdom, with, perhaps, the exception of the malarial parasites. Dr. Bowerbank, who founded the species,

* This Abstract is published by the Society at 3 Hanover Square, London, W., on the Tuesday following the date of Meeting to which it refers. It will be issued, free of extra charge, to all Fellows who subscribe to the Publications, along with the 'Proceedings'; but it may be obtained on the day of publication at the price of *Sixpence*, or, if desired, sent post-free for the sum of *Six Shillings* per annum, payable in advance.

gave a diagnosis that would fit any Ascon, and his type specimens were jumbles of three or four species; consequently Prof. Minchin declared his name to be of no systematic value whatever. To Haeckel's name *Ascandra contorta*, Prof. Minchin referred a sponge extremely abundant on the Mediterranean coasts of France. Haeckel also pointed out that Dr. Bowerbank's diagnosis was not definitive of the species, and diagnosed the species by details of spiculation. In this he was incorrect in saying the monaxons were possessed of lance-head distal ends, and that gastral rays of the quadriradiates "curved."

Prof. Minchin preferred to name *Ascandra contorta* H. as *Clathrina contorta*, having a closely reticulate mode of growth, equiangular triradiate systems, collar-cells with basal nucleus, and parenchymula larva.

He showed that the monaxon spicules were very variable—so much so, as to explain the name *Ascetta spinosa* Len. All specimens of *spinosa* examined by him were of small size, not like the broad spreading growth of *contorta* containing monaxon spicules; and having examined a slide labelled *Ascetta spinosa* in Lendenfeld's handwriting, and having found the triradiate systems exactly similar to those of the true *contorta*, he came to the conclusion that the *Ascetta spinosa* was only an age variation of *Clathrina contorta*, not yet possessing monaxon spicules.

He discussed the question whether there was justification for a new species or whether this should be regarded as a variation only, on the grounds of the formation of spicules, and which were primary monaxons and which were secondary.

Mr. F. E. BEDDARD, F.R.S., read some notes on the Anatomy of the Ferret-Badger (*Helictis personata*), based on a dissection of a specimen that had recently died in the Society's Gardens.

Mr. W. P. PYCRAFT, F.Z.S., read a paper on the Osteology of the *Eurylaemida*, and briefly discussed the question of the systematic position of this group.

While agreeing with the general consensus of opinion as to the primitive character of these birds, he held that the isolated position which they were supposed to occupy with regard to the remaining Passereres was by no means justified by facts.

The pterylography, osteology, and myology of the *Eurylaemida* all tended to show that the nearest allies of these birds were the *Cotingida*.

Although undoubtedly primitive, the group, Mr. Pycraft pointed out, presented a number of specialised characters, which were especially marked in the skull and muscles of the wing.

The next Meeting of the Society for Scientific Business will be held on Tuesday, the 16th May, 1905, at half-past Eight o'clock P M., when the following communications will be made :—

1. MR. F. E. BEDDARD, F.R.S.—A Contribution to the Knowledge of the Encephalic Arterial System in Sauropsida.
 2. DR. E. BERGROTH, C.M.Z.S.—On Stridulating *Halysine*, with Descriptions of new Genera and Species.
 3. SIR HARRY JOHNSTON, G.C.M.G., K.C.B.—On the Classification of the Anthropoid Apes as proposed by the Hon. Walter Rothschild.
-

Communications intended for the Scientific Meetings of the ZOOLOGICAL SOCIETY OF LONDON should be addressed to

P. CHALMERS MITCHELL, *Secretary*.

3 HANOVER SQUARE, LONDON, W.
9th May, 1905.

ABSTRACT OF THE PROCEEDINGS
OF THE
ZOOLOGICAL SOCIETY OF LONDON.*

May 16th, 1905.

G. A. BOULENGER, Esq., F.R.S., Vice-President,
in the Chair.

The SECRETARY read a report on the additions that had been made to the Society's Menagerie during the month of April 1905, and called special attention to a young female Chimpanzee (*Anthropopithecus troglodytes*), deposited; to a young female Giraffe from Northern Nigeria, probably belonging to the race known as *Giraffa camelopardalis peralta*, purchased; to a young male Huanaco (*Lama huanacos*) from Punta Arenas, Tierra del Fuego, presented by Mr. Moritz Braun and Capt. R. Crawshay; and to a pair of Concave-casqued Hornbills (*Dichoceros bicornis*) from India, purchased.

Mr. OLDFIELD THOMAS, F.R.S., exhibited examples of a new Golden Mole which had been obtained in connection with Mr. C. D. Rudd's exploration of South Africa, and which he proposed to call

AMBLYSOMUS CORRIÆ, sp. n.

Smoky blackish above and below, darker than in *A. iris*. Skull less broadened behind than in *A. hottentottus*.

Head and body 129 mm.; hind foot 13; greatest skull length 28.

Hab. Knysna, Cape Colony.

Type. Male. B.M. No. 5.5.5.5. No. 1021 of the Rudd collection.

* This Abstract is published by the Society at 3 Hanover Square, London, W., on the Tuesday following the date of Meeting to which it refers. It will be issued, free of extra charge, to all Fellows who subscribe to the Publications, along with the 'Proceedings'; but it may be obtained on the day of publication at the price of *Sixpence*, or, if desired, sent post-free for the sum of *Six Shillings* per annum, payable in advance.

Mr. H. B. FANTHAM, B.Sc., F.Z.S., exhibited and made remarks upon microscopic slides of *Lankesterella tritonis*, a Hæmogregarine parasitic in the blood-corpuscles of a Newt, *Triton cristatus*. This parasite was recently found by Mr. A. S. Hirst, F.Z.S., and the exhibitor, and their observations had since been independently confirmed by Dr. A. C. Stevenson,

Mr. F. E. BEDDARD, F.R.S., read a paper entitled "A Contribution to the Knowledge of the Encephalic Arterial System in Sauropsida."

Sir HARRY JOHNSTON, G.C.M.G., K.C.B., read a paper containing criticisms of the Hon. Walter Rothschild's proposed classification of the Anthropoid Apes. He was disposed to agree with Mr. Rothschild's classification of the African Apes, but suggested that the proper transcription of the native name for the Bald Chimpanzee should be *nkulunkamba* instead of (as Du Chaillu wrote it) *koolookamba*. Sir Harry, however, could not agree with Mr. Rothschild's proposed change of the generic name of the Orang from *Simia* to *Pongo*; and although considering him right in applying the former name, at present used for the Orang, to the Chimpanzees, he was of opinion that either *Satyrus* or *Pithecius* was a far preferable name to *Pongo* for the Orang. He concluded the paper with a list of words used in several African languages for the name of the Chimpanzee, and with a *précis* of the history of European knowledge of the Anthropoid Apes down to the Eighteenth Century.

Mr. KNUD ANDERSEN contributed a paper on some species of Bats of the genus *Rhinolophus*, in the course of which he showed the progressive evolution from the Austro-Malayan *R. simplex* (allied to *megaphyllus*), through a long series of Oriental forms, to the W. Palearctic *R. ferrum-equinum*, and a similar chain from the Oriental *R. lepidus* (allied to *minor*) to the W. Palearctic *R. blasii* and *R. euryale*. *R. hipposiderus* was traced back to the Oriental *R. minor*. A slight difference between the British colony of *R. hipposiderus* and the Central European form of the same species was pointed out. All the Ethiopian species of *Rhinolophus* were shown to be of Oriental origin.

A paper was read from Dr. E. BERGROTH, C.M.Z.S., containing the results of his observations on the stridulating-organs and descriptions of five new species (two of which were referred to new genera) of the Hemipterous family *Haljinae*.

Dr. P. CHALMERS MITCHELL, Secretary to the Society, read a paper entitled "On the Anatomy of Limicoline Birds, with special reference to the Correlation of Modifications." The paper dealt with the anatomy, chiefly muscular, of *Charadriidae*, *Chionididae*, *Glareolidae*, *Thinocoridae*, *Ædicnemidae*, and *Parridae*.

Mr. R. I. Pocock, F.Z.S., Superintendent at the Gardens, read a paper containing results of observations made upon a female specimen of the Hainan Gibbon (*Hyllobates hainanus*), now living in the Society's Gardens.

The next Meeting of the Society for Scientific Business (closing the Session 1904-05) will be held on Tuesday, the 6th June, 1905, at half-past Eight o'clock P.M., when the following communications will be made:—

1. Col. C. DELMÉ-RADCLIFFE.—Notes on the Natural History of Western Uganda. (Illustrated by lantern-slides.)

2. Mr. MARTIN JACOBY.—Descriptions of new Species of *Ædionychis* and allied Genera.

3. Dr. P. CHALMERS MITCHELL.—On the Intestinal Tract of Mammals.

Communications intended for the Scientific Meetings of the ZOOLOGICAL SOCIETY OF LONDON should be addressed to

P. CHALMERS MITCHELL, *Secretary*.

3 HANOVER SQUARE, LONDON, W.

23rd May, 1905.

ABSTRACT OF THE PROCEEDINGS
OF THE
ZOOLOGICAL SOCIETY OF LONDON.*

June 6th, 1905.

DR. HENRY WOODWARD, F.R.S., Vice-President,
in the Chair.

The SECRETARY read a report on the additions that had been made to the Society's Menagerie during May 1905, and called special attention to a Crowned Duiker (*Cephalophus coronatus*) from West Africa, deposited on May 1st; to a Maxwell's Duiker (*Cephalophus maxwelli*) from West Africa, presented by Lt.-Col. Bartlett, R.A.M.C., on May 16th; to a Nepalese Hornbill (*Aceros nepalensis*) from the Himalayas, received in exchange on May 18th; and to two Sulphur-breasted Toucans (*Rhamphastos carinatus*), purchased on May 13th and 23rd respectively.

MR. OLDFIELD THOMAS, F.R.S., exhibited a specimen of a new Bushbuck, which he proposed to call

TRAGELAPHUS HAYWOODI, sp. n.

Neck well-haired, without short-haired collar. Colour very dark, belly black. Dorsal crest black anteriorly, white on hinder back. Transverse stripes only three, very inconspicuous. Only three or four white spots on haunches. Horns very powerful.

Greatest length of skull 265 mm. Length of horn on curve 470 mm.; basal circumference 171.

Hab. Nyeri, British East Africa.

Type. Male. B.M. 5.5.16.3. Presented by C. W. Haywood, Esq.

MR. OLDFIELD THOMAS also exhibited some mammals and birds from Japan which had been obtained by a collector sent out by the Society's President, His Grace the Duke of Bedford, K.G.,

* This Abstract is published by the Society at 3 Hanover Square, London, W., on the Tuesday following the date of Meeting to which it refers. It will be issued, free of extra charge, to all Fellows who subscribe to the Publications, along with the 'Proceedings'; but it may be obtained on the day of publication at the price of *Sixpence*, or, if desired, sent post-free for the sum of *Six Shillings* per annum, payable in advance.

who, in order to show his sympathy with the technical side of the Society's work, proposed to further Zoological Science by having systematic collections made in that part of the world. The specimens would be laid before the Society from time to time, and after being worked out by specialists, would be presented to the National Museum.

Of the present series Mr. Thomas drew attention to a fine Marten which appeared to be different from the true *Mustela melampus*, and which he proposed to call

MUSTELA MELAMPUS BEDFORDI, subsp. n.

General colour olivaceous isabella, quite different to the golden yellow of true *melampus*. Throat and neck with a strongly contrasted yellow patch.

Hab. Nara district, Southern Central Hondo.

Type. Adult male. Original number 213. Collected by M. P. Anderson.

Mr. R. J. POCOCK, the Superintendent of the Gardens, exhibited a female specimen of the Jamaican Scorpion, *Centrurus insularis*, carrying its young on its back. The specimen had been presented to the Society by Mr. H. Munt, F.Z.S.

Dr. P. CHALMERS MITCHELL, Secretary of the Society, read a paper entitled "On the Intestinal Tract of Mammals," and illustrated it by lantern-slides prepared from some of the drawings which he hoped would accompany the memoir on publication. In the course of the last eight years, the Author had taken every possible opportunity of studying the alimentary tract of Mammals from specimens that had died in the Society's Gardens, and had obtained additional material elsewhere, with the result that his investigations covered over two hundred individuals, and included the greater number of the Mammalian Orders. The paper described the Mammalian Intestinal Tract as being composed of three definite morphological regions:—the duodenum; Meckel's tract, which was derived from the pendent loop of Mammalian embryology, and was an outgrowth corresponding to only a very short part of the primitive straight gut; and the hind-gut. As compared with the disposition in Birds, the Mammalian duodenum was less specialised; Meckel's tract, which in Birds the Author had already shown fell into a series of patterns of systematic importance, was much more homogeneous throughout the Mammalian series; the hind-gut, which was of little importance in Birds, was developed in Mammals in varied patterns which had systematic importance. The Author showed that the single cæcum which was characteristic of Mammals was probably one of an original pair, and that the traces of this paired origin were much more frequent in Mammals than had been supposed. He stated that the primitive paired cæca of Mammals were homologous with those of Birds. The paper then gave a systematic account of the

characters of the intestinal tract in the different Mammalian groups, and concluded with the inferences as to the affinities of these groups that the patterns supplied.

Lieut.-Col. C. DELMÉ-RADCLIFFE, M. V. O., F. Z. S., gave an account, illustrated by a fine collection of specimens and a series of lantern-slides, of the Natural History of Western Uganda, deduced from observations and collections made by him while acting as British Boundary Commissioner on the Uganda frontiers.

Dr. H. GADOW, F. R. S., read a paper on the Distribution of Mexican Amphibia and Reptilia. After a critical revision of the species recorded from Mexico, the Author stated that he grouped them according to the prevailing physical features of the country. It was found that Mexico had received its present fauna from both the Northern and the Southern Continents. The Northern immigrants had spread over high tablelands and mountains, whilst not a few species had descended into the hot lowlands, even into Central America and still further south. On the other hand, the Southerners were divided by the plateau into an Atlantic and a Pacific mass, each having had time to modify many of its members according to the very different physical features. Scarcely any of these Southerners had ascended the plateau, but they were not averse to ascending high outlying mountains. A comparative list of species confined to high altitudes was given, and the conclusion arrived at, with the help of geological data and the fauna of the Antilles, was that the exchange between the North and South took place during the Miocene epoch, at which period alone the Antilles were connected with Central America.

Mr. G. A. BOULENGER, F. R. S., described the new species of Reptiles discovered in Mexico by Dr. H. Gadow.

Mr. G. A. BOULENGER also presented a paper containing an account of the Batrachians and Reptiles collected in South Africa by Mr. C. H. B. Grant and presented to the British Museum by Mr. C. D. Rudd.

Mr. F. E. BEDDARD, F. R. S., communicated some notes on the Anatomy of the Yellow-throated Lizard, *Gerrhosaurus flavigularis*.

Mr. BEDDARD also presented notes on the Cerebellum in the Exanthematic Monitor, *Varanus exanthematicus*, and on the Cerebral Hemispheres in the Taraguira Lizard, *Tropidurus hispidus*.

Mr. RICHARD ASSHETON, F. Z. S., communicated a paper on the Fœtus and Placenta of the Spiny Mouse, *Acomys cahirinus*. The paper pointed out that the fœtus, received from the Society's Gardens, was covered by a thin epitrichium which was perforated

by the stouter hairs. The placenta was discoidal and closely resembled that of the Mouse (*Mus musculus*). The trophoblast was greatly thickened, and formed a distal portion which was broken up into a system of large irregular spaces containing maternal blood, and a proximal portion with more regular channels containing maternal blood between which fetal vessels extended. The proximal wall of the yolk-sac was very vascular and much folded, but the folds did not become involved in the placental tissue as in some other Muridæ. The course of the blood-circulation and details of histology were also described.

A paper was communicated by the Rev. H. S. GORHAM on some new Coleoptera from South Africa. The Beetles referred to were of the families *Malacodermata*, *Cleridæ*, and *Erotylidæ*; and had been collected by Dr. H. Brauns of Willowmore, in Cape Colony, either at Willowmore or at Delagoa Bay in 1900 or 1901; and indicated that the Fauna of South Africa was rich in species of the two first families, and more so than had been supposed in members of the latter family. One new genus was described.

Dr. A. SMITH WOODWARD, F.R.S., communicated a paper by Baron FRANCIS NOPCSA entitled "Remarks on the supposed Clavicle of the Sauropodous Dinosaur *Diplodocus*."

This Meeting closes the Session 1904-1905. The next Session (1905-1906) will commence in November next.

The following Papers have been received:—

1. Mr. MARTIN JACOBY, F.E.S.—Descriptions of new Species of *Oedionychis* and allied genera (Phytophagous Coleoptera).
2. Dr. WALTER KIDD, F.Z.S.—On the Papillary Ridges in Mammals, chiefly Primates.
3. Mr. F. E. BEDDARD, F.R.S.—On some points in the Vascular System of *Hatteria* compared with that of the Lacertilia and Crocodilia.

Communications intended for the Scientific Meetings of the ZOOLOGICAL SOCIETY OF LONDON should be addressed to

P. CHALMERS MITCHELL, *Secretary*.

3 HANOVER SQUARE, LONDON, W.
13th June, 1905,

ABSTRACT OF THE PROCEEDINGS
OF THE
ZOOLOGICAL SOCIETY OF LONDON.*

November 14th, 1905.

G. A. BOULENGER, Esq., F.R.S., Vice-President, in the Chair.

The SECRETARY read a report on the additions that had been made to the Society's Menagerie during the months of June, July, August, September, and October, 1905.

Col. W. H. BROWN exhibited the mounted head and skin of a white Water-buck (*Kobus ellipsiprymnus*) from British East Africa; and two mounted heads of the Rhinoceros, one of which showed abnormal growth of the anterior horn, whilst the other bore four horns, viz. two on the nose, one between the ears, and one nearly at the back of the head.

The Hon. WALTER ROTHSCHILD, F.Z.S., exhibited specimens of a very rare and interesting Marsupial, hitherto unique, in the Paris Museum, viz. *Dactylopsila palpator* Milne-Edw., which differed from *D. trivirgata* by the extremely thin prolonged second finger.

Mr. ROTHSCHILD also exhibited two tusks which had been obtained by Baron Maurice de Rothschild during his recent expedition to Abyssinia. They were so unlike the normal tusks of any known animal that Mr. Rothschild was of opinion they might belong to some new form.

Mr. A. S. HIRST, F.Z.S., exhibited microscopic preparations of a new Hæmosporidian from the blood of an African Stork

* This Abstract is published by the Society at 3 Hanover Square, London W., on the Tuesday following the date of Meeting to which it refers. It will be issued, free of extra charge, to all Fellows who subscribe to the Publications, along with the 'Proceedings'; but it may be obtained on the day of publication at the price of *Sixpence*, or, if desired, sent post-free for the sum of *Six Shillings* per annum, payable in advance.

(*Leptoptilus crumeniferus*). He pointed out that this parasite belonged to the genus *Halteridium*, but differed from *H. danilewskyi* in its greater size (stade moyen 7-10 μ), and also in its method of sporulation, in which the merozoites were more numerous, smaller, and arranged in a ball-like rounded mass. The name *Halteridium crumenium* was proposed for the new species.

Dr. P. L. SCLATER, F.R.S., read a letter addressed to him by Mr. William Rodier, of Tambua Station, Cobar, N.S.W., concerning the continued success of Mr. Rodier's plan for counteracting the Rabbit-pest, and explained the plan, which consisted simply in catching the rabbits alive and killing the females only, letting the males go free.

Mr. HENRY SCHERREN, F.Z.S., made some remarks, illustrated by lantern-slides, on the *Satyros indicus* of Tulpius, said to be the type of the genus *Simia*, with the view of showing that the animal was a Gorilla, and was recognised before the middle of the eighteenth century as differing from a Chimpanzee. The distinction between the *tshego* and the *ngina* was, he said, known in England in the first quarter of the nineteenth century.

Dr. WALTER KIDD, F.Z.S., read a paper, illustrated by lantern-slides, "On the Papillary Ridges in Mammals, chiefly Primates." The arrangements of the ridges on the hand and foot of 24 species were shown and described, and their functions discussed. Arguments were brought forward to show that their primary function was to increase the delicacy of the sense of touch.

Mr. J. LEWIS BONHOTE, F.Z.S., communicated a paper on the Mammals brought back by the Tibet Mission. The collection was very small, containing examples of only some eight species three of which were described as new, viz. :—

(1) *VULPES VULPES WADDELLI*, subsp. n. Similar to *V. v. flavescens*, but the whole coloration much brighter, especially the median dorsal area, which was deep red and markedly distinct from the colour of the flanks.

(2) *CRICETULUS LAMA*, sp. n. Allied to *C. phæus*, but much greyer in general coloration, and the tail somewhat longer and stouter.

(3) *MICROTUS (PHACOMYS) WALTONI*, sp. n. Closely allied in skull-characters to *Ph. blythi*. The general coloration, however, was fulvous-grey, slightly greyer over the anterior part of the body.

A communication from Dr. EINAR LÖNNBERG, C.M.Z.S., contained notes on the geographical distribution of the Okapi.

A communication from Major G. F. EVANS contained notes on observations he had made on the Goral (*Cemas goral*) in Burma.

A paper by Miss DOROTHEA M. A. BATE contained an account of a collection of the Mammals of Crete. Examples of sixteen forms, of which six were described as new subspecies, were contained in the collection, and these were enumerated and remarked upon in the paper.

The next Meeting of the Society for Scientific Business will be held on Tuesday, the 28th November, 1905, at half-past Eight o'clock P.M., when the following communications will be made:—

1. Mr. OLDFIELD THOMAS, F.R.S.—The Duke of Bedford's Exploration in Eastern Asia. List of Mammals obtained by Mr. M. P. Anderson in Japan.
2. Mr. C. TATE REGAN, F.Z.S.—A Revision of the Fishes of the Family *Galaxiidae*.
3. Mr. J. LEWIS BONHOTE, F.Z.S.—The Mammalian Fauna of China.—Part I. *Murineæ*.
4. Mr. R. LYDEKKER, F.R.S.—On Colour-evolution in Guerezas.

The following Papers have been received:—

1. Mr. MARTIN JACOBY, F.E.S.—Descriptions of new Species of *Oedionychis* and allied Genera (Phytophagous Coleoptera).
2. Mr. BASHFORD DEAN.—Notes on the Living Specimens of the Australian Lung-fish (*Ceratodus forsteri*) in the Zoological Society's Collection.
3. Dr. ALFRED DUGÈS.—Description d'un Ophidien nouveau du Mexique (*Morenoa orizabensis*, gen. et sp. nn.).
4. Mr. L. DONCASTER, F.Z.S.—On the Colour-variation of the Beetle *Gonioctena variabilis*.
5. Capt. F. WALL, C.Z.M.S.—Notes on a Collection of Snakes from Japan and the Loo Choo Islands.
6. Mr. PERCY I. LATHY, F.Z.S.—On Three new Forms of Butterfly of the Genus *Heliconius*.
7. Mr. FRANK E. BEDDARD, F.R.S.—On some Points in the Vascular System of *Hatteria* compared with that of the Lacertilia and the Crocodilia.
8. Mr. FRANK E. BEDDARD, F.R.S.—On a new Species of *Pontodrilus* from the Shores of the Red Sea.

9. MR. FRANK E. BEDDARD, F.R.S.—On an Enchytraeid Worm (*Henlea lefroyi*, sp. n.) from India, destructive to the Eggs of a Locust (*Acridium* sp.).

10. MR. FRANK E. BEDDARD, F.R.S.—Further Contributions to the Anatomy, especially of the Vascular System, of Lacertilia.

11. MR. H. R. HOGG, F.Z.S.—On some Spiders of the Family *Lycosidae* from South Australia.

12. DR. J. G. DE MAN.—On Species of Crustaceans of the Genera *Ptychognathus* Stimps. and *Palæmon* Fabr., from Christmas Island.

13. MR. W. STORRS FOX, F.Z.S.—On Bones of the Lynx from Cales Dale, Derbyshire.

14. MR. OLDFIELD THOMAS, F.R.S.—On a Collection of Mammals from Persia and Armenia presented to the British Museum by Col. A. C. Bailward.

15. MR. G. CANDLER.—Field-notes on the Habits of the Vulture.

16. MR. R. STAPLES-BROWNE, F.Z.S.—Note on Heredity in Pigeons.

17. MR. R. LYDEKKER, F.R.S.—The White-maned Serow.

18. MR. E. S. RUSSELL.—On *Trichorhiza*, a new Hydroid Genus

Communications intended for the Scientific Meetings of the ZOOLOGICAL SOCIETY OF LONDON should be addressed to

P. CHALMERS MITCHELL, *Secretary*.

3 HANOVER SQUARE, LONDON, W.

21st November, 1905.

ABSTRACT OF THE PROCEEDINGS
OF THE
ZOOLOGICAL SOCIETY OF LONDON.*

November 28th, 1905.

Dr. HENRY WOODWARD, F.R.S., Vice-President, in the Chair.

Mr. J. T. CUNNINGHAM, M.A., F.Z.S., exhibited some photographs of a horse bearing incipient horns. They were about $\frac{3}{4}$ inch in length, the left being slightly larger than the right, and there could be no doubt that they were outgrowths of the frontal bone. The growths were covered with normal skin and hair.

Mr. FRANK SLADE, F.Z.S., exhibited photographs, which had been taken in the Horniman Museum at Forest Hill, of a Sea-Anemone (*Anemonia sulcata*) in the process of division.

Mr. DOUGLAS ENGLISH exhibited and made remarks upon a living albino specimen of the Field-Vole (*Microtus agrestis*) which had been captured last July in Wales.

Mr. G. A. BOULENGER, F.R.S., exhibited a living lizard, *Lacerta muralis*, from Brozzi, province Florence, which he had received from Dr. A. Banchi, through the mediation of Dr. J. de Bedriaga, C.M.Z.S. The lizard belonged to the typical form of the Wall-Lizard, but was remarkable for its black coloration, above and below. Melanistic forms of the Wall-Lizard were well known on small islands in the Mediterranean, but, so far as Mr. Boulenger was aware, no black specimen had ever been recorded from the mainland. The scales across the body numbered 58 and the lamellar scales under the fourth toe 25 in the specimen exhibited; these two numbers being sufficient to distinguish the Brozzi lizard from the melanotic insulars previously described.

Capt. ALBERT PAM, F.Z.S., made some remarks on a living specimen of the Violet-cheeked Humming-bird (*Petasophora iolota*) which he had recently brought home from Venezuela and presented to the Society's Menagerie. He also gave a general account of the habits of these birds, as observed by him, in a wild

* This Abstract is published by the Society at 3 Hanover Square, London, W., on the Tuesday following the date of Meeting to which it refers. It will be issued, free of extra charge, to all Fellows who subscribe to the Publications, along with the 'Proceedings'; but it may be obtained on the day of publication at the price of *Sixpence*, or, if desired, sent post-free for the sum of *Six Shillings* per annum, payable in advance.

and captive state, and notes on their management and feeding while in confinement.

Mr. W. R. OGILVIE-GRANT, F.Z.S., sent for exhibition a named set of the Birds collected in Japan by Mr. M. P. Anderson in connection with the Duke of Bedford's Exploration in Eastern Asia. No new species were obtained, but several of the specimens were of special interest as illustrating stages of plumage not represented in the British Museum.

Mr. R. LYDEKKER, F.Z.S., contributed a paper in which he described a transition in the general type of colouring from the wholly black *Colobus guereza* in one direction, through several intermediate forms, towards the black-and-white *C. caudatus*, and in another direction towards *C. vellerosus*.

In a second communication Mr. LYDEKKER described a mounted specimen of the White-maned Serow (*Nemorhædus argyrochætes* Heude), of Szechuen, the first example of the species ever received in England, and perhaps in Europe.

Mr. OLDFIELD THOMAS, F.R.S., F.Z.S., read a paper on the Mammals collected in Japan by Mr. M. P. Anderson for His Grace the Duke of Bedford, and presented by the latter to the National Museum. The collection was one of the most valuable for scientific purposes which had ever been received from any one region. Over 600 specimens had been obtained, belonging to 50 species and subspecies, of which several were described as new. But the chief value of the collection lay in the fine series of properly localised specimens of species which had not been sent to Europe since the time of Temminck's 'Fauna Japonica.' By the help of these specimens the distribution of the species was fairly well shown, while the Museum would now possess examples of all the older known species suitable for comparison with their allies from other parts of Eastern Asia, such specimens having been hitherto conspicuous by their absence.

Of the new forms special attention was directed to the following:—

EVOTOMYS BEDFORDIÆ, sp. n.

A *Craseomys* allied to *E. rufocanus*, but coloured more like *E. glareolus*, and with a longer, less hairy tail.

Dimensions of the type:—Head and body 119 mm.; tail 47; hind foot 20.

Hab. Shinshinotsu, Hokkaido.

Type. Male. Original number 23.

EVOTOMYS ANDERSONI, sp. n.

Allied to *E. bedfordiæ*, but with longer tail and conspicuously less powerful teeth.

Dimensions:—Head and body 120 mm.; tail 54; hind foot 18.5

Hab. Tsunagi, N. Hondo.

Type. Male. Original number 76.

EVOTOMYS MIKADO, sp. n.

A true *Evotomys*, coloured very like the European *E. glareolus*, though more strongly rufous.

Dimensions:—Head and body 104 mm.; tail 34; hind foot 17.

Hab. Aoyama, Hokkaido.

Type. Female. Original number 107.

SOREX SHINTO, sp. n.

A small species allied to *S. minutus*, but with an unusually long tail.

Dimensions:—Head and body 50 mm.; tail 49; hind foot 11·5.

Hab. Makado, N. Hondo.

Type. Male. Original number 47.

MR. C. TATE REGAN, B.A., F.Z.S., read a paper entitled "A Revision of the Fishes of the Family *Galaxiidae*." Two genera were recognised, *Galaxias* and *Neochanna*, the latter consisting of a single species only. Twenty-eight species of *Galaxias* were described, including *G. attenuatus* Jenyns, found on the coasts and in the rivers of Australia, New Zealand and Chili, Patagonia, and the Falkland Is., and two peculiar to the Cape of Good Hope, five to New Zealand and the neighbouring islands, five to Chili, Patagonia, and the Falkland Islands, and fifteen to Australia and Tasmania. Five species were described as new to science.

MR. J. LEWIS BONHOTE, F.Z.S., communicated the first of a series of papers dealing with the Mammalian Fauna of China. The present part dealt with the *Murinae*, containing the genera *Mus* and *Micromys*, giving descriptions and synonymy as well as emphasising the distinctive characters by which the various species might be easily distinguished. Two species were described as new, of which the following are preliminary descriptions:—

MUS HUANG, sp. n.

Similar to *Mus confucianus*, but general colour much brighter and tail without white tip.

MUS LING, sp. n.

Smaller than *Mus huang* and paler in general coloration. Very similar to *Mus cremoriventer* Mill., but with bicolor instead of unicolor tail.

MR. F. E. BEDDARD, F.R.S., read a paper entitled "Some Additions to the Knowledge of the Anatomy, principally of the Vascular System, of *Hatteria*, *Crocodylus*, and certain *Lacertilia*."

A communication from Mr. MARTIN JACOBY, F.E.S., contained descriptions of 111 new species of Phytophagous Coleoptera of the family *Halticidae*.

The next Meeting of the Society for Scientific Business will be held on Tuesday, the 12th December, 1905, at half-past Eight o'clock P.M., when the following communications will be made:—

1. Dr. J. E. DUERDEN.—On the Habits and Reactions of Crabs bearing Actinians in their Claws. (Illustrated by lantern-slides.)
2. Capt. F. WALL, C.M.Z.S.—Notes on a Collection of Snakes from Japan and the Loo Choo Islands.
3. Mr. H. R. HOGG, F.Z.S.—On some Spiders of the Family *Lycosidae* from South Australia.
4. Mr. OLDFIELD THOMAS, F.R.S.—On a Collection of Mammals from Persia and Armenia presented to the British Museum by Col. A. C. Bailward.

The following papers have been received:—

1. Mr. BASHFORD DEAN.—Notes on the Living Specimens of the Australian Lung-fish (*Ceratodus forsteri*) in the Zoological Society's Collection.
2. Dr. ALFRED DUGÈS.—Description d'un Ophidien nouveau du Mexique (*Morenoa orizabensis*, gen. et sp. nn.).
3. Mr. L. DONCASTER, F.Z.S.—On the Colour-variation of the Beetle *Gonioctena variabilis*.
4. Mr. PERCY I. LATHY, F.Z.S.—On Three new Forms of Butterfly of the Genus *Heliconius*.
5. Mr. FRANK E. BEDDARD, F.R.S.—On a new Species of *Pontodrilus* from the Shores of the Red Sea.
6. Mr. FRANK E. BEDDARD, F.R.S.—On an Enchytraeid Worm (*Henlea lefroyi*, sp. n.) from India, destructive to the Eggs of a Locust (*Acridium* sp.).
7. Dr. J. G. DE MAN.—On Species of Crustaceans of the Genera *Ptychognathus* Stimps. and *Palæmon* Fabr., from Christmas Island.
8. Mr. W. STORRS FOX, F.Z.S.—On Bones of the Lynx from Cales Dale, Derbyshire.
9. Mr. R. STAPLES-BROWNE, F.Z.S.—Note on Heredity in Pigeons.
10. Mr. E. S. RUSSELL.—On *Trichorhiza*, a new Hydroid Genus.
11. Messrs. CECIL WARBURTON, F.Z.S., and N. D. F. PEARCE.—On new and rare British *Oribatide*.
12. Dr. J. W. JENKINSON.—Notes on the Histology and Physiology of the Placenta in Ungulata.

Communications intended for the Scientific Meetings of the ZOOLOGICAL SOCIETY OF LONDON should be addressed to

P. CHALMERS MITCHELL, *Secretary*.

3 HANOVER SQUARE, LONDON, W.
5th December, 1905.

ABSTRACT OF THE PROCEEDINGS
OF THE
ZOOLOGICAL SOCIETY OF LONDON.*

December 12th, 1905.

HOWARD SAUNDERS, Esq., Vice-President, in the Chair.

The SECRETARY read a report on the additions that had been made to the Society's Menagerie during the month of November 1905.

The SECRETARY also exhibited a coloured print, published by R. Ackermann in July 1812, of Polito's Royal Menagerie at Exeter 'Change, London.

Mr. A. H. COCKS, F.Z.S., exhibited twelve enlarged photographs of Whales taken by him at the Finwhaling Factories in East Finmarken in 1883-89. The species represented were *Megaptera longimana*, *Balænoptera sibbaldii*, *B. musculus*, and *B. borealis*.

Mr. GEORGE P. MUDGE, F.Z.S., exhibited and made remarks upon a Dog-fish with an apparently abnormal disposition of the digestive viscera, and an Earthworm with bifid tail.

Mr. H. B. FANTHAM, B.Sc., F.Z.S., exhibited and made remarks upon a new Hæmosporidian parasite from the blood of a white Rat.

Mr. OLDFIELD THOMAS, F.R.S., exhibited the tail-vertebræ of a Dormouse of the genus *Eliomys*, which showed the phenomenon, hitherto unrecorded among Mammalia, of the regeneration of a bony structure in case of accident.

The caudal vertebra, in this case the twelfth, which had been originally broken across, had grown out into a slender styliform appendix, 15 mm. in length, and rather less than 1 mm. in diameter, the normal vertebra of this part of the tail measuring about 6×2 mm.

* This Abstract is published by the Society at 3 Hanover Square, London, W., on the Tuesday following the date of Meeting to which it refers. It will be issued, free of extra charge, to all Fellows who subscribe to the Publications, along with the 'Proceedings'; but it may be obtained on the day of publication at the price of *Sixpence*, or, if desired, sent post-free for the sum of *Six Shillings* per annum, payable in advance.

On further search two other specimens exhibiting the same structure had been found, and it appeared therefore that Dormice, like Lizards, were able partly to regenerate their tails, when these important balancing-organs got accidentally broken.

Dr. W. G. RIDEWOOD, F.Z.S., exhibited microscopic sections of the skeletal tube found in the restored tail of one of the Dormice (*Graphiurus*) exhibited by Mr. Thomas. He showed that the wall was made up of close-set lamellæ, producing in a transverse section a fine concentric striation. Lacunæ with numerous branching canaliculi were disposed regularly in relation with the concentric striations, and the general effect was that presented by a transverse section of the humerus or femur of a Frog. Internally to the bony layers and contiguous with the central jelly was a moderately thick layer, which was clear, homogeneous, and highly refractive.

Dr. Ridewood also exhibited, by way of contrast, slides of the skeleton of the restored tail of an Iguana Lizard, the skeletal tube in this case being composed of calcified fibro-cartilage and not of bone.

In a paper communicated to the Society by Prof. HICKSON, F.R.S., and illustrated by lantern-slides, Prof. J. E. DUERDEN, of the Rhodes University College, Grahamstown, Cape Colony, gave an account of his observations and experiments on the habits and reactions of Crabs bearing Sea-Anemones in their claws.

A communication from Capt. F. WALL, C.M.Z.S., contained notes on a large collection of Snakes made by Mr. Alan Owston in Japan and the Loo Choo Islands.

Mr. H. R. HOGG, F.Z.S., read a paper on a collection of South Australian Spiders of the family *Lycosidæ* contained in the Museum at Adelaide. He stated that this was one of the most widely distributed families of Arachnida, but that, except in size, the many forms varied but very little in general characteristics from the type species found in Italy and Spain. Thirteen species were remarked upon, ten of which were described as new.

Mr. OLDFIELD THOMAS, F.R.S., read a paper on a collection of Mammals which had been obtained by Col. A. C. Bailward during a shooting-trip through Persia and Armenia during the past summer, and which had now been presented to the National Museum. The specimens had been trapped and prepared by Mr. R. B. Wocsnam, who accompanied Col. Bailward.

31 species were enumerated, and special attention was drawn to the discovery of *Calomyscus*, a primitive Murine the only ally of which, amongst recent forms, was the N. American *Peromyscus*.

The following novelties were described :—

CALOMYSCUS BAILWARDI, g. et sp. nn.

Teeth as in *Peromyscus*. Tail long, heavily pencilled. Ears very large. Colour rich sandy buff above, white below.

Dimensions:—Head and body 78 mm.; tail 87; hind foot 20·5; ear 21·5. Skull: greatest length 26; length of upper tooth-row 3·3.

Hab. Mala-i-Mir, N.E. of Ahwaz, Persia.

Type. Male. B.M. No. 5.10.4.68.

PIPISTRELLUS ALADDIN, sp. n.

A very small species allied to *P. nanus* and *P. minimus*. Small anterior premolar in the tooth-row. Colour pale.

Forearm 31 mm. Greatest length of skull 11·3.

Hab. Derbend, W. of Isfahan.

Type. B.M. No. 5.10.4.13.

ELLOBIUS WOOSNAMI, sp. n.

Colour as in *E. lutescens*. Teeth of much simpler pattern, the last molar, above and below, nearly as simple as in *E. talpinus*.

Head and body 112 mm.; tail 16; hind foot 23. Greatest length of skull 32.

Hab. Dumbeneh, N. of Isfahan.

Type. Female. B.M. No. 5.10.4.65.

A communication from Dr. ALFRED DUGÈS contained the description of a new Mexican Snake.

Mr. LEONARD DONCASTER, F.Z.S., contributed a paper on the colour-variation of the Beetle *Gonioctena variabilis*. The material on which the paper was based was collected almost entirely at Granada, and the Author found that, although the insect was extraordinarily variable, when a large collection was examined the beetles could be classified into two chief groups with but few intermediate forms.

Mr. F. E. BEDDARD, F.R.S., contributed two papers describing two new species of worms, one a *Pontodrilus* from the shores of the Red Sea, and the other an Enchytræid of the genus *Henlea* from India, which was destructive to the eggs of the Locust.

A paper was read from Dr. J. G. DE MAN, in which he described two species of Decapod Crustacea, a Crab and a Prawn, collected by Dr. R. Hanitsch, of Singapore, from a small artificial fresh-water pool on Christmas Island. The interest of their occurrence lies in the fact that previous to the construction of the reservoir, a few years ago, there seems to have been no possible habitat for these animals on the island, and they must have been introduced since that time, perhaps by migration from the sea. The Crab was referred to *Ptychognathus pusillus*, a species described by Heller from the Nicobar Islands forty years ago and not since

found. The Prawn was made the type of a new variety of *Palæmon lar*, both the variety and the typical form having a wide distribution in countries bordering the Indian Ocean.

Mr. RICHARD STAPLES-BROWNE, F.Z.S., contributed a paper containing the results of experiments he had made in connection with the heredity of webbed feet in Pigeons.

Mr. CECIL WARBURTON, F.Z.S., read a paper, prepared by himself and Mr. N. D. F. PEARCE, on new and rare British *Oribatida*. Eleven species were remarked upon, of which seven were described as new to science, and two were recorded for the first time as being British. The nymph of *Serrarius microcephalus* was described for the first time, and it was pointed out that *Gustavia sol* of Kramer was a nymph of an unknown species of *Serrarius*.

The next Meeting of the Society for Scientific Business will be held on Tuesday, the 16th January, 1906, at half-past Eight o'clock P.M., when the following communications will be made:—

1. Mr. W. STORRS FOX, F.Z.S.—On Bones of the Lynx from Cales Dale, Derbyshire.
2. Mr. J. LEWIS BONHOTE, F.Z.S.—On Mammals from South Johore and Singapore collected by Mr. C. B. Kloss.
3. Mr. F. E. BEDDARD, F.R.S.—Contributions to the Anatomy of the Ophidia.
4. Mr. CHARLES S. TOMES, M.A., F.R.S.—On the Minute Structure of the Teeth of Creodonts, with especial reference to their suggested Resemblance to Marsupials.

The following Papers have been received:—

1. Mr. BASHFORD DEAN.—Notes on the Living Specimens of the Australian Lung-fish (*Ceratodus forsteri*) in the Zoological Society's Collection.
2. Mr. PERCY I. LATHY, F.Z.S.—On Three new Forms of Butterfly of the Genus *Heliconius*.
3. Mr. E. S. RUSSELL.—On *Trichorhiza*, a new Hydroid Genus.
4. Dr. J. W. JENKINSON.—Notes on the Histology and Physiology of the Placenta in Ungulata.
5. Miss GERTRUDE RICARDO.—Description of a new Genus of the *Tabanidae*.
6. Dr. JEAN ROUX.—Synopsis of the Genus *Nectophryne*.
7. Mr. J. S. SPURRELL.—On the Angle of the Jaw.

Communications intended for the Scientific Meetings of the ZOOLOGICAL SOCIETY OF LONDON should be addressed to

P. CHALMERS MITCHELL, *Secretary*,

3 HANOVER SQUARE, LONDON, W.
19th December, 1905.

THE ZOOLOGICAL SOCIETY OF LONDON.

THIS Society was founded in 1826 by Sir STAMFORD RAFFLES, Mr. J. SABINE, Mr. N. A. VIGORS, and other eminent Naturalists, for the advancement of Zoology and Animal Physiology, and for the introduction of new and curious subjects of the Animal Kingdom, and was incorporated by Royal Charter in 1829.

COUNCIL.

HIS GRACE THE DUKE OF BEDFORD, K.G., *President.*

SIR ALEXANDER BAIRD, Bt.	J. JACKSON LISTER, Esq., M.A., F.R.S.
GEORGE A. BOULENGER, Esq., F.R.S., <i>Vice-President.</i>	SIR EDMUND GILES LODER, Bt.
THOMAS H. BURROUGHES, Esq.	E. G. B. MEADE-WALDO, Esq.
F. G. D. DREWITT, Esq., M.A., M.D., F.R.C.P.	P. CHALMERS MITCHELL, Esq., M.A., D.Sc., <i>Secretary.</i>
HERBERT DRUCE, Esq., F.L.S., <i>Vice-President.</i>	E. LORT PHILLIPS, Esq.
CHARLES DRUMMOND, Esq., <i>Treasurer.</i>	HOWARD SAUNDERS, Esq., <i>Vice- President.</i>
SIR EDWARD DURAND, Bt., C.B.	H.S.H. PRINCE FRANCIS OF TECK.
FREDERICK GILLETT, Esq.	CHARLES S. TOMES, Esq., M.A., F.R.S., <i>Vice-President.</i>
F. DU CANE GODMAN, Esq., D.C.L., F.R.S., <i>Vice-President.</i>	AUGUSTUS F. WIENER, Esq.
W. R. OGILVIE-GRANT, Esq.	HENRY WOODWARD, Esq., LL.D., F.R.S., <i>Vice-President.</i>

The Society consists of Fellows, and Honorary, Foreign, and Corresponding Members, elected according to the By-Laws.

The Gardens in the Regent's Park are open from Nine o'clock A.M. till Sunset.

The Offices (3 Hanover Square, W.), where all communications should be addressed, are open from Ten till Five, except on Saturdays, when they are closed at Two o'clock P.M.

The Library (3 Hanover Square), under the superintendence of Mr. F. H. WATERHOUSE, Librarian, is open from 10 A.M. to 5 P.M., on Saturdays to 2 P.M. It is closed in the month of September.

The Meetings of the Society for General Business are held at the Office on the Thursday following the third Wednesday in every month of the year, except in September and October, at Four P.M.

The Meetings for Scientific Business are held at the Office twice a month on Tuesdays, except in July, August, September, and October, at half-past Eight o'clock P.M.

The Anniversary Meeting is held on the 29th April, at Four P.M., or the nearest convenient day (April 28, 1905).

TERMS FOR THE ADMISSION OF FELLOWS.

FELLOWS pay an Admission Fee of £5, and an annual Contribution of £3, due on the 1st of January, and payable in advance, or a Composition of £30 in lieu thereof; the whole payment, including the Admission Fee, being £35.

No person can become a FELLOW until his Admission Fee and First Annual Subscription have been paid, or the annual payments have been compounded for.

FELLOWS elected after the 30th of September are not liable for the Subscriptions for the year in which they are elected.

PRIVILEGES OF FELLOWS.

FELLOWS have Personal Admission to the Gardens with Two Companions daily, upon signing their names in the book at the entrance gate.

FELLOWS receive a Book of Saturday and a Book of Sunday Orders every year. These Orders admit *two* persons to the Gardens on each

Saturday and *two* on each Sunday in the year. But the Saturday Orders are *not* available if the FELLOW shall have used his privilege of *personally* introducing two companions on the *same day*.

FELLOWS also receive every year Twenty Free Tickets (Green), each valid for the admission of one adult any day of the week, including Sunday. Children's Tickets (Buff) can be had in lieu of Green Tickets in the proportion of two Children's Tickets to one Adult's. These Tickets, if not made use of in the year of issue, are available for following years.

In no case can two children be passed through the gates as one adult.

FELLOWS, if they wish it, can exchange the Book of Saturday Orders for Twenty Green Tickets available for any day. The Book of Sunday Orders can also be exchanged for a similar packet of Twenty Tickets. These books must, however, be returned entire, and the exchange can only be made during the year of their issue.

The annual supply of Tickets will be sent to each FELLOW on the 1st of January in every year, on his filling up a form of Standing Order stating in what way they should be made up, and to what address they should be sent. Forms for this purpose are supplied on application.

The WIFE of a FELLOW can exercise all these privileges in his absence.

FELLOWS have the privilege of receiving the Society's Publications on payment of the additional Subscription of One Guinea every year. This Subscription is due upon the 1st of January and must be paid *before* the day of the Anniversary Meeting, after which the privilege lapses. FELLOWS are likewise entitled to purchase the Transactions and other Publications of the Society at 25 per cent. less than the price charged to the public. A further reduction of 25 per cent. is also made upon all purchases of Publications issued prior to 1871, if above the value of Five pounds.

FELLOWS also have the privilege of subscribing to the Annual Volume of the Zoological Record for a sum of £1, payable on the 1st July in each year, but this privilege is forfeited unless the subscription be paid *before* the 1st of December following.

FELLOWS may obtain a TRANSFERABLE IVORY TICKET admitting Two Persons, available throughout the whole period of Fellowship, on payment of Ten Pounds in one sum. A second similar ticket may be obtained on payment of a further sum of Twenty Pounds.

Any FELLOW who intends to be absent from the United Kingdom during the space of one year or more may, upon giving to the Secretary notice in *writing*, have his name placed upon the "dormant list," and will be thereupon exempt from the payment of his annual contribution during such absence.

Any FELLOW, having paid all fees due to the Society, is at liberty to withdraw his name upon giving notice in *writing* to the Secretary.

Ladies or Gentlemen wishing to become Fellows of the Society are requested to communicate with the undersigned.

P. CHALMERS MITCHELL, M.A., D.Sc.,
Secretary.

3 Hanover Square, London, W.,
October, 1905.

MEETINGS
OF THE
ZOOLOGICAL SOCIETY OF LONDON
FOR
SCIENTIFIC BUSINESS.
(AT 3 HANOVER SQUARE, W.)

1905.

TUESDAY, NOVEMBER 14 and 28 | TUESDAY, DECEMBER 12

1906.

<p>TUESDAY, JANUARY 16 ,, FEBRUARY 6 and 20 ,, MARCH .. 6 ,, 20</p>		<p>TUESDAY, APRIL .. 10 ,, MAY 1, 15 and 29 ,, JUNE 19</p>
---	--	--

*The Chair will be taken at half-past Eight o'clock in the Evening
precisely.*

LIST OF THE PUBLICATIONS

OF THE

ZOOLOGICAL SOCIETY OF LONDON.

THE scientific publications of the Zoological Society of London are of two kinds—"Proceedings," published in an octavo form, and "Transactions," in quarto.

According to the present arrangements, the "Proceedings" contain not only notices of all business transacted at the scientific meetings, but also all the papers read at such meetings and recommended to be published in the "Proceedings" by the Committee of Publication. A large number of coloured plates and engravings are issued in the volumes of the "Proceedings," to illustrate the new or otherwise remarkable species of animals described in them. Amongst such illustrations, figures of the new or rare species acquired in a living state for the Society's Gardens are often given.

The "Proceedings" for each year are issued in four parts, on the first of the months of June, August, October, and April, the part published in April completing the volume for the last half of the preceding year. From January 1901 they have been issued as two half-yearly volumes.

The "Transactions" contain such of the more important communications made to the scientific meetings of the Society as, on account of the nature of the plates required to illustrate them, are better adapted for publication in the quarto form. They are issued at irregular intervals.

Fellows and Corresponding Members, upon payment of a Subscription of One Guinea *before* the day of the Anniversary Meeting in each year, are entitled to receive the Society's Publications for the year. They are likewise entitled to purchase the Publications of the Society at 25 per cent. less than the price charged for them to the Public. A further reduction of 25 per cent. is made upon purchases of Publications issued prior to 1881, if they exceed the value of five pounds.

Fellows also have the privilege of subscribing to the Annual Volume of the Zoological Record for a sum of 30s. (which includes cost of delivery), payable on the 1st July in each year; but this privilege is forfeited unless the subscription be paid *before* the 1st of December following.

The following is a complete list of the publications of the Society already issued.

[October, 1905.]

TRANSACTIONS OF THE ZOOLOGICAL SOCIETY OF LONDON.

		4to. 16 vols. and Index.		Price to Fellows.	Price to the Public.
Vcl.	I., containing 59 Plates....	(1833-35)	£3 13 6	£4 18 0†
"	II., " 71 "	(1835-41)	4 0 0	5 6 6†
"	III., " 63 "	(1842-49)	3 8 3	4 11 0†
"	IV., " 77 "	(1851-62)	6 2 0	8 2 6†
"	V., " 67 "	(1862-66)	5 4 3	6 19 0
"	VI., " 92 "	(1866-69)	11 5 0	15 0 0
"	VII., " 73 "	(1869-72)	10 4 0	13 12 0
"	VIII., " 82 "	(1872-74)	9 8 3	12 11 0
"	IX., " 99 "	(1875-77)	12 1 6	16 2 0
"	X., " 95 "	(1877-79)	10 0 3	13 7 0
Index, Vols. I.-X.		(1833-79)	0 7 6	0 10 0
Vol.	XI., containing 97 Plates..	(1880-85)	9 12 0	12 16 0
"	XII., " 65 " ..	(1886-90)	5 8 0	7 4 0
"	XIII., " 62 " ..	(1891-95)	6 8 3	8 11 0
"	XIV., " 47 " ..	(1896-98)	5 5 0	7 0 0
"	XV., " 52 " ..	(1898-1901)	..	5 15 6	7 14 0
"	XVI., " 38 " ..	(1901-1903)	..	5 8 0	7 4 0
"	XVII., Pt. 1 " 5 " ..	(Aug. 1903)	..	1 2 6	1 10 0
"	XVII., " 2 " 3 " ..	(Aug. 1903)	..	0 13 6	0 18 0
"	XVII., " 3 " 13 " ..	(Oct. 1904)	1 2 6	1 10 0
"	XVII., " 4 " 8 " ..	(Oct. 1905)	1 2 6	1 10 0

PROCEEDINGS OF THE COMMITTEE OF SCIENCE AND CORRESPONDENCE OF THE ZOOLOGICAL SOCIETY OF LONDON. 8vo. 2 vols. (Letterpress only).

		Price to Fellows.	Price to the Public.
Part I.	1830-31. 1 vol. 8vo.	4s. 6d.	6s.†
"	II. 1832. "	4s. 6d.	6s.

PROCEEDINGS OF THE ZOOLOGICAL SOCIETY OF LONDON. 8vo. 15 vols. (Letterpress only) and Index. (First Series.)

		Price to Fellows.	Price to the Public.			Price to Fellows.	Price to the Public.
Part	I. 1833. 1 vol. 8vo.	4s. 6d.	6s.†	Part	IX. 1841. 1 vol. 8vo.	4s. 6d.	6s.†
"	II. 1834. " "	4s. 6d.	6s.	"	X. 1842. " "	4s. 6d.	6s.
"	III. 1835. " "	4s. 6d.	6s.	"	XI. 1843. " "	4s. 6d.	6s.†
"	IV. 1836. " "	4s. 6d.	6s.	"	XII. 1844. " "	4s. 6d.	6s.
"	V. 1837. " "	4s. 6d.	6s.	"	XIII. 1845. " "	4s. 6d.	6s.
"	VI. 1838. " "	4s. 6d.	6s.	"	XIV. 1846. " "	4s. 6d.	6s.†
"	VII. 1839. " "	4s. 6d.	6s.†	"	XV. 1847. " "	4s. 6d.	6s.†
"	VIII. 1840. " "	4s. 6d.	6s.†	Index	1830-1847. " "	4s. 6d.	6s.

8vo. 13 vols. and Index. (Second Series.)

		Letterpress only.		With Plates coloured.	
		Price to Fellows.	Price to the Public.	Price to Fellows.	Price to the Public.
Part	XVI. 1848. 1 vol. 8vo.	4s. 6d.	6s.	£1 0 8	£1 7 6†
"	XVII. 1849. " "	4s. 6d.	6s.	1 0 8	1 7 6†
"	XVIII. 1850. " "	4s. 6d.	6s.	1 8 6	1 18 0†
"	XIX. 1851. " "	4s. 6d.	6s.	0 15 9	1 1 0†
"	XX. 1852. " "	4s. 6d.	6s.	0 15 9	1 1 0†
"	XXI. 1853. " "	4s. 6d.	6s.	0 18 0	1 4 0†
"	XXII. 1854. " "	4s. 6d.	6s.	0 19 6	1 6 0†
"	XXIII. 1855. " "	4s. 6d.	6s.	1 8 6	1 18 0†
"	XXIV. 1856. " "	4s. 6d.	6s.	1 0 8	1 7 6†
"	XXV. 1857. " "	4s. 6d.	6s.	1 0 8	1 7 6†
"	XXVI. 1858. " "	4s. 6d.	6s.	1 11 6	2 2 0†
"	XXVII. 1859. " "	4s. 6d.	6s.	1 11 6	2 2 0†
"	XXVIII. 1860. " "	4s. 6d.	6s.	1 11 6	2 2 0†
Index	1848-1860. " "	4s. 6d.	6s.		

† Out of print.

PROCEEDINGS OF THE SCIENTIFIC MEETINGS OF THE
 ZOOLOGICAL SOCIETY OF LONDON. 8vo. 40 vols. and 4 Indices.

	Letterpress only.		With Plates uncoloured.		With Plates coloured.	
	Price to Fellows.	Price to the Public.	Price to Fellows.	Price to the Public.	Price to Fellows.	Price to the Public.
1861 ..	4s. 6d.	6s.	9s.	12s.	33s. 9d.	45s.†
1862 ..	4s. 6d.	6s.	9s.	12s.	33s. 9d.	45s.†
1863 ..	4s. 6d.	6s.	9s.	12s.	33s. 9d.	45s.
1864 ..	4s. 6d.	6s.*	9s.	12s.†	33s. 9d.	45s.†
1865 ..	4s. 6d.	6s.	9s.	12s.	33s. 9d.	45s.
1866 ..	4s. 6d.	6s.*	9s.	12s.†	33s. 9d.	45s.
1867 ..			9s.	12s.*	33s. 9d.	45s.
1868 ..			9s.	12s.	33s. 9d.	45s.
1869 ..			9s.	12s.	33s. 9d.	45s.
1870 ..			9s.	12s.	33s. 9d.	45s.
Index, 1861-1870 ..			4s. 6d.	6s.		
1871 ..			9s.	12s.*	33s. 9d.	45s.
1872 ..			9s.	12s.*	33s. 9d.	45s.†
1873 ..			9s.	12s.	33s. 9d.	45s.
1874 ..			9s.	12s.†	36s.	48s.†
1875 ..			9s.	12s.	36s.	48s.
1876 ..			9s.	12s.	36s.	48s.
1877 ..			9s.	12s.	36s.	48s.
1878 ..			9s.	12s.	36s.	48s.
1879 ..			9s.	12s.	36s.	48s.
1880 ..			9s.	12s.	36s.	48s.
Index, 1871-1880 ..			4s. 6d.	6s.		
1881 ..			9s.	12s.	36s.	48s.
1882 ..			9s.	12s.	36s.	48s.
1883 ..			9s.	12s.	36s.	48s.
1884 ..			9s.	12s.	36s.	48s.
1885 ..			9s.	12s.	36s.	48s.
1886 ..			9s.	12s.	36s.	48s.
1887 ..			9s.	12s.	36s.	48s.
1888 ..			9s.	12s.	36s.	48s.
1889 ..			9s.	12s.	36s.	48s.
1890 ..			9s.	12s.	36s.	48s.
Index, 1881-1890 ..			4s. 6d.	6s.		
1891 ..					36s.	48s.
1892 ..					36s.	48s.
1893 ..					36s.	48s.
1894 ..					36s.	48s.
1895 ..					36s.	48s.
1896 ..					36s.	48s.
1897 ..					36s.	48s.
1898 ..					36s.	48s.
1899 ..					36s.	48s.
1900 ..					36s.	48s.
Index, 1891-1900 ..			4s. 6d.	6s.		

* No perfect copies in stock.

† Out of print.

PROCEEDINGS OF THE GENERAL MEETINGS FOR SCIENTIFIC
BUSINESS OF THE ZOOLOGICAL SOCIETY OF LONDON.

8vo. 9 vols.

	Price to Fellows.	Price to the Public.
1901, vol. I.....	18s.	24s.
" " II.....	18s.	24s.
1902, " I.....	18s.	24s.
" " II.....	18s.	24s.
1903, " I.....	18s.	24s.
" " II.....	18s.	24s.
1904, " I.....	18s.	24s.
" " II.....	18s.	24s.
1905, " I.....	18s.	24s.
" " II, pt. 1.....	9s.	12s.

LISTS OF THE ANIMALS IN THE SOCIETY'S GARDENS.

List of the Vertebrated Animals now or lately Living in the Gardens
of the Zoological Society of London. (Eighth Edition.) 8vo.
1883. Cloth, 4s. 6d.

List of the Vertebrated Animals now or lately Living in the Gardens
of the Zoological Society of London. (Ninth Edition.) 8vo.
1896. Cloth, 6s.; Paper, 5s.

Catalogue of the Library of the Zoological Society of London.
(Fifth Edition.) 8vo. 1902. Cloth, 6s.; Paper, 5s.

*These publications may be obtained at the SOCIETY'S OFFICE
(3 Hanover Square, W.), at Messrs. LONGMANS' (Paternoster Row,
E.C.), or through any bookseller.*

THE ZOOLOGICAL RECORD.



THE object of the ZOOLOGICAL RECORD is to give, by means of an annual Volume, complete lists of the Works and Publications relating to Zoology in all its branches that have appeared during the year preceding the issue of the Volume, together with full information as to the points they deal with, arranged in such a manner as to serve as an Index to the literature of Zoology in all parts of the globe, and thus to form a repertory that will retain its value for the Student in future years.

The 'Zoological Record,' after Vol. 40, will be published by the Society at the price of 40s. per volume. But all Members of the Zoological Society of London will have the privilege of receiving it, including the cost of delivery, at a subscription price of 30s. per annum. This Subscription is due on the 1st of July in every year, and the privilege of Subscription is forfeited unless the amount be paid before the 1st of December following.

The Zoological Society, having purchased the entire stock of the 'Zoological Record,' is able to supply complete sets. The thirty-seven Volumes to the end of the nineteenth century, and the Index-Volume (1880-1900) in addition, will be supplied for £15 net (or *without* the Index-Volume, for £14 10s. net). Volumes of any single year (exclusive of the last five volumes and Vol. 6) can likewise be supplied at 10s. per volume net.

The price of the Index Zoologicus (Index-Volume 1880-1900) is 20s., to Fellows 18s.

Members of the Society wishing to subscribe to the 'Record' are requested to apply at this office for a Form, to be returned when filled up and signed by the subscriber. In order to facilitate the payment of the subscription, a Banker's Order Form is also supplied to those who prefer that mode of payment. This order, when filled up and signed, should be sent to the Society's office for registration; it will then be sent to the Agents named therein.

Learned Societies and Institutions and members of the former Zoological Record Association are permitted to subscribe to the 'Record' on the same conditions as are accorded to Members of the Zoological Society.

The divisions of the 'Zoological Record' may be obtained separately as shown on the next page.

SEPARATE DIVISIONS OF THE ZOOLOGICAL RECORD.

At present each Volume of the ZOOLOGICAL RECORD consists of 20 separately paged Divisions. These may be obtained separately, in paper covers, stitched and lettered.

The following are the Divisions and their net prices, viz. :—

	s.	d.
List of abbreviations of journals, etc.	2	0
Special Records, viz. :—		
I. General Subjects	2	6
II. Mammalia	2	6
III. Aves	6	0
IV. Reptilia and Batrachia	2	6
V. Pisces	2	6
VI. Tunicata	1	0
VII. Mollusca	4	0
VIII. Brachiopoda	1	0
IX. Bryozoa	1	0
X. Crustacea	2	6
XI. Arachnida	2	0
XII. Myriopoda	1	6
XIII. Insecta	12	0
XIV. Echinoderma	3	6
XV. Vermes	3	0
XVI. Cœlenterata	1	6
XVII. Spongiæ	2	0
XVIII. Protozoa	2	0
Index of new names of genera and subgenera	2	0

On receipt of the price any Division will be forwarded as soon as ready.

These separate Divisions can be obtained from the Zoological Society, 3 Hanover Square, London, and also from the following Agents: Friedländer & Sohn, 11 Carlstrasse, Berlin; Librairie A. Hermann, 6 rue Sorbonne, Paris. Cheques and Post-Office Orders should be made payable to "The Zoological Society," and crossed "Drummond's."

P. CHALMERS MITCHELL,
Secretary.

October, 1905.

ZOOLOGICAL SOCIETY OF LONDON,
3 HANOVER SQUARE, W.

LIST OF VOLUMES OF THE 'ZOOLOGICAL RECORD.'

The Record of Zoological Literature, 1864-1868, Vols. I.-V.
Edited by ALBERT C. L. G. GÜNTHER, M.A., M.D., Ph.D., F.Z.S., &c.
Price 10s. each Volume. Net.

The Record of Zoological Literature, 1869, Volume Sixth.
Edited by ALBERT C. L. G. GÜNTHER, M.A., M.D., Ph.D., F.R.S.,
F.Z.S., &c. London, 1870. Price 30s.

The Zoological Record for 1870-1872, Vols. VII.-IX. Edited
by ALFRED NEWTON, M.A., F.R.S., F.L.S., V.P.Z.S., &c. Price 10s.
each Volume. Net.

The Zoological Record for 1873-1883, Vols. X.-XX. Edited by
EDWARD CALDWELL RYE, F.Z.S., M.E.S. Price 10s. each Volume. Net.

The Zoological Record for 1884, 1885, Vols. XXI., XXII. Edited
by F. JEFFREY BELL, M.A. Price 10s. each Volume. Net.

The Zoological Record for 1886-1890, Vols. XXIII.-XXVII.
Edited by FRANK E. BEDDARD, M.A., F.Z.S. Price 10s. each
Volume. Net.

The Zoological Record for 1891-1898, Vols. XXVIII.-XXXV.
Edited by D. SHARP, M.A., F.R.S., F.Z.S., &c. Price 10s. each
Volume. Net.

The Zoological Record, Volume the Thirty-sixth; being Records
of Zoological Literature relating chiefly to the year 1899. By
J. A. Thomson, R. Lydekker, R. Bowdler Sharpe, G. A. Boulenger,
W. A. Herdman, E. R. Sykes, E. A. Smith, G. C. Crick, A. W.
Brown, D. Sharp, F. A. Bather, A. Willey, and R. v. Lendenfeld.
Edited (for the Zoological Society of London) by DAVID SHARP, M.A.,
F.R.S., F.Z.S., &c. London, 1900. Price 30s.

The Zoological Record, Volume the Thirty-seventh; being
Records of Zoological Literature relating chiefly to the year 1900.
By J. A. Thomson, R. Lydekker, R. Bowdler Sharpe, G. A. Boulenger,
W. A. Herdman, E. R. Sykes, E. A. Smith, G. C. Crick, A. W.
Brown, D. Sharp, F. A. Bather, A. Willey, and E. A. Minchin.
Edited (for the Zoological Society of London) by DAVID SHARP,
M.A., F.R.S., F.Z.S., &c. London, 1901. Price 30s.

The Zoological Record, Volume the Thirty-eighth; being Records of Zoological Literature relating chiefly to the year 1901. By J. A. Thomson, R. Lydekker, R. Bowdler Sharpe, G. A. Boulenger, Alice L. Embleton, E. R. Sykes, E. A. Smith, S. Pace, Albert Brown, D. Sharp, F. A. Bather, and E. A. Minchin. Edited (for the Zoological Society of London) by DAVID SHARP, M.A., F.R.S., F.Z.S., &c. London, 1902. Price 30s.

The Zoological Record, Volume the Thirty-ninth; being Records of Zoological Literature relating chiefly to the year 1902. By D. Sharp, R. Lydekker, R. Bowdler Sharpe, G. A. Boulenger, W. T. Calman, E. R. Sykes, E. A. Smith, Alice L. Embleton, F. A. Bather, E. A. Minchin, and H. M. Woodcock. Edited (for the Zoological Society of London) by DAVID SHARP, M.A., F.R.S., F.Z.S., &c. London, 1903. Price 30s.

The Zoological Record, Volume the Fortieth; being Records of Zoological Literature relating chiefly to the year 1903. By D. Sharp, R. Lydekker, R. Bowdler Sharpe, G. A. Boulenger, W. T. Calman, E. R. Sykes, E. A. Smith, Alice L. Embleton, F. A. Bather, E. A. Minchin, and H. M. Woodcock. Edited (for the Zoological Society of London) by DAVID SHARP, M.A., F.R.S., F.Z.S., &c. London, 1904. Price 30s.

Index Zoologicus. An alphabetical list of names of genera and subgenera proposed for use in Zoology, as recorded in the Zoological Record, 1880-1900; together with other names not included in the 'Nomenclator zoologicus' of S. H. Scudder. Compiled (for the Zoological Society of London) by CHARLES OWEN WATERHOUSE and edited by DAVID SHARP, Editor of the Zoological Record. London, 1902. Price to Fellows, 18s.; price to the public, 20s.

*These publications may be obtained at the SOCIETY'S OFFICE
(3 Hanover Square, W.).*

THE ZOOLOGICAL SOCIETY OF LONDON.



IN consequence of a re-arrangement of the stock of the 'Transactions,' the Society is now able to offer for sale at the reduced price of £30 sets from Vol. V. to XVI. inclusive; also the following memoirs, separately, at the price stated against each.

MAMMALS.

ADAMS, A. LEITH.	s. d.	BUSK, GEORGE.	s. d.
On a Spécies of Dormouse (<i>Myoxus</i>) occurring in the Fossil State in Malta. (1 plate.)		Description of the Remains of three extinct Species of Elephant, collected by Captain Spratt, C.B., R.N., in the Ossiferous Cavern of Zebbug, in the Island of Malta; partly from the Notes of the late H. Falconer, M.D. (10 plates.)	
vi. 307.	0 6	vi. 227.	8 6
On the Dentition and Osteology of the Maltese fossil Elephants, being a Description of Remains discovered by the Author in Malta between the years 1860 and 1866 (22 plates.) . . ix. 1.	10 6	On the Ancient or Quaternary Fauna of Gibraltar, as exemplified in the Mammalian Remains of the Ossiferous Breccia. (27 plates.) . . x. 53.	7 6
ALLMAN, GEORGE J.		FLOWER, SIR WILLIAM HENRY, K.C.B.	
On the Characters and Affinities of <i>Potamogale</i> , a Genus of Insectivorous Mammals. (2 plates.) vi. 1.	2 6	On the Brain of the Javan Loris (<i>Stenops javanicus</i> Illig.). (1 plate.) v. 103.	1 0
ANDERSON, JOHN.		Description of the Skeleton of <i>Inia geoffrensis</i> and of the Skull of <i>Pontoporia blainvillii</i> , with Remarks on the Systematic Position of these Animals in the Order Cetacea. (4 plates.)	
On the Osteology and Dentition of <i>Hylomys</i> . (1 plate.) viii. 453.	1 0	vi. 87.	5 6
BEDDARD, FRANK E.		On the Osteology of the Cachalot or Sperm Whale (<i>Physeter macrocephalus</i>). (7 plates.)	
On the Structure of Hooker's Sealion (<i>Arctocephalus hookeri</i>). (2 plates.) xii. 369.	3 0	vi. 309.	8 0
Contributions to the Anatomy of the Anthropoid Apes. (9 plates.)		Description of the Skeleton of the Chinese White Dolphin (<i>Delphinus sinensis</i> Osbeck). (2 plates.) vii. 151.	2 0
xiii. 177.	4 0	On Risso's Dolphin (<i>Grampus griseus</i> , Cuv. (2 plates.) viii. 1.	3 0
Contribution towards a Knowledge of the Osteology of the Pigmy Whale (<i>Neobalæna marginata</i>). (3 plates.) . . xvi. 87.	2 0		
— and TREVES, SIR FREDERICK, Bart.			
On the Anatomy of the Sondaic Rhinoceros. (5 plates.) xii. 183.	3 0		

- FLOWER, Sir W. H. (*cont.*). s. d.
- On the Recent Ziphioid Whales, with a Description of the Skeleton of *Berardius arnouxii*. (3 plates.) viii. 203. 3 0
- A further Contribution to the Knowledge of the existing Ziphioid Whales. Genus *Mesoplodon*. (3 plates.) x. 415. 3 0
- On the External Characters of two Species of British Dolphins (*Delphinus delphis* Linn., and *Delphinus tursio* Fabr.). (1 plate.) xi. 1. 1 6
- FORBES, W. A.
- On the Male Generative Organs of the Sumatran Rhinoceros (*Ceratorhinus sumatrensis*). (1 plate.) xi. 107. 1 0
- Notes on the External Characters and Anatomy of the Californian Sea-lion (*Otaria gillespii*). (3 plates.) xi. 225. 2 6
- GARROD, ALFRED HENRY.
- Notes on the Manatee (*Manatus americanus*) recently living in the Society's Gardens. (3 plates.) x. 137. 3 0
- On the Brain of the Sumatran Rhinoceros (*Ceratorhinus sumatrensis*). (1 plate.) x. 411. 1 0
- On the Brain and other parts of the Hippopotamus (*H. amphibius*). (2 plates.) xi. 11. 1 6
- HARMER, SIDNEY F.
- On a Specimen of *Cervus belgrandi* Lart. (*C. verticornis* Dawk.) from the Forest-Bed of East Anglia. (1 plate.) xv. 97. 1 0
- LANKESTER, E. RAY.
- On *Okapia*, a new Genus of *Giraffidae*, from Central Africa. (3 plates.) xvi. 279. 5 6
- MIVART, ST. GEORGE.
- Contributions towards a more complete Knowledge of the Skeleton of the Primates. Part I. The Appendicular Skeleton of *Simia*. (9 plates.) vi. 175. 5 0
- MIVART, ST. GEORGE, and MURIE, JAMES. s. d.
- On the Anatomy of the Lemuroidea. (6 plates.) vii. 1. 7 6
- MURIE, JAMES.
- Researches upon the Anatomy of the Pinnipedia. Part I. On the Walrus (*Trichechus rosomarus* Linn.). (5 plates.) vii. 411. 5 6
- . Part II. Descriptive Anatomy of the Sea-Lion (*Otaria jubata*). (7 plates.) vii. 527. 7 6
- . Part III. Descriptive Anatomy of the Sea-Lion (*Otaria jubata*). (8 plates.) viii. 501. 10 6
- On the Female Generative Organs, Viscera, and Fleshly Parts of *Hyæna brunnea* Thunberg. (1 plate.) vii. 503. 1 0
- On the Form and Structure of the Manatee (*Manatus americanus*). (10 plates.) viii. 127. 6 0
- On the Organization of the Caaing Whale (*Globiocephalus melas*). (9 plates.) viii. 235. 6 0
- Further Observations on the Manatee. (5 plates.) xi. 19. 4 6
- , and MIVART, ST. G.
- On the Anatomy of the Lemuroidea. (6 plates.) vii. 1. 7 6
- NEWTON, E. T.
- On a Skull of *Trogotherium cuvieri* from the Forest-Bed of East Runton, near Cromer. (1 plate.) xiii. 165. 1 6
- OWEN, Sir RICHARD, K.C.B.
- Contributions to the Natural History of the Anthropoid Apes. No. VII. Comparison of the Bones of the Limbs of the *Troglodytes gorilla*, *Troglodytes minor*, and of different Varieties of the Human Race; and on the general Characters of the Skeleton of the Gorilla. (13 plates.) v. 1. 6 0
- . No. VIII. On the External Characters of the Gorilla (*Troglodytes gorilla* Sav.) (7 plates.) v. 243. 4 0

	s.	d.		s.	d.
OWEN, Sir R. (<i>cont.</i>).			ROLLESTON, GEORGE.		
On the Aye-aye (<i>Chiromys</i> Cuvier; <i>Chiromys madagascariensis</i> Desm.; <i>Sciurus madagascariensis</i> Gmel., Sonnerat; <i>Lenur psilodactylus</i> Schreber, Shaw). (13 plates.)	v.	33.	On the Placental Structures of the Tenrec (<i>Centetes ecaudatus</i>) and those of certain other Mammalia; with Remarks on the Value of the Placental System of Classification. (1 plate.)	v.	285.
On some Indian Cetacea collected by Walter Elliot, Esq. (12 plates.)	vi.	17.	1	6	
Note to Memoir on the Indian Cetacea collected by Sir Walter Elliot	vi.	171.	SCLATER, PHILIP LUTLEY.		
On the Osteology of the Marsupialia. Part III. Modifications of the Skeleton in the Species of <i>Phascolomys</i> . (8 plates.)	viii.	345.	On certain Species of Deer now or lately living in the Society's Menagerie. (12 plates.)	vii.	333.
— Part IV. Bones of the Trunk and Limbs of <i>Phascolomys</i> . (6 plates.)	viii.	483.	On the Rhinoceroses now or lately living in the Society's Menagerie. (5 plates.)	ix.	645.
— Part V. Fam. Poephaga, Genus <i>Macropus</i> . (10 plates.)	ix.	417.	5	6	
Description of a Portion of Mandible and Teeth of a large extinct Kangaroo (<i>Palorchestes crassus</i> Ow.) from ancient fluvial Drift, Queensland. (1 plate.)	xi.	7.	SCOTT, JOHN H., and PARKER, T. JEFFERY.		
1	6		On a Specimen of <i>Ziphius</i> recently obtained near Dunedin. (3 plates.)	xii.	241.
PARKER, T. JEFFERY, and SCOTT, JOHN H.			2	0	
On a Specimen of <i>Ziphius</i> recently obtained near Dunedin. (3 plates.)	xii.	241.	THOMAS, OLDFIELD.		
2	0		On the Mammals obtained by Mr. John Whitehead during his recent Expedition to the Philippines; with Field-notes by the Collector. (7 plates.)	xiv.	377.
PETERS, W.			6	0	
Contributions to the Knowledge of <i>Pectinator</i> , a Genus of Rodent Mammalia from North-Eastern Africa. (3 plates.)	vii.	397.	TREVES, Sir FREDERICK, Bt., and BEDDARD, FRANK E.		
2	6		On the Anatomy of the Sondaic Rhinoceros. (5 plates.)	xii.	183.
			3	0	
			WATSON, M.		
			On the Anatomy of the Female Organs of the Proboscidea. (2 plates.)	xi.	111.
			1	6	

BIRDS.

ANDREWS, C. W.			CUNNINGHAM, ROBERT O.		
On the Extinct Birds of Patagonia.—I. The Skull and Skeleton of <i>Phororhachos inflatus</i> Ameghino. (4 plates.)	xv.	55.	On some Points in the Anatomy of the Steamer Duck (<i>Micropterus cinereus</i>). (5 plates.)	vii.	493.
3	0		4	0	

- DEGEN, EDWARD. *s. d.*
- Ecdysis, as Morphological Evidence of the Original Tetradactyle Feathering of the Bird's Fore-limb, based especially on the Perennial Moulting in *Gymnorhina tibicen*. (3 plates.) xvi. 347. 4 6
- FINSCH, OTTO.
- On a Collection of Birds from North-eastern Abyssinia and the Bogos Country. With Notes by the Collector, WILLIAM JESSE, C.M.Z.S., Zoologist to the Abyssinian Expedition. (5 plates.) vii. 197. 9 0
- GADOW, HANS, and NEWTON, SIR EDWARD, K.C.M.G.
- On additional Bones of the Dodo and other Extinct Birds of Mauritius obtained by Mr. Théodore Sauzier. (5 plates.) xiii. 281. 2 6
- GURNEY, J. H.
- On a Raptorial Bird transmitted by Mr. Andersson from Damara-land. (1 plate.) vi. 117. 1 6
- HAAST, JULIUS VON.
- On *Megalapteryx hectori*, a new Gigantic Species of Apterygian Bird. (1 plate.) xii. 161. 1 0
- On *Dinornis oweni*, a new Species of the Dinornithidæ, with some Remarks on *D. curtus*. (2 plates.) xii. 171. 1 6
- JESSE, WILLIAM.
- On a Collection of Birds from North-eastern Abyssinia and the Bogos Country. By OTTO FINSCH, Ph.D., C.M.Z.S. With Notes by the Collector, WILLIAM JESSE, C.M.Z.S., Zoologist to the Abyssinian Expedition. (5 plates.) vii. 197. 9 0
- MIVART, ST. GEORGE.
- On the Axial Skeleton of the Ostrich (*Struthio camelus*). viii. 385. 5 6
- MIVART, ST. G. (*cont.*). *s. d.*
- On the Axial Skeleton of the Struthionidæ x. 1. 3 0
- On the Axial Skeleton of the Pelecanidæ. (7 plates.) x. 315. 6 0
- MUDGE, GEO. P.
- On the Myology of the Tongue of Parrots, with a Classification of the Order, based upon the Structure of the Tongue. (4 plates.) xvi. 211. 4 6
- MURIE, JAMES.
- On the Dermal and Visceral Structures of the Kagu, Sun-bittern, and Boatbill. (2 plates.) vii. 465. 3 6
- NEWTON, ALFRED.
- On a Picture supposed to represent the Didine Bird of the Island of Bourbon (Réunion). (1 plate.) vi. 373. 1 0
- NEWTON, SIR EDWARD, K.C.M.G., and GADOW, HANS.
- On additional Bones of the Dodo and other Extinct Birds of Mauritius obtained by Mr. Théodore Sauzier. (5 plates.) xiii. 281. 2 6
- NEWTON, E. T.
- On the Remains of a Gigantic Species of Bird (*Gastornis klaasseni*, n. sp.) from the Lower Eocene Beds near Croydon. (2 plates.) xii. 143. 1 6
- OWEN, SIR RICHARD, K.C.B.
- Description of the Skeleton of the Great Auk, or Garfowl (*Alca impernis* L.) (2 plates.) v. 317. 1 6
- On *Dinornis* (Part IX.): containing a Description of the Skull, Atlas, and Scapulo-coracoid Bone of the *Dinornis robustus* Owen. (4 plates.) v. 337. 3 0
- On *Dinornis* (Part X.): containing a Description of Part of the Skeleton of a flightless Bird indicative of a new Genus and Species (*Cnemioornis calcitrans* Owen). (5 plates.) v. 395. 3 6

OWEN, Sir R. (<i>cont.</i>).	s. d.	OWEN, Sir R. (<i>cont.</i>).	s. d.
On <i>Dinornis</i> (Part XI.): containing a Description of the Integument of the Sole, and Tendons of a Toe, of the Foot of <i>Dinornis robustus</i> Owen. (1 plate.)	vi. 495. 1 0	On <i>Dinornis</i> (Part XIX.): containing a Description of a Femur indicative of a new Genus of large Wingless Bird (<i>Dromornis australis</i> Owen) from a Post-tertiary Deposit in Queensland, Australia. (2 plates.)	viii. 381. 1 6
On <i>Dinornis</i> (Part XII.): containing a Description of the Femur, Tibia, and Metatarsus of <i>Dinornis maximus</i> Owen. (2 plates.)	vi. 497. 1 6	On <i>Dinornis</i> (Part XX.): containing a Restoration of the Skeleton of <i>Cnemidornis calcitrans</i> Owen, with Remarks on its Affinities in the Lamellirostral Group. (5 plates.)	ix. 253. 6 0
On <i>Dinornis</i> (Part XIII.): containing a Description of the Sternum in <i>Dinornis elephantopus</i> and <i>D. rheides</i> ; with Notes on that Bone in <i>D. crassus</i> and <i>D. casuarinus</i> . (3 plates.)	vii. 115. 2 0	On <i>Dinornis</i> (Part XXI.): containing a Restoration of the Skeleton of <i>Dinornis maximus</i> Owen. With an Appendix on additional Evidence of the Genus <i>Dromornis</i> in Australia. (3 plates.)	x. 147. 3 0
On <i>Dinornis</i> (Part XIV.): containing Contributions to the Craniology of the Genus, with a Description of the Fossil Cranium of <i>Dasornis londinensis</i> Owen, from the London Clay of Sheppey. (7 plates.)	vii. 123. 4 6	On <i>Dinornis</i> (Part XXIII.): containing a Description of the Skeleton of <i>Dinornis parvus</i> Owen. (8 plates.)	xi. 233. 4 0
On <i>Dinornis</i> (Part XV.): containing a Description of the Skull, Femur, Tibia, Fibula, and Metatarsus of <i>Aptornis defossor</i> Owen, from Oamaru, Middle Island, New Zealand; with additional Observations on <i>Aptornis otidiformis</i> , on <i>Notornis mantelli</i> , and on <i>Dinornis curtus</i> . (5 plates.)	vii. 353. 4 0	On <i>Dinornis</i> (Part XXIV.): containing a Description of the Head and Feet, with their dried Integuments, of an Individual of the Species <i>Dinornis didimus</i> Owen. (3 plates.)	xi. 257. 2 0
On <i>Dinornis</i> (Part XVI.): containing Notices of the Internal Organs of some Species; with a Description of the Brain and some Nerves and Muscles of the Head of the <i>Apteryx australis</i> . (3 plates.)	vii. 381. 2 0	On <i>Dinornis</i> (Part XXV.): containing a Description of the Sternum of <i>Dinornis elephantopus</i> . (1 plate.)	xiii. 1. 1 6
On <i>Dinornis</i> (Part XVII.): containing a Description of the Sternum and Pelvis, with an attempted Restoration, of <i>Aptornis defossor</i> Owen. (3 plates.)	viii. 119. 2 0	On the Osteology of the Dodo (<i>Didus ineptus</i> Linn.). (10 plates.)	vi. 49. 9 0
On <i>Dinornis</i> (Part XVIII.): containing a Description of the Pelvis and Bones of the Leg of <i>Dinornis gravis</i> . (4 plates.)	viii. 361. 3 0	On the Dodo. Part II. Notes on the articulated Skeleton of the Dodo (<i>Didus ineptus</i> Linn.) in the British Museum. (3 plates.)	vii. 513. 2 0
		PARKER, T. JEFFERY.	
		On the Cranial Osteology, Classification, and Phylogeny of the <i>Dinornithidee</i> . (7 plates.)	xiii. 373. 5 6
		PARKER, WILLIAM KITCHEN.	
		On the Osteology of Gallinaceous Birds and Tinamous. (9 plates.)	v. 149. 4 6

PARKER, W. K. (<i>cont.</i>).	<i>s. d.</i>	ROTHSCHILD, HON. WALTER.	<i>s. d.</i>
On some Fossil Birds from the Zebbug Cave, Malta. (2 plates.) vi. 119.	2 6	A Monograph of the Genus <i>Casuarinus</i> . By The Hon. WALTER ROTHSCHILD, Ph.D., F.Z.S. With a Dissertation on the Morphology and Phylogeny of the Palæognathæ (Ratitæ and Crypturi) and Neognathæ (Carinatæ). By W. P. PYCRAFT. (24 plates.)	xv. 109. 17 6
On the Osteology of the Kagu (<i>Rhinochetus jubatus</i>). (2 plates.)	vi. 501. 3 0	SALVIN, OSBERT.	
On Ægithognathous Birds. Part I. (9 plates.)	ix. 289. 7 6	On the Avifauna of the Galapagos Archipelago. (6 plates.)	ix. 447. 8 0
On the Skull of the Ægithognathous Birds. Part II. (9 plates.)	x. 251. 7 6	SCLATER, PHILIP LUTLEY.	
On the Morphology of a Reptilian Bird, <i>Opisthocomus cristatus</i> . (4 plates.)	xiii. 43. 4 0	On the Curassows now or lately living in the Society's Gardens. (14 plates.)	ix. 273. 10 6
PERRIN, J. BESWICK.		Supplementary Notes on the Curassows now or lately living in the Society's Gardens. (7 plates.)	x. 543. 6 0
On the Myology of <i>Opisthocomus cristatus</i> . (4 plates.)	ix. 353. 3 6	WALDEN, ARTHUR VISCOUNT.	
PYCRAFT, W. P.		A List of the Birds known to inhabit the Island of Celebes. (8 plates.)	viii. 23. 8 0
A Monograph of the Genus <i>Casuarinus</i> . By The Hon. WALTER ROTHSCHILD, Ph.D., F.Z.S. With a Dissertation on the Morphology and Phylogeny of the Palæognathæ (Ratitæ and Crypturi) and Neognathæ (Carinatæ). By W. P. PYCRAFT. (24 plates.)	xv. 109. 17 6	Appendix to a List of Birds known to inhabit the Island of Celebes. (3 plates.)	viii. 109. 2 6
		A List of the Birds known to inhabit the Philippine Archipelago. (12 plates.)	ix. 125. 10 6

FISHES.

BOULENGER, G. A.		BOULENGER, G. A. (<i>cont.</i>).	
On a Collection of Fishes from the Rio Paraguay. (6 plates.) xiv. 25.	3 0	Second Contribution to the Ichthyology of Lake Tanganyika. —On the Fishes obtained by the Congo Free State Expedition under Lieut. Lemaire in 1898. (3 plates.)	xv. 87. 2 0
On a Collection of Fishes from the Rio Jurua, Brazil. (4 plates.)	xiv. 421. 2 6	Third Contribution to the Ichthyology of Lake Tanganyika. —Report on the Collection of Fishes made by Mr. J. E. S. Moore in Lakes Tanganyika and Kivu during his Second Expedition, 1899–1900. (9 plates.)	xvi. 137. 5 6
Report on the Collection of Fishes made by Mr. J. E. S. Moore in Lake Tanganyika during his Expedition, 1895–96. With an Appendix by J. E. S. MOORE, A.R.C.S. (8 plates.) xv. 1.	5 6		

BRIDGE, T. W.	s. d.	LANKESTER, E. RAY.	s. d.
On the Morphology of the Skull in the Paraguayan <i>Lepidosiren</i> and in other Dipnoids. (2 plates.)	xiv. 325. 2 0	On the Hearts of <i>Ceratodus</i> , <i>Protopterus</i> , and <i>Chimæra</i> , with an Account of undescribed Pocket Valves in the Conus arteriosus of <i>Ceratodus</i> and of <i>Protopterus</i> . (2 plates.)	x. 493. 1 6
BUDGETT, J. S.		On the <i>Lepidosiren</i> of Paraguay, and on the External Characters of <i>Lepidosiren</i> and <i>Protopterus</i> . (1 plate.)	xiv. 11. 1 6
On some Points in the Anatomy of <i>Polypterus</i> . (3 plates.)	xv. 323. 3 6	MIVART, ST. GEORGE.	
On the Breeding-habits of some West-African Fishes, with an Account of the External Features in Development of <i>Protopterus annectens</i> , and a Description of the Larva of <i>Polypterus lapradei</i> . (2 plates.)	xvi. 115. 2 0	Notes on the Fins of Elasmobranchs, with Considerations on the Nature and Homologues of Vertebrate Limbs. (6 plates.)	x. 439. 4 0
On the Structure of the Larval <i>Polypterus</i> . (3 plates.)	xvi. 315. 4 0	PARKER, T. JEFFERY.	
GOELDI, EMIL A.		On the Intestinal Spiral Valve in the Genus <i>Raia</i> . (2 plates.)	xi. 49. 1 6
On the Lepidosiren of the Amazons; being Notes on five Specimens obtained between 1895-97, and Remarks upon an Example living in the Pará Museum. (2 plates.)	xiv. 413. 1 6	Studies in New-Zealand Ichthyology.—I. On the Skeleton of <i>Regalecus argenteus</i> . (5 plates.)	xii. 5. 2 6
GÜNTHER, ALBERT.		PARKER, W. K.	
An Account of the Fishes of the States of Central America, based on Collections made by Captain J. M. Dow, F. Godman, Esq., and O. Salvin, Esq. (25 plates.)	vi. 377. 12 0	On the Structure and Development of the Skull in Sharks and Skates. (9 plates.)	x. 189. 7 6
Description of a Specimen of <i>Schedophilus medusophagus</i> , a Fish new to the British Fauna. (1 plate.)	xi. 223. 1 0	VINCENT, SWALE.	
		Contributions to the Comparative Anatomy and Histology of the Suprarenal Capsules.—The Suprarenal Bodies in Fishes, and their Relation to the so-called Head-Kidney. (6 plates.)	xiv. 41. 4 0

REPTILES AND BATRACHIANS.

BOULENGER, G. A.		BOULENGER, G. A. (cont.).	
On the Reptiles and Batrachians of the Solomon Islands. (7 plates.)	xii. 35. 4 6	On Remains of an Extinct Gigantic Tortoise from Madagascar (<i>Testudo grandidieri</i> Vaillant). (3 plates.)	xiii. 305. 2 0
Catalogue of the Reptiles and Batrachians of Barbary (Morocco, Algeria, Tunisia), based chiefly upon the Notes and Collections made in 1880-1884 by M. Fernand Lataste. (6 plates.)	xiii. 93. 6 0	On a Nothosaurian Reptile from the Trias of Lombardy, apparently referable to <i>Lariosaurus</i> . (1 plate.)	xiv. 1. 1 0

GADOW, HANS.	s. d.	the Egg, on the Hatching, and on the Hatched Young. (From the Huxley Research Laboratory.) (6 plates.)	xvi. 1.	6	0
On the Remains of some Gigantic Land-Tortoises, and of an Extinct Lizard, recently discovered in Mauritius. (3 plates.)	xiii. 313.			2	0
GRAY, JOHN EDWARD.		PARKER, W. K.			
Synopsis of the Species of Recent Crocodilians or Emydosaurians, chiefly founded on the Specimens in the British Museum and the Royal College of Surgeons of England. (4 plates.)	vi. 125.	On the Structure of the Skull in the Chameleons. (5 plates.)	xi. 77.	3	6
		On the Structure and Development of the Skull in the Urodeles. (6 plates.)	xi. 171.	4	0
GÜNTHER, ALBERT.		On the Structure and Development of the Skull in the Crocodilia. (10 plates.)	xi. 263.	6	0
Observations on some rare Reptiles and a Batrachian now or lately living in the Society's Menagerie. (5 plates.)	xi. 215.	SWINNERTON, H. H., and HOWES, G. B.			
		On the Development of the Skeleton of the Tuatara, <i>Sphenodon punctatus</i> ; with Remarks on the Egg, on the Hatching, and on the Hatched Young. (From the Huxley Research Laboratory.) (6 plates.)	xvi. 1.	6	0
HOWES, G. B., and SWINNERTON, H. H.					
On the Development of the Skeleton of the Tuatara, <i>Sphenodon punctatus</i> ; with Remarks on					

MOLLUSCA.

ALDER, JOSHUA, and HANCOCK, ALBANY.		HANCOCK, ALBANY, and ALDER, JOSHUA.			
Notice of a Collection of Nudi-branchiate Mollusca made in India by Walter Elliot, Esq., with Descriptions of several new Genera and Species. (6 plates.)	v. 113.	Notice of a Collection of Nudi-branchiate Mollusca made in India by Walter Elliot, Esq., with Descriptions of several new Genera and Species. (6 plates.)	v. 113.	2	6
GEDDES, PATRICK.		OWEN, Sir RICHARD, K.C.B.			
On the Mechanism of the Odon-tophore in certain Mollusca. (3 plates.)	x. 485.	Descriptions of some new and rare Cephalopoda. (Part II.) (13 plates.)	xi. 131.	6	0

BRYOZOA.

GREGORY, J. W.		On the British Palæogene Bryozoa. (4 plates.)	xiii. 219.	3	0
----------------	--	---	------------	---	---

CRUSTACEA.

BENHAM, W. B. S., LANKESTER, s. d. E. RAY, and BECK, Miss E. J. On the Muscular and Endo- skeletal Systems of <i>Limulus</i> and <i>Scorpio</i> . (12 plates.) xi. 311. 10 6	and <i>Scorpio</i> ; with some Notes s. d. on the Anatomy and Generic Characters of Scorpions. (12 plates.) xi. 311. 10 6
BRADY, GEORGE STEWARDSON. On new or imperfectly known Species of Marine Ostracoda. (6 plates.) v. 359. 3 0	NORMAN, the Rev. A. M., and STEBBING, the Rev. T. R. R. On the Crustacea Isopoda of the 'Lightning,' 'Porcupine,' and 'Valorous' Expeditions. (12 plates.)..... xii. 77. 5 0
A Monograph of the Ostracoda of the Antwerp Crag. (8 plates.)..... x. 379. 5 0	ROBERTSON, DAVID, and STEB- BING, the Rev. T. R. R. On four new British Amphipoda. (2 plates.) xiii. 31. 1 6
A Supplementary Report on the Crustacea of the Group <i>Myodo- copa</i> obtained during the 'Chal- lenger' Expedition, with Notes on other new or imperfectly- known Species. (3 plates.) xiv. 85. 1 6	STEBBING, the Rev. THOMAS R. R. On some new Exotic Amphipoda from Singapore and New Zea- land. (2 plates.) xii. 199. 1 6
On new or imperfectly-known Species of Ostracoda, chiefly from New Zealand. (5 plates.) xiv. 429. 3 0	On the Genus <i>Urothoe</i> and a new Genus <i>Urothoides</i> . (4 plates.) xiii. 1. 3 0
On the Marine Copepoda of New Zealand. (5 plates.) .. xv. 31. 3 0	Descriptions of nine new Species of Amphipodous Crustaceans from the Tropical Atlantic. (5 plates.)..... xiii. 349. 3 0
On new or imperfectly-known Ostracoda, chiefly from a Col- lection in the Zoological Mu- seum, Copenhagen. (5 plates.) xvi. 179. 3 0	—, and NORMAN, the Rev. A. M. On the Crustacea Isopoda of the 'Lightning,' 'Porcupine,' and 'Valorous' Expeditions. (12 plates.) xii. 77. 5 0
LANKESTER, E. RAY, BENHAM, W. B. S., and BECK, Miss E. J. On the Muscular and Endo- skeletal Systems of <i>Limulus</i>	—, and ROBERTSON, DAVID. On four new British Amphipoda. (2 plates.) xiii. 31. 1 6

ARACHNIDA.

LANKESTER, E. RAY, BENHAM, W. B. S., and BECK, Miss E. J. On the Muscular and Endoskeletal Systems of <i>Limulus</i> and <i>Scorpio</i> ; with some Notes on the Anatomy and Generic Characters of Scorpions. (12 plates.)..... xi. 311. 10 6
--

INSECTS.

BUTLER, ARTHUR GARDINER.	s. d.	LEUTHNER, FRANZ.	s. d.
Revision of the Heterocerous Lepidoptera of the Family Sphingidæ. (5 plates.) ix. 511.	7 6	A Monograph of the Odonto- labini, a subdivision of the Coleopterous Family Lucanidæ. (14 plates.)..... xi. 385.	10 6
ELWES, H. J., and EDWARDS, JAMES.		MOORE, F.	
A Revision of the Oriental <i>Hes-</i> <i>periidæ</i> . (10 plates.) xiv. 101.	10 0	On the Genera and Species of the Lepidopterous Subfamily <i>Ophiderinæ</i> inhabiting the In- dian Region. (3 plates). xi. 63.	4 0
FAWCETT, Lt.-Col. J. MALCOLM.		SMITH, FREDERICK.	
Notes on the Transformations of some South-African Lepido- ptera. (4 plates.) .. xv. 291.	4 0	Notes on the Habits of some Hymenopterous Insects from the North-west Provinces of India. By CHARLES HORNE, Esq., B.C.S., F.Z.S. With an Appendix containing Descrip- tions of some new Species of Apidæ and Vespidae collected by Mr. Horne; by FREDERICK SMITH, of the British Museum. Illustrated by Plates from Drawings by the Author of the Notes. (4 plates.) vii. 161.	7 6
HORNE, CHARLES.		WESTWOOD, J. O.	
Notes on the Habits of some Hymenopterous Insects from the North-west Provinces of India. By CHARLES HORNE. With an Appendix containing Descriptions of some new Spe- cies of Apidæ and Vespidae collected by Mr. Horne; by FREDERICK SMITH, of the British Museum. Illustrated by Plates from Drawings by the Author of the Notes. (4 plates.)..... vii. 161.	7 6	Observations on the Uraniidæ, a Family of Lepidopterous Insects, with a Syn psis of the Family and a Monograph of <i>Coronidia</i> , one of the Genera of which it is composed. (4 plates.)..... x. 507.	5 6
KIRBY, W. F.			
A Revision of the Subfamily <i>Libellulina</i> , with Descriptions of new Genera and Species. (7 plates.)..... xii. 249.	5 6		

ECHINODERMS.

BELL, F. JEFFREY.			
Description of a remarkable new Sea-urchin of the Genus <i>Cidaris</i> from Mauritius. (1 plate.)			xiii. 303. 1 0

WORMS.

BEDDARD, FRANK E.	<i>s. d.</i>	M'INTOSH, W. C.	<i>s. d.</i>
On the Anatomy and Systematic Position of a Gigantic Earth-worm (<i>Microchaeta rappi</i>) from the Cape Colony. (2 plates.) xii. 63.	1 6	On British Annelida. (4 plates.) ix. 371.	3 0
		On the Annelida of the 'Porcupine' Expeditions of 1869 and 1870. (3 plates.) ix. 395.	2 6

CŒLEENTERATES.

ALLMAN, G. J.		DUNCAN, P. M. (<i>cont.</i>).	
Report on the Hydroids collected during the Expeditions of H.M.S. 'Porcupine.' (4 plates.) viii. 469.	2 0	A Description of the Madrepোরaria dredged up during the Expedition of H.M.S. 'Porcupine' in 1869 and 1870. Part II. (3 plates.) x. 235.	3 0
BELL, F. JEFFREY.		HICKSON, SYDNEY J.	
Contributions to our Knowledge of the Antipatharian Corals. (2 plates) xiii. 87.	1 6	A Revision of the Genera of the Alcyonaria Stolonifera, with a Description of one new Genus and several new Species. (6 plates.) xiii. 325.	2 6
DUNCAN, P. MARTIN.			
A Description of the Madrepোরaria dredged up during the Expedition of H.M.S. 'Porcupine' in 1869 and 1870. (11 plates.) viii. 303.	6 0		

SPONGES.

DENDY, ARTHUR.			
Observations on the West-Indian Chalinine Sponges, with Descriptions of new Species. (6 plates.) xii. 349.	2 6		

PROTOZOA.

BRADY, HENRY B., PARKER, W. KITCHEN, and JONES, T. RUPERT.			
On some Foraminifera from the Abrohlos Bank. (8 plates.) xii. 211.	3 0		

December 12, 1905.

	Page
The Secretary. Report on the Additions to the Society's Menagerie during the month of November 1905	489
The Secretary. Exhibition of a coloured print of Polito's Royal Menagerie at Exeter 'Change	490
Mr. A. H. Cocks, F.Z.S. Exhibition of a series of photographs of Whales taken in East Finmarken	490
Mr. Geo. P. Mudge, F.Z.S. Exhibition of, and remarks upon, a Dogfish with abnormal viscera	490
Mr. Geo. P. Mudge, F.Z.S. Exhibition of, and remarks upon, an Earthworm with bifid tail	490
Mr. H. B. Fantham, B.Sc., F.Z.S. Exhibition of, and remarks upon, microscopic preparations of a new Hæmosporidian of the genus <i>Piroplasma</i>	491
Mr. Oldfield Thomas, F.R.S., F.Z.S. Exhibition of, and remarks upon, tails of Dormice showing regeneration of the vertebræ	491
Dr. W. G. Ridewood, F.Z.S. Exhibition of microscopic preparations of the regenerated vertebræ of the tails of Dormice	494
1. On the Habits and Reactions of Crabs bearing Actinians in their Claws. By J. E. DUERDEN, Ph.D., A.R.C.Sc. (Lond.), Professor of Zoology, Rhodes University College, Grahamstown, Cape Colony	494
2. Notes on a Collection of Snakes from Japan and the Loo Choo Islands. By Captain F. WALL, C.M.Z.S., Indian Medical Service	511
3. Description d'un Ophidien nouveau du Mexique (<i>Morenoa orizabensis</i> , g. et sp. nn.). Par ALFRED DUGÈS, M.D., C.M.Z.S.	517
4. On a Collection of Mammals from Persia and Armenia presented to the British Museum by Col. A. C. Bailward. By OLDFIELD THOMAS, F.R.S., F.Z.S. (Plate XVI.)	519
5. On the Colour-Variation of the Beetle <i>Goniocetena variabilis</i> . By L. DONCASTER, M.A., F.Z.S.	528
6. On Species of Crustacea of the Genera <i>Ptychognathus</i> Stimps. and <i>Palaemon</i> Fabr. from Christmas Island. By Dr. J. G. DE MAN, of Ierseke, Holland. (Plates XVII. & XVIII.)	537
7. Note on Heredity in Pigeons. By RICHARD STAPLES-BROWNE, F.Z.S.	550
8. On a new Species of Worm of the Genus <i>Pontodrilus</i> from the Shores of the Red Sea. By FRANK E. BEDDARD, M.A., F.R.S., Prosector to the Society	558
9. On a new Enchytraeid Worm (<i>Henlea lejroyi</i> , sp. n.) from India destructive to the Eggs of a Locust (<i>Acridium</i> sp.). By FRANK E. BEDDARD, M.A., F.R.S., Prosector to the Society	562
10. On new and rare British Mites of the Family <i>Oribatidæ</i> . By CECIL WARBURTON, M.A., F.Z.S., and NIGEL D. F. PEARCE, M.A. (Plates XIX. & XX.)	564
11. On some South Australian Spiders of the Family <i>Lycosidæ</i> . By H. R. HOGG, M.A., F.Z.S.	569
Index	593
Titlepage	i
List of Council and Officers	ii
List of Contents	iii
Alphabetical List of Contributors	xi
List of Plates	xxi
List of Text-figures	xxiii
List of New Generic Terms	xxvi

LIST OF PLATES.

1905.—VOL. II.

PART II.

Plate		Page
VIII.	White-maned Serow (<i>Nemorhædus argyrochaetes</i>)	329
IX.	<i>Mustela melampus bedfordi</i>	331
X.	1. <i>Galaxias affinis</i> . 2. <i>G. huttoni</i> . 3. <i>G. punctifer</i> . 4. <i>G. lynx</i> .	}
XI.	1. <i>Galaxias weedoni</i> . 2. <i>G. waitii</i> . 3. <i>G. olidus</i> . 4. <i>G. occidentalis</i>	
XII.	1. <i>Galaxias attenuatus</i> . 2. <i>G. coxii</i>	}
XIII.	1. <i>Galaxias auratus</i> . 2. <i>G. attenuatus</i> . 3. <i>G. findlayi</i> . 4. <i>G. truttaceus</i>	
XIV.	} New species of Bladder-clawed <i>Halticidæ</i>	398
XV.		
XVI.	<i>Calomyscus bailwardi</i>	519
XVII.	Figs. 1-5. <i>Ptychognathus pusillus</i> . Fig. 6. <i>P. barbatus</i>	}
XVIII.	Figs. 7-15. <i>Palaemon (Eupalæmon) lar</i> , var. Figs. 16-19. <i>P. (Eupalæmon) lar</i>	
XIX.	} British <i>Oribatidæ</i>	564
XX.		

NOTICE.

The 'Proceedings' for the year are issued in *four* parts, forming two volumes, as follows:—

VOL. I.

- Part I. containing papers read in January and February, in June.
 II. " " " " " March and April, in August.

VOL. II.

- Part I. containing papers read in May and June, in October.
 II. " " " " " November and December, in April.

'Proceedings,' 1905, Vol. II. Part I. was published on October 17th, 1905.

The Abstracts of the papers read at the Scientific Meetings in November and December are contained in this Part.

P 97070

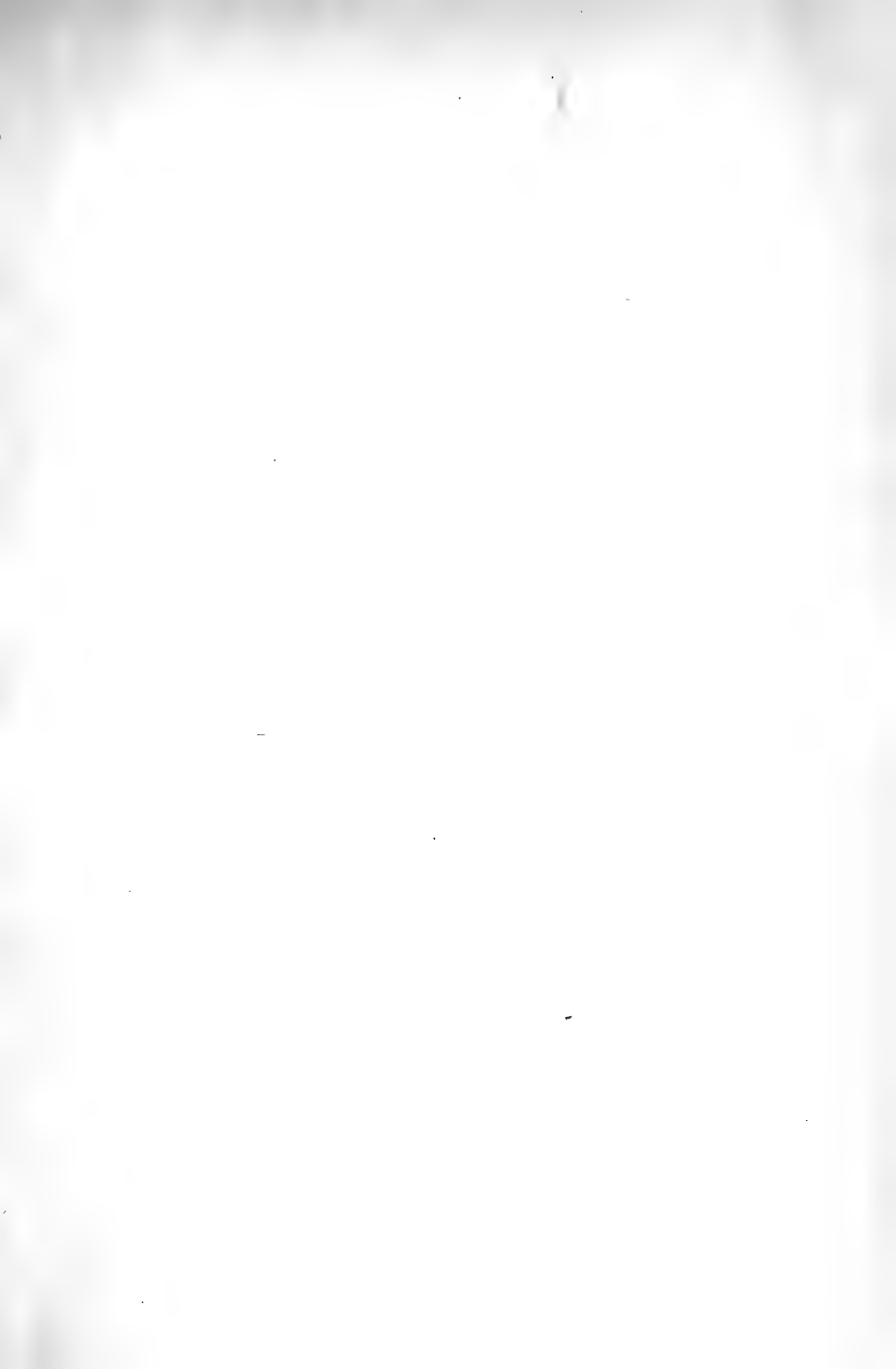



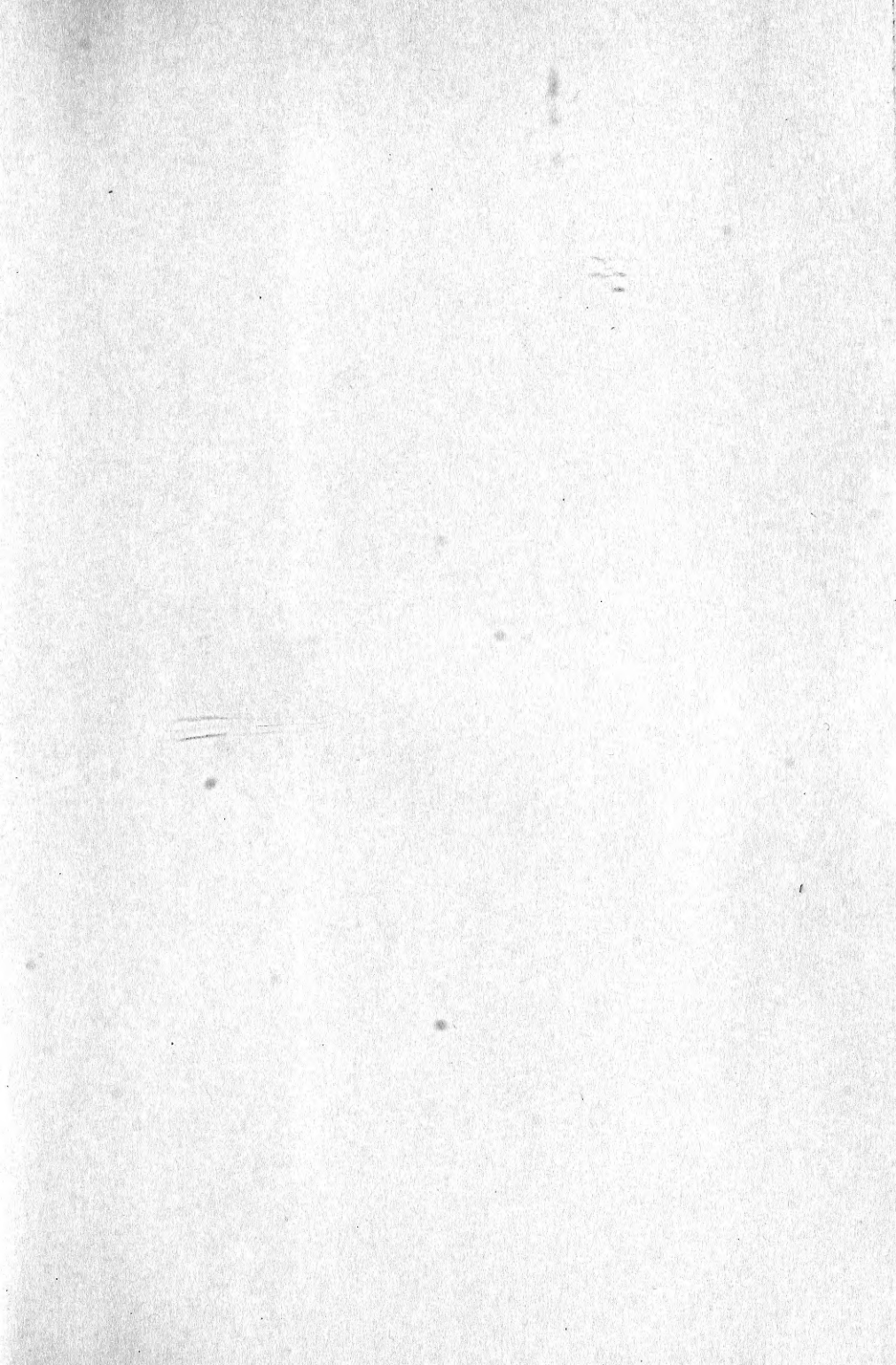

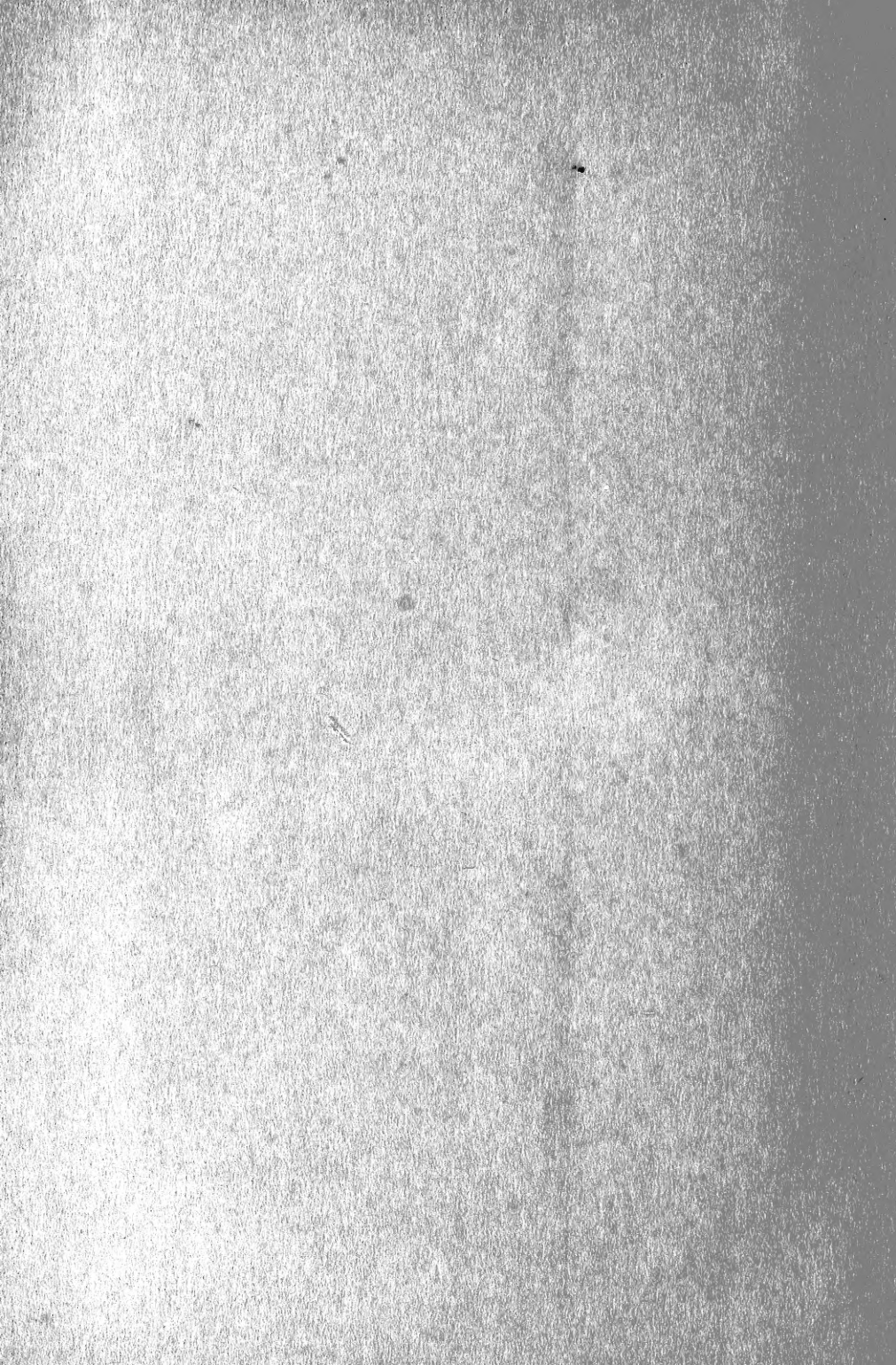



SMITHSONIAN INSTITUTION LIBRARIES



3 9088 00847 2250