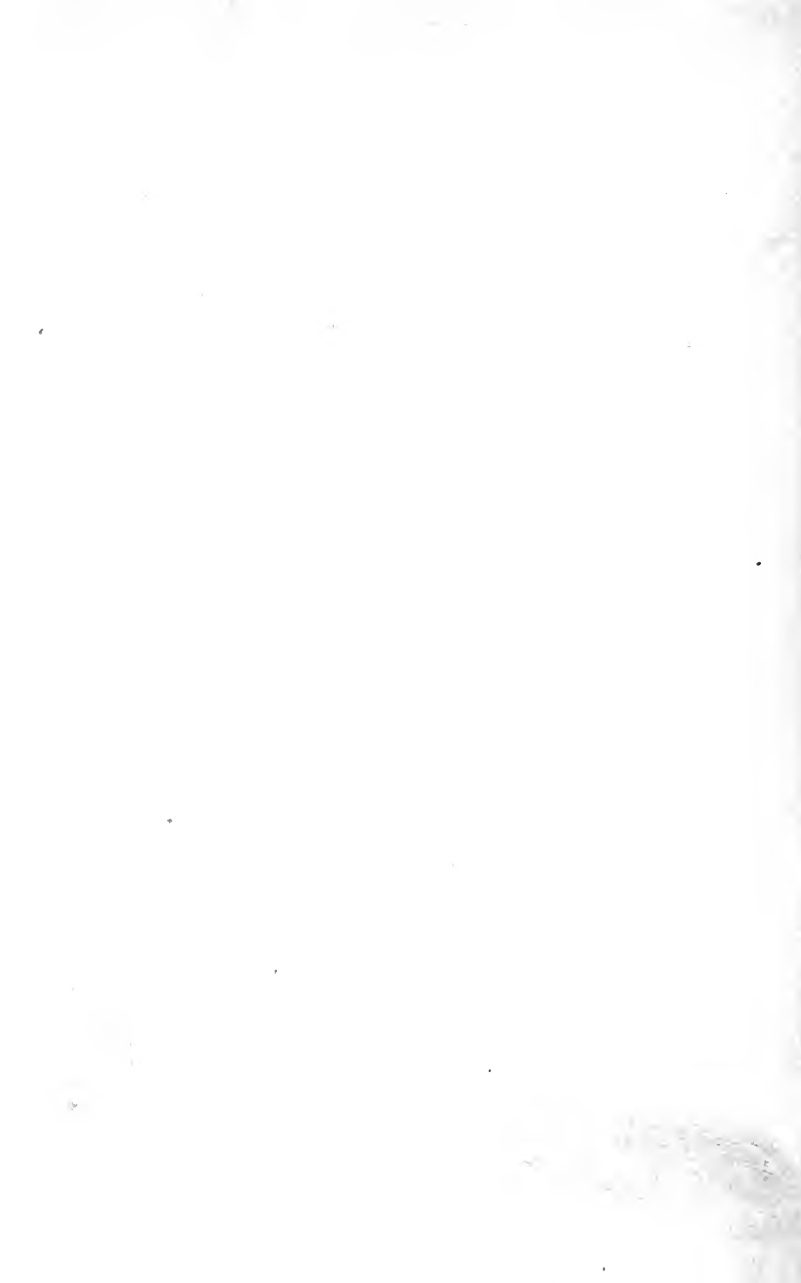
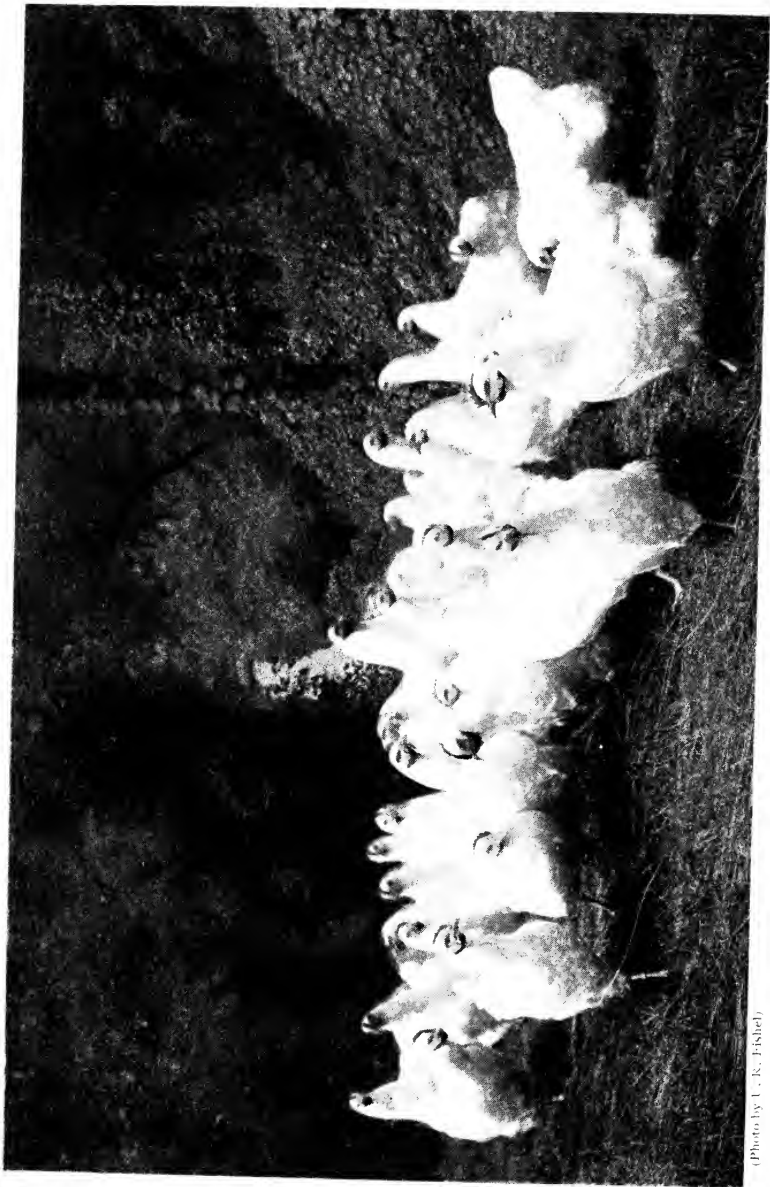


EX LIBRIS









(Photo by U. K. Fishel)

THE FARM FLOCK—WHITE PLYMOUTH ROCKS

'TIS BUT A STEP FROM THE WILDS OF NATURE TO THE ACHIEVEMENTS OF THE MODERN POULTRY YARD

# LIPPINCOTT'S FARM MANUALS

EDITED BY K. C. DAVIS, PH.D. (CORNELL).

---

## PRODUCTIVE POULTRY HUSBANDRY

A COMPLETE TEXT

DEALING WITH THE PRINCIPLES AND PRACTICES  
INVOLVED IN THE MANAGEMENT OF POULTRY

BY

HARRY R. LEWIS, B.S.

POULTRY HUSBANDMAN OF THE NEW JERSEY AGRICULTURAL EXPERIMENT STATION; ASSISTANT PROFESSOR OF POULTRY AND DAIRY HUSBANDRY, NEW JERSEY COLLEGE OF AGRICULTURE (RUTGERS); FORMERLY PROFESSOR OF AGRICULTURE OF THE BARON DE HIRSCH AGRICULTURAL SCHOOL; MEMBER INTERNATIONAL ASSOCIATION OF POULTRY INSTRUCTORS AND INVESTIGATORS; LIFE MEMBER AMERICAN POULTRY ASSOCIATION.

329 ILLUSTRATIONS IN THE TEXT

"If vain our toil,  
We ought to blame the culture, not the soil."  
POPE—*Essay on Man*.



PHILADELPHIA & LONDON  
J. B. LIPPINCOTT COMPANY

5 F 4 17

L45

1913

COPYRIGHT, 1913  
BY J. B. LIPPINCOTT COMPANY

TO THE  
LIBRARY OF

*Electrotyped and printed by*  
J. B. Lippincott Company, Philadelphia, U. S. A.

LIBRARY



DEDICATION.

TO ALL STUDENTS AND LOVERS OF POULTRY  
THIS BOOK IS RESPECTFULLY DEDICATED.  
MAY IT BE TO THEM A STEPPING STONE  
IN THIS GREAT AND GROWING INDUSTRY.

5108

W674

## PREFACE.

THE exceedingly large and ever-increasing demand for poultry and poultry products, at home and for export, has caused the poultry business to become so profitable, when conducted upon a scientific basis, that no breeder can afford to lack the latest knowledge of best methods in all its branches.

A number of poultry books have appeared during the past few years in response to an insistent demand, some dealing with special branches, others covering the entire subject in a general way. But the great need in poultry literature is for a work which covers the subject in a thoroughly scientific yet practical manner, treating each branch in sufficient detail to give entire clarity, and giving to the reader the results of research at the various experiment stations and the methods that are most successful in present-day practice.

Such a book has been the aim of the author. In its preparation there has been an earnest effort to help build the foundation for a systematic, scientific, and greater poultry industry.

The work contains in an abbreviated form the observations, practices, and experience of the author while engaged in various poultry enterprises as practical poultryman, as student, and as teacher.

Of all live-stock, the poultry flock is most often misunderstood and poorly cared for. In recent years much attention has been given to a special study of the needs of poultry, in order to secure reliable data on the subject. It is largely due to this awakening that the poultry industry of America is bounding ahead in such rapid strides. Remember that in the report of the Secretary of Agriculture for 1905, the total value of poultry products in the United States was estimated at five hundred million dollars. In 1907 it had risen to over six hundred million dollars, and in 1910 it was equal to cotton and was next to corn, which is the leading agricultural product. This rapid increase in production, accompanied by a more rapidly increasing demand for home consumption and export, necessitates a better knowledge of requirements underlying production and marketing.

With these conditions in mind, the text has been written to aid

all those interested in every phase of the industry. The book offers, to the student and teacher of poultry husbandry, a complete, concise, systematic course of lessons, commencing with a brief introduction outlining methods of teaching poultry husbandry. The main text opens with a discussion of poultry farming, its opportunities and requirements, the types and systems, methods of starting in the business, and an analysis of foreign poultry conditions. The breeds of poultry are classified and their uses given; methods of management are recommended, including housing, feeding, breeding, and all phases of hatching and rearing.

Every phase of marketing is analyzed and improved methods are recommended. Suggestions are given on the subjects of exhibiting, judging, advertising, and the keeping of records. In discussing methods of management the principles underlying the operations are first given; this is followed with a few of the most successful practices. Illustrations are freely but carefully used to bring out important features.

In the hands of the commercial poultryman the book affords a large field for study, because it points out the practices which prove to be most efficient on large, successful plants, and because it outlines methods which are recommended by experiment stations in the various States and by the Federal Government. By making free use of the index, the poultryman can quickly find information pertaining to almost any point about which he might wish to know. In case of disease, improper feeding, or environmental conditions, the information might be of inestimable value.

To the farm poultryman the text clearly pictures methods which would enable the keeping of more birds with no more labor and a much increased profit. The methods given, if practised, would enable the average farmer to keep from two hundred to five hundred birds, as a "side line" to general farm operations, and realize a handsome revenue.

The text is so arranged that it will meet the needs for systematic reading courses, for farmers' clubs, poultry associations, and granges.

The review questions at the end of each chapter are for the use of students in preparing for recitations, for the instructor in conducting reviews, and for the practical poultryman in grasping the fundamental points in the discussion. Reference lists are given at the close of many of the chapters. Most of the references are to Federal and State publications which can be obtained free of

charge or which can be found in reference libraries. The miscellaneous references in the appendix deal with the entire subject in a general way. It is recommended that references be studied so far as facilities will permit, since a broader conception of the subject will thus be obtained.

That this book may fill a place in the world of poultry literature, may meet the need for a modern text-book, and may help solve the problems which are so annoying to many, whether they be students, poultrymen, or farmers, is the earnest wish of the author.

HARRY R. LEWIS.

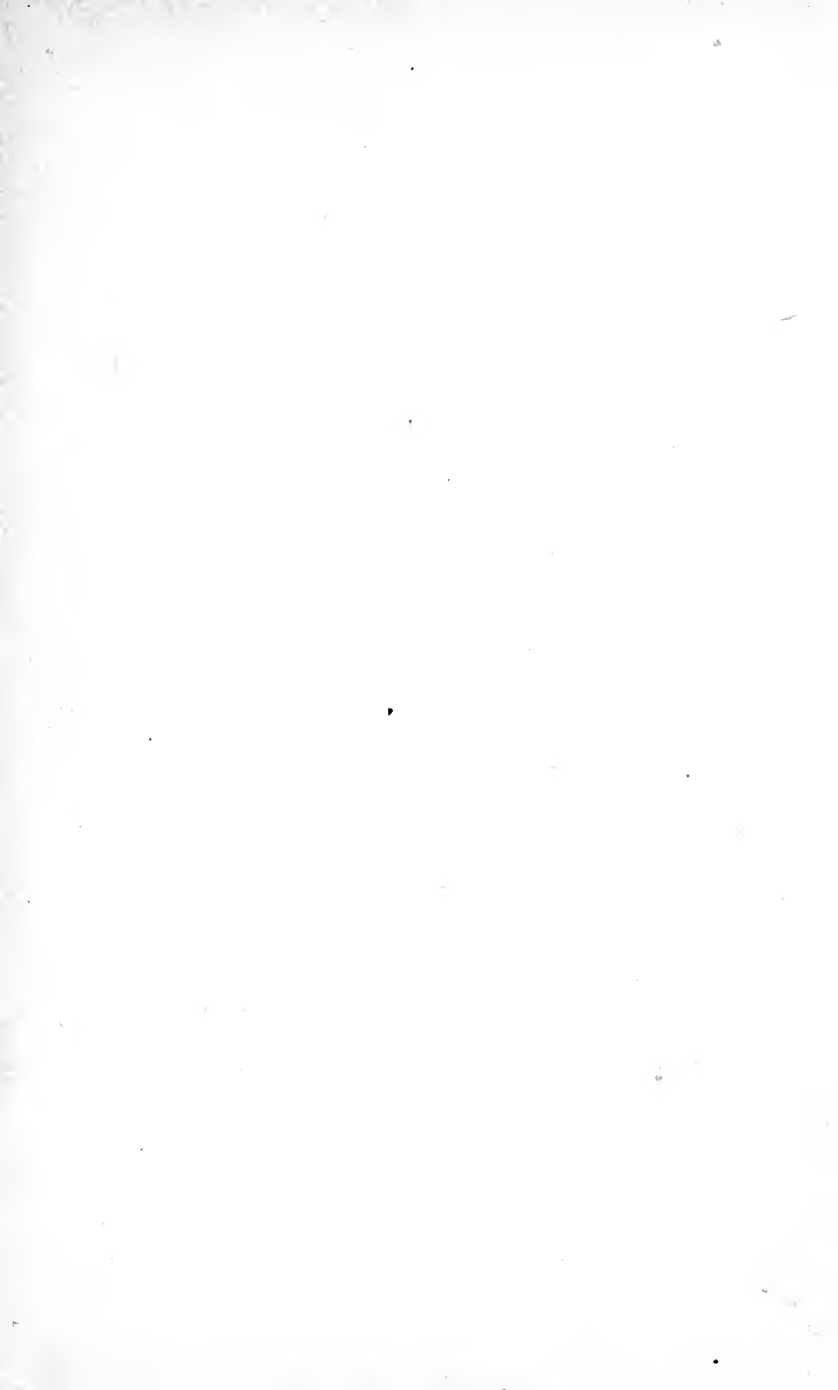
NEW BRUNSWICK, NEW JERSEY,  
October, 1913.



## ACKNOWLEDGMENTS.

THE author wishes to express his obligation to a number of persons who have aided in the preparation of the work. To Mr. Morris Roberts, of Maplewood, New Jersey, is due the credit for a number of the pen-and-ink drawings reproduced in the text. Many photographs have been supplied by the Department of Agriculture, experiment stations, and individuals, credits for which are given. Mrs. Harry R. Lewis has materially aided in the completion of the work. Many practical poultrymen and teachers whose names are not mentioned have offered suggestions and encouragement. To all those who have so earnestly aided in the work the author expresses his appreciation and indebtedness.

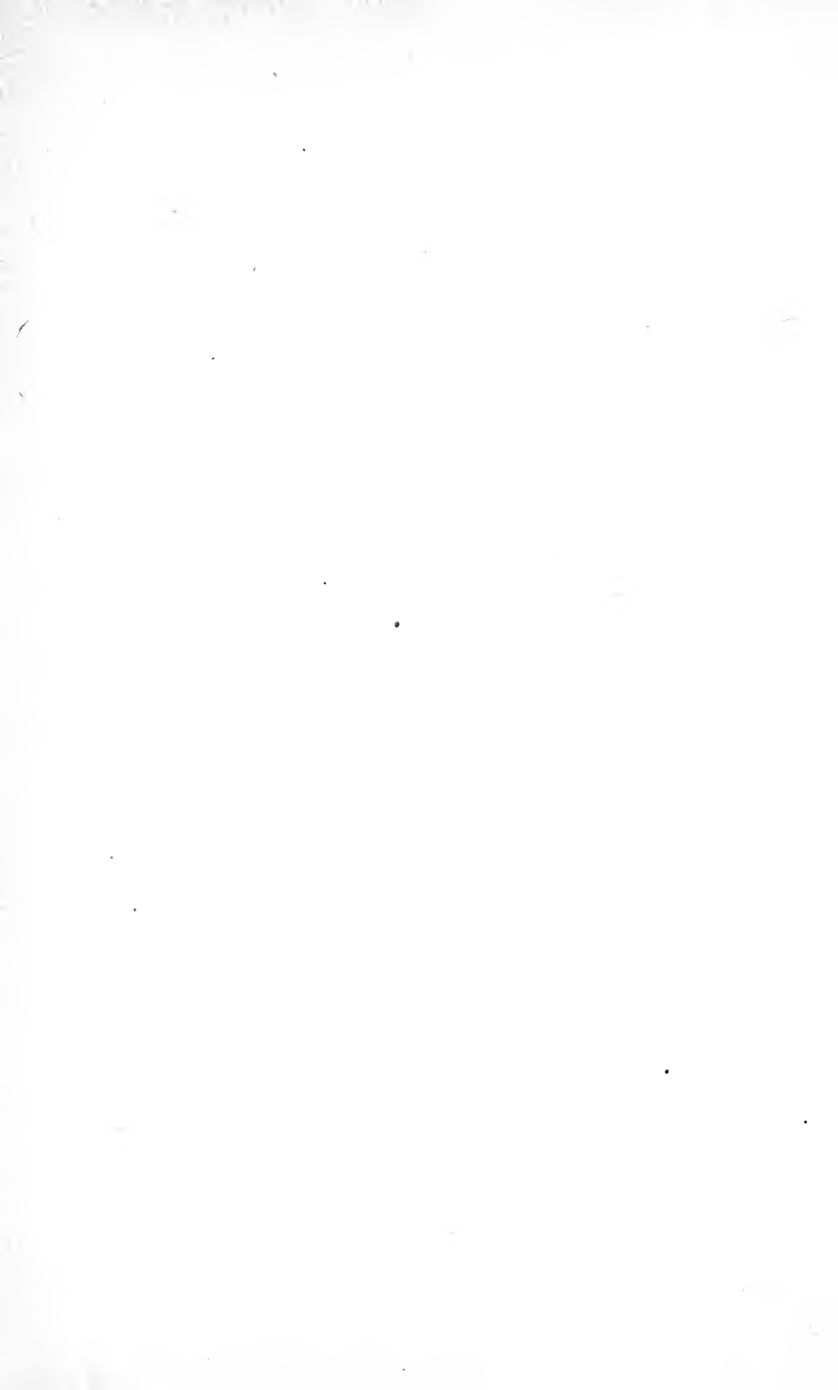
The composition tables given in Chapter XI were compiled from analyses from experiment station reports and various composition tables. The composition of many grains was taken from "Elementary Treatise on Stock Feeds and Feeding," by J. E. Halligan. Valuable material was also obtained from Bulletin 164 of the California Experiment Station, entitled "Poultry Feeding," by M. E. Jaffa. The feeding tables in the appendix are almost entirely from this source.





# CONTENTS.

CHAPTER	PAGE
INTRODUCTION—THE TEACHING OF POULTRY HUSBANDRY . . . . .	1
I. POULTRY FARMING AND WHAT IT MEANS . . . . .	7
II. LOCATION AND SITUATION . . . . .	41
III. MAKING A SUCCESSFUL START . . . . .	56
IV. THE BREEDS OF POULTRY . . . . .	63
V. SELECTION OF STOCK . . . . .	96
VI. PRINCIPLES OF POULTRY-HOUSE CONSTRUCTION . . . . .	104
VII. PRACTICE OF POULTRY-HOUSE CONSTRUCTION . . . . .	124
VIII. POULTRY FIXTURES . . . . .	143
IX. YARDS AND YARDING . . . . .	158
X. PRINCIPLES OF POULTRY FEEDING . . . . .	169
XI. POULTRY FEEDS . . . . .	184
XII. PRACTICE OF POULTRY FEEDING . . . . .	204
XIII. PRINCIPLES OF POULTRY BREEDING . . . . .	221
XIV. PRACTICAL APPLICATION OF BREEDING PRINCIPLES . . . . .	245
XV. MANAGEMENT OF THE LAYING STOCK . . . . .	266
XVI. MANAGEMENT OF THE BREEDING STOCK . . . . .	281
XVII. ANATOMY AND PHYSIOLOGY OF THE FOWL . . . . .	292
XVIII. FORMATION OF THE EGG AND CHICKEN . . . . .	300
XIX. NATURAL INCUBATION AND BROODING . . . . .	312
XX. ARTIFICIAL INCUBATION . . . . .	326
XXI. ARTIFICIAL BROODING . . . . .	348
XXII. CARE OF THE GROWING STOCK . . . . .	368
XXIII. BROILERS, ROASTERS, AND CAPONS . . . . .	376
XXIV. FATTENING, KILLING, AND DRESSING . . . . .	403
XXV. MARKETING THE PRODUCTS . . . . .	422
XXVI. RECORDS, ACCOUNTS, AND ADVERTISING . . . . .	453
XXVII. EXHIBITING AND JUDGING . . . . .	473
XXVIII. PARASITES, DISEASES, AND ENEMIES . . . . .	496
APPENDIX . . . . .	516



## ILLUSTRATIONS.

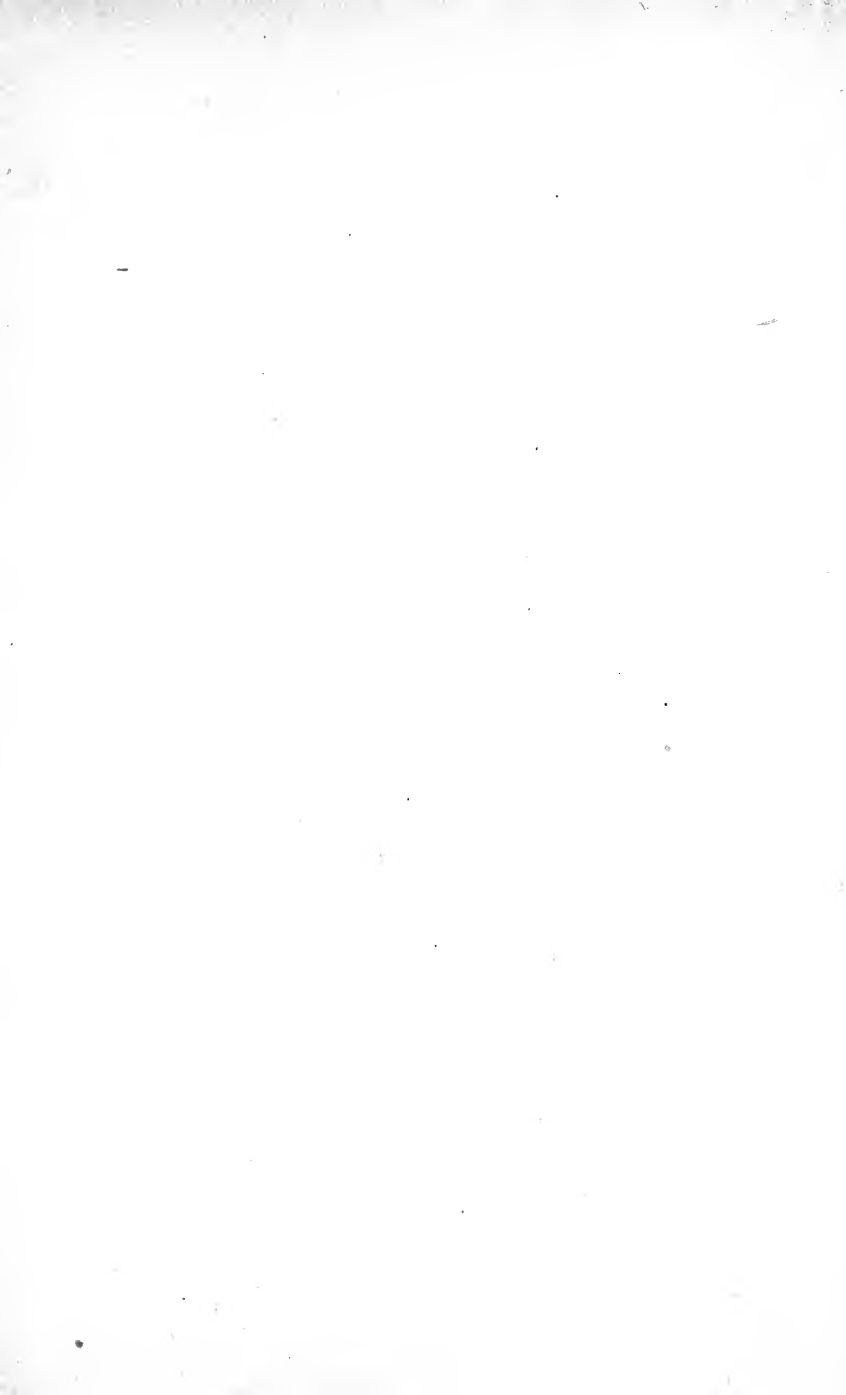
FIG.	PAGE
The Farm Flock.....	<i>Frontispiece</i>
1. Agricultural "Gospel" Train.....	2
2. A Type of Poultry Educational Exhibit.....	3
3. Students Constructing a Poultry House.....	4
4. Students Killing and Picking Poultry.....	5
5. A Modern Farm Poultry Plant.....	8
6. Distribution of Poultry in the United States.....	10
7. Noted Centres of Poultry Production.....	11
8. A Typical Farm Flock in the Middle West.....	12
9. A Large Laying Flock, Petaluma, California.....	13
10. A Large Breeding Flock, Petaluma, California.....	13
11. Interior of Commercial Hatchery, Petaluma, California.....	13
12. A General View in the Petaluma District.....	14
13. A Laying House Common in the Vineland District, N. J.....	15
14. Each House is a 200-bird Unit (Vineland).....	16
15. A House Holding 1000 Birds at Vineland.....	16
16. Scenes from the Little Compton District, R. I.....	17
17. Roaster Growing by Intensive Methods, South Shore District.....	18
18. Well-grown South Shore Roasters.....	18
19. Incubator Cellar, South Shore District.....	19
20. Poultry Plant of the New Jersey State College of Agriculture.....	20
21. Refrigerator Car for Shipping Dressed Poultry and Eggs.....	21
22. Car for Shipping Live Poultry.....	21
23. A Farm for Intensive Egg Production.....	27
24. A Farm for the Production of Fancy Poultry.....	27
25. Poultry on a Yorkshire Farm, England.....	36
26. Plant of a Fancy Poultry Keeper in England.....	36
27. An English Scene of Intensive Poultry Keeping.....	37
28. A Typical Danish Poultry House.....	38
29. A Danish Egg-grading and Packing Room.....	39
30. Rural Trolley Express.....	43
31. Systems of Poultry Farming.....	45
32. Large Community Poultry House.....	46
33. Semi-community Poultry Plant.....	47
34. Colony Houses for Poultry on Extensive Range.....	47
35. Ideal Location for Poultry Farming.....	49
36. Houses and Yards on a Hillside, Giving Good Drainage.....	51
37. Gallus Bankiva Pair.....	63
38. A Pair of Aseel Fowls.....	64
39. Shapes of American Breeds.....	68

40. Buff Orpington Pair.....	69
41. Light Brahma Hen.....	72
42. Buff Leghorns.....	72
43. A Pair of Mottled Anconas.....	74
44. A White Orpington Pair.....	74
45. Black Orpington Hen.....	75
46. Black-tailed White Japanese Bantams.....	77
47. Ideal Egg Shape.....	78
48. A Campine Pair.....	79
49. Single-comb White Leghorns.....	81
50. Single-comb Black Minorca Pair.....	82
51. Ideal Shape of the Meat Type.....	83
52. Buff Cochin Pair.....	84
53. Black Langshan Pair.....	86
54. Ideal General-purpose Shape.....	87
55. Comparison of the Three Utility Types of Poultry.....	88
56. The Most Popular Farm Breed of Poultry—B. P. Rocks.....	90
57. White Plymouth Rock Pair.....	90
58. An Excellent General-purpose Breed—White Wyandottes.....	91
59. Silver Wyandottes.....	92
60. Rhode Island Reds.....	92
61. The Cornish Game.....	93
62. A Comparison of Texture of Meat.....	97
63. Eggs from Pure Breeds and from Mongrels.....	98
64. Antiquated Type of Poultry House.....	104
65. Modern Type of Poultry House.....	105
66. Floor of Standard Multiple-unit Laying House.....	107
67. An Efficient Rear Ventilator for Summer Use.....	109
68. Three Types of Laying Houses.....	111
69. Diagram Showing Lines of Sun's Rays.....	112
70. Shapes of Houses Compared, Showing Amount of Wall Material Required.....	113
71. The Possible Growth of the Multiple-unit Plan.....	113
72. Six Types of Roofs for Poultry Houses.....	114
73. A Well-framed Poultry House.....	115
74. Four Plans for Foundation and Floor Construction.....	116
75. Four Styles of Doors for Poultry Houses.....	119
76. Three Plans for Placing Openings in the Front Wall.....	120
77. Types of Poultry Windows.....	121
78. Two Plans for Constructing Frames for Muslin Curtains.....	122
79. Cross Section of Hillside, Showing Manner of Grading.....	124
80. Diagram Showing Method of Laying Out Foundation.....	125
81. Five Steps in the Construction of a Concrete Foundation.....	126
82. Placing Fresh Concrete in Forms for Wall.....	127
83. Working Plans of Double-unit Laying House.....	129
84. Frame of Standard Multiple-unit Laying House.....	130

85. Double-unit House Completed .....	131
86. Working Plans of Small-unit Laying House .....	132
87. Small-unit Laying House Completed .....	133
88a, b. Working Plans of Laying House with Two-thirds Span Roof	134-135
89. Laying House with Two-thirds Span Roof.....	136
90. Interior View of Two-thirds Span House.....	136
91a. Working Plans of Half-monitor Laying House.....	137
91b. Half-monitor Type of Laying House in Process of Construction and Nearing Completion .....	138
92a. Working Plans of Portable Laying House.....	140
92b. Portable Colony Laying House Completed .....	141
93. Arrangement of Nests, Perches, and Dropping Boards .....	144
94. Roosting Closets to Prevent Drafts at Night.....	145
95. Four Ways of Locating Nests.....	147
96. Dark Wall Nests, Arranged in Tiers .....	148
97. Coops for Broody Hens.....	148
98. Pearl or Maine State Trap Nest.....	149
99. Improved Connecticut Trap Nest.....	149
100. The Cornell Trap Nest.....	150
101. Common Types of Feeding Troughs.....	153
102. A Home-made Dry-mash Hopper .....	154
103. A Practical Drinking Fountain.....	155
104. A Hopper for Grit and Shell.....	156
105. A Group of Commercial Feeding Appliances.....	157
106. A Good Method of Double Yarding and Crop Rotation.....	159
107. Three Methods of Arranging Double Yards.....	161
108. Forms for Making Concrete Fence Posts.....	162
109. Manner of Bracing a Corner Fence Post.....	163
110. A Common Type of Fence Construction.....	165
111. Ways of Bracing Gate Posts.....	166
112. Types of Gate Construction.....	167
113. Graphic Representation of the Composition of the Bird's Body ...	170
114. Cross Section of Wheat Kernel.....	188
115. Rack for Sprouting Oats.....	189
116. A Tray of Sprouted Oats Ready for Feeding.....	190
117. Mangel-wurzel Beets at Harvest Time.....	199
118. Poultry Feed House, Centrally Located.....	205
119. The Poultry Feed Wagon.....	207
120. Morphological Variation, Illustrated with Chicks.....	236
121. Substantive Variations, Light and Dark Males.....	237
122. Meristic Variation, Four-legged Chick.....	238
123. Functional Variation, Eggs of Different Sizes.....	239
124. Rumpless Birds, a Mutation.....	240
125. Inbreeding Chart, Showing Distribution of Inherited Characters...	247
126. Line Breeding Chart.....	249
127. "Lady Lay More," a Wonderful Hen .....	253

128. Strong and Weak Males.....	255
129. Wedge or Angular Shape Common in Good Layers.....	257
130. Belle of Jersey and Lady Cornell, Two Phenomenal Hens.....	258
131. A Light Brahma Pair.....	260
132. An Example of Sexual Dimorphism.....	261
133. A Prize-winning Pair of Columbian Wyandottes.....	262
134. Relation Between Yield, Temperature and Selling Price of Eggs..	266
135. White Leghorns.....	267
136. Ideal Individuals of the Single-comb White Leghorn Breed.....	268
137. A Large-unit Laying Flock.....	271
138. A Simple and Efficient Disinfecting Outfit.....	273
139. The Egg-collecting Pail.....	287
140. Desirable and Undesirable Types of Hatching Eggs.....	288
141. Skeleton of the Fowl.....	293
142. The Digestive Tract.....	296
143. Circulatory System of the Fowl.....	297
144. Male Reproductive System.....	298
145. Female Reproductive Organs.....	301
146. Parts of the Completed Egg.....	303
147. Abnormal Eggs Compared with Normal One.....	306
148. Chick Embryo Thirty-six Hours Old.....	308
149. Chick Embryo Three Days Old.....	308
150. Hatching Time.....	311
151. Two Common Types of Sitting Coops.....	316
152. Manner of Toe Punching for Baby Chicks.....	321
153. A Good, Yet Simple, Chick Leg Band.....	322
154. An Average-sized Flock by Natural Incubation.....	324
155. Working Plans for Incubator Cellar.....	328
156. Views Showing Construction of Hollow-tile Incubator Cellar.....	329
157. A Common Type of Hot-air Incubator.....	331
158. Modern Mammoth Incubators.....	332
159. A Complete Self-regulating Device for Incubators.....	333
160. Interior View of Incubator Cellar.....	340
161. A Useful, Home-made Egg Tester.....	343
162. Eggs Seven Days in Incubator as Seen When Tested.....	344
163. Three Different Types of Long Brooder Houses.....	349
164. Mammoth Hot-water Brooders.....	351
165. Portable Indoor Hovers.....	352
166. Small Portable Outdoor Brooders.....	352
167. Colony Brooder Houses.....	353
168. Portable Gasoline Brooder Houses.....	355
169. Chicks Showing Pronounced Symptoms of White Diarrhœa.....	364
170. Growing Poultry on Free Range.....	369
171. Rearing Chickens under Intensive Conditions.....	370
172. A Desirable Rotation of Crops for Poultry Runs.....	372
173. Four Types of Summer Developing Houses.....	373

174. A Flock of Fowls Ready for Market.....	377
175. Market Types of Broilers.....	379
176. Curves Showing Variation in Supply and Prices for Broilers.....	380
177. Rhode Island Red Broilers Ready for Market.....	382
178. Market Types of Roasting Chickens.....	387
179. Curve Showing Variations in Market Prices for Roasters.....	388
180. A Flock of Capons Five Months Old.....	390
181. Caponizing Instruments.....	394
182. Proper Place to Make Incision in Caponizing.....	395
183. Steps in the Operation of Caponizing.....	396-397
184. Comparison of Weights with Capon and Cockerel.....	401
185. A Portable Battery of Feeding Coops.....	405
186. Common Type of Funnel Used in Cramming.....	408
187. Cramming Machine.....	408
188. Proper Method of Sticking and Dry Picking.....	411
189. An Excellent Killing Knife.....	412
190. Dry Picking Squab Broilers.....	415
191. Scalding Poultry.....	416
192. Roaster Properly Dressed for Retail Trade.....	419
193. Chart Showing Course of Products from Producer to Consumer....	425
194. The Relation of Temperature to Selling Price of Eggs.....	430
195. Interior of Mercantile Exchange, New York City.....	431
196. Egg Grading Table in Use.....	434
197. A Popular Manner of Packing Eggs for Shipment.....	436
198. Effect of Incubation Temperature on Fertile and Infertile Eggs....	438
199. Stages in the Development of the Embryo.....	439
200. A Commercial Egg Candler at Work.....	441
201. Boxes for Shipping Baby Chicks.....	444
202. Undesirable Types of Market Broilers.....	445
203. Soft Roasters Ready for Market.....	445
204. Methods of Packing Fancy Grades of Dressed Poultry.....	446
205. Broilers Box-packed and Iced for Shipment.....	447
206. Three Methods of Keeping Records.....	463
207. Students Washing Live Birds for Exhibition.....	480
208. The Technic of Washing.....	481
209. Baltimore Poultry Exhibit.....	484
210. A Body Louse.....	507
211. A Red Mite.....	508
212. A Scaly-leg Mite.....	508
213. The Work of the Scaly-leg Mite.....	509
214. The Gapeworm.....	511
215. The Common Roundworm.....	511
216. The Tapeworm.....	512
217. Parts of Fowl Shown and Named.....	515





# PRODUCTIVE POULTRY HUSBANDRY.

## INTRODUCTION.

### THE TEACHING OF POULTRY HUSBANDRY.

THE DEMAND for the teaching of poultry husbandry in the public schools and colleges is increasing constantly. Nearly all the State colleges and universities are giving considerable time to its study. All secondary schools of agriculture rank poultry instruction with such subjects as dairying and fruit growing. Recently elementary schools have commenced giving the subject of poultry farming a place in their agricultural teaching.

During the last few years the poultry industry has witnessed an immense growth in popularity. This has been due to several factors: The activity of the poultry press; the many poultry systems; attempts to meet the high cost of living; and a "back to the land" movement on the part of city people.

*The needs* for poultry instruction may be classed as follows: (1) To develop the best system and systematize the various practices; (2) to train men to qualify as managers of large poultry operations; (3) to train all classes of poultrymen to get the most from their birds.

*Diversity of Instruction.*—Poultry keeping involves a clear understanding of many sciences and practices. An outlined course of study must so present these topics that the amateur and practical poultry keeper can grasp the various phenomena as they affect the successful handling of poultry, without an extensive study of the principles underlying the entire science. For example, the principles and practices of feeding must show enough of the chemistry of feed and of digestion to give the student the reasons underlying the practices in feeding. The same might be said of breeding, housing, and sanitation.

*The Value of Practical Application.*—It is very desirable that all students have some previous experience in the handling of a

flock of birds. Such experience will put the student in a position to see the importance of the various lines of instruction. If such previous practice is lacking, much of the value of the work will unconsciously be lost, owing to the inability to grasp the practical application.

**Types of Instruction.**—Poultry instruction of different kinds may be classified as elementary, secondary, collegiate, extension teaching, correspondence courses, and educational associations.

*Elementary instruction* should start in the grammar grades of the public schools, and deal with the external appearance and functional activities of birds of all kinds and of poultry in particular. Many fundamental points may be considered. The student's interest in this line of agriculture may be aroused.



FIG. 1.—Agricultural "Gospel" train (Cornell).

*The secondary instruction* is that given in high schools and schools of agriculture. The work at this time should deal with methods, care, and management; and study may be made of different types and breeds.

*Collegiate instruction* is not only a review of general principles and practices, but it should deal with the deeper scientific principles which underlie all operations. It should consider the economic principles, methods of management, markets, and the relation of supply and demand. Much time during the latter part of the course may be given to original investigation and research work.

*Extension teaching* may be termed the "follow-up" method of instruction, which should be organized as a part of the work of colleges and universities. It should be available not only to stu-

dents but to all persons interested in the keeping of poultry, whether beginners or experienced farmers. Such instruction gives to the poultryman at his home the latest knowledge pertaining to his work. It shows in a concise manner the results of recent investigation and its practical application.

Some of the methods of extension work are as follows: (1) Extension lectures before agricultural and special poultry gatherings. (2) Railroad-train trips through centres of poultry production (Fig. 1). Teaching carried on by lectures and educational exhibits. (3) Educational exhibits at fairs, poultry shows, and grange picnics (Fig. 2). (4) The publication at regular intervals



FIG. 2.—A type of poultry educational exhibit.

of home-reading-course circulars which tell in a concise way the practical application of the latest findings from poultry experiments. (5) Demonstrations showing improved and scientific methods, such as killing, picking, caponizing, grading, and packing.

*Correspondence courses* allow of individual study of a prepared set of lessons and practices; the benefit obtained depends upon the practicability and completeness of the outlined lessons, and the ability of the student to grasp the meaning and to pursue the course until finished. The failure to study all lessons to the end of the course often results in little good to those who attempt to gain their knowledge in this way.

*Educational Associations.*—The possibilities of poultry organization for purposes of education are great. The association may have a broad constitution so that it may, if desired, conduct co-operative buying and selling. The educational feature is usually attained through regular meetings, at which systematic lectures or lessons are outlined and discussed. Much may be gained from general discussion of methods and practices, by members.

**Laboratory Practice.**—In any course of instruction, whether it be elementary or collegiate, the lectures and lessons should be supplemented by as much practical work as equipment and time

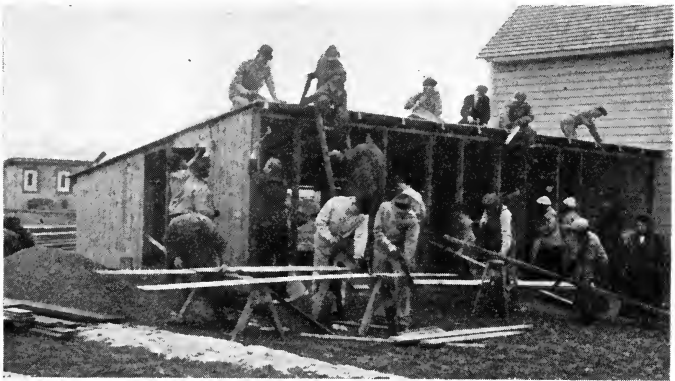


FIG. 3.—Students constructing a poultry house.

will permit. The practice work impresses upon the student the value of one method over another. The efficiency of the instruction is thus greatly increased. The following list includes a few of the more practical operations which should accompany a collegiate course of instruction:

The entire care of a flock of laying birds for a given period, including a complete record, showing cost and income.

The actual work of designing, drawing, and constructing poultry houses (Fig. 3).

Incubation and brooder practice.

Methods of fattening, killing, and marketing poultry (Fig. 4).

The grading and marketing of eggs.

The judging of poultry and the management of a student poultry show.

There are many more important laboratory operations of a scientific nature.

**Collateral Reading.**—All lectures and discussions should be accompanied by a required amount of outside reading. Only standard books and periodicals should be recommended, and from the results of such reading written or oral reviews should be given. Poultry literature from the Department of Agriculture and the



FIG. 4.—Students killing and picking poultry (Cornell).

various experiment stations should be freely used in reference work. Any one may obtain poultry publications from the experiment station of his own State by having his name placed upon the mailing list.

In an exhaustive study of various poultry text-books there will appear an apparent lack of unity on many important points. This in some cases is due to the fact that the present knowledge does not allow complete and positive decision on some points; in other cases the difference is not real, but incomplete statements lead to misunderstanding. A careful analysis, however, will show

a general unity of belief among the standard investigators in regard to nearly all fundamental principles and practices.

**Home Experiments.**—In all types of instruction home practice and experimental work should be encouraged. Each student should be urged to take an interest in the management of the home flock, where possible, starting with the elementary work. This will enthuse the student and create an interest in the work. As the student progresses he may keep a record of the egg yield, cost of feeds, and production of the home flock, and from these data the profits may be calculated.

## CHAPTER I.

### POULTRY FARMING AND WHAT IT MEANS.

POULTRY KEEPING as an industry is so important a subject that at the commencement it is necessary to outline just what is meant by the term "POULTRY FARMING." As the term is generally used we think of it as meaning an exclusive business, as fruit growing or grain farming; with this idea of the subject before us the outlook is not always the brightest.

**Does it pay?**—The general belief is that poultry farming does not pay, and this is only too true in many cases when the term is applied in the sense outlined above. There is no branch of animal husbandry in which so many experimental starts have been made and which have resulted in total ruin as in poultry farming. This is probably due to at least two causes: (1) Beginning with too large an investment of capital and stock which requires an immense amount of energy and money to keep running; or (2) in many cases the business has been ruined at the outset by the inexperience of the promoters who were made to believe, by misleading statements and fascinating statistics, that poultry keeping is the quickest road to a large fortune. While there are many large, exclusive poultry farms which are paying good dividends, and this number is constantly on the increase, yet the true meaning of the term poultry farming does not lie in this phase of the work.

How, then, is the greatest chance of success to be attained? It is by considering poultry keeping as a branch of the farmer's operations and making it one of the many departments of his work. Such a combination brings him continuous profit and pleasure. The large, exclusive poultry plants should be left to those who have had years of experience in the care and management of birds as well as the sale and marketing of the products. By starting the business as a branch of general farming, experience will come as the work goes on, and a careful and systematic increase in the size and production of the plant can be arranged so that the poultry keeper can measure his capacity for large things as the increase accumulates. It is with this thought in view that the subject of poultry farming is approached, the object being to show farmers and amateur poultry keepers that in poultry keeping there

is money to be made, money which in many cases could not be realized at all if it were not for this branch of farming (Fig. 5).

**The Poultry Industry in the United States.**—The United States census bureau takes an enumeration of the poultry interests when taking the regular census every ten years. A brief survey of the last poultry census is interesting. The practice is to consider only



FIG. 5.—A modern farm poultry plant, where poultry raising is a profitable "side line" to general farming.

fowls three months of age or over and only those kept on farms, no enumeration being provided by law for cities, towns, or villages. The elimination of the poultry in these other centres greatly reduces the reported number kept and produced in the United States. Investigations made in New Jersey show that incorporated cities in the State have one adult bird within the city limits for every two and one-half persons enumerated in the census. It is supposed that this will run much higher in towns and villages.

The following table shows the number and value of birds reported by the thirteenth census, compared with the number in the twelfth census.

TABLE I.—United States Poultry Census.

	All fowls.	Chickens.	Turkeys.	Ducks.	Geese.
1910—Number.....	295,880,190	280,345,133	3,688,708	2,906,525	4,431,980
Value.....	\$154,663,220	\$140,205,607	\$6,605,818	\$1,567,164	\$3,194,507
Average value....	\$0.52	\$0.50	\$1.79	\$0.54	\$0.72
Farms reporting..	5,585,032	5,578,525	871,123	503,704	662,324
Per cent of all farms.....	87.8	87.7	13.7	7.9	10.4
1900—Number.....	250,624,038	233,566,021	6,594,695	4,785,850	5,676,788

The table shows that 94.7 per cent of all birds reported were domestic fowls which are classified as "chickens," in distinction



from the other kinds of poultry. There was an increase in chickens of 17 per cent. The average value per fowl in 1910 was fifty-two cents, while in 1900 it was only thirty-four cents, the average value having increased over 52.9 per cent.

Table II shows the number and value of chickens, reported by geographic divisions.

TABLE II.—*Geographic Distribution of Fowls.*

Division or section.	Chickens.			
	Number.			Value.
	1910.	1900.	In-crease.	1910.
			<i>Per cent.</i>	
United States . . . . .	280,345,133	233,566,021	20.0	\$140,205,607
New England . . . . .	6,841,918	6,440,678	6.2	4,975,551
Middle Atlantic . . . . .	24,449,500	21,511,436	13.7	16,346,161
East North Central . . . . .	69,471,413	58,104,189	19.6	36,609,410
West North Central . . . . .	85,192,651	65,364,879	30.3	41,207,295
South Atlantic . . . . .	25,627,003	22,293,912	15.0	11,894,700
East South Central . . . . .	24,495,054	22,965,751	6.7	10,272,636
West South Central . . . . .	29,176,294	27,333,880	6.7	10,393,418
Mountain . . . . .	5,467,343	3,116,639	75.4	3,005,103
Pacific . . . . .	9,623,957	6,434,657	49.6	5,501,333
The North . . . . .	185,955,482	151,421,182	22.8	99,138,417
The South . . . . .	79,298,351	72,593,543	9.2	32,560,754
The West . . . . .	15,091,300	9,551,296	58.0	8,506,436
East of the Mississippi . . . . .	150,884,888	131,315,966	14.9	80,098,458
West of the Mississippi . . . . .	129,460,245	102,250,055	26.6	60,107,149

It will be seen that in 1910 the West North Central division reported 30 per cent of the total number of fowls in the country. The East North Central division ranked next with 24.3 per cent, and the West South Central next with 10.6 per cent.

Figure 6 shows graphically the distribution of fowls by States and divisions.

The number of farms reporting fowls raised in 1909 was 5,655,754, or 88.9 per cent of all farms in the United States; and the number of such fowls was 488,468,354, or an average of 86.4 fowls per farm. The total value of such fowls was \$202,506,272, as against \$136,830,152 in 1899. The value of the poultry produced during the decade shows an increase of over 48 per cent.

In 1909 there were produced in the United States 1,591,311,371 dozens of eggs, valued at \$306,688,960. The production in 1899 was 1,293,662,433 dozens of eggs, and the value \$144,240,541. While the production of eggs during the ten years increased but twenty-three per cent, the value more than doubled, the exact amount of gain being \$162,488,419, or 112.6 per cent. These numbers show an increase in the value of poultry and poultry

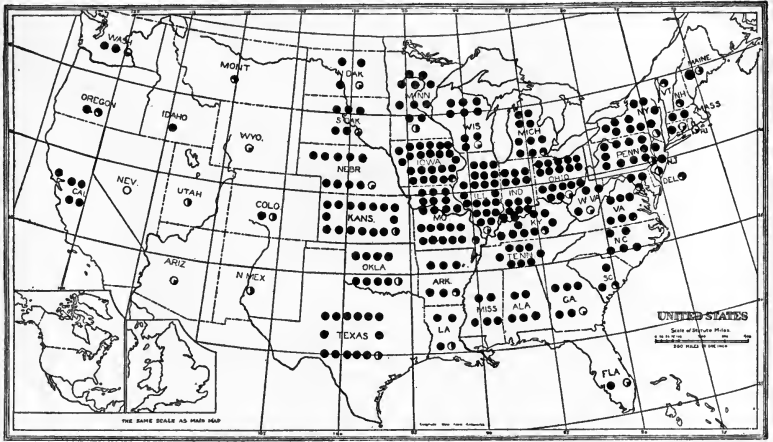


FIG. 6.—Distribution of poultry in the United States. Each black dot represents one million birds on farms.

products. This has been brought about by an increased demand for good products and by an improvement in quality of products.

The ten States leading in their total value of poultry are:

Iowa.....	\$12,270,000	Indiana.....	\$7,762,000
Missouri.....	11,871,000	Pennsylvania.....	7,674,000
Illinois.....	11,697,000	Kansas.....	7,377,000
Ohio.....	9,533,000	Michigan.....	5,611,000
New York.....	7,879,000	Texas.....	4,807,000

In these ten States the total value of the poultry is \$86,481,000, or 55.9 per cent of the total value of poultry in the continental portion of the United States.

**Noted Centres of Production.**—While the production of eggs in the United States is widespread, only the central States of Ohio, Indiana, Illinois, Iowa, Minnesota, Nebraska, Kansas, Missouri, Texas, Tennessee, and Kentucky produce more than are consumed in their immediate vicinity. The great numbers of

eggs shipped to the eastern markets are classified as "westerns" and come from this section of the country. This section constitutes the "backbone of the egg industry," and a brief account of the conditions is here given (Fig. 7).

In the Central States production is not continuous throughout the year, as climatic conditions affect the laying. In Kentucky and Tennessee the season of natural production is from December

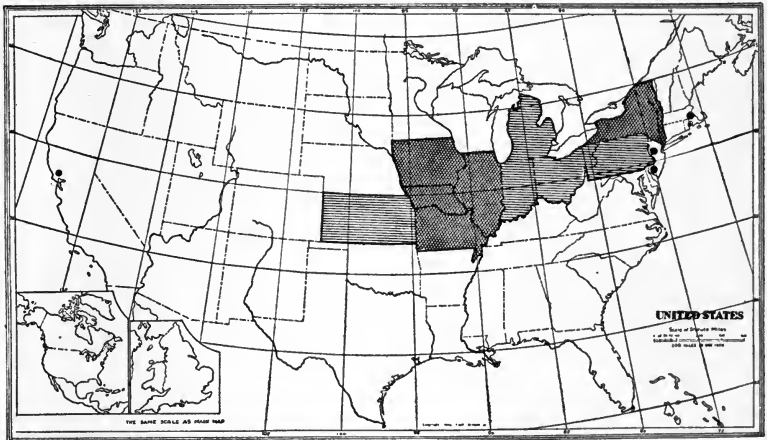


FIG. 7.—Noted centres of poultry production. In California the Petaluma district; in Massachusetts the "South Shore" Roaster district; in Rhode Island the Little Compton district; in New Jersey the Hunterdon and the Vineland districts. Darkly shaded States are the leading poultry States, lighter shaded ones come next.

to April. During March and April the supply from Ohio and Missouri appears on the market; this is supplemented by eggs from Texas and Kansas. Later in the spring the central northern States, Minnesota and Michigan, supply the markets with eggs. The supplies of both the southern and northern sections of this egg belt fail to meet the demand of the consuming public. The population in this section is limited, and large quantities of eggs are shipped to the centres of population to supplement production in those sections. Owing to the cheap price of grain and land, the eggs from central sections compete very profitably with those produced near large markets, even with lower prices and poorer quality.

The eggs produced during the early spring are usually of fine quality. But they are produced on farms where advantages of

grading are not appreciated, and are handled so carelessly that the quality is often very bad when they reach the point of consumption. Conditions are worse during late spring and early summer, when the weather is warm and extra care is necessary to cause the eggs to reach the market in good condition.

The eggs produced in this section are sold to local merchants, "case count," and often hauled many miles over rough roads and exposed to hot sunlight before being sold. They are then often held many days, and are finally shipped by local freight to some



FIG. 8.—A typical farm flock in the Middle West. (Photo by U. S. Dept. of Agriculture.)

central shipping point where they are candled and graded. The loss during the warm months is very great. The price drops all along the line, because the quality is poor.

Improved methods in marketing can best be attained through coöperation. A general practice on the part of merchants to buy all eggs "loss off" will do much to increase the quality. This will bring greater returns to the poultry raisers in this great territory (Fig. 8).

*The Petaluma district of California* is well known by the general public and poultry raisers as one of the most intensive egg-producing centres of the country (Fig. 9). The industry is confined to a limited area near Petaluma, California, and is carried on by very intensive artificial methods. The chief product is white-shelled eggs of high quality for the large markets on the western coast. The farms are small, ranging from five to fifteen

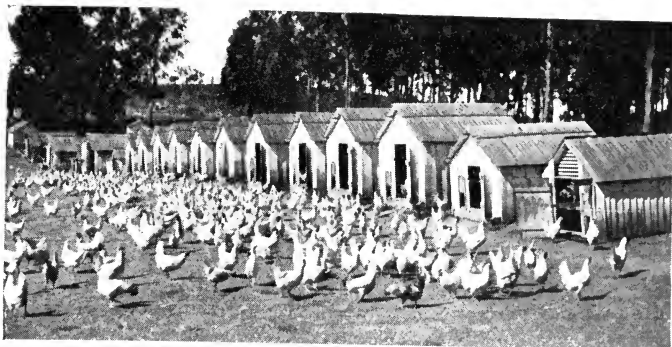


FIG. 9.—A large laying flock, Petaluma, Cal., with characteristic portable laying houses.

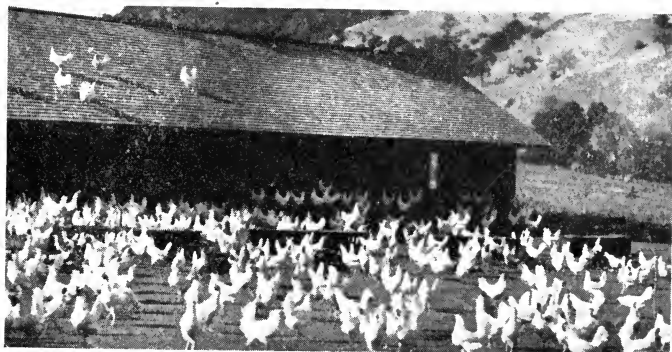


FIG. 10.—A large breeding flock at a commercial hatchery, Petaluma, Cal.

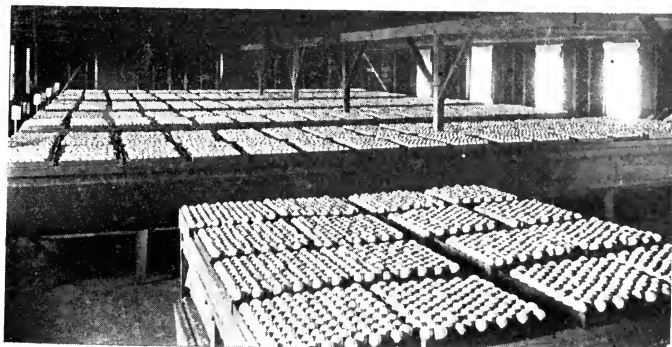


FIG. 11.—Interior of a commercial hatchery, Petaluma, Cal.



FIG. 12.—A general view in the Petaluma district, Cal.

acres. The birds are kept in large flocks, having the entire range of the farm; and the houses are often located in groups. Each poultry farmer simply cares for his mature stock, as there are often as many as two thousand birds on a five-acre farm. All hatching and much of the early brooding is done by specialists who own and operate large commercial hatcheries (Figs. 10 and 11). Most of such establishments have their own breeding stock. The egg producers keep no males with their flocks, but buy enough chicks from the hatchery to supply their needs each year. The breeding birds on such hatching plants are given free range; and care in mating and breeding is practised to maintain a high degree



FIG. 13.—A laying house common in the Vineland district, N. J.

of vitality. The methods at Petaluma are different from those practised elsewhere in America, and poultrymen will watch with much interest the intensive methods being followed there (Figs. 9, 10, 11, and 12).

*The Vineland district in New Jersey* is another specialized section, which resembles, in many respects, the Petaluma district. It centres around the city of Vineland (Figs. 13 and 14). The white Leghorns are kept, with the object of supplying the New York City market with white-shelled eggs of highest quality. The farms in this section are small, ranging from one to ten acres. Each farm has from five hundred to two thousand layers (Fig. 15); but there are some exceptionally large farms in the same community. Most of the farmers hatch and rear their own birds, artificial methods being the most common. The birds are kept,

two hundred to five hundred together, in long, shed-roof laying houses. The soil is very sandy and the winters mild, thus offering ideal conditions for such large flocks. The district comprises about ten square miles. It is estimated that over one hundred thousand adult Leghorn fowls are here kept under these intensive conditions.



FIG. 14.—Each house is a 200-bird unit (Vineland).

*Hunterdon County.*—There is another section in the same State which comprises the whole of one county,—namely, that of Hunterdon, in the north-central part of New Jersey. It is primarily a section for general and dairy farming. But upon each farm there are usually kept from two hundred to one thousand laying hens, white Leghorns predominating. The object is white



FIG. 15.—A house holding one thousand birds at Vineland. Large units are coming into more general use.

eggs for the New York City markets. This county alone winters over three hundred thousand laying hens. The methods practised in this district are noticeably extensive, the farms being large and the birds being given unlimited range. This is one of the oldest egg-producing sections of note in America, and the extensive methods practised for years are still proving the most profitable under the existing conditions.



The *Little Compton district* in Rhode Island produces brown eggs for the New England markets. Here the colony system is exclusively used (Fig. 16). The birds are kept in small flocks, in isolated houses scattered over a large area and no fences are used. The feeding and watering are done from wagons at regular inter-



FIG. 16.—Scenes from the Little Compton district, R. I. Note the extensive colony system and the cheap houses. (Photos by P. W. Almy.)

vals. Owing to the poor character of the soil, general farm crops are not profitably grown. In this district the cost of production of eggs is small, and the financial returns are good. This is due to the reduced labor and the small investment in houses. Natural methods in hatching and rearing are almost entirely used.

*Market Poultry.*—There are two sections interesting for their

production of market poultry, the soft roaster district, commonly known as the South Shore district of eastern Massachusetts, and the capon district of New Jersey.



FIG. 17.—Roaster growing by intensive methods, South Shore district. (Photo by E. O. Damon, owner.)

*The South Shore district* is noted for the high quality of soft roasting chickens which are marketed. The work is usually secondary to other lines of agricultural endeavor; but there are many



FIG. 18.—Well-grown South Shore roasters. (Photo by E. O. Damon, owner.)

specialized plants, producing from two thousand to six thousand roasters in a season (Figs. 17, 18, and 19). The smaller producers raise from one hundred to five hundred. The profit from this work is very satisfactory, ranging from eighty cents to one dollar

per bird. This is due to the short period necessary to hold each individual before selling.

The *capon district*, previously mentioned, is made up of thousands of general farms in the western part of central New Jersey. Each farmer raises yearly from one hundred to five hundred capons for the Philadelphia and New York markets. The birds are given free range throughout the entire period of their growth, and are allowed to roost in sheds or other outbuildings. The cost for feed is low, as grain farming is practised quite commonly and the birds have the run of the fields after harvest. The profit per bird under the existing conditions varies from one to two dollars. The practice of caponizing is gaining rapidly in this section, owing to the success of those already engaged in this work.



FIG. 19.—Incubator cellar in the South Shore district, Mass., showing economical construction with field stones laid in mortar. (Photo by E. O. Damon, owner.)

#### Modern Developments.—

Recent years have witnessed great changes in the poultry industry. The changes have been toward greater concentration and specialization. There are now many exclusive egg farms scattered over the more thickly populated sections. Many of them have from two thousand to fifteen thousand layers. This specialization has placed the poultry business upon a scientific basis. This development of special egg farms has brought about great improvements in methods of marketing. There is a closer relation between producer and consumer. This is largely accomplished by guaranteeing a strictly fresh and clean product, for a definite price above regular wholesale quotations. This naturally leads to more care in marketing the products and an endeavor to meet market requirements as they are found in the various sections.

The industry has taken on a very popular aspect, and many people who are engaged in occupations other than agriculture have gone into poultry raising in a small way. This popularity has called for and has been met by rapid development in the facilities for poultry education at the various State colleges, and poultry departments have been established at many experiment stations (see Appendix). The work of experiment stations tends to make poultry raising an exact science. Many colleges

offer short courses in poultry husbandry of from six to twelve weeks during the winter months, the time being devoted largely to lectures, demonstrations, and practical work (Fig. 20). These are of much value to the amateur who desires to become familiar with the details and requirements of the business, as well as to the practical poultryman who desires to become familiar with the most modern ideas pertaining to his occupation.

**Poultry Organizations.**—Among the greatest factors which are working for the improvement of the industry are the numerous organizations being formed in all sections. The majority were formerly organizations of fanciers, but the element of utility has more recently been included. Associations working

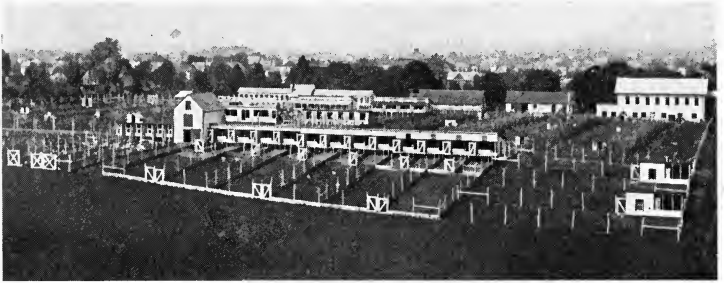


FIG. 20.—A plant used for instruction and experimental work, New Jersey College of Agriculture.

along both fancy and utility lines should do a great good. Organization for educational purposes alone is gaining ground every day. New Jersey, for example, has an association in each county and a State organization composed of delegates from each county association. Its main purposes are education and coöperation.

**Changes in Management.**—Great changes have been made in the general management of the flocks themselves. The most prominent of these is the general substitution of dry-mash feeding for wet mash. Another change is the housing of birds in open or curtain-front, well-ventilated houses, in contrast to the old types of closed, warm houses.

**Publications.**—The value of systematic advertising has become more fully recognized, as will be readily seen by an examination of the poultry press. This calls attention to another great development,—namely, that of poultry magazines and

papers. There are numerous periodicals devoted entirely to poultry topics. Aside from these, practically all the agricultural papers devote some space to the subject. Columns or departments are set aside for poultry matters in many daily and weekly newspapers. Some of the leading daily papers employ special poultry editors.

**The fattening industry** has not progressed in the same ratio as other branches. This is due largely to the fact that there is not enough demand for the high quality of meat which could thus be produced. When market requirements call for such artificial methods in producing better fowls, for table use, that branch will show a rapid improvement. That time is not far distant.



FIG. 21.—Refrigerator car used for shipping dressed poultry and eggs. An important factor in widening the market for the Western poultry keeper. (U. S. Department of Agriculture.)



FIG. 22.—Cars for shipping live poultry. (U. S. Department of Agriculture.)

**Duck Raising.**—The growing of broiler and roaster ducks has seen an almost unprecedented rise during recent years. Formerly very few were produced and it was very hard to market at a profit the few which were grown. With the advent of the meat-fed broiler, conditions changed. It did not then take long to educate the consumer to the desirability of having broiler ducks for table purposes. In certain sections of the East, especially, this industry has reached immense proportions. On Long Island there are many plants which annually produce over fifty thousand broiler ducks. It is undoubtedly one of the most remunerative branches of the entire industry.

**Shipping.**—The improved facilities for transporting poultry and eggs long distances by rail at a reasonable cost constitute a step in advance. Shipments are made under almost perfect storage and sanitary conditions by the extensive use of refrigerator cars by fast freight and express (Figs. 21 and 22).

**The Future.**—In view of the great developments which have taken place, combined with the constantly increasing demand for poultry of all classes, there is a very bright future for the industry as a whole.

**Poultry Keeping for Business and Pleasure.**—Profit is the main object of poultry farming, yet the pleasure which accompanies it is often an important consideration. The complexity of the branches makes it difficult to separate these two objects. All poultry keeping falls under one of the following heads: Poultry keeping (1) as a business; (2) as an employment; (3) as an investment; (4) for family use; (5) for fancy points.

*Poultry Keeping as a Business.*—This phase of poultry keeping is carried on by one who invests both his time and money in the enterprise. It may be either an exclusive poultry business or a side line to general farm operations. Many thousands of small producers consider poultry of secondary importance. The number of poultry keepers making a living from the production of eggs and poultry is rapidly on the increase. These have usually commenced the business in a small way, and have started to specialize as their experience grew.

To make the business successful, a man must have become expert in the care and management of fowls, must have a good business training, good judgment, and must be accurate, prompt, and methodical. These qualities are only gained by training and experience. The beginner has the example of many earlier poultry keepers to guide him, and thus the road to success is much quicker and surer; books and papers are within the reach of all; and practical instruction is easy to obtain after the rudimentary principles are learned. These must be secured before work, even for instructional purposes, can be obtained on any of the large plants.

A man should never start out in poultry keeping as an extensive business until he has learned it thoroughly by experience.

*Poultry keeping as an employment* is taken to include all examples where one gives his entire time to poultry work, receiving compensation for time so given. The demand for poultry labor, both skilled and unskilled, is constantly on the increase. The opportunities are very similar to those offered by other branches of farm work. The wages received by skilled labor vary with the experience and ability of the man, size of the plant, and the amount of responsibility assumed. The size of the plant is the smallest factor. The poultry laborer has fairly long hours of work and moderate rate of pay, but his work is sure to be steady. For one

who likes it, there is always a great pleasure to be derived from it as well as a great variety in the day's routine.

Unskilled poultry labor receives about the same rate of wage as the average farm laborer of the same locality; but there is a much greater chance for study and rapid advancement for those who are anxious and ambitious to reach better things.

The field of poultry labor lies open to young men who are desirous of taking up some form of farm work and who have not the time nor money to devote to an extended education along other lines of agriculture. A few months spent in one of the modern poultry short courses will equip an energetic and ambitious young man so that he can get a start. He can learn the fine points of the business by experience on poultry plants and, at the same time, get an income from it.

*Poultry Keeping as an Investment.*—This phase of poultry keeping is the placing of one's money in the poultry business without devoting any time or labor to its management. The investment of surplus funds where the investor does not manage the business is generally a bad policy. Success largely depends (1) on the selection of a manager, (2) on the owner's knowledge of the business and its requirements, and (3) on the amount of capital which can be used when necessity demands.

Poultry raising, being a business of details, requires very careful and conscientious management, more so than any other branch of farm work. The manager must be well trained in the practical side of poultry raising as well as the theoretical. The more years of actual experience he has had the better. If the one who is investing his funds in poultry work has a fair knowledge of the business in a practical way, good results are much surer. Location and situation with reference to markets are important items to be considered before making a heavy investment. If one has a large amount of capital, he is much surer of making a success; he is then able to meet any emergency of any kind and still continue the business. Set-backs and poor seasons will happen, and one should never invest his entire means. Keep a reserve to help in extreme cases.

The first investment should not be too heavy. It is better to start in a limited way until one can determine what the returns will actually be. The investment can be increased yearly as the business increases. A slow normal increase is much better and surer than an extremely rapid and abnormal one. Poultry keeping as an investment must be on a large scale, and it often takes years

to build up a large plant before it is on a paying basis. For this reason inexperienced investors often blame their managers for things which they cannot avoid. Due care should be exercised in the selection of the manager. Then it is best to outline the character of the work to be followed and leave the details to the manager.

Before investing in any way, one should get all information possible from all sources. A good poultry text-book should be supplemented by poultry journals. Take trips to large, up-to-date poultry plants; and make a study of general and local market conditions. There are many opportunities open to the investor which offer surer returns than poultry keeping. This is shown clearly when the conditions, causing the failure of so many of our large poultry plants, are studied closely.

*Poultry Keeping for Family Use.*—The object of keeping small flocks of poultry on most of our farms and suburban lots is twofold: (1) to supply eggs and fresh poultry for the home table; (2) to market, at a profit, what is not consumed at home.

On very many general farms, the fowls are considered as a side issue and of no great importance. Consequently, in the majority of cases, neglect is found and unsatisfactory results must be expected. There is usually no one to take special care of the birds; there is no judgment used in breeding—scrubs and mongrels are often kept; any house which will barely keep the birds dry is considered good enough; and scraps from the table and steady rations of corn are considered sufficient. Not until some member of the family, whether child or parent, takes hold of the matter and changes the improper conditions, does the flock show its true worth. It must be recognized that the farm flock, no matter what its size, has a direct financial value. The greater care and attention the fowls receive the greater will be the returns. By breeding and selection, the mongrels should be eliminated and pure-bred stock introduced. This will increase the value of the birds for market and breeding purposes. The birds must be given well-built and sanitary houses and proper feed to secure the products which are expected of them. Often a start made in this small way develops until the owner finds himself a breeder of no small rank.

The main purpose of the family flock is usually profit, and the pleasure side of it is often under-estimated. The owner should consider the fowls scattered about the home as an asset in beautifying the same, and making it more livable. They give the poorer man in the country and city who loves domestic animals a luxury



at small cost, for which his wealthy neighbor is willing to pay liberally. The family flock is usually a success so far as profit is concerned, as there is very little outlay in feed and time. The refuse from the table constitutes the bulk of the feed. So the eggs are produced at a smaller cost per dozen than would be possible if the birds were kept in large flocks, all of the feed purchased, and extra help needed to care for them. The beginner often reasons that if a few birds pay a large profit, then one hundred times as many birds will increase the profit one hundred fold. That such is not the case, he will find upon trial, to his own grief.

It is by the small flocks that the great mass of our market eggs and poultry are produced. Anything which tends to increase their productiveness and raise them from their inconspicuous place in the farmer's mind will do much for the industry.

*Poultry Keeping for Fancy Points.*—The breeding of fancy poultry means the breeding of high-class, pure-bred birds which approach perfection as near as possible. Each fancier must place before him a standard of excellence and strive to reach it. The exhibition of the best birds at poultry shows and the winning of prizes bring an income which pays well to the one who succeeds. Many fanciers breed poultry just for the joy and recreation which they get from it, yet the majority figure on a good financial profit as well.

Breeding fancy specimens which approach perfection is an art; it requires much careful thought and a training and study in the laws of breeding and selection. Usually a breeder selects one particular breed and devotes his entire attention to that. Sometimes it is the improvement of an old and well-established breed which is undertaken. At other times an entirely new breed is developed.

The poultry fanciers of to-day rarely depend upon the plumage pattern of their birds alone to bring them in the greatest return, but combine *utility* qualities with fancy points. Wherever the breeding of fowls for fancy points has been successfully carried on, there has always been a general improvement of the common stock. The fancier must never forget the utility qualities of his birds and sacrifice them for the finer fancy points. The result would be a general weakening rather than an upbuilding of the stock. The tendency of overestimating the value of some minor fancy points, to the sacrifice of utility, is rapidly disappearing.

Many of our most noted breeders of to-day started with a small beginning and by breeding for quality rather than quantity

have achieved marked success. The breeders of pure-bred poultry have united in forming National and State organizations. Every breed has its favorites who have formed special breed associations and clubs for the advancement of that particular breed. One of the largest and most extensive poultry organizations in the world is the American Poultry Association. Its members represent the leaders in all branches of poultry throughout America.

When once having started to breed pure-bred birds, due vigilance and care in management and in breeding must be maintained. Birds left to shift for themselves will tend to revert to the former type and usually become less beautiful and less useful.

The field of the breeder of fancy and pure-bred poultry is limitless.

**Separate Poultry Industries.**—Poultry keeping as an industry may be grouped under two main divisions,—namely, exclusive poultry keeping, and poultry keeping as a side line to some other branch of work. The former is properly called specialized farming, as all endeavors of the farmer are centred on the care and management of poultry. In the majority of cases poultry keeping is carried on as a side line. The extent of that one branch of the farm work may vary from a very small place in the time and attention of the owner to that of the largest branch of the work. Most poultry products are from the general farms of the country.

Exclusive poultry keeping may be subdivided again into special industries, as (1) egg farming and (2) meat farming. These special industries may be, and often are, combined; but one is usually given the greater prominence. Egg production is often the leading one with the production of meat an adjunct to it. Large, exclusive egg farms are usually located in the thickly settled sections of the country, near large cities, and a special price is received for the guaranteed marketed product (Fig. 23). Some egg farms make a specialty of eggs only twenty-four hours old, the date of laying being stamped on the shell; others sell sterile eggs, for which an increased price is paid, if properly marketed.

Poultry meat farms may be grouped under the heads: broiler, roaster, or capon farms. These may be run exclusively or in combination, or either one may be run in connection with egg farming. The latter is undoubtedly the best practice. Where the production of meat is the leading part of the business, it requires much more careful management, owing to the fact that the returns are not continuous the entire year. There are certain seasons during which

large revenues are received for the various classes of market poultry; at other seasons of the year it would not pay to ship them. The broiler season extends from September to January; a good roaster can be sold at any time of the year, but often at a reduced price per pound; capons bring the highest prices from

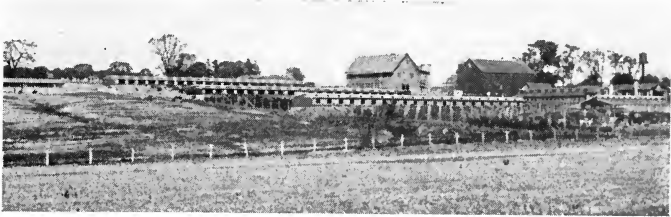


FIG. 23.—A farm for intensive egg production. Three thousand birds housed on five acres.

November to March. A broiler during the height of the season often brings as high as fifty or sixty cents per pound. Out of the season twenty cents is a good price, which may be less than the cost of production.

A new phase of the poultry business is the *community hatchery* (Fig. 11). A poultryman who understands the business and is



FIG. 24.—A farm for the production of fancy poultry. Note the small units, systematically arranged, making special matings possible. (Courtesy of Harmony Park.)

suitably located takes eggs from smaller poultrymen, hatches them, and delivers the chicks at hatching time, or in some cases broods them to the age of three or more weeks.

One of the greatest specialties of the business is that of the poultry breeder who improves his birds by careful matings, exhibits at shows, and sells eggs, chicks, and adult birds entirely for breeding purposes (Fig. 24). Success in this branch depends on the name and standing which the breeder has.

There are not only the various specialties outlined here, but many other branches, as the keeping of ducks, geese, turkeys, and wild game. The broiler-duck business, for instance, is one of the largest and most profitable branches of poultry keeping.

**The advantages of poultry keeping** are many. The amount of land and capital required is not great. There are a great variety of products. These are easy to market. The money invested brings quick returns. The business is suited to persons of either sex. Land is made more fertile. Poultry utilize waste products.

*Land and Capital Required.*—It is safe to say that in no other branch of animal industry is there so little need of an extended outlay in land and capital to make a successful start as in poultry keeping. The investment in land is least for those birds which are not of a roving nature, as ducks and heavy fowls. With turkeys, and some other classes which by nature are wild, more land is required. They do not thrive so well in close confinement. Five acres will amply accommodate one thousand laying hens and provide room for the rearing of the young stock to replace the old ones. Experiments show that less land is required than was formerly supposed. When many birds are kept on a small area the cultivation and sanitation must be more thorough. If scarcity of land is not a difficulty to be met, then the most economical method is to allow free range. If the feed is to be grown at home, much more land is required,—about an acre for every one hundred birds. Growing chicks require much more range than adult birds. An abundance of park room or large runs should be allowed the young pullets and cockerels. Fattening fowls require very little room; it is desirable to keep them closely confined during the finishing period, as a much greater gain in weight is secured by so doing.

The first question usually asked by a person starting out in any business is, "How much will it cost?" Unlike most other ventures, the poultry business may be started in a small way with very little capital. When starting in egg production for market purposes, the first cost for stock is very small; but if starting into the breeding of fancy or show birds, this item is much greater. A modest beginning is best. This can later be extended and more and newer equipment can be purchased as the business grows. The small flock on the average farm will thrive with little scientific care. As the numbers are increased there is a greater chance for disease and a greater need of careful and systematic attention to detail of management, which can come only from experience.

*Great Variety of Products.*—The poultry business is made up of so many different branches that the beginner is enabled to select the one which will best fit his own conditions. He must first study market requirements and land conditions. The poultryman having only a small plat can go into the breeding of pure-bred stock and the production of market eggs. The rearing of chicks to be marketed later as roasters or capons requires a much larger area and different conditions. On the average farm which is run exclusively for egg production, there are a number of by-products which bring in a large revenue. Next in order after egg production is the raising and sale of market poultry, both the surplus males and the old stock. Aside from this is the poultry manure, which if properly gathered and stored can be sold as fertilizer to truck farmers and growers of small fruits. There is also a revenue from feathers if they are dry-picked and well cured.

*Products Easy to Market.*—With modern means of transportation, it is possible for the poultryman to put upon a special market, many miles away, eggs which are not over twenty-four hours old, and for which an extra price is easily received. It is also possible to ship poultry products much farther, and yet have them reach market in much better condition than many other farm products, as market milk, perishable vegetables, and tender fruits. It should be the aim of every poultryman to produce the best which is possible and then to market the product in the most attractive and sanitary way. By so doing he may get a quick and sure market for all his shipments. As soon as customers learn that a worthy article is regularly produced, a great demand is immediately developed for that particular product from the same source. A permanent market is easily secured in this way.

With all poultry products a great value is represented in small bulk. They are much easier to handle, both in preparing for market and during shipment, than the bulky agricultural products. Express charges are relatively small, considering the value carried.

Poultry products, especially eggs, owing to their small bulk and high food value, can be easily stored, and if properly handled can be kept for from six months to one year in cold storage and still be useful as human food. This practice of holding eggs from season to season in storage is used for speculative purposes, and eggs are sometimes kept much longer than desirable from the food standpoint. It is very easy to hold them from spring, when large numbers are laid, until the next winter, when they may bring good

prices on the wholesale markets. The extended storage of eggs over periods of two or more years for speculative purposes is discouraged by law. There will always be a demand for fresh eggs, because "An egg is an egg,"—that is, a fresh egg is known to contain certain food materials that cannot be adulterated.

With poultry products, more than with any other kind of farm products, one can determine months in advance the approximate price to be realized. The production of eggs is affected by temperature, and the price varies accordingly. During the spring months a heavy production is certain, and the price is always lowest then. During the winter production is limited, and the price received per dozen is high. Knowing this, the egg farmer should try, by all known methods of care and management, to get a maximum egg yield during the winter months, when the price is high and a first-class market for fresh eggs is certain.

*Quick Returns for Money Invested.*—The investor with small capital must get returns quickly if he is to make a success of his investment. Poultry keeping offers inducements to this kind of investor, as there is no branch of animal husbandry which offers such quick returns. In any branch of the business—whether eggs, broilers, roasters, capons, or fancy stock—the products are ready for market in a very short time. Considering the longest possible course which one could pursue,—namely, the saving of eggs for hatching to raise pullets to be kept for egg production,—the products will be ready for market in from five to nine months, depending on the breed kept. This one fact of quick returns explains why many small investors are always starting into the business.

*Suited to Persons of Either Sex.*—Poultry keeping requires no complicated machinery or heavy equipment. For this reason it is well suited to women as well as men. It is also suited to persons who are unable to perform hard manual labor and who are willing to put time and thought into the work at hand.

More than half of the poultry of the country is on farms where farmers' wives and daughters do most in taking care of the flocks. Some of our largest poultry plants to-day are successfully managed by women. As a rule, a plant large enough to make a living for a family is beyond a woman's strength. In many cases some male member of the family can do the heavy work about the plant and assist a woman in keeping a flock of five hundred to eight hundred birds. The family income may thus be given a substantial increase.

Many women have been successful as fanciers and as poultry breeders. As a rule, women succeed much better with the brooding and care of little chicks, as they are willing to give them careful attention during the critical period. To the extent of paying attention to details, women make the best poultry keepers, and are usually very successful in making small flocks pay.

*Invalids* are attracted to poultry keeping in a small way, as it is an occupation with much outdoor work. The work is not heavy, yet the poultry keeper must be out in all kinds of weather. If the sickness is such that this is impossible, the work should not be attempted. An invalid engaged in poultry keeping may expect to make some part of his living from it. If he increases in physical strength, he may increase the plant accordingly. One may safely enter the business feeling that he is not physically unfitted for the work required, provided he likes it and has the perseverance to push ahead.

*Increase Fertility of the Soil.*—Aside from the commercial value of the poultry manure there is a great increase in the fertility of the land over which the birds run. On a general farm it is probably more economical to use all the poultry manure than to attempt to sell it. The fertilizing constituents of poultry droppings in the fresh state are about as follows: Nitrogen and phosphoric acid each 16 pounds and potash 8 pounds in a thousand pounds of droppings. Poultry manure is the richest of all the farm manures. Compared with commercial fertilizers the three ingredients mentioned make the fresh droppings worth about \$7.50 per ton. The manure should be carefully collected and used as a concentrated fertilizer for farm crops.

*Utilize Waste Products.*—Poultry help to save many waste seeds and grains on the general farms. They consume many of the by-products which otherwise would be an entire loss. This is true of inferior fruits and vegetables, and refuse from the table. Many insects and weed seeds are consumed. A market value can be realized on these when selling poultry products.

**Disadvantages of Poultry Keeping.**—The business may at times demand more hard work and sacrifice of time than is agreeable to the parties concerned. Even with modern methods of sanitation there will be occasional outbreaks of contagious disease which will cause a large loss of life and greatly diminish profits.

**Profits from Poultry.**—The first question asked of any business is, "Does it pay?" It can safely be said that poultry keeping pays

a surer income, year after year, on the money invested than any other business with which the farmer is connected. The time has passed when it was the unanimous opinion that poultry does not pay. There are too many men actively engaged in it and making a comfortable living, as well as too great a number with yearly incomes well up into the thousands, for there to be any doubt in the matter. It has been proved over and over again that failure cannot be laid to the business, but to the man at the head of the business.

There is no danger of the business being overdone for many years to come, because the demand is greatly ahead of the supply and is constantly on the increase. The United States is compelled to import millions of dozens of eggs, besides other poultry products, each year to keep up with the demand. There have been times when the prices would fluctuate out of season, due to speculation in cold-storage products, but with better laws governing the storage of products this becomes less possible. There need never be any fear of large combines being formed to "freeze out" the small producer, because the industry is composed of thousands of small units, and the middleman or dealers must have their products.

It is possible to make enormous profits from the poultry business, some of our noted breeders making \$30,000 or over in one year. On the other hand, there are men who, to all outward appearances equally as well fitted for the work, have lost that much on poultry in a very short time.

Great mistakes are made by the uninitiated in figuring profits on paper. The enthusiastic amateur will usually work it out as follows: One hen will lay twelve dozen eggs a year, which at twenty-five cents a dozen will bring in three dollars. It costs one dollar to feed her, which will leave a profit of two dollars per hen per year. If five hundred hens are kept, they will return a profit of \$1,000, and if one thousand hens, \$2,000; and so on until he knows he is to be a millionaire. This is not meant to show that this rate of profit cannot be realized. In fact many of our experienced poultrymen are doing better, but it is only after years of experience. Therefore, the best advice to the amateur would be to start in a small way and find out by actual experience just what can be made out of the business. In this way experience may be gained without having to pay dearly for it, as would be the case in a heavy first investment.

Profit depends largely on cost and *methods of feeding*. The cost of poultry feed has risen considerably during recent years.



Poultry keepers have learned more fully the feed requirements for winter egg production. It is found in most cases to be impossible to feed the laying hen for less than \$1.50 per year. Formerly this could be done for \$1.00 to \$1.20. Heavy producing flocks often run up to \$2.00 or over. There is much need of experience in profitable feeding. The profit from feeding comes from the feed which is consumed over and above the amount which is required for the maintenance of the body. The following may be considered about the average to be expected on a commercial plant which is managed by one with years of successful experience.

*Production of the Average Hen on a Well-managed Plant.*

Eggs laid per year.....	120	
Value of eggs at an average of 2½ cents.....		\$3.00
Cost of feed.....		1.50
Cost of labor per year.....		.30
Profit over cost of feed.....		1.50
Net profit.....		1.20

In explanation of the above it may be said that 120 eggs was found to be the average of sixteen commercial plants in the State of New Jersey during 1911. The average farm flock is not up to this, yet, with a little more care and a slightly increased outlay in feed and improved buildings, the average production of the farm flock could be greatly increased, and the profit per bird doubled. The average production of all farm flocks during the same time was estimated to be 92 eggs per hen per year. Two and one half cents apiece was below the average wholesale price for New Jersey eggs the same year. Numerous experiments and observations carried on by the writer show the approximate cost of labor per bird to be thirty cents. This cost was when a double system of yarding was used and green feed was grown directly in the runs.

It will be interesting to compare the above figures with the following results which were obtained during the "Money-in-Poultry" contest held under the management of the *American Agriculturist*, which closed April 1, 1901, with over 500 contestants:

*Production of the Average Hen.*

Eggs laid per year.....	82	
Value of eggs at 2¼ cents.....		\$1.85
Cost of feed.....		.94
Cost of labor.....		.34
Profit over cost of feed.....		.91
Net profit.....		.57

From a comparison of the two tables it will readily be seen that the quality of the average hen is increasing, especially as regards number of eggs. This is due undoubtedly to better feeding and more careful and systematic breeding.

When it is necessary to estimate the yearly profit from a hen, a cost of \$1.50 for feed and a return of \$1.00 over cost of feed are pretty safe figures to rely on. If there is any error it will be on the safe side. It must be understood that it will take a well-managed plant to equal this. At the same time it should not be forgotten that results far superior to the above are very common on modern plants when much thought and energy are thrown into the work. A number of different plants have been closely studied by the author, in various parts of the country, which have turned out yearly profits of from 18 to 27 per cent on the investment. The largest percentage of profit was on moderately small plants of from 200 to 400 birds. The 18 per cent profit was on a plant with a laying capacity of over 2,000. This illustrates a very common fact: Usually as the plant becomes larger and more birds are kept, the owner or manager is less able to look after the necessary details; as these details are left to others, there is too apt to be a corresponding loss. This is not figured when making calculations of profits on paper.

Here a word of warning will not be out of place: Beware of the poultry advertiser, or "poultry system," which claims immense profits per bird per year. These are constantly seen in poultry papers, with special advertisements claiming from \$5.00 to \$8.00 profit. It is well for the prospective investor to weigh the statements carefully and if possible obtain the advice of an expert before investing heavily in such "systems." The advertiser may be doing all that he claims and be acting in good faith, yet many of the systems would be an utter failure in inexperienced hands. In this connection it should be remembered that profits which are derived from the various branches of the business vary greatly. It is possible for the breeder of high-class exhibition birds to make a large income from a few birds; this is only after years of breeding and the winning of many high prizes at poultry shows.

**Risks in the Business.**—The poultry business, as with all other established enterprises, is subject to certain risks which no amount of forethought can entirely overcome.

In the first place, prices will at times fluctuate, and profits

must vary according to the character and amount of fluctuation. But, as was previously stated, this fluctuation is at all times less, and can be more readily foreseen, than in any other business.

In the second place, there are causes entirely beyond control which may cause failure or delay success,—such as ravages of disease, fire, or close competition in a local market. All these influences must be taken into consideration by the investor, and the remotest chance of the occurrence of any one of them avoided if possible. The poultry business, while unique in many respects, is not exempt from the influences affecting other lines of normal business.

The vital question confronting the American poultryman to-day is not, How can I get better prices for poultry products? but, How can I produce a higher quality at a lower cost? This same question was the important one years ago, and its solution will always be of vital moment. The factors which can be made to partially solve the problem at the present time are: (1) Better birds; (2) more careful mating and breeding; (3) scientific study of laws governing nutrition; (4) more liberal feeding during heavy producing periods; (5) more economical and sanitary housing of the laying stock; and (6) more attention to the handling and marketing of poultry products. With thought and attention to these points the yearly profit per bird would show a great increase.

**Brief Review of Foreign Poultry Keeping.**—European countries as a whole have received a great awakening along poultry lines during recent years, there being a great increase in the number of fowls kept, also a great improvement in the breeds maintained and in the methods adopted.

*In England* the poultry industry is greatly handicapped by the preservation of foxes for the purpose of the hunt. There is a special tax which goes to defray the injury done to poultry from this source, yet in many cases justice is not done. In some instances false claims are entered which tend to make unpleasant conditions common.

In spite of this handicap the industry has increased annually until the yearly production has reached about ten million dollars. The one great peculiarity of the English system is the use of small portable houses, sometimes on wheels, which can be easily moved from place to place, thus giving the birds new ground at all times. The majority of English flocks of poultry are kept on small

farms and made to pay good dividends, considering the time and money spent for their care (Figs. 25, 26, and 27).

England is the home of the Orpington fowl, large numbers of



FIG. 25.—Poultry on a Yorkshire farm. Several varieties are commonly kept on one farm. (Photo by Edward Brown.)

which have been sent to the United States and to several European countries by English breeders. Conditions could be easily reversed so far as America is concerned. By studying European demands American breeders could find a market for well-bred birds of their most popular breeds.

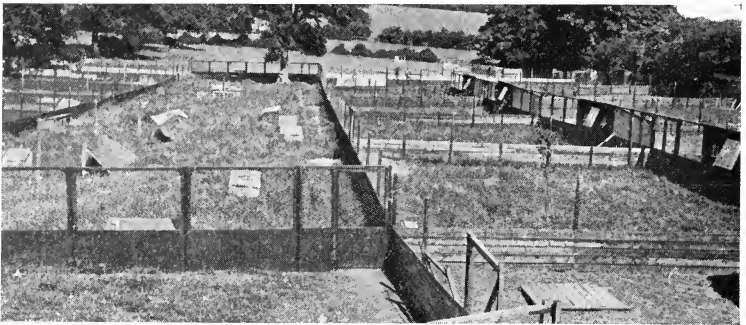


FIG. 26.—Plant of a fancy poultry keeper in England. (Photo by Edward Brown.)

*Scotland and Wales* are not noted as poultry countries. In the former very few birds are kept, ducks and geese predominating, and in Wales there are considerable numbers kept on ranges, but they are of very poor quality.

*Ireland* has received within the last few years a great amount

of help and instruction through government aid. Her poultry industry is rapidly coming to the front, especially the production and immediate marketing of eggs. In methods of fattening and finishing birds for markets she has yet much to learn. Ireland is a country of small farms, especially suited for this work.

*In France* conditions are entirely different. The industry is almost universal and has been so for hundreds of years. The Ministry of Agriculture lends its powerful influence, and each year large shows are held under its supervision. These include all classes of poultry as well as eggs and dressed poultry. France



FIG. 27.—An English scene of intensive poultry keeping, with small, elevated, unit houses. (Photo by Edward Brown.)

not only supplies her own needs but exports large amounts to England. It is estimated that the value of poultry and eggs produced yearly in France is over \$76,000,000, which is nearly double the amount produced in the British Isles, and above one-fourth the value of the poultry products in the United States for the year 1900. Poultry keeping is made a part of all farm operations. It is especially used in combination with vineyards, where it helps to keep insects in check. Fowls are always allowed free range, except during the season when the fruit is ripening, and the best birds are produced on the same areas where the best grapes are produced. The French fowls are known the world over for quality of flesh and size of egg.

In *Belgium* poultry keeping is carried on to a relatively important extent. The intensive methods characteristic of Belgian farmers are in vogue. Large numbers of young birds are fattened for export trade, and recently the production of eggs for export has taken a rapid stride forward. The egg industry has been increased by importing from Italy thousands upon thousands of young pullets, mostly Leghorns, at from three to five months of age. These are kept entirely for the purpose of securing a lot of eggs in a short time for export trade.

*The German Empire* is not a heavy producer of eggs nor poultry, but imports large quantities from Russia and Italy.

*Denmark* has shown the same unequalled success in her poultry work which has been characteristic of all her agricultural endeavors.



FIG. 28.—A typical Danish poultry house. A roosting room is at each end with a glass-front scratching shed between. Brick is commonly used.

During the ten years from 1890 to 1900 the number of birds more than doubled. At the beginning of that period egg production was practically nonexistent. The Danes are noted for coöperation, and their poultry industry has been greatly benefited by the organization of poultry societies, which help the farmers to secure better markets. As a consequence they have introduced what is undoubtedly the most perfect system of grading and crating, as well as a system of marketing in the shortest possible time. Up to the present time market poultry has not received a prominent place in their industry; but they have proven themselves capable of such wonderful development and organization that it is impossible to foretell what they will accomplish in the future (Figs. 28 and 29).

*Italy* does not hold the place in the world's poultry keeping

which should be expected of a country where two of the greatest egg breeds of to-day originated. The Leghorns and Anconas are from the Italian peninsula. The northern part of the country is especially suited to the work, as the agricultural districts are divided into small farms. The soil and climatic conditions are all that could be desired. There are movements toward coöperation which should yield excellent results in the future.

*Austria-Hungary* has made rapid strides, due largely to organization and coöperation in shipping and marketing. The lighter



FIG. 29.—A Danish egg-grading and packing room. Eggs are packed in bulk, in nests of excelsior.

birds are predominant. It is stated by the Hungarian Poultry Association that, of all branches of agriculture, poultry keeping is best suited to the soil and climate of the country. The statements are also made that Hungary exports as much value in poultry products as in grain, and that poultry pays ten times as much as any other branch of its agriculture. There is a great future ahead in Hungary for poultry keeping.

*Russia* is a great exporting country, owing to its large area, but is backward in its methods and results. The fowls, as a rule, are small and poorly bred. The majority are kept by peasants, and the flocks are very small. From ten to twenty is the average number kept by one peasant. Under these conditions the eggs produced

can be sold very cheaply, as the fowls are fed almost entirely on waste and allowed at night to stay under any shelter which is most convenient. The Russian government has made several endeavors to aid the industry, but is hindered by the ignorance of a large mass of the population.

*In European countries*, as a rule, the mass of the production is upon small farms and from small flocks. The greatest advance has been attained in sections where the producers have coöperated in securing better market conditions and better methods of shipping and marketing, and where there has been a steady and conscientious attempt to improve both the stock and methods of management. The one great fact which the United States should learn and make use of from these countries is the necessity, if the best results are to be attained, of immediate steps toward systematic organization and coöperation, to see that the producer receives adequate returns for his products.

#### REVIEW.

1. What is meant by the term poultry farming?
2. Give the number and value of poultry in the United States in 1910.
3. Give the percentage increase in numbers and production during the preceding ten years.
4. Where is the greatest egg producing section of the United States?
5. Describe the method of poultry farming in the Petaluma district, Cal.
6. Describe the method of poultry farming in the Vineland district, N. J.
7. For what is the Little Compton district famous?
8. For what is the South Shore district famous?
9. Name five modern developments which have revolutionized the poultry industry.
10. Discuss poultry keeping as a business.
11. As an employment.
12. As an investment.
13. For family use.
14. For fancy purposes.
15. Enumerate the various separate poultry industries.
16. Name and discuss the advantages of poultry keeping.
17. What are the possible disadvantages?
18. What do you consider a reasonable profit from poultry?
19. What are the risks of the business?
20. Give a brief review of poultry keeping in the leading European countries.

**References.**—The Twelfth and Thirteenth Census of the United States: Agriculture, "Distribution and Magnitude of the Poultry and Egg Industry," by G. F. Thompson, U. S. Bureau of Animal Industry, Report, 1902.



## CHAPTER II.

### LOCATION AND SITUATION.

*Location* is a term used especially to designate different sections of the country. By it is meant the particular place which is selected for the poultry plant with reference to markets and climate.

*Situation* deals with more definite points in regard to planning and lay-out of the plant, as position of buildings and yards. It has to do with the selection of the particular site for the plant on the farm chosen. The study of the situation of the plant is applicable to all classes of poultry keeping, while the study of location is not important to the farmer owning his own farm or to the suburban poultry keeper who only keeps enough for his own use on land already acquired.

**Factors in Location.**—The following factors have a definite relation to the matter of location and should be considered carefully by the prospective investor: (1) Markets; (2) means of rapid communication and transportation; (3) type of poultry farming; (4) systems of poultry farming; (5) climatic and soil conditions.

As in every business, a location which is adapted to the needs of the business is absolutely essential. Poor location has been the direct cause of many failures.

*Markets.*—In the consideration of markets there are always two factors which are antagonistic,—namely, nearness to market and price of land. The nearer to the city the business is located the greater will be the amount of money required to be invested in land. This is especially true where it is desired to locate on the very outskirts of a large centre of population. Owing to the fact that poultry products can be shipped reasonable distances by rail, it is not always necessary to pay the price required for a close proximity to market.

It is very essential, with keepers of small plants who desire to retail their products, that they be within short hauling distance of a market which will demand the amount and kind of product they expect to furnish. Such home markets can usually be found in small towns or villages where the price of near-by land is not a prohibitive factor.

With the commercial plant, most of the products are sold at wholesale or contracted for in large quantities, so that a near location is not essential. It will be found, by looking over the extensive poultry sections of the country, that the exclusive poultry farms are invariably located within a reasonable shipping distance of one or more of the large cities on the Atlantic or Pacific coast, or near the thickly populated sections of the Middle States, and sometimes near large health and pleasure resorts.

The idea is to be near a market which is large enough to avoid all danger of a surplus supply of products.

Not only must markets be considered with reference to the adaptability of disposing of products, but a constant and reliable source of supplies and feed stuffs should be within easy reach.

Poultry farms in the Western States have the advantage of cheap land and cheap grain. These factors, combined with improved methods of transportation, are bringing about a greater distribution of the industry than ever before. In the past it has been considered more economical to transport grain long distances than to attempt to ship eggs so far, owing to the poor facilities offered and the great loss in transit.

Poultry keeping is a business which adapts itself very readily to waste land or unimproved land. Very desirable sites may often be secured within easy hauling distance of a large market for very reasonable considerations, owing to the fact that the land is not suited to other branches of farm enterprise. Before selecting a location this question should receive careful consideration, thus avoiding a mistake at the very outset.

*Rapid Communication and Transportation.*—It is essential to keep in close communication with the purchaser, whether the location be at a considerable distance from or very near the market. In this way the prices, which are changing daily, can be determined, and the products disposed of at a time when the best returns will be realized. During frequent fluctuations of the market this may mean a saving of many dollars. It is desirable to keep informed regarding the needs of the purchaser, whether he be the commission merchant or the consumer.

If one has these facilities, it will be possible to save much in the purchasing of feed and other supplies during periods of low prices.

There are many times when some machines or parts of machines need repair, and much time can often be saved by

making a quick order for prompt delivery. This is especially true in incubation and brooding, where injury to the heating equipment may be quickly repaired, thus saving many dollars from loss of chicks or eggs.

*Means of Communication.*—The following are the more common means of rapid communication, essential for the satisfactory management of modern poultry plants in this age of competition: (1) Rural free mail delivery, (2) local telephone, (3) long-distance telephone or telegraph connections.

Not only does the presence of these necessities aid in facilitating marketing, but farm values are greatly enhanced. By free mail delivery better roads are induced. These make it possible for the farmer to be much more prompt in all business proceedings. They also help greatly to banish isolation, which formerly was one of the greatest disadvantages of all the many types of farming.

*Shipping Facilities.*—The site selected should be not far from a suitable trolley line which carries freight, or a railroad freight and express depot. The necessity of transporting the products from the plant to the consumer as quickly as possible is thus met. The advantage to be derived by having all purchased feeds and supplies delivered by rail within easy and quick reach of the plant is important. Two or more competing lines within easy reach are to be desired, as a guarantee of good service at reasonable rates. The presence of good roads between the farm and depot should be sought, as the character of the load hauled is governed by the poorest place in the whole road. The presence of an interurban trolley system leading to a market centre is especially desirable, owing to the quickness with which the products can be sent by trolley express if desired, and this usually with very short haul at either end (Fig. 30).

All poultry products are of such a perishable nature that a long haul over rough roads to distant markets or shipping points will so handicap the poultryman that he will find it impossible to compete with others who have the modern advantages outlined

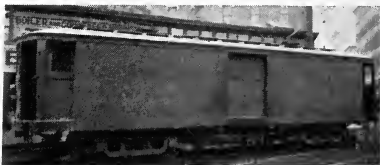


FIG. 30.—Rural trolley express, a convenient means of marketing poultry products. Trolley lines are near many poultry plants. (Photo by Rhode Island Co.)

above; hence the importance of considering these matters carefully before selecting a location.

*Type of Poultry Farming.*—The first question which a poultryman should decide is the type of farming which he wishes to carry on, and then find a location suitable for this purpose. For the farmer already located, it is a question of finding a type which is especially suited to his particular location as regards land and market.

The following may be termed general types of poultry farming under which all the various branches will fall, each requiring peculiar conditions when considering desirable location: Egg farming, meat farming, and fancy poultry farming.

*Market Eggs.*—In any branch of egg farming, especially that of market eggs, a first-class market within short shipping distance is essential if the highest price is to be received. Every producer of market eggs should try to build up a demand for strictly fresh eggs. They should be guaranteed and put on the market when they are not over three or four days old. The best price can be received by shipping each day if the output will warrant it. This requires close proximity to markets. A location directly at the point of shipment is desirable, owing to the fact that if eggs are hauled great distances over rough roads the constant jarring tends to break the internal membranes and spoil the eggs for a high-class trade.

*Meat Farming.*—With the production of meat entirely different conditions are met, the most noticeable one being the small amount of land which is required in any class of this type. On a piece of land containing from one to two acres, used for the production of market broilers, the profits during one year may be many thousands of dollars; providing feed and eggs for hatching are purchased, as is generally the case. For the production of capons or roasters more land is required, and this branch is best suited to farm conditions, where the birds can have unobstructed range during the developing season. Where the production of meat is made the main issue, the site selected must be near the point of consumption, so that the shipments, even in the summer months, will arrive at the consuming point with but one icing; otherwise they must be sent by refrigerator cars and an extra expense entailed thereby.

*Fancy Poultry Farming.*—In the rearing of fancy poultry or high-class breeding stock a great latitude of choice is allowed the

investor. He should secure conditions which will guarantee the best development of the fowls. Then the markets will take care of themselves. If the breeder once secures good stock and, by careful breeding, produces a winning strain, he will not have to hunt for markets. There are, however, certain locations where high-class birds have been bred for a longer time and where a greater demand has developed. In such places a market is much surer for the beginner with small investment. He will be aided in selling good birds by the reputation of the locality. He must be content in producing for local market at first, until he has become expert in competition with breeders of established reputation. Another point to be considered is the fact that many of

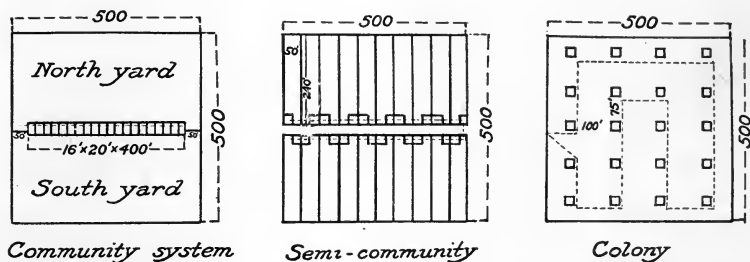


FIG. 31.—System of poultry farming. No fences are used in the community system. The most fencing is required in the semi-community system. Most labor is required in the colony system.

our noted breeders are compelled to sell a quantity of their birds for meat at market prices. A suitable location with respect to this is an advantage. Where markets are suitable, it is often possible to combine market and fancy poultry raising, with excellent results.

*Systems of Poultry Farming.*—The common systems of poultry keeping which have given success in all parts of the country may be classified as follows: Community system, semi-community, and colony system (Fig. 31).

*Community system* is a term applied to that method of housing in which the birds are confined in large flocks under one roof. The poultry houses are usually of the long-house type, in some cases as long as five hundred feet. The yards, if any, run to the front, and in some instances both to the front and to the rear. In this system the amount of land required is relatively small, con-

sidering the large number of birds kept. It is well adapted to egg farms located on expensive land very near large centres of population. The birds are closely confined and under observation at all times. The disadvantages are danger of fire and of disease, and extra expense required for fencing. This type of long house is often used with only one to two yards. The house is then not divided into small pens, as many as five hundred birds being kept in one flock (Fig. 32).

*Semi-community* is a term applied to plants in which the birds are kept in smaller units, consisting usually of single or, at the most, double pen houses arranged along streets or roads with yards running to the front or rear. The pens are from twenty-five to one



FIG. 32.—Large community house, holding five hundred birds.

hundred feet apart, depending on the length of the runs. This type requires more land than the former and more labor to attend. Advantages are: Giving the birds much more room, doing away with the danger of fire, and reducing the risk of the transmission of disease.

These first two systems are suited to the production of market eggs. In the breeding of high-class exhibition and fancy specimens, it is absolutely essential to keep the different flocks separate. The semi-community system does this well. It is also adapted to the village or farm flock where the nearness of a neighbor or the presence of some crop which would easily be destroyed makes it desirable to keep them securely yarded (Fig. 33).

*Colony system* is a term applied to the method of dividing birds into small flocks of from twenty to fifty and scattering them in

small colony houses about the farm; no fencing is used; the birds have free range at all times. The feeding and other work is usually



FIG. 33.—Semi-community poultry plant. Hatching and brooding buildings in background, and isolated single-pen and double-pen laying houses distributed over the rest of the plant. Roads and double yarding are common in this system.

done by an attendant driving around from coop to coop with a wagon. This system is adapted to low-priced land located at



FIG. 34.—Colony houses for poultry on extensive range. The house in the foreground shows cheap construction.

considerable distance from cities; it can be used to excellent advantage on waste land, such as brush fields or rocky wooded hillsides (Fig. 34). It is suited to the raising of roasters, capons,

and turkeys on a large scale, since they do much better on free range and the cost of feed is reduced to a minimum. The cost of labor per bird is usually high where a system of this kind is employed, but by the use of wagons or feed carts it should not be excessive.

The colony system works out to very good advantage in combination with other branches of farm work, such as fruit growing. The colony houses may be scattered among the trees, thus making the same land produce two crops. With dairy or beef farming, the houses may be scattered about the permanent pastures, where they can be easily attended and do no damage.

*Climatic and Soil Conditions.*—Poultry will do well on nearly all kinds of soil and under nearly all climatic conditions. But there are certain soils which should be avoided, or expensive means will be necessary to correct them.

Dry air should always be chosen for a site. Along the banks or valleys of large streams and along seashores it is apt to be too damp during the winter months and foggy at other seasons. Poultry will thrive well during very cold weather, providing the roosting quarters are kept above freezing. Fowls always do better in well-ventilated, cool houses than in close, stuffy, damp, warm ones; the latter are unsanitary. Sudden changes in weather are to be avoided. The weather record for many years back should be consulted to find the average conditions which are to be expected. The prevailing wind direction, its velocity, and the character of weather which it brings should be determined.

A mild climate is to be desired rather than an exceedingly hot one. The most southern States will never be as desirable for poultry keeping as the more northern latitude, say above 35 degrees, owing to the extreme heat during the most of the summer months. Dampness from the Gulf Stream is a drawback for the southeastern States. High dry areas are very desirable, one of the best ones in the country being the central plain running from Dakota to Texas. Birds of maximum size can be more easily and cheaply produced in this section than in any other region of similar extent in the United States. With the perfection of cold-storage systems and improved means of transportation, the Central West will undoubtedly some day be the poultry centre of North America. Especially will this be true as the centres of population keep moving westward.

The *type of soil* best suited for poultry keeping is a sandy loam.



It should be friable and porous, so as to dry up quickly after a rain. There should be a porous, gravelly subsoil, which insures perfect underdrainage. This cleanses the yards and carries manure into the soil where plants and grass roots can use it. The water table should be so low that in no place moisture appears above the surface, even by the presence of damp soil when turned over by the plow. It should be a warm soil, and if warm it will be dry.

The runs should be so constructed that it will be possible to get into them with a plow to turn under the manure and cleanse them. A system of alternate cropping should be devised to utilize the manure which is voided in the runs. Green feed can be more easily and cheaply supplied in this way than in any other.

A heavy muck or clay soil should always be avoided, as poor results are sure to follow its use. If it is necessary to locate on



FIG. 35.—Ideal location for poultry farming. Rolling land gives good drainage and proper air circulation. (Photo by Southern Railway Land Department.)

such a soil, it can be greatly improved by tile underdrains and by heavy applications of lime. If the area is small it can be much improved by mixing sand with the top soil.

*Character of Country.*—A slightly rolling country (Fig. 35) is much better than perfectly level stretches or an extreme mountainous section. There is better atmospheric drainage than on level sections, and much less liability of heavy winds. A contour and soil map of the country under study or observation will help greatly, if it is impossible to spend the desired time in a personal inspection. It is very desirable that the ground be gone over thoroughly by the prospective investor himself.

**Situation.**—In considering the matter of situation the important factors which must be constantly borne in mind are: (1) To have the conditions as nearly perfect as possible for the health of the

birds, and (2) the consideration of labor and time required in attendance. This should be reduced to the lowest possible point without impairing the efficiency. The following factors should be considered carefully in reference to the above before buildings are started: (1) Size and shape of land; (2) soil and surface drainage; (3) slope or land contour; (4) water supply; (5) economy of time and labor; (6) arrangement of buildings; (7) an attractive appearance when complete.

*Size and Shape of Land.*—The area of land secured will largely influence the system of housing and yarding which will be followed. A farm of forty or fifty acres will allow of developing an immense business on the colony plan as well as giving ample space for growing much of the feed at home. A farm of four or five acres will take care of approximately 1,000 layers on a very intensive community basis, and provide range for raising the young chicks. No feed except pasture can be grown on such a small area.

If possible some land on the place should be in trees, preferably fruit trees, so as to have shade available. Artificial shade can be constructed, but it is not so satisfactory as the cool, moist shade provided by growing trees.

The shape of the farm is an important factor. A square lot of land has the following advantages over a long rectangular one.

1. If the area is large it is better to place the buildings in the centre near the dwelling house and work the farm all ways from this central location, thus saving much time which would be spent in going long distances many times a day to do the work, as is required when the farm is narrow and the buildings located at one end.

2. It is practically impossible to have all the flock constantly under the eye of the attendant when they are too scattered; the danger from loss by hawks and thieves of all kinds is apt to be much greater.

3. If the plant can be planned to have the runs arranged as nearly as possible in the form of squares, the cost for fencing and posts will be less and the amount of green feed grown in them will last much longer than in the long narrow yards.

*Soil and Surface Drainage.*—The particular site selected for the houses and runs must, above all else, be perfectly dry, and if not naturally drained it should be underdrained. A wet soil is usually cold, owing to the exclusion of warm air and to the temperature being lowered by evaporation. Wet soils are unhealthy, as there

is no sunlight or air entering to purify them; and many of the common poultry diseases are spread by this one improper condition. The drainage, whether natural or artificial, should be away from the poultry house and not toward it (Fig. 36). This applies especially to surface drainage.

After heavy showers in summer or during melting snows in winter, there is usually a heavy surface wash on sloping land, and the buildings should be arranged to be out of line with it. If this is impossible artificial means, such as open gutters, should be so constructed as to protect the buildings from such water. The



FIG. 36.—Houses and yards on a hillside, giving good drainage.

presence of grass about the houses and in the runs tends to stop the surface washing and should be encouraged. Hillside which are exceptionally springy should be avoided, as it is then almost impossible to secure dry soil conditions. This makes the houses and fence posts rot away quickly if great care is not used in their construction. It also makes wet conditions underfoot for both poultryman and birds. Wet soil gives the hens wet, dirty feet, making clean eggs impossible; and clean eggs are one of the requisites of a guaranteed trade.

*Slope or Land Contour.*—Air drainage is very essential, and atmospheric conditions should be studied before making the selection. Air at all times contains moisture. When there are no general winds the air is always acted upon by gravity. The cool,

moist air flows down the slopes and settles in valleys, swamps, and low places. Thus, a rolling country is most desirable, and the plant should be placed on high ground with a slight slope. A swampy place should be avoided, not only from the fact that there is a constant stream of damp air falling into it, but it is also the natural catch basin for all surface drainage from the higher land around. In nearly every case of this kind it will be impossible to drain or put it in proper condition for health of the flock.

A southerly, southeasterly, or southwesterly slope is the best for the more northern parts of the country. If the prevailing wind is westerly, a southeastern slope is the one desired. In general, the morning sun directly in the house is the best. It is not a good policy to place the house on the very crest of a hill, as there is usually not sufficient protection against the northern winds in winter. If the house is placed on the south side just over the crest, the air currents from the north are deflected up and over the house, thus making it much warmer and of a much even temperature at all times. Forest growths on the north and west sides of the farm shut out much of the undesirable wind.

A southern slope has the great advantage of receiving the direct rays of the sun, and is thus much warmer, due to the radiation thus secured. A moderate slope is to be preferred to a very steep one. With steep slopes there is great washing and gulying during heavy rains. The labor of carrying feed and attending to the flock, if a large one, is greatly increased by going up and down steep grades.

*Water Supply.*—Stagnant waters about the poultry farm are very undesirable, but a constant supply of fresh, pure water for drinking purposes is a great asset to any plant. A satisfactory supply of water may be attained by any of the following methods, which are arranged in the order of their value:

1. A perpetual stream of running water through the farm, which not only acts as a source of pure water but aids perfect soil and surface drainage. This method is most economical, and is desirable where the colony system is used. Where the birds are kept by the community plan, a large number in small runs, it is not advisable to have a brook running through the yards, due to the danger of contamination.

2. It is often possible to dam such a stream to form a head of water on elevated ground not far from the plant, so that

a small reservoir may be formed and pipes run to the desired points of distribution.

3. The presence of a never-failing spring at some elevated position may be utilized in the same way, there being no power required for distribution.

4. If the source of water supply is below the level of the plant, the water can be elevated to standpipes or reservoirs in any of the following ways: Hydraulic rams, gasoline engines, water-wheels, or windmills.

5. The use of a driven well and compression storage tank operated by gasoline engine will be found an efficient and economical method of furnishing water where natural sources are absent.

The one point of most importance in laying out a water system is to take the water from above the plant and carry the waste water below, thus doing away with contamination. The more naturally this system can be brought about, the more desirable is the location, as a greater economy in labor is secured.

*Economy of Time and Labor.*—The poultry plant, whether large or small, should be laid out with the idea of saving steps. The greatest saving in this respect can be made by care in planning the location of the buildings. The main building should be centrally located. It usually contains a feed room and general work-room, as for fattening, killing, and picking. The incubation and brooding equipment and the laying houses should be so placed in relation to the main building that the entire round of work can be done without retracing steps and with the shortest distance possible. Chick ranges should be located as near the centre of the plant as practicable, as the birds require feeding much oftener when young.

A good system of roads and paths should be constructed so as to be dry at all times; nothing is more disagreeable than a muddy walk. These should be in direct communication with the public highway.

The two heaviest expenses in connection with egg production are feed and labor; the latter can be materially reduced by care in planning the plant.

*Arrangement of Buildings.*—The direction of the most objectionable winds should be studied, and the buildings so arranged that the back or low portion is toward the strongest wind. If it is north or west, all windows, doors, and yards should be in the front, which would be protected by the building itself. If no

natural windbreaks are present, it is advisable to make plantings of hardy evergreens near the different houses to break the force of strong winds. The buildings for housing the birds should be so located as to receive the early morning sun, and the windows so placed that sun will shine directly into them during the entire day. During some part of the day the sun should strike every part with which the birds come in contact.

*An Attractive Appearance when Complete.*—The general arrangement and grouping of the buildings should be such as will give a pleasing appearance to the place as a whole when complete. The general shape and character of all structures should harmonize when finished. The largest and most attractive buildings should be placed in the most conspicuous place, usually nearest the highway, where they will give a solid appearance to the passerby. Usually they will be more conveniently located in such a position. In a fancy or high-class breeding plant, and to a greater or less degree on any kind of a poultry farm, the general appearance of the plant as a whole will serve as advertising. If the individual buildings and the group are neat and attractive in appearance, the natural supposition is that care and skill are exercised in the handling and breeding of stock.

**Adapting Business to Conditions.**—The farmer or poultryman who began in a small way and has developed his business to a large magnitude cannot now reconsider location. His present location represents a large investment which it is impossible in most cases to move. Future growth and development must be adapted to the present conditions. It is more a question of what branch of the business will be best suited to the present location.

The preceding paragraphs in regard to location will help persons so located to select that branch best suited to their circumstances. It is only to the poultryman who is starting an entirely new enterprise or the one who has decided to move to a more ideal location before greatly increasing his plant that the items of location are important. In most instances it is a case of meeting present market requirements rather than moving to others. For instance, the production of market poultry combined with egg production is found to suit market conditions in some sections and pay the greatest return. In other sections the large markets may demand broilers, or in many cases a premium is offered for ducks. In either instance development should be along the lines required, to the extent which the poultryman's capital and skill will warrant.

The system of housing will also be governed by the amount and character of land available on the *present location*. The several paragraphs regarding the three systems of housing already given in this chapter should be reread by the student with this type of poultryman in mind.

A general knowledge of the whole subject of poultry is necessary before one can make a wise selection. One who already has a farm can usually find at least one or more branches of the business which will work out under his conditions. Those factors which are not desirable can be eliminated or corrected, as drainage and windbreaks. In most cases the problem is one of situation rather than one of location.

#### REVIEW.

1. Define the terms "location" and "situation."
2. Discuss location with reference to markets.
3. What are the essentials in rapid communication and transportation?
4. What is the influence of type of poultry farming upon location?
5. Enumerate and define the three systems of poultry farming.
6. Discuss location with reference to soil conditions.
7. What climate and character of country are best adapted to poultry keeping?
8. How will the size and shape of the farm affect the situation of the plant?
9. Why is there need of good soil drainage and surface drainage?
10. What is meant by atmospheric drainage?
11. Why should the poultry plant be situated on a southern slope?
12. Give in their order of efficiency the possible sources of water supply.
13. What is the direct value of having the plant systematically arranged?
14. What is the value of an attractive plant?
15. Do you consider it advisable to attempt to adapt business to location and other circumstances? Under what conditions?

## CHAPTER III.

### MAKING A SUCCESSFUL START.

**A Modest Beginning.**—With every business enterprise, a successful beginning—that is, organizing and planning the character and scope of the work to be followed—is of the utmost importance. Ultimate success will depend largely on the method of making the start. A modest beginning is likely to bring good results in much quicker time than a start on a larger scale. The tendency too often is for the beginner to lay a foundation beyond his experience. Many mistakes and great disappointments can be avoided by taking a little longer time for development and to allow the business to rest on safe and sure principles. Such a course is better than to begin with the handicap of too much stock and too little experience.

Mistakes are made by those who have had years of experience, as well as by the amateur. Many instances might be cited wherein poultry keepers, even with years of experience, have taken false steps in the way of increasing their plants, in changing their methods, or in reorganization. Such examples tend to prove the advisability of a modest start, followed by normal development each year until the maximum efficiency of the plant is reached. This point will vary with different poultry keepers and in different locations even under the same methods of management. So many factors are to be considered that it will be impossible to foretell the exact extent to which a business can be safely developed until careful trials and comparisons have been made.

**Importance of Personality.**—Both experience and training are essential; but another factor which overreaches either of them in the matter of insuring success is the personality of the poultryman himself. In other words, he must be sure of himself first. He must submit to a careful self-examination and analyze his own feelings and manner of living and thinking in order to know whether he is suited to his chosen work. The first requisite is to have a personal liking for the business; and if his ancestors have been lovers of the work and have succeeded in it, so much the better. If this analysis shows factors which would tend to hinder him, the step should by all means be avoided. There is perhaps no



other business which requires more unremitting attention to details and conscientious thought and action than poultry keeping.

The following qualities are to be looked for in a successful poultryman:

The first requisite is that of sound common sense. Many instances will arise where no previous action or condition can guide, and where quick, correct decisions will mean the avoidance of disaster.

He must also be capable of planning well and carefully so as to figure probable success and failure very minutely.

Not only must he plan well, but he must execute completely, for one requisite without the other means nothing.

He should be methodical, so as to develop a careful system in all the details of the work.

He must be alert, capable of seeing an opportunity when it offers.

These qualities should be combined with sagacity and shrewdness, especially in the marketing end of the enterprise. He should have steadfastness of purpose,—that is, he should not be changeable. This is important in the poultry business, because there are so many varying beliefs and systems in the different operations of hatching and rearing. If the poultry keeper is not sure of his own method, he will succeed at none.

Lastly, he must be capable of concentrating his time and attention on the work. He must have system in all the details; and he must carry their essentials constantly in mind, as in this way only can he be sure that nothing is neglected.

**Learning the Poultry Business.**—A person desiring to learn the poultry business to-day has many advantages which formerly could not be realized. Among the greatest of these are the results of accumulated experience. The opportunities for knowledge available to the average amateur who wishes to become versed in the details and requirements of poultry keeping may be grouped under one of the following heads: (1) Farm experience, (2) practical work at large poultry plants, (3) personal observation, (4) reading of papers and books, (5) scientific and practical training in college or school.

For the poultryman to realize a combination of all these opportunities would be very desirable. At least two of them should always go together,—namely, the actual farm or poultry experience and as much scientific and systematic training as possible.

A young man who has had the advantage of being brought

up on a farm has the training which gives him a general idea of the subject in a practical way. If he desires to pursue poultry keeping on an extensive scale, he should spend at least one season at some large commercial plant, so that he may become familiar with the planning and execution of the work under the right conditions. If he intends to devote some time to a scientific study of the subject, it is advisable to acquire the practical experience first, as he will thus get more out of the advanced training.

To any poultry keeper, whether old or young, experienced or inexperienced, the poultry press offers a fine field for the study and expression of ideas and teachings. The reasons for this are brought about by the constantly changing conditions. No matter in which of the various ways he acquires his experience and training, if he is able to apply the factor of personal observation and to deduce therefrom correct principles, the learner is well on the road to success.

**Land, Labor, and Capital.**—Success in any branch of agriculture is dependent largely on the proper adjustment of three economic factors,—land, labor, and capital. The poultryman's capital may be considered as either fixed or circulating.

*Fixed capital* is the term applied to investment in permanent equipment, as land, buildings, teams, appliances, tools, and machinery—things which are constantly used in production.

*Circulating capital* is limited to that which is consumed in the process of production, and which is being used up and replaced by material of the same kind, or which having been returned is being reinvested. It is this form of capital which is constantly changing, each time coming back with increase, provided the business is conducted at a profit.

*The Poultryman's Capital.*—The following classification may serve to illustrate:

1. Fixed capital or permanent investment:

(a) Land: Natural value plus all permanent improvements, such as roads, fences, wells, drains, and orchards.

(b) Buildings: Dwelling; farm buildings, as barn; poultry buildings, as henhouses, feed houses, and incubator cellar; building equipment which is a permanent part of the building, or fixtures.

(c) Equipment: Team; implements for working the land; incubators and brooders; fowls which are used in production—excluding young birds and birds grown for meat only.

2. Circulating capital:

Feed, seeds, and miscellaneous supplies; market eggs or live poultry growing or unsold; money on hand which is required to pay labor and carry on the business.

*The proper adjustment* of capital depends largely on the type of poultry farm, the character of the market, and the personality of the poultryman himself. In working out the problem of adjustment it must always be remembered that production is limited by the minimum of any one of three factors. With a small area of land, production cannot be large, no matter how much capital and labor one may have at his disposal. With a scarcity of suitable labor a large investment in land and equipment means little. Likewise an abundance of land and labor without suitable buildings and equipment will bring poor results.

In deciding on the proportion of the original fund to invest as fixed capital and that to be kept for running the plant, no absolute rule can be laid down; but it must be remembered that many failures are caused by an overcapitalization at the start. One-half in fixed capital is perhaps a safe rule for the beginner, leaving one-half for the running expenses of the enterprise. This should be kept constantly on the move, and each time it should come back with increase. After the business has become well established, it may be found profitable to increase the fixed capital so as to make a larger production possible, and it can be more safely done at that time.

As the business increases in size and efficiency the proportionate investment in circulating capital will grow as a natural consequence, carrying with it greater profits.

*Land* is a special form of capital. It is a natural agent, limited in extent. A considerable area of land is to be desired for the best results on a poultry farm. If sufficient land is available, it will be possible to give the birds an abundance of room for range and in that way keep the ground clean and free from disease and general disorders. There is little danger of having too much land. If there is an abundance of land, the farm can be so planned that a large proportion, if not the entire supply, of grain can be grown at home. The feed bill is the poultryman's greatest expense and calls for a large reserve in circulating capital. With the increasing prices for cereal feed, the more of it that can be grown at home the better.

A mistake too often made is that of hiring and developing a large business on land which is not owned by the poultryman. This arrangement is almost sure to be unfortunate. The erection of buildings on hired land is always a direct loss, if they are of a permanent nature. They become a part of the property and can

not be taken away. Then there is the danger of having to move at any time, unless a lease is held. Even a long lease has disadvantages. A maximum profit cannot be realized except when the farm itself is owned by the poultryman, enabling him to plan his rotations and development with a definite scheme of growth in mind.

*The investment in buildings* should be limited to the economical and safe housing of the live stock on the plant. The cost, varying in different sections of the country, will depend on climatic conditions and the cost of building material. Expensive buildings are undesirable, requiring a large first investment and tying up too much of the capital in the beginning. The interest on the investment is an important item, and the cost of repairs is usually much more.

*Any equipment*, such as a windmill or engine, if in accord with the size and character of the plant, has a definite economic value in being a great labor saver and a constant source of indirect revenue. An undercapitalization in equipment means a high cost and limited amount of products, which will, of necessity, greatly lower the profits. In choosing an equipment, durability rather than first cost should be considered. In purchasing supplies, such as incubators and brooders, the most satisfactory results are generally realized by obtaining reliable, tested apparatus, even though the first cost be greater.

*Labor.*—The character and amount of labor must be governed largely by local conditions, and it will always be found that this factor usually decides, more than any other, the degree of success in poultry endeavors. The average investor, if wise, will usually start with his own labor only, and later increase the magnitude of operations enough to warrant hiring outside help if considered expedient. This way is slower but much surer. In all branches of poultry work there is a great chance for brains to replace labor to a large extent. The idea should always be to reduce labor to the minimum by the use of such labor-saving devices as are efficient and which do not tend to eliminate the personal factor.

**System for Beginners.**—For most persons starting with small investments, either in capital or experience, the colony system, wherein the birds are kept in small flocks scattered over considerable areas, will be the best and surest way. This requires the smallest possible investment in fixed capital, and will give a maximum production with the least amount of scientific care and

attention. Later on, if found desirable, the business may be intensified and the method of management changed to meet changed conditions.

**Time to Start.**—For the production of market eggs the best time to begin actual operations will be with the spring hatching. The houses may be built during the summer and made ready for the mature pullets in the fall. This will give good results in the least possible time. When it is desirable to start with adult birds for egg production, it will be necessary to have the houses built during the fall and winter and have the birds in them by January, so that they can be fed and cared for at least two months before the eggs are saved for hatching.

Where market broilers are the object, the incubator and brooder houses should be completed by the first of September, so that the first hatches can be accommodated by that time. The broilers may then be ready by Thanksgiving time, which is the opening of the broiler season.

All things considered, the spring of the year will generally be the best time to start, as the birds can be cared for during the summer much easier than during the winter. It is cheaper to hatch and rear young birds than to purchase a considerable number of adults. The buyer of adults is not always sure of getting good layers. The purchase of a few adults of known ancestry and good breeding is the safest way to start. Their eggs may be hatched and a good strain built up in that way.

**To Achieve Success.**—A small beginning, with from 200 to 500 birds, in connection with some other branch of farm work, from which the support of the family can come, may develop in a few years into a sound and profitable business. The growth of the work each year can be governed by the success attained, by allowing the profits to pay for each yearly increase. This method, combined with as much previous practical training as possible, will be a safe guarantee of success and will afford a pleasant occupation to any prospective poultryman.

**Hindrances to Success.**—The three main causes of failure are the following: (1) A wrong personality of the poultryman himself, in not being suited either mentally or physically to the work. (2) Next in importance is the nonattention to details, or leaving them to others whose interest is not what it should be. (3) Starting with weak, impure, or poorly bred birds. This last factor seriously needs to be considered, and it will pay the purchaser well

to look far and carefully before purchasing the adult birds which are to make or mar his whole future.

*System the Key Word.*—The one point above all others which the poultryman must be sure to consider is the absolute necessity of system in all branches of his work. The poultry business, which is composed largely of definite details, requires a careful systematizing, not only in the keeping of books and accounts, but in all the routine work,—as, feeding, hatching, brooding, breeding, and preparing for market. The work can be done much more easily and cheaply by having system; it can be done each time with the same degree of care, and the danger of overlooking any detail is lessened. The three stepping-stones to success in the work are system, promptness, and energy.

#### REVIEW.

1. Why is a modest beginning to be desired?
2. Why is the right personality so essential in poultry keeping?
3. Enumerate the qualities of a successful poultryman.
4. Name four ways in which it is possible to learn the poultry business.
5. What are the three business principles of poultry keeping?
6. Give a classification of a poultryman's capital.
7. What is meant by fixed and by circulating capital?
8. In what respect is land capital?
9. What should be the economic limit to investment in buildings?
10. What is the invariable result of overcapitalization at the start?
11. Discuss the economic limitation of production in respect to capitalization.
12. How is the colony system especially adapted to the small investor?
13. What influences the time to start in the poultry business?
14. What is the safest procedure to achieve success?
15. Enumerate factors which tend to hinder success.
16. What is the value of system in all operations?

## CHAPTER IV.

### THE BREEDS OF POULTRY.

THE breeds and varieties of poultry are so numerous and represent so many mixed characteristics and features that it is practically impossible to give a simple complete classification, allowing each breed and variety its legitimate place. A practical classification, in order to be of any definite value, must consider economic features as well as external points of shape, size, and color.

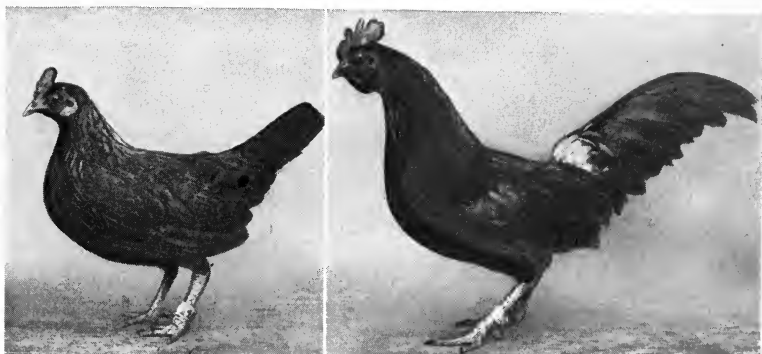


FIG. 37.—Pair of jungle fowl (*Gallus bankiva*), one of the ancestors of the present domestic breeds. The light, active breeds resemble this ancestor. (Photos of Figs. 37 and 38 by the Station of Experimental Evolution, Cold Spring Harbor, L. I.)

It is the purpose of this chapter to give a general discussion of the breeds of poultry as we know them to-day, consider the origin of the domestic breeds, and give a classification of them.

**Origin of the Domestic Fowl.**—The domestic fowl belongs to a group of scratching birds which includes turkeys, guinea-fowls, pheasants, partridges, and others. The progenitors of the domestic hen of to-day were wild species, and it is probable that it originated from the crosses or mingling of the blood of two quite different species, the most important one being the wild fowl common in the jungles of India and Southern China, which is known as *Gallus bankiva* (Fig. 37).

The jungle fowl is about one-third the size of the domesticated one, having a flattened tail, single comb, and wattles resembling

those of the domestic fowl. The female is much smaller and has less comb and wattles than the male. The shanks of both sexes are willow colored, resembling those of the black-breasted red game fowl. They are capable of considerable flight, but in other habits resemble to a great extent the domestic forms. Breeding experiments show that they are completely fertile with the domestic birds.

The reason for concluding that a second species, other than the *Gallus bankiva*, was present in the evolution of the present type is the existence of characteristics which it is impossible to

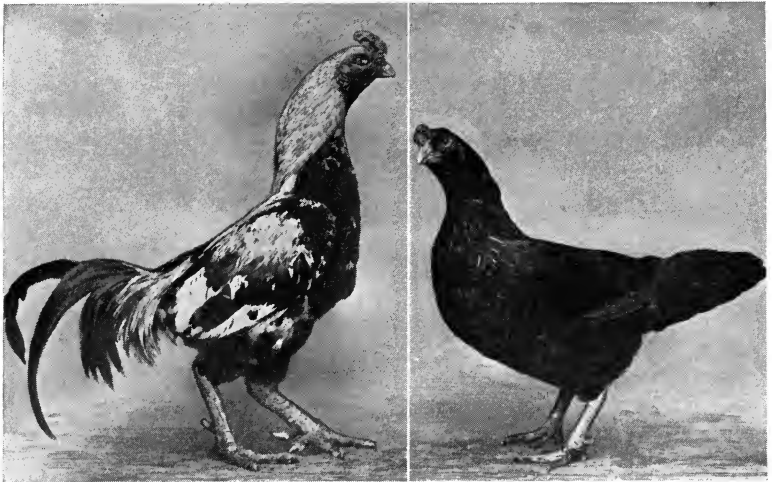


FIG. 38.—A pair of Aseel fowls, the Malay ancestor of domestic birds. The heavy meat breeds resemble this ancestor.

breed from the jungle fowl alone. With the use of the Aseel or Malay fowl as one parent (Fig. 38) a complete ancestry is explained, and an intelligent history of the domestication can be written. This ancient Aseel fowl is now practically extinct, but was undoubtedly the oldest fowl in domestication, having been bred in India 3,000 years ago. These Aseel fowls show a pea comb, stout yellow legs, a stocky body, and an unwillingness to fly high in the air. These characteristics are entirely different from those of the *bankiva* fowls, which are so prominent in our heavier breeds, as Brahmas and Cochins.

The process of domestication can be traced from about 1000



B.C., where the Institute of Menu alludes to the sport of cock-fighting, which was probably carried on with the Aseel. From that time on we find domestic fowls constantly referred to in early records, and their improvement was consistent with the advance in civilization. They were gradually distributed westward and over the continent, coming into Europe from Central China by way of Siberia and Russia. They were carried to the New World early in the period of colonization, where they had formerly been entirely unknown.

**Place of Poultry in the Animal Kingdom.**—As members of *Gallus bankiva* are, undoubtedly, the leading ancestors of our domestic breeds of to-day, it is interesting to trace the place which poultry occupy in the animal kingdom and to determine their relation to other types of birds. The following analysis gives in an abbreviated form the place of poultry in the animal kingdom:

KINGDOM,	<i>Animal.</i>	
SERIES,	<i>Metazoa:</i>	consisting of animals with cellular tissues and true eggs.
BRANCH,	<i>Vertebrata:</i>	animals having an internal skeleton, backbone, and dorsal nervous cord which is separated from the body cavity; circulation complete; limbs not more than four.
DIVISION II,	<i>Craniota:</i>	animals of the subkingdom <i>Vertebrata</i> having skull, heart, and brain.
PROVINCE II,	<i>Sauropsida:</i>	<i>Craniota</i> with amnion and allantois; no gills; epidermal scales or feathers.
CLASS IV,	<i>Aves:</i>	true birds; feathered; four limbs, hind pair for progression on land or water, front pair for flight; no teeth; three eyelids; heart with four cavities; lungs.
SUBCLASS II,	<i>Carinatae:</i>	birds having a keel or breastbone and functional wings.
ORDER VI,	<i>Rasores:</i>	an order of <i>Carinatae</i> which are terrestrial in their habits, having short, stout legs, suited to scratching; and with stout, arched beak for seed eating. <i>Gallus</i> is a true representative of this order, and is the ancestor of our domestic fowls.

The class *Aves*, or birds, represents one of the most clearly defined classes of the whole animal kingdom, having a great many divisions or subclasses. They are aquatic, terrestrial, and aerial in their habits; all types, however, show great similarity of structure. The order *Rasores*, to which our domestic fowls belong, contains a great many birds which are very valuable to man. This order, in general, is characterized by short, arched beak; short concave wings, unfit for extended flight; stout legs of medium

length; four toes, usually three in front, these being united by a short web. The features of the body are large and coarse as compared to birds of flight. The males have brighter-colored plumage than the females. Their main feed is grain. Common representatives of this order are domestic chickens, turkeys, pheasants, partridges, and grouse.

**Two Classifications of Poultry.**—Two general classifications of poultry may be made: First is the so-called *standard classification*. A book on this is edited and published by the American Poultry Association. The points in this classification are intended to guide judges and breeders of exhibition poultry. The book does not serve as a practical guide to the economic points of the breeds. This classification is based primarily upon the origin and distribution of the breeds, and not so much upon their economic importance. In a great many cases their economic possibilities have been the direct outgrowth of environment at their place of origin.

The second classification might be termed *utility*. It is based on the economic possibilities which the different breeds offer for market purposes.

Either of these classifications must be relatively arbitrary. There are a number of breeds which possess characteristics, any one of which, considered singly, might place them in one class and then in another.

#### STANDARD CLASSIFICATION.

The standard classification of domestic poultry includes all classes, representing thirty-eight different breeds which contain 109 varieties. It is impossible to give here a detailed description of each. The breeds and varieties are given in a classified form; this is followed by an outline of their historical development and distribution.

#### *Standard Classification of Domestic Fowls.*

Class No. and name.	Breed.	Variety.
1. American . . . . .	Plymouth Rock: ✓	Barred, white, buff, silver pencilled, partridge, and Columbian.
	Wyandotte: ✓	Silver, golden, white, buff, black, partridge, silver pencilled, and Columbian.
	Java:	Black and mottled.
	Dominique:	Rose comb.
	Rhode Island Red: ✓	Single comb and rose comb.
	Buckeye:	Pea comb.
2. Asiatic . . . . .	Brahma: ✓	Light and dark.
	Cochin: ✓	Buff, partridge, white, and black.
	Langshan: ✓	Black and white.

3. Mediterranean...	Leghorn: ✓	Single-comb brown, rose-comb brown, single-comb white, single-comb buff, rose-comb buff, single-comb black, and silver.
	Minorca: ✓	Single-comb black, rose-comb black, and single-comb white.
	Spanish:	White-faced black.
	Blue Andalusian.	
	Ancona.	
4. English.....	Dorking:	White, silver gray, and colored.
	Redcap:	Rose comb.
	Orpington: ✓	Single-comb buff, single-comb black, and single-comb white.
5. Polish.....	Polish:	White-crested black, bearded golden, bearded silver, bearded white, buff laced, nonbearded golden, nonbearded silver, and nonbearded white.
6. Hamburg.....	Hamburg:	Golden spangled, silver spangled, golden pencilled, silver pencilled, white, and black.
7. French.....	Houdan:	Mottled.
	Crevecoeur:	Black.
	La Fleche:	Black.
8. Game and Game		
	Bantam.....	Game:
		Black-breasted red, brown-red, golden duckwing, silver duckwing, birchen, red pyle, white, and black.
		Game Bantam:
		Black-breasted red, brown-red, golden duckwing, silver duckwing, birchen, red pyle, white, and black.
9. Oriental.....	Cornish:	Dark, white, and white-laced reds.
	Sumatra:	Black.
	Malay:	Black-breasted red.
	Malay Bantam:	Black-breasted red.
10. Ornamental		
	Bantam.....	Sebright:
		Golden and silver.
		Rose comb:
		White and black.
		Booted:
		White.
		Brahma:
		Light and dark.
		Cochin:
		Buff, partridge, white, and black.
		Japanese:
		Black-tailed, white and black.
		Polish:
		Bearded white, buff-laced, and non-bearded.
11. Miscellaneous...	Silkie:	White.
	Sultan:	White.
	Frizzle:	Any color.

Classes 12, 13, and 14 are omitted here, as they include ducks and geese, which are not considered in this volume. All students of poultry husbandry should secure a copy of the "American Standard of Perfection" and become thoroughly familiar with the details and requirements of the breeds as outlined.



Fig. 39.—Shapes of breeds. Plymouth Rock has shape of a gravy bowl; Wyandotte of a circle; and Rhode Island Red of a rectangle. (Drawings by W. H. Card.)

*Terms Explained.*—It should be noted in the above outline and description given later that the three terms, *class*, *breed*, and *variety*, are used with distinctive meanings.

*Class* is used to include the larger groups of birds. The classes relate to their place of origin or their natural habitat, as, for instance, American class, English class, French class.

*Breed* is used almost entirely to designate body shape and form. For instance, in the American class are the Plymouth Rock, Wyandotte, and Rhode Island Red, each one a distinct breed and each one having distinctive body shape or type. The Plymouth

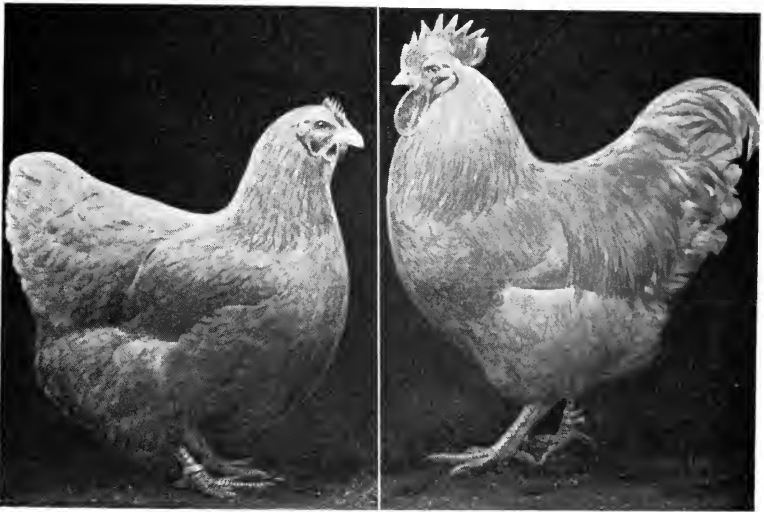


FIG. 40.—Buff Orpington pair, a popular variety of this English breed. (Photo by Sunswick Poultry Farm.)

Rocks' bodies are represented by oval curves, the Wyandottes' by circular curves, and the Rhode Island Reds' by rectangles. This difference can easily be distinguished from the accompanying sketches (Fig. 39).

"Breed" is also used to designate both shape and variety color, yet in such cases the proper distinction has been partially overlooked. This error is especially pronounced in the Orpington breed; there the tendency has been to create new varieties at a sacrifice of shape, it being quite common to find Buff Orpingtons with a buff color, but representing anything but the Orpington shape (Fig. 40). Another example is among White

Wyandottes. There are many white, rose-comb birds commonly called Wyandottes which possess Plymouth Rock shape. The aim should be to eliminate this fallacy as much as possible and breed true to body shape and breed type, as well as to variety color.

*The standard weights of the breeds are given in Table III.*

TABLE III.—*Standard Weights.*

Class.	Cocks.	Hens.	Cockerels.	Pullets.
	<i>Pounds.</i>	<i>Pounds.</i>	<i>Pounds.</i>	<i>Pounds.</i>
American class:				
Plymouth Rocks.....	9½	7½	8	6
Wyandottes.....	8½	6½	7½	5½
Javas.....	9½	7½	8	6½
Dominiques.....	7	5	6	4
Rhode Island Reds.....	8½	6½	7½	5
Buckeyes.....	9	6	8	5
Asiatic class:				
Brahmas.....	12	9½	10	8
Cochins.....	11	9½	9	7
Langshans.....	9½	7½	8	6½
Mediterranean class:				
Minorcas.....	9	7½	7½	6½
Spanish.....	8	6½	6½	5½
Blue Andalusians.....	6	5	5	4
English class:				
Dorkings.....	7½	6	6½	5
Redcaps.....	7½	6	6	5
Orpingtons.....	10	8	8½	7
French class:				
Houdans.....	7½	6½	6½	5½
Crevecoeurs.....	8	7	7	6
La Fleche.....	8½	7½	7½	6½
Oriental class:				
Cornish.....	9	7	8	6
Malays.....	9	7	7	5
	<i>Ounces.</i>	<i>Ounces.</i>	<i>Ounces.</i>	<i>Ounces.</i>
Malay Bantams.....	26	24	24	22
Game Bantam class:				
Game Bantams.....	22	20	20	18
Ornamental Bantam class:				
Sebrights.....	26	22	22	20
Rose Comb.....	26	22	22	20
Booted.....	26	22	22	20
Brahma.....	30	26	26	24
Cochin.....	30	26	26	24
Japanese.....	26	22	22	20
Polish.....	26	22	22	20

Breeds not mentioned, such as Leghorns, Anconas, Hamburgs, Games, and others, have no "standard" weights.

*Variety* refers chiefly to color pattern of plumage. For instance, there are six varieties of Plymouth Rocks, and all should be exactly the same shape, the only difference being in the color of the plumage. So with Wyandottes; there are eight distinct color varieties. In some cases, however, variety is used to designate the character of comb, the color being the same.

*Type* means the form and function of the body, or plan of structure, as related to the formation of some special product; for example, egg type or meat type. The term is used later in this chapter.

**Description of Breeds.**—1. *The American class* includes the breeds of poultry which have originated in America and which were created and improved with the idea of dual-purpose achievement. They constitute the great mass of poultry kept on American farms and are the popular general-purpose fowls of America. They average in weight from five pounds in the case of immature females to about ten pounds for the mature male bird.

The Barred Plymouth Rock is undoubtedly the leading breed in popularity,—more are grown each year than any other variety. This variety is the result of crossing a male Dominique and female Java. The idea was to develop the best possible utility bird.

The Wyandottes were originated in New York State, early in 1868, and probably contain intermingled blood of Hamburg, Cochin, and Dark Brahma. They are one of the strongest American breeds, and are very popular in exhibitions and on general farms.

The Rhode Island Red is a breed of more recent origin. There was probably a great intermingling of different breeds in its make-up. Birds of this breed were developed largely in southern New England, but have become very popular for farm purposes in many sections of the country.

2. *The Asiatic Class.*—Three distinct breeds are here included. Each is noted for its large size, and all the varieties are meat-producing fowls. This class includes the Brahma, which is the largest of all domestic fowls, often attaining a weight of from twelve to thirteen pounds. They have their origin in types and varieties imported from Asia, as the class name implies.

The Brahmas were originated in New England, and contain the blood from what was then known as the Gray Chittagong and the Brahmaputra (Fig. 41).

The Cochin originated in England, about the time that the Brahma was creating so much interest in America. It was developed from what was known as the Shanghai fowl, which probably came in the beginning from a port in China by that name.

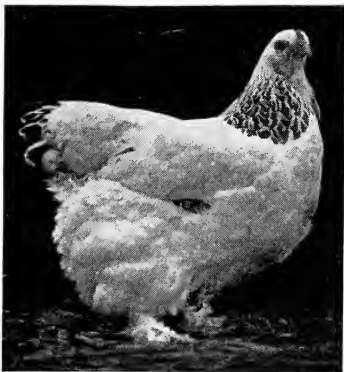


FIG. 41.—Light Brahma hen, one of the most popular of heavy fowls. This is a good example of the pea comb.

The Langshans were developed largely in England; their early history is somewhat obscure, and there is some dispute as to their ancestry.

### 3. *The Mediterranean Class.*—

This group of birds had their origin on the shores of the Mediterranean Sea. The five families or breeds of this class are recognized as the world's best egg producers, and they have probably become more generally distributed throughout the world than any other group.

The Leghorns (Fig. 42) are by far the most popular breed of

The Leghorns (Fig. 42) are by far the most popular breed of

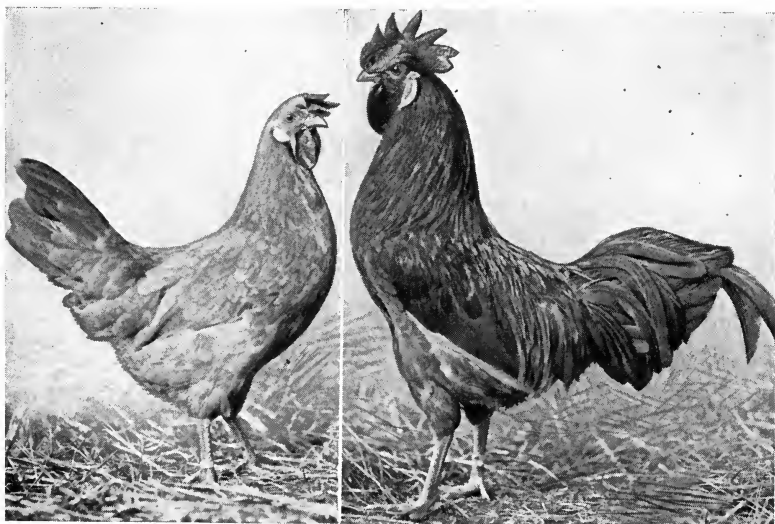


FIG. 42.—Buff Leghorns. The carriage shown here is characteristic of the breed.



this class, and are rapidly gaining in numbers and distribution in America, as they are considered the most economic egg producers in sections where the white-shelled eggs are preferred. These birds were imported to this country in 1850 from Leghorn, Italy. Since then they have been slowly developed until they have assumed the characteristics as we know them to-day.

The Minorcas originally came from the Island of Minorca, off the coast of Spain. Early in their development they were known as the Red-faced Spanish. The original Minorcas, when imported to this country, were much smaller and not nearly so productive as are the representatives to-day. The best specimens rank second to the Leghorn in the Mediterranean class as egg producers.

The White-faced Black Spanish is one of the oldest breeds in existence. They were originally called the Black Spanish fowls. The large white face has been produced after many years of selected breeding for this one feature alone. This breeding has resulted in the lowering of other qualities, so that the breed is not so popular nor so profitable for market purposes as it might be.

The Blue Andalusian is a breed almost as old as history itself. The ancestry is not known. Birds of this type are constantly being produced and have been produced throughout the world as the result of crossing black and white varieties of the same breed. Both England and Canada have been quite extensive breeders of pure and high-grade Andalusians. The Andalusian is midway between a Leghorn and Minorca in size and shape. Owing to the color of the skin and other characteristics, they have not attained any great degree of popularity in the United States.

The original home of Anconas was probably Italy, where they are now quite abundant. They require care and attention to perfect their color markings, and are bred by the true fancier. The general characteristics of Anconas are very similar to Leghorns. It is owing to this fact that many claim Leghorns as the true ancestors of Anconas (Fig. 43). As a breed they have very little economic value, since there are many others which are far superior to them for both eggs and meat.

4. *The English class* is represented by three breeds,—Dorkings, Red Caps, and Orpingtons.

The oldest of these, in fact one of the oldest of all breeds, is the Dorking. One peculiar characteristic is the fifth toe, which was early mentioned in agricultural literature. The Dorkings are supposed to have been imported from England by the Romans.

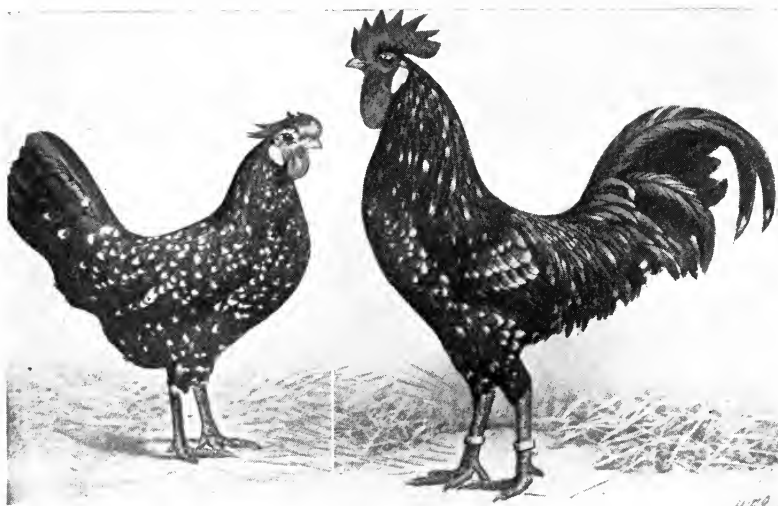


FIG. 43.—A pair of Mottled Anconas—typical of the Mediterranean class. (Photo from Urban Farm, Buffalo, N. Y.)

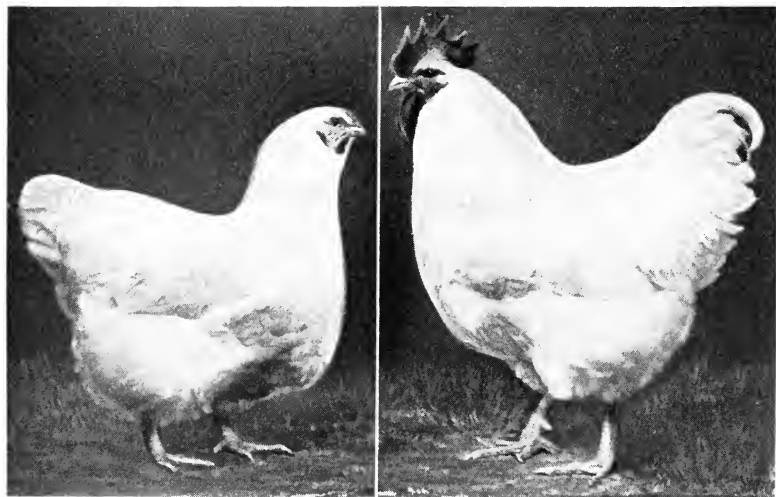


FIG. 44.—A White Orpington pair—an English general-purpose type. (Photo from Harmony Park, Scotch Plains, N. J.)

The White Dorking is probably the oldest variety of this breed, while the Silver Gray variety is one of the most popular. In America the Dorkings have not attained any great degree of popularity, due, no doubt, to the fact that other breeds are considered better.

The Red Caps are well known to fanciers. They have many useful qualities, but are not practically considered among the breeds in America.

The Orpington has recently come to be one of the most promising breeds of poultry (Fig. 44). The honor of originating this breed belongs to Mr. William Cook, late of England. The direct object in its make-up was to secure a typical English breed with general-purpose qualities to take the place in England which is occupied in this country by the Plymouth Rock and the Wyandotte. The English requirements call for white beak, shanks, and flesh. In America these points are not preferred. The Orpingtons are gaining rapidly in popularity among American fanciers, and if the present wave of popularity continues they will undoubtedly find a place among the leading general-purpose breeds (Fig. 45).

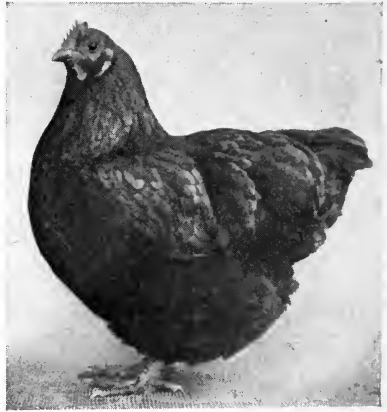


FIG. 45.—Black Orpington hen, representing the ideal Orpington type, not yet attained in any other than the black variety. (Photo from Sunswick Poultry Farm.)

5. *The Polish class* includes only one breed, with many varieties. These are admired for their fancy qualities. They have peculiar formations of the skull and nostrils, and are distinctive in having a V-shaped comb. The Polish fowls were originally called Polanders, from the fact that they were supposed to have originated in Poland. English fanciers have done much toward improving this breed. The Canadian poultrymen have also taken considerable interest in the breed and in its improvement. One notable feature which fanciers have developed is the size of the crest. This was attained by the breeding of birds which have relatively large knobs on the head, for it was found that the size of the crest and the knob have a direct relation to each other.

6. *The Hamburgs* are of one breed represented by six varieties. They are noted for their extremely fancy plumage and peculiar carriage. They are supposed to have been originally imported from Hamburg, and hence are often spoken of as "Dutch" breed. They were probably developed in England by crossing them with other varieties with fancy plumage for show purposes. These birds have not attained any great degree of popularity in America.

7. *The French breeds* are represented in America by only the Houdan, Crevecœur, and La Fleche. There is another breed very popular in France, namely, the Faverolle. All these breeds are raised very extensively in France, and are used largely for table poultry. There is said to be Polish blood in their make-up.

The La Fleche most nearly corresponds to our egg type of birds. The other three French breeds are heavier meat breeds, and correspond more or less to the Asiatic type, having a peculiar pinkish-white skin and flesh. France is noted for its extensive market-poultry industry. The four breeds mentioned have not attained any great degree of popularity in America, as they are not considered superior to the Asiatic breeds for meat purposes.

8. *Games and Game Bantams*.—The game fowl represents a distinct type in regard to shape. This type has been in existence as long as poultry has been known. Legends say that game fowls were in existence in India previous to the existence of any authentic record. There are eight well-defined varieties, all of which are fairly uniform as to shape. The type bred in America is very similar to that bred in England. This group of birds is characterized by a very erect carriage, the result of years of careful selection and mating with the original Pit Game type. Their commercial possibilities are very limited; therefore they are excluded from the average poultry farm. Each of the varieties of Game Bantams has the identical type of the standard-size varieties, but is much smaller.

9. *The Orientals*.—The four breeds of birds in this class are the Cornish, Sumatra, Malay, and Malay Bantam, all of which are of the game type. Their main difference in appearance from the ordinary game type is a much heavier body, short neck, and strong shanks. The Sumatra and Malay are said to have originated in Oriental countries. It is said that the Cornish fowl, as we know it to-day, originated in Cornwall, England, as a result of crossing the Black-breasted Red Game upon Aseel birds imported from India; and later Sumatra blood was introduced. The effect of this

intermingling is very noticeable in the Cornish Games of to-day. They are often spoken of as "Cornish Indian Games."

10. *Ornamental Bantams*.—This class is represented by five breeds and many varieties. They are entirely ornamental, and are bred for pleasure and fancy. They do, however, possess some desirable poultry qualities. Many of them are egg layers, and the Cochin Bantam hens are profitable when used to hatch the eggs of pheasants and other small fowls.

In this group the Brahma and the Cochin Bantams are the exact image of the standard-size birds of the same name.

The Rose-comb Bantams are prototypes of the Hamburgs.

Sebright Bantams are said to have originated in England after a great many years of careful breeding, and they are one of the most remarkable poultry breeds in the points of sex similarity and diminutive size.

The Polish Bantams closely resemble the large Polish breed.

The Japanese Bantams are curiosities from the fact that they have exceedingly short legs in proportion to size of body. The male bird is odd in having sword-shaped sickles, carried vertically (Fig. 46).

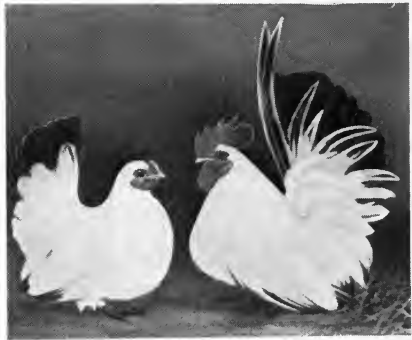


FIG. 46.—Black-tailed White Japanese Bantams—remarkable for their short legs. (Photo by Urban Farms, Buffalo, N. Y.)

11. *Miscellaneous*.—

Three breeds which cannot well be placed in any other class are included here. It may be said they are freaks in certain characteristics. The Silkies derived their name from the peculiar formation of their plumage. Their feathers are webless and of a silky texture. This characteristic makes the breed interesting, since this feature is not possessed by any other standard variety. The face is purple and prominent, the back broad, legs short and feathered, and the body profusely feathered. Silkies are kept in this country more for fancy stock than for any utility value which they possess.

The Sultans are less common than the Silkies. They have coarse muff and beard, vulture-like hock, and very abundant shank and toe feathering.

The Frizzles are named from the fact that the feathers have a tendency to curl upward at the outer end. This curling is especially noticeable in the hackle, giving the birds a general fluffy appearance as though covered with curls.

#### UTILITY CLASSIFICATION.

The utility classification, or commercial classification, is of direct practical importance because it takes into consideration the economic and commercial value of the different breeds. It is of direct importance to the farm poultry breeder as well as the large commercial poultry plant. It is based upon the points which are conducive to the production of eggs and meat. At best, a classification of this kind is largely arbitrary. The useful points of a number of popular breeds will be considered.

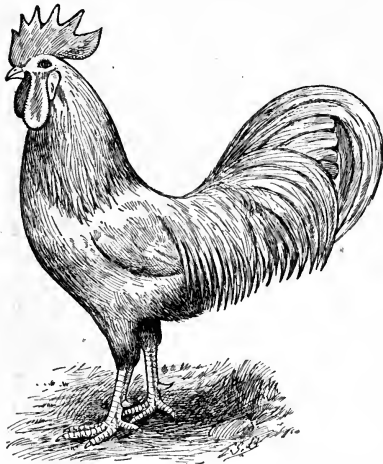


FIG. 47.—Ideal egg shape, as shown in the Leghorn breed.

Four economic types include all breeds having any marked degree of use to man: (1) Egg breeds; (2) meat breeds; (3) general-purpose breeds; and (4) fancy breeds. Only the more popular breeds are here classified.

**Egg Breeds.**—Included in this group are small or medium fowls which have a pronounced tendency toward egg production. They vary slightly in size and form, but are somewhat of a uniform type. They differ materially from birds of the other types mentioned, as will be shown. They are possessed of a neat, trim carriage, which gives them an active and light appearance. They are relatively long-legged, the legs being free from feathers, and it is the aim of breeders to keep down the weight of birds in this class—from three to eight pounds. The aim is not to sacrifice egg production for increased body growth.

The *Leghorns*, *Minorcas*, *Hamburgs*, *Anconas*, *Andalusians*, *Spanish*, and *Houdans* are the most distinctive breeds of this class. The *Leghorns* and *Minorcas* are far in the lead in America (Fig. 47). The *Campine* breed (Fig. 48), of French origin, is a good layer of large, white eggs.

*Disposition.*—The true egg producers are naturally light, active, easily frightened, and of a more nervous disposition than any of the other types. It is therefore hard to enclose them. They do better on an extended range, during the growing period, where they can take necessary exercise. This seems essential to their proper development. If care is used in handling them when young, the tendency to fly can be partially overcome. Owing to their temperament, it is necessary when caring for egg breeds to handle

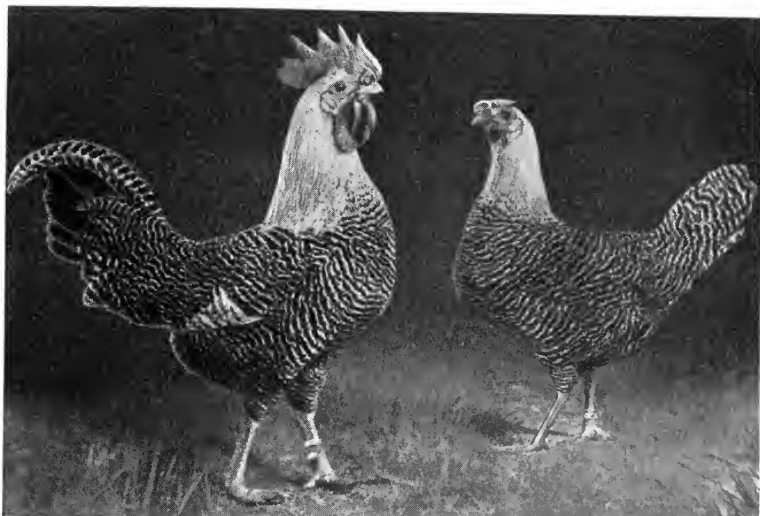


FIG. 48.—A Campine pair, showing the characteristic narrow white and wide dark bars, with light hackle. (Photo by M. R. Jacobus.)

them carefully and quietly so as not to intensify the habit of flight. It rests largely with the feeder and the one who cares for the birds to keep them gentle. Their temperament need not restrict their use, as it can be governed by thought and care. In practice it has been found best to provide them with one of two conditions,—either keep them in close confinement, housing the entire flock throughout the year, or give them unlimited range. Restricted range seems to develop restlessness and the habit of flight.

*Mature Early.*—The egg breeds are early in maturing, and both sexes usually attain the attitude and distinctive features of the adults at an early age. The male Leghorn grows tail feathers, heavy comb, and is fully feathered at the age of nine to ten weeks. As the birds become completely feathered they are

better able to stand bad weather under a great variety of conditions. Previous to this a rapid feather growth takes place, which causes a heavy strain on the system of the growing chick. This requires careful handling up to twelve weeks of age. Undoubtedly early feather growth is the cause of many deaths of Leghorn chicks. Leghorn pullets will be mature and begin laying eggs when from four to five months of age, under favorable conditions; six months is perhaps a better age for laying to begin.

*Poor Sitters.*—Egg breeds are by nature poor sitters and poor mothers, due largely to their nervous temperament and disposition to be always on the move. This is true of the entire Mediterranean class. Breeders have tried for many years to improve the sitting quality in this type of bird, with little success. The tendency has been to develop the egg-laying propensities of the hens and thus obliterate the mother instinct. They become more and more like mere egg machines.

There are cases of Leghorns making good sitters and mothers. Such hens are the exception rather than the rule. In many instances the desire to sit may be very pronounced at the beginning of the spring brooding period, but does not last for many days. The breeder using such hens will often find a nest of eggs chilled and deserted, due to the fickleness of individuals of this type. Exclusive egg farms either use artificial methods of incubation or make use of broody hens of some other breed.

*Foraging Abilities.*—Birds of the egg type are noted for their foraging abilities. Owing to their active disposition and their desire to roam, they will go a long way from the roosting quarters in search of feed. Egg breeds can be kept much more cheaply than the heavier breeds, as they will obtain a great deal more natural feed on their foraging expeditions. When it is impossible to give them free range, it is necessary to provide exercise in some other form. This can best be done by inducing the birds to scratch in search of grain scattered in deep litter. When proper attention is given to exercise, this type of bird thrives very well, in spite of close confinement. On large egg plants, the most economical method of keeping this type of hens during the summer is on free range. They get a large amount of green feed and secure a great many grubs and other insects which to some extent take the place of meat scrap.

*Susceptible to Cold.*—The egg breeds have large combs and wattles and are enveloped by close plumage, which tend to make



them susceptible to cold. In practice, however, it has been found that the birds do not suffer severely if the house is kept well ventilated. An abundance of fresh air and oxygen keeps up the circulation of the blood and removes surplus moisture. The presence of moist air is very detrimental and tends to produce frozen combs in winter. Frozen combs and wattles must be avoided, as they impair the physical condition of the birds, and greatly reduce, for a time at least, the egg-laying capacity, due to the impaired vitality.

The close feathering does not offer the protection against cold that is found in the meat breeds or loosely feathered birds. A thick growth of feathers offers better protection.

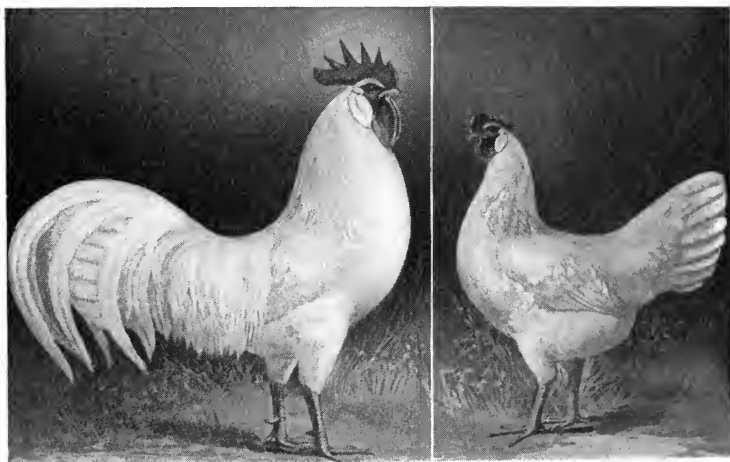


FIG. 49.—Single-comb White Leghorns, the most popular of the egg breeds. (Photo by International Correspondence Schools.)

A reason which is advanced for the breeding of rose-comb birds is the supposed hardiness of such combs. In practice, the wattles and the spikes of the rose combs are often frozen. It has been impossible to breed as high a producing strain of rose-comb birds as of single-comb birds. The Leghorns, in spite of the danger of suffering from cold, have proved to be one of the hardiest breeds kept in this country. For winter egg production, they have proved their worth in practically all sections. When provided with proper houses and the right kind of feed, they are well able to withstand the winters.

*Leghorns* outclass all others in popularity for egg-producing

purposes. They lay extremely large white-shelled eggs which top the market at the best prices. The birds are small in size and are not suitable for table purposes (Fig. 49). Where they are kept, little attention is devoted to the production of meat; the revenues from birds sold for this purpose are comparatively small. They

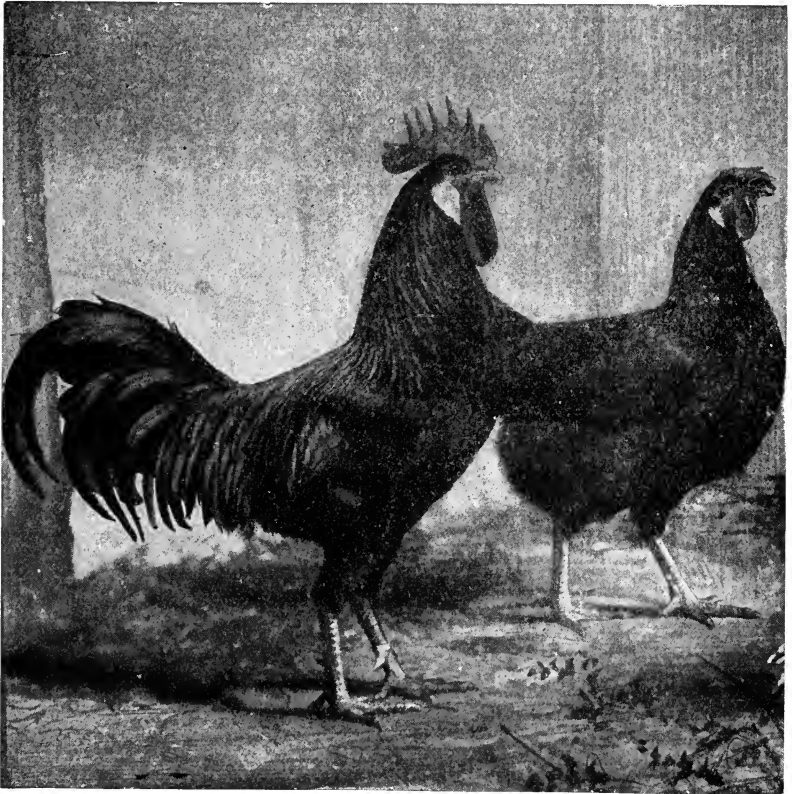


FIG. 50.—Single-comb Black Minorca pair, a breed noted for large eggs with white shells.

lay so many eggs that the sales for meat can be eliminated. Records show individuals that have produced more than two hundred eggs per year, and in rare instances large flocks have averaged as high as this. Leghorns, owing to their small size, are light eaters, both during their growth and after maturity. All things considered, it costs less to produce eggs with Leghorns than with any other breed. The Brown Leghorns have become

quite popular, but they do not equal the white variety. Solid-colored birds, as the White Leghorns, are more satisfactory to the poultryman, as they are easier to breed true to color. The primary object, in this case, is the production of eggs, and he does not wish to consider the fancy points of color plumage.

*Minorcas* rank second to Leghorns in egg production (Fig. 50). They are the heaviest breed in the Mediterranean class, but in appearance resemble the Leghorns. They have larger combs and wattles, increasing the danger of freezing. They lay extremely large, white eggs, the largest of any standard breed kept for egg production. The shells are thin and there is danger of breakage during shipment. The size of the eggs is in their favor, but a special type of carton or filler is required to ship them. For a high-class retail trade the large, ivory-white eggs always bring a premium. This breed has never become so popular in America as the Leghorns, owing perhaps to the fact that the shanks have a dark-blue color. They have meaty bodies, but, owing to the color of the skin and flesh, they are not demanded by the general trade. *Minorcas* are much harder to raise to maturity than Leghorns, having less vitality. There are fewer raised, and hence less selection for vigor and vitality is practised.



FIG. 51.—Ideal shape of the meat type, as shown in the Brahma.

The other egg breeds mentioned are of no great economic importance in America, and will not be discussed in detail here.

**Meat Breeds.**—The second type or group of birds to consider from the economic standpoint are those adapted for meat purposes. These birds are of good size, compactly built, and are noted for quality and quantity of flesh. Birds of the Asiatic group undoubtedly fulfil these requirements best. In every respect large birds are preferred, as there is less waste in bone and offal, and

large fowls can be served on the table to better advantage than small ones (Fig. 51).

*Brahmas*, *Cochins* (Fig. 52), and *Langshans* represent the meat type in the highest degree. They are larger and blockier than the egg breeds; and have good depth and breadth of body, with very full breast. The legs have the appearance of being very short; but this is an illusion, due to the extreme fulness of the feathers. A large, soft-meated bird with an abundance of flesh and plumage is the most highly prized. The breeds may be subdivided accord-

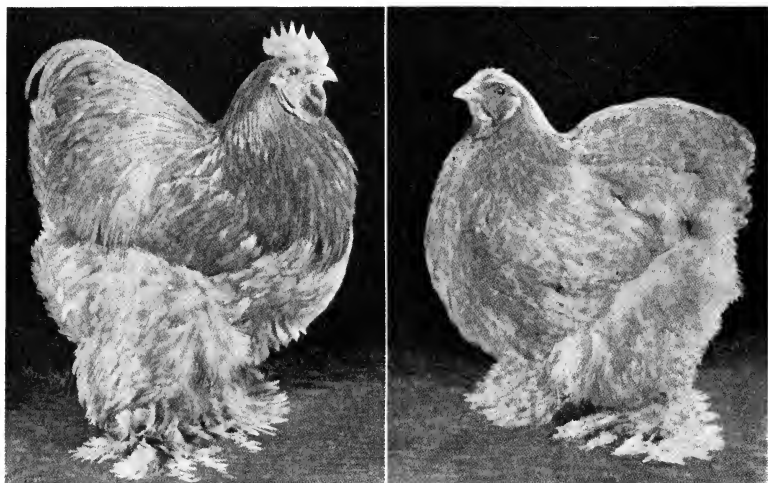


FIG. 52.—Buff Cochins, one of the heaviest of the meat breeds.

ing to the character and quality of meat. Some are suited for broilers, others for roasters, and others for capons.

Many of the general-purpose breeds are used extensively for meat purposes, but they are not strictly included in the meat class, as they do not represent the greatest quality or quantity which it is possible to attain.

*Disposition.*—They are slow in movement and are not easily frightened. If properly handled when young, they become very gentle, and do not dislike handling and attention as do the egg breeds. The meat breeds have a lazy disposition, and require more care in feeding than the lighter breeds.

*Mature Late.*—The meat breeds are very slow in maturing,

not assuming the adult features very young. They are slow in feathering and are always slow growers. It takes from six to eight months or longer to mature a pullet to laying condition. The males do not assume or attain the highest degree of perfection for meat until from seven to ten months of age. Owing to their slow development and slow feathering, they are rather hard to raise during the first four months. Rainy weather and even damp, unsettled weather seem to chill the young chicks, as they have very little, if any, protection in the form of feathers. Although growth takes place very late in the development of the birds, yet the meat remains soft, so that at twelve months of age the flesh may be as tender as it is at five or six months in the lighter breeds. Later it becomes very fibrous.

*Persistent Sitters.*—They are naturally very persistent sitters and good mothers; but, owing to their large size, feathered shanks, and clumsy movements, they are apt to break the eggs or crush the chicks in the nest. As there are several general-purpose breeds which make as good or better sitters, hens of the meat breeds are less used for that purpose. The Bantam meat breeds make very good mothers, and are often used for that purpose.

*Poor Foragers.*—The heavy meat fowls are not, by nature, adapted to seeking their own feed, and will not roam a great distance from the roosting quarters in search of it. They are easily enclosed, a three-foot fence being sufficient in most cases. They are adapted to the small farm or city lot, where they are confined in small areas. They are not persistent scratchers, and can be given the freedom of a city lot without danger of seriously disfiguring it.

*Extreme Hardiness.*—Fowls of the meat breeds are heavily feathered, have small combs and wattles, and protected shanks; this makes them well suited to withstand extremely low temperatures. This fact should not encourage breeders to take undue risk when providing winter quarters. No birds, regardless of their make-up, will thrive in a house poorly ventilated or having an excess of moisture. The Brahma is especially well protected from the cold, owing to the small wattles and pea comb. The Langshan (Fig. 53), on the other hand, has a rather large comb and suffers more in this respect under adverse conditions.

*Egg-Laying.*—This group is not noted for its egg-laying propensities, being the lowest of any group. General-purpose breeds surpass them in this respect. It is always true in animal breeding

that usefulness in an animal attains its highest perfection in one direction only. When the animal shows a marked advance along one line, it is at the expense of some other feature. So there has not been a tendency to develop, to any great extent, the egg-laying properties of the meat breeds. The Light Brahma has, however, been considered a good layer, considering its size and weight. Modern poultrymen, keeping the heavy breeds, consider

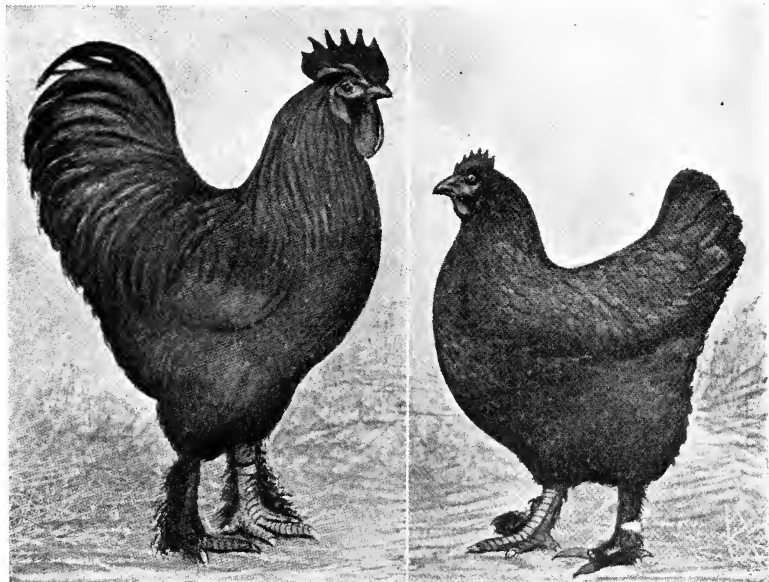


FIG. 53.—Black Langshan pair, a meat breed noted for great height. (Photo by Urban Farms, Buffalo, N. Y.)

them useful for turning out flesh of superior quality. They get eggs enough from them to perpetuate the breed and to supply enough young for market purposes.

**General-Purpose Breeds.**—A number of breeds have been developed and bred for two purposes, namely, the production of both meat and eggs. Birds of this type are most generally kept on American farms and are credited with the great mass of poultry and egg products sent to market. The majority of farmers, keeping small flocks, desire a type which can furnish the home table and market with both eggs and meat. After the fowls have passed

their usefulness as egg producers they bring considerable revenue when sold for meat. The males of this class make the best market broilers; and, as the surplus must be disposed of, they bring good prices when marketed as broilers. Their strong constitution is one factor in making them popular.

Fowls of this class are good layers, and some breeds of the group are good winter layers. In fact, some strains have been so developed that they nearly equal, and in some instances excel, the Leghorns. They have been developed for winter eggs because eggs produced at that season bring higher prices than those produced at any other time. Another reason why this type is so popular is that the hens become broody and make good natural incubators and are good mothers. On the average farm it is not profitable, owing to the small number of chicks hatched, to use artificial incubators; hence this quality is of great importance. Fowls of the general-purpose type may be said to hold a medium place in nearly all respects between the egg and meat types, in some degree combining the good qualities of each (Figs. 54 and 55).

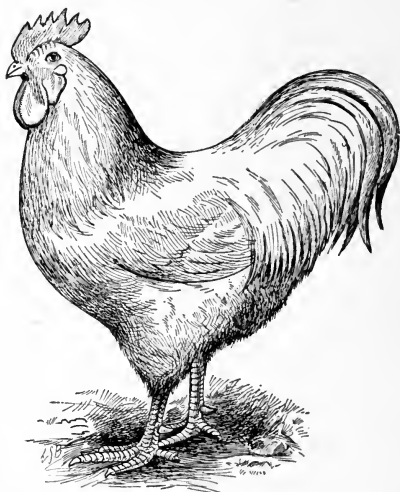


FIG. 54.—Ideal general-purpose shape, as shown in the Plymouth Rock breed.

*Disposition.*—Birds of the general-purpose breeds are gentle, not easily frightened, and of a quiet disposition. They are much more easily confined than the egg breeds, since they are heavier and it is much harder for them to fly over a given height of fence. A fence six feet high is usually sufficient to turn birds of this group, except in cases where the habit of flight is unusually well developed. They are of medium size, have blocky, compact bodies and rather short legs. The blocky appearance is more pronounced than in nearly all other breeds.

*Maturity.*—Chicks of this type mature quicker, passing through the delicate stages more rapidly and stronger, than those of the meat type. They grow more quickly but do not take on mature

features as early as chicks of the egg breeds. They are quick in maturing, the pullets laying at from five to six months. A good time for hatching is April, as this brings them to maturity at about the right time in the fall. They reach the market broiler age at about ten to fifteen weeks, depending upon the size and type of

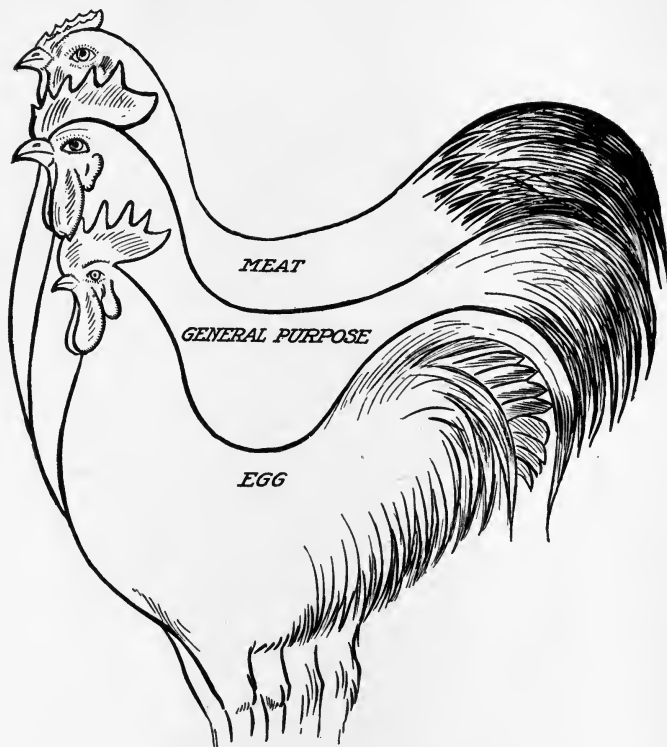


FIG. 55.—Comparison of the three utility types of poultry.

broiler desired; and they may prove very profitable when disposed of in season at this early age.

*Good Sitters.*—They are not as persistent sitters as hens of the meat breeds, yet they will make much better sitters and mothers. They are lighter in weight and do not have feathered shanks. Yearlings and two-year-old hens are good for this purpose. One objection to certain breeds of this group, from the egg-production standpoint, is the large number of broody hens during the spring;



this feature lowers the total yield of eggs. The Rhode Island Reds are often objected to for this reason.

*Good Foragers.*—These birds do not roam as far as those of the lighter breeds, yet they are very good foragers, and will seek out a living if given an opportunity to do so. The young of this group, during their development, will cover an extensive range in search of green feed and insects, and will make a very satisfactory growth with very little supplemental feed. It is the best practice, from the standpoint of a quick and economic growth, to check this habit by supplying considerable feed in the vicinity of their quarters.

*Hardiness.*—The general-purpose breeds are protected from cold nearly as well as the meat breeds, having loose, fluffy plumage, medium-sized combs and wattles, and compact bodies. They are thus able to withstand severe weather. They are much better protected than the egg breeds, and will often lay better during the winter months, when the quarters are not the most favorable.

*The most prominent representatives* of this group are the Plymouth Rocks, Wyandottes, Rhode Island Reds, Orpingtons, Javas, Dominiques, Dorkings, and sometimes Cornish Indian Games. The four mentioned first are by far the most popular in America at the present time, their popularity being approximately in the order named. The Orpingtons are gaining rapidly, and it is probable that they may surpass the Rhode Island Reds. The Plymouth Rocks, Wyandottes, and Rhode Island Reds have bright-yellow skin, shanks, and beak, which is a desired asset in market poultry. The Orpingtons have white shanks and beak. This color tends to work against them as market poultry.

It cannot be said that any one of these four breeds is better than the others in all respects. They all have desirable points and, in fact, are very similar in many respects. There is often a greater difference between the strains of the same breed than there is between the breeds themselves. In selecting a breed the best plan is to pick out the one which appeals to the poultryman's ideal, and then, by breeding and selection, develop this strain to be the best one of the breed.

*Plymouth Rocks* are undoubtedly the leaders of these four breeds, the barred variety being the most popular (Fig. 56 and 57). These fowls resemble the meat breeds in size and the Leghorns in egg production. The flesh is of fine quality; they are blocky fowls, having a rather long body, plump and well proportioned. The laying qualities of the Plymouth Rocks have been

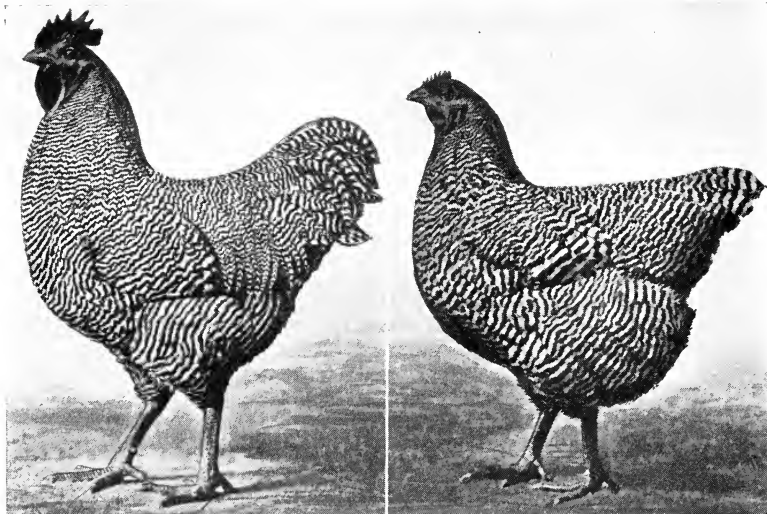


FIG. 56.—The most popular farm breed of poultry—Barred Plymouth Rock pair. (Photo from Grove Hill Poultry Yards, Waltham, Mass.)

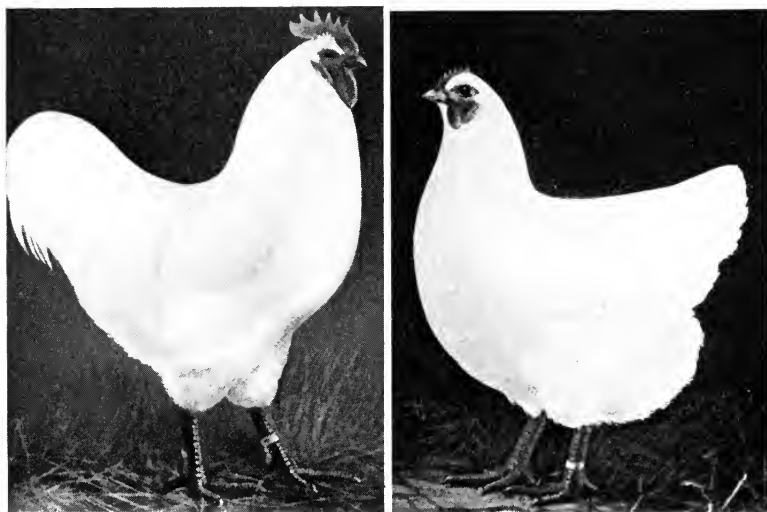


FIG. 57.—White Plymouth Rock pair. (Photo by Urban Farms, Buffalo, N. Y.)

well developed. There are many reliable records of approximately two hundred and fifty eggs per hen from well-bred birds. In their first year the Plymouth Rocks make good winter layers, better in some cases than the so-called egg breeds. When confined they also do well. There is probably no other breed better adapted to the varying conditions of environment,—certainly none that combines in one type so many desirable qualities. Some poultrymen prefer the White Plymouth Rocks for market poultry, as they appear better when dressed. The white pin-feathers are less showy after

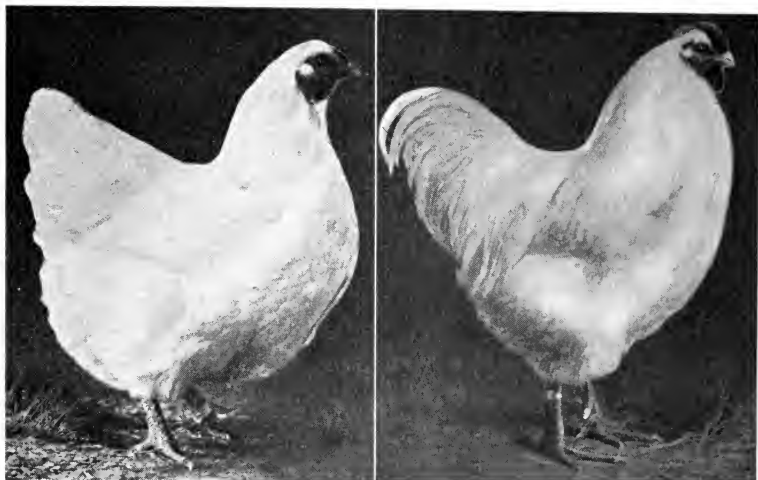


FIG. 58.—An excellent general-purpose breed—White Wyandotte pair. (Photo from Onlya Farm, Florham Park, N. J.)

dressing. There is practically no difference between the varieties of this breed in other respects.

*The Wyandottes* (Figs. 58 and 59) are rapidly gaining in popularity, and probably rank second to the Plymouth Rocks. The breed is newer, having been recognized since 1883. They are a little smaller in size, with blockier, deeper body than the Plymouth Rocks; and have rose combs. They have a neat and trim appearance, and a full plump breast, with an abundance of white meat, which makes them useful as roasters. The good breast meat also makes them valuable for medium and large broilers. Records show that they are good layers. The white variety (Fig. 58) leads in popularity, as they are much easier to breed true to color.

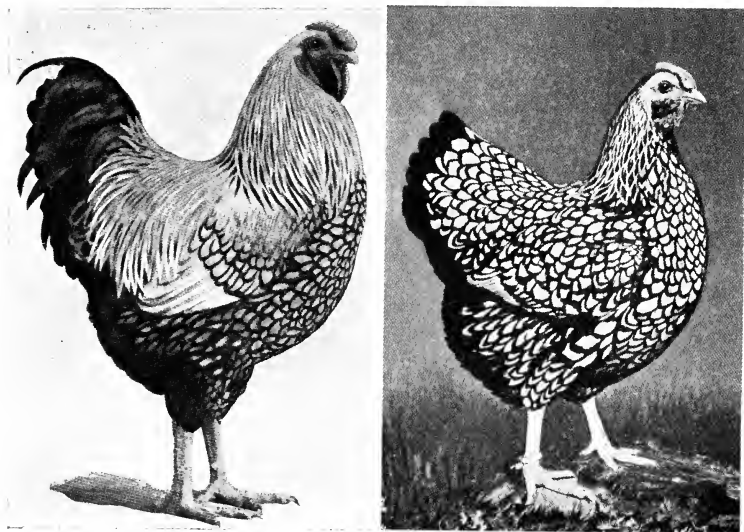


FIG. 59.—Silver Wyandottes, noted for their beauty of plumage.

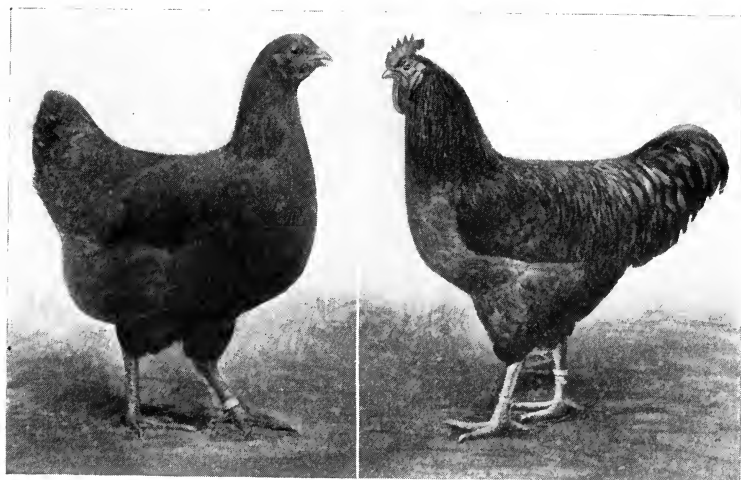


FIG. 60.—Rhode Island Reds, a general-purpose breed gaining in popularity. (Photo by Dearborn and Sharp, Blairstown, N. J.)

*Rhode Island Reds* are gaining rapidly in popularity, owing to the fact that they have proved to be good winter layers. They are very hardy, and are somewhat smaller than the *Plymouth Rocks*, having long, rectangular-shaped bodies (Fig. 60). Objections to them are the tendency to vary in color of plumage and the variation in size and color of eggs. Compared with the *Plymouth Rocks* and *Wyandottes*, they are more active and mature considerably earlier, the pullets often reaching maturity in from

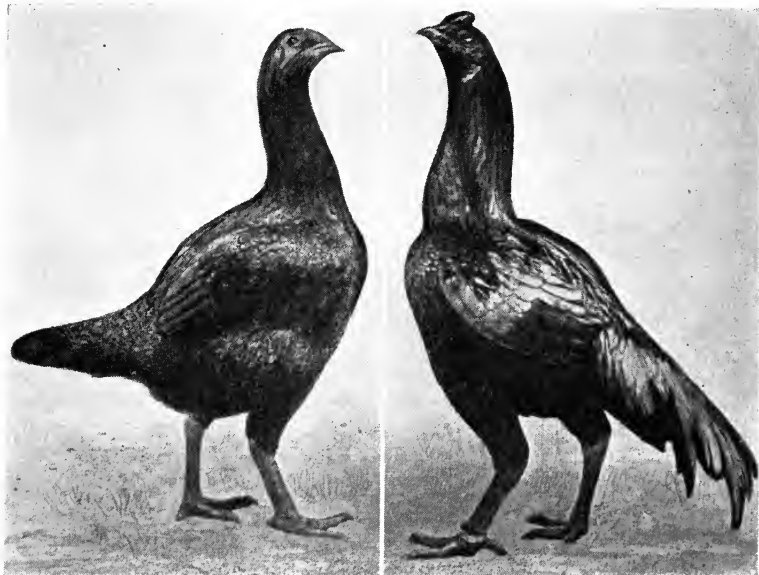


FIG. 61.—The *Cornish Game*, a close-feathered, heavy-meated breed. (Photo by Oak Hill Poultry Yards.)

four and one-half to five months. In sections where they have been introduced they are highly prized as farm fowls.

*Cornish Indian Games* are sometimes included in the general-purpose group. By some they are classed with the meat breeds. They make very excellent table fowls when young. The hens are good sitters and excellent mothers, but not prolific layers (Fig. 61). Their distribution is on the decrease rather than on the increase.

*The Dorkings* are an English breed which approaches the ideal of general-purpose qualities more than any other foreign breed. They are low, heavy-bodied birds and are very good layers.

*The Houdans* are the most popular French breed of the general-purpose type. They are especially noted for heavy egg production, and furnish considerable meat of excellent quality.

**Fancy Breeds.**—This group includes breeds and varieties kept and bred mainly for exhibition purposes. Most of these varieties carry peculiar and highly developed color patterns or plumage markings. Many fowls of this group are good layers. This quality might be intensified by selection and breeding. Many of them are capable of producing meat of most excellent quality. But there are special breeds better adapted to these purposes; and the fancy breeds have not attained wide distribution and are not common on farms.

Those mentioned here are a few of the better known breeds representing this type. The varieties of the *Polish* breed have extremely fancy plumage, and a large crest on the top of the head. The exhibition and ornamental Games may also be grouped here. The *Silkie*s, *Sultans*, and *Frizzles* are birds which are bred primarily for exhibition purposes. Each is of interest because of some peculiar feature. The *Bantams* are bred for fancy or ornamental purposes, as they contain few, if any, utility qualities.

In this connection it must be understood that all breeds of poultry, regardless of their utility value, are bred for fancy points. There is an increasing tendency to select the best utility breeds for this purpose. This is a step in the right direction. The *Wyandottes*, *Orpingtons*, and *Plymouth Rocks* are useful breeds which are taking more prominent places in the large shows; this is resulting in better quality and more fixed type in these breeds.

**Fancy Qualities.**—The term "fancy qualities" is often used to mean purely show features. It is also used to describe standard-bred poultry. The latter use is the more correct, since it includes all requirements to represent the height of perfection from every standpoint. Certain breeders opposed to the work of the American Poultry Association often use the term "fancy" in such a way as to leave a misunderstanding as to its exact meaning. All birds, if they are standard-bred, should possess the requirements of color and plumage markings for the best birds in their breed. In many cases to attain the intricate pattern and plumage requires careful selection and breeding.

The term "standard-bred" covers the requirements of size, shape, and general conformation of body considered necessary or useful for market poultry, and the size and weight of body for egg

production. The present use of the term does not, however, consider form and conformation for egg production.

As breed types become more fixed and a better understanding is obtained of the different breeds, the fancy and the utility requirements will more nearly coincide.

## REVIEW.

1. Trace the origin of the domestic fowl.
2. Give the zoölogical classification of birds, showing their place in the animal kingdom.
3. Describe the class *Aves*, or birds.
4. Name the two common classifications of poultry.
5. How many different varieties are recognized in the standard classification?
6. Enumerate the class numbers and names.
7. Enumerate the breeds and their varieties in classes 1 to 4.
8. What is the relative variation in weights in classes 1, 2, and 3?
9. Upon what features is the standard classification based?
10. Give the origin of the Plymouth Rock, Leghorn, and Light Brahma.
11. What does the Bantam class represent?
12. Give the meanings of *class*, *breed*, and *variety*.
13. What is the basis of the utility classification?
14. Give the four divisions of this classification.
15. Discuss the egg breeds as to disposition, maturity, and hardiness.
16. Name the two leading breeds in this group; compare them.
17. Discuss the meat breeds as regards disposition, maturity, fecundity, and foraging abilities.
18. Name the three leading meat breeds.
19. What position do the general-purpose breeds fill in the utility classification?
20. Discuss the general-purpose group with respect to disposition, sitting qualities, and hardiness.
21. Name four leading breeds in this group.
22. What are the most distinctive differences between the egg, meat, and general-purpose types?
23. Discuss the so-called fancy group.

**References.**—Breeds of Chickens, by James Dryden, Oregon Reading Course Lesson II; Standard Varieties of Chickens, by G. E. Howard, U. S. Farmers' Bulletin 51; A Test of Breeds, by F. E. Emery, North Carolina Bulletin 167.

The Plymouth Rocks, Bulletin 29, The Wyandottes, Bulletin 31; American Breeds of Fowls, Report 1901: All by T. F. McGrew, U. S. Bureau of Animal Industry.

## CHAPTER V.

### SELECTION OF STOCK.

THE DIFFERENCE between success and failure in poultry keeping is often measured by the kind and quality of stock with which the start is made. Poorly bred birds of low vitality, which are not by nature adapted to the purpose in view, will not bring to the owner a profitable business. Great care should be exercised in the selection of the stock which is to be used as the source of many generations of future producers.

**Pure-bred Stock Best.**—Pure-bred birds possess every advantage over mongrels, and failure to see and appreciate this fact often results in limited returns and possible failure. The following discussion of the possibilities of pure-bred poultry is given with the hope that it may impress upon all poultry farmers the wisdom of keeping pure-bred poultry.

*Pure-bred* is a term applied to birds without the admixture of alien blood,—birds having pure blood lines through many years of ancestry.

**Advantages of Pure Breeds over Mongrels.**—There is *more reliability in their breeding*. A pure-bred flock of some standard breed, having been purely bred for many generations, will reproduce their kind with an unfailing certainty. There is no alien blood to bring out objectionable characteristics, and the breeder has a much greater opportunity of knowing what to expect from a given mating. This strong hereditary tendency of one type, due to many years of straight breeding, is not found in cross-breeds or mixed flocks.

**Larger Egg Production.**—It is fair to state, and experience proves the assertion, that pure-bred poultry represented by the breeds which have been bred for egg production for many generations, will lay a larger number of eggs than will birds of mixed breeding. This is due to the fact that the pure-bred breeds have been so bred that every tendency and every spark of surplus energy go toward this function. They have been bred so that every particle of feed which is not utilized for maintenance and energy will naturally, due to the constitutional make-up of the bird, go toward the formation of eggs and not toward flesh growth.



*Improved Quality of Meat.*—The same assertion holds true with reference to the meat breeds, namely, that they have been bred true for generations, the idea being to breed into them the tendency to take all surplus feed and put it into flesh of a superior quality and texture. An example of the superiority of a meat breed, from the meat standpoint, over an egg breed, is shown by comparing the Leghorn and Plymouth Rock. In Leghorns the flesh is limited in amount, is much more tenacious, with less fatty tissue, and has a large percentage of connective tissue or fibrous bands (Fig. 62).

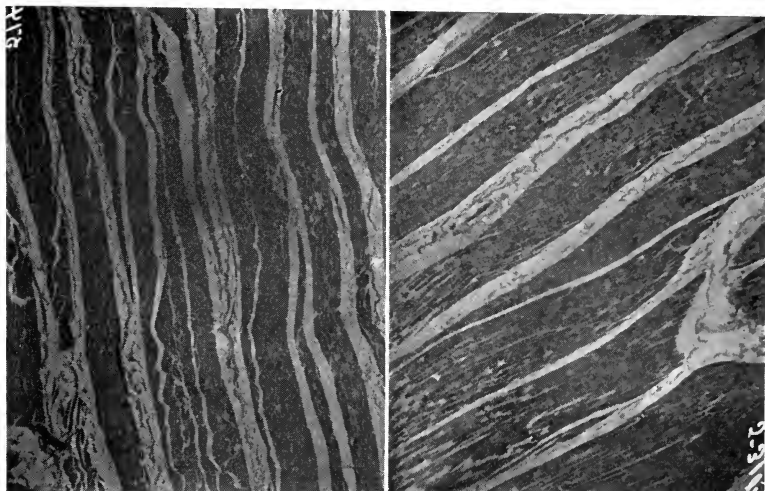


FIG. 62.—Flesh of fowls, showing difference in texture in the egg and the meat breeds. Highly magnified. Left, White Leghorn; right, Barred Plymouth Rock.

In the Plymouth Rocks, which represent the highest perfection in the pure-bred meat breeds, the flesh growth is noted for its abundance; it has considerable fatty tissue among the layers of lean meat, and a small amount of connective or fibrous tissue, giving it a finer texture and making it much more tender when cooked. The meat breeds are superior to mongrels as table fowls.

*Uniformity of Eggs.*—Pure-bred birds show a greater uniformity in the eggs produced, as to size, color, and shape. Each breed has its distinctive shape and color of egg, and, when there is an attempt to cross breeds, no dependence can be put upon the uniformity or character of the eggs produced. This is of special

significance, for most markets desire eggs of some definite color, or at least that they shall be uniform in color. A medium large egg always brings a higher price. Whatever the type, they must be uniform in size and shape to command the best price. When breeds producing eggs of different color and size are crossed, the resulting product will be anything but uniform (Fig. 63).

*More Attractive Appearance.*—A flock of birds, whether ten or one thousand, uniform in size, shape, and color makes a much more pleasing appearance than a mixed lot. Furthermore, such a flock is a credit and an advertising factor to the breeder, for such a flock shows system in all the operations of breeding and leaves a

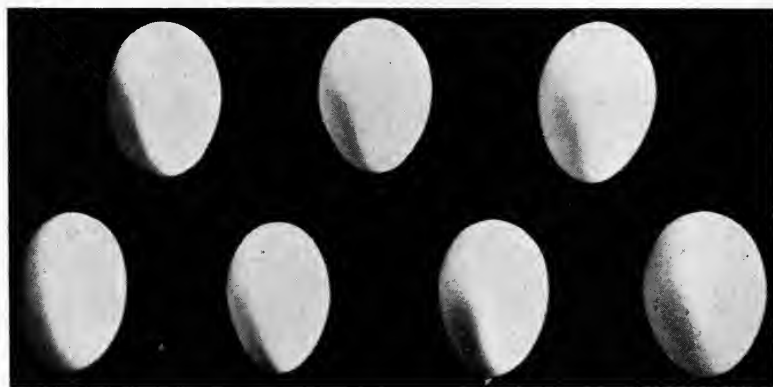


FIG. 63.—Eggs, from pure breeds and from mongrels. Upper row, pure-bred White Leghorns, uniform in texture, color and shape; lower row, from cross of Leghorns and Plymouth Rocks, showing lack of uniformity.

pleasing impression upon the prospective purchaser who may happen that way. Appearance in some cases may not have a direct commercial value, yet it has a secondary value in creating a name for the flock or strain. This is often underestimated.

*First Cost is but Slightly More.*—Many pure-bred farm animals cost so much that the price is prohibitive for the average farmer. He is compelled to practise grading up. With fowls the cost of a few high-class, standard-bred birds is small, compared with their increased value. Every poultryman should begin right by selecting a few, at least, of the best birds he can get, representing the type best adapted to his desired purpose. By hatching from these he can soon have a large flock at little extra expense over the cost of mongrels.

*Cost of Keep no Greater.*—It costs no more to keep a given number of pure-bred birds than it does to keep the same number of mongrels. The requirements for maintenance are the same in each case. The requirements for production vary in different individuals, according to their amount of production, and vary in one class the same as in another.

*More Efficiency from Feeding.*—There is more efficiency from the feed consumed when pure-breds are kept, for a breeder will naturally select a type which is adapted to his purpose, as eggs or meat. These pure-bred types have been developed and selected with a purpose in view. The nature of that particular type is to bend all its energy toward the product for which it is best suited. For example, greater efficiency is developed from feeding Leghorns when eggs are desired than there would be from feeding Cochins or mongrels. On the other hand, there would be greater economy in feeding Brahmas when meat is the object than there would be in feeding Leghorns or mongrels.

*Demand for Breeding Purposes.*—A poultryman who makes a specialty of one or more pure breeds and develops considerable ability to produce good birds of that breed finds an increasing demand for his stock and eggs for breeding purposes. The price received for them under such conditions is always considerably higher than for market purposes. Even when he makes a specialty of breeding for some commercial product, as market eggs or meat, he can always dispose of surplus cockerels, yearling hens, and a large number of eggs during the breeding season, at a greatly increased price. Any breeder who does not consider these opportunities and take advantage of them is not getting everything out of the business that is in it.

*A Greater Selling Value.*—Pure-bred poultry will always be found to have a greater selling value, whether it be for meat, eggs, or breeding purposes. The same care devoted to a standard-bred flock that is devoted to a mixed flock would result in a better quality of meat, in eggs more nearly uniform and a greater number of them, or in birds which have a relatively higher value as breeding stock.

The standard-bred flock has come to the American farm to stay. It has been shown by many experiments in all parts of the country that for no purpose do crossed or mongrel birds produce a better result or return a greater revenue. One of the first and best assurances of success is to start with standard-bred birds.

**Breed Adapted to Purpose.**—The breed which best fits the market requirements for the product desired should be selected. The requirements of a market demanding a good-sized, white-shelled egg can best be met by keeping the Single-comb White Leghorn. Where a full-meated broiler is desired, such a breed as Wyandotte or Rhode Island Red will meet conditions to the best advantage. Where an extremely large bird for meat purposes is the aim, as for large roasters or capons, no better selection could be made than the Light Brahma.

The breed, however, does not signify everything. Particular strains of the same breed often vary more than different breeds of similar general type. It is possible after the first selection of stock has been made to increase continuously the efficiency of the particular strain in hand by careful mating and continuous rigid selection. The first point for consideration should be the exact character of product desired, and then it is a much simpler proposition to find a breed suited to that purpose.

**Manner of Acquiring Stock.**—There are three general methods possible in securing foundation stock: (1) Purchasing eggs and hatching them; (2) buying the birds as adults or before they reach maturity; (3) buying day-old chicks.

In the first plan there is always the danger of getting eggs from birds which do not come up to the standard set by the purchaser, and the danger of loss during incubation and brooding. There is expense and trouble in inspecting the stock from which the eggs came. It is never safe to buy either stock or eggs from flocks which the purchaser has not personally seen or in some manner become acquainted with.

The most satisfactory method, where time will permit, is to purchase a number of pure-bred birds of the type desired, usually in the fall, and mate them during the late winter, getting them into good breeding condition by spring, so that a maximum number of fertile eggs will be laid during the breeding season. In this way a large flock can be quickly raised from parents of known quality and breeding, the cost being much less than where all the eggs must be purchased at high prices.

The second method takes a little more time, but in reality the actual breeding and improvement of the flock starts sooner, and definite improvement from breeding will be apparent more quickly.

A third plan for starting in the poultry business is quite com-

mon. If it is possible to purchase day-old chicks from a reliable breeder, this means can safely be employed to get an immediate start in the spring. It avoids the danger of loss in hatching, yet puts considerable responsibility upon the amateur during the brooding season.

In starting by any of these methods, stock of only reliable breeders should be purchased,—breeders who are known for the quality of their birds. Where possible, the records of the parent stock purchased should be studied in regard to production and breeding.

The poultry industry, in order to show continued improvement, must be developed through the increased quality of the flock. In order to bring this about, the individual bird must be made more and more the unit of study, rather than the total production of all the birds. In this way the poor producers and the barren females may be entirely eliminated, thus bringing about a higher average production for less birds kept. This can only be done by breeding each year from the best birds, and continued selection from hatching to maturity, keeping only the best for future breeders.

**Selecting Live Birds.**—When selecting the birds which are to be the parents of future stock the following points should be considered carefully:

*Health.*—No bird should be purchased or used in the breeding pen which has ever had any poultry disease. Some diseases, such as white diarrhœa (*Bacterium polorum*), are known to be inherited. Others, such as tuberculosis, enteritis, and roup, weaken the individual constitutionally, and the offspring inherit lack of vitality. This makes them especially susceptible to take on these same diseases. Any affection which impairs the strength or vitality of a bird makes it lose just so much and impairs it for use as a breeder. It should be established beyond a doubt that all the birds selected have always been free from all forms of disease to which they are subject.

*Age.*—In buying birds for breeding, yearlings are the most desirable, as they have at least two years before them during which their eggs can be profitably used for hatching purposes. Pullets should not be used for this purpose, as their eggs run smaller in size, and therefore hatch chicks which are smaller, and develop into smaller individuals at maturity. Birds of exceptional quality may be profitably kept for breeding purpose as long as they lay

a good number of fertile eggs which hatch into vigorous chicks; but the purchase of such individuals is rarely profitable.

*Size.*—The stock purchased should be of good size for the breed. Lack of size is usually a sign of improper management during growth, of forced maturity due to late hatching, or of an inherited lack of vitality. Any one of these should stamp the bird as unsuitable to be the parent of profitable layers or meat producers. The standard weight should be taken as a guide, and excess rather than under weight is to be preferred. When purchasing cockerels, an allowance must be made for age. With proper development they may make valuable birds in the breeding pen.

*Weight.*—In the choosing of birds for meat purposes, the weight should be considered above size. Large, full-feathered birds may give the appearance of depth and height but show, when dressed, very little flesh development of a desirable character. In extremely old birds (three years or more) excessive weight should be avoided in the heavy breeds, as the tendency is for them to take on surplus fat in the nature of fatty deposits rather than an evenly distributed fat throughout the body. This makes them poor layers, with a low fertility and loss of vitality to the offspring.

*Shape.*—The standard shape of the breed chosen should be studied and selection made accordingly, for by so doing the progeny will conform more closely to the type selected and more nearly fit the purpose desired. Only by having the flock uniform in shape can they be considered strictly standard bred. By constantly selecting toward one shape, a greater uniformity will be gained in appearance and character of meat produced. This is of importance when broilers or roasters are dressed and packed for fancy or high-class trade.

*Color.*—The endeavor should be made to have the color of the birds selected as near the standard requirements as possible. It may not be the purpose of the breeder to exhibit his birds for fancy points, yet the added attractiveness and appearance of his flock will warrant a constant attempt to breed the birds true to color markings as well as size and shape. The idea in selecting birds should be to combine the qualities which will fit them for the particular purpose in view and at the same time show the effect of breeding and selection for color, thus combining the fancy and utility sides of poultry keeping in a harmonious and coordinate way.

*Vigor.*—Strong, vigorous constitutions in both males and

females are of paramount importance, and should supersede all other considerations. They will impart vigor to their progeny. It is this characteristic which will maintain the vitality and productive power of future generations. Care in the selection of the foundation stock should be considered first. Without that, the best of management, good houses, and proper feed will avail little.

## REVIEW.

1. Define the term pure bred.
2. Give ten advantages of pure-bred birds over mongrels.
3. Discuss each of these advantages.
4. Discuss breed selection with reference to object desired.
5. Name and give possibilities of three methods of acquiring stock.
6. Enumerate seven points which should receive careful consideration when selecting live birds.
7. Tell of the importance of proper care in the selection of foundation stock.

## CHAPTER VI.

### PRINCIPLES OF POULTRY-HOUSE CONSTRUCTION.

SUPPLYING poultry with suitable environment is one of the most essential features of poultry management. A suitable environment means the right kind of house properly located. Many types of poultry houses are in use throughout the country, representing a great variety of ideas and theories. This diversity is largely due to the fact that amateurs start out in business with



FIG. 64.—Antiquated type of poultry house, with no muslin in windows. Glass prevents ventilation and holds the moisture.

ideas of their own, and incorporate these in their houses, whether they have been tested and found desirable or not. There are a few simple rules or principles which should be followed in the construction of the house, and there are a number of different types which furnish these requirements. There is no one best type, suitable under all conditions and for all sections of the country.

**Recent Changes.**—There have been marked changes and rapid developments in the perfection of poultry houses. It was formerly considered necessary to have a perfectly tight house, double boarded, with single or double glass sash in the front (Fig. 64). This type of house served as a shelter for the birds, and theoretically would keep them warm; yet in practice it has been found



that the closed, glass-front house was easily affected by changes of outside temperature and moisture, unless some adequate system of ventilation was provided. Such a house could not supply to the birds the abundance of fresh air which they need without causing a draft to blow directly upon them.

It has been found that a house constructed on a plan entirely opposite the one just described is more efficient. All up-to-date poultry houses provide an abundance of fresh air during the night, to keep the birds in the best physical condition. This is being done almost entirely by the use of "muslin fronts." This feature is regarded as essential and is prevalent throughout the entire United States, from Oregon to Maine (Fig. 65).

The type of poultry house selected should be adapted to the system in use: (1) The colony system requires, under general conditions, a house conforming to the size of the flock to be kept as a unit and single-pen construction, with or without scratching shed. (2) The semi-community system can be made most profitable by using a double-pen scratching shed. (3) For the community system the long laying house, from 14 to 20 feet in depth, and divided into pens of convenient size, is the type most employed.

Before building or planning a house, the needs of the birds and the means of attaining them should be studied carefully to determine just what type of construction will meet the conditions best. The principles involved will hold true under all conditions. Some variations must be made to suit extreme temperature or moisture conditions.

**Essential Features.**—The features of a good design may be enumerated as follows: (1) Economy; (2) convenience; (3) sunlight; (4) freedom from moisture; (5) abundance of ventilation; (6) plenty of room; (7) protection from excessive heat or cold; (8) proof against rats and mice; (9) sanitation.

*Economy of Construction.*—It is not always necessary to purchase all new lumber for poultry houses. Often old farm buildings or second-hand lumber can be utilized to good advantage. Only



FIG. 65.— Modern type of poultry house with both muslin and glass in front, providing an abundance of light and ventilation without drafts.

sound boards and timbers should be used. In many cases there are buildings about the farm which, with little expense for material, can be remodelled into efficient poultry houses by laying a moisture-proof floor and by providing openings for muslin curtains and a suitably sheltered roosting place.

When purchasing new lumber, a good sill and frame is important to insure permanence and rigidity. The very best grade of lumber is not necessary for roofing boards and side walls. One of the most economical methods of construction is to build the roof and side walls of tongued and grooved material, yellow pine "seconds" being satisfactory. The roof and back wall are then covered with a good grade of prepared roofing paper.

Elaborate planning, expensive construction, and fancy trimmings have a tendency to reduce economy and efficiency. The comfort of the birds is not increased by such practice.

*Convenience.*—In planning the house, thought should be given to practical labor-saving devices—such as double swinging doors between the pens, with friction stops; curtains which are easily and quickly raised or lowered; large, self-feeding hoppers for dry mash, which will require filling but once a week at the most; drinking vessels which are easily and quickly cleaned and filled; dropping boards which are easily and perfectly cleaned; nests which are easy of access; and an inside finish which can be quickly and easily cleaned. Convenience in removing litter and manure and in supplying new litter is important. Facility in collection of eggs should be considered.

Elaborate mechanical devices which are designed to save labor, and do automatically much that should be done by the attendant, do not as a rule prove practical, or furnish suitable conditions for the birds that are kept in such houses.

*Sunlight* should penetrate every part of the house as much of the day as possible. Sunlight is a perfect germ destroyer, purifying the parts of the house where it shines, besides adding warmth and making surroundings more congenial. It acts as a tonic to the birds during the short winter days and induces a heavier production.

The house should be placed so that the sun will shine in at the openings every possible hour of the day during the winter months. The openings in the front should be of good height, and so placed that they will allow of a complete distribution of the sunlight in the house throughout the day. If possible, the entire

floor of the house should receive the direct rays of the sun at some time during each day (Fig. 66).

*Freedom from Moisture.*—Three kinds of moisture are frequently present in poultry houses where layers are kept: (1) Atmospheric moisture, (2) condensation moisture, and (3) soil moisture.

Atmospheric moisture is always bad if the room is poorly ventilated.



FIG. 66.—Floor of standard multiple-unit laying house, showing distribution of sunlight at different seasons, sun elevation at 10 o'clock.

Condensation moisture is caused by the moisture condensing from the air and hanging in drops from the roof and rafters. This is sometimes caused by lack of sufficient head room, but more often by insufficient fresh air. A concrete or solid masonry bank wall is very damp, as it acts as a wick, sucking outside moisture through during wet weather. This condition can be corrected by replacing glass sash in the front with muslin, thus insuring circulation.

Soil moisture has a tendency to work under the foundation and up through the floor, dampening the litter. This should be corrected by the construction of proper drains under the foundation when the house is built. A properly constructed concrete floor will keep out much soil moisture, as it is impervious to water. This is made with a layer of tar paper or tar paint beneath the finish coat of cement.

*Ventilation.*—The house should be well ventilated, without causing drafts to blow directly on the birds. An abundance of oxygen is essential if the birds are to perform their normal body functions. When a large number are continually crowded together in close quarters during the entire winter, as is the case in most commercial laying houses, a large amount of fresh air is required. This can best be supplied by the use of muslin curtains in the front of the house, thus allowing at all times fresh air to pass in, and the moist, foul air to pass out. This change takes place without any drafts or rapid movements of air, the muslin acting as a sieve or buffer. In extremely cold sections, with birds not naturally suited to stand extremely low temperature, it is advisable to have a second muslin curtain suspended in front of the roosting quarters to conserve the heat given off by their bodies at night.

In the coldest climates special air shafts on the plan of King ventilators are sometimes used successfully instead of muslin curtains, or in combination with them. The out-take shaft is most essential. It may consist of a six-inch galvanized stove-pipe extending from near the floor up through the highest point of the roof and projecting two feet or more above it. This pipe will be large enough for fifty fowls, and will take out the bad air and moisture if fresh air is allowed to enter through an in-take pipe or a small muslin curtain.

A properly ventilated house will mean healthy birds, and less labor will be needed in keeping the house clean (Fig. 67).

*Plenty of Room for Exercise.*—Exercise is essential for the health of the birds, and to keep them from taking on too much surplus fat, which would be detrimental to heavy egg production. This latter purpose is important with the heavier breeds during the second and third year. Exercise can best be provided by the feeding of grain rations in deep litter on the floor.

The number of birds which can safely be kept in a house of given dimensions will depend somewhat upon the breed and upon

the experience of the poultryman caring for them. Under general conditions it is safest for the amateur or for the one with little experience not to crowd the birds too closely,—about one bird to every four and a half or five square feet of floor space. The expert who thoroughly understands the needs and methods of sanitation can successfully keep as high as one bird to every two and one-half or three square feet of floor space. A desirable area for birds under close confinement during the winter months, when a heavy egg yield is desirable, is approximately four square feet per bird.



FIG. 67.—An efficient rear ventilator for summer use. It allows the air to enter the back of the house, and circulate between the sheathing and the roof, cooling the roosting quarters on summer nights. This is most valuable for shed-roofed houses that are covered with paper.

*Excessive Heat and Cold.*—Protect the birds from cold, but do not keep them too hot. Birds will stand a great degree of cold; they do better in cold quiet air than in warmer drafty air. This latter condition is generally the starting point of colds which may develop into forms of roup, quickly putting the birds out of laying condition. The house should be so constructed that at any time the temperature will never get low enough to freeze the combs. This condition will vary with (1) the breed kept, (2) the vitality of the birds, (3) the scratching or other exercise, and (4) the amount of moisture in the house.

Large-comb breeds must be given better protection and warmer

houses than small- or close-comb breeds. Birds of low vitality with poor circulation will be much more liable to freeze their combs than those of high vitality. A cold, damp atmosphere will do more damage than a cold, dry atmosphere. The house should be so arranged that the temperature of the birds' bodies may be conserved. At night during very cold weather the use of muslin drop-curtains in front of the perches is sometimes helpful.

Any arrangement which will make it possible to cool the house off during the hot summer nights will be very desirable. One method used is to provide a small hinged opening in the back of the house which when open allows the air to circulate freely between the ceiling and roof over the roosting quarters.

*Rats and Mice.*—The house should be built, as nearly as possible, to be proof against rats and mice. These enemies are often a source of great loss. The cost of a good concrete floor will often be saved in one year by keeping out rats. The protection against rats affords great saving in the feed bill, for a family of full-grown rats will eat or waste as much dry mash as a flock of twenty-five laying hens.

*Sanitation.*—The internal construction of the house should be as plain as possible. If matched lumber is used, it offers less hiding-places for bacteria, lice, and mites, so that a spraying with a good disinfecting solution will reach all possible hiding places. All internal fixtures, such as nests and perches, should be made movable, so that they can be taken out of the house and thoroughly cleaned and disinfected.

**Size and Type of House.**—The exact form of house has a definite influence on the cost of construction. The type selected will be determined by the number of birds to be kept and by the character of the land upon which it is to be located. The small colony house costs more for its capacity than the continuous house. In the latter a light door or muslin partition answers for two outside end walls. Aside from the importance of economy of construction, the colony house is colder, having more surface exposed to the varying weather conditions, and more labor is required to care for the birds kept in them. The larger the house and the larger the flock, the less will be the cost per bird for shelter and labor in caring for them. There are three different designs into which all types of poultry houses might logically be grouped: (1) The small single-pen colony house. (2) The long, continuous house of two or more pens. (3) The large single-unit

house, ranging from fourteen to twenty feet deep and from forty to over one hundred feet long where large numbers are kept in one flock. The last is the most economical unit where eggs are of primary consideration (Fig. 68).

**Simplicity of Design.**—In planning and building poultry houses it should be the idea to have the design and construction as simple as possible. All extra trimming and ornamental features add greatly to the cost and do not enhance the efficiency. Quality in construction should also be considered, to make all permanent buildings as durable as possible. Movable structures of small

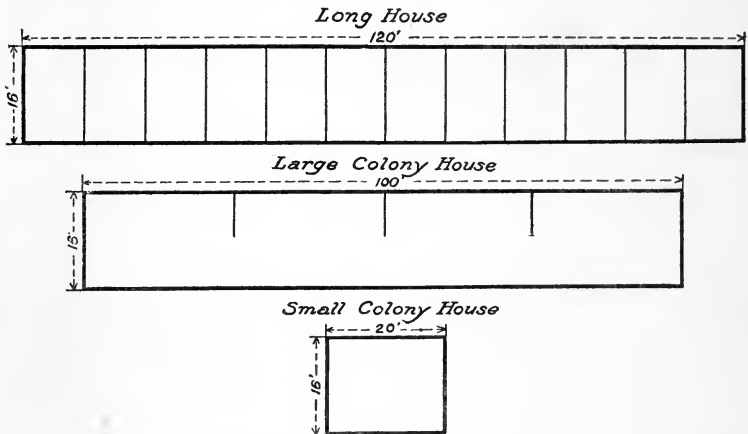


FIG. 68.—Three types of laying houses. The long house is used for small-unit flocks with intensive methods for breeding purposes. The large colony house is for large flocks for market eggs. The small colony house is used for breeding in small flocks.

size should be built strong enough to stand the handling and moving to which they are subjected. In some sections it is the practice to build extremely cheap houses directly on the ground; in such cases the walls and posts rot and the building is not very long lived. This practice cannot be generally recommended, but it may prove practical where low-grade lumber can be secured at low prices.

**Materials for Laying Houses.**—Materials used for poultry houses are: Wood, hollow tile, brick, concrete blocks, and solid concrete. The first two are the only ones which prove good for the laying house. Brick and concrete walls are apt to make the interior of the house damp and cold in the winter. Roup has been very prevalent where the walls were of concrete. Concrete-block

houses have been used successfully, but they are expensive both as to cost of material and labor, and are not so dry as houses built of wood or tile. In most locations and under most conditions the use of wood with a shingled or paper-covered roof would be the most economical and furnish the best conditions. The house of tile with stucco finish offers favorable conditions for laying hens, but the cost is about one-third more than where wood is used.

**Height of House.**—A low house, provided it allows head room for the attendant, is more economical to construct, easier to warm, retains heat better, and suffers less from various changes in outside weather than does the higher house. A good plan is to have the

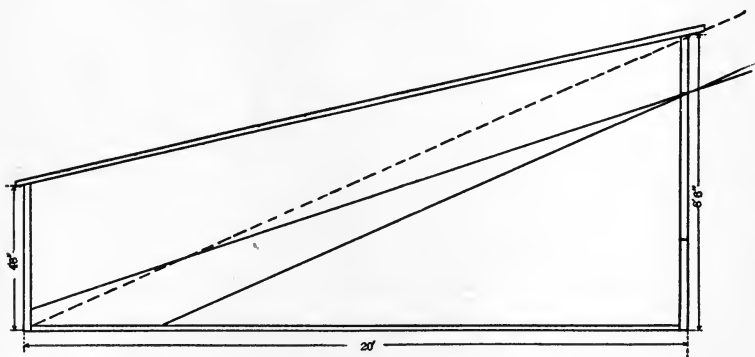


FIG. 69.—Diagram showing lines of sun's rays in September and December. The front of the house is 8 ft. 6 in. high and the back 4 ft. 6 in. high, with a width from front to back of 20 feet.

house high enough so that all work can be done by the attendant without danger of striking his head against the rafters. With a muslin front, this height will provide ample air for as many birds as the floor space will accommodate (Fig. 69).

**Shape of the House.**—The nearer the house approaches a square the less lumber will be required to build it; therefore, the deeper the house, all things considered, the more economical its construction (Fig. 70). Poultry houses which are built very narrow require a front and back wall of nearly the same height as a much deeper house. The only extra expense in the deeper house is the extension of the roof and part of the end walls. To increase the depth from front to back would give a greater floor space with less cost per square foot of floor space; this would mean less cost per bird. The limit to the depth of the house should be determined, in large part, by the facility with which the sunlight can get into the back part.



A depth of twenty feet in a shed-roof type of construction is deep enough; a greater depth requires a half-monitor roof, which has many undesirable features (Fig. 72).

NOTE.—The nearer the rectangle approaches a square the smaller will be its perimeter, the area remaining the same.

### Standard Poultry-house Unit.

—The use of a standard unit of known capacity gives a basis from which to work in extending the plant. It may be necessary to vary it considerably. For the shed-roof type of construction, one of the most economical units is a room twenty by twenty feet. If it is high enough to give ample amount of head room for the attendant, there will be

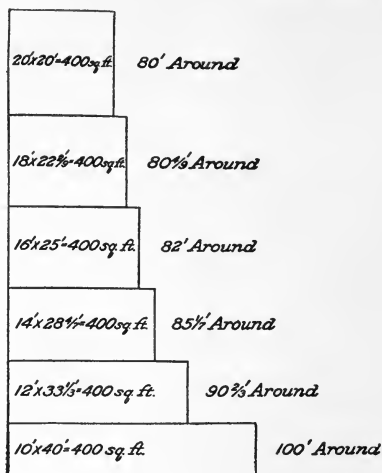


FIG. 70.—Shapes of houses compared, showing the requirements of wall material. As the shape approaches a square the perimeter becomes shorter.

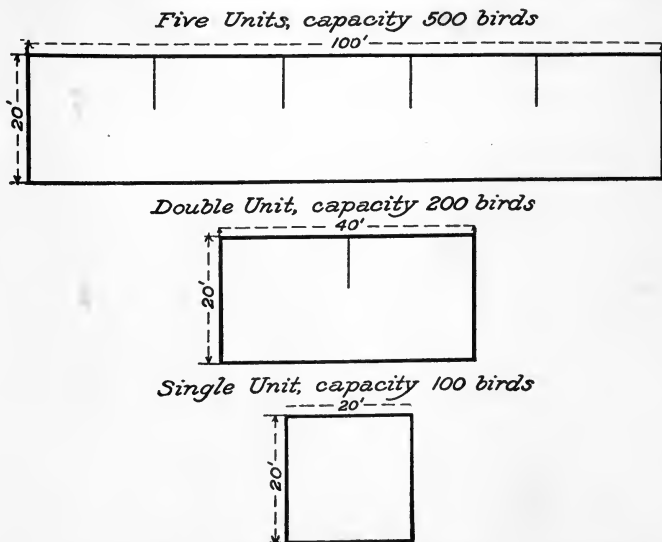


FIG. 71.—The possible growth of the multiple-unit plan,—single, then double, and an indefinite future increase.

sunlight in the back part of the house and the floor space is very large. Such a unit will have a capacity of one hundred birds, allowing four square feet per bird; it is adapted to all climates where poultry are commercially kept in the United States, and is one of the most efficient producing units. This unit is adapted to both the intensive poultry farm and the general farm where large flocks are kept. The capacity of houses with this unit can be increased indefinitely by the addition of other such units. For example, if five units were used the house would be twenty by one hundred feet and would have a capacity of five hundred birds (Fig. 71).

**Type of Roof.**—The type or form of roof should be studied carefully, as it is the most expensive part of the house. It usually covers only one floor, and must be made water tight and strong

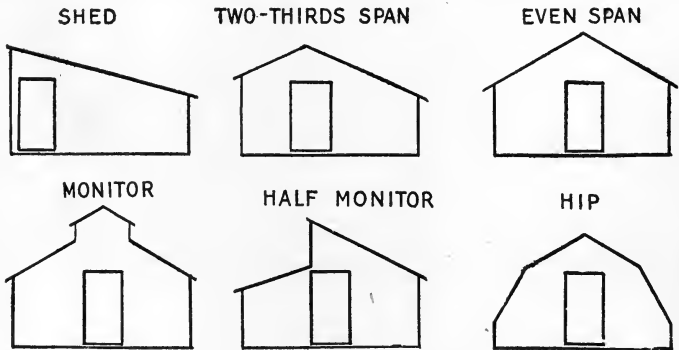


FIG. 72.—Six types of roofs for poultry houses. The shed roof is most common and is the best.

enough to support heavy snows and windstorms. The accompanying sketch (Fig. 72) shows six different types of roofs used for poultry houses. Each of these has a variety of uses. There is much difference in the lumber and labor required to build the different types. Care should be used to build the best and get the most economical type. The three which offer the best conditions in most instances are the shed roof, the two-thirds span, and the even-span or gable roof. In these three types of roofs with a uniform floor space and equal pitch, the amount of material is about the same.

In actual practice it is possible to construct the shed roof with less pitch. When this is done, the shed roof is the most economical, requiring less labor to erect; a higher front is possible, which enables

a greater amount and better distribution of sunlight. All the roof water is carried to the rear; this does away with half the amount of eave troughs required on a two-pitch roof, and keeps the front of the house dry and clean. A shed-roof house is also much cooler in summer; the slope of the roof, being toward the north, does not receive the vertical rays of the sun. The shed roof is well adapted to any house twenty feet or less in width. The greater width is most economical. In such construction a central girder or purlin should reach the entire length of the house, with posts every ten feet, to support the roof (Fig. 73).

A gable roof provides garret space, which can be stuffed with straw to make the house dryer and warmer; but it increases the amount of labor and offers a hiding place for mites and parasites.

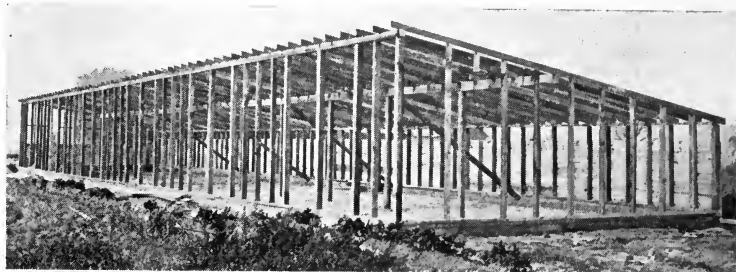


FIG. 73.—A well-framed poultry house.

The combination or two-thirds span roof is often used, where it is desired to have an alley in the back of the house, as more head room can be obtained in the back portion of the house without having excessive height in front. This type requires more labor to build, as there is much more fitting and sawing to be done.

For houses greater than twenty feet in width, the half-monitor type of roof is the most desirable, and especially where it is necessary to have a central work alley with pens on both sides. The upper window allows the sun to penetrate to the back half of the house and gives an abundance of ventilation. This type of house is apt to be cold in the winter, as the warm air rises and comes in contact with the cold glass in the peak and cools rapidly. This can be partially counteracted by stretching muslin over the inside of the sash to keep the warm air from circulating directly against the glass.

The A-roof is a very economical method of covering a given

floor space, but has not been used to any great extent, as it does not provide ample head room. It is sometimes used for small, single-pen houses where small flocks are kept, if it is not necessary to enter the house to perform all the work.

**Foundation.**—An efficient foundation adds durability and aids in keeping the house dry. The materials used are brick, stone, concrete, and wooden posts. Posts of locust, cedar, or other durable wood may be used on a stone or cinder footing. They are apt to settle and are not so durable as masonry walls. They do

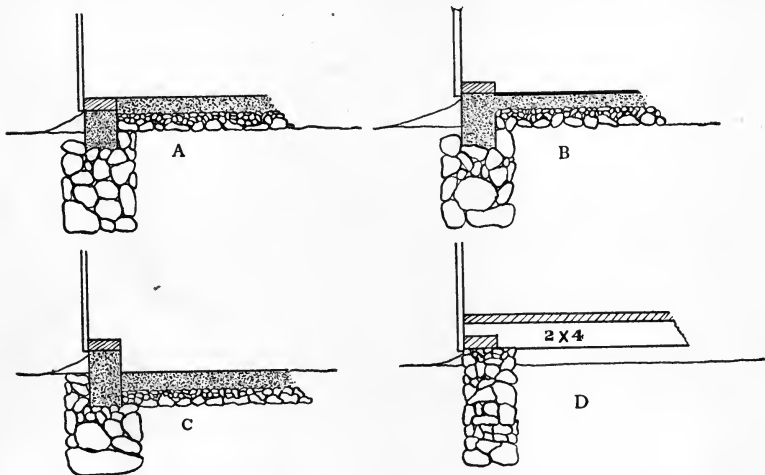


FIG. 74.—Four plans for foundation and floor construction. A, Floor flush with top of sill; B, finished floor flush with bottom of sill, the latter being laid in cement; C, foundation wall extending above floor level; D, construction suitable for board floor.

not aid in keeping out rats. The most efficient plan is a solid wall of masonry. The foundation should be built deep enough to prevent heaving by frost and to help keep out water. It should support the building without any settling. The foundation should also be economical as to cost of labor and material. A brick or stone wall, especially the former, is expensive from a standpoint of labor, as the brick and stone have to be laid in mortar by experienced masons. Stone or brick walls built loose are not permanent and, therefore, not desirable. The concrete foundation, if properly built, furnishes the most durable wall. Care should be taken to have the underdrainage deep enough, the foundation course properly tamped, and the mixtures rich in cement (Fig. 74).

A good foundation is made as follows: A trench is dug about one foot wide and from two to three feet deep, depending on the climate and the nature of the soil. The bottom should be filled to a depth of one foot with loose stones or cinders to give drainage. The rest is filled with concrete, the wall being carried about six inches above the level of the ground. Bolts are imbedded in it every fifteen feet, to later hold the sill in place.

**Floor.**—There are three different types of floors used,—earth, wood, and concrete. In deciding which one of these floors to use, the following factors are to be considered: (1) Dryness; (2) a smooth, hard surface which can be easily cleaned; (3) rat and mouse proof; (4) economy of construction.

The floors should be a few inches above the outside grade so that surface water will not run into the house. An improperly constructed floor means damp houses and an unhealthy flock. The earth floor is not generally desirable, because soil water is brought to the surface by capillary action, and there is the possibility of surface water soaking under the foundation and dampening the litter or flooding the floor.

On high, well-drained sandy soils with a low water table, the earth floors prove satisfactory; but it is necessary, if the house is to be kept perfectly clean, to expend an excessive amount of labor in cleaning at frequent intervals by removing four or five inches of top soil and replacing it with clean sand. Even with this precaution there is always danger of disease germs lurking in the soil and at some future time causing infection.

Board floors are undesirable, for the following reasons: They rot out quickly if they are not raised above the ground so as to allow the air to circulate freely under them. If raised very high the house is much colder, which is not desirable in winter. If the floors are raised only a few inches above the ground, they offer harbor for rats. They are also hard to keep clean, no matter how carefully they are constructed, as there are always crevices which offer hiding places for lice and mites and disease germs.

A cement floor, if properly constructed, offers ideal conditions, and it is unquestionably the most desirable for laying houses. It is absolutely moisture-proof if it has the moisture insulation, practically rat-proof, easily cleaned, and quickly and thoroughly disinfected. It costs no more to build than a good wooden floor and remains good for all future time.

The following construction for concrete floors is recommended:

Excavate the soil inside of the house to a depth of at least eight inches below the top of the foundation wall, place a layer of crushed stone, cinders, or coarse gravel about eight inches thick over the bottom, tamping thoroughly and leaving it level. Over this place a rough coat of concrete about three inches thick, made by mixing one part of good cement with three parts of fine sharp sand and five parts of coarse gravel or cinders. Put one thickness of tarred building paper over the rough coat while fresh, lapping and cementing the seams, nailing it down every two feet with roofing nails, letting the heads stick out about a quarter of an inch to hold the finish coat. One inch of finish coat should be laid over the paper. This is composed of one part of cement to three parts of coarse sand.

**Material for Framing.**—The frame should be built of material large enough to give rigidity to the building, and yet not so heavy as greatly to increase the cost. For a laying house twenty feet or less in width, 2 x 6 inch lumber doubled should be used for sills, firmly bolted to the foundation. Hemlock, yellow pine, chestnut, or other material of equal grade may be used. The lumber used depends upon the kind which is the cheapest in the vicinity. For studding use 2 x 4 inch pieces, and double these for corner posts. The plates are best constructed of 2 x 4 inch material doubled, spiking them together and breaking joints. One great advantage of double sills and plates is the possibility of strengthening weak places and of correcting any crooked or warped timbers that might be used. For rafters use 2 x 6 inch material for anything greater than ten-foot spans, 2 x 4 inch being sufficiently strong for anything under that length. For a purlin or girder in a wide house 2 x 6 inch material is used. For all light partitions 2 x 3 inch material is heavy enough, and this may be laid flat. The rafters and studding should be placed not more than two feet apart,—better, sixteen inches. If the outside boards run up and down, the studding may be six feet apart, with 2 x 4 inch intermediates parallel with the sill (Fig. 84).

**Walls and Partitions.**—A necessary feature in the construction of walls is to have them tight, to eliminate the danger of drafts. One of the best materials which can be used is tongue-and-groove boards, securely driven together. It is not well to use boards greater than eight inches in width, as they are apt to warp, and when they dry out leave open spaces. If siding boards are used, the lap or “novelty” siding makes tight walls, leaving a smooth inside wall. If shingles are used on the outside of the walls, a

tight board wall should be laid first, so that the house can be easily cleaned and kept free from vermin; it will greatly increase warmth in the winter. When it is desired to line the inside back wall of the house, tongue-and-groove boards are the best. They should be free from extra beading. It is rarely necessary to ceil inside the roof of the poultry house, except perhaps over the roosting places in cold climates.

In the construction of intermediate walls or partitions, a good method is to board the bottom part about thirty inches solid, the remaining distance being covered with wire or cloth. The use of cloth makes the building cheaper, but is less durable and collects dust. In houses over forty feet long, one cross partition or more should be put in to prevent a draft blowing through the house.

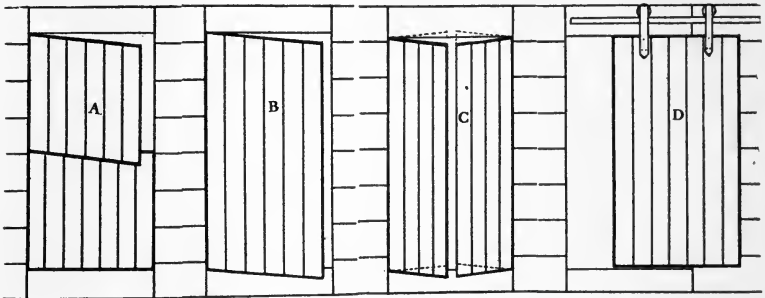


FIG. 75.—Four styles of doors for poultry houses. A, Brooder house door, cut in the centre so that the top half only need be opened, providing ventilation but preventing floor draft; B, door hung to swing both ways; C, double doors for use where overhead trolleys are used; D, sliding door.

**Doors.**—All doors in laying houses should be large enough to permit the attendant to pass through quickly with feed and water. They should admit of easy opening and closing with a minimum loss of time. They should be so placed that the work can be done with the least possible retracing of steps, and should be strong and durable, as they are much used. The doors between pens should be arranged in a straight line, hinging on one side with double-action spring hinges, so that they may be opened from either side and will close automatically as the attendant passes through, being held in place by friction stops. All doors should be raised above the floor at least eight inches, so that in opening and closing they will be clear of the litter on the floor. The sketch shows types and methods of hanging poultry doors (Fig. 75).

**Windows and Curtains.**—Window and curtain openings in the poultry house are valuable, in that they admit sunlight and fresh air, cleansing the house, and making it a congenial place for the birds. They should be so arranged that they can be opened quickly and easily, and the danger of breakage thus reduced to a minimum.

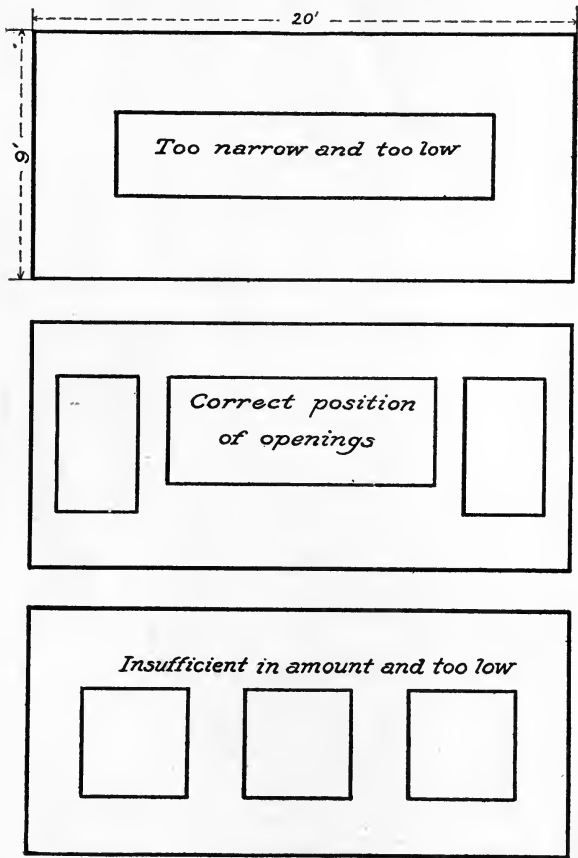


FIG. 76.—Three plans for placing openings in front wall of poultry houses.

Sunlight is necessary to the fowls, but too much glass makes the house cold at night and too warm in the daytime. An excessive amount of glass makes the house too expensive. A good rule for large houses using muslin openings is to allow one square foot of



glass to every sixteen square feet of floor space, or one square foot for every four birds. The amount of muslin can be determined by allowing double the number of square feet that there is glass, or one square foot of muslin to every eight square feet of floor space. The windows should be placed high up in front and run vertically rather than be horizontal. In this way the sun's rays will have a chance to sweep across the entire floor at some time of the day, drying and purifying the entire area (Fig. 76). The sunlight is most needed in the winter when the sun is lowest. In the summer the hot noontime sun is kept out by a projecting roof (Fig. 89).

The direct rays of the sun should strike all of the floor area possible (Fig. 66), but it is not practicable to have the house high enough to let the direct rays strike the dropping boards at the

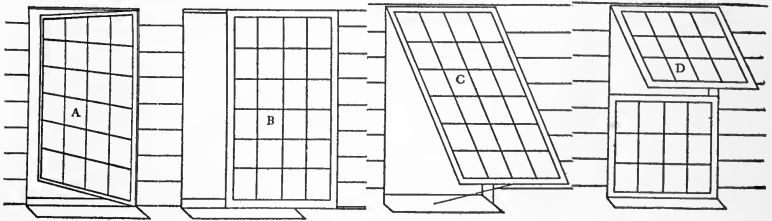


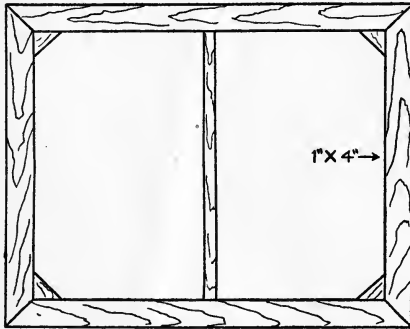
FIG. 77.—Types of poultry windows. A, Hinged at the side and opening inward, the method preferred; B, sliding window; C, hinged at the top and opening outward; D, upper sash hinged at the top and opening outward and lower sash stationary.

back of the room. This would tend to cause the birds to congregate there in the winter when they should be working in the litter on the floor.

Extremely large sizes of window lights should be avoided, as they are expensive to replace when broken. Very small lights are undesirable, as the sash bars shut out a great deal of sunlight and the glass is hard to clean. Where possible, a single sash should be used in an opening, as it is cheaper than a divided sash. Single ones require very simple frames which can be made at home; they also allow of hinging on the side or top, making them easy to open. Figure 77 shows different plans for windows used in poultry houses.

Muslin curtains should be stretched on light frames built of 1 x 3 inch strips and hinged at the top. The frames are raised up inside by means of pulleys and cord. Sometimes they are hung on cords and pulley and hang below the windows outside the house.

When made, light-weight muslin should be used, canvas being too heavy and cheesecloth too light. At best a great deal of dust is present in the poultry house, which requires that these muslin curtains be beaten or swept occasionally to clean them so the air can pass through freely. Too large or too long frames are objectionable, as they get out of shape easily and give trouble in raising and lowering them.



A frame about 4 x 5 feet is a very convenient size (Fig. 78). A glass sash is sometimes placed in the centre of the frame so that, when the curtain is down on stormy days, sunlight can get into the house—if there is no other glass window.

#### Material for Roofing.—

The material used to cover the roof depends almost entirely upon the angle or pitch. A roof with less than one-third pitch should not be covered with shingles, as the water does not run off quickly and the roof will rot. A driving rain is apt to run under the shingles and cause the roof to leak. A good grade of roofing paper may be used, as it is much cheaper and if properly cared for is as durable as shingles. Such paper can be used on roofs which are nearly flat.

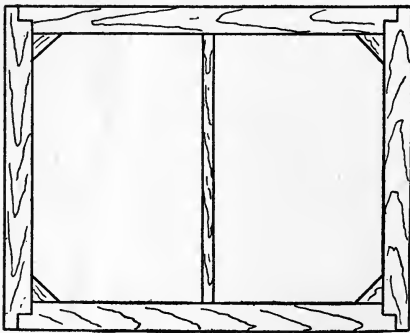


FIG. 78.—Two plans for constructing frames for muslin curtains.

A roof with low pitch and tight paper is warmer in summer and also warmer in winter than a shingle roof. It can be made cooler in the summer by providing ample ventilation from the rear over the roosts (Fig. 67).

**Preservation of Buildings.**—When permanent buildings are erected, it is poor policy not to preserve them both outside and in. Give the exterior two or more coats of paint if dressed lumber is

used, and treat the inside with a good whitewash mixture made to adhere well. The latter will act as a cleanser and disinfectant. All window sashes should be well painted. If roofing paper is used, the directions that come with it should be followed closely. Where extremely cheap buildings are constructed of rough lumber, the cost of painting them may be too great. Whitewash may be applied with a spray pump.

Tar is one of the best preservatives known. It is a by-product from coal in the manufacture of gas and is very cheap. It may be diluted with gasoline and used in warm weather without artificial heat. It should be used on all posts, sills, and parts exposed to great moisture. It is suitable for all kinds of roofs except those covered with tin. It is used also to paint the outside of buildings, but its monotonous black color should be relieved by yellow or other appropriate trimming. Tar will last longer than oil paints, is much cheaper, and preserves wood better. It may be used on the dropping boards, roosts, and nests to fill crevices where lice would hide.

#### REVIEW.

1. Contrast the old and new ideas in poultry-house construction.
2. Discuss type of house in its relation to three systems of poultry farming.
3. Enumerate nine features in a good poultry house.
4. Discuss the five features which you consider most important.
5. Tell of three types of laying houses.
6. What two features should be considered in deciding on height of house?
7. Describe a standard unit and discuss its possible development.
8. Name materials often used in poultry-house construction.
9. Which is most generally used, and why?
10. Name and define six types of roofs.
11. Which roof type is best?
12. Give the several types of foundations used in poultry-house construction.
13. Discuss the use for floors of dirt, wood, and concrete.
14. Give specifications for constructing a concrete floor.
15. What sizes of lumber are used for framing?
16. What kinds of lumber are used for walls?
17. Discuss the use of doors and manner of hanging.
18. How should the windows and curtains be placed?
19. Describe methods of hanging windows.
20. Tell of muslin frames, and manner of opening and closing.
21. On what pitches of roof may shingles be used? When use roofing paper?
22. Give reasons for using paint, whitewash, and tar.

**References.**—Poultry-house Construction and its Influence on the Domestic Fowl, by C. L. Opperman, Maryland Bulletin 146. Poultry-house Construction, by H. R. Lewis, Bulletin New Jersey Board of Agriculture. Poultry-house Construction, by W. A. Brown, Maine Extension Bulletin, volume 4, No. 111. Building Poultry Houses, by Rice and Rogers, Cornell Bulletin 274. Poultry-house Construction, by Halpin and Ocock, Wisconsin Bulletin 215.

## CHAPTER VII.

### PRACTICE OF POULTRY-HOUSE CONSTRUCTION.

THE LOCATION of the house having been decided upon, the desired height of the floor should be determined,—marked *Z* in figure 80. This level should be at least six inches above the highest point of the ground site of the house. In cases where the house is built on very sloping land, it may be desirable to do some grading by cutting away the higher portions, using this material to fill up the lower level before the foundation is laid out (Fig. 79).

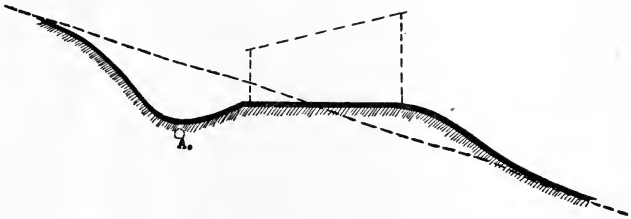


FIG. 79.—Cross section of hillside, showing manner of grading before laying out foundation. The long dotted line shows original slope and the heavy black line shows the surface graded for the poultry house. The house is shown in outline. Drain tile may be placed at *A* to carry water below the house.

**Methods of Laying out Foundation.**—Locate the corner of the building *O* (Fig. 80), and drive around this corner three stakes, as *L*, *M*, and *N*, about three feet apart. On each of these stakes find the level of the floor *Z*, by the use of the levelling board or transit. Connect these stakes with boards, shown as *LM* and *MN*, having the top of each board level with *Z*. In using the levelling board and spirit level in small buildings, it is well to locate a stake in the centre of the house which is level with *Z*, and work from this to the four corners. In long houses it is necessary to start from the point *Z*, and work to the different corners in a direct line by the use of intermediate stakes, all of which should be level with *Z*. Next stretch a line, *HI*, over the point *O*, which is the corner of the building, in a direction which will represent the back of the house. Measure off from the point *O* on this line the number of feet which will represent the length of the house.

Drive a stake, marked *P*, the top of which will be level with *Z*. About this stake drive three other stakes, *L'*, *M'*, *N'*, and connect these with two boards, the tops of which are level with *Z*. Next pass a string, *R S'*, over the point *P* at right angles to the line *O P*. The best way to determine the right angle is by the use of the right-angle triangle. Measure off on the line *P S'* eight feet, and on the line *P O* six feet. Move the string back and forth until the distance between these two points is ten feet. When this angle is determined, measure off on the line *P S'* the distance equal to the width of the building, and drive a stake at this point, *S*. Construct the regular corner boards about this point, level

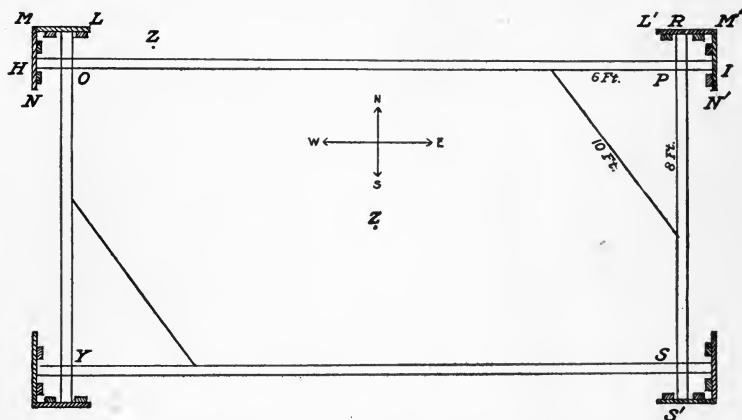


FIG. 80.—Diagram showing method of laying out foundation. (See text for directions.)  
The foundation cannot be laid out too carefully.

with *Z*. Determine the corner *Y* by measuring from *S* in the direction of *Y*, the distance being equal to the length of the house, and also from *O* in the direction of *Y*, the distance being equal to the width of the house. The intersection of these two lines will be the point *Y*. Construct the regulation corner boards about this corner, level with the point *Z*. Stretch two lines which will locate the outside of the finished wall. This line will be level with the point *Z*. For laying out the length of the wall or trench, other lines may be stretched parallel to these, indicating the width of the trench or wall desired.

**Digging the Trench.**—The trench for the foundation wall should be dug at least four inches wider than the thickness of the wall to be built. The dirt is thrown outside so that later on it

can be graded up against the foundation, turning the water away. The trench should be dug approximately three feet deep, or below the average frost line. Before laying the foundation, if the ground is moist, it is well to lay a three-inch tile in the bottom of the trench (Fig. 81, *a*), running it to some suitable outlet at a lower level. After laying the tile, the trench should be filled up to a depth of about one foot below ground with stones or coarse cinders (Fig. 81, *b*). This should be firmly tamped and levelled. This gives a good foundation on which to lay the stone, brick, or concrete foundation wall, with little danger of heaving. A concrete wall is the most desirable and economical for the foundation.

**Making Frames for Concrete Walls.**—The frames for concrete walls are usually made of one-inch material, preferably eight to

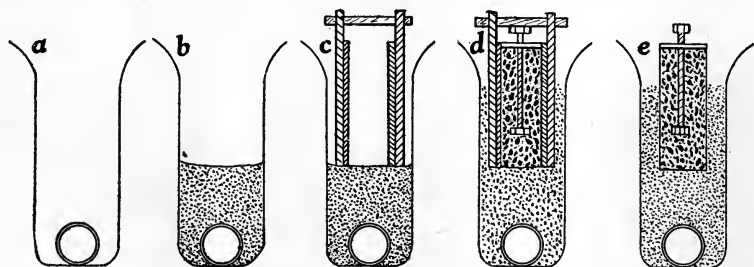


FIG. 81.—Five steps in the construction of a concrete foundation. *a*, Tile in the bottom of trench; *b*, tamped cinders over drain tile; *c*, forms ready for pouring concrete; *d*, forms filled with concrete, sill bolt in place; *e*, forms removed, foundation completed, and cinders filled in on both sides.

ten inches wide. These frames should be made in sections, cleats being used to fasten them together, all cleats being on the outside. If the wall is to be eighteen inches high, the frames should be constructed eighteen inches wide. They may be from eight to sixteen feet in length, so they can be easily handled. After the frames are made, they should be set in the trench so that the top is level with the top of the foundation wall when completed. They can be held securely in place with stakes outside of the frame (Fig. 82). The corners should be securely nailed together to prevent bulging. Every three feet, cross pieces should be nailed to keep the frames from spreading while the concrete is being poured (Fig. 81 *c, d*). The frames should be constructed and set up so that they can be readily taken to pieces without breaking the wall. One set of frames can be used over and over again. If they are no longer desired for that purpose, the boards can be used for roofing or

other purposes in the building itself. If an extra-high frame is built, it is necessary to brace it above ground with diagonal stakes to prevent bulging.

**Concrete Foundations.**—For the construction of the wall itself, the following materials will be necessary: cement, sharp coarse sand, and some material which will serve as aggregate or filler, as coarse gravel, stone, or cinders. For making the mixture, a mixing board should be made, large enough to allow room for shoveling the mixture over and over in two different piles (Fig. 82). A floor 10 x 12 feet will give ample room for the work. A desirable mixture for the wall itself is what is known as 1-3-5, or one part cement, three of sand, and five of the aggregate. These should be measured, and should be mixed on the board in alternate



FIG. 82.—Placing fresh concrete in completed forms for foundation wall.

layers. A wheelbarrow of known capacity is very desirable. After the ingredients are on the mixing board, the entire batch should be shoveled over to insure a perfect mixing. To facilitate mixing, it is desirable to have a man with a garden rake do this work during the shoveling. After the mixing, all the water should be added that the mixture will hold; but not enough should be put on to allow any to run off; this would be a waste of cement and weaken the mixture. When thoroughly mixed with water, the concrete is ready to put into the trench, which may be done with a wheelbarrow or shovel. While the concrete is being poured, long bolts are placed about ten feet apart to later hold the sill. Thorough tamping is important, and to be complete the concrete should be

tamped enough to bring the water to the surface. The frame should be filled to within about an inch of the top (Fig. 81, *d*, *e*), and the remaining space should be filled with a wearing coat composed of one part of cement and three parts of sand, mixed in the same way. This should be smooth and the corners bevelled to prevent chipping. During the process of pouring the concrete, anchor bolts should be imbedded every ten feet, allowing them to project above the frame about five inches if a 4 x 6 inch sill is used. It will require from two to three days for the mixture to harden before taking the frames away, but before much pressure is put on the wall it should be allowed to season. It will season more quickly and become harder during moist weather than when it is exceptionally dry. For this reason, it is desirable during very dry weather to wet the wall down occasionally. Fifteen days is usually required for proper seasoning before the operation of building the house should be commenced.

**Construction of Frame.**—After the concrete wall is finished, the guide lines should be re-stretched in order that the sills may be laid true. They should be laid to the outside string, as they are apt to vary some in width. The sills should be bolted firmly to the foundation, washers being used so that the nuts may be set very tight and not wear into the wood. The corner stud posts should be nailed to the sill, flush with the outside of the sill. The corner posts should be made plumb and held perpendicular by nailing scantling braces running each way; if these four posts are properly plumbed, the plates being nailed on them, a perfectly upright building is secured. It is possible by the use of the square to insure perfect fit when marking and cutting the rafters. But usually it is desirable to cut one pattern rafter, putting it in place to see if it fits properly, then using it to cut the others by.

**Plans and Specifications of Laying Houses.**—The following description of the plan shown in figure 85 gives the important features for a *standard-unit* laying house.

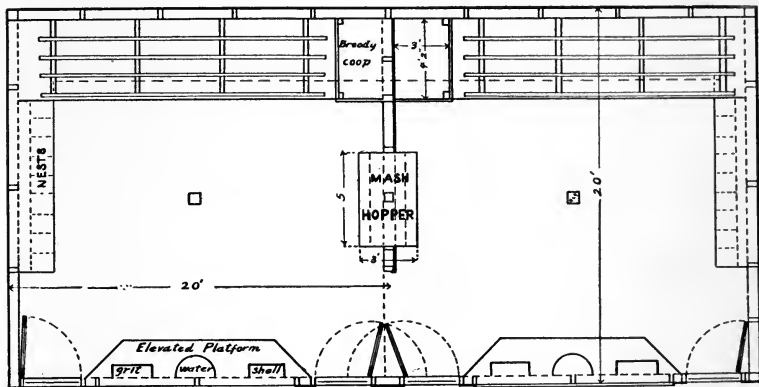
**Double-Unit House.**—The outside dimensions are 40 x 20 feet, sills to be 4 x 6 inches, and to be bolted to a concrete foundation wall eight inches wide and twenty inches deep. This is laid on tamped cinder or crushed stone, the entire depth of the foundation trench being three feet.

The shed-roof type of construction is used, with nine-foot studding in front and a height of four and one-half feet in the back (Figs. 83, 84, and 85). All studding and rafters are 2 x 4 inch

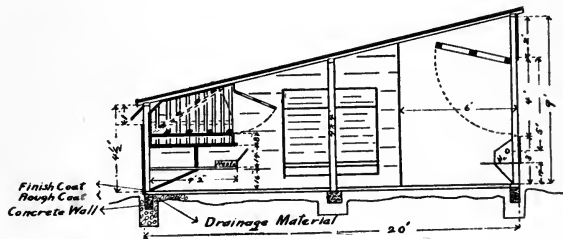


hemlock or yellow pine. A 2 x 6 inch girder runs the length of the building supporting the rafters along their centre. The girder is

Floor Plan.



Cross Section.



Front View.

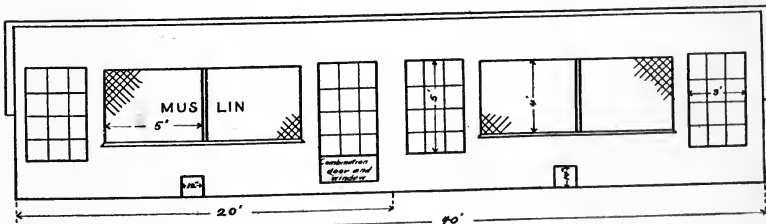


FIG. 83.—Working plans of a double-unit laying house. Each unit 20 x 20 feet, with a capacity of 100 birds.

supported every ten feet by 4 x 4 inch posts, resting on concrete piers. The plates which rest on studs should be made of 2 x 4 inch material doubled, and joints "broken."

All outside walls and roof are single boarded, preferably of eight-inch tongue-and-groove yellow pine. White pine can be used, but is much more expensive. The roof and back wall should be covered with a good patent roofing paper; all joints should be carefully lapped and cemented.

The muslin curtains in the front wall are hinged at the top and can be lifted up. The 3 x 5 foot windows are hinged at the side and open as indicated on the floor plan. One window in each pen should be so constructed that part of the wall will open when desired, thus making a combination door and window. This will greatly facilitate cleaning.

The dropping boards, perches, and nests are best arranged on the back wall. The perches are hinged to the wall so that they

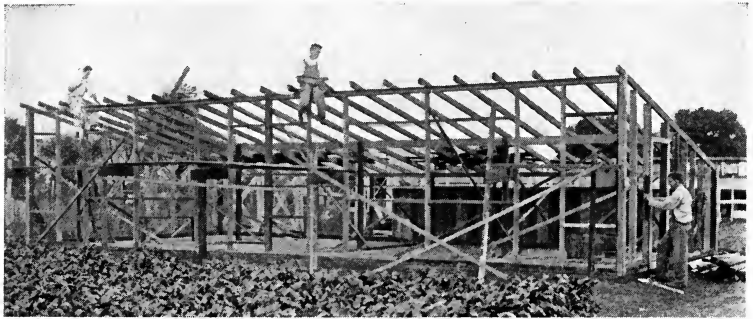


FIG. 84.—Frame of standard multiple-unit laying house—light, cheap, yet durable.

may be hooked up when cleaning. The nests are darkened by a hinged door in front, which may be let down when it is desired to remove the eggs.

The dividing partition between the units is built of boards and extends from the back wall to within six feet of the front wall; the remaining space is left entirely open. This protects the birds from any drafts when on the roosts. When desired, portable light-wire partitions may be used to separate the units.

A large dry-mash hopper should be built in this middle partition (Fig. 83). If four or more units are built, it is necessary to have only one hopper in the centre of each two units, the other dividing partition being used for nesting space. The construction of the hopper is shown in the following chapter.

There is an elevated platform under the muslin front, which provides room for the water fountain and grit and shell hoppers.

When the house is completed, a concrete floor should be laid, and should consist of three or four distinct layers. First, a layer of about six to ten inches of cinders or coarse gravel, tamped thoroughly. This serves for drainage purposes to keep the soil moisture away from the bottom of the floor. Next, a rough coat of concrete about four inches thick, and over this a finished coat of two parts of sand with one of cement, trowelled smooth.

Where there is danger of much moisture coming up from below, it is advisable to put a layer of tarred building paper between the rough and finish coats of cement. It should be nailed down with

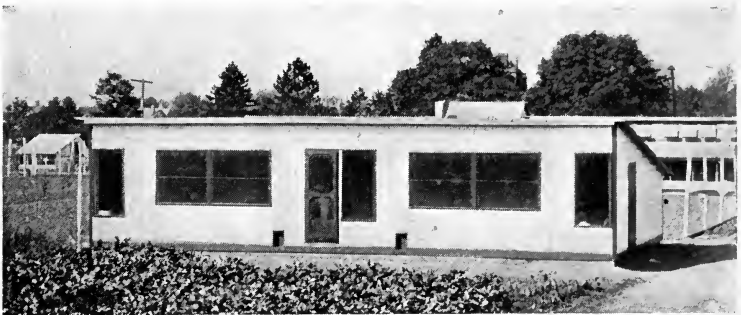


FIG. 85.—Double-unit house completed. Note the combination door and window, and the arrangement of openings for light and ventilation.

flat-headed nails; the heads of the latter should be left sticking out about one-quarter of an inch to hold the top coat of cement.

Such a floor is moisture proof and vermin proof, and is easily and quickly cleaned.

The completed house is shown in figure 85.

*Materials.*—In the following list of materials required for building a double unit, as shown in the working drawings given in figure 83, the prices quoted are only approximate:

LUMBER: Sills.....	6 ps. 4" x 6" x 20'
Plates.....	8 ps. 2" x 4" x 20'
Posts.....	2 ps. 4" x 4" x 14'
	2 ps. 4" x 4" x 18'
Studding.....	9 ps. 2" x 4" x 18'
	4 ps. 2" x 4" x 14'
Rafters.....	22 ps. 2" x 4" x 22'
Frame for nests and dropping boards.....	5 ps. 2" x 3" x 16' hemlock.
Roof, dropping boards, walls, and nests, 8-inch tongue-and-groove boards.....	2,200 sq. ft.
Curtain frames and trim, 1" x 2" white pine.....	200 linear feet

Nests 1" x 4" white pine.....	100 linear feet
Broody coop.....	one bundle plaster lath.
NAILS.....	10 lbs. 20-penny wire.
	50 lbs. 10-penny wire.
	20 lbs. 8-penny wire.

Approximate cost of the above materials.....	\$ 75.54
Roofing paper, 1,060 sq. ft., or 11 rolls, at \$3.00.....	33.00
Four special sash, 3' x 5', at \$2.00.....	8.00
Muslin, 8 sq. yards, at 12½ cents per yard.....	1.00
Hardware, as hinges, locks, tacks, hooks, and wire.....	4.75
Foundation and floor—	
Cement, 35 bags, at 50 cents.....	\$17.50
Cinders or gravel, 30 yards at \$1.00.....	30.00
Sand, 5 yards.....	7.50
	55.00

Total cost, not including labor, if concrete floor is put in the house and cinders and sand have to be purchased ..... \$176.29  
 This gives a cost per square foot of floor space of \$0.222.  
 A cost per running foot of house of \$4.44.  
 A cost per bird, allowing 4 sq. ft. per bird, of \$0.888.  
 Adding labor to this at one-fourth the cost of material, the total cost is \$222.36, or \$1.11 per bird.

**Long Laying House of Small Units.**—This house is intended for breeding pens. It is built in three sections, each forty-eight feet long, with solid partitions between them. The plan shown is for one section only, —the material for three sections.

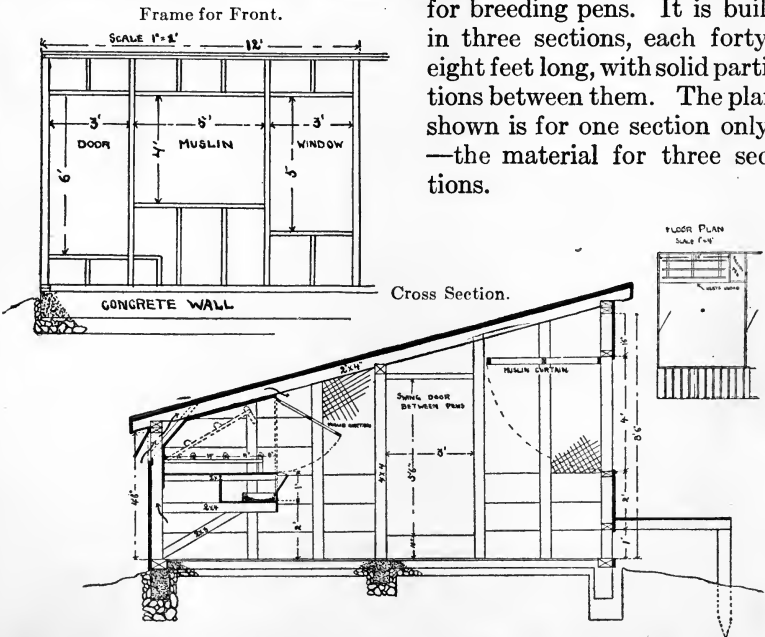


FIG. 86.—Working plans of small-unit laying house. (See text for description.)

It will be noticed that a door is in the front of each pen (Figs. 86 and 87); this is necessary in a house to be used for educational and experimental work, but is not desirable in a farm poultry house where one attendant will care for the entire flock. The muslin curtain should then be extended to cover this space.

Attention is called to the presence of an elevated walk in front of the house, to allow easy access to each pen and yet allow the birds to enter the yards which extend to the south or front side.

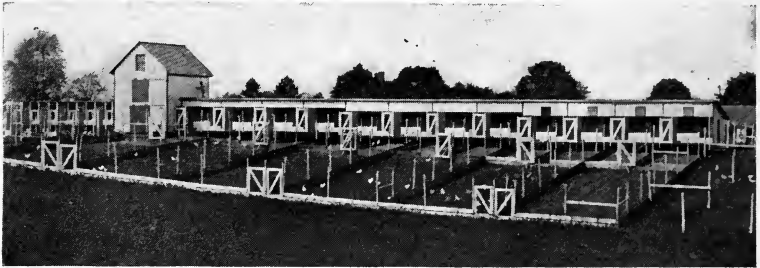


FIG. 87.—Long laying house as planned in figure 86. The small units are suitable for breeding purposes.

Note the hinged clapboard on the outside of the back wall, which can be opened, and thus allow air to circulate around the perches on hot summer nights (Figs. 67 and 86).

*Materials.*—The following list of material is required to build three sections of this type, making 16 x 48 feet:

Foundation, 2 feet deep and 8 inches wide—20 bags cement, 2 cubic yards gravel, 6 cubic yards cinders.

All framing material hemlock or yellow pine—

Sills.....	8 ps. 2" x 6" x 20'
	8 ps. 2" x 6" x 16'
	3 ps. 2" x 4" x 16'
End and division studs.....	10 ps. 2" x 4" x 8'
	15 ps. 2" x 4" x 7'
	10 ps. 2" x 4" x 6'
Side wall studs .....	36 ps. 2" x 4" x 8½'
	23 ps. 2" x 4" x 5½'
Extras for short pieces .....	3 ps. 2" x 4" x 12'
Corner and division posts (doubled).....	18 ps. 2" x 4" x 8½'
	10 ps. 2" x 4" x 5½'
Rafters.....	25 ps. 2" x 4" x 18'
Girder (doubled) .....	4 ps. 2" x 4" x 20'
	2 ps. 2" x 4" x 8'
Plates.....	8 ps. 2" x 4" x 20'
	4 ps. 2" x 4" x 8'

Roof boards.....	900 sq. ft. ship-lap.
Roof paper.....	900 sq. ft.
Supports for dropping boards, etc.....	32 ps. 2" x 3" x 4'
	20 ps. 2" x 4" x 3'
Perches.....	12 ps. 2" x 2" x 10'
Inside back sheathing, dropping boards, partitions, etc..	700 sq. ft. ship-lap.
Nest platform.....	250 linear ft. shingle lath.
Siding.....	550 sq. ft. novelty siding.
	4 cloth curtains, 4' x 5'
	4 window sash, 5' x 3'
Trimming, doors, nests, etc., dressed white pine.	200 linear ft., 1" x 2"
	100 linear ft., 1" x 3"
	500 linear ft., 1" x 4"
	200 square ft., 1" x 8" matched.
Hardware—	
3 prs. double-swing butts.	
5 prs. double-strap hinges for doors.	
12 prs. double-strap hinges for windows, curtains, and small doors.	
5 barn-door latches.	

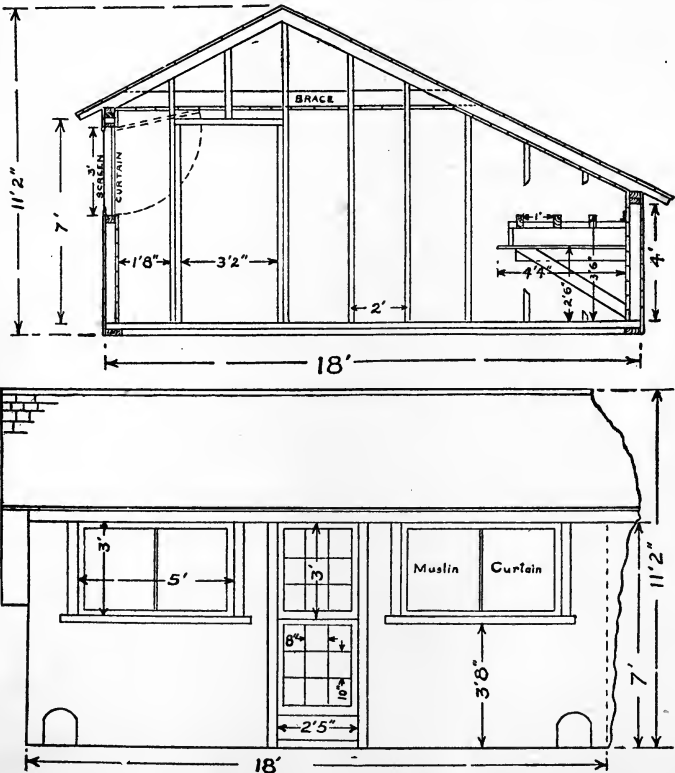


FIG. 88a.—End and front views of a part of laying house with two-thirds span roof.

This material will cost approximately \$217.00; for 48 linear feet will cost \$4.52 per running foot; or \$0.28 per sq. ft. for the area of 768 sq. ft. Allowing 4 sq. ft. per bird, the cost per bird is \$1.12.

**Two-thirds Span Laying House.**—Figures 88a and 88b show drawings of a single section of the long laying house at the Michigan Agricultural college, each section being eighteen feet square,

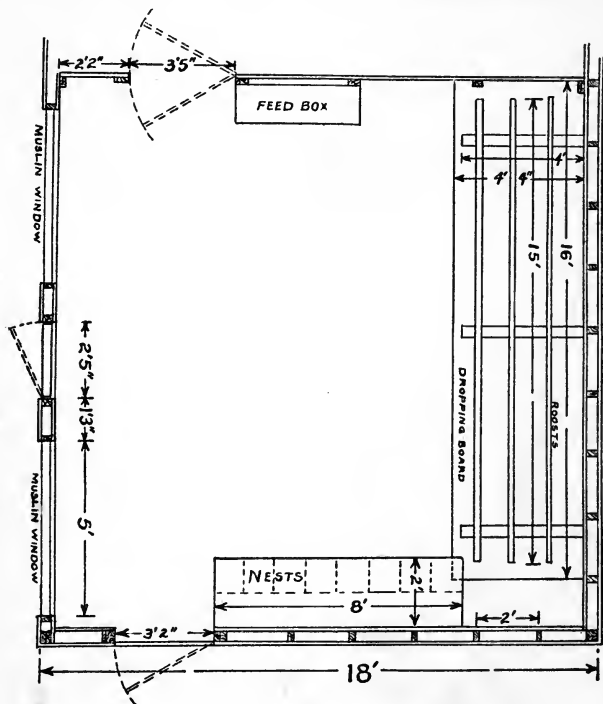


FIG. 88b.—Working plans of laying house with two-thirds span roof.—Floor plan of one section.

thus accommodating sixty-five birds. The sills are made of two 2 x 6 inch pieces and the plates of two 2 x 4 inch. The front is seven feet eight inches high and the back four feet eight inches; the studs are seven feet and four feet long, respectively. The roof is of combination type, being comparatively steep, having one foot rise to every two feet horizontal run. Shingles are used instead of prepared roofing, being adapted to the steep roof. No alleyway is used in this house, and the pens are connected by a series of

doors. This utilizes all the space and compels the attendant to mingle with the birds where he is able to study their needs and conditions much more thoroughly (Figs. 89 and 90).



FIG. 89.—Laying house with two-thirds span roof. A neat house. The cost is greater and the front lower than with the shed roof.

In the centre of the south side is a glass door made by hinging two 9-light 9 x 12 inch glass windows. This affords fifteen square

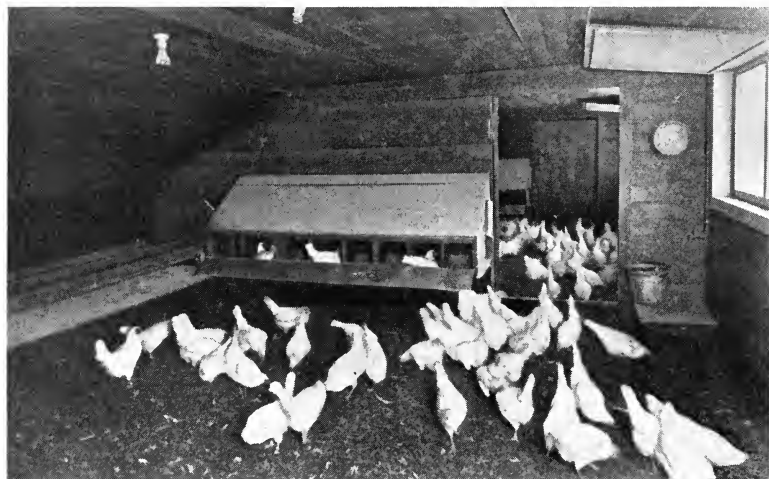


FIG. 90.—Interior view of house, Fig. 89, showing arrangement of nests and perches. (Photo from Michigan Agricultural College.)

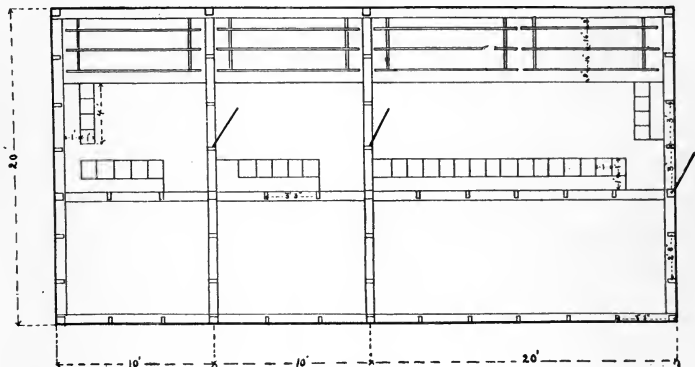
feet of glass to 324 square feet of floor space. The door can be opened for cleaning purposes.

The open-front method of muslin ventilation is used in this

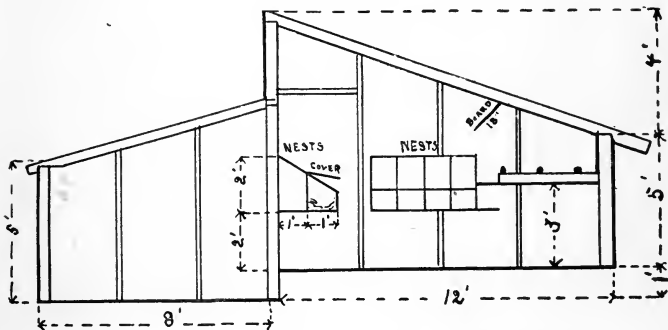


house. On both sides are muslin frames 3 x 5 feet, which being four feet from the floor do not permit drafts on the birds when open. One is opened every day during the winter, but closed at night.

Floor Plan.



Cross Section.



Front View.

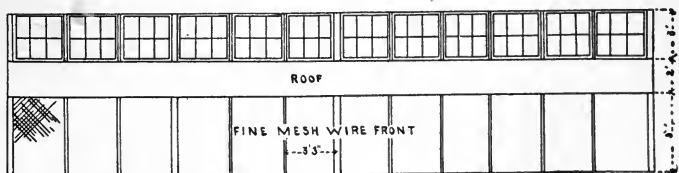


Fig. 91a.—Half-monitor type of laying house: Working plans.

The house is lined on all sides and above. This would not be advisable in a commercial house.

The roosts are also set on 2 x 4 inch pieces in the form of a

frame which is hinged at the back and can be raised for cleaning. It is desirable to raise the roosts so as to force lazy hens to the floor.

The floor is made of cement, and any tendency toward cold is eliminated by the liberal use of straw, which in addition compels the hen to exercise in her search for feed. Cement floors are cold because of dampness. This may be prevented by the use of a layer of tar paper in the construction, as already described.

Frame in process of construction.



Nearing completion.



FIG. 91b.—Half-monitor type of laying house: Under construction.

For ease in cleaning, all fixtures are portable, and all nests and boxes have sloping tops, thus eliminating the accumulation of filth on the internal fixtures. This house is well adapted for commercial use.

**A Half-monitor Laying House.**—This house has an entire glass front in the peak (Figs. 91a and 91b). The extension in front is

left entirely open two feet above the ground. The opening is covered with small-mesh poultry netting, no curtains being provided for it. The nests and perches are in the back part of the main house, and are protected and separated from the open front by a solid board partition extending from the lower part of the windows to within two feet of the floor. The windows in the peak are equipped with transom sash, so that they may be opened, being hinged at the top and opening outward.

*List of Materials.*—The following is a list of material required for the half-monitor house complete, 20 x 40 feet:

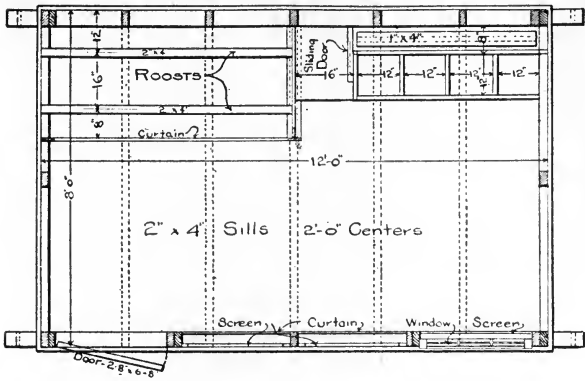
Foundation, concrete wall as deep as necessary and 8 inches wide—22 bags cement, 2 cubic yards gravel, 4 cubic yards cinders.

Sills.....	12 ps. 2" x 6" x 20'
	4 ps. 2" x 6" x 12'
	4 ps. 2" x 6" x 8'
Corner and division posts (doubled).....	16 ps. 2" x 4" x 5'
	8 ps. 2" x 4" x 9'
End wall and division studs.....	6 ps. 2" x 4" x 6'
	12 ps. 2" x 4" x 8'
Side wall studs and long partition.....	28 ps. 2" x 4" x 5'
	9 ps. 2" x 4" x 9'
Plates.....	8 ps. 2" x 4" x 20'
Girder, sill under windows.....	2 ps. 2" x 4" x 20'
Rafters.....	21 ps. 2" x 4" x 14'
	21 ps. 2" x 4" x 10'
Extra pieces for window work, dropping boards, etc.....	10 ps. 2" x 4" x 12'
Supports for dropping boards.....	12 ps. 2" x 4" x 10'
Perches.....	16 ps. 2" x 2" x 10'
Partitions, nests, and dropping boards.....	720 sq. ft. ship-lap.
Roof.....	1,000 sq. ft. ship-lap.
Roofing paper.....	1,000 sq. ft.
Sash.....	12, 34" x 34"
Trimming.....dressed white pine.....	.50 linear ft. 1" x 2"
	150 linear ft. 1" x 3"
	80 linear ft. 1" x 4"
	120 linear ft. 1" x 6"

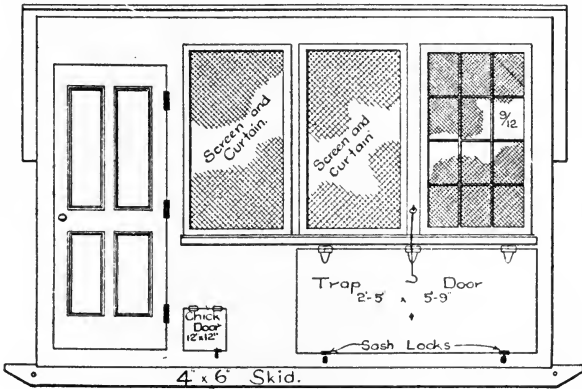
This material will cost approximately \$219.50. The house of forty linear feet will cost \$5.48 per running foot; or \$0.27 per sq. ft. for the total area of 800 sq. ft. The cost per bird, allowing 4 sq. ft. each, is \$1.08, not including labor.

**Portable Laying House.**—This house has two curtain openings and one large window in front (Figs. 92a and 92b). These provide ample sunlight and ventilation. The openings for the curtains are

Plan.



Front Elevation.



Framing of Front.

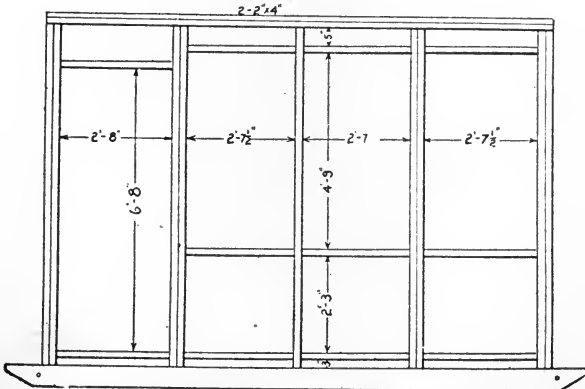


FIG. 92a.—Portable laying house: Working plans.

covered with netting, the curtains being so arranged as to swing up to the rafters. The front wall directly below the window and one of the curtains is made to open and admit sunlight directly on the floor near the front wall. The door is hinged at the top and provided with a hook to hold it up, this opening also being covered with poultry netting. The roosts and dropping boards are placed along the back wall about two feet from the floor. The nests are

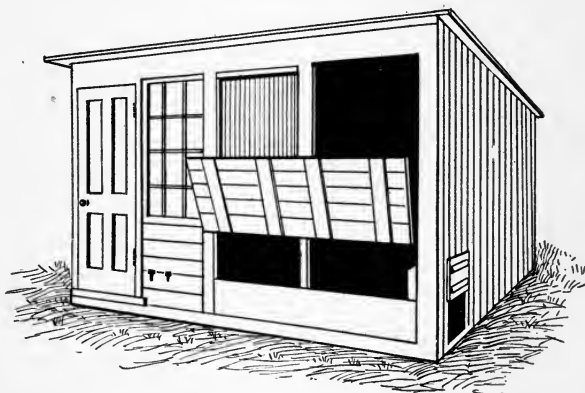


FIG. 92b.—Portable colony laying house completed.

placed on the continuation of the dropping board, the roosts and nests filling the back portion.

*List of Materials.*—The following materials (lumber chiefly yellow and white pine) will cost approximately \$60.00:

Skids.....	2 ps. 4" x 6" x 14'
Sills.....	7 ps. 2" x 4" x 8'
Studs.....	9 ps. 2" x 4" x 8'
	2 ps. 2" x 4" x 7'
	7 or 9 ps. 2" x 4" x 6'
Girders and plates.....	5 ps. 2" x 4" x 12'
	2 ps. 2" x 4" x 8'
Rafters.....	7 ps. 2" x 4" x 9'
Floor.....	17 ps. 1" x 6" x 12'
Siding.....	18 ps. 1" x 6" x 10'
	17 ps. 1" x 6" x 14'
Sheathing.....	21 ps. 1" x 6" x 12'
Roofing.....	1¼ rolls best 3-ply roofing.
One door.....	4-panel 2' 8" x 6'
One window.....	12 light 9" x 12"

Finish for curtain frames . . . . .	1 pc. 1 1/4" x 6" x 12'
Roosts and nests . . . . .	2 ps. 2" x 4" x 6'
	6 ps. 2" x 4" x 3'
	2 ps. 1" x 4" x 12'
	8 ps. 1" x 12" x 6'
	2 ps. 1/2" x 12" x 6'
Miscellaneous . . . . .	2 ps. 1/4" rod 12'
	2 ps. 1/4" rod 10'
Hardware. . . . .	1 1/2 prs. 3" wrought steel butts for main door.
	4 1/2 prs. 4" T hinges for chick door, curtain frames, and nests.
	1 1/2 prs. 6" T hinges for trap door.
	3 sash locks.
	1 rim lock.
	1/2 doz. screw hooks and eyes.
	1 special long hook for trap door.
	25 lbs. 8d. nails.
	8 lbs. 10d. nails.
	20 lbs. 20d. nails.
	20 feet of wire cloth or poultry netting 36 inches wide.

## REVIEW.

1. How should sloping land be graded for the laying house?
2. Describe in detail a correct method of laying out a foundation.
3. What are the essential points in digging the foundation trench?
4. How should the forms be made and held in place?
5. Describe manner of mixing and pouring concrete.
6. Enumerate essential points in framing house.
7. Discuss the standard-unit laying house in detail: (a) Plans; (b) specifications; (c) materials required; (d) cost; (e) efficiency.
8. Discuss the small-unit breeding house, using the same five points.
9. Discuss the two-thirds span laying house, in like manner.
10. Discuss the half-monitor laying house, in like manner.
11. Discuss the portable laying house, in like manner.

**References.**—Farm Poultry-houses, by Davidson and Lippincott, Bulletin 132, Iowa Station. Practical Poultry Building, by H. L. Blanchard, Washington Station, Bulletin 4. Poultry-houses, by W. J. Lane, Minnesota Extension, Bulletin 8. Poultry-houses, Pennsylvania Extension, Circular 8.

## CHAPTER VIII.

### POULTRY FIXTURES.

IN THE planning and arrangement of the various appliances which are necessary for the proper equipment of a poultry house, the following features should be considered, as poor fixtures, improperly designed and located, do not serve their purposes in the pen:

**Simplicity.**—All interior fixtures should be of simple design and construction, thereby making them more sanitary and reducing labor in caring for the birds.

**Cleanliness.**—As many of the appliances as possible should be portable, so as to be easily taken from the wall or standard and readily cleaned out of doors. By having them movable, there are fewer crevices in which to harbor lice and mites. Cleanliness is of paramount importance in the laying house. All fixtures should be constructed with this idea in view, having as few joints as possible, and so designed that they can be taken apart, if necessary, to reach all unexposed parts. They should be so made that a disinfectant solution, when thoroughly applied, will reach all parts.

**Location.**—The house is designed for the birds, the capacity being determined largely by the number of square feet of floor space; therefore, none of the portable fixtures should be placed on the ground, but should be raised above the floor at least a foot (Fig. 93), on elevated platforms or hanging on the walls. Attention to this one feature will give birds more room for exercise, or more birds can be kept in the house, thus reducing the cost per bird. In order to economize wall space, in some pens, it is necessary to plan carefully the arrangement of the fixtures.

**Perches.**—It is the natural habit of all kinds of poultry (not including water fowls) to perch or roost at night on elevated places, as branches of trees. It is not a good practice to allow mature birds, of the heavy breeds, to roost directly on the floor. For the heavy Asiatic breeds low perches should be provided, only a foot or two above the floor. The natural tendency of birds of the lighter breeds is to seek as high roosting places as possible, and thus protect themselves from enemies and from cold.

The perches should be placed on the lowest side or back of the house, farthest from the curtain front, as this part of the house is

the warmest. By so doing space is utilized which usually is not high enough to allow the attendant to work conveniently (Fig. 93).

*Amount of Space Required.*—The amount of perch room depends on the size of the birds. Birds need more roosting space in the summer than in the winter, but under general conditions the following amount of room would be needed by the various breeds: About seven or eight inches of perch room is required by a hen of the lighter breeds, such as Leghorns; about eight to nine inches for the Plymouth Rocks and others of medium size; and about ten or twelve inches for the largest birds, such as Brahmas and Cochins. In the winter months they will not occupy all of this

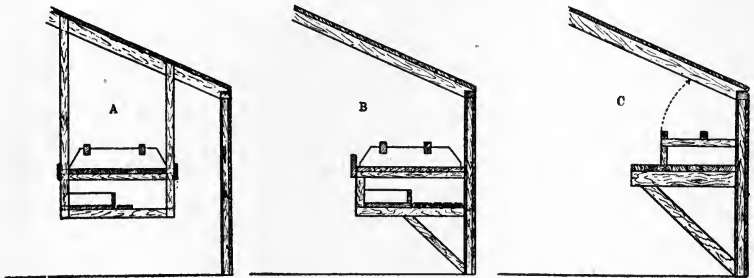


FIG. 93.—Arrangement of nests, perches, and dropping boards. A, suspended; B and C, attached to back wall.

room, but it allows them sufficient space to gain access to the perches and to move about without interfering.

*Materials.*—Perches can be made from 2 x 2 inch, 2 x 3 inch, or 2 x 4 inch scantling, placed either on edge or with the wide surface up. There is a great variety of opinion as to which method is the best, but it is certain that wide perches do not allow the birds to lock themselves securely while sleeping, as nature intended, and narrow perches are apt to develop corns. It is well to round the two upper corners, doing away with the extremely sharp edges. Dressed lumber should be used, as unplanned material is often very rough, furnishing places for red mites.

*Construction of Perches.*—The perches should always be easily removed, either as a unit or separately. There are a number of different ways of supporting them. When narrow pens are used they are sawed the exact width of the pen and allowed to set in notches cut in strips, the strips being fastened to the inside wall. For wider pens the roosts must be provided with supports in the centre. When 2 x 2 inch scantling is used, they should be sup-



ported every five feet; when 2 x 4 inch is used every eight feet will do. If dropping boards are used, the perches are usually placed above them at a distance of about eight inches, or high enough so that a hoe can be freely manipulated under them when cleaning.

A very simple and efficient method of constructing perches is to make them as one unit, hinging the unit to the back wall and supporting it by two or more legs at the front. Such a perch can be raised when cleaning, and also it may be hooked to the ceiling during winter days, thus keeping the birds off their perches and on the floor where they will be working. In determining the exact height of the perch, the character of the birds is to be considered.

The light, active birds fly high with no injury to themselves, and perches for Leg-horns can safely be four feet above the ground; for the Cochins and Langshans one or two feet is usually high enough. The roosts in any one room must always be level with each other. The height of the perch will be determined in part by the character of the floor. With a soft floor provided with an abundance of litter, there is less danger of birds injuring their feet when jumping from the roosts.



FIG. 94.—Roosting closets to prevent drafts at night. Curtains may be placed in front of these in cold climates.

There are a number of patented roosts and supports on the market, made of iron and other material; the general advantage claimed for these is that they are proof against mites and lice, but they have little if any advantage over well-constructed, portable wood roosts.

**Roosting Closets.**—When the roosts are placed at the back of the building, it is often the practice to build solid partitions between the pens. In long houses this partition may be constructed every twelve or fifteen feet at right angles to the perches and back wall, extending two feet beyond the front perch. This divides the roosting area into separate compartments, which are often called “closets” (Fig. 94). These may be still more securely enclosed by providing muslin drop curtains in front. Such roosting closets are used in large pens where but few birds are kept; also where the more delicate, active breeds are housed in extremely cold, unprotected locations. The use of the muslin curtain in front of the roosts should be limited in mild weather, as it is possible to keep

the birds too closely confined. They may not be supplied with enough fresh air; this may result in getting them into a tender condition, making them liable to have frozen combs and winter colds.

**Dropping Boards.**—In order to provide some means of more easily removing the droppings and keeping the house in a better sanitary condition, dropping boards or platforms under the perches have come into quite general use. This facilitates the saving of large amounts of manure for fertilizer purposes. The dropping boards are placed under the perches, usually at a distance of eight to ten inches, being supported from the floor by legs or hung from the ceiling by rods or wires. In narrow pens they rest on cleats nailed to the walls. In small houses dropping boards are often made movable so that they will slide similar to a drawer. They should be constructed of matched lumber, having a perfectly smooth upper surface. It is best to have the boards run perpendicular to the perches, or in the direction which it is necessary for the attendant to work when cleaning them with a hoe. It is necessary to clean them, under general conditions, about twice a week. It is possible by the use of absorbents, such as land plaster or dry loam, to keep the droppings dry. This will allow of less frequent cleaning. Eliminating the dropping boards by the substitution of an absorbing material, such as peat moss, on the floor under the perches is possible. This reduces labor; but also reduces the floor space, which more than balances the labor item.

**Nests.**—All breeds of poultry have by nature a nesting habit, and they desire to find some secluded spot, usually darkened, for their eggs. For this reason, nests should be provided which will offer the most inducement to the birds to lay in one place; thus the danger of losing the eggs will be prevented. Clean eggs will be insured and much labor saved in their collection if good nests are provided. Even when allowed free range the birds will usually come back to their roosting place to lay if there are suitable nests. It is a natural habit for hens to make their own nests, yet the more domesticated they become the less pronounced is this habit. Some prefer to lay in nests with other hens. Nest eggs are useful because they induce the birds to lay in the same place each time, and tend to cause a greater distribution of eggs and less crowding in the nests.

*Nest Construction.*—(1) Nests should be darkened, so that the birds feel secluded and protected. After laying they do not remain so long on the nests and break the eggs. If eggs are broken in light nests, it may result in developing the habit of egg eating.

(2) Nests should be so constructed that it is easy for the attendant to see and remove any eggs in them.

(3) They should be constructed large enough for the birds to sit on the nest; 12 x 14 inches may be required for the large breeds and 8 x 12 inches or 10 x 12 inches for the light breeds. If nests are too large, eggs are broken by two or more hens crowding into them at once.

(4) Nests should be movable, so that they can be easily taken out and thoroughly cleaned. The nesting material is the first place in the house where mites and lice are usually found, and if they can be controlled there, freedom from such enemies is more easily maintained.

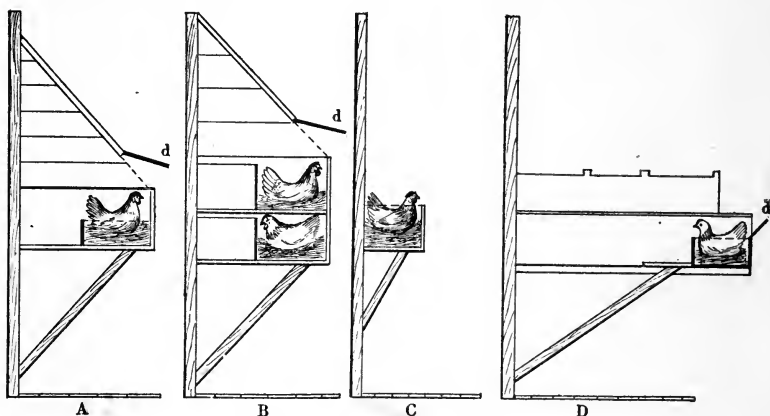


FIG. 95.—Four ways of locating nests,—end boards are removed to show construction. Eggs are taken out from the covered nests by raising the door, *d*.

*Number of Nests.*—There should be nests enough so that the hens will not be compelled to crowd. Number is determined by the size of the flock in the spring or during the heavy laying season. A safe number is one nest to every three or four layers.

*Materials Used.*—Wood smoothly planed is usually used in the construction of the nests. They should be securely built. Boards seven-eighths inch thick and ten or twelve inches wide, with square edges, can be made into very good nests. Soap-boxes, nail-kegs, lemon-crates, and egg-cases are often made over into good poultry nests, but they are less sanitary than well-made nests.

*Types of Nests.*—There are a great number of types and designs in nest construction, each having advantages and disadvantages. Figure 95 shows some of these types.

**Location of Nests.**—The exact location of the nests depends upon: (1) The plan of the house; (2) the amount of space available; (3) the character of the birds; and (4) the type of nest. The most economical place is to have them suspended under the dropping board and arranged so that the birds enter them from the back; a hinged door on the front allows the eggs to be removed easily. Space is utilized which otherwise could not be used. A



FIG. 96.—Dark wall nests, arranged in tiers.

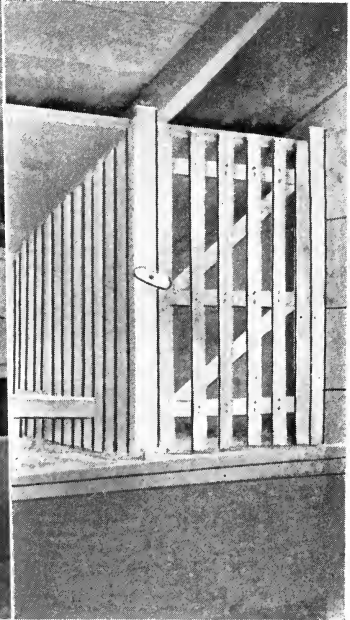


FIG. 97.—Coop for broody hens. Hens are confined until "cured."

great many pens of the long type do not provide enough wall room for all the nests. Where large numbers of nests are necessary, it is sometimes advisable to place them two or three tiers high (Fig. 96).

**Advantages of Trap Nests.**—Trap nests are recommended for use by poultrymen who desire to get individual laying records and special pedigrees of their stock. Trap nests aid in picking out the best producers and elimination of the poor layers. They aid in the detection and isolation of diseases, such as white diarrhoea.

They are used on many of the large poultry plants where special breeding pens are kept, and then only during the winter and early spring months. Breeders of fancy poultry find much benefit from their use, as they are able to study the qualities transmitted by each individual. It is possible to make matings with a greater degree of certainty as to the results which will be obtained. Increased profits come largely through the keeping of better birds; this means the selection and breeding from the best. It is not practicable to use trap nests for the average laying flock.

If trap nests are used, they must be attended to regularly and the birds let out at frequent intervals. A complete round should be made at least every hour, starting at nine o'clock in the morning, until the laying is over for the day.

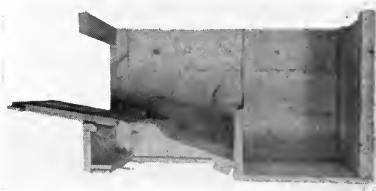
If this is not done, the vitality and usefulness of the birds confined is greatly impaired, and their production is sure to decrease. Much labor is thus required, but trained persons are not necessary.

#### *Designs of Trap Nests.*

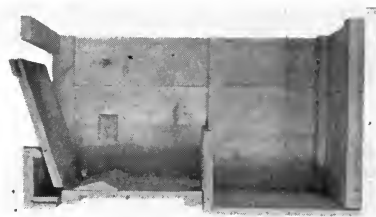
—There are a great many types of nests made, only a few of which work well.

In practically all types the

nests are so constructed that when the hen enters she releases a spring or trigger which allows the door to close behind her, and she cannot leave the nest nor can another hen enter until the attendant has removed her and reset the trap.



A.



B.

FIG. 98.—Pearl or Maine State trap nest, side removed. A, open; B, sprung or shut. The weight of the hen on the hinged bottom keeps the door closed. (Photo by Raymond Pearl.)



FIG. 99.—Improved Connecticut trap nest. Centre nest open; the hen on entering raises the door and allows the trigger to fall; this locks the door shut until the attendant comes. (Tops removed for photographing.)

The following points should be considered in the design and construction of a trap nest. It should be large and roomy, and of considerable depth, so that the egg will not be trampled upon while the hen is waiting to be removed. About twelve inches wide, eighteen to twenty inches deep, and fourteen inches high is a very efficient size. The trap arrangement should be so delicate that the bird cannot enter without causing the door to lock automatically and keep her from leaving the nest and prevent another hen

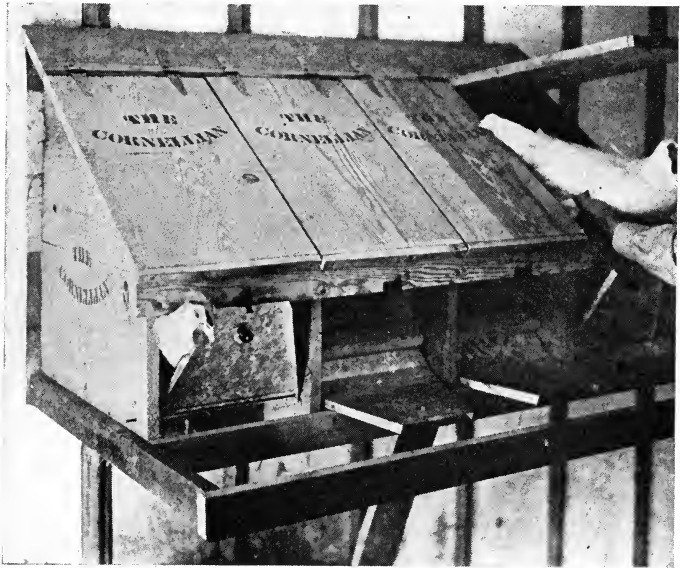


FIG. 100.—The Cornell trap nest. When entering, the hen steps on the wooden cleat which closes the door behind her. A latch at the top holds it closed. The fourth nest shows attendant removing the hen. (Courtesy J. E. Rice.)

from entering. It must be so constructed that only one bird can enter the nest at one time. The trap arrangement should be so located that it will remain free from obstruction, such as nesting material, which would hinder its proper working. Simplicity in the manner of trapping is to be desired; the fewer working parts the better, as they are less liable to get out of order. Figures 98, 99, and 100 show some efficient types of trap nests.

**Broody Coops.**—Every pen should be provided with an available coop for the isolation of broody hens (Fig. 97). A very de-

sirable place for such a coop is at one end of the perches, on a level with the dropping board. A slatted bottom is essential, as it keeps broody hens from squatting on the floor. The sides of the coop may be constructed of slats or one-inch-mesh wire. They should be so made as to admit of easy cleaning, a door being provided which will allow the birds to be easily removed or placed in the coop.

Such a coop may also be used for the housing of surplus cockerels when the alternating system is used. It is a desirable and necessary adjunct in the equipment of the laying house.

**Dust Boxes.**—Large, deep, dust boxes are essential in the laying pens. A dust bath is as necessary for the health of birds as a water bath is to the health of many other animals. By its use the bird is enabled to rid itself of lice and to remove all scales and dirt from the skin. It should be deep enough to hold about six inches of dusting material, and is usually located in a corner of the pen, elevated above the floor so that it will not get filled with straw or other litter from the floor. If flat-topped nests are used, the dust box may be placed above the nests. In some cases it is placed at one end of the dropping board. Some authorities recommend the enclosing of the dust box, allowing the birds to enter and leave through a small opening. It is claimed that the inside of the house is kept cleaner and more free from dust, which may have a detrimental effect upon the birds. Practice hardly warrants the enclosing of the box, as the birds usually come from the box to shake their feathers, bringing the dust with them.

For dusting, the substance should be very light, fine, and dry. The finer the better. Being designed to kill lice, it must be fine enough to fill the breathing pores of these parasites. Sandy loam mixed with road dust makes a fairly good dusting material. If sand or road dust is used, sifted coal ashes aid in making it finer. A good dusting material is composed of equal parts of loam, sand, and sifted coal ashes, with about three per cent by weight of kerosene oil, thoroughly mixed together. The dust box should be placed where sunlight can shine into it, and must be kept free from all litter and other foreign matter.

**Alleys**, or hall-ways, are often constructed in the rear of long poultry houses with the idea of facilitating the work of caring for the birds. Each separate pen opens from the alley. If extremely long houses are divided into a large number of small pens, the alleys have many advantages. It is sometimes practicable to construct a

house of this type and have the partition between the pen and the alley so arranged that all the work of cleaning the dropping boards, collecting the eggs, watering, and feeding can be done directly from the alley, but it is doubtful if the work can always be done with the greatest degree of efficiency in this manner.

There are a number of disadvantages in having an alley in the house. The alley, being at the rear, requires the building to have a high roof. The house is much colder, as there is from one-fifth to one-seventh additional head room to heat up and no extra increase in floor space. The roosting quarters are not in a desirable location, the centre often being drafty, and no means is provided for conserving the heat from the bodies of the fowls. Such houses cost more to construct compared with the number of birds. They are always more or less drafty, as the long, narrow alley in the back offers an unobstructed passage for air to sweep from one end of the building to the other. The use of cloth doors at intervals across the alley may be used to check the draft. The house with an alley is not desirable except in the case of a long exhibition house for display purposes, brooder houses, or fattening sheds, in which case the alley should be in the centre if the house is wide enough. In every case the alley should be wide enough to allow an attendant to pass easily with a load in each hand.

**Feed troughs** are used principally for the feeding of wet mashes, chopped vegetables, or sprouted oats. They should not be used for the feeding of ground or whole grains, for a large proportion of the ground feed is wasted, and the grain is better fed in litter so the birds are compelled to exercise sufficiently while eating. There are a number of different types of construction (Fig. 101); the idea should be to make them deep enough to hold the feed and to protect the contents from contamination and waste by keeping the birds from standing in them while eating.

The best material for the construction of feed troughs is planed lumber one inch thick and from eight to twelve inches wide. All joints should be made tight, and they should be so constructed that they cannot be overturned by the birds. It is better to have a number of small troughs from six to twelve inches wide and two to five feet long than one large one, as they can be readily carried from place to place and are more easily cleaned. The birds can shift from place to place, thus allowing the weak ones a better chance at the feed. They should be made so that they can be easily cleaned; this is necessary, as they are used for material which sours easily.



**Self-feeding Hoppers.**—A great number of styles and types of feed hoppers are used for the feeding of dry ground grains and whole grains. They are used more generally for the feeding of dry mash kept before the birds all the time. Where they have been used in the feeding of whole grains, it is doubtful if they have proved efficient except in the case of growing chicks on free range. The

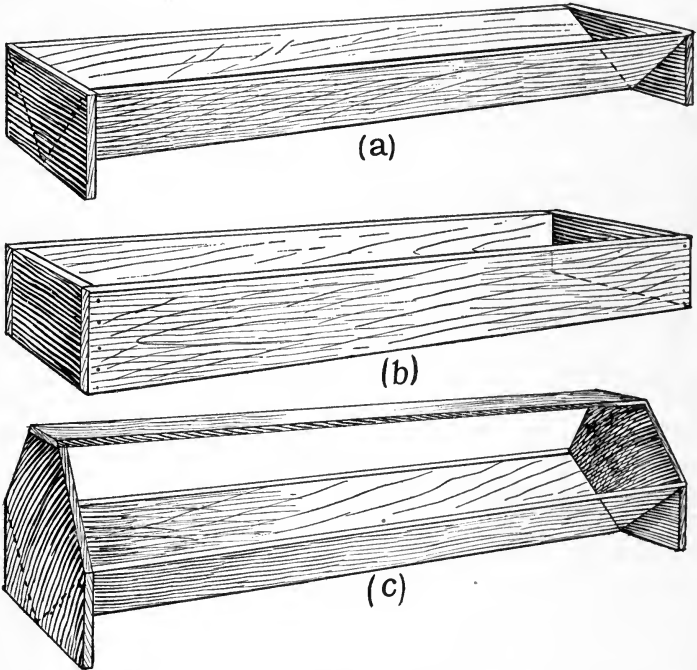


FIG. 101.—Common types of feeding troughs. a, Open V-shaped; b, square form; c, V-shaped, covered.

hoppers designed to feed whole grain automatically do not induce sufficient exercise. They supply grain too liberally unless they become clogged.

The pens should be visited often enough to supply the grain ration in litter.

A *successful dry-mash hopper* should possess the following features:

It should be of large capacity, thus economizing labor in filling. A hopper holding from two to four bushels will not require filling

oftener than once every two or three weeks, depending, of course, upon the number of birds having access to it.

To be labor saving it should be automatic, in that it is self-feeding; as the birds eat the mash away from the opening, other material should gradually come down. While this feature is attempted, in a great many types of hoppers the mash is found to clog, and it requires considerable attention to keep the mash feeding properly. Hoppers with small throats and extensive taper to the sides have a tendency to clog in this manner.

The feeding surface should be provided with a hinged cover, so arranged as to admit of closing it when desired. It is best to leave the hopper open only a few hours of the day, in the case of fat hens of the heavier breeds. It is often well to close the hopper at night to keep out rats.

It is important that the hopper should be nonwasting. The practice of feeding dry mash in self-feeding hoppers is usually one of the most efficient feeding methods, provided the right hoppers are used; but if the birds while eating waste the mash it is a most inefficient practice.

The hopper should be easily and quickly filled.

It should be long enough so that a number of birds can feed from it at one time.

The top should slope to prevent birds from roosting upon it.

*Types of Hoppers.*—There are a great many types of commercial hoppers for sale by leading poultry-supply houses, representing a great variation in efficiency and cost. Most of these commercial hoppers are made of metal and are of limited capacity, and there are very few types which fulfil all the requirements outlined above. The average poultryman can construct a hopper of wood at a low cost which will meet all the requirements. Figure 102 shows a good type of home-made hopper for the laying house.

In constructing a hopper, the size should be determined by the

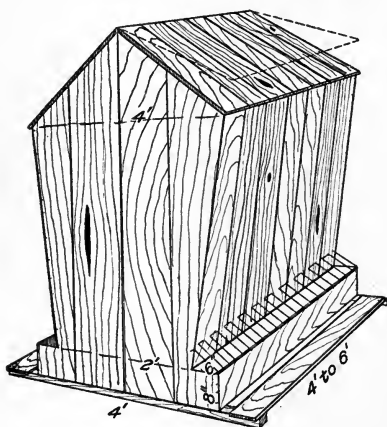


FIG. 102.—A home-made dry-mash hopper, feeding from both sides, for large flocks.

number of birds that are to feed from it. A hopper holding five bushels is much more efficient and more practical than one holding one-half bushel. Tongue-and-groove lumber without beads is a suitable material for the construction of a hopper.

**Drinking Vessels.**—There are two distinct types of drinking utensils,—open and closed. The open vessels are those from which the birds drink directly at the surface, and as the water is consumed the surface is constantly lowered. The closed form of drinking utensil is usually of the “vacuum” type. In deciding on what type to use, the following features should be considered:

(1) Drinking water should be kept clean and free from dust and litter; therefore, a covered drinking vessel is better. (2) The vessel should also be of a type quickly filled or emptied, and be easily and quickly cleaned. (3) It should be so constructed as to prevent the birds from roosting on it and polluting the water with their droppings. (4) It should be of relatively large capacity, for a larger volume of water remains cool longer in the summer and does not freeze so quickly in the winter as in the case of an extremely small volume.

*Location of Fountain.*—If possible the drinking fountain should be raised above the floor. A good place is a small shelf or platform raised a foot or more above the floor, considerably larger than the fountain, so that the birds will have room enough to stand on the platform when drinking. In the summer it should be located, if possible, where no sun will shine directly upon it and warm it up quickly. In the winter it is better to have the fountain in as sunny a place as possible.

*Types of Drinking Vessels.*—Two types of drinking vessels have been mentioned. The open drinking utensils are the ones generally found on poultry farms. They usually consist of a pail or tub, kept as full as possible of fresh water, located on the floor or on an elevated platform. When it is desired to provide an abundance of fresh water in extremely warm weather, the open

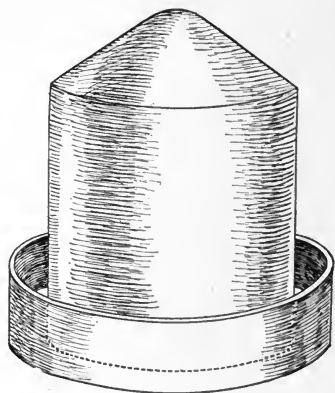


FIG. 103.—A practical drinking fountain. A ten-quart galvanized fire pail inverted in a milk pan with three-inch rim.

V-shaped troughs are sometimes used, but they must be made water-tight. Earthen pans or vessels are sometimes used, and if glazed and kept clean they make very economical open vessels.

The "vacuum" fountain consists of a large chamber filled with water having only one outlet, which is in the lower part of the chamber, communicating directly with a shallow pan or trough, the edges of which are above the opening in the water chamber.

When the vessel is filled and set upright, and the water has filled the saucer or cup, air is prevented from entering the water chamber, and a closed chamber called a "vacuum" is formed on the top. Outside air pressure holds the water in.

From among the various commercial types of drinking vessels which are found on the market a number of practical ones can be selected. In selecting a commercial drinking fountain it is very desirable to secure one which allows of separating the water chamber from the drinking pan, as more easily and perfectly cleaned and more easily filled. These commercial drinking fountains can be secured in all sizes from that required for baby chicks to those for adult flocks.

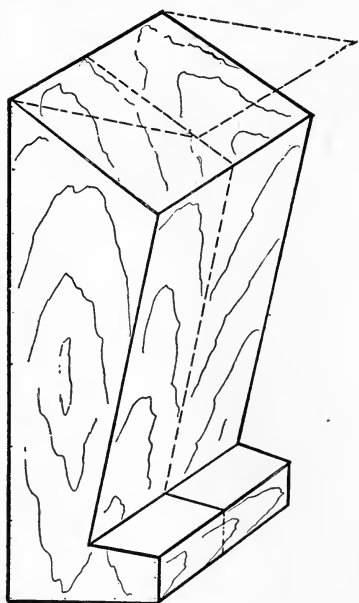


FIG. 104.—A hopper for grit and shell. These materials are usually fed separately—not with dry mash.

The usual commercial fountains are not large enough for a large number of hens and they are rather expensive. Figure 103 shows a practical device which answers all the requirements outlined.

**Grit and Shell Boxes.**—The most economical way to feed grit and shell is to keep it before the birds all the time. There are hoppers constructed for that purpose (Fig. 104). In this way the birds can have constant access to this material, and the cost of feeding it is reduced to a minimum. These hoppers resemble in style a large dry-mash hopper, but are usually much smaller. A very common practice, and a very good one, is to partition off

one or more small compartments in the large dry-mash hopper for the feeding of grit and shell. These materials are much heavier

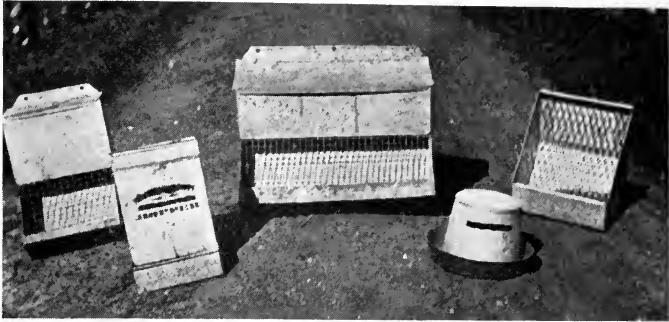


FIG. 105.—A group of commercial feeding appliances.

than ground grains, and will feed through small openings without clogging, and there is much less waste by the birds (Fig. 105).

#### REVIEW.

1. Give five essential features to be considered in planning poultry fixtures.
2. How much perch room is required per bird? Give variation.
3. Discuss location and construction of perches.
4. What are roosting closets, and what are their advantages?
5. Give the points in the construction of dropping boards.
6. Give the principles of nest construction.
7. Tell of the number of nests required and common types used.
8. What are the essential points of a good trap nest?
9. Describe the following nests: (a) Cornell; (b) Pearl; (c) Connecticut.
10. What are the possible uses of "broody coops," and how are they made?
11. Why are dust boxes needed?
12. Give a good dusting material.
13. Describe a house with alley; give advantages and disadvantages.
14. What are the uses of open feeding troughs?
15. Give points in their construction.
16. Give the necessary features of a good dry-mash hopper.
17. Describe an efficient home-made hopper.
18. Describe two types of fountains.
19. What are the desirable points in a drinking fountain?
20. Why have grit and shell hoppers?

**References.**—Labor-saving Poultry Appliances, by Rice and Rogers, Cornell Bulletin 284. New Poultry Appliances, by Rice and Lawry, Cornell Bulletin 248. Hoppers for Poultry Feeding, in United States Farmers' Bulletin 316. Water Pan for Poultry, in United States Farmers' Bulletin 317. Poultry-house Plans and Appliances, by C. A. Rogers, Cornell Circular No. 1.

## CHAPTER IX.

### YARDS AND YARDING.

ONE of the vital questions for each poultryman to answer is: Will it be necessary to provide yards for the birds or will it be possible to give them free range? Yards, at their best, are a disadvantage in successful poultry keeping, as poultry do better under all conditions if given an abundance of range. On small intensive plants or where crops would be injured by the birds, close yarding is necessary.

On commercial plants the restriction or confinement of the stock to a small enclosure should be avoided if possible. If a number of breeds are kept for fancy purposes, it is necessary to insure a complete separation of the flocks and fencing is essential.

**Size.**—When fences are required, the area enclosed should be made as large as possible. The amount of yard room required will vary with the breed kept, and the shape of the yard, the character of the soil, and whether or not the yard is to be kept permanently in sod. The light, active breeds are more destructive, and also require greater area when kept in confinement. The heavy meat breeds require only a small area enclosed with a low fence.

Fertile soils, capable of producing good crops, will provide forage material in abundance. This will require a smaller area than for yards on poor and unproductive soils. It is best to keep a permanent yard in sod, thus providing green feed with a minimum amount of labor. If the yards are small and the crops are frequently planted, much labor and seed are required in maintaining them.

With permanent sod yards in good condition, one hundred to one hundred and fifty square feet per bird will provide ample room, and the sod will remain permanent except near the house. If green feed is to be grown in alternate yards, from fifty to seventy-five square feet or more should be allowed each bird. Enough yard room should be provided to insure a constant supply of forage material. If this is done, the birds will rarely attempt to fly over fences in search of other feed.

When temporary yards are used and changed occasionally, much smaller areas than given above will do, if crops on them are

rotated, or if rest periods of a year or more are allowed between the periods of use.

**The Shape of the Yard Influences the Cost.**—It is much cheaper to fence a square yard than a rectangular one, as it requires less fencing material and less labor. Long yards insure a more permanent growth, but square yards are more easily worked and seeded. Triangular yards with acute angles in the corners should be avoided, as they form a catch-all for leaves and rubbish and do not readily allow of plowing nor cultivation. Long and narrow yards provide a larger amount of green feed than the same area



FIG. 106.—A good method of double yarding and crop rotation. The corn provides shade while the fruit trees are growing. (Photo from Purdue University.)

in the form of a square, as the birds stay near the house and do not feed at a distance until that near at hand is consumed.

**Advantages of Double Yarding.**—A system of double yarding is often provided when it is impossible to give birds free range. When double yards are used, a more nearly constant supply of green feed can be grown (Fig. 106). The double yards allow a change in rotation of the birds from one yard to another. They are thus kept clean and free from filth, which is important on heavy soil. Even with small runs it will be found profitable to divide them in half and rotate, the birds feeding on one part and then on the other. Single yarding may require the feeding of green feed from outside sources, which entails extra labor in harvesting and feeding it to them. This feature is eliminated by double yarding.

**Crops to Use.**—The following system of crop rotation has been found to work out very satisfactorily where a double yard is used for one pen:

DATE.	YARD A.	YARD B.
March to April 30.....	Peas and oats.....	Feeding
April 30 to May 25.....	Feeding.....	Peas and barley
May 25 to June 15.....	Dwarf Essex, rape.....	Feeding
June 15 to July 10.....	Feeding.....	Buckwheat and oats
July 10 to August 1.....	Buckwheat.....	Feeding
August 1 to August 20.....	Feeding.....	Cow peas and millet
August 20 to September 20...	Rye, vetch, clover.....	Feeding
September 20 to December 1.	Feeding.....	Rye and vetch

The dates mentioned are for the latitude of Philadelphia and will vary slightly with location, but the crops mentioned will grow well in most parts of the country. The birds should not be allowed to feed on any crop until it is from four to six inches tall; if allowed on the crop too soon it will not last so long.

In following the above scheme, the rye and vetch which were seeded in yard B about September 20 should be allowed to grow until planting time in the spring; they will then furnish green feed until the spring-planted crops are ready.

It is not necessary to plow the yards for each planting. Two plowings, spring and fall, are sufficient on most soils. A cultivator will serve for preparing the ground, and a smoothing harrow for covering the seed when sown broadcast.

The average cost of growing and feeding succulent green feed by the above system was found by actual experiment to be only five cents per hundred pounds. The feed grown on outside land and carried to the birds costs eleven cents per one hundred pounds.

**Methods of Double Yarding.**—There are three general plans for constructing double yards (Fig. 107). 1. On many poultry plants where the semi-community system is used it is best to provide two front or two back yards. The large single yard which is commonly found may be divided, and will give an abundance of room for the growing of crops.

2. On extensive plants where long houses are used, it may be possible to have front and back yards, planning the rotation so that in fall and winter the birds will be ranging in the front yards while a crop is growing in the back yards for use in early spring. During the summer both yards should be rotated as often as possible.



3. When it is impossible to provide rear yards with the intensive long house, the following method of providing green forage at the New Jersey Station is productive. The term applied to this system is the "double unit" feeding yard. All pens, regardless of size, have exercise yards which are plowed only once or twice during a season, and they are usually bare. Communicating with each pair of these exercise yards is a larger feeding and grazing yard in which green crops are grown, the birds being allowed access to these yards on alternate days. It is not as good a system as regular double yards, yet it enables the keeper to supply green feed to the birds in the most economical form.

**Posts.**—Light wooden posts are usually available, and will answer very well for poultry fences. The size of the posts used will depend upon the kind of wood and height of fence.

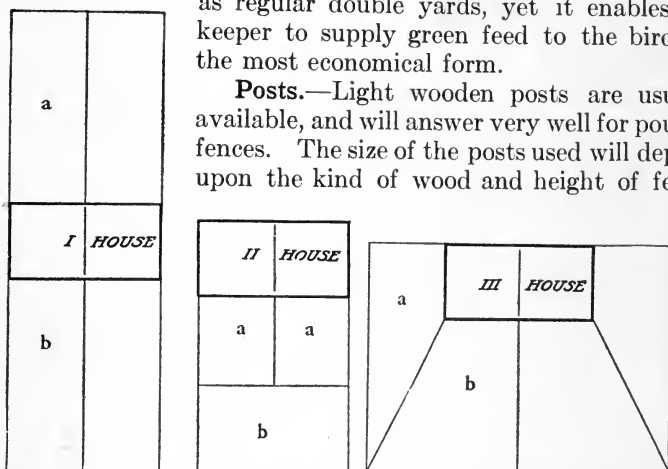


FIG. 107.—Three methods of arranging double yards with reference to the houses. I, Front and back yard; II, *a*, exercise yards; *b*, feeding yard; III, double yards at the front and side of each compartment of the house.

Red cedar is very durable, and the cost, in regions where it grows naturally, should not be prohibitive. A good red-cedar post should be at least ten feet long and not smaller than three inches at the small end. Chestnut, locust, and other hard woods which have natural rot-resisting qualities are good.

It has been found profitable to dip the lower part of the post in tar, letting the tarred portion extend about six inches above the ground line. The charring of that portion, by burning over a slow fire, also has a preservative effect. The bark should not be allowed to remain on the post below or above the ground line, as water accumulates and hastens rotting. Where natural round posts are not available, sawed timber may be used, 4 x 4 inches

and 3 x 4 inches being suitable sizes. Some preservative should always be applied below the ground; and even with proper treatment sawed hemlock and yellow pine last only about two-thirds as long as good cedar posts. Where prices of wooden posts are prohibitive, cement may be economically used (Fig. 108).

It is sometimes desired to have a neat and attractive fence regardless of expense. Iron posts may then be used; either round iron piping or U-shaped iron, the latter being more expensive. When iron is used, it is well to set the posts in concrete to insure stability. The poultry netting should be fastened to the posts by means of small, twisted wire. A very cheap and attractive fence

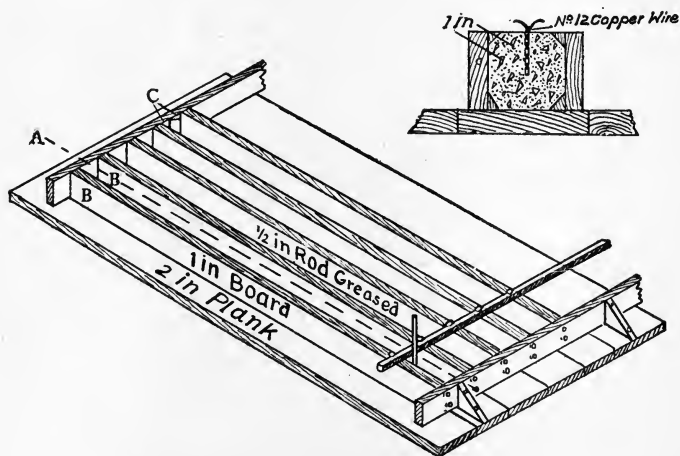


FIG. 108.—Forms for making concrete fence posts.

can be made by using one and one-quarter inch, second-hand iron pipes, setting them in small holes two feet deep filled with poured concrete. The wire can be attached by means of notches or holes bored through the pipe before it is set. Small wooden knobs can be placed on top of the pipes to give a finished effect.

*Manner of Setting Posts.*—Care should be taken in setting posts to have them in true lines. Before starting to dig the holes, the exact location should be marked with a stake, to insure a straight, neat, and attractive appearance when complete. The distance between them for the average poultry fence should be about twelve feet. The distance at corners near gates, or where bracing must be used, should be ten feet. The holes should be dug about two

and one-half feet deep, and considerably larger than the diameter of the posts to allow some movement for alignment, and to allow of tamping the soil thoroughly when the holes are being filled. If wooden posts are used, it is very desirable to fill the bottom of the hole with crushed stone, cinders, or coarse gravel, to give better drainage, thus increasing the life of the post by drawing the moisture away from it. When filling the post hole, the post should be held in line and the dirt tamped securely from the very bottom of the hole to the top to insure permanence and rigidity from the start.

When long stretches of wire are used it is necessary to securely brace the corner posts and all points where the greatest pull occurs.

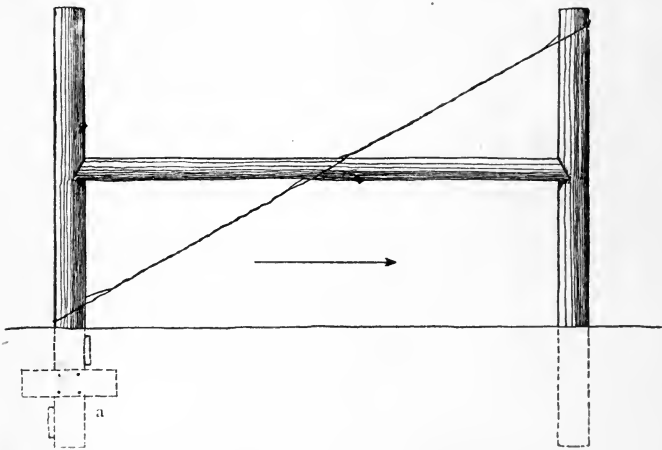


FIG. 109.—Manner of bracing a corner fence post (a). The pull is in the direction of the arrow. The cleats on the bottom of the corner post prevent its turning or twisting.

They should be braced below ground to prevent twisting, and above ground to prevent leaning. Figure 109 shows this construction.

**Fencing Material.**—The most common material used for poultry fences is wire netting with hexagonal or octagonal meshes of different widths. It is sold under various trade names. In purchasing poultry netting be sure that it is properly galvanized; preferably the wire should be galvanized before and after weaving, so it will not rust out at the joints so quickly. This netting comes in various sizes of mesh from three-quarters of an inch up to three inches. The two-inch mesh is desirable for adult birds and the three-quarter inch for baby chicks.

The height of the fence will be determined by the number and type of birds to be kept and the area of the range. Under most conditions, even with the active breeds an eight-foot fence is the limit to which it is profitable to go, for a bird that will fly over an eight-foot fence will just as easily fly over a twelve-foot one. When it is desired to enclose a large field, a five-foot fence is usually high enough. When building poultry fences that are six feet or more in height, it is a good practice to stretch two lengths of poultry netting, one above the other, using three-foot or four-foot widths, according to the height desired. The middle selvage edges should be twisted together, after the lower one is firmly stretched and secured in place. Such a fence, when complete, looks neater, can be stretched better, and is more efficient than if made of one strand of six-foot wire.

Where small chicks are to be confined, or on ranges for growing stock, it may be desirable to use one width of small-mesh wire at the bottom. This will have a tendency to keep out rats, skunks, and weasels, as well as confine the chicks when put on range at an early age. In small yards in front of long houses where small flocks are kept, each with different males, it is well to use small-mesh wire to the height at least of two feet above the ground. This prevents the male birds from injury in fighting.

There are two methods of fastening the poultry fence to the ground: (1) Stapling it to a base board; (2) burying the edge in the ground. Stretch the wire with one edge level with the ground; then nail a base board to the posts, setting it slightly in the ground. The wire and board are lapped a little and the selvage edge of the poultry netting is stapled to the board. It is good practice, where many males are kept in adjacent pens, to use base boards to a height of thirty inches, placing them half an inch apart, with poultry netting above them. This prevents the male birds from injuring themselves or each other, which is important if they are highly prized birds or to be used for show purposes.

Another plan is to place the lower edge of the wire three or four inches in the ground (Fig. 110). This is done by plowing a shallow furrow along the line before the wire is stretched in place. Nail the bottom selvage to the posts about four inches below the ground line. Before filling the trench it is desirable to drive a forked stake in the ground about midway between the posts, holding the wire in place. When the trench is filled, this gives the fence a neat and attractive appearance and does not allow enemies to

burrow under it, nor does it allow the birds to work under it, as is possible under a base board.

Where small yards are necessary, it is sometimes better to build complete wooden fences; on the exposed side of the yard they may serve as windbreaks. Such a fence must be built very high, as birds will more easily fly over a wooden fence than a wire one. They can readily see the top and have a place to light upon. Fences built of narrow slats or pickets are occasionally used, but

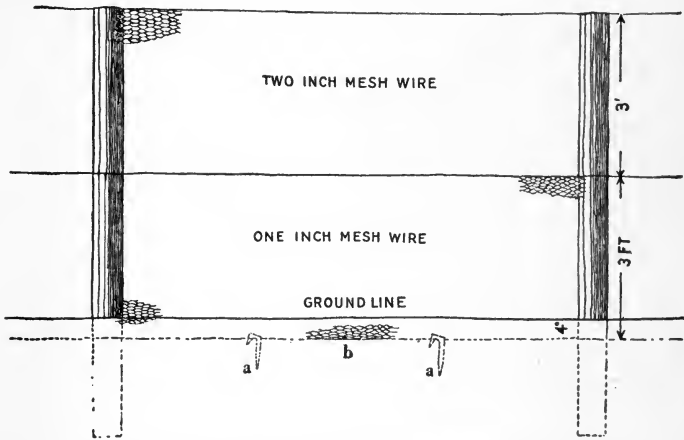


FIG. 110.—A common type of fence construction. *a*, Manner of anchoring wire under ground; *b*, wire buried a few inches under ground.

the cost is usually prohibitive and the appearance is no better than a well-built wire fence.

**Best Construction.**—One of the best and cheapest poultry fences that it is possible to build is approximately seven feet high; with cedar posts, twelve feet apart; with two strips of poultry netting, the first strip of inch-mesh wire three feet wide set four inches in the ground, and the second strip of two-inch mesh four feet wide. In nailing the wire to the posts care should be taken to have the selvage edges the same distance apart on each post. If an attempt is made to stretch the wire wider than its natural width, it is drawn out of shape and does not make a neat fence.

**Gates.**—The gate problem is one of the most perplexing for the poultryman; for, at best, gates are a necessary evil. They are expensive to construct, and it takes time to open and close them. Where double yarding is practised or where the birds are divided

into small flocks, as in small-unit systems, a large number of gates are necessary. In each of these cases, they must be used frequently for watering and feeding, and should be located in the natural or shortest path of the attendant, so that he can do the work with the fewest steps. Where gates are to be placed in the fences, the gate posts should be firmly braced as shown in figure 111.

*Construction of Gates.*—In the construction of gates, durability should be of first consideration. They are constantly subject to a large amount of wear, and the more permanently they are made the less repair will be necessary. For large gates, 2 x 3 inch hem-

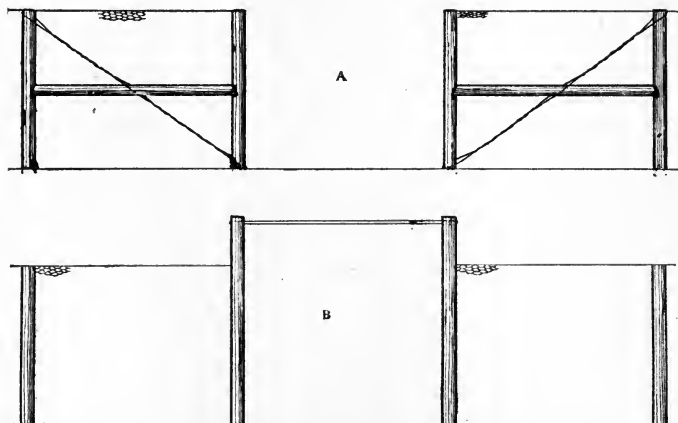


FIG. 111.—Ways of bracing gate posts. A, By using next post in line, similar to corner bracing; B, by overhead wire, especially useful with narrow gates.

lock or yellow pine, or other material of equal grade, should be used. All joints should be mitered and bolted together with washered bolts. Corner braces should be used, and the whole gate braced diagonally with round iron. For small gates between community pens, 1 x 4 inch boards can be used, lapping them at the corners, and providing a diagonal brace running from the bottom of the gate on the hinged side to the top of the gate on the free side. This brace board prevents the gate from sagging and adds greatly to its rigidity. Figure 112 shows a number of types of construction.

Gates should be large enough to allow an attendant to pass through with a load in each hand, and to pass a wheelbarrow through when desired; four feet may be about the right width for

such purposes. When it is desired to construct wider gates to allow a two-horse team to pass through, it is better to have them constructed in two parts, opening in the centre and swinging each way.

Double strap hinges should be used; T-hinges are apt to pull out. Strap hinges will allow of some latitude in lining up the gate to make it swing true. The gate should be hung so that when it is allowed to swing free it will spring shut. All gates should be provided with some method of fastening, such as hooks, latches, or springs. Gates should be hung high enough above the ground

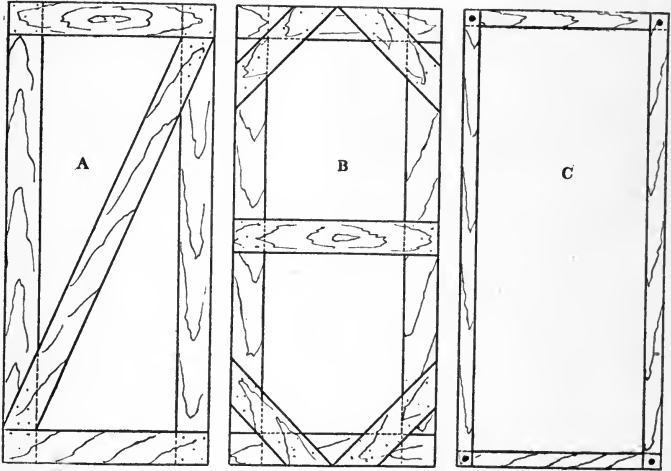


FIG. 112.—Types of gate construction. A, Best type, 1 x 6 inch white pine is used; B, same material with different bracing; C, corners mortised and bolted, 2 x 3 inch material used.

to give ample allowance for swinging. It is sometimes well to place a 6-inch or 8-inch base board between the ground and the bottom of the gate, allowing the gate to hang when shut just clear of this board. If wheelbarrows or wagons are to pass through, the base board is omitted.

**Maintenance.**—Poultry fences constitute a heavy first cost, and the depreciation is great. They are a constant item of expense, and should be looked after constantly. Any broken hinges or hooks, torn wire, rotting posts, or other defects should be immediately repaired. Torn places in the fence can be easily mended by weaving new wire over the opening. In making such repairs or when building the fence, care should be used to allow no long

sharp points to project into the yard, as they are apt to injure the birds. As the galvanizing on most poultry wire is very short-lived, it is found profitable to paint the poultry netting with a good coat of oil paint after it has been up a few years or before signs of rusting appear.

#### REVIEW.

1. What factors will determine the advisability of yarding or free range?
2. Give the area of yard necessary.
3. What is the effect of shape of yard upon the cost and efficiency of feeding?
4. What is meant by double yarding?
5. Give a good crop rotation through the season for double yarding.
6. Enumerate three methods of double yarding.
7. Name and discuss materials used for poultry fence posts.
8. Describe manner of setting posts.
9. How should corner posts be braced?
10. Name and describe materials used for poultry fences.
11. Tell of two methods of fastening fence to the ground.
12. Give construction of a desirable poultry fence.
13. Tell of two methods of bracing gate posts.
14. Tell how to make a good poultry gate.
15. What points should be considered in locating poultry gates?
16. Give importance, and tell how to keep poultry fences in repair.

**References.**—Preservation Treatment of Poles, by William H. Kempfer, U. S. Forestry Service Bulletin 84. Concrete and Concrete Fence Posts, by Bainer and Bonebright, Colorado Bulletin 148. Construction of Concrete Fence Posts, U. S. Farmers' Bulletin 403.



## CHAPTER X.

### PRINCIPLES OF POULTRY FEEDING.

BIRDS differ in a number of ways from other farm animals, especially in digestion and assimilation of the feed and in their requirement for maintenance and production. They are characterized by intense vitality. The transformation of feed in the growing animal and the production of eggs in the adult are exceedingly rapid; their lives are never sluggish.

Dr. W. H. Jordan, of the New York (Geneva) Agricultural Experiment Station, has compared a Leghorn fowl that weighs  $3\frac{1}{2}$  pounds and lays 200 eggs (weighing 25 pounds) with a Jersey cow that weighs 1,000 pounds and gives in a year 7,000 pounds of milk containing 14 per cent of solids. He states:

“If you take the dry matter of the hen and compare it with the dry matter of the eggs she lays in a year, there will be  $5\frac{1}{2}$  times as much dry matter in the eggs as in her whole body. The weight of the dry matter in a cow's body will be to the weight of the dry matter in the milk as 1 to 2.9. In other words, based upon the dry matter, the hen does twice as well as the cow. I suspect that the hen is the most efficient transformer of raw material into the finished product that there is on the farm. Her physiological activity is something remarkable, so in that particular the hen stands in a class by herself.”

The temperature of the bird's body is high, ranging from  $102^{\circ}$  to  $110^{\circ}$  F. in different species. The energy necessary to keep up this high temperature is great, and material of the right kind is in constant demand to supply it. Birds are characterized by a heavy appetite, which indicates intensive needs; this is accompanied by a very rapid digestion which must be kept in order and constantly supplied with pure feed. The nature of birds of the poultry group is to subsist largely on seeds. They are therefore classed as granivorous (seed-eating) rather than as omnivorous, yet in actual practice the feeding of meat to some extent is found advantageous.

**Composition of the Bird's Body.**—The great variety of substances and compounds constituting the bird's body may be grouped under four general headings,—water, ash, protein, and fat. Along with the bony skeleton are ligaments, muscles, and tendons, which hold the bones together and move them, the skin and feathers which cover and protect the body, also all internal organs of circulation, digestion, respiration, and reproduction,—

all these and more may be regarded as composed primarily of these four substances. In the body of the mature hen these are found in about the following proportions: Water, 55.8 per cent; ash, 3.8 per cent; protein, 21.6 per cent; and fat, 17 per cent (Fig. 113).

*Water.*—Usually more than half, and in some birds as much as three-fifths, of the weight of the living bird consists of water. This water content is greatest in young and lean animals, and decreases as they become more mature or fatten. This latter feature is shown in the capon or soft roasters, in which the water is often as low as 40 per cent.

*Ash.*—The ash content or mineral matter is that portion of the body which is left after the volatile and combustible elements are driven off by heat. Ash is found to a limited extent in all parts, and it is essential to provide a sufficient amount of this material. The

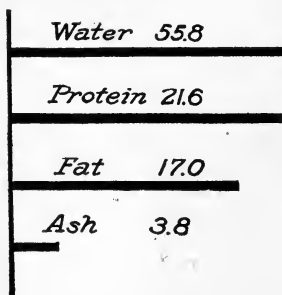


FIG. 113.—Graphic representation of the approximate composition of the bird's body.

weight of ash ranges from 3 to 3.8 per cent of the bird's body.

*Protein.*—The term protein is used to designate a large group of substances differing from other components of the body in that they contain more sulphur, combined usually with about 17 per cent of nitrogen. Common examples of protein are the whites of

eggs, lean meat which has been washed free from fat particles, the casein in milk, and the gluten in wheat flour. Besides the elements already named, protein contains carbon, hydrogen, and oxygen. These elements are known as organic substances, as no mineral or ash is left after burning in air. Protein is the most important group of materials found in the body, as it forms the base of all living tissue, largely making up the material called protoplasm, which is the substance through which life is manifested. In the body, protein is always associated with the ash and water present.

*Fat.*—The fourth group of materials found in the tissues of all birds represents a reserve value, usually in the form of fat. When the feed does not furnish the required supply of nutrients, this reserve of surplus fat helps to counteract the deficiency. The fatty particles in the normal body act as cushions between the

various organs, and also form a protecting layer under the skin, giving it a plump, full appearance. The proportion of fat in the bird's body varies from 15 to 34 per cent, being lowest in the adult bird which is emaciated from disease or improper feeding, and highest in birds which are well fattened.

*Glycogen*.—Another material called *glycogen*, very similar to starch, is stored in relatively small amounts in the organs of a healthy animal. This substance resembles fat in that it contains neither nitrogen nor sulphur, but is composed entirely of hydrogen, oxygen, and carbon, in the same proportion as in starch. It may be called animal starch.

**Nutrition** is the process by which life is maintained and individual growth is promoted. It controls the wearing away and the building up of the body tissues, converts feed into heat and energy, and supplies the material for products which are essential to normal life. The chief processes of nutrition are digestion, absorption, circulation, assimilation, and respiration.

**Nutrients**.—Materials in feeds, as seen in their raw state, are not transformed directly into living tissue, but they are first broken up into simple compounds, called nutrients, which go toward the formation of the solids and fluids of the body. Their classification is the same as that of the components of the body already considered, with an added group (carbohydrates), making five in all,—namely, (1) protein, (2) fat, (3) carbohydrates, (4) mineral matter (or ash), and (5) water.

*Protein*.—The group of nutrients classed as protein includes compounds which contain those elements that are found in the tissues of all plants and animals used in feeds. The classes of materials which provide protein are always necessary, are the most expensive to buy, and are the hardest to produce at home; hence, in purchasing feed stuffs for the various rations, the proportion of protein they contain is usually the factor which determines the price to be paid.

*Fat*.—In the form of oils, in seeds, in vegetable products, and in animal tissues, fat is familiar to all. Most feed stuffs, especially if from vegetable sources, are relatively poor in oil content. Some vegetables, as flax and cotton, store up oil instead of starch and are at the same time rich in protein; but, as a rule, the materials commonly available for poultry feeding though poor in fat are rich in carbohydrates.

*Carbohydrates*.—This third class of nutrients includes the starches, sugars, and fibres which are chiefly valuable for producing

energy. In vegetable feeding stuffs they constitute a distinct group. In animal feeding stuffs they are represented chiefly by the small proportion of glycogen present. Their principal elements are carbon, hydrogen, and oxygen. Like fat, they contain neither nitrogen nor sulphur, but they differ from fat in that they contain less carbon and more oxygen. Carbohydrates can usually be produced at home; very little should be purchased on a well-managed poultry plant, provided there is land enough for the growing of the proper crops. As found in feeding stuffs, carbohydrates may be divided into two general classes:

(1) Substances which go to make up the cells or framework of the plant, such as cellulose and fibrous materials difficult to separate, represented in the analysis by the term "crude fibre."

(2) Substances illustrated by starches and sugars found stored up in cells as reserve material, dissolving readily in water and sometimes represented in analysis tables by the term "nitrogen-free extract."

*Ash.*—The mineral matter in feeding stuffs which supplies the incombustible material to the bird's body is called ash. This ingredient is very necessary, especially in the growing of young animals, and can be supplied to poultry in the form of grit, shell, bone, and feeds such as bran and alfalfa, which are rich in ash.

**Uses of Nutrients in the Body.**—All the nutrients in the ration, minus the water present, constitute what is commonly termed the total dry matter. Each nutrient has a definite work to do in nourishing the body. In an efficient method of feeding they must all be supplied in abundance and in the right proportion.

The most obvious use of *protein* is the production of tissue, as desired in growing chicks or young animals, the repairing and building up of the waste tissue in the adult, and the supplying of material which goes into the formation of feathers, claws, and similar parts. The second use is exemplified by the part which protein takes in the production of the egg. In compounding the ration it must be remembered that protein is indispensable and that its place cannot be satisfactorily filled by carbohydrates or fat. If, however, the protein content of the feed consumed is in excess of that required for tissue building and egg production, it is burned in the body like carbohydrates and furnishes material for the formation of fat.

The uses of the *carbohydrates* and the *fats* of feeding stuffs are so similar that they may be considered together. Three uses are given: (1) They are burned and produce heat, which keeps the

bird's body warm; (2) they are burned and produce the energy required by the bird in moving; (3) if the supply of either is greater than that required for heat and energy, the excess gives rise to the laying up of fatty tissues. The principal difference between these two formers of heat and energy lies in the fact that fat has the greater energy value, being rated at two and a fourth times that of carbohydrates.

Little care need be taken to supply *ash* for the uses of the adult animal, because the substances which furnish it are usually present in the ordinary ration in sufficient amounts; but the growing birds, especially the maturing pullets, require a greater proportion. Care must be taken to supply for their use an abundance of mineral matter, as it goes toward the formation of the bony framework of the body, and a large, well-developed body is impossible without an adequate frame. Mineral matter can best be supplied to the young birds in the form of wheat bran, which is easily and quickly digested, or by feeding finely ground oyster shells and lime grit. Laying birds require a ration well supplied with ash to provide material for the formation of the shells of their eggs.

The three principal nutrients, protein, carbohydrates, and fat, are the important ones to consider when buying feeds, and it is well to determine the value of the purchased material by the weight of digestible protein which it contains.

*Water Supply.*—The prime necessity of an abundant supply of water is too often overlooked, and the matter of cleanliness should not be neglected. Water has four definite functions to perform in the bird's body: (1) It fills up and distends the tissues, giving them a plump appearance; (2) it aids in digestion by dissolving particles of feed, so that the digestive fluids can act on them more readily; (3) it aids in transporting digested matter and greatly hastens assimilation by stimulating diffusion; (4) it aids greatly in the regulation of body temperature. The need of keeping a supply of fresh, pure water constantly accessible to birds cannot be too strongly emphasized.

**Digestion and Assimilation.**—Much of the feed of domestic birds is in the form of seeds, whole grains, and the like. Such materials as are hard and lumpy, or are encased in hard, fibrous husks which resist the action of the digestive juices, cannot be immediately available as nourishment; they must be ground and crushed by the digestive organs before they can be used in the body. The natural means provided for this purpose are hereafter described.

Some of the feed eaten is not digested and is voided with the droppings. Only that part which is capable of digestion is of value in nutrition and worthy of consideration by the feeder. The undigested residue must be subtracted from the original material in computing nutritive value. It is only the digestible nutrients which are available for assimilation. This fact is important and should be borne in mind in selecting feeds, as many which are rich in certain nutrients have a very low digestibility. The percentage of a feed which is digestible is called the "digestion coefficient." For example, whole wheat grains contain 11.9 per cent of protein, only 80 per cent of which is digestible or of assimilative value; hence, out of every 100 pounds fed, containing 11.9 pounds of protein, only 9.5 pounds are of use to the fowl. Digestion bears a direct ratio to the health of the flock; and the stronger and healthier the birds are the better able they will be to digest a large amount of feed and get all of the possible good out of it. The following are some of the factors which affect the value or the digestibility of feeds:

(1) Young, tender shoots of grasses and forage plants are more digestible than mature tissues; hence, they have a higher value than if allowed to become old and woody.

(2) Grains or by-products if exposed to rains or dampness during the process of curing or storing will have a greatly reduced value as compared to those cured under favorable conditions.

(3) A ration not properly balanced will tend to waste the surplus nutrients. (See Chapter XII.)

(4) The digestibility of feed for poultry is seldom increased and often found to be decreased by cooking.

(5) The indigestible portion of feeds may serve in some instances to give needed bulk to a ration, but it often places a heavy tax on the energy of the fowl and sometimes offsets entirely the nutritive value.

Aside from the digestibility of feed, the question of its physical effect on the condition of the individual is an important consideration. The point to determine is whether the ration is best suited to the birds to which it is fed. Feeds which in themselves are valuable may cause disastrous results if improperly fed or if given to a wrong type of birds; for example, ground green bone is highly nutritious, but if fed in excess will often upset the digestive system and thus retard the object sought,—namely, that of increasing egg production. Hence, ease of digestion is as important a factor as total digestibility. Milk is both entirely digestible and easily

digested. Pork scraps are digested with great difficulty, yet their digestible coefficient is high. (For an account of the digestive organs see Chapter XVII.)

**Objects of Feeding.**—The feeding of different types and ages of poultry may be grouped in accordance with their several objects as follows: (1) Growth, which mostly includes the formation of lean meat and other tissues incident to the gain in weight exemplified by the growing individual; (2) maintenance, which includes the repair of waste in the body tissues resulting from the vital processes while performing their necessary functions, but does not allow for any increase either in weight or in product; (3) production, exemplified in birds by egg laying, incident to the important function of reproduction; and (4) fattening, which covers the special preparation of fowls for market.

**Feed Requirements.**—Important experiments have been carried on in America to determine the feed requirements of domestic fowls, some reliable work having been done by the New York and the New Jersey Stations. The results of these investigations afford a basis of various feeding standards. While no rules can be laid down for absolute observance under all conditions, their judicious observance in a general way will serve as a guide to the feeder, who may vary the ration in accordance with practical experience. The requirements for the growth of chicks from hatching to maturity, for the maintenance of adult fowls, and for egg production in laying hens are shown in Table IV. (After Wheeler.)

TABLE IV.—*Feed Requirements of Chickens per Day for each 100 Pounds of Live Weight.*

Birds.	Digestible nutrients (pounds).					Fuel value (calories).	Nutri-tive ratio.
	Pro-tein.	Fat.	Carbo-hydrates	Ash.	Total dry matter.		
Growing chicks:							
First two weeks . . . . .	2.00	0.40	7.20	0.50	10.1	18,800	1 to 4.1
Two to four weeks . . . . .	2.20	.50	6.20	.70	9.6	17,830	1 to 3.4
Four to six weeks . . . . .	2.00	.40	5.60	.60	8.6	15,640	1 to 3.3
Six to eight weeks . . . . .	1.60	.40	4.90	.50	7.4	13,780	1 to 3.7
Eight to ten weeks . . . . .	1.20	.30	4.40	.50	6.4	11,680	1 to 4.3
Ten to twelve weeks . . . . .	1.00	.30	3.70	.40	5.4	10,000	1 to 4.4
Adults (maintenance only):							
Capon, 9 to 12 pounds . . . . .	.30	.20	1.74	.06	2.3	4,600	1 to 7.5
Hen { 5 to 7 pounds . . . . .	.40	.20	2.00	.10	2.7	5,300	1 to 6.2
Hen { 3 to 5 pounds . . . . .	.50	.30	2.95	.15	3.9	7,680	1 to 7.4.
Egg production:							
Hen { 5 to 8 pounds . . . . .	.65	.20	2.25	.20	3.3	6,240	1 to 4.2
Hen { 3 to 5 pounds . . . . .	1.00	.35	3.75	.30	5.4	10,300	1 to 4.6

*Growth and Maintenance.*—Owing to the increase in weight which is taking place, the requirements of the growing animal are constantly changing. Larger birds require more nutrients per day per bird. Whether the object is for growth, for maintenance simply, or for production, the larger birds require more feed, but much less in proportion to live weight. It must be borne in mind that, while the classification of weights given in Table IV is convenient, the grouping is only tentative; for example, it should not be presumed that a hen just under five pounds in weight must always have a ration supplying nutrients exactly as outlined, or one just above five pounds should have the other ration; there is a natural blending, the point of division being flexible.

Under normal conditions, about three-fourths as much nutritive material is required in a ration to maintain a flock of hens without production as to keep them in full laying condition. Maintenance varies at different seasons of the year; as, for example, the energy necessary to keep a hen's body at the normal temperature of 105° F. during the winter requires more feed than to maintain the same temperature in summer.

*Egg Production.*—Mature birds in full laying condition require rations which have a much higher protein and ash content than those required for maintenance, the increase being approximately 100 per cent. The carbohydrates and fat are not required in nearly the same increasing amounts, yet the producing bird requires an increase in energy or fuel value of approximately 30 per cent over that for maintenance.

*Fattening.*—The exact requirements for a fowl during the period of fattening have never been worked out. The best results in practice have followed a slight reduction in protein content and an increase of about 75 to 100 per cent of carbohydrates and fat as compared to egg production requirements. During the finishing process a nutritive ratio of about 1 to 8 can be freely fed.

**Practicability of Feeding Standards.**—One great need in studying nutrition is reliable and actual scientific data pertaining to the digestibility of feeding stuffs when fed to poultry. Volumes of carefully collected data pertaining to digestion in other farm animals have been published, but birds as a class have received very little consideration. Owing to this lack of correct information it is necessary to use the rules which are supposed to apply to animals in common in figuring poultry rations. It is probable



that the accepted laws of nutrition observed with other animals hold true to only a limited extent in regard to poultry, but they form the best guide until more accurate data can be obtained. Birds have a type of digestive system entirely different from that of any other group of animals, are of a much more active disposition, and of a much higher body temperature, so that it is only reasonable to suppose that the same coefficients of digestion and the same energy values would not in all cases apply. The standards here given are as practical and reliable as are at present obtainable.

*Digestion experiments* have been carried on with poultry at the Maine Station with certain definite results. Corn showed a higher digestibility than any other grain tested. Wheat bran when fed to adult birds showed a rather low digestibility. A mixture of finely cut clover and corn meal was a more economical feed than bran. It was found that any great proportion of crude fibre was undesirable, being but slightly digested and of little value other than giving bulk to the ration; and that the addition of about seven per cent of bone ash slightly increased the digestion coefficient of a mixture containing vegetable matter.

Considerable experimental work has been done by the United States Department of Agriculture pertaining to the digestibility of poultry rations. The results of the work show that corn in the ration is one of the most economical sources of crude protein, nitrogen-free extract, and fat, because corn is highly digestible. Oats and wheat should be utilized for their crude protein and fat. Where wheat is used extensively, adequate provision must be made for the deficiency of fat in this grain. It was found that protein and fat in beef show high coefficients of digestibility, the protein considerably higher and the fat but slightly lower than the corresponding nutrients in corn.

Until recently, all feeding determinations have been based on standards and coefficients of digestibility derived from German sources. When these standards are used, the total nutrients in the ration are considered, and the requirements of the individual animal determine the exact feed stuffs and the proportion in which they should be combined. It must be remembered that no standard, however derived, can be properly used as the basis of absolute, inflexible rules. They can be used as the starting point for the feeder, more especially the beginner, and are not supposed to eliminate the use of judgment.

**Relation of Feed to Character of Product.**—Table V shows the composition of various poultry feeds and of finished products. Note the relatively high proportion of protein in the egg and in the mature pullet; also the high fat content of the capon and the large percentage of water present in the egg. Admitting the close relationship which exists between the composition of feed consumed and the products resulting therefrom, the feeder is able to select those feeds which will be the most productive of the results desired. For example, the richness of corn in fat and carbohydrates would lead to the selection of that grain as the basis of a ration for the feeding of capons. In like manner meat scrap and green clover would occupy a prominent place in feeding the mature hen for egg production, because of the large percentage of protein in meat and the high water content of clover.

TABLE V.—*Composition of Feeds and of Finished Poultry Products.*

Materials and products.	Water.	Crude protein.	Fat.	Carbo-hydrates.	Ash.
<b>Feeds:</b>					
Corn.....	10.6	10.3	5.0	72.6	1.5
Oats.....	11.0	11.8	5.0	69.2	3.0
Meat scrap.....	10.7	60.2	25.0	..	4.1
Green clover.....	70.8	4.4	1.1	21.6	2.1
<b>Finished products:</b>					
Hen.....	55.8	21.6	18.8	..	3.8
Pullet.....	55.5	21.2	18.9	..	3.4
Capon.....	41.6	19.4	35.3	..	3.7
Fresh egg.....	66.7	12.2	8.9	..	12.2

Table V also shows why a high egg yield cannot be reasonably expected from birds that are fed on an exclusive corn diet, and why other feeds than corn are required to bring the pullet to maturity in good laying condition. The importance of a properly balanced ration is also manifest, which simply means that the ration must show a proper relation between its nutrient content and the compounds desired in the product. When eggs are considered as the manufactured product, it is plain that raw materials of the right kind and in proper amount are essential to their abundant production.

A bird is in reality a machine, which may be compared to an automobile whose engine must be kept running at a low speed but which must have reserve power available when needed. The fuel required for maintaining the ordinary speed may be likened to the feed required for the bird's maintenance. When

it is desired to get a greater amount of energy from the engine, additional fuel is supplied and its speed is increased. So it is with the bird. When a certain product is desired, feed in addition to that required for maintenance must be supplied in the proper proportion and of the composition which will best attain the desired end.

**Special Features.**—It has been shown by careful experiments that the observance of certain important factors in poultry feeding leads to better results.

*Need of Meat in the Ration.*—Under natural conditions, with free range, birds will hunt for worms and insects and thus largely supply the meat requirements of their ration. When fowls are kept in close confinement, it is necessary that this meat requirement be artificially supplied. The feeding of meat scrap is the best form of meeting this demand. In practice it is found necessary to sterilize the scrap completely in order to destroy toxic properties and increase the keeping qualities. Approved brands are sterilized and thus form excellent feed, but they must be fed with caution. In purchasing meat scrap it is safest to buy only that with guaranteed analysis and from a known and reliable firm.

It is safe to feed meat in an egg-producing ration at the rate of 5 to 10 per cent of the total feed. The exact percentage varies with the analysis of the meat and the character of the other components of the ration. Meat is usually fed to the birds by mixing it with the dry mash, where they can have constant access to it. When it is desirable to force them for a short time for some particular purpose, the scrap is often fed in separate hoppers. They must have meat in some form, and in order to do their best the quantity must be ample.

*Natural Feeds for Fowls.*—If it were necessary to limit birds to only one character or one type of feed, they would subsist longest and would do best on a ration entirely of grain. A large part of their feed, therefore, should be in the form of whole or cracked grains. Many kinds of grain are available, each with its own peculiar composition and value, and the feeder is thus allowed great latitude of choice in compounding rations.

Corn is probably the grain most widely fed; moreover, it is greatly relished by all classes of poultry. Corn is very fattening and birds eat it greedily. If laying fowls are fed too exclusively on corn, they are likely to take on too much flesh, the excess of which retards egg production.

Wheat and its by-products constitute one of the best groups of feed stuffs for poultry. Oats when clipped are relished by birds and make an economical grain ration. Barley is also a good grain to feed. Buckwheat is rather fattening and usually expensive, so it is best given during the winter and at the evening feeding. Peas are generally expensive; but, being rich in protein and much relished by the birds, they are very desirable when their cost is not too great.

*Need of Variety in the Ration.*—Animals as well as people tire of a steady diet. A variety in the ration increases the palatability, and, by adding relish, enhances its digestibility. Variety in the ration allows the birds, if they have a preference, to select the grains which they desire, and those are usually the ones which they most need. Variety can be supplied both in the grain ration and in the dry mash. When changes are made, they should be gradual, allowing birds to become accustomed to them slowly.

*Necessity of Fresh Water.*—It will be remembered that more than 65 per cent of the egg and 55 per cent of the bird's body are water (Table V); hence the necessity of keeping an abundant supply before the laying hens and the growing birds at all times, in addition to what they secure from grains and succulent feeds. During heavy laying a flock of 100 hens will drink approximately 10 to 15 quarts of water each day, depending upon the size of the birds and the season of the year.

*Relation of Fat to Laying Condition.*—Hens with an excessive amount of body fat, due to lack of exercise and the use of fattening feeds, are not in good laying condition, and the egg yield will invariably be retarded. It has, however, been proved by experiment that some surplus fat on the body is essential. A fat hen has some surplus energy, but a lean hen requires all the feed she can digest to maintain and build up body weight and cannot use any for production. The laying hen requires considerable fat in the manufacture of the yolk, which contains about 60 per cent of fat.

*Value of Exercise.*—In order to keep her body warm and in proper health, a hen should be compelled to hunt or exercise for the grains which she receives. It is the usual habit of these birds, even little chicks from the time of hatching, to scratch in search of feed. Exercise increases the circulation and enhances vitality. It is true that exercise takes energy, and all energy must be produced from feed; yet the increased amount of feed is amply paid

for in healthy birds and an increased egg yield. To promote exercise it is well to keep the floor of the laying pen or scratching shed covered to a depth of four or more inches with good litter, and during the winter throw therein at least half of all the feed consumed.

*Digestibility of Ground Grains.*—Experiments show that a greater efficiency is obtained from feed consumed if a part of the grains are fed in ground form or as a dry mash. Experiments covering a period of two years show that birds receiving whole grains give a product valued at only 48 per cent above the cost of feed, while those receiving part of the ration in the form of ground grains showed an excess of 68 per cent. The actual difference in the total value of product was found to be about one-third greater with the hens having ground grains in the ration. More energy is required in the digestion of whole grains than ground grains. The exact determination of whether or not it will pay to feed ground grains will depend on the nature of the ration. If too much time and energy are required for fowls to grind the feed, egg production will be retarded; but, on the other hand, if all grains are fed ground, exercise will be restricted and the health of the birds impaired by reason of the tendency toward too great a concentration. This undue stimulation to an unnatural egg yield is likely to result in lowering the bird's vitality.

*Mineral Matter for Laying Hens.*—The ash content of different feeds varies considerably, and the bird's requirements also vary during the different periods of its life. The problem is to adjust properly these varying factors to each other. During the growing stage and during egg production, more ash is required than is supplied by the ash content in vegetable feeding stuffs. Wheat bran is very rich in digestible ash, and is easily adapted to the feeding of baby chicks, but it does not supply enough to meet the requirements of laying hens. The lack of ash in the ration of laying birds tends to induce egg eating, because soft-shelled eggs are then likely to be produced. This condition can be prevented by keeping crushed oyster shell, ground bone, and similar material constantly before the hens. The shell constitutes 8 per cent of the whole egg, and to lay 160 eggs in a year the hen will require 1.6 pounds of mineral matter for the shells alone.

*Use of Sharp Grit.*—Birds have no teeth with which to grind feed, this mastication being performed in the gizzard by muscular action. In order that this work may be properly done, sharp grit

must be present to aid in crushing and wearing the feed into fine particles. The harder and sharper the grit the better, and it should be kept always before the birds. Digestion does not take place until the feed is ground in the gizzard, and when new, sharp grit is not present the feed must remain unground in the gizzard until it becomes soft and falls to pieces; this process is slow and results in imperfect digestion.

*Stimulating Feeds.*—The use of condimental or stimulating feeds, such as the so-called “stock feeds,” “poultry panaceas,” and “egg feeds,” should not be permitted except when birds seem to be lacking in appetite and it is desired to increase the palatability of their ration; and such use should be stopped as soon as the birds recover. It is a very bad practice to feed forcing and condition powders to strong, healthy birds. The habitual use of such stimulants in the ration causes the individual to become immune to the good effect which they may at first seem to have on the system. Their action on a healthy bird is very similar to that of alcohol on the human system; for a short time there is an excessive stimulation, but the after effects are depressing because of the tendency to break down or unnecessarily wear out the tissue. The use of these stimulating substances should be discouraged. Their actual value as nourishment is usually only a small fraction of their cost, and their value for promoting palatability is not equal to that of common salt, which may be safely added occasionally for this purpose in the proportion of about one ounce of salt to twenty-five pounds of dry feed.

#### REVIEW.

1. Compare poultry with other farm animals.
2. Compare a hen with a cow as a transformer of raw materials.
3. What is the temperature of a fowl's body, and how does it affect the feed requirements?
4. Give the composition of a fowl's body.
5. Discuss the following components in detail: (a) Water, (b) ash, (c) protein, (d) fat.
6. Define nutrition; nutrient.
7. Name three important nutrients and give their general composition.
8. Give the uses of the following nutrients in the body: (a) Protein, (b) carbohydrates, and (c) fat.
9. Discuss digestibility of feeding stuffs.
10. Name and discuss the three objects of feeding.
11. Compare maintenance requirements of the capon and the hen.
12. Discuss requirements for growth.

13. Discuss feed requirements for fattening.
14. Compare production requirements of large and small hens.
15. What are the possible uses of feeding standards?
16. Discuss the relation of feed to product.
17. Enumerate ten factors which must be considered in studying the principles of poultry feeding.
18. How and when may stimulating feed be used?

**References.**—Feeding of Laying Hens, by James E. Rice, Cornell Reading Course Bulletin 17. Digestive Experiments with Poultry, by J. M. Bartlett, Maine Bulletin 184. Principles and Practices of Poultry Feeding, by H. R. Lewis, Bulletin New Jersey Board of Agriculture. Digestion Experiments with Poultry, by E. W. Brown, U. S. Bureau of Animal Industry Bulletin 156. Feeding of Laying Hens, by A. G. Phillips, Kansas Bulletin 164. The Economy of using Animal Feed in Poultry Feeding, by W. P. Wheeler, New York Bulletin 149. The Adaptability of Concentrated By-products for Poultry Feeding, by W. P. Wheeler, New York Bulletin 27. Experiments with Whole *versus* Ground Grains, by W. P. Wheeler, New York Bulletin 106. Poultry Feeding Experiments, by Horace Atwood, West Virginia Bulletin 88. Mineral Elements in Animal Nutrition, by E. B. Forbes, Ohio Bulletin 201.

## CHAPTER XI.

### POULTRY FEEDS.

THE previous chapter has dealt with the requirements of the individual and the principles of nutrition. It was shown that the requirements of birds for different purposes are constantly changing, and that special factors are to be considered in selecting suitable feeds for the various purposes. It is the plan of this chapter to take up the various materials which are available and practical for poultry feeding, their classification, and the way in which they can be most economically used. The analyses given are taken from reports of experiment stations and represent many hundreds of samples in each case. Only whole grains and their common by-products are considered. There are a multitude of manufactured poultry feeds and ready-mixed rations sold under special brand names. To learn the composition and desirability of such special rations, poultrymen should refer to feed analysis—bulletins published in each State in which they are sold.

**Sources of Nutrients.**—All materials fed to poultry may be divided into two classes,—organic and inorganic. The inorganic or mineral feeds are water, salt, lime, and phosphate. These natural substances are found only in limited quantities in vegetable feeds, such as grains.

*Water.*—As has been stated, water is essential in the ration to maintain right conditions in the bird's body and to supply the amount required for the manufacture of eggs, as one dozen eggs contain approximately one pint of water. Water is supplied to the birds in the following ways: (1) Fresh water to drink, and (2) succulent feeds to eat, such as green grass, sprouted oats, beets, cabbage, and other vegetables.

*Salt.*—Salt is supplied to increase palatability and to aid digestion by diffusion. It should be supplied when necessary in the ration to the extent of not over four ounces to every one hundred pounds of dry feed.

*Lime.*—The shell of the fresh egg is composed almost entirely of lime. Compounds of lime are used in building bone and are found to a limited extent in other body tissues. Grains are rather deficient in lime, and it is necessary to supply other lime if birds are kept in close confinement. The practical sources



usually available are oyster shells, limestone grit, and dry ground bone. Their composition is shown in Table VI.

TABLE VI.—*Composition of Sources of Lime (pounds in 100).*

Sources of lime.	Protein.	Lime (CaO).	Equivalent to carbonate of lime.	Phosphoric acid (P <sub>2</sub> O <sub>5</sub> ).
Crushed oyster shells. . . . .	..	53	95	0.08
Limestone grit. . . . .	..	18	32	.10
Dry ground bone. . . . .	26	27	49	24.18

**Phosphate.**—Less than four per cent of the body of the adult bird is mineral matter, consisting almost entirely of phosphate of lime, and the use of phosphate has been found to be especially profitable and practical in rations for growing chicks. Bone ash is supplied in the form of granulated bone, bone meal, or cut bone.

**Organic Feeds.**—The feeds grouped under this heading are: (1) Grains and their by-products, which are termed concentrated feeds, and (2) grasses, hay, and straw, which are called roughage. Concentrates take their name from the fact that high nutrient content is represented in small bulk; and roughage from the fact that a larger amount of fibre or cellulose is present, and a larger bulk represents only a small nutrient content.

The leading grains must be relied upon mainly for poultry. The different organic feeds naturally group themselves into the following divisions: Grains and their by-products, animal feeds, hays, grasses, and vegetables. As the by-products are closely associated with the grains from which they are derived, these two groups will be discussed together.

**Corn and its by-products** are the principal sources of feed for poultry, the great value of this grain lying in its available energy, due to its high percentage of easily digested carbohydrates and fat and the absence of all poisonous substances.

When birds have access to a variety of grains, they usually select the corn first, showing that it is extremely palatable. There is very little difference in analysis between yellow and white corn. The yellow corn, however, is preferred where it can be secured, as it has a tendency to impart its color to the flesh of the birds feeding on it, and also colors the egg yolk a deeper yellow. It is a better practice to feed cracked rather than whole corn, as it necessitates more exercise to secure a sufficient amount for one meal. The composition of the two is the same, except that in

sifted cracked corn the protein content is slightly lower, due to the loss of germ meal. Corn is very easily digested and assimilated. The facts that corn is easily digested and is a rapid fat former make it a very undesirable feed for mature birds in close confinement if egg-laying is desired. A great many of the farm flocks throughout the country are maintained almost entirely upon an exclusive corn diet, which results in a very small and usually an unprofitable egg yield. Corn does not contain the nutrients in the proportion in which they are required in the manufacture of eggs, and therefore it should be used in connection with other grains, its particular function being to supply heat and energy.

Care should be taken in feeding whole or cracked corn to avoid the use of moldy feed. New corn which has not been properly dried may mold and heat; in this condition it is a very unsafe feed.

*Corn meal* is used both in dry and in wet mashes. Coarse corn meal is usually preferred as the basis of this feed, as it is more bulky. As much inferior corn is ground up and sold as corn meal, it is safer to have meal prepared from home-grown grain. Care must be exercised for a few days after grinding to avoid heating. This can be done by spreading the sacks out on a dry floor and turning them a few times for the first few days.

In some instances corn-and-cob meal is profitable, but its use as a poultry feed is of doubtful value, owing to the large amount of fibre in the cob, which contains very little nourishment. It has a low digestibility. It is better practice to omit the cob from the corn meal, and increase its bulk by the addition of wheat bran, short-cut alfalfa, or ground oats.

*Gluten meal* is a by-product of corn carrying a high percentage of protein. It is separated from corn by mechanical processes in the manufacture of glucose and starch. Its composition is very uniform, and it furnishes a very good source of vegetable protein in the poultry ration. The one objection to feeding gluten meal is the fact that some mature birds not accustomed to this feed will often refuse to eat it. If it is desired to use gluten meal in the rations, it should be given the birds when they are quite young.

*Gluten feed* is a term used for defining prepared rations or feed mixtures containing a certain percentage of gluten meal combined with other less expensive, bulky products. It is generally a poor practice to purchase the so-called gluten feeds without a guaranteed analysis. Even in such cases the true gluten meal is to be preferred, as it has a known digestibility.

*Hominy meal* is a by-product from the manufacture of hominy grits. In some localities it is used as a substitute for corn meal. Owing to its being a by-product, it can often be secured at lower prices than corn. Its feeding value is about the same as corn meal.

*Germ-oil meal* is a by-product of the starch industry. Although rather limited in supply for feeding purposes, it is fairly high in protein and contains over ten per cent of fat. It is used in some localities in wet mashes for the finishing and fattening of poultry for market.

**Wheat.**—Birds are fond of wheat, whether fed whole or ground. Feeding experiments show quite clearly that the feeding value of wheat for poultry is slightly greater than that of corn, pound for pound. Wheat is a more perfectly balanced ration for poultry feeding than any other single kind of grain. There are a great many grades of wheat offered for this purpose, the variations being in purity, soundness, color, plumpness, and hardness. In selecting wheat for feeding purposes, if a choice is possible, the samples which are pure, hard, and dark in color are usually the richest in protein, and hence more valuable. The whole wheat kernel can be fed to poultry exclusively for a longer period of time than any other grain, with no apparent detrimental effect. The price of wheat fluctuates considerably, and very often inexperienced feeders use a greater percentage of corn, owing to the increased price of wheat, believing that they get more value for the money spent. Such, however, is usually not the case.

*Wheat Bran and Middlings.*—In the process of manufacturing flour, the layers of wheat kernels are split up into different components or grades. These are known as bran, middlings or shorts, and flour. Shorts are essentially the same as middlings, except that a larger amount of fine bran may be present. Bran consists of the outer coatings of wheat kernels left in large flakes with portions of the inner layer of protein-bearing cells. The product is light, bulky, and fibrous. Middlings contain a larger proportion of the inner layers, including some flour, and have less of the outer coats and are more starchy than bran (Fig. 114). Wheat bran, mixed with corn meal, usually forms the basis of most poultry mashes. Wheat bran contains a relatively high percentage of nutrients, but its digestibility is rather low,—not much greater than that of a good grade of legume hay. Middlings may well form a part of a dry-mash mixture, but are rather too sticky for the wet mash. Coarser products should go with them in all cases.

*Wheat screenings* consist of shrunken wheat, broken or crushed wheat, and some weed seeds screened from wheat before the milling process begins. When this material is not composed largely of foreign matter, such as weed seeds, hulls, and dirt, it may be a very desirable feed. It can often be secured for 15 to 20 cents per bushel less than the price of good wheat. Its use should be rather limited, however, owing to the great variation in quality which is found.

*Bread* is a valuable article in the poultry ration. It contains considerable digestible material and can usually be secured rela-

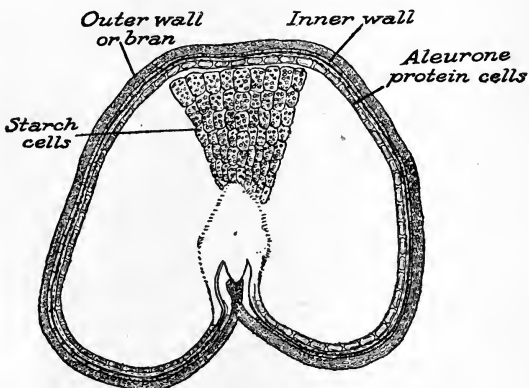


FIG. 114.—Cross section of wheat kernel (greatly enlarged).

tively cheap. Restaurants, hotels, bakeshops, and stores often have stale bread to dispose of.

**Oats.**—Whole oats are nearly equal to whole wheat in feeding value. Owing to the large percentage of hulls, they are not relished so well, but will be freely eaten by the birds when they become accustomed to them. In feeding oats those of best quality and large kernels should be selected, as very inferior oats are on the market. It is a profitable practice to use clipped oats, the birds eating them much better, as they have a much less percentage of fibrous material. Ground oats are extensively used in poultry mashes, both wet and dry.

*Oat meal* has for a great many years been considered a very good poultry feed. The price is high, but a slightly inferior grade can usually be purchased relatively cheap in bulk. Oat meal is very digestible and a good feed for baby chicks, supplying nutrients

in small bulk and in a form that the birds can readily see. It is used extensively in fattening poultry for market, and is suitable for use in wet mashes during the finishing periods. Rolled or crushed oats with hulls may take its place; but if hulls are present, the advantage is entirely with the purer oat meal.

*Sprouted Oats.*—The feeding of sprouted oats when they are from four to six inches high is a very economical method of supplying green feed to all classes of poultry. The cost is slight, the time required for growth short, and the amount of succulent material is very large. The following method is generally followed in the sprouting of grain, the idea being to incorporate as much water into them as possible during the sprouting period.

*Manner of Sprouting.*—Only the best grade of plump, heavy feed oats should be used, and handled in such a manner that they will reach maximum growth quickly. Six quarts of clean oats are placed in a ten-quart galvanized pail, which is then filled with water at a temperature of not over 100° F., to which are added ten drops of formalin to prevent

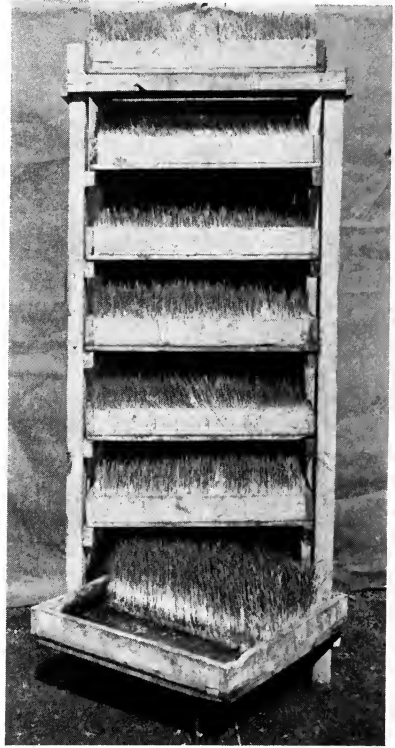


FIG. 115.—Rack for sprouting oats; large enough to provide five hundred laying hens with a continuous supply of succulent food.

mold. The oats are allowed to soak in this in a warm room for forty-eight hours, during which time they will swell and fill the pail, having absorbed all the water. Next they are poured on a flat box or tray of the sprouting rack to a thickness of one inch. The sprouting rack used can be home made. It is built seven feet high and two feet square, equipped with seven trays, one for each day in the week, each tray being about two feet square. Figure 115 shows such

a rack. The rack is kept in a room where the temperature is not less than 60° F., and the sprouting oats are thoroughly sprinkled with water twice daily. In from seven to ten days, depending on the temperature of the room, the sprouts reach their best development, which is from four to six inches. After this, if they are not fed quickly, they go backward, owing to lack of nourishment in the seed. It is found that on the seventh day, with a temperature of 75° F., the oats are in the best condition to feed, having taken up during the soaking and sprouting period three and two-thirds their original weight of water. Figure 116 shows the oats on the seventh day ready to feed. The best

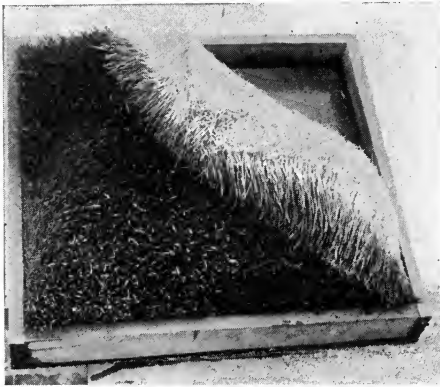


FIG. 116.—A tray of sprouted oats ready for feeding. Each bird receives one square inch per day.

way to feed them is in broad, flat, open troughs, placing as much of the green material in the trough at one time as the birds will clean up immediately, leaving none to be scratched out and wasted. Under average flock conditions one square inch of feeding surface per bird per day is sufficient to satisfy their appetites and supply the succulence necessary, without causing diarrhœa. The sprouting

oats are very palatable, being relished by every bird in the flock. It has been tried in some cases with sick birds which would not eat grain, and in nearly every instance was eaten greedily.

*Advantage of Sprouted Oats.*—(1) Sprouting of oats for feeding is a simple process, requiring little time and attention, and in every case results are certain. A sprouting rack similar to the one shown in figure 115 is capable of supplying a continuous quantity of green feed for over 500 laying hens during the winter months. (2) Oats so prepared and fed to laying birds are very palatable and satisfying, much more so than when fed as whole grain. (3) This is the most economical method of feeding oats, 366 pounds of succulent feed being obtained from every one hundred pounds of dry oats. In every case where sprouted oats were fed to birds

an increased production was noted. (4) Sprouted oats are a very efficient source of feed compared with other succulent feed which could be stored.

One hundred pounds of fresh sprouted oats contain about the following: Water 75.9; ash 0.8; protein 3.2; fibre 2.5; other carbohydrates 16.3; fat 1.3.

This shows a total dry matter of 24.1 pounds as compared with 20 in potatoes, 12 in beets, and only 10 in cabbage.

The analysis shows a protein content of 3.2 pounds as compared with 2.1 in potatoes, 1.3 in beets, and 2.4 in cabbage.

**Buckwheat** is highly prized as a poultry feed in some sections where the price is not prohibitive, and especially in sections where white meat is desired. It is usually fed mixed with other grains, its principal properties being to supply heat and energy. Owing to its extremely large size and angular fibrous hull, birds, as a rule, do not relish it in large quantities. When ground and separated in making buckwheat flour, two by-products are found,—bran and middlings. The middlings are prized for their high percentage of protein and fat. Buckwheat bran, being composed chiefly of hulls, is of little value in poultry feeding, even when ground exceedingly fine. Buckwheat feeds are used in Europe, where poultry with pink flesh is preferred over yellow. In most sections of the United States the yellow-fleshed, corn-fed birds command a premium.

**Barley** is a suitable feed for nearly all classes of poultry and is a good substitute for corn. It is nearly equal in feeding value, and in Europe it largely takes the place filled by corn in America. It is usually fed whole with other grains as a scratching ration. Barley grains are coming into increased favor in barley-growing communities. They are usually relished by the birds, next to corn and wheat. Barley screenings are similar to wheat screenings, and are generally of a very good quality and desirable as a feed, but, owing to the possibility of adulterants, their analysis should be determined before extensive use is made of them. Malt sprouts and brewer's grains are by-products of barley. They have not been used extensively for poultry feeding. Theoretically malt sprouts may be a good source of succulent material, but, owing to the demand for this product as dairy feed, it has not been extensively tried by poultrymen.

**Rye.**—Whole rye resembles very closely the wheat kernel, both in analysis and general appearance; but the birds do not eat it readily and it does not produce good results. Persons raising rye

extensively will find it more profitable to market this material and purchase other feeds for poultry purposes. Sprouted rye is very palatable, and birds do well on it. The main by-products of rye are rye bran and distiller's grains, but, owing to limited supply, they are very seldom used.

**Rice.**—Whole or crushed rice is used to some extent, the crushed product being used in the feeding of chicks and pigeons. Usually the grades of rice which become available for poultry feeding are in limited amounts and the supply is uncertain, so that they cannot be considered as a constantly available poultry feed.

**Flax seed and cotton seed** do not enter into any class of poultry feeds except through their by-products,—viz., linseed meal and cottonseed meal. The former consists of ground flax seed from which the oil has been extracted. In the "old process" the oil is extracted by pressure only; in the "new process" a much greater percentage of the oil is removed by pressure and the use of gasoline or other solvents. The old process meal is more desirable for feeding purposes, especially during the molting season, as it hastens the growth of the new feathers. These meals when used are usually mixed with the dry mash. Cottonseed meal is not so generally used for poultry feeding, as it is supposed to have certain toxic or poisonous properties which may prove detrimental to the best results, and when used is fed in small quantities.

**Sorghum seed**, when it can be obtained, makes a very satisfactory variation in the compounding of grain rations. It is very similar to corn in composition, the kernel itself being much smaller than wheat and very smooth.

**Broom corn, kafir, and milo maize**, when obtainable at reasonable prices, may be used with beneficial results. Their production, however, is very limited both in area and distribution. With the large number of grains more extensively produced it is doubtful if the above will ever assume a prominent rôle in grain rations for poultry, except in the dryer parts of the country.

**Millet seed** is relished by poultry. Its high cost prohibits the general use of it in rations for adult birds. Its high fibre content makes it undesirable for chicks.

**Sunflower seed** is very desirable for poultry during the molting season. It is rich in vegetable oil and aids greatly in the formation of new feathers, giving the feathers a clean, glossy appearance, which cannot be obtained without such oil.

**Peas and Beans.**—These legumes are grown in limited amounts and cannot be considered as standard poultry feeds, but, where



available, either in the green or dried condition, they may be profitably used, as they are very rich in protein and easily digested.

TABLE VII.—*Composition of Grains and their By-products.*  
(Total ingredients are given, regardless of their digestibility.)

Feed.	Water.	Ash.	Protein.	Fibre.	Carbo- hydrates.	Fat.
	<i>Per cent.</i>	<i>Per cent.</i>	<i>Per cent.</i>	<i>Per cent.</i>	<i>Per cent.</i>	<i>Per cent.</i>
<i>Corn group.</i>						
Dent corn.....	10.6	1.5	10.3	2.2	70.4	5.0
Flint corn.....	11.3	1.4	10.5	1.7	70.1	5.0
Sweet corn.....	8.8	1.9	11.6	2.8	66.8	8.1
Pop corn.....	10.7	1.5	11.6	1.8	69.2	5.2
Corn meal.....	12.0	1.3	8.7	2.1	71.2	4.7
Corn meal (sifted).....	12.0	1.0	8.9	1.3	72.0	4.8
Corn-and-cob meal.....	15.1	1.5	8.5	6.6	64.8	3.5
Gluten meal.....	8.2	.9	29.3	3.3	46.5	11.8
Gluten feed.....	8.5	1.7	26.2	7.2	53.3	3.1
Hominy meal.....	11.0	2.5	10.4	4.2	64.1	7.8
<i>Wheat group.</i>						
Whole wheat.....	10.5	1.8	11.9	1.8	71.9	2.1
Wheat screenings.....	11.6	2.9	12.5	4.9	65.1	3.0
Wheat bran.....	11.9	5.8	15.4	9.0	53.9	4.0
Wheat middlings.....	12.1	3.3	15.6	4.6	60.4	4.0
Low-grade flour.....	12.4	.6	10.0	.9	75.0	1.1
Old bread.....	31.2	Variable	6.9	Variable	44.2	.9
<i>Oat group.</i>						
Oats, whole or ground...	11.0	3.0	11.8	9.5	60.7	5.0
Clipped oats.....	11.2	2.8	12.0	7.4	61.6	5.0
Oat meal.....	7.9	2.0	14.7	.9	67.4	7.1
Rolled oats.....	8.5	1.9	15.0	.6	66.0	8.0
<i>Buckwheat group.</i>						
Buckwheat.....	12.6	2.0	10.0	8.7	64.5	2.2
Buckwheat bran.....	10.5	3.1	12.4	31.9	38.8	3.3
Buckwheat middlings.....	13.2	4.9	28.9	4.1	41.9	7.0
<i>Barley group.</i>						
Barley.....	10.9	2.4	12.4	2.7	69.8	1.8
Barley meal.....	11.9	2.6	10.5	6.5	66.3	2.2
Barley screenings.....	12.4	3.6	12.2	7.6	61.6	2.6
Malt sprouts.....	10.2	5.7	23.2	10.7	48.5	1.7
<i>Other grains.</i>						
Linseed meal (o. p.).....	9.2	5.7	32.9	8.9	35.4	7.9
Cottonseed.....	10.2	3.5	18.4	23.2	24.7	19.9
Cottonseed meal.....	8.2	7.2	42.3	5.6	23.6	13.1
Rye.....	11.6	1.9	10.6	1.7	72.5	1.7
Rice.....	12.8	.7	7.5	.5	78.1	.4
Sorghum seed.....	12.8	2.1	9.1	2.6	69.8	3.6
Broom corn seed.....	12.7	3.4	10.2	7.1	63.6	3.0
Millet seed.....	14.0	3.3	11.8	9.5	57.4	4.0
Sunflower-seed.....	8.6	2.6	16.3	29.9	21.4	21.2
Canada field peas.....	13.4	2.4	22.4	6.4	52.6	3.0
Cowpeas.....	14.8	3.2	20.8	4.1	55.7	1.4
Soy beans.....	10.8	4.7	34.0	4.8	28.8	16.9

**Mixed Feeds and Manufactured Products.**—Certain classes of products designed for poultry feeding are manufactured in different sections of the United States. In some instances it has not been proved that these materials are objectionable, but in nearly every case experiments show that the ingredients which are supposed to be furnished can be more economically secured from natural sources. A great variety of so-called ready-mixed feeds are advertised. They are supposed to contain a given amount of nutrients in a very economical form. In practice a great majority of such feeds should be avoided, as many of them are adulterations containing a large amount of filler and make-weight material. Analyses made at various experiment stations show the following materials to be occasionally used in such feeds: Oat hulls, ground peanut shucks, cut straw and hay, sand, and other foreign substances, which are used to increase the bulk and the weight of the feed. It is a much more economical practice for poultrymen to purchase the standard grains and by-products and do their own mixing. Any plan which will lower the grain bill will be helpful.

**Animal Feeds.**—Leading authorities agree that, for the best results in poultry feeding, the birds should be given protein and other nutrients from animal as well as from vegetable sources. All feeding experiments show that where animal protein is entirely withheld the birds do not make so good nor economical growth, and cannot be made to produce as many eggs in a given period. There are several sources from which nutrients of an animal origin can be obtained. Their use depends somewhat on location and upon the price of the different ingredients in local markets.

*Meat scrap* is undoubtedly the most popular of the different forms of animal matter for poultry. There are many grades on the market, which may be grouped as high grade or low grade.

The high-grade meat usually contains about 60 per cent of protein and the low-grade about 35 to 40 per cent. It will always be found more economical to purchase high-grade meat scrap, as the price per pound of protein will be less. Then, too, the high-grade meat is usually more sanitary and better prepared. A commercial practice is to cook the carcasses or pieces of meat under steam pressure for a given number of hours, to render out the fat. This sterilizes them completely and kills any bacteria of a detrimental nature which might be present. Scrap prepared in this way is not apt to contain poisonous matter. On the other hand,

it is sometimes found in the manufacture of low-grade meat scrap that no treatment is given to meat which would purify it; in other instances it is treated with a strong acid. When such methods are followed, there is danger of disease bacteria in the feed, or a strong acid residue may remain when ready for market. Beef scrap of this last character has been known to cause considerable injury and loss of valuable birds.

Pork scrap is sometimes available for poultry feeding, but it contains a larger amount of fat and has a low digestibility, for which reasons it is not as desirable as beef scrap.

*Bone products* come next to meat scrap in popularity and efficiency as animal matter for poultry. They are fed either green or dried. The practice in preparing green bones is to secure them daily from the meat shop and grind them up in bone cutters and feed them fresh. If this method is followed, they have to be fed in limited quantities, as the birds will not stand a heavy feeding. The dried, crushed bone is a very efficient source of protein and ash in baby-chick feeding. (See also page 201.)

*Animal Meal.*—Meat scrap, mixed with quite a large percentage of bone and fat, is often ground up exceedingly fine, thoroughly dried, and sold in the form of “animal meal.” It has about the same feeding value as meat scrap, but there is a greater possibility of adulteration, and the feeder cannot be so sure of what he is using.

*Dried Blood.*—This is a dried product of slaughter-houses, and, when properly sterilized and stored in dry places, will keep indefinitely. It can be used to good advantage in limited amounts in poultry mashes, especially to check diarrhœa; however, it possesses no advantage over a high-grade meat scrap or bone product.

*Fish Scrap.*—The feeding of fresh fish was quite extensively practised at one time in localities where it could be obtained, but, owing to the fact that it tainted the eggs and the flesh of poultry, the practice was discontinued. Properly prepared fish scrap, from which the oil has been entirely removed, is being fed with very good results in certain sections, especially in California. A very essential feature in the manufacture of fish scrap for poultry feeding is that all the oil, which carries the objectionable odor and flavor, should be removed. Some high-grade fish scrap is manufactured at about one-half of the cost of meat scrap. This contains considerable protein. If possible to obtain this, it will make a very satisfactory substitute.

Clams and other shell fish, if available in sufficient quantities,

may be fed to poultry. They are palatable and supply some digestible material.

*Milk.*—If they can be obtained in sufficient quantities at a price which is not prohibitive, milk and its by-products are very economical feeds. When used in large quantities, they furnish protein in an easily digested form. One undesirable feature is the increased labor and trouble in feeding them, especially when milk itself in the natural state is used.

*Skim milk* is probably more often used in the neighborhood of large creameries or skimming stations than any other of the milk products. This material will supply concentrated protein in the ration when wet mashes are mixed with it. If desired it may also be given in the drinking fountains in place of water. Birds consume large quantities with very beneficial effects. It is used in commercial fattening of poultry, the wet mashes being moistened with it. Reports show that the feeding of buttermilk or sour skim milk to baby chicks is good practice, as the lactic acid present reduces the danger of infection and the spread of white diarrhoea.

TABLE VIII.—*Composition of Animal Feeds.*

(Total ingredients are given, regardless of their digestibility.)

Feed.	Water.	Ash.	Protein.	Fibre.	Carbo- hydrates.	Fat.
	<i>Per cent.</i>	<i>Per cent.</i>	<i>Per cent.</i>	<i>Per cent.</i>	<i>Per cent.</i>	<i>Per cent.</i>
Meat scrap (high grade)..	10.70	4.10	60.20	....	....	25.00
Meat scrap (low grade)...	15.40	2.50	45.00	....	....	37.10
Pork scrap .....	11.0	2.2	55.0	....	....	31.8
Ground bone (dry).....	8.19	56.95	31.36	....	....	3.50
Green cut bone.....	38.94	26.12	20.37	....	....	11.67
Animal meal.....	4.90	42.65	30.45	3.30	10.32	8.38
Blood meal.....	10.61	4.65	75.69	1.28	1.46	7.11
Dried blood .....	6.70	6.60	65.10	....	5.30	16.30
Fresh fish.....	44.0	1.00	10.50	42.00	....	2.50
Fish scrap (variable) ...	5-10	2-8	34.0-50	....	....	17.0
Clams and other shell fish	34.10	2.30	6.00	55.00	2.00	.60
Whole milk.....	87.2	.6	3.6	....	4.9	3.7
Skim milk.....	90.6	.7	3.1	....	5.3	.3
Buttermilk.....	90.1	.7	4.0	....	4.0	1.2
Whey.....	93.8	.4	.6	....	5.1	.1
Cheese.....	40.6	3.4	23.7	....	1.7	30.6
Milk albumen.....	18.0	3.(?)	43.0	....	(?)	1-5
Granulated milk.....	28.5	3.6	13.7	....	51.1	3.1
Hens' egg (others similar)	66.7	12.2	12.2	....	....	8.9

*Whey.*—This by-product of cheese making should be used when it can be obtained. It does not have the nutrients which the buttermilk and skim milk contain, but it is relished by the birds.

*Granulated Milk.*—A milk product available for poultry feeding is known as granulated or powdered milk. It is whole milk evaporated and crystallized. Its cost is very high, and in most cases prohibitive. The only case where it can profitably be used is in the feeding of chicks for the first few weeks of their growth.

*Milk Albumen.*—Another milk by-product upon the market in large quantities, and so well distributed that all poultrymen can use it if they desire, is milk albumen. This is formed from skim milk during the manufacture of milk sugar. It comes in various sizes and grades, suitable both for use in dry mashes and in scratching rations. It varies considerably in composition according to method of manufacture.

*Eggs.*—On most poultry plants there are infertile eggs which are tested and taken out of incubators at the different stages of incubation. These eggs, if it is not possible to dispose of them legitimately for baking purposes, should be utilized in the feeding of the birds. The best practice is to boil them hard and feed them to baby chicks or growing stock, it being a good plan to cut them up fine and mix with wheat bran. It is not recommended to feed whole eggs with the shells on to adult birds, as it has a tendency to teach them to eat eggs. It is also not a safe practice to feed hard-boiled eggs to extremely young chicks. A better time to start is when the chicks are about two weeks old. Eggs which contain dead germs, if the hatch is tested on the fifth to the seventh day, may be used equally well. In feeding hard-boiled eggs, the practice should be to feed only what the birds will clean up soon. If eggs are allowed to remain on the floor or the brooder or in the feeding yard, they will sour and produce an unsanitary feed.

**Legumes and grasses** are usually fed to poultry in two different forms: First, in the cured state in the form of hay; and second, in the form of green succulence. In the dry condition they are usually cut fine and mixed in the dry mash to increase bulkiness. Alfalfa, clover, and certain mixed grasses are generally used for this purpose. There are on the market short-cut clover and alfalfa hay and also clover and alfalfa meal. Where alfalfa or clover cannot be raised on the farm, it is profitable to include one of these in the short-cut form in the dry mash for the laying birds during the winter.

Alfalfa hay, both<sup>d</sup> in the short-cut and meal forms, offers exceedingly good opportunity for the use of adulterants; for this reason the short-cut form is most desired, as the percentage of

adulterated material can easily be detected. Clean alfalfa hay is bright green in color and has the true alfalfa smell.

Cut timothy is often used as an adulterant, and this can easily be detected by the large amount of yellow or brown material present; this adulteration cannot easily be detected in fine-ground or meal form.

TABLE IX.—*Composition of Hays and Grasses.*

(Total ingredients are given, regardless of their digestibility.)

	Water.	Ash.	Protein.	Fibre.	Carbo- hydrates.	Fat.
	<i>Per cent.</i>	<i>Per cent.</i>	<i>Per cent.</i>	<i>Per cent.</i>	<i>Per cent.</i>	<i>Per cent.</i>
Alfalfa (green).....	80.00	1.80	4.90	4.70	7.90	.07
Alfalfa (dry).....	11.90	7.13	14.12	27.09	37.34	2.42
Clover (green).....	70.80	2.10	4.40	8.10	13.50	1.10
Clover (dry).....	10.00	8.10	16.32	17.84	45.99	1.75
Lawn clippings (green)...	76.40	2.40	2.30	4.10	13.80	1.00
Lawn clippings (dry)....	15.30	5.50	7.40	27.20	42.10	2.50
Barley (green).....	76.00	7.30	2.71	6.90	7.00	.09
Peas and oats (green)....	80.50	1.74	2.90	6.00	8.80	.06

The green crops which are raised for poultry feeding most extensively are alfalfa, clover, peas, beans, cereals, and buckwheat. All green succulent grasses are desirable, and the one which grows best during a given month should be ready at that time. Legumes are most desirable for feed, as they contain considerable protein and produce a heavy yield. A small alfalfa field should be run in connection with every poultry plant, and will allow from three to six cuttings of the same field during the season, supplying a continuous source of green feed.

**Vegetables.**—A valuable property of vegetables in poultry feeding is the amount of water they contain. They make very desirable succulent feed where they can be grown successfully. Fresh, leafy vegetables can be used for only a short time, as they wilt and spoil quickly. Some of the root crops, such as mangels and beets, maintain their succulent condition for a long time, and will furnish succulence well through the winter if properly stored.

The leading vegetable crops found most useful in supplying succulence, during certain seasons of the year, are considered here. It is rather hard to keep vegetable crops in storage for any considerable time during the winter without a special place, as in an underground root cellar. They are often used up soon after their natural season to prevent loss in storage.

*Potatoes.*—Potatoes are not extensively used for poultry feeding, and should be fed sparingly. Birds eat them readily, especially when cooked and mixed with a mash. The results of eating a great many of them in this form are to decrease the appetite for complete rations at future feedings, and to put on excessive fat, due to high content of carbohydrate. Raw potatoes are not eaten readily by birds.

*Beets,* as a group, form one of the most valuable succulent crops. The several types are garden beets, mangel-wurzels, and sugar beets. Mangel-wurzels are valued for their extremely large size and large yields per acre. They contain considerable water



FIG. 117.—Mangel-wurzel beets at harvest time. The tops are cut green and fed immediately; the roots are pulled and, after curing a few days, are stored for winter feeding.

in the fresh state, are easily preserved in good condition well into the winter, are relished by the fowls, and will produce no harmful results. They will not entirely replace greens as a source of succulence, but are among the best substitutes available (Fig. 117). Dried beet pulp, which is a by-product of the beet-sugar industry, has been tried to a limited extent as a means of supplying succulence to poultry during the winter when other sources were not available. Results tend to show that it can be profitably used for the purpose.

*Other Root Crops.*—Turnips, carrots, and parsnips are used in limited amounts where they are available. When fresh and cut in vegetable cutters, birds relish them as well as they do mangels. It is generally the practice to use only small roots which cannot

be sold for market purposes, and it is not possible to hold large quantities of them over for any length of time, as they begin to rot quickly and the feeding of rotted or decayed products of this kind tends to produce bad flavors in the eggs.

*Onions* have always been considered as a tonic when fed to poultry in small quantities, the general practice being to cut them up fine and feed them in wet mashes. Birds relish onions in all forms. It is necessary to limit the amount fed, however, as they are apt to impart some of their odor to the eggs and flesh. Limited quantities of chopped onion tops are a desirable addition to rations for growing chicks.

TABLE X.—*Composition of Vegetables.*

(Total ingredients are given, regardless of their digestibility.)

Feed.	Water.	Ash.	Protein.	Fibre.	Carbo- hydrates.	Fat.
	<i>Per cent.</i>	<i>Per cent.</i>	<i>Per cent.</i>	<i>Per cent.</i>	<i>Per cent.</i>	<i>Per cent.</i>
<i>Roots.</i>						
Potatoes (white).....	78.9	1.0	2.1	.6	17.3	0.1
Potatoes (sweet).....	71.1	1.0	1.6	1.3	24.6	.4
Beets (mangel).....	90.9	1.1	1.4	.9	5.5	.2
Beets (sugar).....	86.4	.9	1.8	.9	9.8	.1
Beet pulp (dry).....	8.0	5.4	9.5	15.4	61.3	.4
Beet pulp (wet).....	89.8	.6	.9	2.4	6.3	..
Onions.....	87.6	.6	1.4	.7	9.4	.3
Turnips.....	90.5	.8	1.1	1.2	6.2	.2
Carrots.....	88.6	1.0	1.1	1.3	7.6	.4
Artichokes.....	80.0	1.0	2.5	.8	15.5	.2
<i>Leaves.</i>						
Cabbage.....	90.5	1.4	3.8	1.5	2.4	.4
Lettuce.....	95.9	.8	1.6	.5	1.0	.2
Beet tops.....	88.0	2.4	4.4	2.2	2.6	2.2
Rape.....	89.2	2.0	3.4	2.6	2.3	.5
Onion tops.....	91.0	1.1	3.9	3.0	.8	.2
Chard (Swiss).....	87.8	2.4	4.4	2.9	2.5	.4

*Cabbage* is one of the most popular and most valuable vegetables for succulent poultry feed. The crop grows rapidly and a large yield is possible from a small area. Its keeping qualities are as good as or better than most other vegetables. It is the best practice when growing cabbage for poultry feeding to allow it to head up well, because the total weight of succulent feed is thereby greatly increased. Cabbage may either be fed chopped fine and mixed with mashes, or it may be suspended on a cord or on a hook and the birds allowed to eat it directly from the head.



*Lettuce* is as desirable a source of succulent feed as cabbage, but, owing to the smaller yield, its poor keeping qualities, and its high market value for human consumption, it is little used for poultry. It is often economical to raise small quantities of lettuce for the feeding of baby chicks, as they relish it and thrive on it.

*Kohl-rabi* may be spoken of as a turnip-cabbage. The fleshy stem is used for its succulence. In value it is about equal to turnip, and the keeping qualities are good.

*Rape* is used where it is desired to sow the crop broadcast and either allow the birds access to it or harvest it with a scythe. It is very hardy and will grow in the fall as late as cabbage.

*Swiss chard* is planted in rows and cultivated, the crop being supplied to the birds at regular intervals. The chard will grow continually after each successive cutting, and one seeding will produce a large amount of succulent feed in a season.

**Minerals for Poultry.**—The importance of minerals in poultry rations has been much neglected in the past. Recent experiments tend to show that the character, composition, and source of minerals or ash in a ration are the determining features as to the efficiency of a given ration.

*Dried ground bone*, either in the form of bone meal or granulated bone, has proved to be a very good source of both protein and phosphate. Samples averaging 25 per cent protein and 24 per cent of mineral matter can be purchased so reasonably as to make them, beyond doubt, a very economical source of protein and ash. Birds relish dried bone. It has no laxative properties, and is recommended for the feeding of baby chicks and growing stock.

*Fresh cut bone* consists of refuse bone and clippings from butcher-shops. This product when available, ground in especially prepared cutters, is a very good source of protein and mineral matter. The supply is usually limited, and the price rather high. Where a large number of birds are to be fed, it is better to purchase the bones in bulk, and grind them by the use of a power bone cutter on the plant. Fresh bone is not good for growing chicks, but will produce excellent results when fed to laying stock. It is very forcing when fed in large quantities, and it is the best practice to limit it to less than 15 per cent of the dry-mash ration. (See also page 195.)

*Crushed oyster shell* is the best source of lime in the ration. Ash from this source is important for the formation of egg shells

in the case of laying hens. It seems to be of less value for growing chicks, as it contains little if any phosphate. Samples of crushed oyster shells usually run over 95 per cent carbonate of lime. Crushed shells are especially valuable when they can be fed fresh, that is, gathered regularly from the beach, or after the oysters or clams have been removed, and immediately crushed or ground.

*Sources of Phosphate.—Composition (pounds in 100).*

	Protein.	Phosphoric acid, P <sub>2</sub> O <sub>5</sub> .
Granulated bone (dry).....	25	24
Green cut bone.....	19 to 34	23 to 25
Phosphate rock.....	..	28 to 32

*Poultry grit* is not valuable as a source of ash, as it usually contains little if any lime, and very little phosphate, the main component being silica. The function of grit is that of grinding.

*Other Sources of Mineral Matter.*—There are a great many advertised sources of mineral matter for poultry feeding. Few of the commercial forms, however, seem to supply the particular kind of mineral in the best form. Raw phosphate rock gives fair results, but the available mineral matter is small in comparison with its bulk. There are certain advertised commercial feeds which are guaranteed to contain a large quantity of ash. Some of these, owing to their physical properties, are of little value, and are not economical when compared with the results obtained by the use of cheaper and better-known materials, such as bone products.

*Ash in Grains.*—Wheat bran is a very efficient source of ash and is fed quite extensively with this purpose in view. Considering only its value as a protein carrier, the cost of wheat bran is relatively high, but considering its palatability and high ash content it can be highly recommended. It is desirable in the feeding of baby chicks. There are other grains, such as barley and oats, which contain enough ash to be worth considering.

*Double Function of Minerals.*—Experiments show that the ash content in a ration bears a definite relation to the complete use of other nutrients in it. Not only is the actual availability of the mineral matter itself of value, but mineral compounds have a very noticeable effect in increasing the digestibility of other nutrients in the ration, especially protein. Minerals thus perform a double function.

## REVIEW.

1. Into what two great groups can all feeds be divided?
2. Name the inorganic substances used for feed.
3. Discuss the use of water in digestion and assimilation.
4. When and where should salt be used?
5. When are phosphates especially useful?
6. What is meant by organic feeds? Give several examples.
7. Where does corn rank as a poultry feed?
8. What by-products of corn are used in poultry feeding?
9. Discuss wheat and its by-products as a poultry feed.
10. Name the parts of the wheat kernel and what feed each forms after milling.
11. Tell of the value of oats as a poultry feed.
12. Discuss sprouted oats, their use, and methods of sprouting.
13. Give the composition of sprouted oats.
14. Discuss the use of each of the following grains in poultry feeding: Buckwheat; barley; rye; rice; sorghum seed; sunflower seed; peas and beans.
15. What is the source of oil meal?
16. What is the advice regarding the use of ready-mixed feeds and manufactured product?
17. Enumerate the important feeds of animal origin.
18. With respect to what nutrient are they especially important?
19. Give the composition of beef scrap, and discuss its use as a feed.
20. Give the composition of ground bone, and its use as a poultry feed.
21. From what standpoints is milk a desirable feed?
22. Discuss the use of skim milk in poultry feeding.
23. Under what conditions can eggs be profitably used in feeding poultry?  
Tell how.
24. Discuss, in detail, hays and grasses as to their uses as feeds.
25. What vegetables are often grown for feeding poultry?
26. Discuss mangel-wurzel beets as feed for poultry.
27. Give the sources of mineral matter in the ration.
28. Discuss minerals and their effect upon digestibility.

**References.**—The Economic Value of Root Crops, by E. R. Minn, Cornell Bulletin 317. Poultry Feeding Stuffs, by H. J. Wheeler, Rhode Island Bulletin 84. Poultry Feeding, by M. E. Jaffa, California Bulletin 164. Condimental Feeds, Delaware Report, 1901. Commercial Feeding Stuffs, United States Bureau of Chemistry Bulletin 108. Alfalfa Meal as a Feeding Stuff, in U. S. Farmers' Bulletin 259.

## CHAPTER XII.

### PRACTICE OF POULTRY FEEDING.

BEFORE discussing the requirements of a successful ration and the practice commonly used in the feeding of poultry, it is well that the design and construction of the feed house be considered and that the equipment be reviewed.

#### FEEDING EQUIPMENT.

**The Poultry Feed House.**—A great many poultry plants, whether small or large, owing to improper facilities for the handling of feed and the mixing of rations, lose large sums of money through waste and labor which could easily be saved by careful attention to better methods.

In the design and laying out of a poultry plant, one of the things to be considered is the location of the feed house. It should be centrally located on rather high ground, if possible, giving good drainage and freedom from dampness; it should be easy of access both from the main highway and from the different units or laying houses themselves. In some instances it is desirable to locate the feeding room in the centre of the long laying house, having overhead tracks running from the feeding room directly to the different houses. This is a great labor-saving device, and proves very serviceable in the caring for adult birds in the intensive house. In equipping broiler plants, where a special feed room is required for chick rations, the overhead track system has been found very economical and practical.

In planning the style and construction, two things should be borne in mind: First, to have the building large enough for the storing of grains and the proper housing of the feeding appliances; and, second, to have it, as far as possible, proof against mice and rats.

The feed house is often two stories in height (Fig. 118), with the grain-storage bin located on the second floor and the rations falling through chutes to the lower floor. This gives ample room on the lower floor for the proper arrangement of mixers, grinders, and other appliances. There must be room for feed pails, for drinking fountains, for hoppers, and for storage when needed.

It may be possible during certain seasons of the year to buy at reduced prices large quantities of grain and hold it for later use. Thus much can be saved. This practice is impossible without large storage bins.

The feature of having the house proof against rats and mice is important; for, if these enemies gain access to the grains, a constant and considerable loss will be going on which may be almost unnoticed. On an extensive plant it may be feasible to construct the entire feed room of concrete or hollow tile; but where, owing to limited funds or other reasons, it is necessary to erect a frame building, it will be found a very desirable practice to fill in concrete



FIG. 118.—Poultry feed house centrally located, with long laying house on either side. The upper floor is used for storage of hay and grain, and the lower floor for mixing and weighing.

between the inside sheathing and the outside weather boarding to a height of about thirty inches from the ground. If this is done during the construction of the house, it adds very little to the cost and prevents rats and mice from gnawing through from the outside. In addition to this, a good, heavy concrete floor should be laid on a crushed stone or cinder bottom. If the moisture insulation of tar paper be used, as described in Chapter VII, it will insure dryness, which is essential to keep the grains from molding, besides adding to the rat-proof feature.

**Special Feed-room Equipment.**—The amount, character, and size of the appliances required properly to equip the feed room for work will be determined largely by the size of the plant and the character of the work to be done. A poultry plant making a

specialty of egg production, with market broilers and dressed poultry on the side, may require under average conditions the following equipment in the feed room: Caldron, dry-mash mixer, vegetable cutter, hay cutter, bone cutter, and power.

*Caldron.*—A cooker or steamer is useful for the cooking of hot mashes during the winter, in the preparation of special mashes for special feeding purposes, and in heating or scalding any moldy or partially injured grains to restore their feeding value. Water may be heated in it for the scalding of utensils. Such a caldron should be of from thirty to fifty gallons capacity and strongly built.

*Dry-mash Mixer.*—On plants where a large number of birds are fed and where such materials as green cut clover and ground bone are used in the mashes, it is necessary to mix them daily; where this is done a good power mixer will save labor. Most of these mixers are similar to a baker's dough mixer. An important feature in the mixer is that the basin can be easily emptied. The floats or mixers should do the work thoroughly and quickly.

On small plants such an equipment is not required. One of the most economical methods is to mix the ration on the floor by means of scoop shovels, mixing from 500 to 1,000 pounds at one time and storing it in bins ready for use.

*Vegetable Cutter.*—A vegetable cutter is often used if many vegetables, such as beets, are fed. Birds seem to relish them better and eat more of them if they are finely cut and fed in troughs; there is less waste but more labor than if they are fed whole.

*Hay Cutter.*—Fresh clover, alfalfa, and other green, succulent materials are often run through a hay cutter, which can also be used for the cutting of dry hay, such as alfalfa, and straw for litter.

*Bone Cutter.*—In localities where it is possible to secure a supply of fresh bones, it may be well to have a power bone cutter. Some forms can be used either for dry or green bones. Cut bones provide a very economical source of animal protein and ash.

*Power.*—A plant large enough to warrant the extensive equipment as outlined should have some source of power to run the machines. The gasoline engine will doubtless prove the cheapest and best on a farm. Near large centres of population an electric motor will probably supply the power more cheaply. In the equipment of the feed room an effort should be made to reduce the labor item to a minimum. This will allow one man to care for an increased number of birds; in other words, it will lower the labor

cost per bird during the year. The labor item is the second greatest item in the cost of production,—feed being first.

**Feed Wagons.**—On large plants where the attendant makes his rounds and must cover considerable distance, it is found very feasible to do the feeding from a wagon constructed for the purpose (Fig. 119). This wagon may contain egg cases for the collection of eggs, and a box or receptacle for the removal of droppings when the houses are cleaned. Such a wagon is also useful for the transportation of young stock to and from the range.

**Compounding Rations.**—By a ration is meant the amount of feed given a bird or flock of birds in a day. It includes the feed



FIG. 119.—The poultry feed wagon is a great labor saver in caring for poultry on the range. (Photo from Cornell University.)

given both naturally on the range or in the yard and that provided by the feeder.

In compounding the ration or daily diet for a laying hen, several factors should be carefully considered: Breed, age of birds, housing condition, season, and range. The prices of feed and the amount of labor must be taken into account. Other points are discussed under the headings that follow.

**Sufficient Nutrients.**—The first requisite in a successful ration is that it contains a sufficient amount of feed adapted to the purpose desired. The nourishing parts of feed are called “nutrients”; these are of several kinds: Protein, carbohydrates, and fat. The nutrients in a feed may be expressed either in the amount required per bird or the amount required per 100 pounds in live weight. Owing to the great variation in the weight of the individuals, it

is usually expressed in the latter form. Two features must be considered in this respect: (1) The amount of each of the three nutrients—protein, carbohydrates, and fat—that 100 pounds live weight will require; and (2) the heat or energy which the ration will develop when consumed.

As stated in a previous chapter, standards have been devised that give approximately the amounts of different nutrients and the number of heat units required. Wheeler's standard shows digestible nutrients per day for 100 pounds live weight for hens in full laying condition. By this standard it will be noted that as birds increase in size the amount of feed required by the individual is increased per individual, but actually decreased for each 100 pounds live weight. This is due to the fact that fewer individuals are required to make the 100 pounds weight. Feeders often fail to supply enough nutrients for heavy layers.

*Nutrients must be in the Right Proportion.*—It is just as essential that the nutrients in the ration be of the right proportion as that they should be sufficient in amount. The right proportion will be determined by the purpose of feeding and by the age and character of the individuals themselves. For instance, if the purpose is to feed for fat and flesh, as in the preparation of birds for market, an increased proportion of fat and carbohydrates in the feed will be required. On the other hand, if the feeding is for egg production, a large amount of protein material will be essential.

The age and the breed of the specimens being fed influence the proportion of nutrients in the following manner: The heavier breeds naturally have a tendency to take on flesh quickly, and, therefore, large proportions of fat-forming nutrients are not required when feeding for egg production. With more active breeds, as the Leghorns, more of such nutrients may be used. As the individual gets older the natural tendency becomes more and more pronounced to take on excessive flesh, and this character of feed should be withheld.

*Nutritive Ratio.*—The proportion of nutrients in any ration is called the "nutritive ratio." By nutritive ratio is therefore meant the relative value of the particular nutrients, and it might be expressed as a measure of quality. The ratio is expressed in numbers giving the protein as one and comparing this with the combined carbohydrates and fat. For instance, a ration containing 100 pounds of protein and 400 pounds of carbohydrates and fat will be expressed as having a nutritive ratio of one to four.



The nutrients must first be reduced to the same value. The fat in a feed is richer than the others in heat value. Fat has been found to have an energy value of two and one-quarter times that of carbohydrates, so that it is necessary, in order to reduce them to the same value, to use this coefficient in the solution. Nutritive ratio can be expressed in the following manner, by formula: Given a ration containing 10 pounds protein, 30 pounds carbohydrates, and 5 pounds fat.

Nutritive ratio = 1: 4.13

Protein	:	carbohydrates	+	(fat × 2.25)
10	:	30	+	(5 × 2.25)
10	:	41.25		
1	:	4.13		

It will be noticed in the above calculation that the amount of fat present was multiplied by 2.25.

*Potential Energy.*—It is often helpful to know the heat values which the nutrients present in a ration will develop when consumed by the birds. This capacity is expressed by the term “potential energy.” This means the measure of value in units of heat or energy in the nutrients themselves.

Potential energy is expressed in calories per ounce. A calory is a unit of heat or energy. It is the amount of heat necessary to raise one gram (about  $\frac{1}{8}$ s of an ounce) of water one degree of temperature on the centigrade thermometer. It is known that one ounce of carbohydrates or of protein has a potential energy of 116 calories, while one ounce of fat has a potential energy of 264 calories. In actual practice the energy value of any ration may be quickly determined by using the following multiples: One pound of protein or of carbohydrates will develop 1,860 calories, and one pound of fat will develop 4,220 calories.

*Balanced Rations.*—It is possible by careful calculation to approximately compound a ration which will contain a sufficient amount of nutrients in the right proportion for the laying hen. When this is done the ration is expressed as being balanced, or, better, as being proportioned to meet the requirements of the individual for combined maintenance and production. In actual practice it is possible to balance rations for only short intervals. The ration as combined may leave nothing to be desired, yet the birds exercise their power of selection, some individuals getting an entirely different diet from others. Individual desires and inclinations differ. The actual feeding practice should be to form an

approximately correct ration, watch its effect upon the individual flocks, and modify such rations as judgment may indicate.

*Rations must Contain Succulence and be Palatable.*—The ration as compounded must supply to the birds an abundance of succulent material. If not present under natural conditions, it will be necessary to supply it daily from an artificial source for at least one feeding. Where the birds have free range and an abundance of green grass, artificial sources are not necessary. In the winter, sprouted oats, mangel beets and cabbage, one or all, may be economically used. In the summer the feeding of green crops either by soiling methods or pasture should be largely depended upon, according to area and character of the range.

The palatability of the rations should not be overlooked, for if the birds do not like a ration it usually means that they will not consume a sufficient amount to supply their needs. The natural craving for a good ration will increase the amount consumed. In most cases the digestibility of a ration is increased by being palatable, because secretion of digestive juices is increased. Variety is an important factor in palatability.

*Sufficient Bulk.*—Rations that are too concentrated should be avoided. When consumed they do not distend the digestive organs enough to allow a thorough mixing with the digestive juices. The feed is insufficiently digested, resulting in a tendency to produce diarrhoea and other disorders. Such materials as wheat bran, short-cut alfalfa, ground oats, and others, when added to a dry mash, increase bulk and make it more digestible than if the ration is composed of only middlings, corn meal, gluten, and meat scrap.

There is a possibility, on the other hand, of having a ration too bulky, so that it will be necessary for the birds to consume extremely large amounts in order to get the required amount of digestible nutrients. The bulky materials added usually contain much fibre with little nutritive value. Care must be exercised in the preparation of rations to have them of proper bulk.

*Economical but not Cheap.*—The cheapest feeds which can be purchased are not always the most economical. For instance, 100 pounds of meat scrap analyzing 40 per cent protein can now be purchased for \$50 a ton, and meat scrap purchased for \$60 a ton usually analyzes 60 per cent protein. If the low-grade meat scrap is purchased, the poultryman pays \$6.25 for every hundred pounds of protein, whereas for the high-grade meat he would pay

only \$5.00 for every hundred pounds of protein. In other words, the purchase should be based on the total amount of digestible material which can be procured for \$1.00, and not on the price of 100 pounds of the material in bulk.

Just because a moldy feed, perhaps cracked corn, which has become heated, can be purchased at a low price, it does not necessarily follow that it is the most economical cracked corn which can be purchased. In such cases the reverse will usually be true. In selecting poultry feed stuffs from which to form a ration, quality should come first and cost second.

*The Cost of a Pound of Protein.*—It is often necessary to purchase practically all the protein feed stuffs, while many of the carbohydrate feeds can be produced on the farm if there is sufficient room to admit of the growing of such crops as corn. In all cases protein feeds are the most expensive. It is usually the most economical practice, in deciding which feed to buy, to determine the amount of digestible protein present. Wheat bran containing 12 per cent of protein has 12 pounds of protein in a hundred. Corn containing 8 per cent of protein has 8 pounds in a hundred. Oil meal containing 30 per cent of protein has 30 pounds of protein in a hundred. High-grade meat scrap containing 60 per cent of protein has 60 pounds of protein in a hundred. (The number of pounds per hundred as given here is sometimes referred to as units per ton.) Take these weights of protein as a basis for figuring cost value. A unit of protein in such feed stuffs can now be purchased for about \$1.00; this means five cents per pound.

For example, high-grade meat scrap showing 60 per cent of protein will contain 1,200 pounds of protein in every ton. Divide the cost of a ton, which is \$60, by 1,200, the total amount of protein, and we have the cost of a pound, five cents.

The above method will be found very efficient in determining the most economical feed to purchase to supplement home-grown or purchased carbohydrate feeds.

*Ration Easily Mixed and Stored.*—Since labor is an expensive item on the poultry plant, it will be found economical, from a standpoint of time and labor, to compound the ration of such materials as are easily mixed, and store them in large quantities ready for use. It should be the practice to mix both the dry mash and scratching rations separately in large quantities at one time. It is well to purchase grains, as far as possible, in large amounts at frequent intervals, in order to save labor in handling. It will

often be found possible to buy grains in bulk out of season at a much reduced price.

Another great advantage in mixing rations in large quantities is that a greater uniformity in feeding is secured than when each ration is mixed daily. Unless a great deal of care is exercised, there is always a wide variation in the composition when mixed in single lots.

*Rations Correctly Fed.*—Regularity in poultry feeding is an important requisite. The birds become accustomed to a given hour and expect their feed at that time. Any variation from this order will soon result in a reduced production.

Having combined the best possible ration, intelligence is required in feeding it if the best results are to be obtained. Conditions in the flock and the season are constantly changing. Corresponding changes in the ration and methods of feeding should be made to maintain a uniform condition in health, weight, and productivity.

**Grit, Shell, Charcoal, and Salt.**—In addition to the rations containing the right amounts of nutrients, it is necessary to keep before the birds at all times a hopper containing crushed grit. This is needed to enable the birds properly to grind and digest the grains fed. The function of the grit is to act as “teeth,” and should be extremely hard and angular. As a rule, it is found unnecessary to supply grit often when the birds have free range.

Crushed oyster shells should always be available to the birds to furnish the lime necessary to form the shell of the newly formed eggs.

Powdered or crushed charcoal is also very desirable, as it acts as a cleanser or purifier, cleansing the system and keeping the birds in good condition. It is also rich in mineral matter. It may be mixed with the dry mash in self-feeding hoppers or fed in separate hoppers. It can profitably be used at the rate of five per cent by weight in the mash, but less than this is common.

Salt added to the ration in limited amounts increases palatability, and hence induces the birds to eat it more readily. Its use in large quantities is detrimental.

#### SYSTEM OF FEEDING.

A great many general systems are practised in poultry feeding, many of which contain good points, many bad. The best system to use in any case will be determined largely by the object

sought. All systems have been analyzed carefully and will fall under one of the four following combinations: (1) Trough feeding of wet mash; (2) hopper feeding of dry mash; (3) scratch feeding of cracked grains; (4) hopper feeding of cracked grains.

Combinations of two or more of these are often used, and undoubtedly give better results than the exclusive use of any one alone.

**Trough Feeding of Wet Mash.**—This system is recommended for use where a small number of birds is to be fed, and only when it is possible to devote considerable time and attention to them. It may also be used when it is desired for some reason to force for an increased production, as in the case of adult birds which are laying poorly; to hasten maturity, as in the case of late-hatched pullets; during very cold winter weather, when it is desired to give the birds increased warmth by feeding them mashes mixed with hot water; it is also recommended for fattening purposes, especially for the finishing period.

*Advantages.*—When care is used and this ration is fed properly, it is probably a little more productive of results, as the birds are induced to eat more.

*Disadvantages.*—More labor is required in mixing and feeding; if not fed with a great deal of care, and if allowed to become sour or moldy, it may produce indigestion and diarrhoea. If the troughs are not very large, it does not give each bird an equal chance. This method requires constant attention to the details of feeding, careful watching of the condition of the birds, and the practising of absolute cleanliness.

*General Usage.*—This method is usually practised on small farms where flocks are small, and where there is sufficient time for the feeder to do the work properly. It is sometimes used on large plants in connection with dry mash during the winter. It is always practised in the fattening of poultry.

**Hopper Feeding of Dry Mash.**—This method is one of the best in the feeding of large flocks when it is desired to lessen the amount of labor, and especially in feeding concentrated parts of the ration to laying hens. One important factor in the hopper feeding of dry mash is that a successful hopper be used. The essential factors of a desirable hopper are given in Chapter VIII.

*Advantages.*—When dry mash is fed in the right kind of a hopper, it saves much labor. The diet itself is very helpful from the standpoint of digestion. It does not require such careful

study or attention on the part of the feeder, and it allows the birds themselves a greater freedom in arranging and balancing their own diet. It also allows of perfect cleanliness in feeding.

*Disadvantages.*—This method is wasteful if not fed in the correct type of hopper; for this reason great care should be used in the making or selection of a hopper. In some instances it has been noted that birds, not accustomed to dry-mash feeding for a considerable period, eat very little, and do not relish what they do eat. This can usually be corrected gradually, and at an early age.

*General Usage.*—This system is in general use on large commercial plants. In most cases it is used to supplement the feeding of cracked grains in litter. It has supplemented or almost entirely taken the place of wet-mash feeding on all egg farms.

**Scratch Feeding of Ground Grains.**—This method of feeding is very profitably used to supplement the feeding of dry or wet mashes. It may also be used as an exclusive ration when birds show excessive gain in weight, as it induces a larger amount of exercise. When it is desired to check maturity, this method is sometimes employed. To get the greatest benefit, the grains should be scattered in some good scratching material which should be clean and dry and four or more inches deep. It should be coarse enough to hide the feed, but not so coarse or bulky that the birds cannot move it by scratching to find the grains. Materials often used for this purpose are straw, shavings, cut corn fodder, and dry leaves.

*Advantages.*—There are several advantages of this system of scratch feeding. It induces the birds to exercise, thus increasing circulation and keeping up vigor. It also keeps them in good flesh, especially in the case of old hens, by not allowing them to get too fat. It enables the attendant to study the condition of the birds. Considerable labor is required in feeding by this method, but the general practice of cutting down labor can be carried to an extreme by the use of too many automatic or labor-saving devices. This daily feeding of grain in litter offers one of the general methods whereby the feeder can keep in touch with his flock.

*Disadvantages.*—During certain seasons of the year the litter may get damp and moldy. After drying, dust is increased in the house while the birds are scratching, and this is apt to cause the development of certain fungous diseases. This trouble can be avoided by the use of clean, sweet litter.

*General Usage.*—Scratch feeding is used to supplement dry-mash feeding on large utility plants, and nearly every such flock of adult birds in the entire country is fed at some time of the day by this system.

**Hopper Feeding of Cracked Grains.**—In some cases it is difficult to secure good litter for the floor of the house, or it is desired to reduce labor of daily feeding; then it may be well to use large hoppers for feeding of cracked or whole grains. For growing chicks on the range, the feeding of cracked grains from self-feeding hoppers is a very common and efficient practice, greatly reducing the labor and increasing efficiency.

*The advantages* attendant on this method are the reduction of the labor item; and, where no litter is present, it causes the birds to exercise to a limited extent.

*Disadvantages.*—Hoppers used for this purpose are usually of commercial types, and it is found in actual practice that they do not always work properly, which results in the birds being neglected. In some cases they feed too abundantly. It eliminates almost entirely the personal attention of the poultryman, which is so essential. It does not provide enough physical exercise.

*General Usage.*—This system is rarely used with laying stock, but is quite generally used on the range in the rearing of the growing chicks. It is sometimes used on utility plants to supplement the night feeding of cracked grains in litter.

**The Best System.**—For the average laying flock the best system to follow, both winter and summer, is a combination of scratch feeding of cracked grains in deep litter at night, and the hopper feeding of dry mash. This requires the least amount of labor consistent with the greatest efficiency and the proper personal attention.

**Simple Laying Rations.**—Only laying rations will be discussed in this case. Rations for other purposes are given in the chapters that deal with those particular phases of the work.

*New Jersey Rations.*—The following is the New Jersey dry mash, with the supplemental rations which are designed for the complete feeding of laying hens throughout the winter and the modifications necessary for summer feeding.

The quality of the different brands of meat scrap is very variable, and should a lower grade with less protein and more fat be used it would raise the nutritive ratio slightly.

This mash is kept before the birds all the time in large self-feeding hoppers.

TABLE XI.—*Dry Mash, Mixture No. 1.*

Kind of feed.	Amount by weight.	Amount by measure.	Dry matter.	Ash or mineral matter.	Protein.	Carbo-hydrates plus fat x 2¼	Cost. (1913).
	<i>Lbs.</i>	<i>Qts.</i>	<i>Lbs.</i>	<i>Lbs.</i>	<i>Lbs.</i>	<i>Lbs.</i>	
Wheat bran . . . .	200	380	176.0	11.6	24.2	90.6	\$3.20
Wheat middlings	200	240	176.0	7.6	25.6	121.4	3.50
Ground oats . . . .	200	200	178.0	6.0	18.4	113.6	3.30
Corn meal . . . . .	100	95	89.0	1.5	7.9	76.4	1.65
Gluten meal . . . .	100	80	92.0	.8	25.8	65.6	1.70
Meat scrap, high grade . . . . .	100	86	39.3	4.1	66.2	31.1	3.00
Alfalfa, cut short	100	200	92.0	7.4	11.0	42.3	1.60
Total . . . . .	1,000	1,281	892.3	39.0	179.1	541.0	17.95
Average to pound . . . . .	.....	1.28	.892	.039	.179	.541	.018

Nutritive ratio, 1 : 3.02.

The above dry mash is designed especially for the feeding of White Leghorns. Where heavier breeds are kept, such as Plymouth Rocks or Wyandottes, the tendency will be to take on an excess of fat. Under these conditions it is the best policy to restrict the amount of mash eaten by leaving the hopper open during the afternoon only, thus inducing the birds to work more for the grain fed in the litter.

During the molting season, or in the months of July, August, and September, oil meal is substituted for the gluten in the same proportion, to hasten the growth of feathers. In the spring, as soon as the birds get out on green grass, the alfalfa can be gradually omitted. Meat scrap is gradually reduced in amount as soon as the birds get out on free range and can find insects and worms. The extent to which the above mash can be changed or reduced during summer will depend upon the character and amount of range which the birds have during that time.

The following modification of the New Jersey dry mash is very economical for summer feeding, the change from one to the other being made gradually as soon as the birds are on free range with plenty of forage:



TABLE XII.—*Summer Dry Mash, Mixture No. 1A.*

Kind of feed.	Amount by weight.	Amount by measure.	Dry matter.	Ash or mineral matter.	Protein.	Carbo-hydrates plus fat x 2¼.	Cost. (1913).
	<i>Lbs.</i>	<i>Qts.</i>	<i>Lbs.</i>	<i>Lbs.</i>	<i>Lbs.</i>	<i>Lbs.</i>	
Wheat bran.....	200	380	176.0	11.6	24.2	90.6	\$3.20
Wheat middlings	100	120	88.0	3.8	12.8	60.7	1.75
Ground oats.....	100	100	89.0	3.0	9.2	56.8	1.65
Gluten meal.....	50	40	46.0	.4	12.9	32.8	.85
Meat scrap.....	25	21	22.3	1.0	16.5	8.0	.75
Total.....	475	661	421.3	19.8	75.6	248.9	8.20
Average to pound.....		1.39	.887	.04	.158	.524	.017

Nutritive ratio, 1 : 3.22.

As supplemental to the dry mash, the following scratching ration of whole grain is fed about 9 o'clock every morning in deep litter. Its primary object, aside from its nutritive value, is to induce exercise. About five pounds of the scratching ration is fed to each 100 birds on the floor of the house or under some shelter, where the litter is dry and where there is protection from cold winds.

TABLE XIII.—*Scratching Ration, Mixture No. 2.*

Kind of feed.	Amount by weight.	Amount by measure.	Dry matter.	Ash or mineral matter.	Protein.	Carbo-hydrates plus fat x 2¼.	Cost. (1913).
	<i>Lbs.</i>	<i>Qts.</i>	<i>Lbs.</i>	<i>Lbs.</i>	<i>Lbs.</i>	<i>Lbs.</i>	
Wheat.....	100	53	90	1.8	10.2	73.0	\$2.20
Clipped oats.....	100	98	89	3.0	9.2	56.8	1.93
Total.....	200	151	179	4.8	19.4	129.8	4.13
Average to pound.....		.755	.839	.024	.097	.649	.0206

Nutritive ratio, 1 : 6.6.

In the afternoon, about four or five o'clock, depending on the season, a "night ration" is fed, composed of whole grains and cracked grains at the rate of ten pounds to each 100 birds.

It will be noted that this manner of feeding gives to the birds the materials suitable for supplying the heat to the body during

the night. The night ration given is designed for White Leghorns; when feeding heavier breeds, it is better to eliminate one-half of the cracked corn and to substitute barley for the buckwheat. During the summer months a night ration of equal parts of cracked corn, wheat, oats, and barley is given, the amount depending on the size and condition of the range.

TABLE XIV.—*Night Ration, Mixture No. 3.*

Kind of feed.	Amount by weight.	Amount by measure.	Dry matter.	Ash or mineral matter.	Protein.	Carbo- hydrates plus fat x 2¼	Cost. (1913).
	<i>Lbs.</i>	<i>Qts.</i>	<i>Lbs.</i>	<i>Lbs.</i>	<i>Lbs.</i>	<i>Lbs.</i>	
Cracked corn.....	200	120	178	3.0	15.8	152.8	\$3.30
Wheat.....	100	53	90	1.8	10.2	73.0	2.20
Clipped oats.....	100	98	89	3.0	9.2	56.8	1.93
Buckwheat.....	100	66	87	2.0	7.7	53.3	2.00
Total.....	500	337	444	9.8	42.9	335.9	9.43
Average to pound.....		.674	.888	.019	.085	.671	.018

Nutritive ratio, 1 : 7.8.

A good rule in feeding the night ration is to feed all that the birds will eat, or rather more, so as to have a little left for them to go to work on in the morning. A good feeder will occasionally go among the birds at night when they are on the perches and feel their crops. If they are not full early in the evening, he will conclude that either the layers are not getting enough or that they have lost their appetite. In either case, the defect should be immediately corrected.

Twenty birds, if fed dry mash and scratch feed, will receive during the winter months the following nutrients per day:

Lbs.	Protein.	C.H. plus fat.	Cost.
8.0	1.1	4.87	\$0.14

The yearly cost of feed averages about \$1.40 per bird.

The feeding of some succulent material in addition to this ration cannot be too strongly recommended.

*Cornell Rations.*—The following complete rations for laying hens are recommended by the poultry department of Cornell University.

“The fowls should eat about one-half as much mash by weight as whole grain. Regulate the proportion of grain and ground feed by giving a light feeding of grain in the morning and about all they will consume at the after-

TABLE XV.—*Whole-Grain Mixture fed Morning and Afternoon in Litter.*

By weight, winter.	By measure, winter.	By weight, summer.	By measure, summer.
60 lbs. wheat	32 qts. wheat	60 lbs. wheat	32 qts. wheat
60 lbs. corn	36 qts. corn	60 lbs. corn	36 qts. corn
30 lbs. oats	30 qts. oats	30 lbs. oats	30 qts. oats
30 lbs. buckwheat	20 qts. buckwheat		

TABLE XVI.—*Dry Mash fed in a Hopper, open Afternoons only.*

By weight, winter and summer.	By measure, winter and summer.
60 lbs. corn meal	57 qts. corn meal
60 lbs. wheat middlings	71 qts. wheat middlings
30 lbs. wheat bran	57 qts. wheat bran
10 lbs. alfalfa meal	20 qts. alfalfa meal
10 lbs. oil meal	8 qts. oil meal
50 lbs. beef scrap	43 qts. beef scrap
1 lb. salt	½ qt. salt

noon feeding (in time to find grain before dark). In the case of pullets or fowls in heavy laying, restrict both night and morning feeding to induce heavy eating of dry mash, especially in the case of hens. This ration should be supplemented with beets, cabbage, sprouted oats, green clover, or other succulent feed, unless running on grass-covered range. Grit, cracked oyster shell, and charcoal should be accessible at all times. Green feed should not be fed in a frozen condition. All feed and litter used should be strictly sweet, clean, and free from mustiness, mold, or decay. Serious losses frequently occur from disease, due to the fowls taking into their bodies, through their intestinal tract or lungs, the spores of molds."

*California Rations.*—The following are two dry-mash formulas recommended by the California Station: "They are calculated for 100 hens a day, and if fed with nine to twelve pounds of grain, according to weight of hens, and some green stuff, they will form a well-balanced ration. The mash may be fed wet or dry."

	Quarts.	Pounds.		Quarts.	Pounds.
Bran.....	6.0	3.0	Bran.....	4.0	2.0
Middlings.....	.5	.5	Alfalfa meal.....	1.0	.5
Linseed meal O. P..	.5	.5	Corn meal.....	1.0	1.5
Gluten feed.....	.8	1.0	Shorts.....	2.0	1.5
Ground oats.....	1.0	.75	Barley meal.....	1.0	1.1
Corn meal.....	1.5	2.25	Ground beans.....	1.0	1.1
Beef scrap.....	1.0	1.50	Beef scrap.....	1.0	.5
Coarse bone meal...	0.5	1.00	Coarse bone meal...	.5	1.0

10.50

9.2

"Salt should be added to every mash, about an ounce being sufficient. Pepper may be added occasionally. Fresh lean meat may be substituted for beef scrap in any of the formulas, three quarts of the fresh being equal to one of the dried. Cottage cheese may be substituted in the same proportion, except that it is advisable not to replace all of the meat, one-half quart beef scrap and one and a half quarts cottage cheese being a much better proportion. The equivalent in pounds is given for convenience in ordering. The quarts represent the amount for 100 hens and may be multiplied or divided *ad libitum*."

### REVIEW.

1. Give points to consider in the location of the feed house.
2. Give two important points in the design of the feed house.
3. Give the special equipment necessary to equip the feed room properly.
4. Define ration. What does it include?
5. Tell of the necessity of having sufficient nutrients in a ration.
6. Why is a certain proportion with respect to nutrients necessary?
7. What is the meaning of the term nutritive ratio? Give example.
8. What is potential energy as related to feeds? How can it be quickly determined?
9. Define balanced ration.
10. Discuss the need of succulence in a ration.
11. What is the effect of varying degrees of palatability?
12. Discuss bulkiness in poultry rations.
13. What is meant by an economical ration?
14. Explain how to find the cost price of a pound of protein in any purchased feed. Give examples.
15. How does ease of mixing and storing affect the economy of feeding?
16. Of what use is personal attention in feeding?
17. Enumerate the functions of grit, shell, charcoal, and salt.
18. Mention four systems of poultry feeding.
19. Discuss possibilities and usage of each of the four systems.
20. Give the advantages and disadvantages of each.
21. Outline the best combination of these systems.
22. Outline a complete system of feeding laying hens.
23. Give the rations and amounts for one of the States mentioned in this chapter.

**References.**—Four Methods of Feeding Early Hatched Pullets, by James E. Rice, Cornell Bulletin 249. Feeding for Eggs, by James Dryden, Oregon Reading Course, Lesson 3. Feeding for Egg Production, by J. S. Jeffrey, North Carolina Bulletin 211. Feeding for Winter Eggs, Pennsylvania Extension Circular 11. Feeding Laying Hens, by James E. Rice, Cornell Reading Course, Bulletin 17. Rations for Poultry, by James E. Rice, Cornell Reading Course, Bulletin 18. Forcing the Moults, by Stewart and Atwood, West Virginia Bulletin 83. Methods of Feeding Poultry, in the United States Farmers' Bulletin 244. The Forced Moulting of Fowls, in United States Farmers' Bulletin 412.

## CHAPTER XIII.

### PRINCIPLES OF POULTRY BREEDING.

**Poultry Breeding.**—By poultry breeding is meant the science which treats of the reproduction and improvement of the domestic fowl. It may be said to be both a science and an art. It is truly a science in so far as it deduces and systematically applies facts and principles as they are demonstrated. It is an art in so much as the knowledge and experience thus acquired and the principles deduced may be utilized for the continued improvement of the animals.

A few and rather hazy suggestions pertaining to the improvement of fowls have been handed down from remote ages, but most of the earlier work on animal breeding was carried on with larger and more easily recorded domestic animals. In recent years many of the principles which govern successful breeding have become better understood, and the knowledge obtained has been more thoroughly disseminated than ever before, largely owing to the fact that experiment stations are making a special study of this science, and in many instances are using poultry as the study medium. As a rule, it may be stated that the laws of breeding which apply to all animals are equally applicable to poultry.

**Breeding a Complex Problem.**—Breeding is not an art which can be learned entirely from books or from the study of results obtained by a few crossings or matings; it is acquired by experience and by the actual study of the progeny resulting from such matings, generation after generation, and in large numbers.

To be successful, one must be familiar with the subject from both points of view, theoretical and practical. It is impossible to apply principles to a profitable use until they are thoroughly understood. These scientific principles have, in great measure, been derived directly from the methods of the more successful breeders, and hence are fundamental.

**Need of Improvement.**—The improvement of the flocks of poultry which are found in greater or less numbers on practically all American farms has not received the attention which it merits, and which the results from such improvement would warrant. The breeding of poultry in a practical way has been left almost entirely

to the fancier, who keeps a smaller number of birds and aims to secure color pattern rather than utility qualities. This tendency is changing in recent years, and the value of well-bred birds for egg production and market poultry is becoming better appreciated.

The chief reason for the lack of interest in the improvement of poultry has been the fact that most farmers regard the raising of poultry as a side issue, and hence give it little consideration. Another cause is the erroneous view which many farmers take in regarding the value of the products, and the possibilities offered through study and improvement, as matters entirely too small to deserve attention.

Many of our most successful keepers still believe that improvement can best be brought about through feeding, and that selection, when practised, is not rigid enough or along the lines which would insure direct improvement.

The birds of any poultry flock, wherever kept for profit, should be considered and treated as machines,—living machines, which, when given raw material in the form of feed, will transform it into finished agricultural products, such as eggs and meat. These manufactured products represent great value in small bulk, and can be shipped great distances at little cost. In the production of market eggs this concentration of the finished product is very noticeable. One dozen eggs weighing about twenty-four ounces ( $1\frac{1}{2}$  lbs.) contain more human food material than the same weight of milk.

TABLE XVII.—*Composition of Eggs Compared with Milk.*

24 ounces ( $1\frac{1}{2}$ lb.)	Water.	Ash.	Protein.	Carbo- hydrates.	Fat.	Dry matter.
	Lbs.	Lbs.	Lbs.	Lbs.	Lbs.	Lbs.
Eggs.....	0.99	0.18	0.16	0.00	0.12	0.46
Milk.....	1.30	.01	.05	.07	.05	.18

If the domestic hen is to be considered as a machine, and if the most profitable returns are to be realized from her, this machine must be carefully selected, and trained to the highest degree of efficiency. If a bird of a certain type will lay more eggs in a year, of larger and more uniform size than another bird, and meet all the requirements of the egg market, this type should be given the preference by egg producers. Again, if one type or breed of birds

produces more and better flesh in a given time, hence yielding a larger return when put on the market, this particular type should be selected and improved for market poultry.

The aim should be to choose the type of machine best adapted to the desired purpose; then, by breeding and selection, to develop this machine into the most economical transformer of raw material into the desired product that it is possible to secure.

**Great Aim in Poultry Breeding.**—The foremost aim in poultry breeding should be the improvement of poultry in those qualities which have a definite market value; as, increased egg production, quality and quantity of flesh growth, and perfection of color pattern. All these qualities are associated more or less with perfection of proportion or symmetry of the individual, and any improvement which is continuous and which progresses toward a given ideal will materially improve the general appearance of the progeny and conduce to uniformity.

**Problems of the Poultry Breeder.**—There are certain questions which stand out clearly before the mind of a practical breeder and represent the problems which he must attempt to master. With our present limited knowledge many of them cannot be definitely answered, yet a clear comprehension of the problems involved will lead to a better understanding of the subject and make possible a systematic plan. These problems may be grouped as follows:

1. To what extent are the characteristics of the particular individual at maturity due to its ancestry or heredity, and to what extent are they due to environmental conditions, such as feed, climate, and housing?

2. What is the exact appearance which inherited characteristics assume when transmitted to future generations?

3. May characteristics of the individual due to environment be transmitted?

4. What are the possibilities of controlling variation through selection?

5. Does improvement in egg production come about by raising the standard absolutely, or is the general average raised by eliminating the poorer producers? That is, is it possible to improve the best, or must the mass be brought up to a higher level?

6. What are the proper standards in selecting for a definite purpose?

7. To what extent can individual performance be made the basis for selection?

8. What is the relative influence of sire and dam upon transmitted characteristics,—say in egg production?

9. To what extent does the condition of parents at the time of service affect the offspring?

10. To what extent may conditions previous to and during incubation affect the offspring?

11. What are the advantages and disadvantages of inbreeding, line breeding, and out-crossing?

12. How can definite and practical results be secured with the least expenditure of time and numbers?

Upon the answers to many of these problems depend the future methods of poultry breeding. Our information is complete on many points, yet other scientific knowledge is wanting. Much labor is being expended in the solving of these problems; meanwhile the breeder must utilize the material at hand as best he may. The summary following in this chapter will, in a general way, cover the present knowledge of the subject.

**Basis of Value in Poultry.**—The basis of value in poultry keeping is the power of the individual to produce a given product at a profit. The relative value of the individual depends upon its adaptation to one or more particular uses and the returns which it yields above the feed consumed. For example, the best laying hen is the one which converts the largest amount of feed into eggs of the best quality with the least possible waste of the feed consumed. While a large consumption of feed is necessary to heavy production, it is not in itself a guarantee of heavy production. The mongrel hen is often a heavy consumer of feed; but, owing to the fact that her bodily functions are not developed sufficiently to turn every atom of feed not required for maintenance into eggs, she does not yield a profit. A certain amount of feed is required to maintain the body, and observation proves that the individual which consumes the most feed in proportion to its live weight will, in the majority of cases, be the most profitable; hence the necessity of studying individuals closely, and breeding from those which possess the qualities to be desired in their young.

The records of a few noted hens show what breeding and selection will do; and also show that in order to increase the productive, or basic, value of poultry, one must study the individuality of his flock, and mate from the very best, with the idea of eliminating the poorer birds and of intensifying in the progeny the desired qualities which are pronounced in the selected parents.



**Fundamental Principles.**—As a science, breeding is both complex and varied. This is in part due to the obscurity surrounding many of the phenomena, and to the great degree of variation in results obtained under apparently the same conditions, also in part to the influence which the purity of the individual exerts, as shown in the results of future transmission.

Fortunately, however, the fundamental principles of the science of breeding, the complete understanding of which is essential to success in practical breeding, are few in number, and readily understood. These principles are as follows:

1. Decide upon a standard of excellence, which may be either real or imaginary, and always breed toward it.

2. Always breed from parents both of whom conform as closely as possible to this standard.

3. Always breed from parents which are as purely bred as it is possible to obtain them,—that is, birds which have long been bred without the addition of alien blood.

4. Study the individuals, and endeavor to mate them so that the faults of the parents will be corrected in the offspring.

5. Practise a rigorous selection from hatching time to maturity, and especially when mating the breeding hens.

6. Always consider environment, such as housing and feeding conditions.

Breeding toward a standard of excellence gives the breeder a guide by means of which he can frequently estimate his progress. By following this guide without deviation definite results may be much more quickly attained. The standard may be written or it may be carried in the mind of the one engaged in breeding. In the former case, one prepared by an association is generally used. At the present time the American Poultry Association publishes the "American Standard of Perfection," in which are given the requirements of all standard-bred poultry. In the absence of this standard the high excellence and uniformity now attained, as seen at the large poultry shows, would be impossible.

The necessity of breeding only from parents which conform as nearly as possible to the standard is based on the law of heredity—that like produces like, and that, in order to secure a given progeny, the more nearly the parents conform to the standard the greater are the chances that the offspring will develop the desired qualities.

The study of the science of breeding has shown that with an increased admixture of alien or foreign blood there is always a pro-

portionately greater variation in the transmitted qualities; hence the necessity of breeding from parents as purely bred as it is possible to obtain them. By eliminating alien blood the desired properties become dominant, so to speak; that is, they become intensified, and there are fewer contending characteristics to crowd them out. The longer a family of individuals can be bred purely, so much more powerful will its dominant traits become. (The mating and selection of individuals is discussed in the next chapter.)

The influence of environment on future generations is important. All conditions and operations included in the care and management of birds will more or less influence the individual, and also leave their mark upon the offspring; lack of proper environment may tear down and soon destroy all that has been accomplished by years of hard work in selection and breeding; hence the necessity of understanding the natural requirements of the birds before practising or experimenting with the laws of breeding.

**Controlling Factors.**—The influences which are active in the propagation or breeding of poultry are numerous and varied. They may be grouped under three heads:

All characteristics which are transmitted from parent to offspring, this group being termed *inheritance*.

All characteristics which are due to external conditions surrounding the individual, these being termed *environment*.

All characteristics which are functional in nature, and in many cases influenced by man's activities. In demonstration these functions are nearly all influenced directly by man, while in the wild state they are given freedom of exercise. This group may be termed *functional activities*.

*Inheritance.*—Inheritance, in the sense here used, is a much broader term than when employed to define the law of heredity. It embraces all the powers, qualities, and characteristics which are transmitted from the parents to the progeny through the egg, the combining or merging of traits possessed by both male and female into one, and the new characteristics of the resulting chicks.

This factor of inheritance affects or influences a great variety of conditions. Among these are the shape and size of the body, and the quality and color pattern of the plumage; all internal bodily functions, such as the development of the digestive system, the power of the circulatory system, and the capacity of the respiratory system; the texture and structure of muscles, bones, and

ligaments. It also affects the habits of the future progeny, their capacity for consuming feed, and indirectly their power of reproduction.

Disease is both directly and indirectly transmitted. In the former case diseases which attack the reproductive organs, such as white diarrhoea, are directly transmitted through the egg to the resulting offspring. In other instances diseases, such as tuberculosis and cholera, by affecting the parent tend to generate in the progeny a weakness of that organ or group of organs which makes the offspring more susceptible to the infection of that particular disease. The specific germs of such diseases are not inherited, yet the predisposition is. It is this factor of inheritance which marks out an orderly and progressive path for the development of poultry breeding, and enables the fancier and utility breeders to show every year a systematic advance in the methods of mating their best birds.

*Environment.*—From the time the egg is laid it is susceptible to external conditions, such as temperature, moisture, and physical changes. These factors are entirely different from the group previously mentioned, as they can be directly influenced or regulated by man. If the embryo is to develop normally and regularly during the incubation period, and the chick be successfully hatched, these external factors of temperature, moisture, and purity of air, as well as certain physical changes, must all be regulated or borne in mind.

The external conditions, such as shelter and feed, which exist immediately after hatching, influence to a great extent the characteristics of the progeny at maturity, and they affect indirectly the future breeding possibilities of the individual.

All the problems of environment can be most safely solved by planning everything with a view to the comfort of the birds; otherwise, their growth will not be satisfactory, nor can they be expected to produce a profitable quantity of eggs.

Cleanliness and sanitary surroundings are very essential, as they tend to minimize the danger of communicable diseases and create an atmosphere of contentment.

Maintenance of favorable environment is very important during the brooding and rearing period, for a low brooder temperature will chill the young and cause crowding, which will result in weakly developed chicks, if not in their immediate death. Later, during the growing period and when on the range, they need a large area of shade, and an abundance of nourishment, including green feed,

if the blood elements which they inherited from their parents are to be given an opportunity for full development.

Another important factor in the environment is the supply of feed, which must be sufficient in amount, wholesome, and of the right degree of concentration. Instances have been known in which the excessive forcing of mature birds during their first laying season had so weakened their vitality that their records in egg production were not nearly as high as those of their parents, whereas, after selected mating and breeding, they should have excelled them if conditions had been right. Birds which are kept by man in a state of domestication are dependent upon him for shelter and feed, which largely make up their environment, and a careful and proper regulation of this is essential if the inherited qualities are to be given opportunity for their highest development.

*Functional Activities.*—From the time the chick is hatched, the degree of development which it will ultimately attain depends in large measure upon the extent to which it performs its normal bodily functions. The normal activity of an organ increases its power to perform its function in a healthy and normal manner. For example, the blacksmith by the constant use of his right arm gradually attains a greater muscular development in this than in the other arm which does not get this regular and systematic exercise. In a similar way the poultryman may, by careful handling and feeding of his birds and by allowing them sufficient exercise, keep them in a normal and healthy condition. Should he restrict their exercise, and increase the concentrated feed stuffs, such as corn meal, the birds would soon become lazy, take on excessive fat, and gradually become poorer and poorer layers until the function would finally cease. If the conditions were not corrected, the functional activities of the body would become congested and clogged and death would result.

In the same way it is possible to develop excessively the growth and maturity of certain organs; as, for instance, in the forcing of pullets for early maturity. The egg-forming organs are stimulated to activity before they attain their normal development, and the resulting eggs are small in size, in many instances containing weak germs, especially if the pullets are mated to males of early development. Their eggs when hatched will produce chicks small in size and of light weight, many of them cripples and weaklings. Not only will the eggs be small, but the bird itself, because of its early maturity, will never attain the size and shape which would

have been possible with a slower bodily development and later maturity. Thus we see the folly of attempting to force early laying at the expense of other functions of the body. The aim should be to give the bodily functions every incentive to healthy, normal growth and maturity, after which time, with the strength and vitality incident to strong functional activity, the greatest usefulness of the individual can be expected.

**Laws of Breeding.**—There are certain definite laws which govern breeding, but in the science of breeding many principles and interpretations either remain undiscovered or cannot in every instance be explained. The purpose in the following sections will be to outline some of the more fundamental laws, and assist the student to such an understanding of the knowledge of to-day as will enable him to pursue the art of breeding with a clearer insight and with greater certainty of success.

Many of the laws or rules of breeding which have been expressed scientifically during the last two hundred years had been previously handed down from generation to generation in traditional form. The fact that early statistics were not kept in definite form militated against the general diffusion of knowledge of results, and is partly responsible for the slow development made in the study and progress of the science of breeding prior to the last two centuries. In recent years more progress has been made and many principles established.

**Law of Heredity.**—The law of heredity as usually stated is: *Like begets like*. It implies that the characteristics of the parent will appear in a more or less marked degree in the offspring, and refers directly to the transmission of individual characteristics to future generations. Heredity is too broad a term to apply merely to one individual parent or offspring, but should include a group of individuals which constitute the parentage, as well as a group of offspring. The law of heredity and the principles for which it stands are fundamental to all breeding operations. The poultry breeder must become familiar with all that concerns preceding generations in order properly to plan for and achieve results in succeeding generations. The difficult problem confronting the student is to determine or predict to what degree the progeny will resemble the parent, since many factors are at work which may cause variations from the type, and also produce entirely new traits and characteristics.

**Practical Examples.**—When applied to classes of poultry, the law that "like begets like" finds ample illustration in the dis-

tinctive peculiarities common to different breeds. Each of the eleven different groups into which all birds have been divided has its distinctive peculiarities. These relate to physical form, color, and functional development. This is further seen in the division and subdivision of each breed into varieties. So strong may be the resemblance between them that it is often possible, from a flock of considerable number, to pick out daughters or, more often, sons from a given mating, because they possess certain family or mating characteristics peculiar to one or both of the parents. These resemblances are not accidental, but are the direct expression of this, the greatest law of breeding.

**Benefits from this Law.**—The actual benefits from this law may be grouped into three divisions:

It makes possible the improvement of poultry by breeding to a fixed standard. The highest degree of perfection which it is possible to attain will probably never be reached so long as the standard of excellence is only gradually raised.

It enables breeders to maintain improvement after it is once established. Everywhere in nature there is a strong tendency toward deterioration, and the proper manipulation of individuals by the action of this law will aid in checking this retrograde tendency. Poultry, if neglected for even one or two generations, are especially susceptible to this process of deterioration, the degree depending upon the vitality and purity of the blood when the race was at its best.

By the action of this law it is possible to fix new types and standards after they have once been created by a selection of variants. The tendency of poultry breeding in the past has been to attempt to create new breeds. In many cases the breeder did not clearly understand just what type he was after, or the exact value of a desired characteristic, could it be secured. The result is that we have to-day a great many breeds of poultry which are duplicates in many respects. The great need in the immediate future is the improvement of well-established breeds rather than the creation of new ones.

**Heredity in Cross Breeds.**—By *hybridizing* is meant the crossing of two varieties, or breeds, the object being to produce a combination of the desirable qualities of the two. At some future time the qualities of three or more breeds may be combined. For example, let us suppose that a breeder who had produced an excellent strain of single-comb White Leghorns found that, owing to the

excessive size of the comb and its becoming frosted, the productivity of the individuals was impaired. He desired to remedy this by replacing the single comb with a pea comb, but in order to do this it would be necessary to cross his birds with Indian Games possessing finely developed pea combs. The pea-comb trait would be fixed in the early generations, since this is a dominant character. It would require, however, many generations of breeding and selection to eliminate the color pattern which was brought into the flock by the intermixture of the game blood.

In a study of characters which may possibly result from hybridizing and the frequency of their occurrence, knowledge of Mendel's law will be helpful.

**Mendel's Law.**—Mendel's law states that, when crossed forms or hybrids are bred together the opposing characters possessed by the original parents tend to combine in definite proportion. The offspring from such hybrid individuals (AB) will assume the algebraic form  $A^2+2 AB+B^2$ . In the formula A represents one of the contrasting characters, while B represents the opposite trait. This formula means, in numbers, that, out of every 100 chicks resulting from a cross, twenty-five will possess one of the characters, or will be pure A, twenty-five will be pure B, while the remaining fifty (represented by the figures 2 AB) will be a mixture of the two opposing characters.

Mendel's law also states that where there is a pair of contrasting characters,—for example, single comb and rose comb,—one will be dominant over the other, the result being that a majority of the progeny will show this dominant character. The other opposing character is termed *recessive*, for it recedes from view in the presence of the stronger or more prominent one. Dominance of a character does not imply that the recessive one is absent, but simply that in the development of the new individual the dominant character is bound to appear. A pigmented condition of the plumage is dominant over absence of pigment; an extra toe is dominant over a normal number; feathers on the shanks are dominant over their absence, the rose comb over the single comb, and so on through a great variety of characters. Only one pair of contrasting characters is to be considered at any one time. This second phase of Mendel's law may be expressed by the following formula:

$$D^2+2 Dr+R^2$$

$$\frac{1}{4}+\frac{1}{2} +\frac{1}{4}$$

D, being the dominant character, will be present in three-fourths of the progeny. In one-fourth of the progeny represented by  $D^2$ , the character will be pure. In one-half represented by 2 Dr, it will be mixed with the recessive, but, owing to its dominance, will suppress the recessive (as to appearance). The other one-fourth of the progeny,  $R^2$ , will have only the recessive character.

If the breeding of individuals resulting from the first cross be continued, interesting phenomena of this law will appear.  $D^2$  and  $R^2$  will continue indefinitely to breed true if bred to themselves, as they respectively contain only pure dominant and pure recessive characters. Mendel's law refers specially to the hybrids or the apparently crossed portion of the progeny represented by 2 Dr.

When individuals of the Dr group are bred together, their offspring will in turn be split in the same algebraic ratio of

$$\frac{D^2 + 2\text{ Dr} + R^2}{\frac{1}{4} + \frac{1}{2} + \frac{1}{4}}$$

which was apparent in the first cross when pure forms were allowed to breed together. This ratio will continue indefinitely when the hybrids of future generations are bred together. The same will hold true of the dominant and recessive characters possessed by the hybrids,—namely, that the dominant character will always show in the Dr group even when the recessive is also present. In this second generation  $D^2$  and  $R^2$  are pure and will breed pure. (They are technically called homozygotes.) The other individuals resulting from the same cross, represented by the letters 2 Dr, are hybrids like their parents (and are technically called heterozygotes).

From the above discussion it will be seen that, since the Dr group, or mixed group, always exhibit the dominant character, it is often a difficult problem to differentiate them from the dominant group  $D^2$ .

*To test a dominant*, mate it to a recessive, and if all the offspring are pure dominants no recessive character will appear. If this parent is not pure, but mixed, the offspring will be one-half dominant and one-half recessive, having followed the combination: (Dr) + (RR).

All hybrids which produce only pure dominant characters may



be used to start a pure race with such characters; hence, by the elimination of one recessive character at a time, it is possible to breed a race with special desired characters.

Mendel's law, from its complexity and apparent confusion, will not be of definite value to the average farm poultryman, yet it is essential that the student have a clear understanding of the subject in order that the behavior of characteristics in transmission can be better appreciated. The principles which the law presents have led to other important discoveries in the phenomena of breeding. Some of Mendel's deductions in his original records are discredited, owing to faulty analysis, yet the results of his work are more far-reaching than those attained by any other one man.

**Inheritance of Fecundity.**—The transmission of the character of producing a large quantity of eggs is one of the most important problems before the poultry breeder, and some valuable work is being done at agricultural experiment stations.

The discussions pertaining to the inheritance of fecundity, or egg production, as given here are based upon the work of Dr. Raymond Pearl at the Maine Station. Quotations and facts are taken from his papers on the subject; more especially, Maine Bulletin 192.

Among the leading biologists who are at present making a study of breeding problems, two general views are held as to certain fundamental principles of heredity: (1) The "statistical" conception of inheritance, and (2) the "genotype" conception of inheritance.

*The statistical* conception of inheritance is that point of view which assumes, either by direct assertion or by implication, that all variations are of equal significance, and consequently that all may be treated statistically as one homogeneous mass, provided that they conform to purely statistical laws of similarity.

In studying heredity in the past, the mistake has been made of noting a few individuals only, and these exceptional cases have often led to conclusions which are worse than useless because of their extreme range of variability. The advocates of this line of study use this as an argument in favor of their point of view, and make the statement that to study inheritance with any degree of reliability the race as a whole must be considered, and not simply the individuals which go to make it up. This method is comparatively new, especially when applied to poultry, and necessitates a large mass of material representing sufficiently large numbers of the breed under consideration to be actually representative.

The most extensive statistical work which has been carried on in America is that which was done at the Maine Station from 1898 to 1907. Here the practice was followed of breeding continuously, year after year, from the heaviest layers, regardless of all other considerations except vigor and health. The final results of this mass selection, after nine years' work, did not show that mass selection from high producers of eggs, on the basis of the trap-nest records of the individuals, brought about continuous improvement in the average flock production, or that the progeny from the heaviest layers were better producers than those from birds selected from the general flock. These may be considered "negative results."

The *genotype* conception of heredity, on the other hand, lays down the fundamental truth, firmly based on breeding experience, that two sorts of variations can be distinguished:

1. Those variations that are represented in the *germinal* matter, and are inherited without substantial modifications, as in pure lines.

2. Those characters that are *somatic*\* are not inherited. This group is not connected with germinal matter, but with the *soma* or body proper.

It is only possible by actual breeding tests to ascertain to just which group a given variation belongs.

The keynote to this latter conception of inheritance of fecundity comes from the analysis of individual pedigrees, by which method the behavior of each individual in inheritance can be determined. The leading thought in this new conception is, that the germ cell (egg or sperm) and not the body (or soma) is the factor of primary importance in generation. For example, the individual's body (somatic) characteristics are not determined by the body characteristics of its parents, but by the composition or constituents of the parental germ cells or gametes. Thus the size of a hen is not determined by the size of its parents, but by the gametic construction of the latter. Recent practical applications of this conception of the inheritance of fecundity have shown:

1. That the gametic make-up of the male is of greater importance than that of the female; since, in the average flock, the

---

\*"For the student not familiar with the technical terms of biology it may be said that somatic is a term used to designate those characters of the organism which pertain to all parts except the reproductive or germ cells. The reproductive cells are called gametes, and the adjective gametic means pertaining to germ cells, in opposition to somatic, which means pertaining to any or all parts of the organism other than the germ cells."

gametic constitution of the male is perceptible in all the progeny, while that of the female appears in a smaller percentage of cases.

2. That it is possible systematically to breed males with a high productive gametic constitution.

3. That in breeding to increase egg laying the production has been divided into two kinds,—namely, (a) normal or natural production, which takes place during the natural breeding season or spring months, the average in this period being about thirty eggs; and (b) excess laying period, which is possessed by fewer birds, and which represents from 100 to 175 eggs laid during the fall and winter. The problem, then, is how to breed birds which shall possess in their gametic make-up germ cells representing both of these periods.

4. That improvement in egg production comes about by raising the general average through elimination of the poor producers; or, in other words, by bringing the mass to a higher level, and not to any great extent by raising the standard and improving the best.

5. That in order to accomplish this improvement, as above outlined, it is necessary to know what has been the individual performance of the members of the flock for a number of generations in succession, and this can only be determined by keeping small breeding pens and by trap nesting.

While the application of the genotype theory is comparatively new, studies so far are in entire accord with it. They indicate, first, that fecundity in fowls is transmitted; second, that this inheritance is in accord with the genotype concept, even where it is almost impossible to establish true blood lines.

**Law of Variation.**—This law may be defined as the tendency of individuals to produce progeny which differ in type from either parent. It is constantly working in opposition to the law of heredity, and might be expressed as the law that “like does not produce like.”

In the light of present knowledge, the causes of variations are in many cases obscure. It will be noted, however that in many cases the progeny are not like the parent. In some instances the differences may be slight and exhibited only in one or two characters, while in others the variations may be very marked and cover a great variety of traits and forms. As applied to poultry two general principles are held:

1. That all characters, whether structural or functional, are exceedingly variable.

2. That ordinary variation is the result of a change in the relations between a number of closely associated characters brought

about by an alteration in one or more of them. This variation is not caused by, nor is it the result of, the introduction of an absolutely new character.

The fact that individuals do vary makes improvement possible through selection and breeding which would otherwise be impossible. Indeed, without this factor there would be no chance for either improvement or deterioration; the type would be fixed in all its characteristics.

Variations are of two kinds,—those which increase the usefulness of the individual and those which are undesirable or create

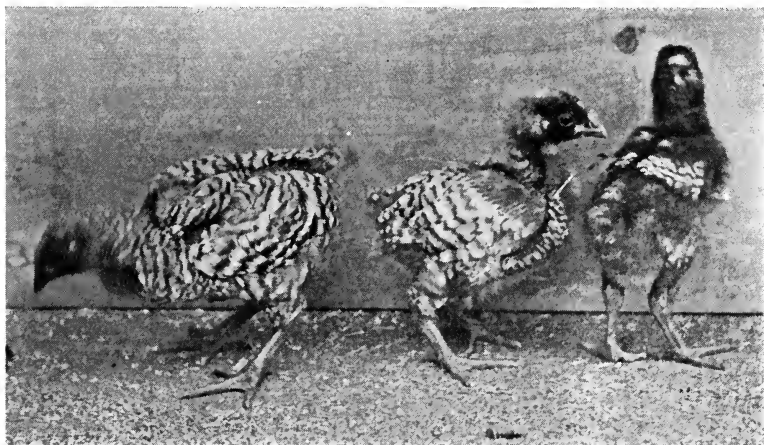


FIG. 120.—Barred Plymouth Rock chicks from the same mating and of the same age, showing morphological variation.

an inferior condition. It is the duty and purpose of the breeder to select and intensify desirable variations whenever possible.

**Types of Variation.**—The unit of variability is not the individual, but the breed; and different individuals in the same group are made up of different combinations of the same characteristics. The real unit of variation is, then, the racial characteristic, but the individual must be made the unit of selection. Four distinct types of variation have been found, and a clear perception of these is necessary for the intelligent study of the causes and behavior of variations. These types are (1) morphological, (2) substantive, (3) meristic, and (4) functional.

*Morphological variation* has to do with differences in form or

size which are quantitative in character. This type of variation is very common, a simple example being two chicks which are exactly alike except that one is larger than the other (Fig. 120). In this instance there is no difference in the characteristics of the two individuals, but merely the fact that in one growth had been more rapid and proceeded farther than in the other. This type of variation is especially important in breeding for large-sized birds for market poultry.

*Substantive variation* is shown by differences in the quality of different individuals as distinct from mere size and form. Such

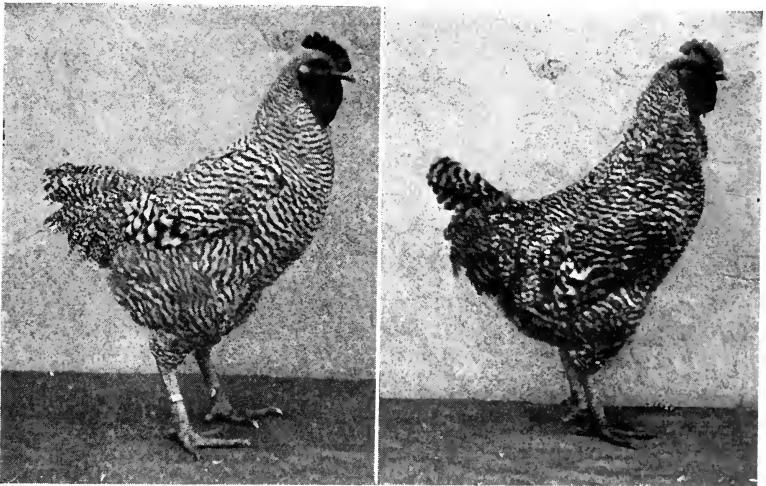


FIG. 121.—Two birds of the same parentage, showing variation in color only—an example of substantive variation.

variations are qualitative rather than quantitative in nature. This type of variation refers to the constitution or nature of the individual, and is manifested by differences between individuals of the same breed (Fig. 121) and between different breeds. In regard to the character of flesh, some are hard (Games) and others soft (Brahmas). In the quality and taste of the meat, wild and domestic species differ widely.

Birds of the same breed differ in their power to withstand cold. Individuals differ as to their power to resist certain communicable diseases.

Variations in color are dependent upon quality and are based upon certain chemical constituents in the feathers, or upon the refraction and reflection of light due to the character of the surfaces.

Substantive variations are undoubtedly of the greatest service in poultry breeding. They are closely associated with efficiency, utility, color pattern, quality of flesh and bone, color of flesh and skin.

*Meristic variation* represents alternations in the form or in the repetition of parts. It usually manifests itself by a departure

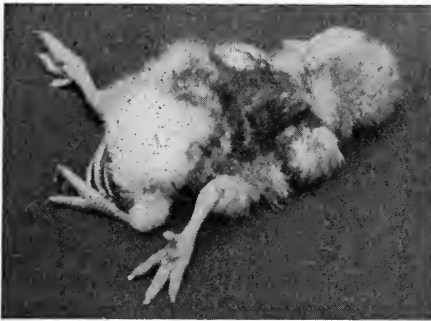


FIG. 122.—Chick with four legs—an example of meristic variation.

from the normal systematic or specific plan of the birds. For example, the normal chicken has two legs; the addition of other legs would constitute a meristic variation in the type (Fig. 122). Meristic variations are of little economic importance, as they usually appear as abnormalities which have no practical value. To the student of biology they

open up a vast field concerning the real nature of living matter.

*Functional variation* relates to alteration in the normal activity of the various organs or parts of the bird, such as muscular activity, glandular secretions, and the like (Fig. 123). It has to do, not with the form of the organs, but with their functions. The best examples of functional variation are the individual variation in egg production in females and the variation in the prepotency of males and their power to fertilize a given number of eggs. Functional activities are influenced, and variations caused, by many factors, among the more important of which are exercise, feed, improper environment, and care. All of these should be regulated by the careful poultry breeder, if his efforts in mating and breeding are to be followed by the fullest development and improvement.

*Mutations*.—Mutations, as distinct from ordinary variations, may be described as unlooked-for or accidental deviations from type. The new type formed is not the result of slow continuous selection and fluctuation, but, with no intermediate stage between the old type and the new, there is a sudden change of form. Muta-

tions are commonly called "sports"; they are of little economic value, owing to the impossibility of predicting their appearance and to the readiness with which they disappear. If inbred with the parent stock they frequently cease to reproduce. The better method for improvement is the slow one of gradual selection from time to time of all variations which tend toward the ideal

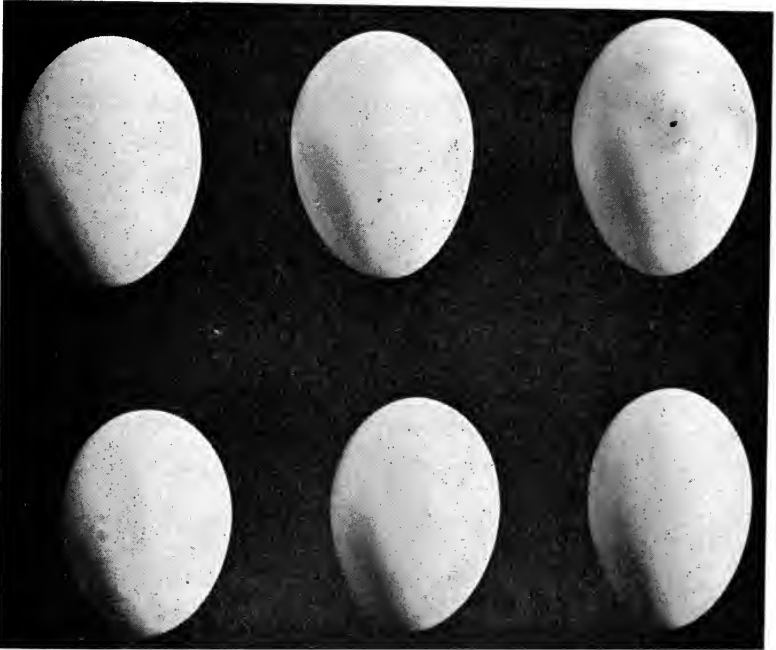


FIG. 123.—Eggs of different size, showing functional variation. Upper and lower rows laid by different hens. The difference in size is a result of functional variation due to varying rapidity in the development of the ovum and variations in glandular secretions in the oviduct.

type. A typical example of mutation is the rumpless or tailless bird (Fig. 124), which shows an inability to reproduce when closely bred, and when bred to tailed birds produces very few rumpless progeny.

*Causes of Variation.*—All variations are influenced to a greater or less degree by two groups of causes,—namely, internal and external. Accurate knowledge pertaining to this first group of influences is so limited, and the subject so complex, that it is of

little value to the poultry breeder. The small breeder, and even the casual observer, cannot, however, fail to note the great variation in breeds of poultry owing to diverse conditions in their environment. By this is meant all the external conditions of their life; as feed, climate, housing, enemies, and especially with young growing birds, their range. All internal processes of development are dependent upon external influences for their natural expression; hence the breeder has every incentive to create external conditions which will conduce to the growth and highest

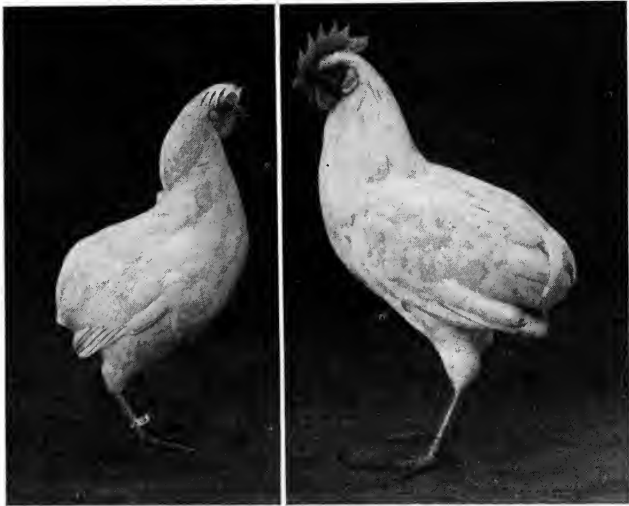


FIG. 124.—Rumpless birds—a common example of spontaneous variation or mutation.

development of the individual, and these conditions will in themselves contribute to the development of the particular type or variation which is desired.

**Atavism.**—By atavism is meant the invariable tendency of individuals to revert to the original type. It is sometimes called reversion, retrogression, or breeding back. It differs from the law of heredity in the fact that the characters cropping out represent ancestry more or less remote rather than that near at hand. An excellent example of atavism is the frequent hatching of black offspring from apparently pure-bred Barred Plymouth Rock matings. This is a reversion in type to the original Black Java



hen which was the female ancestor of the Barred Plymouth Rock breed. Atavism may be shown in form, color, or functional activities. Its tendencies are of two kinds:

1. Those characteristics which are apparently lost but which crop out in pure birds after many years or generations of straight breeding.

2. Those outcropping characteristics which appear in the descendants of crossbred birds, and which have not previously shown themselves in any descendants of the cross or which soon disappeared after the original cross.

The prevalence of either of these tendencies is governed or largely influenced by the following factors:

1. The degree of purity, or the time elapsed since pure breeding was begun. The more generations there have been of pure breeding, the less likelihood is there of reversion to show.

2. The purity of breeding of either parent when new blood is introduced for desired vigor and vitality. It is safest practice to do one's own breeding so far as possible, as when purchasing alien males there can be no certainty of their purity with respect to certain desirable traits.

3. Lack of prepotency in either or both parents permits reversion to crop out, because they lack the power to subdue latent characteristics.

The results which atavism may accomplish are of no practical value to the breeder. But a knowledge of its workings convinces him of the folly of using grade sires of unknown ancestry in breeding for either eggs or meat purposes, also that to produce definite results and to develop a pure line of standard-bred poultry he must avoid crossing.

**Law of Correlation.**—By correlation is meant the relation which exists between the form and functions of various organs of the bird's body. Correlation exists between all forms of animal life and makes possible their systematic classification.

Poultry offers an exceptionally fertile field for the study of correlated features, as they have many variable and easily defined parts. Some of the following are especially interesting correlatives. The form and size of the individual is often proportional to the form and size of its parts. For example, a bird with a long neck is very apt to be "rangy" throughout, with long body, legs, and head. The reverse is also true, and a bird with short, compact body and neck usually has short, stout legs, back, and head.

There is also a relation between the color of the comb and wattles and the health and vigor of the bird; the latter being associated with a bright red comb, and disease or lack of vigor with a dull color or lack of color.

In different breeds there is a definite relation between the size and weight of the body and the development of wings. In the lighter breeds this results in powers of flight which are lacking in the heavier breeds.

Many false notions as to correlation are often advanced. For instance, there is a belief that the color of the skin indicates the quality and flavor of the flesh; that the color of eggs influences the quality of the contents; that white birds are often of weaker constitution than pigmented birds,—all of these are without substantial proof.

**Body Character and Functional Activity.**—Poultry breeders and experimenters have for a number of years persistently endeavored to find some correlation between egg production and some readily detected external characteristics, but with little success. As was previously stated, egg production seems to be an inherited function based on the gametic constitution of the individual, and has not been consistently indicated by any other factor. A bright red comb, full bright eyes, erect carriage, compact and solid body are all signs of the vigor and vitality which are necessary for heavy egg production, but none can be said to be always associated with it.

The author has noted a consistent relation between shape of barrel or body and the power of reproduction. Heavy egg production was found to be associated with great depth and breadth of body in proportion to its length. There is need for much statistical work to test such a relationship, and accurate results cannot be claimed until a great number of individuals have been studied. Wherever it is possible to associate certain external features with functional activity or vitality or constitution, it is a simple matter to put into practice a rigid selection,—using only birds which show this external character.

**Prepotency.**—By prepotency is meant the increased power which one parent has over the other of imparting its characteristics to the offspring. It is really the power which an individual has to transmit its own characteristics. This question of prepotency is of the utmost value to the breeder, because of the direct influence which it is bound to have upon the improvement of his flock,

whether for meat or fancy points. An individual may be all that could be desired with respect to certain characteristics, yet might not transmit these particular traits to its progeny because it lacks prepotency.

Certain breeds are especially prepotent with regard to some well-defined characteristics; for example, Games, when crossed with other breeds, transmit their distinctive traits to a large percentage of the progeny.

Prepotency in individuals varies greatly, and is indicated both by the resemblance of the progeny to the parent and to one another. Prepotency is increased in the individual and in the breeds with increased purity of blood, stronger constitutional vigor, and inbreeding.

**Sex Limitation.**—The power of one sex to transmit characteristics, and the limitation of the other sex in the same respect, is a disputed point among the closest students. In the light of recent work the general opinion seems to be that there is such a difference between sexes, and that it is very important in breeding poultry either for color pattern or for egg production. In egg production the male parent is believed to have the greater transmitting power.

#### REVIEW.

1. Define poultry breeding.
2. In what respect is this science a complex one?
3. Point out some facts which call for marked improvement in our breeds.
4. Compare the composition of milk and eggs.
5. What is the chief aim of the poultry breeder?
6. Enumerate some of the problems which are confronting the poultry breeder.
7. What is the basis of value in poultry?
8. Enumerate and discuss six fundamental principles which underlie progressive breeding.
9. Define three fundamental factors which affect all individuals in greater or less degree.
10. Discuss environment and its relation to all progeny.
11. Discuss the effect of functional activities upon the individual and its offspring.
12. State briefly the development of the laws of breeding.
13. Define the law of heredity and give a practical example.
14. Discuss three direct benefits to be derived from the action of this law.
15. Define crossbreeding or hybridizing.
16. What is the first assertion of Mendel's law?
17. Discuss the influence of a dominant character when a cross is made. Explain with equation, according to Mendel's law.

18. Explain procedure in testing an individual to determine its purity of breeding.
19. Define fecundity.
20. Outline two views now held as to the transmission of fecundity.
21. Enumerate five points which cover the practical application of the teaching of inheritance of egg production.
22. Define the law of variation.
23. Enumerate, define, and give examples of four distinct types of variations.
24. What is a mutation? Give an example.
25. Define atavism.
26. Name three factors which influence reversion.
27. Define the law of correlation.
28. Exemplify by comparing the body characteristics of the fowl with egg production.
29. Define prepotency; give example.

## CHAPTER XIV.

### PRACTICAL APPLICATION OF BREEDING PRINCIPLES.

THE AIMS of all commercial poultry breeders may be summed up into four definite objects. Some may be striving for all of these, but in the majority of cases efforts are concentrated on one, or perhaps two, of the following purposes:

1. To develop the most efficient egg machine possible,—one capable of turning out the maximum number of eggs of high quality during the season of high prices, at the lowest possible cost for feed and labor,

2. To develop a type of bird for table purposes which will attain the greatest weight in the shortest possible time, the flesh so formed being of high quality, and this to be achieved with the least expenditure for feed and labor, thus leaving the greatest possible margin of profit.

3. Often it is the aim to develop a type of bird which shall possess both egg and meat characteristics, these traits to be developed to the highest degree of perfection which it is possible for them to attain in combination. This is the type of fowl usually classed as general purpose, and the type found on the majority of poultry farms in America, especially where the farmer keeps them in small numbers as a side issue. This is the hardest type of fowl to develop, for improvement in either of the above-mentioned qualities means deterioration in the other, for meat and egg qualities are the results of opposite characteristics which it is impossible to develop to their greatest efficiency in one individual.

4. To develop a bird with plumage of a given color pattern is also the aim of a large class of poultry breeders. Breeding for any other fancy points may also be included here. This breeding of poultry to a color standard is practised by many at the sacrifice of meat and egg qualities; in other instances it is an important feature in connection with breeding for other utility qualities.

All breeding of poultry legitimately comes under one, or a combination, of these four purposes. This chapter deals with the practical application of the laws of breeding as well as with the methods to be followed and the practical results to be expected.

## BREEDING SYSTEMS.

**Crossbreeding or Hybridizing.**—Crossbreeding may be defined as the breeding together of birds of different breeds, varieties, or families, with the hope of securing progeny exhibiting in one individual the desirable characteristics of both parents. This form of breeding is only applicable in the formation of new breeds. The effect of its use is so thoroughly to mix blood lines and pedigrees that all records of the performances of the ancestry are lost or of no value. Crossing is one of the most certain means of producing variability.

Where birds possessed of similar characteristics are mated together, the progeny of the first cross usually show a fair degree of uniformity with regard to the desired trait. Further breeding of this crossbred progeny, or hybrid, will result in a great variety of types and variations in the characteristics.

When birds of opposite or unlike characters are mated together, the results are varied and disappointing, even in the first generation.

A good rule is to avoid crossing wherever possible, and to resort to it only as the last extreme toward a definite aim.

*Grading up* is a term applied to a method quite generally used to improve the quality and characters of a mongrel flock. This is usually accomplished by the use of pure-bred males in a mixed flock. The resulting progeny are called grades, since they are the offspring of a pure-bred animal and one of mixed or common breeding. In poultry raising the cost of birds which are pure bred and true to type is relatively so small, in comparison with their superiority over mixed stock, that, as a rule, it is more satisfactory and economical to begin with pure-bred birds, and if need be to start with but a small number. Where grading up is practised, the mating may be made either way, but the male is generally taken for the pure-bred parent, since he represents half the flock as far as progeny are concerned. By this method it is possible to raise a practically pure flock from mongrels in a certain number of generations.

The great disadvantage of grading up is the fact that it is not likely to be closely followed continuously after a certain degree of perfection is reached, and, just as soon as the breeder uses a grade male bird, improvement ceases and retrogression begins.

**Inbreeding.**—The terms inbreeding and in-and-in breeding are used to designate the breeding together of animals which are of the same pedigree. Inbreeding commonly means the mating

of individuals related for one generation, while in-and-in breeding indicates those showing a longer period and closer degree of relationship. The two terms simply express a difference in the degree of relationship of the mated birds. Three ways in which it is possible to inbreed are:

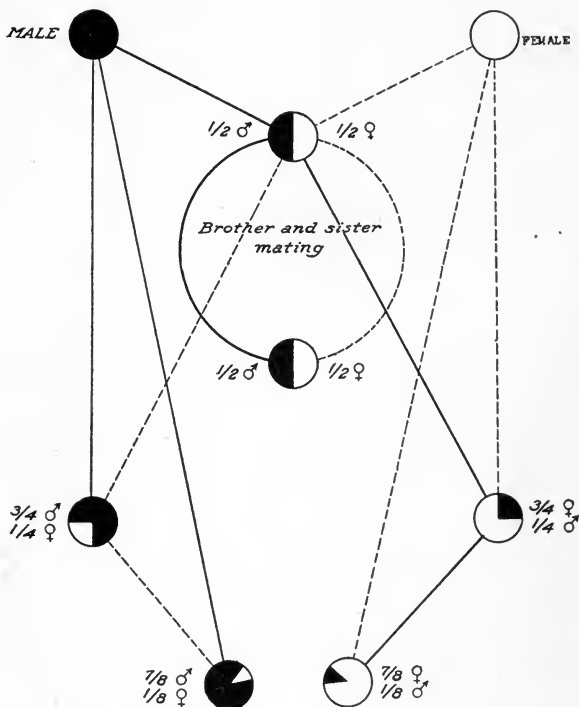


FIG. 125.—Inbreeding chart showing distribution of inherited characters. The black represents the blood lines of the male, and the white the blood lines of the female. The solid black lines represent that a male has been chosen from the group from which they start and the dotted lines that a female has been chosen. Inbreeding is traced through four generations and the results are shown at the bottom of the chart.

1. Breeding sire and daughter, which produces progeny with one-fourth blood like the mother.

2. Breeding son and mother, which gives progeny with three-fourths blood like the mother.

3. Breeding brother and sister, which produces progeny with blood lines from both sire and dam in equal proportion. This latter method is undesirable in general practice (Fig. 125).

The chief advantage of inbreeding is the possibility which it offers of fixing or making permanent the blood of some valuable individual. In-bred progeny are exceptionally potent. Another advantage is that it avoids the introduction of new blood which might produce objectionable characteristics. Inbreeding is the greatest force known to intensify existing blood lines, and this factor makes it one of the best as well as the worst system to use; for it intensifies all characteristics of the individual, whether bad or good. Therefore the breeder who resorts to this method of mating must exercise special care in eliminating objectionable factors which would be intensified equally with the good ones. It is often supposed that inbreeding tends to reduce vigor and vitality; but, when this is the case, it is undoubtedly due to the fact that these characteristics exist already and are intensified in the progeny. If poultry breeders were more careful in selecting for vigor and vitality, this apparent objection to inbreeding would be overcome and less heard of.

**Line Breeding.**—Line breeding may be defined as the breeding of individuals which are selected from, or restricted to, a single line of descent. For example, it is the process of breeding within one family or within a limited number of families all of which have a common ancestry and represent similar types (Fig. 126).

Line breeding offers good opportunity for improvement, since it excludes everything outside of the chosen line of descent and combines in the progeny the characteristics especially desired. The result is the rapid purification of the pedigree and the fixing of a type. There is slight danger of outside or alien traits appearing. This is a very conservative system of breeding, and is the one practised by many of the best poultry breeders. It has resulted in building up some of our best strains of standard-bred poultry. The leading advantages of line breeding are two: (1) The probable certainty with which results may be predicted, thus allowing the breeder to work with his eyes open; (2) the progeny of line-bred birds are backed up by a strong hereditary influence which results in hastening improvements in the one desired direction, owing to the lack of alien or mixed blood.

In practising line breeding there is one point of caution,—namely, the necessity of making the matings both from the pedigree records and by individual selection in the pens. Some breeders are apt to neglect the latter factor of individual condition, and make their matings from paper only; in consequence, a few genera-



tions of weak birds may be used, and this will speedily ruin all past and future results. Line breeding is one of the best systems for improvement if understood and correctly managed. The chart (Fig. 126) will enable the poultryman to understand the system, so that he may proceed in safety and get sure results.

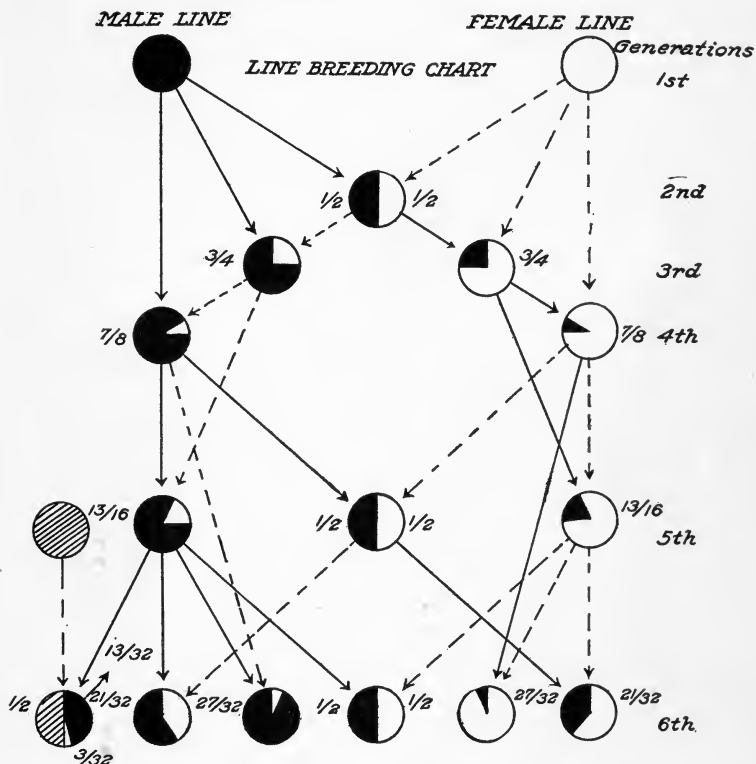


FIG. 126.—Line-breeding chart. In this chart the black and white circles and segments represent the blood lines, black standing for the male line and white for the female line. The solid black lines represent that a male has been chosen from the group from which they start and the dotted lines that a female has been chosen. The cross-lined circle at the left shows what takes place when out-crossing or the bringing in of new blood lines is practised. (After I. K. Felch.)

**Out-crossing**, as generally practised, is the use of a male bird of unrelated blood with females of the same breed which have been in-bred or line-bred for a number of generations. It does not mean the introduction of blood of a different breed, but of

new blood of the same breed. It is usually done with two objects in view: (1) To correct some defect which it is apparently impossible to correct within the line which has been established and followed; or (2) to introduce some desirable feature which the established line does not possess.

If careful selection has been made in line breeding, it is doubtful if out-crossing should be resorted to except for one of the above-mentioned reasons. Even under these conditions, out-crossing should be cautiously done, lest the variations which are produced follow a different line or direction from that which is desired.

**Reciprocal Crosses.**—By reciprocal crossing is meant the alternate crossing of male and female of two different breeds or varieties. The behavior of reciprocal crosses in poultry breeding is an interesting phenomenon. When two races of the same general type and character are crossed, the progeny are similar, no matter which type was used as the male parent. If, however, the parents are widely different, the resulting progeny will vary with the varying size of the parents. For example, if one parent is a bantam and the other a large bird, the size of the egg, and therefore of the chick, will be like that of the mother. If the mother is a bantam the chicks will be small; if the mother is of full size the chicks also will be full size. There are many minor features which give similar results, but generally the progeny resemble each other regardless of parent alternations.

**Control of Sex.**—A problem concerning which there is much speculation and discussion is the possibility of controlling sex. From the standpoint of economy and profit, it would be a great advantage in poultry breeding to have a large majority of the progeny females, since one male is sufficient for a considerable number of hens, and the female is the real economic producing unit. Despite the fact that numerous rules have been formulated for controlling this factor, our present knowledge of the laws of reproduction does not permit us to expect any great variation in either direction from the usual 50 per cent of each sex. Sex is undoubtedly determined, in birds at least, at the time of fertilization by the union of certain kinds of germ cells, and its control is at present beyond human power. The sex of the egg after being laid is not known.

**Summary of Breeding Systems.**—Considerable has been said concerning different systems of breeding. The choice of a method should be governed entirely by the purpose to be accomplished.

If the purpose is breed improvement, using as a basis family lines already established, then line breeding and, to some extent, inbreeding should be followed. When new types or breeds are desired, two courses are open,—either to watch for and fix mutations or sports as they occur, or, more often, to accelerate possible variations by crossing, and then from the hybrid progeny attempt to develop desired characters. But Mendel has shown this to be a difficult and tedious proposition at the best, and impracticable on the average poultry farm.

If the purpose is to improve common stock at small expense, then grading up is the best method. In all cases the idea should be to breed from the best of the fowls which have the desired trait developed to the highest degree of perfection.

**Selection.**—Regardless of the extent or the method of breeding, the poultryman has always at command the power of selection, and it is the real source of improvement. It is made possible by variation, and is responsible for many of the most noted developments in poultry breeding.

By selection is meant the ability to choose stock for propagating purposes which possess desirable qualities, and which are prepotent with regard to these characteristics, so that, with proper care, the resulting progeny will be of a high standard of excellence which can be maintained. To select consistently and bring about definite improvement, a breeder must have a clear idea of his purpose, and work continuously toward it. He must know the breed with which he is working as well as its ancestry, must understand the principles underlying selection, and use judgment in departing from certain well-defined lines when compelled thereto for economic or commercial reasons.

In selection there is the important fundamental advantage that it results in absolute improvement of quality, and not merely in the elevation of the flock to a higher standard by the elimination of the lower or average members. It accomplishes two well-defined results: (1) It increases the production of individuals, thereby making it possible to secure increasingly higher individual records; and (2) it stimulates the average production by raising the average of the mass, by eliminating the poor producers, and by substituting heavier layers in their place.

Selection should be continuously practised, not only in the breeding pen, but in the elimination of weak or sick birds throughout the entire brooding and growing period. Fowls which show,

at any time, a lack of constitutional vigor will never prove profitable for any purpose.

Further possibilities in selection are discussed under the subject of breeding for definite purposes.

#### BREEDING FOR EGG PRODUCTION.

It is probable that more poultrymen are endeavoring to increase the egg-producing qualities of their birds indirectly by breeding and selection than are attempting to improve all other qualities combined. This is due to the fact that egg production represents a direct money return which, under farming conditions, is the one factor of greatest definite value.

Breeding for egg production necessitates not only careful mating and a knowledge of the laws of breeding, but also a clear idea of the so-called "egg quality" and egg type among birds which will lead to progressive selection.

The following rules should be kept in mind when breeding for egg production: (1) Keep only pure-bred birds; (2) breed from heavy producers and persistent layers; (3) breed from mature birds; (4) practise line breeding; (5) breed from early-producing pullets; (6) breed from late molters; (7) breed from heavy eaters; (8) breed from early risers and late retirers; (9) practise proper management.

**Keep pure-bred birds** of one well-established egg breed. They have proved to be the most economical producers of market eggs, laying the greatest quantity of excellent quality, while the feed consumed is utilized to better advantage than in other types. There is also greater uniformity in the shape, size, and color of the eggs, and a greater demand and selling value in general and special markets. The uniformity with which pure-bred birds may be bred and developed for a given purpose, such as egg production, is much greater than with mixed or impure stock.

**Breed from Heavy Producers.**—This is one of the leading rules in breeding for egg production. The average productive power of the progeny may be greatly increased. This can only be accurately carried on by the use of the trap nest and by special matings for breeding purposes. The most persistent layers are those which begin to lay early in the fall (October or November) and continue to lay regularly throughout the winter and spring months, also laying well during the summer, and which, after undergoing a quick, complete molt, begin again to lay in the early fall of the following year. In selecting a breeder it is not safe to take the

bird which is a heavy layer merely during the three spring months, for she is often found to lack the persistency so essential to a heavy yearly production.

**Only mature birds**, male and female, should be used in breeding for egg production, for these are more prepotent, and will produce offspring with more vigor and vitality and of larger size when adults. Hens should be used, not pullets.

**Practise line breeding** to fix and intensify the good qualities of the strain in regard to fecundity. This avoids the dangers attendant upon out-crossing. The introduction of low fecundity lines by the use of males of unknown pedigree is evidently a very bad mistake.

**Early-producing Pullets.**—By selecting for breeders hens which were early producers in their pullet year, it is possible to intensify this characteristic in the progeny, and not only is this quality in itself desirable, but a heavy yearly production is seldom attained without it. Early production, say October of the pullet year, means an early winter start, which signifies a good yield for the winter months and promises for the individual a high yearly total.



FIG. 127.—“Lady Lay More,” a white Plymouth Rock hen that laid 281 eggs in twelve months, winning the international egg-laying contest 1911-12. Note the ragged condition of the plumage, the pale shank and the bright, prominent eye.

**Late Molters.**—It has been proved by experiment and observation that the bird which molts the latest is, in the majority of cases, the heaviest layer; in other words, the hen that molts in July or August, and gets her new plumage and makes a fine appearance early, is not the one that is the heavy layer (Fig. 127). The one that is laying eggs until cool weather in the fall is the one that does not molt until late, but looks shabby and raw during that time; nevertheless, when she does start, the molt is usually rapid and complete, leaving her in good condition to commence laying in early winter. This external feature, the molt, is of practical value in selecting persistent layers.

**Birds with Large Appetites.**—The consumption of a large amount of feed is essential in the case of the heavy layer, in order to secure the materials necessary for the egg, and it has been found that heavy egg production is always accompanied by heavy eating. The bird with a vigorous appetite should be selected, not the one which is a small and delicate feeder. A bird which does not eat cannot provide material for both maintenance and production, and hence is unprofitable, even though her cost for keep is but slight.

**Early Risers and Late Retirers.**—In the selection of breeders, it is well to choose birds which are off the roost early in the morning and the last on the roost at night. This habit indicates a keen appetite, since they are up with the first break of morn looking for feed, and are the last to give up the search at night. This also shows vitality, for any bird out of condition or with low vitality will leave the roost late in the morning and with reluctance.

**Selection.**—At the same time that one is breeding for this quality in accordance with the preceding brief suggestions, it is essential to select for the following features: (1) Constitutional vigor; (2) egg type; and (3) size.

**Constitutional vigor** means the health, activity, and vitality seen in strong fowls, the lack of which in weak ones makes them unsatisfactory producers and reproducers.

There is great need of breeding and selecting for constitutional vigor, because we are expecting more of the modern hen in proportion to her live weight and size than from any other class of domestic or farm animals (not including honeybees). As a result of heavy strain from overproduction, fowls often break down, and the effect is shown in the future progeny. Much of the low fertility and low hatching power in poultry, the weakness of chicks and mortality in mature stock, when such conditions arise, can be traced in large measure to the broken-down constitution of the fowl under exacting requirements.

A good hen is expected, on an average, to lay in one year five times her body weight in eggs. This would equal one egg every three days during the year. In order to accomplish what is expected of her, she must consume about 30 times her body weight of feed.

By observing one or more flocks, it will be noted that from hatching time till death fowls differ considerably in regard to their constitutional vigor, all flocks showing strong and weak fowls, regardless

of breed or strain (Fig. 128). Breeding and selection will make it possible to reduce the number of weak ones to a minimum.

**Lack of Vigor.**—The following are some of the more important contributory causes to loss or lack of vigor:

1. *Increased Productiveness.*—In its wild life the ancestor of the domestic hen laid but few eggs a year, perhaps a dozen. The modern hen is expected by good care and management to lay from 120 to 160 a year, and, at the same time, these eggs, or some

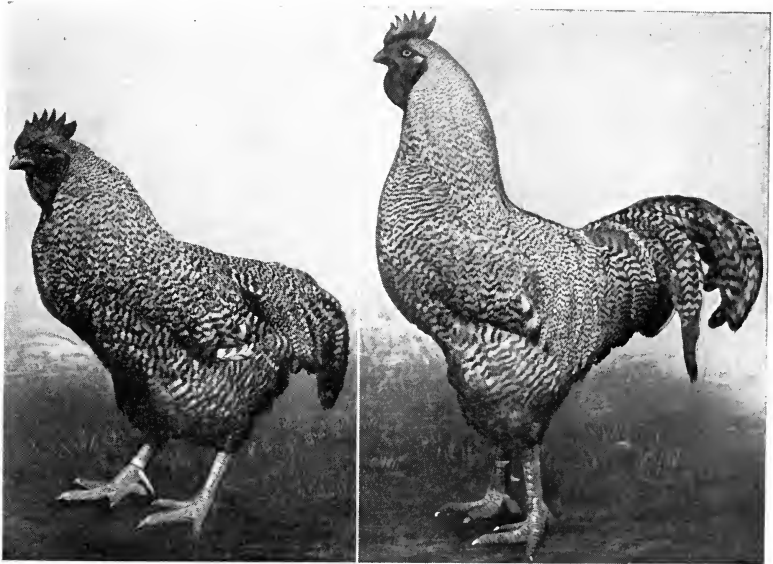


FIG. 128.—Strong and weak males. Contrast the bright protruding eye, erect carriage, and short heavy spur in the one and the low tail, sunken eye, long slender spur, and drooping carriage in the other.

of them, must be hatched into chicks with as much strength and vigor as the parent. It is evident that any increase in the production of eggs must be accomplished by a proportionate increase in the physical strength of the bird, to enable her to assimilate the increased amount of feed required for this increased production.

2. *In-and-in Breeding Without Regard to Vigor.*—Inbreeding is often resorted to in order that the high producing qualities may be better and more quickly fixed; but, where due consideration is not at the same time given to vigor, loss of vitality is bound to follow.

3. *The use of pullets instead of hens for breeding* will lower vigor by producing progeny from immature parents.

4. *Too heavy feeding* during the fall and winter with the object of increasing production. Under normal conditions the fowl is allowed a part of the year in which to rest and store up energy for future seasons of heavy production, and it will be found that forced feeding and heavy production are antagonistic to the highest fertility and greatest degree of vigor in the offspring. It is well, therefore, at as early a date as possible, to pick out all the adults which are desirable for use as breeders, and give them time to store up energy and physical strength.

5. *Excessive Crowding or Congesting of Breeding Stock.*—The modern intensive system of handling poultry is responsible for much of the present low vitality. Where it is desirable to raise future economic producers, it should be the policy to handle the breeding fowls on extensive farms rather than on intensive producing poultry plants. Both young stock and breeders have more vigor when raised on land used for other purposes, as fruit growing, grass, and grain crops that are being raised mostly for pasture and green forage.

6. *Lack of exercise for breeding stock* is another direct cause of low fertility and subsequent low vitality.

7. *Carelessness and improper methods of hatching* and rearing chicks give bad results.

8. *Failure to select breeding stock* with superior physical vigor. If the desire is to increase or even maintain a high degree of vitality this selection is paramount.

*Signs of high vitality or lack of it* are easily distinguished. The following are a few:

The actions and movements of fowls probably best indicate their physical condition. The physically weak are inactive and dull, and more likely to sit than to stand. They do not range to any extent in search of forage, nor do they scratch in search of feed. They are longest on the perch, possibly spending the entire day there.

The loudness and frequency of the crow of the male, and the cackle of the female, are indications of physical strength and superiority. The weak fowls seldom crow or sing.

There are certain body signs which indicate lack of vigor in a fowl; as, for instance, long neck, thin beak, narrow head, a long, slender body, long legs and thighs, or a stilted appearance, while the reverse is true of vigorous birds.



In the young, growing chick common signs of low vitality are stunted growth, accompanied by slow feathering and a pronounced crow-like beak, drooping wings and head, and a low, squatting walk.

The strong bird at any age should have a bright prominent eye, a well-developed, blocky body, bright plumage, and erect carriage, bright comb and wattles, and should be active and sprightly in movement.

It is evident that there is a relation between the physical characteristics of fowls and their vitality; hence it should be the

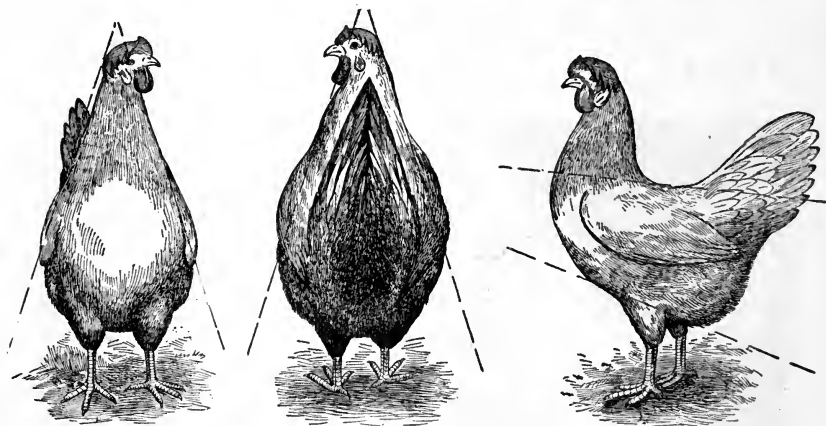


FIG. 129.—Showing the wedge or angular shape which is so common in good layers. The heavy development toward the back may be seen from side, front, and rear.

rule systematically to select for constitutional vigor at all ages and for all purposes.

**Egg Type.**—The development of an ideal body type, and the constant selection of breeders which resemble or approach that type, will aid greatly in developing a uniform flock; and, if the features which go to make up this type are those associated with heavy egg production, it may be termed an egg type.

While it has not been proved that there is any definite relation between a certain type as a whole and egg production, yet the following features are associated with the possibility of heavy production:

In discussing type, the mistake must not be made of disregarding the breed shape or type, for it can readily be seen that

there cannot be one egg type for all breeds, owing to the differences in body shape. The egg breeds bear a close similarity in their breed type, and it may thus be assumed that this general conformation represents the desired form (Fig. 129). These are here outlined. They are valueless unless combined with health and vitality.

1. Width of body comes first; as, without ample room for the digestive and reproductive organs, they cannot attain their maximum development.

2. Depth of body is essential for the same reason.

3. A rather long body carried somewhat high in front and low behind, with the largest part of the body lying back of the leg joint.

BELLE OF JERSEY

LADY CORNELL

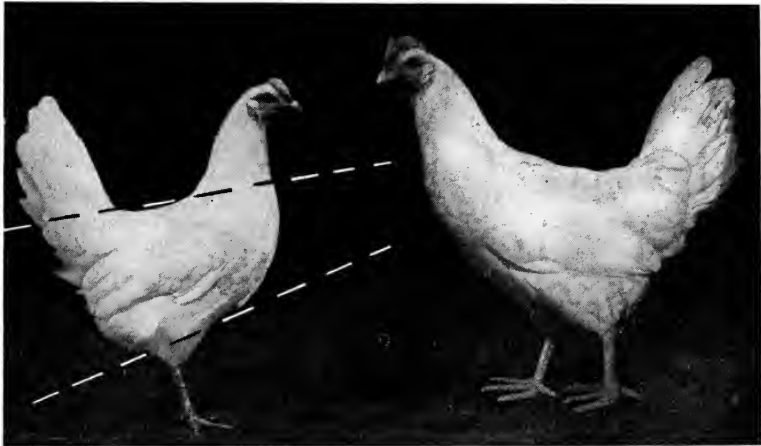


FIG. 130.—Two phenomenal hens.

A COMPARISON.

<i>Belle of Jersey.</i>		<i>Lady Cornell.</i>	
Body weight, lbs.....	3.8	Body weight, lbs.....	3.2
Lbs. feed consumed.....	118.5	Lbs. feed consumed.....	110.0
Eggs laid in one year.....	246	Eggs laid in one year.....	257
Weight of eggs laid, lbs.....	29.5	Weight of eggs laid, lbs.....	28.8

FINANCIAL STATEMENT.

Cost of feed.....	\$1.79	Cost of feed.....	\$1.66
Labor, and interest.....	1.00	Labor, and interest.....	1.00
Total debit.....	2.79	Total debit.....	2.66
Value of eggs at \$0.35.....	7.18	Value of eggs at \$0.35.....	7.43
Value of manure.....	.33	Value of manure.....	.29
Total credit.....	7.51	Total credit.....	7.72
Net profit.....	4.72	Net profit.....	5.06

4. Neck medium in length and rather full hackle.
5. Tail carried rather high, showing vigor.
6. Head medium, and comb and wattles large and well colored.
7. Body **V**-shaped when viewed from side, top, and rear. This **V**-shape is very characteristic, and when present in marked degree the heavy development lies well back in the abdominal region (Fig. 130).

8. Close, compact feathering, and short, stout beak, with bright eyes, are other signs which indicate a good layer, hence are requisite in the ideal type.

9. Legs rather short and widespread.

**Size.**—Other things being equal, it is the best practice, when breeding for egg production, to select fowls of good size, for such birds are capable of digesting more feed and have a greater body weight, which are characteristic of physical strength. They also lay larger eggs, and have a large abdominal cavity, which provides more room for the vital organs.

#### BREEDING FOR MEAT PRODUCTION.

The following points will be of value in making the best selection for the breeding pen. Only those factors are discussed which are needed in addition to those required for egg production.

*Use Pure Breeds of the Meat Type.*—The pure-bred bird will give the highest percentage of progeny capable of the highest development for meat purposes, owing to long-continued breeding for that purpose. The feed they consume will also be utilized for the desired purpose to a greater extent than that of mongrels or crosses. The finished product, when killed and packed for shipment, will show greater uniformity and be of higher quality.

*Large, Well-developed Birds.*—Size is of the utmost importance in mating for meat purposes. If rightly managed a large frame is capable of putting on more flesh than a small one. Not only should a large frame be selected, but it should be abundantly covered with flesh, especially the breast, thigh, and back. It may be said that the meat type is represented by a bird large in size and free from sharp angles, with a wide deep body and heavy development ahead, an abundance of flesh, and having a compact rather than rangy appearance.

*Character of Product.*—The character of the product desired will to some extent determine the method of breeding. For example, with broiler raising as the object, a bird should be chosen

which develops rapidly and will attain considerable size at an early age, as Wyandottes and Plymouth Rocks. When large-sized late roosters are desired, the type of bird selected is one which is capable of attaining extremely large size, accompanied by a tenderness and good quality of flesh when considerably advanced in age, but it need not be of exceptionally rapid growth, as Brahmas.

Associated with these three factors should be good health and an abundance of vigor, which under proper methods of management will

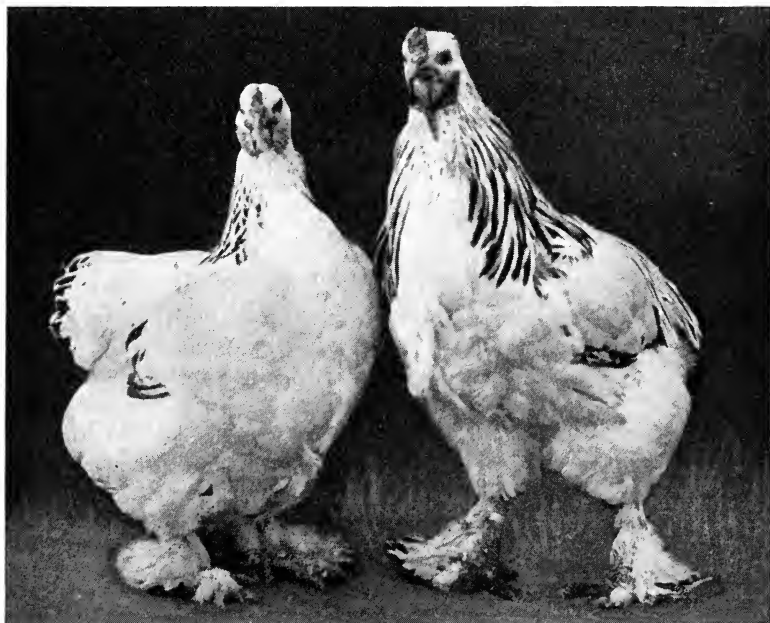


FIG. 131.—A light Brahma pair—ideal for meat production.

give the individuals every possible opportunity to develop to their fullest extent all the inherited qualities of flesh growth (Fig. 131).

#### BREEDING FOR COLOR AND PLUMAGE MARKINGS.

Years of practice are required to learn all the combinations and possibilities which result from various methods and practices of mating for certain colors. The best way to produce variations in pattern and color, as required by the standard for each breed, must be learned, especially variations of sex in the same variety.

**Double Matings.**—Before discussing color variations in detail, it is necessary to understand what is meant by the term “double mating.” Double matings are quite different from the reciprocal crosses described elsewhere. They have been developed largely through the sexual dimorphism which is so pronounced in most breeds of poultry, and especially through the desire of breeders to exaggerate this difference between the sexes. These are often designated as cockerel and pullet matings.

Examples of such exaggerated differences are found between the hen and cock birds of Dark Brahmas. It is the desire to per-

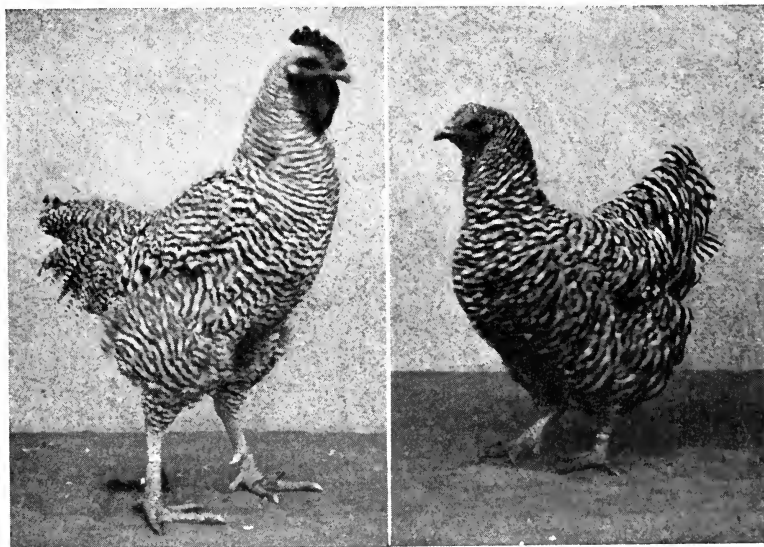


FIG. 132.—A difference in color pattern due to sex—an example of sexual dimorphism.

fect the penciling of the hens, while in the males it is to group the colors in masses. In order that this difference may be highly developed, the practice is to make two matings, one for females and the other for males. To produce females the practice is to mate the best penciled hens with a cock bird which shows as much lacing as possible. To produce males the darkest hens are mated with cock birds which show as little lacing as possible.

The sexual difference may be noted in Barred Plymouth Rocks, the males showing narrower bars and being lighter throughout,

while the females show wider bars and are darker throughout. The best marked birds of this breed are bred by double matings. By continuing this process throughout many generations, it is possible to develop some excellent specimens according to standard requirements; yet breeders have thus practically split some breeds into two well-defined and separate varieties according to sex color pattern (Fig. 132).

This method is also practised extensively in securing Leghorns of the desired comb type, the male requirement being a straight,

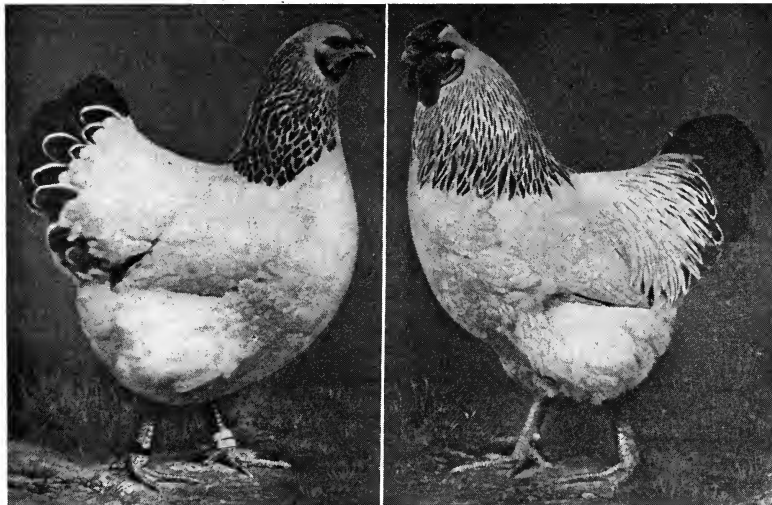


FIG. 133.—A prize-winning pair of Columbian Wyandottes, with coloration similar to the light Brahmas. (Photo by Sunnybrook Farm, Eatontown, N. J.)

upright comb, and the female a lopped comb, these differences being exaggerated by the use of double matings.

Breeding successfully through double matings necessitates a thorough understanding of the breed and the laws of heredity. It is an artificial procedure, while single mating is natural.

**Breeding for Color.**—There are a great many rules and directions for the breeding of partly colored birds, especially those with fancy plumage pattern; as, for example, the penciled and stippled breeds (Fig. 133). But, since a full understanding of these is needed only by the true fancier, and can be acquired only by years of actual practice, they will not be discussed here. A few references will be made, however, to common well-known facts.

Breeding for desired solid color is by selection and grading, not by the formation of new colors from crossing of birds of different colors. The latter procedure would result in progeny with the characteristic colors of both sire and dam arranged in motley array; while by selection through many generations it is possible to attain different degrees of color and shade, as, for example, variations in red and buff.

Under color is of great importance in fixing external color, for it affects the outside color by toning it down or intensifying it, according to the contending combinations of outer and under color.

Another interesting factor is that of color harmony or the relation between certain colors, also their association with definite colors in other body parts. For example, the Rhode Island Red, or any red bird, with stripe in the saddle or hackle is invariably accompanied with yellow shank and skin. Were the same plumage to be combined with willow-colored or blue shanks, a lack of color harmony would immediately be noticed.

The same is true with all black plumage. For example, in the Minorca and Black Langshan the black feathers are always associated with blue-black shanks and white skin, since any other color (yellow, for instance) would produce a lack of color harmony. Furthermore, these relations seem to be very firmly fixed, and even after repeated trials it is extremely difficult to substitute the opposing color. There are certain black breeds which have yellow shanks, yet this association is accompanied with a peculiar sheen which might be described as a bronze tinge, while the true black color of blue-shanked birds has a greenish sheen. There might be named numerous combinations of colors which seem to be fixed.

“*Brassiness and creaminess*” are defects which may be due in greater or less degree to one or more of the following three causes:

An unequal distribution of black pigment in plumage of breeds which have a slate under color of dark stripes on saddle or hackle (for example, Columbian Wyandottes). This effect is especially noticeable in newly established breeds before color pattern has become thoroughly fixed. In its earlier stages this effect is termed “smoky,” but the cloudiness later changes to a slight yellowish tinge. Such a defect can soon be bred out by fixing the color type.

Creaminess or brassiness may also be caused in white breeds by an excess of fat, induced in many cases by the feeding of too much corn and corn meal. Not that the corn necessarily causes

the creaminess, but the large deposit of fat under the skin gives the white plumage a yellowish tinge.

It is also caused in many cases by the "burning" of the white plumage during the summer when the birds are exposed continuously to the rays of the sun. Most of the noted breeders of exhibition white birds keep them confined practically all the time, letting them out only toward night.

*Soil Effects on Plumage and Shank.*—The presence of certain alkalies in the soil may make it almost impossible to secure the greatest degree of color in plumage and shanks. In certain sections it is impossible to get and keep the clear yellow shank, owing to the presence of alkalies in the soil. Certain highly colored soils, of a clay or shale nature, are a great hindrance to the breeder by compelling him to confine his birds. (For further discussions on breeding for color see references, page 265.)

**Breeding Fallacies.**—There are two alleged facts in breeding which should be explained.

The influence of a previous sire or impregnation on the character of subsequent chicks. In the case of fowls, even after a cock bird has been removed from the pen he may become the parent of chicks hatched from eggs subsequently laid by these hens, for the sperm continues active within the hen for from ten days to two weeks. But if, after the eggs laid have ceased to be fertile, a new cock be added, different from the first, there is no proof of any influence of the previous male bird. Experiments by Waite show that at least three weeks must elapse before one can be sure that the effect of a previous mating has ceased.

Another alleged effect is that of imagination upon the subsequent progeny. For example, there is no ground for believing that, if two pens of birds, one black and the other white, run side by side, any splashing or mixing shown in the progeny is due to the effect of sight or imagination. A more sane hypothesis would be that the opposing cock bird jumped the fence and fertilized the eggs.

#### REVIEW.

1. Name four objects toward which all poultry breeding of a commercial nature is tending.
2. What are the commercial possibilities of crossbreeding?
3. Define "grading up," and state its commercial possibilities.
4. Define "inbreeding," and name three ways in which it is possible to inbreed.
5. What can you say of the prepotency of in-bred progeny?



6. Define line breeding; what are its possibilities in commercial breeding?
7. Define "out-crossing" and give its use.
8. What is meant by reciprocal crosses?
9. What are the possibilities of sex control?
10. Give a brief summary of the possibilities of different breeding systems.
11. Define and give the fundamental advantage of selection.
12. Give two results of proper selection.
13. Enumerate and discuss briefly nine rules which should be considered in breeding for egg production.
14. Give three features which should be considered in selecting for egg production.
15. Discuss the factor of constitutional vigor in breeding.
16. Enumerate some of the contributory causes to lack of vigor.
17. What are some of the signs of vitality and lack of it?
18. Give nine points which are associated with high egg production.
19. What is the value of good size among egg breeds?
20. Discuss three factors which should be considered when breeding for meat production.
21. Discuss "double matings" for color and plumage markings.
22. What is meant by sexual dimorphism?
23. Give some important considerations in breeding for color.
24. What are the causes of "brassiness or creaminess"?
25. Name some soil effects upon plumage and shank color.
26. What, if any, is the effect of a previous impregnation upon subsequent chicks?

**References.**—Breeding Poultry for Egg Production, by Raymond Pearl, Maine Bulletin 192. Importance of Constitutional Vigor in the Breeding of Poultry, by Rice and Rogers, Cornell Reading Course Bulletin 45. Inheritance of Fecundity, by Pearl and Surface, Maine Bulletin 166. Appliances and Methods for Pedigree Poultry Breeding, by Pearl and Surface, Maine Bulletin 159. A Barometrical Study of Egg Production in the Domestic Fowl, by Pearl and Surface, U. S. Bureau of Animal Industry Bulletin 110 (in two parts). The Single Testing System of Breeding for Egg Production, by D. F. Laurie, Department of Agriculture, South Australia. Breeding for Egg Production and Egg Types, by James Dryden, Utah Bulletin 92.

## CHAPTER XV.

### MANAGEMENT OF THE LAYING STOCK.

The primary object in the management of a flock of laying hens is the profit which accrues from the sale of eggs for use as human food, as distinguished from the production of eggs to be used for hatching in the propagation of future layers and breeders.

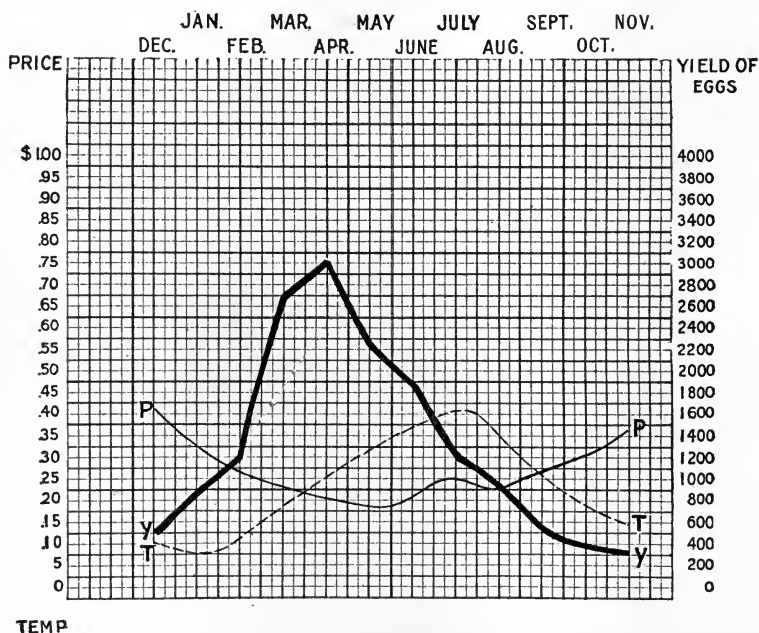


FIG. 134.—Curves showing the relation between yield (y), temperature (T) and selling price (P) of eggs during the year 1911.

In the former case the idea is to secure a maximum egg yield throughout the year, especially during the months when the price of eggs is high, owing to a large demand and limited production. This usually occurs during the cold months, or during November, December, January, and February (Fig. 134).

The endeavor is to secure a maximum winter egg yield if the greatest profit in market eggs is to be realized; while, in the case

of production of eggs for breeding purposes, the actual laying season for the eggs which are selected is very short, and during the more natural season of heavy production.

The exact profit which will be realized depends on two factors,—cost and amount of production. All the necessary factors of environment and feed should be provided at a minimum cost without decreasing the efficiency, keeping in mind that larger production means a greater amount of products for sale. The aim is to get the maximum production at the minimum cost. If records are carefully and regularly kept, there will be found a limit beyond which increased expenditure in feed and labor is not compensated



FIG. 135.—White Leghorns. There is every sign of high vitality. (Photo by Rancoeas Poultry Farm.)

for by an increased yield. The relation between cost and amount of production should invariably be studied.

**Proper management** for successful egg production may be briefly summarized under the four headings: (1) Selection of stock; (2) suitable environment; (3) proper feeding at all seasons; (4) care in marketing. These may be considered the four cornerstones upon which is built the successful management of laying stock, all other conditions being secondary.

*Selection of Stock.*—The best way to start is to build up the home flock with winter egg production as the main object. The breed to be selected depends upon market requirements and upon the size and character of the farm. Large, extensive plants will yield large amounts of eggs which must be shipped to special markets at some distance. The poultryman should first determine

the color of egg (white or brown) demanded by that particular market, and then aim to produce that for which the highest price is paid. The stock selected should be constitutionally vigorous, and well bred for several preceding generations. If possible, they should be from a heavy producing strain, as the offspring of such are much more apt to be good producers (Figs. 135 and 136).

*Suitable Environment.*—The laying stock, if economical production is to be assured, should be given congenial surroundings and an environment conducive to good health,—hence, to increased

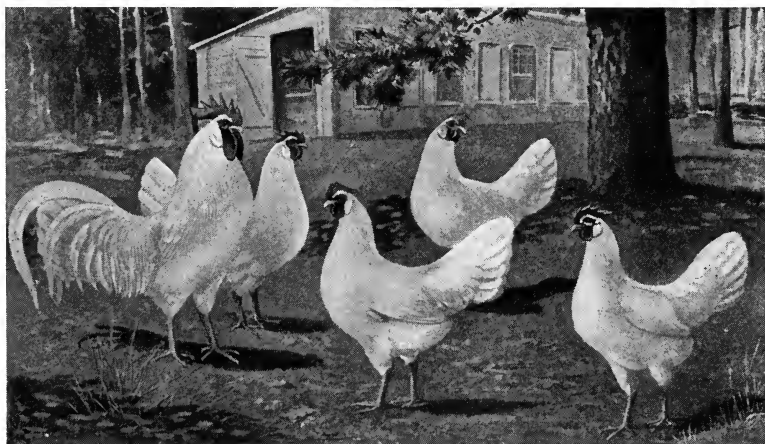


FIG. 136.—Ideal individuals of the single-comb White Leghorn breed—unsurpassed as producers of large, white eggs, for commercial purposes. (Photo by International Correspondence School.)

egg production. Environment depends upon the size and style of house and the care of house and yards. Good care is important in the management of laying flocks.

*Proper feeding* of laying birds at different seasons should be studied, and proper changes made to meet the changing conditions of season, weather, and age of the birds. The cost of feed should be kept as low as possible, and yet it must supply the nutrients required and in the forms most conducive to health and production.

*Care in Marketing.*—Profit from good production does not depend alone upon a large yield of eggs; but, if the best prices and profits are to be realized, the eggs must be marketed in a manner, and at markets, which will insure the highest revenue.

For this reason a poultryman producing eggs commercially must make a careful study of egg types and grades, as well as of market conditions, in order to solve these questions intelligently.

**Fall Management of Laying Stock.**—During the growing season of the pullets which are being raised for future layers, great care must be exercised to keep them growing uniformly from hatching to maturity, as a check or setback will cause them to mature too late for winter laying. They should be brought to maturity as rapidly as is consistent with normal development and body growth. Development is best promoted by free range with an abundance of shade and green feed. At all stages of their growth dry mash should be within reach, as it allows the birds an equal chance to obtain the nutrients they require. Maturity should be reached within six to eight months from the time of hatching, this depending upon the breed, the Leghorn being one of the earliest to mature. All birds depended upon for winter egg production should be brought to the laying age by the middle of October at the latest, or before extremely cold weather sets in. It is often possible, by varying the amount and character of feed and the mode of feeding, to mature all birds, even though of different hatchings, at approximately the same time by giving them forcing or retarding mashes. It is not desirable to mature birds too early in the fall (previous to September 1), as they are apt to molt the same season, in which case they will not be profitable for winter egg production. On the other hand, maturity should not occur too late, since the advent of cold weather retards it for from two to three months. It is best to endeavor to get a maximum egg yield of at least twenty-five per cent by the first or middle of November at the latest. If such a yield is secured it is very easy to maintain it or increase it during the winter by proper management. On the other hand, if the egg yield is small in November it will be nearly impossible to obtain a profitable yield from the birds during the next three months.

*In Winter Laying Quarters Early.*—The pullets should be put in their winter quarters at least a month before they are expected to commence laying, for two reasons: (1) In order that they may become accustomed to their quarters, for birds are very susceptible to changes in environment, and will not produce the maximum number of eggs if changed about from pen to pen. (2) It is much easier for the poultryman to study his birds, watch their ultimate maturity more closely, and, if need be, vary the food to suit

changing circumstances, when they are in their quarters than when they are scattered about over the range. (For types of houses see Chapter VII.)

Before putting pullets into winter quarters it is advisable to plan the arrangement of the birds in their permanent pens for the ensuing year, so as to insure permanence and avoid the labor of transferring them.

*Practise Rigid Selection at Maturity.*—Only strong, vigorous birds should be put in the laying pen, and to secure the best results selection should be made from hatching time to maturity, carefully weeding out all sick or crippled birds and those which show lack of stamina or vitality. This selection should be especially rigid when the final choice is made in the fall; only those of good size, healthy, mature, and vigorous should be chosen, as these characteristics are usually combined with prolific laying of large eggs.

*Size of Flock.*—The number of birds to be placed in each flock will depend upon the type of farm and upon the extent of the business. Of the two extremes, it has been demonstrated that the highest individual production can be secured where a small number of birds (from 10 to 20) are kept as the unit. But increased individual production means increased labor; therefore it follows that large flocks, of two hundred to five hundred birds, can be expected to produce a large number of eggs more economically. In the latter case the yield per bird will usually be slightly lower, but the cost of labor will be so much reduced that the advantage will be on the side of the large flock (Fig. 137).

**Winter Management of the Layers.**—The problem of winter management is to create, in so far as possible, ideal artificial conditions, by making or producing an environment which approaches in a great measure the natural conditions of spring, which is the natural laying season of the hen. The creation of this artificial environment necessitates careful and continuous study of the birds and their needs.

*Proper Feeding.*—The first requisite in the winter management of the laying flock is that the birds be provided with sufficient feed containing nutrients in the right proportion to supply all their requirements for maintenance and production, also that they be given an abundance of succulent material, which is an incentive to egg production, especially during the winter. The proper feed will vary with the breed, the season of the year, and the weather. During extremely cold weather an increase in corn will enable the

birds to maintain their body heat with a lower consumption of the materials regularly supplied in the ration, and will help to keep up the normal production. The feeding of hot mashes occasionally during extremely cold weather will also help to keep them warm.

*Exercise.*—Hens kept in close confinement, as is the case with the laying flock in winter, should be made to take sufficient exercise to keep the body in normal flesh without depositing surplus fat. More care in this respect is required when the heavier breeds are kept, such as Plymouth Rocks and Wyandottes; with Leghorns there is less danger. When not at liberty the exercise taken



FIG. 137.—A large-unit laying flock (500). An abundance of range and plenty of shade. (Photo by Rancocas Poultry Farm.)

by hens is principally walking and scratching, but birds in confinement can be compelled to exercise by placing practically all their grain feed in deep litter on the floor of the house. Better results can be obtained through the winter from birds kept closely confined and induced to exercise in this way than when they are let out on wet snowy ground and chilled. The actual amount of exercise necessary must be determined largely by the judgment of the feeder and by the flesh condition of the birds in the flock. Keep them plump,—neither thin nor excessively fat.

*Health and Cleanliness.*—A healthy condition of the laying birds is a fundamental requisite, and is best insured by keeping everything about the poultry house reasonably clean. The breaking out of head colds of a rousy nature in a flock of birds in the

winter will immediately cut down the egg yield perceptibly, in some cases more than half, and it will be a number of weeks before the condition is remedied and the birds are back to their normal production. Three special matters must be considered in the sanitation and cleansing of the poultry house. They are embraced under the following headings: (1) Frequent removal of the droppings; (2) keeping the litter in perfect condition; (3) a general cleaning and spraying of the house at least twice a year.

*Removal of Droppings.*—The exact time and frequency of cleaning the dropping boards will depend upon the number of birds in the house, the weather, and the kind and amount of absorbents used on the dropping boards. A good rule is to clean the boards whenever the droppings become moist, for they then give off objectionable odors and fumes that are detrimental. This is apt to take place more quickly if the weather is damp than when it is dry or when exceptionally cold in the winter. As long as the droppings can be kept dry by the use of absorbents, such as dust, gypsum, sand, and phosphate "floats," they emit no odors and are not objectionable. It is not economy to clean them too often, owing to the large amount of labor involved. The usual custom is to clean them about twice a week, but the rule varies according to the conditions outlined.

*Care of Litter.*—The litter on the floor of the poultry house is placed there to hide the grain, and this object is best accomplished if the litter is loose, dry, and rather coarse. The frequency with which it should be removed and replaced with new litter depends upon several circumstances. A safe rule is to clean out the old litter and put in new (1) whenever it becomes so fine that it packs down and does not hide the grain; (2) whenever it becomes moist and damp, due to foggy weather or the beating of rain into the house, in which case it is very apt to produce roup or colds; (3) whenever it becomes much soiled with the poultry manure.

A good plan is to start in the fall by putting about two or three inches of litter in the house and then add to it, a little every week or two, thus keeping clean litter on the top all the time. In actual practice it is advisable to clean the litter all out three or four times each winter, but this depends almost wholly upon the kind of litter used.

*What to use for Poultry Litter.*—Where poultry raising is carried on in conjunction with general farm operations, there is usually



an abundance of material at hand for use as litter, such as straw, cheap hay, leaves, or cut corn stover. Of these four materials, grain straw is undoubtedly the best; leaves crush quickly and do not hide the grain, while cut corn stover is rather coarse, the birds have a tendency to eat it, and this often produces a trouble known as "crop bound."

On the large commercial poultry plants where litter must be purchased, one method is to use planer shavings, which can be bought by the bale, mixed with the same proportion of wheat, oat, or rye straw. This mixture lasts longer than straw alone, is always loose and porous, does not pack, and the droppings dry up quickly. By adding a little fresh material from time to time a well-ventilated house will not need frequent cleaning.

*Spraying the Interior of the House.*

*House.*—Before the birds are put in the laying house in the fall, and again each spring, each pen should be given a thorough cleansing, which means the removal of all portable fixtures and placing them in the sun for a few hours, as well as the spraying of the interior of the house and fixtures with a good disinfecting solution (Fig. 138).

A good mixture is one containing lime to whiten the house, a disinfectant which will kill disease germs, and kerosene or crude oil to kill mites. This is very desirable, as it accomplishes three purposes with one application. (See Chapter XXVIII.)

*Careful Attention to Details Necessary.*—The poultryman should always bear his birds in mind and make special efforts to meet all changes in weather. Keep the house as dry as possible by closing the curtains and windows on stormy days, especially if the wind is from such a quarter that it will blow directly into the house; also protect the birds from extremely cold weather by means



FIG. 138.—A simple and efficient disinfecting outfit.

of properly adjusted muslin curtains. Frozen combs should be particularly guarded against, for a laying flock exposed to this condition will show a marked decline in egg production. The birds should not be allowed out of doors when there is snow on the ground or when the ground is wet, for wet feet and the eating of snow are known to decrease egg production. If a heavy production is desired during the winter, the best policy is to keep the birds continually confined, regardless of weather.

*Care of Broody Hens.*—As soon as an individual hen has laid a number of eggs, her natural tendency is to try to incubate them. This instinct is much more pronounced during late winter and spring, and, if a continuous heavy production is desired, it is necessary to break up the broody habit as soon as possible, for two reasons. If hens are allowed to sit continuously, they do not begin again to lay for a month or more, and they are also apt to spoil the eggs laid by other hens in the same pen. The best way to break up broody hens is to confine them from three to five days, as a rule, in specially constructed coops with slatted bottoms, feeding them light rations of wheat, with plenty of water. Withhold all heating feed, such as corn, and keep them away from their natural nests. The desire to sit is thus more quickly discouraged. The sooner the habit is broken up, the sooner the birds will start laying again. Inattention to the proper management of broody hens will mean a large number of them in the nests, especially during the spring. This will greatly curtail the egg yield and will hinder other hens from laying where they should.

**Summer management** of laying birds resolves itself into three topics: (1) How to handle the birds in the most economical manner; (2) the selection of birds which are to be kept over for future layers; (3) carrying the birds safely through the molt. All these matters should be considered from the standpoint of economy of feed and labor, as well as immediate and future egg production.

*Handling the Birds in the Most Economical Manner.*—As soon as warm weather comes in the spring, the birds should be permitted as much range as possible, since this supplies them with an abundance of natural green feed. Freedom of range will greatly reduce the amount of feed required and will keep the birds in much better health. When it is impossible to pasture the birds on green feed, it is necessary to grow and feed it to them in the form of a soiling crop.

*Reduce the Ration Gradually, According to Range Conditions.*—Discard all special concentrated commercial feed if it is possible for birds to get the equivalent from home-grown sources. No sudden changes should be made from one method of feeding to another. When it is impossible to provide summer layers with an abundance of range and green feed, they must be fed right through the summer practically the same rations which they received during the winter. Extensive forcing of layers at any season should be discouraged, as it is apt to weaken them physically, shorten their term of profitable production, and at the same time unfit them for breeding during the breeding season. Feeding for forcing can be successfully carried on during a few of the winter months without injury, but not in the summer. The birds should then be given a rest in which to get back any lost vitality or vigor.

In the management of the summer flock an important requisite is that the houses be cool with an abundance of fresh air. This can be secured by leaving the curtains up and windows open, and by admitting cool air from the back of the house. Any of the open-front convertible houses can in this way be made into desirable laying houses for summer. This is especially important in low shed-roofed houses covered with paper, as they are apt to be very hot in the summer. By inducing a circulation of cool air during the night, the birds will keep in much better condition, and respond with a larger yield.

*Selection of Layers for Second Year.*—The age when birds are most profitable as layers depends almost entirely upon their management during the pullet year, and upon the health and vigor of the birds at the end of their first laying season. There are two general methods on commercial plants regarding the holding of birds for laying.

The first one is to keep only pullets for commercial egg production. They are brought to maturity and forced for continuous maximum egg production, and at the end of one year's laying are disposed of for meat. A start is made again each year with an entirely new lot of layers. This method necessitates the hatching of an exceedingly large number of chicks every year, and great risk is run in the danger and liability of late hatches and poor broods.

The other method, which is quite extensively followed, is to keep a definite number of birds during the pullet year,—say, for example, one thousand. At the end of the first year select five

hundred of the best to be kept for egg production, and bring into the laying flock five hundred additional pullets. Subsequently, the older half of each flock should be disposed of at the end of its second laying season, and five hundred pullets brought in each year as new layers. All things considered, this system is undoubtedly the safest and the most productive of satisfactory results on the average egg farm. It is the method generally used on the average farms of the country, but in some cases the selection is much more rigid than here indicated.

It is, however, true that the greatest number of eggs are laid during the pullet year, and the next greatest number the year following. Each succeeding year the number of eggs rapidly diminishes, and it is doubtful whether, under average conditions, it is profitable to keep a bird for egg production after her second year unless she is especially valuable for breeding purposes.

It is well to inspect the birds at the end of the pullet year, and make two selections during the summer,—the first one before extremely warm weather begins, and the other before the hens are put into laying quarters for the winter. In these selections the following points should be carefully noted: (1) Discard all birds which are not healthy and vigorous. (2) Discard any which have not grown well during their first year. (3) Discard any which during that time were subject to disease. (4) Spasmodic layers, as those which lay rapidly for only a short time followed by long periods of rest, are also undesirable.

Any hens which are not in good laying condition at the first selection of the summer can profitably be left over until the fall, since there is then an exceptionally good demand for dressed poultry, while there is a fairly good price for eggs during the months of August and September. When making the last selection in the fall, it is wise to withdraw from the mass 5 to 10 per cent of those which more nearly approach the ideal type, these being the most vigorous, and the ones which have proved to be the best layers. They should be put in a special pen, separate from the other birds, and mated for breeding purposes, for it is only by selecting and breeding from the best that any improvement can be brought about.

*Care at Molting Time.*—Much interest has been manifested in recent years in the subject of the management of the flock during the molting period. Generally it is unprofitable to subject the molting flock to a period of fasting followed by a period

of heavy feeding. It has been shown that during the fast the birds lose weight and their vitality and stamina decline, and after heavy feeding has been resumed it takes much longer to get back the weight that was lost; this is usually gotten back before the birds start laying. The best practice is to feed the birds on a normal, well-balanced ration throughout July and August, and allow them to molt naturally; it will be found that some specimens are early molters and some late. The late molters are usually the heavy producers; therefore, in making the last selection in the fall, birds which are rather ragged at that time will usually prove more profitable as layers in the following winter than those which molted and got their new plumage very early. Where limited feeding is the rule, the egg yield is immediately shut off, and the balance of the summer is wasted for that purpose.

It is a fact, however, that the feeding of a certain ration containing a high percentage of fat or oil and much protein will have a tendency to form new feathers and to make them glossy and attractive. For this reason, increasing quantities of oil meal and sunflower seed are recommended at this time.

Conclusions in regard to the management of the molt may be grouped as follows: (1) It does not pay to force the molt by fasting. (2) It is good policy to encourage the hens by careful feeding to lay during the late summer and fall. (3) When the hens want to lay, let them lay, and the molt will follow in due time according to the character of the individual. (4) In most individuals the molt is subservient to egg production.

**What Constitutes a Good Egg Yield.**—The exact number of eggs which a hen will lay in a year varies greatly with the breed, and with different individuals in the same breed, and it cannot be said that one breed is always a better egg producer than another. The strain is a better indication of good production than the breed; in other words, it is the breeding back of the individual which counts. The individual egg yield from an average flock of birds will vary greatly, ranging from 100 to 150, a fair estimate being about 130. There are many exaggerated statements in regard to a 200-egg strain, but a family of birds averaging such a height of production is yet to be developed. There are undoubtedly heavy-laying strains, but a successful egg yield depends as well on feeding and management, and its maintenance or increase upon future breeding and selection. As was said before, the profitable egg yield is produced during the winter months; a commercially profit-

able yield for December, January, and February is about 30 or 33 per cent; that is, a well-bred flock, properly cared for and kept for egg production, should lay one-third as many eggs as there are hens. During the spring and early summer it can usually be raised to 50 or 60 per cent, and in some cases even higher for a short time.

Where very small flocks of five to ten birds are kept, it is sometimes possible to get exceptionally high individual records,—often as high as a 100 per cent egg yield for the flock for periods of short duration. In large commercial flocks in which many fowls must be considered in getting an average, annual egg yields over 160 or 170 eggs per bird are exceptions rather than the rule, and it can not be expected that whole flocks will average this number or anything like it.

**Improvements in Egg Production.**—The efforts of the poultryman in managing the laying flock should not only be concentrated upon present production, but upon means and methods of increasing future production. Improvements in this line necessitate a close study of the individual, for it is the individual which makes the average, and a few poor birds greatly reduce the average of the better ones. In a flock of one hundred hens, it will be found that, on the average, perhaps 10 to 30 per cent rarely lay an egg during the profitable months of the year, another 5 to 10 per cent are totally barren, the remainder being fairly good egg layers. The best way to obviate this is to select or weed out the poor layers and keep only the best. It often proves more profitable to take one hundred birds out of a flock of one hundred and fifty, after which, with less labor, one can get nearly as many eggs and a much more profitable yield per bird.

Where the selection is not made, the poor birds are fed at the expense of the better ones. Improvements will come largely by the coöperation of three factors: (1) Rigid selection at the end of the pullet year and the mating of a breeding pen from the best birds. (2) By trap-nesting the individuals in this breeding pen during the winter and early spring, and hatching future layers from males and females that are themselves from prolific layers. (3) By producing relatively early hatches, and selecting rigidly throughout the growing season, keeping only the best youngsters for future production.

**The Keeping of Egg Records.**—Every poultryman, regardless of the number of birds kept, should post in the laying-pen record

blanks upon which to record daily the number of eggs laid and the feed consumed, so that he will be able to tell at any time whether or not the flock is proving profitable. These records, if carefully kept, furnish a good guide to feeding, and are especially useful on large plants where one man does the feeding and another collects the eggs. They are also of value in revealing any disease or weakened conditions of the birds, which is indicated immediately by fluctuation in the egg yield. In addition, such records will stimulate interest in the work, and quickly bring about a more careful study of the problem, on the part of the laborer as well as the owner.

**Nest Eggs.**—China eggs should be used in the nests, simply for the reason that they induce the birds to lay continuously in the same place. If it were not for their presence the birds would, after all the eggs had for a few times been removed, seek a new place to lay, usually the floor; this would result in cracked or broken eggs, many being entirely lost. China eggs are good to use in connection with trap nests, where it is necessary to keep the birds from laying on the floor.

**Egg Eating.**—The habit or vice of egg eating usually results from the birds getting a taste of a fresh egg when one has been cracked in the nest. It is a habit difficult to break when once established. The following conditions will tend to prevent their acquiring the habit and, possibly, to suppress the vice: Darkened nests; large roomy nests; frequent removal of eggs; the immediate removal of any broken shells or egg contents.

Patented nests are advertised which allow the egg to roll down out of reach of the bird, but they are usually undesirable.

#### REVIEW.

1. Give the primary and secondary objects in managing a flock for egg production.
2. Discuss the constant relation between selling price of eggs and temperature or season.
3. Upon what two factors does profit from egg production depend?
4. Discuss four factors which enter into the profitable management of the laying flock.
5. Discuss the fall management of the laying stock.
6. What is the best time at which to place pullets in winter quarters?
7. Point out the necessity of making rigid selection at maturity.
8. Discuss size of flock.
9. What are the essential features in winter management of the layers?
10. Discuss three factors which are necessary to promote cleanliness in the laying pen.

11. What is the most practical method of handling broody hens?
12. Name the two most important considerations in summer management.
13. What is the profitable age of birds as layers?
14. Discuss the selection of layers for the second year.
15. Discuss management during the fall molt.
16. What is a good egg yield?
17. Name three factors which tend toward improvement in egg production.
18. Are egg records valuable? Why?
19. Of what use are china nest eggs?
20. Discuss the vice of egg eating and state how it may be controlled.

**References.**—The Yearly Record of Three Flocks, by H. H. Wing, Cornell Bulletin 211. A Record of Six Hundred Hens, by Horace Atwood, West Virginia Bulletin 115. Cost of Egg Production, by Henry H. Wing, Cornell Bulletin 204. Winter Egg Production, by H. R. Lewis, Circular, New Jersey Board of Agriculture. Poultry Keeping for Egg Production, by W. P. Brooks, Massachusetts Bulletin 122. Feeding and Management of Poultry for Egg Production, by J. S. Jeffrey, North Carolina Bulletin 211. Essentials of Profitable Egg Production, by H. R. Lewis, New Jersey Bulletin 244.



## CHAPTER XVI.

### MANAGEMENT OF THE BREEDING STOCK.

THE primary object in managing a pen of birds for breeding purposes is to secure fertile eggs in season, the aim being not to get the greatest possible number of eggs, but to secure the most abundant yield compatible with a large and uniform size of the eggs and a high percentage of fertility.

**Breeding by Selection.**—In order to secure this and at the same time year by year consistently to build up a strain, one point must be carefully borne in mind, for it means many dollars a year to the farm poultryman, as well as to the commercial poultry breeder. This point is, special matings each year for special breeding purposes. These are best made just previous to the breeding season, usually in January or February, by selecting the finest females in the flock and mating them with choice males of known pedigree. Such matings should be made early enough to allow at least four weeks to elapse before the eggs are saved for hatching, so that the effects of previous matings are gone, and a higher degree of fertility will be assured. To secure the best results, the breeding pens should be relatively small, ranging from ten to fifteen birds. Where this is the rule, more care and attention can be given to individual breeders, and the small number of males required will get along better than if too many are in the same pen. Such matings are advisable for many reasons, the following being the more important:

1. By breeding from the best the progeny, in accordance with the laws of heredity, will not only resemble the parent in many respects, but will be of higher type than if the entire flock had been used for breeding.

2. Mass breeding does not assure superiority; in other words, when eggs are selected, year after year, from those of the entire flock, all that can be expected is to maintain in a succeeding generation the same degree of perfection which was attained by the parent. In breeding for egg production natural selection is of no value. In fact, experience seems to show that it tends to cause retrogression. When breeding from the mass many fowls will fall below the standard in type and production, and these will work havoc in the breeding pen.

3. It is impossible to study individuality when large flocks are used for breeding. The possibility of future improvement lies in a study of the individual and efforts to raise the average of production; this can best be done by individual matings for breeding purposes. Such matings should be based not only upon external characteristics, but upon production as well, pedigree record blanks being placed in each pen and trap-nest records kept during the winter and spring months. With a small number of birds this necessitates very little labor, while the benefits accruing and the interest created will offset the slight expense.

4. In matings of this kind a high percentage of fertility will be realized, from the fact that greater care can be exercised in picking both the females and the breeding male, also because the results will be better if one or two males are confined in a small pen of this kind than when many males are allowed to run with large flocks. It is also much easier to keep track of the condition of the breeders and to eliminate anything which might tend to infertility.

5. The handling and selection of eggs from pens of this type will be more careful. The percentage of eggs hatched and the resulting progeny depend to a great extent upon the care and handling of the eggs after they are laid. Where a poultryman has a small number of eggs of high value, as is the case with these small matings, he will naturally give them closer attention than where he has to handle an enormous quantity, which, under normal conditions, are good only for market.

Poultrymen, when breeding their prospective layers, should seriously consider the advisability of making special breeding pens, during the breeding season at least. It is still better to make them in the fall and keep accurate records throughout the winter, for by so doing the breeder is enabled gradually to improve the quality of his birds at very little expense. He can also eliminate the very poor layers from the flock; it is by discarding such birds and breeding from the best that superiority is ultimately brought about.

*Points in Selection of Breeders.*—In the selection of desirable birds, both male and female, for the breeding pen, the first consideration should be whether the resulting progeny is to be used for meat, eggs, or both, and only ideal birds in these respects should be chosen. The breeder must first decide upon an ideal type and bear this in mind when he mates the birds. He should

base his selection not only upon the external appearance, but upon type, as well as the color of the eggs, since uniformity in this respect is important.

Next should be considered the ancestry or pedigree of the birds. At the beginning, owing to lack of records, it will be impossible to know the exact ancestry of the breeders, and external appearances must count for much; but, when possible, the best plan is to purchase the male bird for this foundation stock from a reliable breeder who is known to carry the best birds of the type desired. Even if he costs a considerable sum of money, a good male means much to the future progeny and will be a profitable investment. It is often said that a good male is worth half the flock, but he is worth more than that, for even in the first generation he means fifty per cent of the blood of the progeny. If he should be prepotent as to his characteristics and is bred to his daughters, he represents three-fourths of the blood of the progeny in the second generation; and so on, until, through line breeding, uniformity of type is attained. If this method be followed continuously, it is possible to raise fowls inheriting almost entirely the pure blood of the first male. After selection has been thorough, it is a very simple matter to trap-nest during the rest of the year, as records show that the winter layers are the most prolific, hence the ones from which we should breed.

It is important to choose for the breeding pen females noted for their high production of eggs, which fitly represents the commercial worth of the individual. They should have laid their eggs, or a large proportion of them, during the fall or winter. The male used in this pen should be descended from high producers, which means he should be the son of a prolific hen. In this way high productivity will be inherited from both parents.

Prepotency of the pair is also of prime importance; they should not only possess the desired characteristics, but the power of transmitting them to their progeny. This trait can be studied for a number of generations by means of pedigree records, and is shown by the resemblance of offspring to their parents. If a fowl capable of high production is not prepotent, and there are many of this type, she is of little value in the breeding pen, and it is wise to make a study of this from a practical standpoint.

External characteristics should be considered, yet not be given greater weight than the functional. For instance, birds should not be introduced into the breeding pen for the sake merely of

external qualities, nor should a bird be discarded from the breeding pen because her color markings are not of the best. But so far as is possible, those birds should be selected which conform to the standard, both as to shape and color pattern of plumage.

The health of the breeding birds is important. None should be put in the breeding pen which show signs of disease, and it should be the rule to mark with color bands any birds in the general flock, as well as in the breeding pen, which have ever been afflicted with disease; for such birds, even after recovery, do not make good breeders, and in the case of certain hereditary diseases there is always the danger of transmitting them to the progeny. Hence the health of both male and female in the past, as well as the present, should be noted, and only birds of good constitution and vitality and free from taint of disease should be used.

**Age of Breeding Stock.**—The age at which hens make the best breeders is the second or third laying season. At this time they have reached maturity, have attained their maximum development, they produce large eggs, hence large chicks, and the breeder has the advantage of having studied their individual possibilities in the pullet year. All things considered, yearling hens during the second laying season undoubtedly make the best breeders. With males, however, it is a good plan to use well-developed cockerels. This is often done, and the best results are secured by using a cockerel of a relatively early hatch but full maturity. When, for any reason, it is necessary to use pullets for breeding, they should be hatched early, fully matured, and mated with old cocks, not cockerels.

**Pullets as Breeders.**—The mistake is often made, especially by poultrymen who desire to hasten matters by hatching their own birds, of using immature pullets. This is always poor policy unless the pullets are fully matured, and approximately one year old. For instance, birds hatched early in January and February may perhaps make satisfactory breeders next year in March or April, but it is rarely the case. The following are some of the chief reasons why disaster accompanies this practice:

Where pullets are used as breeders, a large percentage of the eggs set are infertile, undoubtedly as the result of immaturity. The chicks at hatching time and at maturity prove to be small, and the size of the chick will prove to be in direct proportion to the size of the egg.

The resulting progeny show a pronounced lack of vitality, both

during their growing period and at maturity; and if the practice be continued, there is rapid deterioration. There is a case in point where broiler raisers made a practice of crossing White Wyandottes and Light Brahmas, as they considered that a better broiler was secured, but they found they had to make an original cross from standard-bred birds every year in order to secure any degree of uniformity in the resultant chicks. In consequence, they were obliged to hatch each year from pullets, and it was invariably necessary to get new stock, as there was a noticeable loss of vitality and decrease in size of the progeny. The trouble was corrected in a large measure by using pure-bred White Wyandottes for the broiler end of the business, and hatching from yearling hens.

The progeny resulting from pullet eggs are small and at maturity do not attain the maximum size. This is due to their early handicap in the small size of the egg and of the chick when hatched. When continued, this tendency leads gradually to a decrease in the size of that particular strain.

The factors enumerated have in the course of succeeding generations of pullet breeding led to a noticeable deterioration, which is often expressed as "a running out of the stock." This trouble can easily be corrected by breeding from mature birds only.

**Proportion of Males to Females.**—The number of females, and the relation between females and males in special mating, depend upon certain conditions, such as the breed, the size of the flock, and the season.

Where light, active egg breeds are mated, it is unnecessary to maintain as great a proportion of males to females as when the heavier, slower breeds are kept. For example, one Leghorn male to ten females is ample to insure a high fertility, whereas with the heavier breeds, which are slow and of less nervous temperament, one male to seven or eight females is as high a ratio as is conducive to the best results.

Season also influences this question. When the breeder desires eggs for hatching at other than the natural breeding season of spring, he must run a greater proportion of males in a flock of given size, this ratio, however, depending upon the number of eggs being produced.

The size of the flock, to quite an extent, also affects the fertility. The smaller the flock, the larger the number of males necessary to a given number of females, and the larger the flock the smaller the proportion of males. The best practice is to mate

them according to a well-established scale, and study the resulting fertility. Any great excess of infertility will probably be due to poor methods of breeding the birds, rather than to the relative number of males.

**Care During Mating Season.**—A few points in the care of breeding birds during the breeding season must be specially borne in mind, and those which follow are of paramount importance.

The style and type of the house should not be noticeably different from a good open-front laying house, but it should be so planned as to get an abundance of fresh air and sunlight. The extreme open front is probably the best for this purpose, as, not being used during cold weather, the birds need no protection from cold. Sunlight in the house is most essential.

Plenty of room is needed. Breeding birds should never be crowded, for this will prevent some of them from getting sufficient exercise and sunlight, and will increase the tendency to disease and parasites. Moreover, it is impossible to study individual type and keep a careful watch on the health of the birds when too many are crowded into a pen of insufficient size.

The birds in the breeding pen should be given plenty of exercise, and this can best be accomplished by feeding considerable grain in deep litter, or by varying the amount of mash which they eat, by the length of time which the hopper is left open, according to their body fat. Lack of exercise tends to increase deposition of fat, and this to decrease fertility.

**Feed for Breeding Hens.**—The feed required by the breeding hen is almost identical with that of the laying hen, and can be supplied by giving a good laying ration. But a few important factors must be emphasized. The feed must contain an abundance of nutrients, since any lack of these will decrease the egg yield and the chances of fertility; it may also result in small-sized eggs, which is an important and undesirable feature.

Protein in some form, preferably a high grade of beef scrap, has been shown by experiments to be invaluable for maintaining a high degree of fertility as well as for promoting a good egg yield. Just preceding the breeding season it is safe to give as much as fifteen or twenty per cent of beef scrap in the dry mash. But previous to this time, or during heavy winter production, forcing by this means is tabooed, as it is apt to lower vitality and to cause sterility or weak germs later in the season.

Green feed is a necessity. Experiments have shown that it

increases fertility, and the birds relish it in large quantities. Where it has been given to, or withheld from, breeding flocks for alternate periods, the effect upon fertility has been shown absolutely. This advantage is approximately from eight to twelve per cent.

The feed should contain only a limited amount of carbohydrates or fat-forming elements, especially for the heavier breeds, since, under normal conditions, they have a tendency to take on flesh rapidly, and this results in an excess of fat, a decreased production, and accompanying infertility. Plenty of feed and care in the method of giving it are most essential.

**Collecting Eggs for Hatching.**—Eggs laid during the breeding season are to be used for hatching; hence much care should be

exercised in their collection and handling (Fig. 139). After mating, it is well to wait from two to four weeks before saving eggs for breeding purposes, two weeks being the usual time, but in the case of heavy breeds four are necessary and safer at any season. (See page 281.) It is well to collect the eggs two or three times a day, thus averting the dangers of their being broken, or becoming extremely dirty by a number of hens treading on them. It also lessens the danger of incubation being started by



FIG. 139.—The egg-collecting pail should be of heavy construction to avoid breakage. A nest of soft material may be placed in the bottom.

broody hens, and in cold weather of the eggs being chilled. Any violent motion of the egg, such as shaking or jarring, should be avoided, as this is apt to rupture the internal membranes and make the egg useless for incubation.

**Selecting Eggs for Hatching.**—On collecting the eggs they should immediately be sorted, and any egg unfit for hatching should be disposed of for the table. Select eggs uniform in type, shape, size, and color, discarding all that are cracked, extremely dirty, badly shaped, or which have a rough, thin, or irregular shell. Extremely small or exceptionally large eggs should not be used (Fig. 140). This careful selection of eggs for hatching means the saving of money in the course of a season, since all eggs of unsurt-

able type which would not produce living chicks can at this time be disposed of at a profit. If put into an incubator, they would result only in a hatch of weak or malformed chicks, and the revenue which might have accrued from the sale of eggs would be lost.

**Keeping Eggs for Hatching.**—Many eggs are ruined for hatching purposes during the time they are held previous to incubation. Eggs should be kept at a relatively low temperature, 50° F. being the most desirable. Experiments show, and embryologists tell us, that the embryo in the egg begins to develop at a temperature of 70°, but if this temperature is not maintained it immediately dies. During this short period it will not have attained any size, and cannot be detected by candling, but may be classed as

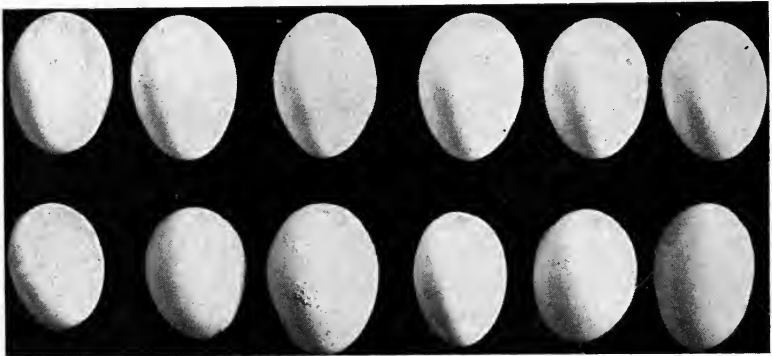


FIG. 140.—Desirable and undesirable types of hatching eggs. Upper row quite uniform as to size and shape; lower row, too long, too round, or with imperfect shells.

infertile. This fact undoubtedly accounts for the exceptionally high percentage of apparently infertile eggs on farms and small poultry plants during the late winter and early spring, when, in order to keep the eggs from freezing, they are placed behind the kitchen stove.

It is advisable to place hatching eggs so that they can be regularly and carefully turned once a day. The embryo floats in the upper portion of the yolk, and, if the egg is left in one position for a considerable time, the yolk may come into closer contact with the shell, and, if not turned, it may become attached. Moreover, if eggs are not regularly turned, the air cell will assume an abnormal position, since the fluid in an egg has a tendency to settle and the air to rise. Eggs left in one position for a consider-



able time will show air cells of irregular shape, often on the side of the egg. The result is that the chick will occupy the wrong position in the shell, and in most instances a successful hatching is impossible.

The length of time which the eggs are kept previous to hatching bears an important relation to the hatch. Experiments show that the longer eggs are kept, regardless of the manner of keeping, the smaller will be the percentage of hatch. Eggs set in from two to five days will yield the highest percentage of chicks. Under average conditions it is not desirable to keep eggs for hatching longer than one week, but if they are carefully turned and kept at a temperature of 50° or below, satisfactory hatches may be obtained after keeping them even three weeks.

**Some Causes of Infertility.**—Since infertility proves one of the greatest sources of loss, and probably depends in large measure upon the breeding stock and the mode of handling eggs, it is well to recognize a few of its common causes. They are here outlined as follows:

Immature or extremely aged breeding stock, the former being the more common cause.

Insufficient time between mating and the saving of eggs for hatching.

Weakened vitality of the breeding stock

Excessively fat breeders.

Insufficient exercise.

Lack of green feed.

Lack of sufficient animal protein.

Excess of females to one male.

Unsuitable environment.

The following are some of the causes of "apparent infertility" or death of the germs: (1) Low vitality of breeders; (2) keeping eggs at too high a temperature; (3) keeping eggs too long before incubation; (4) insufficient turning.

Fertility is the one thing above all others which the breeder is seeking, especially after having mated his fowls for breeding purposes, usually at considerable expense. Want of attention to any of the above factors may result in a loss of this important requisite.

**Care of Young Breeders Until Maturity.**—Birds hatched from high producing stock, and to be matured for breeding purposes,

require attention differing somewhat from that given to stock raised for production only.

Hatch chicks early, to give them time for full development. If this is neglected, and they are forced to premature maturity, the resulting progeny will be of small size, and this will be persistent throughout.

Brood in small units, so that the individual may have a chance to develop to the utmost. Where breeding in extremely large flocks is practised, the fowls do not have an equal chance to develop, some of the smaller ones becoming stunted by insufficient feed or crowding, when they otherwise would have developed into good birds. From the standpoint of economy and efficiency, in the commercial flock the large unit is practicable; but with a few birds of exceptionally high quality and value, the smaller unit has the advantage.

Give the growing youngsters free range where there is an abundance of natural green feed, and well ventilated coops or shelters.

Separate the sexes as soon as practicable, and raise each independently until maturity.

Mark indelibly any chick which shows signs of weakness or disease at any stage of its growth. Any that are malformed or show decided lack of vitality should be slaughtered. Those of a type unsuitable for breeding purposes should be placed in the laying pens.

Give the fowls an unrestricted opportunity to develop to the highest possible degree, since when fully developed and matured the breeder has a flock of prepotent birds capable of turning out the best progeny.

**Summary.**—Poultry breeding is a natural process, and artificial conditions must be adapted to its requirements. Standard-bred birds are of a nervous temperament and possess great powers of production and reproduction, but this indicates that they need extra care and attention. Under normal conditions these birds lay but few eggs during the spring season, when it is easiest to hatch and rear the young, their sole instinct being to reproduce their kind. With birds under domestication the idea is not only to reproduce them in kind, but to obtain a commercial product, and, in order to develop this industry to its highest degree, man has transformed the fowl into a "machine." Here the conditions differ from the natural instincts and habits of fowls, and, in order to run such a machine to its highest efficiency

and to bring about steady improvement, constant thought is necessary. One cannot expect to get maximum results or superiority in his flock without more or less continuous care in selection and mating.

## REVIEW.

1. What is the chief object in managing breeding stock?
2. Discuss the desirability of selected matings for breeding purposes.
3. Discuss six points which should be considered in selecting breeding birds.
4. What is the most desirable age for breeding stock?
5. Give five disadvantages resulting from using pullets as breeders.
6. Discuss conditions regulating the number of males and females in the breeding pen.
7. Give three features which require special consideration during the mating season.
8. What four special points should be considered in feeding breeders?
9. What points do you consider of special significance in collecting eggs for hatching?
10. What points should be considered when selecting hatching eggs?
11. Mention three factors which affect the keeping quality of hatching eggs.
12. Give nine causes which tend to produce infertility.
13. Mention four causes of apparent infertility or early death of the embryo.
14. What five points are of special significance in the care of young breeders until maturity?
15. Compare the wild bird and the domesticated species in reference to reproduction and artificial breeding.

**Reference.**—Fertility of Eggs, North Dakota Farmers' Bulletin 251.

## CHAPTER XVII.

### ANATOMY AND PHYSIOLOGY OF THE FOWL.

BIRDS, considered as a great class of animals, are one of the most clearly defined classes in the animal kingdom. There is a great variety of types, representing different forms, sizes, and habits, yet in general their structure is very similar. Birds are more closely allied to the reptile group than to the mammals. There are over eight thousand species in the class.

The fowl is a warm-blooded, air-breathing, egg-laying, feathered vertebrate, with four limbs. Those in front are for flying (which use has been greatly diminished during domestication), while the hind ones are for walking, scratching, perching, and swimming. Since the fowl is a true bird and is organized for flight, it possesses an exceedingly light skeleton. Its muscular tissue is capable of great contraction, and its respiratory system is exceedingly well developed.

**The Bird's Skeleton.**—There are four marked points in which the bird's skeleton differs materially from mammals:

1. The extreme lightness of the bones, making flight possible.
2. The tendency of bones to fuse, thus giving greater rigidity to the body proper.
3. The adaptation of the limbs to allow of walking as well as flight.
4. The great length of the spinal column, especially the neck, this being as long as the rest of the column combined.

The bird's skeleton (Fig. 141) is very compact, much more so than that of mammals, and the bones are harder and whiter. It contains fewer bones than the mammal, many being grown together to form one, as the skull bones, the dorsal vertebra, and the tarsal and metatarsal bones. The neck is very long and flexible, giving the bird great latitude in movements of the head. The ribs are joined in the middle as well as to the backbone and sternum, the latter being highly developed to furnish the seat or location of the muscles used in flight.

**Wings.**—Parts corresponding to the hands and forearms of the human skeleton are found in the wings of the bird, and from them are developed respectively the primary and secondary wing feathers. The wings are carried folded on the back.

The hind limbs of the bird represent more modifications and a greater number of bones. The tibia is the principal bone, while the most noticeable characteristic is the fused tarsus and meta-

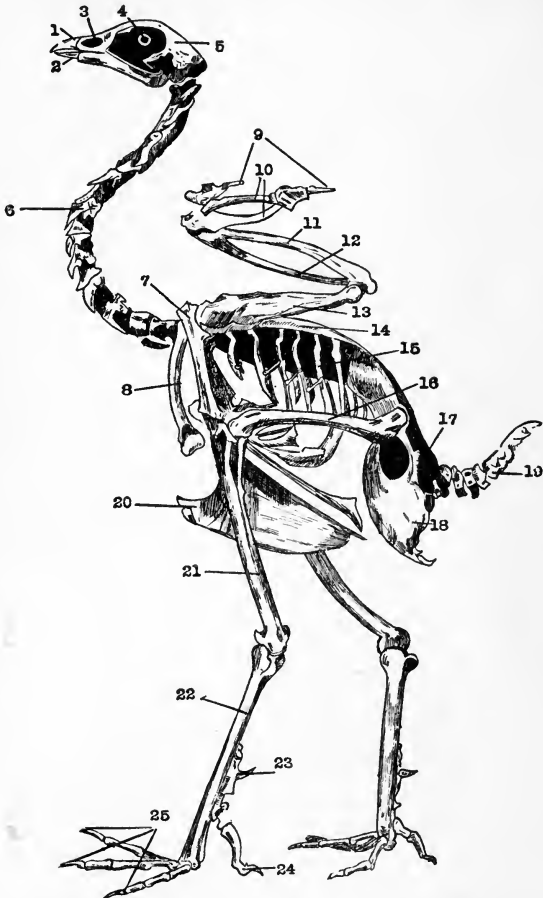


FIG. 141.—Skeleton of fowl. 1, Upper jaw; 2, lower jaw; 3, nasal cavity; 4, eye cavity; 5, skull; 6, neck vertebrae; 7, scapula; 8, clavicles (wish bone); 9, digits; 10, bones of forewing; 11, ulna; 12, radius; 13, humerus; 14, backbone; 15, ribs; 16, femur; 17, acetabulum; 18, ischium; 19, pygostyle or tail bones; 20, breastbone or sternum; 21, tibia; 22, tarsometatarsus; 23, spur; 24, rear toe; 25, toes.

tarsus. The thigh bones are exceedingly short, and when the bird is in full plumage are never seen. The fowl normally has only four toes. The fifth one is missing. (The Dorking and Houdan

are exceptions). The toes end in claws which aid in scratching and perching. The four toes are arranged with three in front and one behind, except in the five-toed breeds, which have two behind. The spur above the toes is most developed in males as a means of defence.

*The sternum*, or breast bone, is one of the most highly developed bones in the fowl's skeleton. It is very large and projects far back beyond the ribs, forming a large part of the abdominal wall. It is so situated as to protect the vital organs lying above it. There is a thin blade called the keel, which forms an attachment for the flight muscles, and its size varies greatly as the sizes of the wings vary. Some breeds with small wings have no incentive to flight. They have small keels and a correspondingly small amount of breast meat.

*The two clavicles*, commonly called in the human skeleton the collar bones, are thin bones, the lower points being attached and the upper slightly spread, thus forming a spring which aids in working the wings. The united clavicles are often called the "wish bone."

*The fowl's head* is small in comparison with other body parts, and is characterized by lightness and the fusion of cranial bones. The jaws are commonly called mandibles and form the bird's beak. Just back of the upper mandible are the nasal cavities, which are relatively small and open by means of small slits into the interior of the mouth. These slits are found open when the bird's head is down, and closed when the head is elevated; hence the necessity for the bird to raise its head when drinking, to keep the water from running out of the nostrils.

*The vertebral column* of the fowl is characterized by the great length of the neck, by its mobility, and by the rigidity of the back, loin, and tail.

*The pelvic arch* is composed of the ilium and acetabulum above and the ischium coming down each side, forming what are commonly called the "lay bones" in the hen. These four bones assume various positions at different stages of the laying period.

**The Physiological Organization of the Fowl.**—It is well to understand the elementary parts of the animal structure and their relation to one another. These are the cells, various kinds of tissues, organs, and their resulting system.

A cell is the most elementary living part of the body. There are millions of these, of various shapes, according to the tissues

they form. They are very minute. Each living and growing cell is made up of a cell wall containing a mass of protoplasm with its nucleus, cell sap, and other cell contents. Protoplasm resembles the white of an egg, but may be jellylike in consistency. Living cells grow and multiply in large numbers together. Those of one kind or structure are united to form a certain kind of tissue.

There are six kinds of tissues recognized in the body: (1) Muscular tissue; (2) epithelial tissue, or skin; (3) nervous tissue; (4) connective tissue, which surrounds other tissues and organs, holding them in place; (5) bony tissue; (6) fatty tissue.

In order to accomplish a definite purpose and to work to the best advantage, several kinds of tissues are usually associated together to form organs. For example, the heart is a group of different tissues working for a definite purpose. Each organ has a work to perform, which is closely associated with other organs working in coöperation with it. Such a combination is called a system. The following systems make up the working parts of the fowl's body: Muscular, digestive, circulatory, respiratory, reproductive, and nervous systems. The nervous system, and others of minor importance to the poultryman, will not be discussed here.

**Muscular System.**—The muscular system has a double function to perform in the case of the fowl: (1) To furnish the means by which the bird can move, (2) to cover the bones and fill out the body contour. This latter function tends to give the show bird the highest degree of type and perfection of bodily proportions and the standard shape.

The character and extent to which the muscular tissue has been developed determine in a large measure the value of the bird for table purposes. The character and form of muscles in any breed are largely inherited, but they can be influenced by feeding and management. For example, the effect of close confinement compared with liberal exercise on the structure of the muscular tissue is easily shown. The former will produce soft flesh, fine in texture, and relatively free from connective tissue; the latter will produce less flesh, coarse in structure, with an increased amount of connective tissue.

Muscles vary greatly in size and thickness in different parts of the body. Those of most importance, from a commercial standpoint, are found chiefly on the breast and limbs. The former are the muscles which control flight.

**The Digestive Organs.**—The digestive system is one of the most complex combinations of organs in the bird's body (Fig. 142).

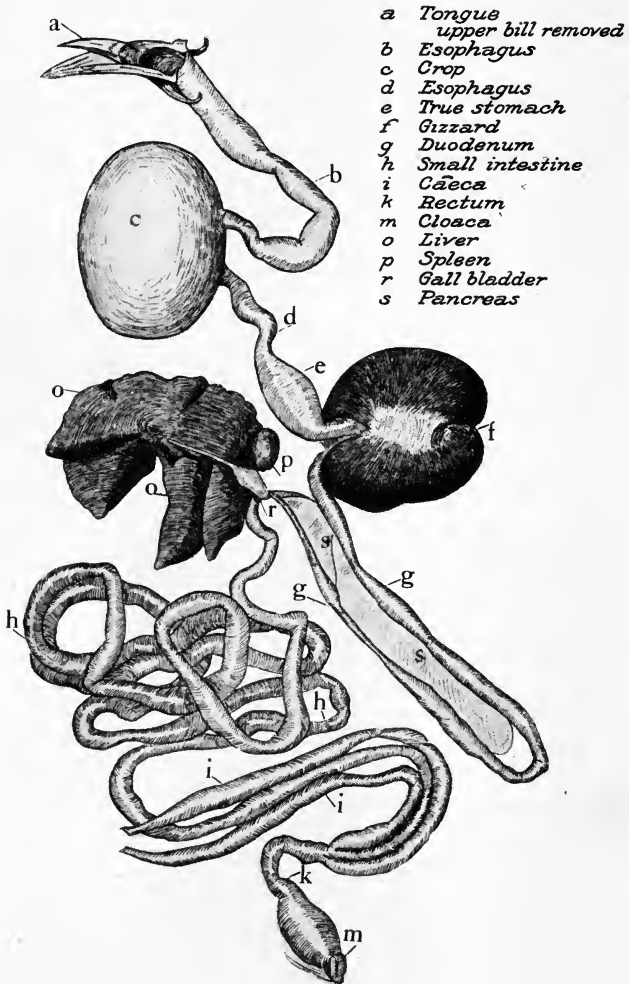


FIG. 142.—The digestive tract.

Teeth, though found in prehistoric birds, are wanting in birds of the present time. The digestive organs of domestic fowls are as



follows: (1) The beak, or mandibles, for picking up feed and sometimes cutting or tearing it; (2) the gullet, through which feed passes, after being moistened in the mouth with saliva; (3) the crop, or temporary receptacle; (4) the stomach (proventriculus), where gastric juice is secreted and mixed with it; (5) the gizzard, a strong muscular sac, where, by means of small stones and sharp grit (serving as the teeth of the bird), the feed is ground more finely than in the mouths of many of the larger animals; and (6) the intestine, a long tube which receives the pulped material from the gizzard, subjects it to the action of several juices from the pancreas, the liver, and other glands, and absorbs the digested and dissolved portions; the undigested residue passes along to (7) the cloaca, where it mixes with the waste materials from the genito-urinary canal, which empties into the intestine at this point.

**Circulatory System.**—The circulatory system of the fowl is very similar to that of mammals, being composed of a heart with four cavities, from which the blood is pumped to all parts of the body, through blood vessels, some of which convey nourishment, while others purify the body by carrying away its waste material. The blood of birds is about two or three degrees warmer than that of mammals.

The circulatory system is composed of two distinct circuits or courses which the blood takes in passing through the body. The diagram (Fig. 143) shows the course of the blood. The heart is designed to pump two streams of blood at once, its left side pumping the blood through the body and the right side through the

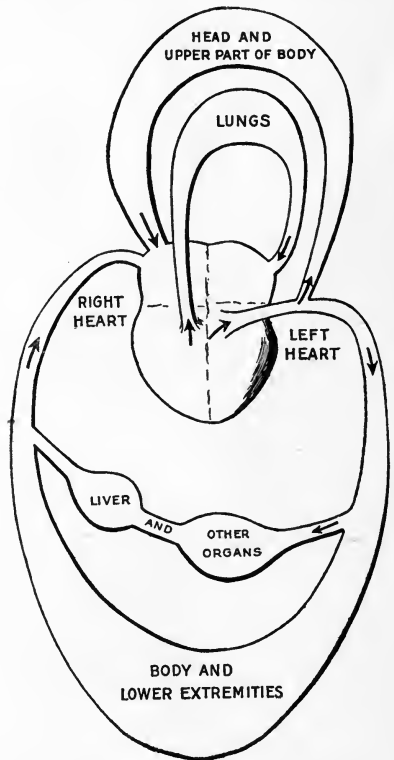


FIG. 143.—Circulatory system of the fowl.

lungs, just as in the human system. (Refer to text-books on physiology for a description of the human circulation.)

**Respiratory System.**—Breathing is carried on in the lungs. The air enters these through the trachea or windpipe, which is a long tube, dividing just before it reaches the lungs into two bronchial tubes, one of which enters each lung. It is in the lungs that the blood gives up the poisonous material which it has gathered, and takes up its supply of oxygen to carry through the body. The lungs are

surrounded by large air sacs in the breast and abdomen, there being nine in all. These increase the size of the bird in proportion to its weight and enable it to fly better.

**Reproductive Systems.**—

The female's reproductive system consists of two main organs, the ovaries and oviduct. The hen has two ovaries, only one of which is active. In general this resembles a bunch of grapes, the ova (or eggs) varying in size from small specks to full-size yolks, when the bird is in condition for laying. Each ovum (or egg) as it comes to maturity enters the oviduct, where it may be fertilized by the sperm of the male; as it passes down the oviduct successive layers of albumin are added, and finally just before being laid the shell is put on.

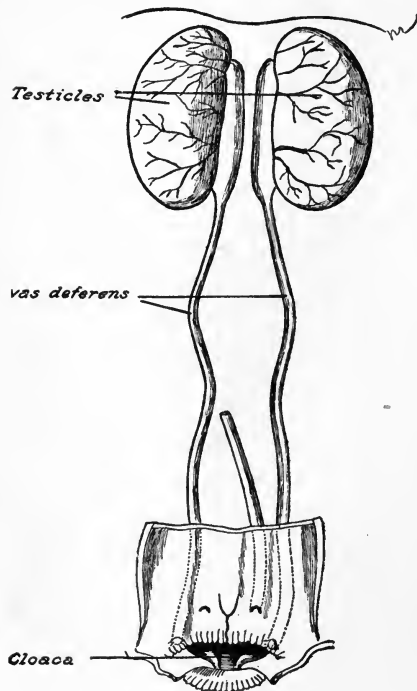


FIG. 144.—Male reproductive system.

A description of the formation of the egg is given in Chapter XVIII.

The reproductive glands of the male bird, called testicles, two in number, are near the backbone just in front of the kidneys and about opposite the last ribs. These secrete the male sperm, which is transported through two tubes, called *vas deferens*, to the cloaca (Fig. 144).

**The Development of the Senses.**—The fowl has a well-devel-

oped brain, but the senses are much inferior to those of mammals in general. The sense of touch is limited, since the skin is covered with feathers, the quills of which end in small bulbs or hollows under the skin. The sense of smell is not very keen, while the sense of taste varies considerably in individuals. All fowls reject things which are objectionable to them; probably, however, this is as much from sight as from taste; but it is clearly demonstrated that they have a sense of taste quite well developed, since they show a partiality for certain kinds of feed, whether there is any great difference in the physical nature of the feeds or not. Palatability is an important consideration in poultry feeding. The sense of sight is very highly developed as well as the sense of hearing.

## REVIEW.

1. Give a physiological description of the domestic fowl.
2. Name the leading parts of the bird's skeleton.
3. Discuss four points in which the bird's skeleton differs from that of mammals.
4. Discuss briefly or define cells, tissues, organs, and systems.
5. Name several tissues; several organs; several systems.
6. What are the functions of the muscular system?
7. Locate and give the functions of the various organs of the digestive system.
8. Give two uses for the circulation of blood through the bird.
9. How does the plan of circulation compare with that in the human body? Describe it.
10. Locate and give the use of the respiratory system.
11. Discuss the special senses in fowls.

**Reference.**—Ligaments of the Oviduct of the Domestic Fowl, by M. R. Curtis, Maine Bulletin 176.

## CHAPTER XVIII.

### FORMATION OF THE EGG AND CHICKEN.

THE reproductive organs of birds, and especially of the domestic fowl, are among the most complicated, since they must not only produce the ovum, but must enclose it in a protective envelope or sac, and supply nourishment for the embryo when growth subsequently takes place. As the ovum is developed after it is outside of the body, this elaborate protection is necessary in order to preserve it in its original form, to retard evaporation of water, and at the same time to permit the absorption of oxygen and moisture. The reproductive organs are composed of the ovary and the oviduct (Fig. 145). The oviduct is divided into two distinct parts, one secreting albumin and the other the shell.

**The Ovary.**—The active ovary lies on the left side of the body posteriorly, close to the backbone. It resembles closely a bunch of grapes which vary in size from that of a walnut, when the ovum is fully developed, down to that of a pin-point. The ovum corresponds to the yolk or yellow part of the egg. All hens have at maturity a certain number of embryonic ova, which represent all the eggs or yolks which it will be possible for them to develop during life, the rapidity with which these will mature depending upon management and feeding. The development of the ovum is brought about through an excess of feed, that is, material beyond what is required for maintenance and growth; hence egg production cannot attain its maximum unless plenty of feed be given. By the accumulation of yellow or yolk the ovum is brought to maturity, the yolk sac or calyx distends, and, as development progresses, the yolk sac becomes detached from the ovary and completely covers the ovum. When the ovum reaches maturity, the calyx or yolk sac gradually recedes along the white stigma line, allowing the egg or yolk proper to slip from the capsule, at which time it drops into the expanded, upturned opening of the oviduct. The remaining calyx immediately contracts, rapidly diminishes in size, and is soon entirely absorbed.

**The oviduct** is a large tube, whitish in color, which starts from a point just below the ovary and ends at the cloaca. During the breeding season it becomes much enlarged, and is covered with a

network of fine blood vessels. The upper opening of the oviduct is expanded in the shape of a funnel to facilitate the entrance of the ovum when it emerges from the yolk sac. The duct on its

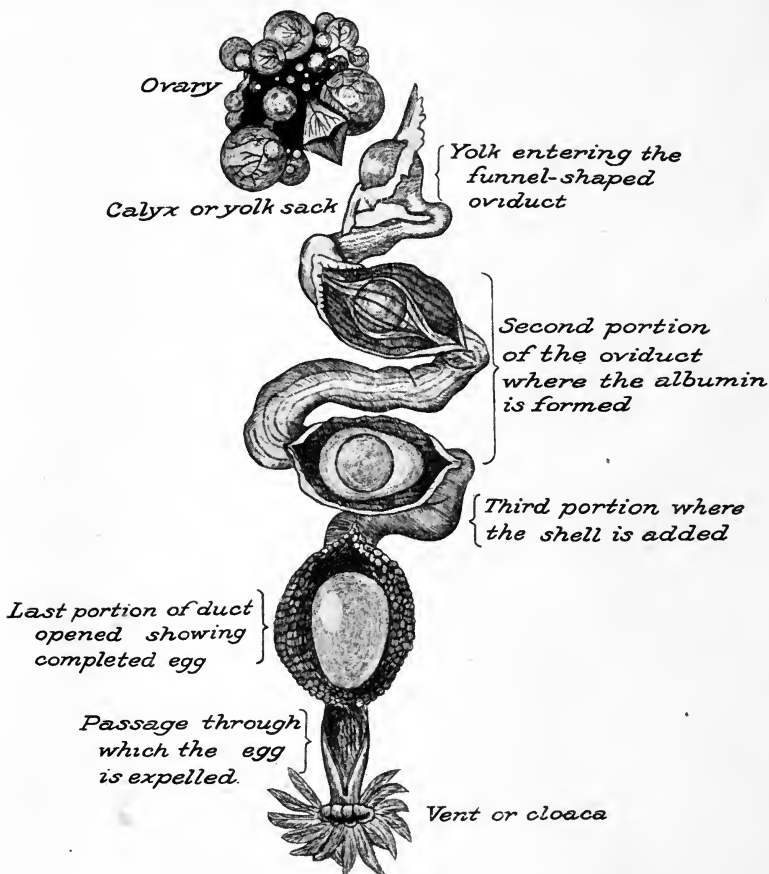


FIG. 145.—Female reproductive organs.

way to the cloaca lies in folds, being lapped upon itself three times before it finally passes into the cloaca.

When the yolk enters the oviduct it consists of a yellow mass, called the "vitellus," enclosed in a thin membrane, the "vitelline" membrane. Fertilization takes place in the upper part of the oviduct before any albumin has been added, and if at this time the

yolk be examined there will be found, just beneath the vitelline membrane, a small circular whitish body, about one-eighth of an inch in diameter, which will always float uppermost, no matter in what position the egg is laid. In the fertilized egg this disk has three well-defined areas,—an outer white rim, within which is a clear zone, and in the centre of this zone a somewhat elongated structure which is the embryo itself. These three parts constitute what is known as the blastoderm of the hen's egg, the part whose function is reproduction; all the rest of the egg is directly utilized for nutrition and protection.

The passage of the egg down the oviduct, from this time on, is marked by the following processes:

By the muscular contraction of the walls of the oviduct, the yolk is propelled to the cloaca. The passage of the yolk stimulates the walls of the duct to secrete successive layers of albumin. The first layer is thick, and has thickened portions which are fastened to the opposite poles of the yolk, to hold it in place. These thickened portions are called chalazæ; they are heavy twisted threads of albumin. After the thick layer of albumin two layers are added, each of which is thinner and more watery than the preceding one. When the egg reaches the lower or contracted part of the oviduct, two very tenacious but thin layers of albumin are added, to form the inner and outer shell membranes. The air cell, which is always perceptible at the larger end of the fully developed egg, is not present at first, but is formed by the evaporation of the fluids of the albumin and the entrance of atmospheric air to replace these fluids after the egg is laid. Just before the egg is discharged into the cloaca, it passes through a section of the oviduct where the shell is added, in the form of a coating of thin liquid secretion containing lime, which hardens quickly.

The perfect egg with its hardened shell is retained in the cloaca a short time before being laid. The power to hold the egg in the cloaca is under the control of the bird, so that, if she is frightened from her nest or unable to reach it, she can retain the egg for some time, the exact period varying with individuals.

**The parts of the completed egg** are the shell, shell membranes, albumin, and yolk (Fig. 146). The use of each is discussed in the following paragraphs.

*The shell* is the outer envelope of the egg, and its function is primarily that of protection. Soft-shelled eggs are those that have either no shell or else a very thin one. This is due to a deficiency

of lime salts in the feed, hence the necessity of supplying lime. It is estimated that one hen laying 100 eggs of average size will produce in a year about 22 ounces of carbonate of lime. The bird gets this large amount of lime from such materials as shells, dust, stones, and pieces of bone, which it constantly picks up when at liberty; if confined, oyster shell is given to supply the deficiency. The egg-shell itself is composed chiefly of carbonate of lime, phosphate of lime, and a little animal matter. It is extremely porous, hence permeable by air, which is needed to supply oxygen to the embryo during incubation. Microscopic examination reveals thousands of

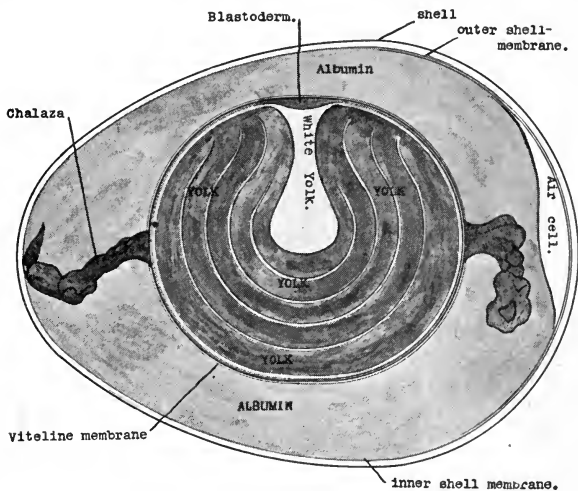


FIG. 146.—Parts of the completed egg.

minute pores in the shell, by means of which evaporation is going on constantly from the time of laying. The degree of this evaporation is a sure indication of the age of the egg or the conditions under which it has been kept. Evaporation proceeds much more rapidly in warm weather than in cold, and in dry air than in moist; hence the difficulty of keeping eggs fresh for any length of time in summer. This time could be greatly increased if it were possible to close these pores or openings and thus stop evaporation, which, however, would make the egg unfit for hatching.

*Shell Membranes.*—Immediately under the shell are two membranes, called the inner and outer shell membranes. Both of these adhere closely to the shell, the outer one being in direct con-

tact, while the inner one is adherent to the outer. At the large end, however, they are separate, and form a small cavity or sac known as the air cell. This is filled with air which has been drawn into the egg owing to the evaporation of the liquids, the size of the air cell increasing as the age of the egg increases. If this cell is found in any place but the large end of the egg, it usually denotes that the egg has been kept for some time, and has not been turned; thus the liquids settle and force the air to the highest point.

*Albumin.*—Next is seen the albumin or white of the egg. This is a translucent liquid without definite structure, and, in the fresh egg, free from smell and taste. The albumin is easily coagulated by heat, only about 140 degrees being required. It is soluble in water. Under chemical analysis albumin is rather complex, being composed of varying proportions of oxygen, hydrogen, sulphur, phosphorus, and carbon. The albumin can be readily divided into three distinct layers; a thin outer coat, a thicker middle layer, and a very much thickened inner stratum. In the latter can be found the chalazæ, which are thickened strings or cords of albumin, having an outer terminus in the outer layer of albumin, and an inner securely interwoven in and around the yolk; they run lengthwise of the egg, are twisted in opposite directions, and hold the yolk in place. In appearance they resemble twisted cords. The albumin has two distinct functions; the first is that of protection, by forming a thick layer of material around the germ, at the same time that it furnishes the material in which it floats, thus protecting it from shocks which otherwise might prove fatal. The second purpose is that it provides material which goes directly into the formation of tissue for the embryo.

*The Yolk.*—The yolk or ovum may be called the most important part of the egg, since it contains within its outer wall, or vitelline membrane, the germ or embryo and also the nourishment of the growing embryo. The yolk is nearly round, and light yellow in color, the degree or intensity of color varying with the character of the feed. In composition the yolk is considerably richer than the albumin, especially in phosphate of lime, there being but a trace in the albumin. The yolk is composed of two distinct portions arranged in concentric rings or layers, one being light in color and not coagulable upon the addition of heat, the other darker yellow in color and easily coagulable at a high temperature. In the lighter portion of the yolk is a hollow or indentation, in the upper part of which, and next to the vitelline membrane, lies the



germ, which can easily be distinguished by its whitish color and circular shape.

The function of the yolk is to nourish the chick for the first few hours after hatching and during the early stages of its growth. It is just as essential to the young chick as is the colostrum to the calf. It supplies nutrients in easily digestible form, at the same time exerting a laxative influence which starts the digestive processes.

*Composition of the Egg.*—Aside from its shell, and being fundamentally a chick, the hen's egg resembles in its composition the adult bird. Analysis of the dry matter of the egg, exclusive of the shell, shows the following proportion of constituents, water not considered: 49.8 protein; 3.4 ash; 38.5 fat.

Considering the total dry matter in the whole egg, shell included, we find the proportions to be: 38.5 protein; 35.6 ash; 25.4 fat.

A fresh-laid egg with a good sound shell, including water, shows the following analysis: 13.2 protein; 11.4 shell, 0.8 other ash; 8.9 fat; 65.7 water.

The ash found in the egg, aside from the shell, is rich in phosphate. The shell consists almost entirely of carbonate of lime.

**Malformed Eggs and their Causes.**—Soft-shelled eggs are due either to the absence of shell-forming material in the feed or to disease in the lower part of the oviduct which results in an insufficient secretion of lime salts. In rare cases, however, they may be caused by the fowls not eating enough of shell-forming material, even when an abundant supply is available. Sometimes the bird is too fat, and this results in an absence of muscular tonicity, the egg being passed down the oviduct so rapidly that the secretions are not supplied in sufficient amount.

In the ordinary course of eggs down the oviduct, they should mature at such times that only one will be laid at a time; but in consequence of improper feed, usually too much of carbohydrates or fat, the bird deposits excessive fat, the organs contract and do not permit the free passage of the ovum, finally one of two things may result. Two ova may pass into the oviduct nearly at the same time, or one may be held near the upper end until another is formed there, when the combined force of the two will propel them down the oviduct, this resulting in an egg being laid with two yolks,—the commonly seen double-yolked egg, which is usually of excessive size because of the twin yolks.

Another peculiar condition which is often interesting to the uninitiated is the presence of a perfectly formed egg within another egg. This is due to the fact that, by the contraction of the oviduct, the completed egg has been forced back into the albumin-secreting section of the duct after being coated by the shell liquid. It remains there until it is met by another yolk, when the two pass together through the uterus, or shell-forming part of the oviduct, and the entire mass receives another shell.

Extremely small eggs are common at the beginning or end of a laying period; this is in part due to a diminution in the size, hence in the lessened secreting power, of the oviduct.

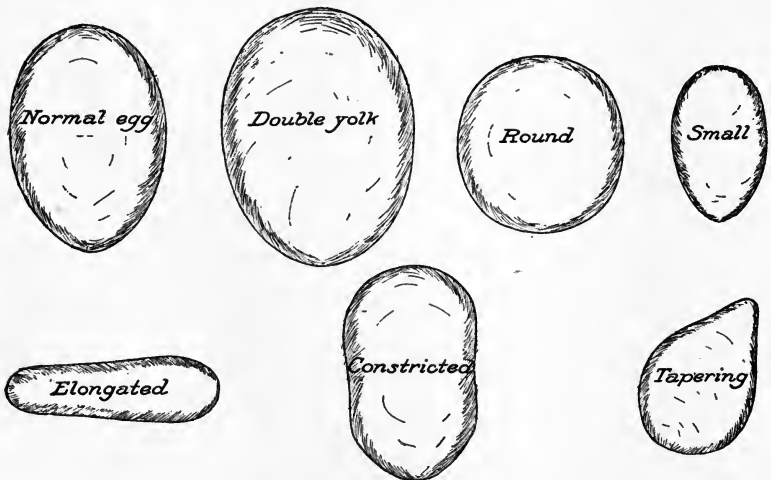


FIG. 147.—Abnormal eggs shown in comparison with a normal one. The elongated form is due to the contraction of the oviduct.

Distorted and misshapen eggs are accounted for by a diseased condition of the lower part of the oviduct and an accompanying contraction which prevents the expansion necessary when the egg leaves the oviduct and enters the cloaca; consequently, it is forced through a small opening and, as the shell is soft, is compressed into peculiar or elongated shape. These malformations are largely the effects of domestication, and are rare when the flock receives proper care and feeding (Fig. 147).

**Fertile Eggs.**—Every egg, whether fertile or not, contains the female germ, which, however, cannot develop or grow until it has been fertilized by the male germ. The latter is contained in a

cavity at the upper end of the oviduct, and there, as the naked yolk passes into the oviduct, before albumin has been added, the necessary union takes place.

It is a common but mistaken belief among the inexperienced that a male bird in the pen is necessary for the production of eggs. This is true so far as the laying of fertile eggs is concerned; and, while it is true that the primary object of egg production is reproduction, yet impregnation is unnecessary for the production of the egg, and hens will lay just as many eggs when no male bird runs with the flock as they will with one. In fact, it is becoming a rule on the larger egg farms to produce infertile eggs for market, since they are less likely to spoil, and there is no danger of the germ developing and ruining the eggs for eating. Fertilization is not an incentive to egg production among domestic fowls.

The egg, then, is a productive sac surrounding a female germ cell, which may or may not be fertilized. In the latter case the egg is termed infertile and cannot possibly be hatched, because to produce life there must be the union of the male and female germ cells.

**Formation of the Chick.**—The first stage in the development of the embryo takes place before the egg is laid, probably due to the heat from the bird's body. This change is termed "segmentation," and results in the multiplication of cells which form a cap over the germ vesicle and a group of cells under it. In the normal egg, development is arrested at this stage, and a certain amount of heat is necessary to renew it after the egg is laid.

After segmentation and application of the right degree of heat, incubation begins. The germinal disk divides into two layers, between which a third stratum soon forms. The upper layer (called the epiblast) produces ultimately the skin, brain, spinal cord, eye, and internal ear. From the lower layer (hypoblast) is formed the lining of the digestive tract, while from the middle layer (mesoblast) are developed all the other organs, such as bones, nerves, and muscles. This middle layer thickens rapidly, forming two parallel ridges running lengthwise of the germ, with a groove between them which is termed the medullary canal; the walls of this groove gradually extend and finally meet, forming a tube or neural groove, in which the brain and spinal cord develop later.

The notochord just below the tube can be distinguished from the first day of incubation. It marks out the future bony axis of the body, or the vertebral column. From the notochord are

formed certain lateral plates, which later form the ribs. From the above brief description it is evident that even during the first day, many of the important structures of the body are clearly outlined (Fig. 148).

During the second day of incubation the remaining important structures take shape, and those already formed develop further; there is a decided increase in the number of the protovertebræ;

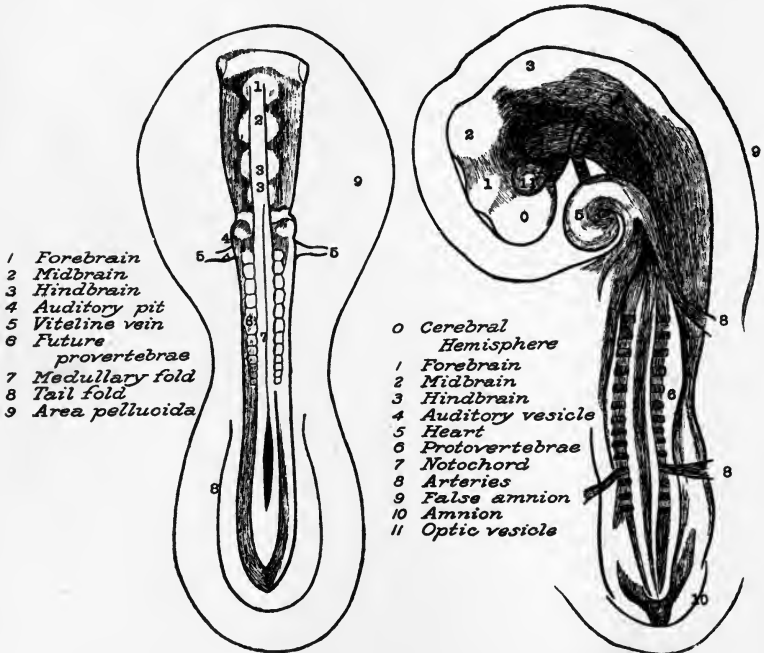


FIG. 148.—Chick embryo thirty-six hours old.

FIG. 149.—Chick embryo three days old.

the tubular heart and larger blood vessels are formed. Most noticeable of all is the development in the region of the head of the three cerebral vesicles at the extremity of the neural groove; these are called the anterior, middle, and posterior vesicle. In front of them the developing cerebrum may be seen. The eye or optic vesicle develops from the front cerebral vesicle, while the rudimentary ear and the auditory pit are formed from the posterior vesicle. The early formation of the heart and the rapid development of the vascular system are important features of the second

day's growth; these are essential for the nourishment of the embryo, hence they are early active, delivering a constant blood stream.

*The progress during the third day* (Fig. 149) is in the nature of continued development of structures already formed rather than in the formation of new ones. Up to this time the embryo has been lying face downward, but it now turns on its left side with the head bent downward. The vitelline circulation is completed, the heart is subdivided and further developed, and additional arteries and veins are formed. Some of the special senses are now formed or developed; among the most noticeable are the formation of the lens of the eye and the development of the nasal pits. The cerebral hemispheres are more clearly defined, the hindbrain separates into the cerebellum and medulla oblongata, and many of the larger nerves branch out from the nerve centres. The alimentary canal increases in size and its parts are more clearly differentiated; the œsophagus, stomach, and duodenum becoming well defined. The lungs now make their appearance as an outgrowth from the alimentary tract. By the third day the allantois can be outlined; it is a temporary membranous structure closely associated with the alimentary tract, and from it is soon developed a complete system of blood vessels which carry blood to and fro. On the ninth day it is well developed, and can be seen spreading over the back of the embryo, close to the shell. It is the medium through which respiration is effected in the embryo, and at hatching time it shrivels up and is cast off.

*The fourth day* is characterized by a rapid increase in the size of the embryo, combined with a noticeable diminution in the amount of albumin, and the embryo lies very close to the shell. The vascular area at this time is about one inch in diameter and carries an increasing amount of blood. The body proper develops rapidly, not only in size but in the formation of the limbs, the legs being short and thick, while the wings are long and slender. In the female rudimentary sexual organs make their appearance on this day.

From the *fifth day* the growing embryo reveals development rather than the formation of structures, since these are now established in greater or less degree. On the fifth day, certain cartilaginous processes can be detected, which subsequently develop into bones.

*The sixth and seventh days* mark that special development in the embryo of the fowl which is to distinguish it from that of a mammal or reptile, for in the first four or five days the development of all vertebrates is very similar. After this time the more

pronounced specializations are the definite formation of body walls and a rudimentary growth of feathers. At this period the white or albumin has practically disappeared. The beak is formed, and gives the embryo a distinctly birdlike appearance. The head is proportionately large, and the eyes extremely so. The body is very bulky, owing to the large size of the heart and liver. The legs have increased greatly in size, and the division of the extremities into toes is very marked. The yolk sac, while yet large, is very flabby, from the absorption of nutriment.

The feathers may be distinctly seen on the *ninth day*. They are enclosed in a small sac, in which they grow to about one-quarter of an inch in length before hatching time, but the sac is not broken until then. By the thirteenth day the beak and nails have taken on a hard, horny appearance.

*Motion* can be discerned in the embryo on about the sixth day, but it is very slight, and there is no pronounced movement of the entire embryo until the *fourteenth day*. Up to this latter time the chick has been lying with its body at right angles to the long axis of the egg. Now it turns, so that the body lies lengthwise of the egg, the beak in contact with the inner membrane of the shell about one-quarter of the way from the large end of the egg. The air cell is now much enlarged, owing to evaporation of the fluids, and the additional space so formed is utilized by the chick at hatching. Infrequent turning of the eggs, or weakness of the embryo, will not permit the change of position on the fourteenth day; there will be what is termed a "false presentation," and, in the majority of cases, the chick will not be able to get out of the shell.

*By the twentieth day* the embryo will have grown so that it occupies all of the egg except the air cell, the yolk will have been nearly all absorbed, and what remains is drawn into the body at the umbilicus (navel opening), the body walls closing over the opening. This process of absorption is an important factor in the early life of the chick, since it is the source of nourishment until the chick can digest and assimilate feed from outside sources.

**Process of Hatching.**—The process of hatching is one of the most striking phenomena connected with the development of the young chick, and is interesting alike to the experienced and inexperienced. The process is approximately as follows:

When ready to leave the shell, which is usually on the twentieth or twenty-first day, the chick tears the inner shell membrane with its beak, stretches its neck, and, occupying the extra air space, at once begins to breathe the air which it contained. As a result of

this extra oxygen, the pulmonary circulation becomes active, the embryonic circulation ceases, and the allantois shrivels up, since its use is no longer needed. The chick now has room to move its head, and it begins to break the shell by dealing blow after blow with its beak upon one spot on the inside until the shell is punctured (Fig. 150). This performance is repeated, in a new place each time, until the shell is broken all around about one-third of the distance from the large end. All the chick now has to do to get out from the shell is to force these two parts of the shell apart by pressing its feet against the small end and its head against the large one, which it throws off. It takes the chick some time to dry off and get the use of its legs, and usually from one to three hours elapse after hatching before it becomes very active.



FIG. 150.—Hatching time. One egg completely pipped ready for the final effort of the chick; the other chick is resting after the effort. (Photo by Hearson, Ltd.)

#### REVIEW.

1. Why need the fowl's reproductive system be so complicated?
2. The hen's reproductive system is composed of what two parts?
3. Where is the ovary located and what is its work?
4. Describe the appearance of the ovary and yolk sacs.
5. Describe the maturity of an ovum and its entrance into the oviduct.
6. What is the oviduct? What are its uses?
7. Where is the egg fertilized?
8. Describe the changes in the egg during its passage through the oviduct.
9. Enumerate the parts of a completed egg, and give the use of each part.
10. Give the approximate composition of the whole egg, with and without the shell.
11. Mention the types of malformed eggs, and give the cause of each.
12. Discuss the fertile and infertile egg.
13. Describe the development of the embryo which takes place before the egg is laid.
14. Describe the first day's development during incubation.
15. Describe the appearance of the embryo when thirty-six hours old.
16. Describe the appearance of the embryo when seventy-two hours old.
17. Give subsequent development from third day to hatching time.
18. Describe the process of hatching.

**Reference.**—Reproductive Organs of the Hen, by D. F. Laurie, South Australia Department of Agriculture Bulletin 72.

## CHAPTER XIX.

### NATURAL INCUBATION AND BROODING.

Two distinct methods of incubating the eggs of the domestic fowl are in use on different types of poultry plants,—one, commonly called the natural method, in which the hen herself generates the heat necessary for incubation; the other, commonly called artificial incubation, in which heat is supplied in some manner other than by the hen. In the artificial way heat is generated by the combustion of some fuel, the hen as a mother being left out of consideration entirely. Each of these methods has advantages and disadvantages, and each is adapted to certain types of poultry husbandry. The advantages and disadvantages of each are here given.

**Advantages of Natural Incubation.**—(1) It is more economical, where a small number of eggs are to be hatched and where first cost only is considered. The installation of a medium-sized incubator costs from fifteen to twenty-five dollars, whereas the same number of eggs can be hatched under hens with but little initial expense. (2) Chicks brooded by the hen appear to have as much or more stamina, and are subject to fewer diseases, than those artificially bred; it is doubtful, however, if there is as much difference in this respect as is generally supposed. (3) A great many progressive poultrymen, hatching relatively large numbers, continue to use the hen exclusively, for they consider that the progeny are of superior quality.

**The disadvantages of the natural incubation** are numerous, and all are well grounded and self-evident. (1) It is not always possible to have a supply of sitting hens on hand. If a large hatch is desired early in the spring, it is practically impossible to depend with any degree of certainty upon the hen, since the natural period of broodiness does not usually begin until well along in the spring. It would have been impossible to develop the broiler industry, as it has been developed, by the natural method, for there are few, if any, sitting hens on the average plant during the fall and winter. (2) There is invariably the danger and liability of the hens leaving the nest at any time they see fit. They may, as far as outward appearances go, be exceptionally good sitters when selected, and may sit on the eggs for a time; but the period of broodiness may



cease, and, if the exact temper of the sitters is not carefully noted, great loss of eggs and time may result from their fickleness. This is even more true of the light nervous breeds than it is of the heavier meat producers and general-purpose fowls. The hen is never absolutely under man's control; she has a will of her own; hence, the poultryman at best cannot be certain of definite results until after the hatch. (3) If the hen used is of nervous temperament and large size, she is apt to crush the eggs or chicks under her feet. Some hens have a greater tendency to break eggs than others; this is due largely to their clumsiness in the nest, and is especially true of the large meat breeds, which have such a mass of feathers on their shanks that they are clumsy in getting about. (4) Even under ideal conditions the hen can hatch only a limited number of chicks at each sitting. When a large hatch is desired there must be a great many sitters, and it may be practically impossible to secure them; moreover, the limited results obtained do not compensate for the necessary care and handling.

**Advantages of the Artificial Method.**—Much may be said of the merits of artificial incubation. It may be briefly summed up in the statement that, with good eggs from good stock in an incubator properly and intelligently managed, equally good or better results can be realized than with natural incubation. (1) The chief advantage of artificial incubation lies in the fact that it can be absolutely regulated by man. Eggs may be hatched at any season of the year if it is possible to secure fertile eggs for that purpose,—whether it be for broilers, in the fall and winter; for early pullets, in January and February; or for future layers, in March and April. (2) By an intelligent use of the incubator, the poultryman can so regulate the temperature, moisture, and ventilation as to secure those uniform conditions during the hatch which insure uniform results. (3) The element of chance is practically eliminated, and, with care and attention, approximately the same results can be secured in continuous hatches and during successive years. (4) The incubator is cheaper in the long run. Taking a period of five years, and considering the initial expense and labor, it is much cheaper to hatch a given number of eggs in an incubator than under hens.

**Disadvantages of the Artificial Method.**—The disadvantages, if any, of this method are largely due to brooding. (1) It is, however, doubtful whether the percentage of fertile eggs hatched in the incubator will year after year run quite as high as when under

the hen. This will depend largely upon the intelligence and experience of the man caring for the hatch. (2) Artificially brooded chicks need more attention than those brooded by the hen. The hen as a mother is left out of consideration, and the poultryman must use his judgment in supplying conditions which will be the best adapted to the growth and development of the chicks. (3) All things considered, artificially brooded chicks are more liable to disease; or, it might better be said that, owing to the large number handled, they do not get the individual attention which they do in natural brooding, hence the chick with low vitality succumbs to infection much more readily. (4) The percentage of loss is usually greater; but, with more accurate knowledge of brooding requirements and good care, this loss while brooding should be reduced greatly.

**Summary.**—If one wants early chicks in considerable quantity and has the time for their proper handling and brooding, he should get an incubator. On the other hand, where only a few chicks are wanted, or the poultryman has only limited time to give them, the old hen is the best.

Artificial methods rarely pay if one has less than fifty hens, except in those cases in which it is desirable to hatch the whole yield of eggs for breeding or broiler purposes.

On an egg farm for laying breeds exclusively, an incubator is a necessary part of the equipment,—much more so than where general utility breeds are raised.

**Broodiness.**—Natural incubation is dependent upon a normal instinct which fowls possess in greater or less degree, and which is called “broodiness.” It is an entirely natural phenomenon, dependent upon the physical instinct of all animals to reproduce their kind, but it has been demonstrated that this instinct gradually diminishes, where the tendency is continually to breed for heavy egg production. The natural period of broodiness follows the laying of a certain number of eggs; this number depends almost wholly upon the hen, and varies greatly. Sometimes hens that have been persistent layers will become broody immediately after laying from six to ten eggs; others will lay from two to four dozen. The egg breeds rarely ever develop this characteristic to any marked degree. It is called a breed characteristic, and is especially marked in the heavy breeds, less so in the lighter ones.

The natural period of broodiness is in the spring, after the birds have laid their first clutch of eggs. In northern climates

this is usually in April. Several signs will enable one to pick out the broody hen. The first thing noted is her persistent sitting upon the nest after laying. The non-broody hen will leave immediately after laying and is easily disturbed when she is laying, while the reverse is true of the broody hen. Other distinctive signs are the looseness of the feathers on the breast, and the viciousness with which the sitting hen will attack the poultryman when he attempts to remove her from the nest or to search for eggs. There is also a tendency to ruffle up the feathers, and when on the nest to sit close with wings outspread. Another characteristic is the increased body heat, which can be felt by placing the hand under the breast. This is a natural phenomenon brought about by an increased flow of blood into that part during this period. The best time to pick out a broody hen is in the late afternoon, since birds rarely lay their eggs later than two or three o'clock in the afternoon, and after this time all hens on the nest show more or less broodiness.

**When to Set the Hen.**—When hens are used for incubation, the time at which they can be most safely depended upon is during the natural hatching season in the spring. Any birds with a well-developed broody tendency, and of a breed which can be depended upon, can be safely used for hatching. At this time the percentage of loss due to fickleness and other causes will be reduced to the minimum.

**Where to Set the Hen.**—There are two methods of arranging nests for natural hatching, and a choice will depend almost wholly upon the breeds to be used and the number of eggs to be hatched. One can use either a large, specially constructed house for sitting or a small coop of suitable type. The large sitting houses are adapted to natural hatching when carried on extensively. Usually these are large rooms in houses of simple construction. Have them water-tight and free from wind, but well ventilated. One of the best types is the shed-roof structure, with the entire front closed only with wire. The inside of the house is equipped with tier upon tier of large, roomy nests for the hens. Hens are allowed, at regular intervals, to get down on the ground to scratch and eat. This method reduces labor to a minimum, and enables one man to take care of a great many sitting hens.

The second method, or the use of special shelters, is merely the placing of such coops in a secluded place; preferably in the lee of a windbreak, in any place protected by buildings, or on the

south side of a stone wall if available. High ground should be selected, so that during long periods of wet weather the water will not collect in or about the shelters. If possible they should be placed near the residence, so that they can be carefully watched.

*Materials used for such Shelters.*—As a matter of fact, a great variety of materials are used in the construction of individual coops. Small **A**-shaped (Fig. 151) or shed-roof coops represent the best types, since they are easy to construct and answer all the purposes. Barrels placed on the side may be used, and tight boxes or berry crates are often satisfactory if a piece of waterproof paper is placed over the top. The protection necessary

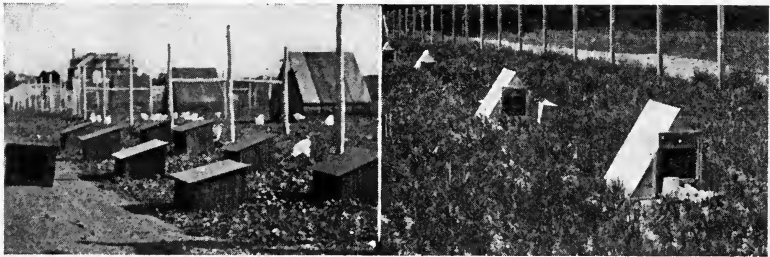


FIG. 151.—Two common types of sitting coops.

depends upon the season of the year when the hatch is to take place. Protect the nest both from rain water and soil moisture, and make it so that it can be closed at night.

The following points should be considered in constructing a special sitting house of the large type: (1) It should be proof against rats and skunks,—that is, made so that the front of the coop can be covered at night with small-mesh wire to keep animals from entering. (2) It should be free from large cracks or crevices and have a smooth inside finish, because of damage from mites. (3) It is a great advantage to have a false bottom in each nest.

The small coops can be used with or without such bottom, but it is most useful when the chicks are very young, or early in the spring when the ground is wet. Moreover, by having the bottom movable it is much easier to cleanse the inside. The coop should be built with the idea of using it for a brooding coop after the hatch, and it should be so planned as to confine the hen yet give the chicks freedom. This can be done by putting slats over the front of the coop, sufficiently far apart to allow passage of the

chicks and yet confine the hen. Such coops should be constructed of light material so that they can be easily carried from place to place, and should be made at very low cost.

*Rules for Making a Good Nest.*—The main requisite of a good nest is a depression in the centre, so that there can be no danger of the eggs being shoved out and rolled into the corners. This is important, for many eggs may easily be lost in this way. Where the nest is built directly upon the ground, the best plan is to hollow or scoop out the centre, banking up the loose dirt around the edges, and covering the floor with nesting material. Where, however, the nest is built on a wooden or portable floor, it is well to put in two or three inches of dirt, scooping this out in the same way, then place the nesting material upon it. When a barrel is used or any box with a large flat bottom, the nest should be partially formed from other matter before putting in the nesting material. In the case of the barrel, a brick at front and back will help to shape the nest, and confine it to one place. The hollow in the nest should be large enough to accommodate all the eggs to be hatched; a good rule is to make it at least a foot in diameter at the top and sloping toward the bottom, where it should be from two to three inches in depth. Soil in the bottom will help to form and preserve the shape of the nest, and it maintains a certain degree of atmospheric moisture, which is desirable.

*Nesting Material.*—Many materials are excellent for finishing a nest; the best, however, is straw or hay, cut in about six-inch lengths. If extremely long and coarse uncut straw is used, it will be hard to shape the nest, and the eggs will very likely be caught in it or roll under the large wisps so that it will be impossible for the hen properly to care for them. Leaves may be used to good advantage; but, whatever the material, there must be no grain, as the birds are apt to destroy the nest in picking at the grain. Shavings are suitable for laying nests, but objectionable for hatching nests, because they are loose, the eggs often become buried in them, and they do not retain as high a degree of heat as is needed.

*Selecting the Hen.*—In selecting a hen for hatching purposes the following considerations should be borne in mind, for reasons stated: (1) Her size is important, that is, her ability to cover the desired number of eggs completely. The small hen can cover only a few, and there is danger that those near the edge will not be kept warm enough. The larger the hen the better, other things being equal. (2) Be sure that the hen selected has the broody

inclination well developed. This can be ascertained by watching her before making the selection. (See p. 314). (3) The temper of the bird should be observed. While some viciousness is desirable, since it is an indication of broodiness and reveals the maternal instinct to brood and protect, yet hens with this characteristic highly developed do not all make good sitters, for in their attempts to fight they are apt to break or crack the eggs. Those of a nervous, flighty disposition should not be selected. (4) The next consideration should be that of health and general condition. No bird should be selected that does not show plenty of fat, or which does not indicate by a bright red comb and bright eyes that she is in good vigor. Any hen with a tendency to disease, especially diarrhoea, should be discarded. The brooding period is at best a heavy strain on the bird, and she needs a vigorous constitution at the beginning in order to perform her function. It is poor policy to use a hen more than once the same season. (5) The age of the bird is also to be considered. Pullets do not make as good sitters as yearlings or two-year-old hens, and when possible the latter should be used. (6) Where selection can be made from one or more breeds, it is wise to make the first choice from a strain known to possess the broody instinct in a high degree. For example, it is known that in the general-purpose breeds this instinct is highly developed, and of all this group the Rhode Island Reds are conceded to exhibit it in the most extreme degree.

**Process of Setting the Hen.**—It is best to take the bird from the laying nest at night, as it can then be done more conveniently and there is less danger of frightening her. At night the hen takes more naturally to new surroundings. Having selected the bird, she should be thoroughly dusted with a good lice powder, working it well into the plumage, especially under the wings, breast, and body. Previous to setting the hen, the nest should be shaped and the eggs placed in it. It is well to set her on false or china eggs for a day or two in order to test her and see how she takes to new conditions; this often prevents broken eggs and ruined nests. By this method, too, the hen herself will, in great measure, shape the nest, and one need not be so careful in making the nest previous to setting her. She should be placed on the nest very cautiously, letting her feel the eggs underneath before releasing her. For a few days it is best to confine her in the nest, so that there will be no danger of her forsaking it.

**Number of Eggs.**—The number of eggs to be placed under a

hen varies according to the size of the hen, size of the eggs, and the season of the year. Birds of medium size will cover from nine to twelve eggs with very little difficulty, while larger birds will cover twelve to eighteen. It is safest to put in the nest one or two less than the hen can conveniently cover rather than too many. If there are too many eggs, some are liable to be broken or injured, for their position in the nest will be changed continually, and all will receive a lessened degree of heat. Under ordinary conditions the average hen will cover fifteen eggs without inconvenience. With larger eggs, such as duck eggs, not so many can be placed in the same nest, eight to ten duck eggs under one hen being about the right number, while five goose eggs and six turkey eggs can be covered by a single hen. During warm weather more eggs can be placed in a nest than during cold weather, so that in the winter it is well to reduce the above numbers by one or two to insure the most abundant hatch.

**Care of the Sitting Hen.**—In the care of the sitting hen system is worth more than all other points combined; for, in the absence of this, the birds may become mixed, the eggs disarranged, the hatching time of the different nests forgotten or confounded, and certain loss will be the result. In the management of sitting hens, it is a safe rule to keep them all confined except when they are let out for feed and water. This will obviate any danger of their becoming mixed. They should be provided with feed and water at a regular time each day, for this teaches them to expect it at such time, and they will immediately come off the nest to eat and soon return; therefore less time is consumed in feeding them satisfactorily. The nests should be numbered in rotation. It is a good plan to set hens on the same day each week, as this will bring all the testing and hatching on certain days, thereby precluding the embarrassment of not knowing when this work ought to be done. Since natural incubation is essentially a matter of detail, most careful and thoughtful attention should be given to it.

**Feed for the Sitting Hen.**—The main feed of the hen should be whole or cracked grain, which may be fed either on the floor in the vicinity of the nest or, better, in self-feeding hoppers. A constant supply should be kept before them, corn being an important constituent of the ration. No wet feed, such as wet mashes, should be given, for it tends to produce looseness of the bowels, which is detrimental.

Fresh water should be provided in a clean vessel. During

exceptionally hot weather in the summer or late spring, it is well to leave an open pan or low bucket on the ground, so that, when the birds desire, they can immerse their plumage in the water.

*Cleanliness* in the sitting coop or nest is of paramount importance, since it means the prevention of vermin, improved health of the hen, and more ideal conditions for the chicks. Three points should be here considered: (1) The droppings should be frequently removed, as well as any cracked shells or extremely dirty litter. This can best be done when the birds are off the nest to eat. (2) An abundance of dust should be provided in a box within easy access of the nest, so that the sitting hens can dust themselves, which is just as essential to them as a bath is to human beings, and it also helps to keep away body lice and mites. (3) The necessity of dusting the hen with a good insect powder once or twice during the incubation period. The most convenient times are on the seventh and fourteenth days when the eggs are tested.

**Testing the Eggs.**—In order to determine the fertility of the eggs and the development of the embryo, which is the gauge of the efficiency of the hatch, it is advisable to candle eggs at least once, and probably twice, during the hatch. This process is described in the following chapter (p. 343).

Take out all which will not hatch, thus enabling the hen to better cover the remaining eggs. Or, when fertility is rather low and two or more hens are sitting, take the fertile eggs from one hen and put them under others. If the eggs are tested twice during the hatch, the most convenient times will be on the seventh and fourteenth days. In natural incubation it may be best to test but once, since testing has a tendency to disturb the hen more than some consider advisable.

**Importance of Keeping Sitting Records.**—In natural incubation, records should be kept of each sitting hen, in order to ascertain just how the hatches are running and to perfect the method. Such records should state the number of the nest, the breed of the hen, the date when set, the variety or kind of eggs, the day of first test, and the number of fertile, infertile, and dead germs, also the date of second test, giving the number of fertile and dead germs. The percentage of hatch, or the number of live chicks taken from the nest, should also be stated. This record may be kept on cards in a rack above the nest or in a book. Such a record will show the keeper when his hens are due to hatch, when fertility is running low, and perhaps enable him to make a pedigree hatch.



**Period of Incubation.**—The hen's egg requires approximately twenty-one days for incubation. This period, however, varies considerably in eggs from different breeds; for instance, the white-shelled eggs of the Leghorns, under uniform conditions, will pip and a great many hatch on the twentieth day, while under the same circumstances the Brahma eggs will take at least twenty-two days. This is probably due to quicker development of the germ of the Leghorns and to the fact that the eggshell is thinner. The periods of incubation required for other birds are: Ducks, twenty-eight days; swans, from thirty-two to thirty-five, usually thirty-five days; geese, thirty to thirty-five days; turkeys, peafowls, and guineas, twenty-eight days. These are the average natural incubation periods; in artificial incubation the time varies somewhat. They may also be affected by the degree of heat which the broody hen develops. The closer she sits and the greater heat she generates, the shorter will be the incubation period. Chicks which hatch much in advance of the normal period or exceedingly late are of no value, for this indicates low vitality. The best chicks are those which are hatched at a uniform time, the great majority breaking the shell on or about the times mentioned. A severe chilling of the eggs during incubation will often kill the embryo, or at least retard the hatch from twenty-four to forty-eight hours.

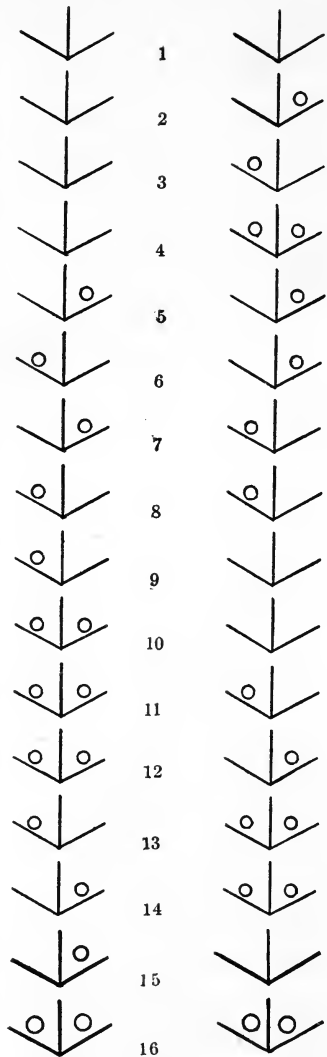


FIG. 152.—Manner of toe punching for baby chicks, showing sixteen combinations, making it possible to identify sixteen different matings.

**Care at Hatching Time.**—As hatching time approaches the hen sits very close to the nest, and often refuses to come off to eat. This is natural, as a high temperature is now necessary. She should be kept in the nest, for many hens at this time become nervous, and try to leave it after a few chicks are hatched. The nest should be so prepared that the chicks, as they hatch, cannot get away from the hen and fall out of it. It is well to feel under the hen occasionally, and remove any shells or weak and crushed chicks, but normal chicks should not be taken away from the hen until they are twenty-four to thirty-six hours old, or until the hen of her own will takes the flock out in search of feed.

**Causes of a Poor Hatch.**—The causes of a poor hatch with the natural method when known can easily be guarded against. They are: (1) Poor sitters; (2) poor eggs; (3) the presence of vermin; (4) improper management. These are all equally important, and a successful hatch depends upon attention to all, from the fact that neglect of any one means almost certain failure.

**Marking Chicks.**—It is often desirable to keep a record of the new chicks; it may be merely for the time of hatching or more detailed information as to parent stock. To mark the chicks permanently and without injury, the poultryman uses one of two methods, toe punching and leg banding. The system of toe punching allows of sixteen different numbers. These are shown in figure 152. If the marks are carefully made, this method will answer very well. It is more quickly done than leg banding and does not



FIG. 153.—A good, yet simple, leg band for chicks.

necessitate much clerical work; but, if not properly done, toe markings are apt to be grown over or the web to be torn. With leg bands (Fig. 153) accurate and full records must be kept, which means considerable expense in time and material; but, where superiority through breeding is desired, this money and time are well spent.

#### NATURAL BROODING.

In the rearing of chicks with the hen, one of the first essentials is a suitable brooder coop, which should be designed as follows: It should be light and portable. It must allow the chicks to have

free range, if desired, but should confine the hen. It should provide ample shelter for both hen and chicks during wet weather. In the construction of such coops, 1 x 2 inch strips and plaster laths make an excellent yard for the hen and chicks to exercise in, and shelter and sleeping coop can be built at one end. The brooder coop should be located in a spot sheltered from the wind, where there is plenty of green grass and some protection from enemies. The floor should be elevated, and covered to quite a depth with sand, to keep it dry and to facilitate cleaning. The hen and chicks should be transferred to the brooder coop about sixty hours after the hatch, or when the chicks have dried off and are ready to leave the nest in search of feed. In making the transfer it is best to carry the hen under the arm and the chicks in a basket or other handy receptacle, the chicks being put in the coop first, and the hen gently placed in after them. By this procedure there is less danger of the hen trampling on her chicks.

**Care of the Young Chicks.**—The chicks should be kept close to the hen for a few days, until they get accustomed to the coop and know where to run for protection. It should also be made certain that they are securely fastened in the coop with the hen at night, also that they are under shelter in the coop in spells of rainy weather during the first few weeks after hatching.

*Feeding the Young Chicks.*—It is important that the chicks be given feed which is easily digested. The belief that feed should be withheld from chicks naturally hatched, with the idea that the newly absorbed yolk will nourish them for a considerable length of time, is a mistaken one. In artificial brooding this question of feeding must be considered, but it is of no practical importance in natural brooding, because the hen will see to the feeding. As soon as they have been put in the brooder coop, give the hen a good feed of whole corn and place water where she and the chicks can drink it, then throw a little rolled oats on the sand. This is probably the best feed for young chicks, because, owing to its light color, it attracts their attention and they can see to eat it. Bread crumbs soaked in milk make an excellent first feed for naturally hatched chicks, as do hard-boiled eggs, to which use infertile eggs can be put. The general practice, however, and it is a good one, is to start the chicks on fine cracked corn or wheat. For the first few days only a limited amount of the grain should be given, but after they have learned to eat they should be fed two or three times a day with good feed which they can clean up

in a short time. Where skim-milk is available, it is well to give the chicks all of it they wish to drink. Unless they have access to green grass (Fig. 154) in the runs, a little chopped lettuce or other green feed should be furnished. In the absence of any fine sand or gravel on the floor of the coop, chick grit should be supplied. After the first few weeks the ration can be gradually simplified and made less expensive. Cracked corn or wheat should serve as its basis, in addition to which the chicks should be given animal and green feed, also grit. The feeding of young stock naturally hatched is a much more simple proposition than the feeding of artificially hatched chicks in the brooder; for, in the first case, the hen sees to their welfare to a great extent. (For principles and methods of chick feeding see Chapter XXI.)



FIG. 154.—An average-sized flock by natural incubation. (Photo by Kellerstrass Farm, Kansas City.)

*Chick Ration.*—A good ration for the first week for chicks brooded by the hen contains equal parts of cracked corn, crushed wheat, and oatmeal.

Put the feed where the hen cannot reach it, she being given three times daily a grain ration of equal parts of corn and wheat. During the second and succeeding weeks gradually eliminate the oatmeal, and as the chicks grow larger substitute whole wheat for the crushed. After the first week begin to give them dry mash similar to that used in artificial brooding.

*Parasites.*—One great evil to which naturally hatched chicks are prone is the presence of lice, notably head lice, which if in great numbers sap the vitality, weaken the constitution, and stunt the growth. The best means of ridding chicks of lice is to grease the head with lard or carbolized vaseline; this will not only drive the lice away, but tend to keep others from coming. Unless the parent is kept well dusted, chicks are also infested at an early age by body lice, and, for this reason, it is well to dust the hen at regular intervals of about two weeks until the chicks are weaned.

*Weaning and Separation of Sexes.*—As soon as the chicks are old enough to look out for themselves, the hen should be removed, for two reasons: Because if put back in the pen she will soon begin

to lay, and because the chicks grow faster after the hen is removed. The age at which the hen should be allowed to wean her chicks depends upon the weather and season,—usually from four to six weeks is the average.

At about ten weeks, or as soon as sex can be distinguished, the sexes should be separated if maximum growth is to be realized.

## REVIEW.

1. What terms are used to define the two methods of incubation?
2. Enumerate disadvantages of natural incubation.
3. Discuss artificial incubation.
4. Mention three points which will aid one in determining which system to follow.
5. Describe the broody hen.
6. When is the best time to set the hen?
7. Name and describe two methods of setting hens in large numbers.
8. Give the desirable features in individual sitting coops.
9. How would you make a good nest, and what material could be used?
10. Enumerate five points which should be considered when selecting the sitting hen.
11. Describe the procedure in setting the hen.
12. How many eggs under one hen?
13. Describe method of caring for and feeding the sitting hen.
14. Give three cautions to insure cleanliness in and around the nest.
15. Is it important to test the eggs? Why?
16. What factors should be recorded in sitting records?
17. Name the periods of incubation for different species of birds.
18. What special attention is required at hatching time?
19. Give four causes of poor hatches.
20. Describe two methods of marking newly hatched chicks; why used?
21. Describe a good brooding coop for hen and chicks.
22. Outline the care of the young chicks.
23. Outline a complete system of feeding baby chicks in natural brooding.
24. What is the effect of body parasites upon the growing chicks? How prevented?
25. What are the advantages of early weaning?

## CHAPTER XX.

### ARTIFICIAL INCUBATION.

ARTIFICIAL incubation and brooding means the hatching and rearing of chicks by use of incubators and brooders. The hen's heat and maternal instinct are entirely disregarded.

**Historical.**—Artificial incubation has been successfully practised since prehistoric times. The earliest reliable records are found in accounts of Egyptian egg ovens: The eggs were placed in large baskets made of reeds, and surrounded by fermenting manure which supplied the heat. The method was very crude, yet productive of excellent results. This artificial hatching was carried on by different families, generation after generation, and they thus became very expert in manipulating the equipment.

This simple method was superseded by the use of ovens, remains of which have recently been found in Egypt, where the practice of hatching eggs in large ovens has lately been revived. These ovens have capacities ranging from one thousand to three hundred thousand eggs in a season. As a rule, they are centrally located in some large village in an agricultural district. The eggs are purchased by the manager of the oven, and the chicks sold when hatched. Such eggs can usually be purchased for \$2.50 to \$3.00 per thousand, and the resulting chicks sold for \$1.00 per hundred. These large hatching plants are marvels of simplicity. They consist of a large, low building constructed of clay, through the centre of which runs a long alley, and opening out of this are small, circular compartments with two floors, the second being about four feet above the first. The eggs are placed on straw, the heat being generated by burning fuel set on an elevated ledge around the sides of each room, the amount of fuel used regulating the heat. There is an aperture in each room which carries off the smoke and surplus heat. In the centre of each compartment is an opening where the operator stands when turning and handling the eggs. As they hatch the chicks are removed to the central alley, which is somewhat cooler, and kept there until sold.

Early historical records show that artificial incubation was carried on in China in ovens similar to the above. The appliances were very crude, and success depended almost entirely upon the

judgment, skill, and close attention of the operator. The next development of the artificial method was in France during the fifteenth century, but little actual progress was made. In the latter part of the eighteenth century water was first used as a means of supplying heat to the eggs, all preceding work having been done by heated air.

In 1845 a self-regulating valve was invented, which regulated the temperature or reduced it when too high. This device opened the way and made possible the modern self-regulating incubator. The following year, in an attempt to imitate the natural method, a special apparatus was constructed to supply heat from above. There was no noticeable advance from this time until the last quarter of the nineteenth century when, owing to the increasing demand for poultry, largely because of increased population, much construction work was done in this country and abroad, resulting in many new and superior types of incubators.

To Charles Cyphers belongs much of the credit for developing in America the commercial artificial incubator. While he was not by any means the first experimenter in this line, yet he accomplished much, and made improvements which soon reduced the process to a practical science, and enabled any one of limited means to own and successfully to operate an incubator. Since 1870 many improvements have been worked out, with the result that different models have been put on the market. Many of these are good structures of desirable type, but many, too, are faulty in design and poorly built, therefore cannot be expected to work successfully. The aim has been to construct an incubator which would be operated by any one, in any place, with the least possible care and oversight, and in great measure this has been accomplished. Yet in many important ways the incubator must be improved in order to make it as efficient as the hen.

**Incubator Houses and Cellars.**—The successful operation of any incubator depends largely upon the place in which it is located, and the rapidity and ease with which the operator can secure and hold the desired temperature. Therefore, the design, construction, and location of the building or room in which the incubators are to be placed must be carefully considered. The requirements of the incubator room are briefly stated as follows: (1) Even temperature, (2) plenty of ventilation, (3) abundance of moisture.

It must be possible to maintain in the incubator room approximately an even temperature of any desired degree. Variation

within certain limits is permissible, but sudden fluctuations beyond this limit will preclude the maintenance of an even temperature within the machine.

The room should be so constructed that it can be thoroughly and frequently ventilated, for fresh air is essential to the growing embryo, and good ventilation will carry off the fumes from the lamps.

Arrangements should also be made to materially increase the moisture in the atmosphere when desired, since it has been proved conclusively that moist atmosphere is essential in incubation.

*Design.*—These require-

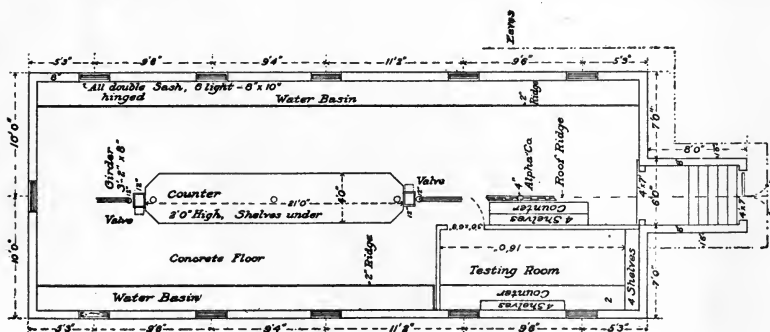
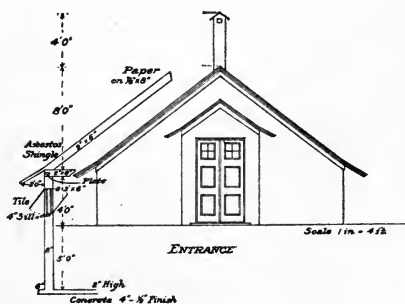


FIG. 155.—Working plans for incubator cellar.

ments are best met by a house built partly below the ground (Fig. 155). The machines are then placed low, as this makes them less susceptible to changes of weather,—the room will be cooler in summer and warmer in winter. Two courses are open: Either to put up an incubator room in some permanent building, or to construct a low one-story house specially for the purpose. The latter is the usual plan, and, all points considered, is undoubtedly the best. Where a room is fitted up in a building designed for other purposes, there is always danger of fire, and the rate of insurance is higher. Besides, unless the structure is exceedingly well built, the eggs are liable to be injured by shock or jarring from above.



A building put up expressly for incubation purposes need not be very expensive; but a few requirements must be provided (Fig. 156, A, B, C, D). The floor should be from four to five feet below the level of the ground, and the ceiling from eight to ten feet high, giving about five feet below ground and five feet above. Double walls, especially above the ground, are essential, as they aid materially in keeping the temperature uniform. The subgrade, or wall below the ground, is best constructed of poured concrete

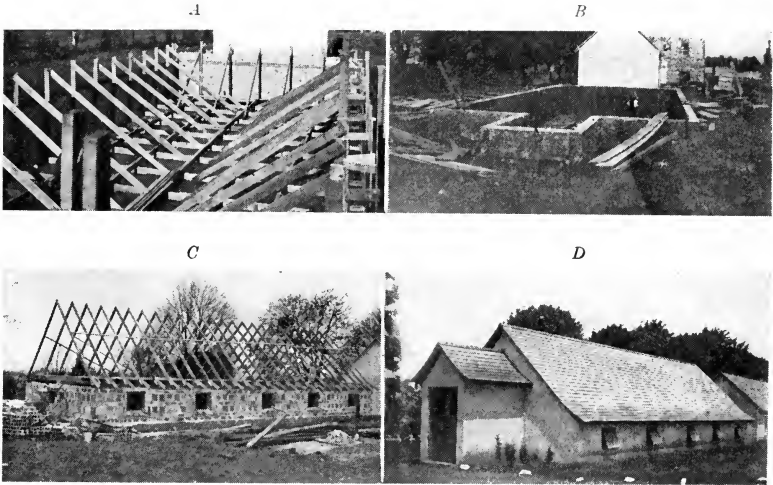


FIG. 156.—Four views showing construction of hollow-tile incubator cellar. A, Forms ready for pouring concrete foundation wall; B, forms removed; C, hollow-tile construction, and manner of framing roof; D, completed cellar.

or stone (Fig. 81), while the side wall above ground can be made of lumber,—2 x 4 inch studding, sheathed inside and out. Or it can be constructed of hollow tile, which has proved satisfactory, as it is almost a non-conductor of heat. Such a tile, well stuccoed inside and out, is economical, durable, easily built, not susceptible to temperature and moisture variations, and can be quickly and easily cleaned.

The building should have a loft overhead, to insure uniformity of temperature. For this purpose, a two-pitch or gable roof is best, and it is advisable to put in heavy ceiling rafters and a solid board floor, so that the loft can be used for storage purposes.

*Ventilation.*—It is unnecessary to install an expensive ventilat-

ing system in the incubator cellar. The best plan is to cut in the wall single-sash windows, three by three feet, one for every thousand cubic feet of air space. These windows should be double, the outer sash hinged at the top, to be raised upward and outward, the inner sash hinged at the bottom and opening inward and downward. Neither sash should be open more than about 45 degrees, which will permit the air to circulate freely through the cellar, but not to blow directly upon the machines. A direct draught over them, especially during the high winds of early spring, is apt to make the lamps smoke, or to blow them out entirely. The use of double sash creates an air chamber which helps to keep the temperature and humidity even. It is well to have a vestibule with double swinging doors at the entrance of the building or cellar, to cut off drafts of outside air.

*Interior.*—A specially constructed incubator cellar should be plastered with cement, and have a concrete floor, raised a little in the centre so as to carry the water off to either side. This permits the thorough wetting of the floor, and also helps to maintain the right degree of humidity. A part of the incubator cellar should be partitioned off into a small room which can be easily darkened and used for testing. Here shelves should be built at a convenient height for holding testing lamps and egg traps, and a long table may be placed in the centre of the room for turning and cooling; the necessity of this depends somewhat upon the type of the incubator, for some are so constructed that the trays may be placed on top. It is desirable to have a shelf covered with tin or asbestos, preferably the former, for filling and trimming lamps, and over this other shelves for the storage of extra lamps, wicks, and other supplies. The safest way to handle the oil is to bring it in from the storage tank through a feed pipe, which does away with the necessity of carrying small oil cans around, and perhaps saturating parts with oil. There should be a closet or shelf for thermometers, hygrometers, and incubator records. Running water should be piped into the building, and a faucet conveniently located with hose attachment for sprinkling.

The cost of such a building is an item, and it is best to figure this out from the capacity in dozens of eggs. Of course, the cost of a building specially designed will be greater than if a room is fitted up in a building meant for other purposes, but the advantages of the former will counterbalance the cost. An estimate, per dozen-egg capacity, will vary considerably, according to its type

and the size and style of the incubators. An economical cellar using many small machines in single tiers can be constructed for about \$1.00 per dozen eggs, possibly less—even as low as fifty cents per dozen eggs.

*Location.*—One of the best locations for an incubator building or cellar is on a side hill. Setting the building on the slope does away with one-half of the excavating, and at the same time permits an entrance on the same grade as the cellar floor. This furnishes a good outlet for air, and obviates the necessity of coming up and down stairs upon entering or leaving the cellar.

The building should be near the dwelling or the keeper's quarters, since it needs attention early in the morning and late at night. If within easy access of the brooder house, it will minimize labor when removing the chicks, and also lessen the danger of chilling them.

#### Types of Incubators.

—There are two general types of incubators, the distinction being based on the manner in which heat is supplied to the eggs. The problem in artificial incubation is to maintain a steady temperature of approximately 103° F. and carefully to regulate the atmospheric moisture. In the various makes

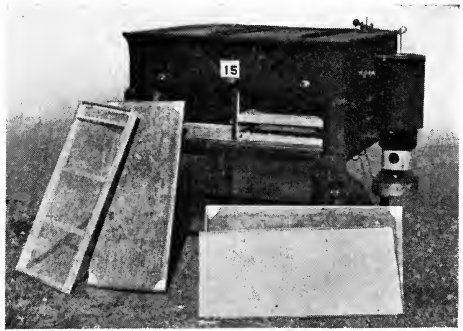


FIG. 157.—A common type of hot-air incubator. The incubator is given a "sun bath" before the next hatch.

of incubators heat is imparted to the eggs in two ways,—directly by hot air from a kerosene lamp (Fig. 157); and by air heated by coming into contact with a hot-water tank over a kerosene lamp.

A brief comparison of these two methods may be made. With a hot-air machine an even temperature can be kept up. Since the air is heated directly by the lamp, any increase or reduction of the flame is immediately felt in the egg chamber; whereas with a hot-water machine the heat from the lamp must be imparted to the water, thence to the air in the incubator, and this consumes more time. With hot-air machines there is no copper or tin tank to be kept filled with water, hence no danger of this corroding and leaking in the middle of a hatch, the water soaking the machine

and spoiling the eggs. A strongly built copper tank, with proper care, should last many years, but a thin copper or tin tank cannot be expected to last longer than two or three seasons. Sediment soon forms in the bottom of the tank, especially if hard water be used. The tank is hard to clean, and this sediment accumulates in different parts of the circuit and causes uneven radiation, with variation in the temperature of the different parts of the machine. Hot-water machines will hold the heat longer than the hot-air type; they have the advantage that when, for any reason, the lamp goes out in the night, there is less danger of an incubator cooling down to a dangerous degree before it is discovered.

A

B

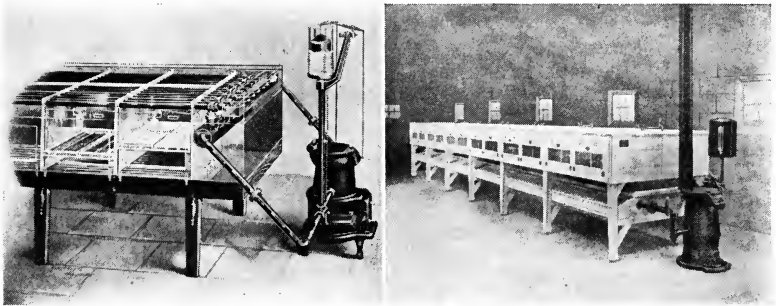


FIG. 158.—Modern mammoth incubators. *A*, Phantom view showing arrangement of pipes and circulation of water; *B*, another make of incubator with brooders below. (Photos, *A*, Hall Mammoth Incubator Co.; *B*, Candee Incubator Co.)

The hot-air incubators seem to be the most popular, no doubt because they require less attention, are cheaper, less complicated, and less liable to get out of repair. There are a number of excellent hot-water incubators on the market, but, all things considered, the hot-air type is the safest and best.

Incubators, according to their size and type, are also classified as individual, or small, and mammoth incubators. The small ones are composed of single compartments for the eggs, with capacities of fifty to five hundred, each unit being a separate machine heated by its own lamp. The mammoth incubator consists of multiple units—a number of egg chambers—the entire machine having a capacity of from two thousand to fifteen or twenty thousand eggs, heat being generated in a central heating plant or boiler, and conveyed to all the compartments by means of hot-water pipes extending above the egg trays (Fig. 158).

The type selected will depend largely upon the number of eggs to be hatched, the mammoth incubator being best adapted to large poultry plants, or community centres where there is a demand for custom-hatched and day-old chicks. It is being used to some extent on large broiler plants, and more and more in commercial hatching; but its popularity is only of recent origin. In custom hatching a compartment or a number of compartments are rented at so much per hatch, the person who hires the compartment supplying the eggs and taking the chicks, and the operator furnishing the heat and doing the work connected with running the

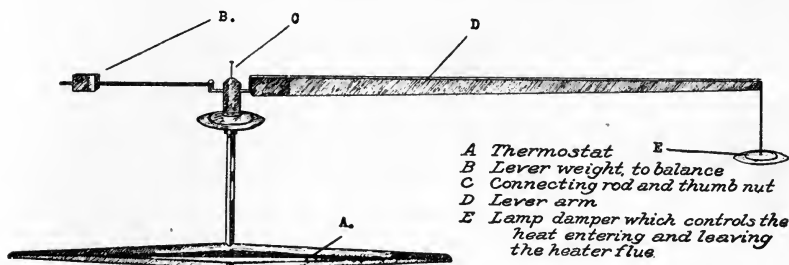


FIG. 159.—A complete self-regulating device for incubators heated by lamps.

machine. The chief advantages of this are its large capacity and small cost for labor and fuel.

Profitable hatching by artificial incubation depends upon securing a good incubator in a good location. Some of the points to consider in selecting an incubator are:

The machine should be best adapted in size to the conditions,—the mammoth incubator where thousands of chicks are to be hatched within a short time, the individual lamp machine for much smaller numbers on small poultry plants or farms.

The simplicity of the machine should always be taken into account. The more mechanism there is, the greater the danger of mistakes in management; the more parts there are to get out of order and work poorly, the less satisfactory the machine will be.

Since the effectiveness of the machine depends in great measure upon the maintenance of a uniform temperature of desired degree, the regulating apparatus should be carefully examined (Fig. 159). This apparatus should combine four requisites: (a) A sensitive well-built thermostat; (b) a simple but certain method of trans-

mitting the action of the thermostat to the lamp; (c) arrangements for easy adjustment or regulation; (d) mechanism that will not get out of order with use.

It is well to look into the mechanical construction of the machine if great and permanent efficiency is to be expected. A good incubator should be built of well-seasoned, kiln-dry lumber, and well put together, so that it will not swell or warp, or the joints come apart when subjected to heat, or rack and come apart when moved. It should be substantial, both in appearance and detailed construction.

It should be of plain design, well finished, with several coats of varnish, making it as nearly waterproof as possible, so that the great humidity often present will not affect the wood.

The past record of the machine should be investigated,—not only the advertisements, but also the practical results attained by those who have owned and used one. The reputation which a machine has made is usually its best recommendation and the safest one to rely upon.

The machine bought should be of not less than one hundred eggs capacity or, better still, two or three hundred, since a small machine requires as much time and labor to operate it, and nearly as much fuel; it is also harder to keep it at a uniform temperature, because, owing to its small size, it is more easily influenced by changes in weather. In most cases the poultryman intends to increase the amount of hatching at some future time; the larger machine can be run at one-half capacity the first year or two, if desired, and the number of eggs increased when necessary without extra investment.

Summary.—It is well to emphasize the fact that an incubator should never be placed in a damp, dark, musty cellar in a dwelling house, for proper conditions cannot be maintained nor can it be well ventilated. Nor should it be put in an upstairs room in a dwelling house, owing to the great variations in temperature day and night, and the certain increase in insurance rates.

The room selected should be well ventilated, free from drafts, and of an even temperature day and night. The air should contain a moderate amount of moisture, and it should be possible to increase this humidity if desirable. The machine should be so set as to eliminate all danger of fire; the lamp box should be at least four or five feet from any combustible material, such as a wooden partition. It should be shielded from the direct rays of

the sun, for this would materially raise the temperature in the machine if permitted for any length of time.

The best place is a cellar constructed primarily for the running of an incubator, the requirements having been thoroughly understood by the designer and builder.

**Care of the Incubator.**—The incubator should be kept in perfect order, not only during the time of year when it is being operated, but when idle as well. It should be carefully inspected and overhauled before each period of operating. A few days before putting in the eggs, the machine should be started, to test its accuracy and see that it is properly adjusted, also that the lamp and wick are in good condition, and to dry out the moisture. If it has been allowed to stand in a damp cellar, it should be worked until the excess moisture has been so dried out that the doors and ventilators will open easily. This preparation of the machine is essential in order to prevent trouble in the future; it is also important from the standpoint of the amateur, for, by operating it for a few days or a week, one becomes familiar with its workings.

As a rule, the instructions sent out with the incubator should be carefully studied, and the machine operated accordingly, at least until a better method is evolved. The manufacturer should best understand his apparatus, and is the person most interested in getting the best results from that particular machine. Caring for the incubator is a matter of routine; a plan should be marked out and closely adhered to.

**Care of the Lamp.**—Since the lamp is the source of the heat, which is the vital requirement, its workings must be thoroughly understood. The following suggestions may be useful:

1. Trim and fill the lamp at a regular time every day; if this is done regularly, it will not be overlooked or forgotten. It should never be trimmed or filled just before turning the eggs, because, if the hands are oily when handling the eggs, the oil has a tendency to fill up the pores and check evaporation and the free passage of air.

2. Be sure that the lamp is set firmly and properly in the frame or standard, and that the burner and chimney flue fit evenly, thus preventing danger from smoke and possible fire. If the lamp is improperly placed in the machine, it will flicker badly, and may give less heat than is required.

3. Do not fill the lamp too full. Leave a little space at the top for air and for the movement of the oil. If too full it will flicker and may go out entirely.

4. To trim the lamp, take it from the machine and lower the wick to prevent smoking. Do not cut the wick with scissors except once in three or four days, then most of the charred portion can be cut off. Each time the lamp is filled, scrape off the charred portion of wick with a small piece of wood or match. This is best accomplished by turning the wick high enough to bring the charred portion above the wick guard, then the charred end can be quickly scraped off. When the flame has a tendency to point upward at either end, forming a crescent, clip the corners slightly; or, if it points up in the middle, trim the centre a little lower. The wick guard often becomes bent, and either wider or narrower in places, which makes the wick burn unevenly. This can be remedied by straightening it. Have a uniform even flame with curved top, the centre being a trifle higher than either end.

5. After filling, any oil on the lamp should be wiped off with a cloth. Keep it as clean as possible, and so prevent odor and danger of fire.

6. After lighting the lamp, put it in the machine and turn it low for about five minutes, after which the wick may be raised as high as desirable. If turned high at once, the flame may flare up, and the lamp smoke.

7. Leave the flame so low that there can be no danger of smoke. The wick should be large enough to furnish the necessary heat without having to burn at a dangerous height. This should be borne in mind when selecting the machine.

8. In regulating the temperature, the best method is to keep the lamp wick always at the same height, and regulate it with the thumbscrew. An exception to this rule, however, may be made on or about the nineteenth day, when, owing to the large amount of heat given off by the mature embryo, it may be desirable to turn the lamp wick down slightly.

9. Be sure to place the lamp so that no draft can blow directly upon it, as this will make the light flicker or smoke, if it does not go out entirely.

10. The burner box should be kept clean, free from dust, and the glass openings as clear as possible. Watch to see that they are not broken or removed, in which case the force of the air will make the lamp burn poorly.

**Filling the Egg Chamber.**—The following points should be borne in mind: (1) Avoid subjecting the eggs to a too sudden change of temperature by bringing them immediately from a



cool room of perhaps  $45^{\circ}$  or  $50^{\circ}$  to one with a temperature of  $100^{\circ}$  to  $103^{\circ}$ . Allow the eggs to warm up for a short time in the incubator room before placing them in the incubator. (2) It is a good plan to set the eggs on end, large end up, for six to twelve hours previous to putting them into the incubator. This allows the air cell to adjust itself, and the yolk to float in normal position. (3) When placed in the tray, the eggs should completely cover it, but not be piled one upon another. The temperature varies approximately one degree for every inch of height, and it would be impossible to subject all the eggs to a uniform temperature. The process of turning, too, would be more laborious, with greater danger of cracking the eggs. (4) When it is desirable, for any reason, to keep a record of the ancestry of the progeny, pedigree egg trays must be used, except where a small number of eggs are so hatched; in such cases, it may be possible to put eggs from hens of different color in the same compartment, although this practice is not always conducive to the best results in hatching. Pedigree egg trays are composed of small compartments in which eggs of different hens or different breeds may be incubated, the chicks when hatched being plainly marked for future identification.

**Source of Heat.**—Keep up the degree of heat best suited to develop and hatch vigorous chicks; in natural incubation this heat is generated by the mother hen. To accomplish it artificially, oil, coal, gas, and electricity are commonly used. The kind of fuel used is immaterial, so long as it is adapted to the machine used. The small or individual incubator is usually heated by oil. A very good method is to have the machine piped for illuminating gas, a round burner being used; this provides a uniform degree of heat with a minimum amount of labor. Electricity is sometimes used in the individual machine, but not commonly. Coal is used almost entirely in the mammoth machines.

**The temperature** of eggs during incubation is approximately  $103^{\circ}$  F., or from two to three degrees lower than the body temperature of the hen. The temperature of eggs under hens has been found to vary from  $101^{\circ}$  to  $104^{\circ}$ , the average being approximately  $103^{\circ}$ .

There are two methods of testing the temperature of the incubator; one is by placing the bulb of the thermometer in contact with an egg, and the other is to take the temperature of the air above the eggs. The former permits a possible error from the fact that the bulb of the thermometer may rest upon an infertile

egg or one containing a dead germ, and such eggs have less warmth. When the temperature of the air is taken, the results will be much more uniform. When recording temperature by the latter method, take it on a level with the eggs by placing the thermometer in the egg tray, or just above the eggs by suspending a thermometer from the top of the egg chamber. The latter method seems to be the better, because the thermometer is always in place and does not need to be removed when the eggs are turned, it is easy to read, and, if hung in the centre, it will record the average temperature of the entire machine. If thermometers are placed in the egg tray during hatching time, they are constantly liable to be tipped over or turned around, so that it is impossible correctly to read the temperature.

A thermometer suspended with its bulb about one inch above the eggs should register one degree higher than when on a level with the eggs.

The following temperatures are desirable during the incubation period, if a suspended thermometer be used above the eggs. The first week  $101^{\circ}$  to  $103^{\circ}$ , preferably  $103^{\circ}$ . This should be maintained as uniformly as possible until the last few days of the hatch, when it is advisable to increase it to  $103.5^{\circ}$ , but not over  $104^{\circ}$ . If the temperature of the room is considerably below  $60^{\circ}$ , it will be wise to run the temperature higher than given, as this is for a room of  $60^{\circ}$  or above. Never let the temperature go above  $106^{\circ}$ ; if it registers so high, it is well to cool the eggs down to  $100^{\circ}$ . A high temperature during the first part of the hatch is more apt to be fatal than after the twelfth day, when a temperature of even  $110^{\circ}$ , if not prolonged, may not prove disastrous. If, at any time immediately after filling the lamp or adjusting the machine, the temperature is found to be  $100^{\circ}$  to  $101^{\circ}$ , it is not alarming, since the eggs require considerable time to warm up after cooling.

It is best to read temperatures morning and night before attending to the machine. Do not try to force the temperature up, for it has a tendency to rise rather than fall, unless the room is very cool. On the contrary, if the temperature goes up to  $104^{\circ}$  or above, the thermostat or regulator must be adjusted.

There are in the market a good many automatic devices designed to notify the attendant when the temperature is abnormal, but they are of little practical value. The incubator should have one operator, who will look after it and be responsible for it, until the hatch is completed.

**Turning.**—The turning of eggs during artificial incubation is a process designed to duplicate the motion which the hen gives to the eggs in natural hatching. The effect of the turning is to change the position of the germ; for, owing to the high temperature, the albumin has a tendency to break up, the yolk rising higher and higher, allowing the germ to come in contact with the shell. Turning is also necessary to supply oxygen to the growing embryo, for the germ absorbs oxygen from the albumin, and the albumin in turn gets oxygen from the air cell or through the shell of the egg. If the egg is not turned, especially during the later stages, the embryo will not be of the right shape or in the right position in the egg, and therefore is unable to hatch.

The following is a comprehensive rule for turning. Begin turning on the evening of the third day, continue this process each day, morning and evening, until the evening of the eighteenth or nineteenth day, or until the eggs show signs of pipping. Then prepare the machine for hatching, and do not remove the tray for any purpose.

Several methods are recommended for turning, and a number of appliances come with different machines. The most common of these is the turning frame, the eggs being placed between the slots, the theory being that when this frame is moved back and forth the eggs are rolled about. As a matter of fact, however, many of the eggs, especially if of different sizes, are found to be in the same position, and the small ones are apt to be cracked. The best method, undoubtedly, is that of hand turning, which consists in placing the palm of the hands on some of the eggs from the centre, and moving them about the tray, trying, so far as possible, to put them into a different position. If the hands are pressed firmly on the eggs, this method promotes uniformity, and very few, if any, eggs are cracked or broken. It is unnecessary to mark the eggs and turn them halfway over each time; this requires extreme care, and the amount of time and labor expended is not productive of any better results. If the incubator is of the double-tray type, the trays should be shifted before replacing them after turning, and the ends reversed twice daily, thus counteracting any variation in temperature in the different parts of the machine (Fig. 160).

*Cooling* takes place during the process of turning, the object again being to imitate nature. It not only allows the egg to cool off, but at the same time permits it to secure a greater amount of

oxygen than would be possible in the machine itself. The length of time for cooling depends upon the temperature of the room and the season of the year, and also upon the ventilation of the machine. It is impossible to lay down definite rules; but it is safe to begin cooling on the fifth day, and cool from four to five minutes in a room heated to about 60°. Do not let them cool any longer than the time required for turning; in a room which is much cooler than this. After the fifth day, the time for cooling should be gradually increased, until, during warm weather and in the latter



FIG. 160.—Interior view of incubator cellar. Operator turning and cooling eggs. Water is used on the floor to increase moisture in the incubators.

part of the hatch, the eggs may be cooled from fifteen to twenty minutes with very good results. The exact degree and process of cooling are more or less disputed points, experiments proving that environment varies so much that no positive rule can be laid down. It is evident that the eggs are considerably cooled during turning, and that the machine also cools off somewhat while the eggs are being taken out and replaced. Stop the cooling at the same time that the turning is stopped, or about the eighteenth or nineteenth day.

**Ventilation** is essential, in order that the gas generated by the egg may be thrown off and replaced by a supply of fresh air and

oxygen. The problem is, how to supply fresh air without too great a loss of moisture from the egg, due to evaporation. Evaporation of the fluid in the egg is influenced by the rapidity with which the air circulates through the egg chamber, and by the humidity of the air itself; hence the factors of ventilation and moisture are closely related.

There are three methods of ventilating the smaller or individual incubator. The first, and most efficient, is by the introduction of fresh air into the machine, the intake being at the lamp box and the pure air heated as it enters the machine. The second is by the use of small ventilators controlled by sliding valves which lead directly to the inside of the machine through the wall. The third is ventilation through the bottom of the incubator, the bottom being provided with openings or slits, and, in some cases, so constructed that it can be let down. In some machines these three modes are combined, while in others only one or at the most two are used. Whatever the system used, there should be an abundance of fresh air passing slowly through the chamber, and this can be regulated by muslin or burlap curtains to cut off any draft.

*Evaporation and Moisture.*—The real gauge of the ventilation is the evaporation which takes place within the egg in a given time; hence, one of the best means of ascertaining the exact relation between ventilation and moisture is a study of this evaporation. It can be determined by testing or candling the eggs, and noting the increased size of the air cell. For instance, when the egg is first put into the machine the air cell is very small, being only about one-eighth of an inch in depth. Under normal conditions it will have increased on the third day to about one-quarter of an inch in depth, on the eighth day to about three-eighths, on the fifteenth day to about five-eighths, and on the nineteenth day to about three-quarters. This is caused by air penetrating the shell and taking the place formerly occupied by the evaporated liquids.

The evaporation which takes place in the normal egg during incubation has been determined as follows: One hundred eggs of average size will lose during the first five days of incubation 8.28 ounces, during the next seven days 12.05 ounces, and during the next seven days 12.044 ounces. This shows the high degree of loss, and the loss becomes still greater as the hatch progresses.

Many experiments have been conducted to determine the de-

sirability of retarding evaporation in artificial incubation by increasing the humidity of the air in the egg chamber, yet at the same time permitting free ventilation.

Experiments have been conducted involving one thousand eggs set in eight machines, four with low and four with high humidity, the average in the dry machines being 56 degrees, and in the wet 68 degrees. The results showed that increased moisture was desirable, and that there was much less loss in weight during the incubating period. The average loss of weight for the wet machines was 0.145 pound, and for the dry 0.23 pound, being nearly double in the case of the dry machines.

This same experiment also proved that increasing the moisture within certain limits produced the following results: (1) It increased the percentage of hatch, which was 62.0 per cent for the dry and 69.6 per cent for the wet. (2) The resulting chicks weighed much more at hatching time and were more vigorous, being 0.079 for the dry and 0.081 for the wet, there being five cripples in the dry machines against one in the wet. (3) Produced greater uniformity in the hatch, both from the standpoint of lapse of time from pipping to complete hatching, as well as uniformity in the chicks themselves. (4) The chicks from the moisture machines were much more successfully brooded, the percentage being 52.3 for the dry against 89.5 for the wet.

The retardation of evaporation is an important matter. The extent to which it should be carried depends on atmospheric conditions surrounding the egg and in the incubator room. Evaporation may be checked by increasing the humidity in any of the following ways: By frequent sprinkling of the floor and walls with water; by placing under the egg trays moisture pans, usually filled with sand which is kept wet; by putting a sponge or other material saturated with water in the machine; by sprinkling the eggs at frequent intervals with warm water; or by limiting the ventilation by partially closing the ventilators.

As a matter of fact, it is doubtful whether the humidity can be kept too high. Humidity is ascertained by an instrument called a hygrometer. The degree of moisture is computed by comparing the readings from two thermometers, the bulb of one being wrapped in a moist wick or cloth, while the other is dry. The lower reading of the wet bulb is due to evaporation, hence the difference between the two readings. The amount of evaporation depends upon the humidity in the air. It is impossible to

keep the wick of a wet-and-dry-bulb hygrometer in good condition in the incubator, because the high temperature will quickly dry it out and make frequent changes of the wick necessary. For practical purposes, the spiral or horse-hair hygrometer is much more satisfactory. To the inexperienced operator, however, the increasing size of the air cell will be the safest guide.

**Testing.**—To determine the fertility of the eggs, as well as to study the developing embryos and thus ascertain whether the machine is running properly, it is advisable to test or candle the eggs once or, better, twice during the hatch, preferably on the seventh and fourteenth days. The egg tray should be removed to a dark testing room, and the light for testing provided either by a kerosene lamp or an acetylene or electric light placed in a small tight box with circular opening about one inch in diameter. Electric light is the best, the light from a kerosene lamp not being powerful enough to penetrate the shell of the egg (Fig. 161).

The egg tray should be placed on the right-hand side of the lamp box, the person standing in front, with a duplicate empty tray at his left hand in which to put the eggs as tested. The testing lamp should be so placed that the opening is about six inches above the waist line and one foot in front of the operator. The untested eggs should be taken two or three at a time from the full tray, and transferred one at a time to the other hand, grasping them between the thumb and forefinger with the large or air cell end outward. As the eggs are moved, they are brought one at a time in front of the opening, and given a gentle rotary motion. This will move the contents, and the light penetrating the shell will reveal the presence or absence of the germ, and its condition. The chief points to be determined in the seventh day's test are the size and location of the air cell,

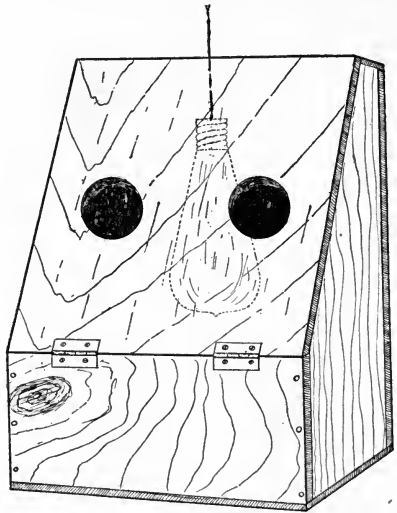


FIG. 161.—A useful, home-made egg tester. Electric light is used. Two holes allow the testing of two eggs at once.

the infertility of the eggs, dead germs, germs apparently sticking to the shell, and cracked eggs (Fig. 162).

The size of the air cell, as previously stated, will vary with the period of incubation and the amount of ventilation; if it appears too large or too small, steps to correct this should be immediately taken. If the air cell is too large, the moisture in the air must be increased to lessen evaporation, and if too small, evaporation must be promoted by increasing ventilation. Air cells not properly located at the larger end of the egg are due either to the fact that the eggs were kept too long in one position before being put in the machine, or to improper turning prior to the seventh day.

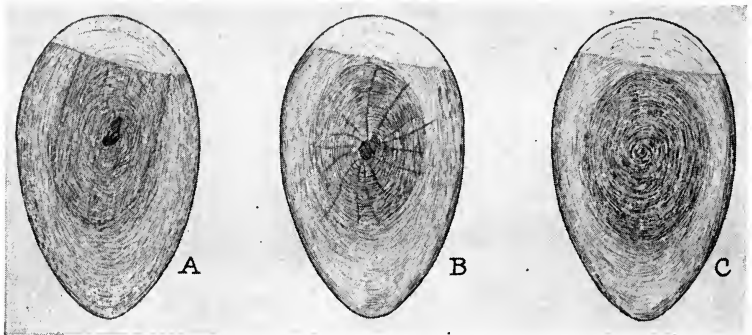


FIG. 162.—Eggs seven days in the incubator as seen when tested. A, Dead germ; B, living germ; C, infertile egg.

An egg which appears to be absolutely clear or translucent without a dark spot with converging lines is infertile. All such eggs should be plainly marked and put in a separate place. These can be profitably used for chick feeding, by boiling them hard and feeding them separately or mixed with mashes. White-shelled eggs, if tested out on the fourth or fifth day, may be safely used for baking purposes. The normal egg at this time will have a clearly defined air cell; the germ will be noted about one-third of the way from the large end, looking like two dark spots lying close together, one a trifle larger and darker than the other; radiating from the germ will be seen numerous dark lines, crossing and recrossing, which are the veins of the embryo. If the germ is not readily detected, it can be brought to the surface by rotating the egg slightly. At this time an infertile egg, especially in a strong light, will show a slight dark area in the centre, which is yolk.



Eggs showing a bright-red line fixed to the shell in the form of a semicircle, with the germ in the centre, contain dead embryos. A dark-red spot seen against the shell is undoubtedly a germ which died from want of turning. A hazy air cell and small faint germ indicate weakness and lack of vitality, and the chances are that the egg will not be hatched.

When the testing is finished, eggs which have passed inspection should be immediately returned to the machine. When making the test the usual turning and cooling are unnecessary, as the eggs get enough of both during the process. On the fourteenth day the same routine is followed; this time, however, the object is merely to determine the increased size of the air cell and its requirement of moisture, as well as to remove any eggs in which the germ has died during the intervening time. Normal eggs will now show a rather large air cell, with a clear-cut and distinct dividing line, the remainder of the egg being extremely but uniformly dark in color. By rotating it slowly the outline of the embryo chick, greatly increased in size, can be seen. Any which at this time show no sign of vitality, but a haziness around the air cell with a clear area near the edges, should be discarded, as they undoubtedly are dead or will not hatch into vigorous chicks. All eggs which denote dead or weak germs should be marked, placed in a separate tray, and subsequently buried, as they are now unfit for eating. During extremely cold weather, to prevent chilling, the eggs should not be left out any longer than is necessary.

**Records.**—The running of an incubator is a matter of detail, and the study of past records will enable one to determine the best method to pursue under given conditions, and the incubation possibilities of a given flock. Hence, it is advisable to keep an accurate account of all the operations connected with each hatch, but the method should be so simple and convenient as to reduce the clerical work to a minimum. Such a history will not only establish the record of one particular incubator, but will acquaint the poultryman with the conditions in his breeding pen as regards the fertility and hatching power of eggs. Such a record sheet can be tacked to a light, smooth board suspended in front of or under the incubator. (See Chapter XXVI.)

**Attention During Hatching.**—From the time the machine is closed, when the first egg is seen to pip, it should be absolutely undisturbed, so that the right degree of temperature—approximately 103.5° to 104°—may be maintained. Before closing it,

the sand tray or other device for moisture should be removed, and the nursery tray placed in proper position. The wire in front of the egg trays should be opened, and the tray placed with this opening in front, so that, when the chicks are attracted to the front by the light, they will fall down into the nursery. In most machines it is well to cover the glass with a cloth or burlap during the hatching. This keeps the chicks more contented and prevents crowding, and when the burlap or cloth is removed they are stronger and better able to protect themselves.

If the hatch has been properly conducted, it should start about the nineteenth or twentieth day after the eggs were placed in the machine, and all chicks which are to hatch will probably be out at the beginning of the twenty-first or twenty-second day. This, however, will vary somewhat with the temperature at which the machine has been operated and with the character or type of eggs set. The higher the temperature the earlier the hatch will start; large brown-shelled eggs from the heavy breeds require from one-half day to a day longer than the thinner-shelled eggs from the lighter breeds. The one important thing at this time is that the hatch should be uniform and complete soon after the first pipping.

A prolonged hatch is rarely a successful one. If a hatch does not turn out properly, it is well for the operator to look over the records and see if he is at fault. The chicks should be left in the machine from twenty-four to thirty-six hours after all are hatched. As soon as the hatch is complete, the egg tray should be removed, and a little fine grit and oatmeal be thrown into the nursery; this will stimulate the digestive system of the chicks and teach them to pick up feed. It is rarely of any use to remove from the shell chicks which are incapable of getting out themselves.

Poor hatches may be due to various causes, such as poor eggs, faulty condition of the breeding stock, or want of care previous to putting in incubator. Given good eggs at the start, disappointment is most often the result of inexperience and poor management of the machine, especially shown by irregularity in attendance and imperfect regulation of the ventilation and humidity. To operate an incubator successfully the attendant must make up his mind to put considerable thought and effort into the work and to perform the duties methodically.

Another factor in low hatching is a poor thermometer. To prevent this, the accuracy of the thermometers should be tested at the beginning of each season by comparing them with a clinical

thermometer in warm water. A thermometer one or two degrees out of register will ruin a hatch, even if all other conditions are favorable. When the correction is not more than two degrees, it may be marked on the thermometer and allowance made for the error when reading.

## REVIEW.

1. What is meant by artificial incubation and brooding?
2. Describe ancient methods of artificial incubation.
3. Discuss the development of artificial hatching up to the present time.
4. Discuss three essentials of an efficient incubator cellar.
5. Discuss in detail incubator cellar design.
6. Describe the double-sash plan for securing ventilation.
7. Where is the best location for the incubator cellar? Why?
8. Compare hot-air and hot-water incubators.
9. Discuss the possibilities and uses of a mammoth incubator.
10. What seven points should be considered when selecting an incubator?
11. Where is the best place to run an incubator? Why?
12. Why test the machine before filling the egg chamber?
13. Give nine points to remember in the care of the lamp.
14. What care should be exercised in filling the egg trays?
15. What are the proper temperatures at different times for incubation?
16. Describe two methods of taking the temperature in the incubator.
17. Give rule and methods for turning the eggs.
18. Why are the eggs turned?
19. What factors influence cooling?
20. Tell of the purpose of ventilation, and give the methods.
21. Discuss in detail the relation of moisture to a successful hatch.
22. How is the percentage of moisture determined?
23. When should the eggs be tested? Give reasons.
24. Describe an efficient tester, and give method of testing.
25. Describe the appearance of: (1) An infertile egg, (2) an egg with a dead germ, (3) an egg with a growing germ, on the seventh day.
26. Describe the appearances of eggs with a dead germ and eggs with a live germ on the fourteenth day.
27. What special attention is required during the final hatching?
28. Give the causes of poor hatches.

**References.**—Poultry Experiments, by James Dryden, Utah Bulletin 102. Incubation and Incubators, by R. H. Wood, U. S. Farmers' Bulletin 236. Loss of Weight in Eggs during Incubation, by Horace Atwood, West Virginia Bulletin 73. The Fertility and Hatching of Eggs, by Pearl and Surface, Maine Bulletin 168. Some Factors Influencing the Vigor of Incubator Chicks, by Horace Atwood, West Virginia Bulletin 124. Incubation of Chicks, by W. R. Graham, Ontario Bulletin 163. Artificial Incubation, by G. Bradshaw, New South Wales Farmers' Bulletin 22. Chinese Incubation, by D. G. Brill, U. S. Bureau of Animal Industry, 1900 Report. Carbon Dioxide under Setting Hens, Connecticut Report, 1907. Humidity in Relation to Incubation, by W. H. Day, Ontario Bulletin 163.

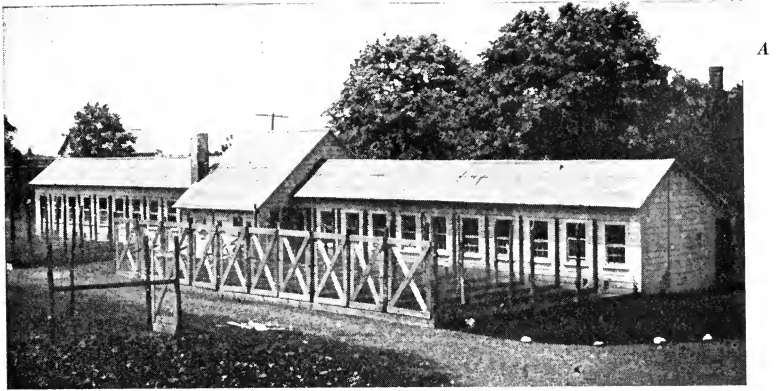
## CHAPTER XXI.

### ARTIFICIAL BROODING.

**ARTIFICIAL** brooding usually follows artificial incubation, but, where only a few hundred chicks have been hatched in a machine, they are sometimes brooded under hens, because this necessitates less attention. Artificially brooded chicks are more subject to certain diseases, and if neglected may not make as rapid growth as if brooded under hens, while at the same time they need more care. The possibilities in artificial brooding, however, are many; and, if the type of brooder and methods are good, and the chick's requirements as to feed and temperature are understood, just as good, if not better, results can be secured as when the hen is used. The great advantage of the artificial method is the large number of chicks which can be handled. Were it not for the development of this branch of poultry keeping, the broiler industry as we know it to-day would have been impracticable, and on the large intensive egg farms it would have been impossible to brood each year the many thousands of chicks required to supply future layers. There are many brooder systems and many types of brooder houses, all possessing advantages and disadvantages, and all adapted to certain conditions.

**Brooder Houses.**—In the construction of brooder houses we find two general plans. (1) Long brooder houses are permanent. They may be from fourteen to twenty feet wide, and from fifty to several hundred feet in length (Fig. 163). (2) Colony brooder houses are nearly always portable, and contain from fifty to one hundred square feet of floor space; some, however, are very small, and contain only ten to twelve square feet of floor space.

In choosing which type or system of brooding to use, three things must be considered: (1) The number of chicks to be brooded; (2) the season of the year; (3) funds available for permanent equipment of this kind. The intensive brooder equipment of the long-house type is adapted to broiler raising on a large scale, to the production of many hundreds, or perhaps thousands, of pullets for laying purposes, or to any poultry farm where thousands of chicks are to be brooded to advanced age.



A



B



C

FIG. 163.—Three different types of long brooder houses. *A*, Feed house and boiler room in centre. The high fences make it possible to keep adult birds in the runs when they are not used for chicks. *B*, Wide "half-monitor" type of roof, allowing a centre walk and brooder pens on each side. *C*, House with gable roof and automatic ventilation.

On the small plant, with an average farm flock, raising from two hundred to perhaps a thousand chicks, the portable colony house, especially the gasoline brooder, is one of the best types to select.

*Long brooder houses* may be grouped under four heads, according to the methods of brooding. One system has continuous or overhead pipes with hover boards above the pipes. Here the pipes usually extend along the top of each brooder compartment, these being from four to five feet in width. The hover consists of light boards hinged at the back, which can be lifted up to facilitate cleaning, the hover usually covering the entire end of the brooder pen. This was the first system extensively employed, but it is becoming obsolete because of better types. The brooder compartments are large and permit the handling of many chicks. There is not uniformity of temperature nor adequate control of it. It is especially adapted for use in the first week, but, owing to the great expense involved by having two houses, this type has given way to a system adapted to the entire brooding period. In this class of brooder house, the pipes are from six to eight inches above the brooder floor, the back of the hover compartments usually being ventilated by apertures covered with muslin. In front of the hover board is suspended a slotted burlap or felt curtain.

The second brooding method, which is very popular and being more and more generally adopted, has at the back of each individual pen a specially constructed compartment with a circular portable hover (Fig. 164). Here the heat is conveyed from a chamber below the brooder floor, through a galvanized metal pipe from four to six inches in diameter, and distributed into the hover just below the hover top. In this type of brooder it is essential that the hot-air chamber below be entirely isolated, so that no heat can escape and provide bottom heat, the objection being that it causes weakness of legs and loss of vitality. The hot-air chamber is heated by means of hot-water pipes passing through it from a central heating plant. The exact arrangement of the hover compartment itself admits of many variations. Some of original models provide excellent advantages; among the best being a damper in the metal pipe which makes possible the control of each compartment.

The third method of equipping the long brooder house is to install individual brooders, either single or double units.

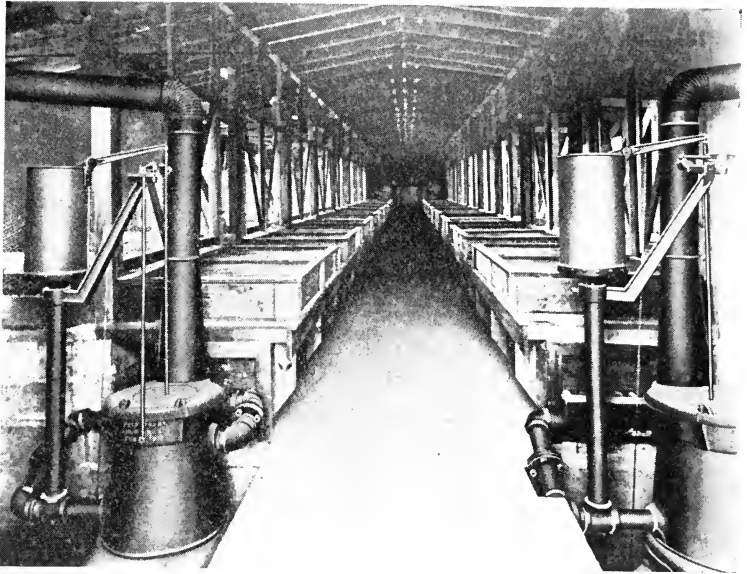
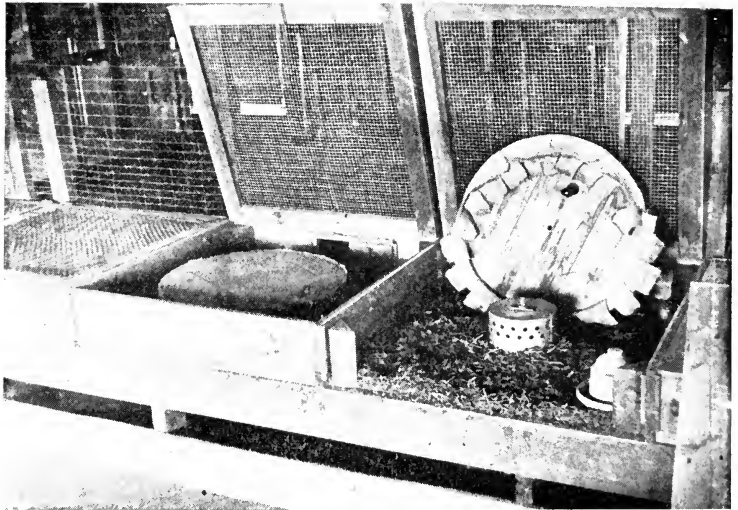
*A**B*

FIG. 164.—*A*, Interior of long house with double-pen brooders. *B*, Single compartment and its hover. (Courtesy of Hall and Candee Companies.)

These units are heated by kerosene lamps (Fig. 165). The usual method is to maintain a uniform temperature in the

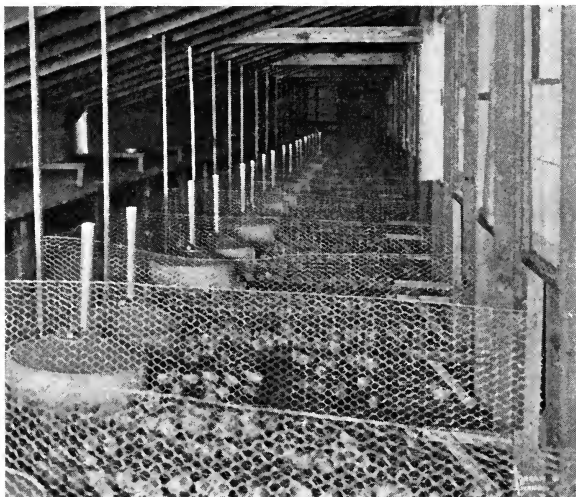


FIG. 165.—Portable indoor hovers make it possible to use the laying houses for brooding purposes. (Photo by Rancocas Poultry Farm.)

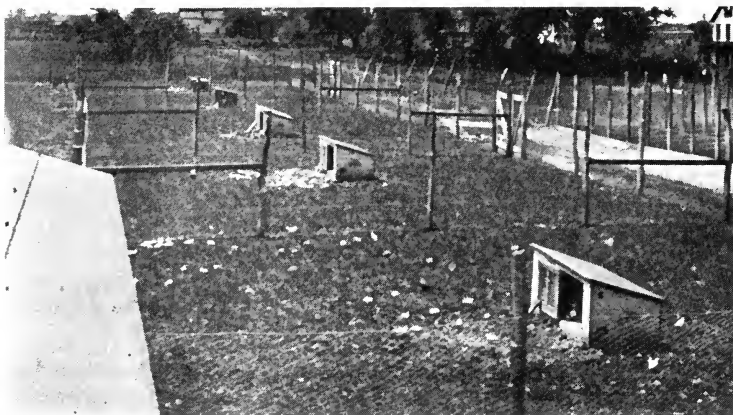


FIG. 166.—Small portable outdoor brooders heated by kerosene lamps.

brooder house by the use of a few coils of hot-water pipe and then to increase the hover temperature to any desired degree by the



use of a lamp. If properly carried out, this method will give almost ideal brooding conditions, yet the labor involved is so great, as compared with the central heating system, that, where a large number of chicks are to be cared for, the latter is by far the best.

The fourth method, practised to only a limited extent, is to equip the long brooder house with fireless brooders or hovers, so constructed that they conserve the heat given off by the bird itself. The troubles are that they are hard to ventilate properly, that their use induces a loss of vitality, and that very few birds can be grouped in a single flock,—not over twenty-five with safety. Fireless brooders have not been, and probably never will be, used very extensively.

*Colony brooder houses* are of three types, varying in size and other respects. Those of extremely small size, often only three by five feet, are equipped with a portable hover, the heat being generated by a kerosene lamp. These are commonly called portable outdoor brooders (Fig. 166), and have a capacity of approximately fifty chicks each. They necessitate considerable labor and attendance, are hard to clean, and the lamp is inaccessible. In the early spring, too, it is difficult



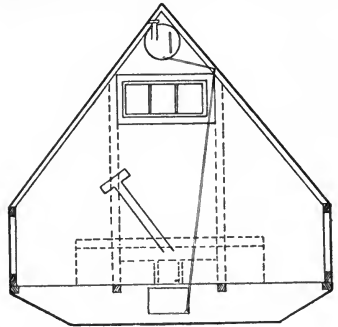
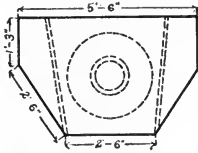
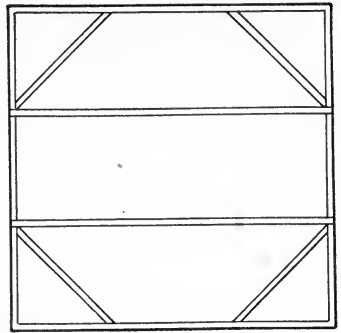
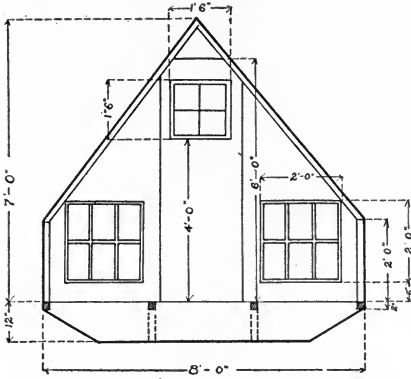
FIG. 167.—Colony houses built on runners and equipped with hovers heated by kerosene lamps. (Photo from Maine Experiment Station.)

to maintain the required degree of heat, as they are always extremely susceptible to outside changes in temperature. These brooders are well adapted to the needs of the small poultryman, who broods only two or three hundred chicks.

The second type of colony brooder house is much larger, usually six by eight or eight by eight feet at the base, and there are various styles of construction. The shed-roof house is common (Fig. 167). Such houses are equipped with one or two, usually two, portable or adaptable hovers, which are heated with kerosene lamps. The lamp may be placed outside or inside of the building as seems most desirable. Being of large size, these houses will accommodate a considerable number of chicks. After the chicks have grown sufficiently, the hovers can be re-



A



B



FIG. 168.—Portable gasoline brooder houses. A, Working plans; B, brooders in actual operation.

The tank, hover, burner, and other metal parts are made especially for this brooder.

**Requirements of a Successful Brooder.**—Regardless of the type of brooder selected and the method of supplying heat, there are at least three, and perhaps four, requirements for the best brooding of chicks. (1) A clean, easily accessible, well-ventilated hover, partially darkened, to which the chicks may have free access at any time to warm up quickly. (2) A well-ventilated, lighted, and moderately warm compartment which will provide exercise room for the young chicks, also a place for them to stay when the brooder run is cool and they do not need the high temperature under the hover. (3) A brooder run or pen protected from storms, sun, and wind, and enclosed within the brooder house itself. (4) An outside yard for use in pleasant weather, providing an abundance of range, also a place for growing green feed.

It will be seen from these requirements that the indoor brooder adapted to the intensive brooder house must meet the first two requirements, while an outdoor brooder must provide the first three. The gasoline brooder offers the first three of these, the second being secured by placing a board, temporarily, a little in front of the hover, thus confining the chicks in close proximity for the first two or three days, after which time the board is removed and the chicks given the freedom of the entire floor.

**Preparation of the Brooder.**—Before the chicks are placed in the brooder, put it in the best possible order. It should be cleaned thoroughly with a stiff bristle brush; if necessary the floor should be scraped with a putty knife to remove any droppings, and the interior should afterward be thoroughly sprayed with a good disinfecting solution (50 per cent carbolic acid or zenoleum). After the brooder has been cleaned the floor should be covered to a depth of one-quarter of an inch with clean white sand, and over this with short-cut alfalfa or fine-cut straw. The lamp should be burning for a day before the chicks are put in, so as to heat the brooder to an approximate temperature of about 98° under the hover. It is not advisable to heat the hover compartment to 100° or 105°, as is sometimes recommended, because a high temperature tends to lower the vitality of the chicks,—to make them much more tender and more easily injured by bad methods.

It is well to inspect the brooder and see that it is in good repair, also that the canvas curtains in front of the hover or sur-

rounding the same are in order; if not, new ones should be supplied, canvas being better than felt. Before lighting the lamp put in a new wick. After the temperature has been kept at approximately 98° for twenty-four hours, the brooder is ready for the chicks.

**Transferring the Chicks.**—The main point in transferring the chicks from the incubator to the brooder is to do this as rapidly as possible and with the least chilling. It can best be done by taking the chicks from the incubator and placing them in a basket, which can be covered with burlap or cotton cloth, if the distance they are to be carried is great. Some incubators are equipped with a nursery drawer which has a cloth cover, and this has the advantage of making it unnecessary to handle the chicks twice during the transfer. After moving the chicks from the incubator, any toe punching or leg banding necessary for pedigree breeding should be done quickly. (See Chapter XIX.) If the process is lengthy, the chicks should be taken from the incubator and placed in another warm machine as they are successively marked. It is not wise to carry many chicks at once, as they are apt to be crowded and injured; from fifty to one hundred, according to the size of the tray or basket used, is safe.

**Proper Temperature.**—The two most important factors in the management of the brooder are temperature and feed. The following temperatures are recommended. Start the brooder at 98° to 100° under the hover; during the second week run it at from 94° to 96°, the third week from 90° to 92°, during the fourth at about 85°. Experiments conducted at the New Jersey Station demonstrate that an exceedingly high temperature continued for many days will lower the vitality of the brood and cause a heavy mortality. Any extreme variation of temperature, especially if rapidly produced, will cause a heavy death rate. Deaths usually occur at the time of or immediately after extreme variations, either up or down. Variations in the brooder temperature, especially during the first two weeks, are responsible for much of the mortality in artificial brooding. The figures given were found to represent the most desirable hover temperature. It is a good rule to keep the hover just warm enough so that the chicks will spread out over the floor and not crowd. On the other hand, the temperature should never be high enough to cause panting. With Leghorn chicks it is unwise to run the hover at low average or to lower the temperature too suddenly, for the young chicks

will try to keep warm by crowding, and much loss results,—chiefly from suffocation and a general condition of weakness due to lowered vitality.

The question of sunlight is important. It is not well to allow direct sun rays to strike the brooder floor, because all the chicks will attempt to get into this one spot, and will thus be drawn away from the hover heat and will injure one another by crowding or be suffocated. Floods of sunlight produce no such conditions, so that it should be a point to have either an abundance of sunshine or no direct rays at all. The direct rays of the sun should never shine upon the hover, as this causes great variations.

**Feeding Brooder Chicks.**—The feeding of the artificially brooded chicks is one of the most important factors in poultry keeping, and successful nutrition should begin with hatching and extend throughout the growing period. The first four weeks are the most trying, for this period covers the delicate stage of the chick's growth, and is the time when the death rate is greatest and when mistaken methods will be shown by poor broods. The following principles apply to baby-chick feeding, a discussion of which will better fix them in the mind of the feeder. The object is to economically keep the chicks growing.

1. *Feeding Too Soon.*—Just prior to hatching, the yolk is drawn into the bird's body, and supplies the growing chick with nourishment for a number of hours after hatching. It is undesirable to tempt or force the chick to eat within a period of from forty-eight to sixty hours after hatching. The best practice is to supply fresh water and an abundance of fine grit when putting chicks in the brooder, withholding all solid feed for at least the first twelve hours in the brooder. A good plan is to put the chicks in the brooder in the afternoon, and give them their first solid feed in the morning.

2. *First Feed Easily Seen and Nutritious.*—The young chick artificially hatched has to be taught many things which under natural conditions it learns from the mother hen; such as searching for feed, and the elementary process of eating. The natural instinct of the chick is to pick up bright things; for this reason, feed which is easily seen is desirable. A good practice is to throw a limited amount of rolled oats on the floor of the brooder,—only what the chicks will eat in an hour or two. Rolled oats are very nutritious, are relished by the chicks, and make an excellent first feed; but their continued use is not advisable. Hard-boiled

eggs mixed with bread crumbs may also be used as a first feed for young chicks. Dry cracked grains are sometimes fed, but they are less easily seen.

3. *Grit and Shell*.—Grit to enable the digestive organs to perform their functions, and shell to supply the lime so essential in the formation of bone, should not be omitted. The sand placed on the floor of the brooder will help, but will not of itself be as effective as two or three handfuls of sharp granite grit and fine oyster shell placed in several conspicuous places in the brooder.

4. *Plenty of fresh water* is essential, since the chick gains weight rapidly, much of this gain being water. Stale or stagnant water carries disease germs and is liable to produce digestive disorders in the flock. Keep fresh water before them constantly, using a small siphon fountain, which can be rinsed out daily to keep it from getting slimy.

5. *Dry Cracked Grains vs. Wet Mash*.—Dry cracked grains are the best, all things considered, since they supply the elements required and in a form which cannot lead to injurious results. When the chicks are from six to ten days old, this can be economically supplemented with bran and dry mashes. Experiments in comparing cracked grains with wet mash show: (1) That wet-mash feeding will increase the weight only slightly more than the feeding of dry mash or dry cracked grains alone. (2) Besides an increased weight, a greatly increased mortality was found where the wet-mash system was used. (3) This increased mortality as the effect of the wet mash is not noticeable to any extent after the second week; hence it is apparent that at this time the chick's digestive system has developed to such an extent that it may eat almost any feed without detriment. The practical application of these conclusions is to feed the baby chick throughout the first two critical weeks with cracked grains and dry mash, paying special attention during this time to health and vigor; after this critical period is safely passed, future feeding should be governed largely by the purpose in view. For example, if the aim is increased gain in weight, as for broiler raising, wet mashes can safely be fed; whereas, if the maturing or breeding stock is the main object, a dry mash supplemented with cracked grains should be the choice, if normal development at the lowest possible cost is desired.

6. *Wheat bran* is an important asset in the feeding of the baby chick, since it is easily digested and contains a form of vegetable

ash which is very readily assimilated. Wheat bran alone may be kept in small hoppers, and will furnish nearly a balanced ration for the first few weeks.

7. *Ash Very Essential.*—The young chick should not only gain flesh, but must also rapidly make bone; and, in order to do this, a large amount of ash must be supplied in the form of lime and phosphates. A certain amount of this is consumed in the form of vegetable juices, but it must also be furnished from a mineral and animal source. Shell and limestone grit are the two most common mineral sources, and meat scrap and crushed bone the two most common animal sources. Experiments show that of these products bone is the most efficient, producing greater gain in weight more quickly and with lower mortality and less cost.

8. *Feed Little and Often.*—Owing to the small size of the digestive system of the young chick, and its heavy feed requirements in proportion to its size, it is wise to give only small amounts of feed at a time and to feed often. The practice should be to feed four or five times a day during the first week, gradually diminishing the number of feedings until the end of the second week. Cracked grains may be fed three times a day, and dry mash kept before them all the time after the second week.

9. *Avoid Sloppy Wet Feed.*—The young chick's digestive system is not well adapted to the assimilation of wet mashes, even after it is possible to feed them. Moreover, they make it impossible to keep the floor of the brooder in a clean, sanitary condition, and to prepare and feed them involves a great deal of labor, so that their use during the early growing period should be discouraged, except in the case of broiler raising.

10. *Animal Protein.*—When mixing a ration it is well to use some protein from an animal source, experiments showing that the best gain in weight follows the feeding of a ration from two to ten per cent of which is animal substance, the common sources being meat scrap and bone. It is not advisable, however, to feed more than about two per cent of this material for the first week, since it is rather hard to digest; after that time the amount can be increased until, at the end of the fourth week, it reaches about ten per cent.

11. *Keep Chicks Busy and Hungry.*—The practice should be to feed only what the chicks will eat up quickly, so that at the next feeding they are anxious and ready for feed. This prevents the loss of feed by its becoming dirty, in which case they will not eat it, and also gives them an appetite and a chance to exercise.



12. *Succulent material* is just as essential in the baby-chick ration as it is in that of the laying hen. It can best be supplied in the form of sprouted oats, lettuce, or ground vegetables, such as mangels, beets, and turnips.

13. *Feed Early and Late*.—It is just as necessary to feed extremely early and rather late as it is to feed little and often. The time between the feeding at night and the first feeding in the morning is at best rather long, and it can be materially shortened by feeding early and late.

14. *Induce Exercise*.—In order to keep the chicks in good physical condition and growing, give them plenty of exercise. This can best be done by covering a considerable area of the brooder floor with a thin layer of chaff or fine litter, and after the first day or two feed the ground grain in this material.

15. *Clean Feeding*.—Health is the one great essential, and in order to promote this the feed must be clean. This point is important when feeding wet mashes. The mash should not be allowed to remain from one period to another, since it will become sour. Nothing will upset the digestive system of the chick more quickly than sour feed. The litter and sand in the feeding compartment should be kept as free as possible from droppings, and should be changed frequently.

**Many methods of feeding** are in use, some of which bring uniformly good results and are especially recommended. Two methods or plans are here outlined. It must be remembered that there is no such thing as a best ration to suit all conditions.

The first eighteen hours in brooder,—grit, shell, and water, with short-cut alfalfa on the floor of the brooder.

The day following,—pinhead oatmeal, three feedings.

The next five days,—feed the following cracked-grain ration on the brooder floor five times daily, giving only what they will clean up between feedings:

Cracked corn.....	20 lbs.	Granulated milk (fine).....	10 lbs.
Fine cracked wheat.....	25 lbs.	Crushed peas.....	3 lbs.
Pinhead oatmeal.....	5 lbs.	Fine charcoal.....	3 lbs.

Supplemental to this ration,—hard-boiled eggs once a day, sprouted oat tops twice daily in small amounts.

The seventh day,—start feeding wheat bran in small hoppers, letting it stand before the chicks two hours, and omit the noon grain feeding.

The eighth to fourteenth day,—bran constantly in hoppers, and cracked grain four times daily.

The third to eighth week,—keep the following dry-mash continually before them and feed grain three times: 10 lbs. bran; 5 lbs. corn meal; 5 lbs. sifted ground oats; 1 lb. meat scrap, increased in two weeks to about 2 lbs.

*Another Plan.*—The following rations are for feeding chicks to be raised as breeders, or as layers, from hatching to maturity:

#### *First Week.*

1. Equal parts by weight of rolled oats, bread crumbs, chick-size grit, and half part chick charcoal. Feed five times a day in a tray as much as will be cleaned up in fifteen minutes.

2. Equal parts wheat bran and sifted beef scrap in a hopper before the chicks all the time.

3. Sour milk or buttermilk to drink,—no water.

#### *Second Week.*

4. One-half of formula for first week, and half good commercial chick feed, mixed and scattered over litter four times a day.

5. Same as No. 2.

6. Same as No. 3.

#### *Third to Sixth Week.*

7. Commercial chick feed that does not contain over twenty per cent corn or two parts cracked wheat, two parts pinhead oatmeal, one part millet, and one part cracked corn, fed liberally once a day, about 4 P.M., in litter three or four inches deep and to be thoroughly mixed with litter.

8. Equal parts bran, wheat middlings, and beef scrap, always available and in hopper.

9. Equal parts sour milk and water.

10. Beef scrap, grit, oyster shells, and charcoal always available in hopper.

#### *Seventh to Tenth Week.*

11. Equal parts whole wheat, hulled oats, and cracked corn in deep litter once a day.

12. Equal parts of bran, wheat middlings, corn meal, and one-half part linseed meal.

13. Fresh water.

14. Same as No. 10.

*Eleventh Week to Maturity.*

15. Equal parts whole wheat, oats, and cracked corn always available in hopper.

16. Same as No. 12. 17. Same as No. 13. 18. Same as No. 14.

*Dry-Mash for Chicks.*—The following dry-mash is well adapted for general feeding of growing chicks during any period, such as developing them for laying or breeding purposes or the feeding of cockerels which are later to be finished for roasters:

Wheat bran.....	50 lbs.	Alfalfa.....	10 lbs.
Ground oats.....	10 lbs.	Meat scrap.....	5 lbs.
Gluten.....	10 lbs.	Bone.....	5 lbs.
Corn meal.....	10 lbs.		
		Total.....	100 lbs.

The above ration should be fed dry in self-feeding hoppers, and some of it kept before the birds all the time.

**Common Causes of Death in the Brooder.**—As was previously stated, a high mortality usually accompanies artificial brooding, averaging from 5 to 30 per cent. But under proper brooding methods it should be possible to brood, at least on the average, 80 per cent of vigorous chicks. These are good results. Frequently cases of 95 per cent are found. Where a great loss occurs, it is usually due to one or more of the following causes:

*Chilling.*—If the hover temperature during the first week or two drops considerably and stays low for any length of time, especially during the night when the birds are under the hover, they become chilled, their body heat not sufficing to maintain the right degree of temperature, and this results in digestive disorders and a subsequently heavy death rate. The possibility of this occurrence should constantly be guarded against.

*The crowding* of young chicks is usually because they are chilled, but it may be caused by their huddling together in rays of sunlight on the brooder floor, or by putting too many chicks in one brooder compartment. The latter is due to inexperience, but it results in some of them being insufficiently fed and getting insufficient exercise. The direct result of crowding is suffocation,—therefore immediate death,—while the indirect result may be a lack of vitality, which will either result in a dwarf chick or cause lingering death.

*Overheating.*—If the brooder temperature is allowed to rise too high, the chicks, by getting accustomed to this high tem-

perature, will be made weak and thus more susceptible to any possible variations in other directions. Owing to this weakness they have a desire to stay under the brooder, and this results in a loss of vitality and in many deaths.

*Cannibalism.*—From lack of sufficient ash in the ration or insufficient animal protein, chicks often acquire the habit of devouring one another. This trouble is usually started by the taste of blood which is gotten when one member of the flock becomes injured in some way, and the others pick at the wound until, in many cases, the entire chick is devoured. To avoid this any chick with injured parts should be immediately removed.



FIG. 169.—Chicks showing pronounced symptoms of white diarrhoea.

If flocks have acquired the habit, they should be given the following feed mixture in pans where all will have an equal chance to get at it: Equal parts of meat scrap, dried bone, oyster shell, and wheat bran. The feeding of this ration and the removal of any injured chick should check the trouble.

*Contagious White Diarrhoea.*—This is undoubtedly the greatest scourge of the poultryman, being in large measure beyond his control and not directly due to mismanagement. There is no positive cure known. This disease is called *bacteria polorum*, is highly infectious, and is known to be transmitted to the offspring by infected parents, the infection passing through the egg, the most critical infection period being the first four days of the chick's life. The symptoms are a lack of vitality, small stunted body and drooping wings, and a narrow contracted appearance viewed from behind (Fig. 169). When a flock is known to be

infected, the best possible procedure is to isolate and slaughter the infected adults and thus prevent future outbreaks. Thorough disinfection of brooders and incubators will prevent the transmission of infection through future hatches. The organisms are easily destroyed by dilute acids; hence the feeding of sour milk to infected flocks for the first few days is advisable. Every poultryman hatching chicks should make all possible effort to understand and prevent this disease, since it causes much loss.

**Hardening Process.**—In order to prepare the chicks for removal to the range, after the second week, a hardening process should be begun. This consists in the gradual lowering of the temperature, with the idea of dispensing entirely with artificial heat in from three to six weeks, according to the weather. The best method is gradually to reduce the artificial heat until it can be entirely given up, then raise the hover a little at a time until it is safe to remove it and replace it with muslin-covered frames hung to the hover wall; these can be raised in front a little more each night until the chicks can do without them. It is impracticable to take chicks from a warm brooder house and put them in a colony house unless they are gradually accustomed to the change. The idea should be to get them on the range as early as possible. After they are four weeks old, the sooner they are out on the ground in a cool atmosphere, and have large, well-ventilated quarters with free range and plenty of green feed, the faster they will grow, and the more hardy and vigorous they will be at maturity.

**Systems of Heating Brooder Houses.**—There are two general systems of heating large brooder houses,—namely, hot water and steam. Hot water is the more generally used. It maintains a more uniform temperature with less variation either way, and the heat is retained much longer than by steam. The brooder house is a compact building requiring no complicated system of piping which would make steam necessary.

*The Heating Plant.*—In a long brooder house the boiler should be centrally located. It is poor policy to run the brooder pipes more than one hundred feet, as the loss of heat is great, the pipes become cool, and it is impossible to maintain an even temperature in all the hovers. With the hot-water system the heater should be located in a pit, in order to provide for the circulation and return of the cold water. Whatever type be selected, the heating plant should be installed by an expert. He must

understand the fixtures, the size of the pipes, and the running of the boiler to secure the required degree of heat in a given type of building. The construction of the building and the amount of glass or muslin in front will influence the amount of heat required. In a brooder house one hundred feet long the best plan is to run two coils of two-inch pipe one on the back wall and one on the front, each coil containing two flow pipes and one return, in addition to the hover heat. In most conditions this should maintain a steady temperature of from 60° to 75° in all kinds of weather. In a brooder house in which the hovers are heated from a central heating plant, so much wall pipe may not be necessary, since considerable heat will be given off by the hover pipes themselves.

Before starting up the fire at the beginning of the brooding season, one should make sure that the system is full of water; if so, there will be water in the bottom of the glass in the expansion tank. If the air valves are not automatic, all of them should be left open when water is flowing into the tank, so that the air may escape from the pipes and permit them to fill with water. Neglect of this precaution, and starting the fire with too little water in the system, may burst the boiler.

A good practice is to start the fire and get it well under way before putting any coal on it. The use of coal is recommended, since it burns longer, gives a more uniform heat, and does not require much attention. To make the fire burn briskly, the pipe damper should be open and the upper door closed. When the fire is well started and there is a good bed of coals, and the water has reached the desired temperature, check the fire by closing the pipe damper and the damper in the ash-pit door, and leave the upper door ajar—how much ajar can only be learned by practice. This depends on the type of boiler, the varying amounts of water in the system, and will also be influenced by weather, wind, and rain. Never let the water in a hot-water system reach a temperature of 212°, for steam will then be formed, the water in the system will be greatly reduced, and there is danger of its boiling away and leaving the boiler dry. When it approaches this degree of temperature, the water should immediately be cooled by banking the fire and cutting off all drafts. If steam should form in the coils, some of it must be allowed to escape by opening the air valves, then let fresh water into the system gradually. It is best to have automatic valves. All ashes should be removed from the ash pit daily, for if they are allowed to remain they will

burn out the grate bars, as well as stop the drafts. The glass gauge should be examined frequently to ascertain whether there is plenty of water in the system. A desirable feature is a float valve on the expansion tank which will permit the automatic inflow of water when needed.

A thermometer connected with the heater to register the temperature of the water is very desirable, but, if one of these instruments is installed, it should be of reliable make, as a good deal of dependence is put upon it. All pipes in the brooder house which are not actually needed for direct radiation of heat should be covered with asbestos to conserve the heat, and all pipes used directly for heating should receive a good coat of paint to prevent rust.

#### REVIEW.

1. Describe two distinct systems in artificial brooding.
2. What three factors will aid in determining which type to select?
3. Discuss types and possibilities of the long brooder-house system.
4. Describe three types of colony brooders.
5. Discuss the possibilities of the "gasoline brooder house."
6. What are the four requirements of a successful brooder?
7. How would you prepare a brooder for young chicks?
8. How can the chilling of the chicks in transferring them be prevented?
9. Discuss proper brooder temperatures for different times.
10. Enumerate twelve principles of baby-chick feeding.
11. Why is ash so important?
12. What is the reason for not feeding soon after hatching?
13. Outline a desirable method of feeding baby chicks for the first six weeks; give rations.
14. Give five common causes of death of young chicks.
15. Discuss prevention against the white diarrhoea disease.
16. What are the dangers at the time the heat is removed?
17. What points are of special importance in locating and installing a heating plant for a long brooder house?

**References.**—The Principles of Brooding, by Rice and Rogers, Cornell Bulletin 277. A Successful Brooder House, by F. H. Stoneburn, Connecticut Bulletin 33. Raising Chickens, by James E. Rice, Cornell Reading Course Bulletin 19. Raising Chicks Artificially, by Horace Atwood, West Virginia Bulletin 98. Feeding Experiments with Chickens, by J. Williard Bolte, Rhode Island Bulletin 126. Seven Methods of Feeding Young Chickens, by Rice and Nixon, Cornell Bulletin 282. The Mortality of Incubator Chicks, by G. W. Fields, Rhode Island Bulletin 61. Hatching and Rearing Chickens, by W. R. Graham, Ontario Bulletin 163. Skim Milk for Growing Chicks, by Plum and Anderson, Indiana Bulletin 76. The Baby Chick, by T. E. Quisenberry, Missouri Poultry Station Bulletin 1. Working Plans of N. Y. State Brooder House, Cornell Circular 4.

## CHAPTER XXII.

### CARE OF THE GROWING STOCK.

THE direct object in the feeding and care of all chicks, from hatching time to maturity, is growth. Uniform development is necessary for the laying birds or breeders. When meat production is the object, a rapid gain in flesh is desired to bring about a maximum profit in the least time. The discussions in this chapter will deal with the growing chick from weaning time to maturity.

**Weaning the Chicks.**—The best time to wean the chicks, whether it be from the mother hen or the brooder, will depend on the breed, the season of the year, the location of the colony houses, and the degree of protection which can be afforded them.

Leghorns and other light, active breeds are very susceptible to sudden changes early in their development. This is due to the strain on the system by excessive feather growth. Greater care must be used when changing them. They crowd badly if the temperature is too low; a heavy mortality follows. In the cold weather of early spring the weaning period must be postponed until the chicks attain a greater age than would be required if they were hatched later in the spring and were transferred during warmer weather. It is very undesirable to wean the chicks during damp weather.

The colony houses should be located in protected spots, especially early in the season, and near to the poultryman's residence. For the first few weeks after weaning, the chicks require quite close watching, as they have to be protected from sudden showers and extreme changes in weather conditions. The coops often require special manipulation during cool spells in late spring. If it is possible to arrange a portable hover in the centre of the colony house the chicks can be weaned much earlier. Such a hover may be made two feet square with felt or canvas curtains tacked to the edges of the board. Suspend this from the roof with cord and pulley, leaving it at first about ten inches from the floor. As the chicks develop and become accustomed to the changed conditions, the hover can be gradually raised, depending upon weather conditions, until they finally require it no longer.



It can then be stored away for use another year. This practice is very satisfactory with early-hatched Leghorn chicks.

**Factors Affecting Growth.**—There are many factors affecting the growth and development of chicks. They logically fall under one of these heads: (1) Inherited characteristics; (2) environmental conditions; (3) supply of feed. The last two might be combined, but are considered separately because of the importance of feeding.

**Inherited characteristics** determine the constitutional make-up of the individual at birth. The effect of environment is constantly acting and controls the development of inherited characteristics. The pronounced difference in apparent size and strength of the chicks at hatching time is largely due to inheritance, beyond the control of the poultryman. The difference in size is very pro-



FIG. 170.—Growing poultry on free range is the most satisfactory method. Gasoline-heated brooders are used on this farm. (Photo by Cornell University.)

nounced in every hatch. Chicks of the same breed vary greatly in size and weight at hatching time, and will not develop uniformly, some feathering early and others late. Some remain dwarfed and never make a satisfactory development. Every poultry raiser should practise a rigid selection from hatching time to maturity, weeding out those lacking inherited vigor and strength. Experiments show that such chicks never make profitable layers, sure breeders, or desirable market poultry, and the sooner they can be disposed of the better. The best practice is to select at weaning time all that are strong and vigorous, placing them on the range in the developing houses. Take all that are left and place them in suitable quarters, with restricted range, if necessary, and force them for broiler purposes. They may not make the best broilers, yet it is the most profitable use

to which they can be put. If they are kept for a longer time, they eat a large amount of feed for which no return is realized.

Select the physically strong chicks, and maintain their high vitality throughout the growing period. They are to be matured into profitable layers and breeders at the end of the summer.

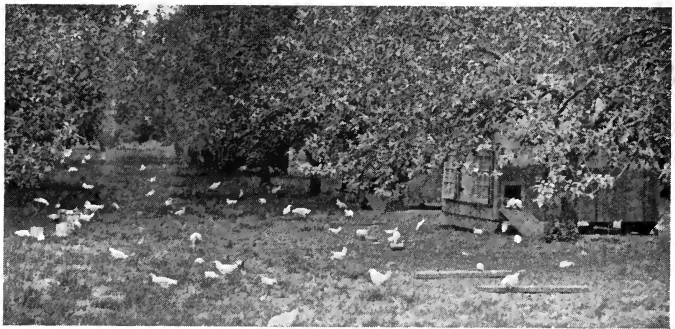


FIG. 171.—Rearing chicks under intensive conditions on open range. *A*, Corn is useful to provide shade while the trees are small. *B*, An orchard of large trees supplies plenty of shade. The birds check the ravages of insects.

The maintenance of their vigor is essentially within the control of the poultryman.

**Environmental conditions** can be conveniently grouped for discussion under five heads: (1) Free range; (2) green feed; (3) shade; (4) housing; (5) management.

*Free Range.*—The best growth and the most vigorous chicks can only be realized by giving the growing birds an abundance of free range (Figs. 170 and 171). Overcrowding, both as to area of

land and housing space, will cause much trouble during the developing period. With small flocks it may be possible to rear birds satisfactorily on limited range or in bare yards, but this is the exception. Such a plan requires more time and expensive methods of feeding. Many large farms have tried limited range for the growing birds, and have abandoned the practice. Large areas for young stock are preferred even if close confinement is practised with the layers. Abundance of range room not only means more vigor, but it also aids in reducing the cost of feeding. Much feed can be obtained from worms and insects. If the range is properly seeded in alfalfa or other leguminous crops, the grains fed can be reduced in proportion to the amount of such green feed available.

*Green feed* is absolutely essential during the growing period, and can most economically be supplied by growing it on the range. Where limited range is attempted, considerable expense must be incurred in supplying green feed from an outside source in the form of cabbage, grass clippings, or sprouted grains. A range which can be kept seeded down to permanent sod is the best. When birds are kept in such numbers as to destroy the grass, it will be found desirable to divide the range and practise rotation. Raise quick-growing succulent crops and allow the birds to eat them directly, first from one yard, then from another (Chapter IX).

The crops used (Fig. 172) should be planted early, the wheat and rye being seeded as soon as the birds leave in the fall, and the peas and oats as early as possible in the spring. The corn should be seeded so that it will be about one foot high before the birds are placed on the range in the spring. With this rotation the birds are provided with an abundance of green feed, and the corn furnishes plenty of shade. Each year the practice should be to move the rotation one series ahead, to bring a new crop on each plat. This will necessitate moving the houses, and it is better to place them in the wheat, since that is the first crop ready for feeding. This yearly moving also does away with the danger of disease about the houses.

*An abundance of shade* is necessary for a normal healthy development. The most desirable shade is that which is made by a growing plant, as it is much cooler and gives off considerable moisture (Fig. 171). The best practice is to plant the range in fruit trees, such as peaches, plums, or apples. An old apple or

peach orchard can be profitably maintained as a range area for the shade which can be derived.

When no trees are present, or while the trees are getting their growth, it will be found profitable to plant such crops as corn, sunflowers, and, if there are fences, flowering beans may be grown. A good plan for rotation of crops is shown in figure 172.

Artificial shelters may be made of muslin frames or branches of trees supported a few feet above the ground.

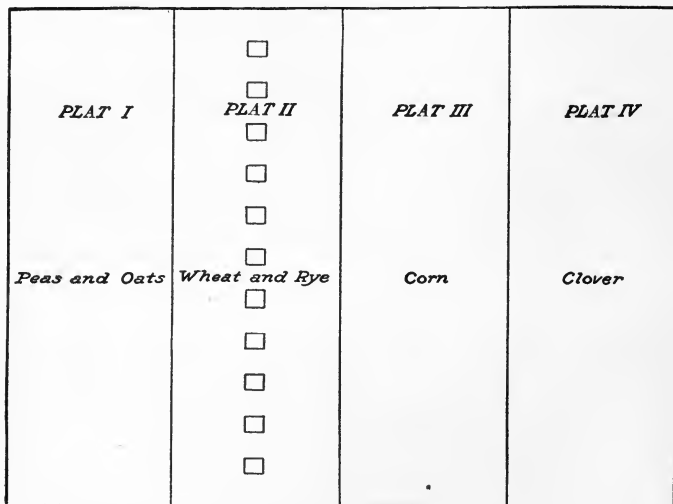


FIG. 172.—A desirable rotation of crops for poultry runs. Each year it is moved ahead one plat, the houses always being located on the wheat and rye.

*Housing.*—In the design and construction of range or summer developing houses, there are three essential features to consider,—namely, portability, fresh air, and size.

The houses should be moved from place to place as the range is changed. They may be used during the winter as laying houses for small flocks. They should be so constructed as to provide an abundance of ventilation and fresh air to the growing chicks (Fig. 173). Crowded, stuffy quarters will weaken the vitality of the chicks. When providing this ventilation, drafts across the roosts must be avoided. It is a mistake to build colony houses too small. Such a house is hard to ventilate properly, and the tendency is to crowd too many chicks into one flock, with disas-

trous results. About fifty chicks is a large enough number in a single colony house. In some sections the practice is to place only twenty-five in each house. The capacity will depend upon the floor space and fresh-air feature. A house 6 x 8 feet, if properly ventilated, will accommodate fifty growing pullets without any trouble. Colony houses are usually elevated above the ground from ten to twelve inches and provided with a wooden floor.

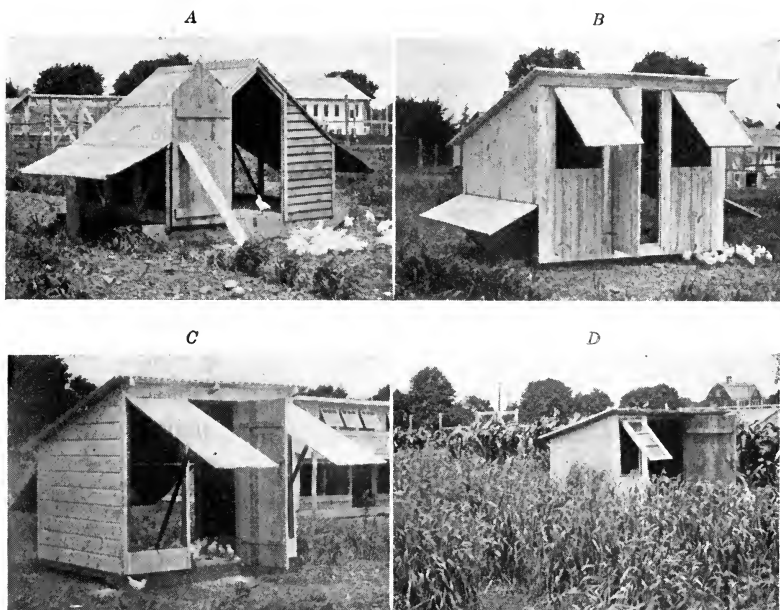


FIG. 173.—Four types of summer developing houses. *A*, Fresh-air house so constructed that both side walls hinge and open upward, allowing an unlimited circulation of air; *B*, shed-roof colony house; *C*, a wide-open house; *D*, a portable summer chick shelter, showing a luxuriant vegetation furnishing an abundance of green feed and shade.

The houses should be located at frequent intervals about the range (Fig. 170), care being taken to place them on high spots that are not damp or muddy during wet weather. If they are some distance apart, there will be less possibility of the birds mixing. One hundred feet will provide ample range, and, if the birds are confined for two or three days when first placed on the range, there will be little mixing in their houses. Roosts should not be placed in the colony houses until the birds are at least four

months old. If allowed to roost too early, crooked or twisted breast-bones will be the result. The floor should be covered with a good dry litter of an absorbent nature. The litter should be cleaned out at least once a month, or oftener if the droppings show signs of remaining moist.

*Management.*—The plan should be to take the chicks directly from the brooder house to their permanent developing houses. Frequent changing and transferring is undesirable, as it keeps the birds unsettled and they will not grow properly. In feeding and caring for them disturb them as little as possible.

As soon as sex can be distinguished readily, the time varying with different breeds, the males should be separated and placed on another range. If they are allowed to remain in a mixed flock, neither sex will develop to the size and vigor at maturity which they would attain if separated. Thereafter the management of the two sexes is entirely different. The pullets should develop to normal size so that they will be in good laying condition at the proper time in the fall. The males should be in market condition at as early an age as possible. The males to be matured as breeders should be selected and given separate range, while those for broiling or roasting should be more closely confined.

*Supply of Feed.*—In feeding the growing chicks, provide them with an abundance of feed of the right composition, and supply this in such a way as to reduce the labor to the lowest point and yet be consistent with best results. This can be done by using dry-mash supplemented by cracked grains. The dry-mash should be fed in large, outdoor, self-feeding hoppers, which are made waterproof. It is also possible to feed a part of the cracked grain in hoppers, but at least one feeding a day should be made by an attendant going around from house to house and scattering it. This provides a certain amount of personal attention which is necessary for best results. In the case of growing stock this personal attention can be cut down more than in any other line of the poultry work, but should never be entirely eliminated.

In handling the growing stock induce continuous growth from the time the birds are put on the range until they are placed in winter quarters. A check in growth, due to improper housing or feeding conditions, may retard the ultimate development many weeks, resulting in smaller fowls with low vitality. It is very important in caring for pullets to bring them to maturity at the

right time in the fall. If growth is retarded, their development is slow, and they will be unprofitable as winter egg producers.

*Rations.*—The following dry-mash is good for feeding growing stock, from twelve weeks of age to maturity. This is to be kept constantly before the birds in self-feeding hoppers.

Wheat bran.....	100 lbs.
Ground oats.....	50 lbs.
Corn meal.....	50 lbs.
Alfalfa meal.....	10 lbs.
Meat scrap.....	20 lbs.
	<hr/>
Total.....	230 lbs.

The composition of the dry-mash must be varied somewhat according to the character of the range.

A grain ration should be fed twice daily or kept before the birds in grain hoppers. This may consist of cracked corn, 100 lbs., and wheat, 200 lbs.

#### REVIEW.

1. Discuss effect of varying weather conditions upon chicks at weaning time.
2. Discuss inherited characteristics and their effect upon the growth of the chicks.
3. Name five environmental conditions which affect the chicks' growth.
4. Of what use is free range to growing stock?
5. Will chicks grow well without green feed? How is it supplied?
6. What is the most desirable shade for poultry?
7. Give three desirable features in summer colony houses.
8. Describe an efficient colony house.
9. Give special points in the management of growing stock.
10. How does the feeding of growing stock differ from the feeding of laying stock?
11. Tell of the harm of allowing a check in growth of the young stock.
12. Give a complete ration for feeding the growing stock.

## CHAPTER XXIII.

### BROILERS, ROASTERS, AND CAPONS.

THE production of poultry for meat offers to the small poultryman, the intensive poultry keeper, and the farmer alike a possible source of considerable revenue at slight expense. It offers exceptional opportunities on the farm, for there range is usually abundant and cheap, and the raising of broilers, and especially roasters, can be well combined with the average farm routine. Again, for the production of market eggs many pullets are hatched each year. There will always be surplus cockerels, which if properly handled and marketed will yield a good revenue. There is a steady demand for first-class prime dressed and live poultry at exceedingly attractive prices, the demand being more constant than with other types of meat. The various kinds of dressed poultry have their seasons and corresponding fluctuations in price. It becomes the problem of the poultryman, if he counts on any income from this source, to study seasons and markets and adjust his stock to meet these requirements.

**Types of Market Poultry.**—Commercially, market poultry may be divided into the following classifications, which are recognized by all commission houses, retail jobbers, and the trade. Prices are quoted regularly on the basis of this classification: Fowls, broilers, fryers, roasters, capons.

**Fowls.**—In the markets the term "fowl" means all female birds one year old or over (Fig. 174). The great majority of these are usually sold in the summer and fall when they have finished their second or third year of laying, and are then disposed of to make room for incoming pullets. Such fowls bring the lowest price in the market, with the one exception of roosters, or old male birds, for which there is little demand, owing to inferior quality. A large number of fowls are sold alive, and shipped by carloads to heavy consuming centres. In the East a leading factor in the control of the live-poultry market is the heavy demand during the Jewish holidays which come in the fall of the year. Variation in the selling price of fowls throughout the year is very slight,—less, in fact, than of any other market type.

Plump, moderately fat fowls are in the greatest demand, thin



or excessively fat birds being undesirable. A large mass of solid fat protruding from the lower posterior part of the abdomen makes the bird unsuitable for the best trade.

**Broiler raising** is one of the greatest specialties of the poultry industry. Its conception and development as an exclusive business was first attempted in the year 1885. It was at first carried on as a side issue to general farming, especially fruit growing and market gardening. The prevailing high prices for rapidly grown young chicks during winter and spring, combined with the introduction of improved methods in artificial incubation and brooding, were largely responsible for this development and rapidly increas-



FIG. 174.—A flock of fowls ready for market.

ing popularity. Great numbers of people went into the business; a few succeeded where many failed. As with everything else which starts with a boom, a reaction followed.

At the present time the poultryman has come to realize that the most profitable, and really most suitable, place for the raising of market broilers is a general poultry farm, where the time given to their production can be regulated by the market price and the labor required. A few of these large and exclusive broiler plants are in existence to-day and paying good dividends. The country is dotted here and there with traces of the boom when it was at its height. The amount of money sunk in this one line of poultry work, largely because of inexperience and lack of capital of the investors, is enormous.

The great bulk of broilers which reach the larger markets come from general farms and egg farms, and are shipped to the markets in the late spring and early summer. They are not produced as a main source of revenue, but are a by-product, as it

were, from the hatching and rearing of pullets for laying. It is this sudden influx of the general supply which brings the price down and makes it unprofitable for the specialists to produce for a yearly market. The specialist or the general poultry farmer who wishes to cater to the seasonable broiler trade must send his birds to market from January to May in order to get a price which will pay him for his trouble. This is why broiler raising can be so well carried on with general poultry farming. It utilizes a part of the equipment and the labor at a time of the year when there is least to do. The growing of broilers as a side line to egg farming, or as a special branch of general poultry farming, is well worth the time and attention of a poultryman who has the necessary equipment and can furnish the labor at the proper season..

The following summary of the broiler industry and its requirements sets forth the essential features to be understood and considered, both theoretically and practically, before launching out in the business, either exclusively or as a side line. The production of a few broilers each year in connection with egg farming is the best and, practically, the only method of safely learning the "ins and outs" of broiler raising.

To be successful, the poultryman must consider the following points: (1) What a broiler really is; (2) market types of broilers; (3) broiler seasons and the effect of natural supply; (4) desirable features in a broiler; (5) breeds best adapted to broiler raising; (6) special features in broiler management; (7) prices, cost, and profits.

A *broiler* is a young, rapidly grown chicken, which, owing to its size and prime flesh condition, is in general demand for broiling. Before starting out to produce anything, the producer must have a clear conception of the desired product and what purpose it is to serve, for this will enable him the better to meet the requirements and secure the best quality.

*The market* classifies broilers in three groups: Large, medium, and small or squab (Fig. 175).

A pair of large broilers should weigh from three to four pounds, or one and one-half to two pounds each. Large broilers are also used extensively as fryers, and are in great demand during the latter part of the broiler season, bringing at this time as much per pound as small broilers.

Medium broilers should weigh from one to one and one-half pounds each, or from two to three pounds to the pair. The me-

dium broiler is very popular, and brings the highest price during the broiler season proper, but after that time brings no more per pound than the large broiler, or even the larger frying chicken.

Small or squab broilers weigh from three-quarters to one pound each, or from one and one-half to two pounds to the pair. This grade of broiler is the most expensive for the consumer, and is used only at high-class luncheons and dinners, or in high-class hotel and restaurant trade; consequently it is in much less demand.

The true squab broiler should be considered rather as an incidental in the broiler industry, while the medium broiler constitutes the leading type, from the standpoint of both demand and supply, during the season of high prices.

The commission merchant handles during the season the great mass of broilers, the large buyers of this grade of meat being

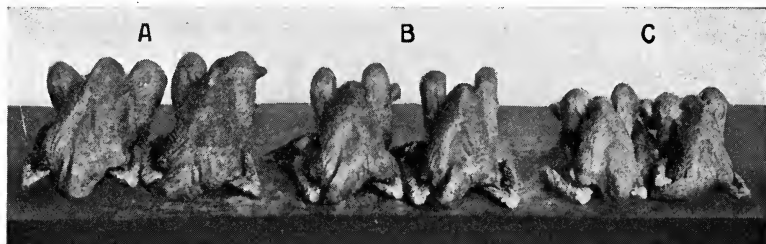


FIG. 175.—Market types of broilers. A, Large; B, medium; C, small or squab.

first-class hotels, restaurants, and well-to-do families. It is customary in serving to give half of a large broiler, or the entire bird of the small or squab grade, to each person, this dish usually forming but one course of the meal. The medium broilers are served either whole or in half, according to the place which they occupy in the meal. During the latter part of the season, when prices drop and large broilers come into market, the demand is much greater. Because of lower prices, persons of small means can afford them. The demand then is for larger broilers, which can be served so as to constitute the only meat course.

*The broiler seasons* are determined largely by the demand and supply (Fig. 176). There is comparatively little demand for broilers until November, owing largely to the fact that during the summer there are fewer functions or dinners requiring them. Besides, most of the well-to-do families are away for the summer, and the hotels and restaurants which constitute over eighty per cent of

the consumers have no call for this product. The demand begins in November and December, continuing and increasing until the middle of February, when it is at its height. From this time until July, the demand is approximately steady; but, after the last of March, there is a constantly increasing supply, which keeps the price from rising, and in fact makes it slowly fall. There is no great decline until the last of May, when the price drops suddenly. This is largely because of the enormous natural and seasonable supply brought to market as a surplus product from the hatching of pullets. The profitable season, then, for specialized broiler

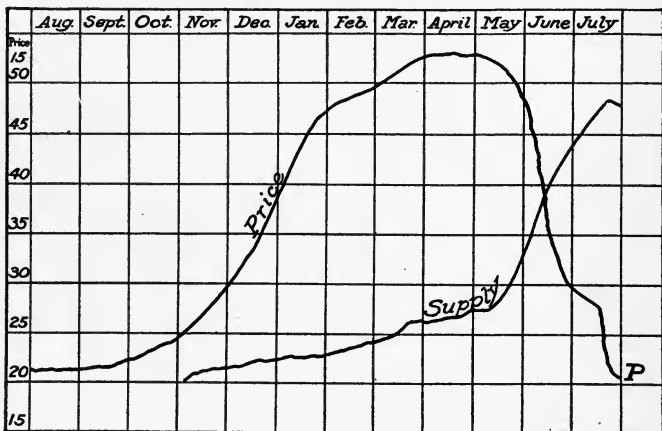


FIG. 176.—Curves showing seasonal variations in price and the supply of broilers. This shows that the supplies of March, April, and May are met by a high price.

growing is in the months of December, January, February, March, and April, with its "high-water mark" during March. The chart (Fig. 176) shows the curve of demand and price, the effect of the incoming natural supply, and the correspondingly increased demand due to lower price.

*Desirable Features in a Broiler.*—To fulfil the definition of a broiler, hence to meet market requirements and the demands of the trade, a chicken should come up to the following standard: (1) It should be plump all over, well filled out, especially breast and thighs. (2) It should have comparatively small bones, large bones giving a rangy and lanky appearance to the bird when dressed. (3) It should be meaty everywhere; want of flesh

not only makes an undersized and light bird; but greatly detracts from the general appearance of the fowl when dressed, showing the bony framework of the body. (4) Yellow skin and yellow legs are preferred. This question of the color of the skin is merely a market demand, but it is very pronounced. Of two shipments, equal in every respect, one with white or dark legs and the other with yellow, the latter will always be bought first at higher price. (5) White or light-feathered birds are best. After plucking, there are no dark pins and pits to detract from the appearance; this feature is less important than those previously mentioned, yet it does have weight. (6) Broilers should have been hatched from a quick-maturing strain or breed, from parents which were quickly matured. The broilers must be brought to maturity as quickly as possible to economize time, to secure tenderness and texture of flesh, and to reduce the cost of feeding and labor. A broiler which has developed slowly, and taken twice the usual time to attain a given weight, will never be a profitable bird, for the margin of profit is small. An understanding of the above requirements, and their bearing on price and demand, is necessary in order that the possibilities of the broiler industry may be fully realized.

*Breeds Best Adapted to Broiler Raising.*—As a rule, it may be stated that the American or general utility breeds more nearly fulfil the requirements for broiler raising than any other class of fowls; this is especially true of the large broiler. The Wyandottes, Plymouth Rocks, and Rhode Island Reds, if properly managed, will attain a quick growth in twelve to fifteen weeks, weighing at that time from one and one-half to two pounds each, and they dress well and are always in demand. The White Wyandottes probably offer as great opportunities for this class of broilers as any one breed. It must here be emphasized that it is not always the breed, but the breeding back of the particular strain, which tells the story.

In the hands of different breeders, various breeds may be made to excel one another. The aim should be to select a good breed, with the distinctive characteristics desired, and then by breeding attempt to intensify those characteristics, at the same time breeding to develop early maturity and vitality (Fig. 177). For the squab and medium broiler trade, it is possible to turn out the highest quality of poultry in the shortest possible time and at the least expense by using White Leghorns. They are quick to

mature; a well-managed flock of fifty should average one pound at from nine to ten weeks of age. They have a bright yellow skin and shanks, their meat is of the highest quality when young, and they grow very quickly. It is a great mistake in broiler raising to use, either by crossing or direct breeding, any of the slow-maturing, heavy Asiatic breeds. It is true they will attain size, but they mature so very slowly that they are unprofitable; at a one-pound weight they are bony, and have a long, lean appearance when picked. Pure-bred birds should always be used for broilers, since in crossbreeding it is impossible to fix the characteristics desired, and the progeny are neither uniform nor reliable. The greatest



FIG. 177.—Rhode Island Red broilers ready for market. Uniformity in size and finish is necessary.

objection to crossing is the resulting variability in size and quality. This is an important consideration, for uniformity adds to an attractive appearance and usually guarantees a high price.

*Special Features in Broiler Management.*—The management of broilers is similar to that required in the growing of young chicks. The chief difference is that the best season comes during the winter, a time of year when a complete artificial brooding equipment is necessary; the chicks must be fed for rapid growth, and at the same time kept healthy and vigorous. The features for special consideration are: (1) Hatch only strictly fresh eggs which come from well-mated, vigorous birds, being sure that the eggs have not been chilled. (2) Maintain the right degree of hover temperature, which will promote continuous growth. Too much heat will mean slow growth, and too little warmth will cause crowding and entirely check it. (3) Do not run too large flocks, as crowding tends to exaggerate inherited inequalities in vigor and growth, the smaller ones not getting a chance. Twenty-five to thirty in a pen are enough for the best results. (4) Continual

selection, weeding out the culls and deformed chicks at as early an age as possible, and maintaining flocks of uniform size. It never pays to run small birds with a flock of larger ones. (5) The inducing of exercise keeps the birds in excellent health as well as appetite. The more the birds eat the greater their gain in weight. (6) Systematic feeding, similar to that recommended for growing chicks, but with a greater percentage of flesh-forming materials, bone and meat scrap and abundance of green feed promote growth and influence the color of the flesh by producing a yellowish pigment. (7) In finishing broilers there is rarely a special time for fattening, the custom being to mature the chicks rapidly throughout the entire growth period, keeping them soft and plump and ready for killing all the time.

*Prices, Cost, and Profits.*—Before attempting to raise broilers, it is advisable to have a clear understanding of the probable cost of production, of selling prices, and of the profits under average conditions. In broiler raising these factors are variable, and the season of high and profitable prices is short. Generally the possibility of profits makes the work attractive, yet the risks are great. The cost of producing broilers varies because of differences in management, differences in breeds, unavoidable losses, and variations in the season. On special broiler plants, the average cost of producing a broiler weighing from one to one and a half pounds, including price of eggs and labor, is approximately twenty-five to twenty-six cents. It may be possible slightly to reduce this figure, but not materially. Other items in the cost of production are the high price of eggs at the season when they are hatched for winter broilers, the loss from low fertility, and the small percentage of hatches compared with what could be obtained during the natural hatching season.

The approximate cost is given here. These figures are for the winter season, and vary considerably during this period:

Cost of chick at hatching, including egg and incubator.....	\$0.06
Feed cost from hatching to marketing.....	.10
Labor cost, not including picking or packing.....	.03
Expense of marketing, including picking, express, and commission	.07
Total.....	.26

It is probable that chicks raised under natural conditions during the spring of the year can be produced for about three-quarters of the above total. The cost will depend largely upon

the condition of the bird, the character of the range, and whether it furnishes an unlimited amount of the best green feed.

The estimated cost of the average farm broiler during the natural season is here given:

Cost of chick.....	\$0.035
Cost of feed.....	.06
Cost of labor.....	.02
Cost of marketing.....	.07
	<hr/>
Total.....	.185

It will be noted that this great reduction in cost is due to the lower price of the eggs and the cheaper feed. The comparison shows that profit during the winter season depends upon low cost of production and good market prices, and that during the natural spring season the profits are not remarkable, but the idea is to dispose of surplus products without loss, and usually with a slight gain.

There are certain risks which even the broiler grower of established reputation and experience must always run, and these are largely beyond his control: (1) A loss from poor hatches due to low fertility, and this increases the cost of hatching chicks. (2) Loss by death, which may be due to poor management or carelessness, or, as is often the case, to white diarrhœa, or some inherited weakness or lack of vitality. (3) Losses may be caused by fluctuation in market prices; this is especially true if the poultryman has started rather late and runs his season too late. The usual spring drop in price may catch him with a considerable number on hand, which must often be sold below cost.

Market prices, however, are much more steady during the season than formerly, and it is now possible to forecast market conditions far ahead of the time for shipment. The chief cause of many disappointments and failures in the specialized broiler industry lies in the attractive possibilities,—attractive to people of limited capital and still less experience,—a combination bound to result in failure. The business requires a considerable fixed investment of capital in buildings and in incubation and brooding equipment. To be profitable the birds must be marketed in prime condition. A few days earlier or later than the proper time for marketing means either increased cost for feed and labor if they are kept too long, or a lower price if marketed too early.

A disputed question on the large, exclusive, broiler plant is the desirability or undesirability of the broiler raiser producing his



own eggs for hatching. In general the practice is not to produce them at all; or, if any, merely a part. The great difficulty is the necessity of keeping a large flock to produce the eggs in winter, and it would require considerable time and attention successfully to solve this proposition. It is becoming the custom for the broiler grower to make contracts with the larger poultrymen in the vicinity to supply him with eggs at the season desired. He guarantees to take a certain number, and to pay usually from three to five cents a dozen more than the market price for selected eggs in good hatching condition. In order to secure strong vitality and as high fertility as possible, many of the growers agree to furnish the male birds for the flocks, and by purchasing large, vigorous males of other breeding the value of the eggs for their purpose is greatly increased.

It is poor policy to gather eggs in small lots from the country where no pains have been taken to make them fit for hatching.

Broiler raising, as an exclusive and distinct poultry industry, is on the decline. Poultrymen are coming to realize the possibilities offered by making the production of market eggs the main issue, and are devoting only so much time to the raising of prime broilers in season as may be profitably taken from other work. This change in economic conditions results in greater profit from the broiler produced, in more persons shipping broilers, and in a steadier supply, and in a more stable selling price.

**Fryers.**—By a frying chicken is meant a young, rapidly grown bird a few weeks older than a large broiler, weighing from two and one-half to three and one-half pounds. There is little demand for birds of this age and weight, and the price paid is so low that it is customary either to dispose of them when at the large broiler size, or, if they are beyond this stage, to hold them for soft roasters at four pounds and above. The term "fryers" is not distinctive, for chicks at all ages are used for frying, especially large broilers.

**Roasters.**—The growing of prime roasters as an industry is centralized in two well-defined sections in the East, namely, along the south shore of Massachusetts and in south-central New Jersey. In these two sections much time and attention are devoted to this as an exclusive industry, but often as a side issue in general farming. In Massachusetts the industry is carried on more exclusively, while in New Jersey the great majority of farmers plan to raise and finish from one hundred to five hundred and, in some cases, over one thousand roasters. Roaster grow-

ing is undoubtedly more profitable when carried on as a side line to some branch of agriculture, for its season is short, and the amount of labor required from hatching time to finishing is small. The returns are very satisfactory, but the cost of producing varies greatly, this depending upon the amount and kind of range for grazing. There are two great advantages which the roaster growers of the New Jersey district have,—namely, large fields for range after grain crops, or green pasture following the first cutting of hay. These areas serve admirably for supplying plenty of the required nutriment at so little expense that the cost of production is materially reduced.

Roaster growing on an exclusive basis may call for the investment of a large amount of capital in buildings and equipment, and the production must be considerable to pay an interest on the investment. Some returns are coming in constantly, yet the heavy demand and high prices are in the first two summer months, and the poultryman must plan to sell much of his product at that time. Expenses on a specialized roaster plant are almost continuous, and they must be met by a short period of heavy income.

One disadvantage of the industry is the long time which one has to carry his crop before it is marketed, and this is expensive. An endeavor has been made to combine broiler and roaster farming, but with little success. This is largely due to the fact that, with a given location and certain conditions, either one or the other will be found to be the more profitable, and by attempting both the poultryman fails to make as much out of either. If they are combined, he must carry two distinct types of breeding birds which need entirely different management, hatching must take place at different seasons, and there must be an altogether different method of finishing and marketing; therefore it is wise to confine one's endeavors to one branch and to master it.

To succeed in the growing of prime roasters, a poultryman must become familiar with the following general factors: (1) What the term "roaster" implies; (2) market types of roasters; (3) natural seasons of demand and variation in price; (4) features of a desirable roaster; (5) breeds best adapted to roaster growing; (6) special points in management.

*What the Term Roaster Implies.*—A roaster is a young, quickly developed but fully grown bird, with tender meat of fair weight, and, owing to its large size and good quality of flesh, in prime condition for roasting.

In roaster growing it is absolutely necessary that the producer know the requirements, and the difference between a bird in prime condition for roasting and one which is not, for they vary greatly according to breed characteristics and management.

*Market Types of Roaster.*—Commercially, roasters are classified as small and large. The greatest demand is for small roasters weighing from eight to ten pounds to the pair, or four to five pounds each. Such birds suit the average family better than larger ones. Large roasters, weighing twelve pounds to the pair or more, are in considerable demand, especially during holiday seasons (Fig. 178). They often weigh singly as much as the



FIG. 178.—Market types of roasting chickens. A, Large roaster, six pounds; B, small roaster, four pounds.

smaller ones will average per pair. The production of these large roasters for seasonable markets is one of the most profitable branches of poultry keeping, especially if there is abundant green grass range. The demand for them is steadily on the increase.

*Roaster Seasons and Prices.*—There is a good market for a prime roaster at any season of the year, but the problem of the specialist is how to bring his birds to maturity at the time of natural shortage and correspondingly higher prices. This period is from the first of June to the middle of August; it constitutes the shipping season of the south-shore section and of heavy income. The fall of the year is the natural roaster period. The prices then are slightly lower, due to the large supply of birds from general and mixed farms shipped to market at about this time.

Another profitable shipping period is late November and

December, or during the holiday season. This is the market to which the great mass of roaster growers attempt to cater,—that is, those who carry on the business in connection with some other well-defined branch of agriculture. There is never a time when the supply so nearly equals the demand as to make the prices drop low enough to be unprofitable. There have been periods of glutted markets, but only for an extremely short time. These have been due to heavy shipments, during the fall, to the large consuming centres from the Central West. The season's prices vary considerably, due almost entirely to demand and supply. The chart shows this price curve (Fig. 179).

*Features of a Desirable Roaster.*—In general, the description of a prime broiler also applies to a roaster. In addition, however, the following points are desirable in the roaster: Great length of

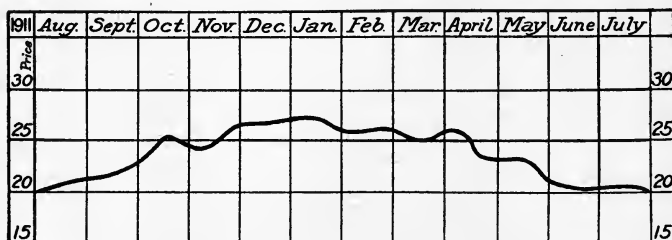


FIG. 179.—Curve showing seasonal variations in market prices for roasters. Highest prices realized during winter months.

body with extremely full breast, the entire carcass to be full and plump, and rounded rather than angular. Yellow skin and shanks are preferable in most markets. The color of the feathers is of less consequence in roasters than in broilers, because the pin-feathers are not large enough to be evident. Although fully matured, the flesh of the roaster must be soft and tender, with plenty of fat and little connective tissue such as would be found in full-grown Leghorns.

*Breeds Adapted to Roaster Growing.*—In regard to maturity the requirements for the two types of commercial roasters are wholly different. For example, the small roaster is marketed at an earlier age and earlier season, consequently he must be matured earlier; while with the large, full-grown roaster, which was slowly matured, juicy and tender flesh is demanded.

For small roasters the general utility breeds, especially the

Plymouth Rocks, Rhode Island Reds, and Wyandottes, are very suitable. The Orpington makes good flesh growth, but the color of the shanks is discounted by the consumer. This type of fowl matures rather quickly and has juicy meat at maturity. The early maturity reduces the period of feeding; hence each pound of flesh is produced more cheaply than would be possible with the larger Asiatic breeds. These breeds do not attain sufficient size to admit of their being finished and marketed as large roasters. It is necessary, then, to secure a bird of larger growth which will have very tender flesh at maturity.

The Asiatics are good for this purpose, the best being the Brahma, and the light variety being generally preferred. With good care and abundant feed they will slowly grow to a very great size, and will reach maturity in time for the fall and winter demand, the flesh being very tender when killing time comes. They will also finish profitably, as they are naturally of a quiet temperament and stand close confinement well. The Light Brahma and some fowls of the American class are sometimes crossed, but there is no decided advantage in doing this.

*Special Features of Roaster Management.*—Roaster growing as an exclusive business requires an extensive equipment for late fall and winter hatches and suitable houses in which to grow the chicks during the cold winter weather. On the contrary, roaster growing for the fall and winter trade requires only the simplest kind of pens or houses for developing the birds. The size and style of the hatching equipment depend upon the number to be run through, which is usually so small that no expensive outfit is necessary. Extensive range and the keeping of the birds in flocks of not over one hundred are customary. The best and cheapest method is to give them free range, if possible, with small developing houses scattered at short distances apart.

Expensive and systematic feeding is unnecessary during the growing period, if the birds have range which furnishes an abundance of green feed and insects. Costly feeding comes just before the time of marketing, when the birds should be closely confined to put them in first-class condition by forced or systematic feeding. The confinement stops their continuous exercise. Ground grains are usually sufficient during the summer feeding period. If we wish to hasten the growth, a dry-mash may be given. Shade on the range is essential, as well as an abundance of fresh drinking water, for the flesh of the well-grown roaster requires much water.

The production of market poultry, especially of roasters, could be made very profitable on a great majority of the general farms which now carry only a small flock for home consumption, the labor item being almost infinitesimal, except during the finishing and marketing periods. Under these conditions the cost for feed is slight and the extra labor required comes at the slack time of the year. The general farm flock produces the great mass of poultry and eggs. Let it do so to a still greater extent, and multiply the income of the farmer.

**Capons.**—There are great possibilities in the more extended practice of capon production. The industry is in its infancy, and



FIG. 180.—A flock of capons five months old.

each year sees a great increase in the number of capons produced. The possibilities must be clearly understood. The poultryman should become thoroughly acquainted with the operation before attempting the practice commercially. The art of caponizing has been understood and practised for many years, yet its possibilities are just becoming understood and being developed.

A capon is a male bird from which the reproductive organs have been removed at an early age. Emasculation changes the entire physical make-up of the cockerel, altering his shape and the appearance of his plumage; he loses his masculine characteristics and gains weight very rapidly (Fig. 180).

*Advantages of Caponizing.*—From the standpoint of production of poultry meat of high flavor and quality, caponizing is very desirable. Its advantages are: Larger and heavier fowls at killing

time; sweeter meat of finer flavor; a much higher selling price; a lower cost, due to ease of fattening; a more docile disposition and better endurance of close confinement; can be used when desired for hovering young chicks.

During the same period of growth it is possible to produce capons which will weigh one-half more than they would normally weigh. A cockerel of the American breeds at eight months of age will weigh from four to five pounds. The same bird, if caponized when about twelve weeks old, can easily be made to weigh from six to eight pounds at eight months, and at the same time the flesh of the capon will be more tender, of finer texture, and of superior flavor. True capon flesh is much sweeter than that from the cockerel of the same age. The term "Philadelphia capon" is familiar to everybody connected with the industry, or who appreciates excellent quality in chicken flesh. At marketing time, or eight months of age, the capon will command on the market from twenty-two to thirty cents a pound, according to the season, while the cockerel would bring only from thirteen to twenty-five cents. These differences vary considerably throughout the year, the highest capon prices being during the holidays. The cost of feeding the capon during the eight-months' period will have been much less than that for the cockerel, due to the fact that more of the feed consumed is stored up in the body as flesh, and less converted into energy. After caponizing, the disposition is modified: The birds become more quiet and gentle, endure close confinement quite well, and lose inclination to fly over obstacles, or to quarrel and fight one another.

When desired, the capon can be used in colony houses during the early spring to hover and furnish heat for chicks as they are put on the range. The capon develops such a maternal instinct that he will protect and care for the young chicks.

The greatly enhanced value, resulting from such a simple operation, is a good reason why more capons should be produced. Another reason is that the markets throughout the country are but sparingly supplied with capons, and the demand for them from lovers of delicate poultry meat is great. In many European countries few, if any, surplus cockerels are allowed to reach maturity as cockerels, but they are caponized and converted into a high-grade and greatly demanded table luxury. France is noted for the high quality of her poultry meat. The time will doubtless come when the poultryman will find it difficult to dispose

of surplus cockerels unless they are caponized. The sooner the general poultryman and farmer appreciate this fact, the sooner will the quality of poultry meat be so improved that the income and profit from its sale will bring an increasing revenue to the producer.

*Market Requirements.*—It may be said that there is no definite capon season, for the demand is constant throughout the year, and the supply does not begin to meet even a fractional part of it. December to March is the season when most capons are marketed, yet it is almost impossible to find any at general markets because they are immediately bought up at high prices. The better an article is, the greater the demand for it at correspondingly high prices, and ordinary chicken meat has no chance compared with capon meat. This fact is being realized by the more progressive poultrymen. The demand is continuous, the price paid is the highest for any kind of meat, and there are no commercial seasons to make it necessary to produce at that time only. The best birds for capons are hatched in the early spring, and the operation is performed during the early summer before extremely hot weather sets in. The birds are then ready for market during and after the holiday season, when there is always the greatest demand for market poultry.

*Best Breeds for Caponizing.*—Cockerels of any breed can be made to increase greatly in weight by being caponized; but the larger breeds permit of larger gains and are the most desirable. For the production of capons on the farm, the Plymouth Rocks are one of the best breeds. The pullets may be kept for eggs and all the surplus cockerels caponized. If the production of capons is a specialty, one of the heavier breeds, especially the Brahma, will prove more satisfactory. The Light Brahma is undoubtedly the best capon breed. It is not an uncommon occurrence to get a flock of such capons at eight to ten months of age to weigh from twelve to fifteen pounds each. The light capons, such as are produced from Plymouth Rocks, will probably always be in greater demand, because they furnish more nearly the amount of meat required by the average family, while the larger capon will serve instead of a turkey for special occasions, such as holidays and celebrations, or for hotel and restaurant demands. Crossing is practised in the growing of capons, with varying results. One method is to cross the Barred Plymouth Rocks and Light Brahmas in order to get plumpness of breast, a little quicker maturity, and



a decided yellowness of skin and legs. It is doubtful, however, if this procedure is profitable in the long run. A bird with handsome plumage is more attractive as a capon, for in dressing much of the plumage is left on; hence the partridge-colored birds are used to a considerable extent.

*Proper Age for Caponizing.*—Cockerels can be caponized at any age, but it is not advisable to perform the operation after the birds are six months old, for by that time the natural function of the organs becomes so firmly established that their removal is apt to be disastrous. Neither is it wise to caponize a bird when too young, for the organs are not sufficiently developed to be easily removed, being very soft and easily torn. In determining the proper time to caponize, size should be the guide rather than age, the best time being when the birds weigh from one to one and one-half pounds, or after they are two months old. June, July, August, and September are the best months for the operation, because the spring-hatched chicks then reach the right size; birds caponized at this time will be ready for market during the months of December, January, February, and March, the season of the greatest demand and best prices. High prices at this time are partly due to a falling off in the supply of cockerels, which are so abundant in the fall and early winter; the capons fill in the gap caused by this reduced supply of cockerels on the one hand, and the natural supply of spring broilers on the other. This is not necessarily the capon season; it is only so termed from the fact that few, if any, are produced at any other season.

*Instruments and Equipment Necessary.*—Before performing the operation, one should either see it done by an expert or practise on dead birds until familiar with the location and appearance of the organs to be removed and the place for the incision and the manner of making it, after which perfection in the operation is simply a matter of practice. The student of caponizing should first secure a reliable set of instruments and become familiar with the name and purpose of each. There are many sets on the market which are far from perfect in design, but the ones here illustrated are in most respects similar to those used by professional caponizers. Instruments should be chosen for their rigidity and durability, as well as efficiency and design. The best sets are made double,—that is, each end of an instrument is designed for some particular purpose. The set illustrated (Fig. 181) comprises four instruments, as follows: Spoon and hook, forceps and

knife, cannula threaded with horsehairs, and spreader. A cord with hooks is a part of the set.

In reality the above set consists of six instruments so designed as to be combined into only four, thus lessening the time lost by handling so many instruments. The horsehairs are thick and about eighteen inches long. These form a loop for the cannula.

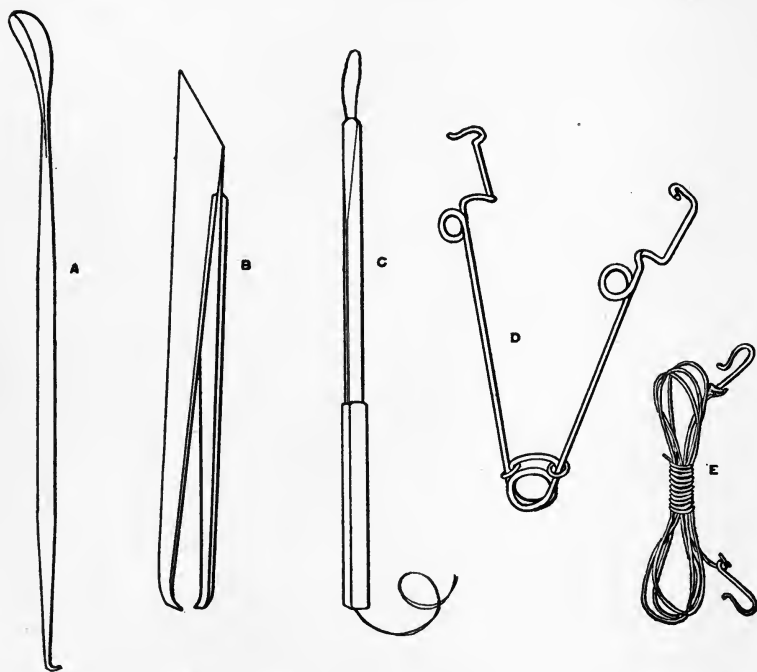


FIG. 181.—Caponizing instruments. A, Spoon and hook; B, forceps and knife; C, cannula threaded with horsehair; D, spreader; E, cord and hooks.

A suitable table or board is needed to operate on. A barrel top may be used, the bird being fastened down to it by means of strings with wire hooks at either end. To one end of each string a weight is fastened, while one of the free ends is tied around the wings near the body and the other around the shanks at the hock joint. Where many birds are to be caponized, it is advisable to have a special board which is firm and holds the bird securely, and so arranged that he may be quickly tied or released.

*Preparation of the Birds.*—For twenty-eight to thirty-six

hours before the operation the cockerels selected should be kept in a clean, airy coop, all feed and water being withheld; this abstinence will empty the intestines and the operation can be performed more easily. It is a good plan to shut them up at night, keeping them confined for thirty-six hours and performing the operation the second morning after. If the time set is cloudy or wet, the operation should be postponed until fair weather, as a bright light is necessary for the best work.

The amateur should follow the directions closely, for the overlooking of some slight detail may result in a ruptured artery or the tearing of a vital organ, which may mean death. Caponizing is the most dangerous of all forms of emasculation, since the organs lie wholly within the cavity of the body close to the heart, lungs, and large arteries; hence the necessity of following directions closely.

*The Operation.*—Place the operating board on a barrel or table out of doors in some sheltered place, but where the sun shines brightly. Have the coop with the starved birds handy. Provide a shallow pan filled with a disinfecting solution, one per cent creolin being good, in which the instruments can be placed. Take the bird from the coop, lay it on its left side with its back toward the operator, and fasten to the table in the manner before described. Moisten the hands in the disinfecting solution, and pluck the feathers in the vicinity of the last rib, leaving a bare space free from feathers, bounded by the third rib, backbone, and thigh. Next take the knife or lancet in the right hand, cutting edge from the operator, and with the left hand press the two ribs about one-half inch from the backbone (Fig. 182). When the knife enters the skin, the bird will struggle a little, but after this there will be little movement of any kind. The incision should be quickly made by making a cut up and down about one inch long, always cutting away from the backbone, and not removing the knife from the cut until it is of the desired size. The cut should be made deep enough to penetrate the skin and body walls, but not deep enough to cut the intestines. The danger of

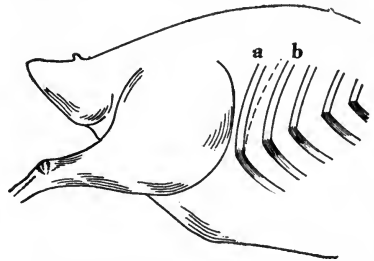


FIG. 182.—Dotted line shows proper place to make incision for caponizing. *a* and *b*, last ribs.

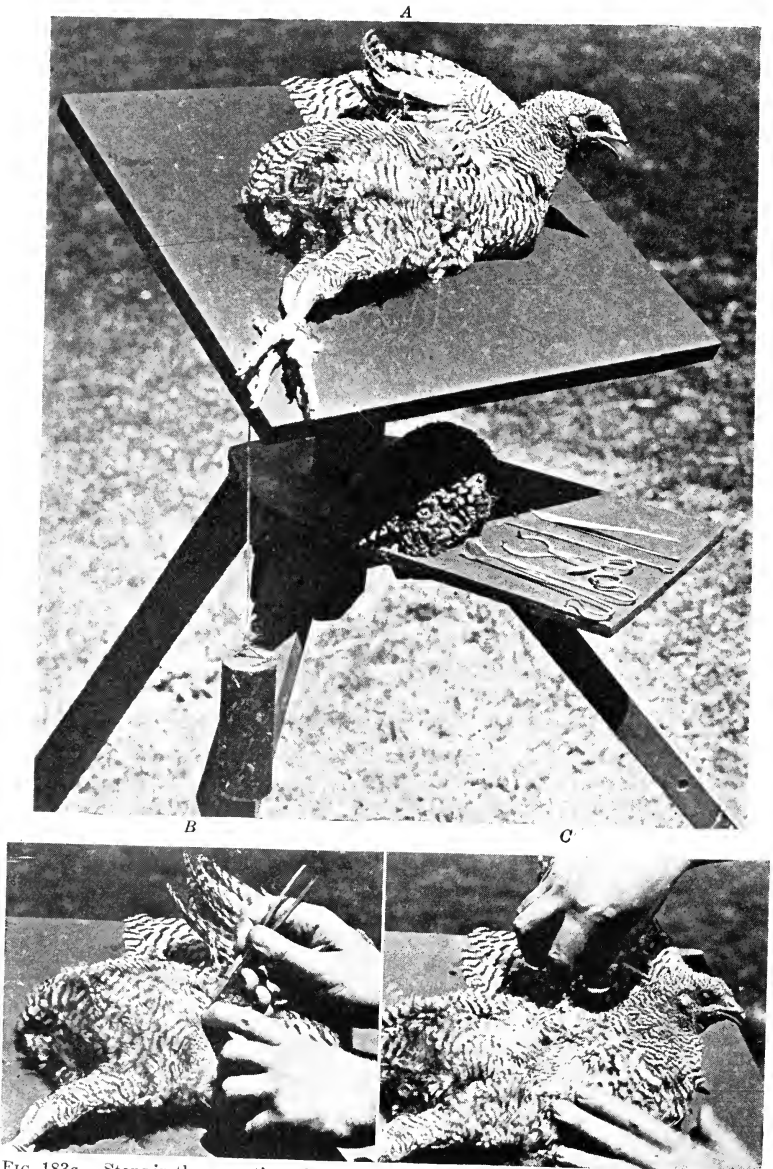
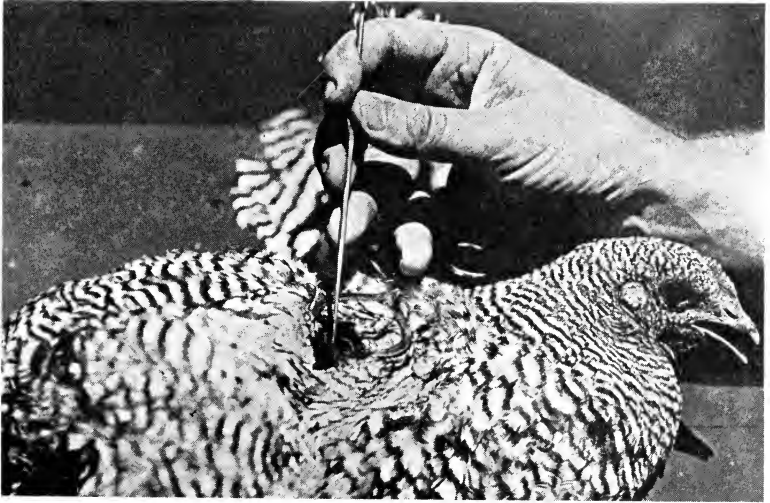


FIG. 183a.—Steps in the operation of caponizing. *A*, Table, instruments, and bird in position; *B*, starting the incision; *C*, inserting the spreader.

D



E



F

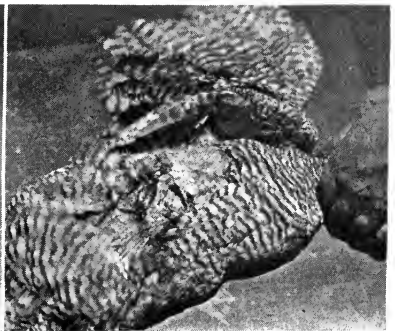


FIG. 183.—Steps in the operation of caponizing (*continued*). *D*, Tearing the peritoneum; *E*, the organ exposed and ready for removal; *F*, appearance of the wound after the operation; the skin covers the opening when the bird is released. (Photos from Kansas Station.)

this is, however, very slight if the bird has been properly starved. Little or no blood should appear unless some veins which lie directly over the rib are cut. This can be avoided by pulling the skin back before making the first incision (Fig. 183a).

Next insert the flat hooks of the spring spreader, allowing

them to press against the ribs on either side, and thus hold the incision open, the opening being controlled by the size of the chicken. A thin, tissue-like skin will now be perceived on looking into the cut, and it is next necessary to rupture this by using the hook on the end of the spoon. Care should be used in tearing this not to rupture the intestines or arteries. The tear should be right under the incision, and no larger than the opening. On looking into the opening the testicles can now be seen, attached to the back. At the age of three months they will appear as little rolls of fat, yellow in color, about one-half an inch long, and about the size of a kernel of wheat.

Now comes the delicate and hard part of the operation,—namely, the securing and removal of these organs. The best procedure is as follows: Take the spoon in the left hand, and press the intestines back with same until the lower testicle lies in the spoon, then take the cannula, which has been previously threaded with horsehair, leaving a loop about double the size of the testicle, the hair being knotted at the upper end, leaving a large loop of such size as to admit the thumb, and small enough so that it will be possible to draw the lower loop tight by an upward movement of the thumb. After fixing the cannula firmly in the right hand, place the small loop over the testicle with the aid of the spoon, gradually elevating the thumb until the lower testicle is firmly held in the loop, then by an upward movement of the thumb and a gradual drawing up of the cannula, at the same time twisting it slightly, the testicle and the sac in which it is enclosed will be entirely removed. The spoon should be held under the testicle to catch it when it is severed. The same procedure should follow in the removal of the upper one, except that it will be found much easier, as it lies near the top in better view and is more easily reached. The object of removing the lower one first is that, in case of any bleeding from prior removal of the upper one, it would be impossible to find the lower one. After both testicles are removed, take out the spreader, and the skin will slip back over the opening. The bird should be immediately released. It has sometimes been suggested that the testicle be removed by an incision on both sides of the bird; but this is unnecessary, except in the case of the first few birds done by an amateur, or where the birds have not fasted long enough.

*Slips and Deaths.*—If during the operation the tissue of the testicle is ruptured or torn, there is a possibility of some of it

remaining attached to the body, in which case the organ will start to develop and a slip will result. This means that the operation was incomplete, that some of the organ remains in the body, and that the bird will not develop capon characteristics nor grow as desired. In commercial caponizing this accident occurs in from three to five per cent of all birds operated upon. The possibility of fatalities is very slight after one has acquired the art. Death usually results from the rupture of a large artery which runs along the back of the body, and to which the testicle sac is closely attached. When this occurs, either from a misuse of the hook or a too deep knife cut near the backbone, or, in some cases, as a result of not getting the right hold on the testicle with the hair loop, the birds will immediately bleed to death. Such rupture is indicated by the presence of a large amount of blood in the cavity of the body, and perhaps by the noise which the escaping blood makes. These birds should be immediately plucked, for they can be used as broilers, the bleeding being the same as would be caused by sticking in the throat. The careless operator sometimes ruptures the lungs or cuts a rib, which may lead to complications at a later date, but this occurrence is very rare. A loss ranging from one to three per cent by death is a safe estimate.

*Marking Capons.*—It is essential that all birds which have undergone the operation, whether successfully or not, should be plainly marked, so that there will be no possibility of "slips" getting into the breeding pens. Toe punching and leg banding are often done, but in either case there is danger of the mark becoming obscured or, in leg banding, lost. In commercial work it is the custom, immediately after the operation and before removing the bird, to sever the nail of the right middle toe. This slight wound heals almost immediately, causes no pain, and leaves a permanent mark, the end of the toe never growing out again. These toes are usually collected by the paid caponizer, and hung in a little box under his board, to serve as his record of the number of birds caponized.

*Treatment After the Operation.*—The bird should be removed from the operating table, the proper way being to carry him by the wings, and placed in a clean, airy coop which will permit neither flying nor roosting, for the effort of flying to roost is apt to keep the wound open. Fresh water and plenty of soft feed should be immediately supplied. The birds will immediately begin to eat, and one would never imagine that a delicate opera-

tion had just been performed. An abundance of feed and water should be kept before them for the first week after the operation, for they develop an enormous appetite as a result of the operation and the previous abstinence from feed. Two or three days after the operation the birds should be inspected to see if there are any wind puffs under the skin in the region of the wound, due to the formation of gases after it had healed. These should be reduced by pricking the skin with a needle or sharp-pointed knife and allowing the air to escape. With some birds it may be necessary to repeat this operation a number of times. At the end of two weeks the wound will be entirely healed, and the capon can be put permanently on range, and treated as any other growing bird where flesh growth is the object.

*Changes in Appearance and Characteristics.*—After the operation the disposition and external appearance of the birds seem to change. Their bodies increase in size very rapidly, but the combs and wattles entirely cease to grow, and they lose the power to crow. They become exceedingly tame and lazy, develop heavy and beautiful plumage, and the spurs cease to grow. When running with a mixed flock, they keep aloof from the roosters and hens and seek the company of little chicks. They may often be seen hovering the chicks. The more extensive capon producers claim caponizing is a preventive of disease, and large flocks of capons can run on limited range with no apparent ill effects. As a rule, they are strong, vigorous, and healthy, only requiring during development clean, light, and properly ventilated houses and regularity in feeding.

*Practice and Profits.*—Enough has been said in the preceding pages of the possibilities and advantages to be derived from a more general practice of caponizing. It is earnestly recommended to the farmer and poultry raiser as a means of increasing profits and as an advertising medium by creating a demand for poultry meat of unexcelled quality. In a community of small poultry farmers it is possible to hire the work done by professionals, but if the poultryman has a great number of fowls he should do the work himself.

The cost of feeding a capon to maturity, or for twelve months, is from seventy-five cents to one dollar, depending on condition and range. Add to this the cost of the operation—five cents—and the cost of the chick at hatching, and we have a total of ninety cents to one dollar and fifteen cents at most. Assuming



an average weight of eight pounds for a year-old bird and a selling price of thirty cents, we have a market value at killing time of two dollars and forty cents; this leaves a profit of over one dollar and twenty cents. But the price and weight may each be less. A comparison of profits from capons and cockerels, as shown in figure 184, proves the value of caponizing.

**Spaying.**—By spaying is meant the removal of the ovaries or productive organs of the pullet or female in much the same

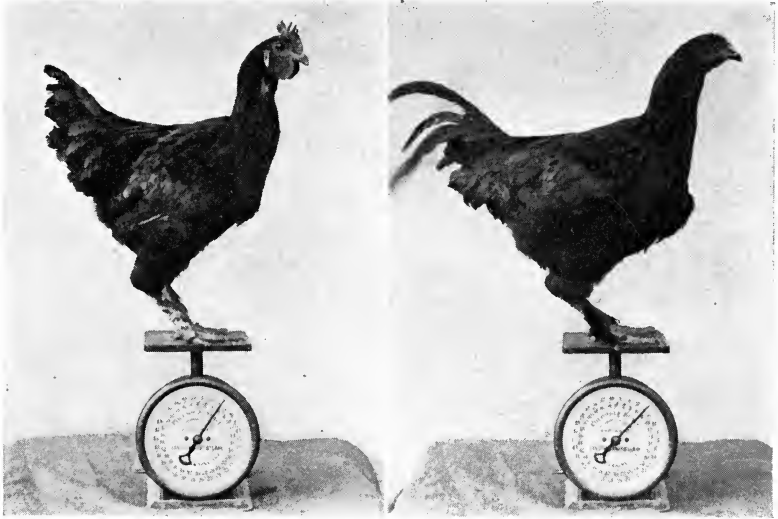


FIG. 184.—The comparison of weights (cockerel  $5\frac{3}{4}$  lbs., capon  $7\frac{1}{4}$  lbs.) proves the advantage of caponizing. Both are from the same brood of Langshans, seven months old.

manner as caponizing is performed. From a practical standpoint it will never become general, for the following reasons:

The value of pullets for egg production is so high that it is doubtful if they would ever be as profitable if disposed of for meat.

After the operation there is no pronounced change in characteristics, nor is there the rapid development of flesh seen in capons.

It is almost impossible to remove the ovaries so completely that they will not again develop,—even with the greatest care and the use of caustics to kill any remaining tissue.

Therefore the results of spaying are not such as to warrant its general practice.

## REVIEW.

1. Name five types of market poultry and tell which is in greatest demand.
2. How does broiler raising rank as a branch of the poultry industry?
3. Define a broiler.
4. Give the market types of broilers.
5. Outline broiler seasons.
6. Give six features required in a desirable broiler.
7. Which type of bird is best adapted to broiler raising?
8. Outline the essential features in broiler management.
9. Discuss broiler prices at different seasons.
10. What is the relation between cost of production and profits?
11. What is a fryer?
12. What sections are noted for roaster growing?
13. What is a roaster? Give the desirable features.
14. Discuss the market types of roasters.
15. What breeds are best adapted to roaster growing?
16. Discuss roaster seasons and prices.
17. What can you say of the capon industry?
18. Give seven advantages of capons over cockerels for meat.
19. Discuss market requirements and demand for capons.
20. What is the proper age to caponize? Why?
21. Describe the instruments necessary.
22. How should the bird be prepared for the operation?
23. Describe the operation in detail.
24. What is a "slip"?
25. Describe the resulting changes in the appearance of a capon.
26. How should capons be marked?
27. What is spaying? Why not profitable?

**References.**—Feeding Experiments with Capons, New York Bulletin 53. Capons and Caponizing, by Robert R. Slocum, U. S. Farmers' Bulletin 452. Capons for Kansas, by W. A. Lippincott, Kansas Circular 27. Capons, by O. M. Watson, South Carolina Bulletin 62. Capons and Caponizing, by F. L. Washburn, Oregon Bulletin 31.

## CHAPTER XXIV.

### FATTENING, KILLING, AND DRESSING.

**Fattening.**—The operation of fattening is distinctly a finishing or ripening process, to have the bird's flesh in the best possible condition for human consumption. The condition, when attained, may be perceived both externally and internally; externally, in the plumpness of the fowl and the color of the skin; internally, by the presence of enough oily or fatty tissue to make it delicious eating. There is always a demand for dressed poultry, whether good or poor. There is, however, rarely a time when the inferior product brings more than a very low price, and this often means loss. Birds of high quality, especially prepared for market, always yield a profit.

When only a few birds are to be killed, it is doubtful whether extensive preparations for fattening will be found profitable; but when large numbers are marketed every year, a close study of the relation between weight, cost, and selling price will demonstrate to the poultryman the profit to be derived from systematic and careful fattening. These terms are used to describe dressed poultry: Thin, plump, and fat. Plump birds are by far in greatest demand at the highest prices. There is very little sale for excessively fat birds of any type. Thin birds are produced in great numbers on the general farms of the country, and are disposed of with no attempt to put them in condition. Such birds are not attractive when dressed and displayed, hence not in general demand, yet they are usually disposed of in large numbers at low prices to a trade that cannot afford to pay higher prices for a better product. Thin birds have a shrunken, knotted appearance and prominent bones; when cooked, unless very young birds, the flesh is tough and dry for want of fat. A large percentage of poultry marketed in America is unfinished and of inferior grade.

*Special Fattening Processes.*—There are three distinct ways of finishing birds previous to killing. A choice depends upon the age of the bird and the quality of flesh desired. These methods are: Flock or pen fattening, crate fattening, and cramming.

*Flock or Pen Fattening.*—This is the common method of fattening cockerels and fowls, although old hens usually do not

require much finishing, as it is natural for them to take on fat and to be plump and of good weight. With cockerels the custom is to confine them in small yards, usually in large numbers, the total number of cockerels in one pen running from ten up to one hundred. Their exercise is restricted by limiting the range, and they are fed often, corn constituting the bulk of the ration. In some instances wet mashers are given. In the majority of cases, cracked corn and wheat supplement a dry-mash which contains a large amount of corn meal and at least thirty per cent of meat. The rations fed under farm conditions vary greatly in different communities, according to the number of birds to be marketed.

This method of pen or flock fattening is often applied to the finishing of broilers. As a rule, young broiler chickens are not finished, owing to their rapid growth and, consequently, their fine flesh. It is often profitable to vary the ration during the last week or two before killing, feeding skim milk and corn meal mashers plentifully with a larger allowance of meat; if they have been on range, comparatively close confinement during the last weeks is desirable. Usually, however, broilers grown in season are closely confined during the entire growing period, as out-of-door conditions do not allow them range.

*Crate Fattening.*—This mode of fattening is used by large plants having a heavy output of poultry for meat, but its development is greatest in the large and special poultry-fattening and slaughter houses in the central and south-central sections of the country. These firms buy poorly nourished live poultry from the South and West, which is shipped to them by carloads. Then it is sorted and put through a special course of finishing, after which it is sold at a profit. When the improvement and profits resulting from crate fattening are clearly understood, this will doubtless be more generally practised among poultry producers, with the result that a higher quality of dressed poultry will be displayed at our larger markets. The methods here described are the ones in use in extensive fattening establishments.

These fattening stations consist of buildings used exclusively for the fattening of chickens, and are usually operated in connection with large poultry and egg-packing houses. Such stations are generally found in poultry-producing centres, where the farmer sells his poultry in comparatively poor condition, provided there are facilities for shipping and marketing or for holding it in cold storage. These stations are usually located at or near railroad.

junctions, in order that stock for fattening can be secured from a large surrounding territory.

Two types of crates are used, the stationary and the portable. These crates are usually constructed so that a number of them form a unit, each unit being called a battery. The stationary batteries are rapidly falling into disuse, and portable ones are taking their place, much less labor being required to operate the portable ones. They can be arranged so as to fit any room or building. An excellent feeding battery is shown in figure 185. It is constructed as follows: This battery is divided into eight coops, four tiers of two coops each, and holds eighty spring chickens or sixty-four hens. It is 2 feet 7½ inches wide, and 5 feet 9 inches high. The slats in front are 1 ⅞ inches apart. Each set of slats is 8¼ inches wide, and is fastened by buttons, so that it can be easily removed and a set of slats closer together or farther apart quickly inserted. As the chickens' heads vary considerably in size during the season, this adjustable front is necessary. The dropping pans are 1¾ inches below the floors, which are made of heavy, square-mesh wire, roosting poles are 2 inches wide, ¾ of an inch thick, and 2 feet 6 inches long. The first floor is 6 inches from the ground, and it is 15 inches from the wire floor to the top of each coop; thus each tier, including the dropping pans, is 16¾ inches deep. The battery rolls on four wheels, two double-pivot wheels in front, and two wheels connected by a bar in the rear. The sliding doors on the sides are fitted with hooks which fasten into eyes on the battery. The whole battery is made of furring, 1 ⅞ by ⅞ inches, covered with 2-inch-mesh wire and laths. The feeding troughs are 3½ inches across the top, inside measurement, and 3 inches from top to bottom, outside measurement. These troughs are held in place by flexible bent wires which yield if the troughs hit any obstacle, thus preventing breakage. A wire partition divides the battery into two equal parts.

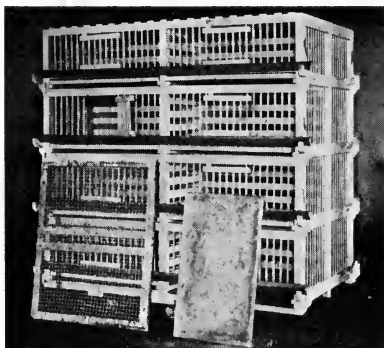


FIG. 185.—A portable battery of feeding coops, used in commercial crate fattening. The weighing, feeding, and moving of the birds can be done without taking them from the coops. (Photo by U. S. Bureau of Chemistry.)

*Care in Crate Fattening.*—From six to ten birds, according to size, are placed in each division of the battery. They should be weighed when placed in the crates so that the gain can be determined. Many mixtures of grain have proved successful. The best rations are usually composed of corn meal and low-grade flour, about 60 per cent of the former and 40 per cent of the latter. Six per cent of tallow is sometimes added to this ration, with varying results. Grit is generally provided, especially if the birds are kept on feed for two weeks or more, and four pounds to each hundred birds are given twice a week. Clover or alfalfa meal, meat meal, blood meal, charcoal, and sometimes salt, are added to the ration, according to the ideas of various feeders, but their use is not essential.

The excessive feeding of very concentrated rations often has the effect of making the birds pull feathers and pick at each other; they often keep at it until they have eaten much of the flesh of live chickens. In such cases reduce the concentration and substitute greens and a small amount of meat or blood meal.

Milk or buttermilk is essential in all fattening rations. Milk in some form is used to soften the rations, and acts on the digestive processes, keeping the birds in good condition during forcing. If much milk is given, the amount of meat may be reduced. Buttermilk and skim milk are generally used, and the milk may be either sweet or sour, but usually it is sour. The feed should be thoroughly mixed, either with a rake or a machine, according to the quantity, so that there will be no lumps or dry masses. The consistency should be about that of cream, or so that it will drip from the tip of a large wooden spoon. Chickens seem to prefer a thicker mixture, but it is doubtful if they get sufficient nourishment from it, for their hunger is much sooner satisfied than when compelled to eat the thin one. The percentage of milk to use in the mixture depends upon the grains, the weather, and method of feeding; about 60 per cent seems to give the best results. Successful fattening depends largely upon whether the feeder watches his birds and notes their condition. The first two or three feeds should be light and the amount gradually increased until the birds can be given all they will eat up clean.

The birds are usually fed from two to five times daily, but three is best for the small or amateur feeder. The use of milk has a tendency to produce white flesh, which in certain markets is not as desirable as yellow; this, however, is merely a matter of

choice, not of quality. Birds specially fattened are usually dressed. Small lots are shipped direct to the point of consumption. In the case of large feeding stations, they are put into cold storage and held for future shipment. The shrinkage in dressing is approximately 14 per cent.

When crate fattening is the method, care must be exercised to keep the crates in well-ventilated buildings, for fresh air is essential to the process. The coops must be cleaned regularly every other day, and disinfected at least every week. Careful records should be kept of the feed consumed and the gain in weight during the feeding period, to determine whether or not the practice is profitable, and to what extent.

Extensive experiments with this method of fattening, made by the United States Department of Agriculture, led to the following conclusions:

The Plymouth Rocks and other general-utility breeds can be fattened at less cost than the Mediterranean breeds, such as Leghorns.

Chickens of the same breed vary greatly in the amount of flesh they put on during the fattening period.

Where a number of birds are to be fattened, the use of portable coops or batteries is found most profitable; less labor is required, and the birds turn out in better condition.

Low-grade wheat flour is one of the most economical feeds, being far superior to oatmeal.

It will take approximately from three to three and one-half pounds of grain to produce one pound of flesh; hence the feed cost averages six to eight cents for each pound gained. The cost of labor per pound of increase is from one to three cents, according to the number and arrangement of the pens; therefore the total cost of a pound of gain, counting feed and labor, is approximately seven to eleven cents.

Less expensive gain in flesh is usually made by short feeding periods ranging from seven to ten days.

Hens do badly under crate fattening, and it is usually unprofitable to attempt it; if fattening is necessary, the flock method will give the best results at small cost.

Records should always be kept so that the gains can be estimated; for it often happens that birds are carried through in small flocks by inexperienced feeders at a loss not only of money but in weight as well.

*Cramming* means the introduction of feed into the bird's crop by physical force, with no aid or desire on the part of the bird. There are three distinct methods of cramming,—namely, hand, funnel, and machine cramming.

Hand cramming is rarely resorted to in this country, but is done quite extensively on small plants in England. The method is to place feed in the bird's mouth in the form of a pellet, force it down with the finger, and then work it into the crop by pressing the hand downward on the outside of the gullet. It is occasionally

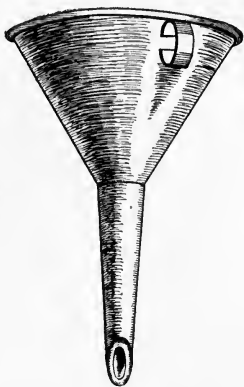


FIG. 186.—Common type of funnel used in cramming. The point is rounded to prevent injury to the bird's throat.



FIG. 187.—Cramming machine used extensively in Europe, but as yet very little in America.

done in this country in the fattening of geese, but is so laborious that it is impracticable.

Funnel cramming is a method not extensively employed in America, but it is more effective and more rapid than hand cramming. In this process the feed is mixed into a thin paste of about the consistency of cream, and poured through a long-necked funnel so shaped that it will not injure the bird when passed down the gullet until the lower end enters the crop (Fig. 186). On inserting it care must be taken not to choke the bird, and only enough feed should be introduced to fill the crop.

Machine cramming is widely practised in Europe, but not to a great extent in this country as yet (Fig. 187). It consists in



forcing feed into the crop with a specially constructed machine. The feed is placed in a metallic vessel or cylinder, and then by a plunger, operated by foot power, is forced into a tube which is passed down the bird's gullet and into the crop. With practice this can be done very rapidly, and, when done by skilful operators, tends to produce the choicest quality of flesh. The development of artificial feeding in this country will depend upon an increased demand for a superior quality of meat. The profits from machine-fed poultry are large, even counting the increased cost of labor, because of the great gain in weight and improved quality of meat.

Regardless of the method practised, the following points should be borne in mind: The object is constant growth; restricted exercise; no overfeeding; birds allowed to become hungry between feedings; period not too long, or loss will follow.

**Killing.**—If dressed poultry is to reach the consumer in the best possible condition as regards flavor, wholesomeness, appearance, and perfect state of preservation, it must be properly killed. Much of the loss resulting from the shipping and storage of dressed poultry that soon spoils is due to improper sticking and bleeding and to neglect before killing.

*Preparation for Killing.*—In the preservation of good market qualities in a well-fed fowl or chicken, it is well to starve it for twenty-four hours before killing, supplying it, however, during this time with fresh, clean water. This period of fasting empties the crop, and partially the intestines also. A distended crop makes the bird look unattractive, and the contents will discolor the flesh during storage. The same is true of the intestines; if full, a discoloration soon appears, and the contents offer a fertile field in which putrefactive bacteria may grow and multiply when taken from storage, or even during display.

*Methods of Killing.*—The essential point in slaughtering is to empty the blood-vessels, and to do this in such a way as to facilitate the plucking of the feathers. With dry picking this is of special importance. It is estimated that fully thirty per cent of all poultry shipped into the larger cities is improperly bled, and much of it in such poor condition as to be retailed at a loss ranging from two to five cents a pound, when compared with similar birds which had been well bled and are in good order. Insufficient bleeding not only gives to the carcass a bad appearance, but makes it spoil quickly, the flesh loses its firmness sooner, and its flavor is not so good. The common odor of stale flesh, and

later of putrefaction, is soon perceptible, and in every way the product is more perishable.

There are three distinct methods of killing poultry,—dislocating the neck, sticking and beheading.

*Dislocation.*—Neck dislocation is not very common except in the case of squabs. It consists in holding the bird's head just back of the jawbone, with the right hand, while the left grasps the body at the shoulders; the neck is bent on the back and twisted or turned about three-quarters of the way around, then extended quickly and with considerable force. This quick rotary movement dislocates the upper vertebra at the base of the skull, rupturing the spinal column and causing instant death. The advantage of this method is its rapidity and cleanliness, but an objection to its general adoption is the fact that it does not permit free bleeding, and this is necessary to produce a well-dressed specimen which will keep a long time.

*Sticking.*—The method known as sticking consists in the severing of the arteries of the neck through the mouth, making no outside cut whatsoever. When the feathers are to be removed by scalding, the bird is merely bled to death; but if dry picking is to be done, there are two procedures,—namely, the severing of an artery in the neck to cause bleeding and the sticking of the brain to paralyze the muscles of the feathers.

The process of sticking can be briefly described as follows (Fig. 188):

1. When ready to kill, grasp the bird by the bony prominence of the skull just back of the angles of the jaw, being careful not to let the fingers touch the neck, as this might cause pressure upon the artery and check the free flow of blood.

2. Make a cut with a small, sharp-pointed knife on the right side of the roof of the mouth where the bones of the skull terminate.

3. Brain for dry picking by forcing the knife through the groove which runs along the median line of the roof of the mouth until it touches the skull midway between the eyes. The point of the blade should then be moved backward and forward to rupture the nerve tissue, thus paralyzing the bird, yet not causing instantaneous death. This latter operation is sometimes performed by thrusting the knife under the eye at such an angle that the point will touch the skull in the same place,—midway between the eyes. The outside cut, however, disfigures the bird, and is no better than the inside thrust. The position of hands and knife are shown in figure 188.

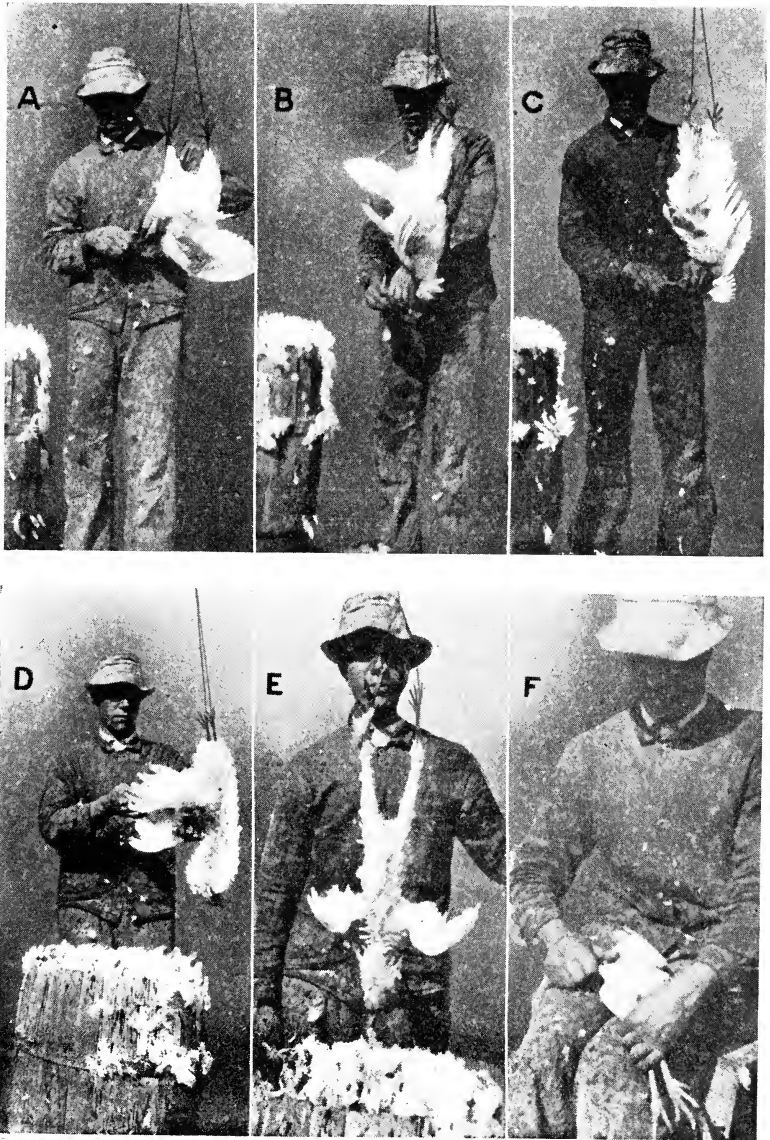


FIG. 188.—Proper method of sticking and dry picking. *A*, Sticking the jugular vein to cause bleeding; *B*, spreading the beak to cause free bleeding; *C*, piercing the brain to cause relaxation of muscles, allowing the feathers to be removed without tearing the skin; *D*, plucking main tail and wing feathers; *E*, bird roughed and ready for pinning; *F*, removing pin feathers, called "pinning."

4. The best knife blade to use is one not more than two inches long and one-fourth of an inch wide, with a sharp point, a straight cutting edge, and a thin, flat handle. Figure 189 shows the kind of knife recommended by the United States Department of Agriculture. The knife should be stiff, so that it does not bend; of the best steel, so that it can be kept sharp and will not be nicked in braining; and the handle and blade should be in one piece. Such a knife, with the aid of an emery wheel or grindstone and oilstone, can be made from an 8-inch flat file.

To make this knife, the handle of the file should first be ground off. Then the blade should be shaped from the small end of the file as shown in figure 189. The curve of the point should slope from the back downward. A blade of this shape reaches the blood-vessels to be cut more surely than does a blade on which

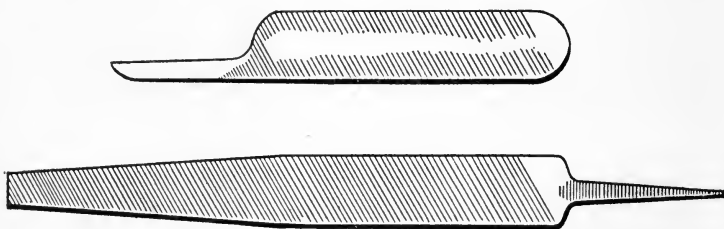


FIG. 189.—An excellent killing knife can be made from an ordinary file.

the point curves upward. After the blade is made, the ridges on the file should be ground down, leaving just enough roughness to prevent the knife slipping in the hand of the killer. The length of the knife over all should be seven inches.

Before sticking, the bird is usually suspended by its feet, the head down and on a level with the waist of the operator. A looped cord is frequently used to hold the bird; but a better plan is to bend a piece of wire into the shape shown in figure 188, A, the bird's legs being caught in the loops at the bottom. This device is quickly and easily fastened in place, and it holds the bird securely with its legs spread, thus facilitating picking.

Instead of sticking the brain, it was formerly the custom to stun the bird, and partially paralyze it, by striking the head with a piece of wood; but this method is being generally superseded by cutting and sticking. With large, old birds, stunning is sometimes resorted to in order to stop their struggles.

A number of special appliances have been designed with the idea of systematizing and facilitating the killing and plucking of chickens, and one of the most popular of these is known as the Cornell killing and picking box.

*Beheading.*—The practice of beheading chickens is at present largely confined to farms where one or only a few birds are killed for family use or retail trade. Poultry killed in this way is not in demand at the larger markets; it does not keep well and is unattractive when displayed for sale. The customary way is to grasp the bird by the legs and wings,—brought together and held in the same hand,—the head and neck being placed on a heavy piece of wood or chopping-block, and the neck severed about one inch from the base of the skull with a sharp hatchet. The accuracy of the blow can be assured if the head is held firmly on the block by means of large nails driven in the edge of the block about one inch apart, the neck being placed between these, and the body drawn away from them until the skull and jawbones are against the nails. This distends the neck and does not permit the bird to flop or move its head.

After beheading, the body should be held firmly and the neck pressed against an old piece of burlap to prevent spattering until the bird has become quiet. For home consumption this method is quick, and, if the fowl is scalded and meat cooked immediately, the plan is a good one. The market objects to a beheaded bird, on account of its spoiling sooner. Besides, the head indicates the breed and sex, also the condition of the bird when killed. Beheading, therefore, is not permissible in the killing of dressed poultry for shipping and storage.

**Plucking.**—There are two distinct methods for removing feathers,—dry picking and scalding.

*Dry picking* consists in plucking the feathers immediately after sticking, without immersing the body in hot water, and is called for by nearly all markets, especially the wholesale trade. The advantages of this method may be summed up as follows: (1) Better preservation. (2) Better appearance of the finished carcass. (3) It is possible to save the feathers, and have them in better condition for sale. (4) There is no danger of ruining the meat by parboiling it with the hot water used in scalding.

Dry picking is an art, and perfection in it calls for considerable practice. The knack of grasping the feathers and removing

them rapidly in large clusters, without tearing or injuring the skin, can only be acquired by learning the principles involved and by the constant application of these to the work until the knack is acquired.

The usual custom is to pluck the feathers first from the parts of the body which tear the easiest, the order of plucking being as follows: Breast, neck, shoulder, and thighs, these small feathers being tossed into a barrel at the side of the picker; next the large wing and tail feathers are removed, and usually thrown on the floor and discarded, as they are of little commercial value. The small or fluffy feathers are next removed, care being taken when plucking not to bruise the skin with the fingers or nails. The feathers are grasped between the thumb and forefinger with just enough pressure to pull them out. The picker becomes accustomed to holding feathers just tight enough to let them slip through his fingers before the skin tears.

After the feathers are removed the bird is said to be "roughed" (Fig. 188, *E*). Next it must be gone over and the pinfeathers extracted. This is usually accomplished with a knife, the small pins and broken feathers being grasped between the knife blade and the thumb, the knife being passed over the skin in a direction opposite to that in which the pinfeathers grow.

In large poultry-picking establishments the work of "roughing" is usually done by one group of pickers, and the "pinning" by another; thus a larger number can be turned out, for "pinning" takes practically as long as picking, and yet does not require as much practice and can be done by cheaper labor. On the average farm where one man does all the work, one hundred birds is a good, ten-hour day's work (Fig. 190).

There are two modes of picking,—standing and lap picking,—the former being more generally used. Lap picking is quite common in New England; the operator sits beside a box and holds the bird in his lap with its head between the box and his right leg, the fine feathers being thrown into the box while picking. The greatest objection to this method is the danger of bruising the bird's flesh by rubbing its skin against the legs. This can be averted by suspending the bird.

*Scalding.*—This method of plucking fowls is quite generally used on farms throughout the country, and especially for retail trade. Undoubtedly it is the easiest way to remove feathers, and, if properly done, does not materially injure the bird for

immediate consumption. But the inferior grade of much of the scalded product put on the market results in much criticism of the practice.

In scalding poultry two essential factors must be remembered: (1) Have a vessel large enough so that the bird can be easily and completely immersed. (2) Have the water at the desired temperature, neither too hot nor too cold. The water should be



FIG. 190.—Dry picking squab broilers. Where a large number are to be killed the work should be systematized, each man having a special work to do. *A*, Sticking; *B*, roughing; *C*, pinning. (Photo by Ranecocas Poultry Farm.)

below the boiling point,—at about 200° F.,—and the temperature taken by means of a hot-water thermometer.

If too cold it will not loosen the feathers, and they will be as hard or harder to remove than by dry picking. If a pail is used and boiling water is poured into the pail, the reduction in temperature due to the cold pail will make the water just about right to use immediately. The bird should be taken by the feet and thoroughly soured up and down in the water until the feathers are all ruffled and wet, clear to the skin (Fig. 191). If the bird

is to be marketed with the head on, it is best to hold both the head and feet, keeping the head and neck feathers out of the water. Full fluffy-feathered birds must be held in the water longer than thin or sparsely feathered birds. After scalding, the bird should be allowed to drain before picking. The method of picking depends upon the four following conditions:

1. Age of the bird. The general practice is to scald fowls, since scalding has less effect on their appearance and preservation than on young birds.

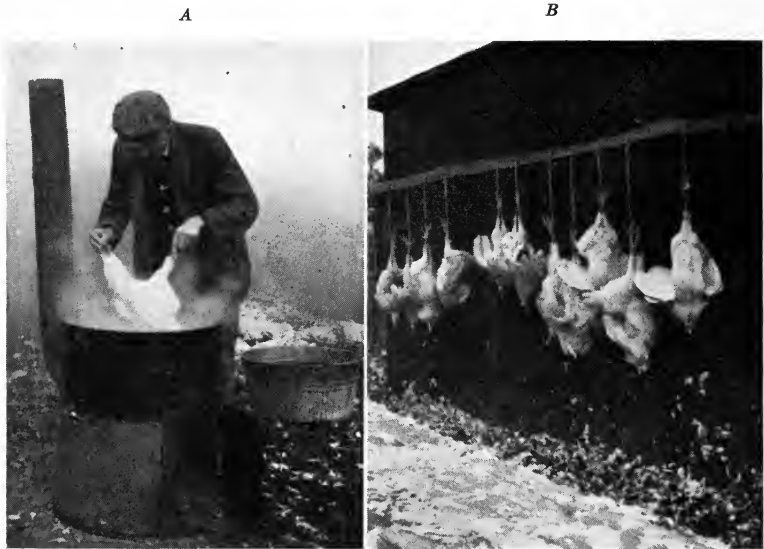


FIG. 191.—Scalding before picking is a method adapted only to retail or home trade. *A*, The bird, after bleeding, is grasped by the head and feet and immersed in hot water; *B*, the scalded birds are hung to drain before plucking. (Photo by Oakland Poultry Farm.)

2. Purpose for which the birds are to be used. Birds which are to be cut up and used for stewing or for chicken pies can be scalded, as the damage matters less than when they are wanted for roasting.

3. Length of time before cooking. When they are to be immediately cooked, as is the case with birds for the home table or a near-by retail trade, there will probably be no objection to or discrimination against properly scalded birds.

4. Market requirements. When to scald and when to dry



pick should be determined largely by the demand of the market to which the birds are shipped. If market quotations show a preference for dry-picked birds, then dry picking should be preferred to scalding.

**Plumping or Cooling.**—As soon as the birds are picked by either method, it is a common practice to immerse them in a tub or pail of cold water for at least an hour. This accomplishes several objects: (1) It removes the animal heat from the bird, making it keep longer by retarding decomposition. (2) It also lessens the excessive red color of comb and wattles, and gives them a better appearance. (3) The entrance of water into the pores makes the flesh plump and distends the skin.

Whenever possible, dry-picked birds should be allowed to cool in dry air. Cold weather makes this possible for all. In summer it is done by refrigeration, but this practice is limited to large commercial establishments. It is well first to immerse them a few minutes in water at about blood heat, then wash the shanks and toes to remove dirt, take the clot of blood from the mouth, and wash all blood from face and head. After washing they are usually immersed for one hour in ice water, and then hung up to drain before packing. When killing, plan to leave sufficient time for them to cool before packing for shipment. In warm weather ice is necessary during transit, so they need not be drained. If poultry is to be shipped a considerable distance, and is cooled down thoroughly before shipment, the longer it will stay cool and the better will be the condition upon receipt.

**Shaping.**—The process of shaping improves the appearance of the bird by forcing its breast forward and making it look full of meat. It may be done during cooling if the process is refrigeration. Although not general in this country, shaping is extensively done in Europe. The method is to place the birds in wooden frames or V-shaped troughs so that, when pressure is applied from above, the flesh is forced into the desired part and stays there after cooling and hardening. With good, well-grown, plump-breasted birds little if any benefit is to be derived from the process. At best it will improve the appearance only of those birds which are naturally thin or not in prime condition when killed, giving them a more plump appearance.

**Dressing.**—The necessity and manner of dressing depend upon the market and the fowl. When poultry is marketed through

wholesale channels, it should never be drawn or cut. Experiments prove that undrawn poultry decomposes more slowly than does poultry which has been wholly or partly drawn. Full-drawn poultry—that is, with head and feet removed as well—decomposes the more rapidly. Drawing also mars the appearance of the bird for display in the markets, and there is greater danger of its becoming fly-blown. The work of dressing is left to the middle man to perform, in accordance with the customer's requirements. When plucking for the wholesale market,—for example, broilers, roasters, and fowls,—all the feathers are removed except a few around the neck just back of the head. In the case of capons, the neck, thigh, tail, and wing feathers are left on the bird. This is the characteristic capon plucking, and distinguishes them from cockerels, for the feathers are left on those parts which show the distinctive feminine or capon plumage. When dressing for the home table or a restricted retail trade, it is usually desired that the birds be ready for cooking, and the following methods are common for broilers and roasters.

*In preparing broilers* so they will look attractive for a private trade, they should be carefully plucked and the legs and head cut off. Then with a heavy knife or cleaver cut each side of the entire length of the backbone, severing the ribs. These incisions should meet at the neck and just below the vent. It is then possible to remove the neck, backbone, and entire intestines with no other cutting. In the case of large broilers which are to be halved, the breast should also be cut lengthwise in the centre with a cleaver or meat saw. The giblets should be cleaned, and accompany the dressed carcass.

*Preparing roasters.*—(Fig. 192) For fine trade proceed as follows: Singe the bird after it is cool and thoroughly dry by holding it over a flame from burning straw. Be careful not to blacken the skin; this is why paper is objectionable.

1. Remove the shanks and the tough sinews which extend through the legs and impair the quality of the drumstick. To remove these sinews run a knife down the back of the shank bone, between it and the sinews. Place this cut over a hook or big nail and pull gradually; in large old birds it may be necessary to place the hook under each sinew, one at a time. The sinew will break at the upper end, and can then be removed with the shank, leaving the thigh free.

2. Pull the skin of the neck toward the body and sever the

neck with a sharp cleaver about midway between head and body. Thus, when the skin is released, about one inch of free neck skin will remain, to cover the cut bone.

3. Make a cut about two inches long at the left side of the breast well up toward the neck, and remove the crop, being careful not to increase the size of the opening.

4. Turn the bird with the tail toward the operator and make a longitudinal cut about two inches in length from the vent toward the point of the breastbone. Insert the forefinger and remove the tissue and fat which cover the intestines. When they

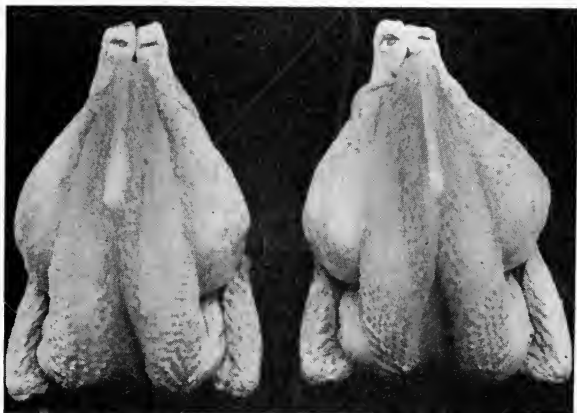


FIG. 192.—Roasters properly dressed for retail trade. (Photo by U. R. Fishel.)

are fully exposed, hook the finger into a loop of the intestines, and cautiously pull them out, taking care not to injure any part. When they are all removed, make a circular cut around the vent, and remove it with the intestines.

5. Next remove all internal organs, such as the gizzard, liver, heart, lungs, spleen, and reproductive organs, taking care not to enlarge the opening.

6. Next wash the bird thoroughly with warm water followed by cold water.

7. Open gizzard and heart, wash thoroughly, and, with the liver, replace in the body cavity.

8. Take clean white cotton string and tie the skin of the neck over the end of the neck.

9. Lay the wings flat, and secure them to the sides by a string

passed twice around the whole body, then fasten; this holds them secure while cooking.

10. Tie a piece of string around the hock joints, leaving them about two inches apart, one on each side of the keel; then bring them down, and fasten securely to the tail.

11. If desired, immerse the bird in clear cold water for one hour; this will set the muscles firmly. After draining and drying the bird is ready for the customer.

Fowls are usually cut up for stews or meat pies, but this work is rarely done by the producer.

*Boning.*—It is sometimes desirable to dress an extra fancy product which retails for an exceptionally high price. In such cases it is customary to remove all or most of the bones from the fowl through an opening in front of the shoulder. The flesh is afterward stuffed and roasted like an ordinary roaster; but when serving one can cut right through the entire bird, and get light and dark meat and dressing at one cut. This process is termed “boning,” is rather difficult, and can only be successfully done after considerable practice.

#### REVIEW.

1. What is the object of fattening?
2. Give three methods of fattening.
3. What is flock fattening, and when is it used?
4. What is crate fattening?
5. To what extent is crate fattening employed?
6. Describe a desirable fattening crate.
7. Discuss in detail methods employed in commercial crate fattening.
8. What is cramming? Give three methods.
9. Discuss cramming as practised in America.
10. What is the object in forced feeding? Give essentials.
11. How does proper killing affect the quality?
12. Why should the bird be starved before killing?
13. Give three methods of killing.
14. How is the neck dislocated?
15. Describe the process of sticking.
16. Describe a desirable type of killing knife.
17. Describe a good method of suspending before killing.
18. Describe a good method of beheading.
19. Give two methods of plucking.
20. Give the advantages of dry picking.
21. Describe the procedure in dry picking.
22. Describe the process of scalding poultry.
23. What four factors should determine whether to dry pick or scald?

24. What is the object of cooling?
25. How can the birds be shaped?
26. Describe two methods of dressing broilers for retail or home trade.
27. Describe the dressing of a roaster for retail trade.

**References.**—Fattening Poultry, by Alfred R. Lee, U. S. Bureau of Animal Industry Bulletin 140. How to Kill and Bleed Market Poultry, by Pennington and Betts, U. S. Bureau of Chemistry Circular 61. The Comparative Rate of Decomposition in Drawn and Undrawn Market Poultry, by M. E. Pennington, U. S. Bureau of Chemistry Circular 70. Practical Suggestions for the Preparation of Frozen and Dried Eggs, by M. E. Pennington, U. S. Bureau of Chemistry Circular 98. Trussing and Boning Chicken for Fancy Trade, by Wm. A. Lippincott, Iowa Bulletin 125.

## CHAPTER XXV.

### MARKETING THE PRODUCTS.

THE successful poultryman must not only produce first-class poultry products, but he must be a capable salesman and man of business as well. The maximum number of eggs may be produced during the winter; but unless the poultryman understands business principles and market requirements, big profits cannot be realized. Whatever increases or decreases the ultimate selling value to the producer is worthy of careful consideration.

**The Salesman.**—When poultry raising is conducted on a limited scale, the poultryman himself is both producer and salesman; if, however, the business is large and there is a group of poultry raisers in a community, they may be able to cooperate in marketing with good results. In such case if an expert salesman is allowed to handle the market end of the business, he will dispose of the products in such a way as to get the largest returns for the producer and at the same time increase the demand. The successful salesman must, nevertheless, have some experience in poultry production, for this makes him a better and more intelligent seller. A good salesman must know how to advertise, if he is advantageously to dispose of a variety of products offered for sale. He must drive a good bargain and be shrewd yet honest in all his dealings, if he is to retain the confidence of his best customers.

For the small poultryman, and especially the farm poultryman, the most important requisite is that he keep accurately posted as to market prices, fluctuations, and conditions. The easiest way to increase an income without greatly increasing expenses is to add to the profits by raising products of high quality, and marketing them at the right time and place in a neat and attractive manner.

**The Markets.**—The expense of marketing poultry products is comparatively small, as they are of high value, small in bulk, and can be shipped a considerable distance with little shrinkage. The high-class trade in the large cities is the most profitable, and, where one can ship a guaranteed quantity during the entire year, or the season, of such product as broilers, he can safely compete in this market, but where his output is limited it is a waste of time. There is often a home market which, with a little care, can be

developed satisfactorily and will pay the small producer much better than the larger city trade.

A great variety of markets are open to the poultryman, and, according to his location and production, he may choose any one of the following methods: (1) Selling direct to the consumer; (2) selling direct to the retailer; (3) shipping to commission merchants.

*Selling direct to the consumer* insures the largest revenue, as all expense of commission and extra handling is eliminated. This market is usually limited, unless one lives near a small city or village, in which case he can generally build up a retail route which will take his entire output. A disadvantage is the amount of time consumed in taking orders and distributing. To determine whether or not this method pays best, the time spent in distribution should be balanced against the lower price and extra expense of commission when shipping by the third method, the cost of production being in each case the same.

The most satisfactory way of selling direct to consumers is to supply hotels, restaurants, and clubs, as they usually contract for the entire output and are willing to pay a good price, and it is much easier to ship the entire output to one place at certain specified times than to spend time and labor in disposing of it among many small consumers. This last method offers an excellent chance of advertising,—an advantage to both the poultryman and the purchaser of the products.

*Selling Direct to Retailer.*—Often one can sell both eggs and dressed poultry direct to some retail grocer, who is glad to get them and to pay a good price. Knowing they are perfectly fresh, he can sell them to his high-class trade and develop a good market for the poultryman. It may be necessary to go to a distant city or distribution point to find his market, but it will always pay when once secured.

*Shipping to Commission Merchants.*—The easiest and simplest way in which to dispose of the bulk of poultry products is through the commission merchant for sale in the open market. In isolated cases the merchant can perhaps secure a special market for a guaranteed product, and this is becoming easier each year. But by this method the cost of marketing is very high and the price realized is the lowest. The commission, transportation, cartage, and, in most cases, loss by breakage, are always charged to the shipper. The commission usually amounts to five per cent of the gross receipts.

If one has a large output and can ship through a commission house which makes a specialty of high-grade products, he can usually secure prices much above the market quotations,—provided his shipments are always regular and of high quality. Most commission houses are on the alert for such products and will give the shipper the best of service.

The exact market to select depends, then, upon the amount and character of products for sale. The wholesale market is best adapted to poultry enterprises with a large and regular output, which are located at a considerable distance from the point of distribution and consumption. The retail trade, on the other hand, is especially suitable for the poultryman with a limited supply of good products. He can create a strong demand for these products at such a price as to yield a profit on his output.

*Relative Returns.*—Receipts and net profit are always much higher when the products are sold direct to the consumer, although the aggregate profits may not be great, owing to the limited demand, hence limited sales.

Returns, hence net profits, are lowest when the products are sold at wholesale through commission houses; but, owing to the great demand, there is more chance of a high total profit, provided the shipments are large. The sale of products directly to the retail store probably nets the highest selling price and the largest revenue in proportion to the labor required in packing and distribution.

Where the producer can make a contract with prominent and reliable retail stores for a fine product, the demand for his goods among the patrons of that store, if in a large consuming centre, will become almost limitless. This mode of marketing cuts out two of the middle men through whose hands most products sold at wholesale must pass, hence yields greater profit to the producer and seller, and the product reaches the consumer more quickly and in better condition.

The following prices show the average received for eggs marketed through the common channels of trade and by direct selling. These prices are merely comparative:

Huckster.....	20 cents, trade.
Grocer.....	23 cents, trade.
Wholesale buyer.....	21 cents, cash.
Retail trade.....	27 cents, cash.
Fancy trade.....	30 cents, cash.



It is difficult to realize that, with a small or medium-sized flock, a slightly increased selling price for eggs per dozen throughout the year will result in a very decided total profit. For example, 150 hens laying 1,800 dozens of eggs, selling at 18 cents per dozen, will produce an additional profit of \$36 when the selling price of each dozen is increased only two cents.

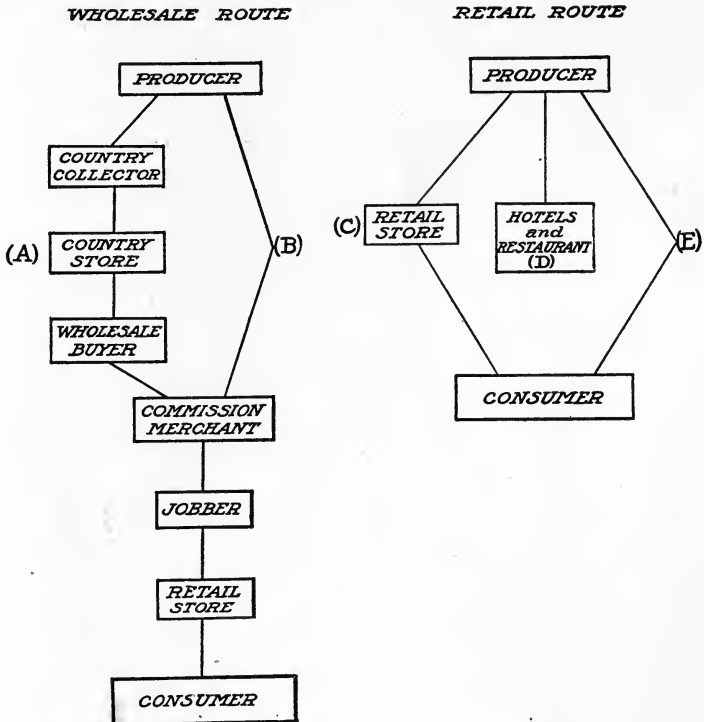


FIG. 193.—Chart showing the courses through which eggs may pass in going from the producer to the consumer. *A*, The course taken by the great bulk of the "western" product in reaching the eastern markets; *B*, the course taken by the eastern output in reaching New York and other large centres of distribution; *C*, direct selling through the retail store; *D*, the hotel and restaurant trade; *E*, products going direct from producer to consumer.

**From Producer to Consumer.**—It is interesting to note the many channels of trade and the great number of hands through which every shipment may and usually does pass before it reaches the consumer. Figure 193 is a diagram portraying the different courses which poultry products may take.

The doing away with much of this unnecessary handling will reduce the ultimate cost of the product for the consumer, and the quality at point of consumption will be better.

**Customers' Interests.**—To do justice to both, a good salesman must take the viewpoint of the consumer as well as that of the producer; and, in order to do this, customers may be arbitrarily divided into five well-defined classes, according to their financial standing, as follows: (1) Poor, (2) of moderate means, (3) high class, (4) wealthy, (5) hotels and restaurants.

It is evident at a glance that the quality of products demanded by these five classes will vary considerably. The well-to-do consumer demands and is willing to pay for a high-class product, whereas the poorer customer with limited means will purchase a lower quality for less money. The poorer customer purchases but a small amount, while the higher class of trade will buy a much larger quantity.

There is a marked variation according to the season, the poorer classes demanding products at the season of abundant supply when the prices are correspondingly low, while the wealthier classes and hotel trade will demand and gladly pay a higher price for a product out of its natural season.

All customers, regardless of their financial standing, have the same personal interest at heart, and are governed by the same thought when purchasing,—namely, to get the largest possible quantity of the best quality of product available for the money. These interests may be classified under the following six headings:

Quality, price, supply, accessibility, systematic delivery, responsibility of salesman.

*Quality* is the first requisite, and may be estimated by the following factors: Freshness, whether in dressed poultry or eggs; care in handling, from producer to point of consumption; wholesomeness, which means absence of any taint; type of egg as to size and color; weight, whether of eggs or meat; method of production; price, in so far as it represents quality.

*Price.*—Price is a consideration with all classes, but the actual purchasing power of money is estimated differently by these different groups, according to the amount on hand for their purpose. To the producer, the price depends upon variations in quality; shortage or abundance; competition, both in selling and buying; the middle man's profits, which vary according to the

number of hands through which the product has passed; cost of production; and cost of handling, which varies with the market and manner of fitting for market.

*Supply.*—In many ways the supply of poultry products in various markets is affected by the following: Quality; the higher the quality the less the supply; variations in amount of products, such as eggs, being produced in great numbers, while with capons and turkeys, for example, the production is very limited. The source of supply very often affects the amount of a given product in certain markets according to the distance from place of production and size of producing plant. The amount of capital invested in production and distribution affects the total supply, especially during seasons of limited output. The extent to which business is carried on in a community determines largely the available supply of products handled.

*Accessibility.*—This is one of the chief factors from the consumer's standpoint, for if large quantities of first-class products are in the vicinity, yet not readily accessible, they are of no value. Distance from point of consumption, proximity of reserve supplies, telephone and railroad connections, mail facilities,—all play an important part in bringing producer, middle man, and consumer closer together.

*Systematic Delivery.*—The customer desires regular and systematic supply, whether it be eggs or dressed poultry, and this supply is affected by the location of the distributing point, express rates, method and regularity of final delivery to customer. The exact method of delivery varies according to the customer.

*Responsibility of Salesman.*—The ultimate seller has the responsibility of delivering goods to the consumer that will be satisfactory and thus keep up the demand for these goods. His ability to please the customer will depend largely on his distance from the consumer, his business methods, care in filling orders, financial standing, acquaintance with customers, and amount of business handled.

The consumer is a valuable partner in a profitable poultry trade, and the salesman who caters to the interests of the consumer will not only increase the demand for his products, but can demand—and will be gladly paid by the customer—a price so much higher that it will more than cover the time and expense involved.

## TRADE IN EGGS FOR HATCHING.

Eggs are marketed for two purposes,—for human food and for hatching. When marketing them for breeding purposes four important points must be considered,—namely, securing the market, method of shipping, chance of fertility, and value of guarantee.

**Securing the Market.**—If a large number are to be sold, the market is usually secured by systematic advertising. Where the breeder has an established reputation, which his birds have maintained for years by winning prizes at shows, and there are pleased customers in all parts of the country, there is little need of advertising. High-class eggs for breeding purposes call for special markets and enormous expense in marketing. The output must be disposed of by making a great many small shipments to many customers. In marketing eggs for food all the output, if desired, can be shipped regularly and in considerable quantity to the same customer. To counterbalance the labor and heavy expense of marketing eggs for breeding purposes, an exceedingly high price is usually received for such eggs.

**Method of Shipping.**—In shipping eggs for hatching, chilling or overheating must be avoided, also breaking or unnecessary jarring. The usual method is to pack them in ordinary market baskets, pasteboard containers being first put in the basket; after the eggs are placed in these, the whole layer is filled with bran or dry sawdust to prevent jarring or cracking. Eggs thus packed are much more likely to reach their destination safely than when they are shipped in heavy and tight wooden boxes, in which case the handler is ignorant of the contents and takes no extra precautions.

Express companies charge an extra rate for handling eggs for hatching, hence are expected to give them unusual care. The package, of whatever type, should be plainly marked, stating the nature of the contents and the danger of breakage. During extremely cold weather when there is danger of chilling, it is advisable to wrap each egg in paper before putting it in the container.

**Chance of Fertility.**—Since the hatching egg has no value unless fertile, the greatest care should be exercised during the selling season not only to produce fertile eggs, but to handle them so that the germ will be kept alive and will develop into a vigorous chick. The percentage of fertility varies considerably in different seasons, being highest during the natural hatching

season in the spring and lowest during the coldest winter months. Nothing will so soon disgust the purchaser of hatching eggs, or make him more quickly seek a new source of supply, than a low percentage of fertility; hence, the great effort made to secure the highest fertility.

*Value of Guarantee.*—When an order is taken for eggs, some definite guarantee is usually given with them, especially stating the breed and the degree of development toward a standard, as well as the percentage of fertility. If the breeder wishes to satisfy his customer and to retain his trade in future years, this guarantee must be given in good faith. As a rule, a fertility of at least eighty per cent is guaranteed, as well as the replacing of all eggs below this percentage which prove to be deficient. When eggs from advertised show matings are sold, the resulting progeny are expected to show, and should show, the desired characteristics. When, on the other hand, the sale is advertised as being from utility matings, the purchaser will not, and can not, expect exhibition progeny. The keeping of a guarantee means the satisfaction of customers, and this is the best possible kind of advertising.

#### MARKETING EGGS FOR HUMAN FOOD.

The great mass of eggs produced on the majority of farms, as well as the surplus supply from fancy plants, is used at home or sold for food. The principles and methods of marketing are of practical importance. The egg is the backbone of commercial poultry craft, and the production of meat secondary.

**Prices and their Variation.**—The price of eggs for food is governed by fluctuations in demand and supply, especially the latter. There is always a brisk call for strictly fresh eggs, but the variations noted are due largely to the effect on supply caused by changes of season. Prices for poultry products in general, and especially eggs, are peculiar, in that they differ but slightly in the same season year after year.

The diagram (Fig. 194) shows the range in prices of eggs in a period of twenty-five years. The heavy line represents changes in temperature. It will be seen that eggs bring the highest prices each year during January, November, and December, and the lowest price during May. The same is true of the various classes of meat; and if the poultryman aims at big profits from his production, he must market it at that season when the price is sure

to be the highest. With some products it is practically impossible to make any profit out of season.

*Ultimate Price Regulation.*—The New York markets for eggs and dressed poultry, owing to the vast quantities received, fix, in greater or less degree, the price of these products in a large part of the country. The general public, and rural communities especially, know very little about the regulation of these prices.

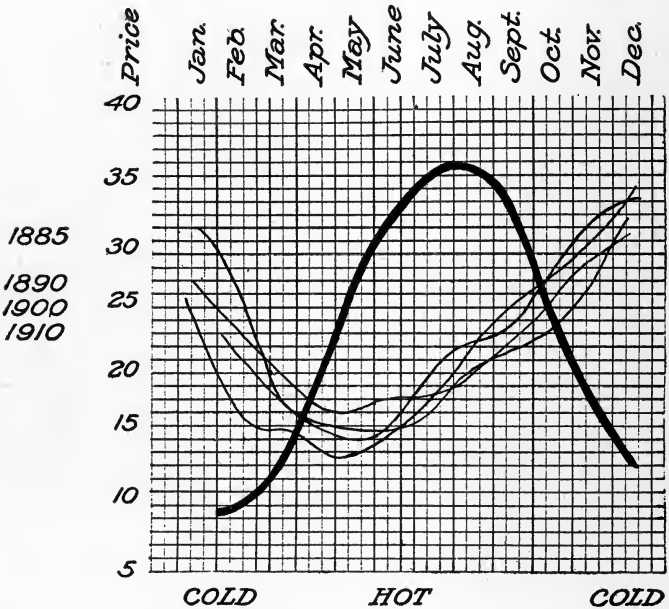


FIG. 194.—Curves showing the relation of temperature to the selling price of eggs. The heavy black line represents temperature, and the light lines variation in wholesale prices for market eggs for four years, from 1885 to 1910.

Small egg shippers all over the country speak of the “market price” without knowing how or where it originates.

The Mercantile Exchange of New York City has a membership of several hundred men, all of whom are interested in the buying and selling of poultry and dairy products (Fig. 195). Membership is quite exclusive, and only men of sound financial standing and good business reputation are invited to join. Here at ten o'clock every business day the members gather to buy and sell these products in quantity. From the business here transacted, the dealers

get a very accurate idea of the ratio between immediate supply and existing demand. The prices which prevail at these sales are accepted by the dealers as a guide for that day. The dealers hold that some such basis as this is absolutely necessary. They say that, without some fixed standard, speculation would be heavily indulged in, and the handling and storage of eggs would be essentially a gamble.

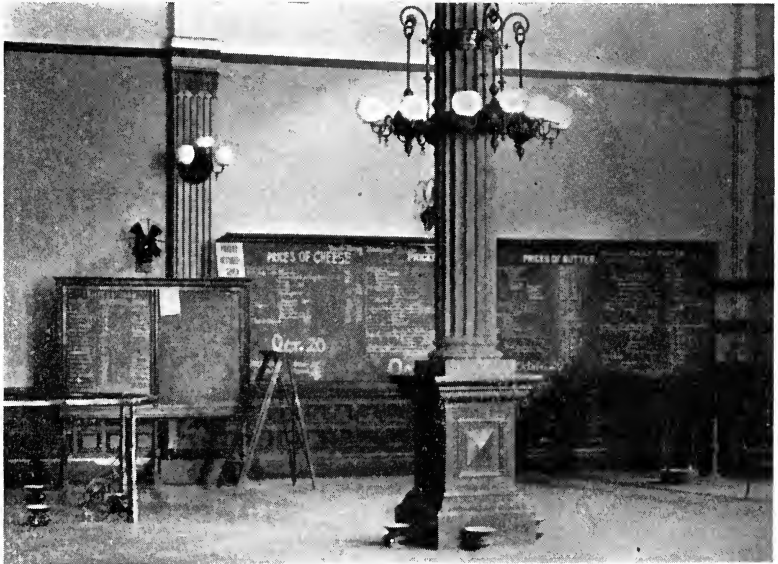


FIG. 195.—Interior view of the Mercantile Exchange, New York City.

The storage of eggs in the mammoth cold-storage houses in large cities has become a controlling factor in fixing the price of poultry products. Eggs are bought in the Western States during the early spring when the supply is abundant and the prices low. They are perfectly stored at a temperature of about 30 degrees for several months. This wholesale buying in the flush of the season tends largely to keep the price from going any lower. In the late fall and winter, when fresh eggs become scarce, storage supplies are drawn upon to furnish eggs which, although not fresh, serve the purpose fairly well, and place this fine food product within the reach of almost everybody.

No doubt there is much speculation in the business; yet this occurs in all branches of commerce. There are hundreds of sharpers who make a living by sending out cards offering attractive prices or false quotations to shippers; they scour the express offices and hang around delivery wagons, getting the names and addresses of the shippers. Such is human nature. Many of the shippers who receive these false quotations immediately send their next consignment to these "pikers," as they are called. Not until the lapse of weeks with no returns do they realize their mistake in not looking up the standing and reputation of the consignees before giving them the goods. (See New Jersey Station Report, 1911.)

**Points in Collecting.**—The method of handling market eggs has much to do with their ultimate selling price, and the system and manner of collecting is of vital importance. Clean houses help to keep the birds in healthy condition, just as a clean nest will help to keep the eggs in good state. Nests for laying should always be clean, for nesting material is cheap, and it is much easier to change it occasionally than to cleanse the eggs. Washed eggs spoil more quickly; therefore they should be cleaned by dry brushing with a stiff-bristled brush. The eggs should be collected regularly, once, or, if a special fancy product, twice a day. A covered pail with strong handle is the best receptacle for them, as it holds a large number, and there is no danger of crushing them, as there might be in a basket, the weight making it sag at the sides.

**Selecting and Grading.**—There should be a regular system of selecting and grading eggs, to insure uniformity and high quality. Before discussing the principles of grading, some understanding of commercial grades will serve to illustrate the importance of home grading. The general classification of eggs in all large markets is as follows: Extra hennery white; extra hennery brown; first hennery white; first hennery brown; first hennery mixed; seconds; thirds; dirties.

The extras must all be of large and uniform size, perfectly clean, with chalk-white shells, not tinted in the least, and only a few days old. The firsts must be clean and of uniform color, but need not run quite so large. The seconds are smaller or of varying size, and the thirds still smaller. Fresh eggs are often sold for half price because they are dirty.

Large wholesale markets classify according to degree of freshness. This classification, given below, was evolved by the egg



committee of the Mercantile Exchange, which committee is appointed by the president. The sliding scale was devised in order to meet the variations in the price of eggs during different seasons, and to permit the practical adjustment of these fluctuations. This classification is, of course, not ideal, but it is a practical one, designed to meet the conditions in a market, not as they ought to be, or as they would be under ideal conditions, but as they actually are. In speaking of a best egg we cannot have in mind the best egg for the whole year, but the best one possible at the particular time in question. This sliding scale becomes especially valuable in those seasons when an absolutely good, fresh, clean egg is not obtainable. At such times, with a system as outlined above, the whole classification slides to a lower scale, as shown by the A, B, C of the classification. With a reliable committee, this shifting of the scale will only be to a reasonable extent, and should be a benefit to all.

1. "Eggs shall be classified as 'fresh-gathered,' 'held,' 'refrigerator,' and 'limed.'
2. "There shall be grades of 'extras,' 'extra firsts,' 'firsts,' 'seconds,' 'thirds,' 'Nos. 1 and 2 dirties,' and 'checks.'
3. "Fresh-gathered extras shall be free from dirt, of good uniform size, reasonably fresh, sweet eggs, with full, strong bodies, at the discretion of the egg committee, as follows: A, 90 per cent; B, 80 per cent; C, 65 per cent.
4. "Fresh-gathered firsts (or extra firsts) shall be reasonably clean and of good average size, and shall be reasonably fresh and full, strong-bodied, sweet eggs, at the discretion of the egg committee, as follows: A, 75 per cent; B, 65 per cent; C, 50 per cent; D, 40 per cent.
5. "Fresh-gathered seconds shall be reasonably clean, of fair average size, and shall be reasonably fresh and full eggs, at the discretion of the egg committee, as follows: A, 65 per cent; C, 40 per cent; D, 30 per cent."

The following classification of fresh eggs shows the comparative prices paid for different grades of eggs in the New York market, according to size and color (Fig. 196):

Whites:	Large, 27 ounces and above.....	40 cents
	Medium, 21 to 27 ounces.....	38 cents
	Small, 18 to 27 ounces.....	30 cents
	Culls, under 18 ounces.....	20 cents
Browns:	Large, 27 ounces and above.....	32 cents
	Medium, 21 to 27 ounces.....	30 cents
	Small, 18 to 21 ounces.....	25 cents
	Culls, under 18 ounces.....	20 cents
Mixed:	Large, 27 ounces and above.....	31 cents
	Medium, 21 to 27 ounces.....	28 cents
	Small, 18 to 21 ounces.....	24 cents
	Culls, under 18 ounces.....	20 cents

The above prices were those in effect for first-class, strictly fresh eggs, on the first of October, 1912, but the same relation might be expected on any other date.

In the Boston market the whites and browns would exchange places with regard to demand and price, the browns being worth more.

After studying these commercial classifications, the following grouping of the principles of grading will emphasize their value. Uniformity is the main thing, and eggs must be so graded that there will be uniformity as to cleanliness, size, and color.

No dirty eggs should be shipped to market, for they lower the selling price of the whole shipment, and the poultryman's



Fig. 196.—Egg grading table in use. Grading of eggs according to size and color, at home, brings better returns.

standing suffers. Careful grading of eggs according to size always pays; those abnormally large or small should be consumed at home. An extremely large egg placed with a dozen of uniform and average size will lower the selling price, as it tends to make the normal egg look small.

Where eggs of different colors are produced, a careful matching as to color will pay in most markets. White and brown should not be shipped in the same case, as there is a higher price for one color. New York always pays a premium for white-shelled eggs, Boston for brown-shelled ones, Philadelphia has little preference but demands uniformity, and Chicago and San Francisco manifest no decided partiality.

In marketing experiments carried on by the New Jersey Station, there was a difference of two to seven cents per dozen in favor of white-shelled eggs over mixed. During February the

greatest difference was apparent; at that time assorted eggs by the case, guaranteed, brought the following prices in the open market: Whites, 34 cents; browns, 30 cents; mixed brown and white, 27 cents. The average increase in the selling price of the white eggs over the mixed ones was three and one-quarter cents per dozen.

If the eggs are cleaned and graded, the work must be done—and the crating and packing as well—at a regular time, and always with the same care.

**Care in Packing.**—The regulation egg case of thirty-dozen capacity is the most economical shipping case for a wholesale trade; but it should be substantially made. If used the second time, it should be renailed before filling, and all old, broken, or flimsy containers replaced by new ones. In packing, a layer of straw or excelsior on the bottom of the case will break the jar by permitting a certain springiness. The eggs should be placed in the fillers small end down, no large eggs being packed, as they are likely to be broken and spoil the appearance and quality of others. After all are in, a thin layer of hay or straw should be spread over the top under the lid. The lid should be nailed securely at each end, but not in the middle; this leaves room for spring, and often prevents the breaking of many eggs.

When shipping to a limited trade or to private customers, it may be well to use the standard fifteen-dozen case instead of the thirty-dozen. Corrugated pasteboard boxes varying in capacity from one to five dozen, if properly packed, are very satisfactory. Light weight and durability are two important requisites in an egg container. For high-class wholesale or fancy trade, the one-dozen cartons are the most profitable for home grading, and they are a guarantee of the product. The 2 x 6 cartons (Fig. 197) are the best, being designed to fit the regulation thirty-dozen case. When they are used, it is better to ship in a reinforced case, which can be utilized indefinitely for shipping, being returned to the shipper empty after each trip. Such a case can be locked, and the product will reach the consumer untampered with; hence the guarantee is protected.

In using the cartons, the guarantee can be printed upon them, together with the name of the farm (Fig. 197) and the producer. Eggs guaranteed in this way should be sealed to guard against any fraudulent subsequent use of the carton for inferior eggs; for, in any case, if the seal is broken the guarantee is void.

The stenciling of the shipping case or box is advisable; for if a superior product is always shipped in such a case, there will naturally be an increasing demand for it, and the trade-mark becomes the symbol of quality and a selling card for the eggs. If a guarantee is once given, the shipper must be careful never to ship anything below the standard, for a few inferior eggs will do more harm than years of careful selection can undo. A neat, durable, attractively labeled case is an excellent investment (Fig. 197).

**Shipping.**—Eggs should be shipped frequently, especially during the summer, the frequency depending largely upon the output. If held for considerable time,—one to three weeks,

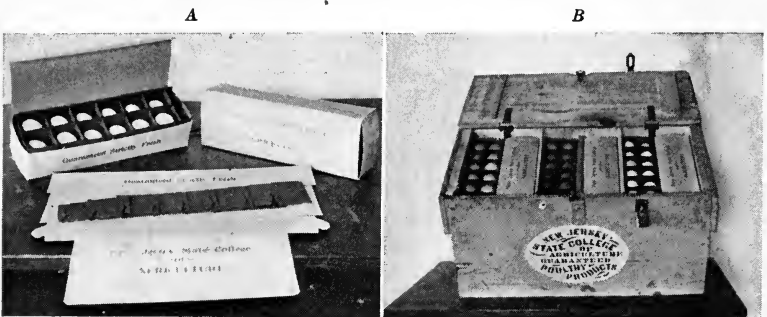


FIG. 197.—A popular method of packing eggs for shipment. A, Well-built 2 x 6 cartons used in the producer-to-consumer trade. The trade name should guarantee the quality. B, Substantial case filled with high-grade eggs. The cartons should be sealed, to protect the guarantee.

according to the season,—eggs deteriorate rapidly, and are then termed “helds,” which bring a much lower price. Even in cold weather it is well to ship at least once a week, in order to guard against freezing,—or overheating, if the eggs are kept in a warm room to prevent freezing, as is often the case on a farm. Eggs should always be shipped by express, the charges to be collected from the receiver, for he is in a better position to recover damages from the transportation company in case of breakage. It is very difficult to recover anything from the company because of delay; hence, the necessity of studying train schedules, and, if shipment can be made by several routes, determine which is the best, and the best time for loading. The shipment should start as soon after loading as possible. It is a good plan to send the consignee a postal card apprising him of the shipment, so

that he can be on the outlook for it, and thus prevent delay at the receiving end.

**Preventable Losses in Market Eggs.**—It is estimated that seventeen per cent of all eggs shipped to wholesale markets have no commercial value, hence are a total loss; and that these losses could be almost wholly prevented by better management, grading, and methods of marketing. These preventable losses are divided approximately as follows:

Dirty eggs.....	2	per cent.
Breakage.....	2	per cent.
Chicks developed.....	5	per cent.
Shrunken or "held".....	5	per cent.
Rotten.....	2½	per cent.
Moldy, bad flavor.....	½	per cent.
Total.....	17	per cent.

Of course, this loss, resulting in decreased wholesale prices and heavy commissions, must be paid for by the poultryman and farmer.

*Prevention of Such Losses.*—The following conditions, if adhered to, will almost entirely eliminate the possibility of loss, and even increase the profits from the production of market eggs. Eggs for market should weigh from one and one-half to two pounds per dozen; be uniform in size; be free from dirt, but not washed; be strong-shelled and sound, be fresh, not over five days old; be infertile. They should be laid in clean nests; be gathered often; never be taken from an incubator; never be taken from stolen nests; and should be kept in a cool, dry place.

**The Value of Infertile Eggs for Market.**—Much of the loss, especially during spring and summer, is due to the development of the germ in fertile eggs. This is brought about by keeping the eggs in too warm a place, such as a warm room near a fire, by exposure to the sun while being carried to the shipping point or while *en route*, by a broody hen sitting on the nest, and by irregular gathering of the eggs. The production of infertile eggs alone for table purposes would eliminate all danger of germ development, and their advantages over fertile eggs can be summed up as follows: They do not hatch; contain no germs to be developed; withstand heat; bear shipment well; are easily preserved; are slow to decay; best for cold storage; less costly than fertile eggs; male birds not required; and are produced just as abundantly as

fertile eggs. There is probably nothing the poultryman can do which would so much improve the quality of eggs for table use as the production of infertile eggs (Figs. 198 and 199).

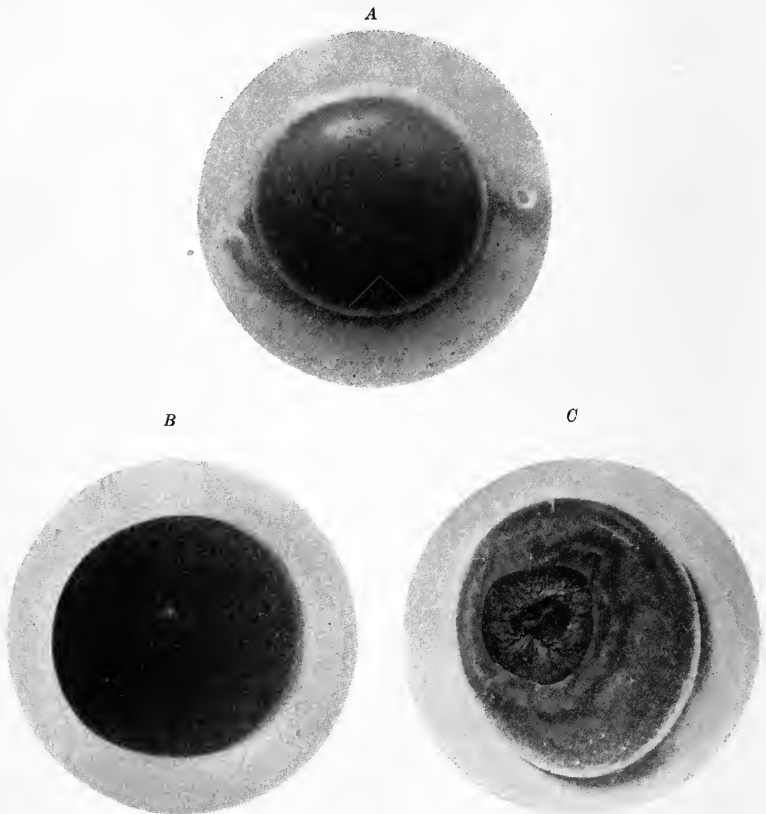


FIG. 198.—A comparison showing the effect of incubation temperature on fertile and infertile eggs. *A*, Strictly fresh egg with fertile germ. *B*, Infertile egg after being in incubation temperature for 48 hours. The sterile germ never shows any development. *C*, Fertile germ after 48 hours of development. Eggs with sterile germs keep much longer and are much safer to use for human food.

**Candling.**—It is evident from the above that all kinds of eggs are found in the egg market,—stale, shrunken, unclean, broken, cracked, and even rotten eggs. These conditions are indirectly due to one of the following causes: Carelessness on the poultry farm, carelessness in marketing, and climatic conditions.

In order to detect in the general run of eggs those which are of poor quality, and the causes, they are subjected to a procedure known as candling. Size, cleanliness, and color are apparent on external inspection; freshness is indicated by firm body;

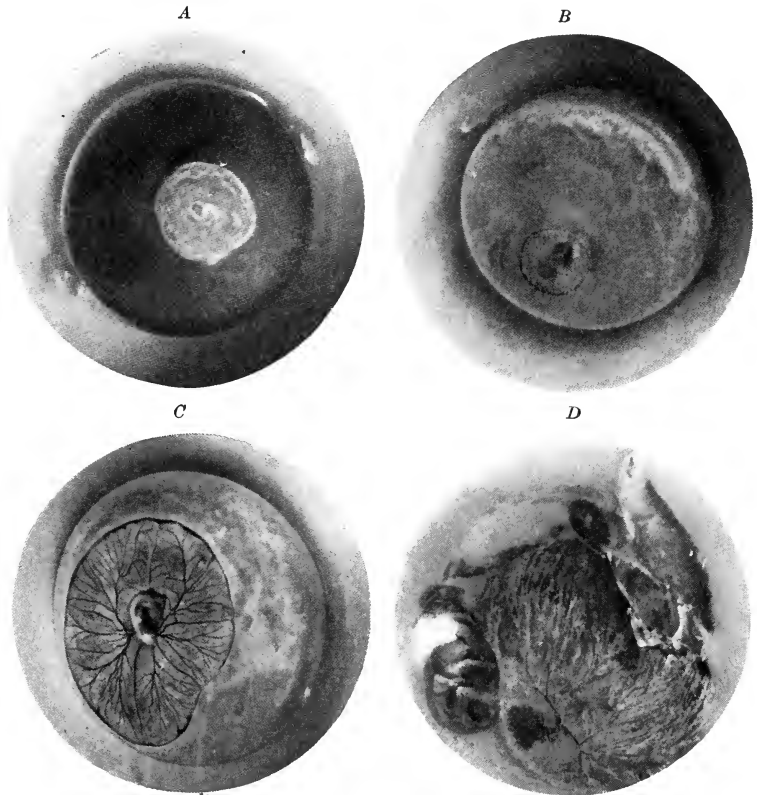


FIG. 199.—Stages of development of the embryo during the first week of incubation. *A*, 24 hours; *B*, 36 hours (see drawing, Fig. 148); *C*, 72 hours (see drawing, Fig. 149); *D*, 7 days; note the very large head with eyes of large proportion (compare Fig. 162).

and proper care of the egg from the time it was laid can be readily determined by holding it before a strong light in such a way that the rays of light will shine through the egg and reveal its contents to the operator. A candling equipment consists of a bright light enclosed in an opaque box or shield, the light for testing shining out through a hole in front slightly less in diam-

eter than the short axis of the egg. The eggs are candled in the same way as when tested during incubation. Certain conditions should be looked for, and the operator divides the eggs into lots, each in a different receptacle according to its class, as follows: Rots, spots, checks, seconds, firsts, and extras.

A fresh, newly laid egg can be recognized by the fact that the contents entirely fill the shell. As cooling takes place, the contents of the egg contract, leaving a small empty space at the large end which is termed the air cell. As the egg ages, this cell rapidly increases in size, because of the escape of moisture through the shell. In extremely stale eggs or those not properly taken care of, the cell may occupy half of the shell; such eggs are said to be shrunken. Shrunken or stale eggs have lost their fine fresh flavor, and sell in all markets at a low price.

In a strictly fresh egg, the yolk shows faintly as a dark mass in the centre of the shell; when the egg is moved, this dark mass moves about, sometimes becoming more distinct, and again less so as it settles at the farthest side of the egg. Before the candle the rotten egg looks opaque or very dark colored and appears as a homogeneous mass; during the process of decay the membranes give way and the contents mix; for this reason a rotten egg, if shaken, will sound sloppy. Such eggs are a total loss. Eggs may rot from one or two causes:

1. The presence of a partially developed chick which decomposes immediately after death.
2. The presence of a fungus, which penetrates the shell through cracks or pores, and develops rapidly, if the egg is not properly cared for.

In eggs classified as "spots" the yolk is found adhering to the shell, or there is a fungous growth, or a partially developed embryo. Such eggs are not edible. Until recently it was the custom in large candling establishments to break and strain these eggs, canning the strained material for cooking purposes; it was put on the market as canned eggs. This practice has been abolished by recent pure-food legislation. The number of such eggs on the market, especially during the spring and summer months, is enormous; such eggs are legitimately used in finishing leather.

The class of eggs designated by the candler as "checks" includes all eggs which are cracked, exceptionally small, or dirty. Eggs so badly cracked as to permit part of the contents to ooze



out are termed "leaks," and can be sold for food if consumed immediately.

Second-quality eggs are clean and sound shelled, but undersized; they may be fresh, or may be held so long that they become shrunken and stale. Full-sized and clean but stale eggs also rank as seconds.

First-quality eggs are not candled, being guaranteed by the shipper, who is responsible for their quality on reaching the consumer. Candling is constantly practised for the protection of the consumer and the wholesale merchant, and is made necessary by the lack of care and consideration on the part of the producer (Fig. 200).

**Preservation.**—From the fact that eggs are produced most abundantly during the spring when the price is consequently low, and that production decreases and selling price advances during the winter season, a simple but satisfactory method of preserving eggs for the home table or a restricted retail trade seems most desirable. People have appreciated this fact for many years, and at-

tempts have been made to preserve them. The best way is by the use of *water-glass*, which will preserve a small number of eggs for family use at slight cost. It cannot, however, be used for eggs at wholesale. Eggs may be preserved for a year, and yet be sufficiently fresh for cooking. It is often impossible to distinguish eggs preserved in *water-glass* from eggs only six or seven days old; in fact, if properly done, the preserved egg is often superior to the apparently fresh one; as, for instance, when the latter has been

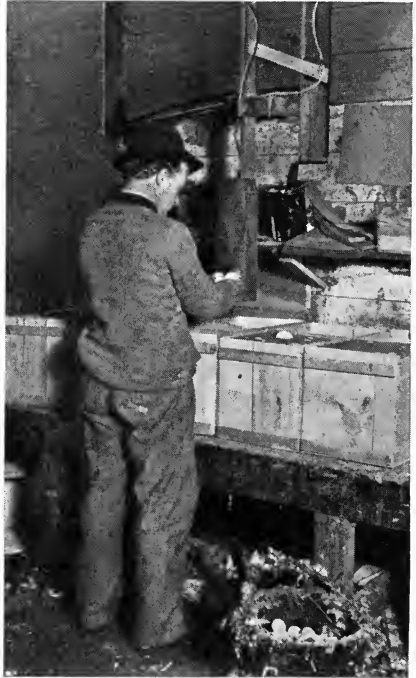


FIG. 200.—A commercial egg candler at work. The electric light is here enclosed in a stovepipe with two holes in the side. Each grade of eggs is placed in its own case.

exposed to a warm August sun during the greater part of the time intervening between laying and marketing.

Perfect preservation depends upon two factors;—the condition of the eggs when preserved and the method of preserving.

Eggs which are to be preserved should be from a perfectly healthy flock which has been supplied with enough shell-forming material to make it certain that the shells are of fair and uniform thickness. The nests should be clean and well ventilated, so that the eggs cannot become infected while in them. The eggs should be gathered daily, to prevent any heating by broody hens, and should be kept in a dry, cool room away from the direct rays of the sun. Use only clean ones, and preserve them the day they are laid. Those eggs laid in April, May, and June should be preserved, for there is less profit at other seasons.

*Method.*—A cool and dry but dark cellar in which the temperature does not rise higher than 60 degrees is the best place in which to keep them. Clean stone jars holding about fifteen dozen eggs are the best receptacles. To ten quarts of clean, boiled water, which has been allowed to cool, add one quart of water-glass, and stir until thoroughly mixed.

The eggs should be placed in the receptacle, being sure that none are dirty or cracked, and over them the liquid should be poured until all are completely submerged. They should be kept submerged about an inch below the top of the liquid. The receptacle should be covered to stop evaporation; if left exposed, the mixture turns a milky white and does not preserve the eggs properly. The jars should be placed on a shelf or dry platform out of the direct rays of the sun. The preserving solution should not be used for more than one batch of eggs or more than one season. If correctly done the shrinkage in weight by this process, over a period of nine months, is not more than one per cent.

*Storage.*—The cold storage of eggs has come to be a recognized part of the commercial business. It is much the safest, as well as the most economical, way by which to preserve large quantities of eggs for an extended period. It enables the poultryman to sell his product at a profit the year round. If he could not store them during the time of heavy production, eggs would be so plentiful during the spring that they could not be sold, and during the winter few could be had at any price. The holding back of eggs by means of artificial refrigeration is a source of larger annual

profit to the egg producer, and yet makes eggs cheaper for consumers in winter.

Commercial cold storage consists in keeping eggs in scrupulously clean rooms at a temperature of from 29° to 32° F., from March or April until the following January or February, or even later if the winter is severe and the spring supply comes in slowly. During these latter months fresh prime eggs usually sell for thirty to fifty cents, while fancy Western storage eggs bring from twenty-five to thirty-five. The storage egg never equals the fresh egg in quality, yet it is just as good for cooking purposes, and its lower price at this time enables the housewife to secure an abundance of good eggs at reasonable cost.

#### MARKETING LIVE POULTRY.

In shipping live birds to market under a guarantee, they must be just as carefully selected and graded as any other poultry product. They should be up to the designated weight, and as uniform as it is possible to have them. The small producer shipping small quantities will usually find it impracticable to guarantee such a shipment, but will dispose of the entire lot at the current price for mixed goods.

The great mass of live poultry which reaches the Eastern markets is shipped from the Central-Western States in carload lots. These cars are built for the purpose, being made with four or five floors or tiers.

When shipping short distances to local markets, specially constructed but strong and durable shipping cases are used. If breeding birds are shipped, care must be exercised to protect them from injury and from colds due to drafts.

Live birds for food are usually shipped by freight, and, if a considerable distance is to be covered, provision must be made for feeding and watering them. Fowls are usually sold alive, direct from the farm, while such meat birds as broilers and capons are usually dressed, owing to the higher price they bring if so prepared.

Baby chicks should be shipped as soon as they are taken from the incubator,—that is, as soon as they are perfectly dry and on their feet. They should be put in strong light-weight boxes and securely fastened. The box should have holes for ventilation (Fig. 201), and be divided into compartments, with not more than twenty-five chicks in each compartment; this prevents

crowding, and perhaps suffocation. If the bottom is lined with burlap it will keep the chicks from slipping about.

The boxes should be plainly marked, stating nature of contents and name of customer and shipper. They should always



FIG. 201.—Boxes for shipping baby chicks. (Photo by Rancoeas Poultry Farm.)

be sent by express, the customer being notified in advance of the shipment so that the brooder may be in readiness.

#### MARKETING DRESSED POULTRY.

After plucking and cooling, the dressed birds should be sorted, especially if they vary much in size and quality. A box of poultry should contain birds which are alike in character and size. Each box is labeled according to the character of the contents. Defective birds, such as those torn in picking, those which are thin, or which show any deformity, such as crooked breasts and backs, should not be shipped, but may be consumed at home. If packed with the others such birds spoil the appearance of the whole lot (Fig. 202). The selling price of the best, and of the whole box, is reduced by the few poor ones. With market poultry uniformity is just as important as with eggs (Fig. 203).

**Packages and Packing.**—The kind of cases used for shipping depends upon the type of birds and the quality. Broilers are

usually shipped in barrels, but extra-quality broilers are often packed in boxes or small cases, carefully labeled and guaranteed; they must, however, be of fine quality to warrant such procedure.

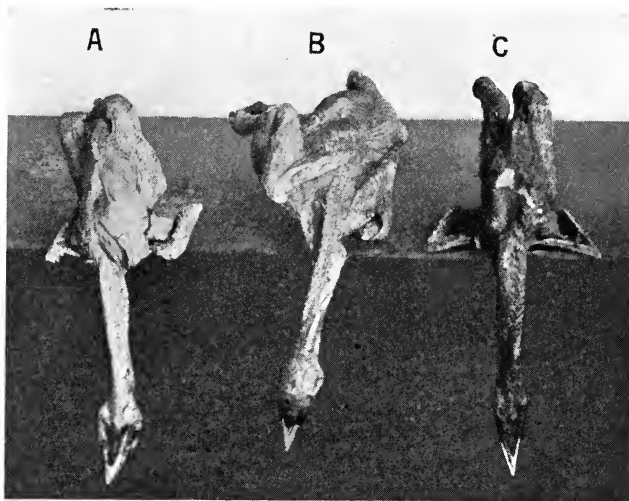


FIG. 202.—Undesirable types of market broilers which should be consumed at home. *A*, Torn during picking; *B*, crooked back; *C*, starved and emaciated.



FIG. 203.—Soft roasters ready for market. Uniformity in size and quality is necessary if the best prices are to be realized. (Photo by Purdue University.)

Roasters and capons are usually packed in boxes, the size depending upon the weight and size of the birds. As a rule, twelve birds are packed in each box.

If water is used for cooling the carcasses, they should after-

ward be laid on a sloping table or may be suspended while they are draining. The barrel or box should be lined with waxed or paraffin paper, to keep them from rubbing against the box and to protect them from staining. When packed in barrels (Fig. 204, A), the wings should be folded over the back, and the birds laid



FIG. 204.—Methods of packing fancy grades of dressed poultry. A, Barrel and box packed, corn-fed pullets; B, roasting chickens showing side pack; C, roasting chickens, showing back pack; D, an extra fancy grade of roasters, packed in pairs, in special pasteboard cartons. Six cartons make a crate. (Photo by U. S. Bureau of Chemistry.)

in the barrel in circular layers; with broilers one can usually form two perfect circles, one within the other, with three birds in the centre to complete the layer. The number of birds in a layer depends upon the size. When the quality warrants it or when roasters or fowls are packed for shipment, boxes are used,

but they must be so packed as to make a good appearance, or the best prices will not be realized. There are three ways of packing the birds, namely, side, breast (Fig. 204, *B*, *C*), and back packing. The side pack, the birds being laid on one side, is the most common.

When shipping in warm weather, crushed ice should be used (Fig. 205), placing first a layer of birds and then a layer of ice, the amount of ice depending on the weather and shipping distance, more of course being necessary in midsummer and none during the winter. In hot weather it is a good plan to place a large cake of ice at the top of the barrel before putting the cover on. As the ice melts, the water percolates down through the contents and



FIG. 205.—A fancy grade of broilers, box packed and iced for shipment. The side pack is used here.

keeps them cool. Holes bored in the bottom of the receptacle will permit the water to escape; otherwise it would spoil the contents.

Plenty of ice must be used, or the birds will deteriorate greatly during shipment and bring a lower price (Fig. 205).

**Shipping.**—Dressed poultry should always be shipped by express, charges to be collected. This is the quickest mode of shipping, the products reaching the consignee in the best condition and being delivered immediately upon receipt. If, by a mistake in handling, they go astray or are held back, having been sent "collect" the express company is made liable, and can more easily be compelled to settle.

Dressed poultry usually finds a better market between the middle and end of the week than during the first of the week. This is especially true of live poultry, the heavy demand being

for Sunday. It is well, therefore, so to plan shipments that they will reach their destination on Thursday, or not later than Friday.

**Cold Storage of Dressed Poultry.**—Where dressed poultry is to be shipped a considerable distance to market, it is usually sent in refrigerator cars, in which the temperature is kept at or below 40° F. by means of salt and ice crushed fine and packed in the bunkers. In this way dressed poultry can be shipped thousands of miles, and will go through in prime condition. Thorough chilling for about forty-eight hours in a mechanical freezer before placing the poultry in the car will help to put the shipment through in good shape.

During periods of heavy production dressed poultry is often placed in cold storage, but it should be held a much shorter time than is the case with eggs. Cold-storage birds deteriorate considerably, especially if not properly bled and dressed; and, owing to this, the practice should be limited to holding for only short periods.

#### OTHER PRODUCTS.

**Preparing and Marketing the Feathers.**—On large plants where many birds are killed and dry picked, the feathers, if properly handled, bring in a considerable revenue. Scalding, however, so reduces their value that they do not pay for drying and curing. White feathers always bring a higher price than those of mixed colors. In dry picking the best method is to have at the side of the picker a barrel or large box in which to put all the soft, fluffy and body feathers, the larger ones with a big quill being kept separate, as they are of no value. The feathers must be kept free from dirt and blood, and at the end of each day's picking they should be spread out about six inches deep on a clean floor to dry. A good place is a dry, well-ventilated loft. They should be turned every few days for three weeks, after which they may be bagged up and sold.

In some sections buyers of poultry and eggs collect feathers also, but there is usually no local collector available for the small producer, whose best course is to get the name of some special feather buyer from trade papers, and communicate with him. Such firms purchase feathers of all qualities, and on request will quote prices and manner of shipping. Extensive shippers of dressed poultry find it to their advantage to secure a regular firm to handle their whole output of feathers at a regular price. In this way the producer learns what quality and methods are



avored by that particular firm, and thus realizes a higher price. Feathers bring from 25 to 40 cents per pound the year round.

Duck feathers are more valuable, and they are very abundant. Goose feathers bring the highest price, but the supply is limited.

**How to Handle the Manure.**—Poultry manure is one of the most valuable fertilizers produced by farm animals, being especially rich in nitrogen, and in demand for truck raising. For this purpose it finds a ready market at seventy-five to eighty cents per barrel the year round: Formerly it was in considerable demand for tanning purposes, but the scarcity of the right quality and the increasing substitution of chemicals have almost entirely driven it out of this market.

Poultrymen who raise crops will probably find that they can realize the most from their manure by using it on their own lands in growing larger crops for feed. If the manure is to retain its fertility, it should be collected regularly and properly taken care of. This necessitates the use of a good absorbent on the dropping boards, or under the perches if dropping boards are not used.

A mixture of equal parts of land plaster and loam is very good for this purpose. Sifted coal ashes are also useful, and dry, pulverized peat moss is excellent. Ground phosphate rock is often used. The material used should absorb the moisture and dry out the droppings quickly, yet in itself be a good fertilizer. Sawdust and shavings are undesirable, as, if used in large quantities, they are injurious to the land. Lime is also objectionable, as it liberates the ammonia containing the nitrogen. The droppings should be placed in a covered receptacle where the rain cannot wash and leach them.

If they can be kept dry so much the better. A large box or storage bin of heavy planking or, better yet, of hollow tile, so constructed that the air will circulate through the mass of droppings, is very effective. If the amount is limited, because of the small number of birds kept, a good way is to use covered barrels in which a few holes are bored to admit air. They are handy from the fact that they can be easily carried to the field when needed for spreading, and save extra labor. The practice of spreading such manure frequently on the fields is better than using storage sheds.

#### COÖPERATIVE MARKETING.

Of all questions confronting the poultryman, that of marketing is by far the most intricate and difficult of solution. It involves efficient methods in production and preparation and good busi-

ness principles in distribution. The methods can be acquired by study and practice; but distribution demands the highest degree of concentration of mind, as well as coöperation between producers, in order effectually to control its factors.

The consumer must be brought closer to the producer. Too much of what the consumers pay goes to the middle men. The Report of the Secretary of Agriculture for 1910 shows that the farmer or poultryman receives for poultry but little more than one-half of what the consumers pay, while for eggs he receives only 69 per cent. The poultryman must better his position by organization and coöperation in buying and selling. Thus he can cut out the charges and profits of the middle men, and can put on the market a large quantity of better-grade products which will insure a continuous demand at profitable prices. It also eliminates the necessity for two or three handlings in the course of distribution, which means a higher price for the producer and a lower one for the consumer. One of the chief causes of the high cost of living at any time is not the high prices received by the producer, but the excessive cost of distribution.

A coöperative movement in marketing must have for its watchword, "Quality and uniformity of products sold"; lacking this it cannot long be successful. An honest spirit of rivalry between the parties is another essential, and is more important than the manner of selling. The success of such an organization depends on the integrity and sincerity of each member. Many such movements have failed because the members did not hold together, or because one of their number tried to sell an inferior product under the guarantee of the association.

Denmark is noted for the success of its agricultural organizations, especially in the coöperative selling of eggs. Canada also has recently achieved marked success in this line. It is carried on by means of "egg circles," which are merely associations of the producers in a given community, who conform to certain standards in the production, collecting, and grading of their eggs, and agree to sell them under a trade name and guarantee. Having a large number to dispose of, it is easy to create a steady demand and to sell them at attractive prices. One member of the organization is elected or hired to collect and ship the eggs from one to three times a week, according to the season.

## REVIEW.

1. What are the qualifications of a good salesman?
2. What are the three types of markets?
3. Discuss the possibilities and advantages of each of the three types.
4. Discuss the relative returns for marketing eggs through different channels of trade.
5. Outline the possible courses of products from producer to consumer.
6. Classify customers according to their financial standing and products purchased.
7. What factors influence the price which the ultimate consumer pays?
8. What factors determine the supply?
9. Why is systematic delivery so important to the customer?
10. For what two objects are eggs marketed?
11. Discuss the packing and shipping of eggs for hatching.
12. Tell of the importance of fertility.
13. What is the value of a guarantee on eggs sold for hatching?
14. Discuss prices and their variation, for market eggs.
15. Tell what you can about the ultimate price regulation of market eggs.
16. What are the important points in collecting market eggs?
17. Give the general market classification of fresh eggs.
18. How are the different degrees of freshness in eggs designated?
19. How do prices vary in regard to size and color?
20. Discuss the packing of table eggs for shipment.
21. What are the advantages of stenciling cases?
22. How should eggs be shipped?
23. Name six preventable losses in market eggs.
24. Give eight means of preventing the above losses.
25. What are the advantages of infertile eggs?
26. Name the causes which make candling necessary.
27. Into what six grades does the commercial candler divide his eggs?
28. In what two ways are rotten eggs produced?
29. Outline a method of preserving eggs for home use.
30. Discuss the cold storage of eggs.
31. What are the essential points in marketing live poultry?
32. Describe packages and method of packing dressed poultry.
33. How should dressed poultry be shipped?
34. How should feathers be handled?
35. Describe a profitable way of deriving revenue from the manure.
36. What are the possibilities of coöperative marketing?

**References.**—The Marketing of Poultry Products, by F. H. Stoneburn, Connecticut Bulletin 38. Marketing Poultry Products, by H. R. Lewis, New Jersey Board of Agriculture Bulletin. Changes Taking Place in Chickens in Cold Storage, by M. E. Pennington, U. S. Department of Agriculture Yearbook 1907. Studies of Poultry from the Farm to the Consumer, by M. E. Pennington, U. S. Bureau of Chemistry Circular 64. Marketing Poultry Products, by James E. Rice, Cornell Reading Course Bulletin 20. Marketing Eggs through the Creamery, by Robert R. Slocum, U. S. Farmers' Bulletin 445.

The Reduction of Waste in Marketing, by Frank Andrews, U. S. Department of Agriculture Yearbook 1911. The Egg Trade of the United States, by Hastings, U. S. Bureau of Animal Industry Circular 140. Eggs and their Use as Food, by G. F. Langworthy, U. S. Farmers' Bulletin 128. Poultry as Food, by H. W. Atwater, U. S. Farmers' Bulletin 182. Poultry as Food, by R. D. Milner, Connecticut Bulletin 27. The Improvement of the Farm Egg, by Lamon and Opperman, U. S. Bureau of Animal Industry Bulletin 141. Selling Eggs by Weight, U. S. Farmers' Bulletin 122. Food Value of Eggs, in U. S. Farmers' Bulletin 87. Analysis of Eggs, Maine Bulletin 75. Preserving Eggs, Arizona Bulletin 60. The Marketing of Eggs, by A. G. Phillips, Kansas Bulletin 162. The Marketing of Eggs, by C. S. Plum, Ohio Extension Bulletin 8. Poultry Manure, in U. S. Farmers' Bulletin 384.

## CHAPTER XXVI.

### RECORDS, ACCOUNTS, AND ADVERTISING.

**Importance of Records.**—Record keeping is essential in any line of business if the owner of that business is to have a clear grasp of its details. But it is doubly necessary in poultry craft, because poultry raising is primarily a matter of detail. The following are some of the chief reasons for the keeping of records:

1. They lessen the strain on memory. Even though the poultryman be gifted with a remarkable memory, he will have sufficient opportunity to exercise it after writing down all the more important of his happenings and transactions.

2. It is the only accurate way to keep track of work previously done. Memory will sometimes fail a man, even though his mental power be remarkable.

3. Records accurately kept may be of great value for reference at a distant time in the future.

4. The comparison of records extending over a period of years will reveal any improvement or deterioration in the running of the plant, and will indicate the continuance or change of these methods, as may be advisable.

5. Records enable the poultryman to detect leaks in the different branches of his business, and to stop them.

6. He can find out at any time how his business stands financially, as well as the effectiveness of the various operations, such as incubation, brooding, and egg production.

7. The poultryman who advertises can back up his advertisements with actual facts from the records of the cost and production of his own flocks.

8. Records make possible home experimentation and improvement in methods.

9. They create a love for and an interest in the work which otherwise might not be awakened.

**Planning Records.**—In planning to keep poultry records, four points must be considered, namely:

1. Simplicity. The records should be so simple, systematic, and orderly as to give at a glance the information desired.

2. They should include all transactions of the business. While

it is advisable to leave a convenient space for general notes, yet the record should be so planned as to cover concisely every possible feature.

3. There should be as little clerical work as possible. The poultryman is a busy man, and complicated systems will prove anything but an asset, for his time will not permit him to keep them accurately. The plan should be to set an item down but once, and in such a way that, if the total of a certain group of items is desired, it can be obtained simply by adding a column of figures regularly tabulated on the record.

4. Record sheets should be of uniform size, so arranged that they can be easily filed and, if desired, transported from place to place.

**Important Records to Keep.**—The records best adapted to a particular poultry enterprise will vary somewhat with the extent and character of the business, yet what may be termed “general poultry records” will be useful on any poultry farm. In some instances more complicated records may be needed; as, for example, on progressive breeding farms, where pedigree matings and lengthy, trap-nest records are to be kept. Types of records and facts to be recorded are here discussed.

*Breeding records* are most important where improvement of stock is systematically brought about by breeding and selection, and also where advertised matings are kept and stock and eggs for hatching sold. Such records show: (1) The matings, designated by number or letter. It is an excellent plan to use both letter and number, one signifying the year and the other the number of the mating. (2) The manner of marking the eggs from each mating. The best method is to use the number of the mating for this purpose, and, if trap-nest records are kept, this number can be written on the large end of the egg, directly over the bird's band number, with a line between. (3) Breeding records should also contain trap-nest records of matings of the birds, as well as a brief description of both male and female. (4) Eggs set and resulting chicks.

The safest way to mark the chicks from pedigree matings is by chick leg bands (Fig. 153), which are subsequently changed for adult bands, the new number being placed on the breeding record at the time of changing.

Another method is to use the toe punch, which, however, is limited to the few combinations which can be designated (Fig. 152); there is also the possibility of the marks not being perma-

ment. The rim punch should always be used, as it is the only instrument which makes a clean hole without tearing. The hole should be made far enough from the edge to minimize the danger of its tearing out.

The following form shows a good way of keeping mating and breeding records :

*Individual Mating Record.*

PARENTAGE { Male No..... DATE..... Mating No.....  
 { Female No..... Pen No.....  
 Experiment No.....

Chick band No.	Adult band No.	Sex.	Hatched.	Remarks.	Hatching weight.	Dead in 4 weeks.	Matings.
Pro vide Blank Lines 1 0							

*Pen Records.*—By a pen record is meant usually a monthly sheet; but in some cases a weekly sheet is posted in the pen, and is so arranged that the products of that pen, the feed consumed, and the condition of the birds for a given period can all be entered on one record. The following form shows a monthly pen record which was used with considerable success in coöperative record keeping:

*Monthly Pen Record.*

Pen No..... Breed..... Number of females..... Number of Males.....  
 Month.....

Date.	Rations.			Suc- c- lence	Shell	Grit	Extra feed	Hens	Eggs	Sickness, Mortality	Broodi- ness
	No. 1	No. 2	No. 3								
Pro vide Blank Lines 3 1											
Total											
Weigh back											
Con- sumed											

Notes.—Leg band numbers.....  
 Average daily production..... Total income from eggs.....  
 Total cost of feed..... Profit or loss from eggs.....

# INCUBATOR REPORT

Experiment No. \_\_\_\_\_  
 Record No. \_\_\_\_\_  
 Incubator No. \_\_\_\_\_  
 Make of Incubator \_\_\_\_\_  
 Date eggs were put in \_\_\_\_\_  
 Name of Operator \_\_\_\_\_

Day of Inc.	Date	Hour	Position of Thermometer.	Position of Regulator (Up or Down)	Changes made (Raised or Lowered)	Temperature of Room	Relative Humidity	Oil Consumed	Oil Consumed	95	96	97	98	99	100	101	102	103	104	105	106	107	108	109	Moisture added	Position of Vent	Were Eggs Turned	Were Eggs Cooled	Minutes Cooled	What Temp. Cooled						
1	Run for 7 days and keep record before putting in the eggs																																			
2																																				
3																																				
4																																				
5																																				
6																																				
7																																				
1																																				
2																																				
3																																				
4																																				
5																																				
6																																				
7																																				
8																																				

Put the eggs in now if the incubator runs perfectly

Test eggs first time



## FINAL REPORT

---

### NUMBER OF EGGS

Put in =  
 Infertile =  
 With dead germs =  
 Broken after second test =  
 With chicks dead in shell =  
 Pipped =

### NUMBER CHICKENS

Crippled =  
 Vigorous =

### PER CENT.

Fertile eggs to total eggs =  
 Dead germs to fertile eggs =  
 Broken to fertile eggs =  
 Dead in shell to fertile eggs =  
 Crippled to fertile eggs =  
 Vigorous chicks to fertile eggs =  
 Vigorous chicks to eggs left in =  
     machine after second test =  
 Vigorous chicks to total eggs =

10	
11	
12	
13	Test eggs second time
14	
15	
16	
17	
18	
19	
20	Note hour when first chicks hatch
21	Note hour when through hatching
22	
23	Date and hour when removed from the machine

Such a record shows at a glance the number of birds, the egg production, and the cost of feed consumed; and it is a simple matter to balance this sheet and find the profit or loss from the sale of the eggs.

*An Inventory.*—In order to ascertain at the end of each fiscal year the present inventory value of the plant, and to know exactly how much money was spent in stock and equipment, it is important to keep some kind of inventory record. This is especially necessary when adding to the stock, which means a reduction in cash for a time with the possibility of increased revenue in the future. Such a record can easily be kept on a sheet of paper ruled into five columns, the equipment values being inventoried under the following five heads: Land, buildings, stock, tools and implements, and miscellaneous equipment.

With the value of these inventoried for one year, the only work necessary at subsequent stated periods is carefully to revalue the stock. During the intervening time a full record can be kept on this sheet of all sales and all purchases, each being placed in its respective column. By dividing the inventory values under headings suggested, it is possible to estimate depreciation or gain in value in each department, and to know the investment in each.

*Incubation Records.*—Where artificial hatching is carried on to any great extent, a simple yet complete record of each hatch is necessary, as a means of determining whether the required efficiency is being maintained, and also the better to point out any fault in operating the machines. This record of fertility and hatching percentages should be kept from year to year for future reference. Such a record should cover the following facts:

Number and name of machine.

Number and kind of eggs set.

Date set.

Temperature in both room and incubator, taken three times a day.

Moisture in the incubator, readings taken at short intervals.

Dates when hatch began and when it was complete.

Number of infertile eggs and dead germs on seventh and fourteenth days.

Figures showing efficiency of hatch: Vigorous chicks hatched; cripples hatched; percentage of eggs hatched; percentage of fertile eggs hatched.

A simple record sheet for this purpose is shown on page 456.

*Sitting Records.*—Where hatching is natural, there should be a simple but accurate record of the different broods hatched and the time when the hatch is expected. The entries should be as





follows: (1) Number of nest and number of hen; (2) date when set; (3) number and kind of eggs; (4) number of eggs tested out on the seventh and fourteenth days; (5) the hatch or number of vigorous chicks taken from the nest.

The above record can best be kept in a small pocket notebook, for nests are usually in places where it would be impossible to post records without danger of loss or soiling.

*Brooding Records.*—Whether brooding is carried on in small outdoor brooders or in the large brooder house, if the poultryman wishes to know just how efficient his system of brooding is, he must keep a record which will give him at a glance the following facts pertaining to the brood: (1) Number of chicks when brood began; (2) temperature of room and brooder, taken three times daily; (3) daily mortality; (4) amount and kind of feed, if desired (this, however, is not of much importance); (5) total mortality up to a certain age; (6) percentage of brood up to that age. A good breeder record is shown.

*Feeding Records.*—Where very detailed and accurate records of cost and amount of feed consumed are desired, the method shown in the form on page 459 will be found advantageous. On the ordinary farm, a feeding record on the monthly pen sheet will be sufficient.

*Labor Records.*—On large poultry plants where many men are employed, or where it is desirable to keep a record of the time consumed in doing a certain kind of work, the method described will be satisfactory.

Have special time cards prepared, one for each laborer, for one week, with his name written upon it. The cards should be ruled horizontally into as many spaces as there are different kinds of work to be recorded, and vertically into nine columns. The first column is for the kind of work, the next seven for the days of the week, and the last one for the total number of hours spent at each kind of work. The accompanying form (p. 462) shows this plan.

By making a different distribution of labor, or by eliminating some detail, it is often possible greatly to reduce the cost in caring for a large flock of birds. Such a record as the one described will aid in solving this problem.

*Young Stock Records.*—It is advisable to keep a record of all young stock put on the range, and to check up this list when they are put into laying quarters in the fall. Because of possible

loss due to shrinkage or to thieves, it is desirable to keep a simple memorandum of the number of birds put on the range and the total number taken from the range. Ascertain from these numbers what percentage of loss can be expected in the future. The need of better preventive measures will be shown.

*Daily Labor Record Card.*

[Designate time spent in minutes.]

Date..... Name.....

KINDS OF WORK	1	2	3	4	5	6	7	TOTAL HOURS
Feeding								
Cleaning								
Building								
Seeding								
Hatching								
Rearing								
Miscellaneous								

**Methods of Keeping Records**—There are three methods of keeping poultry records: Sheet records; books with either loose or permanent leaves; and a card file. The method adopted should be light in weight, compact, and portable. There should be little danger of loss or misplacement. The information should be readily accessible at all times.

Of the above methods the loose leaf records with a strong, easily detachable binder probably offer the greatest advantages, for they meet all requirements. Each sheet may be used independently, or may be filed vertically in a drawer and used like a card system. The great disadvantage of the single sheet file is the danger of loss or misplacement, and the possible injury of some of the sheets. The card system is excellent; but a great drawback is its bulk, and the impracticability of carrying a lot of cards to the pens or about the plant when making notes or

studying records of individuals. Figure 206 shows these three systems. The post binder with loose leaves is undoubtedly the best for general use; but whatever system of records is adopted, uniformity in the size and style of the sheets must be maintained.

#### ACCOUNTS.

**The Poultryman's Diary.**—One of the simplest yet best records for the poultryman to keep is a diary, taking time regularly to enter the chief events of the day, such as any special work which has been done or any important transaction. Record purchases and sales of stock or products. Such a diary is both a day-book

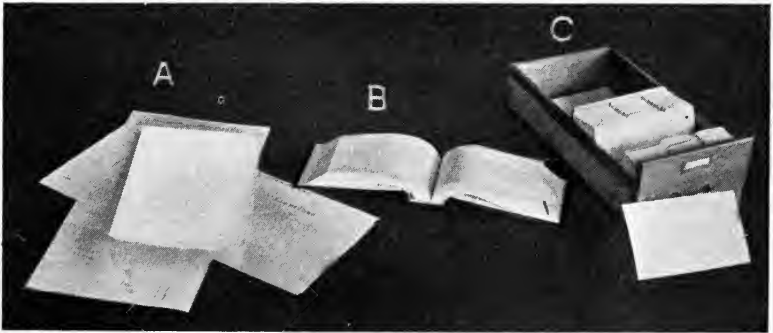


FIG. 206.—Three methods of keeping records. A, Sheet records; B, loose leaf; C, card index.

and an account book. From it the transactions of the day can later be posted in the regular account books. A diary of this kind is very useful if there is variety in the daily transactions. It can be kept year after year, and by referring to the same date in preceding years the general progress and season's work can be determined.

**What Accounts Should Show.**—Account books for a year should show distinctly three things:

1. All the business transactions, showing the items of all money expended and all money received. This will tell the poultryman whether or not his business has been conducted at a profit or loss, and the amount of same. If at a loss, this loss or waste can be traced to one of the different branches of his business. He can also see which is the most profitable line of his

work. The keeping of such a record will not only tell the poultryman just where he stands financially, but tend to develop in him a spirit of economy.

If the poultryman has no time for this work, his wife or one of the children may perhaps be interested in the business and may keep the accounts. A good way to cultivate business habits in the children is to give them a small flock of birds and require them to keep an exact record for the year, thus ascertaining the actual profit from the flock. In this way the keeping of records and accounts will gradually become a mere matter of routine.

2. The system of accounts should include a yearly inventory, the importance of which has been shown on page 458.

3. The system of book-keeping should include the balancing of the books at stated periods to determine the financial condition of the plant.

**Methods of Accounting.**—There are two recognized methods of keeping accounts,—namely, single and double entry. The latter involves considerable clerical work, as separate accounts are kept for each branch of the business. It necessitates entering every transaction twice, once as a debit and once as a credit item. This method has the advantage of checking against mistakes. Every trial balance shows just how each department of the business stands. The work involved is so great that it is suitable only for large plants where one person is employed solely for the accounts and office work.

The single entry is very simple and adapted to any poultry plant. In this system entries are made but once, every transaction being either a debit or credit, against or in favor of the poultry plant.

In this system the inventory value is placed on the debit side of the account. Also on the debit side are entered, as they occur, all items of expense, such as feed, labor, repairs, stock, and tools. On the credit side of the accounts are entered all products sold and all incoming cash,—for example, eggs and fowls sold or consumed at home. Such an account may run for a month or longer before balancing, but the best rule is to balance it each month, in order more closely to watch the expenditures. When it is balanced, both sides of the account are added, the difference is determined, and this difference is entered as a new balance. If the credit column is greater, a profit is shown; but if the debit column is the larger, the difference will be the amount of loss.



## Sample Monthly Sheet.

DR.

Date.	Item.	Feed.	Equip- ment.	Labor.	Miscel- laneous.	Total.
1910						
Apr. 1	100 pounds beef scrap.....	\$3.00	.....	.....	.....	\$3.00
5	4 bushels shelled corn.....	3.00	.....	.....	.....	3.00
5	5 bushels oats.....	3.25	.....	.....	.....	3.25
8	Carpenter work on brooder.....	.....	.....	\$2.00	.....	2.00
8	Lumber.....	.....	.....	.....	\$4.00	4.00
10	1 indoor brooder.....	.....	\$8.00	.....	.....	8.00
10	6 gallons kerosene.....	.....	.....	.....	.72	.72
19	300 eggs for hatching.....	.....	.....	.....	5.75	5.75
20	100 pounds oyster shell.....	.80	.....	.....	.....	.80
25	3 bushels wheat.....	3.75	.....	.....	.....	3.75
	Total.....	\$13.80	\$8.00	\$2.00	\$10.47	\$34.27

CR.

Date.	Item.	Market eggs.	Hatch- ing eggs.	Market poul- try.	Breed- ing stock.	Total.
1910.						
Apr. 4	10 dozen eggs, at 24 cents.....	\$2.40	.....	.....	.....	\$2.40
10	1 pen breeding fowls.....	.....	.....	.....	\$5.00	5.00
12	18 dozen eggs, at 24 cents.....	4.32	.....	.....	.....	4.32
13	1 hen (home use).....	.....	.....	\$0.55	.....	.55
14	3 market hens.....	.....	.....	1.80	.....	1.80
15	8 dozen eggs (home use), at 24 cents.....	1.92	.....	.....	.....	1.92
17	15 dozen eggs, at 23 cents.....	3.45	.....	.....	.....	3.45
19	7 dozen eggs (home use), at 23 cents.....	1.61	.....	.....	.....	1.61
19	300 eggs, hatching (home use).....	.....	\$5.75	.....	.....	5.75
20	50 day-old chicks.....	.....	.....	.....	3.00	3.00
23	7 dozen eggs (home use), at 23 cents.....	1.61	.....	.....	.....	1.61
29	100 eggs, hatching.....	.....	3.00	.....	.....	3.00
30	6 dozen eggs, at 22 cents.....	1.32	.....	.....	.....	1.32
	Total.....	\$16.63	\$8.75	\$2.35	\$8.00	\$35.73

On a wide sheet, place the credit form at right and debit at left.

**Column System.**—It is often desirable to itemize the expenditures and receipts, yet not increase the number of entries. This is easily done by using what is termed a compound single entry system, which consists in having the sheets of the account book ruled in a number of vertical columns in addition to that for date and for dollars and cents. Each of these columns should represent a certain kind of transaction. For example, on the debit side, the columns could be headed: Feed, labor, stock, implements, miscellaneous; while on the credit side the headings could read: Eggs, broilers, breeding stock, and miscellaneous. When the columns are footed up in making a trial balance, one

can tell at a glance which of the scheduled items is the heaviest, and the relations between the different sources of income and expense. This system reduces labor, for it is unnecessary to write each time the source of expense or income, since the column itself is so headed. This is sometimes called the "Column System."

In keeping records and studying expenses, those of labor and feed will, as a rule, be found the heaviest. In some cases labor will be a small item, as the poultryman has a plant of such small size that he can do all the work himself; but the cost of feed is continuous, and this must be watched carefully, and every attempt made to keep it down by purchasing feed direct from producer, by compounding efficient yet economical rations, and by cutting out sources of waste in feeding.

*Yearly Summary Sheet.*

DR.

Date.	Feed.	Equip- ment.	Labor.	Miscel- lane- ous.	Total.
1910.					
January.....	\$11.25	\$18.00	.....	\$2.45	\$31.70
February.....	10.85	.....	\$2.00	2.00	14.85
March.....	11.50	20.00	.....	9.90	41.40
April.....	13.80	8.00	2.00	10.47	34.27
May.....	13.00	.....	.....	5.35	18.35
June.....	15.50	.....	2.50	5.45	23.45
July.....	14.15	.....	.....	1.10	15.25
August.....	13.80	.....	.....	4.95	18.75
September.....	15.00	.....	2.25	.45	17.70
October.....	16.10	.....	.....	2.75	18.85
November.....	4.80	.....	1.00	1.43	17.23
December.....	13.75	.....	.....	8.15	21.90
Total.....	\$163.50	\$46.00	\$9.75	\$54.45	\$273.70

CR.

Date.	Market eggs.	Hatch- ing eggs.	Market poul- try.	Breed- ing stock.	Total.
1910.					
January.....	\$21.65	.....	\$2.35	.....	\$24.00
February.....	24.83	.....	3.30	.....	28.13
March.....	20.66	\$6.50	3.50	\$10.00	40.66
April.....	16.63	8.75	2.35	8.00	35.73
May.....	11.52	4.50	4.25	8.00	28.27
June.....	6.00	5.75	15.20	10.00	36.95
July.....	7.08	2.00	22.15	8.00	39.23
August.....	5.37	.....	13.90	4.00	23.27
September.....	9.10	.....	10.80	3.00	22.90
October.....	8.60	.....	4.40	9.00	22.00
November.....	8.17	.....	7.85	15.00	31.02
December.....	12.56	.....	4.05	20.00	36.61
Total.....	\$152.17	\$27.50	\$94.10	\$95.00	\$368.77

## ADVERTISING.

The advantages of advertising must be decided in each case by the poultryman himself. It is undoubtedly true that advertising pays when it is rightly done; yet an immense amount of money is wasted annually by poor or untimely advertising. It pays best when one has a surplus stock to sell with no available market. If well planned and timely, it leads to and greatly increases sales, which means a larger profit or, perhaps, the changing of an apparent deficit into a profit. On the whole, advertising pays only when well planned, and when there is a large business supplying an abundance of products and customers are few. It will always pay in an enterprise which depends on a few sales of choice specimens, for in no other way could possible purchasers be apprised of the existence of such products.

**How to Advertise.**—There are many methods of legitimate and profitable advertising—so many, in fact, and so simple, that most poultrymen entirely overlook them, and think that the only way to advertise is to expend a lot of money, with no assurance of a proportionate return.

The following are some of the ways which may profitably be employed on most poultry farms:

1. A farm and home of neat and attractive appearance.
2. Neat and attractive appearance of team and wagons when on the road.
3. An attractive and "catchy" name for the farm.
4. A conspicuous yet neat farm bulletin board, on which products for sale may be listed and attract the attention of passers-by.
5. The ownership of birds having heavy egg records, and the publication of such records.
6. The exhibition of pure-bred stock at poultry shows and fairs and the winning of prizes.
7. A neat and attractive label on all shipping crates.
8. Clearly printed letter heads without an excess of printing.
9. Printed circulars and cards which can be mailed to prospective customers, displayed on exhibition cages at shows, and enclosed with all correspondence.
10. Printed blotters, which can be enclosed in correspondence, and keep the breeder and his work constantly before the eye of the prospective customer.

11. Using advertising space in magazines and newspapers.

12. Agreeable manners toward all persons interested in one's business. This is often overlooked, and would-be buyers are antagonized or driven away before the possibility of a purchase can be discussed.

The eleventh method, that of advertising in magazines, is one of the most expensive, since it calls for a definite outlay of money with no definite assurance of return. It should be done carefully at first, but it is the only real way of reaching the majority of poultry purchasers.

**What to Advertise.**—In general it may be said that it pays to advertise for sale any product which is so nearly perfect as to sell readily and satisfy the purchaser, yet not damage the reputation of the breeder. The poultry products generally advertised for sale are fancy and utility stock for breeding, eggs for hatching, and day-old chicks. Dressed poultry and market eggs for food are rarely advertised, since there is a steady demand for them at a standard price through the regular channels of trade.

**When to Advertise.**—There may be said to be three good times to advertise. (1) During the season of natural demand. For example, when the purchasing public is demanding eggs for hatching, this is the time for advertising the fact that one has such a product for sale. It may also be well to run a small advertisement throughout the season as a reminder to the poultry reader. Continuous advertising is less expensive. Advertising expressly to bring immediate results should be during the season of natural demand. (2) It is advisable to advertise at any time during the season if, owing to crowding or some other cause, one has a surplus product to sell. During the late summer and fall one must get rid of old stock to make room for incoming pullets; and breeding cockerels can profitably be advertised for sale from fall until the breeding season in the spring, the heaviest sales being in the late fall and early winter. (3) It is well to advertise when one wishes to secure some particular product or kind of birds. Advertising for products wanted is, however, less profitable, as there are usually many advertisements offering for sale just the product or object desired.

**Where to Advertise.**—In deciding where to advertise, several factors must be considered if the money expended is to bring in the greatest number of sales.

Under most conditions the highest grade of poultry journals

will prove the most profitable advertising mediums. Second-grade papers with a limited circulation in a restricted community rarely prove profitable.

When deciding upon the exact paper with which to make a contract, it is best to select one with a heavy circulation in your own part of the country. If a large number of birds are for sale, it is quite customary to advertise in a number of periodicals; this reaches many more people, and the advertisement is more strongly fixed in the minds of possible purchasers if they see it in a number of different papers.

Another essential point is to select a paper with a heavy circulation among the class of customers one desires. The choice of a good medium is an important consideration. The periodicals which let advertising space of this nature can be grouped under four headings:

1. Country and suburban-life papers. Such papers reach the highest class of possible purchasers. The advertising rates are usually high; hence the breeder must have the best quality of goods and be prepared to give satisfaction if he uses these channels.

2. General agriculture and poultry papers circulate among the great mass of poultry keepers, whether they have only backyard flocks or extensive egg farms; and it is from advertisements in these periodicals that the great majority of sales materialize.

3. Another class of papers, termed "breed and specialty papers," deal exclusively with one or more closely-related breeds of poultry,—pigeon magazines being a good example of this class. Advertisements in such papers are usually read only by the best breeders in their respective lines, and the goods they demand must be of the highest grade and will fetch a good price.

4. A method of advertising has recently developed which is proving very remunerative in small communities. Breeders who have a surplus of a fairly good product may in this way make good sales. It is to utilize the special space for poultry advertising now so often reserved in newspapers, especially in the weekly editions. The space is comparatively cheap, the advertisement reaching an immense number of small poultrymen.

**Preparing Advertisements.**—Too much space may be occupied, or the space allotted may not be utilized judiciously, and much of the information to be given may be overlooked. In writing an advertisement the following points should be borne in mind:

The advertisement should be concise and attractive; these features tend to give the reader the very best impression.

The make-up of the advertisement should be "catchy," attracting the eye of the reader and holding it long enough for him to take in its meaning.

It should be terse, which means that much information and descriptive matter should be condensed into small space; for space costs money, and information is what the breeder wishes to disseminate.

Every statement in the advertisement should be true, and it should be so worded as to leave no exaggerated impression in the mind of the reader. For, when sales are made, the birds must come up to the advertised standard. Exaggeration not only makes this impossible, but dissatisfies the customer.

The advertisement should give no data but what are reasonable or actually possible. The fact that one bird in a flock laid 225 eggs a year does not mean that a strain of such layers can be developed from her eggs, nor that the average of the breeder's entire flock will equal anything like this figure.

Advertisements should show important facts pertaining to the specimens for sale,—as, for example, a record of winning at poultry shows; a brief reference to utility qualities; a statement concerning past breeding and records made; a statement as to vitality and health; the name of strain, if such name has become popular; photographs will add to the attractiveness.

**The size of the advertisement** depends upon the quality and quantity of products, their value, and the money available for advertising. The better the quality and larger the quantity, the greater the space which can be used to advantage.

The greater the value of the products, the greater usually is the profit; hence more advertising space may be used.

Small advertisements are usually the more profitable, and it cannot reasonably be assumed that doubling the size of the advertisement will always double the sales.

Extremely conspicuous advertisements are warranted only when one has a phenomenal product for sale and wishes to enhance his reputation through the possession of such a product. There are numerous instances in which the phenomenal record of one bird has made a world-wide reputation for the breeder.

**Getting the Most Out of Advertising.**—If the heaviest sales are to result from a given sum spent in periodical advertising,

a "follow-up" system must be worked out and the breeder and his product be kept continually before the eye of the prospective customer. In such a system all inquiries by mail must be answered immediately. A short personal letter is best, accompanied by the breeder's card, with circulars describing matings and pointing out the good qualities of the strain. Under separate cover the annual catalogue should be forwarded,—if the breeder's business is extensive enough for him to issue such a booklet. The catalogue should describe in detail all matings and products for sale, and give past winnings and other records. It is also a good plan to give some guarantees as to financial standing, since it is customary to send cash with the order, and this reference makes the purchaser feel more secure.

As a rule, all inquiries should be followed by at least two letters before being dropped; if these fail to bring a response, additional ones would in most cases be a waste of money.

A record should be kept of all sales, so that circulars and catalogues can afterward be mailed to customers, with the idea of keeping their trade year after year. Such a record can be kept on filing cards, and indexed for handy reference. Where advertising is carried on extensively and in a number of different periodicals, it is well to tabulate all inquiries, arranging them under the name of the paper in which the advertisement was noted. This will show the effectiveness of the different papers, and those which are bringing in no return at all can be dropped.

If a business is to prosper year after year, and keep its old customers as well as acquire new ones, the breeder must live up to his advertisement when he fills orders resulting from it. No business will long prosper if the customers are so hoodwinked that they are dissatisfied, and fail to come back every year for additional purchases. The unscrupulous advertiser must depend upon securing enough new customers each year to make up for those lost, which is almost an impossibility. It must be remembered that, after all is said and done, the satisfaction of customers throughout the country is the most extensive advertisement a breeder can have, and the most profitable as well.

#### REVIEW.

1. Give eight advantages of keeping records.
2. What four points should be considered in planning records?
3. What points should be shown in a breeding or mating record?

4. What is meant by a pen record, and what should it show?
5. What should an inventory show?
6. Describe a complete incubator record.
7. Describe a complete brooding record.
8. Describe a form for keeping labor records.
9. Enumerate three methods of keeping general poultry records.
10. Give five features desired in the record plan selected.
11. Outline the possible uses of a diary or memorandum.
12. Discuss the three things which a poultryman's account should show.
13. Name and discuss two general methods of accounting.
14. Describe and give advantages of the column system of single entry.
15. Under what conditions does advertising pay?
16. Outline a complete system of advertising.
17. What products can one profitably advertise?
18. When is it most profitable to advertise?
19. Give three things to be considered in selecting the advertising medium.
20. What would you consider in preparing an advertisement?
21. What should determine size and duration of advertisements?
22. How would you get the most from an advertisement?

**Reference.**—A System of Poultry Accounting, by Robert R. Slocum, U. S. Bureau of Animal Industry Circular 176.



## CHAPTER XXVII.

### EXHIBITING AND JUDGING

THE MANY advantages which a poultryman or farmer derives from exhibiting his poultry and products will be discussed in the following paragraphs.

**Exhibiting for Pleasure.**—There are some poultrymen who keep a few well-bred birds because of the pleasure they derive from mating and breeding them to a certain standard, for the sake of the competition and the possibility of beating the other fellow. They are usually small breeders, and at the small poultry shows they form the majority of the exhibitors. But whether exhibiting for profit or otherwise, and in order to appreciate the work and to get all he can out of it, the breeder must have some of the enthusiasm in competition which characterizes the true exhibitor for pleasure.

**Profit from Prizes.**—The profit from prizes, whether cash, cups, or other articles, is an advantage to be considered. The cost of preparing and exhibiting live birds is, as a rule, much greater than the actual value of prizes, yet the satisfaction of having won enhances the value of the prize in a way that cannot be expressed in dollars and cents. In some of the larger shows sweepstake prizes of considerable value are offered and are well worth winning from a monetary point of view.

**Profit from Advertising.**—Undoubtedly the greatest benefit which can come to an exhibitor is the notoriety which his birds achieve when he is successful in winning some of the leading prizes in that particular class. It brings his name prominently before prospective purchasers of high-priced birds, which creates a demand, and permits him to place a higher value on each of his individual birds. It makes good advertising matter,—material which speaks for itself, and is no mere statement without sufficient backing.

**Profit from the Sale of Birds.**—Another beneficial result of exhibiting is the possibility which it offers of disposing of birds at a price in advance of that obtained without exhibition. The prospective purchaser comes to the show looking for stock for breeding purposes, and the exhibitor goes to the show to exhibit

such stock. In fact, the greatest success which can attend any show, and one which insures its future support, is the fact that exhibitors have been able to make profitable sales. This means also the taking of many orders in the future for eggs to be used for hatching, and for day-old chicks.

**Profiting by Comparison.**—The exhibitor has the opportunity to compare his products with those of his contemporary. He can check up his work; and, knowing something of the methods of his fellow-breeder, can estimate the results and profit by the comparison. This opportunity for comparison might be termed the educational feature of poultry shows, but the advantage to be derived from it will depend upon the time and energy devoted to the study. These shows also furnish opportunity to make a satisfactory comparison of the different appliances and equipments for poultry craft.

The advantages of poultry exhibition are numerous, and are increasing every year. In the world of poultry endeavor exhibits have come to stay, and will have a permanent influence in perfecting breed types and making them popular.

**Development of Poultry Exhibits.**—Ever since distinct types of birds were first recognized, there have been informal gatherings to exhibit birds and discuss their differences. Authenticated records of poultry exhibitions show that they were first held in England, early in the nineteenth century. These meetings were composed almost entirely of small fanciers. Poultry was first exhibited in America at agricultural fairs, where prizes were offered for common barnyard poultry, no distinct line at first being drawn between breed types. In the early exhibitions numbers counted for more than quality. With a clearer distinction between breeds and varieties, and with an ever-increasing interest in breeding to standard, came a marked change and improvement in poultry exhibitions—not only in poultry shows in connection with agricultural fairs, but in the evolution of the typical fancy show which has been everywhere prominent for the past twenty years.

During the past ten years these smaller shows have grown in number and in popularity. The smaller shows are usually conducted by an organization of a few poultry growers in a rather restricted community. Some of these have grown rapidly and now have a world-wide membership. The shows of moderate size are of greatest educational value; in the largest shows the money from prizes is the main object.

Poultry shows and exhibits have so increased in numbers and importance that a professional can now start early in the fall and make a circuit of the larger shows, and thus have birds on exhibition nearly all the show season.

The exhibitor can choose from two types of shows,—namely, county and State fairs and pure poultry exhibitions. The former are patronized to quite an extent by the small breeder who has not yet attained such a degree of perfection as will permit him to compete at the larger and special poultry shows. They are also frequented by the breeder on a large scale as a means of getting his birds into shape for the winter shows. He has a chance to win some prizes, which will offset the need of special effort at home.

**Types of Poultry Exhibitions.**—There are four distinct classes of poultry exhibits: Standard-bred poultry, exhibits which represent merely utility value, exhibits of poultry products, and educational poultry exhibits.

*Standard-bred poultry* predominates, and is found more or less in all poultry exhibitions, regardless of the primary object. The breeding of standard-bred poultry should be, and is, the chief aim of the great majority of poultry breeders, whether they seek ultimately to gain distinction by breeding prize winners or by producing market eggs or the best market poultry. Hence the exhibition of birds which are standard-bred as to color pattern, weight, and shape is a matter of vital interest to all.

*Utility Features.*—Exhibitions of poultry for their utility or commercial food value are now enjoying considerable popularity, and are becoming a regular side issue of the standard poultry exhibition. Prizes are offered, and competent judges appointed to award them. The birds are arranged in two classes,—live and dressed; each may be subdivided, according to their commercial value, as fowls, large roasters, light roasters, large, medium, and squab broilers, and capons. Prizes are awarded according to weight, shape, and appearance. In view of their increasing popularity, these exhibitions will no doubt be extensively developed in the near future.

*Exhibitions of poultry products* now take place in connection with regular shows, and are becoming even more popular than the utility exhibits. These products are usually eggs, prizes being offered and classes arranged for white and brown eggs, for eggs from the different standard breeds, and for commercial eggs

showing methods of crating and marketing. In awarding premiums the size, weight, shape, color, uniformity, texture, and cleanliness are all taken into account. Such exhibits can be made very instructive by showing improvements in grading and marketing, and the higher prices thereby realized.

*Educational exhibits* may be of two distinct kinds,—college poultry shows and poultry extension exhibits. College shows are run by the students themselves as a part of the course of instruction in poultry craft. These shows usually embrace all the types of exhibits, and are purely for educational purposes, the students forming from among their members the organization necessary to run the show properly, outlining classes, erecting coops, and staging the birds. It is generally the custom to let each student make entries from the college flock, the order of selection and entry being drawn by lot. In connection with such a show, there is usually a competitive judging contest, in which the students are given a certain class to judge by comparison, the successful competitors winning cups or other premiums for their excellent work. The information secured and the experience acquired by such an exhibition do more to fix breed types in mind and familiarize the student with the objects and methods of running a show than weeks of study in the classroom would accomplish.

The second distinctive educational exhibit may be termed "poultry extension exhibits at agricultural fairs and poultry shows." Such exhibits are prepared by the poultry departments of the State Agricultural Colleges, and are exhibited at all leading fairs and shows in their respective States. They deal more with methods than with the actual exhibition of birds, although the latter is done to some extent. The housing and care of poultry is taught by means of models and charts, also feeding, sanitation, grading, sorting, and packing.

The possibilities in such work are almost endless and the results far-reaching, for they demonstrate to the farmer the teachings of experimental work and offer to the colleges and experiment stations an opportunity to keep in touch with the conditions in different communities. This same kind of exhibit is often used in connection with educational train work, where a part of a car or a whole one is devoted to a travelling poultry exhibit, which is a supplement to lectures given. Demonstrations in killing, picking, and packing are also given in connection with this educational

train work. Extension teaching in connection with poultry exhibitions is as yet in its infancy, but there are wonderful opportunities for its further development.

#### EXHIBITION OF STANDARD-BRED POULTRY.

**Preparing Birds for Exhibition.**—To train and exhibit poultry in such a manner as to win success calls for a full understanding of the requirements as well as years of experience in the actual work of exhibiting. The amateur should begin with the smaller shows, where there is little competition, and where he can gain the absolutely necessary experience without becoming discouraged. Wherever possible, it is advisable to work for a few years with an experienced and successful exhibitor before starting out for oneself. It is the same in exhibiting as in other lines of work: There are "tricks of the trade" which would require years to learn by experience, also sources of loss which should be learned under careful guidance. Thus the road to success is learned more quickly and more certainly.

**Training the Birds.**—In order to get the birds into prime condition and to have them appear to advantage, it is the custom to place those to be exhibited in small training coops, similar in size to the ones used at the show, and then by constant attention accustom them to seeing people and to being handled. On large exhibition plants special houses are provided for this training; they are fitted up like a regular showroom, the specimens being selected early in the fall. After a short period of training a second selection is usually made, only those being chosen which show the best characteristics and which bear handling. As a matter of fact, preparation for the show is a continuous procedure, beginning at the time the birds are hatched and lasting throughout their exhibition life. The birds designed for exhibition are hatched early, usually in January or February, so that they may attain maturity and standard weight by the time of the fall shows. They are housed and protected from weather which would injure their plumage and are carefully watched for scaly legs or anything else which would impair their show value.

Male birds require special training to help them to maintain their proper symmetry and carriage. The best way is to condition them in small pens, about four feet square, on the floor of the conditioning house, and to place with them three or four

hens, which are not to be exhibited. Under no circumstances should two males be placed in the same conditioning pen. During this training period the birds should be kept free from lice, and not be allowed to tear their combs, wattles, or ear lobes.

The floors of the training coops should be covered about four to six inches deep with clean straw litter. Hard grain should be fed exclusively, except when the putting on of flesh is desired, and then considerable corn and a wet mash may be fed. If during the show the birds are to be fed on some special commercial ration, it is well to accustom them to it by feeding it as part of their ration for the two weeks preceding the show.

Success at the show will depend largely upon the behavior of the birds in the pens. Of two birds that fully come up to the standard, the one that is easy to handle, that is gentle, that does not tear around the cage when the judge is inspecting, but takes a characteristic pose and holds it, is sure to get the highest award. These qualities in show birds are almost wholly due to training, and they will often make an inferior bird come out ahead of one with a higher score that lacks these traits.

**Conditioning and Selection.**—Opinions differ widely as to the extent to which an exhibitor can rightly go in preparing his bird for exhibition. Conditioning is an artificial process; therefore it is hard to say where the line shall be drawn. Of course, if the poultryman is going to the trouble of exhibiting, he should use all legitimate means to put his birds into fine condition. Obviously it is perfectly proper for the poultryman to remove dead or broken feathers so that new ones may grow before the show, to wash birds, to clean the shanks and legs, or to cram for heavier weight; in fact, to do anything which will naturally put the bird in the best possible condition for exhibition.

But some obviously improper procedures are in vogue. Illustrations are: Performing surgical operations to alter the shape of the comb and wattles, removing the feathers from the shanks of clean-legged breeds, trimming the feathers, dyeing the plumage, or bleaching white plumage with bleaching powder.

Some of the debatable questions—excuse for which depends largely upon the moral code of the exhibitor—are the removal of defective feathers in soft plumage and the removal of stubs.

Birds selected for possible exhibition must be free from any blemish, and in shape of body, color, and pattern must conform

to the standard as nearly as possible. In making a selection the following rules will usually hold good:

Study the parts of the head particularly, as they are the most easily seen, and any defect in comb, wattles, or eyes will quickly be noticed by the judge and visitors.

The conformation of the body should be observed, and no bird exhibited which has not the typical shape for that breed.

The color markings are important, and both surface and under color should be studied.

In choosing between two or more birds, the one having a very glaring defect should be discarded for one with minor defects, even though in greater number.

A brassy or creamy tint in the plumage of a white bird is a serious defect. It is impossible to win a prize or even create a pleasing impression with such a specimen.

Large birds which come up to, or a little above, standard weight should be given the preference over small or undersized specimens, if other things are equal. Birds below standard weight may possibly be brought up to the desired point by feeding.

Having selected specimens according to these rules, they should be placed in training pens, and continually posed until they learn to stand in the desired position, the trainer using a small round stick for this purpose. Nervous birds require a much longer time for proper training. The more frequently the birds are handled, the more quickly will they become submissive. Slight defects in the angle of the comb, wattles, or tail, may be wholly or in part corrected by persistent manipulation with the fingers. The exhibitor should send his birds to the show absolutely clean; this means the washing of the comb, wattles, and ear lobes, and of the shanks and toes, with warm water and brush to remove dirt from between the toes and under the scales. After they are clean, they should be sponged with clean cold water, then rubbed with carbolated vaseline, and immediately wiped perfectly dry with a soft cloth.

Birds with soiled plumage should be washed, which greatly improves their appearance. Washing is a delicate operation which, to be well done, requires some experience. The amateur should practise on cull specimens before attempting to wash show birds (Figs. 207 and 208). Washing should be done in a room heated to a temperature of about 85° F. Four large wash-tubs are required. The birds being immersed in the first tub

with only the head out of the water, the feathers should be lathered with a good wool soap, being careful to work the soap into the feathers, but not to rub across the grain or unduly ruffle them. Next the bird is thoroughly rinsed in warm clean water, care being exercised to get all the soap out of the feathers. It is customary next to immerse the bird in a tub of clean cold water to which have been added a few drops of laundry bluing, working it well into the plumage. There must not be too much bluing in the water, or it will give a blue tint to the ear lobes of birds with white lobes. Next the bird is thoroughly rinsed once or



FIG. 207.—Students washing live birds for exhibition. (Photo from Cornell University.)

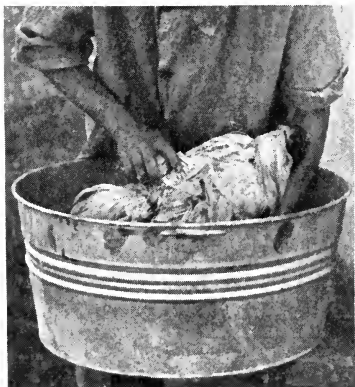
twice in clean cold water. The important point in washing is to remove every bit of the soap, or it will make the feathers curl after drying. Then take a soft towel, and by patting and wrapping it around the bird dry out the water. Then place the bird in a clean coop to dry. The temperature of the room— $85^{\circ}$  at the start—should be gradually cooled to about  $70^{\circ}$ . Too high a drying temperature will make the feathers curl and have a ruffled appearance. To make the feathers stand out from the body, a little laundry starch may be sifted into them. An amateur should not attempt to wash and fit birds for exhibition except under instructions from an experienced person.



A



B



C



FIG. 208.—Birds to be exhibited should be carefully washed and conditioned. *A*, White Wyandotte male ready for washing. The bird should be held so as to prevent fluttering. *B*, All feathers should be completely wet and white soapsuds worked into them clear to the skin. An especially hard place to clean is the back and base of tail. *C*, bird thoroughly rinsed and ready for bluing water.

**Shipping the Birds to the Show.**—Even under the best conditions birds are subjected to considerable rough usage while going to the exhibition; hence they should be shipped in substantial coops so built as to provide enough space for the bird yet not be bulky or heavy. They should be strong enough to bear considerable weight without crushing, as they may be piled high with other packages. They should be protected, yet ventilated on all sides and at the top, thus preventing the possibility of smothering. A slatted crate covered with muslin is excellent.

The coops should be plainly labeled, preferably with two labels, and addressed to the secretary of the poultry show. The secretary of a show usually sends to exhibitors special shipping tags with a designated place for the shipper's name and address.

All exhibition birds should be sent by express. It is not only the quickest way, but they change hands fewer times and are delivered directly at the show building.

**Attention at the Show.**—When the birds are delivered at the showroom, the exhibitor should be on hand and see to their cooping. Immediate cooping is necessary to success. If, from poor management, the birds are allowed to remain in the shipping crates for any length of time, their plumage becomes soiled, and they are apt to become sick or get out of condition.

The exhibitor should see that the exhibition pens allotted to him are protected from strong drafts; if not, he must provide curtains of light-weight muslin. He should also look his birds over carefully when putting them in the pens, to see that they have made the journey without injury, and also to smooth out any rough or disordered plumage. After the birds have been judged and prizes awarded, the exhibitor, if he is to get the full benefit of his exhibit and winnings, should display labels on his pens, giving the name of the owner, the name of the farm, and, if possible, the strain or breeding back of his birds. There is sometimes danger that valuable birds which have won against heavy competition may be stolen; therefore it is advisable to lock the pen with a small, neat padlock. This calls the attention of the visitor to the precautions taken, and indicates the value of the particular bird. While the show is in progress, the fancier will make use of every opportunity to confer with his fellow breeders, to become acquainted with possible customers, to take orders for future shipments of birds and eggs for hatching, as well as to sell the birds on exhibition in the showroom.

The exhibitor should personally attend to cooping his birds for the return journey; for, in the hurry and commotion at the last, there is always danger of mixing the birds, but personal care will prevent it. The exhibitor should secure his premium cards and ribbons for future reference and display. It is unwise to place the ribbons won on the outside of the coop. The best plan is to suspend them from the centre of the coop on the inside, or against the back on the inside, where they can readily be seen from the front. On returning home, the birds should be put in their training coops and kept under quarantine for ten days, to make sure that they have caught no contagion while at the show. If they are soon to be sent to another exhibition, it is well to leave them in the fitting coops during the intervening time.

There are many advantages and possibilities in exhibiting, yet there may be resulting losses. The most common are from disease contracted from neighboring birds, and colds resulting in roup due to improper conditions in the exhibition rooms. The exhibitor must be constantly on the lookout for such troubles during the progress of the show. Quite commonly during transit, either the shipping coops are sent to the wrong place and cannot be traced, or the birds die from severe weather or rough usage.

**Show Associations and the Work.**—Poultry shows are usually held by poultry associations which may or may not be incorporated. The small show is usually started by a few members interested in breeding standard-bred birds. Larger shows, however, are started by an organization incorporated with the object of holding shows. Such an association adopts a constitution and by-laws and elects annually its regular officers, usually a president, vice-president, secretary, and treasurer. It also usually elects or appoints an additional officer, known as the show secretary, who is directly responsible for the financing and operation of the show itself. He, in turn, appoints his assistants and superintendents, the need of these and their number depending upon the size of the show. Many of the larger shows are the outgrowth of small local shows held under the auspices of a small group of breeders. In some sections of the country the small poultry show is gaining favor rapidly.

The first duty of the superintendent of the show and his assistants is to write and issue the premium list, which designates the classes into which entries must be divided, also the premiums which will be paid to the winners. Such a premium list should be

in the hands of the exhibitors at least two months previous to the show. The superintendent should also devote as much space as possible to a commercial exhibit of poultry utensils, feed, and appliances, for such space is usually a source of revenue, as well as an educational feature of the show. He should also arrange for and secure as many special premiums and prizes as possible, as these will heighten interest in the different classes and competitions. He must also set aside certain areas for special non-



FIG. 209.—Baltimore Poultry Exhibit, showing plenty of light and wide aisles, two important factors in a successful poultry show.

competitive displays, since these add to the attractiveness of the show as well as bring in revenue.

One of the first duties of the management is to secure a suitable place for the show (Fig. 209). This in itself is often a hard proposition, because the majority of buildings do not have rooms suited to the purpose, or the price asked is prohibitive, especially for the small shows. The older associations usually hold their annual shows in the same building year after year, and a place for the show need not be considered. As soon as the hall is secured, the pens must be planned and arranged, and spaces set aside for commercial exhibits and special displays. In making the floor plan of the exhibition, these considerations must be borne in mind:

Arrange the aisles and doors so as to reduce to a minimum the possibility of strong drafts of air blowing down the aisles and on the birds in the pens.

Plan for comparatively wide aisles, in order to accommodate the visitors without crowding.

So arrange the aisles that the visitors can systematically make trips through the entire exhibit with the least possible retracing of steps.

Previous to the show, the manager should make all preparations for the immediate cooping of the birds when they reach the exhibition hall, also for feeding them during the show. In the larger shows this privilege of feeding the birds is often given to one of the larger concerns that manufacture poultry feed, and they often take the entire responsibility of cooping and feeding for a merely nominal sum,—sometimes for the advertising value alone.

Arrangements for cleanliness during the show must also be made. This involves the cleaning of the pens and the placing of fresh litter,—usually consisting of shavings or cut straw,—and also the daily spraying of the pens with a good disinfectant.

As soon as premiums have been awarded, the larger poultry shows publish a catalogue of exhibitors and winners, which is a great advertisement for the exhibitors and a very essential feature of the purely financial show.

One of the most important duties of the superintendent is to secure competent judges, and the greatest care must be exercised to choose men of experience, integrity, and force of character.

**Selection of Judges.**—Realizing the desirability of having reliable judges always available, from among whom secretaries of shows can, if they desire, make their choice, the American Poultry Association has organized a licensed bureau of judges, composed of all the available judges of poultry of good character who care to register.

It should be the duty of every secretary so to manage his exhibit that, during the time the judges are performing their work, it will be impossible for any unscrupulous exhibitor purposely or otherwise to bias in any way the decision of the judges. The best plan is to bar all persons except the judges and their secretaries from the showroom during the time that judging is

going on. In order to stamp a higher character on all poultry exhibitions, judges and superintendents of shows should mete out severe punishment on all cases of faking which come to their knowledge.

#### EXHIBITIONS OF POULTRY PRODUCTS.

The competition of classes for dressed poultry and eggs is now coming into prominence at most poultry shows, and is an important feature both from the educational and the commercial standpoint. Such classes will draw a larger number of exhibitors and interested visitors, and prove a most attractive part of the exhibit to the visitors, many of whom have no appreciation of the finer points of a standard-bred bird, but do appreciate good eggs and fine-looking poultry.

It is a much simpler proposition to judge such exhibits than it is to award prizes to live birds. The conflicting characteristics are relatively few, they are in quality only, and are usually seen at a glance. In listing such classes, the publication of the score card to be used in awarding the premiums will help the exhibitor to make his entries, and lead to a more uniform and higher grade of exhibit.

#### JUDGING.

By judging is meant deciding authoritatively upon the respective merits of the birds displayed. Such authority is invested in judges, of whom several are usually employed, the number varying with the number of the entries. Each judge takes the classes with which he is best acquainted, although there are judges who, after extensive experience, can intelligently decide upon points of merit in almost any class.

**The objects of judging may be summed up as follows:**

1. To compare the degree of perfection attained by the specimens to be judged with some recognized and authorized standard. From this standpoint the judges' decision is accepted almost absolutely by exhibitors as determining the efficiency of their breeding and the degree in which they have approached standard requirements.

2. To compare the relative merits of individuals or groups of individuals entered in one class, or which are competitors. This kind of judging is seen at most poultry shows, and results in the competitors taking rank in the order of their excellence.

3. To fix in the mind of the exhibitor the standard requirements. This may be termed an educational purpose to be carried out under supervision or by the individual himself.

**The Principles of Judging.**—Many qualities are needed to make a successful judge, and in judging a show satisfactorily there are important points which in many contests are overlooked. The observance of these at the start will insure just decisions, which satisfy the exhibitor, and without which no poultry show can continue to be successful year after year.

A full knowledge of standard requirements and disqualifications is necessary.

Consistency in judging is essential, and is one of the chief qualifications of a good judge. Some judges have a certain standard fixed in their minds, and, after a few years, an exhibitor under such a judge can select a type which he feels sure the judge will consider the best. This is but natural; hence it is desirable to change the judge from time to time to insure impartial treatment.

Honesty and justice in making decisions form another very important requisite.

The development of a code for judges will promote efficiency and save much time. A simple method would be to make light marks on the display cards while judging to indicate certain defects.

A natural liking for the work is helpful, for greater concentration of effort is sure to follow.

**Methods of Judging.**—There are two general methods of judging poultry,—namely, by comparison and by scoring.

*Judging by comparison* is the natural method of comparing specimens as a whole, giving no one part or combination of parts a numerical value, but awarding the highest prize to the specimen showing the greatest number of good qualities which, taken connectively, surpass all others.

Comparison judging is the method in use for the award of premiums at nearly all poultry shows. Its chief advantage is the rapidity with which one can judge a large class. Even at the first study of the specimens in a class one can discard all those with marked defects, and by comparing several different groups the poorer ones are gradually eliminated, leaving only the best. Premiums are awarded more justly and satisfactorily by this method than by scoring; for birds of inferior type often make a

high score, owing to the aggregate value of the different parts in combination, and also to the fact that it is almost impossible for two judges to cut in exactly the same proportion each time. In comparison, each judge has his own system of marking defects, and by going over a class a few times he can rapidly check off the finest birds. The skill of the judge depends upon his system of checking and his knowledge of standard requirements, combined with an ability to size up the form and glaring defects of a bird at a glance.

*Scoring* is a much more formal method of judging. It is based upon the estimated numerical value of the specimens. This is obtained by giving to each part a value representing its degree of perfection.

Scoring requires a standard score card on which a value is assigned to each part separately considered. This method is in use at some of the smaller poultry shows which are run primarily for educational purposes, and is also used by individuals to determine the relative value of their own specimens. It is also a part of the course of instruction in colleges and agricultural schools, being used to call direct attention to merits and defects.

The chief advantage of this system is that it calls attention to every part of the specimen and to each individual defect. Its purpose is educational. Another superiority which the score card possesses is that, when intelligently used, it forms a complete list of defects with their location, and this is valuable to the breeders for future reference.

The strong feature of the score card is that numerical values represent perfection of the different parts and of the whole. As a tabulated record the success of any score card must depend upon the accuracy with which the specimen is divided into its component values. A disadvantage is that it is impossible for all judges to view a defect in the same light, and to cut in the same proportion. Under the scoring system two judges may arrive at the same total value, yet analysis of their score will show considerable variation in their cuts for individual defects.

**Types of Score Cards.**—The general types of score cards now in use are here briefly described, so that the student or poultryman may apply them to his own specimens, whether birds or poultry products, and get some idea of the merits of each.





The decimal score card is so designed as to give to each part its proportionate rank, the specimen being divided into ten component parts, each of the same value.

In using the standard score card, parts which fall below the requirements are deducted from the perfection value in proportion to the ratio in which they drop below the standard. When the scoring is complete, the cuts are added, and the amount subtracted from 100, which gives the total score of the bird. Ties are quite a common occurrence, but they need not be scored or decided unless it is necessary to determine an award.

The standard score card sets so much value on color markings that its use inclines one, if not careful, to overlook those factors of body shape and apparent vitality which make up the utility or commercial value of the birds. It is, however, true that purity of breeding—hence of color pattern—to a certain extent promotes uniformity. It is also true that by studying color pattern the breeder of standard poultry is led to a closer study of the conformation of the body.

The tendency is, and has been, to sacrifice shape and size for fine feathering, which in the end lowers the commercial value of the breed or strain. Hence if greater stress were laid, in the standard score card, upon conformation of the body, with the view of increasing the utilitarian value of the breed, it would increase the production of standard-bred birds by the general farmer or small poultryman, who must get his living by selling his birds for market purposes.

The perfect bird of any breed is the one which shows perfection in feathering. The utility and standard-bred white Leghorns are good examples of this divergence of values. The fancy Leghorn is a rather small, dainty bird, with small comb and wattles and rather short body; while the Leghorn which yields the highest profits from the sale of eggs is a larger bird, of heavier and coarser development, with long body and larger comb. Such a divergence should not exist; standard-bred birds, to rank as such, should have the typical shape and size developed to their highest degree.

*Score Card for Egg Type of Live Poultry.*—This score card is of use to the breeder of poultry who wishes to breed for maximum egg yield. It fixes in his mind the external characteristics of the bird which are significant of the egg producer. The values given the component parts signify the relative importance of each part in selecting the layers and nonlayers.

*Utility Score Card for Live Poultry.*

Commercial egg production the primary object.

Date..... Exhibitor .....

Entry No..... Breed ..... Age .....

<i>Description.</i>	<i>Counts.</i>	<i>Cuts.</i>
<b>GENERAL APPEARANCE.....</b>	<b>(25)</b>	—
Form, compact and symmetrical, with no undue development in any part, as excessive fat growth, abnormal leg development, or extra long neck...	10	—
Quality, texture of comb fine, skin and flesh soft but not fat, skin mellow and not too thick. Body plump and skin tight, not loose and flabby...	7	—
Temperament, vigorous constitution, active, not lazy. A nervous, energetic temperament is associated with activity.....	8	—
<b>HEAD AND NECK.....</b>	<b>15</b>	—
Head medium to large and broad.....	3	—
Eyes full and prominent; bright, showing vigor.....	3	—
Comb and wattles medium to large in size, and bright red in color. Comb firmly fastened to the head. Comb of single-comb White Leghorn large	5	—
Neck medium in length with full hackle.....	4	—
<b>BODY.....</b>	<b>(50)</b>	—
Hind quarters greatly developed, with heaviest part of the body carried back of the hock joint. V-shaped when viewed from side, top, and front..	15	—
Breast moderately full and wide.....	4	—
Back wide and long, showing great depth from centre of back to point of keel.....	5	—
Fluff abundant, fine, and lying close to the body.....	3	—
Tail carried rather high and well spread.....	2	—
Feathers soft and held close to the body.....	2	—
Wings held well up and carried close to the body.....	3	—
Lay bones soft, pliable, and wide-spread; low-producing females and all females during seasons of low production show these bones much contracted and hardened.....	18	—
<b>LEGS.....</b>	<b>(10)</b>	—
Legs straight, wide-spread, especially at and above the hock joint.....	5	—
Length medium to short; long legs—giving the bird a stilted appearance—are usually associated with lack of vitality and low production.....	2	—
Color of yellow, bluish black, or flesh, depending upon breed characteristics, yellow to have the preference.....	1	—
Shanks free from feathers.....	2	—
<b>Total.....</b>	<b>100</b>	—

Final score..... Judge.....

This score card can be used in two ways,—for instruction concerning the fixing of egg characteristics and for comparison of breeders when selecting for the breeding pen.

In using this score card it must be borne in mind that, if the poultryman is selecting for egg type, vitality should be the first consideration; and, while certain features are usually associated with heavy egg production, yet the trap nest is the only sure way of finding it.

*Score Card for Dressed Poultry.*—This may be used in several ways: For instruction concerning the meat type; by the producer in grading dressed poultry for shipment; by commission men in

determining value of shipments received; and at poultry shows in awarding premiums to dressed poultry. It will help the producer to raise and market a more uniform type of dressed birds, and will indicate to him the special points in killing and packing,—factors which result in a higher market price.

*Score Card for Dressed Poultry.*

Date..... Exhibitor.....  
 Entry No. .... Breed..... Age.....  
 Average weight..... Market type.....

*Description.*

Any sign of poor health or diseased condition is a disqualification. Lack of vigor is a serious defect.

	Counts.	Cuts.
CONDITION.....	(40)	
Weight, perfection being the highest weight allowable in a given class.....	15	—
Plumpness, a full plump development in all parts, especially breast and thighs.....	15	—
Color of shank and skin, according to market requirements: yellow, white, and blue usually preferred in the order named.....	10	—
KILLING AND DRESSING.....	(40)	
Manner of sticking, or bleeding. Perfection is in the throat. For beheading cut five points. For exposed bleeding cut three points.....	10	—
Manner of picking. Dry picking scores highest. For scalding cut three to ten points, depending upon condition.....	15	—
Completeness of picking.....	10	—
Cleanliness and appearance of finished carcass.....	5	—
PACKING AND PACKAGE.....	(20)	
Manner of packing—efficiency, 5 points; uniformity, 5 points.....	10	—
Package, neat, substantial, and attractive.....	5	—
Labeling or guarantee.....	5	—
Total.....	100	—
Final score..... Judge.....		

*Score Card for Market Eggs.*—This brings out the desirable points in first-class market eggs. Such a score card may be used in different ways: For instruction as to market egg requirements; by the producer and shipper to keep in his mind the importance of grading and better methods of packing; at poultry shows in awarding premiums for commercial egg exhibits.

*Score Card for Market Eggs.*

Date..... Exhibitor.....  
 Entry No. .... Breed..... Age.....  
 Weight per dozen in ounces.....

*Description.*

	Counts.	Cuts.
FRESHNESS.....	(30)	
Size of air cell, perfection is one-eighth inch or less in depth. Cut five points for each additional eighth inch in depth.....	20	—
Natural shell lustre, lack of same due to washing or age is a serious defect.....	10	—

	Counts.	Cuts.
<b>WEIGHT</b> .....	(20)	
Weight of total sample, perfection is 27 ounces or more per dozen. Cut one point per dozen for each ounce under weight. Overweight is not a defect.	10	—
Uniformity of sample, all eggs making up a given sample should be of the same weight.	10	—
<b>COLOR</b> .....	(20)	
Color of total sample, pure white or brown is perfect. Creamy or tinted white eggs, a defect. Dark brown eggs have the preference over light brown.	10	—
Uniformity of sample, all eggs in sample should be of same tint. Cut one point for each egg varying in color from average color of sample.	10	—
<b>SHAPE</b> .....	(10)	
Egg shape, the ratio of the large to the small diameter is about one to one and one fifth; this varies slightly with different breeds.	5	—
Uniformity of sample, cut one point for each egg varying from the average shape of all eggs in a given sample.	5	—
<b>APPEARANCE</b> .....	(10)	
Clean, all eggs should be free from dirt or blood stains; cut one-half point for each egg so stained.	5	—
Not cracked or broken, cut one point for each cracked egg in sample. More than five cracked eggs or any egg broken so that the contents leak disqualifies the sample.	5	—
<b>CONDITION OF SHELL</b> .....	(5)	
Smoothness of shell, cut one-half point for each rough-shelled egg.	3	—
Hardness of shell, thin-shelled eggs which break easily and do not offer desirable shipping possibilities are defective.	2	—
<b>PACKAGE</b> .....	(5)	
Neat and attractive package.	3	—
Lightness of package.	1	—
Durability of package.	1	—
Total .....	100	—
Final score .....	Judge .....	

*Score Cards for Poultry Plants.*—This score card indicates some points to be considered in poultry-plant location, construction, and management. The poultryman who is designing or building a plant will find in it valuable suggestions for grouping his buildings and for equipment that will produce the best results.

*Score Card for Educational Inspection of Poultry Plant.*

Owner of farm .....	P.O. Address .....
County .....	State .....
Breed .....	Average production per bird per year .....
Total number of chicks hatched .....	
Total number of adult females wintered .....	
Products sold, wholesale or retail .....	
Other products produced besides eggs .....	
Remarks .....	
Date .....	
	Inspector .....

	Counts.	Cuts.
<b>EQUIPMENT.</b>		
General appearance, as to efficiency .....	3	—
Health of birds .....	8	—
Fowls showing lack of vigor cut 4; fowls showing signs of disease cut 4.		

	Counts.	Cuts.
Comfort of birds.....	4	—
Temperature of house counts 2; moisture conditions count 2		
Location of houses.....	4	—
Well drained, count 2; facing south, count 2		
Construction of houses.....	10	—
Shed roof; perfect, count 2; smooth tight walls, 1; tight sound floor: concrete 3, dirt 2, wood 1; proper type and arrangement of fixtures, 4.		
Light (glass).....	4	—
1 sq. ft. to each 16 sq. ft. of floor space or to each 4 birds, counts perfect; 1 sq. ft. to 8 birds, count 3; to 12 birds, count 2; to 16 birds, count 1.		
Ventilation.....	5	—
Muslin perfect. 1 sq. ft. to 2 birds, count 5; 1 sq. ft. to 4 birds, count 4; 1 sq. ft. to 6 birds, allow 3; no muslin, counts 2 or less.		
Utensils.....	2	—
Facilities for doing work properly, 1; durability, 1.		
Incubation equipment.....	5	—
Location of incubator house, 1; ventilation, 1; means of supplying moisture, 1; arrangement of cellar, 1; efficiency and sufficiency, 1.		
Brooding equipment.....	5	—
Light, 1; ventilation, 1; sanitary conditions, 1; labor-saving devices, 1; efficiency and sufficiency, 1.		
Total for equipment.....	50	—
<b>METHODS.</b>		
Floor space per bird.....	4	—
4 sq. ft. count 4; 3 count 3; 2 count 2.		
Cleanliness of birds.....	5	—
Cleanliness of houses.....	8	—
Perches 2; nests 2; walls 1; curtains 2; glass 1.		
Feeding practices.....		
Dry mash.....	8	—
Wet mash, count 4.		
Scratch grains.....	6	—
Hopper grains, count 2. Consider 4 as the value of manner and time of feeding; and count 2 on condition of litter.		
Water.....	2	—
Clean and fresh, 1; convenient and abundant, 1.		
Succulence, method and efficiency.....	4	—
Count perfect for double yarding, or range, in summer and sprouted oats, vegetables, or root crops in winter.		
General methods of entire feeding practice.....	2	—
Range conditions.....	6	—
Abundance of range, 1; shade, 2; green feed, 2; dry mash, hopper fed, 1.		
Method of handling and marketing the eggs.....	5	—
Regularity of collection, 1; care used in grading, 1; method of packing for shipment, 1; regularity and frequency of shipping, 1; sterility in market eggs, 1.		
Total for method.....	50	—
Cuts equipment.....		
Cuts methods.....		
Total cuts.....		
Final score.....		

### REVIEW.

1. Name five advantages of exhibiting.
2. Discuss the development of poultry exhibits.
3. Name four types of poultry exhibits.
4. What are some of the possibilities in educational exhibits?
5. What would be your procedure in training a bird for exhibition?
6. What would you consider legitimate conditioning?
7. What do you consider illegitimate conditioning?
8. Give the points you would look for in selecting birds for exhibition.
9. Describe how to wash a bird.
10. Give points of caution in shipping birds to the show.

11. What attention do they require at the show?
12. Outline the organization and preliminary work necessary to run a poultry show.
13. How are judges selected?
14. Give best conditions necessary for their doing good work.
15. Give three objects of judging.
16. Name and define two judging methods.
17. Give the advantages of each method.
18. Enumerate five principles underlying successful judging.
19. Give the main points of the official score card for standard poultry.
20. Give the uses of a score card for live poultry of the egg type.
21. What are the uses of a score card for dressed poultry?
22. Outline the main points of a score card for market eggs.

**Reference.**—The Value of the Poultry Show, U. S. Bureau of Animal Industry Report, 1908.

## CHAPTER XXVIII.

### DISEASES, PARASITES, AND ENEMIES.

IN every flock of poultry, regardless of size, an outbreak of disease is always possible. In some cases this is due to environment or management for which the poultryman is directly responsible; in others, disease may break out in a flock well cared for. Every poultryman, therefore, should familiarize himself with the structure and functions of the bird's body, so that the first symptoms of disease will be perceived, and proper steps taken to check its spread. Perfect health depends upon a full understanding of environment and feeding, which have been elsewhere outlined, with a knowledge of the laws of sanitation and prevention of disease.

**Treating Diseased Poultry.**—With the average fowl or average flock it is a well-established principle that it does not pay to treat diseased birds unless they are of exceptionally high value and the disease is not infectious. The reasons are as follows:

Birds which have ever been affected with the common diseases and are supposedly cured are a constant menace to the flock. If allowed to mingle with the others, their identity may be mistaken, and they may be put in the breeding pen, to perpetuate through their offspring a weakened constitution and tendency to similar diseases in succeeding generations.

The value of the individual bird and its production are so small, in comparison with the time which must be devoted to treatment and the cost of medicine, that it is rarely a profitable expenditure of time unless a bird be very valuable.

*Diseases* that are infectious or highly contagious should never be treated with the idea of subsequently using or selling the affected birds. The custom should be to kill all that are diseased, and at once to begin thorough disinfection and keep it up for an indefinite period.

*When to Treat Poultry.*—It is both practicable and profitable to treat sick poultry under any of the following circumstances:

1. When only one or a few fowls need treatment which is simple, easy of administration, and absolutely certain in its effects.
2. When, as in the case of certain common and simple infec-



tions, it is possible to treat the whole flock collectively, with reasonable certainty of benefit.

3. In the case of individual birds of high intrinsic value, the extent and the nature of the treatment must be decided by the poultryman himself. Here, however, there will be a much greater number of diseases that can be profitably treated.

**Prevention Rather than Cure.**—The aim of all poultrymen, whether engaged in a large commercial business, a small backyard poultry plant, or the production of fancy specimens, should be so to care for the birds, and to institute such sanitary measures, that disease will be prevented, rather than to try to cure disease after it is firmly established. This accords with the present attitude of the medical profession, and bears out the old adage, "An ounce of prevention is worth a pound of cure." Vigorous health is the first requisite in preventing and combating disease. The elementary principles involved in maintaining a flock in healthy condition and free from disease will now be considered.

Hereditary vigor of constitution helps to throw off disease, and must be bred into flocks in which it is lacking. Selection must go on continuously from year to year for this purpose.

Practising sanitary and hygienic care,—that is, a system of management absolutely hygienic and an environment perfectly sanitary.

Maintain a careful oversight, and immediately isolate or slaughter any diseased bird or birds, with prompt and thorough disinfection whenever any signs of disease appear.

**Poultry Hygiene and Sanitation.**—Given healthy birds of vigorous constitution, an important necessity is to have absolute cleanliness. While some poultrymen may succeed for a time in defiance of this, yet the time is sure to come when neglect of cleanliness will make itself felt. Of course, disease may come in spite of all precautions, yet the possibility of its doing so can be reduced to a minimum.

The word "hygiene" is practically synonymous with cleanliness, hence its use in the following discussion. The essentials of hygienic care may be summed up in the following groups: Clean housing; clean feeding; clean yards and runs; and clean birds.

*Clean Housing.*—The first step toward securing a clean house, if a dropping board be used, is to remove the droppings at least once a week, and sometimes oftener. If an absorbent is used, a good plan is to clean the dropping boards whenever the droppings become wet or if they do not dry quickly. In a moist state they

emit an objectionable odor, which is not the case if they dry and harden immediately.

The floor should be covered with a good scratching material which should be kept fairly fresh and clean, free from excess moisture, and fairly coarse. It should be removed and replaced with fresh material whenever it becomes damp or is filled with droppings which do not dry.

The house should be given a thorough cleansing at least twice a year, and if necessary oftener. All portable fixtures should be removed, washed, and placed in the sunshine to dry, and all window-panes cleaned. All muslin curtains must be beaten, to rid them of dust and make them more pervious to ventilation. The litter and nesting material must be removed, after which the interior of the house and all fixtures should be thoroughly sprayed with the following disinfecting solution: 5 quarts cream of lime; 1 pint of zenoleum; 1 quart of kerosene.

This mixture should be well shaken and diluted with an equal amount of water, then applied with a force-pump through a fine nozzle. Used thoroughly in this way, the solution will accomplish three things more rapidly and easily than if applied with a brush:

1. A thin coat of whitewash will be evenly applied and spread with force enough to put it into all the cracks and crevices.

2. The zenoleum will kill any disease germs which may be lurking in the house.

3. The kerosene will destroy or drive out all red mites, and to some extent body lice. The former are easily exterminated by this spray, and the latter by means of a good lice powder in connection with the spray.

The above solution, for common use, is cheap, easily applied and a perfect disinfectant, making the house clean, which means more attractive surroundings and healthier birds.

The fixtures should next be replaced, the floor covered with fresh, clean litter, and new nesting material put in the nests.

Besides frequent cleansing, to keep the house sanitary there must be an abundance of sunlight, which in itself is a powerful germ destroyer, and proved to be very beneficial to the health of the birds. The prevention of dampness, too, is a vital consideration, since damp, dark quarters furnish a natural breeding-ground for all types of bacteria,—places where filth cannot be readily detected, and where disease germs may multiply undisturbed.

*Clean Feeding.*—To sum up in few words, clean feeding neces-

sitates the use only of fresh, pure feed stuffs, and the avoidance of all moldy or musty grains and mashes; the supplying of abundance of succulent feed at frequent intervals and in small amounts, so that none will remain from one feeding time to another and become sour. All drinking vessels must be kept sweet and clean, and be filled with clean, fresh water. Drinking vessels should be washed thoroughly every month with a five per cent zenoleum solution. The feeding floor and vessels must be kept clean, especially if wet mashes are given. The birds should not be unduly forced, as this causes loss of vitality and stamina and makes them more likely to contract diseases which the vigorous fowl would resist. Health is also promoted by considerable exercise induced by the feeding of grain in litter and by having plenty of yard room.

One of the most common modes by which infectious diseases are transmitted to a flock is by means of drinking water from the vessels which all use in common. Owing to this fact, it is customary to give to flocks, especially if they show any signs of roup or other infection, a drinking water containing some harmless antiseptic. The best and most common one is potassium permanganate, which can be purchased at any drug store for about twenty-five cents per pound, and from which a stock solution to full saturation should be made, or a solution in which is dissolved as much as possible of the crystal, some being left in the bottom of the jar or pail. This solution should be tightly stoppered, and a little of it can be placed in the fountain each time water is drawn, the proportion being two teaspoonfuls to ten quarts of water, which will give the water a purple color. This is recommended only when the birds show signs of colds.

*Clean Yards.*—Tainted and filthy yards breed infection which transmits disease from one flock to another or from one fowl to another in the same flock. The best and safest rule is to have the yards as large as possible, for the larger the yard the less the danger of excessive filth accumulation. Where there are only small runs, the frequent cultivation of these will greatly reduce the possibility of spread of infection. The raising of succulent green crops for forage will not only dispose of the surface droppings, but will convert them into crops which the birds can later use for feed.

*Clean Birds.*—If poultry are to be healthy and develop their productive powers to the fullest extent, they must be free from parasites, both internal and external. The destruction of parasites will be considered later. They are merely mentioned here as one

of the factors in poultry hygiene. The term "clean birds" means the immediate checking of any symptoms of disease. This necessitates not only the treatment of sick birds, but their immediate isolation, and the proper disposal of dead ones.

The only safe way to dispose of dead birds is to burn them, which is especially necessary if the diseases are highly infectious. If buried, it should be at least three feet deep, to prevent the possibility of dogs or wild animals digging them up. The danger of infection, however, is never entirely averted except by burning. A most unwise practice is to throw the bodies into the bushes, or other out-of-the-way spot, whence the infection, if present, may be carried broadcast.

**The Diagnosis of Disease.**—The first question which confronts a poultryman with sick birds is, "What ails my birds?" It is obviously necessary to determine the nature of the trouble before instituting preventive or curative treatment. But it must be understood that the average poultryman or farmer cannot diagnose poultry diseases, either by external or internal examination, with any degree of certainty. In most cases it is possible by a careful examination to locate the trouble, and thereby to place it in a general group of disorders which affect this or that particular organ in a given way. There are two general methods of making a diagnosis,—external examination and post-mortem examination internally.

*An external examination may show* certain well-defined symptoms which are almost always associated with illness of any nature, and which must be understood before attempting to make an exact diagnosis.

*Symptoms to look for are:* A lack of interest in what is going on about it; a dumpy appearance, caused by contraction of the neck, ruffled feathers, sitting in one place, usually in a dark corner out of the way of other birds; the eyes closed most of the time, giving the bird a sleepy appearance; the wattles and the comb shrivelled up and dark or purple in color, or very pale; decided loss of appetite. When these symptoms are noted, the bird should be isolated, and an attempt made more accurately to define the trouble by a detailed examination.

The following classification of external symptoms may assist the one making the diagnosis in determining which of a number of specific diseases is really present in the specimen. Before accepting this as the direct cause, he should compare the symptoms with an accurate pathological description.

*External Symptoms and the Diseases which they Indicate.*

(From Bulletin published by Maine Experiment Station.)

<i>Symptoms.</i>	<i>Diseases Indicated.</i>
Abdomen swollen.....	Peritonitis; dropsy; white diarrhœa.
Belching of gas.....	Inflammation of the crop.
Breathing abnormal,— <i>i.e.</i> , too slow, too rapid, wheezing, whistling, or snoring.	All diseases of the respiratory system; arsenic poisoning; pericarditis; gapes; air-sac mite.
Choking.....	Arsenic poisoning.
Comb pale.....	Tuberculosis; dropsy; air-sac mite; infectious leukæmia; white diarrhœa.
Comb first pale but later dark..	Enteritis.
Comb very dark.....	Liver disease; blackhead; congestion of lungs; pneumonia.
Comb yellow.....	Liver disease; visceral gout.
Comb with white powdery scurf.	White comb.
Constipation.....	Simple constipation; indigestion; inflammation of the oviduct.
Convulsions.....	Arsenic poisoning; copper, lead, or zinc poisoning; epilepsy; harvest bug.
Cough.....	Diseases of the respiratory system.
Crop enlarged and hard.....	Crop-bound.
Crop enlarged and soft.....	Inflammation of the crop; enlarged crop; gastritis.
Diarrhœa.....	Diseases of the alimentary tract; poisonings of all kinds; blackhead; tuberculosis; cholera; roup; white diarrhœa.
Emaciation.....	Tuberculosis; aspergillois; visceral gout; mites; white diarrhœa.
Eye, expansion of pupil.....	Arsenic poisoning.
Eye, sticky discharge from.....	Catarrh; roup.
Face swollen.....	Roup.
Droppings bright emerald-green.	Cholera.
Fever, very pronounced.....	Peritonitis; aspergillois; infectious leukæmia; inflammation of the oviduct.
Lameness.....	Tuberculosis; aspergillois; rheumatism; scaly legs; bumble foot.
Legs, roughened with scales raised.	Scaly legs.
Mouth, mucous discharge.....	Congestion of the lungs; pneumonia; gapes.
Mouth, white, cheesy patches..	Roup; canker.
Neck bent back.....	Poisoning; congestion of the brain; wry-neck.
Neck limp.....	Limber neck.
Paralysis.....	Poisoning; apoplexy; heat prostration.
Saliva, abundant secretion.....	Arsenic poisoning.
Skin, scaly and incrustated.....	Body mange; favus.
Staggering.....	Congestion of the brain; leg weakness.
Thirst, excessive.....	Hypertrophy of the liver; peritonitis; aspergillois, tapeworms.
Tongue, hard and dry.....	Pip; diseases of the respiratory system.
Tumors on head.....	Roup; chicken pox.
Urates yellow.....	Cholera.
Vent, mass of inflamed tissue projecting from.	Prolapsus of the oviduct.
Vent, skin inflamed with yellow discharge and offensive odor.	Vent gleet.

**Post-mortem Examination.**—Whenever birds die from unknown causes, the poultryman should make a post-mortem examination, and try to determine from the general condition of the internal organs the exact nature of the disease. This may prevent any further outbreak, and the experience acquired by dissecting and studying the birds will enable the poultryman to do it each time more accurately. He should be so familiar with the normal appearance of the organs as to detect at once any unnatural condition. The majority of birds which die are victims either of simple diseases or of complications which have decided internal and visible characteristics, and with a little study such post-mortem examinations will prove both interesting and instructive.

The following procedure is recommended in making such an examination: Lay the dead bird on her back, braced up on a piece of inch board; extend the wings and legs, and fasten with sharp nails to the board. Pluck the feathers from the breast and abdomen; then take a sharp knife, and cut the skin on the median line from the crop to the vent, taking care not to cut through the flesh and rupture any of the organs.

Next take a pair of blunt-pointed, sharp scissors and cut the flesh away from the abdomen, cutting the ribs on either side of the breastbone, so that it may be taken out entire. In doing this be careful not to injure the organs or to make them bleed. After the sternum (breastbone) is removed, the entire cavity of the body is exposed, and the organs will be seen lying in their natural position. Now study each organ, taking the uppermost first, and ascertain if it is normal, or, if not, what is the cause of the abnormal condition.

The liver is the most prominent organ, and in the healthy bird should be rich reddish brown in color and free from any specks or blotches. It should be firm in texture, neither excessively large nor shrivelled up. Both lobes should be approximately of the same size, and the gall-bladder normal in size, bright green in color, and not ruptured.

The heart should next be studied. It should be firm in texture, free from an excessive accumulation of fat, and not excessive in size. Both lobes should be of the same size; if not, it may indicate heart failure. There should be no tubercles or nodules on the heart nor in its sac; either presence may denote tuberculosis.

The lungs are next studied, and will be found on either side of the heart at the back. They are pink in color, and composed of spongy tissue. The lungs should always be examined for nodules

of tuberculosis and for lesions of aspergillosis, the latter being much more common in the fowl than tuberculosis of the lungs. A small piece of the lungs should be placed in a tray of water. It will float if healthy, and sink if unhealthy.

The crop, gullet, and windpipe should next be studied,—especially the crop,—to see that there is no obstruction which would stop the feed from entering the stomach and gizzard. The organs previously examined can now be removed, and careful examination be made of the gizzard and intestines to see that the walls as well as the undigested material within them are normal in appearance. The cæcum should be studied, and the presence or absence of tubercles on the intestinal membranes noted. Next the reproductive organs of the female can be studied, to determine the possible rupture of the oviduct or the breaking of an egg in it.

In making a post-mortem examination, if the disease seems to have been located, a description of the disease should be gone over carefully and compared with the conditions found, to verify or disprove the supposition.

**Diseases of Poultry.**—In studying the diseases of the domestic fowl, the most systematic procedure is to group them, according to their location or the group of organs which they directly affect, as diseases of the digestive system, nervous system, respiratory system, and reproductive system.

Furthermore, there are diseases not associated with any particular group of organs or any one system, which, nevertheless, should be considered. These may be termed miscellaneous diseases.

There is still another group, representing a few diseases of highly infectious nature which may affect one or more parts of the body. These are termed infectious diseases.

The following list gives the common diseases which the average poultryman is apt to meet in every-day work. They are grouped according to the system with which they are associated. Owing to limited space, detailed discussion of these is impossible. At the end of this chapter will be found references to standard authorities on poultry diseases, where detailed information concerning each specific disease may be found.

Diseases of the digestive system: Impacted, inflamed, or enlarged crop; inflammation of the stomach, gastritis; simple diarrhœa; enteritis; indigestion; constipation.

Diseases of the nervous system: Apoplexy; heat prostration; congestion of the brain; epilepsy.

Diseases of the respiratory system: Catarrh; bronchitis; influenza; roup; pip; canker; thrush; aspergillosis; congestion of the lungs; pneumonia.

Diseases of the reproductive system of females: Ovarian tumors; absorption of eggs; enlargement of the yolks; inflammation of the oviduct; prolapse of the oviduct; obstruction of the oviduct; rupture of the oviduct; vent gleet; breaking down behind.

Diseases of the male reproductive organs are of no economic importance.

Miscellaneous diseases: Diseases of the liver; diseases of the skin; chicken pox.

Special diseases of chickens: White diarrhoea; leg weakness.

Infectious diseases: Tuberculosis; diphtheria; cholera.

By the study of one or more of the recommended text-books on diseases, every poultryman and student may become familiar with the symptoms, causes, and common methods of treatment of the diseases outlined. These are by no means all of the diseases of poultry, but they cover the more common affections.

**Poultry Surgery.**—In the case of lacerations, cuts, or other wounds, a little knowledge of surgical methods may enable one successfully to cleanse and sew them up, thus in many cases saving a valuable bird. From a surgical standpoint, there is more latitude with poultry than with almost any other animals, as illustrated in the operation of caponizing. This is usually performed with but little, if any, attention to aseptic precautions.

Cuts or wounds of any degree of severity may be successfully treated by the following method if the value of the bird warrants the time and trouble:

Wash the hands and instruments thoroughly with soap, then rinse the hands in a 1 to 1,000 solution of bichloride of mercury.

Pluck all feathers in the vicinity of the wound and wash the adjoining parts with warm water, using a piece of cotton or soft cloth, then wash with the mercury solution.

If the wound is small, it need not be sewed up; if large, it should be sewed with white silk thread previously soaked in alcohol. If the wound penetrates the muscles or other organs besides the skin, sew each up separately.

When completed, powder the wound with iodoform, put the bird in a small, clean coop, and watch the wound for a few days and keep it clean.

*Bumble Foot.*—This means corns or abscesses on the sole of



the foot caused by injury, usually by jumping or flying from a great height. The treatment is to open the sore spot with a sharp knife, going to the bottom; extract the entire core. Then proceed as when treating wounds, except that it is unnecessary to sew up so small a cut.

*Frozen Combs.*—In the northern part of the United States and Canada, especially during exceptionally cold weather, and if not properly housed or protected, it is a common occurrence for individual fowls, and sometimes whole flocks, to have their combs and wattles frozen. When this misfortune happens, there is an immediate falling off in egg production. If the affected birds are not treated at once, this falling off will be very marked and prolonged, and, if badly frosted, the frozen parts will be lost.

Treatment consists in immersing the frozen parts in cold water for ten minutes, after which they should be manipulated with vaseline once a day, until the comb assumes its normal color and texture. Severe freezing spoils a bird for breeding purposes, therefore it must be guarded against.

**Some Common Poultry Medicines.**—The following kinds of drugs and remedies will often be found useful on poultry plants where sick birds of considerable value are treated, or on any plant for the treatment of a flock. They should be kept in a small cupboard where they are available at all times. The list is recommended by the Maine Station.

*Calomel (Subchloride of Mercury).*—A very useful alterative medicine for fowls of all ages. One-grain pills are usually used. One-fourth grain is a good laxative. It has a very good effect on the liver. When given it should be followed in two hours by a dose of castor oil.

*Cayenne* is an excellent liver stimulant when given in not too large quantities. In case of colds it is very useful, and is often used as one of the ingredients in stimulants so often fed to increase or stimulate winter egg production.

*Catechu* is often used to treat severe cases of diarrhœa. The average dose of powdered catechu is from 2 to 5 grains and of the tincture from 2 to 5 drops.

*Castor Oil.*—One of the best and most common remedies for diarrhœa. This affliction is often caused by some sour or fetid mass in the intestine; a dose of castor oil will often remove this and thus allay the diarrhœa. It is also a valuable factor to aid in reducing an impacted crop. A teaspoonful of castor oil is poured

down the throat and then the crop is manipulated until the softened mass is caused to move on properly.

*Epsom Salts* (Magnesium Sulfate).—It is one of the cheapest and most useful of all drugs. It is especially useful in liver trouble and diarrhœa. Half a teaspoonful for a full-grown fowl is a standard dose. It can be fed by mixing in soft feed; but a much more effective plan is to allow the bird to go without feed for a few hours and then dissolve the salts in warm water and pour down the bird's throat.

*Cottonseed oil and olive oil* are useful when hens are egg bound, for diarrhœa, and for external and internal use in dressing sores, torn flesh, and bound crop.

*Bichloride of Mercury*.—A 1 to 1,000 bichloride solution is a germicide and disinfectant for external use, cleansing wounds and preventing infection. It is highly poisonous, and to prevent it being mistaken for water it is well to color it with laundry blue for identification. One can mix the solution by purchasing the standard bichloride of mercury tablets, or, better yet, have the druggist make a standard solution.

*Medicines in Tablet Form*.—It is often desirable, because much more convenient and easily administered, to have the medicines in compact tablet form. Wholesale drug houses carry complete lines of such tablets graded according to dosage. They are administered very easily by holding the bird's mouth open with one hand and with the other thrusting the tablet far back into the bird's mouth so that it is swallowed. The following four drugs in this form are useful:

*Salicylic acid*, two and one-half grains, for use in cases of rheumatism.

*Aconite Root*, one-tenth grain, for use in fevers.

*Bismuth subnitrate*, one grain, for intestinal irritation.

*Iron, quinine, and strychnine tablets*, for use as a tonic. Dose, 3 per day.

*Antiseptic Ointment*.—The following ointment may be made by the poultryman and will always be found useful in treating cuts, sores, and wounds of all kinds:

Oil of origanum.....	1 ounce
Cresol.....	$\frac{3}{4}$ ounce
Pine tar.....	1 ounce
Resin.....	1 ounce
Clean axle grease (or vaseline).....	8 ounces

The axle grease and resin should be melted and the other ingredients mixed into the melted mass. Pour into a tin or mold and allow to cool.

POULTRY PARASITES.

**External Parasites.**—The prevention or extermination of common external poultry parasites is a tedious and painstaking process, necessitating constant watchfulness and preventive measures. There are some thirty known species of insects and other forms of animal life which are parasitic upon poultry, some living on the skin, some boring under it, while others stay on the bird only long enough to get their nourishment. The presence of these insects forms an economic factor in the health of a flock and the profit from it. Birds infected with parasites do not grow as large, nor do adults lay as many or as large eggs, as when not infested. The parasites suck the blood of the fowls and disturb their rest at night. It is unnecessary for the poultryman to know all of these different species in order to protect his birds from them, but there are four common types which will be here discussed, namely: Lice (Fig. 210); mites; scaly legs; depluming mites.

*Lice.*—These parasites are found more or less on nearly all birds. The strong, healthy fowl in clean quarters with ample space for dusting will probably not be bothered much. But lice seem to thrive best on weak, stunted birds, and intensify this weakness. They usually swarm over the body, always producing a scurvy-like roughness of the skin, and sometimes destroying it. They cause diarrhœa and general debility, manifested by a pale comb and entire cessation of the reproductive function. Lice live on the waste material thrown off by the skin and feathers. They breathe through pores or openings in the sides of their bodies, and can be killed by filling these pores with fine powder, hence the custom of dusting with insect powder.

Sometimes the fowls are dipped or the houses fumigated, but these methods are not recommended, owing to the rumpling of the

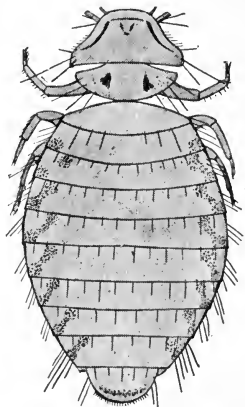


FIG. 210.—Body louse of the domestic fowl, *Menopon biserialatum*. Such lice live on the fowl's body all the time.

bird's plumage after dipping, and to the impossibility of properly fumigating without injuring the birds.

A natural dust-bin should be provided for each flock in some dry, sheltered place, and it is a safe rule to dust the birds at least twice a year with some reliable insect powder, repeating the process twice, at intervals of a week or ten days, to catch the young lice, which are still in the egg at the time of the first dusting. The powder should be liberally sprinkled from a metal box with perforated cover, the birds being held by the feet, and the powder

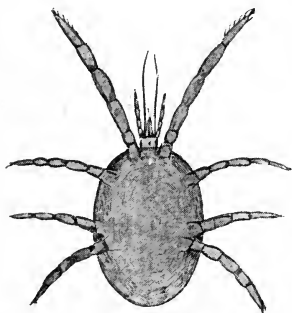


FIG. 211.—The red mite of domestic fowls, *Dermanyssus gallinae*. Such mites stay on the fowl's body only at night; at other times they hide in cracks and crevices about the poultry house. (Highly magnified.)

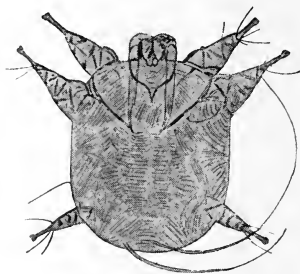


FIG. 212.—The scaly-leg mite, *Sarcoptes mutans*. (Highly magnified.)

worked into the feathers with the fingers. Most of the lice will be found in the down near the vent, and these parts should be well dusted.

Few of the commercial lice powders are reliable, but the following can easily and quickly be made at home, and is sure death if properly applied.

Take 3 parts of gasoline and 1 part of crude carbolic acid, 90 to 95 per cent. strength. Mix these together, and stir in gradually enough plaster of Paris to absorb all the moisture, which will usually be about four quarts of plaster to one quart of liquid. Thorough mixing of the liquid and dry plaster will result in a dry, pinkish-brown powder with a fairly strong carbolic odor.

A commercial apparatus for dusting fowls consists of a hollow cylinder in which the bird and powder are placed and revolved, after which the bird is immediately liberated. This is effective,

but uncomfortable for the fowls from the dust getting into their eyes and mouth.

Lice may be killed quickly and easily by spraying with crude petroleum. The fowl is suspended by one foot in a looped cord, and the spraying may be done with a simple air-gun sprayer. The process is rapid and very effective.

*Mites* (Figs. 211 and 212) differ from lice in that they do not live on the bird's body all the time, but mass together in cracks and crevices under perches and in the walls, whence at night they crawl to the fowl and suck blood, returning to their hiding places



FIG 213.—The work of the scaly-leg mite. Affected birds should be isolated and given immediate treatment to prevent spread of the mites.

before the birds leave the perches. When full of blood they are red, hence the name of red mite or red spider. Spraying with strong kerosene emulsion or crude petroleum will kill all the mites it touches, hence it is well to have fixtures movable so one can get at all parts which might harbor these insects. Painting the perches with crude petroleum every few weeks, in warm weather, will keep mites in perfect control.

*Scaly Legs*.—The form of scabies which affects the legs of fowls (Fig. 213) is due to a burrowing insect, which buries itself under the scales and secretes a calcareous material. This elevates the scales and gives them an uneven appearance, and in some

places the leg enlarges to two or three times its normal diameter. This pest is readily communicated from fowl to fowl, hence the wisdom of destroying it wherever found. The treatment is to stand the bird in a pail of warm water, and allow the scales to soak up thoroughly, then carefully scrape off the crusts without making the legs bleed, after which wipe dry and apply carbolated vaseline once daily. Crude petroleum is very effective in mild cases. In bad cases it may be necessary to repeat the treatment, but ordinarily one soaking and frequent applications of vaseline will soon effect a cure. The treatment should be started on the first sign of trouble.

*Depluming Mites.*—These are minute insects which live on the fowl, taking up their abode at the base of the quills, which they consume or damage so that the feathers subsequently fall out. If the condition persists, the feathers around the neck and head may all drop out. Treatment consists in rubbing crude petroleum or carbolated vaseline frequently into the parts of the skin infested.

*Other Pests.*—Four other common pests are of less importance, but should be mentioned. *Mosquitoes* often attack fowls, and bite the face and comb and wattles, leaving a field for the infection by chicken pox. Treatment is the application of carbolated vaseline. Screening the roosting quarters is sometimes found advisable.

*Harvest mites* abound along wet brushy places, and are common in the central southern part of this country.

*Bedbugs* are also quite common in poultry houses. Turpentine added to the disinfecting solution previously mentioned will be found a preventive.

*Hen fleas* will often be found in unsanitary houses; the treatment recommended for red mites will eradicate them.

**Internal Parasites.**—There are two groups of internal parasites which embrace nearly all the types of economic importance,—namely, (1) parasites which find their way into the trachea of the bird and (2) intestinal parasites.

The first group is represented by the gapeworm (Fig. 214), found only in little chicks, which when affected will stand around with drooping wings, gasping for breath. Gapeworms are little, reddish worms which fasten themselves on the wall of the trachea and suck blood from its mucous lining, causing inflammation. They are about half an inch in length, and may become so numerous as almost to stop the breathing. The disease is especially prevalent in the spring, the infection being transmitted in the soil from one

year to another. If the parasites are known to exist, the best procedure is to plow the ground and lime it thoroughly. Do not use it for young chicks for a year or two—not until some crop has been grown upon it, and the ground worked over considerably. When only a few chicks are affected, the worms can be extracted with a horsehair loop or commercial extractor.

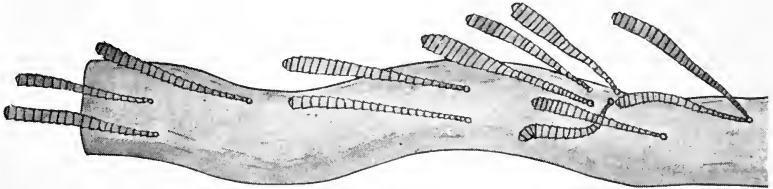


FIG. 214.—The gapeworm, *Syngamus trachealis*, of young chicks, attached to the inside of the trachea. A serious handicap to successful brooding when the soil becomes infested.

*Intestinal Worms.*—Internal parasites are represented by two distinct kinds of intestinal worms, known as roundworm and tapeworm. The former are round, smooth worms (Fig. 215), tapering at each end, pointed in front and blunt in the rear. They derive their nourishment from the feed, and, if present in large numbers,

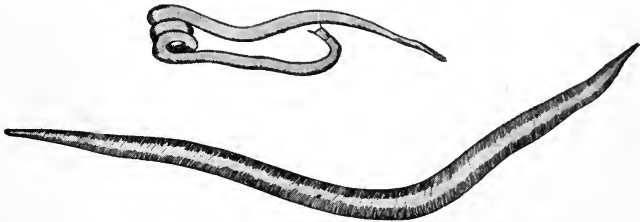


FIG. 215.—The common roundworm, *Heterakis perspicillum*. When present in large numbers they are a serious hindrance to production.

greatly impair the nutrition of the bird, perhaps interfering with digestion and causing obstruction.

The best treatment is to give some drug which will cause them to loosen their hold on the lining of the intestine, and to follow this up with a laxative to expel them. For individual fowls one teaspoonful of oil of turpentine may be given one hour before feeding in the morning, and three hours later one teaspoonful of castor oil.

*The tapeworm* (Fig. 216) represents the second type of intestinal parasites. If present in any number, they will be very detrimental to the flock, making the birds emaciated and weak and causing the feathers to lose their lustre. The treatment outlined for roundworms will also be beneficial with tapeworms. Frequent feeding

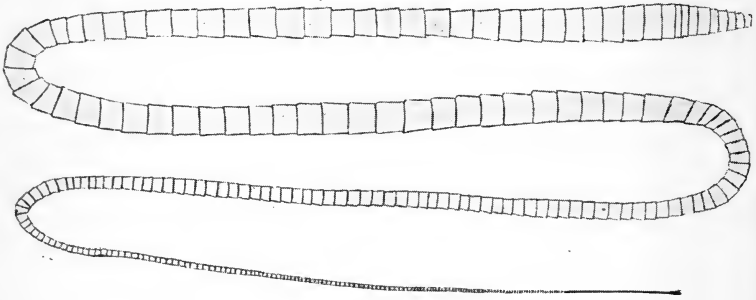


FIG. 216.—The tapeworm. When tapeworms are present in any numbers they greatly impair the efficiency of the birds.

of onions or garlic is said to be a preventive, and powdered pomegranate-root bark, at the rate of one teaspoonful to fifty birds, will help to expel them.

#### ENEMIES OF POULTRY.

There are predatory animals which, if given a chance or if they have once acquired the habit, will do great damage by killing poultry. Prevention is the only sure way of handling them. The *rat* probably ranks first as an enemy, killing a great number of young and growing chicks each year. Concrete floors and runs protected by fine-mesh wire are the best means of keeping them away.

*Weasels and skunks* also delight in killing birds and robbing nests wherever they find them, the weasel preying on growing chicks on the range during the day. Traps and the shotgun are here the best preventives. Poison, if judiciously handled, is one of the best modes of annihilating all four-legged enemies.

*Crows* and some varieties of *hawks* carry off both young and adult birds. The crow is particularly adept in stealing young chicks. He usually alights on some tall pole or post in the vicinity of the chicken yard before swooping down for his prey. One of the best and surest ways of catching him is to place small steel



traps on the tops of some of the tallest poles in the vicinity, and he will soon be a captive. When killed and hung up in the centre of the plant, he serves as a warning to keep others away.

Coops should be securely locked against a chance *sneak thief*; and, in case of systematic theft, the shotgun, combined with a good burglar alarm, gives the surest relief. A good dog is a most valuable asset on the poultry plant. He can be trained not only to watch the yards by night, but to protect the birds during the day.

Occasionally *cats* and *dogs* get into the habit of killing birds, in which case the only sure remedy is to kill the offenders.

#### REVIEW.

1. What is fundamental to a practical knowledge of poultry diseases?
2. Under what conditions is it desirable to treat diseased poultry?
3. When is it not desirable to treat diseased poultry?
4. Discuss prevention as compared with curing.
5. Give three factors essential in maintaining a healthy flock.
6. Define the word hygiene as used in this chapter.
7. What three practices are essential to insure clean houses?
8. Give the composition of a complete disinfecting solution, and tell of its effects.
9. Discuss the effects of sunlight and of moisture in their relation to a sanitary and hygienic house.
10. Discuss clean feeding.
11. What is the best practice to guarantee clean yards?
12. Describe the external appearances of sickness, associated with many disorders.
13. Give external symptoms of roup; tuberculosis; chicken pox; gapes.
14. Outline method of making a post-mortem examination.
15. Name five common poultry medicines; state method of use and effect.
16. Name four common external parasites of poultry.
17. Describe the effects of body lice.
18. Describe a good method of spraying fowls for lice. What is used?
19. Give the composition of a reliable, homemade powder for destroying lice.
20. Describe the chicken mite and his manner of attack.
21. Tell how to keep down the ravages of mites.
22. What is meant by scaly legs? How can the trouble be cured?
23. Are mosquitoes ever injurious to poultry? What are the effects?
24. Describe and give method of combating two common intestinal parasites of poultry.
25. Tell how to control the gapeworm.
26. Name common diseases of the digestive system.
27. Give a list of diseases of the hen's reproductive organs.
28. What diseases affect the respiratory system?
29. When is it desirable to practise poultry surgery?

30. Describe the procedure in treating cuts and wounds.
31. What is bumble foot? Give its cause.
32. How would you treat a frozen comb?
33. Mention predaceous enemies of poultry, and tell how to control each.

**References.**—Poultry Diseases and their Treatment, by Pearl, Surface, and Curtis, Maine Bulletin. Fowl Typhoid, by Cooper Curtice, Rhode Island Bulletin 87. Tapeworm Disease of Fowls, by Gage and Opperman, Maryland Bulletin 139. Tuberculosis in Fowls, by A. R. Ward, California Bulletin 161. Common Diseases of Fowls, their Control and Treatment, by F. D. Chester, Delaware Bulletin 47. Chicken Pox or Sore Head in Poultry, by C. A. Cary, Alabama Bulletin 136. Diseases of Chickens, by H. J. Milks, Louisiana Bulletin 108. Lice and Mites of Poultry, by Nathan Banks, U. S. Bureau of Entomology Circular 92. Tuberculosis, Fowl Cholera, Chicken Pox, and Roup, California Report, 1903. Asthenia (growing light in fowls), by Chas. F. Dawson, U. S. Bureau of Animal Industry Report 15. Some Common Disinfectants, by M. Dorset, U. S. Farmers' Bulletin 345. Gapes in Poultry, by H. Garman, Kentucky Bulletin 70. Causes of Death in Young Chickens, by C. K. Graham, Connecticut Bulletin 44. How to Destroy Rats, by D. E. Lantz, U. S. Farmers' Bulletin 369. Disinfection and Commercial Disinfectants, by Ravenall and Smith, Wisconsin Bulletin 156. Infectious Diseases among Poultry, by D. E. Salmon, U. S. Bureau of Animal Industry Bulletin 8. Healthy Poultry, in U. S. Farmers' Bulletin 305. Lice on Poultry, in U. S. Farmers' Bulletin 435. Fowl Cholera, by A. R. Ward, California Bulletin 156. Fowl Cholera, by P. B. Hadley, Rhode Island Bulletin 144. Avian Coccidiosis, by P. B. Hadley, Rhode Island Bulletin. The Chicken Mite, Mississippi Bulletin 78. Tuberculosis, by E. F. Pemot, Oregon Bulletin 64. Diseases of Chickens, by E. F. Pemot, Oregon Reading Course Bulletin 4. The Common Chicken Mite, by H. C. Pierce, Iowa Press Bulletin 19.

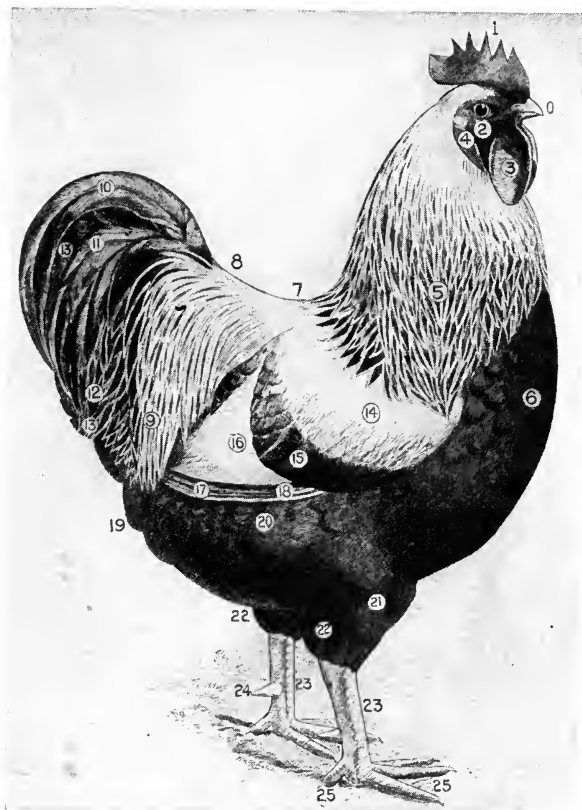


FIG. 217.—Fowl with points named.

- |                 |                        |                     |
|-----------------|------------------------|---------------------|
| 0. Beak.        | 9. Saddle feathers.    | 18. Flight coverts. |
| 1. Single comb. | 10. Sickles.           | 19. Fluff.          |
| 2. Face.        | 11. Lower sickles.     | 20. Body.           |
| 3. Wattles.     | 12. Tail coverts.      | 21. Thigh.          |
| 4. Ear lobes.   | 13. Main tail coverts. | 22. Knee-joint.     |
| 5. Hackle.      | 14. Wing bow.          | 23. Shanks.         |
| 6. Breast.      | 15. Wing coverts.      | 24. Spur.           |
| 7. Back.        | 16. Secondaries.       | 25. Toes.           |
| 8. Saddle.      | 17. Primaries.         |                     |

## APPENDIX.

### MISCELLANEOUS BIBLIOGRAPHY.

- Poultry Experiments, by Pearl and Surface, Maine Bulletins 117, 130, 144, 157, 165 and 179.
- Poultry, by G. Allman, Department of Agriculture Western Australia, Bulletin 23.
- Poultry Raising, by W. E. Vaplon, Colorado Bulletin 164.
- Poultry Experiments, by T. I. Mairs, Pennsylvania Bulletin 87.
- Poultry Raising on the Farm, by D. E. Salmon, U. S. Farmers' Bulletin 141.
- Care and Management of Poultry, by Sheppers and Dynes, North Dakota Bulletin 78.
- Poultry, by C. E. Brown, Minnesota Bulletin 119.
- The Hen's Place on the Farm, by Oscar Erf, Kansas Bulletin 150.
- The Poultry Industry in Maryland, by C. L. Opperman, Maryland Bulletin 138.
- Poultry in Pennsylvania, by T. E. Orr, Department of Agriculture of Pennsylvania, Bulletin 143.
- Farm Poultry, by W. S. Jacobs, Arkansas Bulletin 99.
- Farm Poultry, by Lloyd and Elser, Ohio Circular 118.
- Farm Poultry Management, by James E. Rice, New York Department of Agriculture Circular 11.
- Poultry Raising, by J. G. Halpin, Michigan Bulletin 245.
- Farm Poultry, by J. S. Jeffrey, North Carolina Bulletin 195.
- Poultry Management, by G. A. Bell, U. S. Farmers' Bulletin 287.
- Poultry Keeping on the Farm, by F. S. Cooley, Montana Farmers' Bulletin 3.
- Profitable Poultry, Kansas State Board of Agriculture Bulletin 107.
- Farm Poultry, W. R. Graham, Ontario Bulletin 151.
- Methods of Poultry Management, by Raymond Pearl, U. S. Farmers' Bulletin 357.
- Poultry Management, by Stewart and Atwood, West Virginia Bulletin 115.
- Poultry as Food, by Helen Atwater, U. S. Farmers' Bulletin 182.

**ADDRESSES OF COLLEGES, EXPERIMENT STATIONS, ETC.**

(These devote time to educational and experimental work in poultry husbandry; in most cases bulletins or other publications are issued freely.)

Alabama, Experiment Station, Auburn.  
Alabama, Tuskegee Station, Tuskegee.  
Arizona, Experiment Station, Tucson.  
Arkansas, Experiment Station, Fayetteville.  
California, State College, Berkeley.  
Canada, Ontario Agricultural College, Guelph.  
Colorado, Experiment Station, Fort Collins.  
Connecticut, Agricultural College, Storrs.  
Delaware, Experiment Station, Newark.  
Georgia, Experiment Station, Athens.  
Illinois, Experiment Station, Urbana.  
Indiana, Purdue University, Lafayette.  
Iowa, Agricultural College, Ames.  
Kansas, Agricultural College, Manhattan.  
Kansas, Department of Agriculture, Topeka.  
Kentucky, Experiment Station, Lexington.  
Louisiana, State Station, Baton Rouge.  
Maine, Agricultural College and Experiment Station, Orono.  
Maine, Department of Agriculture, Augusta.  
Maryland, Agricultural College, College Park.  
Massachusetts, Agricultural College, Amherst.  
Massachusetts, Board of Agriculture, Boston.  
Michigan, Agricultural College, East Lansing.  
Minnesota, University, St. Paul.  
Mississippi, Agricultural College, Agricultural College.  
Missouri, Experiment Station, Columbia.  
Missouri, Poultry Station, Mountain Grove.  
Montana, Experiment Station, Bozeman.  
Nebraska, Experiment Station, Lincoln.  
Nevada, Experiment Station, Reno.  
New Jersey, Agricultural College, New Brunswick.  
New South Wales, Department of Agriculture, Victoria.  
New York, Cornell Station, Ithaca.  
New Zealand, Department of Agriculture, Wellington.  
North Carolina, Department of Agriculture, Raleigh.  
North Carolina, College Station, West Raleigh.  
North Dakota, Experiment Station, Agricultural College.  
Ohio, Agricultural College, Columbus.  
Ohio, Experiment Station, Wooster.  
Oklahoma, Experiment Station, Stillwater.  
Oregon, Agricultural College, Corvallis.  
Pennsylvania, Agricultural College, State College.  
Pennsylvania, Department of Agriculture, Harrisburg.  
Rhode Island, Agricultural College, Kingston.  
South Carolina, Experiment Station, Clemson College.  
South Dakota, Agricultural College, Brookings.  
United States Department of Agriculture, Washington, D. C.  
Utah, Experiment Station, Logan.  
Virginia, Experiment Station, Blacksburg.  
Washington, Experiment Station, Pullman.  
West Virginia, Experiment Station, Morgantown.  
Wisconsin, Agricultural College, Madison.

TABLE XVIII.—Pounds of Dry Matter and Digestible Nutrients in Different Quantities of Fodders and Feed Stuffs.

Lbs. of feed.	Dry matter.	Protein.	Carbo-hydrates.	Fat.	Fuel value (calories).	Lbs. of feed.	Dry matter.	Protein.	Carbo-hydrates.	Fat.	Fuel value (calories).
<b>Alfalfa, green, nutritive ratio 1 : 2.3.</b>						<b>Brewer's grains, dry, nutritive ratio 1 : 3.0.</b>					
1	0.2	0.04	0.07	0.006	231	1	0.92	0.16	0.37	0.05	1200
2	.4	.07	.15	.01	462	2	1.84	.32	.73	.10	2400
3	.6	.11	.22	.02	693	3	2.76	.48	1.10	.15	3600
4	.8	.15	.29	.02	924	4	3.68	.64	1.47	.20	4800
5	1.0	.19	.37	.03	1155	5	4.60	.80	1.83	.25	6000
<b>Alfalfa hay or meal (best) nutritive ratio 1 : 3.3.</b>						<b>Brewer's grains, wet, nutritive ratio 1 : 3.2.</b>					
1	.89	.14	.37	.02	1033	1	.24	.04	.09	.01	330
2	1.78	.27	.74	.03	2066	2	.49	.08	.19	.03	660
3	2.67	.41	1.11	.05	3099	3	.73	.12	.28	.04	990
4	3.56	.55	1.48	.06	4132	4	.97	.16	.37	.06	1320
5	4.45	.69	1.85	.08	5165	5	1.21	.20	.46	.07	1650
<b>Barley, green, nutritive ratio 1 : 5.8.</b>						<b>Buttermilk, nutritive ratio 1 : 1.4.</b>					
1	.28	.02	.10	...	242	1	.10	.04	.04	...	179
2	.56	.04	.20	.01	484	2	.19	.08	.09	.01	358
3	.84	.06	.31	.01	726	3	.29	.12	.13	.01	537
4	1.12	.08	.41	.02	968	4	.39	.16	.18	.02	716
5	1.40	.10	.51	.02	1210	5	.48	.20	.22	.02	895
<b>Barley meal, sifted, nutritive ratio 1 : 6.2.</b>						<b>Cheese, cottage, nutritive ratio 1 : 0.3.</b>					
1/2	.46	.06	.33	.01	705	1	.28	.21	.04	.01	507
1	.93	.11	.66	.02	1410	2	.56	.42	.09	.02	1014
2	1.96	.23	1.31	.04	2820	3	.84	.63	.13	.03	1521
3	2.79	.34	1.97	.06	4230	4	1.12	.84	.17	.04	2028
4	3.72	.45	2.62	.07	5640	5	1.40	1.05	.22	.05	2535
5	4.65	.56	3.28	.09	10059	<b>Clover seeds, bur, nutritive ratio 1 : 2.8.</b>					
<b>Barley, rolled, nutritive ratio 1 : 6.9.</b>						1/2	.46	.08	.19	.02	610
1	.9	.09	.60	.02	1370	1	.93	.17	.39	.04	1221
2	1.8	.19	1.19	.04	2740	2	1.87	.34	1.77	.09	2442
3	2.7	.28	1.79	.07	4110	3	2.80	.52	1.16	.13	3663
4	3.6	.37	2.38	.09	5480	4	3.74	.68	1.55	.17	4884
5	4.5	.47	2.98	.11	6850	5	4.67	.86	1.93	.21	6105
<b>Beans, nutritive ratio 1 : 2.9.</b>						<b>Clover, green, nutritive ratio 1 : 2.9.</b>					
1	.87	.17	.49	.01	1272	1	.23	.03	.09	...	256
2	1.75	.35	.97	.02	2544	2	.46	.07	.18	.01	512
3	2.62	.52	1.46	.03	3816	3	.69	.10	.27	.01	768
4	3.49	.69	1.94	.04	5088	4	.92	.14	.36	.02	1024
5	4.73	.87	2.43	.05	6360	5	1.15	.17	.45	.02	1280
<b>Blood, dried, nutritive ratio 1 : 0.11.</b>						<b>Corn, cracked, nutritive ratio 1 : 8.5.</b>					
1/2	.45	.36	.03	.005	746	1	.89	.08	.63	.04	1524
1	.90	.72	.06	.01	1493	2	1.79	.17	1.27	.08	3048
2	1.81	1.44	.12	.02	2986	3	2.68	.26	1.91	.13	4572
3	2.72	2.16	.18	.03	4479	4	3.48	.34	2.55	.17	6096
4	3.62	2.88	.24	.04	5972	5	4.47	.43	3.19	.21	7620
5	4.53	3.60	.30	.05	7475	<b>Cracklings, nutritive ratio 1 : 2.4.</b>					
<b>Bone, poultry</b>						1/2	.47	.23	...	.23	1364
1	.92	.28	...	.03	648	1	.94	.46	...	1.46	2728
2	1.84	.56	...	.06	1296	2	1.88	.86	...	.92	5456
3	2.76	.84	...	.09	1944	3	2.82	1.29	...	1.38	8184
4	3.68	1.12	...	.12	2592	4	3.76	1.72	...	1.84	10912
5	4.60	1.40	...	.15	3240	5	4.70	2.15	...	2.30	13640
<b>Bran, rice, nutritive ratio 1 : 5.9.</b>						<b>Feed flour, nutritive ratio 1 : 8.</b>					
1	.89	.10	.42	.10	1424	1	.88	.09	.67	.01	1465
2	1.78	.20	.84	.20	2848	2	1.76	.17	1.25	.02	2930
3	2.67	.30	1.26	.30	4272	3	2.64	.26	2.02	.03	4395
4	3.56	.40	1.68	.40	5696	4	3.52	.35	2.70	.04	5860
5	4.45	.50	2.00	.50	7120	5	4.40	.44	3.37	.05	7325
<b>Bran, wheat, nutritive ratio 1 : 4.3.</b>						<b>Kale, green, nutritive ratio 1 : 11.5.</b>					
1	.88	.11	.42	.02	1070	1	.15	.03	.10	...	263
2	1.76	.22	.84	.05	2140	2	.30	.05	.20	.01	526
3	2.64	.34	1.26	.07	3210	3	.45	.08	.30	.01	789
4	3.53	.45	1.69	.10	4280	4	.60	.10	.40	.02	1052
5	4.41	.56	2.11	.12	5350	5	.75	.13	.50	.02	1315

Lbs. of feed.	Dry matter.	Protein.	Carbo- hydrates.	Fat.	Fuel value (calories).	Lbs. of feed.	Dry matter.	Protein.	Carbo- hydrates.	Fat.	Fuel value (calories).
Lettuce, green, nutritive ratio 1 : 6.						Meat scrap, first quality, nutritive ratio 1 : 0.27.					
1	0.05	0.01	0.03	...	97	4	3.78	2.16	0.28	0.14	5288
2	.11	.02	.06	...	194	5	4.73	2.70	.35	.17	6610
3	.16	.04	.09	0.01	291	Milk, dried, nutritive ratio 1 : 0.4.					
4	.21	.05	.12	.01	388	½	.45	.26	.08	...	650
5	.27	.06	.15	.02	485	1	.89	.51	.16	.01	1300
Malva, green, nutritive ratio 1 : 7.3						2	1.78	1.02	.32	.02	2600
1	.20	.06	.10	.01	302	3	2.67	1.54	.48	.04	3900
2	.41	.13	.19	.02	604	4	3.56	2.05	.64	.05	5200
3	.61	.19	.29	.03	906	5	4.45	2.56	.80	.06	6500
4	.81	.26	.39	.04	1208	Milk, skim, nutritive ratio 1 : 1.8.					
5	1.02	.32	.49	.05	1510	1	.09	.03	.05	...	268
Meal, coconut oil cake, nutritive ratio 1 : 3.9.						2	.18	.06	.11	...	536
½	.43	.08	.21	.05	750	3	.28	.10	.16	...	804
1	.86	.16	.42	.10	1500	4	.37	.13	.21	...	1072
2	1.72	.33	.85	.20	3000	5	.47	.16	.27	.005	1340
3	2.58	.49	1.27	.30	4500	Millet, nutritive ratio 1 : 2.2.					
4	3.44	.66	1.70	.40	6000	½	.46	.10	.18	.02	586
5	4.30	.82	2.12	.50	7500	1	.92	.20	.35	.04	1173
Meal, corn, nutritive ratio 1 : 11.5.						2	1.84	.39	.69	.08	2346
1	.88	.06	.66	.03	1266	3	2.77	.59	1.04	.11	3519
2	1.76	.13	1.32	.07	2532	4	3.69	.78	1.39	.15	4692
3	2.64	.19	1.99	.10	3798	5	4.61	.98	1.73	.19	5865
4	3.52	.26	2.65	.13	5064	Mixed feed, nutritive ratio 1 : 5.6.					
5	4.40	.32	3.31	.17	6330	1	.89	.10	.47	.03	1186
Meal, cottonseed oil cake, nutritive ratio 1 : 1.0.						2	1.79	.19	.95	.06	2372
½	.45	.21	.08	.06	381	3	2.68	.29	1.42	.09	3558
1	.90	.41	.15	.11	762	4	3.58	.38	1.89	.12	4744
2	1.80	.82	.31	.22	1524	5	4.47	.48	2.37	.15	5930
3	2.70	1.23	.46	.33	2286	Oats, nutritive ratio 1 : 6.2.					
4	3.60	1.64	.62	.44	3048	1	.89	.09	.47	.04	1042
5	4.50	2.05	.77	.55	3610	2	1.78	.18	.95	.08	2084
Meal, gluten, nutritive ratio 1 : 2.9.						3	2.67	.28	1.42	.13	3126
½	.46	.13	.22	.07	938	4	3.56	.37	1.89	.17	4168
1	.92	.26	.43	.14	1876	5	4.45	.46	2.37	.21	5210
2	1.84	.52	.87	.28	3752	Peas, nutritive ratio 1 : 2.7.					
3	2.75	.77	1.30	.42	5628	½	.45	.10	.26	...	335
4	3.67	1.03	1.73	.56	7504	1	.90	.19	.51	...	670
5	4.59	1.29	2.16	.70	9380	2	1.80	.38	1.02	...	1340
Meal, linseed oil (n.p.) nutritive ratio 1 : 2.0.						3	2.70	.57	1.53	...	2010
½	.45	.13	.19	.03	722	4	3.60	.76	2.05	...	2680
1	.89	.26	.38	.07	1444	5	4.50	.95	2.56	.03	3350
2	1.78	.52	.77	.13	2888	Rice, nutritive ratio 1 : 12.8.					
3	2.67	.78	1.15	.20	4332	1	.88	.05	.68	...	1378
4	3.56	1.04	1.54	.26	5772	2	1.75	.11	1.35	...	2756
5	4.45	1.30	1.92	.33	7206	3	2.63	.16	2.03	.01	4134
Meal, soy bean, nutritive ratio 1 : 0.9.						4	3.51	.21	2.70	.01	5512
½	.45	.20	.12	.03	719	5	4.38	.26	3.38	.02	6890
1	.90	.40	.23	.07	1439	Wheat middlings, nutritive ratio 1 : 5.1.					
2	1.80	.80	.45	.13	2878	1	.88	.12	.53	.04	1378
3	2.70	1.20	.67	.19	4317	2	1.76	.24	1.07	.08	2756
4	3.60	1.60	.90	.26	5756	3	2.64	.37	1.60	.11	4134
5	4.50	2.00	1.12	.33	7195	4	3.53	.49	2.13	.15	5512
Meat, fresh, nutritive ratio 1 : 0.4.						5	4.41	.61	2.57	.19	6990
½	.13	.1	...	.01	114	Wheat, plump, nutritive ratio 1 : 6.9.					
1	.26	.2	...	.03	228	1	.89	.09	.61	.01	1354
2	.53	.4	...	.06	456	2	1.77	.18	1.22	.02	2708
3	.79	.6	...	.08	684	3	2.66	.28	1.83	.04	4062
4	1.06	.8	...	.11	912	4	3.54	.37	2.44	.05	5416
5	1.32	1.00	...	.14	1140	5	4.43	.46	3.05	.06	6770
Meat scrap, first quality, nutritive ratio 1 : 0.27.						Wheat, shrunken, nutritive ratio 1 : 4.6.					
½	.47	.27	.04	.02	661	1	.92	.13	.57	.02	1386
1	.94	.54	.07	.03	1322	2	1.83	.26	1.15	.04	2772
2	1.89	1.08	.14	.07	2644	3	2.75	.40	1.72	.05	4158
3	28.4	1.62	.21	.10	3966	4	3.67	.53	2.30	.07	5544
						5	4.58	.66	2.87	.09	6930

TABLE XIX.—Average Weight and Volume of Different Feed Stuffs.

	One qt. weighs (pounds).	One lb. measures (quarts).
Barley meal.....	1.1	0.9
Barley, whole.....	1.5	0.7
Bone meal.....	2.0	0.5
Brewer's dried grains.....	0.6	1.7
Beef scrap.....	1.3	0.8
Corn-and-cob meal.....	1.4	0.7
Corn-and-oat feed.....	0.7	1.4
Corn bran.....	0.5	2.0
Corn meal.....	1.5	0.7
Corn, whole.....	1.7	0.6
Cottonseed meal.....	1.5	0.7
Distiller's dried grains.....	0.5-0.7	1.0-1.4
Germ oil meal.....	1.4	0.7
Gluten feed.....	1.3	0.8
Gluten meal.....	1.7	0.6
Hominy meal.....	1.1	0.9
Linseed meal, new process.....	0.9	1.1
Linseed meal, old process.....	1.1	0.9
Malt sprouts.....	0.6	1.7
Mixed feed (bran and middlings).....	0.6	1.7
Oat feed (variable mixture).....	0.8	1.3
Oat middlings.....	1.5	0.7
Oats, ground.....	0.7	1.4
Oats, whole.....	1.0	1.0
Rye feed (bran and middlings).....	1.3	0.8
Rye meal.....	1.5	0.7
Rye, whole.....	1.6	0.6
Soy-bean meal.....	1.3	0.8
Wheat bran.....	0.5	2.0
Wheat, ground.....	1.7	0.6
Wheat middlings (flour).....	1.2	0.8
Wheat middlings.....	0.8	1.3
Wheat, whole.....	1.9	0.5

TABLE XX.—Poultry Journals.

(Alphabetically arranged by States, with Canadian papers at the last.)

Union Poultry Journal.....	Fort Smith, Ark.
Poultry Journal.....	Haywood, Cal.
Pacific Poultry Craft.....	Los Angeles, Cal.
*Poultry Journal.....	Petaluma, Cal.
Pacific Fanciers' Monthly.....	San Jose, Cal.
Intermountain Poultry Advocate.....	Colorado Springs, Col.
Southern Fancier.....	Atlanta, Ga.
Southern Pit Games (sport).....	Blakely, Ga.
Western Poultry Advocate.....	Lewiston, Idaho.
American Hen Magazine.....	Chicago, Ill.
*American Poultry Journal.....	Chicago, Ill.
Successful Poultry Journal.....	Chicago, Ill.
Poultry Tribune.....	Mount Morris, Ill.

\*Specially recommended.



Modern Poultry	Peoria, Ill.
*Poultry	Peotone, Ill.
Poultry Keeper	Quincy, Ill.
*Reliable Poultry Journal	Quincy, Ill.
Standard and Poultry World	Quincy, Ill.
Poultry Post	Goshen, Ind.
*Inland Poultry Journal	Indianapolis, Ind.
Game Bird	Tell City, Ind.
Western Poultry Journal	Cedar Rapids, Iowa.
Golden Egg	Des Moines, Iowa.
Egg Reporter	Waterloo, Iowa.
Poultry Culture	Topeka, Kans.
Poultry Ideas	Louisville, Ky.
Atlantic Poultry Journal	Baltimore, Md.
American Stock Keeper	Boston, Mass.
*Farm Poultry	Boston, Mass.
Profitable Poultry	Boston, Mass.
Michigan Poultry Breeder	Battle Creek, Mich.
Poultry Pointers	Kalamazoo, Mich.
National Barred Rock Journal	Union City, Mich.
Poultry Herald	St. Paul, Minn.
Useful Poultry Journal	Trenton, Mo.
American Poultryman	Lincoln, Nebr.
Poultry Topics	Lincoln, Nebr.
Poultry News	Newark, N. J.
*American Poultry World	Buffalo, N. Y.
Poultry Review	Elmira, N. Y.
Ancona World	Franklinville, N. Y.
Feathered Warrior (Game fowl)	Lisle, N. Y.
*American Poultry Advocate	Syracuse, N. Y.
*Poultry Husbandry	Waterville, N. Y.
Southern Poultry Review	Charlotte, N. Y.
Poultry Record	Carey, Ohio.
City Farmer	Columbus, Ohio.
Poultry Success	Springfield, Ohio.
Northwestern Poultry Journal	Salem, Oreg.
Keystone Poultry Journal (quarterly)	Beaver Springs, Pa.
Poultry and Incubator News	Garrettsford, Pa.
Poultry Yard	Phoenixville, Pa.
Happy Hen	Pittsburg, Pa.
Poultry and Farm Review	Pittsburg, Pa.
Game Fowl Monthly	Savre, Pa.
Poultry Fancier	Sellersville, Pa.
*Poultry Item	Sellersville, Pa.
Grit and Steel	Gaffney, S. C.
Progressive Poultry Journal	Mitchell, S. Dak.
Industrious Hen	Knoxville, Tenn.
Southern Poultry Magazine	Nashville, Tenn.
Poultry Life of America	Belton, Tex.
Southern Poultry Journal	Dallas, Tex.
Southern Poultryman	Dallas, Tex.
Texas Poultry Journal	Houston, Tex.
West Texas Journal	Loraine, Tex.

\*Specially recommended.

Pacific Poultryman .....	Seattle, Wash.
Feathered World .....	Walla Walla, Wash.
Geflugel Zuchter (German) .....	Hamburg, Wis.
Advance Poultry Journal .....	La Crosse, Wis.
National Partridge Wyandotte Journal .....	Milton, Wis.
Profitable Poultry .....	Milton, Wis.
Successful Poultryman .....	Victoria, B. C.
Fruit Grower, Market and Poultryman .....	Grimsby, Ontario.
Canadian Poultry News .....	Owen Sound, Ontario.
Canadian Poultry Review .....	Toronto, Ontario.
Poultry Advocate .....	Toronto, Ontario.

# INDEX

## A

- Accessibility of products, 427
- Accounting, methods of, 464
  - column system, 465
- Accounts, what they show, 463
- Acquiring stock, methods, 100
- Advertisement, preparation, 469
  - size of, 470
- Advertising, 467
  - profit from, 470, 473
  - ways of, 467
  - what, 468
  - when, 468
  - where, 468
- Age of stock, 101
- Agricultural Colleges, list, 517
  - train, 2
- Aim in breeding, 223
- Air cell, location and formation, 302
- Albumin, secretion, 302
  - structure, 304
- Alfalfa, composition of, 197
- Alleys, disadvantages of, 152
  - location, 152
  - usage, 151
- American Class, breeds of, 71
  - Poultry Association,
    - membership, 26
    - standard of perfection,
      - use of, 67
      - value of, 225
- Anatomy of the fowl, 292
- Ancestry of domestic fowl, 63
  - records of, 283
- Anonas, mottled, 74
  - origin of, 73
- Animal feeds, value of, 194
  - meal, usage, 195
- Appearance, value of, 54
  - uniform flocks, 98
- Appetites, indication of performance, 254
- Appliances, location of, 130
  - for feeding, 206
- Aseel fowl, 64
  - description of, 64
- Ash defined, 170
  - for chicks, 360
  - for egg production, 181

- Ash, function of, 173
  - in eggs, 305
  - in fowl's body, 170
  - in grains, 202
  - sources of, 172
- Asiatic Class, breeds of, 71
- Assimilation, 173
- Associations for holding exhibits, 483
- Atavism, example of, 240
  - defined, 240
  - factors affecting, 241
  - kinds of, 241
- Austria-Hungary, poultry in, 39

## B

- Baby chicks, 443
  - chick boxes, 444
- Balanced rations defined, 209
  - value of same, 209
- Bantams, types and uses, 77
- Barley, composition of, 193
  - value and usage, 191
- Barred Plymouth Rocks, origin of, 71
- Bedbugs, 510
- Beets, composition, 200
  - usage, 199
  - varieties, 199
- Beginning, manner of, 61
- Beheading, 413
- Belgium, poultry keeping in, 38
- Belle of Jersey, record, 259
- Bibliography, miscellaneous, 516
- Bichloride of mercury, use of, 506
- Birds compared with other animals, 169
  - importance of clean, 499
  - preparation for exhibition, 477
  - sale of, 473
  - selection of, 101
- Blood, dried, 195
- Blue Andalusian, origin of, 73
- Body characters, relation to functional activity, 242
  - composition of, 170
  - lice on, 507
- Bolts for foundation, 127, 128
- Bone, composition of, 185, 196, 202
  - cutter, 206
  - dry ground, 201

- Bone, fresh cut, 201  
value of products, 195
- Boning fowl, 420
- Bracing corner fence posts, 163
- Brahma, origin of, 71
- Bran for chicks, 359
- Brassiness, cause of, 263
- Bread, usage, 188
- Breed, adaptation of, 100  
definition, 69  
shapes, 68
- Breeder, problems of, 223
- Breeders, age of, 284  
care during growth, 289  
feed for, 286  
selection of, 282
- Breeding, aim in, 223  
art of, 221  
color pattern, 260, 262  
complexity of, 221  
controlling factors, 226  
demand for, 99  
effect of environment on, 227  
for eggs, rules for, 252  
for meat, 258  
from pullets, 284  
fundamentals of, 225  
laws of, 229  
mass *vs.* individual, 281  
objects of, 245  
principles of, 221, 225, 245  
records, 454  
science of, 221  
stock, management of, 281, 291
- Breeds, description of, 71  
number of, 66
- Broiler, breeds for, 381  
classification of, 378  
cost of, 383  
defined, 278  
features of, 380  
management, 382  
possibilities of, 27  
prices, 383  
profits, 383  
raising, 377  
seasons, 379  
types, 379
- Broilers, chapter on, 376-402  
dressing, 418  
undesirable, 445  
uniformity of, 382
- Brooder, colony, 353  
gasoline, 354, 355  
houses, 348, 349  
portable, 352
- Brooder, preparation of, 356  
record, 460  
requirements, 356  
systems of heating, 365
- Broodiness, indications of, 315  
natural function, 314
- Brooding, artificial, 348-367  
coops for, 323  
deaths in, 363  
natural, 312, 322  
temperature, 357
- Broody coops, 148, 151  
hen, care of, 274
- Broom corn, 192
- Buckwheat, composition of, 193  
value and usage, 191
- Buildings, arrangement of, 53  
investment in, 60
- Bulk, need of, 210
- Bumble foot, 504
- Business, adapting to location, 54  
poultry keeping as a, 22  
risks in, 34

## C

- Cabbage, composition of, 200  
value and usage, 200
- Caldron, location and usage, 206
- Calomel, uses, 505
- Candling, 438
- Cannibalism, prevention of, 364
- Capacity of poultry houses, 108
- Capital, adjustment of, 59  
amount required, 28  
classification of, 58  
defined, 58
- Capon, advantages of, 390  
and cockerel compared, 401  
appearance, 400  
breeds suited for, 392  
definition of, 390  
farming, centres of, 19  
marketing, 399  
markets, 392
- Caponizing, age for, 393  
instruments, 393  
operation, 395  
practice of, 400  
preparation for, 394  
profits from, 400  
slips, 398  
technique of, 396-397  
where to cut, 395
- Capons, chapter on, 376-402
- Carbohydrates, composition of, 172

- Carbohydrates defined, 171  
 function of, 172  
 in feeds, 172
- Card for labor record, 462
- Care during molt, 286
- Castor oil, uses, 505
- Catechu, uses, 505
- Cayenne, uses, 505
- Cell defined, 294
- Centres of poultry production, 11
- Chalazæ, location and function, 304
- Characters, inherited, 369
- Charcoal, value, 212
- Cheapness *vs.* economy, 210
- Chicks, banding of, 322  
 care of, 323  
 death of, 363  
 early feeding of, 373  
 feeding, 358, 361  
 formation of, 300, 307  
 marking, 322  
 parasites on, 324  
 rations for, 324  
 transferring, 357  
 weaning, 324
- Chilling chicks, 363
- Cinders for foundation, 126
- Circulating capital defined, 58
- Circulatory system, distribution of, 297
- Class defined, 69
- Classification of fowl, biological, 65  
 standard and utility, 66  
 utility, 78
- Clavicles, description of, 294
- Clean birds, 499  
 feeding, 498  
 housing, 497  
 yards, 499
- Cleaning poultry houses, 498
- Cleanliness as related to health, 271  
 how maintained, 272  
 importance of spraying, 273  
 in designing fixtures, 143  
 in the sitting coop, 320
- Climate, proper conditions of, 48
- Cloaca, location and function, 297
- Closets, roosting, 145
- Clover, composition of, 197
- Cochin, origin of, 72
- Cold, effect of, 109
- Collateral reading, 5
- Colony brooders, 353  
 system defined, 46  
 possibilities of, 47
- Color, breeding for, 261  
 harmony defined, 263
- Color harmony, existence of, 263  
 value when choosing stock, 102
- Column system in accounting, 465
- Combs, frozen, 505
- Commission merchant, selling to, 423
- Communication, means of, 43  
 need of, 42
- Community house, 46  
 system defined, 45  
 possibilities of, 46
- Comparison judging, 487  
 profiting from, 474
- Composition of bird's body, 169, 170
- Concrete fence posts, 162  
 floor, advantages of, 117  
 construction, 108, 117, 118  
 use of, 110  
 floors, 131  
 foundations, 126-127  
 posts, 162
- Conditioning, 478
- Consumer, selling to, 423
- Contour of land, 49
- Convenience in poultry houses, 106
- Cooling, 417  
 in incubation, 340
- Coöperation in Denmark, 38  
 value of, 40
- Coöperative marketing, 449
- Corn as a food, 179  
 composition of, 193  
 function and usage, 185  
 meal, composition of, 193  
 usage, 186
- Cornell rations for layers, 219
- Cornish fowl, possibilities of, 93
- Correlation, body characters and function,  
 258  
 law of, 241  
 vitality and body characters, 256
- Correspondence courses, 3
- Cost of standard-bred birds, 98
- Cottonseed meal, 192
- Cow, hen compared with, 222
- Cramming, 408  
 machine, usage, 408
- Crate fattening, 404, 405
- Creaminess, causes of, 263
- Crop, location and function, 297  
 rotation, 159, 160, 372
- Cross-breeding defined, 246  
 object of, 246
- Crosses, reciprocal, 250
- Crowding chicks, 363  
 effect on vigor, 256
- Crows, 512

Curtains for laying houses, 120  
 Customers' interests, 426

## D

Dampness, bad effect of, 48  
 Danish egg packing industry, 39  
   poultry house, 38  
 Delivery of products, 427  
 Demand *vs.* supply, 32  
 Denmark, poultry farming in, 38  
 Depluming mites, 510  
 Dermanyssus gallinæ, 508  
 Design of houses, simplicity of, 111  
   to insure economy of labor, 53  
 Details, importance of, 273  
 Diagnosis of disease, 500, 501  
 Diary, 463  
 Digestibility, factors affecting, 174  
   ground grains, 181  
 Digestion coefficient defined, 174  
   experiments, what they show, 176, 177  
   relation of food to, 173  
 Digestive system, organs of, 296  
   tract, 296  
 Dimorphism, sexual, 261  
 Disease, diagnosis, 500, 501  
   inheritance of, 227  
   of poultry, 503  
   prevention of, 497  
   transmission by water, 499  
   treating, 496  
   when to treat, 496  
 Diseases, 496  
 Disinfecting solution, 498  
 Dislocating neck, 410  
 Disposition of egg breeds, 79  
   of general-purpose breeds, 87  
   of meat breeds, 84  
 Distribution of poultry, 10  
 Doctoring poultry, 496  
 Dominant, how to test for, 232  
   meaning in Mendel's law, 231  
 Doors, 119  
 Dorking, origin of, 73  
   possibility of, 93  
 Double matings, example of, 261  
   yarding, advantages of, 159  
   methods of, 160  
 Drainage, 51  
   air, 51  
   soil, 50  
   surface, 50  
   under foundation, 126  
 Dressed poultry, marketing, 444  
   score card for, 491

Dressing, 417  
 Drinking vessels, design, 155  
   location, 155  
 Dropping boards, location and design, 146  
 Droppings, care of, 272  
 Dry-mash, California, 219  
   Cornell, 219  
   mixer, location and usage, 206  
   New Jersey State (summer), 217  
   New Jersey State (winter), 216  
   possibilities, 213  
 Dry picking, 411, 413, 415  
 Duck raising, rise of, 21  
 Dust boxes, 151  
 Dusting material, 152

## E

Economic factors, adjustment of, 58  
 Economy in handling layers, 275  
 Educational associations, 4  
   exhibitions, 476  
 Egg breeds as sitters, 80  
   circles, 450  
   classification of, 78  
   composition of, 196  
   description of type, 78  
   disposition of, 79  
   dry matter in, 305  
   eating, cause of, 279  
   prevention of, 279  
   exhibits, 473  
   expulsion of, 302  
   farming, combinations with, 26  
     locations for, 44  
   fertilization of, 301  
   foraging abilities, 80  
   formation of, 300  
   grades of, 440  
   hardiness of, 80  
   maturity of, 79  
   ovens, Egyptian, 326  
   packages, 436  
   pail, 287  
   parts of, 302  
   passage down oviduct, 301  
   preservation, 441  
   producing States, conditions in, 11  
   production, as affected by physical  
     condition, 180  
     as affected by temperature, 266  
   breeding for, 252  
   controlling factors in, 267  
   distribution of, 235  
   feeding for, 176  
   from pure breeds, 96

- Egg production, how improved, 235, 278  
 leading States in, 11  
 of meat breeds, 85  
 small flock, 25  
 records, importance of, 278  
 type defined, 257  
 meaning of, 71  
 scoring for, 490
- Eggs, collection, 287, 432  
 composition of, 305  
 fertility of, 306  
 for food, 429  
 for hatching, effect of age, 289  
 effect of temperature, 288  
 keeping, 288  
 grading, 432  
 hatching, 428  
 infertile, 437  
 malformed, causes of, 305  
 market classification, 433  
 number under one hen; 318  
 packing, 435  
 preventable losses in, 437  
 prices, 429  
 putting in incubator, 336  
 scoring, 492  
 selection, 287, 432  
 shipping, 436  
 storage of, 442  
 testing of, 320, 343  
 uniformity from pure breeds, 97, 434  
 use of artificial, 279  
 value for feeding, 197  
 yields, amount of, 278
- Eggshell, composition and function, 303
- Egyptian egg ovens, 326
- Embryo, development of, 199, 307, 308, 309, 438  
 location of, 302
- Employment, poultry keeping as an, 22
- Enemies, 512
- England, poultry farming in, 35
- English classes, breeds comprising, 73
- Environment, effect on breeding, 227  
 effect on egg production, 104, 268  
 for young stock, 369
- Epiblast defined, 307
- Epsom salts, 505
- Equipment, amount of, 60  
 choice of, 60  
 for feeding, 204
- Evaporation in incubation, 341
- Examination, post-mortem, 502
- Exercise, effect of insufficient, 256  
 during winter, 271  
 for chicks, 361
- Exercise, how induced, 108  
 importance in breeding, 180, 228
- Exhibiting, 473  
 care at show, 482
- Exhibition, arrangement of, 485  
 development of, 474  
 for pleasure, 473  
 preparing for, 477  
 training for, 477  
 type of, 475
- Exclusive poultry farming defined, 26
- Experience, value of, 58
- Experiment stations, list of, 517
- Extension teaching defined, 2  
 methods of, 3
- F
- Factors affecting breeding, 226  
 bringing greater profits, 35
- Fallacies in breeding, 264
- Family use, poultry for, 24
- Fancier, opportunities of the, 27
- Fancy breeds, classification of, 94  
 purposes of, 94  
 points, breeding for, 25  
 poultry keeping for, 25  
 poultry farming, location for, 45  
 qualities defined, 94
- Farm flock, frontispiece
- Fat, amount in birds, 171  
 appearance and prevalence in feeds, 171  
 as related to laying condition, 180  
 defined, 170  
 function of, 172  
 uses of, in the body, 170
- Fattening, chapter on, 403-420  
 feeding for, 175  
 methods of, 403
- Feathers, care of, 448  
 growth in embryo, 310  
 marketing, 448
- Features essential in poultry houses, 105
- Fecundity, inheritance of, 233
- Feed for breeders, 286  
 trough, 153  
 wagon, 207
- Feed-house design, 204
- Feeding appliances, 206  
 chicks, 358  
 clean, 498  
 during the winter, 270  
 effect of heavy, 256  
 effect on egg production, 268  
 equipment, 204  
 importance of regularity, 212

- Feeding, objects of, 175  
 practice of, 204  
 principles of, 169  
 records, 459, 461  
 standards, their practicability, 176  
 stuffs, weight and volume, 520  
 systems of, 212
- Feeds, animal, 194  
 as related to product, 178  
 for poultry, 184  
 must carry variety, 180  
 natural, 179  
 ready mixed, 194  
 use of stimulating, 182
- Females, number to one male, 285
- Fence bracing, 163  
 height of, 164  
 ideal, 165  
 maintenance of, 167  
 material for, 163
- Fertility, discussion of, 306  
 in hatching eggs, 428  
 increase in, 31
- Figuring ration, 207
- Fish scrap, composition of, 196  
 manufacture, 195
- Fixed capital defined, 58
- Fixtures, location of, 143
- Flax seed, its use and value, 192
- Fleas, 510
- Flock, fattening, 403  
 size of, 270
- Floors, construction of, 117  
 ideal concrete, 131  
 space related to capacity, 109
- Food consumption, 224  
 for egg production, 176  
 for fattening, 176  
 for growing stock, 374  
 for growth and maintenance, 176
- Foraging abilities of egg breeds, 80  
 of general-purpose breeds, 89  
 of meat breeds, 85
- Foreign poultry keeping, 35  
 Austria-Hungary, 39  
 Belgium, 38  
 Denmark, 38  
 English, 35  
 French, 37  
 Ireland, 36  
 Italy, 38  
 Russia, 39
- Foundation, laying out, 124  
 types of construction, 116
- Fowls, 376  
 biological classification of, 65  
 composition of body, 169  
 nomenclature of, 515  
 origin of, 63  
 parts of, 515  
 physiological description of, 292
- Frame, manner of constructing, 128
- Frames for concrete wall, 126
- Framing poultry house materials, 118
- France, poultry farming in, 37
- Free range, 158
- French breeds, possibilities of, 76
- Fresh air, need of, 108
- Frizzles, characteristics of, 78
- Frozen combs, 505
- Fryers, 385
- Functional activity, 242  
 effect in breeding, 228  
 variation, 238
- G
- Gallus bankiva, 63
- Games, ancestry of, 76  
 characteristics, 76
- Gametic defined, 234
- Gapeworm, 511
- Gasoline brooder, 254
- Gate, construction of, 166  
 location, 165
- General-purpose breeds, classification, 89  
 as foragers, 89  
 disposition of, 87  
 hardiness of, 89  
 maturity of, 87  
 sitting qualities, 88  
 type defined, 86
- Geographic distribution of fowls, 9
- Germ oil, 187
- Gizzard, location and function, 297
- Glass windows, proper size, 121
- Gluten feed defined, 186  
 meal defined, 186, 193
- Glycogen, composition, 171
- Grading on side hill, 124  
 up, advantages of, 246
- Grains, composition of, 193  
 digestibility of, 181
- Grasses, value and usage, 198
- Gravity water supply, 52
- Green food, 371  
 for breeders, 287  
 supplying in yards, 160
- Grit for chicks, 359  
 and shell boxes, design, 156  
 usage, 181, 212
- Growing stock, chapter on, 368-375



- Growth, feeding for, 175  
 how affected, 369
- H**
- Half-monitor house, cost of materials, 139  
 plans, 137  
 specifications, 138
- Hamburgs, distribution of, 76
- Hardening-off process, 365
- Hardiness of egg breeds, 80  
 of general-purpose breeds, 89  
 of meat breeds, 85
- Harvest mites, 510
- Hatching, advantages of early, 278  
 centralized, 27  
 eggs, collection of, 287  
 keeping, 288  
 selection of, 287  
 process of, 310
- Hay-cutter, 206
- Head, bones of, 294
- Health, importance of, 101, 271
- Heat, effect on birds, 109  
 in incubator, 337
- Heater, operation of, 366
- Heavy producers, breeding from, 252
- Height of laying house, 112
- Hen compared with cow, 169  
 consumption and production with, 510
- Hen's eggs, composition of, 196
- Heredity, benefits from, 230  
 definition, 229  
 example of, 229  
 law of, 229
- Hollow tile for incubator cellar, 329
- Home practice, value of, 6
- Hominy meal, composition of, 193  
 manufacture, 187
- Hoppers, advantages of, 106  
 design, 154  
 self-feeding, 153  
 types of, 154  
 use of, 130
- Hot-air incubators, 331
- Houdans, possibilities of, 94
- House construction, standard-unit, 113  
 convenience in, 106  
 development of, 104  
 economy in, 105  
 effect of shape on cost, 113  
 grading for, 124  
 principles of, 104  
 roofing materials, 122  
 sanitation, 110  
 design, features of, 105
- Houses, brooder, 348  
 feed, 204  
 for growing stock, 372  
 importance of cleanliness, 497  
 perimeter of, 113  
 preservation of, 122  
 types of, 111
- Hunterdon County, New Jersey, a great  
 egg centre, 16
- Hybridizing defined, 230, 246  
 example of, 231
- Hygiene, 497
- Hypoblast defined, 307
- I**
- Icing poultry, 447
- Imagination as affecting breeding, 264
- Impregnation, effect of a previous, 264
- Improvement, need of, 221.
- Inbreeding defined, 246, 247  
 effect on vigor, 255  
 possibilities of, 248  
 ways of, 247
- Incubation, advantages of artificial, 313  
 advantages of natural, 312  
 artificial, 326  
 cooling during, 339  
 disadvantages of natural, 312  
 eggs under one hen, 318  
 hatching time, 345  
 historical development, 326  
 natural, 312  
 period of development, 321  
 record, 458  
 temperature, 338  
 regulation, 333  
 testing, 344  
 turning, 339
- Incubator, best place for, 335  
 care of, 335  
 cellar for, 329  
 cellar plans, 328  
 development of, 327  
 filling egg chamber, 336  
 house, capacity of, 330  
 interior arrangement, 330  
 location, 331  
 plans of, 328  
 requirements of, 327  
 ventilation, 329  
 lamp, 335  
 moisture for, 341  
 record, 456  
 selection of, 333  
 ventilation of, 340

- Incubators, mammoth, 332  
types of, 331
- Infertile eggs, advantages of, 307, 437
- Infertility, causes of, 289
- Inheritance as affecting breeding, 226  
definition, 226  
genotype conception of, 234  
of disease, 227  
of fecundity, 233  
statistical conception of, 233
- Inherited characters, 369
- Instruction, collegiate, 2  
by correspondence, 3  
demand for, 1  
diversity of, 1  
elementary, 2  
need for, 1  
secondary, 2  
types of, 2
- Internal parasites, 510
- Intestinal worms, 511
- Intestines, location and function, 297
- Inventory making, 458  
record, 455
- Investment in buildings, 60  
in equipment, 60  
poultry keeping as an, 23
- Ireland, poultry farming in, 36
- Italy, poultry farming in, 38
- J
- Journals, list of, 520
- Judges, selection of, 485
- Judging, 486  
by comparison, 487  
by scoring, 488  
methods of, 487  
objects of, 486  
principles of, 487
- Jungle fowl, description of, 63
- K
- Kaffir corn, 192
- Key-word is system, 62
- Killing, chapter on, 403-420  
knife for, 412  
methods of, 409  
preparation for, 409
- L
- Labor, amount of, 60  
economy of, 53  
records, 461
- Labor-saving devices, 60
- Laboratory practice, methods of, 4  
need of, 4
- Lady Cornell, performance of, 259
- Land contour, 49  
form of capital, 59  
ownership vs. rental, 59  
required, 28  
shape of, 50, 51  
size or area, 50
- Langshan, origin, 72
- Law of atavism, 240  
of correlation, 241  
of inheritance, 229  
of variation, 235
- Lawn clippings, 197
- Laws of breeding, 229
- Lay bones, 294
- Laying house, capacity of, 108  
doors, 119  
features of design, 105  
floors, 117  
foundations, 116  
framing, 118  
height of, 112  
materials for, 111  
moisture in, 107  
multiple-unit, 128  
practical types, 128  
roofs, 114  
shapes, 112  
size, 110  
standard-unit, 115  
sunlight, 106  
ventilation, 108  
walls and partitions, 118  
windows and curtains, 120
- relations, California, 219  
Cornell, 218  
New Jersey, 216  
stock, fall management, 269  
management of, 266  
summer management, 274  
winter management, 270
- Leading poultry States, 10
- Learning poultry business, 57
- Levelling board, use of, 124
- Leg banding, importance of, 322, 454
- Leghorns, origin of, 73  
performance of, 81
- Legs, description of, 293
- Legumes, value and usage, 198
- Lettuce, 201
- Lice, body, 507
- Like begets like, meaning of, 229
- Lime in droppings, 449

- Lime sources of, 185
    - uses of, 185
  - Limitation of sex, 243
  - Line-breeding, advantages of, 248
    - chart for, 249
    - defined, 248
    - for eggs, 253
  - Linseed meal, composition of, 193
  - Litter, 272
  - Little Compton District, Rhode Island, 17
  - Live poultry, marketing, 443
    - scoring, 491
  - Liver, 297
  - Location, climatic conditions, 48
    - defined, 41
    - effect on success, 41
    - for egg farming, 44
    - for meat farming, 44
    - soil conditions, 48
  - Long laying house, cost of material, 134
    - material for, 133
    - small units for breeding, 132
    - specifications, 132
- M
- Machine, hen compared with, 222
  - Mail, need of frequent service, 43
  - Maintenance, feeding for, 175
  - Malay fowl, description of, 64
  - Male, importance of, 234
    - birds affecting production, 307
  - Males, proportion to females, 285
  - Mammoth incubators, 332
  - Management, changes in, 20
  - Manure, handling, 449
  - Market poultry, types of, 376
  - Marketing, chapter on, 422
    - coöperation in, 450
    - importance of care, 268
    - methods of, 12
  - Markets, 422
    - course of products, 425
    - distance from, 41
    - nearness *vs.* price of land, 41
    - securing, 428
  - Mash for chicks, 359
  - Mass breeding, 281
  - Materials for laying houses, 111
  - Mating season, care during, 286
  - Matings, double, 261
    - importance of special, 281
  - Mature birds, value in breeding, 253
  - Maturity of egg breeds, 79
    - of general-purpose breeds, 87
    - meat breeds, 84
  - Meal, animal, 195, 196
  - Meat, amount in ration, 179
    - breeds as egg producers, 85
      - as foragers, 85
      - as sitters, 85
    - classification of, 85
    - description of type, 83
    - disposition of, 84
    - hardiness of, 85
    - maturity of, 84
    - farming, 26
      - location for, 44
      - returns from, 26
    - necessity in the ration, 179
    - production, breeding for, 258
    - quality, 97
    - scrap, value and usage, 194
  - Medicines, 506
  - Mediterranean class breeds, 72
  - Mendel's law, essence of, 23
  - Menopon biserialatum, 507
  - Mercantile exchange, function, 430
  - Meristic variation, 238
  - Mesoblast defined 307
  - Methods of judging, 487
  - Milk albumin, composition, 196
    - importance of, 197
    - composition of, 196
    - granulated, composition of, 196
    - manufacture and usage, 197
  - Millet seed, usage, 192
  - Milo maize, 192
  - Mineral matter for laying hens, 181
    - sources of, 202
  - Minerals, double function of, 202
    - for poultry, 201
  - Minorcas, origin, 73
    - performance of, 83
  - Mites, 509, 510
  - Mixed feeds, value of, 194
  - Mixing board for concrete, 127
  - Modern development, 19
  - Moisture in incubation, 342
    - in the poultry house, 107
  - Molt indicative of egg production, 277
  - Molting, care during, 276
    - forcing, 277
    - selection in reference to, 253
  - Morphological variation, 236
  - Motion of embryo, 310
  - Multiple-unit house, 132
    - development of, 113
    - material required, 131
    - specifications, 128
    - working plans for, 129
  - Muscular system, uses of, 295

- Muslin curtains, frames, 121
  - proper size, 120
  - use of, 108
  - weight cloth, 122
- Mutation defined, 238
- example, 239

## N

- Nest construction, 146
  - design, 146
  - eggs, use, 279
  - location, 148
  - materials, 147, 317
  - rules for making, 317
  - special trap nests, 148
  - types, 147
- New Jersey rations outlined, 215
- Nomenclature of fowl, 515
- Noted centres of production, Hunterdon County, N. J., 16
  - Little Compton, R. I., 17
  - Petaluma, Cal., 12
  - South Shore, Mass., 18
  - Vineland, N. J., 15
- Notochord defined, 307
- Nutrients, classified, 171
  - defined, 171
  - in feeding stuffs, 518
  - right proportion, 208
  - sources of, 184
  - sufficient, 207
  - uses of, in the body, 172
- Nutrition defined, 171
  - process of, 171
- Nutritive ratio defined, 208
  - example, 209

## O

- Oatmeal, composition of, 193
  - usage, 188
- Oats, composition, 193
  - sprouted, usage, 189
  - value, 188
- Oil meal, 192
- Olive oil, 506
- Onions, 200
- Organic feeds, classification, 185
- Organization, American Poultry Association, 26
  - breed associations, 26
  - for education, 4
  - growth of, 20
  - in European countries, 40
- Organs, uses of, 295

- Oriental, origin, 76
- Orpingtons, origin, 75
- Out-crossing defined, 249
  - object, 250
- Ovary, location and function, 300
- Oviduct, location and function, 300
- Oyster shell, 185, 201

## P

- Packages for dressed poultry, 444
- Parasites, 507
  - on young chicks, 324
- Peas and oats, 197
- Pedigree, value of, 283
- Pelvic arch, 294
- Pen record, 455
- Perches, construction, 144
  - location and design, 143
- Personality, importance of, 56, 61
- Petaluma, California, 12, 13, 14
- Phosphate rock, composition, 202
  - uses and sources, 185
- Physiological organization of the fowl, 294
- Physiology, 292
- Planning records, 453
- Plans multiple-unit house, 129
- Plucking methods, 413
- Plumping, 417
- Plymouth Rocks, 89
- Polish class, 75
- Poor hatches, causes, 322
- Pork scrap, value, 195, 196
- Portable laying house, materials, 141
  - plans, 140
  - specifications, 139
- Post-mortem examinations, 502
- Posts, bracing, 163
  - materials for, 161
  - setting, 162
- Potatoes, usage, 199
- Potential energy defined, 209
- Poultry, breeds of, 63
  - diseases, 496, 503
  - economics, land, labor and capital, 58
  - exhibitions, 475
  - farming defined, 7
  - feeds, 184
  - fixtures, 143
  - house, standard-unit, 113
  - in cities, 8
  - in the United States, 8, 9, 10
  - journals, list, 520
  - keeping, advantages, 28
    - disadvantages, 31
    - how to learn, 57

Poultry keeping, objects of, 22  
 place in the animal kingdom, 65  
 plants, scoring, 493  
 surgery, 504  
 systems, danger of, 34  
 value of pure-bred, 252

Poultryman, qualifications of, 57

Power, kinds of, 206

Practical application, value of, 1

Prepotency defined, 242  
 how increased, 243  
 importance in breeders, 283

Preservation of eggs, 441  
 of fence posts, 161  
 of fences, 167  
 of houses, 122

Price of products, 426

Prices, regulation of, 430

Principles of breeding, 225  
 of judging, 487

Prizes, profit from, 473

Problems of the breeder, 223

Producer to consumer, 425

Production, amount of, 33  
 as affected by male, 307  
 cost of, 33  
 feeding for, 175  
 noted centres of, 10

Productiveness, effect on vigor, 255

Products as influenced by foods fed, 178  
 easy to market, 29  
 exhibition of, 486  
 variety of, 29

Profits, average yearly, 34  
 determined by, 32, 267  
 effects of rats and mice upon, 110  
 from advertising, 475  
 from prizes, 473  
 from sale of birds, 475  
 how to increase, 35  
 per cent on investment, 34

Protection from cold, 110

Protein, composition of, 170  
 cost of a pound, 211  
 defined, 170  
 for chicks, 360  
 functions of, 172  
 importance of, 172

Protoplasm defined, 295

Proventriculus, 297

Publications, development of, 20

Pullets as breeders, 256, 284  
 early producing, 253

"Pure bred" defined, 96

Pure-bred birds, cost of, 98  
 demand for, 99

Pure-bred birds, efficiency of, 99  
 selling value, 99, 252

Pure breeds, advantages of, 96  
 value for meat, 258

## Q

Qualifications necessary for poultryman, 57

Quality of products, 426

## R

Range, 369

Rape, composition of, 200  
 value, 201

Rations, compounding, 207  
 defined, 207  
 for chicks, 361  
 for growing stock, 375  
 mixing, 207  
 outlined, 215  
 storing, 211  
 summer changes in, 275

Rats, protection against, 110

Recessive, meaning in Mendel's law, 231

Reciprocal crosses, 250

Records, 453  
 breeding, 454  
 brooding, 460, 461  
 egg, 278  
 feeding, 459  
 importance of, 453  
 incubator, 345, 456  
 inventory, 455  
 labor, 461  
 methods of keeping, 462  
 of sitting hens, 320  
 pen, 455  
 planning of, 453  
 sitting, 458  
 young stock, 461

Red mites, 507

Reference literature, 5

Regularity in feeding, 212

Retailer, selling to, 423

Returns, 424  
 rapidity of, 30

Rhode Island Reds, 93  
 origin of, 71

Rice, value, 192

Right-angle triangle, use of, 125

Risks in the business, 34

Roads, 43

Roaster, breeds for, 388  
 defined, 386  
 dressing, 418

- Roaster, farming, South Shore, 18
- Roasters, chapter on, 376-402
  - distribution of, 385
  - features of, 388
  - management, 389
  - prices, 387
  - types, 387
- Roofing materials, 122
- Roofs, types, 114
- Roosting closets, 145
- Root crops, 200
- Roundworms, 511
- Running water, advantages of, 52
- Russia, poultry farming in, 39
- Rye, value and usage, 191

## S

- Salesman, 422
  - responsibility of, 427
- Salt, 185, 212
- Sanitation, 110, 497
- Sarcoptes mutans, 508
- Scalding, 414
- Scaly legs, 509
- Score card, decimal, 490
  - dressed poultry, 492
  - market poultry, 492
  - official, 489
  - types of, 488
- Scoring, 488
  - dressed poultry, 491
  - eggs, 492
  - poultry plant, 493
- Scratch feeding grains, 214
- Scratching ration, Cornell, 219
  - New Jersey, 217
- Segmentation defined, 307
- Selection defined, 251
  - for egg production, 254
  - hatching eggs, 287
  - importance of, 281
  - judges, 485
  - layers, 275
  - live birds, 101
  - pullets at maturity, 270
  - show birds, 479
- Selling value pure-bred birds, 99
- Semi-community system, 46
- Senses, development of, 298
- Setting coops, cleanliness, 320
  - materials for, 316
- Setting the hen, 318
- Sex adaptation, 30
  - control, 250
  - limitation, 243
- Sexes, separation, 324
- Sexual dimorphism, 261
- Shade, 371
- Shape, a breed characteristic, 68
  - of laying house, 112
  - selection for, 102
- Shaping, 417
- Shed roof, 115
- Shell for chicks, 359
  - membranes, 304
  - structure and composition, 302
  - usage, 212
- Shipping dressed poultry, 447
  - methods of, 428
  - need of facility in, 43
  - to exhibition, 482
- Show, arrangement of, 485
  - running, 483
- Side line, poultry keeping as a, 26
- Silkies, 77
- Simplicity, 111, 143
- Sitting hen, care of, 319, 322
  - selection of, 317
  - when to set, 315
  - qualities of egg breeds, 80
    - of general-purpose breeds, 88
    - of the meat breeds, 85
  - records of, 458
- Situation defined, 41
  - important factors in, 49
- Size, importance of in breeding, 258
  - of laying house, 110
  - of stock, 102
- Skeleton, 292
- Skim milk, composition, 196
- Skunks, 512
- Slips, 398
- Slope, best, 52
- Soil effect on color, 264
  - effect on fertility, 31
  - proper condition of, 48
  - undesirable types, 49
- Solid color, breeding for, 263
- Somatic defined, 234
- Sorghum, 192
- South Shore roasters, 18
- Spaying, 401
- Spraying for cleanliness, 273
- Spring, for water supply, 53
- Sprouted oats, advantages, 190
  - composition, 191
  - manner of sprouting, 189
- Standard bred defined, 94
  - poultry, exhibition of, 477
  - classification defined, 66
  - table of, 66, 67
  - of excellence, use of, 225

Standard weights, table, 70  
 Start, small beginning, 56  
 Starting time, 61  
 Sternum, 294  
 Sticking, 410  
 Stimulating feeds, 182  
 Stock, importance of good, 61  
   method of acquiring, 100  
   quality of, 101  
   selection of, 96, 267  
 Storage of dressed poultry, 448  
   of eggs, 442  
 Substantive variation, 237  
 Suburban poultry farming, 24  
 Success and failure, causes of, 96  
   best way to achieve, 7, 56, 61  
 Succulence for chicks, 361.  
   need of, 210  
 Sultans, appearance, 77  
 Sunflower seeds, 192  
 Sunlight, 106  
 Supply, 427  
   *vs.* demand, 32  
 Surgery, 504  
 Swiss chard, 201  
 Symptoms of disease, 500  
 System, best for beginner, 60  
   defined, 295  
   the key to success, 62  
 Systems of feeding, best, 215  
   classified, 212  
   of poultry farming classified, 45

## T

Tapeworm, 512  
 Tar, use as a paint, 123  
 Taste, sense of, 299  
 Telephone, need of, 43  
 Temperature for brooding, 257  
   for holding hatching eggs, 288  
   for incubation, 337  
   fowl's body, 169  
   of houses, 109  
 Testicles, location, 298  
 Testing eggs, 320, 343  
 Thermostat, use of, 333  
 Tile, use under foundation, 126  
 Time to start, 61  
 Tissue defined, 295  
   kinds of, 295  
 Toe punching, 454  
   manner of, 322  
 Training for exhibition, 477  
 Transit, use of, 124  
 Transportation, facilities for, 21

Transportation, need of, 42  
 Trap-nesting to improve egg production, 278  
 Trap nests, 148  
   design, 149  
   usage, 149  
 Trench for foundation, 125  
 Troughs for feeding, 152  
 Turning eggs in incubation, 339  
 Two-thirds span house, specifications, 135  
 Type defined, 71  
   for egg production, 257  
   of incubators, 331  
   of laying houses, 110

## U

Under color, importance of, 263  
 Uniformity of eggs, 97  
   of flocks, 98  
 Unit of protein, cost of, 211  
   standard poultry house, 113  
 United States census table, 8  
 Utility classification, 66, 78  
   exhibitions, 475  
   fancy combined with, 25  
   quality, score card for, 490  
   score card, use of, 491  
   types compared, 88

## V

Value, basis of, 224  
 Variation, causes of, 239  
   functional, 238  
   laws of, 235  
   meristic, 238  
   morphological, 236  
   principles of, 235  
   substantive, 237  
   types of, 236  
 Varieties, number of, 66  
 Variety defined, 70  
   necessity in feeding, 180  
 Vegetable cutter, 206  
 Vegetables, composition of, 198, 200  
 Ventilation, automatic, 108  
   in incubator cellar, 329, 340  
   in poultry house, 108  
 Vigor, cause of lack of, 255  
   constitutional, 254  
   importance of, 254  
   selection for, 102  
 Vineland District, New Jersey, 15  
 Vital question, profitable production, 35  
 Vitality, signs of high, 256

Vitality, signs of low, 256  
 Vitelline membrane, 301  
 Vitellus defined, 301

## W

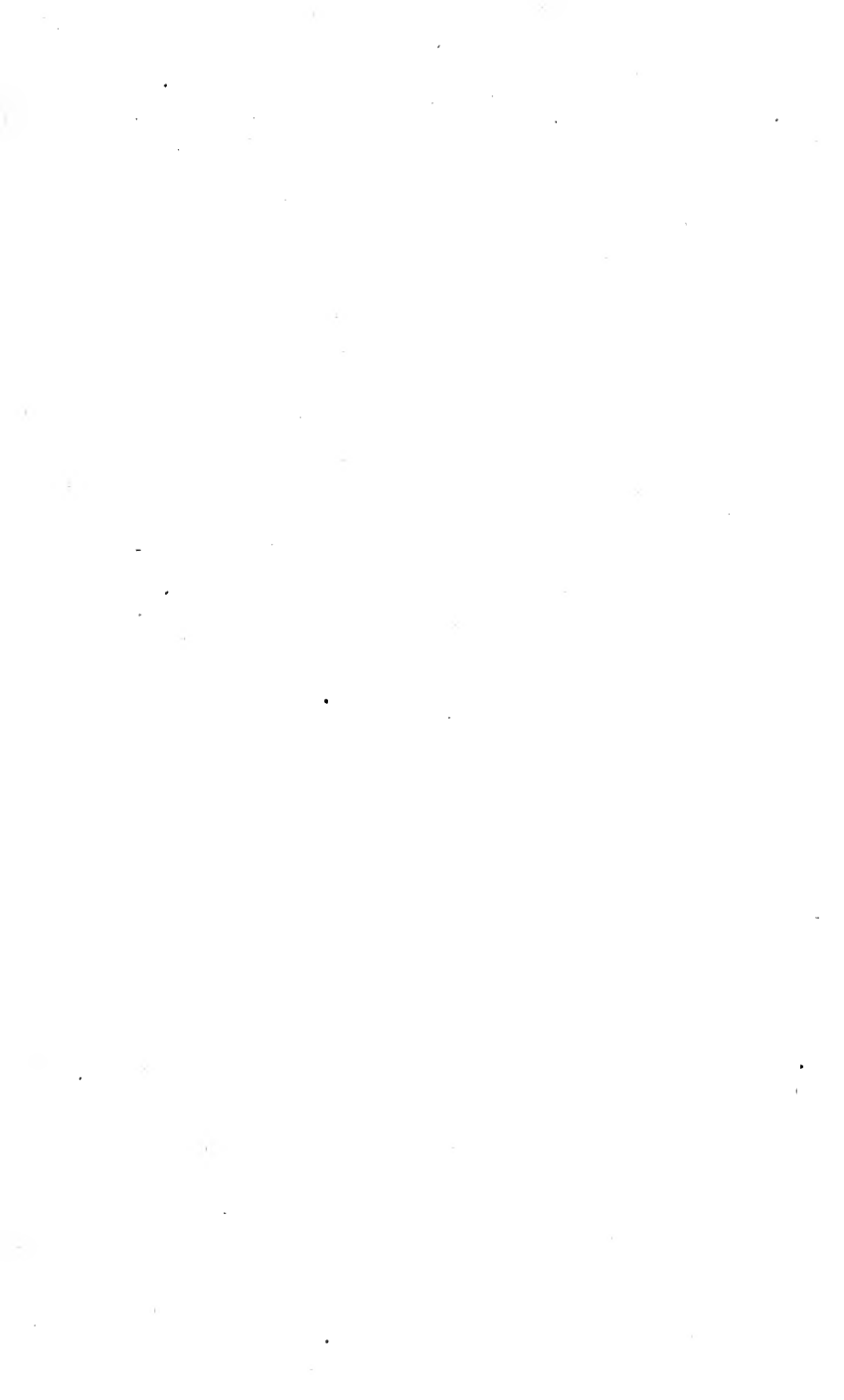
Walls, materials for, 118  
 Washing birds, 479  
 Waste land, 42  
   products, 31  
 Water, elevating for storage, 53  
   for chicks, 359  
   importance of fresh, 52  
   in eggs, 184  
   in fowl's body, 170  
   necessity of, 173, 180  
   sources of, 52, 184  
   uses of, 173  
 Water-glass, use of, 441  
 Weaning chicks, 324, 368  
 Weasels, 512  
 Weight, 102  
 Weights of breeds, table, 70  
 Wet mash, 213  
 Wheat as a poultry food, 179, 193  
   bran, composition, 193  
   manufacture, 187  
   flour, 188

Wheat middlings, 187, 193  
   screening, 188  
 Whey, 196  
 White diarrhoea, 364  
 White-faced Black Spanish, origin, 73  
 Windows, arrangement, 106  
   for laying house, 120  
 Wings, 292  
 Winter quarters, 269  
 Wire, poultry fencing, 163  
 Working plans, half-monitor house, 137  
   long laying house, 132  
   portable laying house, 140  
   two-thirds span house, 135  
 Wyandottes, 71, 91

## Y

Yarding, double, 159  
 Yards and yarding, 158  
   clean, 499  
   cost of, 159  
   crop rotation for, 160  
   shape of, 159  
   size of, 158  
   vs. free range, 158  
 Yolk, 304  
 Young stock, record, 461







YC 20370

SF487

L45

1913

284688

**UNIVERSITY OF CALIFORNIA LIBRARY**

