

UNIVERSITY OF TORONTO

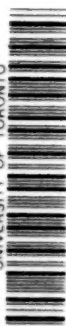

3 1761 01768719 5

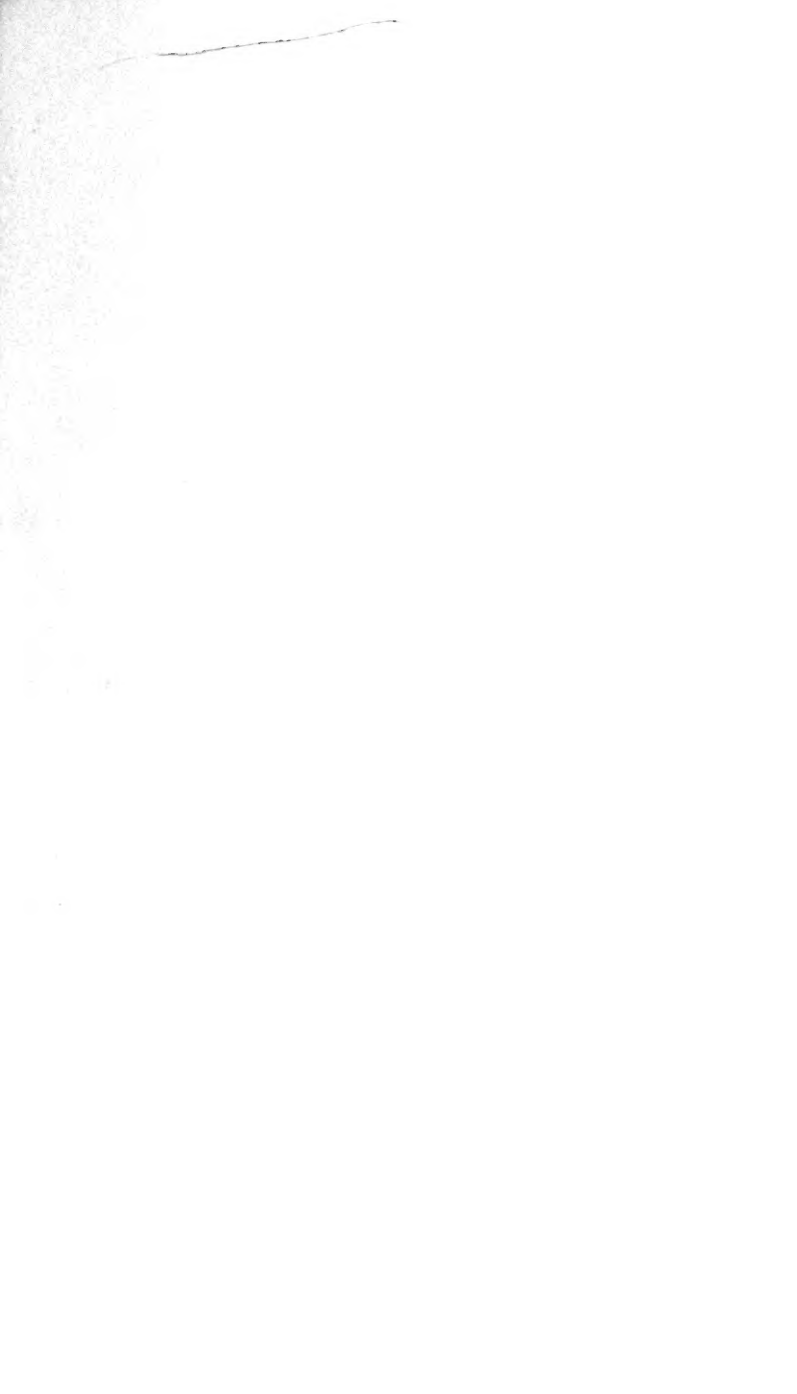



802

73

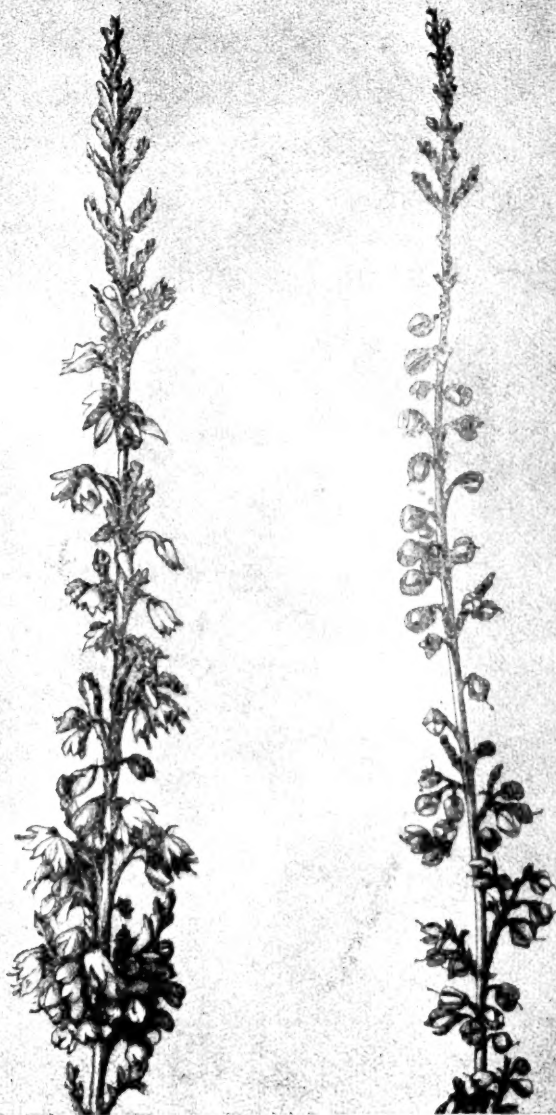

BLOSSOMING AND STRICKEN IN DAYS.

Common Heath. (Ling.)

PROSERPINA

ALSO

ARIADNE FLORENTINA

THE OPENING OF THE CRYSTAL PALACE

ST. MARK'S REST

LECTURES ON ART

THE ELEMENTS OF PERSPECTIVE

BY

JOHN RUSKIN, M.A.

AUTHOR OF "THE SEVEN LAMPS OF ARCHITECTURE," "THE CROWN OF WILD OLIVE,"
"SESAME AND LILIES," ETC.

NEW YORK

LOVELL, CORYELL & COMPANY

310-318 SIXTH AVENUE.

1027

8:10:53

OF THE OR

WANDA B

LECTURE

THE FRONT

PR

5261

P7

18--

CONTENTS.

PROSERPINA.

VOLUME I.

| | PAGE |
|----------------------------------|------|
| INTRODUCTION, | 5 |
| CHAPTER I. | |
| MOSS, | 13 |
| CHAPTER II. | |
| THE ROOT, | 22 |
| CHAPTER III. | |
| THE LEAF, | 31 |
| CHAPTER IV. | |
| THE FLOWER, | 48 |
| CHAPTER V. | |
| PAPAVR RHOEAS, | 63 |
| CHAPTER VI. | |
| THE PARABLE OF JOASH, | 76 |
| CHAPTER VII. | |
| THE PARABLE OF JOTHAM, | 83 |
| CHAPTER VIII. | |
| THE STEM, | 90 |
| CHAPTER IX. | |
| OUTSIDE AND IN, | 107 |

| | PAGE |
|------------------------------|---------------|
| | CHAPTER X. |
| THE BARK, | 119 |
| | CHAPTER XI. |
| GENEALOGY, | 122 |
| | CHAPTER XII. |
| CORA AND KRONOS, | 142 |
| | CHAPTER XIII. |
| THE SEED AND HUSK, | 151 |
| | CHAPTER XIV. |
| THE FRUIT GIFT, | 156 |

VOLUME II.

| | |
|-----------------------|--------------|
| | CHAPTER I. |
| VIOLA, | 165 |
| | CHAPTER II. |
| PINGUICULA, | 194 |
| | CHAPTER III. |
| VERONICA, | 205 |
| | CHAPTER IV. |
| GIULIETTA, | 220 |

INDEX I.

| | |
|-------------------------------------|-----|
| DESCRIPTIVE NOMENCLATURE, | 233 |
|-------------------------------------|-----|

INDEX II.

| | |
|--------------------------|-----|
| ENGLISH NAMES, | 244 |
|--------------------------|-----|

INDEX III.

| | |
|---------------------------------|-----|
| LATIN OR GREEK NAMES, | 246 |
|---------------------------------|-----|

ARIADNE FLORENTINA.

| | PAGE |
|---|------|
| LECTURE I. | |
| DEFINITION OF THE ART OF ENGRAVING, | 249 |
| LECTURE II. | |
| THE RELATION OF ENGRAVING TO OTHER ARTS IN FLORENCE, | 268 |
| LECTURE III. | |
| THE TECHNICS OF WOOD ENGRAVING, | 288 |
| LECTURE IV. | |
| THE TECHNICS OF METAL ENGRAVING, | 306 |
| LECTURE V. | |
| DESIGN IN THE GERMAN SCHOOLS OF ENGRAVING (HOLBEIN AND DURER,) | 324 |
| LECTURE VI. | |
| DESIGN IN THE FLORENTINE SCHOOLS OF ENGRAVING (SANDRO BOTTICELLI), | 350 |

APPENDIX.

| | |
|--|-----|
| ARTICLE I. | |
| NOTES ON THE PRESENT STATE OF ENGRAVING IN ENGLAND . | 385 |
| ARTICLE II. | |
| DETACHED NOTES, | 396 |

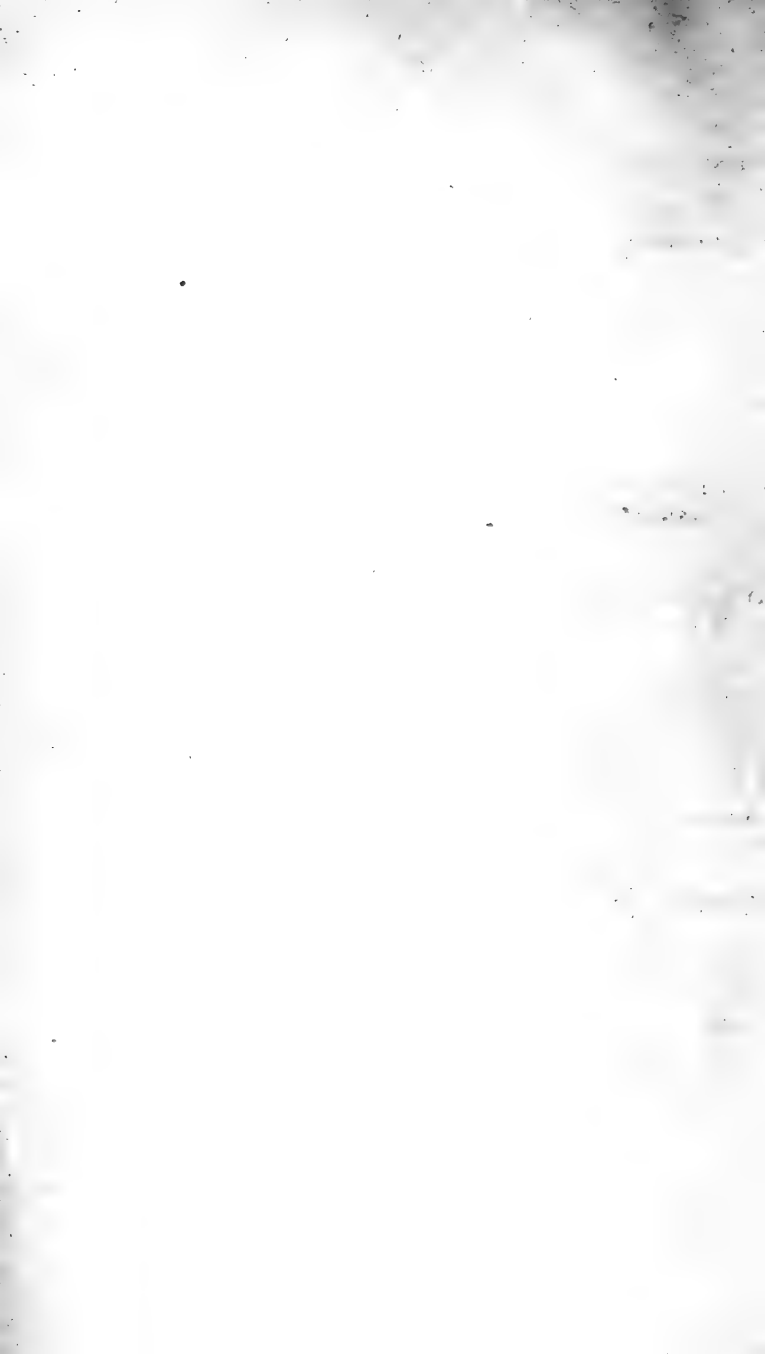

LIST OF ILLUSTRATIONS.

PROSERPINA.

VOLUME I.

| FIGURE | PAGE |
|--|-------|
| 1. FLORÆ DANICÆ | 14 |
| 2. MOSS PLANT | 17 |
| 3. LEAF OF THE ALISMA | 41 |
| 4, 5, 6. DIAGRAMS OF LEAVES. PETALS | 54-56 |
| 7. PRIMROSE | 59 |
| 8, 9. DEVELOPMENT OF PEASE BLOSSOM | 60 |
| 10. WELSH POPPY | 66 |
| 11. PROFILE OF WELSH POPPY | 67 |
| 12. POPPY | 68 |
| 13. OUTLINE OF LEAF OF BURDOCK | 93 |
| 14. BURDOCK LEAF ILLUSTRATED BY PAPER | 94 |
| 15. PRIMULAS | 101 |
| 16, 17. DIAGRAMS OF THREE STEMMED LEAVES | 108 |
| 18. RAGGED ROBIN | 109 |
| 19. MONOCOT PLANT | 109 |

| FIG. | | PAGE |
|------|---|------|
| 20. | ARETHUSAN LEAF | 110 |
| 21. | ARETHUSAN LEAF CUT FROM PAPER | 111 |
| 22. | SPECIES OF GRASS | 112 |
| 23. | FLEUR-DE-LYS LEAF | 114 |

VOLUME II.

| | | |
|----|---------------------------|-----|
| 1. | VIOLET LEAF | 174 |
| 2. | VIOLET | 180 |
| 3. | VIRGULA | 199 |
| 4. | VERONICA REGINA | 211 |
| 5. | FLORA DANICA | 215 |

ARIADNE FLORENTINA.

| | | |
|----|--------------------------------------|-----|
| 1. | SHAPE OF SOLID PLOUGHSHARE | 289 |
| 4. | CROSS HATCHING | 399 |

LIST OF PLATES.

PROSERPINA.

| PLATES | FACING PAGE |
|---|-------------|
| I. BLOSSOMING—AND STRICKEN IN DAYS. (<i>Frontispiece</i>) | |
| II. CENTRAL TYPE OF LEAVES. COMMON BAY LAUREL . | 34 |
| III. ACANTHOID LEAVES. NORTHERN ATTIC TYPE . . . | 82 |
| IV. CRESTED LEAVES. LETTUCE THISTLES . . . | 83 |
| V. OCCULT SPIRAL ACTION. WASTE THISTLE . . . | 97 |
| VI. RADICAL INSERTION OF LEAVES OF ENSATÆ IRIS GER- MANICA | 122 |
| VII. CONTORTO PURPUREA. PURPLE WREATH-WORT . | 125 |
| VIII. MYRTILLA REGINA | 150 |
| IX. VIOLA CANINA | 165 |
| X. VIOLA CANINA. STRUCTURAL DETAILS . . . | 180 |
| XI. STATES OF ADVERSITY | 230 |

ARIADNE FLORENTINA.

| PLATES | PAGE |
|---|------|
| I. THINGS CELESTIAL AND TERRESTRIAL | 302 |
| II. THE STAR OF FLORENCE | 306 |
| III. AT EVENING, FROM THE TOP OF FESOLE | 317 |
| IV. BY THE SPRINGS OF PARNASSUS | 321 |
| V. HEAT CONSIDERED AS A MODE OF MOTION | 335 |
| VI. FAIRNESS OF THE SEA AND AIR | 338 |
| VII. FOR A TIME AND TIMES | 372 |
| VIII. THE NYMPH BELOVED OF APOLLO. MICHAEL ANGELO | 373 |
| IX. IN THE WOODS OF IDA | 373 |
| X. GRASS OF THE DESERT | 376 |
| XI. OBEDIENTE DOMINO VOCI HOMINIS | 385 |
| XII. THE CORONATION IN THE GARDEN | 396 |

PROSERPINA

STUDIES OF WAYSIDE FLOWERS

1792

1792

INTRODUCTION.

BRANTWOOD, 14th March, 1874.

YESTERDAY evening I was looking over the first book in which I studied Botany,—Curtis's Magazine, published in 1795 at No. 3, St. George's Crescent, Blackfriars Road, and sold by the principal booksellers in Great Britain and Ireland. Its plates are excellent, so that I am always glad to find in it the picture of a flower I know. And I came yesterday upon what I suppose to be a variety of a favourite flower of mine, called, in Curtis, "the St. Bruno's Lily."

I am obliged to say "what I suppose to be a variety," because my pet lily is branched,* while this is drawn as unbranched, and especially stated to be so. And the page of text, in which this statement is made, is so characteristic of botanical books, and botanical science, not to say all science as hitherto taught for the blessing of mankind; and of the difficulties thereby accompanying its communication, that I extract the page entire, printing it, on page 7, as nearly as possible in facsimile.

Now you observe, in this instructive page, that you have in the first place, nine names given you for one flower; and that among these nine names, you are not even at liberty to make your choice, because the united authority of Haller and Miller may be considered as an accurate balance to the single authority of Linnæus; and you ought therefore for the present to remain, yourself, balanced between the sides. You may be farther embarrassed by finding that the Anthericum of Savoy

* At least, it throws off its flowers on each side in a bewilderingly pretty way; a real lily can't branch, I believe: but, if not, what is the use of the botanical books saying "on an unbranched stem"?

is only described as growing in Switzerland. And farther still, by finding that Mr. Miller describes two varieties of it, which differ only in size, while you are left to conjecture whether the one here figured is the larger or smaller ; and how great the difference is.

Farther, If you wish to know anything of the habits of the plant, as well as its nine names, you are informed that it grows both at the bottoms of the mountains, and the tops ; and that, with us, it flowers in May and June,—but you are not told when, in its native country.

The four lines of the last clause but one, may indeed be useful to gardeners ; but—although I know my good father and mother did the best they could for me in buying this beautiful book ; and though the admirable plates of it did their work, and taught me much, I cannot wonder that neither my infantine nor boyish mind was irresistibly attracted by the text of which this page is one of the most favourable specimens ; nor, in consequence, that my botanical studies were—when I had attained the age of fifty—no farther advanced than the reader will find them in the opening chapter of this book.

Which said book was therefore undertaken, to put, if it might be, some elements of the science of botany into a form more tenable by ordinary human and childish faculties ; or—for I can scarcely say I have yet any tenure of it myself—to make the paths of approach to it more pleasant. In fact, I only know, of it, the pleasant distant effects which it bears to simple eyes ; and some pretty mists and mysteries, which I invite my young readers to pierce, as they may, for themselves,—my power of guiding them being only for a little way.

Pretty mysteries, I say, as opposed to the vulgar and ugly mysteries of the so-called science of botany,—exemplified sufficiently in this chosen page. Respecting which, please observe farther ;—Nobody—I can say this very boldly—loves Latin more dearly than I ; but, precisely because I do love it (as well as for other reasons), I have always insisted that books, whether scientific or not, ought to be written either in Latin, or English ; and not in a doggish mixture of the refuse of both.

ANTHERICUM LILIASTRUM. SAVOY ANTHEERICUM, or
ST BRUNO'S LILY.



Class and Order.

HEXANDRIA MONOGYNIA.

Generic Character.

Cor. 6-petala, patens. *Caps.* ovata.

Specific Character and Synonyms.

ANTHERICUM *Liliastrum* foliis planis, scapo simplicissimo,
corollis campanulatis, staminibus declinatis.
Linn. Syst. Vegetab. ed. 14. Murr. p. 330.
Ait. Kew. v. I p. 449.

HEMEROCALLIS floribus patulis secundis. *Hall. Hist.*
n. 1230.

PHALANGIUM magno flore. *Bauh. Pin. 29.*

PHALANGIUM *Allobrogicum majus. Clus. cur. app. alt.*

PHALANGIUM *Allobrogicum. The Savoye Spider-wort. Park.*
Parad. p. 150. tab. 151. f. 1.

Botanists are divided in their opinions respecting the genus of this plant; LINNÆUS considers it as an *Anthericum*, HALLER and MILLER make it an *Hemerocallis*.

It is a native of Switzerland, where, HALLER informs us, it grows abundantly in the Alpine meadows, and even on the summits of the mountains; with us it flowers in May and June.

It is a plant of great elegance, producing on an unbranched stem about a foot and a half high, numerous flowers of a delicate white colour, much smaller but resembling in form those of the common white lily, possessing a considerable degree of fragrance, their beauty is heightened by the rich orange colour of their antheræ; unfortunately they are but of short duration.

MILLER describes two varieties of it differing merely in size.

A loamy soil, a situation moderately moist, with an eastern or western exposure, suits this plant best; so situated, it will increase by its roots, though not very fast, and by parting of these in the autumn, it is usually propagated.

PARKINSON describes and figures it in his *Parad. Terrest.*, observing that "divers allured by the beauty of its flowers, had brought it into these parts."

Linnæus wrote a noble book of universal Natural History in Latin. It is one of the permanent classical treasures of the world. And if any scientific man thinks his labours are worth the world's attention, let him, also, write what he has to say in Latin, finishedly and exquisitely, if it take him a month to a page.*

But if—which, unless he be one chosen of millions, is assuredly the fact—his lucubrations are only of local and temporary consequence, let him write, as clearly as he can, in his native language.

This book, accordingly, I have written in English; (not, by the way, that I *could* have written it in anything else—so there are small thanks to me); and one of its purposes is to interpret, for young English readers, the necessary European Latin or Greek names of flowers, and to make them vivid and vital to their understandings. But two great difficulties occur in doing this. The first, that there are generally from three or four, up to two dozen, Latin names current for every flower; and every new botanist thinks his eminence only to be properly asserted by adding another.

The second, and a much more serious one, is of the Devil's own contriving—(and remember I am always quite serious when I speak of the Devil,)—namely, that the most current and authoritative names are apt to be founded on some unclean or debasing association, so that to interpret them is to defile the reader's mind. I will give no instance; too many will at once occur to any learned reader, and the unlearned I need not vex with so much as one: but, in such cases, since I could only take refuge in the untranslated word by leaving other Greek or Latin words also untranslated, and the nomenclature still entirely senseless,—and I do not choose to do this,—there is only one other course open to me, namely, to substitute boldly, to my own pupils, other generic names for the plants thus faultfully hitherto titled.

As I do not do this for my own pride, but honestly for my

* I have by happy chance just added to my Oxford library the poet Gray's copy of Linnæus, with its exquisitely written Latin notes, exemplary alike to scholar and naturalist.

reader's service, I neither question nor care how far the emendations I propose may be now or hereafter adopted. I shall not even name the cases in which they have been made for the serious reason above specified; but even shall mask those which there was real occasion to alter, by sometimes giving new names in cases where there was no necessity of such kind. Doubtless I shall be accused of doing myself what I violently blame in others. I do so; but with a different motive—of which let the reader judge as he is disposed. The practical result will be that the children who learn botany on the system adopted in this book will know the useful and beautiful names of plants hitherto given, in all languages; the useless and ugly ones they will not know. And they will have to learn one Latin name for each plant, which, when differing from the common one, I trust may yet by some scientific persons be accepted, and with ultimate advantage.

The learning of the one Latin name—as, for instance, *Gramen striatum*—I hope will be accurately enforced always;—but not less carefully the learning of the pretty English one—“Ladielace Grass”—with due observance that “Ladies' laces hath leaves like unto Millet in fashion with many white vaines or ribs, and silver strakes running along through the midst of the leaves, fashioning the same like to laces of white and green silk, very beautiful and faire to behold.”

I have said elsewhere, and can scarcely repeat too often, that a day will come when men of science will think their names disgraced, instead of honoured, by being used to barbarise nomenclature; I hope therefore that my own name may be kept well out of the way; but, having been privileged to found the School of Art in the University of Oxford, I think that I am justified in requesting any scientific writers who may look kindly upon this book, to add such of the names suggested in it as they think deserving of acceptance, to their own lists of synonyms, under the head of “Schol. Art. Oxon.”

The difficulties thrown in the way of any quiet private student by existing nomenclature may be best illustrated by my simply stating what happens to myself in endeavouring

to use the page above facsimile'd. Not knowing how far St. Bruno's Lily might be connected with my own pet one, and not having any sufficient book on Swiss botany, I take down Loudon's Encyclopædia of Plants, (a most useful book, as far as any book in the present state of the science *can* be useful,) and find, under the head of Anthericum, the Savoy Lily indeed, but only the following general information:—"809. Anthericum. A name applied by the Greeks to the stem of the asphodel, and not misapplied to this set of plants, which in some sort resemble the asphodel. Plants with fleshy leaves, and spikes of bright *yellow* flowers, easily cultivated if kept dry."

Hunting further, I find again my Savoy lily called a spider-plant, under the article Hemerocallis, and the only information which the book gives me under Hemerocallis, is that it means 'beautiful day' lily; and then, "This is an ornamental genus of the easiest culture. The species are remarkable among border flowers for their fine *orange, yellow, or blue* flowers. The Hemerocallis *cœrulea* has been considered a distinct genus by Mr. Salisbury, and called *Saussurea*." As I correct this sheet for press, however, I find that the Hemerocallis is now to be called 'Funkia,' "in honour of Mr. Funk, a Prussian apothecary."

All this while, meantime, I have a suspicion that my pet Savoy Lily is not, in existing classification, an Anthericum, nor a Hemerocallis, but a Liliium. It is, in fact, simply a Turk's cap which doesn't curl up. But on trying 'Liliium' in Loudon, I find no mention whatever of any wild branched white lily.

I then try the next word in my specimen page of Curtis; but there is no 'Phalangium' at all in Loudon's index. And now I have neither time nor mind for more search, but will give, in due place, such account as I can of my own dwarf branched lily, which I shall call St. Bruno's, as well as this Liliastrum—no offence to the saint, I hope. For it grows very gloriously on the limestones of Savoy, presumably, therefore, at the Grande Chartreuse; though I did not notice it there, and made a very unmonkish use of it when I gathered

it last :—There was a pretty young English lady at the table-d'hôte, in the Hotel du Mont Blanc at St. Martin,* and I wanted to get speech of her, and didn't know how. So all I could think of was to go half-way up the Aiguille de Varens, to gather St. Bruno's lilies ; and I made a great cluster of them, and put wild roses all around them as I came down. I never saw anything so lovely ; and I thought to present this to her before dinner,—but when I got down, she had gone away to Chamouni. My Fors always treated me like that, in affairs of the heart.

I had begun my studies of Alpine botany just eighteen years before, in 1842, by making a careful drawing of wood-sorrel at Chamouni ; and bitterly sorry I am, now, that the work was interrupted. For I drew, then, very delicately ; and should have made a pretty book if I could have got peace. Even yet, I can manage my point a little, and would far rather be making outlines of flowers, than writing ; and I meant to have drawn every English and Scottish wild flower, like this cluster of bog heather opposite,†—back, and profile, and front. But 'Blackwood's Magazine,' with its insults to Turner, dragged me into controversy ; and I have not had, properly speaking, a day's peace since ; so that in 1868 my botanical studies were advanced only as far as the reader will see in next chapter ; and now, in 1874, must end altogether, I suppose, heavier thoughts and work coming fast on me. So that, finding among my notebooks, two or three, full of broken materials for the proposed work on flowers ; and, thinking they may be useful even as fragments, I am going to publish them in their present state,—only let the reader note that while my other books endeavour, and claim, so far as they reach, to give trustworthy knowledge of their subjects, this one only shows how such knowledge may be obtained ; and it is little

* It was in the year 1860, in June.

† Admirably engraved by Mr. Burgess, from my pen drawing, now at Oxford. By comparing it with the plate of the same flower in Sowerby's work, the student will at once see the difference between attentive drawing, which gives the cadence and relation of masses in a group, and the mere copying of each flower in an unconsidered huddle.

more than a history of efforts and plans,—but of both, I believe, made in right methods.

One part of the book, however, will, I think, be found of permanent value. Mr. Burgess has engraved on wood, in reduced size, with consummate skill, some of the excellent old drawings in the *Flora Danica*, and has interpreted, and facsimile'd, some of his own and my drawings from nature, with a vigour and precision unsurpassed in woodcut illustration, which render these outlines the best exercises in black and white I have yet been able to prepare for my drawing pupils. The larger engravings by Mr. Allen may also be used with advantage as copies for drawings with pen or sepia.

ROME, 10th May (*my father's birthday*).

I found the loveliest blue asphodel I ever saw in my life, yesterday, in the fields beyond Monte Mario,—a spire two feet high, of more than two hundred stars, the stalks of them all deep blue, as well as the flowers. Heaven send all honest people the gathering of the like, in Elysian fields, some day!

PROSERPINA.

CHAPTER I.

MOSS.

DENMARK HILL, 3rd November, 1868.

1. It is mortifying enough to write,—but I think thus much ought to be written,—concerning myself, as ‘the author of *Modern Painters*.’ In three months I shall be fifty years old: and I don’t at this hour—ten o’clock in the morning of the two hundred and sixty-eighth day of my forty-ninth year—know what ‘moss’ is.

There is nothing I have more *intended* to know—some day or other. But the moss ‘would always be there’; and then it was so beautiful, and so difficult to examine, that one could only do it in some quite separated time of happy leisure—which came not. I never was like to have less leisure than now, but I *will* know what moss is, if possible, forthwith.

2. To that end I read preparatorily, yesterday, what account I could find of it in all the botanical books in the house. Out of them all, I get this general notion of a moss,—that it has a fine fibrous root,—a stem surrounded with spirally set leaves,—and produces its fruit in a small case, under a cap. I fasten especially, however, on a sentence of Louis Figuier’s, about the particular species, *Hypnum*:—

“These mosses, which often form little islets of verdure at the feet of poplars and willows, are robust vegetable organisms, which do not decay.” *

3. “*Qui ne pourrissent point.*” What do they do with themselves, then?—it immediately occurs to me to ask. And, secondly,—If this immortality belongs to the *Hypnum* only?

* “*Histoire des Plantes.*” Ed. 1865, p. 416.

It certainly does not, by any means : but, however modified or limited, this immortality is the first thing we ought to take note of in the mosses. They are, in some degree, what the "everlasting" is in flowers. Those minute green leaves of theirs do not decay, nor fall.

But how do they die, or how stop growing, then?—it is the first thing I want to know about them. And from all the books in the house, I can't as yet find out this. Meanwhile I will look at the leaves themselves.

4. Going out to the garden, I bring in a bit of old brick, emerald green on its rugged surface,* and a thick piece of mossy turf.

First, for the old brick : To think of the quantity of pleasure one has had in one's life from that emerald green velvet,—and yet that for the first time to-day I am verily going to look at it! Doing so, through a pocket lens of no great power, I find the velvet to be composed of small star-like groups of smooth, strong, oval leaves,—intensely green, and much like the young leaves of any other plant, except in this ;—they all have a long brown spike, like a sting, at their ends.



FIG. 1.

5. Fastening on that, I take the *Flora Danica*,† and look through its plates of mosses, for their leaves only ; and I find, first, that this spike, or strong central rib, is characteristic ;—secondly, that the said leaves are apt to be not only spiked, but serrated, and otherwise angry-looking at the points ;—thirdly, that they have a tendency to fold together in the centre (Fig. 1 ‡); and at last, after an hour's work at them, it strikes me

* The like of it I have now painted, Number 281, CASE XII., in the Educational Series of Oxford.

† Properly, *Floræ Danicæ*, but it is so tiresome to print the diphthongs that I shall always call it thus. It is a folio series, exquisitely begun, a hundred years ago ; and not yet finished.

‡ Magnified about seven times. See note at end of this chapter.

suddenly that they are more like pineapple leaves than anything else.

And it occurs to me, very unpleasantly, at the same time, that I don't know what a pineapple is!

Stopping to ascertain that, I am told that a pineapple belongs to the 'Bromeliaceæ'—(can't stop to find out what that means)—nay, that of these plants "the pineapple is the representative" (Loudon); "their habit is acid, their leaves rigid, and toothed with spines, their bracteas often coloured with scarlet, and their flowers either white or blue"—(what are their flowers like?) But the two sentences that most interest me, are, that in the damp forests of Carolina, the *Tillandsia*, which is an 'epiphyte' (i.e., a plant growing on other plants,) "forms dense festoons among the branches of the trees, vegetating among the black mould that collects upon the bark of trees in hot damp countries; other species are inhabitants of deep and gloomy forests, and others form, with their spring leaves, an impenetrable herbage in the Pampas of Brazil." So they really seem to be a kind of moss, on a vast scale.

6. Next, I find in Gray,* Bromeliaceæ, and—the very thing I want—"Tillandsia, the black moss, or long moss, which, like most *Bromelias*, grows on the branches of trees." So the pineapple is really a moss; only it is a moss that flowers but 'imperfectly.' "The fine fruit is caused by the consolidation of the imperfect flowers." (I wish we could consolidate some imperfect English moss-flowers into little pineapples then,—though they were only as big as filberts.) But we cannot follow that farther now; nor consider when a flower is perfect, and when it is not, or we should get into morals, and I don't know where else; we will go back to the moss I have gathered, for I begin to see my way, a little, to understanding it.

7. The second piece I have on the table is a cluster—an inch or two deep—of the moss that grows everywhere, and that the birds use for nest-building, and we for packing, and

* American,—'System of Botany,' the best technical book I have.

the like. It is dry, since yesterday, and its fibres define themselves against the dark ground in warm green, touched with a glittering light. Note that burnished lustre of the minute leaves; they are necessarily always relieved against dark hollows, and this lustre makes them much clearer and brighter than if they were of dead green. In that lustre—and it is characteristic of them—they differ wholly from the dead, aloe-like texture of the pineapple leaf; and remind me, as I look at them closely, a little of some conditions of chaff, as on heads of wheat after being threshed. I will hunt down that clue presently; meantime there is something else to be noticed on the old brick.

8. Out of its emerald green cushions of minute leaves, there rise, here and there, thin red threads, each with a little brown cap, or something like a cap, at the top of it. These red threads shooting up out of the green tufts, are, I believe, the fructification of the moss; fringing its surface in the woods, and on the rocks, with the small forests of brown stems, each carrying its pointed cap or crest—of infinitely varied 'mode,' as we shall see presently; and, which is one of their most blessed functions, carrying high the dew in the morning; every spear balancing its own crystal globe.

9. And now, with my own broken memories of moss, and this unbroken, though unfinished, gift of the noble labour of other people, the *Flora Danica*, I can generalize the idea of the precious little plant, for myself, and for the reader.

All mosses, I believe, (with such exceptions and collateral groups as we may afterwards discover, but they are not many,) that is to say, some thousands of species, are, in their strength of existence, composed of fibres surrounded by clusters of dry spinous leaves, set close to the fibre they grow on. Out of this leafy stem descends a fibrous root, and ascends in its season, a capped seed.

We must get this very clearly into our heads. Fig. 2, A, is a little tuft of a common wood moss of Norway,* in its fruit season, of its real size; but at present I want to look at the

* '*Dicranum cerviculatum*,' sequel to *Flora Danica*, Tab. MMCCX.

central fibre and its leaves accurately, and understand that first.

10. Pulling it to pieces, we find it composed of seven little company-keeping fibres, each of which, by itself, appears as in Fig. 2, B: but as in this, its real size, it is too small, not indeed for our respect, but for our comprehension, we magnify it, Fig. 2, c, and thereupon perceive it to be indeed composed of, *a*, the small fibrous root which sustains the plant; *b*, the leaf-surrounded stem which is the actual being, and main creature, moss; and, *c*, the aspirant pillar, and cap, of its fructification.

11. But there is one minor division yet. You see I have drawn the central part of the moss plant (*b*, Fig. 2,) half in outline and half in black; and that, similarly, in the upper group, which is too small to show the real roots, the base of the cluster is black. And you remember, I doubt not, how often in gathering what most invited gathering, of deep green, starry, perfectly soft and living wood-moss, you found it fall asunder in your hand into multitudes of separate threads, each with its bright green crest, and long root of blackness.

That blackness at the root—though only so notable in this wood-moss and collateral species, is indeed a general character of the mosses, with rare exceptions. It is their funeral blackness;—that, I perceive, is the way the moss leaves die. They do not fall—they do not visibly decay. But they decay invisibly, in continual secession, beneath the ascending crest. They rise to form that crest, all green and bright, and take the light and air from those out of which they grew; and those, their ancestors, darken and die slowly, and at last become a mass of mouldering ground. In fact, as I perceive farther, their final duty is so to die. The main work of other leaves is in their life,—but these have to form the earth out of which



FIG. 2.

all other leaves are to grow. Not to cover the rocks with golden velvet only, but to fill their crannies with the dark earth, through which nobler creatures shall one day seek their being.

12. "Grant but as many sorts of mind as moss." Pope could not have known the hundredth part of the number of 'sorts' of moss there are ; and I suppose he only chose the word because it was a monosyllable beginning with *m*, and the best English general expression for despised and minute structures of plants. But a fate rules the words of wise men, which makes their words truer, and worth more, than the men themselves know. No other plants have so endless variety on so similar a structure as the mosses ; and none teach so well the humility of Death. As for the death of our bodies, we have learned, wisely, or unwisely, to look the fact of that in the face. But none of us, I think, yet care to look the fact of the death of our minds in the face. I do not mean death of our souls, but of our mental work. So far as it is good *art*, indeed, and done in realistic form, it may perhaps not die ; but so far as it was only good *thought*—good, for its time, and apparently a great achievement therein—that good, useful thought may yet in the future become a foolish thought, and then die quite away,—it, and the memory of it,—when better thought and knowledge come. But the better thought could not have come if the weaker thought had not come first, and died in sustaining the better. If we think honestly, our thoughts will not only live usefully, but even perish usefully—like the moss—and become dark, not without due service. But if we think dishonestly, or malignantly, our thoughts will die like evil fungi,—dripping corrupt dew.

13. But farther. If you have walked moorlands enough to know the look of them, you know well those flat spaces or causeways of bright green or golden ground between the heathy rock masses ; which signify winding pools and inlets of stagnant water caught among the rocks ;—pools which the deep moss that covers them *blanched*, not black, at the root,—is slowly filling and making firm ; whence generally the unsafe ground in the moorland gets known by being *mossy* instead of heathy, and is at last called by its riders, briefly,

'the Moss': and as it is mainly at these same mossy places that the riding is difficult, and brings out the gifts of horse and rider, and discomfits all followers not similarly gifted, the skilled crosser of them got his name, naturally, of 'moss-rider,' or moss-trooper. In which manner the moss of Norway and Scotland has been a taskmaster and Maker of Soldiers, as yet, the strongest known among natural powers. The lightning may kill a man, or cast down a tower, but these little tender leaves of moss—they and their progenitors—have trained the Northern Armies.

14. So much for the human meaning of that decay of the leaves. Now to go back to the little creatures themselves. It seems that the upper part of the moss fibre is especially undecaying among leaves; and the lower part, especially decaying. That, in fact, a plant of moss-fibre is a kind of persistent state of what is, in other plants, annual. Watch the year's growth of any luxuriant flower. First it comes out of the ground all fresh and bright; then, as the higher leaves and branches shoot up, those first leaves near the ground get brown, sickly, earthy,—remain for ever degraded in the dust, and under the dashed slime in rain, staining, and grieving, and loading them with obloquy of envious earth, half-killing them,—only life enough left in them to hold on the stem, and to be guardians of the rest of the plant from all they suffer;—while, above them, the happier leaves, for whom they are thus oppressed, bend freely to the sunshine, and drink the rain pure.

The moss strengthens on a diminished scale, intensifies, and makes perpetual, these two states,—bright leaves above that never wither, leaves beneath that exist only to wither.

15. I have hitherto spoken only of the fading moss as it is needed for change into earth. But I am not sure whether a yet more important office, in its days of age, be not its use as a colour.

We are all thankful enough—as far as we ever are so—for green moss, and yellow moss. But we are never enough grateful for black moss. The golden would be nothing without it, nor even the grey.

It is true that there are black lichens enough, and brown ones: nevertheless, the chief use of lichens is for silver and gold colour on rocks; and it is the dead moss which gives the leopard-like touches of black. And yet here again—as to a thing I have been looking at and painting all my life—I am brought to pause, the moment I think of it carefully. The black moss which gives the precious Velasquez touches, lies, much of it, flat on the rocks; radiating from its centres—powdering in the fingers, if one breaks it off, like dry tea. Is it a black species? or a black-parched state of other species, perishing for the sake of Velasquez effects; instead of accumulation of earth? and, if so, does it die of drought, accidentally, or, in a sere old age, naturally? and how is it related to the rich green bosses that grow in deep velvet? And there again is another matter not clear to me. One calls them ‘velvet’ because they are all brought to an even surface at the top. Our own velvet is reduced to such trimness by cutting. But how is the moss trimmed? By what scissors? Carefullest Elizabethan gardener never shaped his yew hedge more daintily than the moss fairies smooth these soft rounded surfaces of green and gold. And just fancy the difference, if they were ragged! If the fibres had every one of them leave to grow at their own sweet will, and to be long or short as they liked, or, worse still, urged by fairy prizes into laboriously and agonizingly trying which could grow longest. Fancy the surface of a spot of competitive moss!

16. But how is it that they are subdued into that spherical obedience, like a crystal of wavellite? * Strange—that the vegetable creatures growing so fondly on rocks should form themselves in that mineral-like manner. It is true that the tops of all well-grown trees are rounded, on a large scale, as equally; but that is because they grow from a central stem, while these mossy mounds are made out of independent filaments, each growing to exactly his proper height in the sphere—short ones outside, long in the middle. Stop, though; is that so? I am not even sure of that; perhaps they are built

*The reader should buy a small specimen of this mineral; it is a useful type of many structures.

over a little dome of decayed moss below.* I must find out how every filament grows, separately—from root to cap, through the spirally set leaves. And meanwhile I don't know very clearly so much as what a root is—or what a leaf is. Before puzzling myself any farther in examination either of moss or any other grander vegetable, I had better define these primal forms of all vegetation, as well as I can—or rather begin the definition of them, for future completion and correction. For, as my reader must already sufficiently perceive, this book is literally to be one of studies—not of statements. Some one said of me once, very shrewdly, When he wants to work out a subject, he writes a book on it. That is a very true saying in the main,—I work down or up to my mark, and let the reader see process and progress, not caring to conceal them. But this book will be nothing but process. I don't mean to assert anything positively in it from the first page to the last.

—

* LUCCA, Aug. 9th, 1874.—I have left this passage as originally written, but I believe the dome is of accumulated earth. Bringing home, here, evening after evening, heaps of all kinds of mosses from the hills among which the Archbishop Ruggieri was hunting the wolf and her whelps in Ugolino's dream, I am more and more struck, every day, with their special function as earth-gatherers, and with the enormous importance to their own brightness, and to our service, of that dark and degraded state of the inferior leaves. And it fastens itself in my mind mainly as their distinctive character, that as the leaves of a tree become wood, so the leaves of a moss become earth, while yet a normal part of the plant. Here is a cake in my hand weighing half a pound, bright green on the surface, with minute crisp leaves; but an inch thick beneath in what looks at first like clay, but is indeed knitted fibre of exhausted moss. Also, I don't at all find the generalization I made from the botanical books likely to have occurred to me from the real things. No moss leaves that I can find here give me the idea of resemblance to pineapple leaves; nor do I see any, through my weak lens, clearly serrated; but I do find a general tendency to run into a silky filamentous structure, and in some, especially on a small one gathered from the fissures in the marble of the cathedral, white threads of considerable length at the extremities of the leaves, of which threads I remember no drawing or notice in the botanical books. Figure 1 represents, magnified, a cluster of these leaves, with the germinating stalk springing from their centre; but my scrawl was tired and careless, and for once, Mr. Burgess has copied *too* accurately.

Whatever I say, is to be understood only as a conditional statement—liable to, and inviting, correction. And this the more because, as on the whole, I am at war with the botanists, I can't ask them to help me, and then call them names afterwards. I hope only for a contemptuous heaping of coals on my head by correction of my errors from them ; in some cases, my scientific friends will, I know, give me forgiving aid ;—but, for many reasons, I am forced first to print the imperfect statement, as I can independently shape it ; for if once I asked for, or received help, every thought would be frost-bitten into timid expression, and every sentence broken by apology. I should have to write a dozen of letters before I could print a line, and the line, at last, would be only like a bit of any other botanical book—trustworthy, it might be, perhaps ; but certainly unreadable. Whereas now, it will rather put things more forcibly in the reader's mind to have them retouched and corrected as we go on ; and our natural and honest mistakes will often be suggestive of things we could not have discovered but by wandering.

On these guarded conditions, then, I proceed to study, with my reader, the first general laws of vegetable form.

CHAPTER II.

THE ROOT.

1. PLANTS in their perfect form consist of four principal parts,—the Root, Stem, Leaf, and Flower. It is true that the stem and flower are parts, or remnants, or altered states, of the leaves ; and that, speaking with close accuracy, we might say, a perfect plant consists of leaf and root. But the division into these four parts is best for practical purposes, and it will be desirable to note a few general facts about each, before endeavouring to describe any one kind of plant. Only, because the character of the stem depends on the nature of the leaf and flower, we must put it last in order of examination ; and trace the development of the plant first in root and leaf ; then in the flower and its fruit ; and lastly in the stem.

2. First, then, the Root.

Every plant is divided, as I just said, in the main, into two parts, and these have opposite natures. One part seeks the light ; the other hates it. One part feeds on the air ; the other on the dust.

The part that loves the light is called the Leaf. It is an old Saxon word ; I cannot get at its origin. The part that hates the light is called the Root.

In Greek, *ρίζα*, Rhiza.*

In Latin, Radix, "the growing thing," which shortens, in French, into Race, and then they put on the diminutive 'ine,' and get their two words, Race, and Racine, of which we keep Race for animals, and use for vegetables a word of our own Saxon (and Dutch) dialect,—'root ;' (connected with Rood—an image of wood ; whence at last the Holy Rood, or Tree).

3. The Root has three great functions :

1st. To hold the plant in its place.

2nd. To nourish it with earth.

3rd. To receive vital power for it from the earth.

With this last office is in some degree,—and especially in certain plants,—connected, that of reproduction.

But in all plants the root has these three essential functions.

First, I said, to hold the Plant in its place. The Root is its Fetter.

You think it, perhaps, a matter of course that a plant is not to be a crawling thing? It is not a matter of course at all. A vegetable might be just what it is now, as compared with an animal ;—might live on earth and water instead of on meat,—might be as senseless in life, as calm in death, and in all its parts and apparent structure unchanged ; and yet be a crawling thing. It is quite as easy to conceive plants moving about like lizards, putting forward first one root and then another, as it is to think of them fastened to their place. It might have been well for them, one would have thought, to have the power

* Learn this word, at any rate ; and if you know any Greek, learn also this group of words : "ὡς ρίζα ἐν γῆ διψῶσα," which you may chance to meet with, and even to think about, some day.

of going down to the streams to drink, in time of drought;—of migrating in winter with grim march from north to south of Dunsinane Hill side. But that is not their appointed Fate. They are—at least all the noblest of them, rooted to their spot. Their honour and use is in giving immoveable shelter,—in remaining landmarks, or lovemarks, when all else is changed :

“ The cedars wave on Lebanon,
But Judah’s statelier maids are gone.”

4. Its root is thus a form of fate to the tree. It condemns, or indulges it, in its place. These semi-living creatures, come what may, shall abide, happy, or tormented. No doubt concerning “ the position in which Providence has placed *them*,” is to trouble their minds, except so far as they can mend it by seeking light, or shrinking from wind, or grasping at support, within certain limits. In the thoughts of men they have thus become twofold images,—on the one side, of spirits restrained and half destroyed, whence the fables of transformation into trees; on the other, of spirits patient and continuing, having root in themselves and in good ground, capable of all persistent effort and vital stability, both in themselves, and for the human States they form.

5. In this function of holding fast, roots have a power of grasp quite different from that of branches. It is not a grasp, or clutch by contraction, as that of a bird’s claw, or of the small branches we call ‘tendrils’ in climbing plants. It is a dead, clumsy, but inevitable grasp, by swelling, *after* contortion. For there is this main difference between a branch and root, that a branch cannot grow vividly but in certain directions and relations to its neighbour branches; but a root can grow wherever there is earth, and can turn in any direction to avoid an obstacle.*

* “ Duhamel, botanist of the last century, tells us that, wishing to preserve a field of good land from the roots of an avenue of elms which were exhausting it, he cut a ditch between the field and avenue to intercept the roots. But he saw with surprise those of the roots which had not been cut, go down behind the slope of the ditch to keep out of

6. In thus contriving access for itself where it chooses, a root contorts itself into more serpent-like writhing than branches can ; and when it has once coiled partly round a rock, or stone, it grasps it tight, necessarily, merely by swelling. Now a root has force enough sometimes to split rocks, but not to crush them ; so it is compelled to grasp by *flattening* as it thickens ; and, as it must have room somewhere, it alters its own shape as if it were made of dough, and holds the rock, not in a claw, but in a wooden cast or mould, adhering to its surface. And thus it not only finds its anchorage in the rock, but binds the rocks of its anchorage with a constrictor cable.

7. Hence—and this is a most important secondary function—roots bind together the ragged edges of rocks as a hem does the torn edge of a dress : they literally stitch the stones together ; so that, while it is always dangerous to pass under a treeless edge of overhanging crag, as soon as it has become beautiful with trees, it is safe also. The rending power of roots on rocks has been greatly overrated. Capillary attraction in a willow wand will indeed split granite, and swelling roots sometimes heave considerable masses aside, but on the whole, roots, small and great, bind, and do not rend.* The surfaces of mountains are dissolved and disordered, by rain, and frost, and chemical decomposition, into mere heaps of loose stones on their desolate summits ; but, where the forests grow, soil accumulates and disintegration ceases. And by cutting down forests on great mountain slopes, not only is the climate destroyed, but the danger of superficial landslip fearfully increased.

8. The second function of roots is to gather for the plant the nourishment it needs from the ground. This is partly water, mixed with some kinds of air (ammonia, etc.,) but the

the light, go under the ditch, and into the field again." And the Swiss naturalist Bonnet said wittily, apropos of a wonder of this sort, "that sometimes it was difficult to distinguish a cat from a rosebush."

* As the first great office of the mosses is the gathering of earth, so that of the grasses is the binding of it. Theirs the Enchanter's toil, not in vain,—making ropes out of sea-sand.

plant can get both water and ammonia from the atmosphere ; and, I believe, for the most part does so ; though, when it cannot get water from the air, it will gladly drink by its roots. But the things it cannot receive from the air at all are certain earthy salts, essential to it (as iron is essential in our own blood), and of which when it has quite exhausted the earth, no more such plants can grow in that ground. On this subject you will find enough in any modern treatise on agriculture ; all that I want you to note here is that this feeding function of the root is of a very delicate and discriminating kind, needing much searching and mining among the dust, to find what it wants. If it only wanted water, it could get most of that by spreading in mere soft senseless limbs, like sponge, as far, and as far down, as it could—but to get the *salt* out of the earth it has to *sift* all the earth, and taste and touch every grain of it that it can, with fine fibres. And therefore a root is not at all a merely passive sponge or absorbing thing, but an infinitely subtle tongue, or tasting and eating thing. That is why it is always so fibrous and divided and entangled in the clinging earth.

9. "Always fibrous and divided"? But many roots are quite hard and solid !

No ; the active part of the root is always, I believe, a fibre. But there is often a provident and passive part—a savings bank of root—in which nourishment is laid up for the plant, and which, though it may be underground, is no more to be considered its real root than the kernel of a seed is. When you sow a pea, if you take it up in a day or two, you will find the fibre below, which is root ; the shoot above, which is plant : and the pea as a now partly exhausted storehouse, looking very woful, and like the granaries of Paris after the fire. So the round solid root of a cyclamen, or the conical one which you know so well as a carrot, are not properly roots, but permanent storehouses,—only the fibres that grow from them are roots. Then there are other apparent roots which are not even storehouses, but refuges ; houses where the little plant lives in its infancy, through winter and rough weather. So that it will be best for you at once to limit your idea of a root to this,—

that it is a group of growing fibres which taste and suck what is good for the plant out of the ground, and by their united strength hold it in its place: only remember the thick limbs of roots do not feed, but only the fine fibres at the ends of them which are something between tongues and sponges, and while they absorb moisture readily, are yet as particular about getting what they think nice to eat as any dainty little boy or girl; looking for it everywhere, and turning angry and sulky if they don't get it.

10. But the root has, it seems to me, one more function, the most important of all. I say, it seems to me, for observe, what I have hitherto told you is all (I believe) ascertained and admitted; this that I am going to tell you has not yet, as far as I know, been asserted by men of science, though I believe it to be demonstrable. But you are to examine into it, and think of it for yourself.

There are some plants which appear to derive all their food from the air—which need nothing but a slight grasp of the ground to fix them in their place. Yet if we were to tie them into that place, in a framework, and cut them from their roots, they would die. Not only in these, but in all other plants, the vital power by which they shape and feed themselves, whatever that power may be, depends, I think, on that slight touch of the earth, and strange inheritance of its power. It is as essential to the plant's life as the connection of the head of an animal with its body by the spine is to the animal. Divide the feeble nervous thread, and all life ceases. Nay, in the tree the root is even of greater importance. You will not kill the tree, as you would an animal, by dividing its body or trunk. The part not severed from the root will shoot again. But in the root, and its touch of the ground, is the life of it. My own definition of a plant would be "a living creature whose source of vital energy is in the earth" (or in the water, as a form of the earth; that is, in inorganic substance). There is, however, one tribe of plants which seems nearly excepted from this law. It is a very strange one, having long been noted for the resemblance of its flowers to different insects; and it has recently been proved by Mr. Darwin to be depend-

ent on insects for its existence. Doubly strange therefore, it seems, that in some cases this race of plants all but reaches the independent life of insects. It rather *settles* upon boughs than roots itself in them ; half of its roots may wave in the air.

11. What vital power is, men of science are not a step nearer knowing than they were four thousand years ago. They are, if anything, farther from knowing now than then, in that they imagine themselves nearer. But they know more about its limitations and manifestations than they did. They have even arrived at something like a proof that there is a fixed quantity of it flowing out of things and into them. But, for the present, rest content with the general and sure knowledge that, fixed or flowing, measurable or immeasurable—one with electricity or heat or light, or quite distinct from any of them—life is a delightful, and its negative, death, a dreadful thing, to human creatures ; and that you can give or gather a certain quantity of life into plants, animals, and yourself by wisdom and courage, and by their reverses can bring upon them any quantity of death you please, which is a much more serious point for you to consider than what life and death are.

12. Now, having got a quite clear idea of a root properly so called, we may observe what those storehouses, refuges, and ruins are, which we find connected with roots. The greater number of plants feed and grow at the same time ; but there are some of them which like to feed first and grow afterwards. For the first year, or, at all events, the first period of their life, they gather material for their future life out of the ground and out of the air, and lay it up in a storehouse as bees make combs. Of these stores—for the most part rounded masses tapering downwards into the ground—some are as good for human beings as honeycombs are ; only not so sweet. We steal them from the plants, as we do from the bees, and these conical upside-down hives or treasuries of Atreus, under the names of carrots, turnips, and radishes, have had important influence on human fortunes. If we do not steal the store, next year the plant lives upon it, raises its stem, flowers and seeds out of that abundance, and having fulfilled its destiny, and provided for its successor, passes away, root and branch together.

13. There is a pretty example of patience for us in this; and it would be well for young people generally to set themselves to grow in a carrotty or turnippy manner, and lay up secret store, not caring to exhibit it until the time comes for fruitful display. But they must not, in after-life, imitate the spendthrift vegetable, and blossom only in the strength of what they learned long ago; else they soon come to contemptible end. Wise people live like laurels and cedars, and go on mining in the earth, while they adorn and embalm the air.

14. Secondly, Refuges. As flowers growing on trees have to live for some time, when they are young in their buds, so some flowers growing on the ground have to live for a while, when they are young, in what we call their roots. These are mostly among the Drosidæ* and other humble tribes, loving the ground; and, in their babyhood, liking to live quite down in it. A baby crocus has literally its own little dome—domus, or duomo—within which in early spring it lives a delicate convent life of its own, quite free from all worldly care and dangers, exceedingly ignorant of things in general, but itself brightly golden and perfectly formed before it is brought out. These subterranean palaces and vaulted cloisters, which we call bulbs, are no more roots than the blade of grass is a root, in which the ear of corn forms before it shoots up.

15. Thirdly, Ruins. The flowers which have these subterranean homes form one of many families whose roots, as well as seeds, have the power of reproduction. The succession of some plants is trusted much to their seeds: a thistle sows itself by its down, an oak by its acorns; the companies of flying emigrants settle where they may; and the shadowy tree is content to cast down its showers of nuts for swine's food with the chance that here and there one may become a ship's bulwark. But others among plants are less careless, or less proud. Many are anxious for their children to grow in the place where they grew themselves, and secure this not merely by letting their fruit fall at their feet, on the chance of its

* Drosidæ, in our school nomenclature, is the general name, including the four great tribes, iris, asphodel, amaryllis, and lily. See reason for this name given in the 'Queen of the Air,' Section II.

growing up beside them, but by closer bond, bud springing forth from root, and the young plant being animated by the gradually surrendered life of its parent. Sometimes the young root is formed above the old one, as in the crocus, or beside it, as in the amaryllis, or beside it in a spiral succession, as in the orchis; in these cases the old root always perishes wholly when the young one is formed; but in a far greater number of tribes, one root connects itself with another by a short piece of intermediate stem; and this stem does not at once perish when the new root is formed, but grows on at one end indefinitely, perishing slowly at the other, the scars or ruins of the past plants being long traceable on its sides. When it grows entirely underground it is called a root-stock. But there is no essential distinction between a root-stock and a creeping stem, only the root-stock may be thought of as a stem which shares the melancholy humour of a root in loving darkness, while yet it has enough consciousness of better things to grow towards, or near, the light. In one family it is even fragrant where the flower is not, and a simple house-leek is called 'rhodiola rosea,' because its root-stock has the scent of a rose.

16. There is one very unusual condition of the root-stock which has become of much importance in economy, though it is of little in botany; the forming, namely, of knots at the ends of the branches of the underground stem, where the new roots are to be thrown out. Of these knots, or 'tubers,' (swollen things,) one kind, belonging to the tobacco tribe, has been singularly harmful, together with its pungent relative, to a neighbouring country of ours, which perhaps may reach a higher destiny than any of its friends can conceive for it, if it can ever succeed in living without either the potato, or the pipe.

17. Being prepared now to find among plants many things which are like roots, yet are not; you may simplify and make fast your true idea of a root as a fibre or group of fibres, which fixes, animates, and partly feeds the leaf. Then practically, as you examine plants in detail, ask first respecting them: What kind of root have they? Is it large or small in

proportion to their bulk, and why is it so? What soil does it like, and what properties does it acquire from it? The endeavour to answer these questions will soon lead you to a rational inquiry into the plant's history. You will first ascertain what rock or earth it delights in, and what climate and circumstances; then you will see how its root is fitted to sustain it mechanically under given pressures and violences, and to find for it the necessary sustenance under given difficulties of famine or drought. Lastly you will consider what chemical actions appear to be going on in the root, or its store; what processes there are, and elements, which give pungency to the radish, flavour to the onion, or sweetness to the liquorice; and of what service each root may be made capable under cultivation, and by proper subsequent treatment, either to animals or men.

18. I shall not attempt to do any of this for you; I assume, in giving this advice, that you wish to pursue the science of botany as your chief study; I have only broken moments for it, snatched from my chief occupations, and I have done nothing myself of all this I tell you to do. But so far as you can work in this manner, even if you only ascertain the history of one plant, so that you know that accurately, you will have helped to lay the foundation of a true science of botany, from which the mass of useless nomenclature,* now mistaken for science, will fall away, as the husk of a poppy falls from the bursting flower.

CHAPTER III.

THE LEAF.

1. In the first of the poems of which the English Government has appointed a portion to be sung every day for the in-

* The only use of a great part of our existing nomenclature is to enable one botanist to describe to another a plant which the other has not seen. When the science becomes approximately perfect, all known plants will be properly figured, so that nobody need describe them; and unknown plants be so rare that nobody will care to learn a new and difficult language, in order to be able to give an account of what in all probability he will never see.

struction and pleasure of the people, there occurs this curious statement respecting any person who will behave himself rightly: "He shall be like a tree planted by the river side, that bears its fruit in its season. His leaf also shall not wither; and you will see that whatever he does will prosper."

I call it a curious statement, because the conduct to which this prosperity is promised is not that which the English, as a nation, at present think conducive to prosperity: but whether the statement be true or not, it will be easy for you to recollect the two eastern figures under which the happiness of the man is represented,—that he is like a tree bearing fruit "in its season;" (not so hastily as that the frost pinch it, nor so late that no sun ripens it;) and that "his leaf shall not fade." I should like you to recollect this phrase in the Vulgate—"folium ejus non defluet"—shall not fall *away*,—that is to say, shall not fall so as to leave any visible bareness in winter time, but only that others may come up in its place, and the tree be always green.

2. Now, you know, the fruit of the tree is either for the continuance of its race, or for the good, or harm, of other creatures. In no case is it a good to the tree itself. It is not indeed, properly, a part of the tree at all, any more than the egg is part of the bird, or the young of any creature part of the creature itself. But in the leaf is the strength of the tree itself. Nay, rightly speaking, the leaves *are* the tree itself. Its trunk sustains; its fruit burdens and exhausts; but in the leaf it breathes and lives. And thus also, in the eastern symbolism, the fruit is the labour of men for others; but the leaf is their own life. "He shall bring forth fruit, in his time; and his own joy and strength shall be continual."

3. Notice next the word 'folium.' In Greek, *φυλλον*, 'phyllon.'

"The thing that is born," or "put forth." "When the branch is tender, and putteth forth her leaves, ye know that summer is nigh." The botanists say, "The leaf is an expansion of the bark of the stem." More accurately, the bark is a contraction of the tissue of the leaf. For every leaf is born out of the earth, and breathes out of the air; and there are

many leaves that have no stems, but only roots. It is 'the springing thing'; this thin film of life; rising, with its *edge* out of the ground—infinately feeble, infinitely fair. With *Folium*, in Latin, is rightly associated the word *Flos*; for the flower is only a group of singularly happy leaves. From these two roots come *foglio*, *feuille*, *feuillage*, and *fleur*;—*blume*, *blossom*, and *bloom*; our *foliage*, and the borrowed *foil*, and the connected technical groups of words in architecture and the sciences.

4. This *thin* film, I said. That is the essential character of a leaf; to be thin,—widely spread out in proportion to its mass. It is the opening of the substance of the earth to the air, which is the giver of life. The Greeks called it, therefore, not only the born or blooming thing, but the spread or expanded thing—"πεταλον." Pindar calls the beginnings of quarrel, "petals of quarrel." Recollect, therefore, this form, *Petalos*; and connect it with *Petasos*, the expanded cap of Mercury. For one great use of both is to give shade. The root of all these words is said to be *ΠΕΤ* (*Pet*), which may easily be remembered in Greek, as it sometimes occurs in no unpleasant sense in English.

5. But the word '*petalos*' is connected in Greek with another word, meaning to fly,—so that you may think of a bird as spreading its petals to the wind; and with another, signifying Fate in its pursuing flight, the overtaking thing, or overflying Fate. Finally, there is another Greek word meaning 'wide,' *πλατυς* (*platys*); whence at last our '*plate*'—a thing made broad or extended—but especially made broad or 'flat' out of the solid, as in a lump of clay extended on the wheel, or a lump of metal extended by the hammer. So the first we call *Platter*; the second *Plate*, when of the precious metals. Then putting *b* for *p*, and *d* for *t*, we get the blade of an oar, and blade of grass.

6. Now gather a branch of laurel, and look at it carefully. You may read the history of the being of half the earth in one of those green oval leaves—the things that the sun and the rivers have made out of dry ground. *Daphne*—daughter of *Enipeus*, and beloved by the Sun,—that fable gives you at

once the two great facts about vegetation. Where warmth is, and moisture—there also, the leaf. Where no warmth—there is no leaf ; where there is no dew—no leaf.

7. Look, then, to the branch you hold in your hand. That you *can* so hold it, or make a crown of it, if you choose, is the first thing I want you to note of it ;—the proportion of size, namely, between the leaf and *you*. Great part of your life and character, as a human creature, has depended on that. Suppose all leaves had been spacious, like some palm leaves ; solid, like cactus stem ; or that trees had grown, as they might of course just as easily have grown, like mushrooms, all one great cluster of leaf round one stalk. I do not say that they are divided into small leaves only for your delight, or your service, as if you were the monarch of everything—even in this atom of a globe. You are made of your proper size ; and the leaves of theirs : for reasons, and by laws, of which neither the leaves nor you know anything. Only note the harmony between both, and the joy we may have in this division and mystery of the frivolous and tremulous petals, which break the light and the breeze,—compared to what, with the frivolous and the tremulous mind which is in us, we could have had out of domes, or penthouses, or walls of leaf.

8. Secondly ; think awhile of its dark clear green, and the good of it to you. Scientifically, you know green in leaves is owing to ‘chlorophyll,’ or, in English, to ‘green-leaf.’ It may be very fine to know that ; but my advice to you, on the whole, is to rest content with the general fact that leaves are green when they do not grow in or near smoky towns ; and not by any means to rest content with the fact that very soon there will not be a green leaf in England, but only greenish-black ones. And thereon resolve that you will yourself endeavour to promote the growing of the green wood, rather than of the black.

9. Looking at the back of your laurel-leaves, you see how the central rib or spine of each, and the lateral branchings, strengthen and carry it. I find much confused use, in botanical works, of the words Vein and Rib. For, indeed, there are veins *in* the ribs of leaves, as marrow in bones ; and the pro-

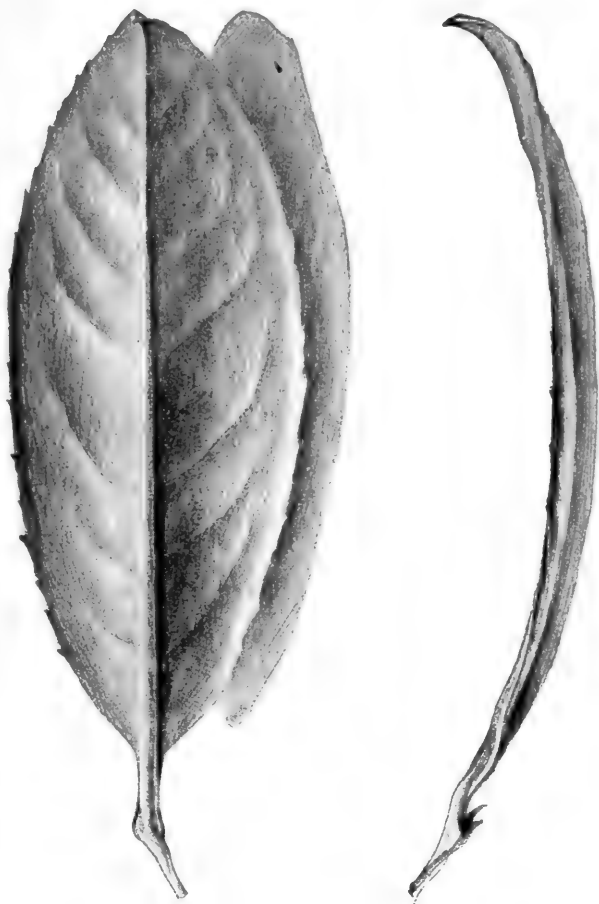

PLATE II.—CENTRAL TYPE OF LEAVES. COMMON BAY LAUREL.



jecting bars often gradually depress themselves into a transparent net of rivers. But the *mechanical* force of the framework in carrying the leaf-tissue is the point first to be noticed ; it is that which admits, regulates, or restrains the visible motions of the leaf ; while the system of circulation can only be studied through the microscope. But the ribbed leaf bears itself to the wind, as the webbed foot of a bird does to the water, and needs the same kind, though not the same strength, of support ; and its ribs always are partly therefore constituted of strong woody substance, which is knit out of the tissue ; and you can extricate this skeleton framework, and keep it, after the leaf-tissue is dissolved. So I shall henceforward speak simply of the leaf and its ribs,—only specifying the additional veined structure on necessary occasions.

10. I have just said that the ribs—and might have said, farther, the stalk that sustains them—are knit out of the *tissue* of the leaf. But what is the leaf tissue itself knit out of ? One would think that was nearly the first thing to be discovered, or at least to be thought of, concerning plants,—namely, how and of what they are made. We say they ‘grow.’ But you know that they can’t grow out of nothing ;—this solid wood and rich tracery must be made out of some previously existing substance. What is the substance?—and how is it woven into leaves,—twisted into wood ?

11. Consider how fast this is done, in spring. You walk in February over a slippery field, where, through hoar-frost and mud, you perhaps hardly see the small green blades of trampled turf. In twelve weeks you wade through the same field up to your knees in fresh grass ; and in a week or two more, you mow two or three solid haystacks off it. In winter you walk by your currant-bush, or your vine. They are shrivelled sticks—like bits of black tea in the canister. You pass again in May, and the currant-bush looks like a young sycamore tree ; and the vine is a bower : and meanwhile the forests, all over this side of the round world, have grown their foot or two in height, with new leaves—so much deeper, so much denser than they were. Where has it all come from ? Cut off the fresh shoots from a single branch of

any tree in May. Weigh them; and then consider that so much weight has been added to every such living branch, everywhere, this side the equator, within the last two months. What is all that made of?

12. Well, this much the botanists really know, and tell us,—It is made chiefly of the breath of animals; that is to say, of the substance which, during the past year, animals have breathed into the air; and which, if they went on breathing, and their breath were not made into trees, would poison them, or rather suffocate them, as people are suffocated in uncleansed pits, and dogs in the Grotta del Cane. So that you may look upon the grass and forests of the earth as a kind of green hoar-frost, frozen upon it from our breath, as, on the window-panes, the white arborescence of ice.

13. But how is it made into wood?

The substances that have been breathed into the air are charcoal, with oxygen and hydrogen,—or, more plainly, charcoal and water. Some necessary earths,—in smaller quantity, but absolutely essential,—the trees get from the ground; but, I believe all the charcoal they want, and most of the water, from the air. Now the question is, where and how do they take it in, and digest it into wood?

14. You know, in spring, and partly through all the year, except in frost, a liquid called 'sap' circulates in trees, of which the nature, one should have thought, might have been ascertained by mankind in the six thousand years they have been cutting wood. Under the impression always that it *had been* ascertained, and that I could at any time know all about it, I have put off till to-day, 19th October, 1869, when I am past fifty, the knowing anything about it at all. But I will really endeavour now to ascertain something, and take to my botanical books, accordingly, in due order.

(1) Dresser's "Rudiments of Botany." 'Sap' not in the index; only Samara, and Sarcocarp,—about neither of which I feel the smallest curiosity. (2) Figuier's "Histoire des Plantes."* 'Sève,' not in index; only Serpolet, and *Shærdia arvensis*, which also have no help in them for me.

* An excellent book, nevertheless.

(3) Balfour's "Manual of Botany." 'Sap,'—yes, at last. "Article 257. Course of fluids in exogenous stems." I don't care about the course just now: I want to know where the fluids come from. "If a plant be plunged into a weak solution of acetate of lead,"—I don't in the least want to know what happens. "From the minuteness of the tissue, it is not easy to determine the vessels through which the sap moves." Who said it was? If it had been easy, I should have done it myself. "Changes take place in the composition of the sap in its upward course." I dare say; but I don't know yet what its composition is before it begins going up. "The Elaborated Sap by Mr. Schultz has been called 'latex.'" I wish Mr. Schultz were in a hogshead of it, with the top on. "On account of these movements in the latex, the laticiferous vessels have been denominated cinenchymatous." I do not venture to print the expressions which I here mentally make use of.

15. Stay,—here, at last, in Article 264, is something to the purpose: "It appears then that, in the case of Exogenous plants, the fluid matter in the soil, containing different substances in solution, is sucked up by the extremities of the roots." Yes, but how of the pine trees on yonder rock?—Is there any sap in the rock, or water either? The moisture must be seized during actual rain on the root, or stored up from the snow; stored up, any way, in a tranquil, not actively sappy, state, till the time comes for its change, of which there is no account here.

16. I have only one chance left now. Lindley's "Introduction to Botany." 'Sap,'—yes,—'General motion of.' II. 325. "The course which is taken by the sap, after entering a plant, is the first subject for consideration." My dear doctor, I have learned nearly whatever I know of plant structure from you, and am grateful; and that it is little, is not your fault, but mine. But this—let me say it with all sincere respect—is not what you should have told me here. You know, far better than I, that 'sap' never does enter a plant at all; but only salt, or earth and water, and that the roots alone could not make it; and that, therefore, the course of it must be, in great part, the result or process of the actual making. But I

will read now, patiently ; for I know you will tell me much that is worth hearing, though not perhaps what I want.

Yes ; now that I have read Lindley's statement carefully, I find it is full of precious things ; and this is what, with thinking over it, I can gather for you.

17. First, towards the end of January,—as the light enlarges, and the trees revive from their rest,—there is a general liquefaction of the blood of St. Januarius in their stems ; and I suppose there is really a great deal of moisture rapidly absorbed from the earth in most cases ; and that this absorption is a great help to the sun in drying the winter's damp out of it for us : then, with that strange vital power,—which scientific people are usually as afraid of naming as common people are afraid of naming Death,—the tree gives the gathered earth and water a changed existence ; and to this new-born liquid an upward motion from the earth, as our blood has from the heart ; for the life of the tree is out of the earth ; and this upward motion has a mechanical power in pushing on the growth. “*Forced onward by the current of sap, the plumule ascends,*” (Lindley, p. 132,)—this blood of the tree having to supply, exactly as our own blood has, not only the forming powers of substance, but a continual evaporation, “approximately seventeen times more than that of the human body,” while the force of motion in the sap “is sometimes five times greater than that which impels the blood in the crural artery of the horse.”

18. Hence generally, I think we may conclude thus much,—that at every pore of its surface, under ground and above, the plant in the spring absorbs moisture, which instantly disperses itself through its whole system “by means of some permeable quality of the membranes of the cellular tissue invisible to our eyes even by the most powerful glasses” (p. 326) ; that in this way subjected to the vital power of the tree, it becomes sap, properly so called, which passes downwards through this cellular tissue, slowly and secretly ; and then upwards, through the great vessels of the tree, violently, stretching out the supple twigs of it as you see a flaccid waterpipe swell and move when the cock is turned to fill it. And the

tree becomes literally a fountain, of which the springing streamlets are clothed with new-woven garments of green tissue, and of which the silver spray stays in the sky,—a spray, now, of leaves.

19. That is the gist of the matter ; and a very wonderful gist it is, to my mind. The secret and subtle descent—the violent and exulting resilience of the tree's blood,—what guides it ?—what compels ? The creature has no heart to beat like ours ; one cannot take refuge from the mystery in a 'muscular contraction.' Fountain without supply—playing by its own force, for ever rising and falling all through the days of Spring, spending itself at last in gathered clouds of leaves, and iris of blossom.

Very wonderful ; and it seems, for the present, that we know nothing whatever about its causes ; nay, the strangeness of the reversed arterial and vein motion, without a heart, does not not seem to strike anybody. Perhaps, however, it may interest you, as I observe it does the botanists, to know that the cellular tissue through which the motion is effected is called Parenchym, and the woody tissue, Bothrenchym ; and that Parenchym is divided, by a system of nomenclature which "has some advantages over that more commonly in use,"* into merenchyma, conenchyma, ovenchyma, atractenchyma, cylindrenchyma, colpenchyma, cladenchyma, and prismenchyma.

20. Take your laurel branch into your hand again. There are, as you must well know, innumerable shapes and orders of leaves ;—there are some like claws ; some like fingers, and some like feet ; there are endlessly cleft ones, and endlessly clustered ones, and inscrutable divisions within divisions of the fretted verdure ; and wrinkles, and ripples, and stitchings, and hemmings, and pinchings, and gatherings, and crumplings, and clippings, and what not. But there is nothing so constantly noble as the pure leaf of the laurel, bay, orange, and olive ; numerable, sequent, perfect in setting,

* Lindley, 'Introduction to Botany,' vol. i., p. 21. The terms "wholly obsolete" says an authoritative botanic friend. Thank Heaven !

divinely simple and serene. I shall call these noble leaves 'Apolline' leaves. They characterize many orders of plants, great and small,—from the magnolia to the myrtle, and exquisite 'myrtille' of the hills, (bilberry); but wherever you find them, strong, lustrous, dark green, simply formed, richly scented or stored,—you have nearly always kindly and lovely vegetation, in healthy ground and air.

21. The gradual diminution in rank beneath the Apolline leaf, takes place in others by the loss of one or more of the qualities above named. The Apolline leaf, I said, is strong, lustrous, full in its green, rich in substance, simple in form. The inferior leaves are those which have lost strength, and become thin, like paper; which have lost lustre, and become dead by roughness of surface, like the nettle,—(an Apolline leaf may become dead by *bloom*, like the olive, yet not lose beauty); which have lost colour and become feeble in green, as in the poplar, or *crudely* bright, like rice; which have lost substance and softness, and have nothing to give in scent or nourishment; or become flinty or spiny; finally, which have lost simplicity, and become cloven or jagged. Many of these losses are partly atoned for by gain of some peculiar loveliness. Grass and moss, and parsley and fern, have each their own delightfulness; yet they are all of inferior power and honour, compared to the Apolline leaves.

22. You see, however, that though your laurel leaf has a central stem, and traces of ribs branching from it, in a vertebrated manner, they are so faint that we cannot take it for a type of vertebrate structure. But the two figures of elm and alisma leaf, given in *Modern Painters* (vol. iii.), and now here repeated, Fig. 3, will clearly enough show the opposition between this vertebrate form, branching again usually at the edges, *a*, and the softly opening lines diffused at the stem, and gathered at the point of the leaf, *b*, which, as you almost without doubt know already, are characteristic of a vast group of plants, including especially all the lilies, grasses, and palms, which for the most part are the signs of local or temporary moisture in hot countries;—local, as of fountains and streams; temporary, as of rain or inundation.

But temporary, still more definitely in the day, than in the year. When you go out, delighted, into the dew of the morning, have you ever considered why it is so rich upon the grass ; —why it is *not* upon the trees ? It is partly on the trees, but yet your memory of it will be always chiefly of its gleam upon the lawn. On many trees you will find there is none at all. I cannot follow out here the many inquiries connected with this subject, but, broadly, remember the branched trees are fed chiefly by rain,—the unbranched ones by dew, visible or invisible ; that is to say, at all events by moisture which they

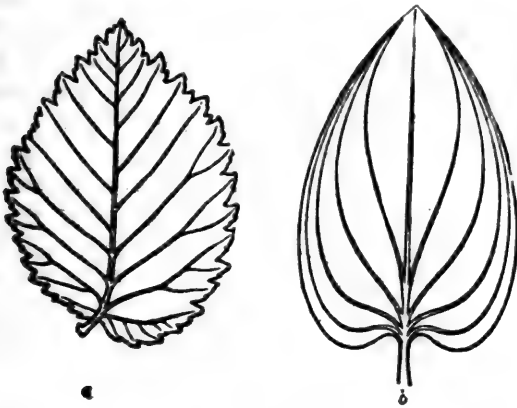

FIG. 3.

can gather for themselves out of the air ; or else by streams and springs. Hence the division of the verse of the song of Moses : “ My doctrine shall drop as the rain ; my speech shall distil as the dew : as the *small* rain upon the tender *herb*, and as the showers upon the grass.”

23. Next, examining the direction of the veins in the leaf of the alisma, *b*, Fig. 3, you see they all open widely, as soon as they can, towards the thick part of the leaf ; and then taper, apparently with reluctance, pushing each other outwards, to the point. If the leaf were a lake of the same shape, and its stem the entering river, the lines of the currents passing through

it would, I believe, be nearly the same as that of the veins in the aquatic leaf. I have not examined the fluid law accurately, and I do not suppose there is more real correspondence than may be caused by the leaf's expanding in every permitted direction, as the water would, with all the speed it can ; but the resemblance is so close as to enable you to fasten the relation of the unbranched leaves to streams more distinctly in your mind,—just as the toss of the palm leaves from their stem may, I think, in their likeness to the springing of a fountain, remind you of their relation to the desert, and their necessity, therein, to life of man and beast.

24. And thus, associating these grass and lily leaves always with fountains, or with dew, I think we may get a pretty general name for them also. You know that Cora, our Madonna of the flowers, was lost in Sicilian Fields : you know, also, that the fairest of Greek fountains, lost in Greece, was thought to rise in a Sicilian islet ; and that the real springing of the noble fountain in that rock was one of the causes which determined the position of the greatest Greek city of Sicily. So I think, as we call the fairest branched leaves ' Apolline,' we will call the fairest flowing ones ' Arethusan.' But remember that the Apolline leaf represents only the central type of land leaves, and is, within certain limits, of a fixed form ; while the beautiful Arethusan leaves, alike in flowing of their lines, change their forms indefinitely,—some shaped like round pools, and some like winding currents, and many like arrows, and many like hearts, and otherwise varied and variable, as leaves ought to be,—that rise out of the waters, and float amidst the pausing of their foam.

25. Brantwood, *Easter Day*, 1875.—I don't like to spoil my pretty sentence, above ; but on reading it over, I suspect I wrote it confusing the water-lily leaf, and other floating ones of the same kind, with the Arethusan forms. But the water-lily and water-ranunculus leaves, and such others, are to the orders of earth-loving leaves what ducks and swans are to birds ; (the swan is the water-lily of birds ;) they are *swimming* leaves ; not properly watery creatures, or able to live under water like fish, (unless when dormant), but just like

birds that pass their lives on the surface of the waves—though they must breathe in the air.

And these natant leaves, as they lie on the water surface, do not want strong ribs to carry them,* but have very delicate ones beautifully branching into the orbéd space, to keep the tissue nice and flat; while, on the other hand, leaves that really have to grow under water, sacrifice their tissue, and keep only their ribs, like coral animals; ('Ranunculus heterophyllus,' 'other-leaved Frog-flower,' and its like,) just as, if you keep your own hands too long in water, they shrivel at the finger-ends.

26. So that you must not attach any great botanical importance to the characters of contrasted aspects in leaves, which I wish you to express by the words 'Apolline' and 'Arethusan'; but their mythic importance is very great, and your careful observance of it will help you completely to understand the beautiful Greek fable of Apollo and Daphne. There are indeed several Daphnes, and the first root of the name is far away in another field of thought altogether, connected with the Gods of Light. But etymology, the best of servants, is an unreasonable master; and Professor Max Müller trusts his deep-reaching knowledge of the first ideas connected with the names of Athena and Daphne, too implicitly, when he supposes this idea to be retained in central Greek theology. 'Athena' originally meant only the dawn, among nations who knew nothing of a Sacred Spirit. But the Athena who catches Achilles by the hair, and urges the spear of Diomed, has not, in the mind of Homer, the slightest remaining connection with the mere beauty of daybreak. Daphne chased by Apollo, may perhaps—though I doubt even this much of consistence in the earlier myth—have meant the Dawn pursued by the Sun. But there is no trace whatever of this first idea left in the fable of Arcadia and Thessaly.

27. The central Greek Daphne is the daughter of one of the great *river* gods of Arcadia; her mother is the Earth.

* "You should see the girders on under-side of the Victoria Water-lily, the most wonderful bit of engineering, of the kind, I know of."— ('Botanical friend.')

Now Arcadia is the Oberland of Greece; and the crests of Cyllene, Drymanthus, and Mænalus* surround it, like the Swiss forest cantons, with walls of rock, and shadows of pine. And it divides itself, like the Oberland, into three regions: first, the region of rock and snow, sacred to Mercury and Apollo, in which Mercury's birth on Cyllene, his construction of the lyre, and his stealing the oxen of Apollo, are all expressions of the enchantments of cloud and sound, mingling with the sunshine, on the cliffs of Cyllene.

“ While the mists
Flying, and rainy vapours, call out shapes
And phantoms from the crags and solid earth
As fast as a musician scatters sounds
Out of his instrument.”

Then came the pine region, sacred especially to Pan and Mænalus the son of Lycaon and brother of Callisto; and you had better remember this relationship carefully, for the sake of the meaning of the constellations of Ursa Major and the Mons Mænalus, and of their wolf and bear traditions; (compare also the strong impression on the Greek mind of the wild leafiness, nourished by snow, of the Bœotian Cithæron,—“ Oh, thou lake-hollow, full of divine leaves, and of wild creatures, nurse of the snow, darling of Diana,” (Phœnissæ, 801). How wild the climate of this pine region is, you may judge from the pieces in the note below † out of

* Roughly, Cyllene 7,500 feet high; Erymanthus 7,000; Mænalus 6,000.

† *March 3rd.*—We now ascend the roots of the mountain called Kastaniá, and begin to pass between it and the mountain of Alonístena, which is on our right. The latter is much higher than Kastaniá, and, like the other peaked summits of the Mænalus range, is covered with firs, and deeply at present with snow. The snow lies also in our pass. At a fountain in the road, the small village of Bazeníko is half a mile on the right, standing at the foot of the Mænalus range, and now covered with snow.

Saetá is the most lofty of the range of mountains, which are in face of Levídhí, to the northward and eastward; they are all a part of the chain which extends from Mount Khelmás, and connects that great summit with Artemisium, Parthenium, and Parnon. Mount Saetá is cov-

Colonel Leake's diary in crossing the Mænalían range in spring. And then, lastly, you have the laurel and vine region, full of sweetness and Elysian beauty.

28. Now as Mercury is the ruling power of the hill enchantment, so Daphne of the leafy peace. She is, in her first life, the daughter of the mountain river, the mist of it filling the valley; the Sun, pursuing, and effacing it, from dell to dell, is, literally, Apollo pursuing Daphne, and *adverse* to her; (not, as in the earlier tradition, the Sun pursuing only his own light). Daphne, thus hunted, cries to her mother, the Earth, which opens, and receives her, causing the laurel to spring up in her stead. That is to say, wherever the rocks protect the mist from the sunbeam, and suffer it to water the earth, there the laurel and other richest vegetation fill the hollows, giving a better glory to the sun itself. For sunshine, on the torrent spray, on the grass of its valley, and entangled among the laurel stems, or glancing from their leaves, became a thousandfold lovelier and more sacred than the same sunbeams, burning on the leafless mountain-side.

And farther, the leaf, in its connection with the river, is typically expressive, not, as the flower was, of human fading and passing away, but of the perpetual flow and renewal of human mind and thought, rising "like the rivers that run among the hills"; therefore it was that the youth of Greece

ered with firs. The mountain between the plain of Levidhi and Alonístena, or, to speak by the ancient nomenclature, that part of the Mænalían range which separates the Orchomenia from the valleys of Helisson and Methydrium, is clothed also with large forests of the same trees; the road across this ridge from Levidhi to Alonístena is now impracticable on account of the snow.

I am detained all day at Levidhi by a heavy fall of snow, which before the evening has covered the ground to half a foot in depth, although the village is not much elevated above the plain, nor in a more lofty situation than Tripolitzá.

March 4th.—Yesterday afternoon and during the night the snow fell in such quantities as to cover all the plains and adjacent mountains; and the country exhibited this morning as fine a snow-scene as Norway could supply. As the day advanced and the sun appeared, the snow melted rapidly, but the sky was soon overcast again, and the snow began to fall.

sacrificed their hair—the sign of their continually renewed strength,—to the rivers, and to Apollo. Therefore, to commemorate Apollo's own chief victory over death—over Python, the corrupter,—a laurel branch was gathered every ninth year in the vale of Tempe ; and the laurel leaf became the reward or crown of all beneficent and enduring work of man—work of inspiration, born of the strength of the earth, and of the dew of heaven, and which can never pass away.

29. You may doubt at first, even because of its grace, this meaning in the fable of Apollo and Daphne ; you will not doubt it, however, when you trace it back to its first eastern origin. When we speak carelessly of the traditions respecting the Garden of Eden, (or in Hebrew, remember, Garden of Delight,) we are apt to confuse Milton's descriptions with those in the book of Genesis. Milton fills his Paradise with flowers ; but no flowers are spoken of in Genesis. We may indeed conclude that in speaking of every herb of the field, flowers are included. But they are not named. The things that are *named* in the Garden of Delight are trees only.

The words are, “every tree that was pleasant to the sight and good for food ;” and as if to mark the idea more strongly for us in the Septuagint, even the ordinary Greek word for tree is not used, but the word ξυλον,—literally, every ‘wood,’ every piece of *timber* that was pleasant or good. They are indeed the “*vivi travi*,”—living rafters of Dante's Apennine.

Do you remember how those trees were said to be watered ? Not by the four rivers only. The rivers could not supply the place of rain. No rivers do ; for in truth they are the refuse of rain. No storm-clouds were there, nor hidings of the blue by darkening veil ; but there went up a *mist* from the earth, and watered the face of the ground,—or, as in Septuagint and Vulgate, “There went forth a fountain from the earth, and gave the earth to drink.”

30. And now, lastly, we continually think of that Garden of Delight, as if it existed, or could exist, no longer ; wholly forgetting that it is spoken of in Scripture as perpetually existent ; and some of its fairest trees as existent also, or only recently destroyed. When Ezekiel is describing to Pharaoh

the greatness of the Assyrians, do you remember what image he gives of them? "Behold, the Assyrian was a cedar in Lebanon, with fair branches; and his top was among the thick boughs; the waters nourished him, and the deep brought him up, with her rivers running round about his plants. Under his branches did all the beasts of the field bring forth their young; and under his shadow dwelt all great nations."

31. Now hear what follows. "The cedars in the Garden of God could not hide *him*. The fir trees were not like his boughs, and the chestnut trees were not like his branches; nor any tree in the Garden of God was like unto him in beauty."

So that you see, whenever a nation rises into consistent, vital, and, through many generations, enduring power, *there* is still the Garden of God; still it is the water of life which feeds the roots of it; and still the succession of its people is imaged by the perennial leafage of trees of Paradise. Could this be said of Assyria, and shall it not be said of England? How much more, of lives such as ours should be,—just, laborious, united in aim, beneficent in fulfilment, may the image be used of the leaves of the trees of Eden! Other symbols have been given often to show the evanescence and slightness of our lives—the foam upon the water, the grass on the housetop, the vapour that vanishes away; yet none of these are images of true human life. That life, when it is real, is *not* evanescent; is *not* slight; does *not* vanish away. Every noble life leaves the fibre of it interwoven for ever in the work of the world; by so much, evermore, the strength of the human race has gained; more stubborn in the root, higher towards heaven in the branch; and, "as a teil tree, and as an oak,—whose substance is in them when they cast their leaves,—so the holy seed is in the midst thereof."

32. Only remember on what conditions. In the great Psalm of life, we are told that everything that a man doeth shall prosper, so only that he delight in the law of his God, that he hath not walked in the counsel of the wicked, nor sat in the seat of the scornful. Is it among these leaves of the perpetual Spring,—helpful leaves for the healing of the na-

tions,—that we mean to have our part and place, or rather among the “brown skeletons of leaves that lag, the forest brook along”? For other leaves there are, and other streams that water them,—not water of life, but water of Acheron. Autumnal leaves there are that strew the brooks, in Vallombrosa. Remember you how the name of the place was changed: “Once called ‘Sweet water’ (Aqua bella), now, the Shadowy Vale.” Portion in one or other name we must choose, all of us, with the living olive, by the living fountains of waters, or with the wild fig trees, whose leafage of human soul is strewed along the brooks of death, in the eternal Vallombrosa.

CHAPTER IV.

THE FLOWER.

ROME, *Whit Monday*, 1874.

1. ON the quiet road leading from under the Palatine to the little church of St. Nereo and Achilleo, I met, yesterday morning, group after group of happy peasants heaped in pyramids on their triumphal carts, in Whit-Sunday dress, stout and clean, and gay in colour; and the women all with bright artificial roses in their hair, set with true natural taste, and well becoming them. This power of arranging wreath or crown of flowers for the head, remains to the people from classic times. And the thing that struck me most in the look of it was not so much the cheerfulness, as the dignity;—in a true sense, the *becomingness* and decorousness of the ornament. Among the ruins of the dead city, and the worse desolation of the work of its modern rebuilders, here was one element at least of honour, and order;—and, in these, of delight.

And these are the real significances of the flower itself. It is the utmost purification of the plant, and the utmost discipline. Where its tissue is blanched fairest, dyed purest, set in strictest rank, appointed to most chosen office, there—and created by the fact of this purity and function—is the flower.

2. But created, observe, by the purity and order, more than by the function. The flower exists for its own sake—not

for the fruit's sake. The production of the fruit is an added honour to it—is a granted consolation to us for its death. But the flower is the end of the seed,—not the seed of the flower. You are fond of cherries, perhaps; and think that the use of cherry blossom is to produce cherries. Not at all. The use of cherries is to produce cherry blossoms; just as the use of bulbs is to produce hyacinths,—not of hyacinths to produce bulbs. Nay, that the flower can multiply by bulb, or root, or slip, as well as by seed, may show you at once how immaterial the seed-forming function is to the flower's existence. A flower is to the vegetable substance what a crystal is to the mineral. "Dust of sapphire," writes my friend Dr. John Brown to me, of the wood hyacinths of Scotland in the spring. Yes, that is so,—each bud more beautiful, itself, than perfectest jewel—*this*, indeed, jewel "of purest ray serene;" but, observe you, the glory is in the purity, the serenity, the radiance,—not in the mere continuance of the creature.

3. It is because of its beauty that its continuance is worth Heaven's while. The glory of it is in being,—not in begetting; and in the spirit and substance,—not the change. For the earth also has its flesh and spirit. Every day of spring is the earth's Whit Sunday—Fire Sunday. The falling fire of the rainbow, with the order of its zones, and the gladness of its covenant,—you may eat of it, like Esdras; but you feed upon it only that you may see it. Do you think that flowers were born to nourish the blind?

Fasten well in your mind, then, the conception of order, and purity, as the essence of the flower's being, no less than of the crystal's. A ruby is not made bright to scatter round it child-rubies; nor a flower, but in collateral and added honour, to give birth to other flowers.

Two main facts, then, you have to study in every flower: the symmetry or order of it, and the perfection of its substance; first, the manner in which the leaves are placed for beauty of form; then the spinning and weaving and blanching of their tissue, for the reception of purest colour, or refining to richest surface.

4. First, the order : the proportion, and answering to each other, of the parts ; for the study of which it becomes necessary to know what its parts are ; and that a flower consists essentially of—Well, I really don't know what it consists essentially of. For some flowers have bracts, and stalks, and toruses, and calices, and corollas, and discs, and stamens, and pistils, and ever so many odds and ends of things besides, of no use at all, seemingly ; and others have no bracts, and no stalks, and no toruses, and no calices, and no corollas, and nothing recognizable for stamens or pistils,—only, when they come to be reduced to this kind of poverty, one doesn't call them flowers ; they get together in knots, and one calls them catkins, or the like, or forgets their existence altogether ;—I haven't the least idea, for instance, myself, what an oak blossom is like ; only I know its bracts get together and make a cup of themselves afterwards, which the Italians call, as they do the dome of St. Peter's, 'cupola' ; and that is a great pity, for their own sake as well as the world's, that they were not content with their ilex cupolas, which were made to hold something, but took to building these big ones upside-down, which hold nothing—*less* than nothing,—large extinguishers of the flame of Catholic religion. And for farther embarrassment, a flower not only is without essential consistence of a given number of parts, but it rarely consists, alone, of *itself*. One talks of a hyacinth as of a flower ; but a hyacinth is any number of flowers. One does not talk of 'a heather' ; when one says 'heath,' one means the whole plant, not the blossom,—because heath-bells, though they grow together for company's sake, do so in a voluntary sort of way, and are not fixed in their places ; and yet, they depend on each other for effect, as much as a bunch of grapes.

5. And this grouping of flowers, more or less waywardly, is that most subtle part of their order, and the most difficult to represent. Take the cluster of bog-heather bells, for instance, Line-study 1. You might think at first there were no lines in it worth study ; but look at it more carefully. There are twelve bells in the cluster. There may be fewer, or more ; but the bog-heath is apt to run into something near that

number. They all grow together as close as they can, and on one side of the supporting branch only. The natural effect would be to bend the branch down; but the branch won't have that, and so leans back to carry them. Now you see the use of drawing the profile in the middle figure: it shows you the exactly balanced setting of the group,—not drooping, nor erect; but with a disposition to droop, tossed up by the leaning back of the stem. Then, growing as near as they can to each other, those in the middle get squeezed. Here is another quite special character. Some flowers don't like being squeezed at all (fancy a squeezed convolvulus!); but these heather bells like it, and look all the prettier for it,—not the squeezed ones exactly, by themselves, but the cluster altogether, by their patience.

Then also the outside ones get pushed into a sort of star-shape, and in front show the colour of all their sides, and at the back the rich green cluster of sharp leaves that hold them; all this order being as essential to the plant as any of the more formal structures of the bell itself.

6. But the bog-heath has usually only one cluster of flowers to arrange on each branch. Take a spray of ling (Frontispiece), and you will find that the richest piece of Gothic spiresculpture would be dull and graceless beside the grouping of the floral masses in their various life. But it is difficult to give the accuracy of attention necessary to see their beauty without drawing them; and still more difficult to draw them in any approximation to the truth before they change. This is indeed the fatallest obstacle to all good botanical work. Flowers, or leaves,—and especially the last,—can only be rightly drawn as they grow. And even then, in their loveliest spring action, they grow as you draw them, and will not stay quite the same creatures for half an hour.

7. I said in my inaugural lectures at Oxford, § 107, that real botany is not so much the description of plants as their biography. Without entering at all into the history of its fruitage, the life and death of the blossom *itself* is always an eventful romance, which must be completely told, if well. The grouping given to the various states of form between bud

and flower is always the most important part of the design of the plant ; and in the modes of its death are some of the most touching lessons, or symbolisms, connected with its existence. The utter loss and far scattered ruin of the cistus and wild rose,—the dishonoured and dark contortion of the convolvulus,—the pale wasting of the crimson heath of Apennine, are strangely opposed by the quiet closing of the brown bells of the ling, each making of themselves a little cross as they die ; and so enduring into the days of winter. I have drawn the faded beside the full branch, and know not which is the more beautiful.

8. This grouping, then, and way of treating each other in their gathered company, is the first and most subtle condition of form in flowers ; and, observe, I don't mean, just now, the appointed and disciplined grouping, but the wayward and accidental. Don't confuse the beautiful consent of the cluster in these sprays of heath with the legal strictness of a foxglove,—though that also has its divinity ; but of another kind. That legal order of blossoming—for which we may wisely keep the accepted name, ' inflorescence,'—is itself quite a separate subject of study, which we cannot take up until we know the still more strict laws which are set over the flower itself.

9. I have in my hand a small red poppy which I gathered on Whit Sunday on the palace of the Cæsars. It is an intensely simple, intensely floral, flower. All silk and flame : a scarlet cup, perfect-edged all round, seen among the wild grass far away, like a burning coal fallen from Heaven's altars. You cannot have a more complete, a more stainless, type of flower absolute ; inside and outside, *all* flower. No sparing of colour anywhere—no outside coarsenesses—no interior secrecies ; open as the sunshine that creates it ; fine-finished on both sides, down to the extremest point of insertion on its narrow stalk ; and robed in the purple of the Cæsars.

Literally so. That poppy scarlet, so far as it could be painted by mortal hand, for mortal King, stays yet, against the sun, and wind, and rain, on the walls of the house of Augustus, a hundred yards from the spot where I gathered the weed of its desolation.

10. A pure *cup*, you remember it is ; that much at least you cannot but remember, of poppy-form among the corn-fields ; and it is best, in beginning, to think of every flower as essentially a cup. There are flat ones, but you will find that most of these are really groups of flowers, not single blossoms ; and there are out-of-the-way and quaint ones, very difficult to define as of any shape ; but even these have a cup to begin with, deep down in them. You had better take the idea of a cup or vase, as the first, simplest, and most general form of true flower.

The botanists call it a corolla, which means a garland, or a kind of crown ; and the word is a very good one, because it indicates that the flower-cup is made, as our clay cups are, on a potter's wheel ; that it is essentially a *revolute* form—a whirl or (botanically) ' whorl ' of leaves ; in reality successive round the base of the urn they form.

11. Perhaps, however, you think poppies in general are not much like cups. But the flower in my hand is a—poverty-stricken poppy, I was going to write,—poverty-strengthened poppy, I mean. On richer ground, it would have gushed into flaunting breadth of untenable purple—flapped its inconsistent scarlet vaguely to the wind—dropped the pride of its petals over my hand in an hour after I gathered it. But this little rough-bred thing, a Campagna pony of a poppy, is as bright and strong to-day as yesterday. So that I can see exactly where the leaves join or lap over each other ; and when I look down into the cup, find it to be composed of four leaves altogether,—two smaller, set within two larger.

12. Thus far (and somewhat farther) I had written in Rome ; but now, putting my work together in Oxford, a sudden doubt troubles me, whether all poppies have two petals smaller than the other two. Whereupon I take down an excellent little school-book on botany—the best I've yet found, thinking to be told quickly ; and I find a great deal about opium ; and, apropos of opium, that the juice of common celandine is of a bright orange colour ; and I pause for a bewildered five minutes, wondering if a celandine is a poppy, and how many petals *it* has : going on again—because I must,

without making up my mind, on either question—I am told to “observe the floral receptacle of the Californian genus *Eschscholtzia*.” Now I can’t observe anything of the sort, and I don’t want to ; and I wish California and all that’s in it were at the deepest bottom of the Pacific. Next I am told to compare the poppy and waterlily ; and I can’t do that, neither—though I should like to ; and there’s the end of the article ; and it never tells me whether one pair of petals is always smaller than the other, or not. Only I see it says the corolla has four petals. Perhaps a celandine may be a double poppy, and have eight, I know they’re tiresome irregular things, and I mustn’t be stopped by them ;*—at any rate, my Roman poppy knew what it was about, and had its two couples of leaves in clear subordination, of which at the time I went on to inquire farther, as follows.

13. The next point is, what shape are the petals of ? And that is easier asked than answered ; for when you pull them

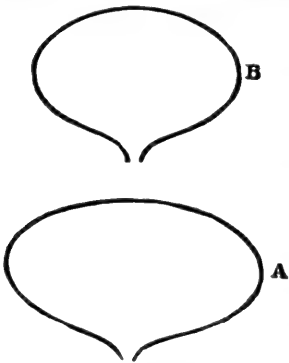

FIG. 4.

off, you find they won’t lie flat, by any means, but are each of them cups, or rather shells, themselves ; and that it requires as much conchology as would describe a cockle, before you can properly give account of a single poppy leaf. Or of a single *any* leaf—for all leaves are either shells, or boats, (or solid, if not hollow, masses,) and cannot be represented in flat outline. But, laying these as flat as they will lie on a sheet of paper, you will find the piece they hide of the paper they lie

on can be drawn ; giving approximately the shape of the outer leaf as at A, that of the inner as at B, Fig. 4 ; which you will

* Just in time, finding a heap of gold under an oak tree some thousand years old, near Arundel, I’ve made them out : Eight divided by three ; that is to say, three couples of petals, with two odd little ones inserted for form’s sake. No wonder I couldn’t decipher them by memory.

find very difficult lines to draw, for they are each composed of two curves, joined, as in Fig. 5 ; all above the line *a b* being the outer edge of the leaf, but joined so subtly to the side that the least break in drawing the line spoils the form.

14. Now every flower petal consists essentially of these two parts, variously proportioned and outlined. It expands from *C* to *a b* ; and closes in the external line, and for this reason.

Considering every flower under the type of a cup, the first part of the petal is that in which it expands from the bottom to the rim ; the second part, that in which it terminates itself on reaching the rim. Thus let the three circles, *A B C*, Fig.

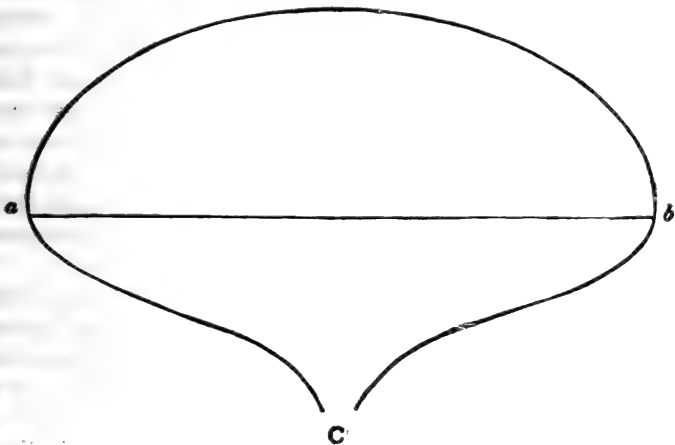

FIG. 5.

6., represent the undivided cups of the three great geometrical orders of flowers—trefoil, quatrefoil and cinquefoil.

Draw in the first an equilateral triangle, in the second a square, in the third a pentagon ; draw the dark lines from centres to angles ; (*D E F*) : then (*a*) the third part of *D* ; (*b*) the fourth part of *E*, (*c*) the fifth part of *F*, are the normal outline forms of the petals of the three families ; the relations between the developing angle and limiting curve being varied according to the depth of cup, and the degree of connection between the petals. Thus a rose folds them over one another,

in the bud ; a convolvulus twists them,—the one expanding into a flat cinquefoil of separate petals, and the other into a deep-welled cinquefoil of connected ones.

I find an excellent illustration in *Veronica Polita*, one of the most perfectly graceful of field plants because of the light alternate flower stalks, each with its leaf at the base ; the flower itself a quatrefoil, of which the largest and least petals are uppermost. Pull one off its calyx (draw, if you can, the outline of the striped blue upper petal with the jagged edge

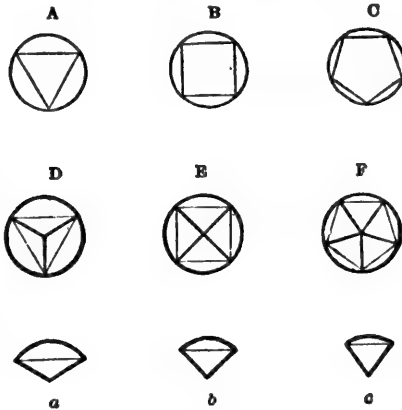

FIG. 6.

of pale gold below), and then examine the relative shapes of the lateral, and least upper petal. Their under surface is very curious, as if covered with white paint; the blue stripes above, in the direction of their growth, deepening the more delicate colour with exquisite insistence.

A lilac blossom will give you a pretty example of the expansion of the

petals of a quatrefoil above the edge of the cup or tube ; but I must get back to our poppy at present.

15. What outline its petals really have, however, is little shown in their crumpled fluttering ; but that very crumpling arises from a fine floral character which we do not enough value in them. We usually think of the poppy as a coarse flower ; but it is the most transparent and delicate of all the blossoms of the field. The rest—nearly all of them—depend on the *texture* of their surfaces for colour. But the poppy is painted *glass* ; it never glows so brightly as when the sun shines through it. Wherever it is seen—against the light or with the light—always, it is a flame, and warms the wind like a blown ruby.

In these two qualities, the accurately balanced form, and

the perfectly infused colour of the petals, you have, as I said, the central being of the flower. All the other parts of it are necessary, but we must follow them out in order.

16. Looking down into the cup, you see the green boss divided by a black star,—of six rays only,—and surrounded by a few black spots. My rough-nurtured poppy contents itself with these for its centre; a rich one would have had the green boss divided by a dozen of rays, and surrounded by a dark crowd of crested threads.

This green boss is called by botanists the pistil, which word consists of the two first syllables of the Latin *pistillum*, otherwise more familiarly Englished into 'pestle.' The meaning of the botanical word is of course, also, that the central part of a flower-cup has to it something of the relations that a pestle has to a mortar! Practically, however, as this pestle has no pounding functions, I think the word is misleading as well as ungraceful; and that we may find a better one after looking a little closer into the matter. For this pestle is divided generally into three very distinct parts: there is a storehouse at the bottom of it for the seeds of the plant; above this, a shaft, often of considerable length in deep cups, rising to the level of their upper edge, or above it; and at the top of these shafts an expanded crest. This shaft the botanists call 'style,' from the Greek word for a pillar; and the crest of it—I do not know why—*stigma*, from the Greek word for 'spot.' The storehouse for the seeds they call the 'ovary,' from the Latin *ovum*, an egg. So you have two-thirds of a Latin word, (*pistil*)—awkwardly and disagreeably edged in between pestle and pistol—for the whole thing; you have an English-Latin word (*ovary*) for the bottom of it; an English-Greek word (*style*) for the middle; and a pure Greek word (*stigma*) for the top.

17. This is a great mess of language, and all the worse that the word *style* and *stigma* have both of them quite different senses in ordinary and scholarly English from this forced botanical one. And I will venture therefore, for my own pupils, to put the four names altogether into English. Instead of calling the whole thing a pistil, I shall simply call

it the pillar. Instead of 'ovary,' I shall say 'Treasury' (for a seed isn't an egg, but it is a treasure). The style I shall call the 'Shaft,' and the stigma the 'Volute.' So you will have your entire pillar divided into the treasury, at its base, the shaft, and the volute; and I think you will find these divisions easily remembered, and not unfitted to the sense of the words in their ordinary use.

18. Round this central, but, in the poppy, very stumpy, pillar, you find a cluster of dark threads, with dusty pendants or cups at their ends. For these the botanists name 'stamens,' may be conveniently retained, each consisting of a 'filament,' or thread, and an 'anther,' or blossoming part.

And in this rich corolla, and pillar, or pillars, with their treasuries, and surrounding crowd of stamens, the essential flower consists. Fewer than these several parts, it cannot have, to be a flower at all; of these, the corolla leads, and is the object of final purpose. The stamens and the treasuries are only there in order to produce future corollas, though often themselves decorative in the highest degree.

These, I repeat, are all the essential parts of a flower. But it would have been difficult, with any other than the poppy, to have shown you them alone; for nearly all other flowers keep with them, all their lives, their nurse or tutor leaves,—the group which, in stronger and humbler temper, protected them in their first weakness, and formed them to the first laws of their being. But the poppy casts these tutorial leaves away. It is the finished picture of impatient and luxury-loving youth,—at first too severely restrained, then casting all restraint away,—yet retaining to the end of life unseemly and illiberal signs of its once compelled submission to laws which were only pain,—not instruction.

19. Gather a green poppy bud, just when it shows the scarlet line at its side; break it open and unpack the poppy. The whole flower is there complete in size and colour,—its stamens full-grown, but all packed so closely that the fine silk of the petals is crushed into a million of shapeless wrinkles. When the flower opens, it seems a deliverance from torture: the two imprisoning green leaves are shaken to the ground;

the aggrieved corolla smooths itself in the sun, and comforts itself as it can ; but remains visibly crushed and hurt to the end of its days.

20. Not so flowers of gracious breeding. Look at these four stages in the young life of a primrose, Fig. 7. First confined, as strictly as the poppy within five pinching green leaves, whose points close over it, the little thing is content to remain a child, and finds its nursery large enough. The green leaves unclose their points,—the little yellow ones peep out, like ducklings. They find the light delicious, and

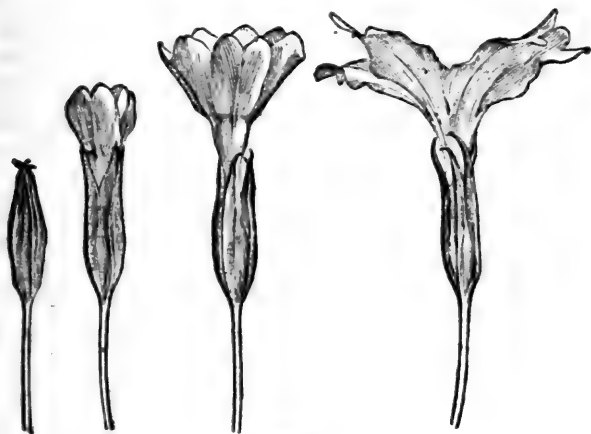

FIG. 7.

open wide to it ; and grow, and grow, and throw themselves wider at last into their perfect rose. But they never leave their old nursery for all that ; it and they live on together ; and the nursery seems a part of the flower.

21. Which is so, indeed, in all the loveliest flowers ; and, in usual botanical parlance, a flower is said to consist of its calyx, (or *hiding* part—Calypso having rule over it,) and corolla, or garland part, Proserpina having rule over it. But it is better to think of them always as separate ; for this calyx, very justly so named from its main function of concealing the flower, in its youth is usually green, not coloured, and

shows its separate nature by pausing, or at least greatly lingering, in its growth, and modifying itself very slightly, while the corolla is forming itself through active change. Look at



the two, for instance, through the youth of a pease blossom, Fig. 8.

The entire cluster at first appears pendent in this manner, the stalk bending round on purpose to put it



FIG. 8.



FIG. 9.

into that position. On which all the little buds, thinking themselves ill-treated, determine not to submit to anything of the sort, turn their points upward persistently, and determine that—at any cost of trouble—they will get nearer the sun. Then they begin to open, and let out their corollas. I give the process of one only (Fig. 9).* It chances to be engraved the reverse way from the bud; but that is of no consequence.

At first, you see the long lower point of the calyx thought that *it* was going to be the head of the family, and curls upwards eagerly. Then the little corolla steals out; and soon does away with that impression on the mind of the calyx. The corolla soars up with widening wings, the abashed calyx retreats beneath; and finally the great upper leaf of corolla—not pleased at having its back still turned to the light,

and its face down—throws itself entirely back, to look at the sky, and nothing else;—and your blossom is complete.

Keeping, therefore, the ideas of calyx and corolla entirely

* Figs. 8 and 9 are both drawn and engraved by Mr. Burgess.

distinct, this one general point you may note of both ; that, as a calyx is originally folded tight over the flower, and has to open deeply to let it out, it is nearly always composed of sharp pointed leaves like the segments of a balloon ; while corollas having to open out as wide as possible to show themselves, are typically like cups or plates, only cut into their edges here and there, for ornamentation's sake.

22. And, finally, though the corolla is essentially the floral group of leaves, and usually receives the glory of colour for itself only, this glory and delight may be given to any other part of the group ; and, as if to show us that there is no really dishonoured or degraded membership, the stalks and leaves in some plants, near the blossom, flush in sympathy with it, and become themselves a part of the effectively visible flower ;—*Eryngo*—*Jura hyacinth*, (*comosus*,) and the edges of upper stems and leaves in many plants ; while others, (*Geranium lucidum*,) are made to delight us with their leaves rather than their blossoms ; only I suppose, in these, the scarlet leaf colour is a kind of early autumnal glow,—a beautiful hectic, and fore-taste, in sacred youth, of sacred death.

I observe, among the speculations of modern science, several, lately, not uningenious, and highly industrious, on the subject of the relation of colour in flowers, to insects—to selective development, etc., etc. There *are* such relations, of course. So also, the blush of a girl, when she first perceives the faltering in her lover's step as he draws near, is related essentially to the existing state of her stomach ; and to the state of it through all the years of her previous existence. Nevertheless, neither love, chastity, nor blushing, are merely exponents of digestion.

All these materialisms, in their unclean stupidity, are essentially the work of human bats ; men of semi-faculty or semi-education, who are more or less incapable of so much as seeing, much less thinking about, colour ; among whom, for one-sided intensity, even Mr. Darwin must be often ranked, as in his vespertilian treatise on the ocelli of the Argus pheasant, which he imagines to be artistically gradated, and perfectly imitative of a ball and socket. If I had him here in Oxford

for a week, and could force him to try to copy a feather by Bewick, or to draw for himself a boy's thumb'd marble, his notions of feathers, and balls, would be changed for all the rest of his life. But his ignorance of good art is no excuse for the acutely illogical simplicity of the rest of his talk of colour in the "Descent of Man." Peacocks' tails, he thinks, are the result of the admiration of blue tails in the minds of well-bred peahens,—and similarly, mandrills' noses the result of the admiration of blue noses in well-bred baboons. But it never occurs to him to ask why the admiration of blue noses is healthy in baboons, so that it develops their race properly, while similar maidenly admiration either of blue noses or red noses in men would be improper, and develop the race improperly. The word itself 'proper' being one of which he has never asked, or guessed, the meaning. And when he imagined the gradation of the cloudings in feathers to represent successive generation, it never occurred to him to look at the much finer cloudy gradations in the clouds of dawn themselves; and explain the modes of sexual preference and selective development which had brought *them* to their scarlet glory, before the cock could crow thrice. Putting all these vespertilian speculations out of our way, the human facts concerning colour are briefly these. Wherever men are noble, they love bright colour; and wherever they can live healthily, bright colour is given them—in sky, sea, flowers, and living creatures.

On the other hand, wherever men are ignoble and sensual, they endure without pain, and at last even come to like (especially if artists,) mud-colour and black, and to dislike rose-colour and white. And wherever it is unhealthy for them to live, the poisonousness of the place is marked by some ghastly colour in air, earth or flowers.

There are, of course, exceptions to all such widely founded laws; there are poisonous berries of scarlet, and pestilent skies that are fair. But, if we once honestly compare a venomous wood-fungus, rotting into black dissolution of dripped slime at its edges, with a spring gentian; or a puff adder with a salmon trout, or a fog in Bermondsey with a clear sky at Berne, we shall get hold of the entire question on its right

side ; and be able afterwards to study at our leisure, or accept without doubt or trouble, facts of apparently contrary meaning. And the practical lesson which I wish to leave with the reader is, that lovely flowers, and green trees growing in the open air, are the proper guides of men to the places which their maker intended them to inhabit ; while the flowerless and treeless deserts—of reed, or sand, or rock,—are meant to be either heroically invaded and redeemed, or surrendered to the wild creatures which are appointed for them ; happy and wonderful in their wild abodes.

Nor is the world so small but that we may yet leave in it also unconquered spaces of beautiful solitude ; where the chamois and red deer may wander fearless,—nor any fire of avarice scorch from the Highlands of Alp, or Grampian, the rapture of the heath, and the rose.

CHAPTER V.

PAPAVER RHOEAS.

BRANTWOOD, *July 11th*, 1875.

1. CHANCING to take up yesterday a favourite old book, *Mavor's British Tourists*, (London, 1798,) I found in its fourth volume a delightful diary of a journey made in 1782 through various parts of England, by Charles P. Moritz of Berlin.

And in the fourteenth page of this diary I find the following passage, pleasantly complimentary to England :—

“The slices of bread and butter which they give you with your tea are as thin as poppy leaves. But there is another kind of bread and butter usually eaten with tea, which is toasted by the fire, and is incomparably good. This is called ‘toast.’”

I wonder how many people, nowadays, whose bread and butter was cut too thin for them, would think of comparing the slices to poppy leaves? But this was in the old days of travelling, when people did not whirl themselves past corn-fields, that they might have more time to walk on paving-

stones; and understood that poppies did not mingle their scarlet among the gold, without some purpose of the poppy-Maker that they should be looked at.

Nevertheless, with respect to the good and polite German's poetically-contemplated, and finely æsthetic, tea, may it not be asked whether poppy leaves themselves, like the bread and butter, are not, if we may venture an opinion—*too thin*,—*improperly thin*? In the last chapter, my reader was, I hope, a little anxious to know what I meant by saying that modern philosophers did not know the meaning of the word 'proper,' and may wish to know what I mean by it myself. And this I think it needful to explain before going farther.

2. In our English prayer-book translation, the first verse of the ninety-third Psalm runs thus: "The Lord is King; and hath put on glorious apparel." And although, in the future republican world, there are to be no lords, no kings, and no glorious apparel, it will be found convenient, for botanical purposes, to remember what such things once were; for when I said of the poppy, in last chapter, that it was "robed in the purple of the Cæsars," the words gave, to any one who had a clear idea of a Cæsar, and of his dress, a better, and even *stricter*, account of the flower than if I had only said, with Mr. Sowerby, "petals bright scarlet;" which might just as well have been said of a pimpernel, or scarlet geranium;—but of neither of these latter should I have said "robed in purple of Cæsars." What I meant was, first, that the poppy leaf looks dyed through and through, like glass, or Tyrian tissue; and not merely painted: secondly, that the splendour of it is proud,—almost insolently so. Augustus, in his glory, might have been clothed like one of these; and Saul; but not David nor Solomon; still less the teacher of Solomon, when He puts on 'glorious apparel.'

3. Let us look, however, at the two translations of the same verse.

In the vulgate it is "Dominus regnavit; decorem indutus est;" He has put on 'becomingness,'—decent apparel, rather than glorious.

In the Septuagint it is *ευπρεπεία*—*well-becomingness*; an ex-

pression which, if the reader considers, must imply certainly the existence of an opposite idea of possible 'ill-becomingness,'—of an apparel which should, in just as accurate a sense, belong appropriately to the creature invested with it, and yet not be glorious, but inglorious, and not well-becoming, but ill-becoming. The mandrill's blue nose, for instance, already referred to, can we rightly speak of this as 'επρεπεύει'? Or the stings, and minute, colourless blossoming of the nettle? May we call these a glorious apparel, as we may the glowing of an alpine rose?

You will find on reflection, and find more convincingly the more accurately you reflect, that there is an absolute sense attached to such words as 'decent,' 'honourable,' 'glorious,' or 'καλος,' contrary to another absolute sense in the words 'indecent,' 'shameful,' 'vile,' or 'αίσχρος.'

And that there is every degree of these absolute qualities visible in living creatures; and that the divinity of the Mind of man is in its essential discernment of what is καλον from what is αίσχρον, and in his preference of the kind of creatures which are decent, to those which are indecent; and of the kinds of thoughts, in himself, which are noble, to those which are vile.

4. When therefore I said that Mr. Darwin, and his school,* had no conception of the real meaning of the word 'proper,' I meant that they conceived the qualities of things only as their 'properties,' but not as their 'becomingnesses;' and seeing that dirt is proper to a swine, malice to a monkey, poison to a nettle, and folly to a fool, they called a nettle *but* a nettle, and the faults of fools *but* folly; and never saw the difference between ugliness and beauty absolute, decency and indecency absolute, glory or shame absolute, and folly or sense absolute.

Whereas, the perception of beauty, and the power of defining physical character, are based on moral instinct, and on the power of defining animal or human character. Nor is it possible to say that one flower is more highly developed, or one animal of a higher order, than another, without the assump-

* Of Vespertilian science generally, compare 'Eagles' Nest,' pp. 23 and 126.

tion of a divine law of perfection to which the one more conforms than the other.

5. Thus, for instance. That it should ever have been an

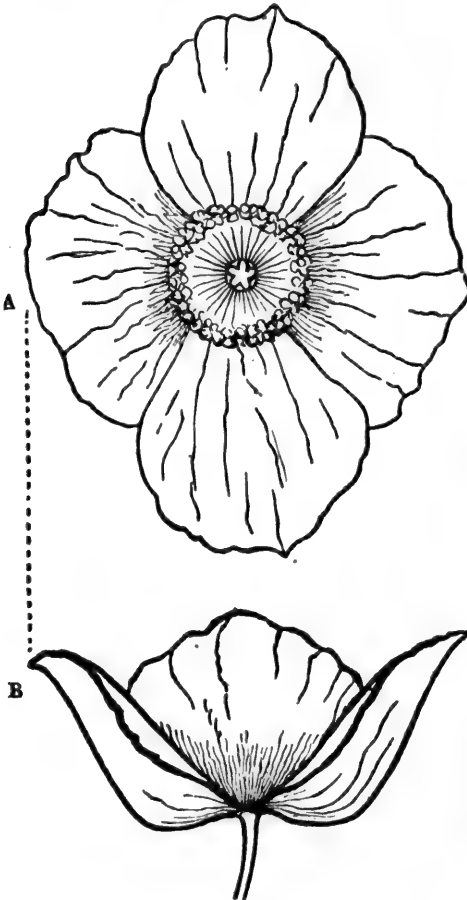

FIG. 10.

open question with me whether a poppy had always two of its petals less than the other two, depended wholly on the hurry and imperfection with which the poppy carries out its plan. It never would have occurred to me to doubt whether an iris had three of its leaves smaller than the other three, because an iris always completes itself to its own ideal. Nevertheless, on examining various poppies, as I walked, this summer, up and down the hills between Sheffield and Wakefield, I find the subordination of the upper and lower petals entirely necessary and normal; and

that the result of it is to give two distinct profiles to the poppy cup, the difference between which, however, we shall see better in the yellow Welsh poppy, at present called *Meconopsis Cambrica*; but which, in the Oxford schools,

will be 'Papaver cruciforme'—'Crosslet Poppy,'—first, because all our botanical names must be in Latin if possible; Greek only allowed when we can do no better; secondly, because meconopsis is barbarous Greek; thirdly, and chiefly, because it is little matter whether this poppy be Welsh or English; but very needful that we should observe, wherever it grows, that the petals are arranged in what used to be, in my young days, called a diamond shape,* as at A, Fig. 10, the two narrow inner ones at right angles to, and projecting farther than, the two outside broad ones; and that the two broad ones, when the flower is seen in profile, as at B, show their margins folded back, as indicated by the thicker lines, and have a profile curve, which is only the softening, or melting away into each other, of two straight lines. Indeed, when the flower is younger, and quite strong, both its profiles, A and B, Fig. 11, are nearly straight-sided; and always, be it young or old, one broader than the other, so as to give the flower, seen from above, the shape of a contracted cross, or crosslet.

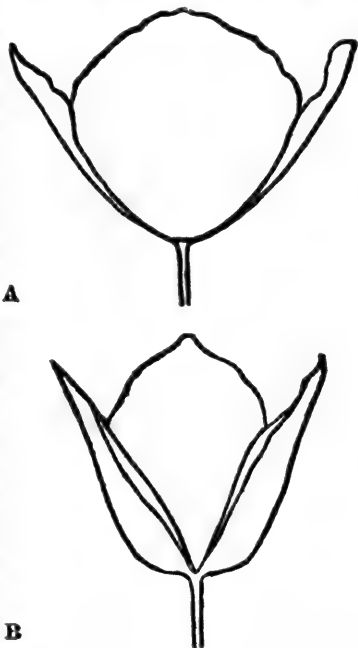

FIG. 11.

6. Now I find no notice of this flower in Gerarde; and in Sowerby, out of eighteen lines of closely printed descriptive text, no notice of its crosslet form, while the petals are only stated to be "roundish-concave," terms equally applicable to at least one-half of all flower petals in the world. The leaves

* The mathematical term is 'rhomb.'

are *said* to be very deeply pinnately partite ; but *drawn*—as neither pinnate nor partite !

And this is your modern cheap science, in ten volumes. Now I haven't a quiet moment to spare for drawing this morning ; but I merely give the main relations of the petals, A, and blot in the wrinkles of one of the lower ones, B, Fig. 12 ; and yet in this rude sketch you will feel, I believe, there is something specific which could not belong to any other flower. But all proper description is impossible without careful profiles of each petal laterally and across it. Which I may not find time to draw for any poppy whatever, because they none

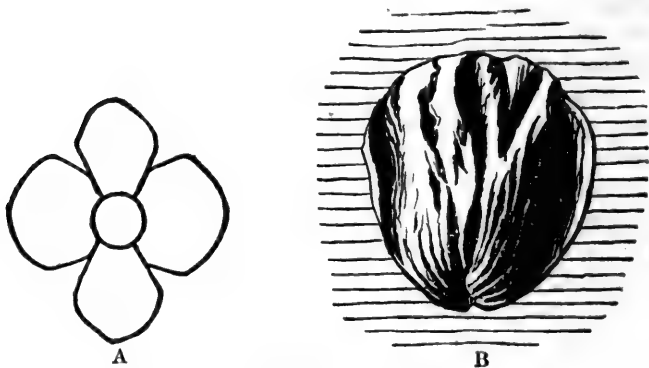

FIG. 12.

of them have well-becomingness enough to make it worth my while, being all more or less weedy, and ungracious, and mingled of good and evil. Whereupon rises before me, ghostly and untenable, the general question, 'What is a weed?' and, impatient for answer, the particular question, What is a poppy? I choose, for instance, to call this yellow flower a poppy, instead of a "likeness to poppy," which the botanists meant to call it, in their bad Greek. I choose also to call a poppy, what the botanists have called "glaucous thing," (glaucium). But where and when shall I stop calling things poppies? This is certainly a question to be settled at once, with others appertaining to it.

7. In the first place, then, I mean to call every flower either one thing or another, and not an 'aceous' thing, only half something or half another. I mean to call this plant now in my hand, either a poppy or not a poppy; but not poppaceous. And this other, either a thistle or not a thistle; but not thistlaceous. And this other, either a nettle or not a nettle; but not nettlaceous. I know it will be very difficult to carry out this principle when tribes of plants are much extended and varied in type: I shall persist in it, however, as far as possible; and when plants change so much that one cannot with any conscience call them by their family name any more, I shall put them aside somewhere among families of poor relations, not to be minded for the present, until we are well acquainted with the better bred circles. I don't know, for instance, whether I shall call the Burnet 'Grass-rose,' or put it out of court for having no petals; but it certainly shall not be called rosaceous; and my first point will be to make sure of my pupils having a clear idea of the central and unquestionable forms of thistle, grass, or rose, and assigning to them pure Latin, and pretty English, names,—classical, if possible? and at least intelligible and decorous.

8. I return to our present special question, then, What is a poppy? and return also to a book I gave away long ago, and have just begged back again, Dr. Lindley's *Ladies' Botany*. For without at all looking upon ladies as inferior beings, I dimly hope that what Dr. Lindley considers likely to be intelligible to *them*, may be also clear to their very humble servant.

The poppies, I find, (page 19, vol. i.) differ from crowfeet in being of a stupefying instead of a burning nature, and in generally having two sepals, and twice two petals, "but as some poppies have three sepals, and twice three petals, the number of these parts is not sufficiently constant to form an essential mark." Yes, I know that, for I found a superb six-petaled poppy, spotted like a cistus, the other day in a friend's garden. But then, what makes it a poppy still? That it is of a stupefying nature, and itself so stupid that it does not know how many petals it should have, is surely not enough distinction?

9. Returning to Lindley, and working the matter farther out with his help, I think this definition might stand : "A poppy is a flower which has either four or six petals, and two or more treasuries, united into one ; containing a milky, stupefying fluid in its stalks and leaves, and always throwing away its calyx when it blossoms."

And indeed, every flower which unites all these characters, we shall, in the Oxford schools, call 'poppy,' and 'Papaver ;' but when I get fairly into work, I hope to fix my definitions into more strict terms. For I wish all my pupils to form the habit of asking, of every plant, these following four questions, in order, corresponding to the subject of these opening chapters, namely, "What root has it? what leaf? what flower? and what stem?" And, in this definition of poppies, nothing whatever is said about the root ; and not only I don't know myself what a poppy root is like, but in all Sowerby's poppy section, I find no word whatever about that matter.

10. Leaving, however, for the present, the root unthought of, and contenting myself with Dr. Lindley's characteristics, I shall place, at the head of the whole group, our common European wild poppy, *Papaver Rhoeas*, and, with this, arrange the nine following other flowers thus,—opposite.

I must be content at present with determining the Latin names for the Oxford schools ; the English ones I shall give as they chance to occur to me, in Gerard and the classical poets who wrote before the English revolution. When no satisfactory name is to be found, I must try to invent one ; as, for instance, just now, I don't like Gerard's 'Corn-rose' for *Papaver Rhoeas*, and must coin another ; but this can't be done by thinking : it will come into my head some day, by chance. I might try at it straightforwardly for a week together, and not do it.

The Latin names must be fixed at once, somehow ; and therefore I do the best I can, keeping as much respect for the old nomenclature as possible, though this involves the illogical practice of giving the epithet sometimes from the flower, (*violaceum*, *cruciforme*), and sometimes from the seed vessel, (*elatum*, *echinosum*, *corniculatum*). Guarding this distinc-

tion, however, we may perhaps be content to call the six last of the group, in English, Urchin Poppy, Violet Poppy, Crosslet Poppy, Horned Poppy, Beach Poppy, and Welcome Poppy. I don't think the last flower pretty enough to be connected more directly with the swallow, in its English name.

| NAME IN OXFORD CATALOGUE. | DIOSCORIDES. | IN PRESENT BOTANY. |
|------------------------------|--------------------------|-----------------------|
| 1. Papaver Rhoëas | μηκων ροιας | Papaver Rhoëas |
| 2. P. Hortense | μ. κηπευτη * | P. Hortense |
| 3. P. Elatum | μ. θυλακίτις † | P. Lamottei |
| 4. P. Argemone | | P. Argemone |
| 5. P. Echinsum | | P. Hybridum |
| 6. P. Violaceum | | Roemeria Hybrida |
| 7. P. Cruciforme | | Meconopsis Cambrica |
| 8. P. Corniculatum | μ. κερατίτις | Glaucium Corniculatum |
| 9. P. Littorale | μ. παραλιος | Glaucium Luteum |
| 10. P. Chelidonium | | Chelidonium Majus |

11. I shall be well content if my pupils know these ten poppies rightly ; all of them at present wild in our own country, and, I believe, also European in range : the head and type of all being the common wild poppy of our cornfields for which the name 'Papaver Rhoëas,' given it by Dioscorides, Gerarde, and Linnæus, is entirely authoritative, and we will therefore at once examine the meaning, and reason, of that name.

12. Dioscorides says the name belongs to it "διὰ τὸ ταχέως τὸ ἄνθος ἀποβάλλειν," "because it casts off its bloom quickly," from *ῥέω*, (*rheo*) in the sense of shedding.† And this indeed it does,—first calyx, then corolla ;—you may translate it 'swiftly ruinous' poppy, but notice, in connection with this idea, how it droops its head *before* blooming : an action which I doubt not, mingled in Homer's thought with the image of its depression when filled by rain, in the passage of the *Iliad*,

* ἦς τὸ σπέρμα ἀρτοποιεῖται.

† ἐπίηκες ἔχουσα τὸ κεφάλιον. Dioscorides makes no effort to distinguish species, but gives the different names as if merely used in different places

‡ It is also used sometimes of the garden poppy, says Dioscorides, "διὰ τὸ ρεῖν ἐξ αὐτῆς τὸν ὄπρον"—"because the sap, opium, flows from it."

which, as I have relieved your memory of three unnecessary names of poppy families, you have memory to spare for learning.

“ μήκων δ' ὡς ἐτέρωσε κάρη βάλεν, ἦτ' ἐνὶ κήφῳ
καρπῷ βριθομένη, νατιῆσι τε εἰάρινῃσι
ὡς ἐτέρωσ' ἤμυσε κάρη πῆληκι βαρυνθέν.”

“And as a poppy lets its head fall aside, which in a garden is loaded with its fruit, and with the soft rains of spring, so the youth drooped his head on one side ; burdened with the helmet.”

And now you shall compare the translations of this passage, with its context, by Chapman and Pope—(or the school of Pope), the one being by a man of pure English temper, and able therefore to understand pure Greek temper ; the other infected with all the faults of the falsely classical school of the Renaissance.

First I take Chapman :—

“ His shaft smit fair Gorgythion, of Praim's princely race
Who in Æpina was brought forth, a famous town in Thrace,
By Castianeira, that for form was like celestial breed.
And as a crimson poppy-flower, surcharged with his seed,
And vernal humours falling thick, declines his heavy brow,
So, a-oneside, his helmet's weight his fainting head did bow.”

Next, Pope :—

“ He missed the mark ; but pierced Gorgythio's heart,
And drenched in royal blood the thirsty dart :
(Fair Castianeira, nymph of form divine,
This offspring added to King Priam's line).
As full-blown poppies, overcharged with rain,
Decline the head, and drooping kiss the plain,
So sinks the youth : his beauteous head, depressed
Beneath his helmet, drops upon his breast.”

13. I give you the two passages in full, trusting that you may so feel the becomingness of the one, and the gracelessness of the other. But note farther, in the Homeric passage, one subtlety which cannot enough be marked even in Chapman's English, that his second word, ἤμυσε, is employed by

him both of the stooping of ears of corn, under wind, and of Troy stooping to its ruin ;* and otherwise, in good Greek writers, the word is marked as having such specific sense of men's drooping under weight ; or towards death, under the burden of fortune which they have no more strength to sustain ; † compare the passage I quoted from Plato, (' Crown of

* See all the passages quoted by Liddell.

† I find this chapter rather tiresome on re-reading it myself, and cancel some farther criticism of the imitation of this passage by Virgil, one of the few pieces of the *Æneid* which are purely and vulgarly imitative, rendered also false as well as weak by the introducing sentence, "*Volvitur Euryalus leto,*" after which the simile of the drooping flower is absurd. Of criticism, the chief use of which is to warn all sensible men from such business, the following abstract of Diderot's notes on the passage, given in the 'Saturday Review' for April 29th, 1871, is worth preserving. (Was the French critic really not aware that Homer *had* written the lines his own way ?)

"Diderot illustrates his theory of poetical hieroglyphs by no quotations, but we can show the manner of his minute and sometimes fanciful criticism by repeating his analysis of the passage of Virgil wherein the death of Euryalus is described :

'Pulchrosque per artus

It cruor, inque humeros cervix collapsa recumbit ;

Purpureus veluti cum flos succisus aratro

Languescit moriens ; lassove papavera collo

Demisere caput, pluvia cum forte gravantur.'

"The sound of 'It cruor,' according to Diderot, suggests the image of a jet of blood ; 'cervix collapsa recumbit,' the fall of a dying man's head upon his shoulder ; 'succisus' imitates the use of a cutting scythe (not plough) ; 'demisere' is as soft as the eye of a flower ; 'gravantur,' on the other hand, has all the weight of a calyx, filled with rain ; 'collapsa' marks an effort and a fall, and similar double duty is performed by 'papavera,' the first two syllables symbolizing the poppy upright, the last two the poppy bent. While thus pursuing his minute investigations, Diderot can scarcely help laughing at himself, and candidly owns that he is open to the suspicion of discovering in the poem beauties which have no existence. He therefore qualifies his eulogy by pointing out two faults in the passage. 'Gravantur,' notwithstanding the praise it has received, is a little too heavy for the light head of a poppy, even when filled with water. As for 'aratro,' coming as it does after the hiss of 'succisus,' it is altogether abominable. Had Homer written the lines,

Wild Olive,' p. 95): "And bore lightly the burden of gold and of possessions." And thus you will begin to understand how the poppy became in the heathen mind the type at once of power, or pride, and of its loss; and therefore, both why Virgil represents the white nymph Nais, "*pallentes violas, et summa papavera carpens*,"—gathering the pale flags, and the highest poppies,—and the reason for the choice of this rather than any other flower, in the story of Tarquin's message to his son.

14. But you are next to remember the word *Rhoeas* in another sense. Whether originally intended or afterwards caught at, the resemblance of the word to '*Rhoea*,' a pomegranate, mentally connects itself with the resemblance of the poppy head to the pomegranate fruit.

And if I allow this flower to be the first we take up for careful study in '*Proserpina*,' on account of its simplicity of form and splendour of colour, I wish you also to remember, in connection with it, the cause of Proserpine's eternal captivity—her having tasted a pomegranate seed,—the pomegranate being in Greek mythology what the apple is in the Mosaic legend; and, in the whole worship of Demeter, associated with the poppy by a multitude of ideas which are not definitely expressed, but can only be gathered out of Greek art and literature, as we learn their symbolism. The chief character on which these thoughts are founded is the fulness of seed in the poppy and pomegranate, as an image of life: then the forms of both became adopted for beads or bosses in ornamental art; the pomegranate remains more distinctly a Jewish and Christian type, from its use in the border of Aaron's robe, down to the fruit in the hand of Angelico's and Botticelli's Infant Christs; while the poppy is gradually confused by the Byzantine Greeks with grapes; and both of these with

he would have ended with some hieroglyph, which would have continued the hiss or described the fall of a flower. To the hiss of '*succisus*' Diderot is warmly attached. Not by mistake, but in order to justify the sound, he ventures to translate '*aratum*' into '*scythe*,' boldly and rightly declaring in a marginal note that this is not the meaning of the word."

palm fruit. The palm, in the shorthand of their art, gradually becomes a symmetrical branched ornament with two pendent bosses; this is again confused with the Greek iris, (Homer's blue iris, and Pindar's water-flag,)—and the Florentines, in adopting Byzantine ornament, read it into their own Fleur-de-lys; but insert two poppyheads on each side of the entire foil, in their finest heraldry.

15. Meantime the definitely intended poppy, in late Christian Greek art of the twelfth century, modifies the form of the Acanthus leaf with its own, until the northern twelfth-century workman takes the thistle-head for the poppy, and the thistle-leaf for acanthus. The true poppy-head remains in the south, but gets more and more confused with grapes, till the Renaissance carvers are content with any kind of boss full of seed, but insist on such boss or bursting globe as some essential part of their ornament;—the bean-pod for the same reason (not without Pythagorean notions, and some of republican election) is used by Brunelleschi for main decoration of the lantern of Florence duomo; and, finally, the ornamentation gets so shapeless, that M. Violet-le-Duc, in his 'Dictionary of Ornament,' loses trace of its origin altogether, and fancies the later forms were derived from the spadix of the arum.

16. I have no time to enter into farther details; but through all this vast range of art, note this singular fact, that the wheat ear, the vine, the fleur-de-lys, the poppy, and the jagged leaf of the acanthus-weed, or thistle, occupy the entire thoughts of the decorative workmen trained in classic schools, to the exclusion of the rose, true lily, and other the flowers of luxury. And that the deeply underlying reason of this is in the relation of weeds to corn, or of the adverse powers of nature to the beneficent ones, expressed for us readers of the Jewish scriptures, centrally in the verse, "thorns also, and thistles, shall it bring forth to thee; and thou shalt eat the herb of the field" (*χopros*, grass or corn), and exquisitely symbolized throughout the fields of Europe by the presence of the purple 'corn-flag,' or gladiolus, and 'corn-rose' (Gerarde's name for *Papaver Rhoeas*), in the midst of carelessly tended corn; and in the traditions of the art of Europe by

the springing of the Acanthus round the basket of the canephora, strictly the basket *for bread*, the idea of bread including all sacred things carried at the feasts of Demeter, Bacchus, and the Queen of the Air. And this springing of the thorny weeds round the basket of reed, distinctly taken up by the Byzantine Italians in the basket-work capital of the twelfth century, (which I have already illustrated at length in the 'Stones of Venice,') becomes the germ of all capitals whatsoever, in the great schools of Gothic, to the end of Gothic time, and also of all the capitals of the pure and noble Renaissance architecture of Angelico and Perugino, and all that was learned from them in the north, while the introduction of the rose, as a primal element of decoration, only takes place when the luxury of English decorated Gothic, the result of that licentious spirit in the lords which brought on the Wars of the Roses, indicates the approach of destruction to the feudal, artistic, and moral power of the northern nations.

For which reason, and many others, I must yet delay the following out of our main subject, till I have answered the other question, which brought me to pause in the middle of this chapter, namely, 'What is a weed?'

CHAPTER VI.

THE PARABLE OF JOASH.

1. SOME ten or twelve years ago, I bought—three times twelve are thirty-six—of a delightful little book by Mrs. Gatty, called 'Aunt Judy's Tales'—whereof to make presents to my little lady friends. I had, at that happy time, perhaps from four-and-twenty to six-and-thirty—I forget exactly how many—very particular little lady friends; and greatly wished Aunt Judy to be the thirty-seventh,—the kindest, wittiest, prettiest girl one had ever read of, at least in so entirely proper and orthodox literature.

2. Not but that it is a suspicious sign of infirmity of faith in our modern moralists to make their exemplary young peo-

ple always pretty ; and dress them always in the height of the fashion. One may read Miss Edgeworth's 'Harry and Lucy,' 'Frank and Mary,' 'Fashionable Tales,' or 'Parents' Assistant,' through, from end to end, with extremest care ; and never find out whether Lucy was tall or short, nor whether Mary was dark or fair, nor how Miss Annaly was dressed, nor, —which was my own chief point of interest—what was the colour of Rosamond's eyes. Whereas Aunt Judy, in charming position after position, is shown to have expressed all her pure evangelical principles with the prettiest of lips ; and to have had her gown, though puritanically plain, made by one of the best modistes in London.

3. Nevertheless, the book is wholesome and useful ; and the nicest story in it, as far as I recollect, is an inquiry into the subject which is our present business, 'What is a weed ?'—in which, by many pleasant devices, Aunt Judy leads her little brothers and sisters to discern that a weed is 'a plant in the wrong place.'

'Vegetable' in the wrong place, by the way, I think Aunt Judy says, being a precisely scientific little aunt. But I can't keep it out of my own less scientific head that 'vegetable' means only something going to be boiled. I like 'plant' better for general sense, besides that it's shorter.

Whatever we call them, Aunt Judy is perfectly right about them as far as she has gone ; but, as happens often even to the best of evangelical instructresses, she has stopped just short of the gist of the whole matter. It is entirely true that a weed is a plant that has got into a wrong place ; but it never seems to have occurred to Aunt Judy that some plants never *do* !

Who ever saw a wood anemone or a heath blossom in the wrong place ? Who ever saw nettle or hemlock in a right one ? And yet, the difference between flower and weed, (I use, for convenience sake, these words in their familiar opposition,) certainly does not consist merely in the flowers being innocent, and the weed stinging and venomous. We do not call the nightshade a weed in our hedges, nor the scarlet agaric in our woods. But we do the corncockle in our fields.

4. Had the thoughtful little tutoress gone but one thought

further, and instead of "a vegetable in a wrong place," (which it may happen to the innocentest vegetable sometimes to be, without turning into a weed, therefore,) said, "A vegetable which has an innate disposition to *get* into the wrong place," she would have greatly furthered the matter for us; but then she perhaps would have felt herself to be uncharitably dividing with vegetables her own little evangelical property of original sin.

5. This, you will find, nevertheless, to be the very essence of weed character—in plants, as in men. If you glance through your botanical books, you will see often added certain names—"a troublesome weed." It is not its being venomous, or ugly, but its being impertinent—thrusting itself where it has no business, and hinders other people's business—that makes a weed of it. The most accursed of all vegetables, the one that has destroyed for the present even the possibility of European civilization, is only called a weed in the slang of its votaries; * but in the finest and truest English we call so the plant which has come to us by chance from the same country, the type of mere senseless prolific activity, the American water-plant, choking our streams till the very fish that leap out of them cannot fall back, but die on the clogged surface; and indeed, for this unrestrainable, unconquerable insolence of uselessness, what name can be enough dishonourable?

6. I pass to vegetation of nobler rank.

You remember, I was obliged in the last chapter to leave my poppy, for the present, without an English specific name, because I don't like Gerarde's 'corn-rose,' and can't yet think of another. Nevertheless, I would have used Gerarde's name, if the corn-rose were as much a rose as the corn-flag is a flag. But it isn't. The rose and lily have quite different relations to the corn. The lily is grass in loveliness, as the corn is grass in use; and both grow together in peace—gladiolus in the wheat, and narcissus in the pasture. But the rose is of

* And I have too harshly called our English Vines, 'wicked weeds of Kent,' in Fors Clavigera, xxvii., vol. i, p. 377. Much may be said for Ale, when we brew it for our people honestly

another and higher order than the corn, and you never saw a cornfield overrun with sweetbrier or apple-blossom.

They have no mind, they, to get into the wrong place.

What is it, then, this temper in some plants—malicious as it seems—intrusive, at all events, or erring,—which brings them out of their places—thrusts them where they thwart us and offend?

7. Primarily, it is mere hardihood and coarseness of make. A plant that can live anywhere, will often live where it is not wanted. But the delicate and tender ones keep at home. You have no trouble in 'keeping down' the spring gentian. It rejoices in its own Alpine home, and makes the earth as like heaven as it can, but yields as softly as the air, if you want it to give place. Here in England, it will only grow on the loneliest moors, above the high force of Tees; its Latin name, for us (I may as well tell you at once) is to be '*Lucia verna*;' and its English one, Lucy of Teesdale.

8. But a plant may be hardy, and coarse of make, and able to live anywhere, and yet be no weed. The coltsfoot, so far as I know, is the first of large-leaved plants to grow afresh on ground that has been disturbed: fall of Alpine débris, ruin of railroad embankment, waste of drifted slime by flood, it seeks to heal and redeem; but it does not offend us in our gardens, nor impoverish us in our fields.

Nevertheless, mere coarseness of structure, indiscriminate hardihood, is at least a point of some unworthiness in a plant. That it should have no choice of home, no love of native land, is ungentle; much more if such discrimination as it has, be immodest, and incline it, seemingly, to open and much-traversed places, where it may be continually seen of strangers.

The tormentilla gleams in showers along the mountain turf; her delicate crosslets are separate, though constellate, as the rubied daisy. But the king-cup—(blessing be upon it always no less)—crowds itself sometimes into too burnished flame of inevitable gold. I don't know if there was anything in the darkness of this last spring to make it brighter in resistance; but I never saw any spaces of full warm yellow, in natural colour, so intense as the meadows between Reading

and the Thames ; nor did I know perfectly what purple and gold meant, till I saw a field of park land embroidered a foot deep with king-cup and clover—while I was correcting my last notes on the spring colours of the Royal Academy—at Aylesbury.

9. And there are two other questions of extreme subtlety connected with this main one. What shall we say of the plants whose entire destiny is parasitic—which are not only sometimes, and *impertinently*, but always, and *pertinently*, out of place ; not only out of the right place, but out of any place of their own ? When is mistletoe, for instance, in the right place, young ladies, think you ? On an apple tree, or on a ceiling ? When is ivy in the right place ?—when wallflower ? The ivy has been torn down from the towers of Kenilworth ; the weeds from the arches of the Coliseum, and from the steps of the Araceli, irreverently, vilely, and in vain ; but how are we to separate the creatures whose office it is to abate the grief of ruin by their gentleness,

“ wafting wallflower scents
From out the crumbling ruins of fallen pride,
And chambers of transgression, now forlorn,”

from those which truly resists the toil of men, and conspire against their fame ; which are cunning to consume, and prolific to encumber ; and of whose perverse and unwelcome sowing we know, and can say assuredly, “ An enemy hath done this.”

10. Again. The character of strength which gives prevalence over others to any common plant, is more or less consistently dependent on woody fibre in the leaves : giving them strong ribs and great expanding extent ; or spinous edges, and wrinkled or gathered extent.

Get clearly into your mind the nature of these two conditions. When a leaf is to be spread wide, like the Burdock, it is supported by a framework of extending ribs like a Gothic roof. The supporting function of these is geometrical ; every one is constructed like the girders of a bridge, or beams of a floor, with all manner of science in the distribution of their

substance in the section, for narrow and deep strength ; and the shafts are mostly hollow. But when the extending space of a leaf is to be enriched with fulness of folds, and become beautiful in wrinkles, this may be done either by pure undulation as of a liquid current along the leaf edge, or by sharp 'drawing'—or 'gathering' I believe ladies would call it—and stitching of the edges together. And this stitching together, if to be done very strongly, is done round a bit of stick, as a sail is reefed round a mast ; and this bit of stick needs to be compactly, not geometrically strong ; its function is essentially that of starch,—not to hold the leaf up off the ground against gravity ; but to stick the edges out, stiffly, in a crimped frill. And in beautiful work of this kind, which we are meant to study, the stays of the leaf—or stay-bones—are finished off very sharply and exquisitely at the points ; and indeed so much so, that they prick our fingers when we touch them ; for they are not at all meant to be touched, but admired.

11. To be admired,—with qualification, indeed, always, but with extreme respect for their endurance and orderliness. Among flowers that pass away, and leaves that shake as with ague, or shrink like bad cloth,—these, in their sturdy growth and enduring life, we are bound to honour ; and, under the green holly, remember how much softer friendship was failing, and how much of other loving, folly. And yet—you are not to confuse the thistle with the cedar that is in Lebanon ; nor to forget—if the spinous nature of it become too cruel to provoke and offend—the parable of Joash to Amaziah, and its fulfilment : "There passed by a wild beast that was in Lebanon, and trode down the thistle."

12. Then, lastly, if this rudeness and insensitiveness of nature be gifted with no redeeming beauty ; if the boss of the thistle lose its purple, and the star of the Lion's tooth, its light ; and, much more, if service be perverted as beauty is lost, and the honied tube, and medicinal leaf, change into mere swollen emptiness, and salt brown membrane, swayed in nerveless languor by the idle sea,—at last the separation between the two natures is as great as between the fruitful earth and fruitless ocean ; and between the living hands that

tend the Garden of Herbs where Love is, and those unclasped,
that toss with tangle and with shells.

* * * * *

13. I had a long bit in my head, that I wanted to write about St. George of the Seaweed, but I've no time to do it; and those few words of Tennyson's are enough, if one thinks of them: only I see, in correcting press, that I've partly misapplied the idea of 'gathering' in the leaf edge. It would be more accurate to say it was gathered at the central rib; but there is nothing in needlework that will represent the actual excess by lateral growth at the edge, giving three or four inches of edge for one of centre. But the stiffening of the fold by the thorn which holds it out is very like the action of a ship's spars on its sails; and absolutely in many cases like that of the spines in a fish's fin, passing into the various conditions of serpentine and dracontic crest, connected with all the terrors and adversities of nature; not to be dealt with in a chapter on weeds.

14. Here is a sketch of a crested leaf of less adverse temper, which may as well be given, together with Plate III, in this number, these two engravings being meant for examples of two different methods of drawing, both useful according to character of subject. Plate III. is sketched first with a finely-pointed pen, and common ink, on white paper; then washed rapidly with colour, and retouched with the pen to give sharpness and completion. This method is used because the thistle leaves are full of complex and sharp sinuosities, and set with intensely sharp spines passing into hairs, which require many kinds of execution with the fine point to imitate at all. In the drawing there was more look of the bloom or woolliness on the stems, but it was useless to try for this in the mezzotint, and I desired Mr. Allen to leave his work at the stage where it expressed as much form as I wanted. The leaves are of the common marsh thistle, of which more anon; and the two long lateral ones are only two different views of the same leaf, while the central figure is a young leaf just opening. It beat me, in its delicate bossing, and I had to leave it, discontentedly enough.

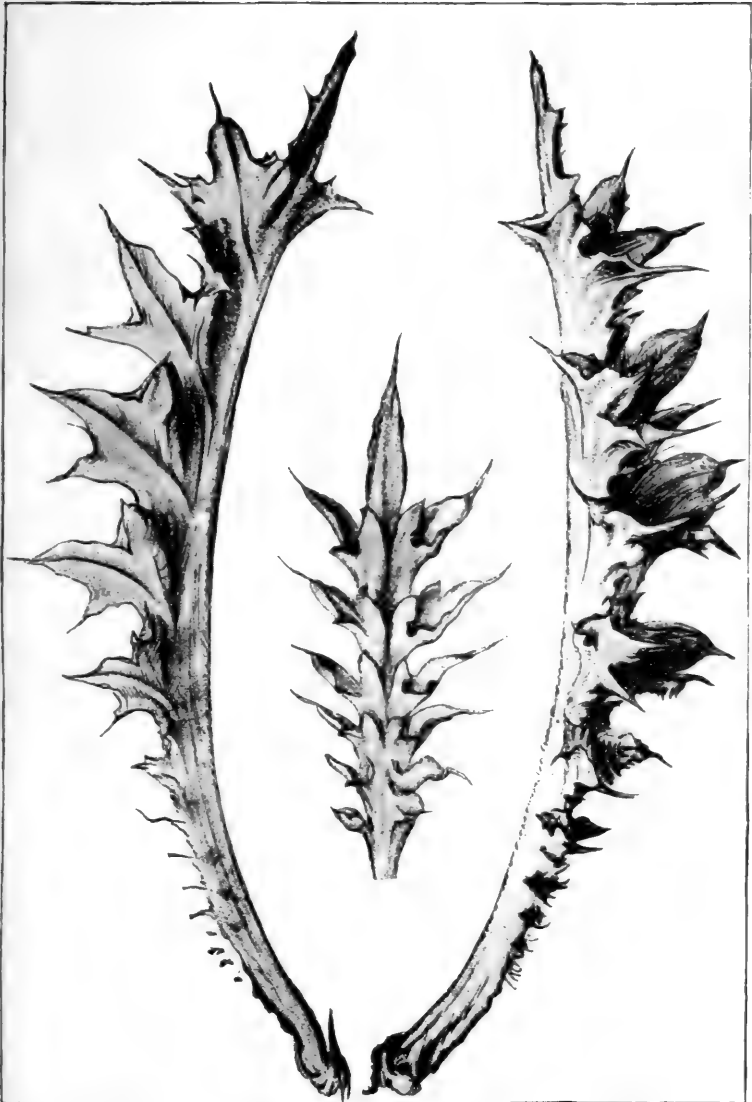

PLATE III.—ACANTHOID LEAVES. NORTHERN ATTIC TYPE.



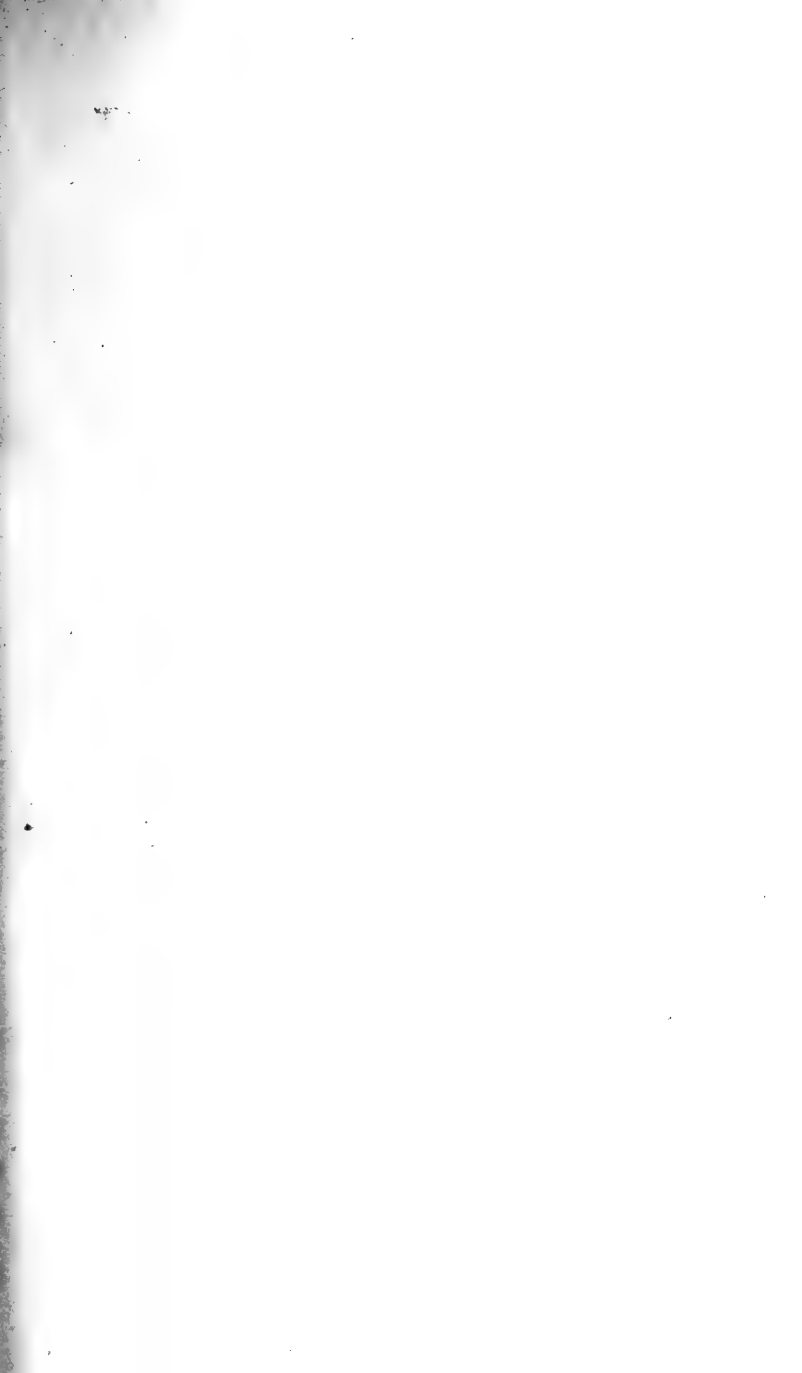



PLATE IV.—CRESTED LEAVES. LETTUCE-THISTLE.

Plate IV. is much better work, being of an easier subject, adequately enough rendered by perfectly simple means. Here I had only a succulent and membranous surface to represent, with definite outlines, and merely undulating folds; and this is sufficiently done by a careful and firm pen outline on grey paper, with a slight wash of colour afterwards, reinforced in the darks; then marking the lights with white. This method is classic and authoritative, being used by many of the greatest masters, (by Holbein continually;) and it is much the best which the general student can adopt for expression of the action and muscular power of plants.

The goodness or badness of such work depends absolutely on the truth of the single line. You will find a thousand botanical drawings which will give you a delicate and deceptive resemblance of the leaf, for one that will give you the right convexity in its backbone, the right perspective of its peaks when they foreshorten, or the right relation of depth in the shading of its dimples. On which, in leaves as in faces, no little expression of temper depends.

Meantime we have yet to consider somewhat more touching that temper itself, in next chapter.

CHAPTER VII.

THE PARABLE OF JOTHAM.

1. I do not know if my readers were checked, as I wished them to be, at least for a moment, in the close of the last chapter, by my talking of thistles and dandelions changing into seaweed, by gradation of which, doubtless, Mr. Darwin can furnish us with specious and sufficient instances. But the two groups will not be contemplated in our Oxford system as in any parental relations whatsoever.

We shall, however, find some very notable relations existing between the two groups of the wild flowers of dry land, which represent, in the widest extent, and the distinctest opposition, the two characters of material serviceableness and unservice-

ableness ; the groups which in our English classification will be easily remembered as those of the Thyme, and the Daisy.

The one, scented as with incense—medicinal—and in all gentle and humble ways, useful. The other, scentless—helpless for ministry to the body ; infinitely dear as the bringer of light, ruby, white and gold ; the three colours of the Day, with no hue of shade in it. Therefore I take it on the coins of St. George for the symbol of the splendour or light of heaven, which is dearest where humblest.

2. Now these great two orders—of which the types are the thyme and the daisy—you are to remember generally as the ‘Herbs’ and the ‘Sunflowers.’ You are not to call them Lipped flowers, nor Composed flowers ; because the first is a vulgar term ; for when you once come to be able to draw a lip, or, in noble duty, to kiss one, you will know that no other flower in earth is like that : and the second is an indefinite term ; for a foxglove is as much a ‘composed’ flower as a daisy ; but it is composed in the shape of a spire, instead of the shape of the sun. And again a thistle, which common botany calls a composed flower, as well as a daisy, is composed in quite another shape, being on the whole, bossy instead of flat ; and of another temper, or composition of mind, also, being connected in that respect with butterburs, and a vast company of rough, knotty, half-black or brown, and generally unluminous—flowers I can scarcely call them—and weeds I will not,—creatures, at all events, in nowise to be gathered under the general name ‘Composed,’ with the stars that crown Chaucer’s Alcestis, when she returns to the day from the dead.

But the wilder and stronger blossoms of the Hawk’s-eye—again you see I refuse for them the word weed ;—and the waste-loving Chicory, which the Venetians call “*Sponsa solis*,” are all to be held in one class with the Sunflowers ; but dedicate,—the daisy to Alcestis alone ; others to Clytia, or the Physician Apollo himself ; but I can’t follow their mythology yet awhile.

3. Now in these two families you have typically Use op-

posed to Beauty in *wildness* ; it is their wildness which is their virtue ;—that the thyme is sweet where it is unthought of, and the daisies red, where the foot despises them : while, in other orders, wildness is their crime,—“ Wherefore, when I looked that it should bring forth grapes, brought it forth wild grapes ? ” But in all of them you must distinguish between the pure wildness of flowers and their distress. It may not be our duty to tame them ; but it must be, to relieve.

4. It chanced, as I was arranging the course of these two chapters, that I had examples given me of distressed and happy wildness, in immediate contrast. The first, I grieve to say, was in a bit of my own brushwood, left uncared-for evidently many a year before it became mine. I had to cut my way into it through a mass of thorny ruin ; black, birds-nest like, entanglement of brittle spray round twisted stems of ill-grown birches strangling each other, and changing half into roots among the rock clefts ; knotted stumps of never-blossoming blackthorn, and choked stragglings of holly, all laced and twisted and tethered round with an untouchable, almost unhewable, thatch, a foot thick, of dead bramble and rose, laid over rotten ground through which the water soaked ceaselessly, undermining it into merely unctuous clods and clots, knitted together by mossy sponge. It was all Nature's free doing ! she had had her way with it to the uttermost ; and clearly needed human help and interference in her business ; and yet there was not one plant in the whole ruinous and deathful riot of the place, whose nature was not in itself wholesome and lovely ; but all lost for want of discipline.

5. The other piece of wild growth was among the fallen blocks of limestone under Malham Cove. Sheltered by the cliff above from stress of wind, the ash and hazel wood spring there in a fair and perfect freedom, without a diseased bough, or an unwholesome shade. I do not know why mine is all encumbered with overgrowth, and this so lovely that scarce a branch could be gathered but with injury ;—while underneath, the oxalis, and the two smallest geraniums (*Lucidum* and *Herb-Robert*) and the mossy saxifrage, and the cross-leaved bed-straw, and the white pansy, wrought themselves

into wreaths among the fallen crags, in which every leaf rejoiced, and was at rest.

6. Now between these two states of equally natural growth, the point of difference that forced itself on me (and practically enough, in the work I had in my own wood), was not so much the withering and waste of the one, and the life of the other, as the thorniness and cruelty of the one, and the softness of the other. In Malham Cove, the stones of the brook were softer with moss than any silken pillow—the crowded oxalis leaves yielded to the pressure of the hand, and were not felt—the cloven leaves of the Herb-Robert and orbed clusters of its companion overflowed every rent in the rude crags with living balm; there was scarcely a place left by the tenderness of the happy things, where one might not lay down one's forehead on their warm softness, and sleep. But in the waste and distressed ground, the distress had changed itself to cruelty. The leaves had all perished, and the bending saplings, and the wood of trust;—but the thorns were there, immortal, and the gnarled and sapless roots, and the dusty treacheries of decay.

7. Of which things you will find it good to consider also otherwise than botanically. For all these lower organisms suffer and perish, or are gladdened and flourish, under conditions which are in utter precision symbolical, and in utter fidelity representative, of the conditions which induce adversity and prosperity in the kingdoms of men: and the Eternal Demeter,—Mother, and Judge,—brings forth, as the herb yielding seed, so also the thorn and the thistle, not to herself, but to thee.

8. You have read the words of the great Law often enough;—have you ever thought enough of them to know the difference between these two appointed means of Distress? The first, the Thorn, is the type of distress *caused by crime*, changing the soft and breathing leaf into inflexible and wounding stubbornness. The second is the distress appointed to be the means and herald of good,—Thou shalt see the stubborn thistle bursting, into glossy purple, which outredden, all voluptuous garden roses.

9. It is strange that, after much hunting, I cannot find authentic note of the day when Scotland took the thistle for her emblem ; and I have no space (in this chapter at least) for tradition ; but, with whatever lightness of construing we may receive the symbol, it is actually the truest that could have been found, for some conditions of the Scottish mind. There is no flower which the Proserpina of our Northern Sicily cherishes more dearly : and scarcely any of us recognize enough the beautiful power of its close-set stars, and rooted radiance of ground leaves ; yet the stubbornness and ungraceful rectitude of its stem, and the besetting of its wholesome substance with that fringe of offence, and the forwardness of it, and dominance,—I fear to lacerate some of my dearest friends if I went on :—let them rather, with Bailie Jarvie's true conscience,* take their Scott from the inner shelf in their heart's library which all true Scotsmen give him, and trace, with the swift reading of memory, the characters of Fergus M'Ivor, Hector M'Intyre, Mause Headrigg, Alison Wilson, Richie Moniplies, and Andrew Fairservice ; and then say, if the faults of all these, drawn as they are with a precision of touch like a Corinthian sculptor's of the acanthus leaf, can be found in anything like the same strength in other races, or if so stubbornly folded and starched moniplies of irritating kindness, selfish friendliness, lowly conceit, and intolerable fidelity, are native to any other spot of the wild earth of the habitable globe.

10. Will you note also—for this is of extreme interest—that these essential faults are all mean faults ;—what we may call ground-growing faults ; conditions of semi-education,

* Has my reader ever thought,—I never did till this moment,—now it perfects the exquisite character which Scott himself loved, as he invented, till he changed the form of the novel, that his habitual interjection should be this word ;—not but that the oath, by conscience, was happily still remaining then in Scotland, taking the place of the mediæval 'by St. Andrew,' we in England, long before the Scot, having lost all sense of the Puritanical appeal to private conscience, as of the Catholic oath, 'by St. George ;' and our uncanonized 'by George' in sonorous rudeness, ratifying, not now our common conscience, but our individual opinion.

of hardly-treated homelife, or of coarsely-minded and wandering prosperity. How literally may we go back from the living soul symbolized, to the strangely accurate earthly symbol in the prickly weed. For if, with its bravery of endurance, and carelessness in choice of home, we find also definite faculty and habit of migration, volant mechanism for choiceless journey, not divinely directed in pilgrimage to known shrines; but carried at the wind's will by a Spirit which listeth *not*—it will go hard but that the plant shall become, if not dreaded, at least despised; and, in its wandering and reckless splendour, disgrace the garden of the sluggard, and possess the inheritance of the prodigal: until even its own nature seems contrary to good, and the invocation of the just man be made to it as the executor of Judgment, "Let thistles grow instead of wheat, and cockle instead of barley."

11. Yet to be despised—either for men or flowers—may be no ill-fortune; the real ill-fortune is only to be despicable. These faults of human character, wherever found, observe, belong to it as ill-trained—incomplete; confirm themselves only in the vulgar. There is no base pertinacity, no overweening conceit, in the Black Douglas, or Claverhouse, or Montrose; in these we find the pure Scottish temper, of heroic endurance and royal pride; but, when, in the pay, and not deceived, but purchased, idolatry of Mammon, the Scottish persistence and pride become knit and vested in the spleuchan, and your stiff Covenanter makes his covenant with Death, and your Old Mortality deciphers only the senseless legends of the eternal gravestone,—you get your weed, earth grown, in bitter verity, and earth-devastating, in bitter strength.

12. I have told you, elsewhere, we are always first to study national character in the highest and purest examples. But if our knowledge is to be complete, we have to study also the special diseases of national character. And in exact opposition to the most solemn virtue of Scotland, the domestic truth and tenderness breathed in all Scottish song, you have this special disease and mortal cancer, this woody-fibriness, literally, of temper and thought: the consummation of which into pure

lignite, or rather black Devil's charcoal—the sap of the birks of Aberfeldy become cinder, and the blessed juices of them, deadly gas,—you may know in its pure blackness best in the work of the greatest of these ground-growing Scotchmen, Adam Smith.

13. No man of like capacity, I believe, born of any other nation, could have deliberately, and with no momentary shadow of suspicion or question, formalized the spinous and monstrous fallacy that human commerce and policy are *naturally* founded on the desire of every man to possess his neighbour's goods.

This is the 'release unto us Barabbas,' with a witness; and the deliberate systematization of that cry, and choice, for perpetual repetition and fulfilment in Christian statesmanship, has been, with the strange precision of natural symbolism and retribution, signed, (as of old, by strewing of ashes on Kidron,) by strewing of ashes on the brooks of Scotland; waters once of life, health, music, and divine tradition; but to whose festering scum you may now set fire with a candle; and of which, round the once excelling palace of Scotland, modern sanitary science is now helplessly contending with the poisonous exhalations.

14. I gave this chapter its heading, because I had it in my mind to work out the meaning of the fable in the ninth chapter of Judges, from what I had seen on that thorny ground of mine, where the bramble was king over all the trees of the wood. But the thoughts are gone from me now; and as I re-read the chapter of Judges,—now, except in my memory, unread, as it chances, for many a year,—the sadness of that story of Gideon fastens on me, and silences me. *This* the end of his angel visions, and dream-led victories, the slaughter of all his sons but this youngest,*—and he never again heard of in Israel!

You Scottish children of the Rock, taught through all your once pastoral and noble lives by many a sweet miracle of dew on fleece and ground,—once servants of mighty kings, and

* 'Jotham,' 'Sum perfectio eorum,' or 'Consummatio eorum.' (Interpretation of name in Vulgate index.)

keepers of sacred covenant ; have you indeed dealt truly with your warrior kings, and prophet saints, or are these ruins of their homes, and shrines, dark with the fire that fell from the curse of Jerubbaal ?

CHAPTER VIII.

THE STEM.

1. As I read over again, with a fresh mind, the last chapter, I am struck by the opposition of states which seem best to fit a weed for a weed's work,—stubbornness, namely, and flaccidity. On the one hand, a sternness and a coarseness of structure which changes its stem into a stake, and its leaf into a spine ; on the other, an utter flaccidity and ventosity of structure, which changes its stem into a riband, and its leaf into a bubble. And before we go farther—for we are not yet at the end of our study of these obnoxious things—we had better complete an examination of the parts of a plant in general, by ascertaining what a Stem proper is ; and what makes it stiffer, or hollower, than we like it ;—how, to wit, the gracious and generous strength of ash differs from the spinous obstinacy of blackthorn,—and how the geometric and enduring hollowness of a stalk of wheat differs from the soft fulness of that of a mushroom. To which end, I will take up a piece of study, not of black, but white, thorn, written last spring.

2. I suppose there is no question but that all nice people like hawthorn blossom.

I want, if I can, to find out to-day, 25th May, 1875, what it is we like it so much for : holding these two branches of it in my hand—one full out, the other in youth. This full one is a mere mass of symmetrically balanced—snow, one was going vaguely to write, in the first impulse. But it is nothing of the sort. White,—yes, in a high degree ; and pure, totally ; but not at all dazzling in the white, nor pure in an insultingly rivalless manner, as snow would be ; yet pure somehow, certainly ; and white, absolutely, in spite of what might be thought failure,—imperfection—nay, even distress and loss in it. For

every little rose of it has a green darkness in the centre—not even a pretty green, but a faded, yellowish, glutinous, unaccomplished green; and round that, all over the surface of the blossom, whose shell-like petals are themselves deep sunk, with grey shadows in the hollows of them—all above this already subdued brightness, are strewn the dark points of the dead stamens—manifest more and more, the longer one looks, as a kind of grey sand, sprinkled without sparing over what looked at first unspotted light. And in all the ways of it the lovely thing is more like the spring frock of some prudent little maid of fourteen, than a flower;—frock with some little spotty pattern on it to keep it from showing an unintended and inadvertent spot,—if Fate should ever inflict such a thing! Undeveloped, thinks Mr. Darwin,—the poor short-coming, ill-blanch'd thorn blossom—going to be a Rose, some day soon; and, what next?—who knows?—perhaps a Pæony!

3. Then this next branch, in dawn and delight of youth, set with opening clusters of yet numerable blossom, four, and five, and seven, edged, and islanded, and ended, by the sharp leaves of freshest green, deepened under the flowers, and studied round with bosses, better than pearl beads of St. Agnes' rosary,—folded over and over, with the edges of their little leaves pouting, as the very softest waves do on flat sand where one meets another; then opening just enough to show the violet colour within—which yet isn't violet colour, nor even "meno che le rose," but a different colour from every other lilac that one ever saw;—faint and faded even before it sees light, as the filmy cup opens over the depth of it, then broken into purple motes of tired bloom, fading into darkness, as the cup extends into the perfect rose.

This, with all its sweet change that one would so fain stay, and soft effulgence of bud into softly falling flower, one has watched—how often; but always with the feeling that the blossoms are thrown over the green depth like white clouds—never with any idea of so much as asking what holds the clouds there. Have each of the innumerable blossoms a separate stalk? and, if so, how is it that one never thinks of the stalk, as one does with currants?

4. Turn the side of the branch to you ;—Nature never meant you to see it so ; but now it is all stalk below, and stamens above,—the petals nothing, the stalks all tiny trees, always dividing their branches mainly into three—one in the centre short, and the two lateral, long, with an intermediate extremely long one, if needed, to fill a gap, so contriving that the flowers shall all be nearly at the same level, or at least surface of ball, like a guelder rose. But the cunning with which the tree conceals its structure till the blossom is fallen, and then—for a little while, we had best look no more at it, for it is all like grape-stalks with no grapes.

These, whether carrying hawthorn blossom and haw, or grape blossom and grape, or peach blossom and peach, you will simply call the ‘stalk,’ whether of flower or fruit. A ‘stalk’ is essentially round, like a pillar ; and has, for the most part, the power of first developing, and then shaking off, flower and fruit from its extremities. You can pull the peach from its stalk, the cherry, the grape. Always at some time of its existence, the flower-stalk lets fall something of what it sustained, petal or seed.

In late Latin it is called ‘petiolus,’ the little foot ; because the expanding piece that holds the grape, or olive, is a little like an animal’s foot. Modern botanists have misapplied the word to the *leaf*-stalk, which has no resemblance to a foot at all. We must keep the word to its proper meaning, and, when we want to write Latin, call it ‘petiolus ;’ when we want to write English, call it ‘stalk,’ meaning always fruit or flower stalk.

I cannot find when the word ‘stalk’ first appears in English :—its derivation will be given presently.

5. Gather next a hawthorn leaf. That also has a stalk ; but you can’t shake the leaf off it. It, and the leaf, are essentially one ; for the sustaining fibre runs up into every ripple or jag of the leaf’s edge : and its section is different from that of the flower-stalk ; it is no more round, but has an upper and under surface, quite different from each other. It will be better, however, to take a larger leaf to examine this structure in. Cabbage, cauliflower, or rhubarb, would any of them be good,

but don't grow wild in the luxuriance I want. So, if you please, we will take a leaf of burdock, (*Arctium Lappa*), the principal business of that plant being clearly to grow leaves wherewith to adorn fore-grounds.*

6. The outline of it in Sowerby is not an intelligent one, and I have not time to draw it but in the rudest way myself; Fig. 13, *a*; with perspectives of the elementary form below, *b*, *c*, and *d*. By help of which, if you will construct a burdock leaf in paper, my rude outline (*a*) may tell the rest of what I want you to see.

Take a sheet of stout note paper, Fig. 14, *A*, double it sharply down the centre, by the dotted line, then give it the two cuts at *a* and *b*, and double those pieces sharply back, as at *B*; then, opening them again, cut the whole into the form *C*; and then, pulling up the corners *c* *d*, stitch them together with a loose thread so that the points *c* and *d*

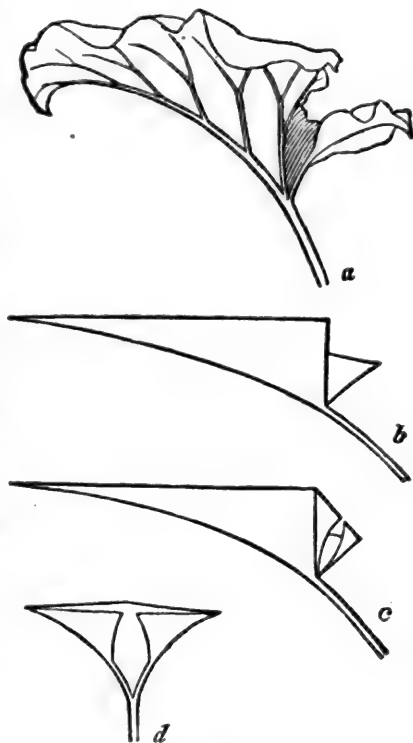

FIG. 13.

shall be within half an inch of each other; and you will have a kind of triangular scoop, or shovel, with a stem, by which you can sufficiently hold it, *D*.

7. And from this easily constructed and tenable model, you may learn at once these following main facts about all leaves.

* If you will look at the engraving, in the England and Wales series, of Turner's Oakhampton, you will see its use.

[L] That they are not flat, but, however slightly, always hollowed into craters, or raised into hills, in one or another direction ; so that any drawable outline of them does not in the least represent the real extent of their surfaces ; and until you know how to draw a cup, or a mountain, rightly, you have no chance of drawing a leaf. My simple artist readers of long ago, when I told them to draw leaves, thought they could do them by the boughful, whenever they liked. Alas, except by old William Hunt, and Burne Jones, I've not seen a leaf painted, since those burdocks of Turner's ; far less sculptured—though

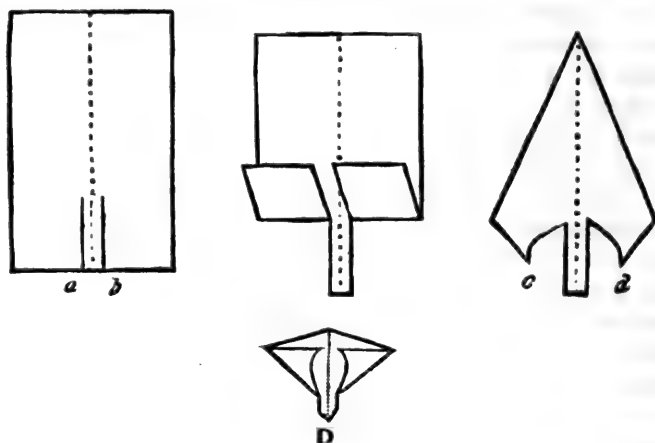

FIG. 14.

one would think at first that was easier ! Of which we shall have talk elsewhere ; here I must go on to note fact number two, concerning leaves.

8. [II.] The strength of their supporting stem consists not merely in the gathering together of all the fibres, but in gathering them essentially into the profile of the letter V, which you will see your doubled paper stem has ; and of which you can feel the strength and use, in your hand, as you hold it. Gather a common plantain leaf, and look at the way it puts its round ribs together at the base, and you will understand the matter at once. The arrangement is modified and

disguised in every possible way, according to the leaf's need : in the aspen, the leaf-stalk becomes an absolute vertical plank ; and in the large trees is often almost rounded into the likeness of a fruit-stalk ;—but, in all,* the essential structure is this doubled one ; and in all, it opens at the place where the leaf joins the main stem, into a kind of cup, which holds next year's bud in the hollow of it.

9. Now there would be no inconvenience in your simply getting into the habit of calling the round petiol of the fruit the 'stalk,' and the contracted channel of the leaf, 'leaf-stalk.' But this way of naming them would not enforce, nor fasten in your mind, the difference between the two, so well as if you have an entirely different name for the leaf-stalk. Which is the more desirable, because the limiting character of the leaf, botanically, is—(I only learned this from my botanical friend the other day, just in the very moment I wanted it,)—that it holds the bud of the new stem in its own hollow, but cannot itself grow in the hollow of anything else ;—or, in botanical language, leaves are never axillary,—don't grow in armpits, but are themselves armpits ; hollows, that is to say, where they spring from the main stem.

10. Now there is already a received and useful botanical word, 'cyme' (which we shall want in a little while,) derived from the Greek *κῦμα*, a swelling or rising wave, and used to express a swelling cluster of foamy blossom. Connected with that word, but in a sort the reverse of it, you have the Greek '*κύμβη*,' the hollow of a cup, or bowl ; whence *κύμβαλον*, a cymbal,—that is to say, a musical instrument owing its tone to its hollowness. These words become in Latin, *cymba*, and *cymbalum* ; and I think you will find it entirely convenient and advantageous to call the leaf-stalk distinctively the 'cymba,' retaining the mingled idea of cup and boat, with respect at least to the part of it that holds the bud ; and understanding that it gathers itself into a V-shaped, or even narrowly vertical, section, as a boat narrows to its bow, for strength to sustain the leaf.

* General assertions of this kind must always be accepted under indulgence,—exceptions being made afterwards.

With this word you may learn the Virgilian line, that shows the final use of iron—or iron-darkened—ships :

“Et ferrugineâ subvectat corpora cymbâ.”

The “subvectat corpora” will serve to remind you of the office of the leafy cymba in carrying the bud ; and make you thankful that the said leafy vase is not of iron ; and is a ship of Life instead of Death.

11. Already, not once, nor twice, I have had to use the word ‘stem,’ of the main round branch from which both stalk and cymba spring. This word you had better keep for all growing, or advancing, shoots of trees, whether from the ground, or from central trunks and branches. I regret that the words multiply on us ; but each that I permit myself to use has its own proper thought or idea to express, as you will presently perceive ; so that true knowledge multiplies with true words.

12. The ‘stem,’ you are to say, then, when you mean the *advancing* shoot,—which lengthens annually, while a stalk ends every year in a blossom, and a cymba in a leaf. A stem is essentially round,* square, or regularly polygonal ; though, as a cymba may become exceptionally round, a stem may become exceptionally flat, or even mimic the shape of a leaf. Indeed I should have liked to write “a stem is essentially round, and constructively, on occasion, square,”—but it would have been too grand. The fact is, however, that a stem is really a roundly minded thing, throwing off its branches in circles as a trundled mop throws off drops, though it can always order the branches to fly off in what order it likes,—two at a time, opposite to each other ; or three, or five, in a spiral coil ; or one here and one there, on this side and that ; but it is always twisting, in its own inner mind and force ; hence it is especially proper to use the word ‘stem’ of it—*στέμμα*, a twined wreath ; properly, twined round a staff, or sceptre : therefore, learn at once by heart these lines in the opening Iliad :

“Στέμματ' ἔχων ἐν χερσὶν ἐκηβόλου Ἀπόλλωνος,
Χρυσίῃ ἀνὰ σκήπτρῳ.”

And recollect that a sceptre is properly a staff to lean upon ; and that as a crown or diadem is first a binding thing, a

* I use ‘round’ rather than ‘cylindrical,’ for simplicity’s sake.

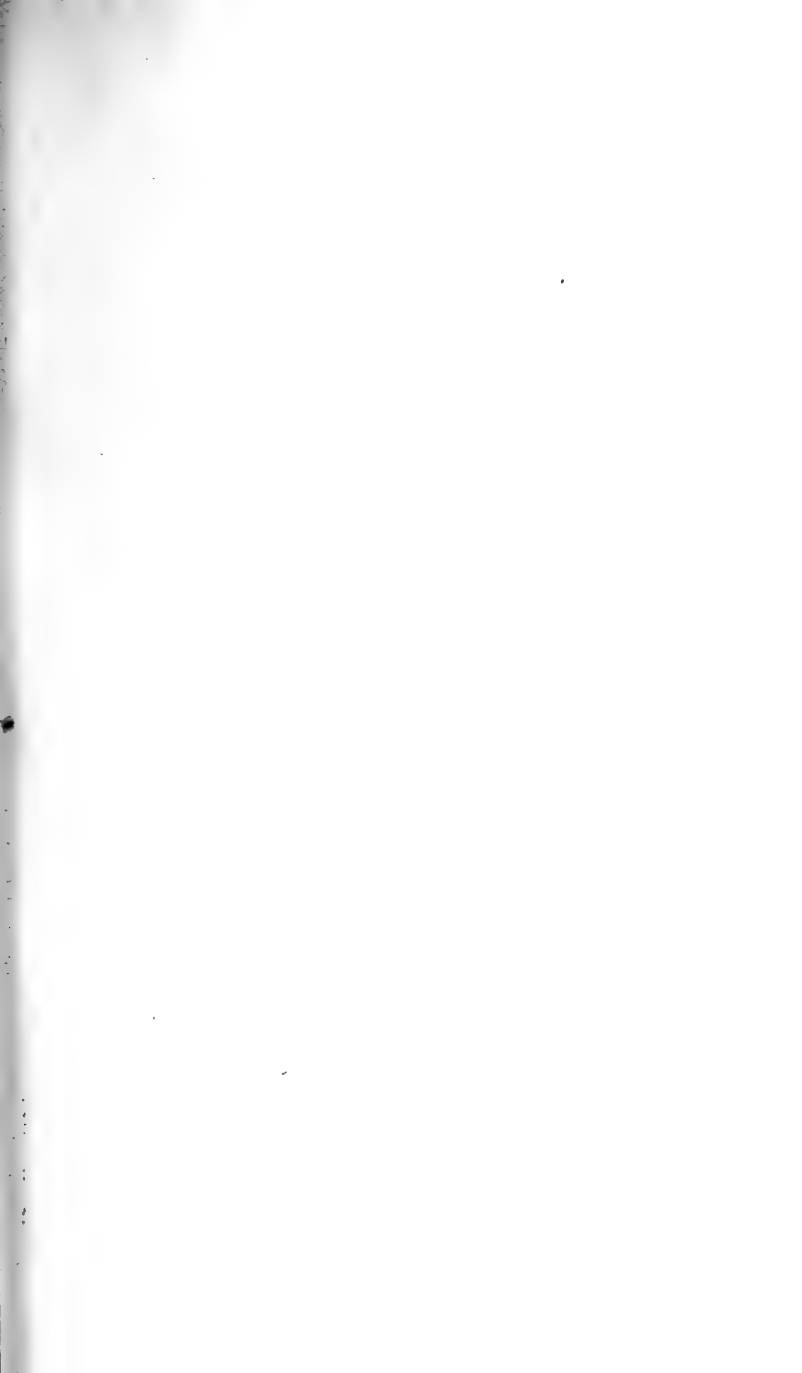



PLATE V.—OCCULT SPIRAL ACTION. WASTE-THISTLE.

'sceptre' is first a *supporting* thing, and it is in its nobleness, itself made of the stem of a young tree. You may just as well learn also this :

“ Ναί μὰ τόδε σκῆπτρον, τὸ μὲν οὐποτε φύλλα καὶ ὕζους
 Φύσει, ἐπειδὴ πρῶτα τομῆν ἐν ὕρεσσι λέλοιπεν,
 Οὐδ' ἀναθλήσει· περὶ γὰρ ῥά ἐ χαλκὸς ἔλειψε
 Φύλλα' τε καὶ φλοιόν· νῦν αὖτε μιν υἴες Ἀχαιῶν
 Ἐν παλάμῃ φορέουσι δικασπόλοι, οἳ τε θέμιστας
 Πρὸς Διὸς εἰρύαται.”

“ Now, by this sacred sceptre hear me swear
 Which never more shall leaves or blossoms bear,
 Which, severed from the trunk, (as I from thee,)
 On the bare mountains left its parent tree ;
 This sceptre, formed by tempered steel to prove—
 An ensign of the delegates of Jove,
 From whom the power of laws and justice springs
 (Tremendous oath, inviolate to Kings).”

13. The supporting power in the tree itself is, I doubt not, greatly increased by this spiral action ; and the fine instinct of its being so, caused the twisted pillar to be used in the Lombardic Gothic,—at first, merely as a pleasant variety of form, but at last constructively and universally, by Giotto and all the architects of his school. Not that the spiral form actually adds to the strength of a Lombardic pillar, by imitating contortions of wood, any more than the fluting of a Doric shaft adds to its strength by imitating the canaliculation of a reed ; but the perfect action of the imagination, which had adopted the encircling acanthus for the capital, adopted the twining stemma for the shaft ; the pure delight of the eye being the first condition in either case : and it is inconceivable how much of the pleasure taken both in ornament and in natural form is founded elementarily on groups of spiral line. The study in our fifth plate, of the involucre of the waste-thistle,* is as good an example as I can give of the more subtle and concealed conditions of this structure.

* *Carduus Arvensis*. ‘Creeping Thistle,’ in Sowerby ; why, I cannot conceive, for there is no more creeping in it than in a furzebush. But it especially haunts foul and neglected ground ; so I keep the Latin

14. Returning to our present business of nomenclature, we find the Greek word, 'stemma,' adopted by the Latins, becoming the expression of a growing and hereditary race ; and the branched tree, the natural type, among all nations, of multiplied families. Hence the entire fitness of the word for our present purposes ; as signifying, "a spiral shoot extending itself by branches." But since, unless it is spiral, it is not a stem, and unless it has branches, it is not a stem, we shall still want another word for the sustaining 'sceptre' of a foxglove, or cowslip. Before determining that, however, we must see what need there may be of one familiar to our ears until lately, although now, I understand, falling into disuse.

15. By our definition, a stem is a spirally bent, essentially living and growing, shoot of vegetation. But the branch of a tree, in which many such stems have their origin, is not, except in a very subtle and partial way, spiral ; nor, except in the shoots that spring from it, progressive forwards ; it only receives increase of thickness at its sides. Much more, what used to be called the *trunk* of a tree, in which many branches are united, has ceased to be, except in mere tendency and temper, spiral ; and has so far ceased from growing as to be often in a state of decay in its interior, while the external layers are still in serviceable strength.

16. If, however, a trunk were only to be defined as an arrested stem, or a cluster of arrested stems, we might perhaps refuse, in scientific use, the popular word. But such a definition does not touch the main idea. Branches usually begin to assert themselves at a height above the ground approximately fixed for each species of tree,—low in an oak, high in a stone pine ; but, in both, marked as a point of *structural change in the direction of growing force*, like the spring of a

name, translating 'Waste-Thistle.' I could not show the variety of the curves of the involucre without enlarging ; and if, on this much increased scale, I had tried to draw the flower, it would have taken Mr. Allen and me a good month's more work. And I had no more a month than a life, to spare : so the action only of the spreading flower is indicated, but the involucre drawn with precision.

vault from a pillar ; and as the tree grows old, some of its branches getting torn away by winds or falling under the weight of their own fruit, or load of snow, or by natural decay, there remains literally a 'truncated' mass of timber, still bearing irregular branches here and there, but inevitably suggestive of resemblance to a human body, after the loss of some of its limbs.

And to prepare trees for their practical service, what age and storm only do partially, the first rough process of human art does completely. The branches are lopped away, leaving literally the 'truncus' as the part of the tree out of which log and rafter can be cut. And in many trees, it would appear to be the chief end of their being to produce this part of their body on a grand scale, and of noble substance ; so that, while in thinking of vegetable life without reference to its use to men or animals, we should rightly say that the essence of it was in leaf and flower—not in trunk or fruit ; yet for the sake of animals, we find that some plants, like the vine, are apparently meant chiefly to produce fruit ; others, like laurels, chiefly to produce leaves ; others chiefly to produce flowers ; and others to produce permanently serviceable and sculptural wood ; or, in some cases, merely picturesque and monumental masses of vegetable rock, "intertwisted fibres serpentine,"—of far nobler and more pathetic use in their places, and their enduring age, than ever they could be for material purpose in human habitation. For this central mass of the vegetable organism, then, the English word 'trunk' and French 'tronc' are always in accurate scholarship to be retained—meaning the part of a tree which remains when its branches are lopped away.

17. We have now got distinct ideas of four different kinds of stem, and simple names for them in Latin and English,—Petiolus, Cymba, Stemma, and Truncus ; Stalk, Leaf-stalk, Stem, and Trunk ; and these are all that we shall commonly need. There is, however, one more that will be sometimes necessary, though it is ugly and difficult to pronounce, and must be as little used as we can.

And here I must ask you to learn with me a little piece of

Roman history. I say, to *learn* with me, because I don't know any Roman history except the two first books of Livy, and little bits here and there of the following six or seven. I only just know enough about it to be able to make out the bearings and meaning of any fact that I now learn. The greater number of modern historians know, (if honest enough even for that,) the facts, or something that may possibly be like the facts, but haven't the least notion of the meaning of them. So that, though I have to find out everything that I want in Smith's dictionary, like any schoolboy, I can usually tell you the significance of what I so find, better than perhaps even Mr. Smith himself could.

18. In the 586th page of Mr. Smith's volume, you have it written that 'Calvus,' bald-head, was the name of a family of the Licinia gens; that the man of whom we hear earliest, as so named, was the first plebeian elected to military tribuneship in B.C. 400; and that the fourth of whom we hear, was surnamed 'Stolo,' because he was so particular in pruning away the Stolons (stolones), or useless young shoots, of his vines.

We must keep this word 'stolon,' therefore, for these young suckers springing from an old root. Its derivation is uncertain; but the main idea meant by it is one of uselessness,—sprouting without occasion or fruit; and the words 'stolidus' and 'stolid' are really its derivatives, though we have lost their sense in English by partly confusing them with 'solid' which they have nothing to do with. A 'stolid' person is essentially a 'useless sucker' of society; frequently very leafy and graceful, but with no good in him.

19. Nevertheless, I won't allow our vegetable 'stolons' to be despised. Some of quite the most beautiful forms of leafage belong to them;—even the foliage of the olive itself is never seen to the same perfection on the upper branches as in the young ground-roses in which the dual groups of leaves crowd themselves in their haste into clusters of three.

But, for our point of Latin history, remember always that in 400 B.C., just a year before the death of Socrates at Athens, this family of Stolid persons manifested themselves at Rome,

shooting up from plebeian roots into places where they had no business ; and preparing the way for the degradation of the entire Roman race under the Empire ; their success being owed, remember also, to the faults of the patricians, for one of the laws passed by Calvus Stolo was that the Sibylline books should be in custody of ten men, of whom five should be plebeian, “ that no falsifications might be introduced in favour of the patricians.”

20. All this time, however, we have got no name for the prettiest of all stems,—that of annual flowers growing high from among their ground leaves, like lilies of the valley, and saxifrages, and the tall primulas—of which this pretty type, Fig. 15, was cut for me by Mr. Burgess years ago ; admirable in its light outline of the foamy globe of flowers, supported and balanced in the meadow breezes on that elastic rod of slenderest life.

What shall we call it ? We had better rest from our study of terms a little, and do a piece of needful classifying, before we try to name it.

21. My younger readers will find it easy to learn, and convenient to remember, for a beginning of their science, the names of twelve great families of cinquefoiled flowers,* of which the first group of three, is for the most part golden, the second, blue, the third, purple, and the fourth, red.

And their names, by simple lips, can be pleasantly said, or sung, in this order, the two first only being a little difficult to get over.

* The florets gathered in the daisy are cinquefoils, examined closely. No system founded on colour can be very general or unexceptionable : but the splendid purples of the pansy, and thistle, which will be made one of the lower composite groups under *Margarita*, may justify the general assertion of this order's being purple.



FIG. 15.

| 1 | 2 | 3 | 4 |
|------------|------------|--------|--------|
| Roof-foil, | Lucy, | Pea, | Pink, |
| Rock-foil, | Blue-bell, | Pansy, | Peach, |
| Primrose. | Bindweed. | Daisy. | Rose. |

Which even in their Latin magniloquence will not be too terrible, namely,—

| 1 | 2 | 3 | 4 |
|------------|-------------|------------|-----------|
| Stella, | Lucia, | Alata, | Clarissa, |
| Francesca, | Campanula, | Viola, | Persica, |
| Primula. | Convolvata. | Margarita. | Rosa. |

22. I do not care much to assert or debate my reasons for the changes of nomenclature made in this list. The most gratuitous is that of 'Lucy' for 'Gentian,' because the King of Macedon, from whom the flower has been so long named, was by no means a person deserving of so consecrated memory. I conceive no excuse needed for rejecting Caryophyll, one of the crudest and absurdest words ever coined by unscholarly men of science; or Papilionaceæ, which is unendurably long for pease; and when we are now writing Latin, in a sentimental temper, and wish to say that we gathered a daisy, we shall not any more be compelled to write that we gathered a 'Bellidem perennem,' or, an 'Oculum Diei.'

I take the pure Latin form, Margarita, instead of Margareta, in memory of Margherita of Cortona, * as well as of the great saint: also the tiny scatterings and sparklings of the daisy on the turf may remind us of the old use of the word 'Margarita,' for the minute particles of the Host sprinkled on the patina—"Has particulas *μερίδας* vocat Euchologium, *μαργαρίτας* Liturgia Chrysostomi." † My young German readers will, I hope, call the flower Gretschen,—unless they would uproot the daisies of the Rhine, lest French girls should also

* See Miss Yonge's exhaustive account of the Name, 'History of Christian Names,' vol. i., p. 265.

† (Du Cange.) The word 'Margarete' is given as heraldic English for pearl, by Lady Juliana Berners, in the book of St. Albans.

count their love-lots by the Marguerite. I must be so ungracious to my fair young readers, however, as to warn them that this trial of their lovers is a very favourable one, for, in nine blossoms out of ten, the leaves of the Marguerite are odd, so that, if they are only gracious enough to begin with the supposition that he loves them, they must needs end in the conviction of it.

23. I am concerned, however, for the present, only with my first or golden order, of which the Roof-foil, or house-leek, is called in present botany, *Sedum*, 'the squatter,' because of its way of fastening itself down on stones, or roof, as close as it can sit. But I think this an ungraceful notion of its behaviour; and as its blossoms are, of all flowers, the most sharply and distinctly star-shaped, I shall call it 'Stella' (providing otherwise, in due time, for the poor little chickweeds;) and the common stonecrop will therefore be '*Stella domestica*.'

The second tribe, (at present *saxifraga*.) growing for the most part wild on rocks, may, I trust, even in Protestant botany, be named *Francesca*, after St. Francis of Assisi; not only for its modesty, and love of mountain ground, and poverty of colour and leaf; but also because the chief element of its decoration, seen close, will be found in its spots, or stigmata.

In the nomenclature of the third order I make no change.

24. Now all this group of golden-blossoming plants agree in general character of having a rich cluster of radical leaves, from which they throw up a single stalk bearing clustered blossoms; for which stalk, when entirely leafless, I intend always to keep the term '*virgula*,' the 'little rod'—not painfully caring about it, but being able thus to define it with precision, if required. And these are connected with the stems of branching shrubs through infinite varieties of structure, in which the first steps of transition are made by carrying the cluster of radical leaves up, and letting them expire gradually from the rising stem: the changes of form in the leaves as they rise higher from the ground being one of quite the most interesting specific studies in every plant. I had set myself once, in a bye-study for foreground drawing, hard on this point; and began, with Mr. Burgess, a complete analysis of the foliation

of annual stems ; of which Line-studies II, III., and IV. are examples ; reduced copies, all, from the beautiful Flora Danica. But after giving two whole lovely long summer days, under the Giesbach, to the blue scabious, ('Devil's bit,') and getting in that time, only half-way up it, I gave in ; and must leave the work to happier and younger souls.

25. For these flowering stems, therefore, possessing nearly all the complex organization of a tree, but not its permanence, we will keep the word 'virga ;' and 'virgula' for those that have no leaves. I believe, when we come to the study of leaf-order, it will be best to begin with these annual virgæ, in which the leaf has nothing to do with preparation for a next year's branch. And now the remaining terms commonly applied to stems may be for the most part dispensed with ; but several are interesting, and must be examined before dismissal.

26. Indeed, in the first place, the word we have to use so often, 'stalk,' has not been got to the roots of, yet. It comes from the Greek *στέλεχος*, (*stelechos*,) the 'holding part' of a tree, that which is like a handle to all its branches ; 'stock' is another form in which it has come down to us : with some notion of its being the mother of branches : thus, when Athena's olive was burnt by the Persians, two days after, a shoot a cubit long had sprung from the 'stelechos,' of it.

27. Secondly. Few words are more interesting to the modern scholarly and professorial mind than 'stipend.' (I have twice a year at present to consider whether I am worth mine, sent with compliments from the Curators of the University chest).—Now, this word comes from 'stips,' small pay, which itself comes from 'stipo,' to press together, with the idea of small coin heaped up in little towers or piles. But with the idea of lateral pressing together, instead of downward, we get 'stipes,' a solid log ; in Greek, with the same sense, *στύπος*, (*stupos*,) whence, gradually, with help from another word meaning to beat, (and a side-glance at beating of hemp,) we get our 'stupid,' the German *stumph*, the Scottish *sumph*, and the plain English 'stump.'

Refining on the more delicate sound of stipes, the Latins

got 'stipula,' the thin stem of straw : which rustles and ripples daintily in verse, associated with *spica* and *spiculum*, used of the sharp pointed ear of corn, and its fine processes of fairy shafts.

28. There are yet two more names of stalk to be studied, though, except for particular plants, not needing to be used,—namely, the Latin *cau-dex*, and *cau-lis*, both connected with the Greek *καυλός*, properly meaning a solid stalk like a handle, passing into the sense of the hilt of a sword, or quill of a pen. Then, in Latin, *caudex* passes into the sense of log, and so, of cut plank or tablet of wood ; thus finally becoming the classical 'codex' of writings engraved on such wooden tablets, and therefore generally used for authoritative manuscripts.

Lastly, 'caulis,' retained accurately in our cauliflower, contracted in 'colewort,' and refined in 'kail,' softens itself into the French 'chou,' meaning properly the whole family of thick-stalked eatable salads with spreading heads ; but these being distinguished explicitly by Pliny as 'Capitati,' 'salads with a head,' or 'Captain salads,' the mediæval French softened the 'caulis capitatus' into 'chou cabus ;'—or, to separate the round or apple-like mass of leaves from the flowery foam, 'cabus' simply, by us at last enriched and emphasized into 'cabbage.'

29. I believe we have now got through the stiffest piece of etymology we shall have to master in the course of our botany ; but I am certain that young readers will find patient work, in this kind, well rewarded by the groups of connected thoughts which will thus attach themselves to familiar names ; and their grasp of every language they learn must only be esteemed by them secure when they recognize its derivatives in these homely associations, and are as much at ease with the Latin or French syllables of a word as with the English ones ; this familiarity being above all things needful to cure our young students of their present ludicrous impression that what is simple, in English, is knowing, in Greek ; and that terms constructed out of a dead language will explain difficulties which remained insoluble in a living one.

But Greek is *not* yet dead : while if we carry our unscholarly nomenclature much further, English soon will be ; and then doubtless botanical gentlemen at Athens will for some time think it fine to describe what we used to call caryophyllaceæ, as the ἐδληφιδες.

30. For indeed we are all of us yet but school-boys, clumsily using alike our lips and brains ; and with all our mastery of instruments and patience of attention, but few have reached, and those dimly, the first level of science,—wonder.

For the first instinct of the stem,—unnamed by us yet—unthought of,—the instinct of seeking light, as of the root to seek darkness,—what words can enough speak the wonder of it.

Look. Here is the little thing, Line-study V. (A), in its first birth to us : the stem of stems ; the one of which we pray that it may bear our daily bread. The seed has fallen in the ground with the springing germ of it downwards ; with heavenly cunning the taught stem curls round, and seeks the never-seen light. Veritable ‘conversion,’ miraculous, called of God. And here is the oat germ, (B)—after the wheat, most vital of divine gifts ; and assuredly, in days to come, fated to grow on many a naked rock in hitherto lifeless lands, over which the glancing sheaves of it will shake sweet treasure of innocent gold.

And who shall tell us how they grow ; and the fashion of their rustling pillars—bent, and again erect, at every breeze. Fluted shaft or clustered pier, how poor of art, beside this grass-shaft—built, first to sustain the food of men, then to be strewn under their feet !

We must not stay to think of it, yet, or we shall get no farther till harvest has come and gone again. And having our names of stems now determined enough, we must in next chapter try a little to understand the different kinds of them.

The following notes, among many kindly sent me on the subject of Scottish Heraldry, seem to be the most trustworthy :

“The earliest known mention of the thistle as the national badge of Scotland is in the inventory of the effects of James III., who probably adopted it as an appropriate illustration of the royal motto, *In defence*.

“Thistles occur on the coins of James IV., Mary, James V., and James VI.; and on those of James VI. they are for the first time accompanied by the motto, *Nemo me impune lacessit*.

“A collar of thistles appears on the gold bonnet-pieces of James V. of 1539; and the royal ensigns, as depicted in Sir David Lindsay's armorial register of 1542, are surrounded by a collar formed entirely of golden thistles, with an oval badge attached.

“This collar, however, was a mere device until the institution, or, as it is generally but inaccurately called, the revival, of the order of the Thistle by James VII. (II. of England), which took place on May 29, 1687.”

Date of James III.'s reign 1460—1488.

CHAPTER IX.

OUTSIDE AND IN.

1. THE elementary study of methods of growth, given in the following chapter, has been many years written, (the greater part soon after the fourth volume of ‘Modern Painters’); and ought now to be rewritten entirely; but having no time to do this, I leave it with only a word or two of modification, because some truth and clearness of incipient notion will be conveyed by it to young readers, from which I can afterwards lop the errors, and into which I can graft the finer facts, better than if I had a less blunt embryo to begin with.

2. A stem, then, broadly speaking, (I had thus began the old chapter,) is the channel of communication between the leaf and root; and if the leaf can grow directly from the root there is no stem: so that it is well first to conceive of all plants as consisting of leaves and roots only, with the condition that each leaf must have its own quite particular root* somewhere.

Let a b c, Fig. 16, be three leaves, each, as you see, with its own root, and by no means dependent on other leaves for its

* Recent botanical research makes this statement more than dubitable. Nevertheless, on no other supposition can the forms and action of tree-branches, so far as at present known to me, be yet clearly accounted for.

daily bread ; and let the horizontal line be the surface of the ground. Then the plant has no stem, or an underground one. But if the three leaves rise above the ground, as in Fig. 17, they must reach their roots by elongating their stalks, and this elongation is the stem of the plant. If the outside leaves grow last, and are therefore youngest, the plant is said to grow from the outside. You know that 'ex' means out, and that 'gen' is the first syllable of Genesis (or creation), therefore the old botanists, putting an o between the two syllables, called the plants whose outside leaves grew last, Ex-o-gens. If the inside leaf grows last, and is youngest, the plant was said to grow from the inside, and from the Greek Endon, within, called an 'Endo-gen.' If these names are persisted in, the

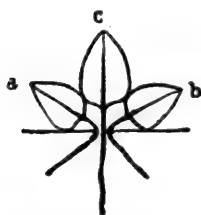

FIG. 16.

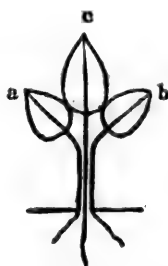

FIG. 17.

Greek botanists, to return the compliment, will of course call Endogens *Ἰνσειδβορῆδες*, and Exogens *Ἐνσειδβορῆδες*. In the Oxford school, they will be called simply Inlaid and Outlaid.

3. You see that if the outside leaves are to grow last, they may conveniently grow two at a time ; which they accordingly do, and exogens always start with two little leaves from their roots, and may therefore conveniently be called two-leaved ; which, if you please, we will for our parts call them. The botanists call them 'two-suckered,' and can't be content to call them *that* in English ; but drag in a long Greek word, meaning the fleshy sucker of the sea-devil,—'cotyledon,' which, however, I find is practically getting shortened into 'cot,' and that they will have to end by calling endogens, monocots, and

exogens, bicots. I mean steadily to call them one-leaved and two-leaved, for this further reason, that they differ not merely in the single or dual springing of first leaves from the seed ; but in the distinctly single or dual arrangement of leaves afterwards on the stem ; so that, through all the complexity obtained by alternate and spiral placing, every bicot or two-leaved flower or tree is in reality composed of dual groups of leaves, separated by a given length of stem ; as, most characteristically in this pure mountain type of the Ragged Robin (*Clarissa laciniosa*), Fig. 18 ; and compare A, and B, Lines-tudy II. ; while, on the other hand, the monocot plants are by close analysis, I think, always resolvable into successively climbing leaves, sessile on one another, and sending their roots, or processes, for nourishment, down through one another, as in Fig. 19.

4. Not that I am yet clear, at all, myself ; but I do think it's more the botanists' fault than mine, what 'cotyledonous' structure there may be at the outer base of each successive bud ; and still less, how the intervenient length of stem, in the bicots, is related to their power, or law, of branching. For not only the two-leaved tree is outlaid, and the one-leaved inlaid, but the two-leaved tree is branched, and the one-leaved tree is not branched. This is a most vital and important distinction, which I state to you in very bold terms, for though there are some apparent exceptions to the law, there are, I believe, no real ones, if we define a branch rightly. Thus, the head of a palm tree is merely a cluster of large leaves ; and the spike of a grass, a clustered blossom. The stem, in both, is unbranched ; and we should be able in this respect to classify plants very simply indeed, but for a provoking species of intermediate creatures whose branching is always in the manner of corals, or sponges, or arborescent minerals, irregular and accidental,



FIG. 18.



FIG. 19.

and essentially, therefore, distinguished from the systematic anatomy of a truly branched tree. Of these presently; we must go on by very short steps: and I find no step can be taken without check from existing generalizations. Sowerby's definition of Monocotyledons, in his ninth volume, begins thus: "Herbs, (or rarely, and only in exotic genera,) trees, in which the wood, pith, and bark are indistinguishable." Now if there be one plant more than another in which the pith is defined, it is the common Rush; while the nobler families of true herbs derive their principal character from being pithless altogether! We cannot advance too slowly.

5. In the families of one-leaved plants in which the young leaves grow directly out of the old ones, it becomes a grave question for them whether the old ones are to lie flat or edgewise, and whether they must therefore grow out of their faces or their edges. And we must at once understand the way they contrive it, in either case.



FIG. 20.

Among the many forms taken by the Arethusan leaf, one of the commonest is long and gradually tapering,—much broader at the base than the point. We will take such an one for examination, and suppose that it is growing on the ground as in Fig. 20, with a root to its every fibre. Cut out a piece of strong paper roughly into the shape of this Arethusan leaf, a, Fig. 21. Now suppose the next young leaf has to spring out of the front of this one, at about the middle of its height. Give it two nicks with the scissors at b b; then roll up the lower part into a cylinder, (it will overlap a good deal at the bottom,) and tie it fast with a fine thread: so, you will get the form at c. Then bend the top of it back, so that, seen sideways, it appears as at d, and you see you have made quite a little flower-pot to plant your new leaf in, and perhaps it may occur to you that you have seen something like this before. Now make another, a little less wide, but with the part for the cylinder twice as long, roll it up in the same way, and slip it inside the other,

with the flat part turned the other way, e. Surely this reminds you now of something you have seen? Or must I draw the something (Fig. 22)?

6. All grasses are thus constructed, and have their leaves set thus, opposite, on the sides of their tubular stems, alternately, as they ascend. But in most of them there is also a peculiar construction, by which, at the base of the sheath, or enclosing tube, each leaf articulates itself with the rest of the stem at a ringed knot, or joint.

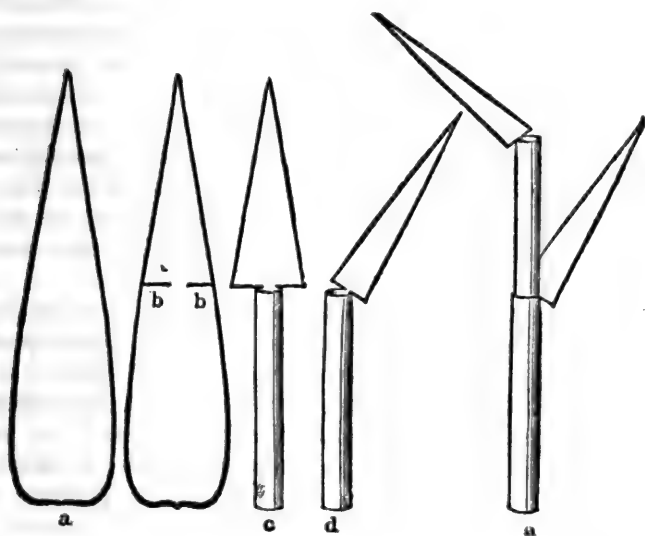

FIG. 21.

Before examining these, remember there are mainly two sorts of joints in the framework of the bodies of animals. One is that in which the bone is thick at the joints and thin between them, (see the bone of the next chicken leg you eat), the other is that of animals that have shells or horny coats, in which characteristically the shell is thin at the joints, and thick between them (look at the next lobster's claw you can see, without eating). You know, also, that though the crustaceans are titled only from their crusts, the name 'insect'

is given to the whole insect tribe, because they are farther jointed almost into *sections*: it is easily remembered, also, that the projecting joint means strength and elasticity in the creature, and that all its limbs are useful to it, and cannot conveniently be parted with; and that the incised, sectional, or insectile joint means more or less weakness,* and necklace-like laxity or license in the creature's make; and an ignoble power of shaking off its legs or arms on occasion, coupled also with modes of growth involving occasionally quite astonishing transformations, and beginnings of new life under new circumstances; so that, until very lately, no mortal knew what a crab was like in its youth, the very existence of the creature, as well as its legs, being jointed, as it were, and made in separate pieces with the narrowest possible thread of connection between them; and its principal, or stomachic, period of life, connected with its sentimental period by as thin a thread as a wasp's stomach is with its thorax.



FIG. 22.

7. Now in plants, as in animals, there are just the same opposed aspects of joint, with this speciality of difference in function, that the animal's limb bends at the joints, but the vegetable limb stiffens. And when the articulation projects, as in the joint of a cane, it means not only that the strength of the plant is well carried through the junction, but is carried farther and more safely than it could be without it: a cane is stronger, and can stand higher than it could otherwise, because of its joints. Also, this structure implies that the plant has a will of

its own, and a position which on the whole it will keep, however it may now and then be bent out of it; and that it has a continual battle, of a healthy and humanlike kind, to wage with surrounding elements.

* Not always in muscular power; but the framework on which strong muscles are to act, as that of an insect's wing, or its jaw, is never insectile.

But the crabby, or insect-like, joint, which you get in seaweeds and cacti, means either that the plant is to be dragged and wagged here and there at the will of waves, and to have no spring nor mind of its own ; or else that it has at least no springy intention and elasticity of purpose, but only a knobby, knotty, prickly, malignant stubbornness, and incoherent opiniativeness ; crawling about, and cogging, and grovelling, and aggregating anyhow, like the minds of so many people whom one knows !

8. Returning then to our grasses, in which the real rooting and junction of the leaves with each other is at these joints ; we find that therefore every leaf of grass may be thought of as consisting of two main parts, for which we shall want two separate names. The lowest part, which wraps itself round to become strong, we will call the 'staff,' and for the free-floating outer part we will take specially the name given at present carelessly to a large number of the plants themselves, 'flag.' This will give a more clear meaning to the words 'rod' (*virga*), and 'staff' (*baculus*), when they occur together, as in the 23rd Psalm ; and remember the distinction is that a rod bends like a switch, but a staff is stiff. I keep the well-known name 'blade' for grass-leaves in their fresh green state.

9. You felt, as you were bending down the paper into the form *d*, Fig. 21, the difficulty and awkwardness of the transition from the tubular form of the staff to the flat one of the flag. The mode in which this change is effected is one of the most interesting features in plants, for you will find presently that the leaf-stalk in ordinary leaves is only a means of accomplishing the same change from round to flat. But you know I said just now that some leaves were not flat, but set upright, edgeways. It is not a common position in two-leaved trees ; but if you can run out and look at an *arbor vitæ*, it may interest you to see its hatchet-shaped vertically crested cluster of leaves transforming themselves gradually downwards into branches ; and in one-leaved trees the vertically edged group is of great importance.

10. Cut out another piece of paper like *a* in Fig. 21, but

now, instead of merely giving it nicks at a, b, cut it into the shape A, Fig. 23. Roll the lower part up as before, but instead of pulling the upper part down, pinch its back at the dotted line, and bring the two points, a and b, forward, so that they may touch each other. B shows the look of the thing half-done, before the points a and b have quite met. Pinch them close, and stitch the two edges neatly together, all the way from a to the point c; then roll and tie up the

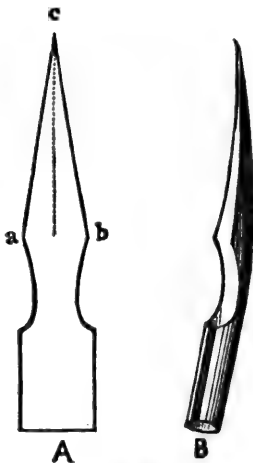

FIG. 23.

lower part as before. You will find then that the back or spinal line of the whole leaf is bent forward, as at B. Now go out to the garden and gather the green leaf of a fleur-de-lys, and look at it and your piece of disciplined paper together; and I fancy you will probably find out several things for yourself that I want you to know.

11. You see, for one thing, at once, how *strong* the fleur-de-lys leaf is, and that it is just twice as strong as a blade of grass, for it is the substance of the staff, with its sides flattened together, while the grass blade is a staff cut open and flattened out. And

you see that as a grass blade necessarily flaps down, the fleur-de-lys leaf as necessarily curves up, owing to that inevitable bend in its back. And you see, with its keen edge, and long curve, and sharp point, how like a sword it is. The botanists would for once have given a really good and right name to the plants which have this kind of leaf, 'Ensatæ,' from the Latin 'ensis,' a sword; if only sata had been properly formed from sis. We can't let the rude Latin stand, but you may remember that the fleur-de-lys, which is the flower of chivalry, has a sword for its leaf, and a lily for its heart.

12. In case you cannot gather a fleur-de-lys leaf, I have drawn for you, in Plate VI., a cluster of such leaves, which are as pretty as any, and so small that, missing the points of a

few, I can draw them of their actual size. You see the pretty alternate interlacing at the bottom, and if you can draw at all, and will try to outline their curves, you will find what subtle lines they are. I did not know this name for the strong-edged grass leaves when I wrote the pieces about shield and sword leaves in 'Modern Painters'; I wish I had chanced in those passages on some other similitude, but I can't alter them now, and my trustful pupils may avoid all confusion of thought by putting *gladius* for *ensis*, and translating it by the word 'scymitar,' which is also more accurate in expressing the curvature blade. So we will call the *ensatæ*, instead, 'gladiolæ,' translating, 'scymitar-grasses.' And having now got at some clear idea of the distinction between outlaid and inlaid growth in the stem, the reader will find the elementary analysis of forms resulting from outlaid growth in 'Modern Painters'; and I mean to republish it in the sequel of this book, but must go on to other matters here. The growth of the inlaid stem we will follow as far as we need, for English plants, in examining the grasses.

FLORENCE, 11th September, 1874.

As I correct this chapter for press, I find it is too imperfect to be let go without a word or two more. In the first place, I have not enough, in distinguishing the nature of the living yearly shoot, with its cluster of fresh leafage, from that of the accumulated mass of perennial trees, taken notice of the similar power even of the annual shoot, to obtain some manner of immortality for itself, or at least of usefulness, *after* death. A Tuscan woman stopped me on the path up to Fiesole last night, to beg me to buy her plaited straw. I wonder how long straw lasts, if one takes care of it? A Leghorn bonnet, (if now such things are,) carefully put away,—even properly taken care of when it is worn,—how long will it last, young ladies?

I have just been reading the fifth chapter of II. Esdras, and am fain to say, with less discomfort than otherwise I might have felt, (the example being set me by the archangel Uriel,) "I am not sent to tell thee, for I do not know." How old is

the oldest straw known? the oldest linen? the oldest hemp? We have mummy wheat,—cloth of papyrus, which is a kind of straw. The paper reeds by the brooks, the flax-flower in the field, leave such imperishable frame behind them. And Ponte-della-Paglia, in Venice; and Straw Street, of Paris, remembered in Heaven,—there is no occasion to change their names, as one may have to change ‘Waterloo Bridge,’ or the ‘Rue de l’Impératrice.’ Poor Empress! Had she but known that her true dominion was in the straw streets of her fields; not in the stone streets of her cities!

But think how wonderful this imperishableness of the stem of many plants is, even in their annual work: how much more in their perennial work! The noble stability between death and life, of a piece of perfect wood? It cannot grow, but will not decay; keeps record of its years of life, but surrenders them to become a constantly serviceable thing: which may be sailed in, on the sea, built with, on the land, carved by Donatello, painted on by Fra Angelico. And it is not the wood’s fault, but the fault of Florence in not taking proper care of it, that the panel of Sandro Botticelli’s loveliest picture has cracked, (not with heat, I believe, but blighting frost), a quarter of an inch wide through the Madonna’s face.

But what is this strange state of undecaying wood? What sort of latent life has it, which it only finally parts with when it rots?

Nay, what is the law by which its natural life is measured? What makes a tree ‘old’? One sees the Spanish-chestnut trunks among the Apennines growing into caves, instead of logs. Vast hollows, confused among the recessed darknesses of the marble crags, surrounded by mere laths of living stem, each with its coronal of glorious green leaves. Why can’t the tree go on, and on,—hollowing itself into a Fairy—no—a Dryad, Ring,—till it becomes a perfect Stonehenge of a tree? Truly “I am not sent to tell thee, for I do not know.”

The worst of it is, however, that I don’t know one thing which I ought very thoroughly to have known at least thirty years ago, namely, the true difference in the way of building the trunk in outlaid and inlaid wood. I have an idea that the

stem of a palm-tree is only a heap of leaf-roots built up like a tower of bricks, year by year, and that the palm-tree really grows on the top of it, like a bunch of fern ; but I've no books here, and no time to read them if I had. If only I were a stronge giant, instead of a thin old gentleman of fifty-five, how I should like to pull up one of those little palm-trees by the roots—(by the way, what are the roots of a palm like ? and, how does it stand in sand, where it is wanted to stand, mostly ? Fancy, not knowing that, at fifty-five !)—that, grow all along the Riviera ; and snap its stem in two, and cut it down the middle. But I suppose there are sections enough now in our grand botanical collections, and you can find it all out for yourself. That you should be able to ask a question clearly, is two-thirds of the way to getting it answered ; and I think this chapter of mine will at least enable you to ask some questions about the stem, though what a stem is, truly, "I am not sent to tell thee, for I do not know."

KNARESBOROUGH, 30th April, 1876.

I see by the date of last paragraph that this chapter has been in my good Aylesbury printer's type for more than a year and a half. At this rate, Proserpina has a distant chance of being finished in the spirit-land, with more accurate information derived from the archangel Uriel himself, (not that he is likely to know much about the matter, if he keeps on letting himself be prevented from ever seeing foliage in spring-time by the black demon-winds,) about the year 2000. In the meantime, feeling that perhaps I *am* sent to tell my readers a little more than is above told, I have had recourse to my botanical friend, good Mr. Oliver of Kew, who has taught me, first, of palms, that they actually stitch themselves into the ground, with a long dipping loop, up and down, of the root fibres, concerning which sempstress work I shall have a month's puzzlement before I can report on it ; secondly, that all the increment of tree stem is, by division and multiplication of the cells of the wood, a process not in the least to be described as 'sending down roots from the leaf to the ground.' I suspected as much in beginning to revise this chapter ; but

hold to my judgment in not cancelling it. For this multiplication of the cells is at least compelled by an influence which passes from the leaf to the ground, and vice versâ ; and which is at present best conceivable to me by imagining the continual and invisible descent of lightning from electric cloud by a conducting rod, endowed with the power of softly splitting the rod into two rods, each as thick as the original one. Studying microscopically, we should then see the molecules of copper, as we see the cells of the wood, dividing and increasing, each one of them into two. But the visible result, and mechanical conditions of growth, would still be the same as if the leaf actually sent down a new root fibre ; and, more than this, the currents of accumulating substance, marked by the grain of the wood, are, I think, quite plainly and absolutely those of streams flowing only from the leaves downwards ; never from the root up, nor of mere lateral increase. I must look over all my drawings again, and at tree stems again, with more separate study of the bark and pith in those museum sections, before I can assert this ; but there will be no real difficulty in the investigation. If the increase of the wood is lateral only, the currents round the knots will be compressed at the sides, and open above and below ; but if downwards, compressed above the knot and open below it. The nature of the force itself, and the manner of its ordinances in direction, remain, and must for ever remain, inscrutable as our own passions, in the hand of the God of all Spirits, and of all Flesh.

“ Drunk is each ridge, of thy cup drinking,
 Each clod relenteth at thy dressing,
 Thy cloud-borne waters inly sinking,
 Fair spring sproutes forth, blest with thy blessing ;
 The fertile year is with thy bounty crowned,
 And where thou go'st, thy goings fat the ground.”

Plenty bedews the desert places,
 A hedge of mirth the hills encloseth,
 The fields with flockes have hid their faces,
 A robe of corn the valleys clotheth.
 Deserts and hills and fields and valleys all,
 Rejoice, shout, sing, and on thy name do call.”

CHAPTER X.

THE BARK.

1. PHILOLOGISTS are continually collecting instances, like our friend the French critic of Virgil, of the beauty of finished language, or the origin of unfinished, in the imitation of natural sounds. But such collections give an entirely false idea of the real power of language, unless they are balanced by an opponent list of the words which signally fail of any such imitative virtue, and whose sound, if one dwelt upon it, is destructive of their meaning.

2. For instance. Few sounds are more distinct in their kind, or one would think more likely to be vocally reproduced in the word which signified them, than that of a swift rent in strongly woven cloth; and the English words 'rag' and ragged, with the Greek *ρήγνυμι*, do indeed in a measure recall the tormenting effect upon the ear. But it is curious that the verb which is meant to express the actual origination of rags, should rhyme with two words entirely musical and peaceful—words, indeed, which I always reserve for final resource in passages which I want to be soothing as well as pretty,—'fair,' and 'air;' while, in its orthography, it is identical with the word representing the bodily sign of tenderest passion, and grouped with a multitude of others,* in which the mere insertion of a consonant makes such wide difference of sentiment as between 'dear' and 'drear,' or 'pear' and 'spear.' The Greek root, on the other hand, has persisted in retaining some vestige of its excellent dissonance, even where it has parted with the last vestige of the idea it was meant to convey; and when Burns did his best,—and his best was above most men's

* It is one of the three cadences, (the others being of the words rhyming to 'mind' and 'way,') used by Sir Philip Sidney in his marvellous paraphrase of the 55th Psalm.

—to gather pleasant liquid and labial syllabing, round gentle meaning, in

“ Bonnie lassie, will ye go,
Will ye go, will ye go,
Bonnie lassie, will ye go,
To the birks of Aberfeldy ? ”

he certainly had little thought that the delicately crisp final *k*, in *birk*, was the remnant of a magnificent Greek effort to express the rending of the earth by earthquake, in the wars of the giants. In the middle of that word ‘*esmaragēse*,’ we get our own beggar’s ‘*rag*’ for a pure root, which afterwards, through the Latin *frango*, softens into our ‘*break*,’ and ‘*bark*,’—the ‘*broken thing*’; that idea of its rending around the tree’s stem having been, in the very earliest human efforts at botanical description, attached to it by the pure Aryan race, watching the strips of rosy satin break from the birch stems, in the *Aberfeldys* of *Imaus*.

3. That this tree should have been the only one which “the Aryans, coming as conquerors from the North, were able to recognize in Hindostan,”* and should therefore also be “the only one whose name is common to Sanskrit, and to the languages of Europe,” delighted me greatly, for two reasons: the first, for its proof that in spite of the development of species, the sweet gleaming of birch stem has never changed its argent and sable for any unchequered heraldry; and the second, that it gave proof of a much more important fact, the keenly accurate observation of Aryan foresters at that early date; for the fact is that the breaking of the thin-beaten silver of the birch trunk is so delicate, and its smoothness so graceful, that until I painted it with care, I was not altogether clear-headed myself about the way in which the chequering was done: nor until Fors to-day brought me to the house of one of my father’s friends at *Carshalton*, and gave me three birch stems to look at just outside the window, did I perceive it to be a primal question about them, what it is that blanches that dainty

* Lectures on the Families of Speech, by the Rev. F. Farrer, Longman, 1870. Page 81.

dress of theirs, or, anticipatorily, weaves. What difference is there between the making of the corky excrescence of other trees, and of this almost transparent fine white linen? I perceive that the older it is, within limits, the finer and whiter; hoary tissue, instead of hoary hair—honouring the tree's aged body: the outer sprays have no silvery light on their youth. Does the membrane thin itself into whiteness merely by stretching, or produce an outer film of new substance? *

4. And secondly, this investiture, why is it transverse to the trunk,—swathing it, as it were, in bands? Above all,—when it breaks,—why does it break round the tree instead of down? All other bark breaks as anything would, naturally, round a swelling rod, but this, as if the stem were growing longer; until, indeed, it reaches farthest heroic old age, when the whiteness passes away again, and the rending is like that of other trees, downwards. So that, as it were in a changing language, we have the great botanical fact twice taught us, by this tree of Eden, that the skins of trees differ from the skins of the higher animals in that, for the most part, they won't stretch, and must be worn torn.

So that in fact the most popular arrangement of vegetative adult costume is Irish; a normal investiture in honourable rags; and decorousness of tattering, as of a banner borne in splendid ruin through storms of war.

5. Now therefore, if we think of it, we have five distinct orders of investiture for organic creatures; first, mere secretion of mineral substance, chiefly lime, into a hard shell, which, if broken, can only be mended, like china—by sticking it together; secondly, organic substance of armour which grows into its proper shape at once for good and all, and can't be mended at all, if broken, (as of insects); thirdly, organic substance of skin, which stretches, as the creature grows, by cracking, over a fresh skin which is supplied beneath it, as in bark of trees; fourthly, organic substance of skin cracked symmetrically into plates or scales which can increase all

* I only profess, you will please to observe, to ask questions in Proserpina. Never to answer any. But of course this chapter is to introduce some further inquiry in another place.

round their edges, and are connected by softer skin, below, as in fish and reptiles, (divided with exquisite lustre and flexibility, in feathers of birds); and lastly, true elastic skin, extended in soft unison with the creature's growth,—blushing with its blood, fading with its fear; breathing with its breath, and guarding its life with sentinel beneficence of pain.

6. It is notable, in this higher and lower range of organic beauty, that the decoration, by pattern and colour, which is almost universal in the protective coverings of the middle ranks of animals, should be reserved in vegetables for the most living part of them, the flower only: and that among animals, few but the malignant and senseless are permitted, in the corrugation of their armour, to resemble the half-dead trunk of the tree, as they float beside it in the tropical river. I must, however, leave the scale patterns of the palms and other inlaid tropical stems for after-examination,—content, at present, with the general idea of the bark of an outlaid tree as the successive accumulation of the annual protecting film, rent into ravines of slowly increasing depth, and coloured, like the rock, whose stability it begins to emulate, with the grey or gold of clinging lichen and embroidering moss.

CHAPTER XI.

GENEALOGY.

1. RETURNING, after more than a year's sorrowful interval, to my Sicilian fields,—not incognisant, now, of some of the darker realms of Proserpina; and with feebler heart, and, it may be, feebler wits, for wandering in her brighter ones,—I find what I had written by way of sequel to the last chapter somewhat difficult, and extremely tiresome. Not the less, after giving fair notice of the difficulty, and asking due pardon for the tiresomeness, I am minded to let it stand; trusting to end, with it, once for all, investigations of the kind. But in finishing this first volume of my School Botany, I must try to give the reader some notion of the plan of the book, as it



PLATE VI.—RADICAL INSERTION OF LEAVES OF ENSATE.

IRIS GERMANICA.



now, during the time for thinking over it which illness left me, has got itself arranged in my mind, within limits of possible execution. And this the rather, because I wish also to state, somewhat more gravely than I have yet done, the grounds on which I venture here to reject many of the received names of plants; and to substitute others for them, relating to entirely different attributes from those on which their present nomenclature is confusedly edified.

I have already in some measure given the reasons for this change; * but I feel that, for the sake of those among my scholars who have laboriously learned the accepted names, I ought now also to explain its method more completely.

2. I call the present system of nomenclature *confusedly* edified, because it introduces,—without, apparently, any consciousness of the inconsistency, and certainly with no apology for it,—names founded sometimes on the history of plants, sometimes on their qualities, sometimes on their forms, sometimes on their products, and sometimes on their poetical associations.

On their history—as ‘Gentian’ from King Gentius, and *Funkia* from Dr. Funk.

On their qualities—as ‘*Scrophularia*’ from its (quite uncertified) use in scrofula.

On their forms—as the ‘*Caryophylls*’ from having petals like husks of nuts.

On their products—as ‘*Cocos nucifera*’ from its nuts.

And on their poetical associations,—as the Star of Bethlehem from its imagined resemblance to the light of that seen by the Magi.

3. Now, this variety of grounds for nomenclature might patiently, and even with advantage, be permitted, provided the grounds themselves were separately firm, and the inconsistency of method advisedly allowed, and, in each case, justified. If the histories of King Gentius and Dr. Funk are indeed important branches of human knowledge;—if the *Scrophulariaceæ* do indeed cure King’s Evil;—if pinks be best described in their likeness to nuts;—and the Star of

* See Introduction, pp. 9-12.

Bethlehem verily remind us of Christ's Nativity,—by all means let these and other such names be evermore retained. But if Dr. Funk be not a person in any special manner needing either stellification or florification; if neither herb nor flower can avail, more than the touch of monarchs, against hereditary pain; if it be no better account of a pink to say it is nut-leaved, than of a nut to say it is pink-leaved; and if the modern mind, incurious respecting the journeys of wise men, has already confused, in its Bradshaw's Bible, the station of Bethlehem with that of Bethel,* it is certainly time to take some order with the partly false, partly useless, and partly forgotten literature of the Fields; and, before we bow our children's memories to the burden of it, ensure that there shall be matter worth carriage in the load.

4. And farther, in attempting such a change, we must be clear in our own minds whether we wish our nomenclature to tell us something about the plant itself, or only to tell us the place it holds in relation to other plants: as, for instance, in the Herb-Robert, would it be well to christen it, shortly, 'Rob Roy,' because it is pre-eminently red, and so have done with it;—or rather to dwell on its family connections, and call it 'Macgregoraceous'?

5. Before we can wisely decide this point, we must resolve whether our botany is intended mainly to be useful to the vulgar, or satisfactory to the scientific élite. For if we give names characterizing individuals, the circle of plants which any country possesses may be easily made known to the children who live in it: but if we give names founded on the connexion between these and others at the Antipodes, the parish school-master will certainly have double work; and it may be doubted greatly whether the parish school-boy, at the end of the lecture, will have half as many ideas.

6. Nevertheless, when the features of any great order of plants are constant, and, on the whole, represented with great clearness both in cold and warm climates, it may be desirable to express this their citizenship of the world in definite nomenclature. But my own method, so far as hitherto developed,

* See Sowerby's nomenclature of the flower, vol. ix., plate 1703.

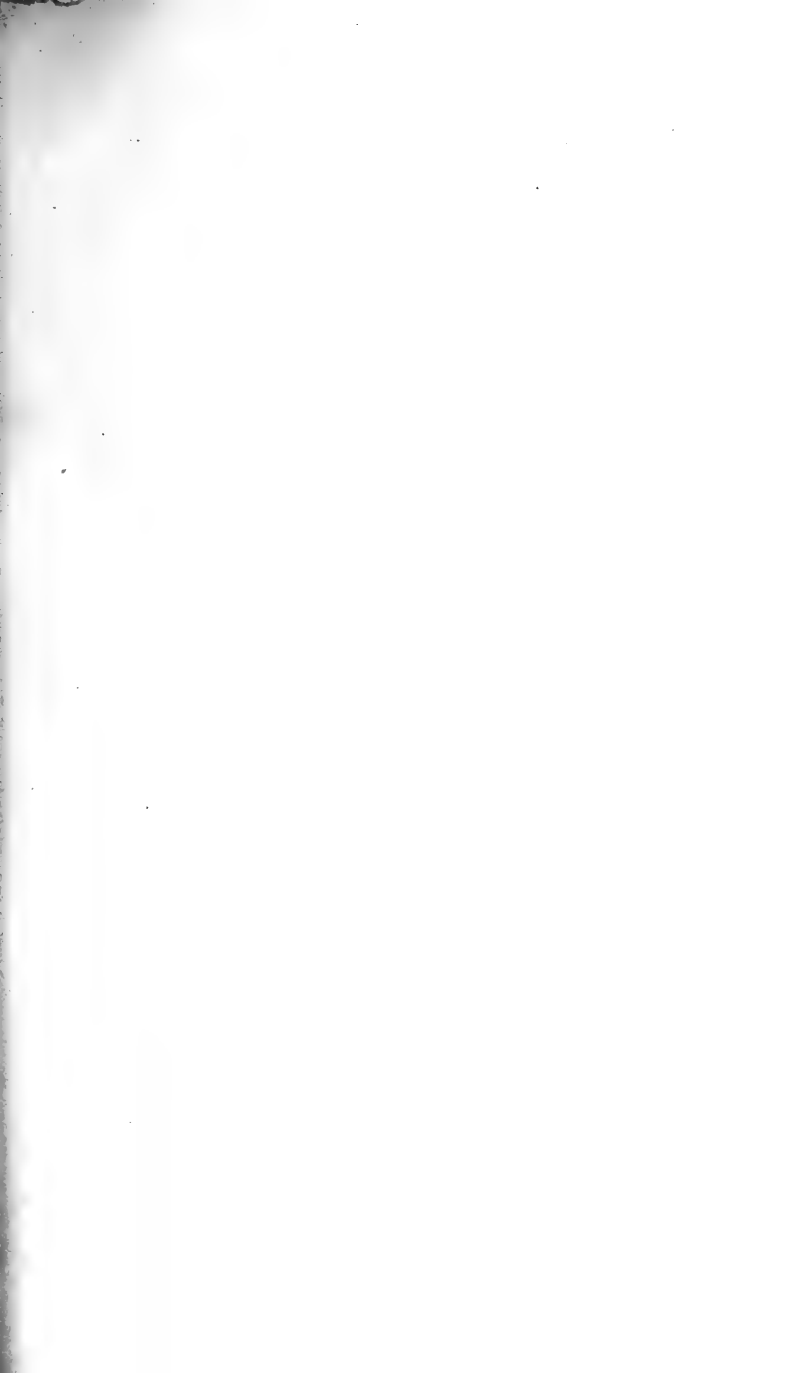



PLATE VII.—*CONTORTA PURPUREA*. PURPLE WREATH-WORT.

consists essentially in fastening the thoughts of the pupil on the special character of the plant, in the place where he is likely to see it; and therefore, in expressing the power of its race and order in the wider world, rather by reference to mythological associations than to botanical structure.

7. For instance, Plate VII. represents, of its real size, an ordinary spring flower in our English mountain fields. It is an average example,—not one of rare size under rare conditions,—rather smaller than the average, indeed, that I might get it well into my plate. It is one of the flowers whose names I think good to change; but I look carefully through the existing titles belonging to it and its fellows, that I may keep all I expediently can. I find, in the first place, that Linnæus called one group of its relations, Ophryds, from Ophrys,—Greek for the eyebrow,—on account of their resemblance to the brow of an animal frowning, or to the overshadowing casque of a helmet. I perceive this to be really a very general aspect of the flower; and therefore, no less than in respect to Linnæus, I adopt this for the total name of the order, and call them ‘Ophrydæ,’ or, shortly, ‘Ophryds.’

8. Secondly: so far as I know these flowers myself, I perceive them to fall practically into three divisions,—one, growing in English meadows and Alpine pastures, and always adding to their beauty; another, growing in all sorts of places, very ugly itself, and adding to the ugliness of its indiscriminated haunts; and a third, growing mostly up in the air, with as little root as possible, and of gracefully fantastic forms, such as this kind of nativity and habitation might presuppose. For the present, I am satisfied to give names to these three groups only. There may be plenty of others which I do not know, and which other people may name, according to their knowledge. But in all these three kinds known to me, I perceive one constant characteristic to be *some* manner of *distortion*; and I desire that fact,—marking a spiritual (in my sense of the word) character of extreme mystery,—to be the first enforced on the mind of the young learner. It is exhibited to the English child, primarily, in the form of the stalk of each

flower, attaching it to the central virga. This stalk is always twisted once and a half round, as if somebody had been trying to wring the blossom off; and the name of the family, in Proserpina, will therefore be 'Contorta'* in Latin, and 'Wreathewort' in English.

Farther: the beautiful power of the one I have drawn in its spring life, is in the opposition of its dark purple to the primrose in England, and the pale yellow anemone in the Alps. And its individual name will be, therefore, 'Contorta purpurea'—*Purple Wreathewort*.

And in drawing it, I take care to dwell on this strength of its colour, and to show thoroughly that it is a *dark blossom*, † before I trouble myself about its minor characters.

9. The second group of this kind of flowers live, as I said, in all sorts of places; but mostly, I think, in disagreeable ones,—torn and irregular ground, under alternations of unwholesome heat and shade, and among swarms of nasty insects. I cannot yet venture on any bold general statement about them, but I think that is mostly their way; and at all events, they themselves are in the habit of dressing in livid and unpleasant colours; and are distinguished from all other flowers by twisting, not only their stalks, but one of their petals, not once and a half only, but two or three times round, and putting it far out at the same time, as a foul jester would put out his tongue: while also the singular power of grotesque mimicry, which, though strong also in the other groups of their race, seems in the others more or less playful, is, in these, definitely degraded, and, in aspect, malicious.

10. Now I find the Latin name 'Satyrium' attached already to one sort of these flowers; and we cannot possibly have a better one for all of them. It is true that, in its first Greek form, Dioscorides attaches it to a white, not a livid, flower; and I dare say there are some white ones of the breed: but, in its full sense, the term is exactly right for the entire group

* Linnæus used this term for the oleanders; but evidently with less accuracy than usual.

† "ἄνθη πορφυροειδῆ" says Dioscorides, of the race generally,—but "ἄνθη δὲ ὑποπόρφυρα" of this particular one.

of ugly blossoms of which the characteristic is the spiral curve and protraction of their central petal : and every other form of Satyric ugliness which I find among the Ophryds, whatever its colour, will be grouped with them. And I make them central, because this humour runs through the whole order, and is, indeed, their distinguishing sign.

11. Then the third group, living actually in the air, and only holding fast by, without nourishing itself from, the ground, rock, or tree-trunk on which it is rooted, may of course most naturally and accurately be called 'Aeria,' as it has long been popularly known in English by the name of Air-plant.

Thus we have one general name for all these creatures, 'Ophryd' ; and three family or group names, Contorta, Satyrium, and Aeria,—every one of these titles containing as much accurate fact about the thing named as I can possibly get packed into their syllables ; and I will trouble my young readers with no more divisions of the order. And if their parents, tutors, or governors, after this fair warning, choose to make them learn, instead, the seventy-seven different names with which botanist-heraldries have beautifully ennobled the family,—all I can say is, let them at least begin by learning them themselves. They will be found in due order in pages 1084, 1085 of Loudon's Cyclopædia.*

12. But now, farther : the student will observe that the name of the total order is Greek ; while the three family are ones Latin, although the central one is originally Greek also.

I adopt this as far as possible for a law through my whole plant nomenclature.

* I offer a sample of two dozen for good papas and mammas to begin with :—

| | | | |
|---------------|----------------|------------------|---------------|
| Angraecum. | Corallorrhiza. | Ornithidium. | Prescotia. |
| Anisopetalum. | Cryptarrhena. | Ornithocephalus. | Renanthera. |
| Brassavola. | Eulophia. | Platanthera. | Rodriguezia. |
| Brassia. | Gymnadenia. | Pleurothallis. | Stenorhyncus. |
| Caelogyne. | Microstylis. | Pogonia. | Trizeuxis. |
| Calopogon. | Octomeria. | Polystachya. | Xylobium. |

13. Farther: the terminations of the Latin family names will be, for the most part, of the masculine, feminine, and neuter forms, *us*, *a*, *um*, with these following attached conditions.

(i.) Those terminating in 'us,' though often of feminine words, as the central Arbor, will indicate either real masculine strength (*quercus*, *laurus*), or conditions of dominant majesty (*cedrus*), of stubbornness and enduring force (*crataegus*), or of peasant-like commonalty and hardship (*juncus*); softened, as it may sometimes happen, into gentleness and beneficence (*thymus*). The occasional forms in 'er' and 'il' will have similar power (*acer*, *basil*).

(ii.) Names with the feminine termination 'a,' if they are real names of girls, will always mean flowers that are perfectly pretty and perfectly good (*Lucia*, *Viola*, *Margarita*, *Clarissa*). Names terminating in 'a' which are not also accepted names of girls, may sometimes be none the less honourable, (*Primula*, *Campanula*,) but for the most part will signify either plants that are only good and worthy in a nursery sort of way, (*Salvia*,) or that are good without being pretty, (*Lavandula*,) or pretty without being good, (*Kalmia*). But no name terminating in 'a' will be attached to a plant that is neither good nor pretty.

(iii.) The neuter names terminating in 'um' will always indicate some power either of active or suggestive evil, (*Conium*, *Solanum*, *Satyrium*,) or a relation, more or less definite, to death; but this relation to death may sometimes be noble, or pathetic,—“which to-day is, and to-morrow is cast into the oven,”—*Lilium*.

But the leading position of these neuters in the plant's double name must be noticed by students unacquainted with Latin, in order to distinguish them from plural genitives, which will always, of course, be the second word, (*Francesca Fontium*, *Francesca* of the Springs.)

14. Names terminating in 'is' and 'e,' if definitely names of women, (*Iris*, *Amaryllis*, *Alcestis*, *Daphne*,) will always signify flowers of great beauty, and noble historic association. If not definitely names of women, they will yet indicate

some specialty of sensitiveness, or association with legend (Berberis, Clematis.) No neuters in 'e' will be admitted.

15. Participial terminations (Impatiens), with neuters in 'en' (Cyclamen), will always be descriptive of some special quality or form,—leaving it indeterminate if good or bad, until explained. It will be manifestly impossible to limit either these neuters, or the feminines in 'is' to Latin forms; but we shall always know by their termination that they cannot be generic names, if we are strict in forming these last on a given method.

16. How little method there is in our present formation of them, I am myself more and more surprised as I consider. A child is shown a rose, and told that he is to call every flower like that, 'Rosaceous';* he is next shown a lily, and told that he is to call every flower like that, 'Liliaceous';—so far well; but he is next shown a daisy, and is not at all allowed to call every flower like that 'Daisaceous,' but he must call it, like the fifth order of architecture, 'Composite'; and being next shown a pink, he is not allowed to call other pinks 'Pinkaceous,' but 'Nut-leafed'; and being next shown a pease-blossom, he is not allowed to call other pease-blossoms 'Peasaceous,' but, in a brilliant burst of botanical imagination, he is incited to call it by two names instead of one, 'Butterfly-aceous' from its flower, and 'Pod-aceous' from its seed;—the inconsistency of the terms thus enforced upon him being perfected in their inaccuracy, for a daisy is not one whit more composite than Queen of the meadow, or Jura Jacinth;† and 'legumen' is not Latin for a pod, but 'siliqua,'—so that no good scholar could remember Virgil's 'siliqua quassante legumen,' without overthrowing all his Pisan nomenclature.

17. Farther. If we ground our names of the higher orders on the distinctive characters of *form* in plants, these are so many, and so subtle, that we are at once involved in more investigations than a young learner has ever time to follow successfully, and they must be at all times liable to disloca-

* Compare Chapter V., § 7.

† "Jacinthus Juræ," changed from "Hyacinthus Comosus."

tions and rearrangements on the discovery of any new link in the infinitely entangled chain. But if we found our higher nomenclature at once on historic fact, and relative conditions of climate and character, rather than of form, we may at once distribute our flora into unalterable groups, to which we may add at our pleasure, but which will never need disturbance ; far less, reconstruction.

18. For instance,—and to begin,—it is an historical fact that for many centuries the English nation believed that the Founder of its religion, spiritually, by the mouth of the King who spake of all herbs, had likened himself to two flowers,—the Rose of Sharon, and Lily of the Valley. The fact of this belief is one of the most important in the history of England,—that is to say, of the mind or heart of England : and it is connected solemnly with the heart of Italy also, by the closing cantos of the *Paradiso*.

I think it well therefore that our two first generic, or at least commandant, names heading the out-laid and in-laid divisions of plants, should be of the rose and lily, with such meaning in them as may remind us of this fact in the history of human mind.

It is also historical that the personal appearing of this Master of our religion was spoken of by our chief religious teacher in these terms: “The Grace of God, that bringeth salvation, hath appeared unto all men.” And it is a constant fact that this ‘grace’ or ‘favor’ of God is spoken of as “giving us to eat of the Tree of Life.”

19. Now, comparing the botanical facts I have to express, with these historical ones, I find that the rose tribe has been formed among flowers, not in distant and monstrous geologic æras, but in the human epoch ;—that its ‘grace’ or favor has been in all countries so felt as to cause its acceptance everywhere for the most perfect physical type of womanhood ;—and that the characteristic fruit of the tribe is so sweet, that it has become symbolic at once of the subtlest temptation, and the kindest ministry to the earthly passion of the human race. “Comfort me with apples, for I am sick of love.”

20. Therefore I shall call the entire order of these flowers

'Charites,' (Graces), and there will be divided into these five genera, Rosa, Persica, Pomum, Rubra, and Fragaria. Which sequence of names I do not think the young learner will have difficulty in remembering; nor in understanding why I distinguish the central group by the fruit instead of the flower. And if he once clearly master the structure and relations of these five genera, he will have no difficulty in attaching to them, in a satellitic or subordinate manner, such inferior groups as that of the Silver-weed, or the Tormentilla; but all he will have to learn by heart and rote, will be these six names; the Greek Master-name, Charites, and the five generic names, in each case belonging to plants, as he will soon find, of extreme personal interest to him.

21. I have used the word 'Order' as the name of our widest groups, in preference to 'Class,' because these widest groups will not always include flowers like each other in form, or equal to each other in vegetative rank; but they will be 'Orders,' literally like those of any religious or chivalric association, having some common link rather intellectual than national,—the Charites, for instance, linked by their kindness,—the Oreiades, by their mountain seclusion, as Sisters of Charity or Monks of the Chartreuse, irrespective of ties of relationship. Then beneath these orders will come, what may be rightly called, either as above in Greek derivation, 'Genera,' or in Latin, 'Gentes,' for which, however, I choose the Latin word, because Genus is disagreeably liable to be confused on the ear with 'genius'; but Gens, never; and also 'nomen gentile' is a clearer and better expression than 'nomen generosum,' and I will not coin the barbarous one, 'Genericum.' The name of the Gens, (as 'Lucia,') with an attached epithet, as 'Verna,' will, in most cases, be enough to characterize the individual flower; but if farther subdivision be necessary, the third order will be that of Families, indicated by a 'nomen familiare' added in the third place of nomenclature, as Lucia Verna,—Borealis; and no farther subdivision will ever be admitted. I avoid the word 'species'—originally a bad one, and lately vulgarized beyond endurance—altogether. And varieties belonging to narrow locali-

ties, or induced by horticulture, may be named as they please by the people living near the spot, or by the gardener who grows them ; but will not be acknowledged by Proserpina. Nevertheless, the arbitrary reduction under Ordines, Gentes, and Familiæ, is always to be remembered as one of massive practical convenience only ; and the more subtle arborescence of the infinitely varying structures may be followed, like a human genealogy, as far as we please, afterwards ; when once we have got our common plants clearly arranged and intelligibly named.

22. But now we find ourselves in the presence of a new difficulty, the greatest we have to deal with in the whole matter.

One new nomenclature, to be thoroughly good, must be acceptable to scholars in the five great languages, Greek, Latin, French, Italian, and English ; and it must be acceptable by them in teaching the native children of each country. I shall not be satisfied, unless I can feel that the little maids who gather their first violets under the Acropolis rock, may receive for them Æschylean words again with joy. I shall not be content, unless the mothers watching their children at play in the Ceramicus of Paris, under the scarred ruins of her Kings' palace, may yet teach them there to know the flowers which the Maid of Orleans gathered at Domremy. I shall not be satisfied unless every word I ask from the lips of the children of Florence and Rome, may enable them better to praise the flowers that are chosen by the hand of Matilda,* and bloom around the tomb of Virgil.

23. Now in this first example of nomenclature, the Master-name, being *pure* Greek, may easily be accepted by Greek children, remembering that certain also of their own poets, if they did not call the flower a Grace itself, at least thought of it as giving gladness to the Three in their dances.† But for French children the word 'Grâce' has been doubly and trebly corrupted ; first, by entirely false theological scholarship,

* "Cantando, e scegliendo fior di fiore

Onde era picta tutta la sua via."—*Purg.*, xxviii. 85.

† "καὶ θεοῖσι τερπνὰ."

mistaking the 'Favor' or Grace done by God to good men, for the 'Misericordia,' or mercy, shown by Him to bad ones; and so, in practical life, finally substituting 'Grâce' as a word of extreme and mortal prayer, for 'Merci,' and of late using 'Merci' in a totally ridiculous and perverted power, for the giving of thanks (or refusal of offered good): while the literally derived word 'Charite' has become, in the modern mind, a gift, whether from God or man, only to the wretched, never to the happy: and lastly, 'Grâce' in its physical sense has been perverted, by their social vulgarity, into an idea, whether with respect to form or motion, commending itself rather to the ballet-master than either to the painter or the priest.

For these reasons, the Master name of this family, for my French pupils, must be simply 'Rhodiades,' which will bring, for them, the entire group of names into easily remembered symmetry; and the English form of the same name, Rhodiad, is to be used by English scholars also for all tribes of this group except the five principal ones.

24. Farther, in every gens of plants, one will be chosen as the representative, which, if any, will be that examined and described in the course of this work, if I have opportunity of doing so.

This representative flower will always be a wild one, and of the simplest form which completely expresses the character of the plant; existing divinely and unchangeably from age to age, ungrieved by man's neglect, and inflexible by his power.

And this divine character will be expressed by the epithet 'Sacred,' taking the sense in which we attach it to a dominant and christened majesty, when it belongs to the central type of any forceful order;—'Quercus sacra,' 'Laurus sacra,' etc.,—the word 'Benedicta,' or 'Benedictus,' being used instead, if the plant be too humble to bear, without some discrepancy and unbecomingness, the higher title; as 'Carduus Benedictus,' Holy Thistle.

25. Among the gentes of flowers bearing girls' names, the dominant one will be simply called the Queen, 'Rose Regina,' 'Rose the Queen' (the English wild rose); 'Clarissa Regina,' 'Clarissa the Queen' (Mountain Pink); 'Lucia Regina,'

'Lucy the Queen' (Spring Gentian), or in simpler English, 'Lucy of Teesdale,' as 'Harry of Monmouth.' The ruling flowers of groups which bear names not yet accepted for names of girls, will be called simply 'Domina,' or shortly 'Donna.' 'Rubra domina' (wild raspberry): the wild strawberry, because of her use in heraldry, will bear a name of her own, exceptional, 'Cora coronalis.

26. These main points being understood, and concessions made, we may first arrange the greater orders of land plants in a group of twelve, easily remembered, and with very little forcing. There must be *some* forcing always to get things into quite easily tenable form, for Nature always has her ins and outs. But it is curious how fitly and frequently the number of twelve may be used for memoria technica; and in this instance the Greek derivative names fall at once into harmony with the most beautiful parts of Greek mythology, leading on to early Christian tradition.

27. Their series will be, therefore, as follows: the principal subordinate groups being at once placed under each of the great ones. The reasons for occasional appearance of inconsistency will be afterwards explained, and the English and French forms given in each case are the terms which would be used in answering the rapid question, 'Of what order is this flower?' the answer being, It is a 'Cyllenid,' a 'Pleiad,' or a 'Vestal,' as one would answer of a person, he is a Knight of St. John or Monk of St. Benedict; while to the question, of what gens, we answer, a Stella or an Erica, as one would answer of a person, a Stuart or Plantagenet.

I. CHARITES.

ENG. CHARIS. FR. RHODIADE.

Rosa. Persica. Pomum. Rubra. Fragaria.

II. URANIDES.

ENG. URANID. FR. URANIDE.

Lucia. Campanula. Convoluta.

III. CYLLENIDES.

ENG. CYLLENID. FR. NEPHELIDE.

Stella. Francesca. Primula.

IV. OREIADES.

ENG. OREIAD. FR. OREADE.

Erica. Myrtilla. Aurora.

V. PLEIADES.

ENG. PLEIAD. FR. PLEIADE.

Silvia. Anemone.

VI. ARTEMIDES.

ENG. ARTEMID. FR. ARTEMIDE.

Clarissa. Lychnis. Scintilla. Mica.

VII. VESTALES.

ENG. VESTAL. FR. VESTALE.

Mentha. Melitta. Basil. Salvia. Lavandula. Thymus.

VIII. CYTHERIDES.

ENG. CYTHERID. FR. CYTHERIDE.

Viola. Veronica. Giulietta.

IX. HELIADES.

ENG. ALCESTID. FR. HELIADE.

Clytia. Margarita. Alcestis. Falconia. Carduus.

X. DELPHIDES.

ENG. DELPHID. FR. DELPHIDE.

Laurus. Granata. Myrtus.

XI. HESPERIDES.

ENG. HESPERID. FR. HESPERIDE.

Aurantia. Aglee.

XII. ATHENAIDES.

ENG. ATHENAID. FR. ATHENAIDE.

Olea. Fraxinus.

I will shortly note the changes of name in their twelve orders, and the reasons for them.

I. CHARITES.—The only change made in the nomenclature of this order is the slight one of 'rubra' for 'rubus': partly to express true sisterhood with the other Charites; partly to enforce the idea of redness, as characteristic of the race, both in the lovely purple and russet of their winter leafage, and in the exquisite bloom of scarlet on the stems in strong young shoots. They have every right to be placed among the Charites, first because the raspberry is really a more important fruit in domestic economy than the strawberry; and, secondly, because the wild bramble is often in its wandering sprays even more graceful than the rose; and in blossom and fruit the best autumnal gift that English Nature has appointed for her village children.

II. URANIDES.—Not merely because they are all of the color of the sky, but also sacred to Urania in their divine purity. 'Convoluta' instead of 'convolvulus,' chiefly for the sake of euphony; but also because pervinca is to be included in this group.

III. CYLLENIDES.—Named from Mount Cyllene in Arcadia, because the three races included in the order alike delight in rocky ground, and in the cold or moist air of mountain-clouds.

IV. OREIADES.—Described in next chapter.

V. PLEIADES.—From the habit of the flowers belonging to this order to get into bright local clusters. *Silvia*, for the wood-sorrel, will, I hope, be an acceptable change to my girl-readers.

VI. ARTEMIDES.—Dedicate to Artemis for their expression of energy, no less than purity. This character was rightly felt in them by whoever gave the name 'Dianthus' to their leading race; a name which I should have retained if it had not been bad Greek. I wish them, by their name 'Clarissa' to recall the memory of St. Clare, as 'Francesca' that of St. Francis.* The 'issa,' not without honour to the greatest of

* The four races of this order are more naturally distinct than botanists have recognized. In *Clarissa*, the petal is cloven into a fringe at

our English moral story-tellers, is added for the practical reason, that I think the sound will fasten in the minds of children the essential characteristic of the race, the cutting of the outer edge of the petal as if with scissors.

VII. VESTALES.—I allow this Latin form, because Hestiades would have been confused with Heliades. The order is named 'of the hearth,' from its manifold domestic use, and modest blossoming.

VIII. CYTHERIDES.—Dedicate to Venus, but in all purity and peace of thought. *Giulietta*, for the coarse, and more than ordinarily false, *Polygala*.

IX. HELIADES.—The sun-flowers.* In English, *Alcestid*, in honor to Chaucer and the Daisy.

X. DELPHIDES.—Sacred to Apollo. *Granata*, changed from *Punica*, in honor to Granada and the Moors.

XI. HESPERIDES.—Already a name given to the order. *Aegle*, prettier and more classic than *Limonia*, includes the idea of brightness in the blossom.

XII. ATHENAIDES.—I take *Fraxinus* into this group, because the mountain ash, in its hawthorn-scented flower, scarletest of berries, and exquisitely formed and finished leafage, belongs wholly to the floral decoration of our native rocks, and is associated with their human interests, though lightly, not less spiritually, than the olive with the mind of Greece.

28. The remaining groups are in great part natural; but I the outer edge; in *Lychnis*, the petal is terminated in two rounded lobes and the fringe withdrawn to the top of the limb; in *Scintilla*, the petal is divided into two sharp lobes, without any fringe of the limb; and in *Mica*, the minute and scarcely visible flowers have simple and far separate petals. The confusion of these four great natural races under the vulgar or accidental botanical names of spittle-plant, shore-plant, sand-plant, etc., has become entirely intolerable by any rational student; but the names 'Scintilla,' substituted for *Stellaria*, and 'Mica' for the utterly ridiculous and probably untrue *Sagina*, connect themselves naturally with *Lychnis*, in expression of the luminous power of the white and sparkling blossoms.

* *Clytia* will include all the true sun-flowers, and *Falconia* the hawkweeds; but I have not yet completed the analysis of this vast and complex order, so as to determine the limits of *Margarita* and *Alcestis*.

separate for subsequent study five orders of supreme domestic utility, the Mallows, Currants, Pease,* Cresses, and Cranesbills, from those which, either in fruit or blossom, are for finer pleasure or higher beauty. I think it will be generally interesting for children to learn those five names as an easy lesson, and gradually discover, wondering, the world that they include. I will give their terminology at length, separately.

29. One cannot, in all groups, have all the divisions of equal importance; the Mallows are only placed with the other four for their great value in decoration of cottage gardens in autumn: and their softly healing qualities as a tribe. They will mentally connect the whole useful group with the three great Æsculapiadæ, Cinchona, Coffea, and Camellia.

30. Taking next the water-plants, crowned in the DROSIDÆ, which include the five great families, Juncus, Jacinthus, Amaryllis, Iris, and Liliium, and are masculine in their Greek name because their two first groups, Juncus and Jacinthus, are masculine, I gather together the three orders of TRITONIDES, which are notably trefoil; the NAIADES, notably quatrefoil, but for which I keep their present pretty name; and the BATRACHIDES,† notably cinqfoil, for which I keep their present ugly one, only changing it from Latin into Greek.

31. I am not sure of being forgiven so readily for putting the Grasses, Sedges, Mosses, and Lichens together, under the great general head of Demetridæ. But it seems to me the mosses and lichens belongs no less definitely to Demeter, in being the first gatherers of earth on rock, and the first coverers of its sterile surface, than the grass which at last prepares it to the foot and to the food of man. And with the mosses I shall take all the especially moss plants which otherwise are homeless or companionless, Drosera, and the like, and as a connecting link with the flowers belonging to the

* The reader must observe that the positions given in this more developed system to any flower do not interfere with arrangements either formerly or hereafter given for memoria technica. The name of the pea, for instance (*alata*) is to be learned first among the twelve cinqfoils p. 134, above; then transferred to its botanical place.

† The amphibious habit of this race is to me of more importance than its outlaid structure.

Dark Kora, the two strange orders of the Ophryds and Agarics.

32. Lastly will come the orders of flowers which may be thought of as belonging for the most part to the Dark Kora of the lower world,—having at least the power of death, if not its terror, given them, together with offices of comfort and healing in sleep, or of strengthening, if not too prolonged, action on the nervous power of life. Of these, the first will be the DIONYSIDÆ,—Hedera, Vitis, Liana ; then the DRACONIDÆ,—Atropa, Digitalis, Linaria ; and, lastly, the MOIRIDÆ,—Conium, Papaver, Solanum, Arum and Nerium.

33. As I see this scheme now drawn out, simple as it is, the scope of it seems not only far too great for adequate completion by my own labour, but larger than the time likely to be given to botany by average scholars would enable them intelligently to grasp : and yet it includes, I suppose, not the tenth part of the varieties of plants respecting which, in competitive examination, a student of physical science is now expected to know, or at least assert on hearsay, *something*.

So far as I have influence with the young, myself, I would pray them to be assured that it is better to know the habits of one plant than the names of a thousand ; and wiser to be happily familiar with those that grow in the nearest field, than arduously cognisant of all that plume the isles of the Pacific, or illumine the Mountains of the Moon.

Nevertheless, I believe that when once the general form of this system in Proserpina has been well learned, much other knowledge may be easily attached to it, or sheltered under the eaves of it : and in its own development, I believe everything may be included that the student will find useful, or may wisely desire to investigate, of properly European botany. But I am convinced that the best results of his study will be reached by a resolved adherence to extreme simplicity of primal idea, and primal nomenclature.

34. I do not think the need of revisal of our present scientific classification could be more clearly demonstrated than by the fact that laurels and roses are confused, even by Dr. Lindley, in the mind of his feminine readers ; the English word

laurel, in the index to his first volume of *Ladies' Botany*, referring them to the cherries, under which the common laurel is placed as '*Prunus Laurocerasus*,' while the true laurel, '*Laurus nobilis*,' must be found in the index of the second volume, under the Latin form '*Laurus*.'

This accident, however, illustrates another, and a most important point to be remembered, in all arrangements whether of plants, minerals, or animals. No single classification can possibly be perfect, or anything *like* perfect. It must be, at its best, a ground, or *warp* of arrangement only, through which, or over which, the cross threads of another,—yes, and of many others,—must be woven in our minds. Thus the almond, though in the form and colour of its flower, and method of its fruit, rightly associated with the roses, yet by the richness and sweetness of its kernel must be held mentally connected with all plants that bear nuts. These assuredly must have something in their structure common, justifying their being gathered into a conceived or conceivable group of '*Nuciferae*,' in which the almond, hazel, walnut, cocoa-nut, and such others would be considered as having relationship, at least in their power of secreting a crisp and sweet substance which is not wood, nor bark, nor pulp, nor seed-pabulum reducible to softness by boiling ;—but quite separate substance, for which I do not know that there at present exists any botanical name,—of which, hitherto, I find no general account, and can only myself give so much, on reflection, as that it is crisp and close in texture, and always contains some kind of oil or milk.

35. Again, suppose the arrangement of plants could with respect to their flowers and fruits, be made approximately complete, they must instantly be broken and reformed by comparison of their stems and leaves. The three *creeping* families of the Charities,—*Rosa*, *Rubra*, and *Fragaria*,—must then be frankly separated from the elastic *Persica* and knotty *Pomum* ; of which one wild and lovely species, the hawthorn, is no less notable for the massive accumulation of wood in the stubborn stem of it, than the wild rose for her lovely power of wreathing her garlands at pleasure wherever they are

fairest, the stem following them and sustaining, where they will.

36. Thus, as we examine successively each part of any plant, new sisterhoods, and unthought-of fellowships, will be found between the most distant orders; and ravines of unexpected separation open between those otherwise closely allied. Few botanical characters are more definite than the leaf structure illustrated in Plate VI., which has given to one group of the Drosidæ the descriptive name of *Ensatae*, (see above, Chapter IX., § 11,) but this conformation would not be wisely permitted to interfere in the least with the arrangement founded on the much more decisive floral aspects of the Iris and Lily. So, in the fifth volume of 'Modern Painters,' the sword-like, or rather rapier-like, leaves of the pine are opposed, for the sake of more vivid realization, to the shield-like leaves of the greater number of inland trees; but it would be absurd to allow this difference any share in botanical arrangement,—else we should find ourselves thrown into sudden discomfiture by the wide-waving and opening foliage of the palms and ferns.

37. But through all the defeats by which insolent endeavors to sum the orders of Creation must be reprov'd, and in the midst of the successes by which patient insight will be surpris'd, the fact of the *confirmation* of species in plants and animals must remain always a miraculous one. What outstretched sign of constant Omnipotence can be more awful, than that the susceptibility to external influences, with the reciprocal power of transformation, in the organs of the plant; and the infinite powers of moral training and mental conception over the nativity of animals, should be so restrained within impassable limits, and by inconceivable laws, that from generation to generation, under all the clouds and revolutions of heaven with its stars, and among all the calamities and convulsions of the Earth with her passions, the numbers and the names of her Kindred may still be counted for her in unfailling truth;—still the fifth sweet leaf unfold for the Rose, and the sixth spring for the Lily; and yet the wolf rave tameless round the folds of the pastoral mountains, and yet the tiger flame through the forests of the night.

CHAPTER XII.

CORA AND KRONOS.

1. OF all the lovely wild plants—and few, mountain-bred, in Britain, are other than lovely,—that fill the clefts and crest the ridges of my Brantwood rock, the dearest to me, by far, are the clusters of whortleberry which divide possession of the lower slopes with the wood hyacinth and pervenche. They are personally and specially dear to me for their association in my mind with the woods of Montanvert; but the plant itself, irrespective of all accidental feeling, is indeed so beautiful in all its ways—so delicately strong in the spring of its leafage, so modestly wonderful in the formation of its fruit, and so pure in choice of its haunts, not capriciously or unfamiliarly, but growing in luxuriance through all the healthiest and sweetest seclusion of mountain territory throughout Europe,—that I think I may without any sharp remonstrance be permitted to express for this once only, personal feeling in my nomenclature, calling it in Latin ‘*Myrtilla Cara*,’ and in French ‘*Myrtille Chérie*,’ but retaining for it in English its simply classic name, ‘Blue Whortle.’

2. It is the most common representative of the group of *Myrtillæ*, which, on reference to our classification, will be found central between the *Ericæ* and *Auroræ*. The distinctions between these three families may be easily remembered, and had better be learned before going farther; but first let us note their fellowship. They are all *Oreïades*, mountain plants; in specialty, they are all strong in stem, low in stature, and the *Ericæ* and *Auroræ* glorious in the flush of their infinitely exulting flowers, (“the rapture of the heath”—above spoken of, p. 63.) But all the essential loveliness of the *Myrtillæ* is in their leaves and fruit: the first always exquisitely finished and grouped like the most precious decorative work of sacred painting; the second, red or purple, like beads of coral or amethyst. Their minute flowers have rarely any

general part or power in the colors of mountain ground ; but, examined closely, they are one of the chief joys of the traveller's rest among the Alps ; and full of exquisiteness unspeakable, in their several bearings and miens of blossom, so to speak. Plate VIII. represents, however feebly, the proud bending back of her head by Myrtilla Regina : * an action as beautiful in *her* as it is terrible in the Kingly Serpent of Egypt.

3. The formal differences between these three families are trenchant and easily remembered. The *Ericæ* are all quatrefoils, and quatrefoils of the most studied and accomplished symmetry ; and they bear no berries, but only dry seeds. The *Myrtillæ* and *Auroræ* are both Cinqfoil ; but the *Myrtillæ* are symmetrical in their blossom, and the *Auroræ* unsymmetrical. Farther, the *Myrtillæ* are not absolutely determinate in the number of their foils, (this being essentially a characteristic of flowers exposed to much hardship,) and are thus sometimes quatrefoil, in sympathy with the *Ericæ*. But the *Auroræ* are strictly cinqfoil. These last are the only European form of a larger group, well named 'Azalea' from the Greek *ἀζα*, dryness, and its adjective *ἀζαλέα*, dry or parched ; and *this* name must be kept for the world-wide group, (including under it *Rhododendron*, but not *Kalmia*,) because there is an under-meaning in the word *Aza*, enabling it to be applied to the substance of dry earth, and indicating one of the great functions of the *Oreïades*, in common with the mosses,—the collection of earth upon rocks.

4. Neither the *Ericæ*, as I have just said, nor *Auroræ* bear useful fruit ; and the *Ericæ* are named from their consequent worthlessness in the eyes of the Greek farmer ; they were the plants he 'tore up' for his bed, or signal-fire, his word for them including a farther sense of crushing or bruising into a heap. The Westmoreland shepherds now, alas ! burn them remorselessly on the ground, (and a year since had nearly set the copse of Brantwood on fire just above the house.) The sense of parched and fruitless existence is

* "*Arctostaphylos Alpina*," I believe ; but scarcely recognize the flower in my botanical books.

given to the heaths, with beautiful application of the context, in our English translation of Jeremiah xvii. 6 ; but I find the plant there named is, in the Septuagint, Wild Tamarisk ; the mountains of Palestine being, I suppose, in that latitude, too low for heath, unless in the Lebanon.

5. But I have drawn the reader's thoughts to this great race of the Oreiades at present, because they place for us in the clearest light a question which I have finally to answer before closing the first volume of Proserpina ; namely, what is the real difference between the three ranks of Vegetative Humility, and Noblesse — the Herb, the Shrub, and the Tree ?

6. Between the herb, which perishes annually, and the plants which construct year after year an increasing stem, there is, of course, no difficulty of discernment ; but between the plants which, like these Oreiades, construct for themselves richest intricacy of supporting stem, yet scarcely rise a fathom's height above the earth they gather and adorn,—between these, and the trees that lift cathedral aisles of colossal shade on Andes and Lebanon,—where is the limit of kind to be truly set?

7. We have the three orders given, as no botanist could, in twelve lines by Milton :—

“ Then herbs of every leaf, that sudden flow'r'd
 Op'ning their various colours, and made gay
 Her bosom smelling sweet ; and, these scarce blown,
 Forth flourish'd thick the clust'ring vine, forth crept
 The swelling gourd, up stood the corny reed
 Embattel'd in her field ; and th' *humble shrub*,
And bush with frizzled hair implicit : last
 Rose, as in dance, the stately trees, and spread
 Their branches hung with copious fruits, or gemm'd
 Their blossoms ; with high woods the hills were crown'd ;
 With tufts the valleys and each fountain side ;
 With borders long the rivers.”

Only to learn, and be made to understand, these twelve lines thoroughly would teach a youth more of true botany than an entire Cyclopædia of modern nomenclature and de-

scription : they are, like all Milton's work, perfect in accuracy of epithet, while consummate in concentration. Exquisite in touch, as infinite in breadth, they gather into their unbroken clause of melodious compass the conception at once of the Columbian prairie, the English cornfield, the Syrian vineyard, and the Indian grove. But even Milton has left untold, and for the instant perhaps unthought of, the most solemn difference of rank between the low and lofty trees, not in magnitude only, nor in grace, but in duration.

8. Yet let us pause before passing to this greater subject, to dwell more closely on what he has told us so clearly,—the difference in Grace, namely between the trees that rise 'as in dance,' and 'the bush with frizzled hair.' For the bush form is essentially one taken by vegetation in some kind of distress ; scorched by heat, discouraged by darkness, or bitten by frost ; it is the form in which isolated knots of earnest plant life stay the flux of fiery sands, bind the rents of tottering crags, purge the stagnant air of crave or chasm, and fringe with sudden hues of unhopéd spring the Arctic edge of retreating desolation.

On the other hand, the trees which, as in sacred dance, make the borders of the rivers glad with their procession, and the mountain ridges statelier with their pride, are all expressions of the vegetative power in its accomplished felicities ; gathering themselves into graceful companionship with the fairest arts and serenest life of man ; and providing not only the sustenance and the instruments, but also the lessons and the delights, of that life, in perfectness of order, and unblighted fruition of season and time.

9. 'Interitura'—yet these not to-day, nor to-morrow, nor with the decline of the summer's sun. We describe a plant as small or great ; and think we have given account enough of its nature and being. But the chief question for the plant, as for the human creature, is the Number of its days ; for to the tree, as to its master, the words are forever true—"As thy Day is, so shall thy Strength be."

10. I am astonished hourly, more and more, at the apathy and stupidity which have prevented me hitherto from learn-

ing the most simple facts at the base of this question! Here is this myrtle bush in my hand—its cluster of some fifteen or twenty delicate green branches knitting themselves downwards into the stubborn brown of a stem on which my knife makes little impression. I have not the slightest idea how old it is, still less how old it might one day have been if I had not gathered it; and, less than the least, what hinders it from becoming as old as it likes! What doom is there over these bright green sprays, that they may never win to any height or space of verdure, nor persist beyond their narrow scope of years?

11. And the more I think the more I bewilder myself; for these bushes, which are pruned and clipped by the deathless Gardener into these lowly thickets of bloom, do not strew the ground with fallen branches and faded clippings in any wise,—it is the pining umbrage of the patriarchal trees that tinges the ground and betrays the foot beneath them: but, under the heather and the Alpine rose.—Well, what is under them, then? I never saw, nor thought of looking,—will look presently under my own bosquets and beds of lingering heather-blossom: beds indeed they were only a month since, a foot deep in flowers, and close in tufted cushions, and the mountain air that floated over them rich in honey like a draught of metheglin.

12. Not clipped, nor pruned, I think, after all,—nor dwarfed in the gardener's sense; but pausing in perpetual youth and strength, ordained out of their lips of roseate infancy. Rose-trees—the botanists have falsely called the proudest of them; yet not trees in any wise, they, nor doomed to know the edge of axe at their roots, nor the hoary waste of time, or searing thunder-stroke, on sapless branches. Continual morning for them, and in them; they themselves an Aurora, purple and cloudless, stayed on all the happy hills. That shall be our name for them, in the flushed Phœnician colour of their height, in calm or tempest of the heavenly sea; how much holier than the depth of the Tyrian! And the queen of them on our own Alps shall be 'Aurora Alpium.'*

* 'Aurora Regina,' changed from *Rhododendron Ferrugineum*.

13. There is one word in the Miltonian painting of them which I must lean on specially ; for the accurate English of it hides deep morality no less than botany. ‘ With hair *implicit*.’ The interweaving of complex band, which knits the masses of heath or of Alpine rose into their dense tufts and spheres of flower, is to be noted both in these, and in stem structure of a higher order like that of the stone pine, for an expression of the instinct of the plant gathering itself into protective unity, whether against cold or heat, while the forms of the trees which have no hardship to sustain are uniformly based on the effort of each spray to *separate* itself from its fellows to the utmost, and obtain around its own leaves the utmost space of air.

In vulgar modern English, the term ‘implicit,’ used of Trust or Faith, has come to signify only its serenity. But the Miltonian word gives the *reason* of serenity : the root and branch intricacy of closest knowledge and fellowship.

14. I have said that Milton has told us more in these few lines than any botanist could. I will prove my saying by placing in comparison with them two passages of description by the most imaginative and generally well-trained scientific man since Linnæus—Humboldt—which, containing much that is at this moment of special use to us, are curious also in the confusion even of the two orders of annual and perennial plants, and show, therefore, the extreme need of most careful initial work in this distinction of the reign of Cora from that of Kronos.

“ The disk of the setting sun appeared like a globe of fire suspended over the savannah ; and its last rays, as they swept the earth, illumined the extremities of the grass, strongly agitated by the evening breeze. In the low and humid places of the equinoxial zone, even when the gramineous plants and reeds present the aspect of a meadow, of turf, a rich decoration of the picture is usually wanting. I mean that variety of wild flowers which, scarcely rising above the grass, seem to lie upon a smooth bed of verdure. Between the tropics, the strength and luxury of vegetation give such a development to plants, that the smallest of the dicotyledonous family become

shrubs.* It would seem as if the liliaceous plants, mingled with the gramina, assumed the place of the flowers of our meadows. Their form is indeed striking; they dazzle by the variety and splendor of their colours; but, too high above the soil, they disturb that harmonious relation which exists among the plants that compose our meadows and our turf. Nature in her beneficence, has given the landscape under every zone its peculiar type of beauty.

"After proceeding four hours across the savannahs, we entered into a little wood composed of shrubs and small trees, which is called El Pejual; no doubt because of the great abundance of the 'Pejoa' (*Gaultheria odorata*), a plant with very odoriferous leaves. The steepness of the mountain became less considerable, and we felt an indescribable pleasure in examining the plants of this region. Nowhere, perhaps, can be found collected together in so small a space of ground, productions so beautiful, and so remarkable in regard to the geography of plants. At the height of a thousand toises the lofty savannahs of the hills terminate in a zone of shrubs, which by their appearance, their tortuous branches, their stiff leaves, and the dimensions and beauty of their purple flowers, remind us of what is called in the Cordilleras of the Andes the vegetation of the *paramos* † and the *punas*. We find there the family of the Alpine rhododendrons, the thibaudias, the andromedas, the vacciniums, and those *befarias* ‡ with resinous leaves, which we have several times compared to the rhododendron of our European Alps.

"Even when nature does not produce the same species in analogous climates, either in the plains of isothermal parallels, or on table-lands the temperature of which resembles that of places nearer the poles, we still remark a striking resem-

* I do not see what this can mean. Primroses and cowslips can't become shrubs; nor can violets, nor daisies, nor any other of our pet meadow flowers.

† 'Deserts.' *Punas* is not in my Spanish dictionary, and the reference to a former note is wrong in my edition of Humboldt, vol. iii., p. 490.

‡ "The Alpine rose of equinoctial America," p. 453.

blance of appearance and physiognomy in the vegetation of the most distant countries. This phenomenon is one of the most curious in the history of organic forms. I say the history; for in vain would reason forbid man to form hypotheses on the origin of things: he is not the less tormented with these insoluble problems of the distribution of beings."

15. Insoluble—yes, assuredly, poor little beaten phantasms of palpitating clay that we are—and who asked us to solve it? Even this Humboldt, quiet-hearted and modest watcher of the ways of Heaven, in the real make of him, came at last to be so far puffed up by his vain science in declining years that he must needs write a Kosmos of things in the Universe, forsooth, as if he knew all about them! when he was not able meanwhile, (and does not seem even to have desired the ability,) to put the slightest Kosmos into his own 'Personal Narrative'; but leaves one to gather what one wants out of its wild growth; or rather, to wash or winnow what may be useful out of its débris, without any vestige either of reference or index; and I must look for these fragmentary sketches of heath and grass through chapter after chapter about the races of the Indian and religion of the Spaniard,—these also of great intrinsic value, but made useless to the general reader by interspersed experiment on the drifts of the wind and the depths of the sea.

16. But one more fragment out of a note (vol. iii., p. 494) I must give, with reference to an order of the Rhododendrons as yet wholly unknown to me.

"The name of vine tree, ' uvas camaronas ' (Shrimp grapes ?) is given in the Andes to plants of the genus *Thibaudia* on account of their *large succulent fruit*. Thus the ancient botanists give the name of Bear's vine, ' *Uva Ursi*,' and vine of Mount Ida, ' *Vitis Idea*,' to an *Arbutus* and *Myrtillus* which belong, like the *Thibaudia*, to the family of the *Ericineæ*."

Now, though I have one entire bookcase and half of another, and a large cabinet besides, or about fifteen feet square of books on botany beside me here, and a quantity more at Oxford, I have no means whatever, in all the heap, of finding out what a *Thibaudia* is like. Loudon's *Cyclopædia*, the only

general book I have, tells me only that it will grow well in camellia houses, that its flowers develop at Christmas, and that they are beautifully varied like a fritillary: whereupon I am very anxious to see them, and taste their-fruit, and be able to tell my pupils something intelligible of them,—a new order, as it seems to me, among my Oreiades. But for the present I can make no room for them, and must be content, for England and the Alps, with my single class, Myrtilla, including all the fruit-bearing and (more or less) myrtle-leaved kinds; and Azalea for the fruitless flushing of the loftier tribes; taking the special name 'Aurora' for the red and purple ones of Europe, and resigning the already accepted 'Rhodora' to those of the Andes and Himalaya.

17. Of which also, with help of earnest Indian botanists, I hope nevertheless to add some little history to that of our own Oreiades; but shall set myself on the most familiar of them first, as I partly hinted in taking for the frontispiece of this volume two unchecked shoots of our commonest heath, in their state of full lustre and decline. And now I must go out and see and think—and for the first time in my life—what becomes of all these fallen blossoms, and where my own mountain Cora hides herself in winter; and where her sweet body is laid in its death.

Think of it with me, for a moment before I go. That harvest of amethyst bells, over all Scottish and Irish and Cumberland hill and moorland; what substance is there in it, yearly gathered out of the mountain winds,—stayed there, as if the morning and evening clouds had been caught out of them and woven into flowers; 'Ropes of sea-sand'—but that is child's magic merely, compared to the weaving of the Heath out of the cloud. And once woven, how much of it is forever worn by the Earth? What weight of that transparent tissue, half crystal and half comb of honey, lies strewn every year dead under the snow?

I must go and look, and can write no more to-day; nor to-morrow neither. I must gather slowly what I see, and remember; and meantime leaving, to be dealt with afterwards, the difficult and quite separate question of the production of

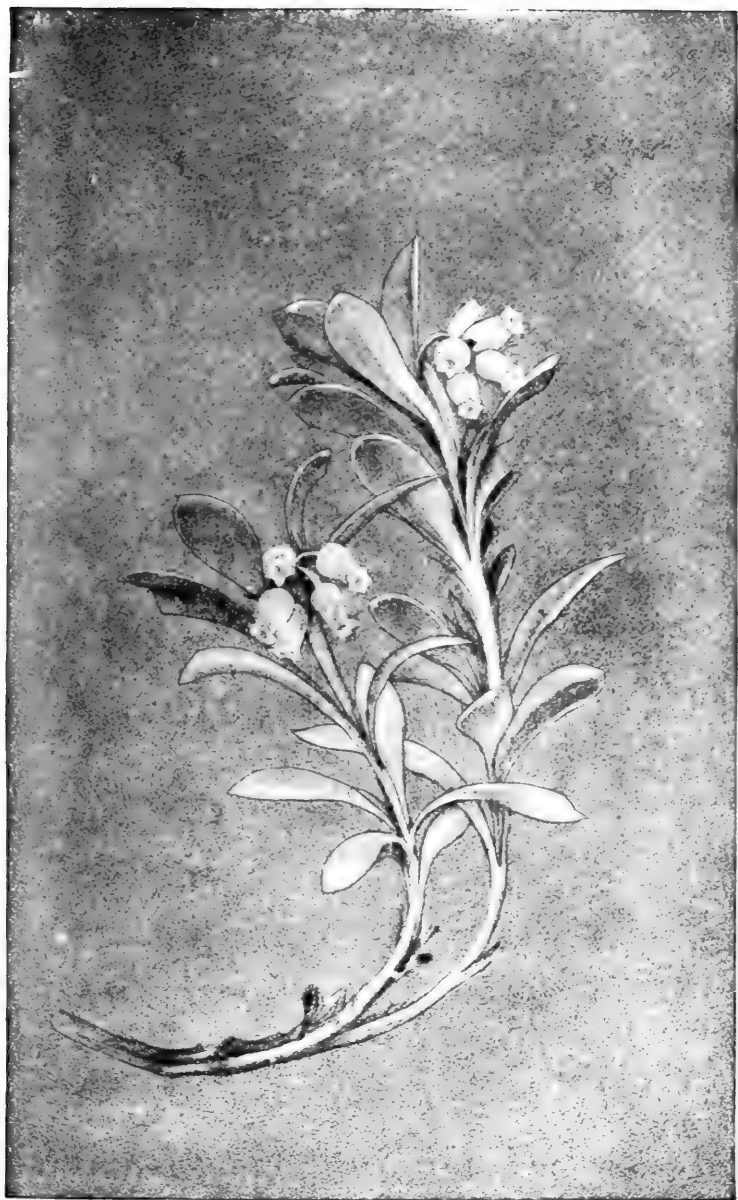

PLATE VIII.—MYRTILLA REGINA.

Sketched for her gesture only. Isella, 1877.

wood, I will close this first volume of Proserpina with some necessary statements respecting the operations, serviceable to other creatures than themselves, in which the lives of the noblest plants are ended : honourable in this service equally, though evanescent, some,—in the passing of a breeze—or the dying of a day ;—and patient some, of storm and time, serene in fruitful sanctity, through all the uncounted ages which Man has polluted with his tears.

CHAPTER XIII

THE SEED AND HUSK.

1. Not the least sorrowful, nor least absurd of the confusions brought on us by unscholarly botanists, blundering into foreign languages, when they do not know how to use their own, is that which has followed on their practice of calling the seed-vessels of flowers ‘egg-vessels,’* in Latin ; thus involving total loss of the power of the good old English word ‘husk,’ and the good old French one, ‘cosse.’ For all the treasuries of plants (see Chapter IV., § 17) may be best conceived, and described, generally, as consisting of ‘seed’ and ‘husk,’—for the most part two or more seeds, in a husk composed of two or more parts, as pease in their shell, pips in an orange, or kernels in a walnut ; but whatever their number, or the method of their enclosure, let the student keep clear in his mind, for the base of all study of fructification, the broad distinction between the seed, as one thing, and the husk as another : the seed, essential to the continuance of the plant’s race ; and the husk, adapted, primarily, to its guard and dissemination ; but secondarily, to quite other and far more important functions.

2. For on this distinction follows another practical one of great importance. A seed may serve, and many do mightily serve, for the food of man, when boiled, crushed, or otherwise

* More literally “ persons to whom the care of eggs is entrusted.”

industriously prepared by man himself, for his mere *sustenance*. But the *husk* of the seed is prepared in many cases for the delight of his eyes, and the pleasure of his palate, by Nature herself, and is then called a 'fruit.'

3. The varieties of structure both in seed and husk, and yet more, the manner in which the one is contained, and distributed by, the other, are infinite; and in some cases the husk is apparently wanting, or takes some unrecognizable form. But in far the plurality of instances the two parts of the plant's treasury are easily distinguishable, and must be separately studied, whatever their apparent closeness of relation, or, (as in all natural things,) the equivocation sometimes taking place between the one and the other. To me, the especially curious point in this matter is that, while I find the most elaborate accounts given by botanists of the stages of growth in each of these parts of the treasury, they never say of what use the guardian is to the guarded part, irrespective of its service to man. The mechanical action of the husk in containing and scattering the seeds, they indeed often notice and insist on; but they do not tell us of what, if any, nutritious or fostering use the rind is to a chestnut, or an orange's pulp to its pips, or a peach's juice to its stone.

4. Putting aside this deeper question for the moment, let us make sure we understand well, and define safely, the separate parts themselves. A seed consists essentially of a store, or sack, containing substance to nourish a germ of life, which is surrounded by such substance, and in the process of growth is first fed by it. The germ of life itself rises into two portions, and not more than two, in the seeds of two-leaved plants; but this symmetrical dualism must not be allowed to confuse the student's conception, of the *three* organically separate parts,—the tough skin of a bean, for instance; the softer contents of it which we boil to eat; and the small germ from which the root springs when it is sown. A bean is the best type of the whole structure. An almond out of its shell, a peach-kernel, and an apple-pip are also clear and perfect, though varied types.

5. The husk, or seed-vessel, is seen in perfect simplicity of

type in the pod of a bean, or the globe of a poppy. There are, I believe, flowers in which it is absent or imperfect; and when it contains only one seed, it may be so small and closely united with the seed it contains, that both will be naturally thought of as one thing only. Thus, in a dandelion, the little brown grains, which may be blown away, each with its silken parachute, are every one of them a complete husk and seed together. But the majority of instances (and those of plants the most serviceable to man) in which the seed-vessel has entirely a separate structure and mechanical power, justify us in giving it the normal term 'husk,' as the most widely applicable and intelligible.

6. The change of green, hard, and tasteless vegetable substance into beautifully coloured, soft, and delicious substance, which produces what we call a fruit, is, in most cases, of the husk only; in others, of the part of the stalk which immediately sustains the seed; and in a very few instances, not properly a change, but a distinct formation, of fruity substance between the husk and seed. Normally, however, the husk, like the seed, consists always of three parts; it has an outer skin, a central substance of peculiar nature, and an inner skin, which holds the seed. The main difficulty, in describing or thinking of the completely ripened product of any plant, is to discern clearly which is the inner skin of the husk, and which the outer skin of the seed. The peach is in this respect the best general type,—the woolly skin being the outer one of the husk; the part we eat, the central substance of the husk; and the hard shell of the stone, the inner skin of the husk. The bitter kernel within is the seed.

7. In this case, and in the plum and cherry, the two parts under present examination—husk and seed—separate naturally; the fruity part, which is the body of the husk, adhering firmly to the shell, which is its inner coat. But in the walnut and almond, the two outer parts of the husk separate from the interior one, which becomes an apparently independent 'shell.' So that when first I approached this subject I divided the general structure of a treasury into *three* parts—husk, shell, and kernel; and this division, when we once have mas-

tered the main one, will be often useful. But at first let the student keep steadily to his conception of the two constant parts, husk and seed, reserving the idea of shells and kernels for one group of plants only.

8. It will not be always without difficulty that he maintains the distinction, when the tree pretends to have changed it. Thus, in the chestnut, the inner coat of the husk becomes brown, adheres to the seed, and seems part of it; and we naturally call only the thick, green, prickly coat, the husk. But this is only one of the deceiving tricks of Nature, to compel our attention more closely. The real place of separation, to *her* mind, is between the mahogany-coloured shell and the nut itself, and that more or less silky and flossy coating within the brown shell is the true lining of the entire 'husk.' The paler brown skin, following the rugosities of the nut, is the true sack or skin of the seed. Similarly in the walnut and almond.

9. But, in the apple, two new tricks are played us. First, in the brown skin of the ripe pip, we might imagine we saw the part correspondent to the mahogany skin of the chestnut, and therefore the inner coat of the husk. But it is not so. The brown skin of the pips belongs to them properly, and is all their own. It is the true skin or sack of the seed. The inner coat of the husk is the smooth, white, scaly part of the core that holds them.

Then,—for trick number two. We should as naturally imagine the skin of the apple, which we peel off, to be correspondent to the skin of the peach; and therefore, to be the outer part of the husk. But not at all. The outer part of the husk in the apple is melted away into the fruity mass of it, and the red skin outside is the skin of its *stalk*, not of its seed-vessel at all!

10. I say 'of its stalk,'—that is to say, of the part of the stalk immediately sustaining the seed, commonly called the torus, and expanding into the calyx. In the apple, this torus incorporates itself with the husk completely; then refines its own external skin, and colours *that* variously and beautifully, like the true skin of the husk in the peach, while the withered leaves of the calyx remain in the 'eye' of the apple.

But in the 'hip' of the rose, the incorporation with the husk of the seed does not take place. The torus, or,—as in this flower from its peculiar form it is called,—the tube of the calyx, alone forms the frutescent part of the hip; and the complete seeds, husk and all, (the firm triangular husk enclosing an almond-shaped kernel,) are grouped closely in its interior cavity, while the calyx remains on the top in a large and scarcely withering star. In the nut, the calyx remains green and beautiful, forming what we call the husk of a filbert; and again we find Nature amusing herself by trying to make us think that this strict envelope, almost closing over the single seed, is the same thing to the nut that its green shell is to a walnut!

11. With still more capricious masquing, she varies and hides the structure of her 'berries.'

The strawberry is a hip turned inside-out, the frutescent receptacle changed into a scarlet ball, or cone, of crystalline and delicious coral, in the outside of which the separate seeds, husk and all, are imbedded. In the raspberry and blackberry, the interior mound remains sapless; and the rubied translucency of dulcet substance is formed round each separate seed, upon its husk; not a part of the husk, but now an entirely independent and added portion of the plant's bodily form.

12. What is thus done for each seed, on the *outside* of the receptacle, in the raspberry, is done for each seed, *inside* the calyx, in a pomegranate; which is a hip in which the seeds have become surrounded with a radiant juice, richer than claret wine; while the seed itself, within the generous jewel, is succulent also, and spoken of by Tournefort as a "baie succulente." The tube of the calyx, brown-russet like a large hip, externally, is yet otherwise divided, and separated wholly from the cinque-foiled, and cinque-celled rose, both in number of petal and division of treasures; the calyx has eight points, and nine cells.

13. Lastly, in the orange, the fount of fragrant juice is interposed between the seed and the husk. It is wholly independent of both; the Aurantine rind, with its white lining and divided compartments, is the true husk; the orange pips are

the true seeds ; and the eatable part of the fruit is formed between them, in clusters of delicate little flasks, as if a fairy's store of scented wine had been laid up by her in the hollow of a chestnut shell, between the nut and rind ; and then the green changed to gold.

14. I have said '*lastly*'—of the orange, for fear of the reader's weariness only ; not as having yet represented, far less exhausted, the variety of frutescent form. But these are the most important types of it ; and before I can explain the relation between these, and another, too often confounded with them—the *granular* form of the seed of grasses,—I must give some account of what, to man, is far more important than the form—the gift to him in fruit-food ; and trial, in fruit-temptation.

CHAPTER XIV.

THE FRUIT GIFT.

1. IN the course of the preceding chapter, I hope that the reader has obtained, or may by a little patience both obtain and secure, the idea of a great natural Ordinance, which, in the protection given to the part of plants necessary to prolong their race, provides, for happier living creatures, food delightful to their taste, and forms either amusing or beautiful to their eyes. Whether in receptacle, calyx, or true husk,—in the cup of the acorn, the fringe of the filbert, the down of the apricot, or bloom of the plum, the powers of Nature consult quite other ends than the mere continuance of oaks and plum trees on the earth ; and must be regarded always with gratitude more deep than wonder, when they are indeed seen with human eyes and human intellect.

2. But in one family of plants, the *contents* also of the seed, not the envelope of it merely, are prepared for the support of the higher animal life ; and their grain, filled with the substance which, for universally understood name, may best keep the Latin one of *Farina*,—becoming in French, '*Farine*,' and

in English, 'Flour,'—both in the perfectly nourishing elements of it, and its easy and abundant multiplicability, becomes the primal treasure of human economy.

3. It has been the practice of botanists of all nations to consider the seeds of the grasses together with those of roses and pease, as if all could be described on the same principles, and with the same nomenclature of parts. But the grain of corn is a quite distinct thing from the seed of pease. In it, the husk and the seed envelope have become inextricably one. All the exocarps, endocarps, epicarps, mesocarps, shells, husks, sacks, and skins, are woven at once together into the brown bran; and inside of that, a new substance is collected for us, which is not what we boil in pease, or poach in eggs, or munch in nuts, or grind in coffee;—but a thing which, mixed with water and then baked, has given to all the nations of the world their prime word for food, in thought and prayer,—Bread; their prime conception of the man's and woman's labor in preparing it—("whoso putteth hand to the *plough*"—two women shall be grinding at the *mill*)—their prime notion of the means of cooking by fire—("which to-day is, and to-morrow is cast into the *oven*"), and their prime notion of culinary office—the "chief *baker*," cook, or pastry cook,—(compare Bedredin Hassan in the Arabian Nights): and, finally, to modern civilization, the Saxon word 'lady,' with whatever it imports.

4. It has also been the practice of botanists to confuse all the ripened products of plants under the general term 'fruit.' But the essential and separate fruit-gift is of two substances, quite distinct from flour, namely, oil and wine, under the last term including for the moment all kinds of juice which will produce alcohol by fermentation. Of these, oil may be produced either in the kernels of nuts, as in almonds, or in the substance of berries, as in the olive, date, and coffee-berry. But the sweet juice which will become medicinal in wine, can only be developed in the husk, or in the receptacle.

5. The office of the Chief Butler, as opposed to that of the Chief Baker, and the office of the Good Samaritan, pouring in oil and wine, refer both to the total fruit-gift in both kinds: but in the study of plants, we must primarily separate our

notion of their gifts to men into the three elements, flour, oil and wine ; and have instantly and always intelligible names for them in Latin, French, and English.

And I think it best not to confuse our ideas of pure vegetable substance with the possible process of fermentation :—so that rather than ‘ wine,’ for a constant specific term, I will take ‘ Nectar,’—this term more rightly including the juices of the peach, nectarine, and plum, as well as those of the grape, currant, and apple.

Our three separate substances will then be easily named in all three languages :

| | | |
|---------|--------|----------|
| Farina. | Oleum. | Nectar. |
| Farine. | Huile. | Nectare. |
| Flour. | Oil. | Nectar. |

There is this farther advantage in keeping the third common term, that it leaves us the words Succus, Jus, Juice, for other liquid products of plants, watery, milky, sugary, or resinous,—often indeed important to man, but often also without either agreeable flavor or nutritious power ; and it is therefore to be observed with care that we may use the word ‘ juice,’ of a liquid produced by any part of a plant, but ‘ nectar,’ only of the juices produced in its fruit.

6. But the good and pleasure of fruit is not in the juice only ;—in some kinds, and those not the least valuable, (as the date,) it is not in the juice at all. We still stand absolutely in want of a word to express the more or less firm *substance* of fruit, as distinguished from all other products of a plant. And with the usual ill-luck,—(I advisedly think of it as demoniacal misfortune)—of botanical science, no other name has been yet used for such substance than the entirely false and ugly one of ‘ Flesh,’—Fr., ‘ Chair,’ with its still more painful derivation ‘ Charnu,’ and in England the monstrous scientific term, ‘ Sarco-carp.’

But, under the housewifery of Proserpina, since we are to call the juice of fruit, Nectar, its substance will be as naturally and easily called Ambrosia ; and I have no doubt that this,

with the other names defined in this chapter, will not only be found practically more convenient than the phrases in common use, but will more securely fix in the student's mind a true conception of the essential differences in substance, which, ultimately, depend wholly on their pleasantness to human perception, and offices for human good ; and not at all on any otherwise explicable structure or faculty. It is of no use to determine, by microscope or retort, that cinnamon is made of cells with so many walls, or grape-juice of molecules with so many sides ;—we are just as far as ever from understanding why these particular interstices should be aromatic, and these special parallelopipeds exhilarating, as we were in the savagely unscientific days when we could only see with our eyes, and smell with our noses. But to call each of these separate substances by a name rightly belonging to it through all the past variations of the language of educated man, will probably enable us often to discern powers in the thing itself, of affecting the human body and mind, which are indeed qualities infinitely more its *own*, than any which can possibly be extracted by the point of a knife, or brayed out with a mortar and pestle.

7. Thus, to take merely instance in the three main elements of which we have just determined the names,—flour, oil, and ambrosia ;—the differences in the kinds of pleasure which the tongue received from the powderiness of oat-cake, or a well-boiled potato—(in the days when oat-cake and potatoes were !)—from the glossily-softened crispness of a well-made salad, and from the cool and fragrant amber of an apricot, are indeed distinctions between the essential virtues of things which were made to be *tasted*, much more than to be eaten ; and in their various methods of ministry to, and temptation of, human appetites, have their part in the history, not of elements merely, but of souls ; and of the soul-virtues, which from the beginning of the world have bade the barrel of meal not waste, nor the cruse of oil fail ; and have planted, by waters of comfort, the fruits which are for the healing of nations.

8. And, again, therefore, I must repeat, with insistance,

the claim I have made for the limitation of language to the use made of it by educated men. The word 'carp' could never have multiplied itself into the absurdities of endo-carps and epi-carps, but in the mouths of men who scarcely ever read it in its original letters, and therefore never recognized it as meaning precisely the same thing as 'fructus,' which word, being a little more familiar with, they would have scarcely abused to the same extent; they would not have called a walnut shell an intra-fruct—or a grape skin an extra-fruct; but again, because, though they are accustomed to the English 'fructify,' 'frugivorous'—and 'usufruct,' they are unaccustomed to the Latin 'fruor,' and unconscious therefore that the derivative 'fructus' must always, in right use, mean an *enjoyed* thing, they generalize every mature vegetable product under the term; and we find Dr. Gray coolly telling us that there is no fruit so "likely to be mistaken for a seed," as a grain of corn! a grain, whether of corn, or any other grass, being precisely the vegetable structure to which frutescent change is forever forbidden! and to which the word *seed* is primarily and perfectly applicable!—the thing to be *sown*, not grafted.

9. But to mark this total incapability of frutescent change, and connect the form of the seed more definitely with its dusty treasure, it is better to reserve, when we are speaking with precision, the term 'grain' for the seeds of the grasses: the difficulty is greater in French than in English: because they have no monosyllabic word for the constantly granular 'seed'; but for us the terms are all simple, and already in right use, only not quite clearly enough understood; and there remains only one real difficulty now in our system of nomenclature, that having taken the word 'husk' for the seed-vessel, we are left without a general word for the true fringe of a filbert, or the chaff of a grass. I don't know whether the French 'frange' could be used by them in this sense, if we took it in English botany. But for the present, we can manage well enough without it, one general term, 'chaff,' serving for all the grasses, 'cup' for acorns, and 'fringe' for nuts.

10. But I call this a *real* difficulty, because I suppose, among

the myriads of plants of which I know nothing, there may be forms of the envelope of fruits or seeds which may, for comfort of speech, require some common generic name. One unreal difficulty, or shadow of difficulty, remains in our having no entirely comprehensive name for seed and seed-vessel together than that the botanists now use, 'fruit.' But practically, even now, people feel that they can't gather figs of thistles, and never speak of the fructification of a thistle, or of the fruit of a dandelion. And, re-assembling now, in one view, the words we have determined on, they will be found enough for all practical service, and in such service always accurate, and, usually, suggestive. I repeat them in brief order, with such farther explanation as they need.

11. All ripe products of the life of flowers consist essentially of the Seed and Husk,—these being, in certain cases, sustained, surrounded, or provided with means of motion, by other parts of the plant; or by developments of their own form which require in each case distinct names. Thus the white cushion of the dandelion to which its brown seeds are attached, and the personal parachutes which belong to each, must be separately described for that species of plants; it is the little brown thing they sustain and carry away on the wind, which must be examined as the essential product of the floret;—the 'seed and husk.'

12. Every seed has a husk, holding either that seed alone, or other seeds with it.

Every perfect seed consists of an embryo, and the substance which first nourishes that embryo; the whole enclosed in a sack or other sufficient envelope. Three essential parts altogether.

Every perfect husk, vulgarly pericarp, or 'round-fruit,'—(as periwig, 'round-wig,')—consists of a shell, (vulgarly endocarp,) rind, (vulgarly mesocarp,) and skin, (vulgarly epicarp); three essential parts altogether. But one or more of these parts may be effaced, or confused with another; and in the seeds of grasses they all concentrate themselves into bran.

13. When a husk consists of two or more parts, each of which has a separate shaft and volute, uniting in the pillar

and volute of the flower, each separate piece of the husk is called a 'carpel.' The name was first given by De Candolle, and must be retained. But it continually happens that a simple husk divides into two parts corresponding to the two leaves of the embryo, as in the peach, or symmetrically holding alternate seeds, as in the pea. The beautiful drawing of the pea-shell with its seeds, in Rousseau's botany, is the only one I have seen which rightly shows and expresses this arrangement.

14. A Fruit is either the husk, receptacle, petal, or other part of a flower *external to the seed*, in which chemical changes have taken place, fitting it for the most part to become pleasant and healthful food for man, or other living animals; but in some cases making it bitter or poisonous to them, and the enjoyment of it depraved or deadly. But, as far as we know, it is without any definite office to the seed it contains; and the change takes place entirely to fit the plant to the service of animals.*

In its perfection, the Fruit Gift is limited to a temperate zone, of which the polar limit is marked by the strawberry, and the equatorial by the orange. The more arctic regions produce even the smallest kinds of fruit with difficulty; and the more equatorial, in coarse, oleaginous, or over-luscious masses.

15. All the most perfect fruits are developed *from exquisite forms either of foliage or flower*. The vine leaf, in its generally decorative power, is the most important, both in life and in art, of all that shade the habitations of men. The olive leaf is, without any rival, the most beautiful of the leaves of timber trees; and its blossom, though minute, of extreme beauty. The apple is essentially the fruit of the rose, and the peach of her only rival in her own colour. The cherry and orange blossom are the two types of floral snow.

* A most singular sign of this function is given to the chemistry of the changes, according to a French botanist, to whose carefully and richly illustrated volume I shall in future often refer my readers. "Vers l'époque de la maturité, les fruits *exhalent de l'acide carbonique*. Ils ne présentent plus dès lors aucun dégagement d'oxygène pendant le jour, et *respirent, pour ainsi dire, à la façon des animaux*." (Figuier, 'Histoire des Plantes,' p. 182. 8vo. Paris. Hachette, 1874.)

16. And, lastly, let my readers be assured, the economy of blossom and fruit, with the distribution of water, will be found hereafter the most accurate test of wise national government.

For example of the action of a national government, rightly so called, in these matters, I refer the student to the *Marie-golas of Venice*, translated in *Fors Clavigera* ; and I close this chapter, and this first volume of *Proserpina*, not without pride, in the words I wrote on this same matter eighteen years ago. "So far as the labourer's immediate profit is concerned, it matters not an iron-filing whether I employ him in growing a peach, or in forging a bombshell. But the difference to him is final, whether, when his child is ill, I walk into his cottage, and give it the peach,—or drop the shell down his chimney, and blow his roof off."

THE JOURNAL OF
THE AMERICAN MEDICAL ASSOCIATION
PUBLISHED WEEKLY
CHICAGO, ILL., U.S.A.
1914





PLATE IX.—VIOLA CANINA.

Fast Sketch, to show Grouping of Leaves.

PROSERPINA.

VOL. II.

CHAPTER I.

VIOLA.

1. **ALTHOUGH** I have not been able in the preceding volume to complete, in any wise as I desired, the account of the several parts and actions of plants in general, I will not delay any longer our entrance on the examination of particular kinds, though here and there I must interrupt such special study by recurring to general principles, or points of wider interest. But the scope of such larger inquiry will be best seen, and the use of it best felt, by entering now on specific study.

I begin with the Violet, because the arrangement of the group to which it belongs—Cytherides—is more arbitrary than that of the rest, and calls for some immediate explanation.

2. I fear that my readers may expect me to write something very pretty for them about violets: but my time for writing prettily is long past; and it requires some watching over myself, I find, to keep me even from writing querulously. For while, the older I grow, very thankfully I recognize more and more the number of pleasures granted to human eyes in this fair world, I recognize also an increasing sensitiveness in my temper to anything that interferes with them; and a grievous readiness to find fault—always of course submissively, but very articulately—with whatever Nature seems to me not to have managed to the best of her power;—as, for extreme instance, her late arrangements of frost this spring, destroying all the

beauty of the wood sorrels; nor am I less inclined, looking to her as the greatest of sculptors and painters, to ask, every time I see a narcissus, why it should be wrapped up in brown paper; and every time I see a violet, what it wants with a spur?

3. What *any* flower wants with a spur, is indeed the simplest and hitherto to me unanswerablest form of the question; nevertheless, when blossoms grow in spires, and are crowded together, and have to grow partly downwards, in order to win their share of light and breeze, one can see some reason for the effort of the petals to expand upwards and backwards also. But that a violet, who has her little stalk to herself, and might grow straight up, if she pleased, should be pleased to do nothing of the sort, but quite gratuitously bend her stalk down at the top, and fasten herself to it by her waist, as it were,—this is so much more like a girl of the period's fancy than a violet's, that I never gather one separately but with renewed astonishment at it.

4. One reason indeed there is, which I never thought of until this moment! a piece of stupidity which I can only pardon myself in, because, as it has chanced, I have studied violets most in gardens, not in their wild haunts,—partly thinking their Athenian honour was as a garden flower; and partly being always led away from them, among the hills, by flowers which I could see nowhere else. With all excuse I can furbish up, however, it is shameful that the truth of the matter never struck me before, or at least this bit of the truth—as follows.

5. The Greeks, and Milton, alike speak of violets as growing in meadows (or dales). But the Greeks did so because they could not fancy any delight except in meadows; and Milton, because he wanted a rhyme to nightingale—and, after all, was London bred. But Viola's beloved knew where violets grew in Illyria,—and grow everywhere else also, when they can,—on a *bank*, facing the south.

Just as distinctly as the daisy and buttercup are *meadow* flowers, the violet is a *bank* flower, and would fain grow always on a steep slope, towards the sun. And it is so poised on its stem that it shows, when growing on a slope, the full space

and opening of its flower,—not at all, in any strain of modesty, hiding *itself*, though it may easily be, by grass or mossy stone, ‘half hidden,’—but, to the full, showing itself, and intending to be lovely and luminous, as fragrant, to the uttermost of its soft power.

• Nor merely in its oblique setting on the stalk, but in the reversion of its two upper petals, the flower shows this purpose of being fully seen. (For a flower that *does* hide itself, take a lily of the valley, or the bell of a grape hyacinth, or a cyclamen.) But respecting this matter of petal-reversion, we must now farther state two or three general principles.

• 6. A perfect or pure flower, as a rose, oxalis, or campanula, is always composed of an unbroken whorl, or corolla, in the form of a disk, cup, bell, or, if it draw together again at the lips, a narrow-necked vase. This cup, bell, or vase, is divided into similar petals, (or segments, which are petals carefully joined,) varying in number from three to eight, and enclosed by a calyx whose sepals are symmetrical also.

• An imperfect, or, as I am inclined rather to call it, an ‘injured’ flower, is one in which some of the petals have inferior office and position, and are either degraded, for the benefit of others, or expanded and honoured at the cost of others.

• Of this process, the first and simplest condition is the reversal of the upper petals and elongation of the lower ones, in blossoms set on the side of a clustered stalk. When the change is simply and directly dependent on their position in the cluster, as in *Aurora Regina*,* modifying every bell just in proportion as it declines from the perfected central one, some of the loveliest groups of form are produced which can be seen in any inferior organism : but when the irregularity becomes fixed, and the flower is always to the same extent distorted, whatever its position in the cluster, the plant is to be rightly thought of as reduced to a lower rank in creation.

• 7. It is to be observed, also, that these inferior forms of flower have always the appearance of being produced by some kind of mischief—blight, bite, or ill-breeding ; they never suggest the idea of improving themselves, now, into anything

* Vol. i., p. 162, note.

better ; one is only afraid of their tearing or puffing themselves into something worse. Nay, even the quite natural and simple conditions of inferior vegetable do not in the least suggest, to the unbitten or unblighted human intellect, the notion of development into anything other than their like : one does not expect a mushroom to translate itself into a pineapple, nor a betony to moralize itself into a lily, nor a snapdragon to soften himself into a lilac.

8. It is very possible, indeed, that the recent phrenzy for the investigation of digestive and reproductive operations in plants may by this time have furnished the microscopic malice of botanists with providentially disgusting reasons, or demoniacally nasty necessities, for every possible spur, spike, jag, sting, rent, blotch, flaw, freckle, filth, or venom, which can be detected in the construction, or distilled from the dissolution, of vegetable organism. But with these obscene processes and prurient apparitions the gentle and happy scholar of flowers has nothing whatever to do. I am amazed and saddened, more than I care to say, by finding how much that is abominable may be discovered by an ill-taught curiosity, in the purest things that earth is allowed to produce for us ;—perhaps if we were less reprobate in our own ways, the grass which is our type might conduct itself better, even though *it* has no hope but of being cast into the oven ; in the meantime, healthy human eyes and thoughts are to be set on the lovely laws of its growth and habitation, and not on the mean mysteries of its birth.

9. I relieve, therefore, our presently inquiring souls from any farther care as to the reason for a violet's spur,—or for the extremely ugly arrangements of its stamens and style, invisible unless by vexatious and vicious peeping. You are to think of a violet only in its green leaves, and purple or golden petals ;—you are to know the varieties of form in both, proper to common species ; and in what kind of places they all most fondly live, and most deeply glow.

“ And the recreation of the minde which is taken heereby cannot be but verie good and honest, for they admonish and stir up a man to that which is comely and honest. For

flowers, through their beautie, varietie of colour, and exquisite forme, do bring to a liberali and gentle manly minde the remembrance of honestie, comeliness, and all kinds of vertues. For it would be an unseemely and filthie thing, as a certain wise man saith, for him that doth looke upon and handle faire and beautiful things, and who frequenteth and is conversant in faire and beautiful places, to have his mind not faire, but filthie and deformed."

10. Thus Gerarde, in the close of his introductory notice of the violet,—speaking of things, (honesty, comeliness, and the like,) scarcely now recognized as desirable in the realm of England; but having previously observed that violets are useful for the making of garlands for the head, and posies to smell to;—in which last function I observe they are still pleasing to the British public: and I found the children here, only the other day, munching a confection of candied violet leaves. What pleasure the flower can still give us, uncandied, and unbound, but in its own place and life, I will try to trace through some of its constant laws.

11. And first, let us be clear that the native colour of the violet is violet; and that the white and yellow kinds, though pretty in their place and way, are not to be thought of in generally meditating the flower's quality or power. A white violet is to black ones what a black man is to white ones; and the yellow varieties are, I believe, properly pansies, and belong also to wild districts for the most part; but the true violet, which I have just now called 'black,' with Gerarde, "the blacke or purple violet, hath a great prerogative above others," and all the nobler species of the pansy itself are of full purple, inclining, however, in the ordinary wild violet to blue. In the 'Laws of Fésole,' chap. vii., §§ 20, 21, I have made this dark pansy the representative of purple pure; the *viola odorata*, of the link between that full purple and blue; and the heath-blossom of the link between that full purple and red. The reader will do well, as much as may be possible to him, to associate his study of botany, as indeed all other studies of visible things, with that of painting: but he must remember that he cannot know what violet colour

really is, unless he watch the flower in its *early growth*. It becomes dim in age, and dark when it is gathered—at least, when it is tied in bunches ;—but I am under the impression that the colour actually deadens also,—at all events, no other single flower of the same quiet colour lights up the ground near it as a violet will. The bright hounds-tongue looks merely like a spot of bright paint ; but a young violet glows like painted glass.

12. Which, when you have once well noticed, the two lines of Milton and Shakspeare which seem opposed, will both become clear to you. The said lines are dragged from hand to hand along their pages of pilfered quotations by the hack botanists,—who probably never saw *them*, nor anything else, in Shakspeare or Milton in their lives,—till even in reading them where they rightly come, you can scarcely recover their fresh meaning : but none of the botanists ever think of asking why Perdita calls the violet ‘ dim,’ and Milton ‘ glowing.’

Perdita, indeed, calls it dim, at that moment, in thinking of her own love, and the hidden passion of it, unspeakable ; nor is Milton without some purpose of using it as an emblem of love, mourning,—but, in both cases, the subdued and quiet hue of the flower as an actual tint of colour, and the strange force and life of it as a part of light, are felt to their uttermost.

And observe, also, that both of the poets contrast the violet, in its softness, with the intense marking of the pansy. Milton makes the opposition directly—

“ the pansy, freaked with jet,
The glowing violet.”

Shakspeare shows yet stronger sense of the difference, in the “ purple with Love’s wound ” of the pansy, while the violet is sweet with Love’s hidden life, and sweeter than the lids of Juno’s eyes.

Whereupon, we may perhaps consider with ourselves a little, what the difference is between a violet and a pansy ?

13. Is, I say, and was, and is to come,—in spite of florists, who try to make pansies round, instead of pentagonal ; and

of the wise classifying people, who say that violets and pansies are the same thing—and that neither of them are of much interest! As, for instance, Dr. Lindley in his ‘Ladies’ Botany.’

“Violets—sweet Violets, and Pansies, or Heartsease, represent a small family, with the structure of which you should be familiar; more, however, for the sake of its singularity than for its extent or importance, for the family is a very small one, and there are but few species belonging to it in which much interest is taken. As the parts of the Heartsease are larger than those of the violet, let us select the former in preference for the subject of our study.” Whereupon we plunge instantly into the usual account of things with horns and tails. “The stamens are five in number—two of them, which are in front of the others, are hidden within the horn of the front petal,” etc., etc., etc. (Note in passing, by the ‘horn of the front’ petal he means the ‘spur of the bottom’ one, which indeed does stand in front of the rest,—but if therefore it is to be called the front petal—which is the back one?) You may find in the next paragraph description of a “singular conformation,” and the interesting conclusion that “no one has yet discovered for what purpose this singular conformation was provided.” But you will not, in the entire article, find the least attempt to tell you the difference between a violet and a pansy!—except in one statement—and that false! “The sweet violet will have no rival among flowers, if we merely seek for delicate fragrance; but her sister, the heartsease, who is destitute of all sweetness, far surpasses her in rich dresses and *gaudy*!!! colours.” The heartsease is not without sweetness. There are sweet pansies scented, and dog pansies unscented—as there are sweet violets scented, and dog violets unscented. What is the real difference?

14. I turn to another scientific gentleman—*more* scientific in form indeed, Mr. Grindon,—and find, for another interesting phenomenon in the violet, that it sometimes produces flowers without any petals! and in the pansy, that “the flowers turn towards the sun, and when many are open at once, present a droll appearance, looking like a number of faces all

on the 'qui vive.'" But nothing of the difference between them, except something about 'stipules,' of which "it is important to observe that the leaves should be taken from the middle of the stem—those above and below being variable."

I observe, however, that Mr. Grindon *has* arranged his violets under the letter A, and his pansies under the letter B, and that something may be really made out of him, with an hour or two's work. I am content, however, at present, with his simplifying assurance that of violet and pansy together, "six species grow wild in Britain—or, as some believe, only four—while the analysts run the number up to fifteen."

15. Next I try Loudon's Cyclopædia, which, through all its 700 pages, is equally silent on the business; and next, Mr. Baxter's 'British Flowering Plants,' in the index of which I find neither Pansy nor Heartsease, and only the 'Calathian' Violet, (where on earth is Calathia?) which proves, on turning it up, to be a Gentian.

16. At last, I take my Figuier, (but what should I do if I only knew English?) and find this much of clue to the matter:—

"Qu'est ce que c'est que la Pensée? Cette jolie plante appartient aussi au genre Viola, mais à un section de ce genre. En effet, dans les Pensées, les pétales supérieurs et latéraux sont dirigés en haut, l'inférieur seul est dirigé en bas: et de plus, le stigmaté est urcéole, globuleux."

And farther, this general description of the whole violet tribe, which I translate, that we may have its full value:—

"The violet is a plant without a stem (tige),—(see vol. i., p. 108,)—whose height does not surpass one or two decimetres. Its leaves, radical, or carried on stolons, (vol. i., p. 111,) are sharp, or oval, crenulate, or heart-shape. Its stipules are oval-acuminate, or lanceolate. Its flowers, of sweet scent, of a dark violet or a reddish blue, are carried each on a slender peduncle, which bends down at the summit. Such is, for the botanist, the Violet, of which the poets would give assuredly another description."

17. Perhaps; or even the painters! or even an ordinary

unbotanical human creature ! I must set about my business, at any rate, in my own way, now, as I best can, looking first at things themselves, and then putting this and that together, out of these botanical persons, which they can't put together out of themselves. And first, I go down into my kitchen garden, where the path to the lake has a border of pansies on both sides all the way down, with clusters of narcissus behind them. And pulling up a handful of pansies by the roots, I find them "without stems," indeed, if a stem means a wooden thing ; but I should say, for a low-growing flower, quite lankily and disagreeably stalky ! And, thinking over what I remember about wild pansies, I find an impression on my mind of their being rather more stalky, always, than is quite graceful ; and, for all their fine flowers, having rather a weedy and littery look, and getting into places where they have no business. See, again, vol. i., chap. vi., § 5.



18. And now, going up into my flower and fruit garden, I find (June 2nd, 1881, half-past six, morning,) among the wild saxifrages, which are allowed to grow wherever they like, and the rock strawberries, and Francescas, which are coaxed to grow wherever there is a bit of rough ground for them, a bunch or two of pale pansies, or violets, I don't know well which, by the flower ; but the entire company of them has a ragged, jagged, unpurpose-like look ; extremely,—I should say,—demoralizing to all the little plants in their neighbourhood : and on gathering a flower, I find it is a nasty big thing, all of a feeble blue, and with two things like horns, or thorns, sticking out where its ears would be, if the pansy's frequently monkey face were underneath them. Which I find to be two of the leaves of its calyx 'out of place,' and, at all events, for their part, therefore, weedy, and insolent.

19. I perceive, farther, that this disorderly flower is lifted on a lanky, awkward, springless, and yet stiff flower-stalk ; which is not round, as a flower-stalk ought to be, (vol. i., p. 235,) but obstinately square, and fluted, with projecting edges, like a pillar run thin out of an iron-foundry for a cheap railway station. I perceive also that it has set on it, just before turning down to carry the flower, two little jaggy and in-

definable leaves,—their colour a little more violet than the blossom.

These, and such undeveloping leaves, wherever they occur, are called 'bracts' by botanists, a good word, from the Latin 'bractea,' meaning a piece of metal plate, so thin as to crackle. They seem always a little stiff, like bad parchment,—born to come to nothing—a sort of infinitesimal fairy-lawyer's deed. They ought to have been in my index at p. 237, under the head of leaves, and are frequent in flower structure,—never, as far as one can see, of the smallest use. They are constant, however, in the flower-stalk of the whole violet tribe.

20. I perceive, farther, that this lanky flower-stalk, bending a little in a crabbed, broken way, like an obstinate person tired, pushes itself up out of a still more stubborn, nondescript, hollow angular, dogs-eared gaspipe of a stalk, with a section

something like this,  but no bigger than  with

a quantity of ill-made and ill-hemmed leaves on it, of no describable leaf-cloth or texture,—not cressic, (though the thing does altogether look a good deal like a quite uneatable old watercress); not salvian, for there's no look of warmth or comfort in them; not cauline, for there's no juice in them; not dryad, for there's no strength in them, nor apparent use: they seem only there, as far as I can make out, to spoil the flower, and take the good out of my garden bed. Nobody in the world could draw them, they are so mixed up together, and crumpled and hacked about, as if some ill-natured child had snipped them with blunt scissors, and an ill-natured cow chewed them a little afterwards and left them, proving far too tough or too bitter.

21. Having now sufficiently observed, it seems to me, this incongruous plant, I proceed to ask myself, over it, M. Figuier's question, 'Qu'est-ce c'est qu'un Pensée?' Is this a violet—or a pansy—or a bad imitation of both?

Whereupon I try if it has any scent: and to my much surprise, find it has a full and soft one—which I suppose is what my gardener keeps it for! According to Dr. Lindley, then,

It must be a violet! But according to M. Figuier,—let me see, do its middle petals bend up, or down?

I think I'll go and ask the gardener what *he* calls it.

22. My gardener, on appeal to him, tells me it is the 'Viola Cornuta,' but that he does not know himself if it is violet or pansy. I take my Loudon again, and find there were fifty-three species of violets, known in his days, of which, as it chances, Cornuta is exactly the last.

'Horned violet': I said the green things were *like* horns!—but what is one to say of, or to do to, scientific people, who first call the spur of the violet's petal, horn, and then its calyx points, horns, and never define a 'horn' all the while!

Viola Cornuta, however, let it be; for the name does mean something, and is not false Latin. But whether violet or pansy, I must look farther to find out.

23. I take the Flora Danica, in which I at least am sure of finding whatever is done at all, done as well as honesty and care can; and look what species of violets it gives.

Nine, in the first ten volumes of it; four in their modern sequel (that I know of,—I have had no time to examine the last issues). Namely, in alphabetical order, with their present Latin, or tentative Latin, names; and in plain English, the senses intended by the hapless scientific people, in such their tentative Latin:—

| | | | |
|------|---|--------------------------|----------|
| (1) | Viola Arvensis | Field (Violet) | No. 1748 |
| (2) | " Biflora. | Two-flowered | 46 |
| (3) | " Canina. | Dog | 1453 |
| (3B) | " Canina. Var. Multicaulis (many-stemmed), a very singular sort of violet—if it were so! Its real difference from our dog- violet is in being pale blue, and having a golden centre | | 2646 |
| (4) | " Hirta. | Hairy | 618 |
| (5) | " Mirabilis. | Marvellous | 1045 |
| (6) | " Montana. | Mountain | 1329 |
| (7) | " Odorata. | Odorous | 309 |
| (8) | " Palustris. | Marshy | 83 |

| | | | |
|------|-----------------|---|------|
| (9) | Viola Tricolor. | Three-coloured | 623 |
| (9B) | “ Tricolor. | Var. Arenaria, Sandy Three-coloured | 2647 |
| (10) | “ Elatior. | Taller | 68 |
| (11) | “ Epipsila. | (Heaven knows what: it is Greek, not Latin, and looks as if it meant something between a bishop and a short letter e) | 2405 |

I next run down this list, noting what names we can keep, and what we can't; and what aren't worth keeping, if we could: passing over the varieties, however, for the present, wholly.

- (1) *Arvensis*. Field-violet. Good.
- (2) *Biflora*. A good epithet, but in false Latin. It is to be our *Viola aurea*, golden pansy.
- (3) *Canina*. Dog. Not pretty, but intelligible, and by common use now classical. Must stay.
- (4) *Hirta*. Late Latin slang for *hirsuta*, and always used of nasty places or nasty people; it shall not stay. The species shall be our *Viola Seclusa*,—Monk's violet—meaning the kind of monk who leads a rough life like Elijah's, or the Baptist's, or Esau's—in another kind. This violet is one of the loveliest that grows.
- (5) *Mirabilis*. Stays so; marvellous enough, truly: not more so than all violets; but I am very glad to hear of scientific people capable of admiring anything.
- (6) *Montana*. Stays so.
- (7) *Odorata*. Not distinctive;—nearly classical, however. It is to be our *Viola Regina*, else I should not have altered it.
- (8) *Palustris*. Stays so.
- (9) *Tricolor*. True, but intolerable. The flower is the queen of the true pansies: to be our *Viola Psyche*.
- (10) *Elatior*. Only a variety of our already accepted *Cornuta*.

(11) The last is, I believe, also only a variety of *Palustris*. Its leaves, I am informed in the text, are either "pubescent-reticulate-venose-subreniform," or "lato-cordate-repando-crenate;" and its stipules are "ovate-acuminate-fimbriodenticulate." I do not wish to pursue the inquiry farther.

24. These ten species will include, noting here and there a local variety, all the forms which are familiar to us in Northern Europe, except only two;—these, as it singularly chances, being the *Viola Alpium*, noblest of all the wild pansies in the world, so far as I have seen or heard of them,—of which, consequently, I find no picture, nor notice, in any botanical work whatsoever; and the other, the rock-violet of our own Yorkshire hills.

We have therefore, ourselves, finally then, twelve following species to study. I give them now all in their accepted names and proper order,—the reasons for occasional difference between the Latin and English name will be presently given.

| | | |
|------|----------------------|--------------------|
| (1) | <i>Viola Regina.</i> | Queen violet. |
| (2) | " <i>Psyche.</i> | Ophelia's pansy. |
| (3) | " <i>Alpium.</i> | Freneli's pansy. |
| (4) | " <i>Aurea.</i> | Golden violet. |
| (5) | " <i>Montana.</i> | Mountain violet. |
| (6) | " <i>Mirabilis.</i> | Marvellous violet. |
| (7) | " <i>Arvensis.</i> | Field violet. |
| (8) | " <i>Palustris.</i> | Marsh violet. |
| (9) | " <i>Seclusa.</i> | Monk's violet. |
| (10) | " <i>Canina.</i> | Dog violet. |
| (11) | " <i>Cornuta.</i> | Cow violet. |
| (12) | " <i>Rupestris.</i> | Crag violet. |

25. We will try, presently, what is to be found out of useful, or pretty, concerning all these twelve violets; but must first find out how we are to know which are violets indeed, and which, pansies.

Yesterday, after finishing my list, I went out again to examine *Viola Cornuta* a little closer, and pulled up a full grip of it by the roots, and put it in water in a wash-hand basin, which it filled like a truss of green hay.

Pulling out two or three separate plants, I find each to consist mainly of a jointed stalk of a kind I have not yet described,—roughly, some two feet long altogether; (accurately, one 1 ft. 10½ in.; another, 1 ft. 10 in.; another, 1 ft. 9 in.—but all these measures taken without straightening, and therefore about an inch short of the truth), and divided into seven or eight lengths by clumsy joints where the mangled leafage is knotted on it; but broken a little out of the way at each joint, like a rheumatic elbow that won't come straight, or bend farther; and—which is the most curious point of all in it—it is thickest in the middle, like a viper, and gets quite thin to the root and thin towards the flower; also the lengths between the joints are longest in the middle: here I give them in inches, from the root upwards, in a stalk taken at random.

| | | | | | |
|--------------------|---|---|---|---|----|
| 1st (nearest root) | . | . | . | . | 0¾ |
| 2nd | . | . | . | . | 0¾ |
| 3rd | . | . | . | . | 1½ |
| 4th | . | . | . | . | 1¾ |
| 5th | . | . | . | . | 3 |
| 6th | . | . | . | . | 4 |
| 7th | . | . | . | . | 3½ |
| 8th | . | . | . | . | 3 |
| 9th | . | . | . | . | 2½ |
| 10th | . | . | . | . | 1½ |

1 ft. 9¾ in.

But the thickness of the joints and length of terminal flower stalk bring the total to two feet and about an inch over. I dare not pull it straight, or should break it, but it overlaps my two-foot rule considerably, and there are two inches besides of root, which are merely underground stem, very thin and wretched, as the rest of it is merely root above ground.

very thick and bloated. (I begin actually to be a little awed at it, as I should be by a green snake—only the snake would be prettier.) The flowers also, I perceive, have not their two horns regularly set *in*, but the five spiky calyx-ends stick out between the petals—sometimes three, sometimes four, it may be all five up and down—and produce variously fanged or forked effects, feebly ophidian or diabolic. On the whole, a plant entirely mismanaging itself,—reprehensible and awkward, with taints of worse than awkwardness; and clearly, no true ‘species,’ but only a link.* And it really is, as you will find presently, a link in two directions; it is half violet, half pansy, a ‘cur’ among the Dogs, and a thoughtless thing among the thoughtful. And being so, it is also a link between the entire violet tribe and the Runners—pease, strawberries, and the like, whose glory is in their speed; but a violet has no business whatever to run anywhere, being appointed to stay where it was born, in extremely contented (if not secluded) places. “Half-hidden from the eye?”—no; but desiring attention, or extension, or corpulence, or connection with anybody else’s family, still less.

26. And if, at the time you read this, you can run out and gather a *true* violet, and its leaf, you will find that the flower grows from the very ground, out of a cluster of heart-shaped leaves, becoming here a little rounder, there a little sharper, but on the whole heart-shaped, and that is the proper and essential form of the violet leaf. You will find also that the flower has five petals; and being held down by the bent stalk, two of them bend back and up, as if resisting it; two expand at the sides; and one, the principal, grows downwards, with its attached spur behind. So that the front view of the flower must be *some* modification of this typical arrangement, Fig. M, (for middle form). Now the statement above quoted from Figuier, § 16, means, if he had been able to express himself, that the two lateral petals in the violet are directed downwards, Fig. 11. A, and in the pansy upwards, Fig. 11. C. And that, in the main, is true, and to be fixed well and clearly in your mind. But in the real orders, one

* See ‘Deucalion,’ vol. ii., chap. i., p. 13, § 18.

flower passes into the other through all kinds of intermediate positions of petal, and the plurality of species are of the middle type, Fig. II. B.*

27. Next, if you will gather a real pansy leaf, you will find it—not heart-shape in the least, but sharp oval or spear-shape, with two deep cloven lateral flakes at its springing from the stalk, which, in ordinary aspect, give the plant the haggled and draggled look I have been vilifying it for. These, and such as these, “leaflets at the base of other leaves” (Balfour’s Glossary), are called by botanists ‘stipules.’ I have not allowed the word yet, and am doubtful of allowing it, because it entirely confuses the student’s sense of the Latin ‘stipula’ (see above, vol. i., chap. viii., § 27) doubly and trebly important in its connection with ‘stipular,’ not noticed in that paragraph, but readable in your large Johnson; we shall have more to say of it when we come to ‘straw’ itself.



A



B



C

FIG. II.

28. In the meantime, one *may* think of these things as stipulations for leaves, not fulfilled, or ‘stumps’ or ‘sumphs’ of leaves! But I think I can do better for them. We have already got the idea of *crested* leaves, (see vol. i., plate); now, on each side of a knight’s crest, from earliest Etruscan times down to those of the Scalas, the fashion of armour held, among the nations who wished to make themselves terrible in aspect, of putting cut plates or ‘bracts’ of metal, like dragons’ wings, on each side of the crest. I believe the custom never became Norman or English; it is essentially Greek, Etruscan, or Italian,—the Norman and Dane always wearing a practical cone (see the coins of Canute), and the Frank or English knights the severely plain beavered helmet; the Black Prince’s at Canterbury, and Henry V.’s at Westminster, are kept hitherto by the great fates for us to see. But the Southern knights constantly wore these lateral dragon’s wings;

* I am ashamed to give so rude outlines; but every moment now is valuable to me: careful outline of a dog-violet is given in Plate X.



PLATE X.—*VIOLA CANINA*. STRUCTURAL DETAILS



and if I can find their special name, it may perhaps be substituted with advantage for 'stipule'; but I have not wit enough by me just now to invent a term.

29. Whatever we call them, the things themselves are, throughout all the species of violets, developed in the running and weedy varieties, and much subdued in the beautiful ones; and generally the pansies have them large, with spear-shaped central leaves; and the violets small, with heart-shaped leaves, for more effective decoration of the ground. I now note the characters of each species in their above given order.

30. I. VIOLA REGINA. Queen Violet. Sweet Violet. 'Viola Odorata,' L., Flora Danica, and Sowerby. The latter draws it with golden centre and white base of lower petal; the Flora Danica, all purple. It is sometimes altogether white. It is seen most perfectly for setting off its colour, in group with primrose,—and most luxuriantly, so far as I know, in hollows of the Savoy limestones, associated with the pervenche, which embroiders and illumines them all over. I believe it is the earliest of its race, sometimes called 'Martia,' March violet. In Greece and South Italy even a flower of the winter.

“The Spring is come, the violet's *gone*,
 The first-born child of the early sun.
 With us, she is but a winter's flower;
 The snow on the hills cannot blast her bower,
 And she lifts up her dewy eye of blue
 To the youngest sky of the selfsame hue.
 And when the Spring comes, with her host
 Of flowers, that flower beloved the most
 Shrinks from the crowd that may confuse
 Her heavenly odour, and virgin hues.
 Pluck the others, but still remember
 Their herald out of dim December,—
 The *morning star* of all the flowers,
 The pledge of daylight's lengthened hours,
 Nor, midst the roses, e'er forget
 The virgin, virgin violet.” *

* A careless bit of Byron's, (the last song but one in the 'Deformed Transformed'); but Byron's most careless work is better, by its innate

31. It is the queen, not only of the violet tribe, but of all low-growing flowers, in sweetness of scent—variously applicable and serviceable in domestic economy:—the scent of the lily of the valley seems less capable of preservation or use.

But, respecting these perpetual beneficences and benignities of the sacred, as opposed to the malignant, herbs, whose poisonous power is for the most part restrained in them, during their life, to their juices or dust, and not allowed sensibly to pollute the air, I should like the scholar to re-read pp. 240, 241 of vol. i., and then to consider with himself what a grotesquely warped and gnarled thing the modern scientific mind is, which fiercely busies itself in venomous chemistries that blast every leaf from the forests ten miles round; and yet cannot tell us, nor even think of telling us, nor does even one of its pupils think of asking it all the while, how a violet throws off her perfume!—far less, whether it might not be more wholesome to ‘treat’ the air which men are to breathe in masses, by administration of vale-lilies and violets, instead of charcoal and sulphur!

The closing sentence of the first volume just now referred to—p. 243—should also be re-read; it was the sum of a chapter I had in hand at that time on the Substances and Essences of Plants—which never got finished;—and in trying to put it into small space, it has become obscure: the terms “logically inexplicable” meaning that no words or process of comparison will define scents, nor do any traceable modes of sequence or relation connect them; each is an independent power, and gives a separate impression to the senses. Above all, there is no logic of pleasure, nor any assignable reason for the difference, between loathsome and delightful scent, which makes the fungus foul and the vervain sacred: but one practical conclusion I (who am in all final ways the most prosaic and practical of human creatures) do very solemnly beg my readers to meditate; namely, that although not recognized by

energy, than other people’s most laboured. I suppress, in some doubts about my ‘digamma,’ notes on the Greek violet and the Ion of Euripides;—which the reader will perhaps be good enough to fancy a serious loss to him, and supply for himself.

actual offensiveness of scent, there is no space of neglected land which is not in some way modifying the atmosphere of *all the world*,—it may be, beneficently, as heath and pine,—it may be, malignantly, as Pontine marsh or Brazilian jungle ; but, in one way or another, for good and evil constantly, by day and night, the various powers of life and death in the plants of the desert are poured into the air, as vials of continual angels : and that no words, no thoughts can measure, nor imagination follow, the possible change for good which energetic and tender care of the wild herbs of the field and trees of the wood might bring, in time, to the bodily pleasure and mental power of Man.

32. II. VIOLA PSYCHE. Ophelia's Pansy.

The wild heart's-ease of Europe ; its proper colour an exquisitely clear purple in the upper petals, gradated into deep blue in the lower ones ; the centre, gold. Not larger than a violet, but perfectly formed, and firmly set in all its petals. Able to live in the driest ground ; beautiful in the coast sand-hills of Cumberland, following the wild geranium and burnet rose : and distinguished thus by its power of life, in waste and dry places, from the violet, which needs kindly earth and shelter.

Quite one of the most lovely things that Heaven has made, and only degraded and distorted by any human interference ; the swollen varieties of it produced by cultivation being all gross in outline and coarse in colour by comparison.

It is badly drawn even in the 'Flora Danica,' No. 623, considered there apparently as a species escaped from gardens ; the description of it being as follows :—

"*Viola tricolor hortensis repens, flore purpureo et cœruleo, C. B. P., 199.*" (I don't know what C. B. P. means.) "Pessim, juxta villas."

"*Viola tricolor, caule triquetro diffuso, foliis oblongis incisis, stipulis pinnatifidis,*" Linn. *Systema Naturæ*, 185.

33. "Near the country farms"—does the Danish botanist mean?—the more luxuriant weedy character probably acquired by it only in such neighbourhood ; and, I suppose, various confusion and degeneration possible to it beyond other

plants when once it leaves its wild home. It is given by Sibthorpe from the Trojan Olympus, with an exquisitely delicate leaf; the flower described as "triste et pallide violaceus," but coloured in his plate full purple; and as he does not say whether he went up Olympus to gather it himself, or only saw it brought down by the assistant whose lovely drawings are yet at Oxford, I take leave to doubt his epithets. That this should be the only Violet described in a 'Flora Græca' extending to ten folio volumes, is a fact in modern scientific history which I must leave the Professor of Botany and the Dean of Christ Church to explain.

34. The English varieties seem often to be yellow in the lower petals, (see Sowerby's plate, 1287 of the old edition); crossed, I imagine, with *Viola Aurea*, (but see under *Viola Rupestris*, No. 12); the names, also, varying between tricolor and bicolor—with no note anywhere of the three colours, or two colours, intended!

The old English names are many.—'Love in idleness,'—making *Lysander*, as *Titania*, much wandering in mind, and for a time mere 'Kits run the street' (or run the wood?)—"Call me to you" (*Gerarde*, ch. 299, *Sowerby*, No. 178), with 'Herb Trinity,' from its three colours, blue, purple, and gold, variously blended in different countries? 'Three faces under a hood' describes the English variety only. Said to be the ancestress of all the florists' pansies, but this I much doubt, the next following species being far nearer the forms most chiefly sought for.

35. III. *VIOLA ALPINA*. 'Freneli's Pansy'—my own name for it, from *Gotthelf's Freneli*, in 'Ulric the Farmer'; the entirely pure and noble type of the Bernese maid, wife, and mother.

The pansy of the Wengern Alp in specialty, and of the higher, but still rich, Alpine pastures. Full dark-purple; at least an inch across the expanded petals; I believe, the '*Mater Violarum*' of *Gerarde*; and true black violet of *Virgil*, remaining in Italian '*Viola Mammola*' (*Gerarde*, ch. 298).

36. IV. *VIOLA AUREA*. Golden Violet. Biflora usually; but its brilliant yellow is a much more definite characteristic; and

needs insisting on, because there is a 'Viola lutea' which is not yellow at all; named so by the garden-florists. My *Viola aurea* is the Rock-violet of the Alps; one of the bravest, brightest, and dearest of little flowers. The following notes upon it, with its summer companions, a little corrected from my diary of 1877, will enough characterize it.

"June 7th.—The cultivated meadows now grow only dandelions—in frightful quantity too; but, for wild ones, primula, bell gentian, golden pansy, and anemone,—*Primula farinosa* in mass, the pansy pointing and vivifying in a petulant sweet way, and the bell gentian here and there deepening all,—as if indeed the sound of a deep bell among lighter music.

"Counted in order, I find the effectively constant flowers are eight; * namely,

"1. The golden anemone, with richly cut large leaf; primrose colour, and in masses like primrose, studded through them with bell gentian, and dark purple orchis.

"2. The dark purple orchis, with bell gentian in equal quantity, say six of each in square yard, broken by sparklings of the white orchis and the white grass flower; the richest piece of colour I ever saw, touched with gold by the geum.

"3 and 4. These will be white orchis and the grass flower. †

"5. Geum—everywhere, in deep, but pure, gold, like pieces of Greek mosaic.

"6. Soldanella, in the lower meadows, delicate, but not here in masses.

"7. *Primula Alpina*, divine in the rock clefts, and on the ledges changing the grey to purple,—set in the dripping caves with

"8. *Viola* (*pertinax*—*pert*); I want a Latin word for various studies—failures all—to express its saucy little stuck-up way,

* Nine; I see that I missed count of *P. farinosa*, the most abundant of all.

† "A feeble little quatrefoil—growing one on the stem, like a *Parnassia*, and looking like a *Parnassia* that had dropped a leaf. I think it drops one of its own four, mostly, and lives as three-fourths of itself, for most of its time. Stamens pale gold. Root-leaves, three or four, grass-like; growing among the moist moss chiefly."

and exquisitely trim peltate leaf. I never saw such a lovely perspective line as the pure front leaf profile. Impossible also to get the least of the spirit of its lovely dark brown fibre markings. Intensely golden these dark fibres, just browning the petal a little between them."

And again in the defile of Gondo, I find "*Viola (saxatilis?)* name yet wanted ;—in the most delicate studding of its round leaves, like a small fern more than violet, and bright sparkle of small flowers in the dark dripping hollows. Assuredly delights in shade and distilling moisture of rocks."

I found afterwards a much larger yellow pansy on the Yorkshire high limestones ; with vigorously black crowfoot marking on the lateral petals.

37. V. *VIOLA MONTANA*. Mountain Violet.

Flora Danica, 1329. Linnæus, No. 13, "*Caulibus erectis, foliis cordato-lanceolatis, floribus serioribus apetalis,*" i.e., on erect stems, with leaves long heart-shape, and its later flowers without petals—not a word said of its earlier flowers which have got those unimportant appendages ! In the plate of the Flora it is a very perfect transitional form between violet and pansy, with beautifully firm and well-curved leaves, but the colour of blossom very pale. "In subalpinis Norvegiæ passim," all that we are told of it, means I suppose, in the lower Alpine pastures of Norway ; in the Flora Suecica, p. 306, habitat in Lapponica, juxta Alpes.

38. VI. *VIOLA MIRABILIS*. Flora Danica, 1045. A small and exquisitely formed flower in the balanced cinquefoil intermediate between violet and pansy, but with large and superbly curved and pointed leaves. It is a mountain violet, but belonging rather to the mountain woods than meadows. "In sylvaticis in Toten, Norvegiæ."

Loudon, 3056, "Broad-leaved : Germany."

Linnæus, Flora Suecica, 789, says that the flowers of it which have perfect corolla and full scent often bear no seed, but that the later 'cauline' blossoms, without petals, are fertile. "*Caulini vero apetali fertiles sunt, et seriores. Habitat passim Upsaliæ.*"

I find this, and a plurality of other species, indicated by

Linnaeus as having triangular stalks, "caule triquetro," meaning, I suppose, the kind sketched in Figure 1 above.

39. VII. VIOLA ARVENSIS. Field Violet. Flora Danica, 1748. A coarse running weed; nearly like *Viola Cornuta*, but feebly lilac and yellow in colour. In dry fields, and with corn.

Flora Suecica, 791; under titles of *Viola 'tricolor'* and '*bicolor arvensis*,' and *Herba Trinitatis*. Habitat ubique in *sterilibus arvis*: "Planta vix datur in qua evidentius perspicitur generationis opus, quam in hujus cavo apertoque stigmatē."

It is quite undeterminable, among present botanical instructors, how far this plant is only a rampant and over-indulged condition of the true pansy (*Viola Psyche*); but my own scholars are to remember that the true pansy is full purple and blue with golden centre; and that the disorderly field varieties of it, if indeed not scientifically distinguishable, are entirely separate from the wild flower by their scattered form and faded or altered colour. I follow the *Flora Danica* in giving them as a distinct species.

40. VIII. VIOLA PALUSTRIS. Marsh Violet. Flora Danica, 83. As there drawn, the most finished and delicate in form of all the violet tribe; warm white, streaked with red; and as pure in outline as an oxalis, both in flower and leaf; it is like a violet imitating oxalis and anagallis.

In the *Flora Suecica*, the petal-markings are said to be black; in '*Viola lactea*' a connected species, (Sowerby, 45,) purple. Sowerby's plate of it under the name '*palustris*' is pale purple veined with darker; and the spur is said to be 'honey-bearing,' which is the first mention I find of honey in the violet. The habitat given, sandy and turfy heaths. It is said to grow plentifully near Croydon.

Probably, therefore, a violet belonging to the chalk, on which nearly all herbs that grow wild—from the grass to the bluebell—are singularly sweet and pure. I hope some of my botanical scholars will take up this question of the effect of different rocks on vegetation, not so much in bearing different species of plants, as different characters of each species.*

* The great work of Lecoq, '*Geographie Botanique*,' is of priceless value; but treats all on too vast a scale for our purposes.

41. IX. VIOLA SECLUSA. Monk's Violet. "Hirta," *Flora Danica*, 618, "In fruticetis raro." A true wood violet, full but dim in purple. Sowerby, 894, makes it paler. The leaves very pure and severe in the Danish one;—longer in the English. "Clothed on both sides with short, dense, hoary hairs."

Also belongs to chalk or limestone only (Sowerby).

X. VIOLA CANINA. Dog Violet. I have taken it for analysis in my two plates, because its grace of form is too much despised, and we owe much more of the beauty of spring to it, in English mountain ground, than to the *Regina*.

XI. VIOLA CORNUTA. Cow Violet. Enough described already.

XII. VIOLA RUPESTRIS. Crag Violet. On the high limestone moors of Yorkshire, perhaps only an English form of *Viola Aurea*, but so much larger, and so different in habit—growing on dry breezy downs, instead of in dripping caves—that I allow it, for the present, separate name and number.*

42. 'For the present,' I say all this work in 'Proserpina' being merely tentative, much to be modified by future students, and therefore quite different from that of 'Deucalion,' which is authoritative as far as it reaches, and will stand out like a quartz dyke, as the sandy speculations of modern gossiping geologists get washed away.

But in the meantime, I must again solemnly warn my girl-readers against all study of floral genesis and digestion. How far flowers invite, or require, flies to interfere in their family affairs—which of them are carnivorous—and what forms of pestilence or infection are most favourable to some vegetable and animal growths,—let them leave the people to settle who like, as *Toinette* says of the Doctor in the 'Malade Imaginaire'—"y mettre le nez." I observe a paper in the last 'Contemporary Review,' announcing for a discovery patent to all mankind that the colours of flowers were made "to attract insects"! †

* It is, I believe, Sowerby's *Viola Lutea*, 721 of the old edition, there painted with purple upper petals; but he says in the text, "Petals either all yellow, or the two uppermost are of a blue purple, the rest yellow with a blue tinge: very often the whole are purple."

† Did the wretch never hear bees in a lime tree then, or ever see one on a star gentian?

They will next hear that the rose was made for the canker, and the body of man for the worm.

43. What the colours of flowers, or of birds, or of precious stones, or of the sea and air, and the blue mountains, and the evening and the morning, and the clouds of Heaven, were given for—they only know who can see them and can feel, and who pray that the sight and the love of them may be prolonged, where cheeks will not fade, nor sunsets die.

44. And now, to close, let me give you some fuller account of the reasons for the naming of the order to which the violet belongs, 'Cytherides.'

You see that the Uranides, are, as far as I could so gather them, of the pure blue of the sky ; but the Cytherides of altered blue ;—the first, Viola, typically purple ; the second, Veronica, pale blue with a peculiar light ; the third, *Giulietta*, deep blue, passing strangely into a subdued green before and after the full life of the flower.

All these three flowers have great strangenesses in them, and weaknesses ; the Veronica most wonderful in its connection with the poisonous tribe of the foxgloves ; the *Giulietta*, alone among flowers in the action of the shielding leaves ; and the Viola, grotesque and inexplicable in its hidden structure, but the most sacred of all flowers to earthly and daily Love, both in its scent and glow.

Now, therefore, let us look completely for the meaning of the two leading lines,—

“ Sweeter than the lids of Juno's eyes,
Or Cytherea's breath.”

45. Since, in my present writings, I hope to bring into one focus the pieces of study fragmentarily given during past life, I may refer my readers to the first chapter of the 'Queen of the Air' for the explanation of the way in which all great myths are founded, partly on physical, partly on moral fact,—so that it is not possible for persons who neither know the aspect of nature, nor the constitution of the human soul, to understand a word of them. Naming the Greek Gods, therefore, you have first to think of the physical power they repre-

sent. When Horace calls Vulcan 'Avidus,' he thinks of him as the power of Fire; when he speaks of Jupiter's red right hand, he thinks of him as the power of rain with lightning; and when Homer speaks of Juno's dark eyes, you have to remember that she is the softer form of the rain power, and to think of the fringes of the rain-cloud across the light of the horizon. Gradually the idea becomes personal and human in the "Dove's eyes within thy locks,"* and "Dove's eyes 'by the river of waters'" of the Song of Solomon.

46. "Or Cytherea's breath,"—the two thoughts of softest glance, and softest kiss, being thus together associated with the flower: but note especially that the Island of Cythera was dedicated to Venus because it was the chief, if not the only Greek island, in which the purple fishery of Tyre was established; and in our own minds should be marked not only as the most southern fragment of true Greece, but the virtual continuation of the chain of mountains which separate the Spartan from the Argive territories, and are the natural home of the brightest Spartan and Argive beauty which is symbolized in Helen.

47. And, lastly, in accepting for the order this name of Cytherides, you are to remember the names of Viola and Julietta, its two limiting families, as those of Shakspeare's two most loving maids—the two who love simply, and to the death: as distinguished from the greater natures in whom earthly Love has its due part, and no more; and farther still from the greatest, in whom the earthly love is quiescent, or subdued, beneath the thoughts of duty and immortality.

It may be well quickly to mark for you the levels of loving temper in Shakspeare's maids and wives, from the greatest to the least.

48. 1. Isabel. All earthly love, and the possibilities of it, held in absolute subjection to the laws of God, and the judgments of His will. She is Shakspeare's only 'Saint.' Queen Catherine, whom you might next think of, is only an ordinary

* Septuagint, "the eyes of doves out of thy silence." Vulgate, "the eyes of doves, besides that which is hidden in them." Meaning—the *dim* look of love, beyond all others in sweetness.

woman of trained religious temper:—her maid of honour gives Wolsey a more Christian epitaph.

2. Cordelia. The earthly love consisting in diffused compassion of the universal spirit; not in any conquering, personally fixed, feeling.

“ Mine enemy’s dog,

Though he had bit me, should have stood that night
Against my fire.”

These lines are spoken in her hour of openest direct expression; and are *all* Cordelia.

Shakspeare clearly does not mean her to have been supremely beautiful in person; it is only her true lover who calls her ‘fair’ and ‘fairest’—and even that, I believe, partly in courtesy, after having the instant before offered her to his subordinate duke; and it is only *his* scorn of her which makes France fully care for her.

“ Gods, Gods, ’tis strange that from their cold neglect
My love should kindle to inflamed respect!”

Had she been entirely beautiful, he would have honoured her as a lover should, even before he saw her despised; nor would she ever have been so despised—or by her father, misunderstood. Shakspeare himself does not pretend to know where her girl-heart was,—but I should like to hear how a great actress would say the “Peace be with Burgundy!”

3. Portia. The maidenly passion now becoming great, and chiefly divine in its humility, is still held absolutely subordinate to duty; no thought of disobedience to her dead father’s intention is entertained for an instant, though the temptation is marked as passing, for that instant, before her crystal strength. Instantly, in her own peace, she thinks chiefly of her lover’s;—she is a perfect Christian wife in a moment, coming to her husband with the gift of perfect Peace,—

“ Never shall you lie by Portia’s side
With an unquiet soul.”

She is highest in intellect of all Shakspeare’s women, and this is the root of her modesty; her ‘unlettered girl’ is like

Newton's simile of the child on the sea-shore. Her perfect wit and stern judgment are never disturbed for an instant by her happiness : and the final key to her character is given in her silent and slow return from Venice, where she stops at every wayside shrine to pray.

4. Hermione. Fortitude and Justice personified, with unwearying affection. She is Penelope, tried by her husband's fault as well as error.

5. Virgilia. Perfect type of wife and mother, but without definiteness of character, nor quite strength of intellect enough entirely to hold her husband's heart. Else, she had saved him : he would have left Rome in his wrath—but not her. Therefore, it is his mother only who bends him : but she cannot save.

6. Imogen. The ideal of grace and gentleness ; but weak ; enduring too mildly, and forgiving too easily. But the piece is rather a pantomime than play, and it is impossible to judge of the feelings of St. Columba, when she must leave the stage in half a minute after mistaking the headless clown for headless Arlecchino.

7. Desdemona, Ophelia, Rosalind. They are under different conditions from all the rest, in having entirely heroic and faultless persons to love. I can't class them, therefore,—fate is too strong, and leaves them no free will.

8. Perdita, Miranda. Rather mythic visions of maiden beauty than mere girls.

9. Viola and Juliet. Love the ruling power in the entire character : wholly virginal and pure, but quite earthly, and recognizing no other life than his own. Viola is, however, far the noblest. Juliet will die unless Romeo loves *her* : "If he be wed, the grave is like to be my wedding bed ;" but Viola is ready to die for the happiness of the man who does *not* love her ; faithfully doing his messages to her rival, whom she examines strictly for his sake. It is not in envy that she says, "Excellently done,—if God did all." The key to her character is given in the least selfish of all lover's songs, the one to which the Duke bids her listen :

“Mark it, Cesario,—it is old and plain,
 The spinsters and the knitters in the sun,
 And the free maids, that *weave their thread with bones*,
 Do use to chaunt it.”

(They, the unconscious Fates, weaving the fair vanity of life with death); and the burden of it is—

“My part of Death, no one so true
 Did share it.”

Therefore she says, in the great first scene, “Was not *this* love indeed?” and in the less heeded closing one, her heart then happy with the knitters in the *sun*,

“And all those sayings will I over-swear,
 And all those swearings keep as true in soul
 As doth that orb'd continent the Fire
 That severs day from night.”

Or, at least, did once sever day from night,—and perhaps does still in Illyria. Old England must seek new images for her loves from gas and electric sparks,—not to say furnace fire.

I am obliged, by press of other work, to set down these notes in cruel shortness: and many a reader may be disposed to question utterly the standard by which the measurement is made. It will not be found, on reference to my other books, that they encourage young ladies to go into convents; or undervalue the dignity of wives and mothers. But, as surely as the sun *does* sever day from night, it will be found always that the noblest and loveliest women are dutiful and religious by continual nature; and their passions are trained to obey them; like their dogs. Homer, indeed, loves Helen with all his heart, and restores her, after all her naughtiness, to the queenship of her household; but he never thinks of her as Penelope's equal, or Iphigenia's. Practically, in daily life, one often sees married women as good as saints; but rarely, I think, unless they have a good deal to bear from their husbands. Sometimes also, no doubt, the husbands have some trouble in managing St. Cecilia or St. Elizabeth; of which questions I shall be obliged to speak more seriously in another

place: content, at present, if English maids know better, by Proserpina's help, what Shakspeare meant by the dim, and Milton by the glowing, violet.

CHAPTER II.

PINGUICULA.

(Written in early June, 1881.)

1. ON the rocks of my little stream, where it runs, or leaps, through the moorland, the common *Pinguicula* is now in its perfectest beauty; and it is one of the offshoots of the violet tribe which I have to place in the minor collateral groups of *Viola* very soon, and must not put off looking at it till next year.

There are three varieties given in Sowerby: 1. *Vulgaris*, 2. Greater-flowered, and 3. *Lusitanica*, white, for the most part, pink, or 'carnea,' sometimes: but the proper colour of the family is violet, and the perfect form of the plant is the 'vulgar' one. The larger-flowered variety is feebler in colour, and ruder in form: the white Spanish one, however, is very lovely, as far as I can judge from Sowerby's (*old* Sowerby's) pretty drawing.

The 'frequent' one (I shall usually thus translate '*vulgaris*'), is not by any means so 'frequent' as the Queen violet, being a true wild-country, and mostly Alpine, plant; and there is also a real '*Pinguicula Alpina*,' which we have not in England, who might be the Regina, if the group were large enough to be reigned over: but it is better not to affect Royalty among these confused, intermediate, or dependent families.

2. In all the varieties of *Pinguicula*, each blossom has one stalk only, growing from the *ground*; and you may pull all the leaves away from the base of it, and keep the flower only, with its bunch of short fibrous roots, half an inch long; looking as if bitten at the ends. Two flowers, characteristically, —three and four very often, —spring from the same root, in places where it grows luxuriantly; and luxuriant growth

means that clusters of some twenty or thirty stars may be seen on the surface of a square yard of boggy ground, quite to its mind ; but its real glory is in harder life, in the crannies of well-wetted rock.

3. What I have called 'stars' are irregular clusters of approximately, or tentatively, five aloeine ground leaves, of very pale green,—they may be six or seven, or more, but always run into a rudely pentagonal arrangement, essentially first trine, with two succeeding above. Taken as a whole the *plant* is really a main link between violets and Droseras ; but the *flower* has much more violet than Drosera in the make of it,—spurred, and *five-petaled*,* and held down by the top of its bending stalk as a violet is ; only its upper two petals are not reverted—the calyx, of a dark sappy green, holding them down, with its three front sepals set exactly like a strong

* When I have the chance, and the time, to submit the proofs of 'Proserpina' to friends who know more of Botany than I, or have kindness enough to ascertain debateable things for me, I mean in future to do so,—using the letter A to signify Amicus, generally ; with acknowledgment by name, when it is permitted, of especial help or correction. Note first of this kind : I find here on this word, 'five-petaled,' as applied to Pinguicula, "Qy. two-lipped ? it is monopetalous, and monosepalous, the calyx and corolla being each all in one piece."

Yes ; and I am glad to have the observation inserted. But my term, 'five-petaled,' must stand. For the question with me is always first, not how the petals are connected, but how many they are. Also I have accepted the term *petal*—but never the word *lip*—as applied to flowers. The generic term 'Labiata' is cancelled in 'Proserpina,' 'Vestales' being substituted ; and these flowers, when I come to examine them, are to be described, not as divided into two lips, but into hood, apron, and side pockets. Farther, the depth to which either calyx or corolla is divided, and the firmness with which the petals are attached to the torus, may, indeed, often be an important part of the plant's description, but ought not to be elements in its definition. Three-petaled and three-sepaled, four-petaled and four-sepaled, five-petaled and five-sepaled, etc., etc., are essential—with me. primal—elements of definition ; next, whether resolute or stellar in their connection ; next, whether round or pointed, etc. Fancy, for instance, the fatality to a rose of pointing its petals, and to a lily, of rounding them ! But how deep out, or how hard holding, is quite a minor question.

Farther, that all plants *are* petaled and sepaled, and never mere cups in saucers, is a great fact. not to be dwelt on in a note

trident, its two backward sepals clasping the spur. There are often six sepals, four to the front, but the normal number is five. Tearing away the calyx, I find the flower to have been held by it as a lion might hold his prey by the loins if he missed its throat; the blue petals being really campanulate, and the flower best described as a dark bluebell, seized and crushed almost flat by its own calyx in a rage. Pulling away now also the upper petals, I find that what are in the violet the lateral and well-ordered fringes, are here thrown mainly on the lower (largest) petal near its origin, and opposite the point of the seizure by the calyx, spreading from this centre over the surface of the lower petals, partly like an irregular shower of fine Venetian glass broken, partly like the wild-flung Medusa-like embroidery of the white Lucia.*

4. The calyx is of a dark *soppy* green, I said; like that of sugary preserved citron; the root leaves are of green just as soppy, but pale and yellowish, as if they were half decayed; the edges curled up and, as it were, water-shrivelled, as one's fingers shrivel if kept too long in water. And the whole plant looks as if it had been a violet unjustly banished to a bog, and obliged to live there—not for its own sins, but for some Emperor Pansy's, far away in the garden,—in a partly boggy, partly hoggish manner, drenched and desolate; and with something of demoniac temper got into its calyx, so that it quarrels with, and bites the corolla;—something of gluttonous and greasy habit got into its leaves; a discomfortable sensuality, even in its desolation. Perhaps a penguin-ish life would be truer of it than a piggish, the *nest* of it being indeed on the rock, or morassy rock-investiture, like a sea-bird's on her rock ledge.

5. I have hunted through seven treatises on botany, namely Loudon's Encyclopædia, Balfour, Grindon, Oliver, Baxter of Oxford, Lindley ('Ladies' Botany'), and Figuier, without being able to find the meaning of 'Lentibulariaceæ,' to which

* Our 'Lucia Nivea,' 'Blanche Lucy;' in present botany, Bog bean! having no connection whatever with any manner of beau, but only a slight resemblance to bean-leaves in its own lower ones. Compare Ch. IV. § 11.

tribe the *Pinguicula* is said by them all (except Figuiet) to belong. It may perhaps be in Sowerby; * but these above-named treatises are precisely of the kind with which the ordinary scholar must be content: and in all of them he has to learn this long, worse than useless, word, under which he is betrayed into classing together two orders naturally quite distinct, the Butterworts and the Bladderworts.

Whatever the name may mean—it is bad Latin. There is such a word as *Lenticularis*—there is no *Lentibularis*; and it must positively trouble us no longer. †

The Butterworts are a perfectly distinct group—whether small or large, always recognizable at a glance. Their proper Latin name will be *Pinguicula*, (plural *Pinguiculæ*.)—their

* It is not. (Resolute negative from A., unsparing of time for me; and what a state of things it all signifies!)

† With the following three notes, 'A' must become a definitely and gratefully interpreted letter. I am indebted for the first, conclusive in itself, but variously supported and confirmed by the two following, to R. J. Mann, Esq., M.D., long ago a pupil of Dr. Lindley's, and now on the council of Whitelands College, Chelsea:—for the second, to Mr. Thomas Moore, F.L.S., the kind Keeper of the Botanic Garden at Chelsea; for the third, which will be farther on useful to us, to Miss Kemm, the botanical lecturer at Whitelands.

(1) There is no explanation of *Lenticulariaceæ* in Lindley's 'Vegetable Kingdom.' He was not great in that line. The term is, however, taken from *Lenticula*, the lentil, in allusion to the lentil-shaped air-bladders of the typical genus *Utricularia*.

The change of the c into b may possibly have been made only from some euphonic fancy of the contriver of the name, who, I think, was Rich.

But I somewhat incline myself to think that the *tibia*, a pipe or flute, may have had something to do with it. The *tibia* may possibly have been diminished into a little pipe by a stretch of licence, and have become *tibula*: [but *tibulus* is a kind of pine tree in Pliny]; when *Lentibula* would be the lens or lentil shaped pipe or bladder. I give you this only for what it is worth. The *lenticula*, as a derivation, is reliable and has authority.

Lenticula, a lentil, a freckly eruption; *lenticularis*, lentil-shaped; so the nat. ord. ought to be (if this be right) *lenticulariaceæ*.

(2) BOTANIC GARDENS, CHELSEA, Feb. 14, 1882.

Lentibularia is an old generic name of Tournefort's, which has been superseded by *utricularia*, but, oddly enough, has been retained in the

English, Bog-Violet, or, more familiarly, Butterwort; and their French, as at present, *Grassette*.

The families to be remembered will be only five, namely,

1. *Pinguicula Major*, the largest of the group. As bog plants, Ireland may rightly claim the noblest of them, which certainly grow there luxuriantly, and not (I believe) with us. Their colour is, however, more broken and less characteristic than that of the following species.

2. *Pinguicula Violacea*: Violet-coloured Butterwort, (instead of 'vulgaris,') the common English and Swiss kind above noticed.

3. *Pinguicula Alpina*: Alpine Butterwort, white and much smaller than either of the first two families; the spur especially small, according to D. 453. Much rarer, as well as smaller, than the other varieties in Southern Europe. "In Britain, known only upon the moors of Roschaugh, Rosshire, where the progress of cultivation seems likely soon to efface it. (Grindon.)

4. *Pinguicula Pallida*: Pale Butterwort. From Sowerby's drawing, (135, vol. iii.,) it would appear to be the most delicate and lovely of all the group. The leaves, "like those of other species, but rather more delicate and pellucid, reticulated with red veins, and much involute in the margin. Tube of the corolla, yellow, streaked with red, (the streaks like those of a pansy); the petals, pale violet. It much resem-

name of the order *lentibularæ*; but it probably comes from *lenticula*, which signifies the little root bladders, somewhat resembling lentils.

(3) 'Manual of Scientific Terms,' Stormonth, p. 234.

Lentibulariaceæ, neuter, plural.

(*Lenticula*, the shape of a lentil; from *lens*, a lentil.) The Butterwort family, an order of plants so named from the lenticular shape of the air-bladders on the branches of *utricularia*, one of the genera. (But observe that the *Butterworts* have nothing of the sort, any of them.—R.)

Loudon.—"Floaters."

Lindley.—"Sometimes with whorled vesicles."

In Nuttall's Standard (?) Pronouncing Dictionary, it is given,—

Lenticularææ, a nat. ord. of marsh plants, which thrive in water or marshes.

bles *Villosa*, (our *Minima*, No. 5,) in many particulars, the stem being hairy, and in the lower part the hairs tipped with a viscid fluid, like a sundew. But the *Villosa* has a slender sharp spur; and in this the spur is blunt and thick at the end." (Since the hairy stem is not peculiar to *Villosa*, I take for her, instead, the epithet *Minima*, which is really definitive.)

The pale one is commonly called '*Lusitanica*,' but I find no direct notice of its Portuguese habitation. Sowerby's plant came from Blandford, Dorsetshire; and Grindon says it is frequent in Ireland, abundant in Arran, and extends on the western side of the British island from Cornwall to Cape Wrath. My epithet, *Pallida*, is secure, and simple, wherever the plant is found.

5. *Pinguicula Minima*: Least Butterwort; in D. 1021 called *Villosa*, the *scape* of it being hairy. I have not yet got rid of this absurd word '*scape*,' meaning, in botanist's Latin, the flower-stalk of a flower growing out of a cluster of leaves on the ground. It is a bad corruption of '*sceptre*,' and especially false and absurd, because a true sceptre is necessarily branched.* In '*Proserpina*,' when it is spoken of distinctively, it is called '*virgula*' (see vol. i., pp. 112, 115, 116). The hairs on the *virgula* are in this instance so minute, that even with a lens I cannot see them in the Danish plate: of which Fig. 3 is a rough translation into woodcut, to show the grace and mien of the little thing. The trine leaf cluster is characteristic, and the folding up of the leaf edges. The flower, in the Danish plate, full purple. Abundant in east of *Finmark* (Finland?), but *always growing in marsh moss*, (*Sphagnum palustre*.)



FIG. 3.

6. I call it '*Minima*' only, as the least of the five here named: without putting forward any claim for it to be the smallest *pinguicula* that ever was or will be. In such sense

* More accurately, shows the pruned roots of branches,—*ἐπειδὴ πρῶτα τομὴν ἐν ὄρεσσι λέλοιπεν*. The *pruning* is the mythic expression of the subduing of passion by rectorial law.

only, the epithets *minima* or *maxima* are to be understood when used in 'Proserpina': and so also, every statement and every principle is only to be understood as true or tenable, respecting the plants which the writer has seen, and which he is sure that the reader can easily see: liable to modification to any extent by wider experience; but better first learned securely within a narrow fence, and afterwards trained or fructified, along more complex trellises.

7. And indeed my readers—at least, my newly found readers—must note always that the only power which I claim for any of my books, is that of being right and true as far as they reach. None of them pretend to be Kosmoses;—none to be systems of Positivism or Negativism, on which the earth is in future to swing instead of on its old worn-out poles;—none of them to be works of genius;—none of them to be, more than all true work *must* be, pious;—and none to be, beyond the power of common people's eyes,* ears, and noses, 'æsthetic.' They tell you that the world is *so* big, and can't be made bigger—that you yourself are also so big, and can't be made bigger, however you puff or bloat yourself; but that, on modern mental nourishment, you may very easily be made smaller. They tell you that two and two are four, that ginger is hot in the mouth, that roses are red, and smuts black. Not themselves assuming to be pious, they yet assure you that there is such a thing as piety in the world, and that it is wiser than impiety; and not themselves pretending to be works of genius, they yet assure you that there is such a thing as genius in the world, and that it is meant for the light and delight of the world.

8. Into these repetitions of remarks on my work, often made before, I have been led by an unlucky author who has just sent me his book, advising me that it is "neither critical nor sentimental" (he had better have said in plain English "without either judgment or feeling"), and in which nearly

* The bitter sorrow with which I first recognized the extreme rarity of finely-developed organic sight is expressed enough in the lecture on the *Mystery of Life*, added in the large edition of 'Sesame and Lilies.'

the first sentence I read is—"Solomon with all his acuteness was not wise enough to . . . etc., etc., etc." ('give the Jews the British constitution,' I believe the man means.) He is not a whit more conceited than Mr. Herbert Spencer, or Mr. Goldwin Smith, or Professor Tyndall,—or any lively London apprentice out on a Sunday ; but this general superciliousness with respect to Solomon, his Proverbs, and his politics, characteristic of the modern Cockney, Yankee, and Anglicised Scot, is a difficult thing to deal with for us of the old school, who were well whipped when we were young ; and have been in the habit of occasionally ascertaining our own levels as we grew older, and of recognizing that, here and there, somebody stood higher, and struck harder.

9. A difficult thing to deal with, I feel more and more, hourly, even to the point of almost ceasing to write ; not only every feeling I have, but, of late, even *every word I use*, being alike inconceivable to the insolence, and unintelligible amidst the slang, of the modern London writers. Only in the last magazine I took up, I found an article by Mr. Goldwin Smith on the Jews (of which the gist—as far as it had any—was that we had better give up reading the Bible), and in the text of which I found the word 'tribal' repeated about ten times in every page. Now, if 'tribe' makes tribal, tube must make tubal, cube, cubal, and gibe, gibal ; and I suppose we shall next hear of tubal music, cubal minerals, and gibal conversation ! And observe how all this bad English leads instantly to blunder in thought, prolonged indefinitely. The Jewish Tribes are not separate races, but the descendants of brothers. The Roman Tribes, political divisions ; essentially Trine : and the whole force of the word Tribune vanishes, as soon as the ear is wrung into acceptance of his lazy innovation by the modern writer. Similarly, in the last elements of mineralogy I took up, the first order of crystals was called 'tesseral' ; the writer being much too fine to call them 'four-al,' and too much bent on distinguishing himself from all previous writers to call them cubic.

10. What simple schoolchildren, and sensible schoolmasters, are to do in this atmosphere of Egyptian marsh,

which rains fools upon them like frogs, I can no more with any hope or patience conceive ;—but this finally I repeat, concerning my own books, that they are written in honest English, of good Johnsonian lineage, touched here and there with colour of a little finer or Elizabethan quality : and that the things they tell you are comprehensible by any moderately industrious and intelligent person ; and *accurate*, to a degree which the accepted methods of modern science cannot, in my own particular fields, approach.

11. Of which accuracy, the reader may observe for immediate instance, my extrication for him, from among the *uvularias*, of these five species of the Butterwort ; which, being all that need be distinctly named and remembered, *do* need to be first carefully distinguished, and then remembered in their companionship. So alike are they, that Gerarde makes no distinction among them ; but masses them under the general type of the frequent English one, described as the second kind of his promiscuous group of ‘Sanicle,’ “which Clusius calleth *Pinguicula* ; not before his time remembered, hath sundry small thick leaves, fat and full of juice, being broad towards the root and sharp towards the point, of a faint green colour, and bitter in taste ; out of the midst whereof sprouteth or shooteth up a naked slender stalke nine inches long, every stalke bearing one flower and no more, sometimes white, and sometimes of a bluish purple colour, fashioned like unto the common Monkshoods” (he means Larkspurs) “called *Consolida Regalis*, having the like spur or Lark’s heel attached thereto.” Then after describing a third kind of Sanicle—(*Cortusa Mathioli*, a large-leaved Alpine *Primula*,) he goes on : “These plants are strangers in England ; their natural country is the alpeish mountains of Helvetia. They grow in my garden, where they flourish exceedingly, except Butterwoort, which groweth in our English *squally* wet grounds,”—(‘*Squally*,’ I believe, here, from *squalidus*, though Johnson does not give this sense ; but one of his quotations from Ben Jonson touches it nearly : “Take heed that their new flowers and sweetness do not as much corrupt as the others’ dryness and squalor,”—and note farther that the word ‘*squall*,’ in the

sense of gust, is not pure English, but the Arabic 'Chnaul' with an s prefixed:—the English word, a form of 'squeal,' meaning a child's cry, from Gothic 'Squæla' and Icelandic 'squilla,' would scarcely have been made an adjective by Gerarde),—"and will not yield to any culturing or transplanting: it groweth especially in a field called Cragge Close, and at Crosbie Ravenswath, in Westmerland; (West-*mere*-land you observe, not *mor*) upon Ingleborough Fells, twelve miles from Lancaster, and by Harwoode in the same county near to Blackburn: ten miles from Preston, in Anderness, upon the bogs and marish ground, and in the boggie meadows about Bishop's-Hatfield, and also in the fens in the way to Wittles Meare" (Roger Wildrake's Squattlesea Mere?) "from Fendon, in Huntingdonshire." Where doubtless Cromwell ploughed it up, in his young days, pitilessly; and in nowise pausing, as Burns beside his fallen daisy."

12. Finally, however, I believe, we may accept its English name of 'Butterwort' as true Yorkshire, the more enigmatic form of 'Pigwilly' preserving the tradition of the flowers once abounding, with softened Latin name, in Pigwilly bottom, close to Force bridge, by Kendal. Gerarde draws the English variety as "*Pinguicula sive Sanicula Eboracensis*,—Butterwort, or Yorkshire Sanicle;" and he adds: "The husbandmen's wives of Yorkshire do use to anoint the dugs of their kine with the fat and oilous juice of the herb Butterwort when they be bitten of any venomous worm, or chapped, rifted and hurt by any other means."

13. In Lapland it is put to much more certain use; "it is called Tâtgrass, and the leaves are used by the inhabitants to make their 'tât miolk,' a preparation of milk in common use among them. Some fresh leaves are laid upon a filter, and milk, yet warm from the reindeer, is poured over them. After passing quickly through the filter, this is allowed to rest for one or two days until it becomes ascenscent,* when it is found not to have separated from the whey, and yet to have attained much greater tenacity and consistence than it would have done otherwise. The Laplanders and Swedes are said to be ex-

* Lat. *acesco*, to turn sour.

tremely fond of this milk, which when once made, it is not necessary to renew the use of the leaves, for we are told that a spoonful of it will turn another quantity of warm milk, and make it like the first." * (Baxter, vol. iii., No. 209.)

14. In the same page, I find quoted Dr. Johnston's observation that "when specimens of this plant were somewhat rudely pulled up, the flower-stalk, previously erect, almost immediately began to bend itself backwards, and formed a more or less perfect segment of a circle; and so also, if a specimen is placed in the Botanic box, you will in a short time find that the leaves have curled themselves backwards, and now conceal the root by their revolution."

I have no doubt that this elastic and wiry action is partly connected with the plant's more or less predatory or fly-trap character, in which these curiously degraded plants are associated with Drosera. I separate them therefore entirely from the Bladderworts, and hold them to be a link between the Violets and the Droseraceæ, placing them, however, with the Cytherides, as a sub-family, for their beautiful colour, and because they are indeed a grace and delight in ground which, but for them, would be painfully and rudely desolate.

* Withering quotes this as from Linnæus, and adds on authority of a Mr. Hawkes, "This did not succeed when tried with cows' milk." He also gives as another name, Yorkshire Sanicle; and says it is called *earning grass* in Scotland. Linnæus says the juice will curdle reindeer's milk. The name for rennet is *earning*, in Lincolnshire. Withering also gives this note: "*Pinguis*, fat, from its effect in CONGEALING milk."—(A.) Withering of course wrong: the name comes, be the reader finally assured, from the fatness of the green leaf, quite peculiar among wild plants, and fastened down for us in the French word 'Grassette.' I have found the flowers also difficult to dry, in the benighted early times when I used to think a dried plant useful! See closing paragraphs of the 4th chapter.—R.

CHAPTER III.

VERONICA.

1. "THE Corolla of the Foxglove," says Dr. Lindley, beginning his account of the tribe at page 195 of the first volume of his 'Ladies' Botany,' "is a large inflated body (!), with its throat spotted with rich purple, and its border divided obliquely into five very short lobes, of which the two upper are the smaller ; its four stamens are of unequal length, and its style is divided into two lobes at the upper end. A number of long hairs cover the ovary, which contains two cells and a great quantity of ovules.

"This" (*sc.* information) "will show you what is the usual character of the Foxglove tribe ; and you will find that all the other genera referred to it in books agree with it essentially, although they differ in subordinate points. It is chiefly (A) in the form of the corolla, (B) in the number of the stamens, (C) in the consistence of the rind of the fruit, (D) in its form, (E) in the number of the seeds it contains, and (F) in the manner in which the sepals are combined, that these differences consist."

2. The enumerative letters are of my insertion—otherwise the above sentence is, word for word, Dr. Lindley's,—and it seems to me an interesting and memorable one in the history of modern Botanical science. For it appears from the tenor of it, that in a scientific botanist's mind, six particulars, at least, in the character of a plant, are merely 'subordinate points,'—namely,

1. (F) The combination of its calyx,
2. (A) The shape of its corolla,
3. (B) The number of its stamens,
4. (D) The form of its fruit,
5. (C) The consistence of its shell,—and
6. (E) The number of seeds in it.

Abstracting, then, from the primary description, all the six inessential points, I find the three essential ones left are, that

the style is divided into two lobes at the upper end, that a number of glandular hairs cover the ovary, and that this latter contains two cells.

3. None of which particulars concern any reasonable mortal, looking at a Foxglove, in the smallest degree. Whether hairs which he can't see are glandular or bristly,—whether the green knobs, which are left when the purple bells are gone, are divided into two lobes or two hundred,—and whether the style is split, like a snake's tongue, into two lobes, or like a rogue's, into any number—are merely matters of vulgar curiosity, which he needs a microscope to discover, and will lose a day of his life in discovering. But if any pretty young Proserpina, escaped from the Plutonic durance of London, and carried by the tubular process, which replaces Charon's boat, over the Lune at Lancaster, cares to come and walk on the Coniston hills in a summer morning, when the eyebright is out on the high fields, she may gather, with a little help from Brantwood garden, a bouquet of the entire Foxglove tribe in flower, as it is at present defined, and may see what they are like, altogether.

4. She shall gather : first, the Euphrasy, which makes the turf on the brow of the hill glitter as if with new-fallen manna ; then, from one of the blue clusters on the top of the garden wall, the common bright blue Speedwell ; and, from the garden bed beneath, a dark blue spire of *Veronica spicata* ; then, at the nearest opening into the wood, a little foxglove in its first delight of shaking out its bells ; then—what next does the Doctor say?—a snapdragon ? we must go back into the garden for that—here is a goodly crimson one, but what the little speedwell will think of him for a relative I can't think ! —a mullein ?—that we must do without for the moment ; a monkey flower ?—that we will do without, altogether ; a lady's slipper ?—say rather a goblin's with the gout ! but, such as the flower-cobbler has made it, here is one of the kind that people praise, out of the greenhouse,—and yet a figwort we must have, too ; which I see on referring to Loudon, may be balm-leaved, hemp-leaved, tansy-leaved, nettle-leaved, wing-leaved. heart-leaved. ear-leaved, spear-leaved, or lyre-leaved.

I think I can find a balm-leaved one, though I don't know what to make of it when I've got it, but it's called a 'Scorodonia' in Sowerby, and something very ugly besides;—I'll put a bit of *Teucrium Scorodonia* in, to finish: and now—how will my young Proserpina arrange her bouquet, and rank the family relations to their contentment?

5. She has only one kind of flowers in her hand, as botanical classification stands at present; and whether the system be more rational, or in any human sense more scientific, which puts *calceolaria* and *speedwell* together,—and *foxglove* and *euphrasy*; and runs them on one side into the mints, and on the other into the nightshades;—naming them, meanwhile, some from diseases, some from vermin, some from blockheads, and the rest anyhow:—or the method I am pleading for, which teaches us, watchful of their seasonable return and chosen abiding places, to associate in our memory the flowers which truly resemble, or fondly companion, or, in time kept by the signs of Heaven, succeed, each other; and to name them in some historical connection with the loveliest fancies and most helpful faiths of the ancestral world—Proserpina be judge; with every maid that sets flowers on brow or breast—from Thule to Sicily.

6. We will unbind our bouquet, then, and putting all the rest of its flowers aside, examine the range and nature of the little blue cluster only.

And first—we have to note of it, that the plan of the blossom in all the kinds is the same; an irregular quatrefoil: and irregular quatrefoils are of extreme rarity in flower form. I don't myself know *one*, except the *Veronica*. The cruciform vegetables—the heaths, the olives, the lilacs, the little *Tormentillas*, and the poppies, are all perfectly symmetrical. Two of the petals, indeed, as a rule, are different from the other two, except in the heaths; and thus a distinctly crosslet form obtained, but always an equally balanced one: while in the *Veronica*, as in the *Violet*, the blossom always refers itself to a supposed place on the stalk with respect to the ground—and the upper petal is always the largest.

The supposed place is often very suppositious indeed—for

clusters of the common veronicas, if luxuriant, throw their blossoms about anywhere. But the idea of an upper and lower petal is always kept in the flower's little mind.

7. In the second place, it is a quite open and flat quatrefoil—so separating itself from the belled quadrature of the heath, and the tubed and primrose-like quadrature of the cruciferæ; and, both as a quatrefoil, and as an open one, it is separated from the foxgloves and snapdragons, which are neither quatrefoils, nor open; but are cinquefoils shut up!

8. In the third place, open and flat though the flower be, it is monopetalous; all the four arms of the cross strictly becoming one in the centre; so that, though the blue foils *look* no less sharply separate than those of a buttercup or a cistus; and are so delicate that one expects them to fall from their stalk if we breathe too near,—do but lay hold of one,—and, at the touch, the entire blossom is lifted from its stalk, and may be laid, in perfect shape, on our paper before us, as easily as if it had been a nicely made-up blue bonnet, lifted off its stand by the milliner.

I pause here, to consider a little; because I find myself mixing up two characteristics which have nothing necessary in their relation;—namely, the unity of the blossom, and its coming easily off the stalk. The separate petals of the cistus and cherry fall as easily as the foxglove drops its bells;—on the other hand, there are monopetalous things that don't drop, but hold on like the convoluta,* and make the rest of the tree sad for their dying. I do not see my way to any systematic noting of decadent or persistent corolla; but, in passing, we may thank the veronica for never allowing us to see how it fades,† and being always cheerful and lovely, while it is with us.

* I find much more difficulty, myself, being old, in using my altered names for species than my young scholars will. In watching the bells of the purple bindweed fade at evening, let them learn the fourth verse of the prayer of Hezekiah, as it is in the Vulgate—"Generatio mea ablata est, et convoluta est a me, sicut tabernaculum pastoris,"—and they will not forget the name of the fast-fading—ever renewed—"belle d'un jour."

† "It is Miss Cobbe, I think, who says, 'all wild flowers know how to die gracefully.'"—A.

9. And for a farther specialty, I think we should take note of the purity and simplicity of its *floral* blue, not sprinkling itself with unwholesome sugar like a larkspur, nor varying into coppery or turquoise-like hue as the forget-me-not ; but keeping itself as modest as a blue print, pale, in the most frequent kinds ; but pure exceedingly ; and rejoicing in fellowship with the grey of its native rocks. The palest of all I think it will be well to remember as Veronica Clara, the "Poor Clare" of Veronicas. I find this note on it in my diary,—

'The flower of an exquisite grey-white, like lichen, or shaded hoar-frost, or dead silver ; making the long-weathered stones it grew upon perfect with a finished modesty of paleness, as if the flower *could* be blue, and would not, for their sake. Laying its fine small leaves along in embroidery, like *Anagallis tenella*,—indescribable in the tender feebleness of it—afterwards as it grew, dropping the little blossoms from the base of the spire, before the buds at the top had blown. Gathered, it was happy beside me, with a little water under a stone, and put out one pale blossom after another, day by day.'

10. Lastly, and for a high worthiness, in my estimate, note that it is *wild*, of the wildest, and proud in pure descent of race ; submitting itself to no follies of the cur-breeding florist. Its species, though many resembling each other, are severally constant in aspect, and easily recognizable ; and I have never seen it provoked to glare into any gigantic impudence at a flower show. Fortunately, perhaps, it is scentless, and so despised.

11. Before I attempt arranging its families, we must note that while the corolla itself is one of the most constant in form, and so distinct from all other blossoms that it may be always known at a glance ; the leaves and habit of growth vary so greatly in families of different climates, and those born for special situations, moist or dry, and the like, that it is quite impossible to characterize Veronic, or Veronique, vegetation in general terms. One can say, comfortably, of a strawberry, that it is a creeper, without expecting at the next moment to

see a steeple of strawberry blossoms rise to contradict us ;— we can venture to say of a foxglove that it grows in a spire, without any danger of finding, farther on, a carpet of prostrate and entangling digitalis ; and we may pronounce of a buttercup that it grows mostly in meadows without fear of finding ourselves at the edge of the next thicket, under the shadow of a buttercup-bush growing into valuable timber. But the *Veronica* reclines with the lowly,* upon occasion, and aspires, with the proud ; is here the pleased companion of the ground-ivies, and there the unrebuked rival of the larkspurs : on the rocks of Coniston it effaces itself almost into the film of a lichen ; it pierces the snows of Iceland with the gentian : and in the Falkland Islands is a white-blossomed evergreen, of which botanists are in dispute whether it be *Veronica* or *Olive*.

12. Of these many and various forms, I find the manners and customs alike inconstant ; and this of especially singular in them—that the Alpine and northern species bloom hardily in contest with the retiring snows, while with us they wait till the spring is past, and offer themselves to us only in consolation for the vanished violet and primrose. As we farther examine the ways of plants, I suppose we shall find some that determine upon a fixed season, and will bloom methodically in June or July, whether in Abyssinia or Greenland ; and others, like the violet and crocus, which are flowers of the spring, at whatever time of the favouring or frowning year the spring returns to their country. I suppose also that botanists and gardeners know all these matters thoroughly : but they don't put them into their books, and the clear notions of them only come to me now, as I think and watch.

13. Broadly, however, the families of the *Veronica* fall into three main divisions,—those which have round leaves lobed at the edge, like ground ivy ; those which have small thyme-like leaves ; and those which have long leaves like a foxglove's, only smaller—never more than two or two and a half inches long. I therefore take them in these connections, though without any bar between the groups ; only separating the Re-

* See distinction between recumbent and rampant herbs, below, under '*Veronica Agrestis*,' p. 212.

gina from the other thyme-leaved ones, to give her due precedence; and the rest will then arrange themselves into twenty families, easily distinguishable and memorable.

I have chosen for *Veronica Regina*, the brave Icelandic one, which pierces the snow in first spring, with lovely small shoots of perfectly set leaves, no larger than a grain of wheat; the

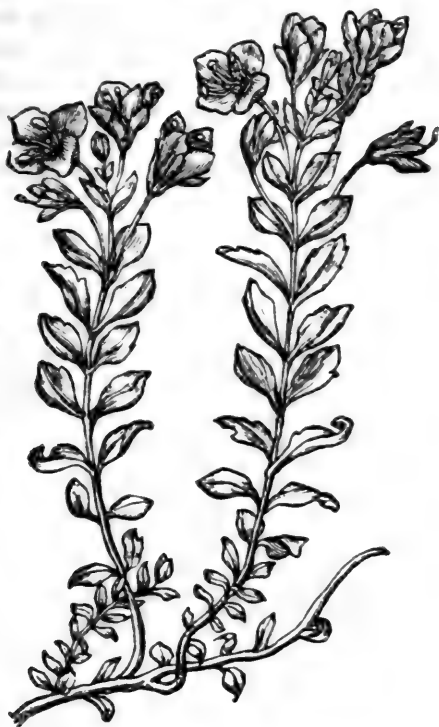

FIG. 4.

flowers in a lifted cluster of five or six together, not crowded, yet not loose; large, for veronica—about the size of a silver penny, or say half an inch across—deep blue, with ruby centre.

My woodcut, Fig. 4, is outlined* from the beautiful en-

* 'Abstracted' rather, I should have said, and with perfect skill, by Mr. Collingwood (the joint translator of Xenophon's *Economics* for the 'Bibliotheca Pastorum'). So also the next following cut, Fig. 5.

graving D. 342,*—there called ‘fruticulosa,’ from the number of the young shoots.

14. Beneath the Regina, come the twenty easily distinguished families, namely :—

1. Chamædrys. ‘Ground-oak.’ I cannot tell why so called—its small and rounded leaves having nothing like oak leaves about them, except the serration, which is common to half, at least, of all leaves that grow. But the idea is all over Europe, apparently. Fr. ‘petit chêne :’ German and English ‘Germander,’ a merely corrupt form of Chamædrys.

The representative English veronica “Germander Speedwell”—very prettily drawn in S. 986 ; too tall and weedlike in D. 448.

2. Hederifolia. Ivy-leaved : but more properly, cymbalaria-leaved. It is the English field representative, though blue-flowered, of the Byzantine white veronica, V. Cymbalaria, very beautifully drawn in G. 9. Hederifolia well in D. 428.

3. Agrestis. Fr. ‘Rustique.’ We ought however clearly to understand whether ‘agrestis,’ used by English botanists, is meant to imply a literally field flower, or only a ‘rustic’ one, which might as properly grow in a wood. I shall always myself use ‘agrestis’ in the literal sense, and ‘rustica’ for ‘rustique.’ I see no reason, in the present case, for separating the Polite from the Rustic flower : the agrestis, D. 449

* Of the references, henceforward necessary to the books I have used as authorities, the reader will please note the following abbreviations :—

C. Curtis’s Magazine of Botany.

D. Flora Danica.

F. Figuier.

G. Sibthorpe’s Flora Græca.

L. Linnæus. Systema Naturæ.

L. S. Linnæus’s Flora Suecica. But till we are quite used to the other letters, I print this reference in words.

L. N. William Curtis’s Flora Londinensis. Of the exquisite plates engraved for this book by James Sowerby, note is taken in the close of next chapter.

O. Sowerby’s English Wild Flowers ; the old edition in thirty-two thin volumes—far the best.

S. Sowerby’s English Wild Flowers ; the modern edition in ten volumes.

and S. 971, seems to me not more meekly recumbent, nor more frankly cultureless, than the so-called Polita, S. 972 : there seems also no French acknowledgment of its politeness, and the Greek family, G. 8, seem the rudest and wildest of all.

Quite a *field* flower it is, I believe, lying always low on the ground, recumbent, but not creeping. Note this difference : no fastening roots are thrown out by the reposing stems of this Veronica ; a creeping or accurately 'rampant' plant roots itself in advancing. Conf. Nos. 5, 6.

4. Arvensis. We have yet to note a still finer distinction in epithet. 'Agrestis' will properly mean a flower of the open ground—yet not caring whether the piece of earth be cultivated or not, so long as it is under clear sky. But when agriculture has turned the unfruitful acres into 'arva beata,'—if then the plant thrust itself between the furrows of the plough, it is properly called 'Arvensis.'

I don't quite see my way to the same distinction in English,—perhaps I may get into the habit, as time goes on, of calling the Arvenses consistently furrow-flowers, and the Agrestes field-flowers. Furrow-veronica is a tiresomely long name, but must do for the present, as the best interpretation of its Latin character, "vulgatissima in cultis et arvis," D. 515. The blossom itself is exquisitely delicate ; and we may be thankful, both here and in Denmark, for such a lovely 'vulgate.'

5. Montana. D. 1201. The first really creeping plant we have had to notice. It throws out roots from the recumbent stems. Otherwise like *agrestis*, it has leaves like ground-ivy. Called a wood species in the text of D.

6. Persica. An eastern form, but now perfectly naturalized here—D. 1982 ; S. 973. The flowers very large, and extremely beautiful, but only one springing from each leaf-axil.

Leaves and stem like *Montana* ; and also creeping with new roots at intervals.

7. Triphylla (not *triphyllos*,—see *Flora Suecica*, 22). Meaning trifid-leaved ; but the leaf is really divided into five lobes, not three—see S. 974, and G. 10. The palmate form of the leaf seems a mere caprice, and indicates no transi-

tional form in the plant: it may be accepted as only a momentary compliment of mimicry to the geraniums. The Siberian variety, 'multifida,' C. 1679, divides itself almost as the submerged leaves of the water-ranunculus.

The triphylla itself is widely diffused, growing alike on the sandy fields of Kent, and of Troy. In D. 627 is given an extremely delicate and minute northern type, the flowers springing as in Persica, one from each leaf-axil, and at distant intervals.

8. Officinalis. D. 248, S. 294. Fr. 'Veronique officinale'; (Germ. Gebrauchlicher Ehrenpreis,) our commonest English and Welsh speedwell; richest in cluster and frankest in roadside growth, whether on bank or rock; but assuredly liking *either* a bank *or* a rock, and the top of a wall better than the shelter of one. Uncountable 'myriads,' I am tempted to write, but, cautiously and literally, 'hundred' of blossoms—if one *could* count,—ranging certainly towards the thousand in some groups, all bright at once, make our Westmoreland lanes look as if they were decked for weddings, in early summer. In the Danish Flora it is drawn small and poor; its southern type being the true one: but it is difficult to explain the difference between the look of a flower which really *suffers*, as in this instance, by a colder climate, and becomes mean and weak, as well as dwarfed; and one which is braced and brightened by the cold, though diminished, as if under the charge and charm of an affectionate fairy, and becomes a joyfully patriotic inheritor of wilder scenes and skies. Medicinal, to soul and body alike, this gracious and domestic flower; though astringent and bitter in the juice. It is the Welsh deeply honoured 'Fluellen.'—See final note on the myth of Veronica, see § 18.

9. Thymifolia. Thyme-leaved, G. 6. Of course the longest possible word—serpyllifolia—is used in S. 978. It is a high mountain plant, growing on the top of Crete as the snow retires; and the Veronica minor of Gerarde; "the roote is small and threddie, taking hold of the *upper surface* of the earth, where it spreadeth." So also it is drawn as a creeper in F. 492, where the flower appears to be oppressed and concealed by the leafage.

10. *Minuta*, called 'hirsuta' in S. 985: an ugly characteristic to name the lovely little thing by. The distinct blue lines in the petals might perhaps justify 'picta' or 'lineata,' rather than an epithet of size; but I suppose it is Gerarde's *Minima*, and so leave it, more safely named as 'minute' than 'least.' For I think the next variety may dispute the leastness.

11. *Verna*. D. 252. Mountains, in dry places in early spring. Upright, and confused in the leafage, which is sharp-pointed and close set, much hiding the blossom, but of extreme elegance, fit for a sacred foreground; as any gentle student will feel, who copies this outline from the *Flora Danica*, Fig. 5.

12. *Peregrina*. Another extremely small variety, nearly pink in colour, passing into bluish lilac and white. American; but called, I do not see why, '*Veronique voyageuse*,' by the French and Fremder Ehrenpreis in Germany. Given as a frequent English weed in S. 927.

13. *Alpina*. *Veronique des Alpes*. Gebirgs Ehrenpreis. Still minute; its scarcely distinct flowers forming a close head among the leaves; round-petalled in D. 16, but sharp, as usual, in S. 980. On the Norway Alps in grassy places; and in Scotland by the side of mountain rills; but rare. On Ben Nevis and Lachin y Gair (S.)

14. *Scutellata*. From the shield-like shape of its seed-vessels. *Veronique à Ecusson*; *Schildfruchtiger Ehrenpreis*. But the seed-vessels are more heart shape than shield. March Speedwell. S. 988, D. 209,—in the one pink, in the other blue; but again in D. 1561, pink.



FIG. 5.

“In flooded meadows, common.” (D.) A spoiled and scattered form; the seeds too conspicuous, but the flowers very delicate, hence ‘*Gratiola minima*’ in Gesner. The confused ramification of the clusters worth noting, in relation to the equally straggling fibres of root.

15. *Spicata*. S. 982: very prettily done, representing the inside of the flower as deep blue, the outside pale. The top of the spire, all calices, the calyx being indeed, through all the veronicas, an important and persistent member.

The tendency to arrange itself in spikes is to be noted as a degradation of the veronic character; connecting it on one side with the snapdragons, on the other with the ophryds. In *Veronica Ophrydea*, (C. 2210,) this resemblance to the contorted tribe is carried so far that “the corolla of the veronica becomes irregular, the tube gibbous, the faux (throat) hairy, and three of the laciniae (lobes of petals) variously twisted.” The spire of blossom, violet-coloured, is then close set, and exactly resembles an ophryd, except in being sharper at the top. The engraved outline of the blossom is good, and very curious.

16. *Gentianoides*. This is the most directly and curiously imitative among the—shall we call them—‘histrionic’ types of *Veronica*. It grows exactly like a clustered upright gentian; has the same kind of leaves at its root, and springs with the same bright vitality among the retiring snows of the Bithynian Olympus. (G. 5.) If, however, the Caucasian flower, C. 1002, be the same, it has lost its perfect grace in luxuriance, growing as large as an asphodel, and with root-leaves half a foot long.

The petals are much veined; and this, of all veronicas, has the lower petal smallest in proportion to the three above—“*triplo aut quadruplo minori.*” (G.)

17. *Stagnarum*. Marsh-*Veronica*. The last four families we have been examining vary from the typical *Veronicas* not only in their lance-shaped clusters, but in their lengthened, and often every way much enlarged leaves also: and the two which we now will take in association, 17 and 18, carry the change in aspect farthest of any, being both of them true

water-plants, with strong stems and thick leaves. The present name of my *Veronica Stagnarum* is however *V. anagallis*, a mere insult to the little water primula, which one plant of the *Veronica* would make fifty of. This is a rank water-weed, having confused bunches of blossom and seed, like unripe currents, dangling from the leaf-axils. So that where the little triphylla, (No. 7, above,) has only one blossom, daintily set, and well seen, this has a litter of twenty-five or thirty on a long stalk, of which only three or four are well out as flowers, and the rest are mere knobs of bud or seed. The stalk is thick (half an inch round at the bottom), the leaves long and misshapen. "Frequens in fossis," D. 203. French, Mouron d'Eau, but I don't know the root or exact meaning of Mouron.

An ugly Australian species, 'labiata,' C. 1660, has leaves two inches long, of the shape of an aloe's, and partly aloeine in texture, "sawed with unequal, fleshy, pointed teeth."

18. *Fontium*. Brook-*Veronica*. Brook-*Lime*, the Anglo-Saxon 'lime' from Latin *limus*, meaning the soft mud of streams. German 'Bach-bunge' (Brook-purse?) ridiculously changed by the botanists into 'Beccabunga,' for a Latin name! Very beautiful in its crowded green leaves as a stream-companion; rich and bright more than watercress. See notice of it at Matlock, in 'Modern Painters,' vol. v.

19. *Clara*. *Veronique des rochers*. *Saxatilis*, I suppose, in Sowerby, but am not sure of having identified that with my own favourite, for which I therefore keep the name 'Clara,' (see above § 9); and the other rock variety, if indeed another, must be remembered, together with it.

20. *Glauca*. G. 7. And this at all events, with the *Clara*, is to be remembered as closing the series of twenty families, acknowledged by *Proserpina*. It is a beautiful low-growing ivy-leaved type, with flowers of subdued lilac blue. On Mount Hymettus: no other locality given in the *Flora Græca*.

15. I am sorry, and shall always be so, when the varieties of any flower which I have to commend to the student's memory, exceed ten or twelve in number; but I am content to gratify his pride with lengthier task, if indeed he will resign

himself to the imperative close of the more inclusive catalogue, and be content to know the twelve, or sixteen, or twenty, acknowledged families, thoroughly; and only in their illustration to think of rarer forms. The object of 'Proserpina,' is to make him happily cognizant of the common aspect of Greek and English flowers; under the term 'English,' comprehending the Saxon, Celtic, Norman, and Danish Floras. Of the evergreen shrub alluded to in § 11 above, the *Veronica Decussata* of the Pacific, which is "a bushy evergreen, with beautifully set cross-leaves, and white blossoms scented like *olea fragrans*," I should like him only to read with much surprise, and some incredulity, in Pinkerton's or other entertaining travellers' voyages.

16. And of the families given, he is to note for the common simple characteristic, that they are quatrifoils referred to a more or less elevated position on a central stem, and having, in that relation, the lowermost petal diminished, contrary to the almost universal habit of other flowers to develop in such a position the lower petal chiefly, that it may have its full share of light. You will find nothing but blunder and embarrassment result from any endeavour to enter into further particulars, such as "the relation of the dissepiment with respect to the valves of the capsule," etc., etc., since "in the various species of *Veronica* almost every kind of dehiscence may be observed" (C. under *V. perfoliata*, 1936, an Australian species). Sibthorpe gives the entire definition of *Veronica* with only one epithet added to mine, "*Corolla quadrifida, rotata, laciniâ infimâ angustiore*," but I do not know what 'rotata' here means, as there is no appearance of revolved action in the petals, so far as I can see.

17. Of the mythic or poetic significance of the veronica, there is less to be said than of its natural beauty. I have not been able to discover with what feeling, or at what time, its sacred name was originally given; and the legend of *S. Veronica* herself is, in the substance of it, irrational, and therefore incredible. The meaning of the term 'rational,' as applied to a legend or miracle, is, that there has been an intelligible need for the permission of the miracle at the time when it is re-

corded ; and that the nature and manner of the act itself should be comprehensible in the scope. There was thus quite simple need for Christ to feed the multitudes, and to appear to S. Paul ; but no need, so far as human intelligence can reach, for the reflection of His features upon a piece of linen which could be seen by not one in a million of the disciples to whom He might more easily, at any time, manifest Himself personally and perfectly. Nor, I believe, has the story of S. Veronica ever been asserted to be other than symbolic by the sincere teachers of the Church ; and, even so far as in that merely explanatory function, it became the seal of an extreme sorrow, it is not easy to understand how the pensive fable was associated with a flower so familiar, so bright, and so popularly of good omen, as the Speedwell.

18. Yet, the fact being actually so, and this consecration of the veronica being certainly far more ancient and earnest than the faintly romantic and extremely absurd legend of the forget-me-not ; the Speedwell has assuredly the higher claim to be given and accepted as a token of pure and faithful love, and to be trusted as a sweet sign that the innocence of affection is indeed more frequent, and the appointed destiny of its faith more fortunate, than our inattentive hearts have hitherto discerned.

19. And this the more, because the recognized virtues and uses of the plant are real and manifold : and the ideas of a peculiar honourableness and worth of life connected with it by the German popular name ' Honour-prize ' ; while to the heart of the British race, the same thought is brought home by Shakespeare's adoption of the flower's Welsh name, for the faithfullest common soldier of his ideal king. As a lover's pledge, therefore, it does not merely mean memory ;—for, indeed, why should love be thought of as such at all, if it need to promise not to forget?—but the blossom is significant also of the lover's best virtues, patience in suffering, purity in thought, gaiety in courage, and serenity in truth : and therefore I make it, worthily, the clasping and central flower of the Cytherides.

CHAPTER IV.

GIULIETTA.

1. SUPPOSING that, in early life, one had the power of living to one's fancy,—and why should we not, if the said fancy were restrained by the knowledge of the two great laws concerning our nature, that happiness is increased, not by the enlargement of the possessions, but of the heart ; and days lengthened, not by the crowding of emotions, but the economy of them ?—if thus taught, we had, I repeat, the ordering of our house and estate in our own hands, I believe no manner of temperance in pleasure would be better rewarded than that of making our gardens gay only with common flowers ; and leaving those which needed care for their transplanted life to be found in their native places when we travelled. So long as I had crocus and daisy in the spring, roses in the summer, and hollyhocks and pinks in the autumn, I used to be myself independent of farther horticulture,—and it is only now that I am old, and since pleasant travelling has become impossible to me, that I am thankful to have the white narcissus in my borders, instead of waiting to walk through the fragrance of the meadows of Clarens ; and pleased to see the milkwort blue on my scythe-mown banks, since I cannot gather it any more on the rocks of the Vosges, or in the divine glens of Jura.

2. Among the losses, all the more fatal in being unfelt, brought upon us by the fury and vulgarity of modern life, I count for one of the saddest, the loss of the wish to gather a flower in travelling. The other day,—whether indeed a sign of some dawning of doubt and remorse in the public mind, as to the perfect jubilee of railroad journey, or merely a piece of the common daily flattery on which the power of the British press first depends, I cannot judge ;—but, for one or other of such motives, I saw lately in some illustrated paper a pictorial comparison of old-fashioned and modern travel, representing, as the type of things passed away, the outside passengers of

the mail shrinking into huddled and silent distress from the swirl of a winter snowstorm ; and for type of the present Elysian dispensation, the inside of a first-class saloon carriage, with a beautiful young lady in the last pattern of Parisian travelling dress, conversing, Daily news in hand, with a young officer—her fortunate vis-à-vis—on the subject of our military successes in Afghanistan and Zululand.*

3. I will not, in presenting—it must not be called, the other side, but the supplementary, and wilfully omitted, facts, of this ideal,—oppose, as I fairly might, the discomforts of a modern cheap excursion train, to the chariot-and-four, with outriders and courier, of ancient noblesse. I will compare only the actual facts, in the former and in latter years, of my own journey from Paris to Geneva. As matters are now arranged, I find myself, at half-past eight in the evening, waiting in a confused crowd with which I am presently to contend for a seat, in the dim light and cigar-stench of the great station of the Lyons line. Making slow way through the hostilities of the platform, in partly real, partly weak politeness, as may be, I find the corner seats of course already full of prohibitory cloaks and umbrellas ; but manage to get a middle back one ; the net overhead is already surcharged with a bulging extra portmanteau, so that I squeeze my desk as well as I can between my legs, and arrange what wraps I have about my knees and shoulders. Follow a couple of hours of simple patience, with nothing to entertain one's thoughts but the steady roar of the line under the wheels, the blinking and dripping of the oil lantern, and the more or less ungainly wretchedness, and variously sullen compromises and encroachments of posture, among the five other passengers preparing themselves for sleep : the last arrangement for the night being to shut up both windows, in order to effect, with our six breaths, a salutary modification of the night air.

4. The banging and bumping of the carriages over the turntables wakes me up as I am beginning to doze, at Fontainebleau, and again at Sens ; and the trilling and thrilling of the

* See letter on the last results of our African campaigns, in the *Morning Post* of April 14th, of this year.

little telegraph bell establishes itself in my ears, and stays there, trilling me at last into a shivering, suspicious sort of sleep, which, with a few vaguely fretful shrugs and fidgets, carries me as far as Tonnerre, where the 'quinze minutes d'arret' revolutionize everything; and I get a turn or two on the platform, and perhaps a glimpse of the stars, with promise of a clear morning; and so generally keep awake past Mont Bard, remembering the happy walks one used to have on the terrace under Buffon's tower, and thence watching, if perchance, from the mouth of the high tunnel, any film of moonlight may show the far undulating masses of the hills of Citeaux. But most likely one knows the place where the great old view used to be only by the sensible quickening of the pace as the train turns down the incline, and crashes through the trenched cliffs into the confusion and high clattering vault of the station at Dijon.

5. And as my journey is almost always in the spring-time, the twisted spire of the cathedral usually shows itself against the first grey of dawn, as we run out again southwards; and resolving to watch the sunrise, I fall more complacently asleep,—and the sun is really up by the time one has to change carriages, and get morning coffee at Macon. And from Amberg, through the Jura valley, one is more or less feverishly happy and thankful, not so much for being in sight of Mont Blanc again, as in having got through the nasty and gloomy night journey; and then the sight of the Rhone and the Salève seems only like a dream, presently to end in nothingness; till, covered with dust, and feeling as if one never should be fit for anything any more, one staggers down the hill to the Hotel des Bergues, and sees the dirtied Rhone, with its new iron bridge, and the smoke of a new factory exactly dividing the line of the aiguilles of Chamouni.

6. That is the journey as it is now,—and as, for me, it must be; except on foot, since there is now no other way of making it. But this *was* the way we used to manage it in old days:—

Very early in Continental transits we had found out that the family travelling carriage, taking much time and ingenuity to load, needing at the least three, usually four—horses, and

on Alpine passes six, not only jolted and lagged painfully on bad roads, but was liable in every way to more awkward discomfitures than lighter vehicles ; getting itself jammed in archways, wrenched with damage out of ruts, and involved in volleys of justifiable reprobation among market stalls. So when we knew better, my father and mother always had their own old-fashioned light two-horse carriage to themselves, and I had one made with any quantity of front and side pockets for books and picked up stones ; and hung very low, with a fixed side-step, which I could get off or on with the horses at the trot ; and at any rise or fall of the road, relieve them, and get my own walk, without troubling the driver to think of me.

7. Thus, leaving Paris in the bright spring morning, when the Seine glittered gaily at Charenton, and the arbres de Judée were mere pyramids of purple bloom round Villeneuve-St.-Georges, one had an afternoon walk among the rocks of Fontainebleau, and next day we got early into Sens, for new lessons in its cathedral aisles, and the first saunter among the budding vines of the coteaux. I finished my plate of the Tower of Giotto, for the 'Seven Lamps,' in the old inn at Sens, which Dickens has described in his wholly matchless way in the last chapter of 'Mrs. Lirriper's Lodgings.' The next day brought us to the oolite limestones at Mont Bard, and we always spent the Sunday at the Bell in Dijon. Monday, the drive of drives, through the village of Genlis, the fortress of Auxonne, and up the hill to the vine-surrounded town of Dole ; whence, behold at last the limitless ranges of Jura, south and north, beyond the woody plain, and above them the 'Derniers Rochers' and the white square-set summit, worshipped ever anew. Then at Poligny, the same afternoon, we gathered the first milkwort for that year ; and on Tuesday, at St. Laurent, the wild lily of the valley ; and on Wednesday, at Morez, gentians.

And on Thursday, the *eighth or ninth* day from Paris, days all spent patiently and well, one saw from the gained height of Jura, the great Alps unfold themselves in their chains and wreaths of incredible crest and cloud.

8. Unhappily, during all the earliest and usefulest years of

such travelling, I had no thought of ever taking up botany as a study; feeling well that even geology, which was antecedent to painting with me, could not be followed out in connection with art but under strict limits, and with sore shortcomings. It has only been the later discovery of the uselessness of old scientific botany, and the abominableness of new, as an element of education for youth;—and my certainty that a true knowledge of their native Flora was meant by Heaven to be one of the first heart-possessiones of every happy boy and girl in flower-bearing lands, that have compelled me to gather into system my fading memories, and wandering thoughts. And of course in the diaries written at places of which I now want chiefly the details of the Flora, I find none; and in this instance of the milkwort, whose name I was first told by the Chamouni guide, Joseph Couttet, then walking with me on the unperilous turf of the first rise of the Vosges, west of Strasburg, and rebuking me indignantly for my complaint that, being then thirty-seven years old, and not yet able to draw the great plain and distant spire, it was of no use trying in the poor remainder of life to do anything serious,—then, and there, I say, for the first time examining the strange little flower, and always associating it, since, with the limestone crags of Alsace and Burgundy,* I don't find a single note of its preferences or antipathies in other districts, and cannot say a word about the soil it chooses, or the height it ventures, or the familiarities to which it condescends, on the Alps or Apennines.

9. But one thing I have ascertained of it, lately at Brantwood, that it is capricious and fastidious beyond any other little blossom I know of. In laying out the rock garden, most of the terrace sides were trusted to remnants of the natural slope, propped by fragments of stone, among which nearly every other wild flower that likes sun and air, is glad sometimes to root itself. But at the top of all, one terrace was brought to mathematically true level of surface, and slope of

* I deliberately, not garrulously, allow more autobiography in 'Proserpina' than is becoming, because I know not how far I may be permitted to carry on that which was begun in 'Fora.'

side, and turfed with delicately chosen and adjusted sods, meant to be kept duly trim by the scythe. And *only* on this terrace does the *Giulietta* choose to show herself,—and even there, not in any consistent places, but gleaming out here in one year, there in another, like little bits of unexpected sky through cloud ; and entirely refusing to allow either bank or terrace to be mown the least trim during *her* time of disport there. So spared and indulged, there are no more wayward things in all the woods or wilds ; no more delicate and perfect things to be brought up by watch through day and night, than her recumbent clusters, trickling, sometimes almost gushing through the grass, and meeting in tiny pools of flawless blue.

10. I will not attempt at present to arrange the varieties of the *Giulietta*, for I find that all the larger and presumably characteristic forms belong to the Cape ; and only since Mr. Froude came back from his African explorings have I been able to get any clear idea of the brilliancy and associated infinitude of the Cape flowers. If I could but write down the substance of what he has told me, in the course of a chat or two, which have been among the best privileges of my recent stay in London, (prolonged as it has been by recurrence of illness,) it would be a better summary of what should be generally known in the natural history of southern plants than I could glean from fifty volumes of horticultural botany. In the meantime, everything being again thrown out of gear by the aforesaid illness, I must let this piece of ‘*Proserpina*’ break off, as most of my work does—and as perhaps all of it may soon do—leaving only suggestion for the happier research of the students who trust me thus far.

11. Some essential points respecting the flower I shall note, however, before ending. There is one large and frequent species of it of which the flowers are delicately yellow, touched with tawny red forming one of the chief elements of wild foreground vegetation in the healthy districts of hard Alpine limestone.* This is, I believe, the only European type of the large

* In present Botany, *Polygala Chamæbuxus* ; C. 316 : or, in English, Much Milk Ground-box. It is not, as matters usually go, a name to be

Cape varieties, in all of which, judging from such plates as have been accessible to me, the crests or fringes of the lower petal are less conspicuous than in the smaller species; and the flower almost takes the aspect of a broom-blossom or pease-blossom. In the smaller European varieties, the white fringes of the lower petal are the most important and characteristic part of the flower, and they are, among European wild flowers, absolutely without any likeness of associated structure. The fringes or crests which, towards the origin of petals, so often give a frosted or gemmed appearance to the centres of flowers, are here thrown to the extremity of the petal, and suggest an almost coralline structure of blossom, which in no other instance whatever has been imitated, still less carried out into its conceivable varieties of form. How many such varieties might have been produced if these fringes of the *Giulietta*, or those already alluded to of *Lucia nivea*, had been repeated and enlarged; as the type, once adopted for complex bloom in the thistle-head, is multiplied in the innumerable gradations of thistle, teasel, hawkweed, and aster! We might have had flowers edged with lace finer than was ever woven by mortal fingers, or tasselled and braided with fretwork of silver, never tarnished—or hoarfrost that grew brighter in the sun. But it was not to be, and after a few hints of what might be done in this kind, the Fate, or Folly, or, on recent theories, the extreme fitness—and consequent survival, of the Thistles and Dandelions, entirely drives the fringed *Lucias* and blue-flushing milkworts out of common human neighbourhood, to live recluse lives with the memories of the abbots of Cluny, and pastors of Piedmont.

12. I have called the *Giulietta* 'blue-flushing' because it is

ill thought of, as it really contains three ideas; and the plant does, without doubt, somewhat resemble box, and grows on the ground;—far more fitly called 'ground-box' than the *Veronica* 'ground-oak.' I want to find a pretty name for it in connection with Savoy or Dauphiné, where it indicates, as above stated, the *healthy* districts of *hard* limestone. I do not remember it as ever occurring among the dark and moist shales of the inner mountain ranges, which at once confine and pollute the air.

one of the group of exquisite flowers which at the time of their own blossoming, breathe their colour into the surrounding leaves and supporting stem. Very notably the Grape hyacinth and Jura hyacinth, and some of the Vestals, empurpling all their green leaves even to the ground: a quite distinct nature in the flower, observe, this possession of a power to kindle the leaf and stem with its own passion, from that of the heaths, roses, or lilies, where the determined bracts or calices assert themselves in opposition to the blossom, as little pine-leaves, or mosses, or brown-paper packages, and the like.

13. The *Giulietta*, however, is again entirely separate from the other leaf-flushing blossoms, in that, after the two green leaves next the flower have glowed with its blue, while it lived, they do not fade or waste with it, but return to their own former green simplicity, and close over it to protect the seed. I only know this to be the case with the *Giulietta Regina*; but suppose it to be (with variety of course in the colours) a condition in other species,—though of course nothing is ever said of it in the botanical accounts of them. I gather, however, from Curtis's careful drawings that the prevailing colour of the Cape species is purple, thus justifying still further my placing them among the *Cytherides*; and I am content to take the descriptive epithets at present given them, for the following five of this southern group, hoping that they may be explained for me afterwards by helpful friends.

14. *Bracteolata*, C. 345.
 Oppositifolia, C. 492.
 Speciosa, C. 1790.

These three all purple, and scarcely distinguishable from sweet pease-blossom, only smaller.

Stipulacea, C. 1715. Small, and very beautiful, lilac and purple, with a leaf and mode of growth like rosemary. The "Foxtail" milkwort, whose name I don't accept, C. 1006, is intermediate between this and the next species.

15. *Mixta*, C. 1714. I don't see what mingling is meant, except that it is just like *Erica tetralix* in the leaf, only, apparently, having little four-petalled pinks for blossoms. This

appearance is thus botanically explained. I do not myself understand the description, but copy it, thinking it may be of use to somebody. "The apex of the carina is expanded into a two-lobed plain petal, the lobes of which are emarginate. This appendix is of a bright rose colour, and forms the principal part of the flower." The describer relaxes, or relapses, into common language so far as to add that 'this appendix' "dispersed among the green foliage in every part of the shrub, gives it a pretty lively appearance."

Perhaps this may also be worth extracting.

"Carina, deeply channelled, of a saturated purple within, sides folded together, so as to include and firmly embrace the style and stamens, which, when arrived at maturity, upon being moved, escape elastically from their confinement, and strike against the two erect petals or alæ—by which the pollen is dispersed.

"Stem shrubby, with long flexile branches." (Length or height not told. I imagine like an ordinary heath's.)

The term 'carina,' occurring twice in the above description, is peculiar to the structure of the pease and milkworts; we will examine it afterwards. The European varieties of the milkwort, except the chamæbuxus, are all minute,—and, their ordinary epithets being at least inoffensive, I give them for reference till we find prettier ones; altering only the *Calcarea*, because we could not have a 'Chalk Juliet,' and two varieties of the *Regina*, changed for reason good—her name, according to the last modern refinements of grace and ease in pronunciation, being *Eu-vulgaris*, var. *genuina*! My readers may more happily remember her and her sister as follows:—

16. (i.) *Giulietta Regina*. Pure Blue. The same in colour, form, and size throughout Europe.

(ii.) *Giulietta Soror-Reginæ*. Pale, reddish-blue or white in the flower, and smaller in the leaf, otherwise like the *Regina*.

(iii.) *Giulietta Depressa*. The smallest of those I can find drawings of. Flowers, blue; lilac in the fringe, and no bigger than pins' heads; the leaves quite gem-like in minuteness and order.

(iv.) *Giulietta Cisterciana*. Its present name 'Calcarea,' is meant, in botanic Latin, to express its growth on limestone or chalk mountains. But we might as well call the South Down sheep, Calcareous mutton. My epithet will rightly associate it with the Burgundian hills round Cluny and Citeaux. Its ground leaves are much larger than those of the *Depressa*; the flower a little larger, but very pale.

(v.) *Giulietta Austriaca*. Pink, and very lovely, with bold cluster of ground leaves, but itself minute—almost dwarf. Called 'small bitter milkwort' by S. How far distinct from the next following one, Norwegian, is not told.

The above five kinds are given by Sowerby as British, but I have never found the *Austriaca* myself.

(vi.) *Giulietta Amara*. Norwegian. Very quaint in blossom outline, like a little blue rabbit with long ears. D. 1169.

17. Nobody tells me why either this last or No. 5 have been called bitter; and Gerarde's five kinds are distinguished only by colour—blue, red, white, purple, and "the dark, of an overworn ill-favoured colour, which maketh it to differ from all others of his kind." I find no account of this ill-favoured one elsewhere. The white is my *Soror Reginæ*; the red must be the *Austriaca*; but the purple and overworn ones are perhaps now overworn indeed. All of them must have been more common in Gerarde's time than now, for he goes on to say "Milkwoort is called *Ambarualis flos*, so called because it doth specially flourish in the Crosse or Gang-weeke, or Rogation-weeke, of which flowers, the maidens which use in the countries to walk the procession do make themselves garlands and nose-gaies, in English we may call it Crosse flower, Gang flower, Rogation flower, and Milk-woort."

18. Above, at page 151, vol. i., in first arranging the *Cytherides*, I too hastily concluded that the ascription to this plant of helpfulness to nursing mothers was 'more than ordi-

narily false'; thinking that its rarity could never have allowed it to be fairly tried. If indeed true, or in any degree true, the flower has the best right of all to be classed with the Cytherides, and we might have as much of it for beauty and for service as we chose, if we only took half the pains to garnish our summer gardens with living and life-giving blossom, that we do to garnish our winter gluttonies with dying and useless ones.

19. I have said nothing of root, or fruit, or seed, having never had the hardness of heart to pull up a milkwort cluster—nor the chance of watching one in seed:—The pretty thing vanishes as it comes, like the blue sky of April, and leaves no sign of itself—that I ever found. The botanists tell me that its fruit “dehiscens loculicidally,” which I suppose is botanic for “splits like boxes,” (but boxes shouldn't split, and didn't, as we used to make and handle them before railways). Out of the split boxes fall seeds—too few; and, as aforesaid, the plant never seems to grow again in the same spot. I should thankfully receive any notes from friends happy enough to live near milkwort banks, on the manner of its nativity.

20. Meanwhile, the Thistle, and the Nettle, and the Dock, and the Dandelion are cared for in their generations by the finest arts of—Providence, shall we say? or of the spirits appointed to punish our own want of Providence? May I ask the reader to look back to the seventh chapter of the first volume, for it contains suggestions of thoughts which came to me at a time of very earnest and faithful inquiry, set down, I now see too shortly, under the press of reading they involved, but intelligible enough if they are read as slowly as they were written, and especially note the paragraph of summary of p. 86 on the power of the Earth Mother, as Mother, and as *Judge*; watching and rewarding the conditions which induce adversity and prosperity in the kingdoms of men: comparing with it carefully the close of the fourth chapter, p. 63,* which contains, for the now recklessly multiplying classes

* Which, with the following page, is the summary of many chapters of 'Modern Painters: ' and of the aims kept in view throughout 'Mu



PLATE XI.—STATES OF ADVERSITY.

of artists and colonists; truths essential to their skill, and inexorable upon their labour.

21. The pen-drawing facsimiled by Mr. Allen with more than his usual care in the frontispiece to this number of 'Proserpina,' was one of many executed during the investigation of the schools of Gothic (German, and later French), which founded their minor ornamentation on the serration of the thistle leaf, as the Greeks on that of the Acanthus, but with a consequent, and often morbid, love of thorny points, and insistence upon jagged or knotted intricacies of stubborn vegetation, which is connected in a deeply mysterious way with the gloomier forms of Catholic asceticism.*

22. But also, in beginning 'Proserpina,' I intended to give many illustrations of the light and shade of foreground leaves belonging to the nobler groups of thistles, because I thought they had been neglected by ordinary botanical draughtsmen; not knowing at that time either the original drawings at Oxford for the 'Flora Græca,' or the nobly engraved plates executed in the close of the last century for the 'Flora Danica' and 'Flora Londinensis.' The latter is in the most difficult portraiture of the larger plants, even the more wonderful of the two; and had I seen the miracles of skill, patience, and faithful study which are collected in the first and second volumes, published in 1777 and 1798, I believe my own work would never have been undertaken.† Such as it is, however, I may still, health being granted me, persevere in it; for my own leaf and branch studies express conditions of shade which even these most ex-

nera Pulveris.' The three kinds of Desert specified—of Reed, Sand, and Rock—should be kept in mind as exhaustively including the states of the earth neglected by man. For instance of a Reed desert, produced *merely* by his neglect, see Sir Samuel Baker's account of the choking up of the bed of the White Nile. Of the sand desert, Sir F. Palgrave's journey from the Djowf to Häyel, vol. i, p. 92.

* This subject is first entered on in the 'Seven Lamps,' and carried forward in the final chapters of 'Modern Painters,' to the point where I hope to take it up for conclusion, in the sections of 'Our Fathers have told us' devoted to the history of the fourteenth century.

† See in the first volume, the plates of *Sonchus Arvensis* and *Tussilago Petasites*; in the second, *Carduus tomentosus* and *Picris Echioides*.

quisite botanical plates ignore ; and exemplify uses of the pen and pencil which cannot be learned from the inimitable fineness of line engraving. The frontispiece to this number, for instance, (a seeding head of the commonest field-thistle of our London suburbs,) copied with a steel pen on smooth grey paper, and the drawing softly touched with white on the nearer thorns, may well surpass the effect of the plate.

23. In the following number of 'Proserpina' I have been tempted to follow, with more minute notice than usual, the 'conditions of adversity' which, as they fret the thistle tribe into jagged malice, have humbled the beauty of the great domestic group of the Vestals into confused likenesses of the Dragonweed and Nettle : but I feel every hour more and more the necessity of separating the treatment of subjects in 'Proserpina' from the microscopic curiosities of recent botanic illustration, nor shall this work close, if my strength hold, without fulfilling in some sort, the effort begun long ago in 'Modern Painters,' to interpret the grace of the larger blossoming trees, and the mysteries of leafy form which clothe the Swiss precipice with gentleness, and colour with softest azure the rich horizons of England and Italy.

INDEX I.

DESCRIPTIVE NOMENCLATURE.

PLANTS in perfect form are said, at page 22, to consist of four principal parts: root, stem, leaf, and flower. (Compare Chapter V., § 2.) The reader may have been surprised at the omission of the fruit from this list. But a plant which has borne fruit is no longer of 'perfect' form. Its flower is dead. And, observe, it is further said, at page 49, (and compare Chapter III., § 2,) that the use of the fruit is to produce the flower: not of the flower to produce the fruit. Therefore, the plant in perfect blossom, is itself perfect. Nevertheless, the formation of the fruit, practically, is included in the flower, and so spoken of in the fifteenth line of the same page.

Each of these four main parts of a plant consist normally of a certain series of minor parts, to which it is well to attach easily remembered names. In this section of my index I will not admit the confusion of idea involved by alphabetical arrangement of these names, but will sacrifice facility of reference to clearness of explanation, and taking the four great parts of the plant in succession, I will give the list of the minor and constituent parts, with their names as determined in Proserpina, and reference to the pages where the reasons for such determination are given, endeavouring to supply, at the same time, any deficiencies which I find in the body of the text.

I. THE ROOT.

| | PAGE |
|---|-------|
| Origin of the word Root..... | 23 |
| The offices of the root are threefold: namely, Tenure, Nourishment, and Animation | 23-28 |
| The essential parts of a Root are two: the Limbs and Fibres..... | 27 |
| I. THE LIMB is the gathered mass of fibres, or at least of fibrous substance, which extends itself in search of nourishment ... | |
| | 26 |
| II. THE FIBRE is the organ by which the nourishment is received | |
| | 27 |
| The inessential or accidental parts of roots, which are attached to the roots of some plants, but not to those of others, (and are, indeed, for the most part absent,) are three: namely, Store-Houses, Refuges, and Ruins..... | |
| | 27 |
| III. STORE-HOUSES contain the food of the future plant..... | |
| | 27 |
| IV. REFUGES shelter the future plant itself for a time..... | |
| | 28 |
| V. RUINS form a basis for the growth of the future plant in its proper order..... | |
| | 29 |
| Root-Stocks, the accumulation of such ruins in a vital order | 30 |
| General questions relating to the office and chemical power of roots | 31 |

The nomenclature of Roots will not be extended, in *Proserpina*, beyond the five simple terms here given: though the ordinary botanical ones—corn, bulb, tuber, etc.—will be severally explained in connection with the plants which they specially characterize.

II. THE STEM.

| | |
|---|-----|
| Derivation of word..... | 96 |
| The channel of communication between leaf and root | 107 |
| In a perfect plant it consists of three parts: | |
| I. THE STEM (<i>STEMMA</i>) proper.—A growing or advancing shoot which sustains all the other organs of the plant..... | |
| | 96 |
| It may grow by adding thickness to its sides without advancing; but its essential characteristic is the vital power of Advance. | |
| | 96 |

| | PAGE |
|--|--------|
| It may be round, square, or polygonal, but is always roundly minded..... | 96 |
| Its structural power is Spiral | 96 |
| It is essentially branched; having subordinate leaf-stalks and flower-stalks, if not larger branches | 98 |
| It develops the buds, leaves, and flowers of the plant. | |
| This power is not yet properly defined, or explained; and referred to only incidentally throughout the eighth chapter..... | 94-97 |
| II. THE LEAF-STALK (CYMBA) sustains, and expands itself into, the Leaf..... | |
| | 94, 95 |
| It is essentially furrowed above, and convex below..... | 95 |
| It is to be called in Latin, the Cymba; in English, the Leaf-Stalk | 95 |
| III. THE FLOWER-STALK (PETIOLUS): | |
| It is essentially round | 92 |
| It is usually separated distinctly at its termination from the flower..... | 92, 93 |
| It is to be called in Latin, Petiolus; in English, Flower-stalk | |
| These three are the essential parts of a stem. But besides these, it has, when largely developed, a permanent form: namely, | |
| IV. THE TRUNK.—A non-advancing mass of collected stem, arrested at a given height from the ground..... | 98 |
| The stems of annual plants are either leafy, as of a thistle, or bare, sustaining the flower or flower-cluster at a certain height above the ground. Receiving therefore these following names:— | |
| V. THE VIRGA.—The leafy stem of an annual plant, not a grass, yet growing upright..... | 104 |
| VI. THE VIRGULA.—The leafless flower-stem of an annual plant, not a grass, as of a primrose or dandelion..... | 104 |

VII. THE FILUM.—The running stem of a creeping plant.

It is not specified in the text for use ; but will be necessary ; so also, perhaps, the *Stelechos*, or stalk proper (26, p. 104) the branched stem of an annual plant, not a grass ; one cannot well talk of the *Virga* of hemlock. The 'Stolon' is explained in its classical sense at page 100, but I believe botanists use it otherwise. I shall have occasion to refer to, and complete its explanation, in speaking of bulbous plants.

VIII. THE CAUDEX.—The essentially ligneous and compact part of a stem. 105

This equivocal word is not specified for use in the text, but I mean to keep it for the accumulated stems of inlaid plants, palms, and the like ; for which otherwise we have no separate term.

IX. THE AVENA.—Not specified in the text at all ; but it will be prettier than 'baculus,' which is that I had proposed, for the 'staff' of grasses. See page 113.

These ten names are all that the student need remember ; but he will find some interesting particulars respecting the following three, noticed in the text :—

STIPS.—The origin of stipend, stupid, and stump. 104

STIPULA.—The subtlest Latin term for straw. 104

CAULIS (Kale).—The peculiar stem of branched eatable vegetables 105

CANNA.—Not noticed in the text ; but likely to be sometimes useful for the stronger stems of grasses.

III. THE LEAF.

Derivation of word. 23

The Latin form 'folium' 32

The Greek form 'petalos' 33

Veins and ribs of leaves, to be usually summed under the term 'rib' 34

Chemistry of leaves. 36

The nomenclature of the leaf consists, in botanical books, of little more than barbarous, and, for the general reader, totally useless attempts to describe their forms in Latin. But

their forms are infinite and indescribable except by the pencil. I will give central types of form in the next volume of *Proserpina*; which, so that the reader sees and remembers, he may call anything he likes. But it is necessary that names should be assigned to certain classes of leaves which are essentially different from each other in character and tissue, not merely in form. Of these the two main divisions have been already given: but I will now add the less important ones which yet require distinct names.

- I. **APOLLINE.**—Typically represented by the laurel. 39
- II. **ARETHUSAN.**—Represented by the alisma. 40
 - It ought to have been noticed that the character of serration, within reserved limits, is essential to an Apolline leaf, and absolutely refused by an Arethusan one.
- III. **DRYAD.**—Of the ordinary leaf tissue, neither manifestly strong, nor admirably tender, but serviceably consistent, which we find generally to be the substance of the leaves of forest trees. Typically represented by those of the oak.
- IV. **ABIETINE.**—Shaft or sword-shape, as the leaves of firs and pines.
- V. **CRESSIC.**—Delicate and light, with smooth tissue, as the leaves of cresses, and clover.
- VI. **SALVIAN.**—Soft and woolly, like miniature blankets, easily folded, as the leaves of sage.
- VII. **CAULINE.**—Softly succulent, with thick central ribs, as of the cabbage.
- VIII. **ALOEINE.**—Inflexibly succulent, as of the aloe or houseleek.

No rigid application of these terms must ever be attempted; but they direct the attention to important general conditions, and will often be found to save time and trouble in description.

IV. THE FLOWER.

- Its general nature and function 49
- Consists essentially of Corolla and Treasury 58
- Has in perfect form the following parts:--

- I. **THE TORUS.**—Not yet enough described in the text. It is the expansion of the extremity of the flower-stalk, in preparation for the support of the expanding flower. 50-154

- II. **THE INVOLUCRUM.**—Any kind of wrapping or propping condition of leafage at the base of a flower may properly come under this head ; but the manner of prop or protection differs in different kinds, and I will not at present give generic names to these peculiar forms.
- III. **THE CALYX (The Hiding-place).**—The outer whorl of leaves, under the protection of which the real flower is brought to maturity. Its separate leaves are called **SEPALS**. 59
- IV. **THE COROLLA (The Cup).**—The inner whorl of leaves, forming the flower itself. Its separate leaves are called **PETALS**. 53
- V. **THE TREASURY.**—The part of the flower that contains its seeds.
- VI. **THE PILLAR.**—The part of the flower above its treasury, by which the power of the pollen is carried down to the seeds. 58
- It consists usually of two parts—the **SHAFT** and **VOLUTE**. 58
- When the pillar is composed of two or more shafts, attached to separate treasury-cells, each cell with its shaft is called a **CARPEL** 162
- VII. **THE STAMENS.**—The parts of the flower which secrete its pollen 58
- They consist usually of two parts, the **FILAMENT** and **ANTHER**, not yet described.
- VIII. **THE NECTARY.**—The part of the flower containing its honey, or any other special product of its inflorescence. The name has often been given to certain forms of petals of which the use is not yet known. No notice has yet been taken of this part of the flower in Proserpina.

These being all the essential parts of the flower itself, other forms and substances are developed in the seed as it ripens, which, I believe, may most conveniently be arranged in a separate section, though not logically to be considered as separable from the flower, but only as mature states of certain parts of it.

V. THE SEED.

I must once more desire the reader to take notice that, under the four sections already defined, the morphology of the plant is to be considered as complete, and that we are now only to examine and name, farther, its *product*; and that not so much as the germ of its own future descendant flower, but as a separate substance which it is appointed to form, partly to its own detriment, for the sake of higher creatures. This product consists essentially of two parts: the Seed and its Husk.

| | PAGE |
|--|---------|
| I. THE SEED.—Defined..... | 152 |
| It consists, in its perfect form, of three parts | 153 |
| These three parts are not yet determinately named in the text: but I give now the names which will be usually attached to them. | |
| A. <i>The Sacque</i> .—The Outside skin of a seed..... | 152 |
| B. <i>The Nutrine</i> .—A word which I coin, for general applicability, whether to the farina of corn, the substance of a nut, or the parts that become the first leaves in a bean | 152 |
| C. <i>The Germ</i> .—The origin of the root | 152 |
| II. THE HUSK.—Defined..... | 153 |
| Consists, like the seed when in perfect form, of three parts. | |
| A. <i>The Skin</i> .—The outer envelope of all the seed structures .. | 153 |
| B. <i>The Rind</i> .—The central body of the Husk | 153-162 |
| C. <i>The Shell</i> .—Not always shelly, yet best described by this general term; and becoming a shell, so called, in nuts, peaches, dates, and other such kernel-fruits | 153 |

The products of the Seed and Husk of Plants, for the use of animals, are practically to be massed under the three heads of BREAD, OIL, and FRUIT. But the substance of which bread is made is more accurately described as Farina; and the

pleasantness of fruit to the taste depends on two elements in its substance: the juice, and the pulp containing it, which may properly be called Nectar and Ambrosia. We have therefore in all four essential products of the Seed and Husk—

| | | |
|--------------|----------------------|-----|
| A. Farina. | Flour | 156 |
| B. Oleum. | Oil | 158 |
| C. Nectar. | Fruit-juice..... | 158 |
| D. Ambrosia. | Fruit-substance..... | 158 |

Besides these all-important products of the seed, others are formed in the stems and leaves of plants, of which no account hitherto has been given in Proserpina. I delay any extended description of these until we have examined the structure of wood itself more closely; this intricate and difficult task having been remitted (p. 122) to the days of coming spring; and I am well pleased that my younger readers should at first be vexed with no more names to be learned than those of the vegetable productions with which they are most pleasantly acquainted: but for older ones, I think it well, before closing the present volume, to indicate, with warning, some of the obscurities, and probable fallacies, with which this vanity of science encumbers the chemistry, no less than the morphology, of plants.

Looking back to one of the first books in which our new knowledge of organic chemistry began to be displayed, thirty years ago, I find that even at that period the organic elements which the cuisine of the laboratory had already detected in simple Indigo, were the following:—

Isatine,
Bromisatine,
Bibromisatine;
Chlorisatine,
Bichlorisatine;
Chlorisatyde,
Bichlorisatyde;

Chlorindine,
Chlorindoptene,
Chlorindatmit;
Chloranile,
Chloranilam, and,
Chloranilammon.

And yet, with all this practical skill in decoction, and accumulative industry in observation and nomenclature, so far are our scientific men from arriving, by any decoctive process of their own knowledge, at general results useful to ordinary human creatures, that when I wish now to separate, for young scholars, in first massive arrangement of vegetable productions, the Substances of Plants from their Essences; that is to say, the weighable and measurable body of the plant from its practically immeasurable, if not imponderable, spirit, I find in my three volumes of close-printed chemistry, no information whatever respecting the quality of volatility in matter, except this one sentence:—

“The disposition of various substances to yield vapour is very different: and the difference depends doubtless on the relative power of cohesion with which they are endowed.”*

Even in this not extremely pregnant, though extremely cautious, sentence, two conditions of matter are confused, no notice being taken of the difference in manner of dissolution between a vitally fragrant and a mortally putrid substance.

It is still more curious that when I look for more definite instruction on such points to the higher ranks of botanists, I find in the index to Dr. Lindley's ‘Introduction to Botany’—seven hundred pages of close print—not one of the four words ‘Volatile,’ ‘Essence,’ ‘Scent,’ or ‘Perfume.’ I examine the index to Gray's ‘Structural and Systematic Botany,’ with precisely the same success. I next consult Professors Balfour and Grindon, and am met by the same dignified silence. Finally, I think over the possible chances in French, and try in Figuier's indices to the ‘Histoire des Plantes’ for ‘Odeur’—no such word! ‘Parfum’—no such word. ‘Essence’—no such word. ‘Encens’—no such word. I try at last ‘Pois de Senteur,’ at a venture, and am referred to a page which describes their going to sleep.

Left thus to my own resources, I must be content for the present to bring the subject at least under safe laws of nomenclature. It is possible that modern chemistry may be entirely

* “Elements of Chemistry,” p. 44. By Edward Turner; edited by Justus Liebig and William Gregory. Taylor and Walton, 1840.

right in alleging the absolute identity of substances such as albumen, or fibrine, whether they occur in the animal or vegetable economies. But I do not choose to assume this identity in my nomenclature. It may, perhaps, be very fine and very instructive to inform the pupils preparing for competitive examination that the main element of Milk is Milkine, and of Cheese, Cheesine. But for the practical purposes of life, all that I think it necessary for the pupil to know is that in order to get either milk or cheese, he must address himself to a Cow, and not to a Pump; and that what a chemist can produce for him out of dandelions or cocoanuts, however milky or cheesy it may look, may more safely be called by some name of its own.

This distinctness of language becomes every day more desirable, in the face of the refinements of chemical art which now enable the ingenious confectioner to meet the demands of an unscientific person for (suppose) a lemon drop, with a mixture of nitric acid, sulphur, and stewed bones. It is better, whatever the chemical identity of the products may be, that each should receive a distinctive epithet, and be asked for and supplied, in vulgar English, and vulgar probity, either as essence of lemons, or skeletons.

I intend, therefore,—and believe that the practice will be found both wise and convenient,—to separate in all my works on natural history the terms used for vegetable products from those used for animal or mineral ones, whatever may be their chemical identity, or resemblance in aspect. I do not mean to talk of fat in seeds, nor of flour in eggs, nor of milk in rocks. Pace my prelatial friends, I mean to use the word 'Alb' for vegetable albumen; and although I cannot without pedantry avoid using sometimes the word 'milky' of the white juices of plants, I must beg the reader to remain unaffected in his conviction that there is a vital difference between liquids that coagulate into butter, or congeal into India-rubber. Oil, when used simply, will always mean a vegetable product; and when I have occasion to speak of petroleum, tallow, or blubber, I shall generally call these substances by their right names.

'There are also a certain number of vegetable materials more or less prepared, secreted, or digested for us by animals, such as wax, honey, silk, and cochineal. The properties of these require more complex definitions, but they have all very intelligible and well-established names. 'Tea' must be a general term for an extract of any plant in boiling water: though when standing alone the word will take its accepted Chinese meaning: and essence, the general term for the condensed dew of a vegetable vapour, which is with grace and fitness called the 'being' of a plant, because its properties are almost always characteristic of the species; and it is not, like leaf tissue or wood fibre, approximately the same material in different shapes; but a separate element in each family of flowers, of a mysterious, delightful, or dangerous influence, logically inexplicable, chemically inconstructible, and wholly, in dignity of nature, above all modes and faculties of form.

INDEX II.

TO THE PLANTS SPOKEN OF IN THIS VOLUME, UNDER THEIR ENGLISH NAMES, ACCEPTED BY PROSERPINA.

- Apple, 74
Ash, 85, 90
Aspen, 94
Asphodel, 10, 29
- Bay, 39
Bean, 75
Bed-straw, 86
Bindweed, 102
Birch, 120
Blackthorn, 85, 90
Blaeberry, 40, 143
Bluebell, 102
Bramble, 85, 135
Burdock, 80, 93
Burnet, 69
Butterbur, 84
- Cabbage, 93, 105
Captain-salad, 105
Carrot, 26, 29
Cauliflower, 93, 105
Cedar, 29, 46, 81,
Celandine, 54
Cherry, 49, 92
Chestnut, 47
 " Spanish, 117
Chicory, 84
Clover, 80
Colewort, 105
Coltsfoot, 79
Corn-cockle, 78
Corn-flag, 76, 78
- Cowslip, 98
Crocus, 29, 30
- Daffodil, 10
Daisy, 83, 102, 145
Dandelion, 83
Devil s Bit, 104
Dock, 93
- Elm, 40
- Fig, 48
Flag, 76
Flax, 116
Foils, Rock, 102
 " Roof, 102, 103
Foxglove, 70, 84, 98
Frog-flower, 43
- Grape, 74, 92
Grass, 40, 41, 42, 111, 113, 114,
 115
- Hawk's-eye, 84
Hazel, 85
Heath, 50, 51, 77, 144
Hemlock, 77
Herb-Robert, 86
Holly, 81, 85
Houseleek, 30, 103
Hyacinth, 49, 50
- Ivy, 80
- Jacinth, 61, 129

- King-cup, 79
 Laurel, 35, 45, 90
 " leaves, 34, 39, 46
 Lichen, 122
 Lilac, 56
 Lily, 5, 29, 40, 75, 78
 Lily, St. Bruno's, 5, 10, 11
 Lily of the Valley, 101
 Lily, Water, 42, 54
 Ling, 51, 52
 Lion's-tooth, 81
 Liquorice, 31
 Lucy, 79, 102

 Mistletoe, 80
 Moss, 13, 15, 122
 Mushroom, 34, 90
 Myrtle, 39

 Nettle, 40, 64, 77
 Nightshade, 78

 Oak, 29, 99
 " blossoms, 50
 Olive, 39, 48, 106
 Onion, 31
 Orange, 39

 Pæony, 91
 Palm, 34, 40, 54, 74, 156, 116
 Pansy, 120, 102
 Papilionaceæ, 102
 Papyrus, 116
 Pea, 27, 102
 Peach, 92, 102
 Pine, 99
 Pineapple, 15
 Pink, 102
 Plantain, 95
 Pomegranate, 74
 Poplar, 40

 Poppy, 52, 56, 63, 73
 Primrose, 59, 102

 Radish, 28, 31
 Ragged Robin, 109
 Rhubarb, 92
 Rice, 40
 Rock-foil, 102
 Roof-foil, 102, 103
 Rose, 48, 52, 56, 75, 78, 85, 86
 91, 102
 Rush, 110

 Saxifrage, 85, 101, 103
 Scabious, 104
 Sedum, 103
 Sorrel-wood, 11
 Spider Plant, 10
 Sponsa solis, 84
 Stella, 102, 103
 " domestica, 103
 Stonecrop, 103
 Sweetbrier, 79

 Thistle, 75, 81, 83, 84, 86, 103 *note*,
 107 *note*.
 Thistle, Creeping, 97
 " Waste, 108
 Thorns, 86, 90
 " Black, 85, 90
 Thyme, 84
 Tobacco, 31, 78
 Tormentilla, 79
 Turnip, 29

 Vine, 75, 78, 99, 106
 Viola, 102

 Wallflower, 80
 Wheat, 90, 116
 Wreathewort, 121

INDEX III.

TO THE PLANTS SPOKEN OF IN THIS VOLUME, UNDER THEIR LATIN OR
GREEK NAMES, ACCEPTED BY PROSERPINA.

Acanthus, 75
Alata, 102
Alisma, 40
Amaryllis, 29, 30
Anemone, 78
Artemides, 136
Asphodel, 10
Aurora, 143
Azalea, 143

Cactus, 33
Campanula, 102
Carduus, 97
Charites, 131
Cistus, 52
Clarissa, 102, 109
Contorta, 121
Convoluta, 103
Cyclamen, 27

Drosidæ, 29, 138

Ensata, 141
Ericæ, 11, 142
Eryngo, 61

Fragaria, 131
Francesca, 102, 103
Frarinus, 135

Geranium, 61, 86
Gladiolus, 75, 78, 115

Hyacinthus, 129
Hypnum, 13

Iris, 29, 74

Lilium (*see* Lily), 10
Lucia, 79, 132

Magnolia, 39
Margarita, 102
Myrtilla, 142

Narcissus, 78
Ophrys, 125
Papaver, 66, 70
Persica, 102
Pomum, 131
Primula, 101

Rosa, 102
Rubra, 131, 136

Satyrium, 126
Stella, 102, 103

Veronica, 56
Viola, 102

ARIADNE FLORENTINA

SIX LECTURES

ON

WOOD AND METAL ENGRAVING

WITH APPENDIX

GIVEN BEFORE THE UNIVERSITY OF OXFORD IN MICHAELMAS
TERM, 1872

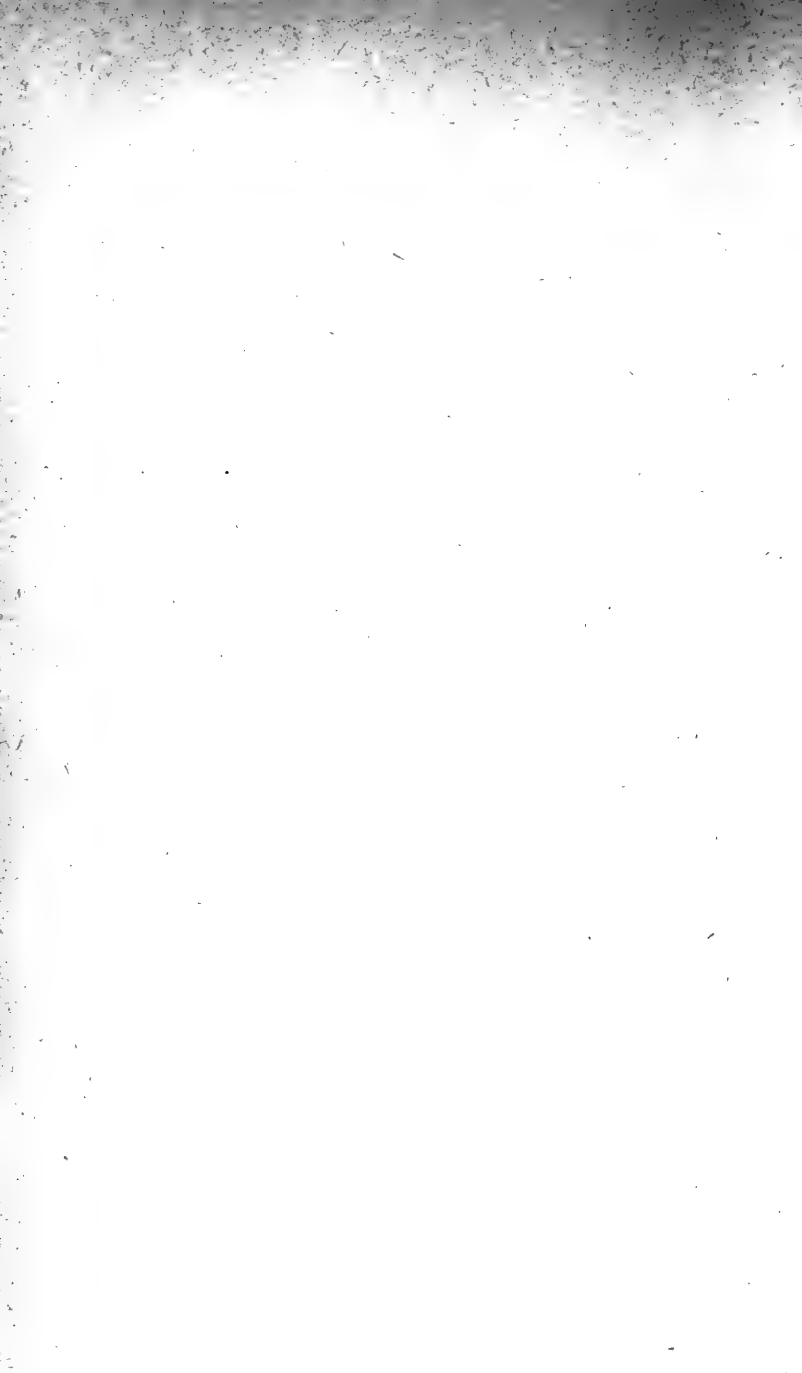

ARIADNE FLORENTINA.

SIX LECTURES

ON

WOOD AND METAL ENGRAVING.

LECTURE I.

DEFINITION OF THE ART OF ENGRAVING.

1. THE entrance on my duty for to-day begins the fourth year of my official work in Oxford; and I doubt not that some of my audience are asking themselves, very doubtfully—at all events, I ask myself, very anxiously—what has been done.

For practical result, I have not much to show. I announced, a fortnight since, that I would meet, the day before yesterday, any gentleman who wished to attend this course for purposes of study. My class, so minded, numbers four, of whom three wish to be artists, and ought not therefore, by rights, to be at Oxford at all; and the fourth is the last remaining unit of the class I had last year.

2. Yet I neither in this reproach myself, nor, if I could, would I reproach the students who are not here. I do not reproach myself; for it was impossible for me to attend properly to the schools and to write the grammar for them at the same time; and I do not blame the absent students for not attending a school from which I have generally been absent

myself. In all this, there is much to be mended, but, in true light, nothing to be regretted.

I say, I had to write my school grammar. These three volumes of lectures under my hand,* contain carefully set down, the things I want you first to know. None of my writings are done fluently; the second volume of *Modern Painters* was all of it written twice—most of it, four times,—over; and these lectures have been written, I don't know how many times. You may think that this was done merely in an author's vanity, not in a tutor's care. To the vanity I plead guilty,—no man is more intensely vain than I am; but my vanity is set on having it *known* of me that I am a good master, not in having it *said* of me that I am a smooth author. My vanity is never more wounded than in being called a fine writer, meaning—that nobody need mind what I say.

3. Well, then, besides this vanity, I have some solicitude for your progress. You may give me credit for it or not, as you choose, but it is sincere. And that your advance may be safe, I have taken the best pains I could in laying down laws for it. In these three years I have got my grammar written, and, with the help of many friends, all working instruments in good order; and now we will try what we can do. Not that, even now, you are to depend on my presence with you in personal teaching. I shall henceforward think of the lectures less, of the schools more; but my best work for the schools will often be by drawing in Florence or in Lancashire—not here.

4. I have already told you several times that the course through which I mean every student in these schools should pass, is one which shall enable them to understand the elementary principles of the finest art. It will necessarily be severe, and seem to lead to no immediate result. Some of you will, on the contrary, wish to be taught what is immediately easy, and gives prospect of a manifest success.

But suppose they should come to the Professor of Logic and Rhetoric, and tell him they wanted to be taught to preach like Mr. Spurgeon, or the Bishop of —.

* Inaugural series, Aratra Pentelici, and Eagle's Nest.

He would say to them,—I cannot, and if I could I would not, tell you how to preach like Mr. Spurgeon, or the Bishop of ——. Your own character will form your style ; your own zeal will direct it ; your own obstinacy or ignorance may limit or exaggerate it ; but my business is to prevent, as far as I can, your having *any* particular style ; and to teach you the laws of all language, and the essential power of your own.

In like manner, this course, which I propose to you in art, will be calculated only to give you judgment and method in future study, to establish to your conviction the laws of general art, and to enable you to draw, if not with genius, at least with sense and propriety.

The course, so far as it consists in practice, will be defined in my Instructions for the schools. And the theory connected with that practice is set down in the three lectures at the end of the first course I delivered—those on Line, Light, and Colour.

You will have, therefore, to get this book,* and it is the only one which you will need to have of your own,—the others are placed, for reference, where they will be accessible to you.

5. In the 139th paragraph, p. 132, it states the order of your practical study in these terms :

“I wish you to begin by getting command of line ;—that is to say, by learning to draw a steady line, limiting with absolute correctness the form or space you intend it to limit ; to proceed by getting command over flat tints, so that you may be able to fill the spaces you have enclosed evenly, either with shade or colour, according to the school you adopt ; and, finally, to obtain the power of adding such fineness of drawing, within the masses, as shall express their undulation, and their characters of form and texture.”

And now, since in your course of practice you are first required to attain the power of drawing lines accurately and delicately, so in the course of theory, or grammar, I wish you

* My inaugural series of seven lectures, published at the Clarendon Press.

first to learn the principles of linear design, exemplified by the schools which at the top of page 130 you will find characterized as the Schools of Line.

6. If I had command of as much time as I should like to spend with you on this subject, I would begin with the early forms of art which used the simplest linear elements of design. But, for general service and interest, it will be better that I should sketch what has been accomplished by the greatest masters in that manner ; the rather that their work is more or less accessible to all, and has developed into the vast industries of modern engraving, one of the most powerful existing influences of education and sources of pleasure among civilized people.

And this investigation, so far from interrupting, will facilitate our examination of the history of the nobler arts. You will see in the preface to my lectures on Greek sculpture that I intend them to be followed by a course on architecture, and that by one on Florentine sculpture. But the art of engraving is so manifestly, at Florence, though not less essentially elsewhere, a basis of style both in architecture and sculpture, that it is absolutely necessary I should explain to you in what the skill of the engraver consists, before I can define with accuracy that of more admired artists. For engraving, though not altogether in the method of which you see examples in the print-shops of the High Street, is, indeed, a prior art to that either of building or sculpture, and is an inseparable part of both, when they are rightly practised.

7. And while we thus examine the scope of this first of the arts, it will be necessary that we learn also the scope of mind of the early practisers of it, and accordingly acquaint ourselves with the main events in the biography of the schools of Florence. To understand the temper and meaning of one great master is to lay the best, if not the only, foundation for the understanding of all ; and I shall therefore make it the leading aim of this course of lectures to remind you of what is known, and direct you to what is knowable, of the life and character of the greatest Florentine master of engraving, Sandro Botticelli ; and, incidentally, to give you some idea of

the power of the greatest master of the German, or any northern, school, Hans Holbein.

8. You must feel, however, that I am using the word "engraving" in a somewhat different, and, you may imagine, a wider, sense, than that which you are accustomed to attach to it. So far from being a wider sense, it is in reality a more accurate and restricted one, while yet it embraces every conceivable right application of the art. And I wish, in this first lecture, to make entirely clear to you the proper meaning of the word, and proper range of the art of, engraving; in my next following lecture, to show you its place in Italian schools, and then, in due order, the place it ought to take in our own, and in all schools.

9. First then, to-day, of the *Differentia*, or essential quality of Engraving, as distinguished from other arts.

What answer would you make to me, if I asked casually what engraving was? Perhaps the readiest which would occur to you would be, "The translation of pictures into black and white by means admitting reduplication of impressions." But if that be done by lithography, we do not call it engraving,—whereas we speak contentedly and continually of seal engraving, in which there is no question of black and white. And, as scholars, you know that this customary mode of speaking is quite accurate; and that engraving means, primarily, making a permanent cut or furrow in something. The central syllable of the word has become a sorrowful one, meaning the most permanent of furrows.

10. But are you prepared absolutely to accept this limitation with respect to engraving as a pictorial art? Will you call nothing an engraving, except a group of furrows or cavities cut in a hard substance? What shall we say of mezzotint engraving, for instance, in which, though indeed furrows and cavities are produced mechanically as a ground, the artist's work is in effacing them? And when we consider the power of engraving in representing pictures and multiplying them, are we to recognize and admire no effects of light and shade except those which are visibly produced by dots or furrows? I mean, will the virtue of an engraving be in ex-

hibiting these imperfect means of its effect, or in concealing them?

11. Here, for instance, is the head of a soldier by Durer,—a mere gridiron of black lines. Would this be better or worse engraving if it were more like a photograph or lithograph, and no lines seen?—suppose, more like the head of Mr. Santley, now in all the music-shops, and really quite deceptive in light and shade, when seen from over the way? Do you think Durer's work would be better if it were more like that? And would you have me, therefore, leaving the question of technical method of production altogether to the craftsman, consider pictorial engraving simply as the production of a light-and-shade drawing, by some method permitting its multiplication for the public?

12. This, you observe, is a very practical question indeed. For instance, the illustrations of my own lectures on sculpture are equivalent to permanent photographs. There can be little doubt that means will be discovered of thus producing perfect facsimiles of artists' drawings; so that, if no more than facsimile be required, the old art of cutting furrows in metal may be considered as, at this day, virtually ended. And, indeed, it is said that line engravers cannot any more get apprentices, and that a pure steel or copper plate is not likely to be again produced, when once the old living masters of the bright field shall have been all laid in their earth-furrows.

13. Suppose, then, that this come to pass; and more than this, suppose that wood engraving also be superseded, and that instead of imperfect transcripts of drawings, on wood-blocks or metal-plates, photography enabled us to give, quite cheaply, and without limit to number facsimiles of the finished light-and-shade drawings of artists themselves. Another group of questions instantly offers itself, on these new conditions; namely, What are the best means for a light-and-shade drawing—the pen, or the pencil, the charcoal, or the flat wash? That is to say, the pen, producing shade by black lines, as old engraving did; the pencil, producing shade by grey lines, variable in force; the charcoal, producing a smoky shadow with no lines in it, or the washed tint, producing a

transparent shadow with no lines in it. Which of these methods is the best?—or have they, each and all, virtues to be separately studied, and distinctively applied?

14. See how curiously the questions multiply on us. 1st, Is engraving to be only considered as cut work? 2nd, For present designs multipliable without cutting, by the sunshine, what methods or instruments of drawing will be best? And now, 3rdly, before we can discuss these questions at all, is there not another lying at the root of both,—namely, what a light-and-shade drawing itself properly is, and how it differs, or should differ, from a painting,—whether by mere deficiency, or by some entirely distinct merit?

15. For instance, you know how confidently it is said, in common talk about Turner, that his works are intelligible and beautiful when engraved, though incomprehensible as paintings. Admitting this to be so, do you suppose it is because the translation into light and shade is deficient in some qualities which the painting had, or that it possesses some quality which the painting had not? Does it please more because it is deficient in the colour which confused a feeble spectator, and offended a dogmatic one,—or because it possesses a decision in its steady linear labour which interprets, or corrects, the swift pencilling of the artist?

16. Do you notice the two words I have just used, *Decision*, and *Linear*?—*Decision*, again introducing the idea of cuts or divisions, as opposed to gradations; *Linear*, as opposed to massive or broad?

Yet we use all these words at different times in praise, while they evidently mark inconsistent qualities. Softness and decision, breadth and delineation, cannot co-exist in equal degrees. There must surely therefore be a virtue in the engraving inconsistent with that of the painting, and vice versâ.

Now, be clear about these three questions which we have to-day to answer.

A. Is all engraving to be cut work?

B. If it need not be cut work, but only the reproduction of a drawing, what methods of executing a light-and-shade drawing will be best?

- C. Is the shaded drawing itself to be considered only as a deficient or imperfect painting, or as a different thing from a painting, having a virtue of its own, belonging to black and white, as opposed to colour?
17. I will give you the answers at once, briefly, and amplify them afterwards.
- A. All engraving must be cut work ;—*that* is its differentia. Unless your effect be produced by cutting into some solid substance, it is not engraving at all.
- B. The proper methods for light-and-shade drawing vary according to subject, and the degree of completeness desired,—some of them having much in common with engraving, and others with painting.
- C. The qualities of a light-and-shade drawing ought to be entirely different from those of a painting. It is not a deficient or partial representation of a coloured scene or picture, but an entirely different reading of either. So that much of what is intelligible in a painting ought to be unintelligible in a light-and-shade study and vice versâ.

You have thus three arts,—engraving, light-and-shade drawing, and painting.

Now I am not going to lecture, in this course, on painting, nor on light-and-shade drawing, but on engraving only. But I must tell you something about light-and-shade drawing first ; or, at least, remind you of what I have before told.

18. You see that the three elementary lectures in my first volume are on Line, Light, and Colour,—that is to say, on the modes of art which produce linear designs,—which produce effects of light,—and which produce effects of colour.

I must, for the sake of new students, briefly repeat the explanation of these.

Here is an Arabian vase, in which the pleasure given to the eye is only by lines ;—no effect of light, or of colour, is attempted. Here is a moonlight by Turner, in which there are no lines at all, and no colours at all. The pleasure given to the eye is only by modes of light and shade, or effects of light. Finally, here is an early Florentine painting, in which there are

no lines of importance, and no effect of light whatever ; but all the pleasure given to the eye is in gaiety and variety of colour.

19. I say, the pleasure given to the *eye*. The lines on this vase write something ; but the ornamentation produced by the beautiful writing is independent of its meaning. So the moonlight is pleasant, first, as light ; and the figures, first, as colour. It is not the shape of the waves, but the light on them ; not the expression of the figures, but their colour, by which the *ocular* pleasure is to be given.

These three examples are violently marked ones ; but, in preparing to draw *any* object, you will find that, practically, you have to ask yourself, Shall I aim at the colour of it, the light of it, or the lines of it ? You can't have all three ; you can't even have any two out of the three in equal strength. The best art, indeed, comes so near nature as in a measure to unite all. But the best is not, and cannot be, as good as nature ; and the mode of its deficiency is that it must lose some of the colour, some of the light, or some of the delineation. And in consequence, there is one great school which says, We will have the colour, and as much light and delineation as are consistent with it. Another which says, We will have shade, and as much colour and delineation as are consistent with it. The third, We will have delineation, and as much colour and shade as are consistent with it.

20. And though much of the two subordinate qualities may in each school be consistent with the leading one, yet the schools are evermore separate : as, for instance, in other matters, one man says, I will have my fee, and as much honesty as is consistent with it ; another, I will have my honesty, and as much fee as is consistent with it. Though the man who will have his fee be subordinately honest,—though the man who will have his honour, subordinately rich, are they not evermore of diverse schools ?

So you have, in art, the utterly separate provinces, though in contact at their borders, of

The Delineators ;
The Chiaroscurists ; and
The Colourists.

21. The Delineators are the men on whom I am going to give you this course of lectures. They are essentially engravers, an engraved line being the best means of delineation. The Chiaroscurists are essentially draughtsmen with chalk, charcoal, or single tints. Many of them paint, but always with some effort and pain. Leonardo is the type of them; but the entire Dutch school consists of them, laboriously painting, without essential genius for colour.

The Colourists are the true painters; and all the faultless (as far, that is to say, as men's work can be so,) and consummate masters of art belong to them.

22. The distinction between the colourist and chiaroscurist school is trenchant and absolute; and may soon be shown you so that you will never forget it. Here is a Florentine picture by one of the pupils of Giotto, of very good representative quality, and which the University galleries are rich in possessing. At the distance at which I hold it, you see nothing but a chequer-work of brilliant, and, as it happens, even glaring colours. If you come near, you will find this patchwork resolve itself into a Visitation, and Birth of St. John; but that St. Elizabeth's red dress, and the Virgin's blue and white one, and the brown posts of the door, and the blue spaces of the sky, are painted in their own entirely pure colours, each shaded with more powerful tints of itself,—pale blue with deep blue, scarlet with crimson, yellow with orange, and green with richer green.

The whole is therefore as much a mosaic work of brilliant colour as if it were made of bits of glass. There is no effect of light attempted, or so much as thought of: you don't know even where the sun is; nor have you the least notion what time of day it is. The painter thinks you cannot be so superfluous as to want to know what time of day it is.

23. Here, on the other hand, is a Dutch picture of good average quality, also out of the University galleries. It represents a group of cattle, and a herdsman watching them. And you see in an instant that the time is evening. The sun is setting, and there is warm light on the landscape, the cattle, and the standing figure.

Nor does the picture in any conspicuous way seem devoid of colour. On the contrary, the herdsman has a scarlet jacket, which comes out rather brilliantly from the mass of shade round it ; and a person devoid of colour faculty, or ill taught, might imagine the picture to be really a fine work of colour.

But if you will come up close to it, you will find that the herdsman has brown sleeves, though he has a scarlet jacket ; and that the shadows of both are painted with precisely the same brown, and in several places with continuous touches of the pencil. It is only in the light that the scarlet is laid on.

This at once marks the picture as belonging to the lower or chiaroscuro school, even if you had not before recognized it as such by its pretty rendering of sunset effect.

24. You might at first think it a painting which showed greater skill than that of the school of Giotto. But the skill is not the primary question. The power of imagination is the first thing to be asked about. This Italian work imagines, and requires you to imagine also, a St. Elizabeth and St. Mary, to the best of your power. But this Dutch one only wishes you to imagine an effect of sunlight on cowskin, which is a far lower strain of the imaginative faculty.

Also, as you may see the effect of sunlight on cowskin, in reality, any summer afternoon, but cannot so frequently see a St. Elizabeth, it is a far less useful strain of the imaginative faculty.

And, generally speaking, the Dutch chiaroscurists are indeed persons without imagination at all,—who, not being able to get any pleasure out of their thoughts, try to get it out of their sensations ; note, however, also their technical connection with the Greek school of shade, (see my sixth inaugural lecture, p. 158,) in which colour was refused, not for the sake of deception, but of solemnity.

25. With these final motives you are not now concerned ; your present business is the quite easy one of knowing, and noticing, the universal distinction between the methods of treatment in which the aim is light, and in which it is colour ; and so to keep yourselves guarded from the danger of being misled by the, often very ingenious, talk of persons who have

vivid colour sensations without having learned to distinguish them from what else pleases them in pictures. There is an interesting volume by Professor Taine on the Dutch school, containing a valuable historical analysis of the influences which formed it ; but full of the gravest errors, resulting from the confusion in his mind between colour and tone, in consequence of which he imagines the Dutch painters to be colourists.

26. It is so important for you to be grounded securely in these first elements of pictorial treatment, that I will be so far tedious as to show you one more instance of the relative intellectual value of the pure colour and pure chiaroscuro school, not in Dutch and Florentine, but in English art. Here is a copy of one of the lost frescoes of our Painted Chamber of Westminster ;—fourteenth-century work, entirely conceived in colour, and calculated for decorative effect. There is no more light and shade in it than in a Queen of Hearts in a pack of cards ; all that the painter at first wants you to see is that the young lady has a white forehead, and a golden crown, and a fair neck, and a violet robe, and a crimson shield with golden leopards on it ; and that behind her is a clear blue sky. Then, farther, he wants you to read her name, “Debonnairete,” which, when you have read, he farther expects you to consider what it is to be debonnaire, and to remember your Chaucer’s description of the virtue :—

She was not brown, nor dun of hue,
But white as suowe, fallen new,
With eyen glad, and browes bent,
Her hair down to her heeles went,
And she was simple, as dove on tree,
Full debonnair of heart was she.

27. You see Chaucer dwells on the color just as much as the painter does, but the painter has also given her the English shield to bear, meaning that good-humour, or debonnair-ete, cannot be maintained by self-indulgence ;—only by fortitude. Farther note, with Chaucer, the “eyen glad,” and brows “bent” (high-arched and calm), the strong life (hair down to

the heels,) and that her gladness is to be without subtlety,—that is to say, without the slightest pleasure in any form of advantage-taking, or any shrewd or mocking wit: “she was simple as dove on tree;” and you will find that the colour-painting, both in the fresco and in the poem, is in the very highest degree didactic and intellectual; and distinguished, as being so, from all inferior forms of art. Farther, that it requires you yourself first to understand the nature of simplicity, and to like simplicity in young ladies better than subtlety; and to understand why the second of Love’s five kind arrows (*Beauté* being the first),

Simplece ot nom, la seconde
 Qui maint homme parmi le monde
 Et mainte dame fait amer.

Nor must you leave the picture without observing that there is another reason for *Debonnairete*’s bearing the Royal shield,—of all shields that, rather than another. “*De-bonne-aire*” meant originally “out of a good eagle’s nest,” the “*aire*” signifying the eagle’s nest or eyrie especially, because it is flat, the Latin “*area*” being the root of all.

And this coming out of a good nest is recognized as, of all things, needfullest to give the strength which enables people to be good-humoured; and thus you have “*debonnaire*” forming the third word of the group, with “gentle” and “kind,” all first signifying “of good race.”

You will gradually see, as we go on, more and more why I called my third volume of lectures *Eagle’s Nest*; for I am not fantastic in these titles, as is often said; but try shortly to mark my chief purpose in the book by them.

28. Now for comparison with this old art, here is a modern engraving, in which colour is entirely ignored; and light and shade alone are used to produce what is supposed to be a piece of impressive religious instruction. But it is not a piece of religious instruction at all;—only a piece of religious sensation, prepared for the sentimental pleasure of young ladies; whom (since I am honoured to-day by the presence of many) I will take the opportunity of warning against such

forms of false theological satisfaction. This engraving represents a young lady in a very long and, though plain, very becoming white dress, tossed upon the waves of a terrifically stormy sea, by which neither her hair nor her becoming dress is in the least wetted ; and saved from despair in that situation by closely embracing a very thick and solid stone Cross. By which far-sought and original metaphor young ladies are expected, after some effort, to understand the recourse they may have, for support, to the Cross of Christ, in the midst of the troubles of this world.

29. As those troubles are for the present, in all probability, limited to the occasional loss of their thimbles when they have not taken care to put them into their workboxes,—the concern they feel at the unsympathizing gaiety of their companions,—or perhaps the disappointment at not hearing a favourite clergyman preach,—(for I will not suppose the young ladies interested in this picture to be affected by any chagrin at the loss of an invitation to a ball, or the like worldliness,)—it seems to me the stress of such calamities might be represented, in a picture, by less appalling imagery. And I can assure my fair little lady friends,—if I still have any,—that whatever a young girl's ordinary troubles or annoyances may be, her true virtue is in shaking them off, as a rose-leaf shakes off rain, and remaining debonnaire and bright in spirits, or even, as the rose would be, the brighter for the troubles ; and not at all in allowing herself to be either drifted or depressed to the point of requiring religious consolation. But if any real and deep sorrow, such as no metaphor can represent, fall upon her, does she suppose that the theological advice of this piece of modern art can be trusted ? If she will take the pains to think truly, she will remember that Christ Himself never says anything about holding by His Cross. He speaks a good deal of bearing it ; but never for an instant of holding by it. It is His Hand, not His Cross, which is to save either you, or St. Peter, when the waves are rough. And the utterly reckless way in which modern religious teachers, whether in art or literature, abuse the metaphor somewhat briefly and violently leant on by St. Paul, simply prevents your understanding the

meaning of any word which Christ Himself speaks on this matter! So you see this popular art of light and shade, catching you by your mere thirst of sensation, is not only undidactic, but the reverse of didactic—deceptive and illusory.

30. This *popular* art, you hear me say, scornfully; and I have told you, in some of my teaching in Aratra Pentelici, that all great art must be popular. Yes, but great art is popular, as bread and water are to children fed by a father. And vile art is popular, as poisonous jelly is, to children cheated by a confectioner. And it is quite possible to make any kind of art popular on those last terms. The colour school may become just as poisonous as the colourless, in the hands of fools, or of rogues. Here is a book I bought only the other day,—one of the things got up cheap to catch the eyes of mothers at bookstalls,—Puss in Boots, illustrated; a most definite work of the colour school—red jackets and white paws and yellow coaches as distinct as Giotto or Raphael would have kept them. But the thing is done by fools for money, and becomes entirely monstrous and abominable. Here, again, is colour art produced by fools for religion: here is Indian sacred painting,—a black god with a hundred arms, with a green god on one side of him and a red god on the other; still a most definite work of the colour school. Giotto or Raphael could not have made the black more resolutely black, (though the whole colour of the school of Athens is kept in distinct separation from one black square in it), nor the green more unquestionably green. Yet the whole is pestilent and loathsome.

31. Now but one point more, and I have done with this subject for to-day.

You must not think that this manifest brilliancy and Harlequin's-jacket character is essential in the colour school. The essential matter is only that everything should be of *its own* definite colour: it may be altogether sober and dark, yet the distinctness of hue preserved with entire fidelity. Here, for instance, is a picture of Hogarth's,—one of quite the most precious things we have in our galleries. It represents a meeting of some learned society—gentlemen of the last century, very gravely dressed, but who, nevertheless, as gentlemen

pleasantly did in that day,—you remember Goldsmith's weakness on the point—wear coats of tints of dark red, blue, or violet. There are some thirty gentlemen in the room, and perhaps seven or eight different tints of subdued claret-colour in their coats; and yet every coat is kept so distinctly of its own proper claret-colour, that each gentleman's servant would know his master's.

Yet the whole canvas is so grey and quiet, that as I now hold it by this Dutch landscape, with the vermilion jacket, you would fancy Hogarth's had no colour in it at all, and that the Dutchman was half-way to becoming a Titian; whereas Hogarth's is a consummate piece of the most perfect colourist school, which Titian could not beat, in its way; and the Dutchman could no more paint half an inch of it than he could summon a rainbow into the clouds.

32. Here then, you see, are, altogether, five works, all of the absolutely pure colour school:—

1. One, Indian,—Religious Art;
2. One, Florentine,—Religious Art;
3. One, English, from Painted Chamber, Westminster,—Ethic Art;
4. One, English,—Hogarth,—Naturalistic Art;
5. One, English,—to-day sold in the High Street,—Caricaturist Art.

And of these, the Florentine and old English are divine work, God-inspired; full, indeed, of faults and innocencies, but divine, as good children are.

Then this by Hogarth is entirely wise and right; but worldly-wise, not divine.

While the old Indian, and this, with which we feed our children at this hour, are entirely damnable art;—every bit of it done by the direct inspiration of the devil,—feeble, ridiculous, —yet mortally poisonous to every noble quality in body and soul.

33. I have now, I hope, guarded you sufficiently from the danger either of confusing the inferior school of chiaroscuro with that of colour, or of imagining that a work must necessarily be good, on the sole ground of its belonging to the

higher group. I can now proceed securely to separate the third school, that of Delineation, from both ; and to examine its special qualities.

It begins, (see Inaugural Lectures, § 137,) in the primitive work of races insensible alike to shade and to colour, and nearly devoid of thought and of sentiment, but gradually developing into both.

Now as the design is primitive, so are the means likely to be primitive. A line is the simplest work of art you can produce. What are the simplest means you can produce it with ?

A Cumberland lead pencil is a work of art in itself, quite a nineteenth-century machine. Pen and ink are complex and scholarly ; and even chalk or charcoal not always handy.

But the primitive line, the first and last, generally the best of lines, is that which you have elementary faculty of at your fingers' ends, and which kittens can draw as well as you—the scratch.

The first, I say, and the last of lines. Permanent exceedingly,—even in flesh, or on mahogany tables, often more permanent than we desire. But when studiously and honourably made, divinely permanent, or delightfully—as on the venerable desks of our public schools, most of them, now, specimens of wood engraving dear to the heart of England.

34. Engraving, then, is in brief terms, the Art of Scratch. It is essentially the cutting into a solid substance for the sake of making your ideas as permanent as possible,—graven with an iron pen in the Rock for ever. *Permanence*, you observe, is the object, not multiplicability ;—that is quite an accidental, sometimes not even a desirable, attribute of engraving. Duration of your work—fame, and the undeceived vision of all men, on the pane of glass of the window on a wet day, or on the pillars of the castle of Chillon, or on the walls of the pyramids ;—a primitive art,—yet first and last with us.

Since then engraving, we say, is essentially cutting into the surface of any solid ; as the primitive design is in lines or dots, the primitive cutting of such design is a scratch or a hole ; and scratchable solids being essentially three—stone,

wood, metal,—we shall have three great schools of engraving to investigate in each material.

35. On tablet of stone, on tablet of wood, on tablet of steel,—the first giving the law to everything; the second true Athenian, like Athena's first statue in olive-wood, making the law legible and homely; and the third true Vulcanian, having the splendour and power of accomplished labour.

Now of stone engraving, which is joined inseparably with sculpture and architecture, I am not going to speak at length in this course of lectures. I shall speak only of wood and metal engraving. But there is one circumstance in stone engraving which it is necessary to observe in connection with the other two branches of the art.

The great difficulty for a primitive engraver is to make his scratch deep enough to be visible. Visibility is quite as essential to your fame as permanence; and if you have only your furrow to depend on, the engraved tablet, at certain times of day, will be illegible, and passed without notice.

But suppose you fill in your furrow with something black, then it will be legible enough at once; and if the black fall out or wash out, still your furrow is there, and may be filled again by anybody.

Therefore, the noble stone engravers, using marble to receive their furrow, fill that furrow with marble ink.

And you have an engraved plate to purpose;—with the whole sky for its margin! Look here—the front of the church of San Michele of Lucca,—white marble with green serpentine for ink; or here,—the steps of the Giant's Stair, with lead for ink; or here,—the floor of the Pisan Duomo, with porphyry for ink. Such cutting, filled in with colour or with black, branches into all sorts of developments,—Florentine mosaic on the one hand, niello on the other, and infinite minor arts.

36. Yet we must not make this filling with colour part of our definition of engraving. To engrave is, in final strictness, “to decorate a surface with furrows.” (Cameos, in accuratest terms, are minute sculptures, not engravings.) A ploughed

field is the purest type of such art ; and is, on hilly land, an exquisite piece of decoration.

Therefore it will follow that engraving distinguishes itself from ordinary drawing by greater need of muscular effort.

The quality of a pen drawing is to be produced easily,—deliberately, always,* but with a point that *glides* over the paper. Engraving, on the contrary, requires always force, and its virtue is that of a line produced by pressure, or by blows of a chisel.

It involves, therefore, always, ideas of power and dexterity, but also of restraint ; and the delight you take in it should involve the understanding of the difficulty the workman dealt with. You perhaps doubt the extent to which this feeling justly extends, (in the first volume of “Modern Painters,” expressed under the head “Ideas of Power.”) But why is a large stone in any building grander than a small one ? Simply because it was more difficult to raise it. So, also, an engraved line is, and ought to be, recognized as more grand than a pen or pencil line, because it was more difficult to execute it.

In this mosaic of Lucca front you forgive much, and admire much, because you see it is all cut in stone. So, in wood and steel, you ought to see that every line has been costly ; but observe, costly of deliberative, no less than athletic or executive power. The main use of the restraint which makes the line difficult to draw, is to give time and motive for deliberation in drawing it, and to ensure its being the best in your power.

37. For, as with deliberation, so without repentance, your engraved line must be. It may, indeed, be burnished or beaten out again in metal, or patched and botched in stone ; but always to disadvantage, and at pains which must not be incurred often. And there is a singular evidence in one of Durer’s finest plates that, in his time, or at least in his manner of work, it was not possible at all. Among the disputes as to the meaning of Durer’s Knight and Death, you will find it sometimes suggested, or insisted, that the horse’s raised foot

* Compare Inaugural Lectures, § 144.

is going to fall into a snare. What has been fancied a noose is only the former outline of the horse's foot and limb, unefaced.

The engraved line is therefore to be conclusive; not experimental. "I have determined this," says the engraver. Much excellent pen drawing is excellent in being tentative,—in being experimental. Indeterminate, not through want of meaning, but through fulness of it—halting *wisely* between two opinions—feeling cautiously after clearer opinions. But your engraver has made up his opinion. This is so, and must for ever be so, he tells you. A very proper thing for a thoughtful man to say; a very improper and impertinent thing for a foolish one to say. Foolish engraving is consummately foolish work. Look,—all the world,—look for evermore, says the foolish engraver; see what a fool I have been. How many lines I have laid for nothing. How many lines upon lines, with no precept, much less superprecept.

38. Here, then, are two definite ethical characters in all engraved work. It is Athletic; and it is Resolute. Add one more; that it is Obedient;—in their infancy the nurse, but in their youth the slave, of the higher arts; servile, both in the mechanism and labour of it, and in its function of interpreting the schools of painting as superior to itself.

And this relation to the higher arts we will study at the source of chief power in all the normal skill of Christendom, Florence; and chiefly, as I said, in the work of one Florentine master, Sandro Botticelli.

LECTURE II.

THE RELATION OF ENGRAVING TO OTHER ARTS IN FLORENCE.

39. FROM what was laid before you in my last lecture, you must now be aware that I do not mean, by the word 'engraving,' merely the separate art of producing plates from which black pictures may be printed.

I mean, by engraving, the art of producing decoration on a surface by the touches of a chisel or a burin; and I mean by

its relation to other arts, the subordinate surface of this linear work, in sculpture, in metal work, and in painting; or in the representation and repetition of painting.

And first, therefore, I have to map out the broad relations of the arts of sculpture, metal work, and painting, in Florence, among themselves, during the period in which the art of engraving was distinctly connected with them.*

40. You will find, or may remember, that in my lecture on Michael Angelo and Tintoret I indicated the singular importance, in the history of art, of a space of forty years, between 1480, and the year in which Raphael died, 1520. Within that space of time the change was completed, from the principles of ancient, to those of existing, art;—a manifold change, not definable in brief terms, but most clearly characterized, and easily remembered, as the change of conscientious and didactic art, into that which proposes to itself no duty beyond technical skill, and no object but the pleasure of the beholder. Of that momentous change itself I do not purpose to speak in the present course of lectures; but my endeavour will be to lay before you a rough chart of the course of the arts in Florence up to the time when it took place; a chart indicating for you, definitely, the growth of conscience, in work which is distinctively conscientious, and the perfecting of expression and means of popular address, in that which is distinctively didactic.

41. Means of popular address, observe, which have become singularly important to us at this day. Nevertheless, remember that the power of printing, or reprinting, black *pictures*,—practically contemporary with that of reprinting black *letters*,—modified the art of the draughtsman only as it modified that of the scribe. Beautiful and unique writing, as beautiful and unique painting or engraving, remain exactly what they were; but other useful and reproductive methods of both have been superadded. Of these, it is acutely said by Dr. Alfred Woltmann,†—

* Compare Aratra Pentelici, § 154.

† “Holbein and His Time,” 4to, Bentley, 1872, (a very valuable book,) p. 17. Italics mine.

“A far more important part is played in the art-life of Germany by the technical arts for the *multiplying* of works; for Germany, while it was the land of book-printing, is also the land of picture-printing. Indeed, wood-engraving, which preceded the invention of book-printing, *prepared the way for it, and only left one step more necessary for it.* Book-printing and picture-printing have both the same inner cause for their origin, namely, the impulse to make each mental gain a common blessing. Not merely princes and rich nobles were to have the privilege of adorning their private chapels and apartments with beautiful religious pictures; the poorest man was also to have his delight in that which the artist had devised and produced. It was not sufficient for him when it stood in the church as an altar-shrine, visible to him and to the congregation from afar; he desired to have it as his own, to carry it about with him, to bring it into his own home. The grand importance of wood-engraving and copperplate is not sufficiently estimated in historical investigations. They were not alone of use in the advance of art; they form an epoch in the entire life of mind and culture. The idea embodied and multiplied in pictures became like that embodied in the printed word, the herald of every intellectual movement, and conquered the world.”

42. “Conquered the world”? The rest of the sentence is true, but this, hyperbolic, and greatly false. It should have been said that both painting and engraving have conquered much of the good in the world, and, hitherto, little or none of the evil.

Nor do I hold it usually an advantage to art, in teaching, that it *should* be common, or constantly seen. In becoming intelligibly and kindly beautiful, while it remains solitary and unrivalled, it has a greater power. Westminster Abbey is more didactic to the English nation, than a million of popular illustrated treatises on architecture.

Nay, even that it cannot be understood but with some difficulty, and must be sought before it can be seen, is no harm. The noblest didactic art is, as it were, set on a hill, and its disciples come to it. The vilest destructive and corrosive art stands at the street corners, crying, “Turn in hither; come, eat of my bread, and drink of my wine, which I have mingled.”

And Dr. Woltmann has allowed himself too easily to fall into the common notion of Liberalism, that bad art, disseminated, is instructive, and good art isolated, not so. The question is, first, I assure you, whether what art you have got is good or bad. If essentially bad, the more you see of it, the worse for you. Entirely popular art is all that is noble, in the cathedral, the council chamber, and the market-place ; not the paltry coloured print pinned on the wall of a private room.

43. I despise the poor!—do I, think you? Not so. They only despise the poor who think them better off with police news, and coloured tracts of the story of Joseph and Potiphar's wife, than they were with Luini painting on their church walls, and Donatello carving the pillars of their Market-places.

Nevertheless, the effort to be universally, instead of locally, didactic, modified advantageously, as you know, and in a thousand ways varied, the earlier art of engraving : and the development of its popular power, whether for good or evil, came exactly—so fate appointed—at a time when the minds of the masses were agitated by the struggle which closed in the Reformation in some countries, and in the desperate refusal of Reformation in others.* The two greatest masters of engraving whose lives we are to study, were, both of them, passionate reformers : Holbein no less than Luther ; Botticelli no less than Savonarola.

44. Reformers, I mean, in the full and, accurately, the only, sense. Not preachers of new doctrines ; but witnesses against the betrayal of the old ones which were on the lips of all men, and in the lives of none. Nay, the painters are indeed more pure reformers than the priests. They rebuked the manifest vices of men, while they realized whatever was loveliest in their faith. Priestly reform soon enraged itself into mere contest for personal opinions ; while, without rage, but in stern rebuke of all that was vile in conduct or thought,—in declaration of the always-received faiths of the Christian

* See Carlyle, Frederick, Book III., chap. viii.

Church, and in warning of the power of faith, and death,* over the petty designs of men,—Botticelli and Holbein together fought foremost in the ranks of the reformation.

45. To-day I will endeavour to explain how they attained such rank. Then, in the next two lectures, the technics of both,—their way of speaking ; and in the last two, what they had got to say.

First, then, we ask how they attained this rank ;—who taught *them* what they were finally best to teach ? How far must every people—how far did this Florentine people—teach its masters, before *they* could teach *it* ?

Even in these days, when every man is, by hypothesis, as good as another, does not the question sound strange to you ? You recognize in the past, as you think, clearly, that national advance takes place always under the guidance of masters, or groups of masters, possessed of what appears to be some new personal sensibility or gift of invention ; and we are apt to be reverent to these alone, as if the nation itself had been unprogressive, and suddenly awakened, or converted, by the genius of one man.

No idea can be more superficial. Every nation must teach its tutors, and prepare itself to receive them ; but the fact on which our impression is founded—the rising, apparently by chance, of men whose singular gifts suddenly melt the multitude, already at the point of fusion ; or suddenly form, and *inform*, the multitude which has gained coherence enough to be capable of formation,—enables us to measure and map the gain of national intellectual territory, by tracing first the lifting of the mountain chains of its genius.

46. I have told you that we have nothing to do at present with the great transition from ancient to modern habits of thought which took place at the beginning of the sixteenth century. I only want to go as far as that point ;—where we

* I believe I am taking too much trouble in writing these lectures. This sentence, § 44, has cost me, I suppose, first and last, about as many hours as there are lines in it ;—and my choice of these two words, faith and death, as representatives of power, will perhaps, after all, only puzzle the reader.

shall find the old superstitious art represented *finally* by Perugino, and the modern scientific and anatomical art represented *primarily* by Michael Angelo. And the epithet bestowed on Perugino by Michael Angelo, 'goffo nell' arte,' dunce, or blockhead, in art,—being, as far as my knowledge of history extends, the most cruel, the most false, and the most foolish insult ever offered by one great man to another,—does you at least good service, in showing how trenchant the separation is between the two orders of artists,*—how exclusively we may follow out the history of all the 'goffi nell' arte,' and write our Florentine Dunciad, and Laus Stultitiæ, in peace; and never trench upon the thoughts or ways of these proud ones, who showed their fathers' nakedness, and snatched their masters' fame.

47. The Florentine dunces in art are a multitude; but I only want you to know something about twenty of them.

Twenty!—you think that a grievous number? It may, perhaps, appease you a little to be told that when you really have learned a very little, accurately, about these twenty dunces, there are only five more men among the artists of Christendom whose works I shall ask you to examine while you are under my care. That makes twenty-five altogether,—an exorbitant demand on your attention, you still think? And yet, but a little while ago, you were all agog to get me to go and look at Mrs. A's sketches, and tell you what was to be thought about *them*; and I've had the greatest difficulty to keep Mrs. B's photographs from being shown side by side with the Raphael drawings in the University galleries. And you will waste any quantity of time in looking at Mrs. A's sketches or Mrs. B's photographs; and yet you look grave, because, out of nineteen centuries of European art-labour and thought, I ask you to learn something seriously about the works of five-and-twenty men!

48. It is hard upon you, doubtless, considering the quan-

* He is said by Vasari to have called Francia the like. Francia is a child compared to Perugino; but a finished working-goldsmith and ornamental painter nevertheless; and one of the very last men to be called 'goffo,' except by unparalleled insolence.

tity of time you must nowadays spend in trying which can hit balls farthest. So I will put the task into the simplest form I can.

Here are the names of the twenty-five men,* and opposite each, a line indicating the length of his life, and the position of it in his century. The diagram still, however, needs a few words of explanation. Very chiefly, for those who know anything of my writings, there is needed explanation of its not including the names of Titian, Reynolds, Velasquez, Turner, and other such men, always reverently put before you at other times.

They are absent, because I have no fear of your not looking at these. All your lives through, if you care about art, you will be looking at them. But while you are here at Oxford, I want to make you learn what you should know of these earlier, many of them weaker, men, who yet, for the very reason of their greater simplicity of power, are better guides for you, and of whom some will remain guides to all generations. And, as regards the subject of our present course, I have a still more weighty reason;—Vandyke, Gainsborough, Titian, Reynolds, Velasquez, and the rest, are essentially portrait painters. They give you the likeness of a man: they have nothing to say either about his future life, or his gods. ‘That is the look of him,’ they say: ‘here, on earth, we know no more.’

49. But these, whose names I have engraved, have something to say—generally much,—either about the future life of man, or about his gods. They are therefore, literally, seers or prophets. False prophets, it may be, or foolish ones; of that you must judge; but you must read before you can judge; and read (or hear) them consistently; for you don’t know them till you have heard them out. But with Sir Joshua, or Titian, one portrait is as another: it is here a pretty lady, there a great lord; but speechless, all;—whereas, with these twenty-five men, each picture or statue is not

* The diagram used at the lecture is engraved on the opposite leaf; the reader had better draw it larger for himself, as it had to be made inconveniently small for this size of leaf.

merely another person of a pleasant society, but another chapter of a Sibylline book.

50. For this reason, then, I do not want Sir Joshua or Velasquez in my defined group ; and for my present purpose, I can spare from it even four others :—namely, three who have *too* special gifts, and must each be separately studied—Correggio, Carpaccio, Tintoret ;—and one who has no special gift, but a balanced group of many—Cima. This leaves twenty-one for classification, of whom I will ask you to lay hold thus. You must continually have felt the difficulty caused by the names of centuries not tallying with their years ;—the year 1201 being the first of the 13th century, and so on. I am always plagued by it myself, much as I have to think and write with reference to chronology ; and I mean for the future, in our art chronology, to use as far as possible a different form of notation.

51. In my diagram the vertical lines are the divisions of tens of years ; the thick black lines divide the centuries. The horizontal lines, then, at a glance, tell you the length and date of each artist's life. In one or two instances I cannot find the date of birth ; in one or two more, of death ; and the line indicates then only the ascertained * period during which the artist worked.

And, thus represented, you see nearly all their lives run through the year of a new century ; so that if the lines representing them were needles, and the black bars of the years 1300, 1400, 1500 were magnets, I could take up nearly all the needles by lifting the bars.

52. I will actually do this, then, in three other simple diagrams. I place a rod for the year 1300 over the lines of life, and I take up all it touches. I have to drop Niccola Pisano, but I catch five. Now, with my rod of 1400, I have dropped Orcagna indeed, but I again catch five. Now, with my rod of 1500, I indeed drop Filippo Lippi and Verrocchio, but I catch seven. And here I have three pennons, with the staves of the

* 'Ascertained,' scarcely any date ever is, quite satisfactorily. The diagram only represents what is practically and broadly true. I may have to modify it greatly in detail.

years 1300, 1400, and 1500 running through them,—holding the names of nearly all the men I want you to study in easily remembered groups of five, five, and seven. And these three groups I shall hereafter call the 1300 group, 1400 group, and 1500 group.

53. But why should four unfortunate masters be dropped out?

Well, I want to drop them out, at any rate ; but not in disrespect. In hope, on the contrary, to make you remember them very separately indeed ;—for this following reason.

We are in the careless habit of speaking of men who form a great number of pupils, and have a host of inferior satellites round them, as masters of great schools.

But before you call a man a master, you should ask, Are his pupils greater or less than himself? If they are greater than himself, he is a master indeed ;—he has been a true teacher. But if all his pupils are less than himself, he may have been a great *man*, but in all probability has been a bad *master*, or no master.

Now these men, whom I have signally left out of my groups, are true *Masters*.

Nicola Pisano taught all Italy ; but chiefly his own son, who succeeded, and in some things very much surpassed him.

Orcagna taught all Italy, after him, down to Michael Angelo. And these two—Lippi, the religious schools, Verrocchio, the artist schools, of their century.

Lippi taught Sandro Botticelli ; and Verrocchio taught Leonardo da Vinci, Lorenzo di Credi, and Perugino. Have I not good reason to separate the masters of such pupils from the schools they created?

54. But how is it that I can drop just the cards I want out of my pack?

Well certainly I force and fit matters a little : I leave some men out of my list whom I should like to have in it ;—Benozzo, Gozzoli, for instance, and Mino da Fiesole ; but I can do without them, and so can you also, for the present. I catch Luca by a hair's-breadth only, with my 1400 rod ; but

1300.

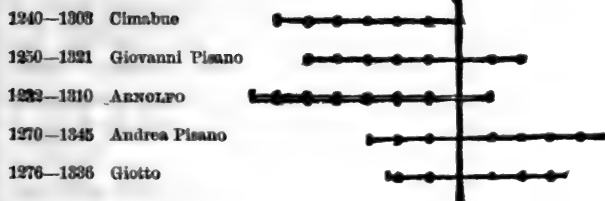

1400.

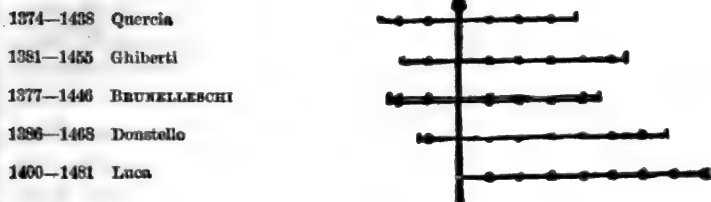

1500.

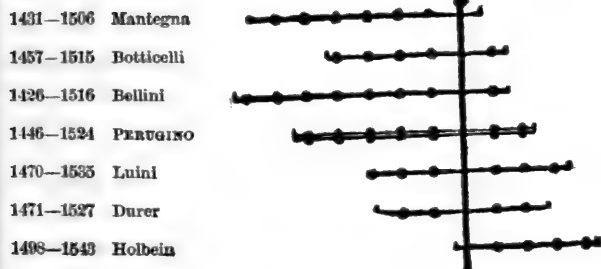

on the whole, with very little coaxing, I get the groups in this memorable and quite literally 'handy' form. For see, I write my list of five, five, and seven, on bits of pasteboard ; I hinge my rods to these ; and you can brandish the school of 1400 in your left hand, and of 1500 in your right, like—railway signals ;—and I wish all railway signals were as clear. Once learn, thoroughly, the groups in this artificially contracted form, and you can refine and complete afterwards at your leisure.

55. And thus actually flourishing my two pennons, and getting my grip of the men, in either hand, I find a notable thing concerning my two flags. The men whose names I hold in my left hand are all sculptors ; the men whose names I hold in my right are all painters.

You will infallibly suspect me of having chosen them thus on purpose. No, honour bright !—I chose simply the greatest men,—those I wanted to talk to you about. I arranged them by their dates ; I put them into three conclusive pennons ; and behold what follows !

56. Farther, note this : in the 1300 group, four out of the five men are architects as well as sculptors and painters. In the 1400 group, there is one architect ; in the 1500, none. And the meaning of that is, that in 1300 the arts were all united, and duly led by architecture ; in 1400, sculpture began to assume too separate a power to herself ; in 1500, painting arrogated all, and, at last, betrayed all. From which, with much other collateral evidence, you may justly conclude that the three arts ought to be practised together, and that they naturally are so. I long since asserted that no man could be an architect who was not a sculptor. As I learned more and more of my business, I perceived also that no man could be a sculptor who was not an architect ;—that is to say, who had not knowledge enough, and pleasure enough in structural law, to be able to build, on occasion, better than a mere builder. And so, finally, I now positively aver to you that nobody, in the graphic arts, can be quite rightly a master of anything, who is not master of everything !

57. The junction of the three arts in men's minds, at the

best times, is shortly signified in these words of Chaucer.
Love's Garden,

Everidele

Enclosed was, and walled well
 With high walls, embatailled,
 Portrayed without, and well entayled
 With many rich portraitures.

The French original is better still, and gives four arts in
unison :—

Quant suis avant un pou alé
 Et vy un vergier grant et le,
 Bien cloz de bon mur batillié
 Pourtrait dehors, et entaillié
 Ou (for au) maintes riches escriptures.

Read also carefully the description of the temples of Mars
 and Venus in the Knight's Tale. Contemporary French uses
 'entaille' even of solid sculpture and of the living form ; and
 Pygmalion, as a perfect master, professes wood carving, ivory
 carving, wax-work, and iron-work, no less than stone sculpt-
 ure :—

Pimalion, uns entaillieres
 Pourtraians en fuz * et en pierres,
 En mettaux, en os, et en cire,
 Et en toute autre matire.

58. I made a little sketch, when last in Florence, of a sub-
 ject which will fix the idea of this unity of the arts in your
 minds. At the base of the tower of Giotto are two rows of
 hexagonal panels, filled with bas-reliefs. Some of these are
 by unknown hands,—some by Andrea Pisano, some by Luca
 della Robbia, two by Giotto himself ; of these I sketched the
 panel representing the art of Painting.

You have in that bas-relief one of the foundation-stones of
 the most perfectly-built tower in Europe ; you have that stone
 carved by its architect's own hand ; you find, further, that this

* For fust, log of wood, erroneously 'fer' in the later printed editions.
 Compare the account of the works of Art and Nature, towards the end
 of the Romance of the Rose.

architect and sculptor was the greatest painter of his time, and the friend of the greatest poet ; and you have represented by him a painter in his shop,—bottega,—as symbolic of the entire art of painting.

59. In which representation, please note how carefully Giotto shows you the tabernacles, or niches, in which the paintings are to be placed. Not independent of their frames, these panels of his, you see !

Have you ever considered, in the early history of painting, how important also is the history of the frame maker ? It is a matter, I assure you, needing your very best consideration. For the frame was made before the picture. The painted window is much, but the aperture it fills was thought of before it. The fresco by Giotto is much, but the vault it adorns was planned first. Who thought of these ;—who built ?

Questions taking us far back before the birth of the shepherd boy of Fesolé,—questions not to be answered by history of painting only, still less of painting in *Italy* only.

60. And in pointing out to you this fact, I may once for all prove to you the essential unity of the arts, and show you how impossible it is to understand one without reference to another. Which I wish you to observe all the more closely, that you may use, without danger of being misled, the data, of unequalled value, which have been collected by Crowe and Cavalcasella, in the book which they have called a *History of Painting in Italy*, but which is in fact only a dictionary of details relating to that history. Such a title is an absurdity on the face of it. For, first, you can no more write the history of painting in Italy than you can write the history of the south wind in Italy. The sirocco does indeed produce certain effects at Genoa, and others at Rome ; but what would be the value of a treatise upon the winds, which, for the honour of any country, assumed that every city of it had a native sirocco ?

But, further,—imagine what success would attend the meteorologist who should set himself to give an account of the south wind, but take no notice of the north !

And, finally, suppose an attempt to give you an account of

either wind, but none of the seas, or mountain passes, by which they were nourished, or directed.

61. For instance, I am in this course of lectures to give you an account of a single and minor branch of graphic art,—engraving. But observe how many references to local circumstances it involves. There are three materials for it, we said;—stone, wood, and metal. Stone engraving is the art of countries possessing marble and gems; wood engraving, of countries overgrown with forest; metal engraving, of countries possessing treasures of silver and gold. And the style of a stone engraver is formed on pillars and pyramids; the style of a wood engraver under the eaves of larch cottages; the style of a metal engraver in the treasuries of kings. Do you suppose I could rightly explain to you the value of a single touch on brass by Finiguerra, or on box by Bewick, unless I had grasp of the great laws of climate and country; and could trace the inherited sirocco or tramontana of thought to which the souls and bodies of the men owed their existence?

62. You see that in this flag of 1300 there is a dark strong line in the centre, against which you read the name of Arnolfo.

In writing our Florentine Dunciad, or History of Fools, can we possibly begin with a better day than All Fools' Day? On All Fools' Day—the first, if you like better so to call it, of the month of *opening*,—in the year 1300, is signed the document making Arnolfo a citizen of Florence, and in 1310 he dies, chief master of the works of the Cathedral there. To this man, Crowe and Cavalcasella give half a page, out of three volumes of five hundred pages each.

But lower down in my flag, (not put there because of any inferiority, but by order of chronology,) you will see a name sufficiently familiar to you—that of Giotto; and to him, our historians of painting in Italy give some hundred pages, under the impression, stated by them at page 243 of their volume, that “in his hands, art in the Peninsula became entitled for the first time to the name of Italian.”

63. Art became Italian! Yes, but *what* art? Your authors give a perspective—or what they call such,—of the upper

church of Assisi, as if that were merely an accidental occurrence of blind walls for Giotto to paint on !

But how came the upper church of Assisi there ? How came it to be vaulted—to be aisled ? How came Giotto to be asked to paint upon it ?

The art that built it, good or bad, must have been an Italian one, before Giotto. He could not have painted on the air. Let us see how his panels were made for him.

64. This Captain—the centre of our first group—Arnolfo, has always hitherto been called ‘Arnolfo di Lapo ;’—Arnolfo the son of Lapo.

Modern investigators come down on us delightedly, to tell us—Arnolfo was *not* the son of Lapo.

In these days you will have half a dozen doctors, writing each a long book, and the sense of all will be,—Arnolfo wasn’t the son of Lapo. Much good may you get of that !

Well, you will find the fact to be, there was a great Northman builder, a true son of Thor, who came down into Italy in 1200, served the order of St. Francis there, built Assisi, taught Arnolfo how to build, with Thor’s hammer, and disappeared, leaving his name uncertain—Jacopo—Lapo—nobody knows what. Arnolfo always recognizes this man as his true father, who put the soul-life into him ; he is known to his Florentines always as Lapo’s Arnolfo.

That, or some likeness of that, is the vital fact. You never can get at the literal limitation of living facts. They disguise themselves by the very strength of their life : get told again and again in different ways by all manner of people ;—the literalness of them is turned topsy-turvy, inside-out, over and over again ;—then the fools come and read them wrong side upwards, or else, say there never was a fact at all. Nothing delights a true blockhead so much as to prove a negative ;—to show that everybody has been wrong. Fancy the delicious sensation, to an empty-headed creature, of fancying for a moment that he has emptied everybody else’s head as well as his own ! nay, that, for once, his own hollow bottle of a head has had the best of other bottles, and has been *first* empty ; first to know—nothing.

65. Hold, then, steadily the first tradition about this Arnolfo. That his real father was called "Cambio" matters to you not a straw. That he never called himself Cambio's Arnolfo—that nobody else ever called him so, down to Vasari's time, is an infinitely significant fact to you. In my twenty-second letter in *Fors Clavigera* you will find some account of the noble habit of the Italian artists to call themselves by their masters' names, considering their master as their true father. If not the name of the master, they take that of their native place, as having owed the character of their life to that. They rarely take their own family name: sometimes it is not even known,—when best known, it is unfamiliar to us. The great Pisan artists, for instance, never bear any other name than 'the Pisan;' among the other five-and-twenty names in my list, not above six, I think, the two German, with four Italian, are family names. Perugino, (Peter of Perugia), Luini, (Bernard of Luino), Quercia, (James of Quercia), Correggio, (Anthony of Correggio), are named from their native places. Nobody would have understood me if I had called Giotto, 'Ambrose Bondone;' or Tintoret, Robusti; or even Raphael, Sanzio. Botticelli is named from his master; Ghiberti from his father-in-law; and Ghirlandajo from his work. Orcagna, who *did*, for a wonder, name himself from his father, Andrea Cione, of Florence, has been always called 'Angel' by everybody else; while Arnolfo, who never named himself from his father, is now like to be fathered against his will.

But, I again beg of you, keep to the old story. For it represents, however inaccurately in detail, clearly in sum, the fact, that some great master of German Gothic at this time came down into Italy, and changed the entire form of Italian architecture by his touch. So that while Nicola and Giovanni Pisano are still virtually Greek artists, experimentally introducing Gothic forms, Arnolfo and Giotto adopt the entire Gothic ideal of form, and thenceforward use the pointed arch and steep gable as the limits of sculpture.

66. Hitherto I have been speaking of the relations of my twenty-five men to each other. But now, please note their

relations altogether to the art before them. These twenty-five include, I say, all the great masters of *Christian art*.

Before them, the art was too savage to be Christian; afterwards, too carnal to be Christian.

Too savage to be Christian? I will justify that assertion hereafter; but you will find that the European art of 1200 includes all the most developed and characteristic conditions of the style in the north which you have probably been accustomed to think of as NORMAN, and which you may always most conveniently call so; and the most developed conditions of the style in the south, which, formed out of effete Greek, Persian, and Roman tradition, you may, in like manner, most conveniently express by the familiar word BYZANTINE. Whatever you call them, they are in origin adverse in temper, and remain so up to the year 1200. Then an influence appears, seemingly that of one man, Nicholas the Pisan, (our first MASTER, observe,) and a new spirit adopts what is best in each, and gives to what it adopts a new energy of its own, namely, this conscientious and didactic power which is the speciality of its progressive existence. And just as the new-born and natural art of Athens collects and reanimates Pelasgian and Egyptian tradition, purifying their worship, and perfecting their work, into the living heathen faith of the world, so this new-born and natural art of Florence collects and animates the Norman and Byzantine tradition, and forms out of the perfected worship and work of both, the honest Christian faith, and vital craftsmanship, of the world.

67. Get this first summary, therefore, well into your minds. The word 'Norman' I use roughly for North-savage;—roughly, but advisedly. I mean Lombard, Scandinavian, Frankish; everything north-savage that you can think of, except Saxon. (I have a reason for that exception; never mind it just now.)*

*Of course it would have been impossible to express in any accurate terms, short enough for the compass of a lecture, the conditions of opposition between the Heptarchy and the Northmen;—between the Byzantine and Roman;—and between the Byzantine and Arab, which form minor, but not less trenchant, divisions of Art-province, for subsequent

All north savage I call NORMAN, all south-savage I call BYZANTINE ; this latter including dead native Greek primarily—then dead foreign Greek, in Rome ;—then Arabian—Persian—Phœnician—Indian—all you can think of, in art of hot countries, up to this year 1200, I rank under the one term Byzantine. Now all this cold art—Norman, and all this hot art—Byzantine, is virtually dead, till 1200. It has no conscience, no didactic power ;* it is devoid of both, in the sense that dreams are.

Then in the 13th century, men wake as if they heard an alarm through the whole vault of heaven, and true human life begins again, and the cradle of this life is the Val d'Arno. There the northern and southern nations meet ; there they lay down their enmities ; there they are first baptized unto John's baptism for the remission of sins ; there is born, and thence exiled,—thought faithless for breaking the font of baptism to save a child from drowning, in his 'bel San Giovanni,'—the greatest of Christian poets ; he who had pity even for the lost.

68. Now, therefore, my whole history of *Christian architecture* and painting begins with this Baptistery of Florence, and with its associated Cathedral. Arnolfo brought the one into the form in which you now see it ; he laid the foundation of the other, and that to purpose, and he is therefore the CAPTAIN of our first school.

For this Florentine Baptistery † is the great one of the world. Here is the centre of Christian knowledge and power.

delineation. If you can refer to my "Stones of Venice," see § 20 of its first chapter.

* Again much too broad a statement: not to be qualified but by a length of explanation here impossible. My lectures on Architecture, now in preparation, will contain further detail.

† At the side of my page, here, I find the following memorandum, which was expanded in the viva-voce lecture. The reader must make what he can of it, for I can't expand it here.

Sense of Italian Church plan.

Baptistery, to make Christians in ; house, or dome, for them to pray and be preached to in ; bell-tower, to ring all over the town, when they were either to pray together, rejoice together, or to be warned of danger.

Harvey's picture of the Covenanters, with a shepherd on the outlook, as a campanile.

And it is one piece of large engraving. White substance, cut into, and filled with black, and dark-green.

No more perfect work was afterwards done ; and I wish you to grasp the idea of this building clearly and irrevocably, —first, in order (as I told you in a previous lecture) to quit yourselves thoroughly of the idea that ornament should be decorated construction ; and, secondly, as the noblest type of the intaglio ornamentation, which developed itself into all minor application of black and white to engraving.

69. That it should do so first at Florence, was the natural sequence, and the just reward, of the ancient skill of Etruria in chased metal-work. The effects produced in gold, either by embossing or engraving, were the direct means of giving interest to his surfaces at the command of the ‘auri faber,’ or orfevre : and every conceivable artifice of studding, chiselling, and interlacing was exhausted by the artists in gold, who were at the head of the metal-workers, and from whom the ranks of the sculptors were reinforced.

The old French word ‘orfroiz,’ (aurifrigia,) expresses essentially what we call ‘frosted’ work in gold ; that which resembles small dew or crystals of hoar-frost ; the ‘frigia’ coming from the Latin frigus. To chase, or enchase, is not properly said of the gold ; but of the jewel which it secures with hoops or ridges, (French, *enchasser**). Then the armourer, or cup and casket maker, added to this kind of decoration that of flat inlaid enamel ; and the silver-worker, finding that the raised filigree (still a staple at Genoa) only attracted tarnish, or got crushed, early sought to decorate a surface which would bear external friction, with labyrinths of safe incision.

70. Of the *security* of incision as a means of permanent decoration, as opposed to ordinary carving, here is a beautiful instance in the base of one of the external shafts of the Cathedral of Lucca ; 13th-century work, which by this time, had it been carved in relief, would have been a shapeless remnant of indecipherable bosses. But it is still as safe as if it had been cut yesterday, because the smooth round mass of the pillar is

* And ‘chassis,’ a window frame, or tracery.

entirely undisturbed ; into that, furrows are cut with a chisel as much under command and as powerful as a burin. The effect of the design is trusted entirely to the depth of these incisions—here dying out and expiring in the light of the marble, there deepened, by drill holes, into as definitely a black line as if it were drawn with ink ; and describing the outline of the leafage with a delicacy of touch and of perception which no man will ever surpass, and which very few have rivalled, in the proudest days of design.

71. This security, in silver plates, was completed by filling the furrows with the black paste which at once exhibited and preserved them. The transition from that niello-work to modern engraving is one of no real moment : my object is to make you understand the qualities which constitute the *merit* of the engraving, whether charged with niello or ink. And this I hope ultimately to accomplish by studying with you some of the works of the four men, Botticelli and Mantegna in the south, Durer and Holbein in the north, whose names I have put in our last flag, above and beneath those of the three mighty painters, Perugino the captain, Bellini on one side—Luini on the other.

The four following lectures * will contain data necessary for such study : you must wait longer before I can place before you those by which I can justify what must greatly surprise some of my audience—my having given Perugino the captain's place among the three painters.

72. But I do so, at least primarily, because what is commonly thought affected in his design is indeed the true remains of the great architectural symmetry which was soon to be lost, and which makes him the true follower of Arnolfo and Brunelleschi ; and because he is a sound craftsman and workman to the very heart's core. A noble, gracious, and quiet labourer from youth to death,—never weary, never impatient,

* This present lecture does not, as at present published, justify its title ; because I have not thought it necessary to write the viva-voce portions of it which amplified the 69th paragraph. I will give the substance of them in better form elsewhere ; meantime the part of the lecture here given may be in its own way useful.

never untender, never untrue. Not Tintoret in power, not Raphael in flexibility, not Holbein in veracity, not Luini in love,—their gathered gifts he has, in balanced and fruitful measure, fit to be the guide, and impulse, and father of all.

LECTURE III.

THE TECHNICS OF WOOD ENGRAVING.

73. I AM to-day to begin to tell you what it is necessary you should observe respecting methods of manual execution in the two great arts of engraving. Only to *begin* to tell you. There need be no end of telling you such things, if you care to hear them. The theory of art is soon mastered ; but ‘dal detto al fatto, v’e gran tratto ;’ and as I have several times told you in former lectures, every day shows me more and more the importance of the Hand.

74. Of the hand as a Servant, observe,—not of the hand as a Master. For there are two great kinds of manual work : one in which the hand is continually receiving and obeying orders ; the other in which it is acting independently, or even giving orders of its own. And the dependent and submissive hand is a noble hand ; but the independent or imperative hand is a vile one.

That is to say, as long as the pen, or chisel, or other graphic instrument, is moved under the direct influence of mental attention, and obeys orders of the brain, it is working nobly ; the moment it moves independently of them, and performs some habitual dexterity of its own, it is base.

75. *Dexterity*—I say ;—some ‘right-handedness’ of its own. We might wisely keep that word for what the hand does at the mind’s bidding ; and use an opposite word—*sinisterity*,—for what it does at its own. For indeed we want such a word in speaking of modern art ;—it is all full of *sinisterity*. Hands independent of brains ;—the left hand, by division of labour, not knowing what the right does,—still less what it ought to do.

76. Turning, then, to our special subject. All engraving, I said, is *intaglio* in the solid. But the solid, in wood engraving, is a coarse substance, easily cut; and in metal, a fine substance, not easily. Therefore, in general, you may be prepared to accept ruder and more elementary work in one than the other; and it will be the means of appeal to blunter minds.

You probably already know the difference between the actual methods of producing a printed impression from wood and metal; but I may perhaps make the matter a little more clear. In metal engraving, you cut ditches, fill them with ink, and press your paper into them. In wood engraving, you leave ridges, rub the tops of them with ink, and stamp them on your paper.

The instrument with which the substance, whether of the wood or steel, is cut away, is the same. It is a solid ploughshare, which, instead of throwing the earth aside, throws it up and out, producing at first a simple ravine, or furrow, in the wood or metal, which you can widen by another cut, or extend by successive cuts. This (Fig. 1) is the general shape of the solid ploughshare:



FIG. 1.

but it is of course made sharper or blunter at pleasure. The furrow produced is at first the wedge-shaped or cuneiform ravine, already so much dwelt upon in my lectures on Greek sculpture.

77. Since, then, in wood printing, you print from the surface left solid; and, in metal printing, from the hollows cut into it, it follows that if you put few touches on wood, you draw, as on a slate, with white lines, leaving a quantity of black; but if you put few touches on metal, you draw with black lines, leaving a quantity of white.

Now the eye is not in the least offended by quantity of white, but is, or ought to be, greatly saddened and offended

by quantity of black. Hence it follows that you must never put little work on wood. You must not sketch upon it. You may sketch on metal as much as you please.

78. "Paradox," you will say, as usual. "Are not all our journals,—and the best of them, *Punch*, par excellence,—full of the most brilliantly swift and slight sketches, engraved on wood; while line-engravings take ten years to produce, and cost ten guineas each when they are done?"

Yes, that is so; but observe, in the first place, what appears to you a sketch on wood is not so at all, but a most laborious and careful imitation of a sketch on paper; whereas when you see what appears to be a sketch on metal, it is one. And in the second place, so far as the popular fashion is contrary to this natural method,—so far as we do in reality try to produce effects of sketching in wood, and of finish in metal,—our work is wrong.

Those apparently careless and free sketches on the wood ought to have been stern and deliberate; those exquisitely toned and finished engravings on metal ought to have looked, instead, like free ink sketches on white paper. That is the theorem which I propose to you for consideration, and which, in the two branches of its assertion, I hope to prove to you; the first part of it, (that wood-cutting should be careful,) in this present lecture; the second, (that metal-cutting should be, at least in a far greater degree than it is now, slight, and free,) in the following one.

79. Next, observe the distinction in respect of *thickness*, no less than number, of lines which may properly be used in the two methods.

In metal engraving, it is easier to lay a fine line than a thick one; and however fine the line may be, it lasts;—but in wood engraving it requires extreme precision and skill to leave a thin dark line, and when left, it will be quickly beaten down by a careless printer. Therefore, the virtue of wood engraving is to exhibit the qualities and power of *thick* lines; and of metal engraving, to exhibit the qualities and power of *thin* ones.

All thin dark lines, therefore, in wood, broadly speaking;

are to be used only in case of necessity ; and thick lines, on metal, only in case of necessity.

80. Though, however, thin *dark* lines cannot easily be produced in wood, thin *light* ones may be struck in an instant. Nevertheless, even thin light ones must not be used, except with extreme caution. For observe, they are equally useless as outline, and for expression of mass. You know how far from exemplary or delightful your boy's first quite voluntary exercises in white line drawing on your slate were? You could, indeed, draw a goblin satisfactorily in such method ;—a round O, with arms and legs to it, and a scratch under two dots in the middle, would answer the purpose ; but if you wanted to draw a pretty face, you took pencil or pen, and paper—not your slate. Now, that instinctive feeling that a white outline is wrong, is deeply founded. For Nature herself draws with diffused light, and concentrated dark ;—never, except in storm or twilight, with diffused dark, and concentrated light ; and the thing we all like best to see drawn—the human face—cannot be drawn with white touches, but by extreme labour. For the pupil and iris of the eye, the eyebrow, the nostril, and the lip are all set in dark on pale ground. You can't draw a white eyebrow, a white pupil of the eye, a white nostril, and a white mouth, on a dark ground. Try it, and see what a spectre you get. But the same number of dark touches, skilfully applied, will give the idea of a beautiful face. And what is true of the subtlest subject you have to represent, is equally true of inferior ones. Nothing lovely can be quickly represented by white touches. You must hew out, if your means are so restricted, the form by sheer labour ; and that both cunning and dextrous. The Florentine masters, and Durer, often practise the achievement, and there are many drawings by the Lippis, Mantegna, and other leading Italian draughtsmen, completed to great perfection with the white line ; but only for the sake of severest study, nor is their work imitable by inferior men. And such studies, however accomplished, always mark a disposition to regard chiaroscuro too much, and local colour too little.

We conclude, then, that we must never trust, in wood, to

our power of outline with white ; and our general laws, thus far determined, will be—thick lines in wood ; thin ones in metal ; complete drawing on wood ; sketches, if we choose, on metal.

81. But why, in wood, lines at all? Why not cut out white *spaces*, and use the chisel as if its incisions were so much white paint? Many fine pieces of wood-cutting are indeed executed on this principle. Bewick does nearly all his foliage so ; and continually paints the light plumes of his birds with single touches of his chisel, as if he were laying on white.

But this is not the finest method of wood-cutting. It implies the idea of a system of light and shade in which the shadow is totally black. Now, no light and shade can be good, much less pleasant, in which all the shade is stark black. Therefore the finest wood-cutting ignores light and shade, and expresses only form, and *dark local colour*. And it is convenient, for simplicity's sake, to anticipate what I should otherwise defer telling you until next lecture, that fine metal engraving, like fine wood-cutting, ignores light and shade ; and that, in a word, all good engraving whatsoever does so.

82. I hope that my saying so will make you eager to interrupt me. 'What! Rembrandt's etchings, and Lupton's mezzotints, and Le Keux's line-work,—do you mean to tell us that these ignore light and shade?'

I never said that *mezzotint* ignored light and shade, or ought to do so. Mezzotint is properly to be considered as *chiaroscuro* drawing on metal. But I do mean to tell you that both Rembrandt's etchings, and Le Keux's finished line-work, are misapplied labour, in so far as they regard *chiaroscuro* ; and that consummate engraving never uses it as a primal element of pleasure.

83. We have now got our principles so far defined that I can proceed to illustration of them by example.

Here are facsimiles, very marvellous ones,* of two of the

* By Mr. Burgess. The toil and skill necessary to produce a facsimile of this degree of precision will only be recognized by the reader who has had considerable experience of actual work.

best wood engravings ever produced by art,—two subjects in Holbein's *Dance of Death*. You will probably like best that I should at once proceed to verify my last and most startling statement, that fine engraving disdained *chiaroscuro*.

This vignette (Fig. 2) represents a sunset in the open mountainous fields of southern Germany. And Holbein is so entirely careless about the light and shade, which a Dutchman would first have thought of, as resulting from the sunset, that, as he works, he forgets altogether where his light comes from. Here, actually, the shadow of the figure is cast from the side, right across the picture, while the sun is in front. And there is not the slightest attempt to indicate gradation of light in the sky, darkness in the forest, or any other positive element of *chiaroscuro*.

This is not because Holbein cannot give *chiaroscuro* if he chooses. He is twenty times a stronger master of it than Rembrandt; but he, therefore, knows exactly when and how to use it; and that wood engraving is not the proper means for it. The quantity of it which is needful for his story, and will not, by any sensational violence, either divert, or vulgarly enforce, the attention, he will give; and that with an unrivalled subtlety. Therefore I must ask you for a moment or two to quit the subject of technics, and look what these two woodcuts mean.

84. The one I have first shown you is of a ploughman ploughing at evening. It is Holbein's object, here, to express the diffused and intense light of a golden summer sunset, so far as is consistent with grander purposes. A modern French or English *chiaroscurist* would have covered his sky with fleecy clouds, and relieved the ploughman's hat and his horses against it in strong black, and put sparkling touches on the furrows and grass. Holbein scornfully casts all such tricks aside; and draws the whole scene in pure white, with simple outlines.

85. And yet, when I put it beside this second vignette, (Fig. 3), which is of a preacher preaching in a feebly-lighted church, you will feel that the diffused warmth of the one subject, and diffused twilight in the other, are complete; and

they will finally be to you more impressive than if they had been wrought out with every superficial means of effect, on each block.

For it is as a symbol, not as a scenic effect, that in each case the chiaroscuro is given. Holbein, I said, is at the head of the painter-reformers, and his Dance of Death is the most energetic and telling of all the forms given, in this epoch, to the *Rationalist* spirit of reform, preaching the new Gospel of Death,—“It is no matter whether you are priest or layman, what you believe, or what you do : here is the end.” You shall see, in the course of our inquiry, that Botticelli, in like manner, represents the *Faithful* and *Catholic* temper of reform.

86. The teaching of Holbein is therefore always melancholy,—for the most part purely rational ; and entirely furious in its indignation against all who, either by actual injustice in this life, or by what he holds to be false promise of another, destroy the good, or the energy, of the few days which man has to live. Against the rich, the luxurious, the Pharisee, the false lawyer, the priest, and the unjust judge, Holbein uses his fiercest mockery ; but he is never himself unjust ; never caricatures or equivocates ; gives the facts as he knows them, with explanatory symbols, few and clear.

87. Among the powers which he hates, the pathetic and ingenious preaching of untruth is one of the chief ; and it is curious to find his biographer, knowing this, and reasoning, as German critics nearly always do, from acquired knowledge, not perception, imagine instantly that he sees hypocrisy in the face of Holbein's preacher. “How skilfully,” says Dr. Woltmann, “is the preacher propounding his doctrines ; how thoroughly is his hypocrisy expressed in the features of his countenance, and in the gestures of his hands.” But look at the cut yourself, candidly. I challenge you to find the slightest trace of hypocrisy in either feature or gesture. Holbein knew better. It is not the hypocrite who has power in the pulpit. It is the *sincere* preacher of untruth who does mischief there. The hypocrite's place of power is in trade, or in general society ; none but the sincere ever get fatal influence

in the pulpit. This man is a refined gentleman—ascetic, earnest, thoughtful, and kind. He scarcely uses the vantage even of his pulpit,—comes aside out of it, as an eager man would, pleading ; he is intent on being understood—is understood ; his congregation are delighted—you might hear a pin drop among them : one is asleep indeed, who cannot see him, (being under the pulpit,) and asleep just because the teacher is as gentle as he is earnest, and speaks quietly.

88. How are we to know, then, that he speaks in vain ? First, because among all his hearers you will not find one shrewd face. They are all either simple or stupid people : there is one nice woman in front of all, (else Holbein's representation had been caricature,) but she is not a shrewd one.

Secondly, by the light and shade. The church is not in extreme darkness—far from that ; a grey twilight is over everything, but the sun is totally shut out of it ;—not a ray comes in even at the window—that is darker than the walls, or vault.

Lastly, and chiefly, by the mocking expression of Death. Mocking, but not angry. The man has been preaching what he thought true. Death laughs at him, but is not indignant with him.

Death comes quietly : *I am going to be preacher now ; here is your own hour-glass, ready for me. You have spoken many words in your day. But "of the things which you have spoken, this is the sum,"—your death-warrant, signed and sealed. There's your text for to-day.*

89. Of this other picture, the meaning is more plain, and far more beautiful. The husbandman is old and gaunt, and has past his days, not in speaking, but pressing the iron into the ground. And the payment for his life's work is, that he is clothed in rags, and his feet are bare on the clods ; and he has no hat—but the brim of a hat only, and his long, unkempt grey hair comes through. But all the air is full of warmth and of peace ; and, beyond his village church, there is, at last, light indeed. His horses lag in the furrow, and his own limbs totter and fail : but one comes to help him. 'It is a long field,' says Death ; 'but we'll get to the end of it to-day, —you and I.'

90. And now that we know the meaning, we are able to discuss the technical qualities farther.

Both of these engravings, you will find, are executed with blunt lines ; but more than that, they are executed with *quiet* lines, entirely steady.

Now, here I have in my hand a lively woodcut of the present day—a good average type of the modern style of wood-cutting, which you will all recognize.*

The shade in this is drawn on the wood (not *cut*, but drawn, observe,) at the rate of at least ten lines in a second : Holbein's at the rate of about one line in three seconds.†

91. Now there are two different matters to be considered with respect to these two opposed methods of execution. The first, that the rapid work, though easy to the artist, is very difficult to the woodcutter ; so that it implies instantly a separation between the two crafts, and that your wood engraver has ceased to be a draughtsman. I shall return to this point. I wish to insist on the other first ; namely, the effect of the more deliberative method on the drawing itself.

92. When the hand moves at the rate of ten lines in a second, it is indeed under the government of the muscles of the wrist and shoulder ; but it cannot possibly be under the complete government of the brains. I am able to do this zigzag line evenly, because I have got the use of the hand from practice ; and the faster it is done, the evener it will be. But I have no mental authority over every line I thus lay : chance regulates them. Whereas, when I draw at the rate of two or three seconds to each line, my hand disobeys the muscles a little—the mechanical accuracy is not so great ; nay, there ceases to be any *appearance* of dexterity at all. But there is, in reality, more manual skill required in the slow work than in the swift,—and all the while the hand is thoroughly under the orders of the brains. Holbein deliberately resolves, for every line, as it goes along, that it shall be

* The ordinary title-page of Punch.

† In the lecture-room, the relative rates of execution were shown ; I arrived at this estimate by timing the completion of two small pieces of shade in the two methods.

so thick, so far from the next,—that it shall begin here, and stop there. And he is deliberately assigning the utmost quantity of meaning to it, that a line will carry.

93. It is not fair, however, to compare common work of one age with the best of another. Here is a woodcut of Tenniel's, which I think contains as high qualities as it is possible to find in modern art.* I hold it as beyond others fine, because there is not the slightest caricature in it. No face, no attitude, is pushed beyond the degree of natural humour they would have possessed in life; and in precision of momentary expression, the drawing is equal to the art of any time, and shows power which would, if regulated, be quite adequate to producing an immortal work.

94. Why, then, is it *not* immortal? You yourselves, in compliance with whose demand it was done, forgot it the next week. It will become historically interesting; but no man of true knowledge and feeling will ever keep this in his cabinet of treasure, as he does these woodcuts of Holbein's.

The reason is that this is base coin,—alloyed gold. There is gold in it, but also a quantity of brass and lead—wilfully added—to make it fit for the public. Holbein's is beaten gold, seven times tried in the fire. Of which commonplace but useful metaphor the meaning here is, first, that to catch the vulgar eye a quantity of,—so-called,—light and shade is added by Tenniel. It is effective to an ignorant eye, and is ingeniously disposed; but it is entirely conventional and false, unendurable by any person who knows what chiaroscuro is.

Secondly, for one line that Holbein lays, Tenniel has a dozen. There are, for instance, a hundred and fifty-seven lines in Sir Peter Teazle's wig, without counting dots and slight cross-hatching;—but the entire face and flowing hair of Holbein's preacher are done with forty-five lines, all told.

95. Now observe what a different state of mind the two artists must be in on such conditions;—one, never in a hurry, never doing anything that he knows is wrong; never doing a line badly that he can do better; and appealing only to the

* John Bull as Sir Oliver Surface, with Sir Peter Teazle and Joseph Surface. It appeared in Punch, early in 1863.

feelings of sensitive persons, and the judgment of attentive ones. That is Holbein's habit of soul. What is the habit of soul of every modern engraver? Always in a hurry; everywhere doing things which he knows to be wrong—(Tenniel knows his light and shade to be wrong as well as I do)—continually doing things badly which he was able to do better; and appealing exclusively to the feelings of the dull, and the judgment of the inattentive.

Do you suppose that is not enough to make the difference between mortal and immortal art,—the original genius being supposed alike in both? *

96. Thus far of the state of the artist himself. I pass next to the relation between him and his subordinate, the wood-cutter.

The modern artist requires him to cut a hundred and fifty-seven lines in the wig only,—the old artist requires him to cut forty-five for the face, and long hair, altogether. The actual proportion is roughly, and on the average, about one to twenty of cost in manual labour, ancient to modern,—the twentieth part of the mechanical labour, to produce an immortal instead of a perishable work,—the twentieth part of the labour; and—which is the greatest difference of all—that twentieth part, at once less mechanically difficult, and more mentally pleasant. Mr. Otley, in his general History of Engraving, says, "The greatest difficulty in wood engraving occurs in clearing out the minute quadrangular lights;" and in any modern woodcut you will see that where the lines of the drawing cross each other to produce shade, the white interstices are cut out so neatly that there is no appearance of any jag or break in the lines; they look exactly as if they had been drawn with a pen. It is chiefly difficult to cut the pieces clearly out when the lines cross at right angles; easier when they form oblique or diamond-shaped interstices; but

* In preparing these passages for the press, I feel perpetual need of qualifications and limitations, for it is impossible to surpass the humour, or precision of expressional touch, in the really golden parts of Tenniel's works; and they *may* be immortal, as representing what is best in their day.

in any case, some half-dozen cuts, and in square crossings as many as twenty, are required to clear one interstice. Therefore if I carelessly draw six strokes with my pen across other six, I produce twenty-five interstices, each of which will need at least six—perhaps twenty, careful touches of the burin to clear out.—Say ten for an average; and I demand two hundred and fifty exquisitely precise touches from my engraver, to render ten careless ones of mine.

97. Now I take up Punch, at his best. The whole of the left side of John Bull's waistcoat—the shadow on his knee-breeches and great-coat—the whole of the Lord Chancellor's gown, and of John Bull's and Sir Peter Teazle's complexions, are worked with finished precision of cross-hatching. These have indeed some purpose in their texture; but in the most wanton and gratuitous way, the wall below the window is cross-hatched too, and that not with a double, but a treble line, Fig. 4.

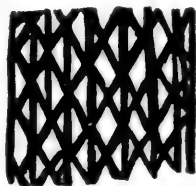

FIG. 4.

There are about thirty of these columns, with thirty-five interstices each: approximately, 1,050—certainly not fewer—interstices to be deliberately cut clear, to get that two inches square of shadow.

Now calculate—or think enough to feel the impossibility of calculating—the number of woodcuts used daily for our popular prints, and how many men are night and day cutting 1,050 square holes to the square inch, as the occupation of their manly life. And Mrs. Beecher Stowe and the North Americans fancy they have abolished slavery!

98. The workman cannot have even the consolation of pride; for his task, even in its finest accomplishment, is not really difficult,—only tedious. When you have once got into the practice, it is as easy as lying. To cut regular holes *without* a purpose is easy enough; but to cut *irregular* holes *with* a purpose, that is difficult, for ever;—no tricks of tool or trade will give you power to do that.

The supposed difficulty—the thing which, at all events, it takes time to learn, is to cut the interstices neat, and each

like the other. But is there any reason, do you suppose, for their being neat, and each like the other? So far from it, they would be twenty times prettier if they were irregular, and each different from the other. And an old woodcutter, instead of taking pride in cutting these interstices smooth and alike, resolutely cuts them rough and irregular; taking care, at the same time, never to have any more than are wanted, this being only one part of the general system of intelligent manipulation, which made so good an artist of the engraver that it is impossible to say of any standard old woodcut, whether the draughtsman engraved it himself or not. I should imagine, from the character and subtlety of the touch, that every line of the Dance of Death had been engraved by Holbein; we know it was not, and that there can be no certainty given by even the finest pieces of wood execution of anything more than perfect harmony between the designer and workman. And consider how much this harmony demands in the latter. Not that the modern engraver is unintelligent in applying his mechanical skill: very often he greatly improves the drawing; but we never could mistake his hand for Holbein's.

99. The true merit, then, of wood execution, as regards this matter of cross-hatching, is first that there be no more crossing than necessary; secondly, that all the interstices be various, and rough. You may look through the entire series of the Dance of Death without finding any cross-hatching whatever, except in a few unimportant bits of background, so rude as to need scarcely more than one touch to each interstice. Albert Durer crosses more definitely; but yet, in any fold of his drapery, every white spot differs in size from every other, and the arrangement of the whole is delightful, by the kind of variety which the spots on a leopard have.

On the other hand, where either expression or form can be rendered by the shape of the lights and darks, the old engraver becomes as careful as in an ordinary ground he is careless.

The endeavour, with your own hand, and common pen and ink, to copy a small piece of either of the two Holbein woodcuts (Figures 2 and 3) will prove this to you better than any words.

100. I said that, had Tenniel been rightly trained, there

might have been the making of a Holbein, or nearly a Holbein, in him. I do not know ; but I can turn from his work to that of a man who was not trained at all, and who was, without training, Holbein's equal.

Equal, in the sense that this brown stone, in my left hand, is the equal, though not the likeness, of that in my right. They are both of the same true and pure crystal ; but the one is brown with iron, and never touched by forming hand ; the other has never been in rough companionship, and has been exquisitely polished. So with these two men. The one was the companion of Erasmus and Sir Thomas More. His father was so good an artist that you cannot always tell their drawings asunder. But the other was a farmer's son ; and learned his trade in the back shops of Newcastle.

Yet the first book I asked you to get was his biography ; and in this frame are set together a drawing by Hans Holbein, and one by Thomas Bewick. I know which is most scholarly ; but I do *not* know which is best.

101. It is much to say for the self-taught Englishman ;—yet do not congratulate yourselves on his simplicity. I told you, a little while since, that the English nobles had left the history of birds to be written, and their spots to be drawn, by a printer's lad ;—but I did not tell you their farther loss in the fact that this printer's lad could have written their own histories, and drawn their own spots, if they had let him. But they had no history to be written ; and were too closely maculate to be portrayed ;—white ground in most places altogether obscured. Had there been Mores and Henrys to draw, Bewick could have drawn them ; and would have found his function. As it was, the nobles of his day left him to draw the frogs, and pigs, and sparrows—of his day, which seemed to him, in his solitude, the best types of its Nobility. No sight or thought of beautiful things was ever granted him ;—no heroic creature, goddess-born—how much less any native Deity—ever shone upon him. To his utterly English mind, the straw of the stye, and its tenantry, were abiding truth ;—the cloud of Olympus, and its tenantry, a child's dream. He could draw a pig, but not an Aphrodite.

102. The three pieces of woodcut from his Fables (the two lower ones enlarged) in the opposite plate, show his utmost strength and utmost rudeness. I must endeavour to make you thoroughly understand both:—the magnificent artistic power, the flawless virtue, veracity, tenderness,—the infinite humour of the man; and yet the difference between England and Florence, in the use they make of such gifts in their children.

For the moment, however, I confine myself to the examination of technical points; and we must follow our former conclusions a little further.

103. Because our lines in wood must be thick, it becomes an extreme virtue in wood engraving to economize lines,—not merely, as in all other art, to save time and power, but because, our lines being necessarily blunt, we must make up our minds to do with fewer, by many, than are in the object. But is this necessarily a disadvantage?

Absolutely, an immense disadvantage—a woodcut never can be so beautiful or good a thing as a painting, or line engraving. But in its own separate and useful way, an excellent thing, because, practised rightly, it exercises in the artist, and summons in you, the habit of abstraction; that is to say, of deciding what are the essential points in the things you see, and seizing these; a habit entirely necessary to strong humanity; and so natural to all humanity, that it leads, in its indolent and undisciplined states, to all the vulgar amateur's liking of sketches better than pictures. The sketch seems to put the thing for him into a concentrated and exciting form.

104. Observe, therefore, to guard you from this error, that a bad sketch is good for nothing; and that nobody can make a good sketch unless they generally are trying to finish with extreme care. But the abstraction of the essential particulars in his subject by a line-master, has a peculiar didactic value. For painting, when it is complete, leaves it much to your own judgment what to look at; and, if you are a fool, you look at the wrong thing;—but in a fine woodcut, the master says to you, “You *shall* look at this or at nothing.”

105. For example, here is a little tailpiece of Bewick's, to



A

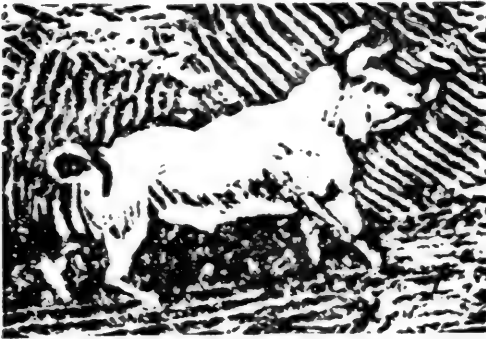

B



C

PLATE I.—THINGS CELESTIAL AND TERRESTRIAL.
As apparent to the English Mind.



the fable of the Frogs and the Stork.* He is, as I told you, as stout a reformer as Holbein, or Botticelli, or Luther, or Savonarola; and, as an impartial reformer, hits right and left, at lower or upper classes, if he sees them wrong. Most frequently, he strikes at vice without reference to class; but in this vignette he strikes definitely at the degradation of the viler popular mind which is incapable of being governed, because it cannot understand the nobleness of kingship. He has written—better than written, engraved, sure to suffer no slip of type—his legend under the drawing; so that we know his meaning:

“Set them up with a king, indeed!”

106. There is an audience of seven frogs, listening to a speaker, or croaker, in the middle; and Bewick has set himself to show in all, but especially in the speaker, essential frogginess of mind—the marsh temper. He could not have done it half so well in painting as he has done by the abstraction of wood-outline. The characteristic of a manly mind, or body, is to be gentle in temper, and firm in constitution; the contrary essence of a froggy mind and body is to be angular in temper, and flabby in constitution. I have enlarged Bewick's orator-frog for you, Plate I., c., and I think you will feel that he is entirely expressed in those essential particulars.

This being perfectly good woodcutting, notice especially its deliberation. No scrawling or scratching, or cross-hatching, or 'free' work of any sort. Most deliberate laying down of solid lines and dots, of which you cannot change one. The real difficulty of wood engraving is to cut every one of these black lines or spaces of the exactly right shape, and not at all to cross-hatch them cleanly.

107. Next, examine the technical treatment of the pig, above. I have purposely chosen this as an example of a white object on dark ground, and the frog as a dark object on light ground, to explain to you what I mean by saying that fine engraving regards local colour, but not light and shade. You see both frog and pig are absolutely without light and shade. The frog, indeed, casts a shadow; but his hind leg is as white as his

* From Bewick's *Æsop's Fables*.

throat. In the pig you don't even know which way the light falls. But you know at once that the pig is white, and the frog brown or green.

108. There are, however, two pieces of *chiaroscuro implied* in the treatment of the pig. It is assumed that his curly tail would be light against the background—dark against his own rump. This little piece of heraldic quartering is absolutely necessary to solidify him. He would have been a white ghost of a pig, flat on the background, but for that alternative tail, and the bits of dark behind the ears. Secondly: Where the shade is necessary to suggest the position of his ribs, it is given with graphic and chosen points of dark, as few as possible; not for the sake of the shade at all, but of the skin and bone.

109. That, then, being the law of refused *chiaroscuro*, observe further the method of outline. We said that we were to have thick lines in wood, if possible. Look what thickness of black outline Bewick has left under our pig's chin, and above his nose.

But that is not a line at all, you think?

No;—a modern engraver would have made it one, and prided himself on getting it fine. Bewick leaves it actually thicker than the snout, but puts all his ingenuity of touch to vary the forms, and break the extremities of his white cuts, so that the eye may be refreshed and relieved by new forms at every turn. The group of white touches filling the space between snout and ears might be a wreath of fine-weather clouds, so studiously are they grouped and broken.

And nowhere, you see, does a single black line cross another.

Look back to Figure 4, page 55, and you will know, henceforward, the difference between good and bad woodcutting.

110. We have also, in the lower woodcut, a notable instance of Bewick's power of abstraction. You will observe that one of the chief characters of this frog, which makes him humorous—next to his vain endeavour to get some firmness into his forefeet—is his obstinately angular hump-back. And you must feel, when you see it so marked, how important a gen-

eral character of a frog it is to have a hump-back,—not at the shoulders, but the loins.

111. Here, then, is a case in which you will see the exact function that anatomy should take in art.

All the most scientific anatomy in the world would never have taught Bewick, much less you, how to draw a frog.

But when once you *have* drawn him, or looked at him, so as to know his points, it then becomes entirely interesting to find out *why* he has a hump-back. So I went myself yesterday to Professor Rolleston for a little anatomy, just as I should have gone to Professor Phillips for a little geology; and the Professor brought me a fine little active frog; and we put him on the table, and made him jump all over it, and then the Professor brought in a charming Squelette of a frog, and showed me that he needed a projecting bone from his rump, as a bird needs it from his breast,—the one to attach the strong muscles of the hind legs, as the other to attach those of the fore-legs or wings. So that the entire leaping power of the frog is in his hump-back, as the flying power of the bird is in its breastbone. And thus this Frog Parliament is most literally a Rump Parliament—everything depending on the hind legs, and nothing on the brains; which makes it wonderfully like some other Parliaments we know of nowadays, with Mr. Ayrton and Mr. Lowe for their æsthetic and acquisitive eyes, and a rump of Railway Directors.

112. Now, to conclude, for want of time only—I have but touched on the beginning of my subject,—understand clearly and finally this simple principle of all art, that the best is that which realizes absolutely, if possible. Here is a viper by Carpaccio: you are afraid to go near it. Here is an arm-chair by Carpaccio: you who came in late, and are standing, to my regret, would like to sit down in it. This is consummate art; but you can only have that with consummate means, and exquisitely trained and hereditary mental power.

With inferior means, and average mental power, you must be content to give a rude abstraction; but if rude abstraction is to be made, think what a difference there must be between a wise man's and a fool's; and consider what heavy responsi-

bility lies upon you in your youth, to determine, among realities, by what you will be delighted, and, among imaginations, by whose you will be led.

LECTURE IV.

THE TECHNICS OF METAL ENGRAVING.

113. WE are to-day to examine the proper methods for the technical management of the most perfect of the arms of precision possessed by the artist. For you will at once understand that a line cut by a finely-pointed instrument upon the smooth surface of metal is susceptible of the utmost fineness that can be given to the *definite* work of the human hand. In drawing with pen upon paper, the surface of the paper is slightly rough; necessarily, two points touch it instead of one, and the liquid flows from them more or less irregularly, whatever the draughtsman's skill. But you cut a metallic surface with one edge only; the furrow drawn by a skater on the surface of ice is like it on a large scale. Your surface is polished, and your line may be wholly faultless, if your hand is.

114. And because, in such material, effects may be produced which no penmanship could rival, most people, I fancy, think that a steel plate half engraves itself; that the workman has no trouble with it, compared to that of a pen draughtsman.

To test your feeling in this matter accurately, here is a manuscript book written with pen and ink, and illustrated with flourishes and vignettes.

You will all, I think, be disposed, on examining it, to exclaim, How wonderful! and even to doubt the possibility of every page in the book being completed in the same manner. Again, here are three of my own drawings, executed with the pen, and Indian ink, when I was fifteen. They are copies from large lithographs by Prout; and I imagine that most of my pupils would think me very tyrannical if I requested them

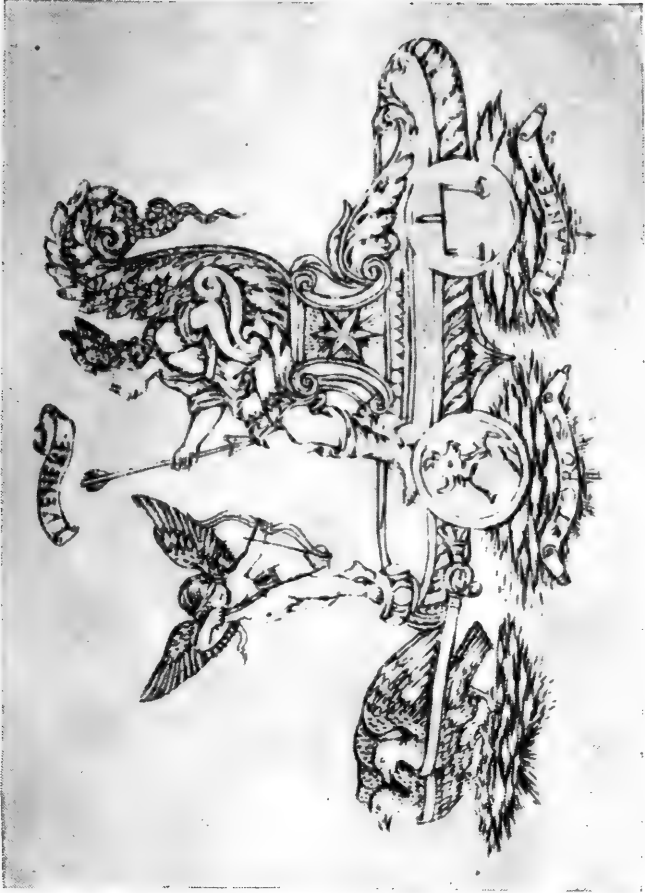

PLATE II.—THE STAR OF FLORENCE.



to do anything of the kind themselves. And yet, when you see in the shop windows a line engraving like this,* or this,* either of which contains, alone, as much work as fifty pages of the manuscript book, or fifty such drawings as mine, you look upon its effect as quite a matter of course,—you never say ‘how wonderful’ *that is*, nor consider how you would like to have to live, by producing anything of the same kind yourselves.

115. Yet you cannot suppose it is in reality easier to draw a line with a cutting point, not seeing the effect at all, or, if any effect, seeing a gleam of light instead of darkness, than to draw your black line at once on the white paper? You cannot really think † that there is something complacent, sympathetic, and helpful in the nature of steel; so that while a pen-and-ink sketch may always be considered an achievement proving cleverness in the sketcher, a sketch on steel comes out by a mere favour of the indulgent metal; or that the plate is woven like a piece of pattern silk, and the pattern is developed by pasteboard cards punched full of holes? Not so. Look close at this engraving, or take a smaller and simpler one, Turner’s Mercury and Argus,—imagine it to be a drawing in pen and ink, and yourself required similarly to produce its parallel! True, the steel point has the one advantage of not blotting, but it has tenfold or twentyfold disadvantage, in that you cannot slur, nor efface, except in a very resolute and laborious way, nor play with it, nor even see what you are doing with it at the moment, far less the effect that is to be. You must *feel* what you are doing with it, and know precisely what you have got to do; how deep, how broad, how far apart your lines must be, etc. and etc., (a couple of lines of etceteras would not be enough to imply all you must know). But suppose the plate *were* only a pen drawing: take your pen—your

* Miller’s large plate of the Grand Canal, Venice, after Turner; and Goodall’s, of Tivoli, after Turner. The other examples referred to are left in the University Galleries.

† This paragraph was not read at the lecture, time not allowing:—it is part of what I wrote on engraving some years ago, in the papers for the Art Journal, called the Cestus of Aglaia.

finest—and just try to copy the leaves that entangle the head of Io, and her head itself; remembering always that the kind of work required here is mere child's play compared to that of fine figure engraving. Nevertheless, take a small magnifying glass to this—count the dots and lines that gradate the nostrils and the edges of the facial bone; notice how the light is left on the top of the head by the stopping, at its outline, of the coarse touches which form the shadows under the leaves; examine it well, and then—I humbly ask of you—try to do a piece of it yourself! You clever sketcher—you young lady or gentleman of genius—you eye-glassed dilettante—you current writer of criticism royally plural,—I beseech you,—do it yourself; do the merely etched outline yourself, if no more. Look you,—you hold your etching needle this way, as you would a pencil, nearly; and then,—you scratch with it! it is as easy as lying. Or if you think that too difficult, take an easier piece;—take either of the light sprays of foliage that rise against the fortress on the right, pass your lens over them—look how their fine outline is first drawn, leaf by leaf; then how the distant rock is put in between, with broken lines, mostly stopping before they touch the leaf-outline; and again, I pray you, do it yourself,—if not on that scale, on a larger. Go on into the hollows of the distant rock,—traverse its thickets,—number its towers;—count how many lines there are in a laurel bush—in an arch—in a casement; some hundred and fifty, or two hundred, deliberately drawn lines, you will find, in every square quarter of an inch;—say *three thousand to the inch*,—each, with skilful intent, put in its place! and then consider what the ordinary sketcher's work must appear, to the men who have been trained to this!

116. “But might not more have been done by three thousand lines to a square inch?” you will perhaps ask. Well, possibly. It may be with lines as with soldiers: three hundred, knowing their work thoroughly, may be stronger than three thousand less sure of their aim. We shall have to press close home this question about numbers and purpose presently;—it is not the question now. Suppose certain results required,—atmospheric effects, surface textures, transparen-

cies of shade, confusions of light,—then, more could *not* be done with less. There are engravings of this modern school, of which, with respect to their particular aim, it may be said, most truly, they “cannot be better done.”

Here is one just finished,—or, at least, finished to the eyes of ordinary mortals, though its fastidious master means to re-touch it;—a quite pure line engraving, by Mr. Charles Henry Jeens; (in calling it pure line, I mean that there are no mixtures of mezzotint or any mechanical tooling, but all is steady hand-work,) from a picture by Mr. Armytage, which, without possessing any of the highest claims to admiration, is yet free from the vulgar vices which disgrace most of our popular religious art; and is so sweet in the fancy of it as to deserve, better than many works of higher power, the pains of the engraver to make it a common possession. It is meant to help us to imagine the evening of the day when the father and mother of Christ had been seeking him through Jerusalem: they have come to a well where women are drawing water; St. Joseph passes on,—but the tired Madonna, leaning on the well’s margin, asks wistfully of the women if they have seen such and such a child astray. Now will you just look for a while into the lines by which the expression of the weary and anxious face is rendered; see how unerring they are,—how calm and clear; and think how many questions have to be determined in drawing the most minute portion of any one,—its curve,—its thickness,—its distance from the next,—its own preparation for ending, invisibly, where it ends. Think what the precision must be in these that trace the edge of the lip, and make it look quivering with disappointment, or in these which have made the eyelash heavy with restrained tears.

117. Or if, as must be the case with many of my audience, it is impossible for you to conceive the difficulties here overcome, look merely at the draperies, and other varied substances represented in the plate; see how silk, and linen, and stone, and pottery, and flesh, are all separated in texture, and gradated in light, by the most subtle artifices and appliances of line,—of which artifices, and the nature of the mechanical

labour throughout, I must endeavour to give you to-day a more distinct conception than you are in the habit of forming. But as I shall have to blame some of these methods in their general result, and I do not wish any word of general blame to be associated with this most excellent and careful plate by Mr. Jeens, I will pass, for special examination, to one already in your reference series, which for the rest exhibits more various treatment in its combined landscape, background, and figures; the Belle Jardinière of Raphael, drawn and engraved by the Baron Desmoyers.

You see, in the first place, that the ground, stones, and other coarse surfaces are distinguished from the flesh and draperies by broken and wriggled lines. Those broken lines cannot be executed with the burin, they are etched in the early states of the plate, and are a modern artifice, never used by old engravers; partly because the older men were not masters of the art of etching, but chiefly because even those who were acquainted with it would not employ lines of this nature. They have been developed by the importance of landscape in modern engraving, and have produced some valuable results in small plates, especially of architecture. But they are entirely erroneous in principle, for the surface of stones and leaves is not broken or jagged in this manner, but consists of mossy, or blooming, or otherwise organic texture, which cannot be represented by these coarse lines; their general consequence has therefore been to withdraw the mind of the observer from all beautiful and tender characters in foreground, and eventually to destroy the very school of landscape engraving which gave birth to them.

Considered, however, as a means of relieving more delicate textures, they are in some degree legitimate, being, in fact, a kind of chasing or jaggling one part of the plate surface in order to throw out the delicate tints from the rough field. But the same effect was produced with less pains, and far more entertainment to the eye, by the older engravers, who employed purely ornamental variations of line; thus in Plate IV., opposite page 87, the drapery is sufficiently distinguished from the grass by the treatment of the latter as an

ornamental arabesque. The grain of wood is elaborately engraved by Marc Antonio, with the same purpose, in the plate given in your Standard Series.

118. Next, however, you observe what difference of texture and force exists between the smooth, continuous lines themselves, which are all really *engraved*. You must take some pains to understand the nature of this operation.

The line is first cut lightly through its whole course, by absolute decision and steadiness of hand, which you may endeavour to imitate if you like, in its simplest phase, by drawing a circle with your compass-pen; and then, grasping your penholder so that you can push the point like a plough, describing other circles inside or outside of it, in exact parallelism with the mathematical line, and at exactly equal distances. To approach, or depart, with your point at finely gradated intervals, may be your next exercise, if you find the first unexpectedly easy.

119. When the line is thus described in its proper course, it is ploughed deeper, where depth is needed, by a second cut of the burin, first on one side, and then on the other, the cut being given with gradated force so as to take away most steel where the line is to be darkest. Every line of gradated depth in the plate has to be thus cut eight or ten times over at least, with retouchings to smooth and clear all in the close. Jason has to plough his field ten-furrow deep, with his fiery oxen well in hand, all the while.

When the essential lines are thus produced, in their several directions, those which have been drawn across each other, so as to give depth of shade, or richness of texture, have to be farther enriched by dots in the interstices; else there would be a painful appearance of network everywhere; and these dots require each four or five jags to produce them; and each of these jags must be done with what artists and engravers alike call 'feeling,'—the sensibility, that is, of a hand completely under mental government. So wrought, the dots look soft, and like touches of paint; but mechanically dug in, they are vulgar and hard.

120. Now, observe, that, for every piece of shadow through-

out the work, the engraver has to decide with what quantity and kind of line he will produce it. Exactly the same quantity of black, and therefore the same depth of tint in general effect, may be given with six thick lines; or with twelve, of half their thickness; or with eighteen, of a third of the thickness. The second six, second twelve, or second eighteen, may cross the first six, first twelve, or first eighteen, or go between them; and they may cross at any angle. And then the third six may be put between the first six, or between the second six, or across both, and at any angle. In the net-work thus produced, any kind of dots may be put in the severally shaped interstices. And for any of the series of superadded lines, dots, of equivalent value in shade, may be substituted. (Some engravings are wrought in dots altogether.) Choice infinite, with multiplication of infinity, is, at all events, to be made, for every minute space, from one side of the plate to the other.

121. The excellence of a beautiful engraving is primarily in the use of these resources to exhibit the qualities of the original picture, with delight to the eye in the method of translation; and the language of engraving, when once you begin to understand it, is, in these respects, so fertile, so ingenious, so ineffably subtle and severe in its grammar, that you may quite easily make it the subject of your life's investigation, as you would the scholarship of a lovely literature.

But in doing this, you would withdraw, and necessarily withdraw, your attention from the higher qualities of art, precisely as a grammarian, who is that, and nothing more, loses command of the matter and substance of thought. And the exquisitely mysterious mechanisms of the engraver's method have, in fact, thus entangled the intelligence of the careful draughtsmen of Europe; so that since the final perfection of this translator's power, all the men of finest patience and finest hand have stayed content with it;—the subtlest draughtsmanship has perished from the canvas,* and sought

* An effort has lately been made in France, by Meissonier, Gérôme, and their school, to recover it, with marvellous collateral skill of engravers. The etching of Gerome's Louis XVI. and Molière is one of the completest pieces of skilful mechanism ever put on metal.

more popular praise in this labyrinth of disciplined language, and more or less dulled or degraded thought. And, in sum, I know no cause more direct or fatal, in the destruction of the great schools of European art, than the perfectness of modern line engraving.

122. This great and profoundly to be regretted influence I will prove and illustrate to you on another occasion. My object to-day is to explain the perfectness of the art itself; and above all to request you, if you will not look at pictures instead of photographs, at least not to allow the cheap merits of the chemical operation to withdraw your interest from the splendid human labour of the engraver. Here is a little vignette from Stothard, for instance, in Rogers' poems, to the lines,

“Soared in the swing, half pleased and half afraid,
'Neath sister elms, that waved their summer shade.”

You would think, would you not? (and rightly,) that of all difficult things to express with crossed black lines and dots, the face of a young girl must be the most difficult. Yet here you have the face of a bright girl, radiant in light, transparent, mysterious, almost breathing,—her dark hair involved in delicate wreath and shade, her eyes full of joy and sweet playfulness,—and all this done by the exquisite order and gradation of a very few lines, which, if you will examine them through a lens, you find dividing and chequering the lip, and cheek, and chin, so strongly that you would have fancied they could only produce the effect of a grim iron mask. But the intelligences of order and form guide them into beauty, and inflame them with delicatest life.

123. And do you see the size of this head? About as large as the bud of a forget-me-not! Can you imagine the fineness of the little pressures of the hand on the steel, in that space, which at the edge of the almost invisible lip, fashioned its less or more of smile.

My chemical friends, if you wish ever to know anything rightly concerning the arts, I very urgently advise you to throw all your vials and washes down the gutter-trap; and if you will ascribe, as you think it so clever to do, in your

modern creeds, all virtue to the sun, use that virtue through your own heads and fingers, and apply your solar energies to draw a skilful line or two, for once or twice in your life. You may learn more by trying to engrave, like Goodall, the tip of an ear, or the curl of a lock of hair, than by photographing the entire population of the United States of America,—black, white, and neutral-tint.

And one word, by the way, touching the complaints I hear at my having set you to so fine work that it hurts your eyes. You have noticed that all great sculptors—and most of the great painters of Florence—began by being goldsmiths. Why do you think the goldsmith's apprenticeship is so fruitful? Primarily, because it forces the boy to do small work, and mind what he is about. Do you suppose Michael Angelo learned his business by dashing or hitting at it? He laid the foundation of all his after power by doing precisely what I am requiring my own pupils to do,—copying German engravings in facsimile! And for your eyes—you all sit up at night till you haven't got any eyes worth speaking of. Go to bed at half-past nine, and get up at four, and you'll see something out of them, in time.

124. Nevertheless, whatever admiration you may be brought to feel, and with justice, for this lovely workmanship,—the more distinctly you comprehend its merits, the more distinctly also will the question rise in your mind, How is it that a performance so marvellous has yet taken no rank in the records of art of any permanent or acknowledged kind? How is it that these vignettes from Stothard and Turnér,* like the

* I must again qualify the too sweeping statement of the text. I think, as time passes, some of these nineteenth century line engravings will become monumental. The first vignette of the garden, with the cut hedges and fountain, for instance, in Rogers' poems, is so consummate in its use of every possible artifice of delicate line, (note the look of *tremulous* atmosphere got by the undulatory etched lines on the pavement, and the broken masses, worked with dots, of the fountain foam,) that I think it cannot but, with some of its companions, survive the re-use of its school, and become classic. I find in like manner, even with all their faults and weaknesses, the vignettes to Heyne's Virgil to be real art-possession.

woodcuts from Tennai, scarcely make the name of the engraver known ; and that they never are found side by side with this older and apparently ruder art, in the cabinets of men of real judgment. The reason is precisely the same as in the case of the Tenniel woodcut. This modern line engraving is alloyed gold. Rich in capacity, astonishing in attainment, it nevertheless admits wilful fault, and misses what it ought first to have attained. It is therefore, to a certain measure, vile in its perfection ; while the older work is noble even in its failure, and classic no less in what it deliberately refuses, than in what it rationally and rightly prefers and performs.

125. Here, for instance, I have enlarged the head of one of Durer's Madonnas for you out of one of his most careful plates.* You think it very ugly. Well, so it is. Don't be afraid to think so, nor to say so. Frightfully ugly ; vulgar also. It is the head, simply, of a fat Dutch girl, with all the pleasantness left out. There is not the least doubt about that. Don't let anybody force Albert Durer down your throats ; nor make you expect pretty things from him. Stot-hard's young girl in the swing, or Sir Joshua's Age of Innocence, are in quite angelic spheres of another world, compared to this black domain of poor, laborious Albert. We are not talking of female beauty, so please you, just now, gentlemen, but of engraving. And the merit, the classical, indefeasible, immortal merit of this head of a Dutch girl with all the beauty left out, is in the fact that every line of it, as engraving, is as good as can be ;—good, not with the mechanical dexterity of a watchmaker, but with the intellectual effort and sensitiveness of an artist who knows precisely what can be done, and ought to be attempted, with his assigned materials. He works easily, fearlessly, flexibly ; the dots are not all measured in distance ; the lines not all mathematically parallel or divergent. He has even missed his mark at the mouth in one place, and leaves the mistake, frankly. But there are no petrifified mistakes ; nor is the eye so accustomed to the look of

* Plate 11th, in the Appendix, taken from the engraving of the Virgin sitting in the fenced garden, with two angels crowning her.

the mechanical furrow as to accept it for final excellence. The engraving is full of the painter's higher power and wider perception ; it is classically perfect, because duly subordinate, and presenting for your applause only the virtues proper to its own sphere. Among these, I must now reiterate, the first of all is the *decorative* arrangement of *lines*.

126. You all know what a pretty thing a damask table-cloth is, and how a pattern is brought out by threads running one way in one space, and across in another. So, in lace, a certain delightfulness is given by the texture of meshed lines.

Similarly, on any surface of metal, the object of the engraver is, or ought to be, to cover it with lovely *lines*, forming a lacework, and including a variety of spaces, delicious to the eye.

And this is his business, primarily ; before any other matter can be thought of, his work must be ornamental. You know I told you a sculptor's business is first to cover a surface with pleasant *bosses*, whether they mean anything or not ; so an engraver's is to cover it with pleasant *lines* whether they mean anything or not. That they should mean something, and a good deal of something, is indeed desirable afterwards ; but first we must be ornamental.

127. Now if you will compare Plate II. at the beginning of this lecture, which is a characteristic example of good Florentine engraving, and represents the Planet and power of Aphrodite, with the Aphrodite of Bewick in the upper division of Plate I., you will at once understand the difference between a primarily ornamental, and a primarily realistic, style. The first requirement in the Florentine work, is that it shall be a lovely arrangement of lines ; a pretty thing upon a page. Bewick *has* a secondary notion of making his vignette a pretty thing upon a page. But he is overpowered by his vigorous veracity, and bent first on giving you his idea of Venus. Quite right, he would have been, mind you, if he had been carving a statue of her on Mount Eryx ; but not when he was engraving a vignette to Æsop's fables. To engrave well is to ornament a surface well, not to create a realistic impression. I beg your pardon for my repetitions ; but the point at issue is the





PLATE III.—AT EVENING, FROM THE TOP OF FÉSOLE.

root of the whole business, and I *must* get it well asserted, and variously.

Let me pass to a more important example.

128. Three years ago, in the rough first arrangement of the copies in the Educational Series, I put an outline of the top of Apollo's sceptre, which, in the catalogue, was said to be probably by Baccio Bandini of Florence, for your first real exercise; it remains so, the olive being put first only for its mythological rank.

The series of engravings to which the plate from which that exercise is copied belongs, are part of a number, executed chiefly, I think, from early designs of Sandro Botticelli, and some in great part by his hand. He and his assistant, Baccio, worked together; and in such harmony, that Bandini probably often does what Sandro wants, better than Sandro could have done it himself; and, on the other hand, there is no design of Bandini's over which Sandro does not seem to have had influence.

And wishing now to show you three examples of the finest work of the old, the renaissance, and the modern schools,—of the old, I will take Baccio Bandini's *Astrologia*, Plate III., opposite. Of the renaissance, Durer's Adam and Eve. And of the modern, this head of the daughter of Herodias, engraved from Luini by Beaugrand, which is as affectionately and sincerely wrought, though in the modern manner, as any plate of the old schools.

129. Now observe the progress of the feeling for light and shade in the three examples.

The first is nearly all white paper; you think of the outline as the constructive element throughout.

The second is a vigorous piece of *white* and *black*—not of *light* and *shade*,—for all the high lights are equally white, whether of flesh, or leaves, or goat's hair.

The third is complete in *chiaroscuro*, as far as engraving can be.

Now the dignity and virtue of the plates is in the exactly inverse ratio of their fulness in *chiaroscuro*.

Bandini's is excellent work, and of the very highest school.

Durer's entirely accomplished work, but of an inferior school. And Beaugrand's, excellent work, but of a vulgar and non-classical school.

And these relations of the schools are to be determined by the quality in the *lines*; we shall find that in proportion as the light and shade is neglected, the lines are studied; that those of Bandini are perfect; of Durer perfect, only with a lower perfection; but of Beaugrand, entirely faultful.

130. I have just explained to you that in modern engraving the lines are cut in clean furrow, widened, it may be, by successive cuts; but, whether it be fine or thick, retaining always, when printed, the aspect of a continuous line drawn with the pen, and entirely black throughout its whole course.

Now we may increase the delicacy of this line to any extent by simply printing it in grey colour instead of black. I obtained some very beautiful results of this kind in the later volumes of 'Modern Painters,' with Mr. Armytage's help, by using subdued purple tints; but, in any case, the line thus engraved must be monotonous in its character, and cannot be expressive of the finest qualities of form.

Accordingly, the old Florentine workmen constructed the line *itself*, in important places, of successive minute touches, so that it became a chain of delicate links which could be opened or closed at pleasure.* If you will examine through a lens the outline of the face of this Astrology, you will find it is traced with an exquisite series of minute touches, susceptible of accentuation or change absolutely at the engraver's pleasure; and, in result, corresponding to the finest conditions of a pencil line drawing by a consummate master. In the fine plates of this period, you have thus the united powers of the pen and pencil, and both absolutely secure and multipliable.

* The method was first developed in engraving designs on silver—numbers of lines being executed with dots by the punch, for variety's sake. For niello, and printing, a transverse cut was substituted for the blow. The entire style is connected with the later Roman and Byzantine method of drawing lines with the drill hole, in marble. See above, Lecture II., Section 70.

131. I am a little proud of having independently discovered, and had the patience to carry out, this Florentine method of execution for myself, when I was a boy of thirteen. My good drawing-master had given me some copies calculated to teach me freedom of hand ; the touches were rapid and vigorous,—many of them in mechanically regular zigzags, far beyond any capacity of mine to imitate in the bold way in which they were done. But I was resolved to have them, somehow ; and actually facsimilied a considerable portion of the drawing in the Florentine manner, with the finest point I could cut to my pencil, taking a quarter of an hour to forge out the likeness of one return in the zigzag which my master carried down through twenty returns in two seconds ; and so successfully, that he did not detect my artifice till I showed it him,—on which he forbade me ever to do the like again. And it was only thirty years afterwards that I found I had been quite right after all, and working like Baccio Bandini ! But the patience which carried me through that early effort, served me well through all the thirty years, and enabled me to analyze, and in a measure imitate, the method of work employed by every master ; so that, whether you believe me or not at first, you will find what I tell you of their superiority, or inferiority, to be true.

132. When lines are studied with this degree of care you may be sure the master will leave room enough for you to see them and enjoy them, and not use any at random. All the finest engravers, therefore, leave much white paper, and use their entire power on the outlines.

133. Next to them come the men of the Renaissance schools, headed by Durer, who, less careful of the beauty and refinement of the line, delight in its vigour, accuracy, and complexity. And the essential difference between these men and the moderns is that these central masters cut their line for the most part with a single furrow, giving it depth by force of hand or wrist, and retouching, *not in the furrow itself, but with others beside it.** Such work can only be done well on copper,

* This most important and distinctive character was pointed out to me by Mr. Burgess.

and it can display all faculty of hand or wrist, precision of eye, and accuracy of knowledge, which a human creature can possess. But the dotted or hatched line is not used in this central style, and the higher conditions of beauty never thought of.

In the Astrology of Bandini,—and remember that the Astrologia of the Florentine meant what we mean by Astronomy, and much more,—he wishes you first to look at the face : the lip half open, faltering in wonder ; the amazed, intense, dreaming gaze ; the pure dignity of forehead, undisturbed by terrestrial thought. None of these things could be so much as attempted in Durer's method ; he can engrave flowing hair, skin of animals, bark of trees, wreathings of metal-work, with the free hand ; also, with laboured chiaroscuro, or with sturdy line, he can reach expressions of sadness, or gloom, or pain, or soldierly strength,—but pure beauty,—never.

134. Lastly, you have the Modern school, deepening its lines in successive cuts. The instant consequence of the introduction of this method is the restriction of curvature ; you cannot follow a complex curve again with precision through its furrow. If you are a dextrous ploughman, you can drive your plough any number of times along the simple curve. But you cannot repeat again exactly the motions which cut a variable one.* You may retouch it, energize it, and deepen it in parts, but you cannot cut it all through again equally. And the retouching and energizing in parts is a living and intellectual process ; but the cutting all through, equally, a mechanical one. The difference is exactly such as that between the dexterity of turning out two similar mouldings from a lathe, and carving them with the free hand, like a Pisan sculptor. And although splendid intellect, and subtlest sensibility, have been spent on the production of some modern plates, the mechanical element introduced by their manner of execution always overpowers both ; nor can any plate of consummate value ever be produced in the modern method.

135. Nevertheless, in landscape, there are two examples in your Reference series, of insuperable skill and extreme beauty :

* This point will be further examined and explained in the Appendix.

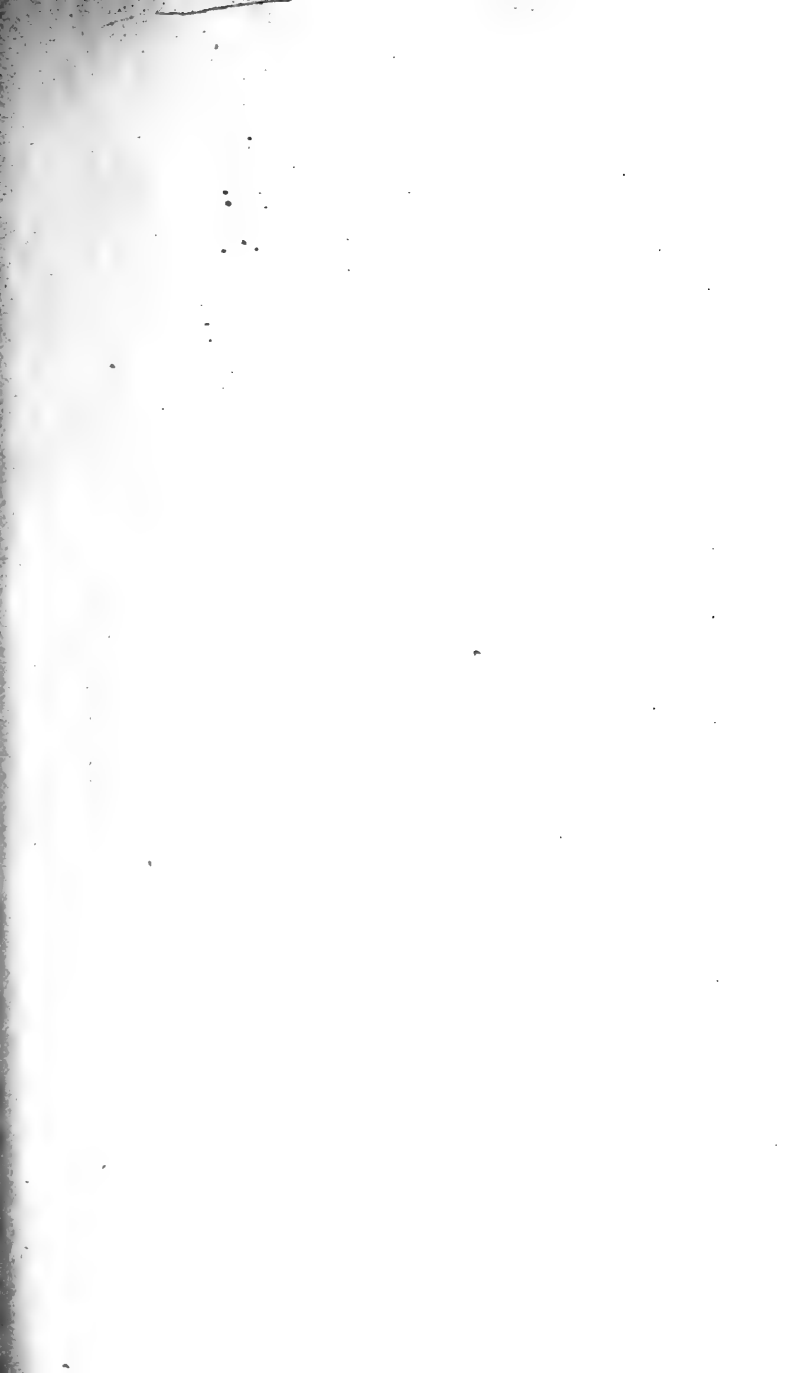



PLATE IV.—“BY THE SPRINGS OF PARNASSUS.”

Miller's plate, before instanced, of the Grand Canal, Venice ; and E. Goodall's of the upper fall of the Tees. The men who engraved these plates might have been exquisite artists ; but their patience and enthusiasm were held captive in the false system of lines, and we lost the painters ; while the engravings, wonderful as they are, are neither of them worth a Turner etching, scratched in ten minutes with the point of an old fork ; and the common types of such elaborate engraving are none of them worth a single frog, pig, or puppy, out of the corner of a Bewick vignette.

136. And now, I think, you cannot fail to understand clearly what you are to look for in engraving, as a separate art from that of painting. Turn back to the 'Astrologia' as a perfect type of the purest school. She is gazing at stars, and crowned with them. But the stars are *black* instead of shining ! You cannot have a more decisive and absolute proof that you must not look in engraving for chiaroscuro.

Nevertheless, her body is half in shade, and her left foot ; and she casts a shadow, and there is a bar of shade behind her.

All these are merely so much acceptance of shade as may relieve the forms, and give value to the linear portions. The face, though turned from the light, is shadowless.

Again. Every lock of the hair is designed and set in its place with the subtlest care, but there is no lustre attempted, —no texture,—no mystery. The plumes of the wings are set studiously in their places,—they, also, lustreless. That even their filaments are not drawn, and that the broad curve embracing them ignores the anatomy of a bird's wing, are conditions of design, not execution. Of these in a future lecture.*

137. The 'Poesia,' Plate IV., opposite, is a still more severe, though not so generic, an example ; its decorative foreground reducing it almost to the rank of Goldsmith's ornamentation. I need scarcely point out to you that the flowing water shows neither lustre nor reflection ; but notice that the observer's attention is supposed to be so close to every dark touch of the

* See Appendix, Article I.

graver that he will see the minute dark spots which indicate the sprinkled shower falling from the vase into the pool.

138. This habit of strict and calm attention, constant in the artist, and expected in the observer, makes all the difference between the art of Intellect, and of mere sensation. For every detail of this plate has a meaning, if you care to understand it. This is Poetry, sitting by the fountain of Castalia, which flows first out of a formal urn, to show that it is not artless; but the rocks of Parnassus are behind, and on the top of them—only one tree, like a mushroom with a thick stalk. You at first are inclined to say, How very absurd, to put only one tree on Parnassus! but this one tree is the Immortal Plane Tree, planted by Agamemnon, and at once connects our Poesia with the Iliad. Then, this is the hem of the robe of Poetry,—this is the divine vegetation which springs up under her feet,—this is the heaven and earth united by her power,—this is the fountain of Castalia flowing out afresh among the grass,—and these are the drops with which, out of a pitcher, Poetry is nourishing the fountain of Castalia.

All which you may find out if you happen to know anything about Castalia, or about poetry; and pleasantly think more upon, for yourself. But the poor dunces, Sandro and Baccio, feeling themselves but 'goffi nell' arte,' have no hope of telling you all this, except suggestively. They can't engrave grass of Parnassus, nor sweet springs so as to look like water; but they can make a pretty damasked surface with ornamental leaves, and flowing lines, and so leave you something to think of—if you will.

139. 'But a great many people won't, and a great many more can't; and surely the finished engravings are much more delightful, and the only means we have of giving any idea of finished pictures, out of our reach.'

Yes, all that is true; and when we examine the effects of line engraving upon taste in recent art, we will discuss these matters; for the present, let us be content with knowing what the best work is, and why it is so. Although, however, I do not now press further my cavils at the triumph of modern line engraving, I must assign to you, in few words, the

reason of its recent decline. Engravers complain that photography and cheap woodcutting have ended their finer craft. No complaint can be less grounded. They themselves destroyed their own craft, by vulgarizing it. Content in their beautiful mechanism, they ceased to learn, and to feel, as artists; they put themselves under the order of publishers and printsellers; they worked indiscriminately from whatever was put into their hands,—from Bartlett as willingly as from Turner, and from Mulready as carefully as from Raphael. They filled the windows of printsellers, the pages of gift books, with elaborate rubbish, and piteous abortions of delicate industry. They worked cheap, and cheaper,—smoothly, and more smoothly,—they got armies of assistants, and surrounded themselves with schools of mechanical tricksters, learning their stale tricks with blundering avidity. They had fallen—before the days of photography—into providers of frontispieces for housekeepers' pocket-books. I do not know if photography itself, their redoubted enemy, has even now ousted them from that last refuge.

140. Such the fault of the engraver,—very pardonable; scarcely avoidable,—however fatal. Fault mainly of humility. But what has *your* fault been, gentlemen? what the patrons' fault, who have permitted so wide waste of admirable labour, so pathetic a uselessness of obedient genius? It was yours to have directed, yours to have raised and rejoiced in, the skill, the modesty, the patience of this entirely gentle and industrious race;—copyists with their *heart*. The common painter-copyists who encumber our European galleries with their easels and pots, are, almost without exception, persons too stupid to be painters, and too lazy to be engravers. The real copyists—the men who can put their soul into another's work—are employed at home, in their narrow rooms, striving to make their good work profitable to all men. And in their submission to the public taste they are truly national servants as much as Prime Ministers are. They fulfil the demand of the nation; what, as a people, you wish to have for possession in art, these men are ready to give you.

And what have you hitherto asked of them?—Ramsgate

Sands, and Dolly Vardens, and the Paddington Station,—these, I think, are typical of your chief demands ; the cartoons of Raphael—which you don't care to see themselves ; and, by way of a flight into the empyrean, the Madonna di San Sisto. And, literally, there are hundreds of cities and villages in Italy in which roof and wall are blazoned with the noblest divinity and philosophy ever imagined by men ; and of all this treasure, I can, as far as I know, give you not *one* example, in line engraving, by an English hand !

Well, you are in the main matter right in this. You want essentially Ramsgate Sands and the Paddington Station, because there you can see yourselves.

Make yourselves, then, worthy to be seen for ever, and let English engraving become noble as the record of English loveliness and honour.

LECTURE V.

DESIGN IN THE GERMAN SCHOOLS OF ENGRAVING.

141. By reference to the close of the preface to 'Eagle's Nest,' you will see, gentlemen, that I meant these lectures, from the first, rather to lead you to the study of the characters of two great men, than to interest you in the processes of a secondary form of art. As I draw my materials into the limited form necessary for the hour, I find my divided purpose doubly failing ; and would fain rather use my time to-day in supplying the defects of my last lecture, than in opening the greater subject, which I must treat with still more lamentable inadequacy. Nevertheless, you must not think it is for want of time that I omit reference to other celebrated engravers, and insist on the special power of these two only. Many not inconsiderable reputations are founded merely on the curiosity of collectors of prints, or on partial skill in the management of processes ; others, though resting on more secure bases, are still of no importance to you in the general history of art ; whereas you will find the work of

Holbein and Botticelli determining for you, without need of any farther range, the principal questions of moment in the relation of the Northern and Southern schools of design. Nay, a wider method of inquiry would only render your comparison less accurate in result. It is only in Holbein's majestic range of capacity, and only in the particular phase of Teutonic life which his art adorned, that the problem can be dealt with on fair terms. We Northerners can advance no fairly comparable antagonist to the artists of the South, except at that one moment, and in that one man. Rubens cannot for an instant be matched with Tintoret, nor Memling with Lippi; while Reynolds only rivals Titian in what he learned from him. But in Holbein and Botticelli we have two men trained independently, equal in power of intellect, similiar in material and mode of work, contemporary in age, correspondent in disposition. The relation between them is strictly typical of the constant aspects to each other of the Northern and Southern schools.

142. Their point of closest contact is in the art of engraving, and this art is developed entirely as the servant of the great passions which perturbed or polluted Europe in the fifteenth century. The impulses which it obeys are all new; and it obeys them with its own nascent plasticity of temper. Painting and sculpture are only modified by them; but engraving is educated.

These passions are in the main three; namely,

1. The thirst for classical literature, and the forms of proud and false tastes which arose out of it, in the position it had assumed as the enemy of Christianity.
2. The pride of science, enforcing (in the particular domain of Art) accuracy of perspective, shade, and anatomy, never before dreamed of.
3. The sense of error and iniquity in the theological teaching of the Christian Church, felt by the highest intellects of the time, and necessarily rendering the formerly submissive religious art impossible.

To-day, then, our task is to examine the peculiar characters of the Design of the Northern Schools of Engraving, as affected by these great influences.

143. I have not often, however, used the word 'design,' and must clearly define the sense in which I now-use it. It is vaguely used in common art-parlance; often as if it meant merely the drawing of a picture, as distinct from its colour; and in other still more inaccurate ways. The accurate and proper sense, underlying all these, I must endeavour to make clear to you.

'Design' properly signifies that power in any art-work which has a purpose other than of imitation, and which is 'designed,' composed, or separated to that end. It implies the rejection of some things, and the insistence upon others, with a given object.*

Let us take progressive instances. Here is a group of prettily dressed peasant children, charmingly painted by a very able modern artist—not absolutely without design, for he really wishes to show you how pretty peasant children can be, (and, in so far, is wiser and kinder than Murillo, who likes to show how ugly they can be); also, his group is agreeably arranged, and its component children carefully chosen. Nevertheless, any summer's day, near any country village, you may come upon twenty groups in an hour as pretty as this;

* If you paint a bottle only to amuse the spectator by showing him how like a painting may be to a bottle, you cannot be considered, in art-philosophy, as a designer. But if you paint the cork flying out of the bottle, and the contents arriving in an arch at the mouth of a recipient glass, you are so far forth a designer or signer; probably meaning to express certain ultimate facts respecting, say, the hospitable disposition of the landlord of the house; but at all events representing the bottle and glass in a designed, and not merely natural, manner. Not merely natural—nay, in some sense non-natural, or supernatural. And all great artists show both this fantastic condition of mind in their work, and show that it has arisen out of a communicative or didactic purpose.

They are the Sign-painters of God.

I have added this note to the lecture in copying my memoranda of it here at Assisi, June 9th, being about to begin work in the Tavern, or Tabernaculum, of the Lower Church, with its variously significant four great 'signs.'

and may see—if you have eyes—children in them twenty times prettier than these. A photograph, if it could render them perfectly, and in colour, would far excel the charm of this painting; for in it, good and clever as it is, there is nothing supernatural, and much that is sub-natural.

144. Beside this group of, in every sense of the word, ‘artless’ little country girls, I will now set one—in the best sense of the word—‘artful’ little country girl,—a sketch by Gainsborough.

You never saw her like before. Never will again, now that Gainsborough is dead. No photography,—no science,—no industry, will touch or reach for an instant this *super-naturalness*. You will look vainly through the summer fields for such a child. “Nor up the lawn, nor by the wood,” is she. Whence do you think this marvellous charm has come? Alas! if we knew, would not we all be Gainsboroughs? This only you may practically ascertain, as surely as that a flower will die if you cut its root away, that you cannot alter a single touch in Gainsborough’s work without injury to the whole. Half a dozen spots, more or less, in the printed gowns of these other children whom I first showed you, will not make the smallest difference to them; nor a lock or two more or less in their hair, nor a dimple or two more or less in their cheeks. But if you alter one wave of the hair of Gainsborough’s girl, the child is gone. Yet the art is so subtle, that I do not expect you to believe this. It looks so instinctive, so easy, so ‘chanceux,’—the French word is better than ours. Yes, and in their more accurate sense, also, ‘Il a de la chance.’ A stronger Designer than he was with him. He could not tell you himself how the thing was done.

145. I proceed to take a more definite instance—this Greek head of the Lacinian Juno. The design or appointing of the forms now entirely prevails over the resemblance to Nature. No real hair could ever be drifted into these wild lines, which mean the wrath of the Adriatic winds round the Cape of Storms.

And yet, whether this be uglier or prettier than Gainsborough’s child—(and you know already what *I* think about

it, that no Greek goddess was ever half so pretty as an English girl, of pure clay and temper,)—uglier or prettier, it is more dignified and impressive. It at least belongs to the domain of a lordlier, more majestic, more guiding, and ordaining art.

146. I will go back another five hundred years, and place an Egyptian beside the Greek divinity. The resemblance to Nature is now all but lost, the ruling law has become all. The lines are reduced to an easily counted number, and their arrangement is little more than a decorative sequence of pleasant curves cut in porphyry,—in the upper part of their contour following the outline of a woman's face in profile, over-crested by that of a hawk, on a kind of pedestal. But that the sign-engraver meant by his hawk, Immortality, and by her pedestal, the House or Tavern of Truth, is of little importance now to the passing traveller, not yet preparing to take the sarcophagus for his place of rest.

147. How many questions are suggested to us by these transitions! Is beauty contrary to law, and grace attainable only through license? What we gain in language, shall we lose in thought? and in what we add of labour, more and more forget its ends?

Not so.

Look at this piece of Sandro's work, the Libyan Sibyl.*

It is as ordered and normal as the Egyptian's;—as graceful and facile as Gainsborough's. It retains the majesty of old religion; it is invested with the joy of newly-awakened childhood.

Mind, I do not expect you—do not wish you—to enjoy Botticelli's dark engraving as much as Gainsborough's aerial sketch; for due comparison of the men, painting should be put beside painting. But there is enough even in this copy of the Florentine plate to show you the junction of the two powers in it—of prophecy, and delight.

148. Will these two powers, do you suppose, be united in the same manner in the contemporary Northern art? That Northern school is my subject to-day; and yet I give you, as

* Plate X., Lecture VI.

type of the intermediate condition between Egypt and England—not Holbein, but Botticelli. I am obliged to do this; because in the Southern art, the religious temper remains unconquered by the doctrines of the Reformation. Botticelli was—what Luther wished to be, but could not be—a reformer still believing in the Church: his mind is at peace; and his art, therefore, can pursue the delight of beauty, and yet remain prophetic. But it was far otherwise in Germany. There the Reformation of manners became the destruction of faith; and art therefore, not a prophecy, but a protest. It is the chief work of the greatest Protestant who ever lived,* which I ask you to study with me to-day.

149. I said that the power of engraving had developed itself during the introduction of three new—(practically and vitally new, that is to say)—elements, into the minds of men: elements which briefly may be expressed thus:

1. Classicism, and Literary Science.
2. Medicine, and Physical Science.†
3. Reformation, and Religious Science.

And first of Classicism.

You feel, do not you, in this typical work of Gainsborough's, that his subject as well as his picture is 'artless' in a lovely sense;—nay, not only artless, but ignorant, and unscientific, in a beautiful way? You would be afterwards remorseful, I think, and angry with yourself—seeing the effect produced on her face—if you were to ask this little lady

* I do not mean the greatest teacher of reformed faith; but the greatest protestant against faith unreformed.

† It has become the permitted fashion among modern mathematicians, chemists, and apothecaries, to call themselves 'scientific men,' as opposed to theologians, poets, and artists. They know their sphere to be a separate one; but their ridiculous notion of its being a peculiarly scientific one ought not to be allowed in our Universities. There is a science of Morals, a science of History, a science of Grammar, a science of Music, and a science of Painting; and all these are quite beyond comparison higher fields for human intellect, and require accuracies of intenser observation, than either chemistry, electricity, or geology.

to spell a very long word? Also, if you wished to know how many times the sevens go in forty-nine, you would perhaps wisely address yourself elsewhere. On the other hand, you do not doubt that *this lady** knows very well how many times the sevens go in forty-nine, and is more Mistress of Arts than any of us are Masters of them.

150. You have then, in the one case, a beautiful simplicity, and a blameless ignorance; in the other, a beautiful artfulness, and a wisdom which you do not dread,—or, at least, even though dreading, love. But you know also that we may remain in a hateful and culpable ignorance; and, as I fear too many of us in competitive effort feel, become possessed of a hateful knowledge.

Ignorance, therefore, is not evil absolutely; but, innocent, may be loveable.

Knowledge also is not good absolutely; but, guilty, may be hateful.

So, therefore, when I now repeat my former statement, that the first main opposition between the Northern and Southern schools is in the simplicity of the one, and the scholarship of the other, that statement may imply sometimes the superiority of the North, and sometimes of the South. You may have a heavenly simplicity opposed to a hellish (that is to say, a lustful and arrogant) scholarship; or you may have a barbarous and presumptuous ignorance opposed to a divine and disciplined wisdom. Ignorance opposed to learning in both cases; but evil to good, as the case may be.

151. For instance: the last time I was standing before Raphael's arabesques in the Loggias of the Vatican, I wrote down in my pocket-book the description, or, more modestly speaking, the inventory, of the small portion of that infinite wilderness of sensual fantasy which happened to be opposite me. It consisted of a woman's face, with serpents for hair, and a virgin's breasts, with stumps for arms, ending in blue butterflies' wings, the whole changing at the waist into a goat's body, which ended below in an obelisk upside-down, to the apex at

* The Cumæan Sibyl, Flate VII., Lecture VI.

the bottom of which were appended, by graceful chains, an altar, and two bunches of grapes.

Now you know in a moment, by a glance at this 'design'—beautifully struck with free hand, and richly gradated in colour,—that the master was familiar with a vast range of art and literature: that he knew all about Egyptian sphinxes, and Greek Gorgons; about Egyptian obelisks, and Hebrew altars; about Hermes, and Venus, and Bacchus, and satyrs, and goats, and grapes.

You know also—or ought to know, in an instant,—that all this learning has done him no good; that he had better have known nothing than any of these things, since they were to be used by him only to such purpose; and that his delight in armless breasts, legless trunks, and obelisks upside-down, has been the last effort of his expiring sensation, in the grasp of corrupt and altogether victorious Death. And you have thus, in Gainsborough as compared with Raphael, a sweet, sacred, and living simplicity, set against an impure, profane, and paralyzed knowledge.

152. But, next, let us consider the reverse conditions.

Let us take instance of contrast between faultful and treacherous ignorance, and divinely pure and fruitful knowledge.

In the place of honour at the end of one of the rooms of your Royal Academy—years ago—stood a picture by an English Academician, announced as a representation of Moses sustained by Aaron and Hur, during the discomfiture of Amalek. In the entire range of the Pentateuch, there is no other scene (in which the visible agents are mortal only) requiring so much knowledge and thought to reach even a distant approximation to the probabilities of the fact. One saw in a moment that the painter was both powerful and simple, after a sort; that he had really sought for a vital conception, and had originally and earnestly read his text, and formed his conception. And one saw also in a moment that he had chanced upon this subject, in reading or hearing his Bible, as he might have chanced on a dramatic scene accidentally in the street. That he knew nothing of the character of Moses,—nothing of his

law,—nothing of the character of Aaron, nor of the nature of a priesthood,—nothing of the meaning of the event which he was endeavouring to represent, of the temper in which it would have been transacted by its agents, or of its relations to modern life.

153. On the contrary, in the fresco of the earlier scenes in the life of Moses, by Sandro Botticelli, you know—not ‘in a moment,’ for the knowledge of knowledge cannot be so obtained; but in proportion to the discretion of your own reading, and to the care you give to the picture, you *may* know,—that here is a sacredly guided and guarded learning; here a Master indeed, at whose feet you may sit safely, who can teach you, better than in words, the significance of both Moses’ law and Aaron’s ministry; and not only these, but, if he chose, could add to this an exposition as complete of the highest philosophies both of the Greek nation, and of his own; and could as easily have painted, had it been asked of him, Draco, or Numa, or Justinian, as the herdsman of Jethro.

154. It is rarely that we can point to an opposition between faultful, because insolent, ignorance, and virtuous, because gracious, knowledge, so direct, and in so parallel elements, as in this instance. In general, the analysis is much more complex. It is intensely difficult to indicate the mischief of involuntary and modest ignorance, calamitous only in a measure; fruitful in its lower field, yet sorrowfully condemned to that lower field—not by sin, but fate.

When first I introduced you to Bewick, we closed our too partial estimate of his entirely magnificent powers with one sorrowful concession—he could draw a pig, but not a Venus.

Eminently he could so, because—which is still more sorrowfully to be conceded—he liked the pig best. I have put now in your educational series a whole galaxy of pigs by him; but, hunting all the fables through, I find only one Venus, and I think you will all admit that she is an unsatisfactory Venus.* There is honest simplicity here; but you regret it; you miss something that you find in Holbein, much more in

* Lecture III., p. 57.

Botticelli. You see in a moment that this man knows nothing of Sphinxes, or Muses, or Graces, or Aphrodites; and, besides, that, knowing nothing, he would have no liking for them even if he saw them; but much prefers the style of a well-to-do English housekeeper with corkscrew curls, and a portly person.

155. You miss something, I said, in Bewick which you find in Holbein. But do you suppose Holbein himself, or any other Northern painter, could wholly quit himself of the like accusations? I told you, in the second of these lectures, that the Northern temper, refined from savageness, and the Southern, redeemed from decay, met, in Florence. Holbein and Botticelli are the purest types of the two races. Holbein is a civilized boor; Botticelli a reanimate Greek. Holbein was polished by companionship with scholars and kings, but remains always a burgher of Augsburg in essential nature. Bewick and he are alike in temper; only the one is untaught, the other perfectly taught. But Botticelli *needs* no teaching. He is, by his birth, scholar and gentleman to the heart's core. Christianity itself can only inspire him, not refine him. He is as tried gold chased by the jeweller,—the roughest part of him is the outside.

Now how differently must the newly recovered scholastic learning tell upon these two men. It is all out of Holbein's way; foreign to his nature, useless at the best, probably cumbersome. But Botticelli receives it as a child in later years recovers the forgotten dearness of a nursery tale; and is more himself, and again and again himself, as he breathes the air of Greece, and hears, in his own Italy, the lost voice of the Sibyl murmur again by the Avernus Lake.

156. It is not, as we have seen, every one of the Southern race who can thus receive it. But it graces them all; is at once a part of their being; destroys them, if it is to destroy, the more utterly because it so enters into their natures. It destroys Raphael; but it graces him, and is a part of him. It all but destroys Mantegna; but it graces him. And it does not hurt Holbein, just because it does *not* grace him—never is for an instant a part of him. It is with Raphael as

with some charming young girl who has a new and beautifully made dress brought to her, which entirely becomes her, —so much, that in a little while, thinking of nothing else, she becomes *it*; and is only the decoration of her dress. But with Holbein it is as if you brought the same dress to a stout farmer's daughter who was going to dine at the Hall; and begged her to put it on that she might not discredit the company. She puts it on to please you; looks entirely ridiculous in it, but is not spoiled by it, — remains herself, in spite of it.

157. You probably have never noticed the extreme awkwardness of Holbein in wearing this new dress; you would the less do so because his own people think him all the finer for it, as the farmer's wife would probably think her daughter. Dr. Woltmann, for instance, is enthusiastic in praise of the splendid architecture in the background of his Annunciation. A fine mess it must have made in the minds of simple German maidens, in their notion of the Virgin at home! I cannot show you this Annunciation; but I have under my hand one of Holbein's Bible cuts, of the deepest seriousness and import —his illustration of the Canticles, showing the Church as the bride of Christ.



You could not find a subject requiring more tenderness, purity, or dignity of treatment. In this maid, symbolizing the Church, you ask for the most passionate humility, the most angelic beauty: "Behold, thou art fair, my dove." Now here is Holbein's ideal of that fairness; here is his "Church as the Bride."

I am sorry to associate this figure in your minds, even for a moment, with the passages it is supposed to illustrate; but the lesson is too important to be omitted. Remember, Holbein represents the temper of Northern Reformation. He has all the nobleness of that temper, but also all its baseness. He represents, indeed, the

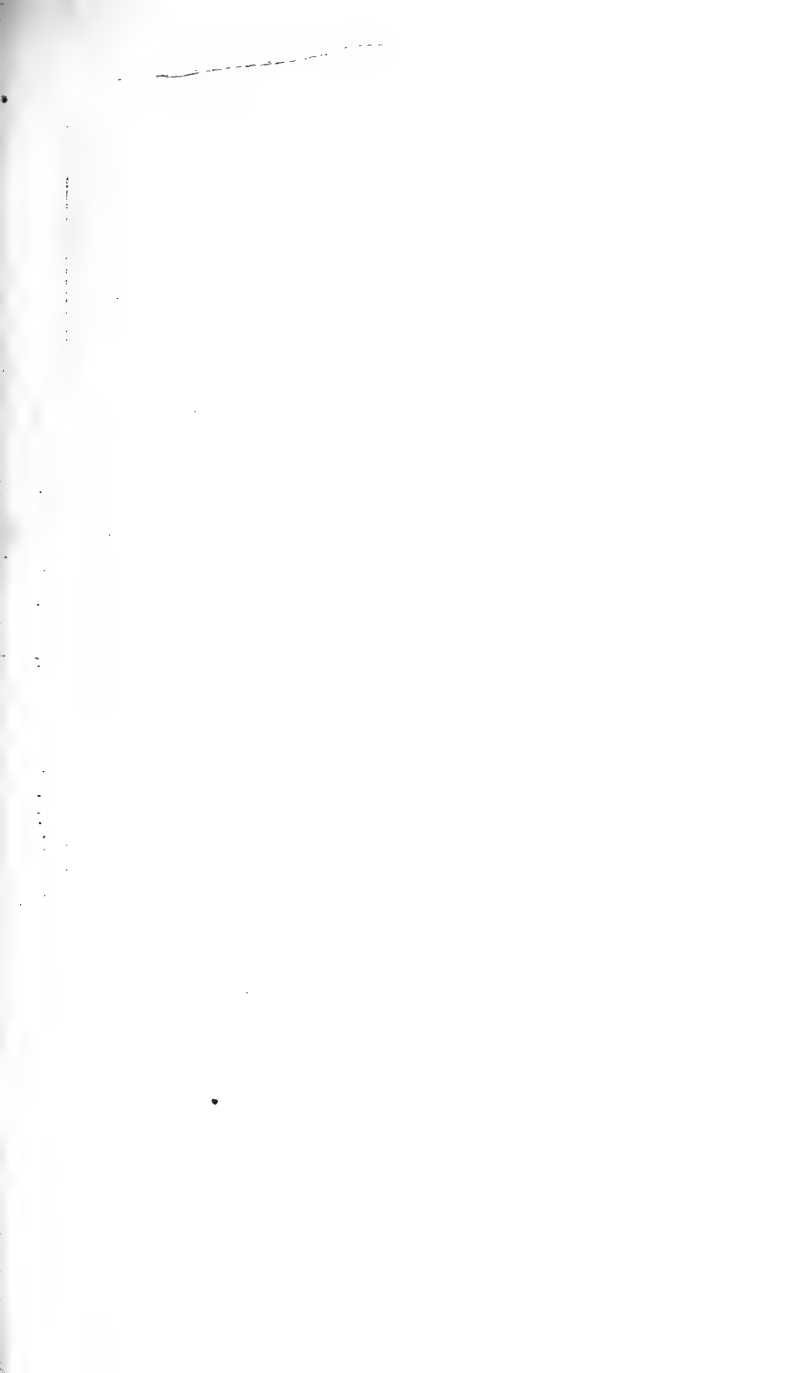

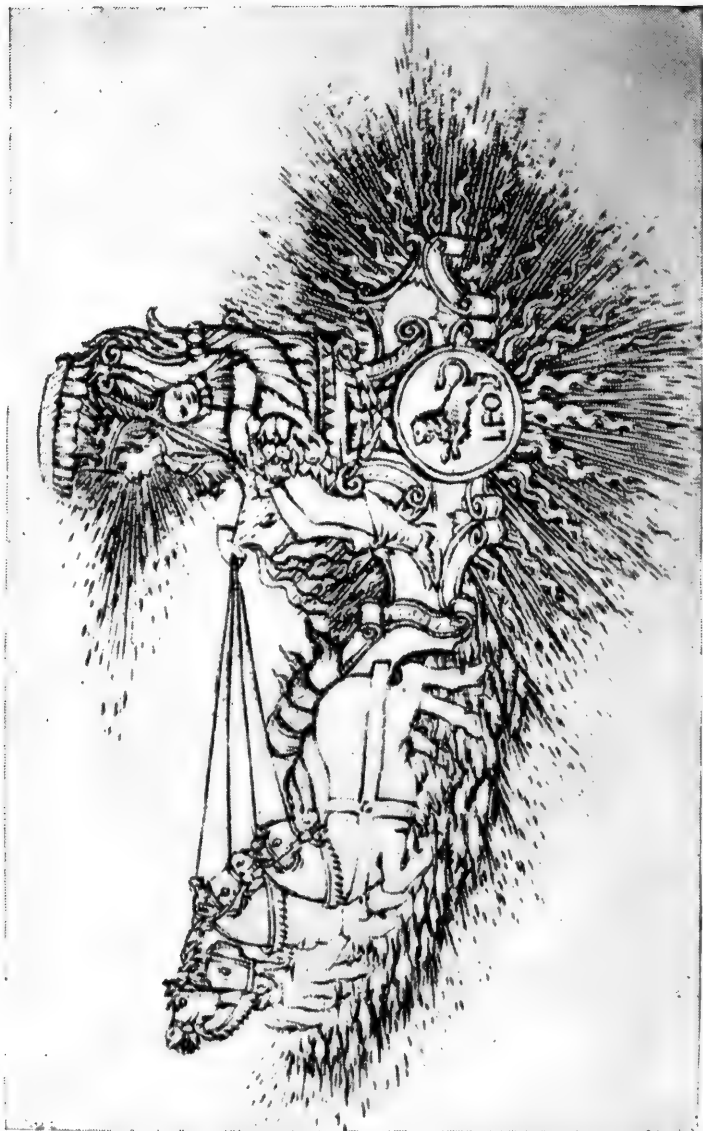

PLATE V.—HEAT CONSIDERED AS A MODE OF MOTION.

Florentine Natural Philosophy.

revolt of German truth against Italian lies ; but he represents also the revolt of German animalism against Hebrew imagination. This figure of Holbein's is half-way from Solomon's mystic bride, to Rembrandt's wife, sitting on his knee while he drinks.

But the key of the question is not in this. Florentine animalism has at this time, also, enough to say for itself. But Florentine animalism, at this time, feels the joy of a gentleman, not of a churl. And a Florentine, whatever he does,—be it virtuous or sinful, chaste or lascivious, severe or extravagant,—does it with a grace.

158. You think, perhaps, that Holbein's Solomon's bride is so ungraceful chiefly because she is overdressed, and has too many feathers and jewels. No ; a Florentine would have put any quantity of feathers and jewels on her, and yet never lost her grace. You shall see him do it, and that to a fantastic degree, for I have an example under my hand. Look back, first, to Bewick's Venus (*Lect. III.*, p. 57). You can't accuse her of being overdressed. She complies with every received modern principle of taste. Sir Joshua's precept that drapery should be "drapery, and nothing more," is observed more strictly even by Bewick than by Michael Angelo. If the absence of decoration could exalt the beauty of his Venus, here had been her perfection.

Now look back to Plate II. (*Lect. IV.*), by Sandro ; Venus in her planet, the ruling star of Florence. Anything more grotesque in conception, more unrestrained in fancy of ornament, you cannot find, even in the final days of the Renaissance. Yet Venus holds her divinity through all ; she will become majestic to you as you gaze ; and there is not a line of her chariot wheels, of her buskins, or of her throne, which you may not see was engraved by a gentleman.

159. Again, Plate V., opposite, is a facsimile of another engraving of the same series—the Sun in Leo. It is even more extravagant in accessories than the Venus. You see the Sun's epaulettes before you see the sun ; the spiral scrolls of his chariot, and the black twisted rays of it, might, so far as types of form only are considered, be a design for some

modern court-dress star, to be made in diamonds. And yet all this wild ornamentation is, if you will examine it, more purely Greek in spirit than the Apollo Belvidere.

You know I have told you, again and again, that the soul of Greece is her veracity ; that what to other nations were fables and symbolisms, to her became living facts—living gods. The fall of Greece was instant when her gods again became fables. The Apollo Belvidere is the work of a sculptor to whom Apollonism is merely an elegant idea on which to exhibit his own skill. He does not himself feel for an instant that the handsome man in the unintelligible attitude,* with drapery hung over his left arm, as it would be hung to dry over a clothes-line, is the Power of the Sun. But the Florentine believes in Apollo with his whole mind, and is trying to explain his strength in every touch.

For instance ; I said just now, “ You see the sun’s epaulettes before the sun.” Well, *don’t* you, usually, as it rises ? Do you not continually mistake a luminous cloud for it, or wonder where it is, behind one ? Again, the face of the Apollo Belvidere is agitated by anxiety, passion, and pride. Is the sun’s likely to be so, rising on the evil and the good ? This Prince sits crowned and calm : look at the quiet fingers of the hand holding the sceptre,—at the restraint of the reins merely by a depression of the wrist.

160. You have to look carefully for those fingers holding the sceptre, because the hand—which a great anatomist would have made so exclusively interesting—is here confused with the ornamentation of the arm of the chariot on which it rests. But look what the ornamentation is ;—fruit and leaves, abundant, in the mouth of a cornucopia. A quite vulgar and meaningless ornament in ordinary renaissance work. Is it so

* I read somewhere, lately, a new and very ingenious theory about the attitude of the Apollo Belvidere, proving, to the author’s satisfaction, that the received notion about watching the arrow was all a mistake. The paper proved, at all events, one thing—namely, the statement in the text. For an attitude which has been always hitherto taken to mean one thing, and is plausibly asserted now to mean another, must be in itself unintelligible.

here, think you? Are not the leaves and fruits of earth in the Sun's hand?*

You thought, perhaps, when I spoke just now of the action of the right hand, that less than a depression of the wrist would stop horses such as those. You fancy Botticelli drew them so, because he had never seen a horse; or because, able to draw fingers, he could not draw hoofs! How fine it would be to have, instead, a prancing four-in-hand, in the style of Piccadilly on the Derby-day, or at least horses like the real Greek horses of the Parthenon!

Yes; and if they had had real ground to trot on, the Florentine would have shown you he knew how they should trot. But these have to make their way up the hillside of other lands. Look to the example in your standard series, *Hermes Eriophoros*. You will find his motion among clouds represented precisely in this labouring, failing, half-kneeling attitude of limb. These forms, toiling up through the rippled sands of heaven, are—not horses;—they are clouds themselves, *like* horses, but only a little like. Look how their hoofs lose themselves, buried in the ripples of cloud; it makes one think of the quicksands of Morecambe Bay.

And their tails—what extraordinary tufts of tails, ending in points! Yes; but do you not see, nearly joining with them, what is not a horse tail at all; but a flame of fire, kindled at Apollo's knee? All the rest of the radiance about him shoots from him. But this is rendered *up* to him. As the fruits of the earth are in one of his hands, its fire is in the other. And all the warmth, as well as all the light of it, are his.

We had a little natural philosophy, gentlemen, as well as theology, in Florence, once upon a time.

161. Natural philosophy, and also natural art, for in this the Greek reanimate was a nobler creature than the Greek who had died. His art had a wider force and warmer glow. I have told you that the first Greeks were distinguished from the barbarians by their simple humanity; the second Greeks—these Florentine Greeks reanimate—are human more strong-

*It may be asked, why not corn also? Because that belongs to Ceres, who is equally one of the great gods.

ly, more deeply, leaping from the Byzantine death at the call of Christ, "Loose him, and let him go." And there is upon them at once the joy of resurrection, and the solemnity of the grave.

162. Of this resurrection of the Greek, and the form of the tomb he had been buried in "those four days," I have to give you some account in the last lecture. I will only to-day show you an illustration of it which brings us back to our immediate question as to the reasons why Northern art could not accept classicism. When, in the closing lecture of Aratra Pentelici, I compared Florentine with Greek work, it was to point out to you the eager passions of the first as opposed to the formal legalism and proprieties of the other. Greek work, I told you, while truthful, was also restrained, and never but under majesty of law; while Gothic work was true, in the perfect law of Liberty or Franchise. And now I give you in facsimile (Plate VI.) the two Aphrodites thus compared—the Aphrodite Thalassia of the Tyrrhene seas, and the Aphrodite Urania of the Greek skies. You may not at first like the Tuscan best; and why she is the best, though both are noble, again I must defer explaining to next lecture. But now turn back to Bewick's Venus, and compare her with the Tuscan Venus of the Stars, (Plate II.); and then here, in Plate VI., with the Tuscan Venus of the Seas, and the Greek Venus of the Sky. Why is the English one vulgar? What is it, in the three others, which makes them, if not beautiful, at least refined?—every one of them 'designed' and drawn, indisputably, by a gentleman?

I never have been so puzzled by any subject of analysis as, for these ten years, I have been by this. Every answer I give, however plausible it seems at first, fails in some way, or in some cases. But there is the point for you, more definitely put, I think, than in any of my former books;—at present, for want of time, I must leave it to your own thoughts.

163. II. The second influence under which engraving developed itself, I said, was that of medicine and the physical sciences. Gentlemen, the most audacious, and the most valuable, statement which I have yet made to you on the sub-

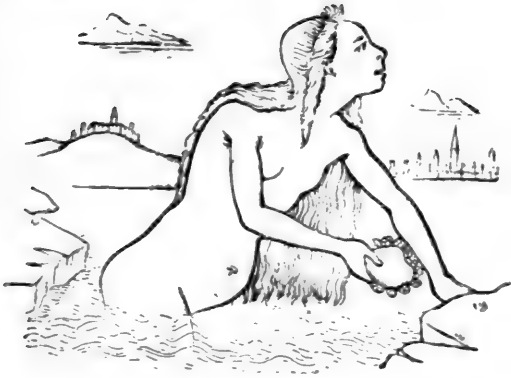

PLATE VI.—FAIRNESS OF THE SEA AND AIR.

In Venice and Athens.

ject of practical art, in these rooms, is that of the evil resulting from the study of anatomy. It is a statement so audacious, that not only for some time I dared not make it to you, but for ten years, at least, I dared not make it to myself. I saw, indeed, that whoever studied anatomy was in a measure injured by it; but I kept attributing the mischief to secondary causes. It *can't* be this drink itself that poisons them, I said always. This drink is medicinal and strengthening: I see that it kills them, but it must be because they drink it cold when they have been hot, or they take something else with it that changes it into poison. The drink itself *must* be good. Well, gentlemen, I found out the drink itself to be poison at last, by the breaking of my choicest Venice glass. I could not make out what it was that had killed Tintoret, and laid it long to the charge of chiaroscuro. It was only after my thorough study of his Paradise, in 1870, that I gave up this idea, finding the chiaroscuro, which I had thought exaggerated was, in all original and undarkened passages, beautiful and most precious. And then at last I got hold of the true clue: "Il disegno di Michel Agnolo." And the moment I had dared to accuse that, it explained everything; and I saw that the betraying demons of Italian art, led on by Michael Angelo, had been, not pleasure, but knowledge; not indolence, but ambition; and not love, but horror.

164. But when first I ventured to tell you this, I did not know, myself, the fact of all most conclusive for its confirmation. It will take me a little while to put it before you in its total force, and I must first ask your attention to a minor point. In one of the smaller rooms of the Munich Gallery is Holbein's painting of St. Margaret and St. Elizabeth of Hungary,—standard of his early religious work. Here is a photograph from the St. Elizabeth; and, in the same frame, a French lithograph of it. I consider it one of the most important pieces of comparison I have arranged for you, showing you at a glance the difference between true and false sentiment. Of that difference, generally, we cannot speak to-day, but one special result of it you are to observe;—the omission, in the French drawing, of Holbein's daring representation of

disease, which is one of the vital honours of the picture. Quite one of the chief strengths of St. Elizabeth, in the Roman Catholic view, was in the courage of her dealing with disease, chiefly leprosy. Now observe, I say *Roman Catholic view*, very earnestly just now; I am not at all sure that it is so in a Catholic view—that is to say, in an eternally Christian and Divine view. And this doubt, very nearly now a certainty, only came clearly into my mind the other day after many and many a year's meditation on it. I had read with great reverence all the beautiful stories about Christ's appearing as a leper, and the like; and had often pitied and rebuked myself alternately for my intense dislike and horror of disease. I am writing at this moment within fifty yards of the grave of St. Francis, and the story of the likeness of his feelings to mine had a little comforted me, and the tradition of his conquest of them again humiliated me; and I was thinking very gravely of this, and of the parallel instance of Bishop Hugo of Lincoln, always desiring to do service to the dead, as opposed to my own unmitigated and Louis-Quinze-like horror of funerals;—when by chance, in the cathedral of Palermo, a new light was thrown for me on the whole matter.

165. I was drawing the tomb of Frederick II, which is shut off by a grating from the body of the church; and I had, in general, quite an unusual degree of quiet and comfort at my work. But sometimes it was paralyzed by the unconscious interference of one of the men employed in some minor domestic services about the church. When he had nothing to do, he used to come and seat himself near my grating, not to look at my work, (the poor wretch had no eyes, to speak of,) nor in any way meaning to be troublesome; but there was his habitual seat. His nose had been carried off by the most loathsome of diseases; there were two vivid circles of scarlet round his eyes; and as he sat, he announced his presence every quarter of a minute (if otherwise I could have forgotten it) by a peculiarly disgusting, loud, and long expectoration. On the second or third day, just as I had forced myself into some forgetfulness of him, and was hard at my work, I was startled from it again by the bursting out of a loud and

cheerful conversation close to me ; and on looking round, saw a lively young fledgling of a priest, seventeen or eighteen years old, in the most eager and spirited chat with the man in the chair. He talked, laughed, and spat, himself, companionably, in the merriest way, for a quarter of an hour ; evidently without feeling the slightest disgust, or being made serious for an instant, by the aspect of the destroyed creature before him.

166. His own face was simply that of the ordinary vulgar type of thoughtless young Italians, rather beneath than above the usual standard ; and I was certain, as I watched him, that he was not at all my superior, but very much my inferior, in the coolness with which he beheld what was to me so dreadful. I was positive that he could look this man in the face, precisely because he could *not* look, discerningly, at any beautiful or noble thing ; and that the reason I dared not, was because I had, spiritually, as much better eyes than the priest, as bodily, than his companion.

Having got so much of clear evidence given me on the matter, it was driven home for me a week later, as I landed on the quay of Naples. Almost the first thing that presented itself to me was the sign of a travelling theatrical company, displaying the principal scene of the drama to be enacted on their classical stage. Fresh from the theatre of Taormina, I was curious to see the subject of the Neapolitan popular drama. It was the capture, by the police, of a man and his wife who lived by boiling children. One section of the police was coming in, armed to the teeth, through the passage ; another section of the police, armed to the teeth, and with high feathers in its caps, was coming up through a trap-door. In fine dramatic unconsciousness to the last moment, like the clown in a pantomime, the child-boiler was represented as still industriously chopping up a child, pieces of which, ready for the pot, lay here and there on the table in the middle of the picture. The child-boiler's wife, however, just as she was taking the top off the pot to put the meat in, had caught a glimpse of the foremost policeman, and stopped, as much in rage as in consternation.

167. Now it is precisely the same feeling, or want of feeling, in the lower Italian (nor always in the lower classes only) which makes him demand the kind of subject for his secular drama ; and the Crucifixion and Pieta for his religious drama. The only part of Christianity he can enjoy is its horror ; and even the saint or saintess are not always denying themselves severely, either by the contemplation of torture, or the companionship with disease.

Nevertheless, we must be cautious, on the other hand, to allow full value to the endurance, by tender and delicate persons, of what is really loathsome or distressful to them in the service of others ; and I think this picture of Holbein's indicative of the exact balance and rightness of his own mind in this matter, and therefore of his power to conceive a true saint also. He had to represent St. Catherine's chief effort ;—he paints her ministering to the sick, and, among them, is a leper ; and finding it thus his duty to paint leprosy, he courageously himself studies it from the life. Not to insist on its horror ; but to assert it, to the needful point of fact, which he does with medical accuracy.

Now here is just a case in which science, in a subordinate degree, is really required for a spiritual and moral purpose. And you find Holbein does not shrink from it even in this extreme case in which it is most painful.

168. If, therefore, you *do* find him in other cases not using it, you may be sure he knew it to be unnecessary.

Now it may be disputable whether in order to draw a living Madonna, one need to know how many ribs she has ; but it would have seemed indisputable that in order to draw a skeleton, one must know how many ribs *it* has.

Holbein is par excellence the draughtsman of skeletons. His painted Dance of Death was, and his engraved Dance of Death is, principal of such things, without any comparison or denial. He draws skeleton after skeleton, in every possible gesture ; but never so much as counts their ribs ! He neither knows nor cares how many ribs a skeleton has. There are always enough to rattle.

Monstrous, you think, in impudence,—Holbein for his care-

lessness, and I for-defending him! Nay, I triumph in him; nothing has ever more pleased me than this grand negligence. Nobody wants to know how many ribs a skeleton has, any more than how many bars a gridiron has, so long as the one can breathe, and the other broil; and still less, when the breath and the fire are both out.

169. But is it only of the bones, think you, that Holbein is careless? * Nay, incredible though it may seem to you,—but, to me, explanatory at once of much of his excellence,—he did not know anatomy at all! I told you in my Preface, already quoted, Holbein studies the face first, the body secondarily; but I had no idea, myself, how completely he had refused the venomous science of his day. I showed you a dead Christ of his, long ago. Can you match it with your academy drawings, think you? And yet he did not, and would not, know anatomy. *He* would not; but Durer would, and did:—went hotly into it—wrote books upon it, and upon ‘proportions of the human body,’ etc., etc., and all your modern recipes for painting flesh. How did his studies prosper his art?

People are always talking of his Knight and Death, and his Melancholia, as if those were his principal works. They are his characteristic ones, and show what he might have been, *without* his anatomy; but they were mere bye-play compared to his Greater Fortune, and Adam and Eve. Look at these. Here is his full energy displayed; here are both male and female forms drawn with perfect knowledge of their bones and muscles, and modes of action and digestion,—and I hope you are pleased.

But it is not anatomy only that Master Albert studies. He has a taste for optics also; and knows all about refraction and reflection. What with his knowledge of the skull inside, and the vitreous lens outside, if any man in the world is to draw an eye, here’s the man to do it, surely! With a hand which can give lessons to John Bellini, and a care which would fain do all so that it can’t be done better, and acquaintance with

* Or inventive! See Woltmann, p. 267. “The shin-bone, or the lower part of the arm, exhibit only one bone, while the upper arm and thigh are often allowed the luxury of two”!

every crack in the cranium, and every humour in the lens,—if we can't draw an eye, we should just like to know who can ! thinks Albert.

So having to engrave the portrait of Melancthon, instead of looking at Melancthon, as ignorant Holbein would have been obliged to do,—wise Albert looks at the room window ; and finds it has four cross-bars in it, and knows scientifically that the light on Melancthon's eye must be a reflection of the window with its four bars—and engraves it so, accordingly ; and who shall dare to say, now, it isn't like Melancthon ?

Unfortunately, however, it isn't, nor like any other person in his senses ; but like a madman looking at somebody who disputes his hobby. While in this drawing of Holbein's, where a dim grey shadow leaves a mere crumb of white paper,—accidentally it seems, for all the fine scientific reflection,—behold, it is an eye indeed, and of a noble creature.

170. What is the reason ? do you ask me ; and is all the common teaching about generalization of details true, then ?

No ; not a syllable of it is true. Holbein is right, not because he draws more generally, but more truly, than Durer. Durer draws what he knows is there ; but Holbein, only what he sees. And, as I have told you often before, the really scientific artist is he who not only asserts bravely what he *does* see, but confesses honestly what he does *not*. You must not draw all the hairs in an eyelash ; not because it is sublime to generalize them, but because it is impossible to see them. How many hairs there are, a sign painter or an anatomist may count ; but how few of them you can see, it is only the utmost masters, Carpaccio, Tintoret, Reynolds, and Velasquez, who count, or know.

171. Such was the effect, then, of his science upon Durer's ideal of beauty, and skill in portraiture. What effect had it on the temper and quantity of his work, as compared with poor ignorant Holbein's ! You have only three portraits, by Durer, of the great men of his time, and those bad ones ; while he toils his soul out to draw the hoofs of satyrs, the bristles of swine, and the distorted aspects of base women and vicious men.

What, on the contrary, has ignorant Holbein done for you? Shakspeare and he divide between them, by word and look, the Story of England under Henry and Elizabeth.

172. Of the effect of science on the art of Mantegna and Marc Antonio, (far more deadly than on Durer's,) I must tell you in a future lecture ;—the effect of it on their minds, I must partly refer to now, in passing to the third head of my general statement—the influence of new Theology. For Durer and Mantegna, chiefly because of their science, forfeited their place, not only as painters of men, but as servants of God. Neither of them has left one completely noble or completely didactic picture ; while Holbein and Botticelli, in consummate pieces of art, led the way before the eyes of all men, to the purification of their Church and land.

173. III. But the need of reformation presented itself to these two men last named on entirely different terms.

To Holbein, when the word of the Catholic Church proved false, and its deeds bloody ; when he saw it selling permission of sin in his native Augsburg, and strewing the ashes of its enemies on the pure Alpine waters of Constance, what refuge was there for *him* in more ancient religion ? Shall he worship Thor again, and mourn over the death of Balder ? He reads Nature in her desolate and narrow truth, and she teaches him the Triumph of Death.

But, for Botticelli, the grand gods are old, are immortal. The priests may have taught falsely the story of the Virgin ;—did they not also lie, in the name of Artemis, at Ephesus ; in the name of Aphrodite, at Cyprus ?—but shall, therefore, Chastity or Love be dead, or the full moon paler over Arno ? Saints of Heaven and Gods of Earth !—shall *these* perish because vain men speak evil of them ? Let *us* speak good for ever, and grave, as on the rock, for ages to come, the glory of Beauty, and the triumph of Faith.

174. Holbein had bitterer task.

Of old, the one duty of the painter had been to exhibit the virtues of this life, and hopes of the life to come. Holbein had to show the vices of this life, and to obscure the hope of the future. “ Yes, we walk through the valley of the shadow

of death, and fear all evil, for Thou art not with us, and Thy rod and Thy staff comfort us not." He does not choose this task. It is thrust upon him,—just as fatally as the burial of the dead is in a plague-struck city. These are the things he sees, and must speak. He will not become a better artist thereby ; no drawing of supreme beauty, or beautiful things, will be possible to him. Yet we cannot say he ought to have done anything else, nor can we praise him specially in doing this. It is his fate ; the fate of all the bravest in that day.

175. For instance, there is no scene about which a shallow and feeble painter would have been more sure to adopt the commonplaces of the creed of his time than the death of a child,—chiefly, and most of all, the death of a country child,—a little thing fresh from the cottage and the field. Surely for such an one, angels will wait by its sick bed, and rejoice as they bear its soul away ; and over its shroud flowers will be strewn, and the birds will sing by its grave. So your common sentimentalist would think, and paint. Holbein sees the facts, as they verily are, up to the point when vision ceases. He speaks, then no more.

The country labourer's cottage—the rain coming through its roof, the clay crumbling from its partitions, the fire lighted with a few chips and sticks on a raised piece of the mud floor,—such dais as can be contrived, for use, not for honour. The damp wood sputters ; the smoke, stopped by the roof, though the rain is not, coils round again, and down. But the mother can warm the child's supper of bread and milk so—holding the pan by the long handle ; and on mud floor though it be, they are happy,—she, and her child, and its brother,—if only they could be left so. They shall not be left so : the young thing must leave them—will never need milk warmed for it any more. It would fain stay,—sees no angels—feels only an icy grip on its hand, and that it cannot stay. Those who loved it shriek and tear their hair in vain, amazed in grief. 'Oh, little one, you must lie out in the fields then, not even under this poor torn roof of thy mother's to-night?'

176. Again : there was not in the old creed any subject more definitely and constantly insisted on than the death of a

miser. He had been happy, the old preachers thought, till then : but his hour has come ; and the black covetousness of hell is awake and watching ; the sharp, harpy claws will clutch his soul out of his mouth, and scatter his treasure for others. So the commonplace preacher and painter taught. Not so Holbein. The devil want to snatch his soul, indeed ! Nay, he never *had* a soul, but of the devil's giving. His misery to begin on his deathbed ! Nay, he had never an unmiserable hour of life. The fiend is with him now,—a paltry, abortive fiend, with no breath even to blow hot with. He supplies the hell-blast *with a machine*. It is winter, and the rich man has his furred cloak and cap, thick and heavy ; the beggar, bare-headed to beseech him, skin and rags hanging about him together, touches his shoulder, but all in vain ; there is other business in hand. More haggard than the beggar himself, wasted and palsied, the rich man counts with his fingers the gain of the years to come.

But of those years, infinite, that are to be, Holbein says nothing. 'I know not ; I see not. This only I see, on this very winter's day, the low pale stumbling-block at your feet, the altogether by you unseen and forgotten Death. You shall not pass *him* by on the other side ; here is a fasting figure in skin and bone, at last, that will stop you ; and for all the hidden treasures of earth, here is your spade : dig now, and find them.'

177. I have said that Holbein was condemned to teach these things. He was not happy in teaching them, nor thanked for teaching them. Nor was Botticelli for his lovelier teaching. But they both could do no otherwise. They lived in truth and steadfastness ; and with both, in their marvellous design, veracity is the beginning of invention, and love its end.

I have but time to show you, in conclusion, how this affectionate self-forgetfulness protects Holbein from the chief calamity of the German temper, vanity, which is at the root of all Durer's weakness. Here is a photograph of Holbein's portrait of Erasmus, and a fine proof of Durer's. In Holbein's, the face leads everything ; and the most lovely qualities of the face lead in that. The cloak and cap are perfectly

painted, just because you look at them neither more nor less than you would have looked at the cloak in reality. You don't say, 'How brilliantly they are touched,' as you would with Rembrandt; nor 'How gracefully they are neglected,' as you would with Gainsborough; nor 'How exquisitely they are shaded,' as you would with Leonardo; nor 'How grandly they are composed,' as you would with Titian. You say only, 'Erasmus is surely there; and what a pleasant sight!' You don't think of Holbein at all. He has not even put in the minutest letter H, that I can see, to remind you of him. Drops his H's, I regret to say, often enough. 'My hand should be enough for you; what matters my name?' But now, look at Durer's. The very first thing you see, and at any distance, is this great square tablet with

"The image of Erasmus, drawn from the life by Albert Durer, 1526,"

and a great straddling A.D. besides. Then you see a cloak, and a table, and a pot, with flowers in it, and a heap of books with all their leaves and all their clasps, and all the little bits of leather gummed in to mark the places; and last of all you see Erasmus's face; and when you do see it, the most of it is wrinkles.

All egotism and insanity, this, gentlemen. Hard words to use; but not too hard to define the faults which rendered so much of Durer's great genius abortive, and to this day paralyze, among the details of a lifeless and ambitious precision, the student, no less than the artist, of German blood. For too many an Erasmus, too many a Durer, among them, the world is all cloak and clasp, instead of face or book; and the first object of their lives is to engrave their initials.

For us, in England, not even so much is at present to be hoped; and yet, singularly enough, it is more our modesty, unwisely submissive, than our vanity, which has destroyed our English school of engraving.

At the bottom of the pretty line engravings which used to represent, characteristically, our English skill, one saw always *two* inscriptions. At the left-hand corner, "Drawn by—so-and-so;" at the right-hand corner, "Engraved by—so-and-

so." Only under the worst and cheapest plates—for the Stationer's Almanack, or the like,—one saw sometimes, "Drawn and engraved by so-and-so," which meant nothing more than that the publisher would not go to the expense of an artist, and that the engraver haggled through as he could. (One fortunate exception, gentlemen, you have in the old drawings for your Oxford Almanack, though the publishers, I have no doubt, even in that case, employed the cheapest artist they could find.*) But in general, no engraver thought himself able to draw; and no artist thought it his business to engrave.

But the fact that this and the following lecture are on the subject of design in engraving, implies of course that in the work we have to examine, it was often the engraver himself who designed, and as often the artist who engraved.

And you will observe that the only engravings which bear imperishable value are, indeed, in this kind. It is true that, in woodcutting, both Durer and Holbein, as in our own days Leech and Tenniel, have workmen under them who can do all they want. But in metal cutting it is not so. For, as I have told you, in metal cutting, ultimate perfection of Line has to be reached; and it can be reached by none but a master's hand; nor by his, unless in the very moment and act of designing. Never, unless under the vivid first force of imagination and intellect, can the Line have its full value. And for this high reason,* gentlemen, that paradox which perhaps seemed to you so daring, is nevertheless deeply and finally true, that while a woodcut may be laboriously finished, a grand engraving on metal must be comparatively incomplete. For it must be done, throughout, with the full fire of temper in it, visibly governing its lines, as the wind does the fibres of cloud.

* The drawings were made by Turner, and are now among the chief treasures of the Oxford Galleries. I ought to add some notice of Hogarth to this lecture in the Appendix; but fear I shall have no time; besides, though I have profound respect for Hogarth, as, in literature, I have for Fielding, I can't criticise them, because I know nothing of their subjects.

The value hitherto attached to Rembrandt's etchings, and others imitating them, depends on a true instinct in the public mind for this virtue of line. But etching is an indolent and blundering method at the best; and I do not doubt that you will one day be grateful for the severe disciplines of drawing required in these schools, in that they will have enabled you to know what a line may be, driven by a master's chisel on silver or marble, following, and fostering as it follows, the instantaneous strength of his determined thought.

LECTURE VI.

DESIGN IN THE FLORENTINE SCHOOLS OF ENGRAVING.

1. In the first of these lectures, I stated to you their subject, as the investigation of the engraved work of a group of men, to whom engraving, as a means of popular address, was above all precious, because their art was distinctively didactic.

Some of my hearers, must be aware that, of late years, the assertion that art should be didactic has been clamorously and violently derided by the countless crowd of artists who have nothing to represent, and of writers who have nothing to say; and that the contrary assertion—that art consists only in pretty colours and fine words,—is accepted, readily enough, by a public which rarely pauses to look at a picture with attention, or read a sentence with understanding.

2. Gentlemen, believe me, there never was any great advancing art yet, nor can be, without didactic purpose. The leaders of the strong schools are, and must be always, either teachers of theology, or preachers of the moral law. I need not tell you that it was as teachers of theology on the walls of the Vatican that the masters with whose names you are most familiar obtained their perpetual fame. But however great their fame, you have not practically, I imagine, ever been materially assisted in your preparation for the schools either of philosophy or divinity by Raphael's 'School of Athens,' by Raphael's 'Theology,'—or by Michael Angelo's 'Judgment.'

My task, to-day, is to set before you some part of the design of the first Master of the works in the Sistine Chapel; and I believe that, from his teaching, you will, even in the hour which I ask you now to give, learn what may be of true use to you in all your future labour, whether in Oxford or elsewhere.

3. You have doubtless, in the course of these lectures, been occasionally surprised by my speaking of Holbein and Sandro Botticelli, as Reformers, in the same tone of respect, and with the same implied assertion of their intellectual power and agency, with which it is usual to speak of Luther and Savonarola. You have been accustomed, indeed, to hear painting and sculpture spoken of as supporting or enforcing Church doctrine; but never as reforming or chastising it. Whether Protestant or Roman Catholic, you have admitted what in the one case you held to be the abuse of painting, in the furtherance of idolatry—in the other, its amiable and exalting ministry to the feebleness of faith. But neither have recognized,—the Protestant his ally,—or the Catholic his enemy, in the far more earnest work of the great painters of the fifteenth century. The Protestant was, in most cases, too vulgar to understand the aid offered to him by painting; and in all cases too terrified to believe in it. He drove the gift-bringing Greek with imprecations from his sectarian fortress, or received him within it only on the condition that he should speak no word of religion there.

4. On the other hand, the Catholic, in most cases too indolent to read, and, in all, too proud to dread, the rebuke of the reforming painters, confused them with the crowd of his old flatterers, and little noticed their altered language, or their graver brow. In a little while, finding they had ceased to be amusing, he effaced their works, not as dangerous, but as dull; and recognized only thenceforward, as art, the innocuous bombast of Michael Angelo, and fluent efflorescence of Bernini. But when you become more intimately and impartially acquainted with the history of the Reformation, you will find that, as surely and earnestly as Memling and Giotto strove in the north and south to set forth and exalt the Cath-

olic faith, so surely and earnestly did Holbein and Botticelli strive, in the north, to chastise, and, in the south, to revive it. In what manner, I will try to-day briefly to show you.

5. I name these two men as the reforming leaders; there were many, rank and file, who worked in alliance with Holbein; with Botticelli, two great ones, Lippi and Perugino. But both of these had so much pleasure in their own pictorial faculty, that they strove to keep quiet, and out of harm's way, —involuntarily manifesting themselves sometimes, however; and not in the wisest manner. Lippi's running away with a novice was not likely to be understood as a step in Church reformation correspondent to Luther's marriage.* Nor have Protestant divines, even to this day, recognized the real meaning of the reports of Perugino's 'infidelity.' Botticelli, the pupil of the one, and the companion of the other, held the truths they taught him through sorrow as well as joy; and he is the greatest of the reformers, because he preached without blame; though the least known, because he died without victory.

I had hoped to be able to lay before you some better biography of him than the traditions of Vasari, of which I gave a short abstract some time back in *Fors Clavigera*; but as yet I have only added internal evidence to the popular story, the more important points of which I must review briefly. It will not waste your time if I read,—instead of merely giving you reference to,—the passages on which I must comment.

6. "His father, Mariano Filipepi, a Florentine citizen, brought him up with care, and caused him to be instructed in all such things as are usually taught to children before they choose a calling. But although the boy readily acquired whatever he wished to learn, yet was he constantly discon-

* The world was not then ready for *Le Père Hyacinthe*;—but the real gist of the matter is that Lippi did, openly and bravely, what the highest prelates in the Church did basely and in secret; also he loved, where they only lusted; and he has been proclaimed therefore by them—and too foolishly believed by us—to have been a shameful person. Of his true life, and the colours given to it, we will try to learn something tenable, before we end our work in Florence.

tented ; neither would he take any pleasure in reading, writing, or accounts, insomuch that the father, disturbed by the eccentric habits of his son, turned him over in despair to a gossip of his, called Botticello, who was a goldsmith, and considered a very competent master of his art, to the intent that the boy might learn the same."

"He took no pleasure in reading, writing, nor accounts"! You will find the same thing recorded of Cimabue ; but it is more curious when stated of a man whom I cite to you as typically a gentleman and a scholar. But remember, in those days, though there were not so many entirely correct books issued by the Religious Tract Society for boys to read, there were a great many more pretty things in the world for boys to see. The Val d'Arno was Pater-noster Row to purpose ; their Father's Row, with books of His writing on the mountain shelves. And the lad takes to looking at things, and thinking about them, instead of reading about them,—which I commend to you, also, as much the more scholarly practice of the two. To the end, though he knows all about the celestial hierarchies, he is not strong in his letters, nor in his dialect. I asked Mr. Tyrwhitt to help me through with a bit of his Italian the other day. Mr. Tyrwhitt could only help me by suggesting that it was "Botticelli for so-and-so." And one of the minor reasons which induce me so boldly to attribute these sibyls to him, instead of Bandini, is that the lettering is so ill done. The engraver would assuredly have had his lettering all right,—or at least neat. Botticelli blunders through it, scratches impatiently out when he goes wrong ; and as I told you there's no repentance in the engraver's trade leaves all the blunders visible.

7. I may add one fact bearing on this question lately communicated to me.* In the autumn of 1872 I possessed myself of an Italian book of pen drawings, some, I have no doubt, by Mantegna in his youth, others by Sandro himself. In examining these, I was continually struck by the comparatively feeble and blundering way in which the titles were

* I insert supplementary notes, when of importance, in the text of the lecture, for the convenience of the general reader.

written, while all the rest of the handling was really superb; and still more surprised when, on the sleeves and hem of the robe of one of the principal figures of women, ("Helena rapita da Paris,") I found what seemed to be meant for inscriptions, intricately embroidered; which nevertheless, though beautifully drawn, I could not read. In copying Botticelli's Zipporah this spring, I found the border of her robe wrought with characters of the same kind, which a young painter, working with me, who already knows the minor secrets of Italian art better than I,* assures me are letters,—and letters of a language hitherto undeciphered.

8. "There was at that time a close connexion and almost constant intercourse between the goldsmiths and the painters, wherefore Sandro, who possessed considerable ingenuity, and was strongly disposed to the arts of design, became enamoured of painting, and resolved to devote himself entirely to that vocation. He acknowledged his purpose at once to his father; and the latter, who knew the force of his inclination, took him accordingly to the Carmelite monk, Fra Filippo, who was a most excellent painter of that time, with whom he placed him to study the art, as Sandro himself had desired. Devoting himself thereupon entirely to the vocation he had chosen, Sandro so closely followed the directions, and imitated the manner, of his master, that Fra Filippo conceived a great love for him, and instructed him so effectually, that Sandro rapidly attained to such a degree in art as none would have predicted for him."

I have before pointed out to you the importance of training by the goldsmith. Sandro got more good of it, however, than any of the other painters so educated,—being enabled by it to use gold for light to colour, in a glowing harmony never reached with equal perfection, and rarely attempted, in the later schools. To the last, his paintings are partly treated as work in niello; and he names himself, in perpetual gratitude, from this first artizan master. Nevertheless, the fortunate fellow finds, at the right moment, another, even more to his mind, and is obedient to him through his youth, as to

* Mr. Charles F. Murray.

the other through his childhood. And this master loves him; and instructs him 'so effectually,'—in grinding colors, do you suppose, only; or in laying of lines only; or in anything more than these?

9. I will tell you what Lippi must have taught any boy whom he loved. First, humility, and to live in joy and peace, injuring no man—if such innocence might be. Nothing is so manifest in every face by him, as its gentleness and rest. Secondly, to finish his work perfectly, and in such temper that the angels might say of it—not he himself—'Iste perfectit opus.' Do you remember what I told you in the Eagle's Nest, that true humility was in hoping that angels might sometimes admire *our* work; not in hoping that we should ever be able to admire *theirs*? Thirdly,—a little thing it seems, but was a great one,—love of flowers. No one draws such lilies or such daisies as Lippi. Botticelli beat him afterwards in roses, but never in lilies. Fourthly, due honour for classical tradition, Lippi is the only religious painter who dresses John Baptist in the camel-skin, as the Greeks dressed Heracles in the lion's,—over the head. Lastly, and chiefly of all,—Le Père Hyacinthe taught his pupil certain views about the doctrine of the Church, which the boy thought of more deeply than his tutor, and that by a great deal; and Master Sandro presently got himself into such question for painting heresy, that if he had been as hot-headed as he was true-hearted, he would soon have come to bad end by the tar-barrel. But he is so sweet and so modest, that nobody is frightened; so clever, that everybody is pleased: and at last, actually the Pope sends for him to paint his own private chapel,—where the first thing my young gentleman does, mind you, is to paint the devil, in a monk's dress tempting Christ! The sauciest thing, out and out, done in the history of the Reformation, it seems to me; yet so wisely done, and with such true respect otherwise shown for what was sacred in the Church, that the Pope didn't mind: and all went on as merrily as marriage bells.

10. I have anticipated, however, in telling you this, the proper course of his biography, to which I now return.

“While still a youth he painted the figure of Fortitude, among those pictures of the Virtues which Antonio and Pietro Pollaiuolo were executing in the Mercatanzia, or Tribunal of Commerce, in Florence. In Santo Spirito, a church of the same city, he painted a picture for the chapel of the Bardi family: this work he executed with great diligence, and finished it very successfully, depicting certain olive and palm trees therein with extraordinary care.”

It is by a beautiful chance that the first work of his, specified by his Italian biographer, should be the Fortitude.* Note also what is said of his tree drawing.

“Having, in consequence of this work, obtained much credit and reputation, Sandro was appointed by the Guild of Porta Santa Maria to paint a picture in San Marco, the subject of which is the Coronation of Our Lady, who is surrounded by a choir of angels—the whole extremely well designed, and finished by the artist with infinite care. He executed various works in the Medici Palace for the elder Lorenzo, more particularly a figure of Pallas on a shield wreathed with vine branches, whence flames are proceeding: this he painted of the size of life. A San Sebastiano was also among the most remarkable of the works executed for Lorenzo. In the church of Santa Maria Maggiore, in Florence, is a Pietà, with small figures, by this master: this is a very beautiful work. For different houses in various parts of the city Sandro painted many pictures of a round form, with numerous figures of women undraped. Of these there are still two examples at Castello, a villa of the Duke Cosimo,—one representing the birth of Venus, who is borne to earth by the Loves and Zephyrs; the second also presenting the figure of Venus crowned with flowers by the Graces: she is here intended to denote the Spring, and the allegory is expressed by the painter with extraordinary grace.”

Our young Reformer enters, it seems, on a very miscellaneous course of study; the Coronation of Our Lady; St. Sebastian; Pallas in vine-leaves; and Venus,—without fig-leaves.

* Some notice of this picture is given at the beginning of my third Morning in Florence, ‘Before the Soldan.’

Not wholly Calvinistic, Fra Filippo's teaching seems to have been! All the better for the boy—being such a boy as he was: but I cannot in this lecture enter farther into my reasons for saying so.

11. Vasari, however, has shot far ahead in telling us of this picture of the Spring, which is one of Botticelli's completest works. Long before he was able to paint Greek nymphs, he had done his best in idealism of greater spirits; and, while yet quite a youth, painted, at Castello, the Assumption of Our Lady, with "the patriarchs, the prophets, the apostles, the evangelists, the martyrs, the confessors, the doctors, the virgins, and the hierarchies!"

Imagine this subject proposed to a young, (or even old) British artist, for his next appeal to public sensation at the Academy! But do you suppose that the young British artist is wiser and more civilized than Lippi's scholar, because his only idea of a patriarch is of a man with a long beard; of a doctor, the M.D. with the brass plate over the way; and of a virgin, Miss —— of the —— theatre?

Not that even Sandro was able, according to Vasari's report, to conduct the entire design himself. The proposer of the subject assisted him; and they made some modifications in the theology, which brought them both into trouble—so early did Sandro's innovating work begin, into which subjects our gossiping friend waives unnecessary inquiry, as follows.

"But although this picture is exceedingly beautiful, and ought to have put envy to shame, yet there were found certain malevolent and censorious persons who, not being able to affix any other blame to the work, declared that Matteo and Sandro had erred gravely in that matter, and had fallen into grievous heresy.

"Now, whether this be true or not, let none expect the judgment of that question from me: it shall suffice me to note that the figures executed by Sandro in that work are entirely worthy of praise; and that the pains he took in depicting those circles of the heavens must have been very great, to say nothing of the angels mingled with the other figures, or

of the various foreshortenings, all which are designed in a very good manner.

“About this time Sandro received a commission to paint a small picture with figures three parts of a braccio high,—the subject an Adoration of the Magi.

“It is indeed a most admirable work : the composition, the design, and the colouring are so beautiful that every artist who examines it is astonished ; and, at the time, it obtained so great a name in Florence, and other places, for the master, that Pope Sixtus IV. having erected the chapel built by him in his palace at Rome, and desiring to have it adorned with paintings, commanded that Sandro Botticelli should be appointed Superintendent of the work.”

12. Vasari's words, “about this time,” are evidently wrong. It must have been many and many a day after he painted Matteo's picture that he took such high standing in Florence as to receive the mastership of the works in the Pope's chapel at Rome. Of his position and doings there, I will tell you presently ; meantime, let us complete the story of his life.

“By these works Botticelli obtained great honour and reputation among the many competitors who were labouring with him, whether Florentines or natives of other cities, and received from the Pope a considerable sum of money ; but this he consumed and squandered totally, during his residence in Rome, where he lived without due care, as was his habit.”

13. Well, but one would have liked to hear *how* he squandered his money, and whether he was without care—of other things than money.

It is just possible, Master Vasari, that Botticelli may have laid out his money at higher interest than you know of ; meantime, he is advancing in life and thought, and becoming less and less comprehensible to his biographer. And at length, having got rid, somehow, of the money he received from the Pope ; and finished the work he had to do, and uncovered it, —free in conscience, and empty in purse, he returned to Florence, where, “being a sophisticated person, he made a comment on a part of Dante, and drew the Inferno, and put it in en-

graving, in which he consumed much time ; and not working for this reason, brought infinite disorder into his affairs."

14. Unpaid work, this engraving of Dante, you perceive,—consuming much time also, and not appearing to Vasari to be work at all. It is but a short sentence, gentlemen,—this, in the old edition of Vasari, and obscurely worded,—a very foolish person's contemptuous report of a thing to him totally incomprehensible. But the thing itself is out-and-out the most important fact in the history of the religious art of Italy. I can show you its significance in not many more words than have served to record it.

Botticelli had been painting in Rome ; and had expressly chosen to represent there,—being Master of Works, in the presence of the Defender of the Faith,—the foundation of the Mosaic law ; to his mind the Eternal Law of God,—that law of which modern Evangelicals sing perpetually their own original psalm, "Oh, how hate I Thy law ! it is my abomination all the day." Returning to Florence, he reads Dante's vision of the Hell created by its violation. He knows that the pictures he has painted in Rome cannot be understood by the people ; they are exclusively for the best trained scholars in the Church. Dante, on the other hand, can only be read in manuscript ; but the people could and would understand his lessons, if they were pictured in accessible and enduring form. He throws all his own lauded work aside,—all for which he is most honoured, and in which his now matured and magnificent skill is as easy to him as singing to a perfect musician. And he sets himself to a servile and despised labour,—his friends mocking him, his resources failing him, infinite 'disorder' getting into his affairs—of this world.

15. Never such another thing happened in Italy any more. Botticelli engraved her Pilgrim's Progress for her, putting himself in prison to do it. She would not read it when done. Raphael and Marc Antonio were the theologians for her money. Pretty Madonnas, and satyrs with abundance of tail, —let our pilgrim's progress be in *these* directions, if you please.

Botticelli's own pilgrimage, however, was now to be accomplished triumphantly, with such crowning blessings as Heaven might grant to him. In spite of his friends and his disordered affairs, he went his own obstinate way; and found another man's words worth engraving as well as Dante's; not without perpetuating, also, what he deemed worthy of his own.

16. What would that be, think you? His chosen works before the Pope in Rome?—his admired Madonnas in Florence?—his choirs of angels and thickets of flowers? Some few of these—yes, as you shall presently see; but “the best attempt of this kind from his hand is the Triumph of Faith, by Fra Girolamo Savonarola, of Ferrara, of whose sect our artist was so zealous a partisan that he totally abandoned painting, and not having any other means of living, he fell into very great difficulties. But his attachment to the party he had adopted increased; he became what was then called a Piagnone, or Mourner, and abandoned all labour; insomuch that, finding himself at length become old, being also very poor, he must have died of hunger had he not been supported by Lorenzo de' Medici, for whom he had worked at the small hospital of Volterra and other places, who assisted him while he lived, as did other friends and admirers of his talents.”

17. In such dignity and independence—having employed his talents not wholly at the orders of the dealer—died, a poor bedesman of Lorenzo de' Medici, the President of that high academy of art in Rome, whose Academicians were Perugino, Ghirlandajo, Angelico, and Signorelli; and whose students, Michael Angelo and Raphael.

‘A worthless, ill-conducted fellow on the whole,’ thinks Vasari, ‘with a crazy fancy for scratching on copper.’

Well, here are some of the scratches for you to see; only, first, I must ask you seriously for a few moments to consider what the two powers were, which, with this iron pen of his, he has set himself to reprove.

18. Two great forms of authority reigned over the entire civilized world, confessedly, and by name, in the middle ages.

They reign over it still, and must for ever, though at present very far from confessed ; and, in most places, ragingly denied.

The first power is that of the Teacher, or true Father ; the Father 'in God.' It may be—happy the children to whom it is—the actual father also ; and whose parents have been their tutors. But for the most part, it will be some one else who teaches them, and moulds their minds and brain. All such teaching, when true, being from above, and coming down from the Father of Lights, with whom is no variableness, neither shadow of turning, is properly that of the holy Catholic 'εκκλησια,' council, church, or papacy, of many fathers in God, not of one. Eternally powerful and divine ; revered of all humble and lowly scholars, in Jewry, in Greece, in Rome, in Gaul, in England, and beyond sea, from Arctic zone to zone.

The second authority is the power of National Law, enforcing justice in conduct by due reward and punishment. Power vested necessarily in magistrates capable of administering it with mercy and equity ; whose authority, be it of many or few, is again divine, as proceeding from the King of kings, and was acknowledged, throughout civilized Christendom, as the power of the Holy Empire, or Holy Roman Empire, because first throned in Rome ; but it is for ever also acknowledged, namelessly, or by name, by all loyal, obedient, just, and humble hearts, which truly desire that, whether for them or against them, the eternal equities and dooms of Heaven should be pronounced and executed ; and as the wisdom or word of their Father should be taught, so the will of their Father should be done, on earth, as it is in heaven.

19. You all here know what contention, first, and then what corruption and dishonour, had paralyzed these two powers before the days of which we now speak. Reproof, and either reform or rebellion, became necessary everywhere. The northern Reformers, Holbein, and Luther, and Henry, and Cromwell, set themselves to their task rudely, and, it might seem, carried it through. The southern Reformers, Dante, and Savonarola, and Botticelli, set hand to their task reverently, and, it seemed, did not by any means carry it through. But the end is not yet.

20. Now I shall endeavour to-day to set before you the art of Botticelli, especially as exhibiting the modesty of great imagination trained in reverence, which characterized the southern Reformers ; and as opposed to the immodesty of narrow imagination, trained in self trust, which characterized the northern Reformers.

‘The modesty of great *imagination* ;’ that is to say, of the power which conceives all things in true relation, and not only as they affect ourselves. I can show you this most definitely by taking one example of the modern, and unschooled temper, in Bewick ;* and setting it beside Botticelli’s treatment of the same subject of thought,—namely, the meaning of war, and the reforms necessary in the carrying on of war.

21. Both the men are entirely at one in their purpose. They yearn for peace and justice to rule over the earth, instead of the sword ; but see how differently they will say what is in their hearts to the people they address. To Bewick, war was more an absurdity than it was a horror : he had not seen battle-fields, still less had he read of them, in ancient days. He cared nothing about heroes,—Greek, Roman, or Norman. What he knew, and saw clearly, was that Farmer Hodge’s boy went out of the village one holiday afternoon, a fine young fellow, rather drunk, with a coloured riband in his hat ; and came back, ten years afterwards, with one leg, one eye, an old red coat, and a tobacco pipe in the pocket of it. That is what he has got to say, mainly. So, for the pathetic side of the business, he draws you two old soldiers meeting as bricklayers’ labourers ; and for the absurd side of it, he draws a stone, sloping sideways with age, in a bare field, on which you can just read, out of a long inscription, the words “glorious victory ;” but no one is there to read them,—only a jackass, who uses the stone to scratch himself against.

22. Now compare with this Botticelli’s reproof of war. *He*

* I am bitterly sorry for the pain which my partial references to the man whom of all English artists whose histories I have read, I most esteem, have given to one remaining member of his family. I hope my meaning may be better understood after she has seen the close of this lecture.

had seen it, and often ; and between noble persons ;—knew the temper in which the noblest knights went out to it ;—knew the strength, the patience, the glory, and the grief of it. He would fain see his Florence in peace ; and yet he knows that the wisest of her citizens are her bravest soldiers. So he seeks for the ideal of a soldier, and for the greatest glory of war, that in the presence of these he may speak reverently, what he must speak. He does not go to Greece for his hero. He is not sure that even her patriotic wars were always right. But, by his religious faith, he cannot doubt the nobleness of the soldier who put the children of Israel in possession of their promised land, and to whom the sign of the consent of heaven was given by its pausing light in the valley of Ajalon. Must then setting sun and risen moon stay, he thinks, only to look upon slaughter ? May no soldier of Christ bid them stay otherwise than so ? He draws Joshua, but quitting his hold of the sword : its hilt rests on his bent knee ; and he kneels before the sun, not commands it ; and this is his prayer :—

“ Oh, King of kings, and Lord of lords, who alone rulest always in eternity, and who correctest all our wanderings,—Giver of melody to the choir of angels, listen Thou a little to our bitter grief, and come and rule us, oh Thou highest King, with Thy love which is so sweet ! ”

Is not that a little better, and a little wiser, than Bewick's jackass ? Is it not also better, and wiser, than the sneer of modern science ? ‘ What great men are we !—we, forsooth, can make almanacs, and know that the earth turns round. Joshua indeed ! Let us have no more talk of the old clothes-man.’

All Bewick's simplicity is in that ; but none of Bewick's understanding.

23. I pass to the attack made by Botticelli upon the guilt of wealth. So I had at first written ; but I should rather have written, the appeal made by him against the cruelty of wealth, then first attaining the power it has maintained to this day.

The practice of receiving interest had been confined, until this fifteenth century, with contempt and malediction, to the

profession, so styled, of usurers, or to the Jews. The merchants of Augsburg introduced it as a convenient and pleasant practice among Christians also; and insisted that it was decorous and proper even among respectable merchants. In the view of the Christian Church of their day, they might more reasonably have set themselves to defend adultery.* However, they appointed Dr. John Eck, of Ingoldstadt, to hold debates in all possible universities, at their expense, on the allowing of interest; and as these Augsburgers had in Venice their special mart, Fondaco, called of the Germans, their new notions came into direct collision with old Venetian ones, and were much hindered by them, and all the more, because, in opposition to Dr. John Eck, there was preaching on the other side of the Alps. The Franciscans, poor themselves, preached mercy to the poor: one of them, Brother Marco of San Gallo, planned the 'Mount of Pity,' for their defence, and the merchants of Venice set up the first in the world, against the German Fondaco. The dispute burned far on towards our own times. You perhaps have heard before of one Antonio, a merchant of Venice, who persistently retained the then obsolete practice of lending money gratis, and of the peril it brought him into with the usurers. But you perhaps did not before know why it was the flesh, or heart of flesh, in him, that they so hated.

24. Against this newly risen demon of authorized usury, Holbein and Botticelli went out to war together. Holbein, as we have partly seen in his designs for the Dance of Death, struck with all his soldier's strength.† Botticelli uses neither satire nor reproach. He turns altogether away from the criminals; appeals only to heaven for defence against them. He engraves the design which, of all his work, must have cost him hardest toil in its execution,—the Virgin praying to her Son in heaven for pity upon the poor: "For these are also my children." ‡ Underneath, are the seven works of Mercy; and

* Read Ezekiel xviii.

† See also the account by Dr. Woltmann of the picture of the Triumph of Riches. 'Holbein and his Time,' p. 352.

‡ These words are engraved in the plate, as spoken by the Virgin.

in the midst of them, the building of the Mount of Pity : in the distance lies Italy, mapped in cape and bay, with the cities which had founded mounts of pity,—Venice in the distance, chief. Little seen, but engraved with the master's loveliest care, in the background there is a group of two small figures—the Franciscan brother kneeling, and an angel of Victory crowning him.

25. I call it an angel of Victory, observe, with assurance ; although there is no legend claiming victory, or distinguishing this angel from any other of those which adorn with crowns of flowers the nameless crowds of the blessed. For Botticelli has other ways of speaking than by written legends. I know by a glance at this angel that he has taken the action of it from a Greek coin ; and I know also that he had not, in his own exuberant fancy, the least need to copy the action of any figure whatever. So I understand, as well as if he spoke to me, that he expects me, if I am an educated gentleman, to recognize this particular action as a Greek angel's ; and to know that it is a temporal victory which it crowns.

26. And now farther, observe, that this classical learning of Botticelli's, received by him, as I told you, as a native element of his being, gives not only greater dignity and gentleness, but far wider range, to his thoughts of Reformation. As he asks for pity from the cruel Jew to the *poor* Gentile, so he asks for pity from the proud Christian to the *untaught* Gentile. Nay, for more than pity, for fellowship, and acknowledgment of equality before God. The learned men of his age in general brought back the Greek mythology as anti-Christian. But Botticelli and Perugino, as pre-Christian ; nor only as pre-Christian, but as the foundation of Christianity. But chiefly Botticelli, with perfect grasp of the Mosaic and classic theology, thought over and seized the harmonies of both ; and he it was who gave the conception of that great choir of the prophets and sibyls, of which Michael Angelo, more or less ignorantly borrowing it in the Sistine Chapel, in great part lost the meaning, while he magnified the aspect.

27. For, indeed, all Christian and heathen mythology had alike become to Michael Angelo only a vehicle for the display

of his own powers of drawing limbs and trunks : and having resolved, and made the world of his day believe, that all the glory of design lay in variety of difficult attitude, he flings the naked bodies about his ceiling with an upholsterer's ingenuity of appliance to the corners they could fit, but with total absence of any legible meaning. Nor do I suppose that one person in a million, even of those who have some acquaintance with the earlier masters, takes patience in the Sistine Chapel to conceive the original design. But Botticelli's mastership of the works evidently was given to him as a theologian, even more than as a painter ; and the moment when he came to Rome to receive it, you may hold for the crisis of the Reformation in Italy. The main effort to save her priesthood was about to be made by her wisest Reformer,—face to face with the head of her Church,—not in contest with him, but in the humblest subjection to him ; and in adornment of his own chapel for his own delight, and more than delight, if it might be.

28. Sandro brings to work, not under him, but with him, the three other strongest and worthiest men he knows, Perugino, Ghirlandajo, and Luca Signorelli. There is evidently entire fellowship in thought between Botticelli and Perugino. They two together plan the whole ; and Botticelli, though the master, yields to Perugino the principal place, the end of the chapel, on which is to be the Assumption of the Virgin. It was Perugino's favourite subject, done with his central strength ; assuredly the crowning work of his life, and of lovely Christian art in Europe.

Michael Angelo painted it out, and drew devils and dead bodies all over the wall instead. But there remains to us, happily, the series of subjects designed by Botticelli to lead up to this lost one.

29. He came, I said, not to attack, but to restore the Papal authority. To show the power of inherited honour, and universal claim of divine law, in the Jewish and Christian Church,—the law delivered first by Moses ; then, in final grace and truth, by Christ.

He designed twelve great pictures, each containing some

twenty figures the size of life, and groups of smaller ones scarcely to be counted. Twelve pictures,—six to illustrate the giving of the law by Moses; and six, the ratification and completion of it by Christ. Event by event, the jurisprudence of each dispensation is traced from dawn to close in this correspondence.

- | | |
|---------------------------------------|--|
| 1. Covenant of Circumcision. | 7. Covenant of Baptism. |
| 2. Entrance on his Ministry by Moses. | 8. Entrance on his Ministry by Christ. |
| 3. Moses by the Red Sea. | 9. Peter and Andrew by the Sea of Galilee. |
| 4. Delivery of Law on Sinai. | 10. Sermon on Mount. |
| 5. Destruction of Korah. | 11. Giving Keys to St. Peter. |
| 6. Death of Moses. | 12. Last Supper. |

Of these pictures, Sandro painted three himself, Perugino three, and the Assumption; Ghirlandajo one, Signorelli one, and Rosselli four.* I believe that Sandro intended to take the roof also, and had sketched out the main succession of its design; and that the prophets and sibyls which he meant to paint, he drew first small, and engraved his drawings afterwards, that some part of the work might be, at all events, thus communicable to the world outside of the Vatican.

30. It is not often that I tell you my beliefs; but I am forced here, for there are no dates to found more on. Is it not wonderful that among all the infinite mass of fool's thoughts about the "majestic works of Michael Angelo" in the Sistine Chapel, no slightly more rational person has ever asked what the chapel was first meant to be like, and how it was to be roofed?

Nor can I assure myself, still less you, that all these prophets and sibyls are Botticelli's. Of many there are two engravings, with variations: some are inferior in parts, many altogether. He signed none; never put grand tablets with 'S. B.' into his skies; had other letters than those to engrave, and no time to spare. I have chosen out of the series three of the sibyls, which have, I think, clear internal evidence of being his; and

* Cosimo Rosselli, especially chosen by the Pope for his gay colouring.

these you shall compare with Michael Angelo's. But first I must put you in mind what the sibyls were.

31. As the prophets represent the voice of God in man, the sibyls represent the voice of God in nature. They are properly all forms of one sibyl, *Διὸς Βουλῆ*, the counsel of God; and the chief one, at least in the Roman mind, was the Sibyl of Cumae. From the traditions of her, the Romans, and we through them, received whatever lessons the myth, or fact, of sibyl power has given to mortals.

How much have you received, or may you yet receive, think you, of that teaching? I call it the myth, or fact; but remember that, as a myth, it is a fact. This story has concentrated whatever good there is in the imagination of visionary powers in women, inspired by nature only. The traditions of witch and gipsy are partly its offshoots. You despise both, perhaps. But can you, though in utmost pride of your supreme modern wisdom, suppose that the character—say, even of so poor and far-fallen a sibyl as Meg Merrilies—is only the coinage of Scott's brain; or that, even being no more, it is valueless? Admit the figure of the Cumaean Sibyl, in like manner, to be the coinage only of Virgil's brain. As such, it, and the words it speaks, are yet facts in which we may find use, if we are reverent to them.

To me, personally, (I must take your indulgence for a moment to speak wholly of myself,) they have been of the truest service—quite material and indisputable.

I am writing on St. John's Day, in the monastery of Assisi; and I had no idea whatever, when I sat down to my work this morning, of saying any word of what I am now going to tell you. I meant only to expand and explain a little what I said in my lecture about the Florentine engraving. But it seems to me now that I had better tell you what the Cumaean Sibyl has actually done for me.

32. In 1871, partly in consequence of chagrin at the Revolution in Paris, and partly in great personal sorrow, I was struck by acute inflammatory illness at Matlock, and reduced to a state of extreme weakness; lying at one time unconscious for some hours, those about me having no hope of my life. I

have no doubt that the immediate cause of the illness was simply, eating when I was not hungry ; so that modern science would acknowledge nothing in the whole business but an extreme and very dangerous form of indigestion ; and entirely deny any interference of the Cumæan Sibyl in the matter.

I once heard a sermon by Dr. Guthrie, in Edinburgh, upon the wickedness of fasting. It was very eloquent and ingenious, and finely explained the superiority of the Scotch Free Church to the benighted Catholic Church, in that the Free Church saw no merit in fasting. And there was no mention, from beginning to end of the sermon, of even the existence of such texts as Daniel i. 12, or Matthew vi. 16.

Without the smallest merit, I admit, in fasting, I was nevertheless, reduced at Matlock to a state very near starvation ; and could not rise from my pillow, without being lifted, for some days. And in the first clearly pronounced stage of recovery, when the perfect powers of spirit had returned, while the body was still as weak as it well could be, I had three dreams, which made a great impression on me ; for in ordinary health my dreams are supremely ridiculous, if not unpleasant ; and in ordinary conditions of illness, very ugly, and always without the slightest meaning. But these dreams were all distinct and impressive, and had much meaning, if I chose to take it.

33. The first* was of a Venetian fisherman, who wanted me to follow him down into some water which I thought was too deep ; but he called me on, saying he had something to show me ; so I followed him ; and presently, through an opening, as if in the arsenal wall, he showed me the bronze horses of St. Mark's, and said, 'See, the horses are putting on their harness.'

The second was of a preparation at Rome, in St. Peter's, (or a vast hall as large as St. Peter's,) for the exhibition of a religious drama. Part of the play was to be a scene in which demons were to appear in the sky ; and the stage servants were arranging grey fictitious clouds, and painted fiends, for it, under the direction of the priests. There was a woman

* I am not certain of their order at this distance of time.

dressed in black, standing at the corner of the stage watching them, having a likeness in her face to one of my own dead friends ; and I knew somehow that she was not that friend, but a spirit ; and she made me understand, without speaking, that I was to watch, for the play would turn out other than the priests expected. And I waited ; and when the scene came on the clouds became real clouds, and the fiends real fiends, agitating them in slow quivering, wild and terrible, over the heads of the people and priests. I recollected distinctly, however, when I woke, only the figure of the black woman mocking the people, and of one priest in an agony of terror, with the sweat pouring from his brow, but violently scolding one of the stage servants for having failed in some ceremony, the omission of which, he thought, had given the devils their power.

The third dream was the most interesting and personal. Some one came to me to ask me to help in the deliverance of a company of Italian prisoners who were to be ransomed for money. I said I had no money. They answered, Yes, I had some that belonged to me as a brother of St. Francis, if I would give it up. I said I did not know even that I *was* a brother of St. Francis ; but I thought to myself, that perhaps the Franciscans of Fèsolo, whom I had helped to make hay in their fields in 1845, had adopted me for one ; only I didn't see how the consequence of that would be my having any money. However, I said they were welcome to whatever I had ; and then I heard the voice of an Italian woman singing ; and I have never heard such divine singing before nor since ; the sounds absolutely strong and real, and the melody altogether lovely. If I could have written it ! But I could not even remember it when I woke,—only how beautiful it was.

34. Now these three dreams have, every one of them, been of much use to me since ; or so far as they have failed to be useful, it has been my own fault, and not theirs ; but the chief use of them at the time was to give me courage and confidence in myself, both in bodily distress, of which I had still not a little to bear ; and worse, much mental anxiety about matters supremely interesting to me, which were turning out

ill. And through all such trouble—which came upon me as I was recovering, as if it meant to throw me back into the grave,—I held out and recovered, repeating always to myself, or rather having always murmured in my ears, at every new trial, one Latin line,

Tu ne cede malis, sed contra fortior ito.

Now I had got this line out of the tablet in the engraving of Raphael's vision, and had forgotten where it came from. And I thought I knew my sixth book of Virgil so well, that I never looked at it again while I was giving these lectures at Oxford, and it was only here at Assisi, the other day, wanting to look more accurately at the first scene by the lake Avernus, that I found I had been saved by the words of the Cumæan Sibyl.

35. "*Quam tua te Fortuna sinet,*" the completion of the sentence, has yet more and continual teaching in it for me now; as it has for all men. Her opening words, which have become hackneyed, and lost all present power through vulgar use of them, contain yet one of the most immortal truths ever yet spoken for mankind; and they will never lose their power of help for noble persons. But observe, both in that lesson, "*Facilis descensus Averni,*" etc.; and in the still more precious, because universal, one on which the strength of Rome was founded,—the burning of the books,—the Sibyl speaks only as the voice of Nature, and of her laws;—not as a divine helper, prevailing over death; but as a mortal teacher warning us against it, and strengthening us for our mortal time; but not for eternity. Of which lesson her own history is a part, and her habitation by the Avernus lake. She desires immortality, fondly and vainly, as we do ourselves. She receives, from the love of her *refused* lover, Apollo, not immortality, but length of life;—her years to be as the grains of dust in her hand. And even this she finds was a false desire; and her wise and holy desire at last is—to die. She wastes away; becomes a shade only, and a voice. The Nations ask her, What wouldst thou? She answers, Peace; only let my last words be true. "*L'ultimo mie parlar sie verace.*"

36. Therefore, if anything is to be conceived, rightly, and chiefly, in the form of the Cumaean Sibyl, it must be of fading virginal beauty, of enduring patience, of far-looking into futurity. "For after my death there shall yet return," she says, "another virgin."

Jam redit et virgo ;—redeunt Saturnia regna,
Ultima Cumaei venit jam carminis aetas.

Here then is Botticelli's Cumaean Sibyl. She is armed, for she is the prophetess of Roman fortitude ;—but her faded breast scarcely raises the corslet ; her hair floats, not falls, in waves like the currents of a river,—the sign of enduring life ; the light is full on her forehead : she looks into the distance as in a dream. It is impossible for art to gather together more beautifully or intensely every image which can express her true power, or lead us to understand her lesson.

37. Now you do not, I am well assured, know one of Michael Angelo's sibyls from another : unless perhaps the Delphian, whom of course he makes as beautiful as he can. But of this especially Italian prophetess, one would have thought he might, at least in some way, have shown that he knew the history, even if he did not understand it. She might have had more than one book, at all events, to burn. She might have had a stray leaf or two fallen at her feet. He could not indeed have painted her only as a voice ; but his anatomical knowledge need not have hindered him from painting her virginal youth, or her wasting and watching age, or her inspired hope of a holier future.

38. Opposite,—fortunately, photograph from the figure itself, so that you can suspect me of no exaggeration,—is Michael Angelo's Cumaean Sibyl, wasting away. It is by a grotesque and most strange chance that he should have made the figure of this Sybil, of all others in the chapel, the most fleshly and gross, even proceeding to the monstrous license of showing the nipples of the breast as if the dress were molded over them like plaster. Thus he paints the poor nymph beloved of Apollo,—the clearest and queenliest in prophecy and com-



LVTTIMO ME PARLARIE ZIVERACIE
 PERO CHE GIUNTI ZONGLIUTIME CANTI
 DEVENIMENTO * DELLO RE DIPACIE -
 OXICICCI ZALVERA NOITVTTI QVANTI
 EPRENDERA CARIVMANA SIGLI PIACIE
 * OZTERRAZZI VMILAT TVTTI CHEVANTI
 * MADRE PRENDE LVMLVERGINELLA
 * VALZARA ZOPROGNI DONNA BELLA

PLATE VII.—FOR A TIME AND TIMES.

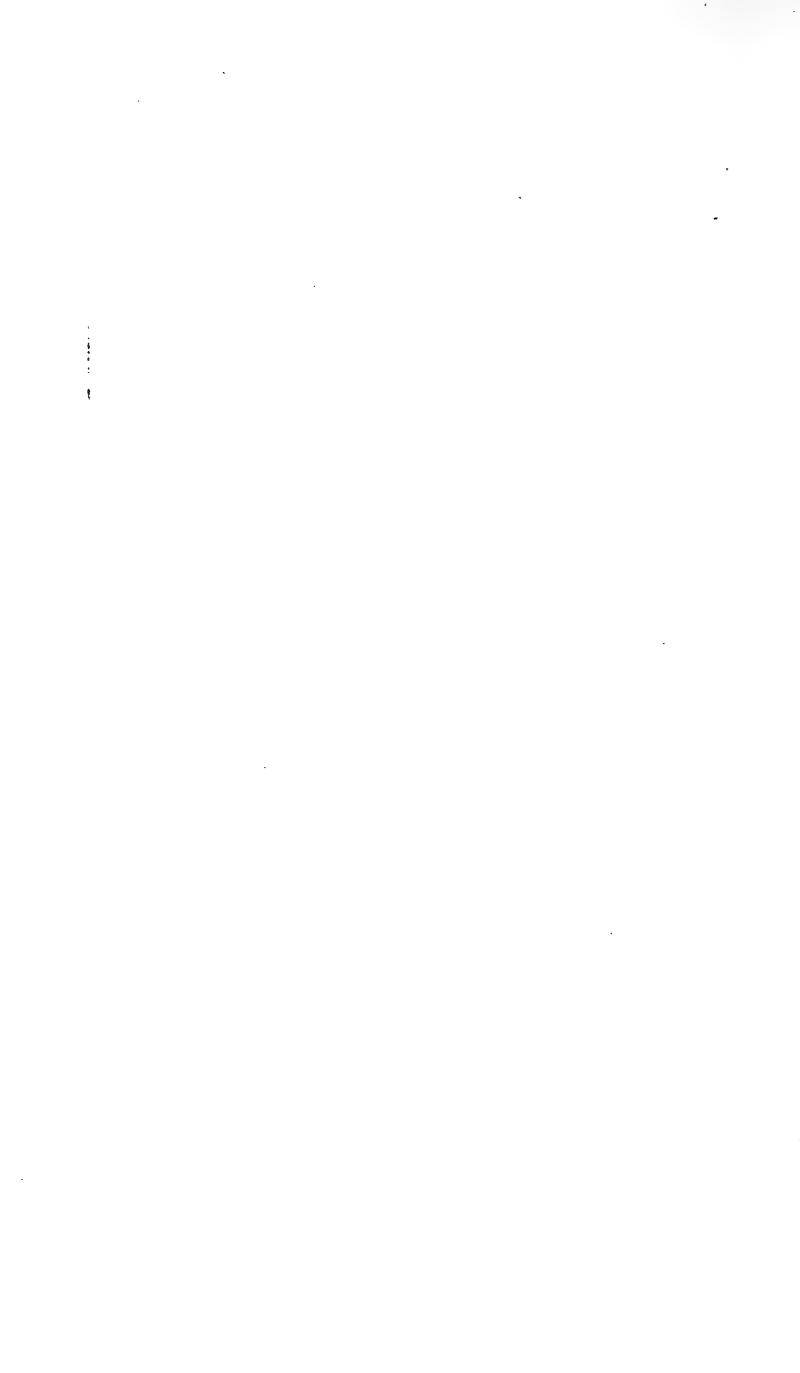

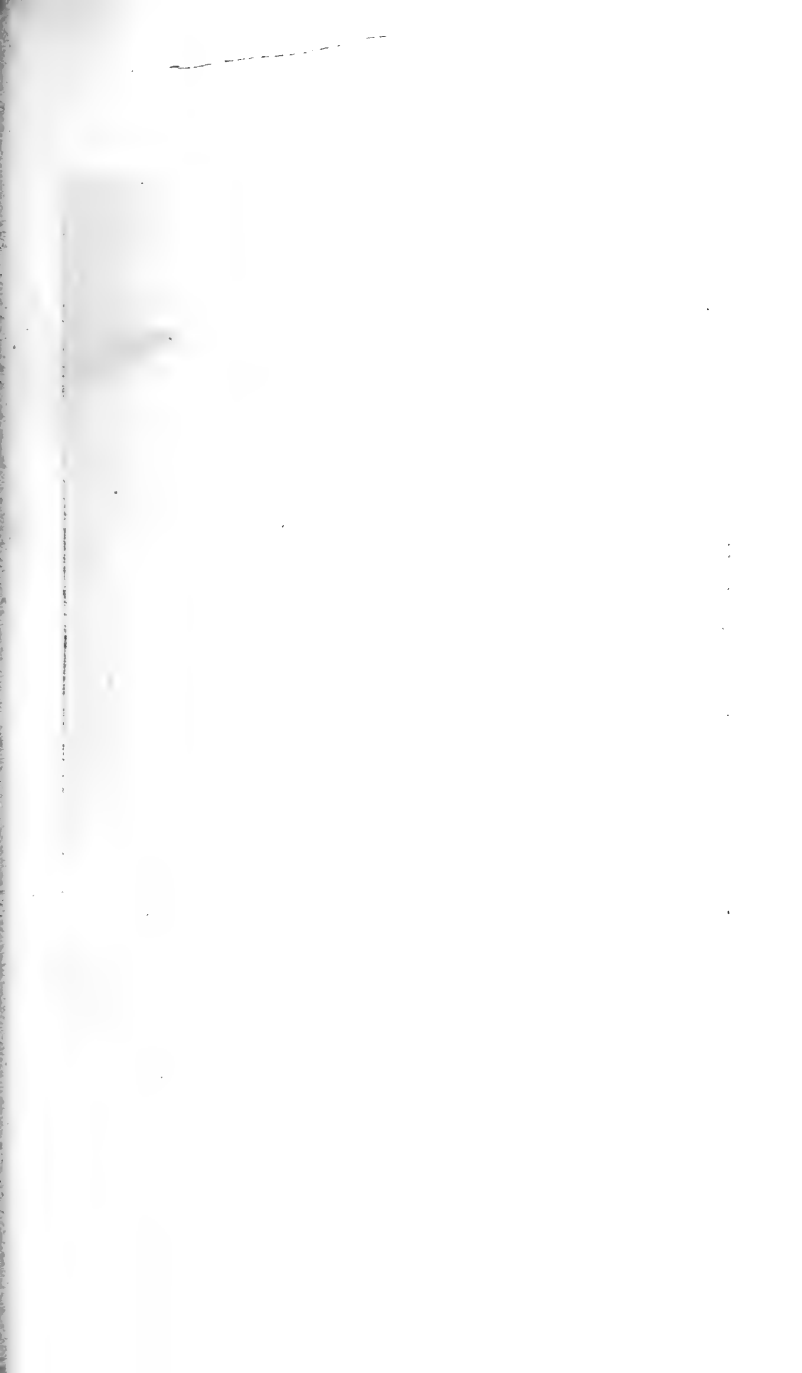

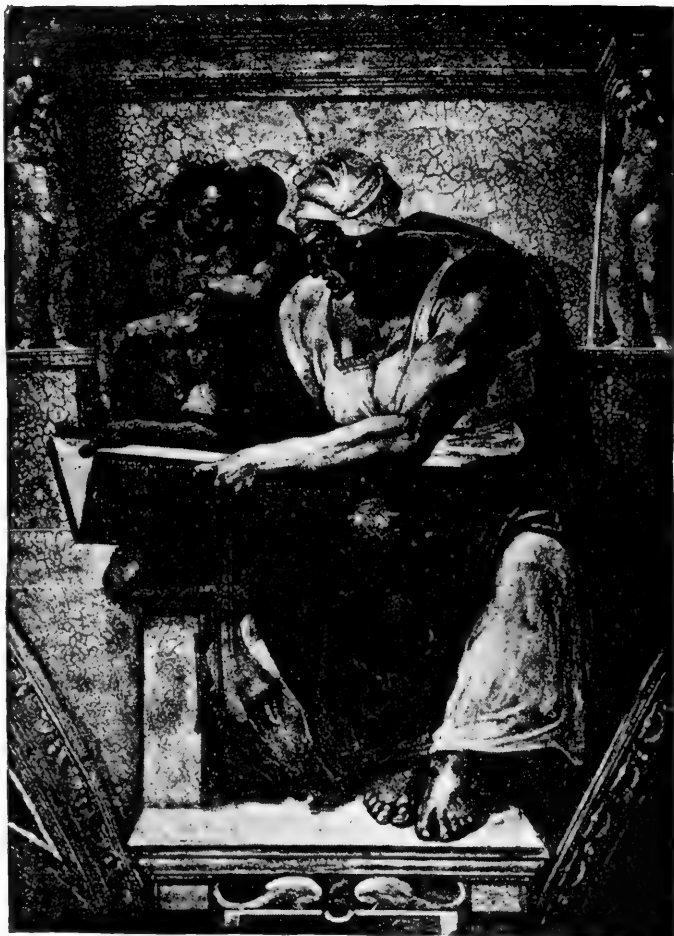
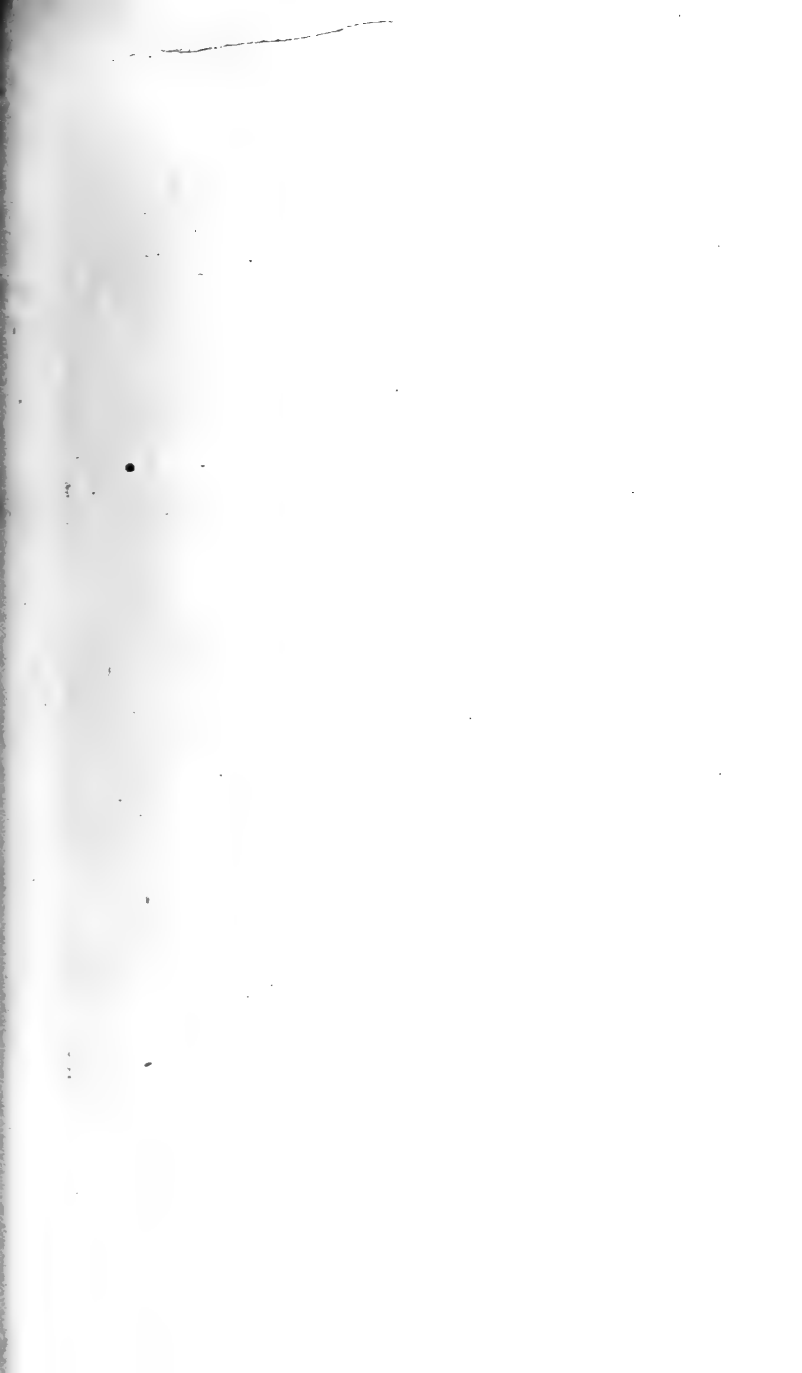

PLATE VIII.—THE NYMPH BELOVED OF APOLLO. MICHAEL ANGELO.





NELLA MIEZCOLA STANDO VIDI FARE
 TANTO IVNA FANTINA GRANDONORE
 QVALEN VERGINITA ZIVVOL ZALVA,
 EPERDIVINA GRAZIA EZZVO VALORE
 DICENDLEI EVIENANCARNARE
 FIGVOLCHEFFIA DITANTO ZPLENDORE
 EFFIE DIDDIO ZVO FIGVOIVERACIE
 CHE TTVT TOLZECOLNOSTRO POSSANTE GAI

PLATE IX.—IN THE WOODS OF IDA.

mand of all the sybils,—as an ugly crone, with the arms of Goliath, poring down upon a single book.

39. There is one point of fine detail, however, in Botticelli's Cumæan Sibyl, and in the next I am going to show you, to explain which I must go back for a little while to the question of the direct relation of the Italian painters to the Greek. I don't like repeating in one lecture what I have said in another ; but to save you the trouble of reference, must remind you of what I stated in my fourth lecture on Greek birds, when we were examining the adoption of the plume crests in armour, that the crest signifies command ; but the diadem, *obedience* ; and that every crown is primarily a diadem. It is the thing that binds, before it is the thing that honours.

Now all the great schools dwell on this symbolism. The long flowing hair is the symbol of life, and the *διάδημα* of the law restraining it. Royalty, or kingliness, over life, restraining and glorifying. In the extremity of restraint—in death, whether noble, as of death to Earth, or ignoble as of death to Heaven, the *διάδημα* is fastened with the mortcloth: "Bound hand and foot with grave-clothes, and the face bound about with the napkin."

40. Now look back to the first Greek head I ever showed you, used as the type of archaic sculpture in Aratra Pentelici, and then look at the crown in Botticelli's Astrologia. It is absolutely the Greek form,—even to the peculiar oval of the forehead ; while the diadem—the governing law—is set with appointed stars—to rule the destiny and thought. Then return to the Cumæan Sibyl. She, as we have seen, is the symbol of enduring life—almost immortal. The diadem is withdrawn from the forehead—reduced to a narrow fillet—here, and the hair thrown free.

41. From the Cumæan Sibyl's diadem, traced only by points, turn to that of the Hellespontic, (Plate 9, opposite). I do not know why Botticelli chose her for the spirit of prophecy in old age ; but he has made this the most interesting plate of the series in the definiteness of its connection with the work from Dante, which becomes his own prophecy in old age. The fantastic yet solemn treatment of the gnarled

wood occurs, as far as I know, in no other engravings but this and the illustrations to Dante ; and I am content to leave it, with little comment, for the reader's quiet study, as showing the exuberance of imagination which other men at this time in Italy allowed to waste itself in idle arabesque, restrained by Botticelli to his most earnest purposes ; and giving the withered tree-trunks hewn for the rude throne of the aged prophetess, the same harmony with her fading spirit which the rose has with youth, or the laurel with victory. Also in its weird characters, you have the best example I can show you of the orders of decorative design which are especially expressible by engraving, and which belong to a group of art-instincts scarcely now to be understood, much less recovered, (the influence of modern naturalistic imitation being too strong to be conquered)—the instincts, namely, for the arrangement of pure line, in labyrinthine intricacy, through which the grace of order may give continual clue. The entire body of ornamental design, connected with writing, in the middle ages seems as if it were a sensible symbol, to the eye and brain, of the methods of error and recovery, the minglings of crooked with straight, and perverse with progressive, which constitute the great problem of human morals and fate ; and when I chose the title for the collected series of these lectures, I hoped to have justified it by careful analysis of the methods of labyrinthine ornament, which, made sacred by Theseian traditions,* and beginning in imitation of physical truth, with the spiral waves of the waters of Babylon as the Assyrian carved them, entangled in their returns the eyes of men, on Greek vase and Christian manuscript—till they closed in the arabesques which sprang round the last luxury of Venice and Rome.

But the labyrinth of life itself, and its more and more interwoven occupation, become too manifold, and too difficult for me ; and of the time wasted in the blind lanes of it, perhaps that spent in analysis or recommendation of the art to which men's present conduct makes them insensible, has been chiefly cast away. On the walls of the little room where I finally revise

* Callimachus, 'Delos,' 304 etc.

this lecture,* hangs an old silken sampler of great-grandame's work : representing the domestic life of Abraham : chiefly the stories of Isaac and Ishmael. Sarah at her tent-door, watching with folded arms, the dismissal of Hagar : above, in a wilderness full of fruit trees, birds, and butterflies, little Ishmael lying at the root of a tree, and the spent bottle under another ; Hagar in prayer, and the angel appearing to her out of a wreathed line of gloomily undulating clouds, which, with a dark-rayed sun in the midst, surmount the entire composition in two arches, out of which descend shafts of (I suppose) beneficent rain ; leaving, however, room, in the corner opposite to Ishmael's angel, for Isaac's, who stays Abraham in the sacrifice : the ram in the thicket, the squirrel in the plum tree above him, and the grapes, pears, apples, roses, and daisies of the foreground, being all wrought with involution of such ingenious needle-work as may well rank, in the patience, the natural skill, and the innocent pleasure of it, with the truest works of Florentine engraving. Nay ; the actual tradition of many of the forms of ancient art is in many places evident,—as for instance in the spiral summits of the flames of the wood on the altar, which are like a group of first-springing fern. On the wall opposite is a smaller composition, representing Justice with her balance and sword, standing between the sun and moon, with a background of pinks, borage, and corncockle : a third is only a cluster of tulips and iris, with two Byzantine peacocks ; but the spirits of Penelope and Ariadne reign vivid in all the work—and the richness of pleasurable fancy is as great still, in these silken labours, as in the marble arches and golden roof of the cathedral of Monreal.

But what is the use of explaining or analyzing it ? Such work as this means the patience and simplicity of all feminine life ; and can be produced, among *us* at least, no more, Gothic tracery itself, another of the instinctive labyrinthine intricacies of old, though analyzed to its last section, has become now the symbol only of a foolish ecclesiastical sect, retained for their shibboleth, joyless and powerless for all good. The very labyrinth of the grass and flowers of our fields, though

* In the Old King's Arms Hotel, Lancaster.

dissected to its last leaf, is yet bitten bare, or trampled to slime, by the Minotaur of our lust; and for the traceried spire of the poplar by the brook, we possess but the four-square furnace tower, to mingle its smoke with heaven's thunder-clouds.*

We will look yet at one sampler more of the engraved work, done in the happy time when flowers were pure, youth simple, and imagination gay,—Botticelli's Libyan Sibyl.

Glance back first to the Hellespontic, noting the close fillet, and the cloth bound below the face, and then you will be prepared to understand the last I shall show you, and the loveliest of the southern Pythonesses.

42. A less deep thinker than Botticelli would have made her parched with thirst, and burnt with heat. But the voice of God, through nature, to the Arab or the Moor, is not in the thirst, but in the fountain,—not in the desert, but in the grass of it. And this Libyan Sibyl is the spirit of wild grass and flowers, springing in desolate places.

You see, her diadem is a wreath of them; but the blossoms of it are not fastening enough for her hair, though it is not long yet—(she is only in reality a Florentine girl of fourteen or fifteen)—so the little darling knots it under her ears, and then makes herself a necklace of it. But though flowing hair and flowers are wild and pretty, Botticelli had not, in these only, got the power of Spring marked to his mind. Any girl might wear flowers; but few, for ornament, would be likely to wear grass. So the Sibyl shall have grass in her diadem; not merely interwoven and bending, but springing and strong. You thought it ugly and grotesque at first, did not you? It was made so, because precisely what Botticelli wanted you to look at.

* A manufacturer wrote to me the other day, "We don't *want* to make smoke!" Who said they did?—a hired murderer does not want to commit murder, but does it for sufficient motive. (Even our shipowners don't want to drown their sailors; they will only do it for sufficient motive.) If the dirty creatures *did* want to make smoke, there would be more excuse for them: and that they are not clever enough to consume it, is no praise to them. A man who can't help his hiccough leaves the room; why do they not leave the England they pollute?

SIBYLLA LIBI
CA

ECCE VENIENTEM DIEM
ET LATENTIA APERIEN
TEM TENEBIT GREMIO
GENTIVM REGINA



I LIDI VERRA CHE LETTERNO SIGNORE
LVME DARA ALLE COSE NASCOSE
ELEGAMI ISCORA DEL NOSTRO ERRORE
FARA LESINAGOGHE LVMINOSE
ESOLVERA LE LABRA AL PECHATORE
E FIE STADRA DI VTE LE COSE
EN GRENBO ALLA REINA DELLE GENTE
SEDRA QVESTO RESANTO EVNENIE

PLATE X.—GRASS OF THE DESERT.

100

100

100

But that's not all. This conical cap of hers, with one bead at the top,—considering how fond the Florentines are of graceful head-dresses, this seems a strange one for a young girl. But, exactly as I know the angel of Victory to be Greek, at his Mount of Pity, so I know this head-dress to be taken from a Greek coin, and to be meant for a Greek symbol. It is the Petasus of Hermes—the mist of morning over the dew. Lastly, what will the Libyan Sibyl say to you? The letters are large on her tablet. Her message is the oracle from the temple of the dew: “The dew of thy birth is as the womb of the morning.”—“*Ecce venientem diem, et latentia aperientem, tenebit gremio gentium regina.*”

43. Why the daybreak came not then, nor yet has come, but only a deeper darkness; and why there is now neither queen nor king of nations, but every man doing that which is right in his own eyes, I would fain go on, partly to tell you, and partly to meditate with you: but it is not our work for to-day. The issue of the Reformation which these great painters, the scholars of Dante, began, we may follow, farther, in the study to which I propose to lead you, of the lives of Cimabue and Giotto, and the relation of their work at Assisi to the chapel and chambers of the Vatican.

44. To-day let me finish what I have to tell you of the style of southern engraving. What sudden bathos in the sentence, you think! So contemptible the question of style, then, in painting, though not in literature? You study the ‘style’ of Homer; the style, perhaps, of Isaiah; the style of Horace, and of Massillon. Is it so vain to study the style of Botticelli?

In all cases, it is equally vain, if you think of their style first. But know their purpose, and then, their way of speaking is worth thinking of. These apparently unfinished and certainly unfilled outlines of the Florentine,—clumsy work, as Vasari thought them,—as Mr. Otley and most of our English amateurs still think them,—are these good or bad engraving?

You may ask now, comprehending their motive, with some hope of answering or being answered rightly. And the an-

swer is, They are the finest gravers' work ever done yet by human hand. You may teach, by process of discipline and of years, any youth of good artistic capacity to engrave a plate in the modern manner ; but only the noblest passion, and the tenderest patience, will ever engrave one line like these of Sandro Botticelli.

45. Passion, and patience ! Nay, even these you may have to-day in England, and yet both be in vain. Only a few years ago, in one of our northern iron-foundries, a workman of intense power and natural art-faculty set himself to learn engraving ;—made his own tools ; gave all the spare hours of his laborious life to learn their use ; learnt it ; and engraved a plate which, in manipulation, no professional engraver would be ashamed of. He engraved his blast furnace, and the casting of a beam of a steam engine. This, to him, was the power of God,—it was his life.

No greater earnestness was ever given by man to promulgate a Gospel. Nevertheless, the engraving is absolutely worthless. The blast furnace *is not* the power of God ; and the life of the strong spirit was as much consumed in the flames of it, as ever driven slaves by the burden and heat of the day.

How cruel to say so, if he yet lives, you think ! No, my friends ; the cruelty will be in you, and the guilt, if, having been brought here to learn that God is your Light, you yet leave the blast furnace to be the only light of England.

It has been, as I said in the note above (p. 167), with extreme pain that I have hitherto limited my notice of our own great engraver and moralist, to the points in which the disadvantages of English art-teaching made him inferior to his trained Florentine rival. But, that these disadvantages were powerless to arrest or ignobly depress him ;—that however failing in grace and scholarship, he should never fail in truth or vitality ; and that the precision of his unerring hand *—

* I know no drawing so subtle as Bewick's, since the fifteenth century, except Holbein's and Turner's. I have been greatly surprised lately by the exquisite water-colour work in some of Stothard's smaller vignettes ; but he cannot set the line like Turner or Bewick.

his inevitable eye—and his rightly judging heart—should place him in the first rank of the great artists not of England only, but of all the world and of all time :—that *this* was possible to him, was simply because he lived a *country* life. Bewick himself, Botticelli himself, Apelles himself, and twenty times Apelles, condemned to slavery in the hellfire of the iron furnace, could have done—NOTHING. Absolute paralysis of all high human faculty *must* result from labour near fire. The poor engraver of the piston-rod had faculties—not like Bewick's, for if he had had those, he never would have endured the degradation ; but assuredly, (I know this by his work,) faculties high enough to have made him one of the most accomplished figure painters of his age. And they are scorched out of him, as the sap from the grass in the oven : while on his Northumberland hill-sides, Bewick grew into as stately life as their strongest pine.

And therefore, in words of his, telling consummate and unchanging truth concerning the life, honour, and happiness of England, and bearing directly on the points of difference between class and class which I have not dwelt on without need, I will bring these lectures to a close.

“I have always, through life, been of opinion that there is no business of any kind that can be compared to that of a man who farms his own land. It appears to me that every earthly pleasure, with health, is within his reach. But numbers of these men (the old statesmen) were grossly ignorant, and in exact proportion to that ignorance they were sure to be offensively proud. This led them to attempt appearing above their station, which hastened them on to their ruin ; but, indeed, this disposition and this kind of conduct invariably leads to such results. There were many of these lairds on Tyneside ; as well as many who held their lands on the tenure of ‘suit and service,’ and were nearly on the same level as the lairds. Some of the latter lost their lands (not fairly, I think) in a way they could not help ; many of the former, by their misdirected pride and folly, were driven into towns, to slide away into nothingness, and to sink into oblivion, while their ‘ha’ houses’ (halls), that ought to have remained in their families

from generation to generation, have mouldered away. I have always felt extremely grieved to see the ancient mansions of many of the country gentlemen, from somewhat similar causes, meet with a similar fate. The gentry should, in an especial manner, prove by their conduct that they are guarded against showing any symptom of foolish pride, at the same time that they soar above every meanness, and that their conduct is guided by truth, integrity, and patriotism. If they wish the people to partake with them in these good qualities, they must set them the example, without which no real respect can ever be paid to them. Gentlemen ought never to forget the respectable station they hold in society, and that they are the natural guardians of public morals and may with propriety be considered as the head and the heart of the country, while 'a bold peasantry' are, in truth, the arms, the sinews, and the strength of the same; but when these last are degraded, they soon become dispirited and mean, and often dishonest and useless.

* * * * *

"This singular and worthy man * was perhaps the most invaluable acquaintance and friend I ever met with. His moral lectures and advice to me formed a most important succedaneum to those imparted by my parents. His wise remarks, his detestation of vice, his industry, and his temperance,

* Gilbert Gray, bookbinder. I have to correct the inaccurate—and very harmfully inaccurate, expression which I used of Bewick, in *Love's Meinie*, 'a printer's lad at Newcastle.' His first master was a goldsmith and engraver, else he could never have been an artist. I am very heartily glad to make this correction, which establishes another link of relation between Bewick and Botticelli; but my error was partly caused by the impression which the above description of his "most invaluable friend" made on me, when I first read it.

Much else that I meant to correct, or promised to explain, in this lecture, must be deferred to the Appendix; the superiority of the *Tusseau* to the Greek *Aphrodite* I may perhaps, even at last, leave the reader to admit or deny as he pleases, having more important matters of debate on hand. But as I mean only to play with *Proserpina* during the spring, I will here briefly anticipate a statement I mean in the Appendix to enforce, namely, of the extreme value of coloured copies by hand, or paintings whose excellence greatly consists in colour, as auxiliary to en-

crowned with a most lively and cheerful disposition, altogether made him appear to me as one of the best of characters. In his workshop I often spent my winter evenings. This was also the case with a number of young men who might be considered as his pupils; many of whom, I have no doubt, he directed into the paths of truth and integrity, and who revered his memory through life. He rose early to work, lay down when he felt weary, and rose again when refreshed. His diet was of the simplest kind; and he ate when hungry, and drank when dry, without paying regard to meal-times. By steadily pursuing this mode of life he was enabled to accumulate sums of money—from ten to thirty pounds. This enabled him to get books, of an entertaining and moral tendency, printed and circulated at a cheap rate. His great object was, by every possible means, to promote honourable feelings in the minds of youth, and to prepare them for becoming good members of society. I have often discovered that he did not overlook ingenious mechanics, whose misfortunes—perhaps mismanagement—had led them to a lodging in Newgate. To these he directed his compassionate eye, and for the deserving (in his estimation), he paid their debt, and set them at liberty. He felt hurt at seeing the hands of an ingenious man tied up in

gravings of them. The prices now given without hesitation for nearly worthless original drawings by first-rate artists, would obtain for the misguided buyers, in something like a proportion of ten to one, most precious copies of drawings which can only be represented at all in engraving by entire alteration of their treatment, and abandonment of their finest purposes. I feel this so strongly that I have given my best attention, during upwards of ten years, to train a copyist to perfect fidelity in rendering the work of Turner; and having now succeeded in enabling him to produce facsimilies so close as to look like replicas, facsimilies which I must sign with my own name and his, in the very work of them, to prevent their being sold for real Turner vignettes, I can obtain no custom for him, and am obliged to leave him to make his bread by any power of captivation his original sketches may possess in the eyes of a public which maintains a nation of copyists in Rome, but is content with black and white renderings of great English art; though there is scarcely one cultivated English gentleman or lady who has not been twenty times in the Vatican, for once that they have been in the National Gallery.

prison, where they were of no use either to himself or to the community. This worthy man had been educated for a priest ; but he would say to me, ' Of a "trouth," Thomas, I did not like their ways.' So he gave up the thoughts of being a priest, and bent his way from Aberdeen to Edinburgh, where he engaged himself to Allan Ramsay, the poet, then a bookseller at the latter place, in whose service he was both shopman and bookbinder. From Edinburgh he came to Newcastle. Gilbert had had a liberal education bestowed upon him. He had read a great deal, and had reflected upon what he had read. This, with his retentive memory, enabled him to be a pleasant and communicative companion. I lived in habits of intimacy with him to the end of his life ; and, when he died, I, with others of his friends, attended his remains to the grave at the Ballast Hills."

And what graving on the sacred cliffs of Egypt ever honoured them, as that grass-dimmed furrow does the mounds of our Northern land ?

NOTES.

I. The following letter, from one of my most faithful readers, corrects an important piece of misinterpretation in the text. The waving of the reins must be only in sign of the fluctuation of heat round the Sun's own chariot :—

“Spring Field, Ambleside,

“February 11, 1875.

“Dear Mr. Ruskin,—Your fifth lecture on Engraving I have to hand.

“Sandro intended those wavy lines meeting under the Sun's right * hand, (Plate V.) primarily, no doubt, to represent the four ends of the four reins dangling from the Sun's hand. The flames and rays are seen to continue to radiate from the platform of the chariot between and beyond these ends of the reins, and over the knee. He may have wanted to acknowledge that the warmth of the earth was Apollo's, by making these ends of the reins spread out separately and wave, and thereby enclose a form like a flame. But I cannot think it.

“Believe me,

“Ever yours truly,

CHAS. WM. SMITH.”

II. I meant to keep labyrinthine matters for my Appendix ; but the following most useful byewords from Mr. Tyrwhitt had better be read at once :—

“In the matter of Cretan Labyrinth, as connected by Vir-

* “Would not the design have looked better, to us, on the plate than on the print ? On the plate, the reins would be in the left hand ; and the whole movement be from the left to the right ? The two different forms that the radiance takes would symbolize respectively heat and light, would they not ?”

gil with the Ludus Trojæ, or equestrian game of winding and turning, continued in England from twelfth century; and having for last relic the maze * called 'Troy Town,' at Troy farm, near Somerton, Oxfordshire, which itself resembles the circular labyrinth on a coin of Cnossus in 'Fors Clavigera.'

"The connecting quotation from Virg., *Æn.*, v., 588, is as follows:

'Ut quondam Creta fertur Labyrinthus in alta
Parietibus textum cæcis iter, ancipitemque
Mille viis habuisse dolum, qua signa sequendi
Falleret indeprensus et inremeabilis error.
Haud alio Teucerum nati vestigia cursu
Impediunt, texuntque fagas et prælia ludo,
Delphinum similes.'"

Labyrinth of Ariadne, as cut on the Downs by shepherds from time immemorial,—

Shakspeare, 'Midsummer Night's Dream,' Act ii. sc. 2:

"Oberon. The nine-men's morris† is filled up with mud;
And the quaint mazes in the wanton green
By lack of tread are undistinguishable."

The following passage, 'Merchant of Venice,' Act iii., sc. 2, confuses (to all appearance) the Athenian tribute to Crete, with the story of Hesione: and may point to general confusion in the Elizabethan mind about the myths:

"Portia. with much more love
Than young Alcides, when he did reduce
The virgin-tribute paid by howling Troy
To the sea monster." †

Theseus is the Attic Hercules, however; and Troy may have been a sort of house of call for mythical monsters, in the view of midland shepherds.

* Strutt, pp. 97-8, ed. 1801.

† Explained as "a game still played by the shepherds, cowkeepers," etc., in the midland counties.

‡ See *Iliad*, 20, 145.

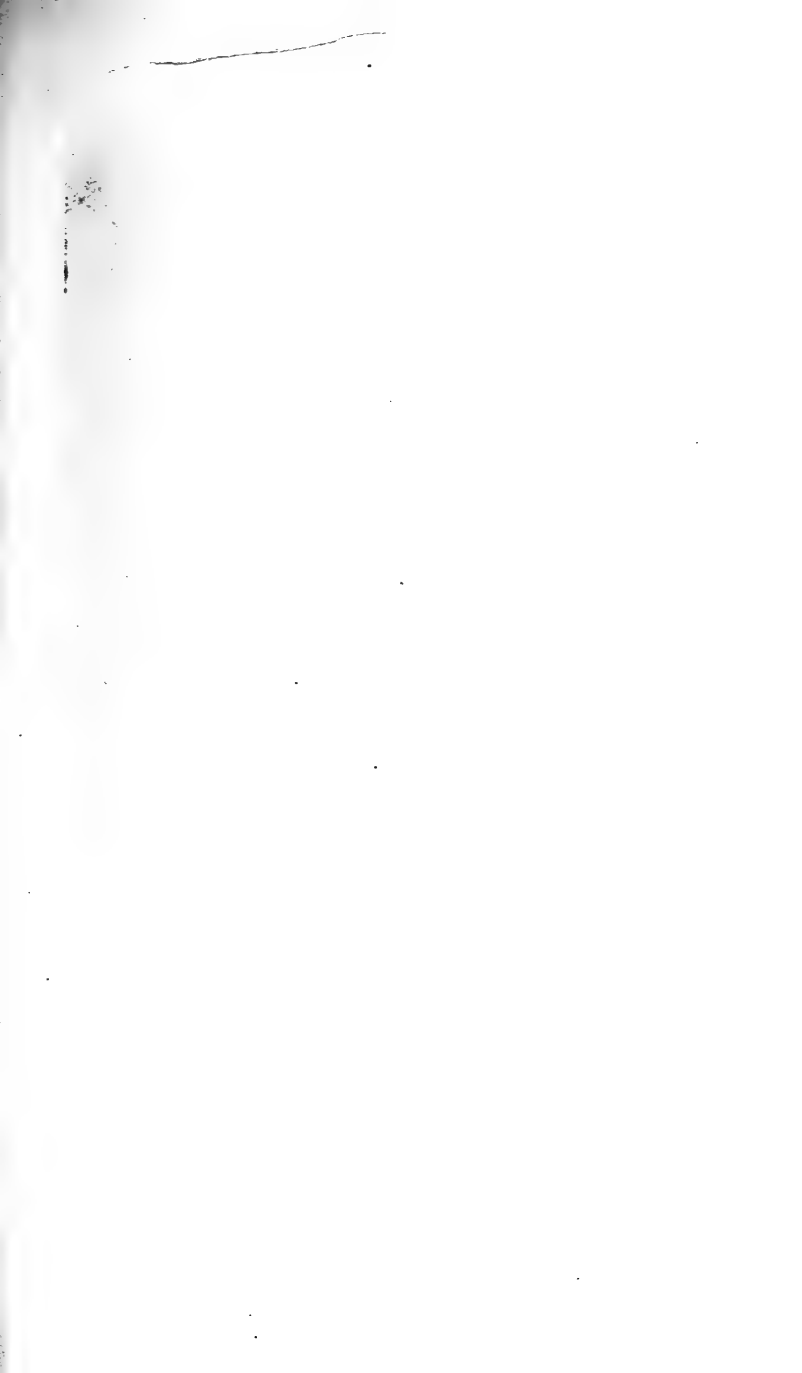

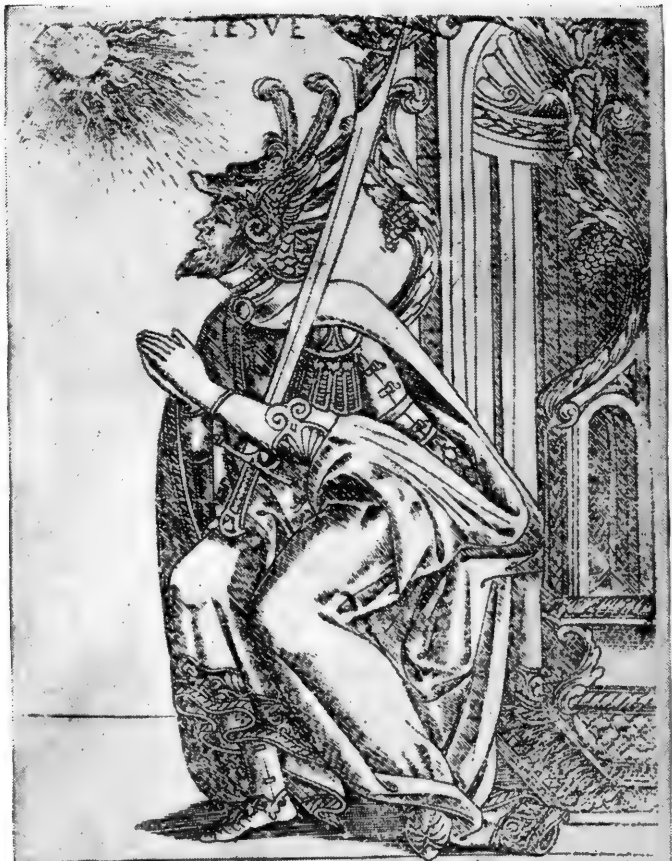

OREDE RE OSIGNORDESIGNORI
 CHE NELLO ETERNO REGGI SENPRE SOLO
 ECHE CHORREGGI TVTTI ENOSTRI ERRORI
 STANDOASSEDEPE SVNELSVTERNO POLO
 OMEI O DIA DEGLANCENCI CHORI
 ASCHOLTA VNPOCHO ELNOSTROAMARO
 EVIENI EREGGI NOI OREALTISSIMO
 COLTVO AMORECHEETANTO DOLCISSE

APPENDIX.

ARTICLE I.

NOTES ON THE PRESENT STATE OF ENGRAVING IN ENGLAND.

I HAVE long deferred the completion of this book, because I had hoped to find time to show, in some fulness, the grounds for my conviction that engraving, and the study of it, since the development of the modern finished school, have been ruinous to European knowledge of art. But I am more and more busied in what I believe to be better work, and can only with extreme brevity state here the conclusions of many years' thought.

These, in several important particulars, have been curiously enforced on me by the carelessness shown by the picture dealers about the copies from Turner which it has cost Mr. Ward and me * fifteen years of study together to enable ourselves to make. "They are only copies," say they,—“nobody will look at them.”

It never seems to occur even to the most intelligent persons that an engraving also is 'only a copy,' and a copy done with refusal of colour, and with disadvantage of means in rendering shade. But just because this utterly inferior copy can be reduplicated, and introduces a different kind of skill in another material, people are content to lose all the composition, and all the charm, of the original,—so far as these depend on the chief gift of a *painter*,—colour; while they are gradually misled into attributing to the painter himself qualities impertinently added by the engraver to make his plate popular: and, which is far worse, they are as gradually and

* See note to the close of this article, p. 152.

subtly prevented from looking, in the original, for the qualities which engraving could never render. Further, it continually happens that the very best colour-compositions engrave worst; for they often extend colours over great spaces at equal pitch, and the green is as dark as the red, and the blue as the brown; so that the engraver can only distinguish them by lines in different directions, and his plate becomes a vague and dead mass of neutral tint; but a bad and forced piece of colour, or a piece of work of the Bolognese school, which is everywhere black in the shadows, and colourless in the lights, will engrave with great ease, and appear spirited and forcible. Hence engravers, as a rule, are interested in reproducing the work of the worst schools of painting.

Also, the idea that the merit of an engraving consisted in light and shade, has prevented the modern masters from even attempting to render works dependent mainly on outline and expression; like the early frescoes, which should indeed have been the objects of their most attentive and continual skill: for outline and expression are entirely within the scope of engraving; and the scripture histories of an aisle of a cloister might have been engraved to perfection, with little more pains than are given by ordinary workmen to round a limb by Correggio, or imitate the texture of a dress by Sir Joshua,—and both, at last, inadequately.

I will not lose more time in asserting or lamenting the mischief arising out of the existing system: but will rapidly state what the public should now ask for.

1. Exquisitely careful engraved outlines of all remaining frescoes of the thirteenth, fourteenth, and fifteenth centuries in Italy, with so much pale tinting as may be explanatory of their main masses; and with the local darks and local lights brilliantly relieved. The Arundel Society have published some meritorious plates of this kind from Angelico,—not, however, paying respect enough to the local colours, but conventionalizing the whole too much into outline.

2. Finished small plates for book illustration. The cheap woodcutting and etching of popular illustrated books have been endlessly mischievous to public taste: they first obtained

their power in a general reaction of the public mind from the insipidity of the lower school of line engraving, brought on it by servile persistence in hack work for ignorant publishers. The last dregs of it may still be seen in the sentimental landscapes engraved for cheap ladies' pocket-books. But the woodcut can never, educationally, take the place of serene and accomplished line engraving; and the training of young artists in whom the gift of delineation prevails over their sense of colour, to the production of scholarly, but small plates, with their utmost honour of skill, would give a hitherto unconceived dignity to the character and range of our popular literature.

3. Vigorous mezzotints from pictures of the great masters, which originally present noble contrasts of light and shade. Many Venetian works are magnificent in this character.

4. Original design by painters themselves, decisively engraved in few lines—(not etched); and with such insistence by dotted work on the main contours as we have seen in the examples given from Italian engraving.

5. On the other hand, the men whose quiet patience and exquisite manual dexterity are at present employed in producing large and costly plates, such as that of the *Belle Jardinière de Florence*, by M. Boucher Desnoyers, should be entirely released from their servile toil, and employed exclusively in producing coloured copies, or light drawings, from the original work. The same number of hours of labour, applied with the like conscientious skill, would multiply precious likenesses of the real picture, full of subtle veracities which no steel line could approach, and conveying, to thousands, true knowledge and unaffected enjoyment of painting; while the finished plate lies uncared for in the portfolio of the virtuoso, serving only, so far as it is seen in the print-seller's window by the people, to make them think that sacred painting must always be dull, and unnatural.

I have named the above engraving, because, for persons wishing to study the present qualities and methods of line-work, it is a pleasant and sufficient possession, uniting every variety of texture with great serenity of unforced effect, and

exhibiting every possible artifice and achievement in the distribution of even and rugged, or of close and open line ; artifices for which,—while I must yet once more and emphatically repeat that they are illegitimate, and could not be practised in a revived school of classic art,—I would fain secure the reader's reverent admiration, under the conditions exacted by the school to which they belong. Let him endeavour, with the finest point of pen or pencil he can obtain, to imitate the profile of this Madonna in its relief against the grey background of the water surface ; let him examine, through a good lens, the way in which the lines of the background are ended in a lance-point as they approach it ; the exact equality of depth of shade being restored by inserted dots, which prepare for the transition to the manner of shade adopted in the flesh ; then let him endeavour to trace with his own hand some of the curved lines at the edge of the eyelid, or in the rounding of the lip ; or if these be too impossible, even a few of the quiet undulations which gradate the folds of the hood behind the hair ; and he will, I trust, begin to comprehend the range of delightful work which would be within the reach of such an artist, employed with more tractable material on more extended subject.

If, indeed, the present system were capable of influencing the mass of the people, and enforcing among them the subtle attention necessary to appreciate it, something might be pleaded in defence of its severity. But all these plates are entirely above the means of the lower middle classes, and perhaps not one reader in a hundred can possess himself, for the study I ask of him, even of the plate to which I have just referred. What, in the stead of such, he can and does possess, let him consider,—and, if possible, just after examining the noble qualities of this conscientious engraving.

Take up, for an average specimen of modern illustrated works, the volume of Dickens's 'Master Humphrey's Clock,' containing 'Barnaby Rudge.'

You have in that book an entirely profitless and monstrous story, in which the principal characters are a coxcomb, an idiot, a madman, a savage blackguard, a foolish tavern-keeper, a mean

old maid, and a conceited apprentice,—mixed up with a certain quantity of ordinary operatic pastoral stuff, about a pretty Dolly in ribands, a lover with a wooden leg, and an heroic locksmith. For these latter, the only elements of good, or life, in the filthy mass of the story,* observe that the author must filch the wreck of those old times of which we fiercely and frantically destroy every living vestige, whenever it is possible. You cannot have your Dolly Varden brought up behind the counter of a railway station; nor your jolly locksmith trained at a Birmingham brass-foundry. And of these materials, observe that you can only have the ugly ones illustrated. The cheap popular art cannot draw for you beauty, sense, or honesty; and for Dolly Varden, or the locksmith, you will look through the vignettes in vain. But every species of distorted folly and vice,—the idiot, the blackguard, the coxcomb, the paltry fool, the degraded woman,—are pictured for your honorable pleasure in every page, with clumsy caricature, struggling to render its dulness tolerable by insisting on defect,—if perchance a penny or two more may be coined out of the Cockney reader's itch for loathsomeness.

Or take up, for instance of higher effort, the 'Cornhill Magazine' for this month, July, 1876. It has a vignette of Venice for an illuminated letter. That is what your decorative art has become, by help of Kensington! The letter to be produced is a T. There is a gondola in the front of the design, with the canopy slipped back to the stern like a saddle over a horse's tail. There is another in the middle distance, all gone to seed at the prow, with its gondolier emaciated into an oar, at the stern; then there is a Church of the Salute, and a Ducal palace,—in which I beg you to observe all the felicity and dexterity of modern cheap engraving; finally, over the Ducal palace there is something, I know not in the least what meant for, like an umbrella dropping out of a balloon, which is the ornamental letter T. Opposite this ornamental design, there is an engraving of two young ladies and a parasol, between

* The raven, however, like all Dickens's animals, is perfect; and I am the more angry with the rest because I have every now and then to open the book to look for him.

two trunks of trees. The white face and black feet of the principal young lady, being the points of the design, are done with as much care,—not with as much dexterity,—as an ordinary sketch of Dumourier's in *Punch*. The young lady's dress, the next attraction, is done in cheap white and black cutting, with considerably less skill than that of any ordinary tailor's or milliner's shop-book pattern drawing. For the other young lady, and the landscape, take your magnifying glass, and look at the hacked wood that forms the entire shaded surface—one mass of idiotic scabble, without the remotest attempt to express a single leaf, flower, or clod of earth. It is such landscape as the public sees out of its railroad window at sixty miles of it in the hour,—and good enough for such a public.

Then turn to the last—the poetical plate, p. 122: “Lifts her—lays her down with care.” Look at the gentleman with the spade, promoting the advance, over a hillock of hay, of the reposing figure in the black-sided tub. Take your magnifying glass to *that*, and look what a dainty female arm and hand your modern scientific and anatomical schools of art have provided you with! Look at the tender horizontal flux of the sea round the promontory point above. Look at the tender engraving of the linear light on the divine horizon, above the ravenous sea-gull. Here is Development and Progress for you, from the days of Perugino's horizon, and Dante's daybreaks! Truly, here it seems

“Si che le bianche e le vermiglie guance
Per troppa etate divenivan rance.”

I have chosen no gross or mean instances of modern work. It is one of the saddest points connected with the matter that the designer of this last plate is a person of consummate art faculty, but bound to the wheel of the modern Juggernaut, and broken on it. These woodcuts, for ‘*Barnaby Rudge*’ and the ‘*Cornhill Magazine*,’ are favourably representative of the entire illustrative art industry of the modern press,—industry enslaved to the ghastly service of catching the last gleams in the glued eyes of the daily more bestial English mob,—rail-

road born and bred, which drags itself about the black world it has withered under its breath, in one eternal grind and shriek,—gobbling,—staring,—chattering,—giggling,—trampling out every vestige of national honour and domestic peace, wherever it sets the staggering hoof of it; incapable of reading, of hearing, of thinking, of looking,—capable only of greed for money, lust for food, pride of dress, and the prurient itch of momentary curiosity for the politics last announced by the newsmonger, and the religion last rolled by the chemist into electuary for the dead.

In the miserably competitive labour of finding new stimulus for the appetite—daily more gross—of this tyrannous mob, we may count as lost, beyond any hope, the artists who are dull, docile, or distressed enough to submit to its demands; and we may count the dull and the distressed by myriads;—and among the docile, many of the best intellects we possess. The few who have sense and strength to assert their own place and supremacy, are driven into discouraged disease by their isolation, like Turner and Blake; the one abandoning the design of his 'Liber Studiorum' after imperfectly and sadly, against total public neglect, carrying it forward to what it is,—monumental, nevertheless, in landscape engraving; the other producing, with one only majestic series of designs from the book of Job, nothing for his life's work but coarsely iridescent sketches of enigmatic dream.

And, for total result of our English engraving industry during the last hundred and fifty years, I find that practically at this moment I cannot get a *single* piece of true, sweet, and comprehensible art, to place for instruction in any children's school! I can get, for ten pounds apiece, well-engraved portraits of Sir Joshua's beauties showing graceful limbs through flowery draperies; I can get—dirt-cheap—any quantity of Dutch flats, ditches, and hedges, enlivened by cows chewing the cud, and dogs behaving indecently; I can get heaps upon heaps of temples, and forums, and altars, arranged as for academical competition, round seaports, with curled-up ships that only touch the water with the middle of their bottoms. I can get, at the price of lumber, any quantity of British

squires flourishing whips and falling over hurdles; and, in suburban shops, a dolorous variety of widowed mothers nursing babies in a high light, with the Bible on a table, and baby's shoes on a chair. Also, of cheap prints, painted red and blue, of Christ blessing little children, of Joseph and his brethren, the infant Samuel, or Daniel in the lion's den, the supply is ample enough to make every child in these islands think of the Bible as a somewhat dull story-book, allowed on Sunday;—but of trained, wise, and worthy art, applied to gentle purposes of instruction, no single example can be found in the shops of the British printseller or bookseller. And after every dilettante tongue in European society has filled drawing-room and academy alike with idle clatter concerning the divinity of Raphael and Michael Angelo, for these last hundred years, I cannot at this instant, for the first school which I have some power of organizing under St. George's laws, get a good print of Raphael's Madonna of the tribune, or an ordinarily intelligible view of the side and dome of St. Peter's!

And there are simply no words for the mixed absurdity and wickedness of the present popular demand for art, as shown by its supply in our thoroughfares. Abroad, in the shops of the Rue de Rivoli, brightest and most central of Parisian streets, the putrescent remnant of what was once Catholicism promotes its poor gilded pedlars' ware of nativity and crucifixion into such honourable corners as it can find among the more costly and studious illuminations of the brothel: and although, in Pall Mall, and the Strand, the large-margined Landseer,—Stanfield,—or Turner-proofs, in a few stately windows, still represent, uncared-for by the people, or inaccessible to them, the power of an English school now wholly perished,—these are too surely superseded, in the windows that stop the crowd, by the thrilling attraction with which Doré, Gérôme, and Tadema have invested the gambling table, the duelling ground, and the arena; or by the more material and almost tangible truth with which the apothecary-artist stereographs the stripped actress, and the railway mound.

Under these conditions, as I have now repeatedly asserted,

no professorship, nor school, of art can be of the least use to the general public. No race can understand a visionary landscape, which blasts its real mountains into ruin, and blackens its river-beds with foam of poison. Nor is it of the least use to exhibit ideal Diana at Kensington, while substantial Phryne may be worshipped in the Strand. The only recovery of our art-power possible,—nay, when once we know the full meaning of it, the only one desirable,—must result from the purification of the nation's heart, and chastisement of its life : utterly hopeless now, for our adult population, or in our large cities, and their neighbourhood. But, so far as any of the sacred influence of former design can be brought to bear on the minds of the young, and so far as, in rural districts, the first elements of scholarly education can be made pure, the foundation of a new dynasty of thought may be slowly laid. I was strangely impressed by the effect produced in a provincial seaport school for children, chiefly of fishermen's families, by the gift of a little coloured drawing of a single figure from the Paradise of Angelico in the Academia of Florence. The drawing was wretched enough seen beside the original : I had only bought it from the poor Italian copyist for charity ; but, to the children, it was like an actual glimpse of heaven ; they rejoiced in it with pure joy, and their mistress thanked me for it more than if I had sent her a whole library of good books. Of such copies, the grace-giving industry of young girls, now worse than lost in the spurious charities of the bazaar, or selfish ornamentations of the drawing-room, might, in a year's time, provide enough for every dame-school in England ; and a year's honest work of the engravers employed on our base novels, might represent to our advanced students every frescoed legend of philosophy and morality extant in Christendom.

For my own part, I have no purpose, in what remains to me of opportunity, either at Oxford or elsewhere, to address any farther course of instruction towards the development of existing schools. After seeing the stream of the Teviot as black as ink, and a putrid carcase of a sheep lying in the dry channel of the Jed, under Jedburgh Abbey, (the entire strength

of the summer stream being taken away to supply a single mill,) I know, finally, what value the British mind sets on the 'beauties of nature,' and shall attempt no farther the excitement of its enthusiasm in that direction. I shall indeed endeavour to carry out, with Mr. Ward's help, my twenty year's held purpose of making the real character of Turner's work known, to the persons who, formerly interested by the engravings from him, imagined half the merit was of the engraver's giving. But I know perfectly that to the general people, trained in the midst of the ugliest objects that vice can design, in houses, mills, and machinery, *all* beautiful form and colour is as invisible as the seventh heaven. It is not a question of appreciation at all; the thing is physically invisible to them, as human speech is inaudible during a steam whistle.

And I shall also use all the strength I have to convince those, among our artists of the second order, who are wise and modest enough not to think themselves the matches of Turner or Michael Angelo, that in the present state of art they only waste their powers in endeavouring to produce original pictures of human form or passion. Modern aristocratic life is too vulgar, and modern peasant life too unhappy, to furnish subjects of noble study; while, even were it otherwise, the multiplication of designs by painters of second-rate power is no more desirable than the writing of music by inferior composers. They may, with far greater personal happiness, and incalculably greater advantage to others, devote themselves to the affectionate and sensitive copying of the works of men of just renown. The dignity of this self-sacrifice would soon be acknowledged with sincere respect, for copies produced by men working with such motive would differ no less from the common trade-article of the galleries than the rendering of music by an enthusiastic and highly-trained executant differs from the grinding of a street organ. And the change in the tone of the public feeling, produced by familiarity with such work, would soon be no less great than in their musical enjoyment, if having been accustomed only to hear black Christys, blind fiddlers, and hoarse beggars scrape or howl about their

streets, they were permitted daily audience of faithful and gentle orchestral rendering of the work of the highest classical masters.

I have not, until very lately, rightly appreciated the results of the labour of the Arundel Society in this direction. Although, from the beginning, I have been honoured in being a member of its council, my action has been hitherto rather of check than help, because I thought more of the differences between our copies and the great originals, than of their unquestionable superiority to anything the public could otherwise obtain.

I was practically convinced of their extreme value only this last winter, by staying at the house of a friend in which the Arundel engravings were the principal decoration; and where I learned more of Masaccio from the Arundel copy of the contest with Simon Magus, than in the Brancacci chapel itself; for the daily companionship with the engraving taught me subtleties in its composition which had escaped me in the multitudinous interest of visits to the actual fresco.

But the work of the Society has been sorely hindered hitherto, because it has had at command only the skill of copyists trained in foreign schools of colour, and accustomed to meet no more accurate requisitions than those of the fashionable traveller. I have always hoped for, and trust at last to obtain, co-operation with our too mildly laborious copyists, of English artists possessing more brilliant colour faculty; and the permission of our subscribers to secure for them the great ruins of the noble past, undesecrated by the trim, but treacherous, plastering of modern emendation.

Finally, I hope to direct some of the antiquarian energy often to be found remaining, even when love of the picturesque has passed away, to encourage the accurate delineation and engraving of historical monuments, as a direct function of our schools of art. All that I have generally to suggest on this matter has been already stated with sufficient clearness in the first of my inaugural lectures at Oxford: and my forthcoming 'Elements of Drawing,' will contain all the directions I can give in writing as to methods of work for such purpose. The

publication of these has been hindered, for at least a year, by the abuses introduced by the modern cheap modes of printing engravings. I find the men won't use any ink but what pleases them, nor print but with what pressure pleases them; and if I can get the foreman to attend to the business, and choose the ink right, the men change it the moment he leaves the room, and threaten to throw up the job when they are detected. All this, I have long known well, is a matter of course, in the outcome of modern principles of trade; but it has rendered it hitherto impossible for me to produce illustrations, which have been ready, as far as my work or that of my own assistants is concerned, for a year and a half. Any one interested in hearing of our progress—or arrest, may write to my Turner copyist, Mr. Ward: * and, in the meantime, they can help my designs for art education best by making these Turner copies more generally known; and by determining, when they travel, to spend what sums they have at their disposal, not in fady photography, but in the encouragement of any good *water-colour* and *pencil draughtsmen* whom they find employed in the *galleries* of Europe.

ARTICLE II.

DETACHED NOTES.

I.

On the series of Sibyl engravings attributed to Botticelli.

SINCE I wrote the earlier lectures in this volume, I have been made more doubtful on several points which were embarrassing enough before, by seeing some better, (so-called,) impres-

* 2, Church Terrace, Richmond, Surrey. NOTE.—I have hitherto permitted Mr. Ward to copy any Turner drawing he was asked to do; but, finding there is a run upon the vignettes of Loch Lomond and Derwent, I have forbidden him to do more of them for the present, lest his work should get the least mechanical. The admirable drawings of Venice, by my good assistant Mr. Bunney, resident there, will become of more value to their purchasers every year, as the buildings from



THE CORONATION IN THE GARDEN.

sions of my favourite plates, containing light and shade which did not improve them.

I do not choose to waste time or space in discussion, till I know more of the matter ; and that more I must leave to my good friend Mr. Reid of the British Museum to find out for me ; for I have no time to take up the subject myself, but I give, for frontispiece to this Appendix, the engraving of Joshua referred to in the text, which however beautiful in thought, is an example of the inferior execution and more elaborate shade which puzzle me. But whatever is said in the previous pages of the plates chosen for example, by whomsoever done, is absolutely trustworthy. Thoroughly fine they are, in their existing state, and exemplary to all persons and times. And of the rest, in fitting place I hope to give complete—or at least satisfactory account.

II.

On the three excellent engravers representative of the first, middle, and late schools.

I have given opposite a photograph, slightly reduced from the Durer Madonna, alluded to often in the text, as an example of his best conception of womanhood. It is very curious that Durer, the least able of all great artists to represent womanhood, should of late have been a very principal object of feminine admiration. The last thing a woman should do is to write about art. They never see anything in pictures but what they are told, (or resolve to see out of contradiction,)—or the particular things that fall in with their own feelings. I saw a curious piece of enthusiastic writing by an Edinburgh lady, the other day, on the photographs I had taken from the tower of Giotto. She did not care a straw what Giotto had meant by them, declared she felt it her duty only to announce

which they are made are destroyed. I was but just in time, working with him at Verona, to catch record of Fra Giocondo's work in the smaller square ; the most beautiful Renaissance design in North Italy.

what they were to *her* ; and wrote two pages on the bas-relief of Heracles and Antæus—assuming it to be the death of Abel.

It is not, however, by women only that Durer has been over-praised. He stands so alone in his own field, that the people who care much for him generally lose the power of enjoying anything else rightly ; and are continually attributing to the force of his imagination quaintnesses which are merely part of the general mannerism of his day.

The following notes upon him, in relation to two other excellent engravers, were written shortly for extempore expansion in lecturing. I give them, with the others in this terminal article, mainly for use to myself in future reference ; but also as more or less suggestive to the reader, if he has taken up the subject seriously, and worth, therefore, a few pages of this closing sheet.

The men I have named as representative of all the good ones composing their school, are alike resolved their engraving shall be lovely.

But Botticelli, the ancient, wants, with as little engraving, as much Sibyl as possible.

Durer, the central, wants, with as much engraving as possible, anything of Sibyl that may chance to be picked up with it.

Beaugrand, the modern, wants, as much Sibyl as possible, and as much engraving too.

I repeat—for I want to get this clear to you—Botticelli wants, with as little engraving, as much Sibyl as possible. For his head is full of Sibyls, and his heart. He can't draw them fast enough ; one comes, and another, and another ; and all, gracious and wonderful and good, to be engraved for ever, if only he had a thousand hands and lives. He scratches down one, with no haste, with no fault, divinely careful, scrupulous, patient, but with as few lines as possible. 'Another Sibyl—let me draw another for heaven's sake, before she has burnt all her books, and vanished.'

Durer is exactly Botticelli's opposite. He is a workman, to the heart, and will do his work magnificently. 'No matter what I do it on, so that my craft be honourably shown. Any-

thing will do ; a Sibyl, a skull, a Madonna and Christ, a hat and a feather, an Adam, an Eve, a cock, a sparrow, a lion with two tails, a pig with five legs,—anything will do for me. But see if I don't show you what engraving is, be my subject what it may'!

Thirdly : Beaugrand, I said, wants as much Sibyl as possible, and as much engraving. He is essentially a copyist, and has no ideas of his own, but deep reverence and love for the work of others. He will give his life to represent another man's thought. He will do his best with every spot and line,—exhibit to you, if you will only look, the most exquisite completion of obedient skill ; but will be content, if you will not look, to pass his neglected years in fruitful peace, and count every day well spent that has given softness to a shadow, or light to a smile.

III.

On Durer's landscape, with reference to the sentence in p. 112 :
 "I hope you are pleased."

I spoke just now only of the ill-shaped body of this figure of Fortune, or Pleasure. Beneath her feet is an elaborate landscape. It is all drawn out of Durer's head ;—he would look at bones or tendons carefully, or at the leaf details of foreground ;—but at the breadth and loveliness of real landscape, never.

He has tried to give you a bird's-eye view of Germany ; rocks, and woods, and clouds, and brooks, and the pebbles in their beds, and mills, and cottages, and fences, and what not ; but it is all a feverish dream, ghastly and strange, a monotone of diseased imagination.

And here is a little bit of the world he would not look at—of the great river of his land, with a single cluster of its reeds, and two boats, and an island with a village, and the way for the eternal waters opened between the rounded hills.*

* The engraving of Turner's "Scene on the Rhine" (near Bingen?) with boats on the right, and reedy foreground on left ; the opening

It is just what you may see any day, anywhere,—innocent, seemingly artless ; but the artlessness of Turner is like the face of Gainsborough's village girl, and a joy forever.

 IV.

On the study of anatomy.

The virtual beginner of artistic anatomy in Italy was a man called 'The Poulterer'—from his grandfather's trade ; 'Pollajuolo,' a man of immense power, but on whom the curse of the Italian mind in this age* was set at its deepest.

Any form of passionate excess has terrific effects on body and soul, in nations as in men ; and when this excess is in rage, and rage against your brother, and rage accomplished in habitual deeds of blood,—do you think Nature will forget to set the seal of her indignation upon the forehead ? I told you that the great division of spirit between the northern and southern races had been reconciled in the Val d'Arno. The Font of Florence, and the Font of Pisa, were as the very springs of the life of the Christianity which had gone forth to teach all nations, baptizing them in the name of the Prince of Peace. Yet these two brother cities were to each other—I do not say as Abel and Cain, but as Eteocles and Polyneices, and the words of Æschylus are now fulfilled in them to the uttermost. The Arno baptizes their dead bodies :—their native valley between its mountains is to them as the furrow of a grave ;—"and so much of their land they have, as is sepulchre." Nay, not of Florence and Pisa only was this true : Venice and Genoa died in death-grapple ; and eight cities of Lombardy divided between them the joy of levelling Milan to her lowest stone. Nay, not merely in city against city, but in

between its mountain banks in central distance. It is exquisitely engraved, the plate being of the size of the drawing, about ten inches by six, and finished with extreme care and feeling.

* See the horrible picture of St. Sebastian by him in our own National Gallery.

street against street, and house against house, the fury of the Theban dragon flamed ceaselessly, and with the same excuse upon men's lips. The sign of the shield of Polynices, Justice bringing back the exile, was to them all, in turn, the portent of death: and their history, in the sum of it and substance, is as of the servants of Joab and Abner by the pool of Gibeon. "They caught every one his fellow by the head, and thrust his sword in his fellow's side; so they fell down together: wherefore that place was called 'the field of the strong men.'"

Now it is not possible for Christian men to live thus, except under a fever of insanity. I have before, in my lectures on Prudence and Insolence in art, deliberately asserted to you the logical accuracy of the term 'demoniacal possession'—the being in the power or possession of a betraying spirit; and the definite sign of such insanity is delight in witnessing pain, usually accompanied by an instinct that gloats over or plays with physical uncleanness or disease, and always by a morbid egotism. It is not to be recognized for demoniacal power so much by its *viciousness*, as its *paltriness*,—the taking pleasure in minute, contemptible, and loathsome things.* Now, in the middle of the gallery of the Brera at Milan, there is an elaborate study of a dead Christ, entirely characteristic of early fifteenth century Italian madman's work. It is called—and was presented to the people as—a Christ; but it is only an anatomical study of a vulgar and ghastly dead body, with the soles of the feet set straight at the spectator, and the rest foreshortened. It is either Castagno's or Mantegna's,—in my mind, set down to Castagno; but I have not looked at the picture for years, and am not sure at this moment. It does not matter a straw which: it is exactly characteristic of the madness in which all of them—Pollajuolo, Castagno, Mantegna, Lionardo da Vinci, and Michael Angelo, polluted their work with the science of the sepulchre,† and degraded it with pre-

* As in the muscles of the legs and effort in stretching bows, of the executioners, in the picture just referred to.

† Observe. I entirely distinguish the study of *anatomy*—i.e., of intense bone and muscle—from study of the nude, as the Greeks practised

sumptuous and paltry technical skill. Foreshorten your Christ, and paint him, if you can, half putrefied,—that is the scientific art of the Renaissance.

It is impossible, however, in so vast a subject to distinguish always the beginner of things from the establisher. To the poulterer's son, Pollajuolo, remains the eternal shame of first making insane contest the only subject of art; but the two *establishers* of anatomy were Lionardo and Michael Angelo. You hear of Lionardo chiefly because of his Last Supper, but Italy did not hear of him for that. This was not what brought *her* to worship Lionardo—but the Battle of the Standard.

it. This for an entirely great painter is absolutely necessary; but yet I believe, in the case of Botticelli, it was nobly restricted. The following note by Mr. Tyrwhitt contains, I think, the probable truth:—

“The facts relating to Sandro Botticelli's models, or rather to his favourite model (as it appears to me), are but few; and it is greatly to be regretted that his pictures are seldom dated;—if it were certain in what order they appeared, what follows here might approach moral certainty.

“There is no doubt that he had great personal regard for Fra Filippo, up to that painter's death in 1469, Sandro being then twenty-two years old. He may probably have got only good from him; anyhow he would get a strong turn for Realism,—i.e., the treatment of sacred and all other subjects in a realistic manner. He is described in Crowe and Cavalcaselle from Filippino Lippi's Martyrdom of St. Peter, as a sullen and sensual man, with beetle brows, large fleshy mouth, etc., etc. Probably he was a strong man, and intense in physical and intellectual habit.

“This man, then, begins to paint in his strength, with conviction—rather happy and innocent than not—that it is right to paint any beautiful thing, and best to paint the most beautiful,—say in 1470, at twenty-three years of age. The allegorical Spring and the Graces, and the Aphrodite now in the Ufficii, were painted for Cosmo, and seem to be taken by Vasari and others as early, or early-central, works in his life: also the portrait of Simonetta Vespucci.¹ He is known to have painted much in early life for the Vespucci and the Medici;—and this daughter of the former house seems to have been innamorata or mistress of Giuliano de' Medici, murdered by the Pazzi in 1478. Now it seems agreed by Crowe and Cavalcaselle, Pater, etc., (and I am quite sure of it myself as to the pictures mentioned)—first, that the same slender and long-

¹ Pitti, Stanza di Prometeo, 348.

V.

Fragments on Holbein and others.

Of Holbein's St. Elizabeth, remember, she is not a perfect Saint Elizabeth, by any means. She is an honest and sweet German lady,—the best he could see ; he could do no better ;—and so I come back to my old story,—no man can do better than he sees : if he can reach the nature round him, it is well ; he may fall short of it ; he cannot rise above it ; “ the best, in this kind, are but shadows.”

* * * * * * *

Yet that intense veracity of Holbein is indeed the strength and glory of all the northern schools. They exist only in be-

throated model appears in Spring, the Aphrodite, Calumny, and other works.¹ Secondly, that she was Simonetta, the original of the Pitti portrait.

“ Now I think she must have been induced to let Sandro draw from her whole person undraped, more or less ; and that he must have done so as such a man probably would, in strict honour as to deed, word, and definite thought, but under occasional accesses of passion of which he said nothing, and which in all probability and by grace of God refined down to nil, or nearly so, as he got accustomed to look in honour at so beautiful a thing. (He may have left off the undraped after her death.) First, her figure is absolutely fine Gothic ; I don't think any antique is so slender. Secondly, she has the sad, passionate, and exquisite Lombard mouth. Thirdly, her limbs shrink together, and she seems not quite to have ‘ liked it,’ or been an accustomed model. Fourthly, there is tradition, giving her name to all those forms.

“ Her lover Giuliano was murdered in 1478, and Savonarola hanged and burnt in 1498. Now, can her distress, and Savonarola's preaching, between them, have taken, in few years, all the carnality out of Sandro, supposing him to have come already, by seventy-eight, to that state in which the sight of her delighted him, without provoking ulterior feelings ? All decent men accustomed to draw from the nude tell us they get to that.

“ Sandro's Dante is dated as published in 1482. He may have been saddening by that time, and weary of beauty, pure or mixed ;—though he went on painting Madonnas, I fancy. (Can Simonetta be traced in

¹ I think Zipporah may be a remembrance of her.

ing true. Their work among men is the definition of what is, and the abiding by it. They cannot dream of what is not. They make fools of themselves if they try. Think how feeble even Shakspeare is when he tries his hand at a Goddess;—women, beautiful and womanly,—as many as you choose; but who cares what his Minerva or Juno, say in the masque of the Tempest? And for the painters—when Sir Joshua tries for a Madonna, or Vandyke for a Diana—they can't even *paint!*

any of them? I think not. The Sistine paintings extend from 1481 to 1484, however. I cannot help thinking Zipporah is impressed with her.) After Savonarola's death, Sandro must have lost heart, and gone into Dante altogether. Most ways in literature and art lead to Dante; and this question about the nude and the purity of Botticelli is no exception to the rule.

“Now in the Purgatorio, Lust is the last sin of which we are to be made pure, and it has to be burnt out of us: being itself as searching as fire, as smouldering, devouring, and all that. *Corruptio optimi pessima*: and it is the most searching and lasting of evils, because it really is a corruption attendant on true Love, which is eternal—whatever the word means. That this is so, seems to me to demonstrate the truth of the Fall of Man from the condition of moral very-goodness in God's sight. And I think that Dante connected the purifying pains of his intermediate state with actual sufferings in this life, working out repentance,—in himself and others. And the ‘torment’ of this passion, to the repentant or resisting, or purity-seeking soul is decidedly like the pain of physical burning.

“Further, its casuistry is impracticable; because the more you stir the said ‘fire,’ the stronger hold it takes. Therefore, men and women are *rightly* secret about it, and detailed confessions unadvisable. Much talk about ‘hypocrisy’ in this matter is quite wrong and unjust. Then, its connexion with female beauty, as a cause of love between man and woman, seems to me to be the inextricable nodus of the Fall, the here inseparable mixture of good and evil, till soul and body are parted. For the sense of seen Beauty is the awakening of Love, at whatever distance from any kind of return or sympathy—as with a rose, or what not. Sandro may be the man who has gone nearest to the right separation of Delight from Desire: supposing that he began with religion and a straight conscience; saw lovingly the error of Fra Filippo's way; saw with intense distant love the error of Simonetta's; and reflected on Florence and *its* way, and drew nearer and nearer to Savonarola, being yet too big a man for asceticism; and finally wearied of all things, and sunk into poverty and peace.”

they become total simpletons. Look at Rubens' mythologies in the Louvre, or at modern French heroics, or German pietisms! Why, all—Cornelius, Hesse, Overbeck, and David—put together, are not worth one De Hooghe of an old woman with a broom sweeping a back-kitchen. The one thing we northerns can do is to find out what is fact, and insist on it: mean fact it may be, or noble,—but fact always, or we die.

Yet the intensest form of northern realization can be matched in the south, when the southernns choose. There are two pieces of animal drawing in the Sistine Chapel unrivalled for literal veracity. The sheep at the well in front of Zipporah; and afterwards, when she is going away, leading her children, her eldest boy, like every one else, has taken his chief treasure with him, and this treasure is his pet dog. It is a little sharp-nosed white fox-terrier, full of fire and life; but not strong enough for a long walk. So little Gershom, whose name was "the stranger" because his father had been a stranger in a strange land,—little Gershom carries his white terrier under his arm, lying on the top of a large bundle to make it comfortable. The doggie puts its sharp nose and bright eyes out, above his hand, with a little roguish gleam sideways in them, which means,—if I can read rightly a dog's expression,—that he has been barking at Moses all the morning, and has nearly put him out of temper:—and without any doubt, I can assert to you that there is not any other such piece of animal painting in the world,—so brief, intense, vivid, and absolutely balanced in truth; as tenderly drawn as if it had been a saint, yet as humorously as Landseer's Lord Chancellor poodle.

Oppose to Holbein's Veracity—Botticelli's Fantasy.

| | | | | |
|---|---|-----------|---|---------|
| " | " | Shade | " | Colour. |
| " | " | Despair | " | Faith. |
| " | " | Grossness | " | Purity. |

True Fantasy. Botticelli's Tree in Hellespontic Sibyl. Not a real tree at all—yet founded on intensest perception of beautiful reality. So the swan of Clio, as opposed to Durer's cock, or to Turner's swan.

The Italian power of abstraction into one mythologic personage—Holbein's death is only literal. He has to split his death into thirty different deaths ; and each is but a skeleton. But Orcagna's death is one—the power of death itself. There may thus be as much *breadth in thought*, as in execution.

* * * * *

What then, we have to ask, is a man *conscious of* in what he sees ?

For instance, in all Cruikshank's etchings—however slight the outline—there is an intense consciousness of light and shade, and of local colour, *as a part* of light and shade ; but none of colour itself. He was wholly incapable of colouring ; and perhaps this very deficiency enabled him to give graphic harmony to engraving.

* * * * *

Bewick—snow-pieces, etc. *Grey* predominant ; *perfect sense of colour*, coming out in patterns of birds ;—yet so uncultivated, that he engraves the brown birds better than pheasant or peacock !

For quite perfect consciousness of colour makes engraving impossible, and you have instead—Correggio.

VI.

Final notes on light and shade.

You will find in the 138th and 147th paragraphs of my inaugural lectures, statements which, if you were reading the book by yourselves, would strike you probably as each of them difficult, and in some degree inconsistent,—namely, that the school of colour has exquisite character and sentiment ; but is childish, cheerful, and fantastic ; while the school of shade is deficient in character and sentiment ; but supreme in intellect and veracity. “The way by light and shade,” I say, “is taken by men of the highest powers of thought and most earnest desire for truth.”

The school of shade, I say, is deficient in character and sentiment. Compare any of Durer's Madonnas with any of Angelico's.

Yet you may discern in the Apocalypse engravings that Durer's mind was seeking for truths, and dealing with questions, which no more could have occurred to Angelico's mind than to that of a two-years'-old baby.

The two schools unite in various degree ; but are always distinguishably generic, the two headmost masters representing each being Tintoret and Perugino. The one, deficient in sentiment, and continually offending us by the want of it, but full of intellectual power and suggestion.

The other, repeating ideas with so little reflection that he gets blamed for doing the same thing over again, (Vasari) ; but exquisite in sentiment and the conditions of taste which it forms, so as to become the master of it to Raphael and to all succeeding him ; and remaining such a type of sentiment, too delicate to be felt by the latter practical mind of Dutch-bred England, that Goldsmith makes the admiration of him the test of absurd connoisseurship. But yet, with under-current of intellect, which gets him accused of free-thinking, and therefore with under-current of entirely exquisite chiaroscuro.

Light and shade, then, imply the understanding of things—Colour, the imagination and the sentiment of them.

In Turner's distinctive work, colour is scarcely acknowledged unless under influences of sunshine. The sunshine is his treasure ; his lividest gloom contains it ; his greyest twilight regrets it, and remembers. Blue is always a blue shadow ; brown or gold, always light ;—nothing is cheerful but sunshine ; wherever the sun is not, there is melancholy or evil. Apollo is God ; and all forms of death and sorrow exist in opposition to him.

But in Perugino's distinctive work,—and therefore I have given him the captain's place over all,—there is simply *no* darkness, *no* wrong. Every colour is lovely, and every space is light. The world, the universe, is divine : all sadness is a part of harmony ; and all gloom, a part of peace.

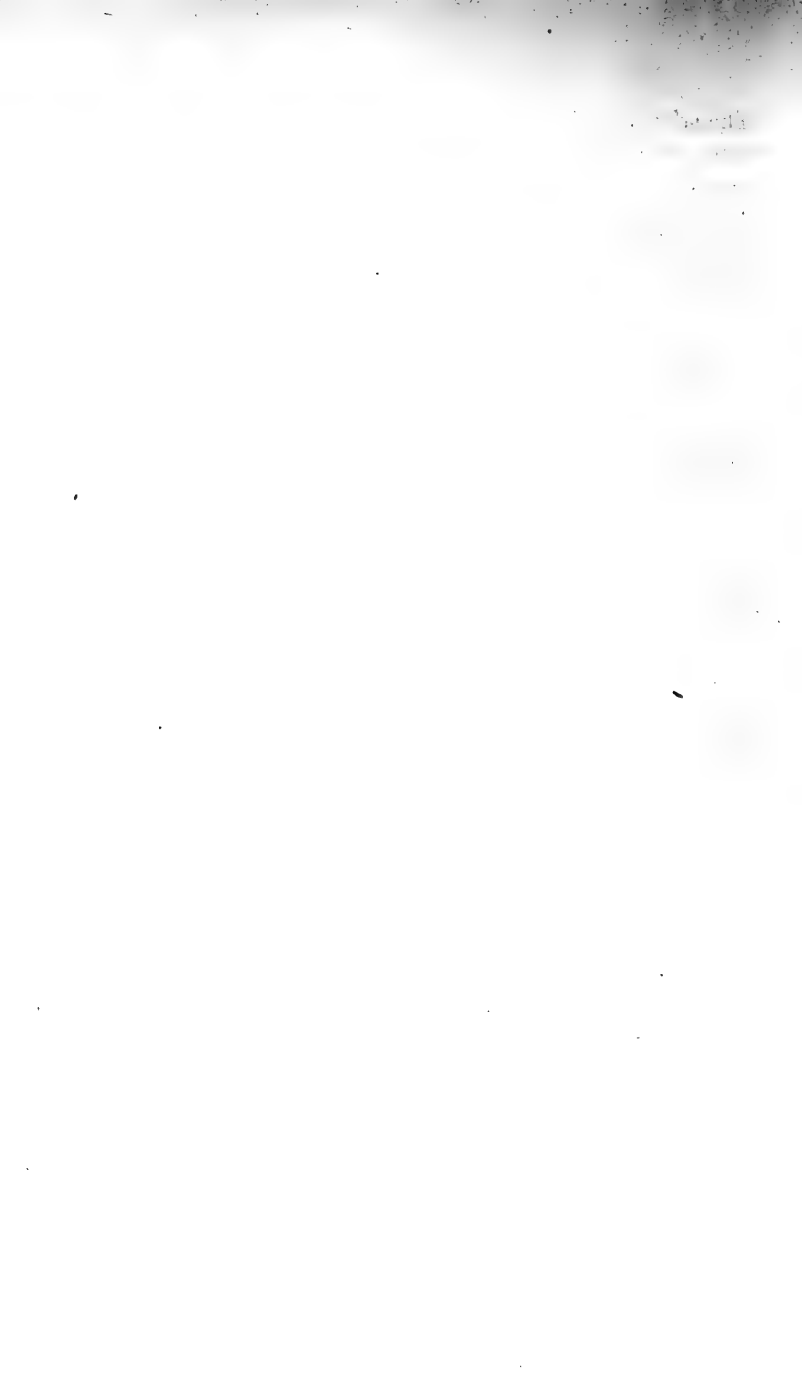

THE OPENING
OF
THE CRYSTAL PALACE

CONSIDERED IN SOME OF ITS RELATIONS TO THE
PROSPECTS OF ART



THE OPENING
OF
THE CRYSTAL PALACE

CONSIDERED IN SOME OF ITS RELATIONS TO THE PROSPECTS OF ART

I READ the account in the *Times* newspaper of the opening of the Crystal Palace at Sydenham, as I ascended the hill between Vevay and Chatel St. Denis, and the thoughts which it called up haunted me all day long, as my road wound among the grassy slopes of the Simmenthal. There was a strange contrast between the image of that mighty palace, raised so high above the hills on which it is built as to make them seem little else than a basement for its glittering stateliness, and those low larch huts, half hidden beneath their coverts of forest, and scattered like gray stones along the masses of far away mountain. Here, man contending with the power of Nature for his existence; there, commanding them for his recreation: here a feeble folk nested among the rocks with the wild goat and the coney, and retaining the same quiet thoughts from generation to generation; there, a great multitude triumphing in the splendour of immeasurable habitation, and haughty with hope of endless progress and irresistible power.

It is indeed impossible to limit, in imagination, the beneficent results which may follow from the undertaking thus happily begun. For the first time in the history of the world, a national museum is formed in which a whole nation is in-

terested ; formed on a scale which permits the exhibition of monuments of art in unbroken symmetry, and of the productions of nature in unthwarted growth,—formed under the auspices of science which can hardly err, and of wealth which can hardly be exhausted ; and placed in the close neighbourhood of a metropolis overflowing with a population weary of labour, yet thirsting for knowledge, where contemplation may be consistent with rest, and instruction with enjoyment. It is impossible, I repeat, to estimate the influence of such an institution on the minds of the working-classes. How many hours once wasted may now be profitably dedicated to pursuits in which interest was first awakened by some accidental display in the Norwood palace ; how many constitutions, almost broken, may be restored by the healthy temptation into the country air,—how many intellects, once dormant, may be roused into activity within the crystal walls, and how these noble results may go on multiplying and increasing and bearing fruit seventy times sevenfold, as the nation pursues its career,—are questions as full of hope as incapable of calculation. But with all these grounds for hope there are others for despondency, giving rise to a group of melancholy thoughts, of which I can neither repress the importunity nor forbear the expression.

For three hundred years, the art of architecture has been the subject of the most curious investigation ; its principles have been discussed with all earnestness and acuteness ; its models in all countries and of all ages have been examined with scrupulous care, and imitated with unsparing expenditure. And of all this refinement of enquiry,—this lofty search after the ideal,—this subtlety of investigation and sumptuousness of practice,—the great result, the admirable and long-expected conclusion is, that in the centre of the 19th century, we suppose ourselves to have invented a new style of architecture, when we have magnified a conservatory !

In Mr. Laing's speech, at the opening of the palace, he declares that "*an entirely novel order of architecture*, producing, by means of unrivalled mechanical ingenuity, the most marvellous and beautiful effects, sprang into existence to provide

a building."* In these words, the speaker is not merely giving utterance to his own feelings. He is expressing the popular view of the facts, nor that a view merely popular, but one which has been encouraged by nearly all the professors of art of our time.

It is to this, then, that our Doric and Palladian pride is at last reduced! We have vaunted the divinity of the Greek ideal—we have plumed ourselves on the purity of our Italian taste—we have cast our whole souls into the proportions of pillars, and the relations of orders—and behold the end! Our taste, thus exalted and disciplined, is dazzled by the lustre of a few rows of panes of glass; and the first principles of architectural sublimity, so far sought, are found all the while to have consisted merely in sparkling and in space.

Let it not be thought that I would depreciate (were it possible to depreciate) the mechanical ingenuity which has been displayed in the erection of the Crystal Palace, or that I underrate the effect which its vastness may continue to produce on the popular imagination. But mechanical ingenuity is *not* the essence either of painting or architecture: and largeness of dimension does not necessarily involve nobleness of design. There is assuredly as much ingenuity required to build a screw frigate, or a tubular bridge, as a hall of glass;—all these are works characteristic of the age; and all, in their several ways, deserve our highest admiration; but not admiration of the kind that is rendered to poetry or to art. We may cover the German Ocean with frigates, and bridge the Bristol Channel with iron, and roof the county of Middlesex with crystal, and yet not possess one Milton, or Michael Angelo.

Well, it may be replied, we need our bridges, and have pleasure in our palaces; but we do not want Miltons, nor Michael Angelos.

Truly, it seems so; for, in the year in which the first Crystal Palace was built, there died among us a man whose name, in after ages, will stand with those of the great of all time. Dying, he bequeathed to the nation the whole mass of his

* See the *Times* of Monday, June 12th.

most cherished works: and for these three years, while we have been building this colossal receptacle for casts and copies of the art of other nations, these works of our own greatest painter have been left to decay in a dark room near Cavendish Square, under the custody of an aged servant.

This is quite natural. But it is also memorable.

There is another interesting fact connected with the history of the Crystal Palace as it bears on that of the art of Europe, namely, that in the year 1851, when all that glittering roof was built, in order to exhibit the petty arts of our fashionable luxury—the carved bedsteads of Vienna, and glued toys of Switzerland, and gay jewellery of France—in that very year, I say, the greatest pictures of the Venetian masters were rotting at Venice in the rain, for want of roof to cover them, with holes made by cannon shot through their canvas.

There is another fact, however, more curious than either of these, which will hereafter be connected with the history of the palace now in building; namely, that at the very period when Europe is congratulated on the invention of a new style of architecture, because fourteen acres of ground have been covered with glass, the greatest examples in existence of true and noble Christian architecture were being resolutely destroyed; and destroyed by the effects of the very interest which was slowly beginning to be excited by them.

Under the firm and wise government of the third Napoleon, France has entered on a new epoch of prosperity, one of the signs of which is a zealous care for the preservation of her noble public buildings. Under the influence of this healthy impulse, repairs of the most extensive kind are at this moment proceeding, on the cathedrals of Rheims, Amiens, Rouen, Chartres, and Paris (probably also in many other instances unknown to me). These repairs were, in many cases, necessary up to a certain point; and they have been executed by architects as skilful and learned as at present exist,—executed with noble disregard of expense, and sincere desire on the part of their superintendents that they should be completed in a manner honourable to the country.

They are nevertheless more fatal to the monuments they

are intended to preserve, than fire, war, or revolution. For they are undertaken, in the plurality of instances, under an impression, which the efforts of all true antiquaries have as yet been unable to remove, that it is possible to reproduce the mutilated sculpture of past ages in its original beauty.

“Reproduire avec une exactitude mathématique,” are the words used, by one of the most intelligent writers on this subject,* of the proposed regeneration of the statue of Ste. Modeste, on the north porch of the Cathedral of Chartres.

Now, it is not the question at present, whether 13th century sculpture be of value, or not. Its value is assumed by the authorities who have devoted sums so large to its so-called restoration, and may therefore be assumed in my argument. The worst state of the sculptures whose restoration is demanded may be fairly represented by that of the celebrated group of the Fates, among the Elgin Marbles in the British Museum. With what favour would the guardians of those marbles, or any other persons interested in Greek art, receive a proposal from a living sculptor to “reproduce with mathematical exactitude” the group of the Fates, in a perfect form, and to destroy the original? For with exactly such favour, those who are interested in Gothic art should receive proposals to reproduce the sculpture of Chartres or Rouen.

In like manner, the state of the architecture which it is proposed to restore, may, at its worst, be fairly represented to the British public by that of the best preserved portions of Melrose Abbey. With what encouragement would those among us who are sincerely interested in history, or in art, receive a proposal to pull down Melrose Abbey, and “reproduce it mathematically?” There can be no doubt of the answer which, in the instances supposed, it would be proper to return. “By all means, if you can, reproduce mathematically, elsewhere, the group of the Fates, and the Abbey of Melrose. But leave unharmed the original fragment, and the existing ruin.” And an answer of the same tenour ought to be given to every proposal to restore a Gothic sculpture or building.

* M. l'Abbé Bulteau, Description de la Cathédrale de Chartres, (8vo. Paris, Sagnier et Bray, 1850), p. 98, note.

Carve or raise a model of it in some other part of the city: but touch not the actual edifice, except only so far as may be necessary to sustain, to protect it. I said above that repairs were in many instances necessary. These necessary operations consist in substituting new stones for decayed ones, where they are absolutely essential to the stability of the fabric; in propping, with wood or metal, the portions likely to give way; in binding or cementing into their places the sculptures which are ready to detach themselves; and in general care to remove luxuriant weeds, and obstructions of the channels for the discharge of the rain. But no modern or imitative sculpture ought *ever*, under any circumstances, to be mingled with the ancient work.

Unfortunately, repairs thus conscientiously executed are always unsightly, and meet with little approbation from the general public; so that a strong temptation is necessarily felt by all superintendents of public works, to execute the required repairs in a manner which, though indeed fatal to the monument, may be, in appearance, seemly. But a far more cruel temptation is held out to the architect. He who should propose to a municipal body, to build in the form of a new church, to be erected in some other part of their city, models of such portions of their cathedral as were falling into decay, would be looked upon as merely asking for employment, and his offer would be rejected with disdain. But let an architect declare that the existing fabric stands in need of repairs, and offer to restore it to its original beauty, and he is instantly regarded as a lover of his country, and has a chance of obtaining a commission which will furnish him with a large and steady income, and enormous patronage, for twenty or thirty years to come.

I have great respect for human nature. But I would rather leave it to others than myself to pronounce how far such a temptation is always likely to be resisted, and how far, when repairs are once permitted to be undertaken, a fabric is likely to be spared from mere interest in its beauty, when its destruction, under the name of restoration, has become permanently remunerative to a large body of workmen.

Let us assume, however, that the architect is always conscientious—always willing, the moment he has done what is strictly necessary for the safety and decorous aspect of the building, to abandon his income, and declare his farther services unnecessary. Let us presume, also, that every one of the two or three hundred workmen who must be employed under him, is equally conscientious, and, during the course of years of labour, will never destroy in carelessness what it may be inconvenient to save, or in cunning, what it is difficult to imitate. Will all this probity of purpose preserve the hand from error, and the heart from weariness? Will it give dexterity to the awkward—sagacity to the dull—and at once invest two or three hundred imperfectly educated men with the feeling, intention, and information, of the freemasons of the 13th century? Grant that it can do all this, and that the new building is both equal to the old in beauty, and precisely correspondent to it in detail. Is it, therefore, altogether *worth* the old building? Is the stone carved to-day in their masons' yards altogether the same in value to the hearts of the French people as that which the eyes of St. Louis saw lifted to its place? Would a loving daughter, in mere desire for gaudy dress, ask a jeweller for a bright facsimile of the worn cross which her mother bequeathed to her on her death-bed?—would a thoughtful nation, in mere fondness for splendour of streets, ask its architects to provide for it facsimiles of the temples which for centuries had given joy to its saints, comfort to its mourners, and strength to its chivalry?

But it may be replied, that all this is already admitted by the antiquaries of France and England; and that it is impossible that works so important should now be undertaken without due consideration and faithful superintendence.

I answer, that the men who justly feel these truths are rarely those who have much influence in public affairs. It is the poor abbé, whose little garden is sheltered by the mighty buttresses from the north wind, who knows the worth of the cathedral. It is the bustling mayor and the prosperous architect who determine its fate.

I answer farther, by the statement of a simple fact. I have

given many years, in many cities, to the study of Gothic architecture ; and of all that I know, or knew, the entrance to the north transept of Rouen Cathedral was, on the whole, the most beautiful—beautiful, not only as an elaborate and faultless work of the finest time of Gothic art, but yet more beautiful in the partial, though not dangerous, decay which had touched its pinnacles with pensive colouring, and softened its severer lines with unexpected change, and delicate fracture, like sweet breaks in a distant music. The upper part of it has been already restored to the white accuracies of novelty ; the lower pinnacles, which flanked its approach, far more exquisite in their partial ruin than the loveliest remains of our English abbeys, have been entirely destroyed, and rebuilt in rough blocks, now in process of sculpture. This restoration, so far as it has gone, has been executed by peculiarly skilful workmen ; it is an unusually favorable example of restoration, especially in the care which has been taken to preserve intact the exquisite, and hitherto almost uninjured sculptures which fill the quatrefoils of the tracery above the arch. But I happened myself to have made, five years ago, detailed drawings of the buttress decorations on the right and left of this tracery, which are part of the work that has been completely restored. And I found the restorations as inaccurate as they were unnecessary.

If this is the case in a most favourable instance, in that of a well-known monument, highly esteemed by every antiquary in France, what, during the progress of the now almost universal repairs, is likely to become of architecture which is unwatched and despised ?

Despised ! and more than despised—even hated ! It is a sad truth, that there is something in the solemn aspect of ancient architecture which, in rebuking frivolity and chastening gaiety, has become at this time literally *repulsive* to a large majority of the population of Europe. Examine the direction which is taken by all the influences of fortune and of fancy, wherever they concern themselves with art, and it will be found that the real, earnest effort of the upper classes of European society is to make every place in the world as much

like the Champs Elysées of Paris as possible. Wherever the influence of that educated society is felt, the old buildings are relentlessly destroyed ; vast hotels, like barracks, and rows of high, square-windowed dwelling-houses, thrust themselves forward to conceal the hated antiquities of the great cities of France and Italy. Gay promenades, with fountains and statues, prolong themselves along the quays once dedicated to commerce ; ball-rooms and theatres rise upon the dust of desecrated chapels, and thrust into darkness the humility of domestic life. And when the formal street, in all its pride of perfumery and confectionery, has successfully consumed its way through the wrecks of historical monuments, and consummated its symmetry in the ruin of all that once prompted to reflection, or pleaded for regard, the whitened city is praised for its splendour, and the exulting inhabitants for their patriotism—patriotism which consists in insulting their fathers with forgetfulness, and surrounding their children with temptation.

I am far from intending my words to involve any disrespectful allusion to the very noble improvements in the city of Paris itself, lately carried out under the encouragement of the Emperor. Paris, in its own peculiar character of bright magnificence, had nothing to fear, and everything to gain, from the gorgeous prolongations of the Rue Rivoli. But I speak of the general influence of the rich travellers and proprietors of Europe on the cities which they pretend to admire, or endeavour to improve. I speak of the changes wrought during my own lifetime, on the cities of Venice, Florence, Geneva, Lucerne, and chief of all on Rouen : a city altogether inestimable for its retention of mediæval character in the infinitely varied streets in which one half of the existing and inhabited houses date from the 15th or early 16th century ; and the only town left in France in which the effect of old French domestic architecture can yet be seen in its collective groups. But when I was there, this last spring, I heard that these noble old Norman houses are all, as speedily as may be, to be stripped of the dark slates which protected their timbers, and deliberately whitewashed over all their sculptures and orna-

ments, in order to bring the interior of the town into some conformity with the "handsome fronts" of the hotels and offices on the quay.

Hotels and offices, and "handsome fronts" in general—they can be built in America or Australia—built at any moment, and in any height of splendour. But who shall give us back, when once destroyed, the habitations of the French chivalry and bourgeoisie, in the days of the Field of the Cloth of Gold?

It is strange that no one seems to think of this! What do men travel for, in this Europe of ours? Is it only to gamble with French dies—to drink coffee out of French porcelain—to dance to the beat of German drums, and sleep in the soft air of Italy? Are the ball-room, the billiard-room, and the Boulevard, the only attractions that win us into wandering, or tempt us to repose? And when the time is come, as come it will, and that shortly, when the parsimony—or lassitude—which, for the most part, are the only protectors of the remnants of elder time, shall be scattered by the advance of civilisation—when all the monuments, preserved only because it was too costly to destroy them, shall have been crushed by the energies of the new world, will the proud nations of the twentieth century, looking round on the plains of Europe, disencumbered of their memorial marbles,—will those nations indeed stand up with no other feeling than one of triumph, freed from the paralysis of precedent and the entanglement of memory, to thank us, the fathers of progress, that no saddening shadows can any more trouble the enjoyments of the future,—no moments of reflection retard its activities; and that the new-born population of a world without a record and without a ruin, may, in the fulness of ephemeral felicity, dispose itself to eat, and to drink, and to die?

Is this verily the end at which we aim, and will the mission of the age have been then only accomplished, when the last castle has fallen from our rocks, the last cloisters faded from our valleys, the last streets, in which the dead have dwelt, been effaced from our cities, and regenerated society is left in luxurious possession of towns composed only of bright saloons,

overlooking gay parterres? If this be indeed our end, yet why must it be so laboriously accomplished? Are there no new countries on the earth, as yet uncrowned by Thorns of cathedral spires, untormented by the consciousness of a past? Must this little Europe—this corner of our globe, gilded with the blood of old battles, and grey with the temples of old pieties—this narrow piece of the world's pavement, worn down by so many pilgrims' feet, be utterly swept and garnished for the masque of the Future? Is America not wide enough for the elasticities of our humanity? Asia not rich enough for its pride? or among the quiet meadow-lands and solitary hills of the old land, is there not yet room enough for the spreadings of power, or the indulgences of magnificence, without founding all glory upon ruin, and prefacing all progress with obliteration?

We must answer these questions speedily, or we answer them in vain. The peculiar character of the evil which is being wrought by this age is its utter irreparableness. Its newly formed schools of art, its extending galleries, and well-ordered museums will assuredly bear some fruit in time, and give once more to the popular mind the power to discern what is great, and the disposition to protect what is precious. But it will be too late. We shall wander through our palaces of crystal, gazing sadly on copies of pictures torn by cannon-shot, and on casts of sculpture dashed to pieces long ago. We shall gradually learn to distinguish originality and sincerity from the decrepitudes of imitation and palsies of repetition; but it will be only in hopelessness to recognise the truth, that architecture and painting can be "restored" when the dead can be raised,—and not till then.

Something might yet be done, if it were but possible thoroughly to awaken and alarm the men whose studies of archæology have enabled them to form an accurate judgment of the importance of the crisis. But it is one of the strange characters of the human mind, necessary indeed to its peace, but infinitely destructive of its power, that we never thoroughly feel the evils which are not actually set before our eyes. If, suddenly, in the midst of the enjoyments of the

palate and lightnesses of heart of a London dinner-party, the walls of the chamber were parted, and through their gap, the nearest human beings who were famishing, and in misery, were borne into the midst of the company—feasting and fancy-free—if, pale with sickness, horrible in destitution, broken by despair, body by body, they were laid upon the soft carpet, one beside the chair of every guest, would only the crumbs of the dainties be cast to them—would only a passing glance, a passing thought be vouchsafed to them? Yet the actual facts, the real relations of each Dives and Lazarus, are not altered by the intervention of the house wall between the table and the sick-bed—by the few feet of ground (how few!) which are indeed all that separate the merriment from the misery.

It is the same in the matters of which I have hitherto been speaking. If every one of us, who knows what food for the human heart there is in the great works of elder time, could indeed see with his own eyes their progressive ruin; if every earnest antiquarian, happy in his well-ordered library, and in the sense of having been useful in preserving an old stone or two out of his parish church, and an old coin or two out of a furrow in the next ploughed field, could indeed behold, each morning as he awaked, the mightiest works of departed nations mouldering to the ground in disregarded heaps; if he could always have in clear phantasm before his eyes the ignorant monk trampling on the manuscript, the village mason striking down the monument, the court painter daubing the despised and priceless masterpiece into freshness of fatuity, he would not always smile so complacently in the thoughts of the little learnings and petty preservations of his own immediate sphere. And if every man who has the interest of Art and of History at heart, would at once devote himself earnestly—not to enrich his own collection—not even to enlighten his own neighbours or investigate his own parish-territory—but to far-sighted and *fore-sighted* endeavour in the great field of Europe, there is yet time to do much. An association might be formed, thoroughly organised so as to maintain active watchers and agents in every town of importance, who, in the first place,

should furnish the society with a *perfect* account of every monument of interest in its neighbourhood, and then with a yearly or half-yearly report of the state of such monuments, and of the changes proposed to be made upon them ; the society then furnishing funds, either to buy, freehold, such buildings or other works of untransferable art as at any time might be offered for sale, or to assist their proprietors, whether private individuals or public bodies, in the maintenance of such guardianship as was really necessary for their safety ; and exerting itself, with all the influence which such an association would rapidly command, to prevent unwise restoration, and unnecessary destruction.

Such a society would of course be rewarded only by the consciousness of its usefulness. Its funds would have to be supplied, in pure self-denial, by its members, who would be required, so far as they assisted it, to give up the pleasure of purchasing prints or pictures for their own walls, that they might save pictures which in their lifetime they might never behold ;—they would have to forego the enlargement of their own estates, that they might buy, for a European property, ground on which their feet might never tread. But is it absurd to believe that men are capable of doing this? Is the love of art altogether a selfish principle in the heart? and are its emotions altogether incompatible with the exertions of self-denial, or enjoyments of generosity?

I make this appeal at the risk of incurring only contempt for my Utopianism. But I should forever reproach myself if I were prevented from making it by such a risk ; and I pray those who may be disposed in anywise to favour it, to remember that it must be answered at once or never. The next five years determine what is to be saved—what destroyed. The restorations have actually begun like cancers on every important piece of Gothic architecture in Christendom ; the question is only how much can yet be saved. All projects, all pursuits, having reference to art, are at this moment of less importance than those which are simply protective. There is time enough for everything else. Time enough for teaching—time enough for criticising—time enough for inventing. But time little

enough for saving. Hereafter we can create, but it is now only that we can preserve. By the exertion of great national powers, and under the guidance of enlightened monarchs, we may raise magnificent temples and gorgeous cities ; we may furnish labour for the idle, and interest for the ignorant. But the power neither of emperors, nor queens, nor kingdoms, can ever print again upon the sands of time the effaced footsteps of departed generations, or gather together from the dust the stones which had been stamped with the spirit of our ancestors.

THE END.

ST. MARK'S REST
THE HISTORY OF VENICE

WRITTEN FOR THE HELP OF THE FEW TRAVELLERS WHO
STILL CARE FOR HER MOUNTAINS



CONTENTS

ST. MARK'S REST.

| | PAGE |
|--|------|
| PREFACE, | 3 |
| CHAPTER I. | |
| THE BURDEN OF TYRE, | 7 |
| CHAPTER II. | |
| LATRATOR ANUBIS, | 15 |
| CHAPTER III. | |
| ST. JAMES OF THE DEEP STREAM, | 25 |
| CHAPTER IV. | |
| ST. THEODORE THE CHAIR SELLER, | 32 |
| CHAPTER V. | |
| THE SHADOW ON THE DIAL, | 43 |
| CHAPTER VI. | |
| RED AND WHITE CLOUDS, | 49 |
| CHAPTER VII. | |
| DIVINE RIGHT, | 55 |
| CHAPTER VIII. | |
| THE REQUIEM, | 62 |
| NOTE ON THE MOSAICS OF ST. MARK'S, | 87 |

SUPPLEMENT I.

PAGE

THE SHRINE OF THE SLAVES, 89

SUPPLEMENT II.

Edited by J. RUSKIN.

THE PLACE OF DRAGONS, 123

APPENDIX TO CHAPTER VIII.

Edited by J. RUSKIN.

SANCTUS, SANCTUS, SANCTUS, 155

INDEX, 181

LECTURES ON ART.

LECTURE I.

INAUGURAL, 197

LECTURE II.

THE RELATION OF ART TO RELIGION, 218

LECTURE III.

THE RELATION OF ART TO MORALS, 238

LECTURE IV.

THE RELATION OF ART TO USE, 257

LECTURE V.

LINE, 275

LECTURE VI.

LIGHT, 290

LECTURE VII.

COLOUR, 310

ELEMENTS OF PERSPECTIVE.

| | PAGE |
|--|------|
| PREFACE, | 325 |
| INTRODUCTION, | 327 |
| PROBLEM I. | |
| TO FIX THE POSITION OF A GIVEN POINT, | 336 |
| PROBLEM II. | |
| TO DRAW A RIGHT LINE BETWEEN TWO GIVEN POINTS, - | 338 |
| PROBLEM III. | |
| TO FIND THE VANISHING-POINT OF A GIVEN HORIZONTAL LINE, 341. | 341 |
| PROBLEM IV. | |
| TO FIND THE DIVIDING-POINTS OF A GIVEN HORIZONTAL LINE, 346 | 346 |
| PROBLEM V. | |
| TO DRAW A HORIZONTAL LINE, GIVEN IN POSITION AND MAGNITUDE, BY MEANS OF ITS SIGHT-MAGNITUDE AND DIVIDING-POINTS, - - - - - | 347 |
| PROBLEM VI. | |
| TO DRAW ANY TRIANGLE GIVEN IN POSITION AND MAGNITUDE, IN A HORIZONTAL PLANE, - - - - - | 350 |
| PROBLEM VII. | |
| TO DRAW ANY RECTILINEAR QUADRILATERAL FIGURE, GIVEN IN POSITION AND MAGNITUDE, IN A HORIZONTAL PLANE, - | 351 |
| PROBLEM VIII. | |
| TO DRAW A SQUARE, GIVEN IN POSITION AND MAGNITUDE, IN A HORIZONTAL PLANE, - - - - - | 352 |

PROBLEM IX.

PAGE

TO DRAW A SQUARE PILLAR, GIVEN IN POSITION AND MAGNITUDE, ITS BASE AND TOP BEING IN HORIZONTAL PLANES, - 355

PROBLEM X.

TO DRAW A PYRAMID, GIVEN IN POSITION AND MAGNITUDE, OR A SQUARE BASE IN A HORIZONTAL PLANE, - - - 356

PROBLEM XI.

TO DRAW ANY CURVE IN A HORIZONTAL OR VERTICAL PLANE, 357

PROBLEM XII.

TO DIVIDE A CIRCLE DRAWN IN PERSPECTIVE INTO ANY GIVEN NUMBER OF EQUAL PARTS, - - - - 361

PROBLEM XIII.

TO DRAW A SQUARE GIVEN IN MAGNITUDE, WITHIN A LARGER SQUARE GIVEN IN POSITION AND MAGNITUDE; THE SIDES OF THE TWO SQUARES BEING PARALLEL, - - - - 363

PROBLEM XIV.

TO DRAW A TRUNCATED CIRCULAR CONE, GIVEN IN POSITION AND MAGNITUDE, THE TRUNCATIONS BEING IN HORIZONTAL PLANES, AND THE AXIS OF THE CONE VERTICAL, - - 365

PROBLEM V.

TO DRAW AN INCLINED LINE, GIVEN IN POSITION AND MAGNITUDE, - - - - - 367

PROBLEM XVI.

TO FIND THE VANISHING-POINT OF A GIVEN INCLINED LINE, 369

PROBLEM XVII.

TO FIND THE DIVIDING POINTS OF A GIVEN INCLINED LINE, 371

PROBLEM XVIII.

PAGE

TO FIND THE SIGHT-LINE OF AN INCLINED PLANE IN WHICH
TWO LINES ARE GIVEN IN POSITION, - - - - 373

PROBLEM XIX.

TO FIND THE VANISHING-POINT OF STEEPEST LINES IN AN IN-
CLINED PLANE WHOSE SIGHT-LINE IS GIVEN, . . . 374

PROBLEM XX.

TO FIND THE VANISHING-POINT OF LINES PERPENDICULAR TO
THE SURFACE OF A GIVEN INCLINED PLANE, - - - 375

APPENDIX.

I.

PRACTICE AND OBSERVATIONS ON THE PRECEDING PROBLEMS, 381

II.

DEMONSTRATIONS WHICH COULD NOT CONVENIENTLY BE IN-
CLUDED IN THE TEXT, 406

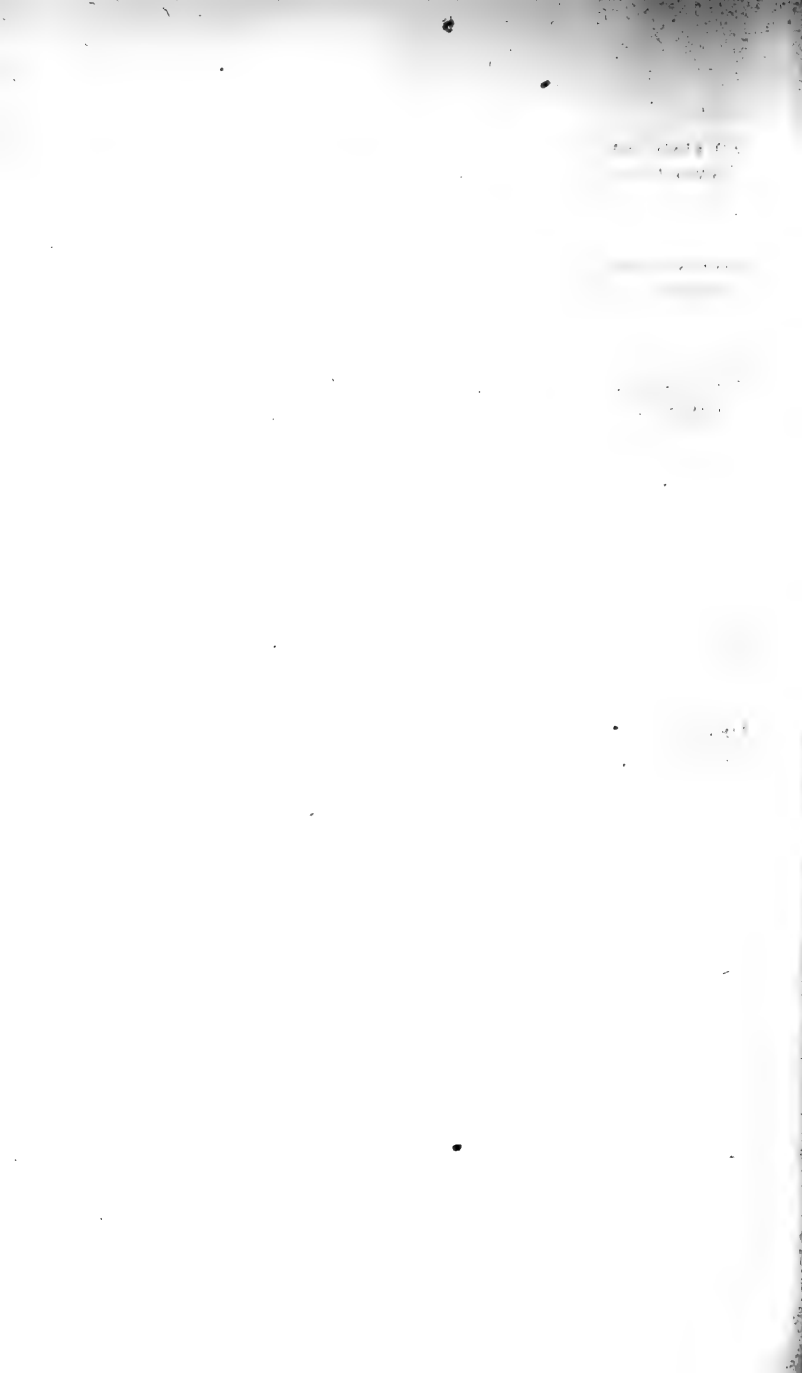

PREFACE.

GREAT nations write their autobiographies in three manuscripts—the book of their deeds, the book of their words, and the book of their art. Not one of these books can be understood unless we read the two others ; but of the three, the only quite trustworthy one is the last. The acts of a nation may be triumphant by its good fortune ; and its words mighty by the genius of a few of its children : but its art, only by the general gifts and common sympathies of the race.

Again, the policy of a nation may be compelled, and, therefore, not indicative of its true character. Its words may be false, while yet the race remain unconscious of their falsehood ; and no historian can assuredly detect the hypocrisy. But art is always instinctive ; and the honesty or pretence of it are therefore open to the day. The Delphic oracle may or may not have been spoken by an honest priestess,—we cannot tell by the words of it ; a liar may rationally believe them a lie, such as he would himself have spoken ; and a true man, with equal reason, may believe them spoken in truth. But there is no question possible in art : at a glance (when we have learned to read), we know the religion of Angelico to be sincere, and of Titian, assumed.

The evidence, therefore, of the third book is the most vital to our knowledge of any nation's life ; and the history of Venice is chiefly written in such manuscript. It once lay open on the waves, miraculous, like St. Cuthbert's book,—a golden legend on countless leaves : now, like Baruch's roll, it is being cut with the penknife, leaf by leaf, and consumed in the fire of the most brutish of the fiends. What fragments of it may yet be saved in blackened scroll, like those withered Cottonian relics in our National library, of which so much has

been redeemed by love and skill, this book will help you, partly, to read. Partly,—for I know only myself in part; but what I tell you, so far as it reaches, will be truer than you have heard hitherto, because founded on this absolutely faithful witness, despised by other historians, if not wholly unintelligible to them.

I am obliged to write shortly, being too old now to spare time for any thing more than needful work; and I write at speed, careless of afterwards remediable mistakes, of which adverse readers may gather as many as they choose: that to which such readers are adverse will be found truth that can abide any quantity of adversity.

As I can get my chapters done, they shall be published in this form, for such service as they can presently do. The entire book will consist of not more than twelve such parts, with two of appendices, forming two volumes: if I can get what I have to say into six parts, with one appendix, all the better.

Two separate little guides, one to the Academy, the other to San Giorgio de' Schiavoni, will, I hope, be ready with the opening numbers of this book, which must depend somewhat on their collateral illustration; and what I find likely to be of service to the traveller in my old 'Stones of Venice' is in course of re-publication, with further illustration of the complete works of Tintoret. But this cannot be ready till the autumn; and what I have said of the mightiest of Venetian masters, in my lecture on his relation to Michael Angelo, will be enough at present to enable the student to complete the range of his knowledge to the close of the story of 'St. Mark's Rest.'

ST. MARK'S REST.

CHAPTER I.

THE BURDEN OF TYRE.

Go first into the Piazzetta, and stand anywhere in the shade, where you can well see its two granite pillars.

Your Murray tells you that they are 'famous,' and that the one is "surmounted by the bronze lion of St. Mark, the other by the statue of St. Theodore, the Protector of the Republic."

It does not, however, tell you why, or for what the pillars are 'famous.' Nor, in reply to a question which might conceivably occur to the curious, why St. Theodore should protect the Republic by standing on a crocodile; nor whether the "bronze lion of St. Mark" was cast by Sir Edwin Landseer, —or some more ancient and ignorant person; nor what these rugged corners of limestone rock, at the bases of the granite, were perhaps once in the shape of. Have you any idea why, for the sake of any such things, these pillars were once, or should yet be, more renowned than the Monument, or the column of the Place Vendôme, both of which are much bigger?

Well, they are famous, first, in memorial of something which is better worth remembering than the fire of London, or the achievements of the great Napoleon. And they are famous, or used to be, among artists, because they are beautiful columns; nay, as far as we old artists know, the most beautiful columns at present extant and erect in the conveniently visitable world.

Each of these causes of their fame I will try in some dim degree to set before you.

I said they were set there in memory of *things*,—not of the man who did the things. They are to Venice, in fact, what the Nelson column would be to London, if, instead of a statue of Nelson and a coil of rope, on the top of it, we had put one of the four Evangelists, and a saint, for the praise of the Gospel and of Holiness :—trusting the memory of Nelson to our own souls.

However, the memory of the Nelson of Venice, being now seven hundred years old, has more or less faded from the heart of Venice herself, and seldom finds its way into the heart of a stranger. Somewhat concerning him, though a stranger, you may care to hear, but you must hear it in quiet ; so let your boatmen take you across to San Giorgio Maggiore ; there you can moor your gondola under the steps in the shade, and read in peace, looking up at the pillars when you like.

In the year 1117, when the Doge Ordelafo Falier had been killed under the walls of Zara, Venice chose, for his successor, Domenico Michiel, Michael of the Lord, ‘Cattolico nomo e audace,’¹ a catholic and brave man, the servant of God and of St. Michael.

Another of Mr. Murray’s publications for your general assistance (‘Sketches from Venetian History’) informs you that, at this time, the ambassadors of the King of Jerusalem (the second Baldwin) were “awakening the pious zeal, and stimulating the commercial appetite, of the Venetians.”

This elegantly balanced sentence is meant to suggest to you that the Venetians had as little piety as we have ourselves, and were as fond of money—that article being the only one which an Englishman could now think of, as an object of “commercial appetite.”

The facts which take this aspect to the lively cockney, are, in reality, that Venice was sincerely pious, and intensely covetous. But not covetous merely of money. She was covetous, first, of fame ; secondly, of kingdom ; thirdly, of pillars of

¹ Marin Sanuto. *Vitæ Ducum Venetorum*, henceforward quoted as V., with references to the pages of Muratori’s edition. See Appendix, Art. 1, which with following appendices will be given in a separate number as soon as there are enough to form one.

marble and granite, such as these that you see ; lastly, and quite principally, of the relics of good people. Such an 'appetite,' glib-tongued cockney friend, is not wholly 'commercial.'

To the nation in this religiously covetous hunger, Baldwin appealed, a captive to the Saracen. The Pope sent letters to press his suit, and the Doge Michael called the State to council in the church of St. Mark. There he, and the Primate of Venice, and her nobles, and such of the people as had due entrance with them, by way of beginning the business, celebrated the Mass of the Holy Spirit. Then the Primate read the Pope's letters aloud to the assembly ; then the Doge made the assembly a speech. And there was no opposition party in that parliament to make opposition speeches ; and there were no reports of the speech next morning in any Times or Daily Telegraph. And there were no plenipotentiaries sent to the East, and back again. But the vote passed for war.

The Doge left his son in charge of the State ; and sailed for the Holy Land, with forty galleys and twenty-eight beaked ships of battle—"ships which were painted with divers colors,"¹ far seen in pleasant splendor.

Some faded likeness of them, twenty years ago, might be seen in the painted sails of the fishing boats which lay crowded, in lowly lustre, where the development of civilization now only brings black steam-tugs,² to bear the people of Venice to the bathing-machines of Lido, covering their Ducal Palace with soot, and consuming its sculptures with sulphurous acid.

The beaked ships of the Doge Michael had each a hundred oars,—each oar pulled by two men, not accommodated with sliding seats, but breathed well for their great boat-race between the shores of Greece and Italy,—whose names, alas, with

¹ 'The Acts of God, by the Franks.' Afterwards quoted as G. (*Gesta Dei*). Again, see Appendix, Art. 1.

² The sails may still be seen scattered farther east along the Riva ; but the beauty of the scene, which gave some image of the past, was in their combination with the Ducal Palace,—not with the new French and English Restaurants.

the names of their trainers, are noteless in the journals of the barbarous time.

They beat their way across the waves, nevertheless,¹ to the place by the sea-beach in Palestine where Dorcas worked for the poor, and St. Peter lodged with his namesake tanner. There, showing first but a squadron of a few ships, they drew the Saracen fleet out to sea, and so set upon them.

And the Doge, in his true Duke's place, first in his beaked ship, led for the Saracen admiral's, struck her, and sunk her. And his host of falcons followed to the slaughter : and to the prey also,—for the battle was not without gratification of the commercial appetite. The Venetians took a number of ships containing precious silks, and “ a quantity of drugs and pepper.”

After which battle, the Doge went up to Jerusalem, there to take further counsel concerning the use of his Venetian power ; and, being received there with honor, kept his Christmas in the mountain of the Lord.

In the council of war that followed, debate became stern whether to undertake the siege of Tyre or Ascalon. The judgments of men being at pause, the matter was given to the judgment of God. They put the names of the two cities in an urn, on the altar of the Church of the Sepulchre. An orphan child was taken to draw the lots, who, putting his hand into the urn, drew out the name of TYRE.

Which name you may have heard before, and read perhaps words concerning her fall—careless always *when* the fall took place, or whose sword smote her.

She was still a glorious city, still queen of the treasures of the sea ;² chiefly renowned for her work in glass and in purple ; set in command of a rich plain, “ irrigated with plentiful and perfect waters, famous for its sugar-canes ; ‘ fortissi-

¹ Oars, of course, for calm, and adverse winds, only ; bright sails full to the helpful breeze.

² “ Passava tuttavia per la piu popolosa e commerciante di Siria.”—Romanin, ‘ Storia Documentata di Venezia,’ Venice, 1853, vol. ii., whence I take what else is said in the text ; but see in the *Gesta Dei*, the older Marin Sanuto, lib. iii., pars. vi. cap. xii., and pars. xiv. cap. ii.

ma, she herself, upon her rock, double walled towards the sea, treble walled to the land ; and, to all seeming, unconquerable but by famine."

For their help in this great siege, the Venetians made their conditions.

That in every city subject to the King of Jerusalem, the Venetians should have a street, a square, a bath, and a bake-house : that is to say, a place to live in, a place to meet in, and due command of water and bread, all free of tax ; that they should use their own balances, weights, and measures (not by any means false ones, you will please to observe) ; and that the King of Jerusalem should pay annually to the Doge of Venice, on the Feast of St. Peter and St. Paul, three hundred Saracen byzants.

Such, with due approval of the two Apostles of the Gentiles, being the claims of these Gentile mariners from the King of the Holy City, the same were accepted in these terms : "In the name of the Holy and undivided Trinity of the Father, the Son, and the Holy Ghost, these are the treaties which Baldwin, second King of the Latins in Jerusalem, made with St. Mark and Dominicus Michael" ; and ratified by the signatures of—

GUARIMOND, Patriarch of Jerusalem ;

EBREMAR, Archbishop of Cæsarea ;

BERNARD, Archbishop of Nazareth ;

ASQUIRIN, Bishop of Bethlehem ;

GOLDUMUS, Abbot of St. Mary's, in the Vale of Jehoshaphat ;

ACCHARD, Prior of the Temple of the Lord ;

GERARD, Prior of the Holy Sepulchre ;

ARNARD, Prior of Mount Syon ; and

HUGO DE PAGANO, Master of the Soldiers of the Temple.

With others many, whose names are in the chronicle of Andrea Dandolo.

And thereupon the French crusaders by land, and the Venetians by sea, drew line of siege round Tyre.

You will not expect me here, at St. George's steps, to give

account of the various mischief done on each other with the dart, the stone, and the fire, by the Christian and Saracen, day by day. Both were at last wearied, when report came of help to the Tyrians by an army from Damascus, and a fleet from Egypt. Upon which news, discord arose in the invading camp; and rumor went abroad that the Venetians would desert their allies, and save themselves in their fleet. These reports coming to the ears of the Doge, he took (according to tradition) the sails from his ships' masts, and the rudders from their sterns,¹ and brought sails, rudders, and tackle ashore, and into the French camp, adding to these, for his pledge, "grave words."

The French knights, in shame of their miscreance, bade him refit his ships. The Count of Tripoli and William of Bari were sent to make head against the Damascenes; and the Doge, leaving ships enough to blockade the port, sailed himself, with what could be spared, to find the Egyptian fleet. He sailed to Alexandria, showed his sails along the coast in defiance, and returned.

Meantime his coin for payment of his mariners was spent. He did not care to depend on remittances. He struck a coinage of leather, with St. Mark's and his own shield on it, promising his soldiers that for every leathern rag, so signed, at Venice, there should be given a golden zecchin. And his word was taken; and his word was kept.

So the steady siege went on, till the Tyrians lost hope, and asked terms of surrender.

They obtained security of person and property, to the indignation of the Christian soldiery, who had expected the sack of Tyre. The city was divided into three parts, of which

¹ By doing this he left his fleet helpless before an enemy, for naval warfare at this time depended wholly on the fine steering of the ships at the moment of onset. But for all ordinary manœuvres necessary for the safety of the fleet in harbor, their oars were enough. Andrea Dandolo says he took a plank ("tabula") out of each ship.—a more fatal injury. I suspect the truth to have been that he simply unshipped the rudders, and brought them into camp; a grave speechless symbol, earnest enough, but not costly of useless labor.

two were given to the King of Jerusalem, the third to the Venetians.

How Baldwin governed his two thirds, I do not know, nor what capacity there was in the Tyrians of being governed at all. But the Venetians, for their third part, appointed a 'bailo' to do civil justice, and a 'viscount' to answer for military defence; and appointed magistrates under these, who, on entering office, took the following oath:—

"I swear on the holy Gospels of God, that sincerely and without fraud I will do right to all men who are under the jurisdiction of Venice in the city of Tyre; and to every other who shall be brought before me for judgment, according to the ancient use and law of the city. And so far as I know not, and am left uninformed of that, I will act by such rule as shall appear to me just, according to the appeal and answer. Farther, I will give faithful and honest counsel to the Bailo and the Viscount, *when I am asked for it*; and if they share any secret with me, I will keep it; neither will I procure by fraud, good to a friend, nor evil to an enemy." And thus the Venetian state planted stable colonies in Asia.

Thus far Romanin; to whom, nevertheless, it does not occur to ask what 'establishing colonies in Asia' meant for Venice. Whether they were in Asia, Africa, or the Island of Atlantis, did not at this time greatly matter; but it mattered infinitely that they were *colonies living in friendly relations with the Saracen*, and that at the very same moment arose cause of quite other than friendly relations, between the Venetian and the Greek.

For while the Doge Michael fought for the Christian king at Jerusalem, the Christian emperor at Byzantium attacked the defenceless states of Venice, on the mainland of Dalmatia, and seized their cities. Whereupon the Doge set sail homewards, fell on the Greek islands of the Egean, and took the spoil of them; seized Cephalonia; recovered the lost cities of Dalmatia; compelled the Greek emperor to sue for peace,—gave it, in angry scorn; and set his sails at last for his own Rialto, with the sceptres of Tyre and of Byzantium to lay at the feet of Venice.

Spoil also he brought, enough, of such commercial kind as Venice valued. These pillars that you look upon, of rosy and gray rock ; and the dead bodies of St. Donato and St. Isidore.

He thus returned, in 1126 : Fate had left him yet four years to live. In which, among other homely work, he made the beginning for you (oh much civilized friend, you will at least praise him in this) of these mighty gaseous illuminations by which Venice provides for your seeing her shop-wares by night, and provides against your seeing the moon, or stars, or sea.

For, finding the narrow streets of Venice dark, and opportune for robbers, he ordered that at the heads of them there should be set little tabernacles for images of the saints, and before each a light kept burning. Thus he commands,—not as thinking that the saints themselves had need of candles, but that they would gladly grant to poor mortals in danger, material no less than heavenly light.

And having in this pretty and lowly beneficence ended what work he had to do in this world, feeling his strength fading, he laid down sword and ducal robe together ; and became a monk, in this island of St. George, at the shore of which you are reading : but the old monastery on it which sheltered him was destroyed long ago, that this stately Palladian portico might be built, to delight Mr. Eustace on his classical tour,—and other such men of renown,—and persons of excellent taste, like yourself.

And there he died, and was buried ; and there he lies, virtually tombless ; the place of his grave you find by going down the steps on your right hand behind the altar, leading into what was yet a monastery before the last Italian revolution, but is now a finally deserted loneliness.

Over his grave there is a heap of frightful modern upholsterer's work,—Longhena's ; his first tomb (of which you may see some probable likeness in those at the side of St. John and St. Paul) being removed as too modest and timeworn for the vulgar Venetian of the seventeenth century ; and this, that you see, put up to please the Lord Mayor and the beadles.

The old inscription was copied on the rotten black slate which is breaking away in thin flakes, dimmed by dusty salt. The beginning of it yet remains: "Here lies the Terror of the Greeks." Read also the last lines:

"WHOSOEVER THOU ART, WHO COMEST TO BEHOLD THIS TOMB OF HIS, BOW THYSELF DOWN BEFORE GOD, BECAUSE OF HIM."

Of these things, then, the two pillars before you are 'famous' in memorial. What in themselves they possess deserving honor, we will next try to discern. But you must row a little nearer to the pillars, so as to see them clearly.

CHAPTER II.

LATRATOR ANUBIS.

I SAID these pillars were the most beautiful known to me, but you must understand this saying to be of the whole pillar—group of base, shaft, and capital—not only of their shafts.

You know so much of architecture, perhaps, as that an 'order' of it is the system, connecting a shaft with its capital and cornice. And you can surely feel so much of architecture, as that, if you took the heads off these pillars, and set the granite shafts simply upright on the pavement, they would perhaps remind you of ninepins, or rolling-pins, but would in no wise contribute either to respectful memory of the Dóge Michael, or to the beauty of the Piazzetta.

Their beauty, which has been so long instinctively felt by artists, consists then first in the proportion, and then in the propriety of their several parts. Do not confuse proportion with propriety. An elephant is as properly made as a stag; but he is not so gracefully proportioned. In fine architecture, and all other fine arts, grace and propriety meet.

I will take the fitness first. You see that both these pillars have wide bases of successive steps.¹ You can feel that these

¹ Restored,—but they always must have had them, in some such proportion.

would be 'improper' round the pillars of an arcade in which people walked, because they would be in the way. But they are proper here, because they tell us the pillar is to be isolated, and that it is a monument of importance. Look from these shafts to the arcade of the Ducal Palace. Its pillars have been found fault with for wanting bases. But they were meant to be walked beside without stumbling.

Next, you see the tops of the capitals of the great pillars spread wide, into flat tables. You can feel, surely, that these are entirely 'proper,' to afford room for the statues they are to receive, and that the edges, which bear no weight, may 'properly' extend widely. But suppose a weight of superincumbent wall were to be laid on these pillars? The extent of capital which is now graceful, would then be weak and ridiculous.

Thus far of propriety, whose simple laws are soon satisfied: next, of proportion.

You see that one of the shafts—the St. Theodore's—is much more slender than the other.

One general law of proportion is that a slender shaft should have a slender capital, and a ponderous shaft, a ponderous one.

But had this law been here followed, the companion pillars would have instantly become ill-matched. The eye would have discerned in a moment the fat pillar and the lean. They would never have become the fraternal pillars—'the two' of the Piazzetta.

With subtle, scarcely at first traceable, care, the designer varied the curves and weight of his capitals; and gave the massive head to the slender shaft, and the slender capital to the massive shaft. And thus they stand in symmetry, and uncontending equity.

Next, for the form of these capitals themselves, and the date of them.

You will find in the guide-books that though the shafts were brought home by the Doge in 1126, no one could be found able to set them up, until the year 1171, when a certain Lombard, called Nicholas of the Barterers, raised them, and

for reward of such engineering skill, bargained that he might keep tables for forbidden games of chance between the shafts. Whereupon the Senate ordered that executions should also take place between them.

You read, and smile, and pass on with a dim sense of having heard something like a good story.

Yes ; of which I will pray you to remark, that at that uncivilized time, games of chance were forbidden in Venice, and that in these modern civilized times they are not forbidden ; and one, that of the lottery, even promoted by the Government as gainful : and that perhaps the Venetian people might find itself more prosperous on the whole by obeying that law of their fathers,¹ and ordering that no lottery should be drawn, except in a place where somebody had been hanged.² But the curious thing is that while this pretty story is never forgotten, about the raising of the pillars, nothing is ever so much as questioned about who put their tops and bases to them !—nothing about the resolution that lion or saint should stand to preach on them,—nothing about the Saint's sermon, or the Lion's ; nor enough, even, concerning the name or occupation of Nicholas the Barterer, to lead the pensive traveller into a profitable observance of the appointment of Fate, that in this Tyre of the West, the city of merchants, her monuments of triumph over the Tyre of the East should forever stand signed by a tradition recording the stern judgment of her youth against the gambler's lust, which was the passion of her old age.

But now of the capitals themselves. If you are the least interested in architecture, should it not be of some importance to you to note the style of them ? Twelfth century capitals, as fresh as when they came from the chisel, are not to be seen every day, or everywhere—much less capitals like these, a fathom or so broad and high ! And if you know the

¹ Have you ever read the 'Fortunes of Nigel' with attention to the moral of it ?

² It orders now that the drawing should be at the foot of St. Mark's Campanile ; and, weekly, the mob of Venice, gathered for the event, fills the marble porches with its anxious murmur.

architecture of England and France in the twelfth century, you will find these capitals still more interesting from their extreme difference in manner. Not the least like our clumps and humps and cushions, are they? For these are living Greek work, still; not savage Norman or clumsy Northumbrian, these; but of pure Corinthian race; yet, with Venetian practicalness of mind, solidified from the rich-clusters of light leafage which were their ancient form. You must find time for a little practical cutting of capitals yourself, before you will discern the beauty of these. There is nothing like a little work with the fingers for teaching the eyes.

As you go home to lunch, therefore, buy a pound of Gruyère cheese, or of any other equally tough and bad, with as few holes in it as may be. And out of this pound of cheese, at lunch, cut a solid cube as neatly as you can.

Now all treatment of capitals depends primarily on the way in which a cube of stone, like this of cheese, is left by the carver square at the top, to carry the wall, and cut round at the bottom to fit its circular pillar. Proceed therefore to cut your cube so that it may fit a round pillar of cheese at the bottom, such as is extracted, for tasting, by magnanimous cheesemongers, for customers worth their while. Your first natural proceeding will of course be to cut off four corners; so making an octagon at the bottom, which is a good part of the way to a circle. Now if you cut off those corners with rather a long, sweeping cut, as if you were cutting a pencil, you will see that already you have got very near the shape of the Piazzetta capitals. But you will come still nearer, if you make each of these simple corner-cuts into two narrower ones, thus bringing the lower portion of your bit of cheese into a twelve-sided figure. And you will see that each of these double-cut angles now has taken more or less the shape of a leaf, with its central rib at the angle. And if, further, with such sculpturesque and graphic talent as may be in you, you scratch out the real shape of a leaf at the edge of the cuts and run furrows from its outer lobes to the middle,— behold, you have your Piazzetta capital. *All but* have it, I should say; only this ‘all but’ is nearly all the good of it,

which comes of the exceeding fineness with which the simple curves are drawn, and reconciled.

Nevertheless, you will have learned, if sagacious in such matters, by this quarter of an hour's carving, so much of architectural art as will enable you to discern, and to enjoy the treatment of, all the twelfth and thirteenth century capitals in Venice, which, without exception, when of native cutting, are concave bells like this, with either a springing leaf, or a bending boss of stone which would become a leaf if it were furrowed, at the angles. But the fourteenth century brings a change.

Before I tell you what took place in the fourteenth century, you must cut yourself another cube of Gruyère cheese. You see that in the one you have made a capital of already, a good weight of cheese out of the cube has been cut away in tapering down those long-leaf corners. Suppose you try now to make a capital of it without cutting away so much cheese. If you begin half way down the side, with a shorter but more curved cut, you may reduce the base to the same form, and—supposing you are working in marble instead of cheese—you have not only much less trouble, but you keep a much more solid block of stone to bear superincumbent weight.

Now you may go back to the Piazzetta, and, thence proceeding, so as to get well in front of the Ducal Palace, look first to the Greek shaft capitals, and then to those of the Ducal Palace upper arcade. You will recognize, especially in those nearest the Ponte della Paglia (at least, if you have an eye in your head), the shape of your second block of Gruyère,—decorated, it is true, in manifold ways, but essentially shaped like your most cheaply cut block of cheese. Modern architects, in imitating these capitals, can reach as far as—imitating your Gruyère. Not being able to decorate the block when they have got it, they declare that decoration is “a superficial merit.”

Yes,—very superficial. Eyelashes and eyebrows—lips and nostrils—chin-dimples and curling hair, are all very superficial things, wherewith Heaven decorates the human skull; making the maid's face of it, or the knight's. Nevertheless, what I

want you to notice now, is but the form of the block of Istrian stone, usually with a spiral, more or less elaborate, on each of its projecting angles. For there is infinitude of history in that solid angle, prevailing over the light Greek leaf. That is related to our humps and clumps at Durham and Winchester. Here is, indeed, Norman temper, prevailing over Byzantine; and it means,—the outcome of that quarrel of Michael with the Greek Emperor. It means—western for eastern life, in the mind of Venice. It means her fellowship with the western chivalry; her triumph in the Crusades,—triumph over her own foster nurse, Byzantium.

Which significances of it, and many others with them, if we would follow, we must leave our stone-cutting for a little while, and map out the chart of Venetian history from its beginning into such masses as we may remember without confusion.

But, since this will take time, and we cannot quite tell how long it may be before we get back to the twelfth century again, and to our Piazzetta shafts, let me complete what I can tell you of these at once.

In the first place, the Lion of St. Mark is a splendid piece of eleventh or twelfth century bronze. I know that by the style of him; but have never found out where he came from.¹ I may now chance on it, however, at any moment in other quests. Eleventh or twelfth century, the Lion—fifteenth, or later, his wings; very delicate in feather-workmanship, but with little lift or strike in them; decorative mainly. Without doubt his first wings were thin sheets of beaten bronze, shred into plumage; far wider in their sweep than these.²

¹ "He"—the actual piece of forged metal, I mean. (See Appendix II. for account of its recent botchings.) Your modern English explainers of him have never heard, I observe, of any such person as an 'Evangelist,' or of any Christian symbol of such a being! See page 42 of Mr. Adams' 'Venice Past and Present' (Edinburgh and New York, 1852).

² I am a little proud of this guess, for before correcting this sentence in type, I found the sharp old wings represented faithfully in the wood-cut of Venice in 1480, in the Correr Museum. Durer, in 1500, draws the present wings; so that we get their date fixed within twenty years.

The statue of St. Theodore, whatever its age, is wholly without merit. I can't make it out myself, nor find record of it: in a stonemason's yard, I should have passed it as modern. But this merit of the statue is here of little consequence,—the power of it being wholly in its meaning.

St. Theodore represents the power of the Spirit of God in all noble and useful animal life, conquering what is venomous, useless, or in decay: he differs from St. George in contending with material evil, instead of with sinful passion: the crocodile on which he stands is the Dragon of Egypt; slime-begotten of old, worshipped in its malignant power, for a God. St. Theodore's martyrdom was for breaking such idols; and with beautiful instinct Venice took him in her earliest days for her protector and standard-bearer, representing the heavenly life of Christ in men, prevailing over chaos and the deep.

With far more than instinct,—with solemn recognition, and prayerful vow, she took him in the pride of her chivalry, in mid-thirteenth century, for the master of that chivalry in their gentleness of home ministries. The 'Mariogola' (Mother-Law) of the school of St. Theodore, by kind fate yet preserved to us, contains the legend they believed, in its completeness, and their vow of service and companionship in all its terms.

Either of which, if you care to understand,—several other matters and writings must be understood first; and, among others, a pretty piece of our own much boasted,—how little obeyed,—Mother-Law, sung still by statute in our churches at least once in the month; the eighty-sixth Psalm. "Her foundations are in the holy Mountains." I hope you can go on with it by heart, or at least have your Bible in your portmanteau. In the remote possibility that you may have thought its carriage unnecessarily expensive, here is the Latin psalm, with its modern Italian-Catholic¹ translation; watery enough, this last, but a clear and wholesome, though little vapid, dilution and diffusion of its text,—making much intelligible to

¹ From the 'Uffizio della B. V. Maria, Italiano e Latino, per tutti i tempi dell' anno, del Padre G. Croiset,' a well printed and most serviceable little duodecimo volume, for any one wishing to know somewhat of Roman Catholic offices. Published in Milan and Venice.

the Protestant reader, which his 'private judgment' might occasionally have been at fault in.

Fundamenta eius in montibus sanctis: diligit Dominus portas Sion super omnia tabernacula Iacob.

Gloriosa dicta sunt de te, civitas Dei.

Memor ero Rahab et Babylonis, scientium me.

Ecce alienigenæ, et Tyrus, et populus Æthiopum hi fuerunt illic.

Numquid Sion dicet: Homo et homo natus est in ea, et ipse fundavit eam Altissimus?

Dominus narrabit in scripturis populorum et principum: horum qui fuerunt in ea.

Sicut lætantium ompium habitatio est in te.

Gerusalemme è fabbricata sopra i santi monti: Iddio ne prende più cura, e l' ama più che tutti gli altri luoghi che dal suo popolo sono abitati.

Quante cose tutte piene di lode sono state dette di voi, città di Dio!

Non lascerò nell' obliuione nè l' Egitto nè Babilonia, dacchè que' popoli mi avranno riconosciuto per loro Dio.

Quanti popoli stranieri, Tiri, Etiopi, sino a quel punto miei nemici, verranno a prestarmi i loro omaggi.

Ognuno dirà allora: Vedete come questa città si è popolata! l' Altissimo l' ha fondata e vuole metterla in fiore.

Egli perciò è l' unico che conosca il numero del popolo e de' grandi che ne sono gli abitanti.

Non vi è vera felicità, se non per coloro che vi haune l' abitazione.

Reading then the psalm in these words, you have it as the Western Christians sang it ever since St. Jerome wrote it into such interpretation for them; and you must try to *feel* it as these Western Christians of Venice felt it, having now their own street in the holy city, and their covenant with the Prior of Mount Syon, and of the Temple of the Lord: they themselves having struck down Tyre with their own swords, taken to themselves her power, and now reading, as of themselves, the encompassing benediction of the prophecy for all Gentile Nations, "Ecce alienigenæ—et Tyrus." A notable piece of

Scripture for them, to be dwelt on, in every word of it, with all humility of faith.

What then is the meaning of the two verses just preceding these?—

“Glorious things are spoken of thee, thou City of God. I will make mention of Rahab and Babylon, with them that know me.”

If you like to see a curious mistake at least of *one* Protestant's ‘private judgment’ of this verse, you must look at my reference to it in *Fors Clavigera* of April, 1876, p. 110, with its correction by Mr. Gordon, in *Fors* for June, 1876, pp. 178–203, all containing variously useful notes on these verses; of which the gist is, however, that the ‘Rahab’ of the Latin text is the Egyptian ‘Dragon,’ the crocodile, signifying in myth, which has now been three thousand years continuous in human mind, the total power of the crocodile-god of Egypt, couchant on his slime, born of it, mistakable for it,—his gray length of unintelligible scales, fissured and wrinkled like dry clay, itself but, as it were, a shelf or shoal of coagulated, malignant earth. He and his company, the deities born of the earth—beast headed,—with only animal cries for voices:—

“Omnigenumque Deúm monstra, et latrator Anubis
Contra Neptunum et Venerem, contraque Minervam.”

This is St. Theodore's Dragon-enemy—Egypt, and her captivity; bondage of the earth, literally to the Israelite, in making bricks of it, the first condition of form for the God: in sterner than mere literal truth, the captivity of the spirit of man, whether to earth or to its creatures.

And St. Theodore's victory is making the earth his pedestal, instead of his adversary; he is the power of gentle and rational life, reigning over the wild creatures and senseless forces of the world. The Latrator Anubis—most senseless and cruel of the guardians of hell—becoming, by human mercy, the faithfullest of creature-friends to man.

Do you think all this work useless in your Venetian guide? There is not a picture,—not a legend,—scarcely a column or an ornament, in the art of Venice or of Italy, which, by this

piece of work, well done, will not become more precious to you. Have you ever, for instance, noticed how the baying of Cerberus is stopped, in the sixth canto of Dante,—

“ Il duca mio
Prese la terra; et con piene le pugne
La gitto dentro alle bramose canne.”

(To the *three*, therefore plural.) It is one of the innumerable subtleties which mark Dante's perfect knowledge—inconceivable except as a form of inspiration—of the inner meaning of every myth, whether of classic or Christian theology, known in his day.

Of the relation of the dog, horse, and eagle to the chivalry of Europe, you will find, if you care to read, more noted, in relation to part of the legend of St. Theodore, in the Fors of March, this year; the rest of his legend, with what is notablest in his 'Mariegola,' I will tell you when we come to examine Carpaccio's canonized birds and beasts; of which, to refresh you after this piece of hard ecclesiastical reading (for I can't tell you about the bases of the pillars to-day. We must get into another humor to see these), you may see within five minutes' walk, three together, in the little chapel of St. George of the Schiavoni: St. George's 'Porphyrio,' the bird of chastity, with the bent spray of sacred vervain in its beak, at the foot of the steps on which St. George is baptizing the princess; St. Jerome's lion, being introduced to the monastery (with resultant effect on the minds of the brethren); and St. Jerome's dog, watching his master translating the Bible, with highest complacency of approval.

And of St. Theodore himself you may be glad to know that he was a very historical and substantial saint as late as the fifteenth century, for in the inventory of the goods and chattels of his scuola, made by order of its master (Gastoldo), and the companions, in the year 1450, the first article is the body of St. Theodore, with the bed it lies on, covered by a coverlid of "pañõ di grano di seta, brocado de oro fino." So late as the middle of the fifteenth century (certified by the inventario fatto a di XXX. de Novembrio MCCCCL. per. Sr nanni di

piero de la colōna, Gastoldo, e suoi campagni, de tutte reliquie e arnesi e beni, se trova in questa hora presente in la nostra scuola), here lay this treasure, dear to the commercial heart of Venice.

Oh, good reader, who hast ceased to count the Dead bones of men for thy treasure, hast thou then thy Dead laid up in the hands of the Living God ?

CHAPTER III.

ST. JAMES OF THE DEEP STREAM.

TWICE one is two, and twice two is four ; but twice one is not three, and twice two is not six, whatever Shylock may wish, or say, in the matter. In wholesome memory of which arithmetical, and (probably) eternal, fact, and in loyal defiance of Shylock and his knife, I write down for you these figures, large and plain :

1. 2. 4.

Also in this swiftly progressive ratio, the figures may express what modern philosophy considers the rate of progress of Venice, from her days of religion, and golden ducats, to her days of infidelity, and paper notes.

Read them backwards, then, sublime modern philosopher ; and they will give you the date of the birth of that foolish Venice of old time, on her narrow island.

4. 2. 1.

In that year, and on the very day—(little foolish Venice used to say, when she was a very child),—in which, once upon a time, the world was made ; and, once upon another time—the Ave Maria first said,—the first stone of Venice was laid on the sea sand, in the name of St. James the fisher.

I think you had better go and see with your own eyes,—tread with your own foot,—the spot of her nativity : so much

of a spring day as the task will take, cannot often be more profitably spent, nor more affectionately towards God and man, if indeed you love either of them.

So, from the Grand Hotel,—or the Swiss Pension—-or the duplicate Danieli with the drawbridge,—or wherever else among the palaces of resuscitated Venice you abide, congratulatory modern ambassador to the Venetian Senate,—please, to-day, walk through the Merceria, and through the Square of St. Bartholomew, where is the little octagon turret-chapel in the centre, for sale of news : and cross the Rialto—not in the middle of it, but on the right hand side, crossing from St. Mark's. You will probably find it very dirty,—it may be, indecently dirty,—that is modern progress, and Mr. Buckle's civilization ; rejoice in it with a thankful heart, and stay in it placidly, after crossing the height of the bridge, when you come down just on a level with the capitals of the first story of the black and white, all but ruined, Palace of the Camerlenghi ; Treasurers of Venice, built for them when she began to feel anxious about her accounts. “Black and white,” I call it, because the dark lichens of age are yet on its marble—or, at least, were, in the winter of '76-'77 ; it may be, even before these pages get printed, it will be scraped and regilt—or pulled down, to make a railroad station at the Rialto.

Here standing, if with good eyes, or a good opera glass, you look back, up to the highest story of the blank and ugly building on the side of the canal you have just crossed from,—you will see between two of its higher windows, the remains of a fresco of a female figure. It is, so far as I know, the last vestige of the noble fresco painting of Venice on her outside walls ;—Giorgione's,—no less,—when Titian and he were house-painters,—the Sea-Queen so ranking them, for her pomp, in her proud days. Of this, and of the black and white palace, we will talk another day. I only asked you to look at the fresco just now, because therein is seen the end of *my* Venice,—the Venice I have to tell you of. Yours, of the Grand Hotels and the Peninsular steamers, you may write the history of, for yourself.

Therein,—as it fades away—ends the Venice of St. Mark's

Rest. But where she was born, you may now go quite down the steps to see. Down, and through among the fruit-stalls into the little square on the right; then turning back, the low portico is in front of you—not of the ancient church indeed, but of a fifteenth century one—variously translated, in succeeding times, into such small picturesqueness of stage effect as it yet possesses; escaping, by God's grace, however, the fire which destroyed all the other buildings of ancient Venice, round her Rialto square, in 1513.¹

Some hundred or hundred and fifty years before that, Venice had begun to suspect the bodies of saints to be a poor property; carrion, in fact,—and not even exchangeable carrion. Living flesh might be bought instead,—perhaps of prettier aspect. So, as I said, for a hundred years or so, she had brought home no relics,—but set her mind on trade-profits, and other practical matters; tending to the achievement of wealth, and its comforts, and dignities. The curious result being, that at that particular moment, when the fire devoured her merchants' square, centre of the then mercantile world—she happened to have no money in her pocket to build it again with!

Nor were any of her old methods of business again to be resorted to. Her soldiers were now foreign mercenaries, and had to be paid before they would fight; and prayers, she had found out long before our English wiseacre apothecaries' apprentices, were of no use to get either money, or new houses with, at a pinch like this. And there was really nothing for it but doing the thing cheap,—since it had to be done. Fra Giocondo of Verona offered her a fair design; but the city could not afford it. Had to take Scarpagnino's make-shift instead; and with his help, and Sansovino's, between 1520 and 1550, she just managed to botch up—what you see surround the square, of architectural stateliness for her mercantile home. Discovery of the Cape of Good Hope, the main

¹ Many chronicles speak of it as burned; but the authoritative inscription of 1601 speaks of it as 'consumed by age,' and is therefore conclusive on this point.

cause of these sorrowful circumstances of hers,—observe sagacious historians.

At all events, I have no doubt the walls were painted red, with some medallions, or other cheap decoration, under the cornices, enough to make the little square look comfortable. Whitewashed and squalid now—it may be left, for this time, without more note of it, as we turn to the little church.¹

Your Murray tells you it was built “in its present form” in 1194, and “rebuilt in 1531, but precisely in the old form,” and that it “has a fine brick campanile.” The fine brick campanile, visible, if you look behind you, on the other side of the street, belongs to the church of St. John Elemosinario. And the statement that the church was “rebuilt in precisely the old form” must also be received with allowances. For the “campanile” here, is in the most orthodox English Jacobite style of the seventeenth century, the portico is Venetian fifteenth, the walls are in no style at all, and the little Madonna inserted in the middle of them is an exquisitely finished piece of the finest work of 1320 to 1350.

And, alas, the church is not only quite other in form, but even other in *place*, than it was in the fifth century, having been moved like a bale of goods, and with apparently as little difficulty as scruple, in 1322, on a report of the Salt Commissioners about the crowding of shops round it. And, in sum, of particulars of authentically certified vicissitudes, the little church has gone through these following—how many more than these, one cannot say—but these at least (see Appendix III.):

I. Founded traditionally in 421 (serious doubts whether on Friday or Saturday, involving others about the year itself.) The tradition is all we need care for.

II. Rebuilt, and adorned with Greek mosaic work by the Doge Domenico Selvo, in 1073; the Doge having married a Greek wife, and liking pretty things. Of this husband and wife you shall hear more, anon.

¹ Do not, if you will trust me, at this time let your guide take you to look at the Gobbo di Rialto, or otherwise interfere with your immediate business.

III. Retouched, and made bright again, getting also its due share of the spoil of Byzantium sent home by Henry Dandolo, 1174.

IV. Dressed up again, and moved out of the buyers' and sellers' way, in 1322.

V. 'Instaured' into a more splendid church (dicto templo in splendidiorem ecclesiam instaurato) by the elected plebanus, Natalis Regia, desirous of having the church devoted to his honor instead of St. James's, 1531.

VI. Lifted up (and most likely therefore first much pulled down), to keep the water from coming into it, in 1601, when the double arched campanile was built, and the thing finally patched together in the present form. Doubtless, soon, by farther 'progresso' to become a provision, or, perhaps, a petroleum-store, Venice having no more need of temples; and being, as far as I can observe, ashamed of having so many, overshadowing her buyers and sellers. Better rend the veils in twain forever, if convenient storeshops may be formed inside.

These, then, being authentic epochs of change, you may decipher at ease the writing of each of them,—what is left of it. The campanile with the ugly head in the centre of it is your final Art result, 1601. The portico in front of you is Natalis Regia's 'instauration' of the church as it stood after 1322, retaining the wooden simplicities of bracket above the pillars of the early loggia; the Madonna, as I said, is a piece of the 1320 to 1350 work; and of earlier is no vestige here. But if you will walk twenty steps round the church, at the back of it, on the low gable, you will see an inscription in firmly graven long Roman letters, under a cross, similarly inscribed.

That is a vestige of the eleventh century church; nay, more than vestige, the *Voice* of it—Sibylline,—left when its body had died.

Which I will ask you to hear, in a little while. But first you shall see also a few of the true stones of the older Temple. Enter it now; and reverently; for though at first, amidst wretched whitewash and stucco, you will scarcely see the true

marble, those six pillars and their capitals are yet actual remnants and material marble of the venerable church; probably once extending into more arches in the nave; but this transept ceiling of wagon vault, with the pillars that carry it, is true remnant of a mediæval church, and, in all likelihood, true image of the earliest of all—of the first standard of Venice, planted, under which to abide; the Cross, engraven on the sands thus in relief, with two little pieces of Roman vaulting, set cross wise;—your modern engineers will soon make as large, in portable brickwork, for London drains, admirable, worshipful, for the salvation of London mankind:—here artlessly rounded, and with small cupola above the crossing.

Thus she set her sign upon the shore; some knot of gelatinous seaweed there checking the current of the 'Deep Stream,' which sweeps round, as you see, in that sigma of canal, as the Wharfe round the shingly bank of Bolton Abbey,—a notablist Crook of Lune, this; and Castrum, here, on sands that will abide.

It is strange how seldom rivers have been named from their depth. Mostly they take at once some dear, companionable name, and become gods, or at least living creatures, to their refreshed people; if not thus Pagan-named, they are noted by their color, or their purity,—White River, Black River, Rio Verde, Aqua Dolce, Fiume di Latte; but scarcely ever, 'Deep River.'

And this Venetian slow-pacing water, not so much as a river, or any thing like one; but a rivulet, 'fiumicello,' only, rising in those low mounds of volcanic hill to the west. "'Rialto,' 'Rialtum,' 'Prealtum'" (another idea getting confused with the first), "dal fiumicello di equal nome che, scendendo dei colli Euganei gettavasi nel Brenta, con esso scorrendo lungo quelle isole dette appunto Realtine."¹ The serpentine depth, consistent always among consistent shallow, being here vital; and the conception of it partly mingled with that of the power of the open sea—the infinite 'Altum;' sought by the sacred water, as in the dream of Eneas, "lacu

¹ Romanin.

fluvius se condidit alto." Hence the united word takes, in declining Latin, the shorter form, *Rialtum*,—properly, in the scholarship of the State-documents, '*Rivoaltus*.' So also, throughout Venice, the Latin *Rivus* softens into *Rio*; the Latin *Ripa* into *Riva*, in the time when you had the running water—not 'canals,' but running brooks of sea,—'*lympha fugax*,'—trembling in eddies, between, not quays, but banks of pasture land; soft '*campi*,' of which, in St. Margaret's field, I have but this autumn seen the last worn vestige trodden away; and yesterday, Feb. 26th, in the morning, a little tree that was pleasant to me taken up from before the door, because it had heaved the pavement an inch or two out of square; also beside the Academy, a little overhanging momentary shade of boughs hewn away, 'to make the street "*bello*,"' said the axe-bearer. 'What,' I asked, 'will it be prettier in summer without its trees?' '*Non x'e bello il verde*,' he answered.¹ True oracle, though he knew not what he said; voice of the modern Church of Venice ranking herself under the black standard of the pit.

I said you should hear the oracle of her ancient Church in a little while; but you must know why, and to whom it was spoken, first,—and we must leave the Rialto for to-day. Look, as you recross its bridge, westward, along the broad-flowing stream; and come here also, this evening, if the day sets calm, for then the waves of it from the Rialto island to the Cà Foscari, glow like an Eastern tapestry in soft-flowing crimson, fretted with gold; and beside them, amidst the tumult of

¹ I observe the good people of Edinburgh have the same taste; and rejoice proudly at having got an asphalt esplanade at the end of Prince's Street, instead of cabbage-sellers. Alas! my Scottish friends; all that Prince's Street of yours has not so much beauty in it as a single cabbage-stalk, if you had eyes in your heads.—rather the extreme reverse of beauty; and there is not one of the lassies who now stagger up and down the burning marle in high-heeled boots and French bonnets, who would not look a thousand-fold prettier, and feel, there's no counting how much nobler, bare-headed but for the snood, and bare-foot on old-fashioned grass by the Nor' loch side, bringing home from market, basket on arm, pease for papa's dinner, and a bunch of cherries for baby.

squalid ruin, remember the words that are the 'burden of Venice,' as of Tyre :—

"Be still, ye inhabitants of the Isle. Thou whom the merchants of Zidon, that pass over the sea, have replenished. By great waters, the seed of Sihor, the harvest of the river, is her revenue ; and she is a mart of nations."

CHAPTER IV.

ST. THEODORE THE CHAIR-SELLER.

THE history of Venice divides itself, with more sharpness than any other I have read, into periods of distinct tendency and character ; marked, in their transition, by phenomena no less definite than those of the putting forth the leaves, or setting of the fruit, in a plant ;—and as definitely connected by one vitally progressive organization, of which the energy must be studied in its constancy, while its results are classed in grouped system.

If we rightly trace the order, and estimate the duration, of such periods, we understand the life, whether of an organized being or a state. But not to know the time when the seed is ripe, or the soul mature, is to misunderstand the total creature.

In the history of great multitudes, these changes of their spirit, and regenerations (for they are nothing less) of their physical power, take place through so subtle gradations of declining and dawning thought, that the effort to distinguish them seems arbitrary, like separating the belts of a rainbow's color by firmly drawn lines. But, at Venice, the lines are drawn for us by her own hand ; and the changes in her temper are indicated by parallel modifications of her policy and constitution, to which historians have always attributed, as to efficient causes, the national fortunes of which they are only the signs and limitation.

In this history, the reader will find little importance at-

tached to these external phenomena of political constitution ; except as labels, or, it may be, securing seals, of the state of the nation's heart. They are merely shapes of amphora, artful and decorative indeed ; tempting to criticism or copy of their form, usefully recordant of different ages of the wine, and having occasionally, by the porousness or perfectness of their clay, effect also on its quality. But it is the grape-juice itself, and the changes in *it*, not in the forms of flask, that we have in reality to study.

Fortunately also, the dates of the great changes are easily remembered ; they fall with felicitous precision at the beginning of centuries, and divide the story of the city, as the pillars of her Byzantine courts, the walls of it, with symmetric stability.

She shall also tell you, as I promised, her own story, in her own handwriting, all through. Not a word shall *I* have to say in the matter ; or ought to do, except to deepen the letters for you when they are indistinct, and sometimes to hold a blank space of her chart of life to the fire of your heart for a little while, until words, written secretly upon it, are seen ;—if, at least, there is fire enough in your own heart to heat them.

And first, therefore, I must try what power of reading you have, when the letters are quite clear. We will take to-day, so please you, the same walk we did yesterday ; but looking at other things, and reading a wider lesson.

As early as you can (in fact, to get the good of this walk, you must be up with the sun), any bright morning, when the streets are quiet, come with me to the front of St. Mark's, to begin our lesson there.

You see that between the arches of its vaults, there are six oblong panels of bas-relief.

Two of these are the earliest pieces of real Venetian work I know of, to show you ; but before beginning with them, you must see a piece done by her Greek masters.

Go round therefore to the side farthest from the sea, where, in the first broad arch, you will see a panel of like shape, set horizontally ; the sculpture of which represents twelve

sheep, six on one side, six on the other, of a throne: on which throne is set a cross; and on the top of the cross a circle; and in the circle, a little caprioling creature.

And outside of all, are two palm trees, one on each side; and under each palm tree, two baskets of dates; and over the twelve sheep, is written in delicate Greek letters, "The holy Apostles;" and over the little caprioling creature, "The Lamb."

Take your glass and study the carving of this bas-relief intently. It is full of sweet care, subtlety, tenderness of touch, and mind; and fine cadence and change of line in the little bowing heads and bending leaves. Decorative in the extreme; a kind of stone-stitching, or sampler-work, done with the innocence of a girl's heart, and in a like unlearned fullness. Here is a Christian man, bringing order and loveliness into the mere furrows of stone. Not by any means as learned as a butcher, in the joints of lambs; nor as a grocer, in baskets of dates; nor as a gardener, in endogenous plants; but an artist to the heart's core; and no less true a lover of Christ and His word. Helpless, with his childish art, to carve Christ, he carves a cross, and caprioling little thing in a ring at the top of it. You may try—you—to carve Christ, if you can. Helpless to conceive the Twelve Apostles, these nevertheless are sacred letters for the bearers of the Gospel of Peace.

Of such men Venice learned to touch the stone;—to become a Lapieida, and furrower of the marble as well as the sea.

Now let us go back to that panel on the left side of the central arch in front.¹

This, you see, is no more a symbolical sculpture, but quite

¹ Generally note, when I say 'right' or 'left' side of a church or chapel, I mean, either as you enter, or as you look to the altar. It is not safe to say 'north and south,' for Italian churches stand all round the compass; and besides, the phrase would be false of lateral chapels. Transepts are awkward, because often they have an altar instead of an entrance at their ends; it will be least confusing to treat them always as large lateral chapels, and place them in the series of such chapels as the sides of the nave, calling the sides right and left as you look either from the nave into the chapels, or from the nave's centre to the rose window, or other termination of transept.

distinctly pictorial, and laboriously ardent to express, though in very low relief, a curly-haired personage, handsome, and something like George the Fourth, dressed in richest Roman armor, and sitting in an absurd manner, more or less tailor-fashion, if not cross-legged himself, at least on a conspicuously cross-legged piece of splendid furniture; which, after deciphering the Chinese, or engineer's isometrical, perspective of it, you may perceive to be only a gorgeous pic-nic or drawing-stool, apparently of portable character, such as are bought (more for luxury than labor,—for the real working apparatus is your tripod) at Messrs. Newman's, or Winsor and Newton's.

Apparently portable, I say; by no means intended as such by the sculptor. Intended for a most permanent and magnificent throne of state; nothing less than a derived form of that Greek *Thronos*, in which you have seen set the cross of the Lamb. Yes; and of the Tyrian and Judæan *Thronos*—Solomon's, which it frightened the queen of Sheba to see him sitting on. Yes; and of the Egyptian throne of eternal granite, on which colossal Memnon sits, melodious to morning light,—son of Aurora. Yes; and of the throne of Isis-Madonna, and, mightier yet than she, as we return towards the nativity of queens and kings. We must keep at present to our own poor little modern, practical saint—sitting on his portable throne (as at the side of the opera when extra people are let in who shouldn't be); only seven hundred years old. To this crossed-legged apparatus the Egyptian throne had dwindled down; it looks even as if the saint who sits on it might begin to think about getting up some day or other.

All the more when you know who he is. Can you read the letters of his name, written beside him?—

SCS

GEORGIUS

—Mr. Emerson's purveyor of bacon, no less!¹ And he *does* look like getting up, when you observe him farther. Unsheathing his sword, is not he?

¹ See *Fors Clavigera* of February, 1873, containing the legends of St. George. This, with the other numbers of *Fors* referred to in the text of 'St. Mark's Rest,' may be bought at Venice, together with it.

No ; sheathing it. That was the difficult thing he had first to do, as you will find on reading the true legend of him, which *this* sculptor thoroughly knew ; in whose conception of the saint one perceives the date of said sculptor, no less than in the stiff work, so dimly yet perceptive of the ordinary laws of the aspect of things. From the bas-reliefs of the Parthenon—through sixteen hundred years of effort, and speech-making, and fighting—human intelligence in the Arts has arrived, here in Venice, thus far. But having got so far, we shall come to something fresh soon ! We have become distinctly representative again, you see ; desiring to show, not a mere symbol of a living man, but the man himself, as truly as the poor stone-cutter can carve him. All bonds of tyrannous tradition broken ;—the legend kept, in faith yet ; but the symbol become natural ; a real armed knight, the best he could form a notion of ; curly-haired and handsome ; and, his also the boast of Dogberry, every thing handsome about him. Thus far has Venice got in her art schools of the early thirteenth century. I can date this sculpture to that time, pretty closely ; earlier, it may be,—not later ; see afterwards the notes closing this chapter.

And now, if you so please, we will walk under the clock-tower, and down the Merceria, as straight as we can go. There is a little crook to the right, bringing us opposite St. Julian's church (which, please, don't stop to look at just now) ; then, sharply, to the left again, and we come to the Ponte de' Baratteri,—“Rogue's Bridge”—on which, as especially a grateful bridge to English business-feelings, let us reverently pause. It has been widened lately, you observe,—the use of such bridge being greatly increased in these times ; and in a convenient angle, out of passenger current (may you find such wayside withdrawal in true life), you may stop to look back at the house immediately above the bridge.

In the wall of which you will see a horizontal panel of bas-relief, with two shields on each side, bearing six fleur-de-lys. And this you need not, I suppose, look for letters on, to tell you its subject. Here is St. George indeed !—our own beloved old sign of the George and Dragon, all correct ; and, if you

know your Seven champions, Sabra too, on the rock, thrilled witness of the fight. And see what a dainty St. George, too! Here is no mere tailor's enthronement. *Eques, ipso melior Bellerophonti*,—how he sits!—how he holds his lance!—how brightly youthful the crisp hair under his light cap of helm,—how deftly curled the fringe of his horse's crest,—how vigorous in disciplined career of accustomed conquest, the two noble living creatures! This is Venetian fifteenth century work of finest style. Outside-of-house work, of course: we compare at present outside work only, panel with panel: but here are three hundred years of art progress written for you, in two pages,—from early thirteenth to late fifteenth century; and in this little bas-relief is all to be seen, that can be, of elementary principle, in the very crest and pride of Venetian sculpture,—of which note these following points.

First, the aspirations of the front of St. Mark's have been entirely achieved, and though the figure is still symbolical, it is now a symbol consisting in the most literal realization possible of natural facts. That is the way, if you care to see it, that a young knight rode, in 1480, or thereabouts. So, his foot was set in stirrup,—so his body borne,—so trim and true and orderly every thing in his harness and his life: and this rendered, observe, with the most consummate precision of artistic touch. Look at the strap of the stirrup,—at the little delicatest line of the spur,—can you think they are stone? don't they look like leather and steel? His flying mantle,—is it not silk more than marble? That is all in the beautiful doing of it: precision first in exquisite sight of the thing itself, and understanding of the qualities and signs, whether of silk or steel; and then, precision of touch, and cunning in use of material, which it had taken three hundred years to learn. Think what cunning there is in getting such edge to the marble as will represent the spur line, or strap leather, with such solid under-support that, from 1480 till now, it stands rain and frost! And for knowledge of form,—look at the way the little princess's foot comes out under the drapery as she shrinks back. Look at it first from the left, to see how it is foreshortened, flat on the rock; then from the

right, to see the curve of dress up the limb :—think of the difference between this and the feet of poor St. George Sartor of St. Mark's, pointed down all their length. Finally, see how studious the whole thing is of beauty in every part,—how it expects *you* also to be studious. Trace the rich tresses of the princess's hair, wrought where the figure melts into shadow ;—the sharp edges of the dragon's mail, slipping over each other as he wrings neck and coils tail ;—nay, what decorative ordering and symmetry is even in the roughness of the ground and rock ! And lastly, see how the whole piece of work, to the simplest frame of it, must be by the sculptor's own hand : see how he breaks the line of his panel moulding with the princess's hair, with St. George's helmet, with the rough ground itself at the base ;—the entire tablet varied to its utmost edge, delighted in and ennobled to its extreme limit of substance.

Here, then, as I said, is the top of Venetian sculpture-art. Was there no going beyond this, think you ?

Assuredly, much beyond this the Venetian could have gone, had he gone straight forward. But at this point he became perverse, and there is one sign of evil in this piece, which you must carefully discern.

In the two earlier sculptures, of the sheep, and the throned St. George, the artist never meant to say that twelve sheep ever stood in two such rows, and were the twelve apostles ; nor that St. George ever sat in that manner in a splendid chair. But he entirely believed in the facts of the lives of the apostles and saints, symbolized by such figuring.

But the fifteenth century sculptor *does*, partly, mean to assert that St. George did in that manner kill a dragon : does not clearly know whether he did or not ; does not care very much whether he did or not ;—thinks it will be very nice if, at any rate, people believed that he did ;—but is more bent, in the heart of him, on making a pretty bas-relief than on any thing else.

Half way to infidelity, the fine gentleman is, with all his dainty chiselling. We will see, on those terms, what, in another century, this fine chiselling comes to.

So now walk on, down the Merceria di San Salvador. Presently, if it is morning, and the sky clear, you will see, at the end of the narrow little street, the brick apse of St. Saviour's, warm against the blue ; and, if you stand close to the right, a solemn piece of old Venetian wall and window on the opposite side of the calle, which you might pass under twenty times without seeing, if set on the study of shops only. Then you must turn to the right ; perforce,—to the left again ; and now to the left, once more ; and you are in the little piazza of St. Salvador, with a building in front of you, now occupied as a furniture store, which you will please look at with attention.

It reminds you of many things at home, I suppose ?—has a respectable, old-fashioned, city-of-London look about it ;—something of Greenwich Hospital, of Temple Bar, of St. Paul's, of Charles the Second and the Constitution, and the Lord Mayor and Mr. Bumble ? Truly English, in many respects, this solidly rich front of Ionic pillars, with the four angels on the top, rapturously directing your attention, by the gracefullest gesticulation, to the higher figure in the centre !

You have advanced another hundred and fifty years, and are in mid seventeenth century. Here is the 'Progresso' of Venice, exhibited to you, in consequence of her wealth, and gay life, and advance in anatomical and other sciences.

Of which, note first, the display of her knowledge of angelic anatomy. Sabra, on the rock, just showed her foot beneath her robe, and that only because she was drawing back, frightened ; but, here, every angel has his petticoats cut up to his thighs ; he is not sufficiently sacred or sublime unless you see his legs so high.

Secondly, you see how expressive are their attitudes,—“What a wonderful personage is this we have got in the middle of us !”

That is Raphael's art of the finest. Raphael, by this time, had taught the connoisseurs of Europe that whenever you admire anybody, you open your mouth and eyes wide ; when you wish to show him to somebody else you point at him vigorously with one arm, and wave the somebody else

on with the other ; when you have nothing to do of that sort, you stand on one leg and hold up the other in a graceful line ; these are the methods of true dramatic expression. . Your drapery, meanwhile, is to be arranged in "sublime masses," and is not to be suggestive of any particular stuff !

If you study the drapery of these four angels thoroughly, you can scarcely fail of knowing, henceforward, what a bad drapery is, to the end of time. Here is drapery supremely, exquisitely bad ; it is impossible, by any contrivance, to get it worse. Merely clumsy, ill-cut clothing, you may see any day ; but there is skill enough in this to make it exemplarily execrable. That flabby flutter, wrinkled swelling, and puffed pomp of infinite disorder ;—the only action of it, being blown up, and away ; the only calm of it, collapse ;—the resolution of every miserable fold not to fall, if it can help it, into any natural line,—the running of every lump of it into the next, as dough sticks to dough—remaining, not less, evermore incapable of any harmony or following of each other's lead or way ;—and the total rejection of all notion of beauty or use in the stuff itself. It is stuff without thickness, without fineness, without warmth, without coolness, without lustre, without texture ; not silk,—not linen,—not woollen ;—something that wrings, and wrinkles, and gets between legs,—that is all. Worse drapery than this, you cannot see in mortal investiture.

Nor worse *want* of drapery, neither—for the legs are as ungraceful as the robes that discover them ; and the breast of the central figure, whom all the angels admire, is packed under its corslet like a hamper of tomato apples.

To this type the Venetians have now brought their symbol of divine life in man. For this is also—St. Theodore ! And the respectable building below, in the Bumble style, is the last effort of his school of Venetian gentlemen to house themselves respectably. With Ionic capitals, bare-legged angels, and the Dragon, now square-headed and blunt-nosed, they thus contrive their last club-house, and prepare, for resuscitated Italy, in continued 'Progresso,' a stately furniture store. Here you may buy cruciform stools, indeed ! and patent oil-cloths, and other supports of your Venetian worshipful dig-

nity, to heart's content. Here is your God's Gift to the nineteenth century. "Deposito mobili nazionali ed esteri; quadri; libri antichi e moderni, ed oggetti diversi."

Nevertheless, through all this decline in power and idea, there is yet, let us note finally, some wreck of Christian intention, some feeble coloring of Christian faith. A saint is still held to be an admirable person; he is practically still the patron of your fashionable club-house, where you meet to offer him periodical prayer and alms. This architecture is, seriously, the best you can think of; those angels are handsome, according to your notions of personality; their attitudes really are such as you suppose to be indicative of celestial rapture,—their features, of celestial disposition.

We will see what change another fifty years will bring about in these faded feelings of Venetian soul.

The little calle on your right, as you front St. Theodore, will bring you straight to the quay below the Rialto, where your gondola shall be waiting, to take you as far as the bridge over the Cannareggio under the Palazzo Labia. Stay your gondola before passing under it, and look carefully at the sculptured ornaments of the arch, and then at the correspondent ones on the other side.

In these you see the last manner of sculpture, executed by Venetian artists, according to the mind of Venice, for her own pride and pleasure. Much she has done since, of artwork, to sell to strangers, executed as she thinks will please the *stranger* best. But of art produced for *her own* joy and in her own honor, this is a chosen example of the last!

Not representing saintly persons, you see; nor angels in attitudes of admiration. Quite other personages than angelic, and with expressions of any thing rather than affection or respect for aught of good, in earth or heaven. Such were the last imaginations of her polluted heart, before death. She had it no more in her power to conceive any other. "Behold thy last gods,"—the Fates compel her thus to gaze and perish.

This last stage of her intellectual death precedes her political one by about a century; during the last half of which,

however, she did little more than lay foundations of walls which she could not complete. Virtually, we may close her national history with the seventeenth century; we shall not ourselves follow it even so far.

I have shown you, to-day, pieces of her art-work by which you may easily remember its cardinal divisions.

You saw first the work of her Greek masters, under whom she learned both her faith and art.

Secondly, the beginning of her own childish efforts, in the St. George enthroned.

Thirdly, the culmination of her skill in the St. George combatant.

Fourthly, the languor of her faith and art power, under the advance of her luxury, in the hypocrisy of St. Theodore's Scuola, now a furniture warehouse.

Lastly, her dotage before shameful death.

In the next chapter, I will mark, by their natural limits, the epochs of her political history, which correspond to these conditions of her knowledge, hope, and imagination.

But as you return home, and again pass before the porches of St. Mark's, I may as well say at once what I can of these six bas-reliefs between them.

On the sides of the great central arch are St. George and St. Demetrius, so inscribed in Latin. Between the next lateral porches, the Virgin and Archangel Gabriel, so inscribed,—the Archangel in Latin, the "Mother of God" in Greek.

And between these and the outer porches, uninscribed, two of the labors of Hercules. I am much doubtful concerning these, myself,—do not know their manner of sculpture, nor understand their meaning. They are fine work; the Venetian antiquaries say, very early (sixth century); types, it may be, of physical human power prevailing over wild nature; the war of the world before Christ.

Then the Madonna and Angel of Annunciation express the Advent.

Then the two Christian Warrior Saints express the heart of Venice in her armies.

There is no doubt, therefore, of the purposeful choosing

and placing of these bas-reliefs. Where the outer ones were brought from, I know not ; the four inner ones, I think, are all contemporary, and carved for their place by the Venetian scholars of the Greek schools, in late twelfth or early thirteenth century.

My special reason for assigning this origin to them is the manner of the foliage under the feet of the Gabriel, in which is the origin of all the early foliage in the Gothic of Venice. This bas-relief, however, appears to be by a better master than the others—perhaps later ; and is of extreme beauty.

Of the ruder St. George, and successive sculptures of Evangelists on the north side, I cannot yet speak with decision ; nor would you, until we have followed the story of Venice farther, probably care to hear.

CHAPTER V.

THE SHADOW ON THE DIAL.

The history of Venice, then, divides itself into four quite distinct periods.

I. The first, in which the fugitives from many cities on the mainland, gathered themselves into one nation, dependent for existence on its labor upon the sea ; and which develops itself, by that labor, into a race distinct in temper from all the other families of Christendom. This process of growth and mental formation is necessarily a long one, the result being so great. It takes roughly, seven hundred years—from the fifth to the eleventh century, both inclusive. Accurately, from the Annunciation day, March 25th, 421, to the day of St. Nicholas, December 6th, 1100.

At the close of this epoch Venice had fully learned Christianity from the Greeks, chivalry from the Normans, and the laws of human life and toil from the ocean. Prudently and nobly proud, she stood, a helpful and wise princess, highest in counsel and mightiest in deed, among the knightly powers of the world.

II. The second period is that of her great deeds in war, and of the establishment of her reign in justice and truth (the best at least that she knew of either), over, nominally, the fourth part of the former Roman Empire. It includes the whole of the twelfth and thirteenth centuries, and is chiefly characterized by the religious passion of the Crusades. It lasts, in accurate terms, from December 6th, 1100, to February 28th, 1297; but as the event of that day was not confirmed till three years afterwards, we get the fortunately precise terminal date of 1301.

III. The third period is that of religious meditation, as distinct, though not withdrawn from, religious action. It is marked by the establishment of schools of kindly civil order, and by its endeavors to express, in word and picture, the thoughts which until then had wrought in silence. The entire body of her noble art-work belongs to this time. It includes the fourteenth and fifteenth centuries, and twenty years more: from 1301¹ to 1520.

IV. The fourth period is that of the luxurious use, and display, of the powers attained by the labor and meditation of former times, but now applied without either labor or meditation:—religion, art, and literature, having become things of custom and “costume.” It spends, in eighty years, the fruits of the toil of a thousand, and terminates, strictly, with the death of Tintoret, in 1594: we will say 1600.

From that day the remainder of the record of Venice is only the diary of expiring delirium, and by those who love her, will be traced no farther. But while you are here within her walls I will endeavor to interpret clearly to you the legends on them, in which she has herself related the passions of her Four Ages.

And see how easily they are to be numbered and remembered. Twelve hundred years in all; divided—if, broadly, we call the third period two centuries, and the fourth, one,—in diminishing proportion, 7, 2, 2, 1: it is like the spiral of a shell, reversed.

I have in this first sketch of them distinguished these four

¹ Compare ‘Stones of Venice’ (old edit.), vol. ii., p. 291.

ages by the changes in the chief element of every nation's mind—its religion, with the consequent results upon its art. But you see I have made no mention whatever of all that common historians think it their primal business to discourse of,—policy, government, commercial prosperity! One of my dates however is determined by a crisis of internal policy; and I will at least note, as the material instrumentation of the spiritual song, the metamorphoses of state-order which accompanied, in each transition, the new nativities of the state's heart.

I. During the first period, which completes the binding of many tribes into one, and the softening of savage faith into intelligent Christianity, we see the gradual establishment of a more and more distinctly virtuous monarchic authority; continually disputed, and often abused, but purified by every reign into stricter duty, and obeyed by every generation with more sacred regard. At the close of this epoch, the helpful presence of God, and the leading powers of the standard-bearer Saint, and sceptre-bearing King, are vitally believed; reverently, and to the death, obeyed. And, in the eleventh century, the Palace of the Duke and lawgiver of the people, and his Chapel, enshrining the body of St. Mark, stand, bright with marble and gold, side by side.

II. In the second period, that of active Christian warfare, there separates itself from the mass of the people, chiefly by pre-eminence in knightly achievement, and persistence in patriotic virtue,—but also, by the intellectual training received in the conduct of great foreign enterprise, and maintenance of legislation among strange people, — an order of aristocracy, raised both in wisdom and valor greatly above the average level of the multitude, and gradually joining to the traditions of Patrician Rome, the domestic refinements, and imaginative sanctities, of the northern and Frankish chivalry, whose chiefs were their battle comrades. At the close of the epoch, this more sternly educated class determines to assume authority in the government of the State, unswayed by the humor, and unhindered by the ignorance, of the lower classes of the people; and the year which I have assigned for the accurate

close of the second period is that of the great division between nobles and plebeians, called by the Venetians the "Closing of the Council,"—the restriction, that is to say, of the powers of the Senate to the lineal aristocracy.

III. The third period shows us the advance of this now separate body of Venetian gentlemen in such thought and passion as the privilege of their position admitted, or its temptations provoked. The gradually increasing knowledge of literature, culminating at last in the discovery of printing, and revival of classic formulæ of method, modified by reflection, or dimmed by disbelief, the frank Christian faith of earlier ages; and social position independent of military prowess, developed at once the ingenuity, frivolity, and vanity of the scholar, with the avarice and cunning of the merchant.

Protected and encouraged by a senate thus composed, distinct companies of craftsmen, wholly of the people, gathered into vowed fraternities of social order; and, retaining the illiterate sincerities of their religion, labored in unambitious peace, under the orders of the philosophic aristocracy;—built for them their great palaces, and overlaid their walls, within and without, with gold and purple of Tyre, precious now in Venetian hands as the colors of heaven more than of the sea. By the hand of one of them, the picture of Venice, with her nobles in her streets, at the end of this epoch, is preserved to you as yet, and I trust will be, by the kind fates, preserved datelessly.

IV. In the fourth period, the discovery of printing having confused literature into vociferation, and the delicate skill of the craftsman having provoked splendor into lasciviousness, the jubilant and coruscant passions of the nobles, stately yet in the forms of religion, but scornful of her discipline, exhausted, in their own false honor, at once the treasures of Venice and her skill; reduced at last her people to misery, and her policy to shame, and smoothed for themselves the downward way to the abdication of their might for evermore.

Now these two histories of the religion and policy of Venice are only intense abstracts of the same course of thought and events in every nation of Europe. Throughout the whole

of Christendom, the two stories in like manner proceed together. The acceptance of Christianity—the practice of it—the abandonment of it—and moral ruin. The development of kingly authority,—the obedience to it—the corruption of it—and social ruin. But there is no evidence that the first of these courses of national fate is vitally connected with the second. That infidel kings may be just, and Christian ones corrupt, was the first lesson Venice learned when she began to be a scholar.

And observe there are three quite distinct conditions of feeling and assumptions of theory in which we may approach this matter. The first, that of our numerous cockney friends,—that the dukes of Venice were mostly hypocrites, and if not, fools; that their pious zeal was merely such a cloak for their commercial appetite as modern church-going is for modern swindling; or else a pitiable hallucination and puerility:—that really the attention of the supreme cockney mind would be wasted on such bygone absurdities, and that out of mere respect for the common sense of monkey-born-and-bred humanity, the less we say of them the better.

The second condition of feeling is, in its full confession, a very rare one;—that of true respect for the Christian faith, and sympathy with the passions and imaginations it excited, while yet in security of modern enlightenment, the observer regards the faith itself only as an exquisite dream of mortal childhood, and the acts of its votaries as a beautifully deceived heroism of vain hope.

This theory of the splendid mendacity of Heaven, and majestic somnambulism of man, I have only known to be held in the sincere depth of its discomfort, by one of my wisest and dearest friends, under the pressure of uncomprehended sorrow in his own personal experience. But to some extent it confuses or undermines the thoughts of nearly all men who have been interested in the material investigations of recent physical science, while retaining yet imagination and understanding enough to enter into the heart of the religious and creative ages.

And it necessarily takes possession of the spirit of such men

chiefly at the times of personal sorrow, which teach even to the wisest, the hollowness of their best trust, and the vanity of their dearest visions ; and when the epitaph of all human virtue, and sum of human peace, seem to be written in the lowly argument,—

“ We are such stuff
As dreams are made of ; and our little life
Is rounded with a sleep.”

The third, the only modest, and therefore the only rational, theory, is, that we are all and always, in these as in former ages, deceived by our own guilty passions, blinded by our own obstinate wills, and misled by the insolence and fantasy of our ungoverned thoughts ; but that there is verily a Divinity in nature which has shaped the rough hewn deeds of our weak human effort, and revealed itself in rays of broken, but of eternal light, to the souls which have desired to see the day of the Son of Man.

By the more than miraculous fatality which has been hitherto permitted to rule the course of the kingdoms of this world, the men who are capable of accepting such faith, are rarely able to read the history of nations by its interpretation. They nearly all belong to some one of the passionately egotistic sects of Christianity ; and are miserably perverted into the missionary service of their own schism ; eager only, in the records of the past, to gather evidence to the advantage of their native persuasion, and to the disgrace of all opponent forms of similar heresy ; or, that is to say, in every case, of nine-tenths of the religion of this world.

With no less thankfulness for the lesson, than shame for what it showed, I have myself been forced to recognize the degree in which all my early work on Venetian history was paralyzed by this petulance of sectarian egotism ; and it is among the chief advantages I possess for the task now undertaken in my closing years, that there are few of the errors against which I have to warn my readers, into which I have not myself at some time fallen. Of which errors, the chief, and cause of all the rest, is the leaning on our own under-

standing ; the thought that we can measure the hearts of our brethren, and judge of the ways of God. Of the hearts of men, noble, yet "deceitful above all things, who can know them?"—that infinitely perverted scripture is yet infinitely true. And for the ways of God! Oh, my good and gentle reader, how much otherwise would not you and I have made this world?

CHAPTER VI.

RED AND WHITE CLOUDS.

Nor, therefore, to lean on our own sense, but in all the strength it has, to use it ; not to be captives to our private thoughts, but to dwell in them, without wandering, until, out of the chambers of our own hearts we begin to conceive what labyrinth is in those of others,—thus we have to prepare ourselves, good reader, for the reading of any history.

If but we may at last succeed in reading a little of our own, and discerning what scene of the world's drama we are set to play in,—drama whose tenor, tragic or other, seemed of old to rest with so few actors ; but now, with this pantomimic mob upon the stage, can you make out any of the story?—prove, even in your own heart, how much you believe that there is any Playwright behind the scenes?

Such a wild dream as it is!—nay, as it always has been, except in momentary fits of consciousness, and instants of startled spirit,—perceptive of heaven. For many centuries the Knights of Christendom wore their religion gay as their crest, familiar as their gauntlet, shook it high in the summer air, hurled it fiercely in other people's faces, grasped their spear the firmer for it, sat their horses the prouder ; but it never entered into their minds for an instant to ask the meaning of it! 'Forgive us our sins : ' by all means—yes, and the next garrison that holds out a day longer than is convenient to us, hang them every man to his battlement. 'Give us this day our daily bread,'—yes, and our neighbor's also, if we have any luck. 'Our Lady and the saints!' Is there any

infidel dog that doubts of them?—in God's name, boot and spur—and let us have the head off him. It went on so, frankly and bravely, to the twelfth century, at the earliest; when men begin to think in a serious manner; more or less of gentle manners and domestic comfort being also then conceivable and attainable. Rosamond is not any more asked to drink out of her father's skull. Rooms begin to be matted and wainscoted; shops to hold store of marvellous foreign wares; knights and ladies learn to spell, and to read, with pleasure; music is everywhere;—Death, also. Much to enjoy—much to learn, and to endure—with Death always at the gates. “If war fail thee in thine own country, get thee with haste into another,” says the faithful old French knight to the boy-chevalier, in early fourteenth century days.

No country stays more than two centuries in this intermediate phase between Faith and Reason. In France it lasted from about 1150 to 1350; in England, 1200 to 1400; in Venice, 1300 to 1500. The course of it is always in the gradual development of Christianity,—till her yoke gets at once too aerial, and too straight, for the mob, who break through it at last as if it were so much gossamer; and at the same fatal time, wealth and luxury, with the vanity of corrupt learning, foul the faith of the upper classes, who now begin to wear their Christianity, not tossed for a crest high over their armor, but stuck as a plaster over their sores, inside of their clothes. Then comes printing, and universal gabble of fools; gunpowder, and the end of all the noble methods of war; trade, and universal swindling; wealth, and universal gambling; idleness, and universal harlotry; and so at last—Modern Science and Political Economy; and the reign of St. Petroleum instead of St. Peter. Out of which God only knows what is to come next; but He *does* know, whatever the Jew swindlers and apothecaries' 'prentices think about it.

Meantime, with what remainder of belief in Christ may be left in us; and helping that remnant with all the power we have of imagining what Christianity was, to people who, without understanding its claims or its meaning, did not doubt for an instant its statements of fact, and used the whole of

their childish imagination to realize the acts of their Saviour's life, and the presence of His angels, let us draw near to the first sandy thresholds of the Venetian's home.

Before you read any of the so-called historical events of the first period, I want you to have some notion of their scene. You will hear of Tribunes—Consuls—Doges; but what sort of tribes were they tribunes of? what sort of nation were they dukes of? You will hear of brave naval battle—victory over sons of Emperors: what manner of people were they, then, whose swords lighten thus brightly in the dawn of chivalry?

For the whole of her first seven hundred years of work and war, Venice was in great part a wooden town; the houses of the noble mainland families being for long years chiefly at *Heraclea*, and on other islands; nor they magnificent, but farm-villas mostly, of which, and their farming, more presently. Far too much stress has been generally laid on the fishing and salt-works of early Venice, as if they were her only businesses; nevertheless at least you may be sure of this much, that for seven hundred years Venice had more likeness in her to old *Yarmouth* than to new *Pall Mall*; and that you might come to shrewder guess of what she and her people were like, by living for a year or two lovingly among the herring-catchers of *Yarmouth Roads*, or the boatmen of *Deal* or *Boscastle*, than by reading any lengths of eloquent history. But you are to know also, and remember always, that this amphibious city—this *Phocæa*, or sea-dog of towns—looking with soft human eyes at you from the sand, *Proteus* himself latent in the salt-smelling skin of her—had fields, and plots of garden here and there; and, far and near, sweet woods of *Calypso*, graceful with quivering sprays, for woof of nests—gaunt with forked limbs for ribs of ships; had good milk and butter from familiarly couchant cows; thickets wherein familiar birds could sing; and finally was observant of clouds and sky, as pleasant and useful phenomena. And she had at due distances among her simple dwellings, stately churches of marble.

These things you may know, if you will, from the following

“quite ridiculous” tradition, which, ridiculous as it may be, I will beg you for once to read, since the Doge Andrea Dandolo wrote it for you, with the attention due to the address of a Venetian gentleman, and a King.¹

“As head and bishop of the islands, the Bishop Magnus of Altinum went from place to place to give them comfort, saying that they ought to thank God for having escaped from these barbarian cruelties. And there appeared to him St. Peter, ordering him that in the head of Venice, or truly of the city of Rivoalto, where he should find oxen and sheep feeding, he was to build a church under his (St. Peter’s) name. And thus he did ; building St. Peter’s Church in the island of Olivolo, where at present is the seat and cathedral church of Venice.

“Afterwards appeared to him the angel Raphael, committing it to him, that at another place, where he should find a number of birds together, he should build him a church : and so he did, which is the church of the Angel Raphael in Dorsoduro.

“Afterwards appeared to him Messer Jesus Christ our Lord, and committed to him that in the midst of the city he should build a church, in the place, above which he should see a red cloud rest : and so he did ; and it is San Salvador.

“Afterwards appeared to him the most holy Mary the Virgin, very beautiful ; and commanded him that where he should see a white cloud rest, he should build a church : which is the church of St. Mary the Beautiful.

“Yet still appeared to him St. John the Baptist, commanding that he should build two churches, one near the other—the one to be in his name, and the other in the name of his father. Which he did, and they are San Giovanni in Bragola, and San Zaccaria.

“Then appeared to him the apostles of Christ, wishing, they

¹ A more graceful form of this legend has been translated with feeling and care by the Countess Isobel Cholmley, in Bermani, from an MS. in her possession, copied, I believe, from one of the tenth century. But I take the form in which it was written by Andrea Dandolo, that the reader may have more direct associations with the beautiful image of the Doge on his tomb in the Baptistery.

also, to have a church in this new city ; and they committed it to him that where he should see twelve cranes in a company, there he should build it. Lastly appeared to him the blessed Virgin Giustina, and ordered him that where he should find vines bearing fresh fruits there he should build her a church."

Now this legend is quite one of the most precious things in the story of Venice : preserved for us in this form at the end of the fourteenth century, by one of her most highly educated gentlemen, it shows the very heart of her religious and domestic power, and assures for us, with other evidence, these following facts.

First ; that a certain measure of pastoral home-life was mingled with Venice's training of her sailors ;—evidence whereof remains to this day, in the unfailing ' Campo ' round every church ; the church ' meadow '—not church-*'yard.'* It happened to me, once in my life, to go to church in a state of very great happiness and peace of mind ; and this in a very small and secluded country church. And Fors would have it that I should get a seat in the chancel ; and the day was sunny, and the little side chancel-door was open opposite into, what I hope was a field. I saw no graves in it ; but in the sunshine, sheep feeding. And I never was at so divine a church service before, nor have been since. If you will read the opening of Wordsworth's ' White Doe of Rylstone,' and can enjoy it, you may learn from it what the look of an old Venetian church would be, with its surrounding field. St. Mark's Place was only the meadow of St. Theodore's church, in those days.

Next—you observe the care and watching of animals. That is still a love in the heart of Venice. One of the chief little worries to me in my work here, is that I walk faster than the pigeons are used to have people walk ; and am continually like to tread on them ; and see story in Fors, March of this year, of the gondolier and his dog. Nay, though, the other day, I was greatly tormented at the public gardens, in the early morning, when I had counted on a quiet walk, by

a cluster of boys who were chasing the first twittering birds of the spring from bush to bush, and throwing sand at them, with wild shouts and whistles, they were not doing it, as I at first thought, in mere mischief, but with hope of getting a penny or two to gamble with, if they could clog the poor little creatures' wings enough to bring one down—"Canta bene, signor, quell' ucellino." Such the nineteenth century's reward of Song. Meantime, among the silvery gleams of islet tower on the lagoon horizon, beyond Mazorbo—a white ray flashed from the place where St. Francis preached to the Birds.

Then thirdly—note that curious observance of the color of clouds. That is gone, indeed ; and no Venetian, or Italian, or Frenchman, or Englishman, is likely to know or care, more, whether any God-given cloud is white or red ; the primal effort of his entire human existence being now to vomit out the biggest black one he can pollute the heavens with. But, in their rough way, there was yet a perception in the old fishermen's eyes of the difference between white 'nebbia' on the morning sea, and red clouds in the evening twilight. And the Stella Maris comes in the sea Cloud ;—Leucothea : but the Son of Man on the jasper throne.

Thus much of the aspect, and the thoughts of earliest Venice, we may gather from one tradition, carefully read. What historical evidence exists to confirm the gathering, you shall see in a little while ; meantime—such being the scene of the opening drama—we must next consider somewhat of the character of the actors. For though what manner of houses they had, has been too little known, what manner of men they were, has not at all been known, or even the reverse of known, —belied.

CHAPTER VII.

DIVINE RIGHT.

ARE you impatient with me? and do you wish me, ceasing preamble, to begin—‘In the year this, happened that,’ and set you down a page of dates and Doges to be learned off by rote? You must be denied such delight a little while longer. If I begin dividing this first period, at present (and it has very distinctly articulated joints of its own), we should get confused between the subdivided and the great epochs. I must keep your thoughts to the Three Times, till we know them clearly; and in this chapter I am only going to tell you the story of a single Doge of the First Time, and gather what we can out of it.

Only, since we have been hitherto dwelling on the soft and religiously sentimental parts of early Venetian character, it is needful that I should ask you to notice one condition in their government of a quite contrary nature, which historians usually pass by as if it were of no consequence; namely, that during this first period, five Doges, after being deposed, had their eyes put out.

Pulled out, say some writers, and I think with evidence reaching down as far as the endurance on our English stage of the blinding of Gloster in King Lear.

But at all events the Dukes of Venice, whom her people thought to have failed in their duty, were in that manner incapacitated from reigning more.

An Eastern custom, as we know: grave in judgment; in the perfectness of it, joined with infliction of grievous Sight, before the infliction of grievous Blindness; that so the last memory of this world’s light might remain a grief. “And they slew the sons of Zedekiah before his eyes; and put out the eyes of Zedekiah.”

Custom I know not how ancient. The sons of Eliab, when Judah was young in her Exodus, like Venice, appealed to it in

their fury : " Is it a small thing that thou hast brought us up out of a land that floweth with milk and honey, except thou make thyself altogether a Prince over us ; wilt thou put out the eyes of these men ? "

The more wild Western races of Christianity, early Irish and the like,—Norman even, in the pirate times,—inflict the penalty with reckless scorn ;¹ but Venice deliberately, as was her constant way ; such her practical law against leaders whom she had found spiritually blind : " These, at least, shall guide no more. "

Very savage ! monstrous ! if you will ; whether it be not a worse savageness deliberately to follow leaders *without sight*, may be debatable.

The Doge whose history I am going to tell you was the last of deposed Kings in the first epoch. Not blinded, he, as far as I read : but permitted, I trust peaceably, to become a monk ; Venice owing to him much that has been the delight of her own and other people's eyes, ever since. Respecting the occasion of his dethronement, a story remains, however, very notably in connection with this manner of punishment.

Venice, throughout this first period in close alliance with the Greeks, sent her Doge, in the year 1082, with a " valid fleet, terrible in its most ordered disposition," to defend the Emperor Alexis against the Normans, led by the greatest of all Western captains, Guiscard.

The Doge defeated him in naval battle once ; and, on the third day after, once again, and so conclusively, that, think-

¹ Or sometimes pitifully : " Olaf was by no means an unmerciful man, —much the reverse where he saw good cause. There was a wicked old King Rærik, for example, one of those five kinglets whom, with their bits of armaments, Olaf, by stratagem, had surrounded one night, and at once bagged and subjected when morning rose, all of them consenting ;—all of them except this Rærik, whom Olaf, as the readiest sure course, took home with him ; blinded, and kept in his own house, finding there was no alternative but that or death to the obstinate old dog, who was a kind of distant cousin withal, and could not conscientiously be killed "—(Carlyle,—' Early Kings of Norway,' p. 121) —conscience, and kin-ship, or " kindness," declining somewhat in the Norman heart afterwards.

ing the debate ended, he sent his lightest ships home, and anchored on the Albanian coast with the rest, as having done his work.

But Guiscard, otherwise minded on that matter, with the remains of his fleet,—and his Norman temper at hottest,—attacked him for the third time. The Greek allied ships fled. The Venetian ones, partly disabled, had no advantage in their seamanship: ¹ question only remained, after the battle, how the Venetians should bear themselves as prisoners. Guiscard put out the eyes of some; then, with such penalty impending over the rest, demanded that they should make peace with the Normans, and fight for the Greek Emperor no more.

But the Venetians answered, “Know thou, Duke Robert, that although also *we should see our wives and children slain*, we will not deny our covenants with the Autocrat Alexis; neither will we cease to help him, and to fight for him with our whole hearts.”

The Norman chief sent them home unransomed.

There is a highwater mark for you of the waves of Venetian and Western chivalry in the eleventh century. A very notable scene; the northern leader, without rival the greatest soldier of the sea whom our rocks and ice-bergs bred: of the Venetian one, and his people, we will now try to learn the character more perfectly,—for all this took place towards the close of the Doge Selvo's life. You shall next hear what I can glean of the former course of it.

In the year 1053, the Abbey of St. Nicholas, the protector of mariners, had been built at the entrance of the port of Venice (where, north of the bathing establishment, you now see the little church of St. Nicholas of the Lido); the Doge Domenico Contarini, the Patriarch of Grado, and the Bishop of Venice, chiefly finding the funds for such edifice.

When the Doge Contarini died, the entire multitude of the people of Venice came in armed boats to the Lido, and the Bishop of Venice, and the monks of the new abbey of St. Nicholas, joined with them in prayer,—the monks in their

¹ Their crews had eaten all their stores, and their ships were flying light, and would not steer well.

church and the people on the shore and in their boats,—that God would avert all dangers from their country, and grant to them such a king as should be worthy to reign over it. And as they prayed, with one accord, suddenly there rose up among the multitude the cry, “Domenico Selvo, we will, and we approve,” whom a crowd of the nobles brought instantly forward thereupon, and raised him on their own shoulders and carried him to his boat; into which when he had entered, he put off his shoes from his feet, that he might in all humility approach the church of St. Mark. And while the boats began to row from the island towards Venice, the monk who saw this, and tells us of it, himself began to sing the *Te Deum*. All around, the voices of the people took up the hymn, following it with the *Kyrie Eleison*, with such litany keeping time to their oars in the bright noonday, and rejoicing on their native sea; all the towers of the city answering with triumph peals as they drew nearer. They brought their Doge to the Field of St. Mark, and carried him again on their shoulders to the porch of the church; there, entering barefoot, with songs of praise to God round him—“such that it seemed as if the vaults must fall,”—he prostrated himself on the earth, and gave thanks to God and St. Mark, and uttered such vow as was in his heart to offer before them. Rising, he received at the altar the Venetian sceptre, and thence entering the Ducal Palace, received there the oath of fealty from the people.¹

¹ This account of the election of the Doge Selvo is given by Sansovino (*Venetia descritta*, Lib. xi. 40; Venice, 1663, p. 477),—saying at the close of it simply, “Thus writes Domenico Rino, who was his chaplain, and who was present at what I have related.” Sansovino seems therefore to have seen Rino’s manuscript; but Romanin, without referring to Sansovino, gives the relation as if he had seen the MS. himself, but misprints the chronicler’s name as Domenico Tino, causing no little trouble to my kind friend Mr. Lorenzi and me, in hunting at St. Mark’s and the Correr Museum for the unheard-of chronicle, till Mr. Lorenzi traced the passage. And since Sansovino’s time nothing has been seen or further said of the Rino Chronicle.—See Foscarini, *“della letteratura Veneziana,”* Lib. ii.

Romanin has also amplified and inferred somewhat beyond Sansovino’s words. The dilapidation of the palace furniture, especially, is

Benighted wretches, all of them, you think, prince and people alike, don't you? They were pleasanter creatures to see, at any rate, than any you will see in St. Mark's field nowadays. If the pretty ladies, indeed, would walk in the porch like the Doge, barefoot, instead of in boots cloven in two like the devil's hoofs, something might be said for them; but though they will recklessly drag their dresses through it, I suppose they would scarcely care to walk, like Greek maids, in that mixed mess of dust and spittle with which modern progressive Venice anoints her marble pavement. Pleasanter to look at, I can assure you, this multitude delighting in their God and their Duke, than these, who have no Paradise to trust to with better gifts for them than a gazette, cigar, and pack of cards; and no better governor than their own wills. You will see no especially happy or wise faces produced in St. Mark's Place under these conditions.

Nevertheless, the next means that the Doge Selvo took for the pleasure of his people on his coronation day savored somewhat of modern republican principles. He gave them "the pillage of his palace"—no less! Whatever they could lay their hands on, these faithful ones, they might carry away with them, with the Doge's blessing. At evening he laid down the uneasy crowned head of him to rest in mere dismantled walls; hands dexterous in the practices of profitable warfare having bestirred themselves all the day. Next morning the first Ducal public orders were necessarily to the upholsterers and furnishers for readornment of the palace-rooms. Not by any special grace this, or benevolent novelty of idea in the good Doge, but a received custom, hitherto; sacred enough, if one understands it,—a kind of mythical putting off all the burdens of one's former wealth, and entering barefoot, bare-body, bare-soul, into this one duty of Guide and Lord, lightened thus of all regard for his own affairs or properties. "Take all I have, from henceforth; the corporal vestments

not attributed by Sansovino to festive pillage, but to neglect after Contarini's death. Unquestionably, however, the custom alluded to in the text existed from very early times.

of me, and all that is in their pockets, I give you to-day; the stripped life of me is yours forever." Such, virtually, the King's vow.

Frankest largesse thus cast to his electors (modern bribery is quite as costly and not half so merry), the Doge set himself to refit, not his own palace merely, but much more, God's house: for this prince is one who has at once David's piety, and soldiership, and Solomon's love of fine things; a perfect man, as I read him, capable at once and gentle, religious and joyful, in the extreme: as a warrior the match of Robert Guiscard, who, you will find, was the soldier *par excellence* of the middle ages, but not his match in the wild-cat cunning—both of them alike in knightly honor, word being given. As a soldier, I say, the match of Guiscard, but not holding war for the pastime of life, still less for the duty of Venice or her king. Peaceful affairs, the justice and the joy of human deeds—in these he sought his power, by principle and passion equally; religious, as we have seen; royal, as we shall presently see; commercial, as we shall finally see; a perfect man, recognized as such with concurrent applause of people and submission of noble: "Domenico Selvo, we will, and we approve."

No flaw in him, then? Nay; "how bad the best of us!" say *Punch*,¹ and the modern evangelical. Flaw he had, such as wisest men are not unliable to, with the strongest—Solomon, Samson, Hercules, Merlin the Magician.

Liking pretty things, how could he help liking pretty ladies? He married a Greek maid, who came with new and strange light on Venetian eyes, and left wild fame of herself: how, every morning, she sent her handmaidens to gather the dew for her to wash with, waters of earth being not pure enough. So, through lapse of fifteen hundred years, descended into her Greek heart that worship in the Temple of the Dew.

Of this queen's extreme luxury, and the miraculousness of

¹ Epitaph on the Bishop of Winchester (Wilberforce); see *Fors*, Letter XLII., p. 210.

it in the eyes of simple Venice, many traditions are current among later historians; which, nevertheless, I find resolve themselves, on closer inquiry, into an appalled record of the fact that she would actually not eat her meat with her fingers, but applied it to her mouth with "certain two-pronged instruments"¹ (of gold, indeed, but the luxurious sin, in Venetian eyes, was evidently not in the metal, but the fork); and that she indulged herself greatly in the use of perfumes: especially about her bed, for which whether to praise her, as one would an English housewife for sheets laid up in lavender, or to cry haro upon her, as the "stranger who flattereth,"² I know not, until I know better the reason of the creation of perfume itself, and of its use in Eastern religion and delight—"All thy garments smell of myrrh, aloes, and cassia, out of the ivory palaces whereby thou hast made me glad"—fading and corrupting at last into the incense of the mass, and the *extrait de Mille-fleurs* of Bond Street. What I do know is, that there was no more sacred sight to me, in ancient Florence, than the Spezieria of the Monks of Santa Maria Novella, with its precious vials of sweet odors, each illuminated with the little picture of the flower from which it had truly been distilled—and yet, that, in its loaded air one remembered that the flowers had grown in the fields of the Decameron.

But this also I know, and more surely, that the beautiful work done in St. Mark's during the Greek girl's reign in Venice first interpreted to her people's hearts, and made legible to their eyes, the law of Christianity in its eternal harmony with the laws of the Jew and of the Greek: and gave them the glories of Venetian art in true inheritance from the angels of that Athenian Rock, above which Ion spread his starry tapestry,³ and under whose shadow his mother had gathered the crocus in the dew.

¹ *Cibos digitis non tangebatur, sed quibusdam fuscinulis aureis et bidentibus suo ori applicabat.* (Petrus Damianus, quoted by Dandolo.)

² Proverbs vii., 5 and 17.

³ I have myself learned more of the real meaning of Greek myths from Euripides than from any other Greek writer, except Pindar. But I do not at present know of any English rhythm interpreting him

CHAPTER VIII

THE REQUIEM.

1. As I re-read the description I gave, thirty years since, of St. Mark's Church ;—much more as I remember, forty years since, and before, the first happy hour spent in trying to paint a piece of it, with my six-o'clock breakfast on the little café table beside me on the pavement in the morning shadow, I am struck, almost into silence, by wonder at my own pert little Protestant mind, which never thought for a moment of asking what the Church had been built for!

Tacitly and complacently assuming that I had had the entire truth of God preached to me in Beresford Chapel in the Walworth Road,—recognizing no possible Christian use or propriety in any other sort of chapel elsewhere ; and perceiving, in this bright phenomenon before me, nothing of more noble function than might be in some new and radiant sea-shell, thrown up for me on the sand ;—nay, never once so much as thinking, of the fair shell itself, “Who built its domed whorls, then ?” or “What manner of creature lives in

rightly—these poor sapless measures must serve my turn—(Woodhull's : 1778.)

“The sacred tapestry

Then taking from the treasures of the God,
 He cover'd o'er the whole, a wondrous sight
 To all beholders : first he o'er the roof
 Threw robes, which Hercules, the son of Jove,
 To Phœbus at his temple brought, the spoils
 Of vanquished Amazons ;
 On which these pictures by the loom were wrought ;
 Heaven in its vast circumference all the stars
 Assembling ; there his courses too the Sun
 Impetuous drove, till ceas'd his waning flame,
 And with him drew in his resplendent train,
 Vesper's clear light ; then clad in sable garb
 Night hasten'd ; hastening stars accompanied
 Their Goddess ; through mid-air the Pleiades,
 And with his falchion arm'd, Orion mov'd.
 But the sides he covered

the inside?" Much less ever asking, "Who is lying dead therein?"

2. A marvellous thing—the Protestant mind! Don't think I speak as a Roman Catholic, good reader: I am a mere wandering Arab, if that will less alarm you, seeking but my cup of cold water in the desert; and I speak only as an Arab, or an Indian,—with faint hope of ever seeing the ghost of Laughing Water. A marvellous thing, nevertheless, I repeat,—this Protestant mind! Down in Brixton churchyard, all the fine people lie inside railings, and their relations expect the passers-by to acknowledge reverently who's *there*:—nay, only last year, in my own Cathedral churchyard of Oxford, I saw the new grave of a young girl fenced about duly with carved stone, and overlaid with flowers; and thought no shame to kneel for a minute or two at the foot of it,—though there were several good Protestant persons standing by.

But the old leaven is yet so strong in me that I am very shy of being caught by any of my country people kneeling near St. Mark's grave.

"Because—you know—it's all nonsense: it isn't St. Mark's

With yet more tapestry, the Barbaric fleet
To that of Greece opposed, was there display'd;
Followed a monstrous brood, half horse, half man,
The Thracian monarch's furious steed subdu'd,
And lion of Nemæa."

" . . . Underneath those craggy rocks,
North of Minerva's citadel (the kings
Of Athens call them Macra), . . .
Thou cam'st, resplendent with thy golden hair,
As I the crocus gathered, in my robe
Each vivid flower assembling, to compose
Garlands of fragrance."

The composition of fragrant garlands out of crocuses being however Mr. Michael Woodhull's improvement on Euripides. Creusa's words are literally, "Thou camest, thy hair flashing with gold, as I let fall the crocus petals, gleaming gold back again, into my robe at my bosom." Into the folds of it, across her breast; as an English girl would have let them fall into her lap.

and never was,"—say my intellectual English knot of shocked friends.

I suppose one must allow much to modern English zeal for genuineness in all commercial articles. Be it so. Whether God ever gave the Venetians what they thought He had given, does not matter to us; He gave them at least joy and peace in their imagined treasure, more than we have in our real ones.

And he gave them the good heart to build this chapel, over the cherished grave, and to write on the walls of it, St. Mark's gospel, for all eyes,—and, so far as their power went, for all time.

3. But it was long before I learned to read that; and even when, with Lord Lindsay's first help, I had begun spelling it out,—the old Protestant palsy still froze my heart, though my eyes were unsealed; and the preface to the *Stones of Venice* was spoiled, in the very centre of its otherwise good work by that blunder, which I've left standing in all its shame, and with its hat off—like Dr. Johnson repentant in Lichfield Market,—only putting the note to it "Fool that I was!" (page 5).¹ I fancied actually that the main function of St. Mark's was no more than our St. George's at Windsor, to be the private chapel of the king and his knights;—a blessed function that also, but how much lower than the other?

4. "Chiesa Ducale." It never entered my heart once to think that there was a greater Duke than her Doge, for Venice; and that she built, for her two Dukes, each their palace, side by side. The palace of the living, and of the,—Dead,—was he then—the other Duke?

"VIVA SAN MARCO."

You wretched little cast-iron gaspipe of a cockney that you are, who insist that your soul's your own, (see "*Punch*" for 15th March, 1879, on the duties of Lent,) as if anybody else

¹ Scott himself (God knows I say it sorrowfully, and not to excuse my own error, but to prevent *his* from doing more mischief,) has made just the same mistake, but more grossly and fatally, in the character given to the Venetian Procurator in the "*Talisman*." His error is more shameful, because he has confused the institutions of Venice in the fifteenth century with those of the twelfth.

would ever care to have it! is there yet life enough in the molecules, and plasm, and general mess of the making of you, to feel for an instant what that cry once meant, upon the lips of men?

Viva, Italia! you may still hear that cry sometimes, though she lies dead enough. Viva, Vittor—Pisani!—perhaps also that cry, yet again.

But the answer,—“Not Pisani, but St. Mark,” when will you hear *that* again, nowadays? Yet when those bronze horses were won by the Bosphorus, it was St. Mark’s standard, not Henry Dandolo’s, that was first planted on the tower of Byzantium,—and men believed—by his own hand. While yet his body lay here at rest: and this, its requiem on the golden scroll, was then already written over it—in Hebrew, and Greek, and Latin.

In Hebrew, by the words of the prophets of Israel.

In Greek, by every effort of the building laborer’s hand, and vision to his eyes.

In Latin, with the rhythmic verse which Virgil had taught,—calm as the flowing of Mincio.

But if you will read it, you must understand now, once for all, the method of utterance in Greek art,—here, and in Greece, and in Ionia, and the isles, from its first days to this very hour.

5. I gave you the bas-relief of the twelve sheep and little caprioling lamb for a general type of all Byzantine art, to fix in your mind at once, respecting it, that its intense first character is symbolism. The thing represented means more than itself,—is a sign, or letter, more than an image.

And this is true, not of Byzantine art only, but of all Greek art, pur sang. Let us leave, to-day, the narrow and degrading word “Byzantine.” There is but one Greek school, from Homer’s day down to the Doge Selvo’s; and these St. Mark’s mosaics are as truly wrought in the power of Daedalus, with the Greek constructive instinct, and in the power of Athena, with the Greek religious soul, as ever chest of Cypselus or shaft of Erechtheum. And therefore, whatever is represented here, be it flower or rock, animal or man, means more than it is in itself. Not sheep, these twelve innocent woolly things,

—but the twelve voices of the gospel of heaven ;—not palm-trees, these shafts of shooting stem and beaded fruit,—but the living grace of God in the heart, springing up in joy at Christ's coming ;—not a king, merely, this crowned creature in his sworded state,—but the justice of God in His eternal Law ;—not a queen, nor a maid only, this Madonna in her purple shade,—but the love of God poured forth, in the wonderfulness that passes the love of woman. *She may forget—* yet will I not forget thee.

6. And in this function of his art, remember, it does not matter to the Greek how far his image be *perfect* or not. That it should be *understood* is enough,—if it can be beautiful also, well ; but its function is not beauty, but instruction. You cannot have purer examples of Greek art than the drawings on any good vase of the Marathonian time. Black figures on a red ground,—a few white scratches through them, marking the joints of their armor or the folds of their robes,—white circles for eyes,—pointed pyramids for beards,—you don't suppose that in these the Greek workman thought he had given the likeness of gods? Yet here, to his imagination, were Athena, Poseidon, and Herakles,—and all the powers that guarded his land, and cleansed his soul, and led him in the way everlasting.

7. And the wider your knowledge extends over the distant days and homes of sacred art, the more constantly and clearly you will trace the rise of its symbolic function, from the rudest fringe of racing deer, or couchant leopards, scratched on some ill-kneaded piece of clay, when men had yet scarcely left their own cave-couchant life,—up to the throne of Cimabue's Madonna. All forms, and ornaments, and images, have a moral meaning as a natural one. Yet out of all, a restricted number, chosen for an alphabet, are recognized always as given letters, of which the familiar scripture is adopted by generation after generation.

8. You had best begin reading the scripture of St. Mark's on the low cupolas of the baptistery,—entering, as I asked you many a day since, to enter, under the tomb of the Doge Andrea Dandolo.

You see, the little chamber consists essentially of two parts, each with its low cupola : one containing the Font, the other the Altar.

The one is significant of Baptism with water unto repentance.

The other of Resurrection to newness of life.

Burial, in baptism with water, of the lusts of the flesh. Resurrection, in baptism by the spirit—here, and now, to the beginning of life eternal.

Both the cupolas have Christ for their central figure : surrounded, in that over the font, by the Apostles baptizing with water ; in that over the altar, surrounded by the Powers of Heaven, baptizing with the Holy Ghost and with fire. Each of the Apostles, over the font, is seen baptizing in the country to which he is sent.

Their legends, written above them, begin over the door of entrance into the church, with St. John the Evangelist, and end with St. Mark—the order of all being as follows :—

| | |
|-------------------------------------|--------------------------|
| St. John the Evangelist baptizes in | Ephesus. |
| St. James | Judæa. |
| St. Philip | Phrygia. |
| St. Matthew | Ethiopia. |
| St. Simon | Egypt. |
| St. Thomas | India. |
| St. Andrew | Achaia. |
| St. Peter | Rome. |
| St. Bartholomew | (legend indecipherable). |
| St. Thaddeus | Mesopotamia. |
| St. Matthias | Palestine. |
| St. Mark | Alexandria. |

Over the door is Herod's feast. Herodias' daughter dances with St. John Baptist's head in the charger, on her head,—simply the translation of any Greek maid on a Greek vase, bearing a pitcher of water on her head.

I am not sure, but I believe the picture is meant to represent the two separate times of Herod's dealing with St. John ; and that the figure at the end of the table is in the former time, St. John saying to him, " It is not lawful for thee to have her."

9. Pass on now into the farther chapel under the darker dome.

Darker, and very dark ;—to my old eyes, scarcely decipherable ;—to yours, if young and bright, it should be beautiful, for it is indeed the origin of all those golden-domed backgrounds of Bellini, and Cima, and Carpaccio ; itself a Greek vase, but with new Gods. That ten-winged cherub in the recess of it, behind the altar, has written on the circle on its breast, “Fulness of Wisdom.” It is the type of the Breath of



the Spirit. But it was once a Greek Harpy, and its wasted limbs remain, scarcely yet clothed with flesh from the claws of birds that they were.

At the sides of it are the two powers of the Seraphim and Thrones : the Seraphim with sword ; the Thrones (TRONIS), with *Fleur-de-lys* sceptre,—lovely.

Opposite, on the arch by which you entered are The Virtues, (VIRTUTES).

A dead body lies under a rock, out of which spring two torrents—one of water, one of fire. The Angel of the Virtues calls on the dead to rise.

Then the circle is thus completed :

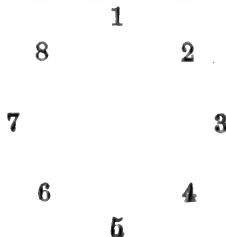

1, being the Wisdom angel ; 8, the Seraphim ; 2, the Thrones ; and 5, the Virtues. 3. Dominations. 4. Angels. 6. Potentates. 7. Princes : the last with helm and sword.

Above, Christ Himself ascends, borne in a whirlwind of angels ; and, as the vaults of Bellini and Carpaccio are only the amplification of the Harpy-Vault, so the Paradise of Tintoret is only the final fulfilment of the thought in this narrow cupola.

10. At your left hand, as you look towards the altar, is the most beautiful symbolic design of the Baptist's death that I know in Italy. Herodias is enthroned, not merely as queen at Herod's table, but high and alone, the type of the Power of evil in pride of womanhood, through the past and future world, until Time shall be no longer.

On her right hand is St. John's execution ; on her left, the Christian disciples, marked by their black crosses, bear his body to the tomb.

It is a four-square canopy, round arched ; of the exact type of that in the museum at Perugia, given to the ninth century ; but that over Herodias is round-trefoiled, and there is no question but that these mosaics are not earlier than the thirteenth century.

And yet they are still absolutely Greek in all modes of thought, and forms of tradition. The Fountains of fire and water are merely forms of the Chimera and the Peirene ; and the maid dancing, though a princess of the thirteenth century in sleeves of ermine, is yet the phantom of some sweet water-carrier from an Arcadian spring.

11. These mosaics are the only ones in the interior of the church which belong to the time (1204) when its façade was completed by the placing of the Greek horses over its central arch, and illumined by the lovely series of mosaics still represented in Gentile Bellini's pictures, of which only one now remains. That *one*, left nearly intact—as Fate has willed—represents the church itself so completed ; and the bearing of the body of St. Mark into its gates, with all the great kings and queens who have visited his shrine, standing to look on ; not conceived, mind you, as present at any actual time, but as always looking on in their hearts.

12. I say it is left *nearly* intact. The three figures on the extreme right are restorations ; and if the reader will carefully study the difference between these and the rest ; and note how all the faults of the old work are caricatured, and every one of its beauties lost—so that the faces which in the older figures are grave or sweet, are in these three new ones as of staring dolls,—he will know, once for all, what kind of thanks he owes to the tribe of Restorers—here and elsewhere.

Please note, farther, that at this time the church had round arches in the second story, (of which the shells exist yet,) but no pinnacles or marble fringes. All that terminal filigree is of a far later age. I take the façade as you see it stood—just after 1204—thus perfected. And I will tell you, so far as I know, the meaning of it, and of what it led to, piece by piece.

13. I begin with the horses,—those I saw in my dream in 1871,—“putting on their harness.” See “*Ariadne Florentina*,” p. 203.

These are the sign to Europe of the destruction of the Greek Empire by the Latin. They are chariot horses—the horses of the Greek quadriga,—and they were the trophies of Henry Dandolo. That is all you need know of them just now ; more, I hope, hereafter ; but you must learn the meaning of a Greek quadriga first. They stand on the great outer archivolt of the façade : its ornaments, to the front, are of leafage closing out of spirals into balls interposed between the figures of eight Prophets (or Patriarchs?)—Christ in their midst on the keystone. No one would believe at first it was thirteenth-century work, so delicate and rich as it looks ; nor is there anything else like it that I know, in Europe, of the date : but pure thirteenth-century work it is, of rarest chiselling. I have cast two of its balls with their surrounding leafage, for St. George's Museum ; the most instructive pieces of sculpture of all I can ever show there.

14. Nor can you at all know how good it is, unless you will learn to draw : but some things concerning it may be seen, by attentive eyes, which are worth the dwelling upon.

You see, in the first place, that the outer foliage is all of one kind—pure Greek Acanthus,—not in the least trans-

forming itself into ivy, or kale, or rose : trusting wholly for its beauty to the varied play of its own narrow and pointed lobes.

Narrow and pointed—but not jagged ; for the jagged form of Acanthus, look at the two Jean d'Acre columns, and return to this—you will then feel why I call it *pure* ; it is as nearly as possible the acanthus of early Corinth, only more flexible, and with more incipient blending of the character of the vine which is used for the central bosses. You see that each leaf of these last touches with its point a stellar knot of inwoven braid ; (compare the ornament round the low archivolt of the porch on your right below), the outer acanthus folding all in spiral whorls.

15. Now all thirteenth-century ornament of every nation runs much into spirals, and Irish and Scandinavian earlier decoration into little else. But these spirals are different from theirs. The Northern spiral is always elastic—like that of a watch-spring. The Greek spiral, drifted like that of a whirlpool, or whirlwind. It is always an eddy or vortex—not a living rod, like the point of a young fern.

At least, not living its own life—but under another life. It is under the power of the Queen of the Air ; the power also that is over the Sea, and over the human mind. The first leaves I ever drew from St. Mark's were those drifted under the breathing of it ;¹ these on its uppermost cornice, far lovelier, are the final perfection of the Ionic spiral, and of the thought in the temple of the Winds.

But perfected under a new influence. I said there was nothing like them (that I knew) in European architecture. But there is, in Eastern. They are only the amplification of the cornice over the arches of the Holy Sepulchre at Jerusalem.

16. I have been speaking hitherto of the front of the arch only. Underneath it, the sculpture is equally rich, and much more animated. It represents,—What think you, or what would you have, good reader, if you were yourself designing the central archivolt of your native city, to companion, and even partly to sustain, the stones on which those eight Patriarchs were carved—and Christ ?

¹ See the large plate of two capitals in early folio illustrations.

The great men of your city, I suppose,—or the good women of it? or the squires round about it? with the Master of the hounds in the middle? or the Mayor and Corporation? Well. That last guess comes near the Venetian mind, only it is not my Lord Mayor, in his robes of state, nor the Corporation at their city feast; but the mere Craftsmen of Venice—the Trades, that is to say, depending on handicraft, beginning with the shipwrights, and going on to the givers of wine and bread—ending with the carpenter, the smith, and the fisherman.

Beginning, I say, if read from left to right, (north to south,) with the shipwrights; but under them is a sitting figure, though sitting, yet supported by crutches. I cannot read this symbol: one may fancy many meanings in it,—but I do not trust fancy in such matters. Unless I know what a symbol means, I do not tell you my own thoughts of it.

17. If, however, we read from right to left, Orientalwise, the order would be more intelligible. It is then thus:

1. Fishing.
 2. Forging.
 3. Sawing. Rough carpentry?
 4. Cleaving wood with axe. Wheelwright?
 5. Cask and tub making.
 6. Barber-surgery.
 7. Weaving.
- Keystone—Christ the Lamb; i. e., in humiliation.
8. Masonry.
 9. Pottery.
 10. The Butcher.
 11. The Baker.
 12. The Vintner.
 13. The Shipwright. And
 14. The rest of old age?

18. But it is not here the place to describe these carvings to you,—there are none others like them in Venice except the bases of the piazzetta shafts; and there is little work like them

elsewhere, pure realistic sculpture of the twelfth and thirteenth centuries ; I may have much to say of them in their day—not now.

Under these labourers you may read, in large letters, a piece of history from the Vienna Morning Post—or whatever the paper was—of the year 1815, with which we are not concerned, nor need anybody else be so, to the end of time.

Not with that ; nor with the mosaic of the vault beneath—flaunting glare of Venetian art in its ruin. No vestige of old work remains till we come to those steps of stone ascending on each side over the inner archivolt ; a strange method of enclosing its curve ; but done with special purpose. If you look in the Bellini picture, you will see that these steps formed the rocky midst of a mountain which rose over them for the ground, in the old mosaic ; the Mount of the Beatitudes. And on the vault above, stood Christ blessing for ever—not as standing on the Mount, but supported above it by Angels.

19. And on the archivolt itself were carved the Virtues—with, it is said, the Beatitudes ; but I am not sure yet of anything in this archivolt, except that it is entirely splendid twelfth-century sculpture. I had the separate figures cast for my English museum, and put off the examination of them when I was overworked. The Fortitude, Justice, Faith, and Temperance are clear enough on the right—and the keystone figure is Constancy, but I am sure of nothing else yet : the less that interpretation partly depended on the scrolls, of which the letters were gilded, not carved :—the figures also gilded, in Bellini's time.

Then the innermost archivolt of all is of mere twelfth-century grotesque, unworthy of its place. But there were so many entrances to the atrium that the builders did not care to trust special teaching to any one, even the central, except as a part of the façade. The atrium, or outer cloister itself, was the real porch of the temple. And *that* they covered with as close scripture as they could—the whole Creation and Book of Genesis pictured on it.

20. These are the mosaics usually attributed to the Doge

Selvo : I cannot myself date any mosaics securely with precision, never having studied the technical structure of them ; and these also are different from the others of St. Mark's in being more Norman than Byzantine in manner ; and in an ugly admittance and treatment of nude form, which I find only elsewhere in manuscripts of the tenth and eleventh centuries of the school of Monte Cassino and South Italy. On the other hand, they possess some qualities of thought and invention almost in a sublime degree. But I believe Selvo had better work done under him than these. Better work at all events, you shall now see—if you will. You must get hold of the man who keeps sweeping the dust about, in St. Mark's ; very thankful he will be, for a lira, to take you up to the gallery on the right-hand side, (south, of St. Mark's interior ;) from which gallery, where it turns into the south transept, you may see, as well as it is possible to see, the mosaic of the central dome.

21. Christ enthroned on a rainbow, in a sphere supported by four flying angels underneath, forming white pillars of caryatid mosaic. Between the windows, the twelve apostles, and the Madonna,—alas, the head of this principal figure frightfully “restored,” and I think the greater part of the central subject. Round the circle enclosing Christ is written, “Ye men of Galilee, why stand ye at gaze ? This Son of God, Jesus, so taken from you, departs that He may be the arbiter of the earth : in charge of judgment He comes, *and to give the laws that ought to be.*”

22. Such, you see, the central thought of Venetian worship. Not that we shall leave the world, but that our Master will come to it : and such the central hope of Venetian worship, that He shall come to *judge* the world indeed ; not in a last and destroying judgment, but in an enduring and saving judgment, in truth and righteousness and peace. Catholic theology of the purest, lasting at all events down to the thirteenth century ; or as long as the Byzantines had influence. For these are typical Byzantine conceptions ; how far taken up and repeated by Italian workers, one cannot say ; but in **their** gravity of purpose, meagre thinness of form, and rigid

drapery lines, to be remembered by you with distinctness as expressing the first school of design in Venice, comparable in an instant with her last school of design, by merely glancing to the end of the north transept, where that rich piece of foliage, full of patriarchs, was designed by Paul Veronese. And what a divine picture it might have been, if he had only minded his own business, and let the mosaic workers mind theirs!—even now it is the only beautiful one of the late mosaics, and shows a new phase of the genius of Veronese. All I want you to feel, however, is the difference of temper from the time when people liked the white pillar-like figures of the dome, to that when they liked the dark exuberance of those in the transept.

23. But from this coign of vantage you may see much more. Just opposite you, and above, in the arch crossing the transept between its cupola and the central dome, are mosaics of Christ's Temptation, and of his entrance to Jerusalem. The upper one, of the Temptation, is entirely characteristic of the Byzantine mythic manner of teaching. On the left, Christ sits in the rocky cave which has sheltered Him for the forty days of fasting: out of the rock above issues a spring—meaning that He drank of the waters that spring up to everlasting life, of which whoso drinks shall never thirst; and in His hand is a book—the living Word of God, which is His bread. The Devil holds up the stones in his lap.

Next the temptation on the pinnacle of the Temple, symbolic again, wholly, as you see,—in very deed quite impossible: so also that on the mountain, where the treasures of the world are, I think, represented by the glittering fragments on the mountain top. Finally, the falling Devil, cast down head-foremost in the air, and approaching angels in ministering troops, complete the story.

24. And on the whole, these pictures are entirely representative to you of the food which the Venetian mind had in art, down to the day of the Doge Selvo. Those were the kind of images and shadows they lived on: you may think of them what you please, but the historic fact is, beyond all possible debate, that these thin dry bones of art were nourishing meat

to the Venetian race : that they grew and throve on that diet, every day spiritually fatter for it, and more comfortably round in human soul :—no illustrated papers to be had, no Academy Exhibition to be seen. If their eyes were to be entertained at all, such must be their lugubrious delectation ; pleasure difficult enough to imagine, but real and pure, I doubt not ; even passionate. In as quite singularly incomprehensible fidelity of sentiment, my cousin's least baby has fallen in love with a wooden spoon ; Paul not more devoted to Virginia. The two are inseparable all about the house, vainly the unimaginative bystanders endeavouring to perceive, for their part, any amiableness in the spoon. But baby thrives in his pacific attachment,—nay, is under the most perfect moral control, pliant as a reed, under the slightest threat of being parted from his spoon. And I am assured that the crescent Venetian imagination did indeed find pleasantness in these figures ; more especially,—which is notable—in the extreme emaciation of them,—a type of beauty kept in their hearts down to the Vivarini days ; afterwards rapidly changing to a very opposite ideal indeed.

25. Nor even in its most ascetic power, disturbing these conceptions of what was fitting and fair in their own persons, or as a nation of fishermen. They have left us, happily, a picture of themselves, at their greatest time—unnoticed, so far as I can read, by any of their historians, but left for poor little me to discover—and that by chance—like the inscription on St. James's of the Rialto.

But before going on to see this, look behind you, where you stand, at the mosaic on the west wall of the south transept.

It is not Byzantine, but rude thirteenth-century, and fortunately left, being the representation of an event of some import to Venice, the recovery of the lost body of St. Mark.

You may find the story told, with proudly polished, or loudly impudent, incredulity, in any modern guide-book. I will not pause to speak of it here, nor dwell, yet, on this mosaic, which is clearly later than the story it tells by two hundred years. We will go on to the picture which shows us things as they *were*, in its time.

26. You must go round the transept gallery, and get the door opened into the compartment of the eastern aisle, in which is the organ. And going to the other side of the square stone gallery, and looking back from behind the organ, you will see opposite, on the vault, a mosaic of upright figures in dresses of blue, green, purple, and white, variously embroidered with gold.

These represent, as you are told by the inscription above them—the Priests, the Clergy, the Doge, and the people of Venice; and are an abstract, at least, or epitome of those personages, as they were, and felt themselves to be, in those days.

I believe, early twelfth-century—late eleventh it might be—later twelfth it may be,—it does not matter: these were the people of Venice in the central time of her unwearied life, her unsacrificed honour, her unabated power, and sacred faith. Her Doge wears, not the contracted shell-like cap, but the imperial crown. Her priests and clergy are alike mitred—not with the cloven, but simple, cap, like the conical helmet of a knight. Her people are also her soldiers, and their Captain bears his sword, sheathed in black.

So far as features could be rendered in the rude time, the faces are *all* noble—(one horribly restored figure on the right shows what ignobleness, on this large scale, modern brutality and ignorance can reach); for the most part, dark-eyed, but the Doge brown-eyed and fair-haired, the long tresses falling on his shoulders, and his beard braided like that of an Etruscan king.

27. And this is the writing over them.

PONTIFICES. CLERUS. POPULUS. DUX MENTE SERENUS.¹

The Priests. the Clergy. the People. the Duke, serene of mind.

Most Serene Highnesses of all the after Time and World,—

¹ The continuing couplet of monkish Latin,

“Laudibus atque choris

Excipiunt dulce canoris,”

may perhaps have been made worse or less efficient Latin by some mistake in restoration.

how many of you knew, or know, what this Venice, first to give the title, meant by her Duke's Serenity! and why she trusted it?

The most precious "historical picture" this, to my mind, of any in worldly gallery, or unworldly cloister, east or west; but for the present, all I care for you to learn of it, is that these were the kind of priests, and people, and kings, who wrote this Requiem of St. Mark, of which, now, we will read what more we may.

28. If you go up in front of the organ, you may see, better than from below, the mosaics of the eastern dome.

This part of the church must necessarily have been first completed, because it is over the altar and shrine. In it, the teaching of the Mosaic legend begins, and in a sort ends;—"Christ the King," foretold of Prophets—declared of Evangelists—born of a Virgin in due time!

But to understand the course of legend, you must know what the Greek teachers meant by an Evangelion, as distinct from a Prophecy. Prophecy is here thought of in its narrower sense as the foretelling of a good that is to be.

But an Evangelion is the voice of the Messenger, saying, it is *here*.

And the four mystic Evangelists, under the figures of living creatures, are not types merely of the men that are to bring the Gospel message, but of the power of that message in all Creation—so far as it was, and is, spoken in all living things, and as the Word of God, which is Christ, was present, and not merely prophesied, in the Creatures of His hand.

29. You will find in your Murray, and other illumined writings of the nineteenth century, various explanations given of the meaning of the Lion of St. Mark—derived, they occasionally mention (nearly as if it had been derived by accident!), from the description of Ezekiel.¹ Which, perhaps, you may have read once on a time, though even that is doubtful in these blessed days of scientific education;—but, boy or girl, man or woman, of you, not one in a thousand, if one, has

¹Or, with still more enlightened Scripture research, from "one of the visions of Daniel"! (Sketches, etc., p. 18.)

ever, I am well assured, asked what was the *use* of Ezekiel's Vision, either to Ezekiel, or to anybody else ; any more than I used to think, myself, what St. Mark's was built for.

In case you have not a Bible with you, I must be tedious enough to reprint the essential verses here.

30. "As I was among the Captives by the River of Chebar, the Heavens were opened, and I saw visions of God."

(Fugitive at least,—and all *but* captive,—by the River of the deep stream,—the Venetians perhaps cared yet to hear what he saw.)

"In the fifth year of King Jehoiachin's captivity, the word of the Lord came *expressly* unto Ezekiel the Priest."

(We also—we Venetians—have our Pontifices ; we also our King. May we not hear ?)

"And I looked, and, behold, a whirlwind came out of the north, and a fire infolding itself. Also in the midst thereof was ¹ the likeness of Four living Creatures.

"And this was the aspect of them ; the Likeness of a Man was upon them.

"And every one had four faces, and every one four wings. And they had the hands of a Man under their wings. And their wings were stretched upward, two wings of every one were joined one to another, and two covered their bodies. And when they went, I heard the noise of their wings, like the noise of great waters, as the voice of the Almighty, the voice of speech, the noise of an Host."

(To us in Venice, is not the noise of the great waters known—and the noise of an Host ? May we hear also the voice of the Almighty ?)

"And they went every one straight forward. Whither the Spirit was to go, they went. And this was the likeness of their faces : they four had the face of a Man " (to the front), "and the face of a Lion on the right side, and the face of an Ox on the left side, and " (looking back) "the face of an Eagle."

And not of an Ape, then, my beautifully-browed cockney friend ?—the unscientific Prophet ! The face of Man ; and of

¹ What alterations I make are from the Septuagint.

the wild beasts of the earth, and of the tame, and of the birds of the air. This was the Vision of the Glory of the Lord.

31. "And as I beheld the living creatures, behold, *one* wheel upon the earth, by the living creatures, with *his* four faces, . . . and their aspect, and their work, was as a wheel in the midst of a wheel."

Crossed, that is, the meridians of the four quarters of the earth. (See Holbein's drawing of it in his Old Testament series.)

"And the likeness of the Firmament upon the heads of the living creatures was as the colour of the terrible crystal.

"And there was a voice from the Firmament that was over their heads, when they stood, *and had let down* their wings.

"And above the Firmament that was over their heads was the likeness of a Throne; and upon the likeness of the Throne was the likeness of the Aspect of a Man above, upon it.

"And from His loins round about I saw it as it were the appearance of fire; and it had brightness round about, as the bow that is in the cloud in the day of rain. This was the appearance of the likeness of the Glory of the Lord. And when I saw it, I fell upon my face."

32. Can any of us do the like—or is it worth while?—with only apes' faces to fall upon, and the forehead that refuses to be ashamed? Or is there, nowadays, no more anything for *us* to be afraid of, or to be thankful for, in all the wheels, and flame, and light, of earth and heaven?

This that follows, after the long rebuke, is their Evangelion. This the sum of the voice that speaks in them, (chap. xi. 16).

"Therefore say, thus saith the Lord. Though I have cast them far off among the heathen, yet will I be to them as a little sanctuary in the places whither they shall come.

"And I will give them one heart; and I will put a new spirit within them; and I will take the stony heart out of their flesh, and will give them a heart of flesh. That they may walk in my statutes, and keep mine ordinances and do them, and they shall be my people, and I will be their God.

“Then did the Cherubims lift up their wings, and the wheels beside them, and the glory of the God of Israel was over them above.”

33. That is the story of the Altar-Vault of St. Mark's, of which though much was gone, yet, when I was last in Venice, much was left, wholly lovely and mighty. The principal figure of the Throned Christ was indeed forever destroyed by the restorer; but the surrounding Prophets, and the Virgin in prayer, at least retained so much of their ancient colour and expression as to be entirely noble,—if only one had nobility enough in one's own thoughts to forgive the failure of any other human soul to speak clearly what it had felt of the most divine.

My notes have got confused and many lost; and now I have no time to mend the thread of them: I am not sure even if I have the list of the Prophets complete; but these following at least you will find, and (perhaps with others between) in this order—chosen, each, for his message concerning Christ, which is written on the scroll he bears.

34.

1. On the Madonna's left hand, Isaiah. “Behold, a virgin shall conceive.” (Written as far as “Immanuel.”)
2. Jeremiah. “Hic est in quo,—Deus Noster.”
3. Daniel. “Cum venerit” as far as to “cessabit unctio.”
4. Obadiah. “Ascendit sanctus in Monte Syon.”
5. Habakkuk. “God shall come from the South, and the Holy One from Mount Paran.”
6. Hosea. (Undeciphered.)
7. Jonah. (Undeciphered.)
8. Zephaniah. “Seek ye the Lord, all in the gentle time” (in mansueti tempore).
9. Haggai. “Behold, the desired of all nations shall come.”
10. Zachariah. “Behold a man whose name is the Branch.” (*Oriens.*)

11. Malachi. "Behold, I send my messenger," etc (angelum meum).
12. Solomon. "Who is this that ascends as the morning?"
13. David. "Of the fruit of thy body will I set upon thy throne."

35. The decorative power of the colour in these figures, chiefly blue, purple, and white, on gold, is entirely admirable, —more especially the dark purple of the Virgin's robe, with lines of gold for its folds; and the figures of David and Solomon, both in Persian tiaras, almost Arab, with falling lappets to the shoulder, for shade; David holding a book with Hebrew letters on it and a cross, (a pretty sign for the Psalms;) and Solomon with rich orbs of lace like involved ornament on his dark robe, cusped in the short hem of it, over gold underneath. And note in all these mosaics that Byzantine "purple,"—the colour at once meaning Kinghood and its Sorrow,—is the same as ours—not scarlet, but amethyst, and that deep.

36. Then in the spandrils below, come the figures of the four beasts, with this inscription round, for all of them.

"QUAEQUE SUB OBSCURIS
DE CRISTO DICTA FIGURIS
HIS APERIRE DATUR
ET IN HIS, DEUS IPSE NOTATUR."

"Whatever things under obscure figures have been said of Christ, it is given to *these*" (creatures) "to open; and in these, Christ himself is seen."

A grave saying. Not in the least true of mere Matthew, Mark, Luke, and John. Christ was never seen *in* them, though told of by them. But, as the Word by which all things were made, He is seen in all things made, and in the poiesis of them: and therefore, when the vision of Ezekiel is related to St. John, changed only in that the four creatures then, him more distinct—each with its single aspect, and not may unfold,—they are full of eyes within, and rest not day them,

nor night,—saying, Holy, Holy, Holy, Lord God Almighty, which art, and wast, and art to come.”

37. We repeat the words habitually, in our own most solemn religious service ; but we repeat without noticing out of whose mouths they come.

“Therefore,” (we say, in much self-satisfaction,) “with Angels and Archangels, and with all the Company of heaven,” (meaning each of us, I suppose, the select Company we expect to get into there,) “we laud and magnify,” etc. But it ought to make a difference in our estimate of ourselves, and of our power to say, with our hearts, that God is Holy, if we remember that we join in saying so, not, for the present, with the Angels,—but with the Beasts.

38. Yet not with every manner of Beast ; for afterwards, when all the Creatures in Heaven and Earth, and the Sea, join in the giving of praise, it is only these four who can say “Amen.”

The Ox that treadeth out the corn ; and the Lion that shall shall eat straw like the Ox, and lie down with the lamb ; and the Eagle that fluttereth over her young ; and the human creature that loves its mate, and its children. In these four is all the power and all the charity of earthly life ; and in such power and charity “Deus ipse notatur.”

39. Notable, in that manner, He was, at least, to the men who built this shrine where once was St. Theodore’s ;—not betraying nor forgetting their first master, but placing his statue, with St. Mark’s Lion, as equal powers upon their pillars of justice ;—St. Theodore, as you have before heard, being the human spirit in true conquest over the inhuman, because in true sympathy with it—not as St. George in contest with, but being strengthened and pedestalled by, the “Dragons and all Deeps.”

40. But the issue of all these lessons we cannot yet measure ; it is only now that we are beginning to be able to read them, in the myths of the past, and natural history of the present world. The animal gods of Egypt and Assyria, the animal cry that there is *no* God, of the passing hour, are, both of them, part of the rudiments of the religion yet to be re-

vealed, in the rule of the Holy Spirit over the venomous dust, when the sucking child shall play by the hole of the asp, and the weaned child lay his hand on the cockatrice den.

41. And now, if you have enough seen, and understood, this eastern dome and its lesson, go down into the church under the central one, and consider the story of that.

Under *its* angles are the four Evangelists themselves, drawn as men, and each with his name. And over *them* the inscription is widely different.¹

“SIC ACTUS CHRISTI
DESCRIBUNT QUATUOR ISTI
QUOD NEQUE NATURA
LITER NENT, NEC UTRINQUE FIGURA.”

“Thus do these four describe the Acts of Christ. And weave his story, neither by natural knowledge, nor, contrariwise, by any figure.”

Compare now the two inscriptions. In the living creatures, Christ himself is seen by nature and by figure. But these four tell us his Acts, “Not by nature—not by figure.” How then?

42. You have had various “lives of Christ,” German and other, lately provided among your other severely historical studies. Some, critical; and some, sentimental. But there is only one light by which you can read the life of Christ,—the light of the life you now lead in the flesh; and that not the natural, but the won life. “Nevertheless, I live; yet not I, but Christ liveth in me.”

Therefore, round the vault, as the pillars of it, are the Christian virtues; somewhat more in number, and other in nature, than the swindling-born and business-bred virtues which most Christians nowadays are content in acquiring. But these old Venetian virtues are compliant also, in a way.

¹ I give, and construe, this legend as now written, but the five letters “liter” are recently restored, and I suspect them to have been originally either three or six, “cer” or “discer.” In all the monkish rhymes I have yet read, I don’t remember any so awkward a division as this of natura-liter.

They are for sea-life, and there is one for every wind that blows.

43. If you stand in mid-nave, looking to the altar, the first narrow window of the cupola—(I call it first for reasons presently given) faces you, in the due east. Call the one next it, on your right, the second window ; it bears east-south-east. The third, south-east ; the fourth, south-south-east ; the fifth, south ; the ninth, west ; the thirteenth, north ; and the sixteenth, east-north-east.

The Venetian Virtues stand, one between each window. On the sides of the east window stand Fortitude and Temperance ; Temperance the first, Fortitude the last : “ he that endureth to the end, the same shall be saved.”

Then their order is as follows : Temperance between the first and second windows,—(quenching fire with water) ;—between the second and third, Prudence ; and then, in sequence,

- iii. Humility.
- iv. Kindness, (Benignitas).
- v. Compassion.
- vi. Abstinence.
- vii. Mercy.
- viii. Long-suffering.
- ix. Chastity.
- x. Modesty.
- xi. Constancy.
- xii. Charity.
- xiii. Hope.
- xiv. Faith.
- xv. Justice.
- xvi. Fortitude.

44. I meant to have read all their legends, but “ could do it any time,” and of course never did !—but these following are the most important. Charity is put twelfth at the last attained of the virtues belonging to human life only : but she is called the “ Mother of the Virtues ”—meaning, of them all, when they become divine ; and chiefly of the four last, which

relate to the other world. Then Long-suffering, (*Patientia*), has for her legend, "Blessed are the Peacemakers"; Chastity, "Blessed are the Pure in Heart"; Modesty, "Blessed are ye when men hate you"; while Constancy (consistency) has the two heads, balanced, one in each hand, which are given to the keystone of the entrance arch: meaning, I believe, the equal balance of a man's being, by which it not only stands, but stands as an arch, with the double strength of the two sides of his intellect and soul. "*Qui sibi constat.*" Then note that "*Modestia*" is here not merely shamefacedness, though it includes whatever is good in that; but it is contentment in being thought little of, or hated, when one thinks one ought to be made much of—a very difficult virtue to acquire indeed, as I know some people who know.

45. Then the order of the circle becomes entirely clear. All strength of character begins in temperance, prudence, and lowliness of thought. Without these, nothing is possible, of noble humanity: on these follow—kindness, (simple, as opposed to malice), and compassion, (sympathy, a much rarer quality than mere kindness); then, *self-restriction*, a quite different and higher condition than temperance,—the first being not painful when rightly practised, but the latter always so;—("I held my peace, even from good"—"*quanto quisque sibi plura negaverit, ab Dis plura feret*"). Then come pity and long-suffering, which have to deal with the sin, and not merely with the sorrow, of those around us. Then the three Trial virtues, through which one has to struggle forward up to the power of Love, the twelfth.

All these relate only to the duties and relations of the life that is now.

But Love is stronger than Death; and through her, we have, first, Hope of life to come; then, surety of it; living by this surety, (the Just shall live by faith,) Righteousness, and Strength to the end. Who bears on her scroll, "The Lord shall break the teeth of the Lions."

46. An undeveloped and simial system of human life—you think it—cockney friend!

Such as it was, the Venetians made shift to brave the war

of this world with it, as well as ever you are like to do ; and they had, besides, the joy of looking to the peace of another. For, you see, above these narrow windows, stand the Apostles, and the two angels that stood by them on the Mount of the Ascension ; and between these the Virgin ; and with her, and with the twelve, you are to hear the angel's word, " Why stand ye at gaze ? as He departs, so shall He come, to give the Laws that ought to be."

DEBITA JURA,

a form of "debit" little referred to in modern ledgers, but by the Venetian acknowledged for all devoirs of commerce and of war ; writing, by his church, of the Rialto's business, (the first words, these, mind you, that Venice ever speaks aloud,) "Around this Temple, let the Merchant's law be just, his weights true, and his covenants faithful." And writing thus, in lovelier letters, above the place of St. Mark's Rest,—

" Brave be the living, who live unto the Lord ;
For Blessed are the dead, that die in Him."

NOTE.—The mosaics described in this number of St. Mark's Rest being now liable at any moment to destruction—from causes already enough specified, I have undertaken, at the instance of Mr. Edward Burne Jones, and with promise of that artist's helpful superintendence, at once to obtain some permanent record of them, the best that may be at present possible: and to that end I have already dispatched to Venice an accomplished young draughtsman, who is content to devote himself, as old painters did, to the work before him for the sake of that, and his own honour, at journeyman's wages. The three of us, Mr. Burne Jones, and he, and I, are alike minded to set our hands and souls hard at this thing: but we can't, unless the public will a little help us. I have given away already all I have to spare, and can't carry on this work at my own cost ; and if Mr. Burne Jones gives his time and care gratis, and without stint, as I know he will, it is all he should be asked for. Therefore, the public must give me enough to maintain my draughtsman at his task: what mode of publication for the drawings may be then possible, is for after-consideration. I ask for subscriptions at present to obtain the copies only. The reader is requested to refer also to the final note appended to the new edition of the "Stones of Venice," and to send what subscription he may please to my publisher, Mr. G. Allen, Sunnyside, Orpington, Kent.

FIRST SUPPLEMENT.

THE SHRINE OF THE SLAVES.

BEING A GUIDE TO THE PRINCIPAL PICTURES BY

VICTOR CARPACCIO

IN VENICE.

THE HISTORY

OF

THE

...

P R E F A C E .

THE following (too imperfect) account of the pictures by Carpaccio in the chapel of San Giorgio de' Schiavoni, is properly a supplement to the part of "St. Mark's Rest" in which I propose to examine the religious mind of Venice in the fifteenth century; but I publish these notes prematurely that they may the sooner become helpful, according to their power, to the English traveller.

The second supplement, which is already in the press, will contain the analysis by my fellow-worker, Mr. James Reddie Anderson, of the mythological purport of the pictures here described. I separate Mr. Anderson's work thus distinctly from my own, that he may have the entire credit of it; but the reader will soon perceive that it is altogether necessary, both for the completion and the proof of my tentative statements; and that without the certificate of his scholarly investigation, it would have been lost time to prolong the account of my own conjectures or impressions.

Handwritten title or header text, possibly including a date or page number.

Main body of handwritten text, consisting of several lines of cursive script. The text is significantly faded and difficult to decipher.

THE SHRINE OF THE SLAVES.

COUNTING the canals which, entering the city from the open lagoon, must be crossed as you walk from the Piazzetta towards the Public Gardens, the fourth, called the "Rio della Pietà" from the unfinished church of the Pietà, facing the quay before you reach it, will presently, if you go down it in gondola, and pass the Campo di S. Antonin, permit your landing at some steps on the right, in front of a little chapel of indescribable architecture, chiefly made up of foolish spiral flourishes, which yet, by their careful execution and shallow mouldings, are seen to belong to a time of refined temper. Over its door are two bas-reliefs. That of St. Catherine leaning on her wheel seems to me anterior in date to the other, and is very lovely: the second is contemporary with the cinque-cento building, and fine also; but notable chiefly for the conception of the dragon as a creature formidable rather by its gluttony than its malice, and degraded beneath the level of all other spirits of prey; its wings having wasted away into mere paddles or flappers, having in them no faculty or memory of flight; its throat stretched into the flaccidity of a sack, its tail swollen into a molluscouc encumbrance, like an enormous worm; and the human head beneath its paw symbolizing therefore the subjection of the human nature to the most brutal desires.

When I came to Venice last year, it was with resolute purpose of finding out everything that could be known of the circumstances which led to the building, and determined the style, of this chapel—or more strictly, sacred hall, of the School of the Schiavoni. But day after day the task was delayed by some more pressing subject of enquiry; and, at

this moment—resolved at last to put what notes I have on the contents of it at once together,—I find myself reduced to copy, without any additional illustration, the statement of Flaminio Corner.¹

“In the year 1451, some charitable men of the Illyrian or Slavonic nation, many of whom were sailors, moved by praiseworthy compassion, in that they saw many of their fellow-countrymen, though deserving well of the republic, perish miserably, either of hard life or hunger, nor have enough to pay the expenses of church burial, determined to establish a charitable brotherhood under the invocation of the holy martyrs St. George and St. Trifon—brotherhood whose pledge was to succour poor sailors, and others of their nation, in their grave need, whether by reason of sickness or old age, and to conduct their bodies, after death, religiously to burial. Which design was approved by the Council of Ten, in a decree dated 19th May, 1451; after which, they obtained from the pity of the Prior of the Monastery of St. John of Jerusalem, Lorenzo Marcello, the convenience of a hospice in the buildings of the Priory, with rooms such as were needful for their meetings; and the privilege of building an altar in the church, under the title of St. George and Trifon, the martyrs; with the adjudgment of an annual rent of four zecchins, two loaves, and a pound of wax, to be offered to the Priory on the feast of St. George. Such were the beginnings of the brotherhood, called that of St. George of the Slavonians.

“Towards the close of the fifteenth century, the old hospice being ruinous, the fraternity took counsel to raise from the foundations a more splendid new one, under the title of the Martyr St. George, which was brought to completion, with its façade of marble, in the year 1501.

The hospice granted by the pity of the Prior of St. John cannot have been very magnificent, if this little chapel be indeed much more splendid; nor do I yet know what rank the school of the Slavonians held, in power or number, among the other minor fraternities of Venice. The relation of the national character of the Dalmatians and Illyrians, not only

¹ “Notizie Storiche,” Venice, 1758, p. 167.

to Venice, but to Europe, I find to be of far more deep and curious interest than is commonly supposed ; and in the case of the Venetians, traceable back at least to the days of Herodotus ; for the festival of the Brides of Venice, and its interruption by the Illyrian pirates, is one of the curious proofs of the grounds he had for naming the Venetians as one of the tribes of the Illyrians, and ascribing to them, alone among European races, the same practice as that of the Babylonians with respect to the dowries of their marriageable girls.

How it chanced that while the entire Riva,—the chief quay in Venice—was named from the Slavonians, they were yet obliged to build their school on this narrow canal, and prided themselves on the magnificence of so small a building, I have not ascertained, nor who the builder was ;—his style, differing considerably from all the Venetian practice of the same date, by its refusal at once of purely classic forms, and of elaborate ornament, becoming insipidly grotesque, and chastely barbarous, in a quite unexampled degree, is noticeable enough, if we had not better things to notice within the unpretending doorway. Entering, we find ourselves in a little room about the size of the commercial parlour in an old-fashioned English inn ; perhaps an inch or two higher in the ceiling, which is of good horizontal beams, narrow and many, for effect of richness ; painted and gilded, also, now tawdrily enough, but always in some such patterns as you see. At the end of the low room, is an altar, with doors on the right and left of it in the sides of the room, opening, the one into the sacristy, the other to the stairs leading to the upper chapel. All the rest mere flat wall, wainscoted two-thirds up, eight feet or so, leaving a third of the height, say four feet, claiming some kind of decent decoration. Which modest demand you perceive to be modestly supplied, by pictures, fitting that measure in height, and running long or short, as suits their subjects ; ten altogether, (or with the altar-piece, eleven,) of which nine are worth your looking at.

Not as very successfully decorative work, I admit. A modern Parisian upholsterer, or clever Kensington student, would have done for you a far surpassing splendour in a few

hours : all that we can say here, at the utmost, is that the place looks comfortable ; and, especially, warm,—the pictures having the effect, you will feel presently, of a soft evening sunshine on the walls, or glow from embers on some peaceful hearth, cast up into the room where one sits waiting for dear friends, in twilight.

In a little while, if you still look with general glance, yet patiently, this warmth will resolve itself into a kind of chequering, as of an Eastern carpet, or old-fashioned English sampler, of more than usually broken and sudden variegation ; nay, suggestive here and there of a wayward patchwork, verging into grotesqueness, or even, with some touch of fantasy in masque, into harlequinade,—like a tapestry for a Christmas night in a home a thousand years old, to adorn a carol of honoured knights with honouring queens.

Thus far sentient of the piece, for all is indeed here but one,—go forward a little, please, to the second picture on the left, wherein, central, is our now accustomed friend, St. George : stiff and grotesque, even to humorousness, you will most likely think him, with his dragon in a singularly depressed and, as it were, water-logged, state. Never mind him, or the dragon, just now ; but take a good opera-glass, and look therewith steadily and long at the heads of the two princely riders on the left—the Saracen king and his daughter—he in high white turban, she beyond him in the crimson cap, high, like a castle tower.

Look well and long. For truly,—and with hard-earned and secure knowledge of such matters, I tell you, through all this round world of ours, searching what the best life of it has done of brightest in all its times and years,—you shall not find another piece quite the like of that little piece of work, for supreme, serene, unassuming, unfaltering sweetness of painter's perfect art. Over every other precious thing, of such things known to me, it rises, in the compass of its simplicity ; in being able to gather the perfections of the joy of extreme childhood, and the joy of a hermit's age, with the strength and sunshine of mid-life, all in one.

Which is indeed more or less true of all Carpaccio's work

and mind ; but in this piece you have it set in close jewellery, radiant, inestimable.

Extreme joy of childhood, I say. No little lady in her first red shoes,—no soldier's baby seeing himself in the glass beneath his father's helmet, is happier in laugh than Carpaccio, as he heaps and heaps his Sultan's snowy crest, and crowns his pretty lady with her ruby tower. No desert hermit is more temperate ; no ambassador on perilous policy more subtle ; no preacher of first Christian gospel to a primitive race more earnest or tender. The wonderfullest of Venetian Harlequins this,—variegated, like Geryon, to the innermost mind of him—to the lightest gleam of his pencil: “*Con più color, sommesse e sopraposte ; non fur mai drappi Tartari ne Turchi ;*” and all for good.

Of course you will not believe me at first,—nor indeed, till you have unwoven many a fibre of his silk and gold. I had no idea of the make of it myself, till this last year, when I happily had beguiled to Venice one of my best young Oxford men, eager as myself to understand this historic tapestry, and finer fingered than I, who once getting hold of the fringes of it, has followed them thread by thread through all the gleaming damask, and read it clear ; whose account of the real meaning of all these pictures you shall have presently in full.

But first, we will go round the room to know what is here to read, and take inventory of our treasures ; and I will tell you only the little I made out myself, which is all that, without more hard work than can be got through to-day, you are likely either to see in them, or believe of them.

First, on the left, then, St. George and the Dragon—combatant both, to the best of their powers ; perfect each in their natures of dragon and knight. No dragon that I know of, pictured among mortal worms ; no knight I know of, pictured in immortal chivalry, so perfect, each in his kind, as these two. What else is visible on the battleground, of living creature,—frog, newt, or viper,—no less admirable in their kind. The small black viper, central, I have painted carefully for the schools of Oxford as a Natural History study, such as Oxford schools prefer. St. George, for my own satisfaction,

also as well as I could, in the year 1872; and hope to get him some day better done, for an example to Sheffield in iron-armour, and several other things.

Picture second, the one I first took you to see, is of the Dragon led into the market-place of the Sultan's capital—submissive: the piece of St. George's spear, which has gone through the back of his head, being used as a bridle: but the creature indeed now little needing one, being otherwise subdued enough; an entirely collapsed and confounded dragon, all his bones dissolved away; prince and people gazing as he returns to his dust.

Picture third, on the left side of the altar.¹

The Sultan and his daughter are baptized by St. George.

Triumphant festival of baptism, as at the new birthday of two kingly spirits. Trumpets and shawms high in resounding transport; yet something of comic no less than rapturous in the piece; a beautiful scarlet—"parrot" (must we call him?) conspicuously mumbling at a violet flower under the steps; him also—finding him the scarletest and mumblingest parrot I had ever seen—I tried to paint in 1872 for the Natural History Schools of Oxford—perhaps a new species, or extinct old one, to immortalize Carpaccio's name and mine. When all the imaginative arts shall be known no more, perhaps, in Darwinian Museum, this scarlet "*Epops Carpaccii*" may preserve our fame.

But the quaintest thing of all is St. George's own attitude in baptizing. He has taken a good platterful of water to pour on the Sultan's head. The font of inlaid bronze below is quite flat, and the splash is likely to be spreading. St. George—carefullest of saints, it seems, in the smallest matters—is holding his mantle back well out of the way. I suppose, really and truly, the instinctive action would have been this, pouring at the same time so that the splash might be towards himself, and not over the Sultan.

With its head close to St. George's foot, you see a sharp-eared white dog, with a red collar round his neck. Not a

¹ The intermediate oblong on the lateral wall is not Carpaccio's, and is good for nothing.

greyhound, by any means ; but an awkward animal : stupid-looking, and not much like a saint's dog. Nor is it in the least interested in the baptism, which a saint's dog would certainly have been. The mumbling parrot, and he—what *can* they have to do with the proceedings? A very comic picture!

But this next,—for a piece of sacred art, what can we say of it?

St. Tryphonius and the Basilisk—was ever so simple a saint, ever so absurd a beast? as if the absurdity of all heraldic beasts that ever were, had been hatched into one perfect absurdity—prancing there on the steps of the throne, self-satisfied;—*this* the beast whose glance is mortal! And little St. Tryphonius, with nothing remarkable about him more than is in every good little boy, for all I can see.

And the worst of it is that I don't happen to know anything about St. Tryphonius, whom I mix up a little with Tropho-nius, and his cave ; also I am not very clear about the difference between basilisks and cockatrices ; and on the whole find myself reduced, in this picture, to admiring the carpets with the crosses on them hung out of the window, which, if you will examine with opera-glass, you will be convinced, I think, that nobody can do the like of them by rules, at Kensington ; and that if you really care to have carpets as good as they can be, you must get somebody to design them who can draw saints and basilisks too.

Note, also, the group under the loggia which the stair-case leads up to, high on the left. It is a picture in itself ; far more lovely as a composition than the finest Titian or Veronese, simple and pleasant this as the summer air, and lucent as morning cloud.

On the other side also there are wonderful things, only there's a black figure there that frightens me ; I can't make it out at all ; and would rather go on to the next picture, please.

Stay—I forgot the arabesque on the steps, with the living plants taking part in the ornament, like voices chanting here and there a note, as some pretty tune follows its melodious

way, on constant instruments. Nature and art at play with each other—graceful and gay alike, yet all the while conscious that they are at play round the steps of a throne, and under the paws of a basilisk.

The fifth picture is in the darkest recess of all the room ; and of darkest theme,—the Agony in the garden. I have never seen it rightly, nor need you pause at it, unless to note the extreme naturalness of the action in the sleeping figures—their dresses drawn tight under them as they have turned, restlessly. But the principal figure is hopelessly invisible.

The sixth picture is of the calling of Matthew ; visible, this, in a bright day, and worth waiting for one, to see it in, through any stress of weather.

For, indeed, the Gospel which the publican wrote for us, with its perfect Sermon on the Mount, and mostly more harmonious and gentle fulness, in places where St. Luke is formal, St. John mysterious, and St. Mark brief,—this Gospel, according to St. Matthew, I should think, if we had to choose one out of all the books in the Bible for a prison or desert friend, would be the one we should keep.

And we do not enough think how much that leaving the receipt of custom meant, as a sign of the man's nature, who was to leave us such a notable piece of literature.

Yet observe, Carpaccio does not mean to express the fact, or anything like the fact, of the literal calling of Matthew. What the actual character of the publicans of Jerusalem was at that time, in its general aspect, its admitted degradation, and yet power of believing, with the harlot, what the masters and the mothers in Israel could not believe, it is not his purpose to teach you. This call from receipt of custom, he takes for the symbol of the universal call to leave all that we have, and are doing. "Whosoever forsaketh not all that he hath, cannot be my disciple." For the other calls were easily obeyed in comparison of this. To leave one's often empty nets and nightly toil on sea, and become fishers of men, probably you might find pescatori enough on the Riva there, within a hundred paces of you, who would take the chance at once, if any gentle person offered it them. James and Jude—Christ's

cousins—no thanks to them for following Him ; their own home conceivably no richer than His. Thomas and Philip, I suppose, somewhat thoughtful persons on spiritual matters, questioning of them long since ; going out to hear St. John preach, and to see whom he had seen. But *this* man, busy in the place of business—engaged in the interests of foreign governments—thinking no more of an Israelite Messiah than Mr. Goschen, but only of Egyptian finance, and the like—suddenly the Messiah, passing by, says “ Follow me ! ” and he rises up, gives Him his hand, “ Yea ! to the death ; ” and absconds from his desk in that electric manner on the instant, leaving his cash-box unlocked, and his books for whoso list to balance !—a very remarkable kind of person indeed, it seems to me.

Carpaccio takes him, as I said, for a type of such sacrifice at its best. Everything (observe in passing) is here given you of the best. Dragon deadliest—knight purest—parrot scarletest—basilisk absurdest—publican publicanest ;—a perfect type of the life spent in taxing one’s neighbour, exacting duties, per-centages, profits in general, in a due and virtuous manner.

For do not think Christ would have called a bad or corrupt publican—much less that a bad or corrupt publican would have obeyed the call. Your modern English evangelical doctrine that Christ has a special liking for the souls of rascals is the absurdest basilisk of a doctrine that ever pranced on judgment steps. That which is *lost* He comes to save,—yes ; but not that which is defiantly going the way He has forbidden. He showed you plainly enough what kind of publican He would call, having chosen two, both of the best : “ Behold, Lord, if I have taken anything from any man, I restore it fourfold ! ”—a beautiful manner of trade. Carpaccio knows well that there were no defalcations from Levi’s chest—no oppressions in his tax-gathering. This whom he has painted is a true merchant of Venice, uprightest and gentlest of the merchant race ; yet with a glorious pride in him. What merchant but one of Venice would have ventured to take Christ’s hand, as his friend’s—as one man takes another’s ? Not re-

pentant, he, of anything he has done ; not crushed or terrified by Christ's call ; but rejoicing in it, as meaning Christ's praise and love. "Come up higher then, for there are nobler treasures than these to count, and a nobler King than this to render account to. Thou hast been faithful over a few things ; enter thou into the joy of thy Lord."

A lovely picture, in every sense and power of painting ; natural, and graceful, and quiet, and pathetic ;—divinely religious, yet as decorative and dainty as a bank of violets in spring.

But the next picture ! How was ever such a thing allowed to be put in a church ? Nothing surely could be more perfect in comic art. St. Jerome, forsooth, introducing his novice lion to monastic life, with the resulting effect on the vulgar monastic mind.

Do not imagine for an instant that Carpaccio does not see the jest in all this, as well as you do,—perhaps even a little better. "Ask for him to-morrow, indeed, and you shall find him a grave man ;" but, to-day, Mercutio himself is not more fanciful, nor Shakespeare himself more gay in his fancy of "the gentle beast and of a good conscience," than here the painter as he drew his delicately smiling lion with his head on one side like a Perugino's saint, and his left paw raised, partly to show the thorn wound, partly in deprecation,—

"For if I should, as lion, come in strife
Into this place, 'twere pity of my life."

The flying monks are scarcely at first intelligible but as white and blue oblique masses ; and there was much debate between Mr. Murray and me, as he sketched the picture for the Sheffield Museum, whether the actions of flight were indeed well given or not ; he maintaining that the monks were really running like Olympic archers, and that the fine drawing was only lost under the quartering of the dresses ;—I on the contrary believe that Carpaccio had failed, having no gift for representing swift motion. We are probably both right ; I doubt not that the running action, if Mr. Murray says so, is rightly

drawn ; but at this time, every Venetian painter had been trained to represent only slow and dignified motion, and not till fifty years later, under classic influence, came the floating and rushing force of Veronese and Tintoret.

And I am confirmed in this impression by the figure of the stag in the distance, which does not run freely, and by the imperfect gallop of St. George's horse in the first subject.

But there are many deeper questions respecting this St. Jerome subject than those of artistic skill. The picture is a jest indeed ; but is it a jest only ? Is the tradition itself a jest ? or only by our own fault, and perhaps Carpaccio's, do we make it so ?

In the first place, then, you will please to remember, as I have often told you, Carpaccio is not answerable for himself in this matter. He begins to think of his subject, intending, doubtless, to execute it quite seriously. But his mind no sooner fastens on it than the vision of it comes to him as a jest, and he is forced to paint it. Forced by the fates,—dealing with the fate of Venice and Christendom. We must ask of Atropos, not of Carpaccio, why this picture makes us laugh ; and why the tradition it records has become to us a dream and a scorn. No day of my life passes now to its sunset, without leaving me more doubtful of all our cherished contempts, and more earnest to discover what root there was for the stories of good men, which are now the mocker's treasure.

And I want to read a good "Life of St. Jerome." And if I go to Mr. Ongaria's I shall find, I suppose, the autobiography of George Sand, and the life of—Mr. Sterling, perhaps ; and Mr. Werner, written by my own master, and which indeed I've read, but forget now who either Mr. Sterling or Mr. Werner were ; and perhaps, in religious literature, the life of Mr. Wilberforce and of Mrs. Fry ; but not the smallest scrap of information about St. Jerome. To whom, nevertheless, all the charity of George Sand, and all the ingenuity of Mr. Sterling, and all the benevolence of Mr. Wilberforce, and a great quantity, if we knew it, of the daily comfort and peace of our own little lives every day, are verily owing ; as to a lovely old

pair of spiritual spectacles, without whom we never had read a word of the "Protestant Bible." It is of no use, however, to begin a life of St. Jerome now—and of little use to look at these pictures without a life of St. Jerome; but only thus much you should be clear in knowing about him, as not in the least doubtful or mythical, but wholly true, and the beginning of facts quite limitlessly important to all modern Europe—namely, that he was born of good, or at least rich family, in Dalmatia, virtually midway between the east and the west; that he made the great Eastern book, the Bible, legible in the west; that he was the first great teacher of the nobleness of ascetic scholarship and courtesy, as opposed to ascetic savageness:—the founder, properly, of the ordered cell and tended garden, where before was but the desert and the wild wood; and that he died in the monastery he had founded at Bethlehem.

It is this union of gentleness and refinement with noble continence,—this love and imagination illuminating the mountain cave into a frescoed cloister, and winning its savage beasts into domestic friends, which Carpaccio has been ordered to paint for you; which, with ceaseless exquisiteness of fancy, he fills these three canvases with the incidents of,—meaning, as I believe, the story of all monastic life, and death, and spiritual life forevermore: the power of this great and wise and kind spirit, ruling in the perpetual future over all household scholarship; and the help rendered by the companion souls of the lower creatures to the highest intellect and virtue of man.

And if with the last picture of St. Jerome in his study,—his happy white dog watching his face—you will mentally compare a hunting piece by Rubens, or Snyders, with the torn dogs rolled along the ground in their blood,—you may perhaps begin to feel that there is something more serious in this kaleidoscope of St. George's Chapel than you at first believed—which if you now care to follow out with me, let us think over this ludicrous subject more quietly.

What account have we here given, voluntarily or involuntarily, of monastic life, by a man of the keenest perception,

living in the midst of it? That all the monks who have caught sight of the lion should be terrified out of their wits—what a curious witness to the *timidity* of Monasticism! Here are people professing to prefer Heaven to earth—preparing themselves for the change as the reward of all their present self-denial. And this is the way they receive the first chance of it that offers!

Evidently Carpaccio's impression of monks must be, not that they were more brave or good than other men; but that they liked books, and gardens, and peace, and were afraid of death—therefore, retiring from the warrior's danger of chivalry somewhat selfishly and meanly. He clearly takes the knight's view of them. What he may afterwards tell us of good concerning them, will not be from a witness prejudiced in their favour. Some good he tells us, however, even here.

The pleasant order in wildness of the trees; the buildings for agricultural and religious use, set down as if in an American clearing, here and there, as the ground was got ready for them; the perfect grace of cheerful, pure, illuminating art, filling every little cornice-cusp of the chapel with its jewel-picture of a saint,¹—last, and chiefly, the perfect kindness to and fondness for, all sorts of animals. Cannot you better conceive, as you gaze upon the happy scene, what manner of men they were who first secured from noise of war the sweet nooks of meadow beside your own mountain streams at Bolton, and Fountains, Furness and Tintern? But of the saint himself Carpaccio has all good to tell you. Common monks were, at least, harmless creatures; but here is a strong and beneficent one. “Calm, before the Lion!” say C. C. with their usual perspicacity, as if the story were that the saint alone had courage to confront the raging beast—a Daniel in the lion's den! They might as well say of Carpaccio's Venetian beauty that she is “calm before the lapdog.” The saint is leading in his new pet, as he would a lamb, and vainly expostulating with his brethren for being ridiculous. The grass on which they have dropped their books is beset with flowers; there is no

¹ See the piece of distant monastery in the lion picture, with its fragments of fresco on wall, its ivy-covered door, and illuminated cornice.

sign of trouble or asceticism on the old man's face, he is evidently altogether happy, his life being complete, and the entire scene one of the ideal simplicity and security of heavenly wisdom: "Her ways are ways of pleasantness, and all her paths are peace."

And now pass to the second picture. At first you will perhaps see principally its weak monks—looking more foolish in their sorrow than ever they did in their fear. Portraits these, evidently, every soul of them—chiefly the one in spectacles, reading the funeral service so perfunctorily,—types, throughout, of the supreme commonplace; alike in action and expression, except those quiet ones in purple on the right, and the grand old man on crutches, come to see this sight.

But St. Jerome himself in the midst of them, the eager heart of him quiet, to such uttermost quietness,—the body lying—look—absolutely flat like clay, as if it had been beat down, and clung, clogged, all along to the marble. Earth to earth indeed. Level clay and inlaid rock now all one—and the noble head senseless as a stone, with a stone for its pillow.

There they gather and kneel about it—wondering, I think, more than pitying. To see what was yesterday the great Life in the midst of them, laid thus! But, so far as they do not wonder, they pity only, and grieve. There is no looking for his soul in the clouds,—no worship of relics here, implied even in the kneeling figures. All look down, woefully, wistfully, as into a grave. "And so Death passed upon all men, for that all have sinned."

This is Carpaccio's message to us. And lest you should not read it, and carelessly think that he meant only the usual commonplace of the sacredness and blessedness of the death of the righteous,—look into the narrow shadow in the corner of the house at the left hand side, where, on the strange forked and leafless tree that occupies it, are set the cross and little vessel of holy water beneath, and above, the skull, which are always the signs of St. Jerome's place of prayer in the desert.

The lower jaw has fallen from the skull *into the vessel of holy water.*

It is but a little sign,—but you will soon know how much this painter indicates by such things, and that here he means indeed that for the greatest, as the meanest, of the sons of Adam, death is still the sign of their sin; and that though in Christ all shall be made alive, yet also in Adam all die; and this return to their earth is not in itself the coming of peace, but the infliction of shame.

At the lower edge of the marble pavement is one of Carpaccio's lovely signatures, on a white scroll, held in its mouth by a tiny lizard.

And now you will be able to enter into the joy of the last picture, the life of St. Jerome in Heaven.

I had no thought, myself, of this being the meaning of such closing scene; but the evidence for this reading of it, laid before me by my fellow-worker, Mr. Anderson, seems to me, in the concurrence of its many clauses, irresistible; and this at least is certain, that as the opposite St. George represents the perfect Mastery of the body, in contest with the lusts of the Flesh, this of St. Jerome represents the perfect Mastery of the mind, in the fulfilment of the right desires of the Spirit: and all the arts of man,—music (a long passage of melody written clear on one of the fallen scrolls), painting (in the illuminated missal and golden alcove), and sculpture (in all the forms of furniture and the bronze work of scattered ornaments),—these—and the glad fidelity of the lower animals,—all subjected in pleasant service to the more and more perfect reading and teaching of the Word of God;—read, not in written pages chiefly, but with uplifted eyes by the light of Heaven itself, entering and filling the mansions of Immortality.

This interpretation of the picture is made still more probable, by the infinite pains which Carpaccio has given to the working of it. It is quite impossible to find more beautiful and right painting of detail, or more truthful tones of atmosphere and shadow affecting interior colours.

Here then are the principal heads of the symbolic evidence, abstracted for us by Mr. Anderson from his complete account of the whole series, now in preparation.

1. "The position of the picture seems to show that it sums up the whole matter. The St. George series reads from left to right. So, chronologically, the two others of St. Jerome; but this, which should according to the story have been first, appears after the death.

2. "The figure on the altar is—most unusually—our Lord with the Resurrection-banner. The shadow of this figure falls on the wall so as to make a crest for the mitre on the altar—'Helmet of Salvation.' . . . The mitre (by comparison with St. Ursula's arrival in Rome it is a cardinal's mitre), censer, and crosier, are laid aside.

3. "The Communion and Baptismal vessels are also laid aside under this altar, not of the dead but of the Risen Lord. The curtain falling from the altar is drawn aside that we may notice this.

4. "In the mosaic-covered recess above the altar there is prominently inlaid the figure of a cherub or seraph 'che in Dio più l'occhio ha fisso.'

5. "Comparing the colours of the winged and four-footed parts of the 'animal binato' in the Purgatory, it is I believe important to notice that the statue of our Lord is gold, the dress of St. Jerome red and white, and over the shoulders a cape of the brown colour of earth.

6. "While candles blaze round the dead Jerome in the previous picture, the candlesticks on the altar here are empty—'they need no candle.'

7. "The two round-topped windows in the line behind the square one through which St. Jerome gazes, are the ancient tables bearing the message of light, delivered 'of angels' to the faithful, but now put behind, and comparatively dim beside the glory of present and personal vision. Yet the light which comes even through the square window streams through bars like those of a prison.

"Through the body's prison bars
His soul possessed the sun and stars,'

Dante Rosetti writes of Dante Allighieri; but Carpaccio hangs the wheels of all visible heaven *inside* these bars.

St. Jerome's 'possessions' are in a farther country. These bars are another way of putting what is signified by the brown cape.

8. "The two great volumes leaning against the wall by the arm-chair are the same thing, the closed testaments.

9. "The documents hanging in the little chamber behind and lying at the saint's feet, remarkable for their hanging seals, are shown by these seals to be titles to some property, or testaments; but they are now put aside or thrown underfoot. Why, except that possession is gotten, that Christ is risen, and that 'a testament is of no strength at all while the testator liveth'? This I believe is no misuse of Paul's words, but an employment of them in their mystic sense, just as the New Testament writers quoted the Old Testament. There is a very prominent illuminated R on one of the documents under the table (I think you have written of it as Greek in its lines): I cannot but fancy it is the initial letter of 'Resurrectio.' What the music is, Caird has sent me no information about; he was to enquire of some friend who knew about old church music. The prominent bell and shell on the table puzzle me, but I am sure mean something. Is the former the mass-bell?

10. "The statuettes of Venus and the horse, and the various antique fragments on the shelf behind the arm-chair are, I think, symbols of the world, of the flesh, placed behind even the old Scripture studies. You remember Jerome's early learning, and the vision that awakened him from Pagan thoughts (to read the laws of the True City) with the words, 'Ubi est thesaurus tuus.'

"I have put these things down without trying to dress them into an argument, that you may judge them as one would gather them hap-hazard from the picture. Individually several of them might be weak arguments, but together I do think they are conclusive. The key-note is struck by the empty altar bearing the risen Lord. I do not think Carpaccio thought of immortality in the symbols derived from mortal life, through which the ordinary mind feels after it. Nor

surely did Dante (V. esp. Par. IV. 27 and following lines).
And think of the words in Canto II:—

“ ‘Dentro dal ciel della Divina Pace
Si gira un corpo nella cui virtute
L'esser di tutto suo contento giace.’

But there is no use heaping up passages, as the sense that in using human language he merely uses mystic metaphor is continually present in Dante, and often explicitly stated. And it is surely the error of regarding these picture writings for children who live in the nursery of Time and Space, as if they were the truth itself, which can be discovered only spiritually, that leads to the inconsistencies of thought and foolish talk of even good men.

“St. Jerome, in this picture, is young and brown-haired, not bent and with long white beard, as in the two others. I connect this with the few who have stretched their necks

“ ‘*Per tempo al pan degli angeli del quale
Vivesi qui ma non si vien satollo.*’

St. Jerome lives here by what is really the immortal bread ; but shall not here be filled with it so as to hunger no more ; and under his earthly cloak comprehends as little perhaps the Great Love he hungers after and is fed by, as his dog comprehends him. I am sure the dog is there with some such purpose of comparison. On that very last quoted passage of Dante, Landino's commentary (it was printed in Venice, 1491) annotates the words ‘*che drizzaste 'l collo,*’ with a quotation,

“ ‘*Cum spectant animalia cetera terram
Os homini sublime dedit, coelum tueri jussit.*”

I was myself brought entirely to pause of happy wonder when first my friend showed me the lessons hidden in these pictures ; nor do I at all expect the reader at first to believe them. But the condition of his possible belief in them is that he approach them with a pure heart and a meek one ; for this

Carpaccio teaching is like the talisman of Saladin, which, dipped in pure water, made it a healing draught, but by itself seemed only a little inwoven web of silk and gold.

But to-day, that we may be able to read better to-morrow, we will leave this cell of sweet mysteries, and examine some of the painter's earlier work, in which we may learn his way of writing more completely, and understand the degree in which his own personal character, or prejudices, or imperfections, mingle in the method of his scholarship, and colour or divert the current of his inspiration.

Therefore now, taking gondola again, you must be carried through the sea-streets to a far-away church, in the part of Venice now wholly abandoned to the poor, though a kingly saint's—St. Louis's: but there are other things in this church to be noted, besides Carpaccio, which will be useful in illustration of him; and to see these rightly, you must compare with them things of the same kind in another church where there are no Carpaccios,—namely, St. Pantaleone, to which, being the nearer, you had better first direct your gondolier.

For the ceilings alone of these two churches, St. Pantaleone and St. Alvisé, are worth a day's pilgrimage in their sorrowful lesson.

All the mischief that Paul Veronese did may be seen in the halting and hollow magnificences of them;—all the absurdities, either of painting or piety, under afflatus of vile ambition. Roof puffed up and broken through, as it were, with breath of the fiend from below, instead of pierced by heaven's light from above; the rags and ruins of Venetian skill, honour, and worship, exploded all together sky-high. Miracles of frantic mistake, of flaunting and thunderous hypocrisy,—universal lie, shouted through speaking-trumpets.

If I could let you stand for a few minutes, first under Giotto's four-square vault at Assisi, only thirty feet from the ground, the four triangles of it written with the word of God close as an illuminated missal, and then suddenly take you under these vast staggering Temples of Folly and Iniquity, you would know what to think of "modern development" thenceforth.

The roof of St. Pantaleone is, I suppose, the most curious example in Europe of the vulgar dramatic effects of painting. That of St. Alvisè is little more than a caricature of the mean passion for perspective, which was the first effect of "science" joining itself with art. And under it, by strange coincidence, there are also two notable pieces of plausible modern sentiment,—celebrated pieces by Tiepolo. He is virtually the beginner of Modernism: these two pictures of his are exactly like what a first-rate Parisian Academy student would do, setting himself to conceive the sentiment of Christ's flagellation, after having read unlimited quantities of George Sand and Dumas. It is well that they chance to be here: look thoroughly at them and their dramatic chiaroscuros for a little time, observing that no face is without some expression of crime or pain, and that everything is always put dark against light or light against dark. Then return to the entrance of the church, where under the gallery, frameless and neglected, hang eight old pictures,—bought, the story goes, at a pawnbroker's in the Giudecca for forty sous each,¹—to me among the most interesting pieces of art in North Italy, for they are the only examples I know of an entirely great man's work in extreme youth. They are Carpaccio's, when he cannot have been more than eight or ten years old, and painted then half in precocious pride and half in play. I would give anything to know their real history. "School pictures," C. C. call them! as if they were merely bad imitations, when they are the most unaccountable and unexpected pieces of absurd fancy that ever came into a boy's head, and scabbled, rather than painted, by a boy's hand,—yet, with the eternal master-touch in them already.

SUBJECTS.—1. Rachel at the Well. 2. Jacob and his Sons before Joseph. 3. Tobias and the Angel. 4. The Three Holy Children. 5. Job. 6. Moses, and Adoration of Golden Calf (C. C.). 7. Solomon and the Queen of Sheba. 8. Joshua and falling Jericho.

¹ "Originally in St. Maria della Vergine" (C. C.). Why are not the documents on the authority of which these statements are made given clearly?

In all these pictures the qualities of Carpaccio are already entirely pronounced ; the grace, quaintness, simplicity, and deep intentness on the meaning of incidents. I don't know if the grim statue in No. 4 is, as C. C. have it, the statue of Nebuchadnezzar's dream, or that which he erected for the three holy ones to worship,—and already I forget how the “worship of the golden calf” according to C. C., and “Moses” according to my note, (and I believe the inscription, for most of, if not all, the subjects are inscribed with the names of the persons represented,) are relatively portrayed. But I have not forgotten, and beg my readers to note specially, the exquisite strangeness of the boy's rendering of the meeting of Solomon and the Queen of Sheba. One would have expected the Queen's retinue, and her spice-bearing camels, and Solomon's house and his servants, and his cup-bearers in all their glory ; and instead of this, Solomon and the Queen stand at the opposite ends of a little wooden bridge over a ditch, and there is not another soul near them,—and the question seems to be which first shall set foot on it !

Now, what can we expect in the future of the man or boy who conceives his subjects, or is liable to conceive them, after this sort ? There is clearly something in his head which we cannot at all make out ; a ditch must be to him the Rubicon, the Euphrates, the Red Sea,—Heaven only knows what ! a wooden bridge must be Rialto in embryo. This unattended King and Queen must mean the pre-eminence of uncounselled royalty, or what not ; in a word, there's no saying, and no criticizing him ; and the less, because his gift of colour and his enjoyment of all visible things around him are so intense, so instinctive, and so constant, that he is never to be thought of as a responsible person, but only as a kind of magic mirror which flashes back instantly whatever it sees beautifully arranged, but yet will flash back commonplace things often as faithfully as others.

I was especially struck with this character of his, as opposed to the grave and balanced design of Luini, when after working six months with Carpaccio, I went back to the St. Stephen at Milan, in the Monasterio Maggiore. In order

to do justice to either painter, they should be alternately studied for a little while. In one respect, Luini greatly gains, and Carpaccio suffers by this trial; for whatever is in the least flat or hard in the Venetian is felt more violently by contrast with the infinite sweetness of the Lombard's harmonies, while only by contrast with the vivacity of the Venetian can you entirely feel the depth in faintness, and the grace in quietness, of Luini's chiaroscuro. But the principal point of difference is in the command which Luini has over his thoughts, every design of his being concentrated on its main purpose with quite visible art, and all accessories that would in the least have interfered with it withdrawn in merciless asceticism; whereas a subject under Carpaccio's hand is always just as it would or might have occurred in nature; and among a myriad of trivial incidents, you are left, by your own sense and sympathy, to discover the vital one.

For instance, there are two small pictures of his in the Brera gallery at Milan, which may at once be compared with the Luinis there. I find the following notice of them in my diary for 6th September, 1876:—

“Here, in the sweet air, with a whole world in ruin round me. The misery of my walk through the Brera yesterday no tongue can tell; but two curious lessons were given me by Carpaccio. The first, in his preaching of St. Stephen—Stephen up in the corner where nobody would think of him; the doctors, one in lecture throne, the rest in standing groups mostly—Stephen's face radiant with true soul of heaven,—the doctors, not monsters of iniquity at all, but superbly true and quiet studies from the doctors of Carpaccio's time; doctors of this world—not one with that look of heaven, but respectable to the uttermost, able, just, penetrating: a complete assembly of highly trained old Oxford men, but with more intentness. The second, the Virgin going up to the temple; and under the steps of it, a child of ten or twelve with his back to us, dressed in a parti-coloured, square-cut robe, holding a fawn in leash, at his side a rabbit; on the steps under the Virgin's feet a bas-relief of fierce fight of men with horned monsters

like rampant snails: one with a conger-eel's body, twining round the limb of the man who strikes it."

Now both these pictures are liable to be passed almost without notice; they scarcely claim to be compositions at all; but the one is a confused group of portraits; the other, a quaint piece of grotesque, apparently without any meaning, the principal feature in it, a child in a parti-coloured cloak. It is only when, with more knowledge of what we may expect from the painter, we examine both pictures carefully, that the real sense of either comes upon us. For the heavenly look on the face of Stephen is not set off with raised light, or opposed shade, or principality of place. The master trusts only to what nature herself would have trusted in—expression pure and simple. If you cannot see heaven in the boy's mind, without any turning on of the stage lights, you shall not see it at all.

There is some one else, however, whom you may see, on looking carefully enough. On the opposite side of the group of old doctors is another youth, just of Stephen's age. And as the face of Stephen is full of heavenly rapture, so that of his opposite is full of darkest wrath,—the religious wrath which all the authority of the conscience urges, instead of quenching. The old doctors hear Stephen's speech with doubtful pause of gloom; but this youth has no patience,—no endurance for it. He will be the first to cry, Away with him,—“Whosoever will cast a stone at him, let them lay their mantle at my feet.”

Again—looking again and longer at the other pictures, you will first correct my mistake of writing “fawn”—discovering the creature held by the boy to be a unicorn.¹ Then you will at once know that the whole must be symbolic; and looking for the meaning of the unicorn, you find it signifies chastity; and then you see that the bas-relief on the steps, which the little Virgin ascends, must mean the warring of the old strengths of the world with lust: which theme you will find presently taken up also and completed by the symbols of St. George's Chapel. If now you pass from these pict-

¹ Corrected for me by Mr. C. F. Murray.

ures to any of the Luini frescoes in the same gallery, you will at once recognize a total difference in conception and treatment. The thing which Luini wishes you to observe is held forth to you with direct and instant proclamation. The saint, angel, or Madonna, is made central or principal; every figure in the surrounding group is subordinate, and every accessory subdued or generalized. All the precepts of conventional art are obeyed, and the invention and originality of the master are only shown by the variety with which he adorns the commonplace,—by the unexpected grace with which he executes what all have done,—and the sudden freshness with which he invests what all have thought.

This external difference in the manner of the two painters is connected with a much deeper element in the constitution of their minds. To Carpaccio, whatever he has to represent must be a reality; whether a symbol or not, afterwards, is no matter, the first condition is that it shall be real. A serpent, or a bird, may perhaps mean iniquity or purity; but primarily, they must have real scales and feathers. But with Luini, everything is primarily an idea, and only realized so far as to enable you to understand what is meant. When St. Stephen stands beside Christ at his scourging, and turns to us who look on, asking with unmistakable passion, "Was ever sorrow like this sorrow?" Luini does not mean that St. Stephen really stood there; but only that the thought of the saint who first saw Christ in glory may best lead us to the thought of Christ in pain. But when Carpaccio paints St. Stephen preaching, he means to make us believe that St. Stephen really did preach, and as far as he can, to show us exactly how he did it.

And, lastly, to return to the point at which we left him. His own notion of the way things happened may be a very curious one, and the more so that it cannot be regulated even by himself, but is the result of the singular power he has of seeing things in vision as if they were real. So that when, as we have seen, he paints Solomon and the Queen of Sheba standing at opposite ends of a wooden bridge over a ditch, we are not to suppose the two persons are less real to him on

that account, though absurd to us ; but we are to understand that such a vision of them did indeed appear to the boy who had passed all his dawning life among wooden bridges, over ditches ; and had the habit besides of spiritualizing, or reading like a vision, whatever he saw with eyes either of the body or mind.

The delight which he had in this faculty of vision, and the industry with which he cultivated it, can only be justly estimated by close examination of the marvellous picture in the Correr Museum, representing two Venetian ladies with their pets.

In the last general statement I have made of the rank of painters, I named two pictures of John Bellini, the Madonna in San Zaccaria, and that in the sacristy of the Frari, as, so far as my knowledge went, the two best pictures in the world. In that estimate of them I of course considered as one chief element, their solemnity of purpose—as another, their unpretending simplicity. Putting aside these higher conditions, and looking only to perfection of execution and essentially artistic power of design, I rank this Carpaccio above either of them, and therefore, as in these respects, the best picture in the world. I know no other which unites every nameable quality of painter's art in so intense a degree—breadth with minuteness, brilliancy with quietness, decision with tenderness, colour with light and shade : all that is faithfullest in Holland, fancifullest in Venice, severest in Florence, naturallest in England. Whatever de Hooghe could do in shade, Van Eyck in detail—Giorgione in mass—Titian in colour—Bewick and Landseer in animal life, is here at once ; and I know no other picture in the world which can be compared with it.

It is in tempera, however, not oil : and I must note in passing that many of the qualities which I have been in the habit of praising in Tintoret and Carpaccio, as consummate achievements in oil-paintings, are, as I have found lately, either in tempera altogether, or tempera with oil above. And I am disposed to think that ultimately tempera will be found the proper material for the greater number of most delightful subjects.

The subject, in the present instance, is a simple study of animal life in all its phases. I am quite sure that this is the meaning of the picture in Carpaccio's own mind. I suppose him to have been commissioned to paint the portraits of two Venetian ladies—that he did not altogether like his models, but yet felt himself bound to do his best for them, and contrived to do what perfectly satisfied them and himself too. He has painted their pretty faces and pretty shoulders, their pretty dresses and pretty jewels, their pretty ways and their pretty playmates—and what would they have more?—he himself secretly laughing at them all the time, and intending the spectators of the future to laugh for ever.

It may be, however, that I err in supposing the picture a portrait commission. It may be simply a study for practice, gathering together every kind of thing which he could get to sit to him quietly, persuading the pretty ladies to sit to him in all their finery, and to keep their pets quiet as long as they could, while yet he gave value to this new group of studies in a certain unity of satire against the vices of society in his time.

Of this satirical purpose there cannot be question for a moment, with any one who knows the general tone of the painter's mind, and the traditions among which he had been educated. In all the didactic painting of mediæval Christianity, the faultful luxury of the upper classes was symbolized by the knight with his falcon, and lady with her pet dog, both in splendid dress. This picture is only the elaboration of the well-recognized symbol of the lady with her pets; but there are two ladies—mother and daughter, I think—and six pets, a big dog, a little dog, a parroquet, a peahen, a little boy, and a china vase. The youngest of the women sits serene in her pride, her erect head pale against the dark sky—the elder is playing with the two dogs; the least, a white terrier, she is teaching to beg, holding him up by his forepaws, with her left hand; in her right is a slender riding-whip, which the larger dog has the end of in his mouth, and will not let go—his mistress also having dropped a letter,¹ he

¹ The painter's signature is on the supposed letter.

puts his paw on that and will not let her pick it up, looking out of gentlest eyes in arch watchfulness to see how far it will please her that he should carry the jest. Behind him the green parroquet, red-eyed, lifts its little claw as if disliking the marble pavement; then behind the marble balustrade with gilded capitals, the bird and little boy are inlaid with glowing brown and red. Nothing of Hunt or Turner can surpass the plume painting of the bird; nor can Holbein surpass the precision, while he cannot equal the radiance, of the porcelain and jewellery.

To mark the satirical purpose of the whole, a pair of ladies' shoes are put in the corner, (the high-stilted shoe, being, in fact, a slipper on the top of a column,) which were the grossest and absurdest means of expressing female pride in the fifteenth and following centuries.

In this picture, then, you may discern at once how Carpaccio learned his business as a painter, and to what consummate point he learned it.¹

And now, if you have begun to feel the power of these minor pictures, you can return to the Academy and take up the St. Ursula series, on which, however, I find it hopeless to reduce my notes to any available form at present:—the question of the influence of this legend on Venetian life being involved with enquiries belonging properly to what I am trying to do in "St. Mark's Rest." This only you have to observe generally, that being meant to occupy larger spaces, the St. Ursula pictures are very unequal in interest, and many portions seem to me tired work, while others are maintained by Mr. Murray to be only by the hands of scholars. This, however, I can myself assert, that I never yet began to copy or examine any portion of them without continually increasing admiration; while yet there are certain shortcomings and morbid faults through-

¹ Another Carpaccio, in the Correr Museum, of St. Mary and Elizabeth, is entirely lovely, though slighter in work; and the so-called Mantegna, but more probably (according to Mr. Murray) early John Bellini, —the Transfiguration,—full of majesty and earnestness. Note the inscribed "talk" with Moses and Elias,—“Have pity upon me, have pity upon me, oh ye my friends.”

out, unaccountable, and rendering the greater part of the work powerless for good to the general public. Taken as a connected series, the varying personality of the saint destroys its interest totally. The girl talking to her father in 539 is not the girl who dreams in 533; and the gentle little dreamer is still less like the severe, stiffly dressed, and not in any supreme degree well favoured, bride, in 542; while the middle-aged woman, without any claim to beauty at all, who occupies the principal place in the final Gloria, cannot by any effort of imagination be connected with the figure of the young girl kneeling for the Pope's blessing in 546.

But indeed had the story been as consistently told as the accessories are perfectly painted, there would have been no occasion for me now to be lecturing on the beauties of Carpaccio. The public would long since have discovered them, and adopted him for a favourite. That precisely in the particulars which would win popular attention, the men whom it would be most profitable for the public to study should so often fail, becomes to me, as I grow older, one of those deepest mysteries of life, which I only can hope to have explained to me when my task of interpretation is ended.

But, for the sake of Christian charity, I would ask every generous Protestant to pause for a while before the meeting under the Castle of St. Angelo, (546).

"Nobody knows anything about those old things," said an English paterfamilias to some enquiring member of his family, in the hearing of my assistant, then at work on this picture. Which saying is indeed supremely true of us nationally. But without requiring us to know anything, this picture puts before us some certainties respecting mediæval Catholicism, which we shall do well to remember.

In the first place, you will find that all these bishops and cardinals are evidently portraits. Their faces are too varied—too quiet—too complete—to have been invented by even the mightiest invention. Carpaccio was simply taking the features of the priesthood of his time, throwing aside, doubtless, here and there, matter of offence;—the too settled gloom of one, the evident subtlety of another, the sensuality of a

third ; but finding beneath all that, what was indeed the constitutional power and pith of their minds,—in the deep of them, rightly thoughtful, tender, and humble.

There is one curious little piece of satire on the fault of the Church in making cardinals of too young persons. The third, in the row of four behind St. Ursula, is a mere boy, very beautiful, but utterly careless of what is going on, and evidently no more fit to be a cardinal than a young calf would be. The stiffness of his white dress, standing up under his chin as if he had only put it on that day, draws especial attention to him.

The one opposite to him also, without this piece of white dress, seems to be a mere man of the world. But the others have all grave and refined faces. That of the Pope himself is quite exquisite in its purity, simple-heartedness, and joyful wonder at the sight of the child kneeling at his feet, in whom he recognizes one whom he is himself to learn of, and follow.

The more I looked at this picture, the more I became wonderstruck at the way the faith of the Christian Church has been delivered to us through a series of fables, which, partly meant as such, are over-ruled into expressions of truth—but how much truth, it is only by our own virtuous life that we can know. Only remember always in criticizing such a picture, that it no more means to tell you as a fact¹ that St. Ursula led this long procession from the sea and knelt thus before the Pope, than Mantegna's St. Sebastian means that the saint ever stood quietly and happily, stuck full of arrows. It is as much a mythic symbol as the circles and crosses of the Carita ; but only Carpaccio carries out his symbol into delighted realization, so that it begins to be absurd to us in the perceived impossibility. But it only signifies the essential truth of joy in the Holy Ghost filling the whole body of the Christian Church with visible inspiration, sometimes in old men, sometimes in children ; yet never breaking the laws of established authority and subordination—the greater saint

¹ If it *had* been a fact, of course he would have liked it all the better, as in the picture of St. Stephen ; but though only an idea, it must be realized to the full.

blessed by the lesser, when the lesser is in the higher place of authority, and all the common and natural glories and delights of the world made holy by its influence : field, and earth, and mountain, and sea, and bright maiden's grace, and old men's quietness,—all in one music of moving peace—the very procession of them in their multitude like a chanted hymn—the purple standards drooping in the light air that yet can lift St. George's gonfalon ;¹ and the angel Michael alighting—himself seen in vision instead of his statue—on the Angel's tower, sheathing his sword.

What I have to say respecting the picture that closes the series, the martyrdom and funeral, is partly saddening, partly depreciatory, and shall be reserved for another place. The picture itself has been more injured and repainted than any other (the face of the recumbent figure entirely so) ; and though it is full of marvellous passages, I hope that the general traveller will seal his memory of Carpaccio in the picture last described.

¹ It is especially to be noted with Carpaccio, and perhaps more in this than any other of the series, that he represents the beauty of religion, always in animating the present world, and never gives the charm to the clear far-away sky which is so constant in Florentine sacred pictures.

SECOND SUPPLEMENT.

THE PLACE OF DRAGONS.

JAMES REDDIE ANDERSON, M.A.

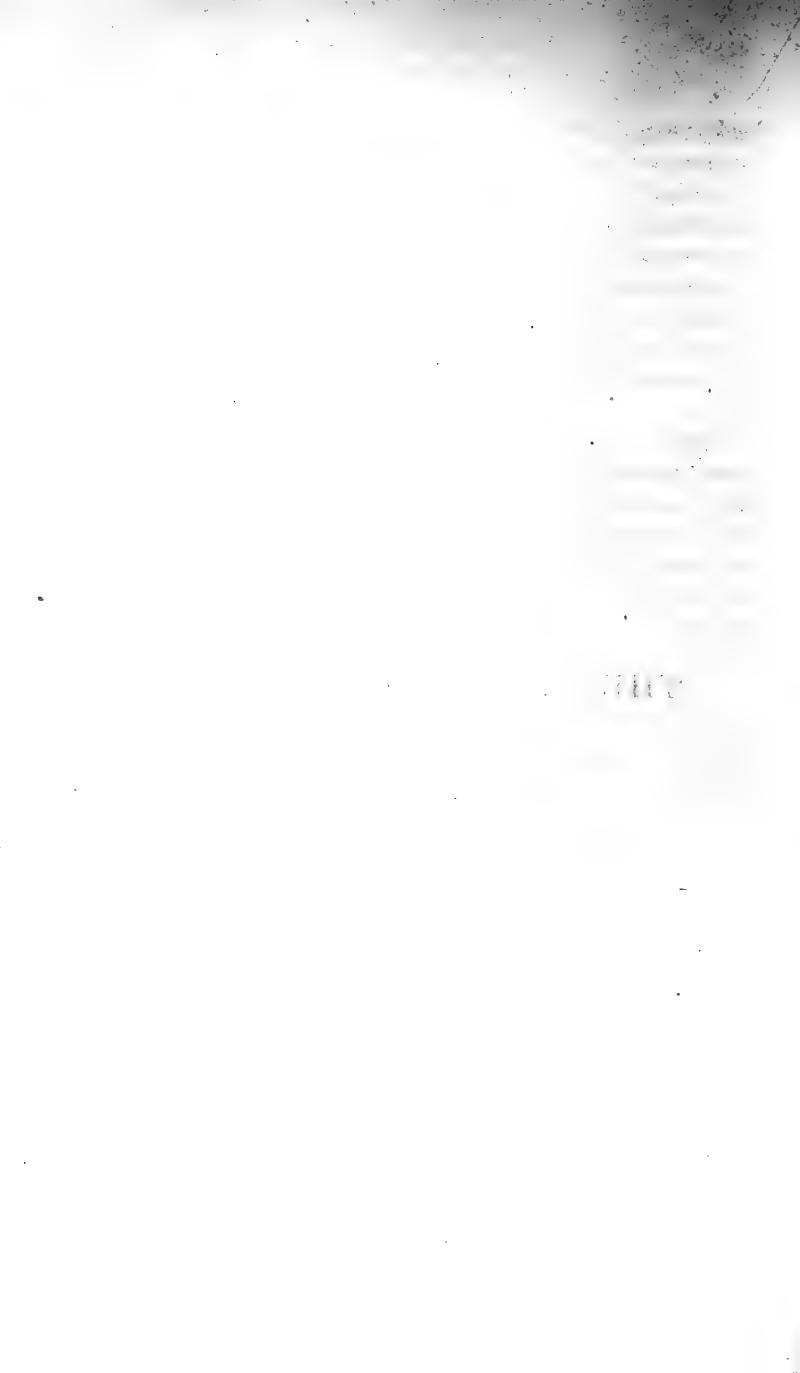

PREFACE.

Among the many discomforts of advancing age, which no one understands till he feels them, there is one which I seldom have heard complained of, and which, therefore, I find unexpectedly disagreeable. I knew, by report, that when I grew old I should most probably wish to be young again; and, very certainly, be ashamed of much that I had done, or omitted, in the active years of life. I was prepared for sorrow in the loss of friends by death; and for pain, in the loss of myself, by weakness or sickness. These, and many other minor calamities, I have been long accustomed to anticipate; and therefore to read, in preparation for them, the confessions of the weak, and the consolations of the wise.

But, as the time of rest, or of departure, approaches me, not only do many of the evils I had heard of, and prepared for, present themselves in more grievous shapes than I had expected; but one which I had scarcely ever heard of, torments me increasingly every hour.

I had understood it to be in the order of things that the aged should lament their vanishing life as an instrument they had never used, now to be taken away from them; but not as an instrument, only then perfectly tempered and sharpened, and snatched out of their hands at the instant they could have done some real service with it. Whereas, my own feeling, now, is that everything which has hitherto happened to me, or been done by me, whether well or ill, has been fitting me to take greater fortune more prudently, and do better work more thoroughly. And just when I seem to be coming out of school—very sorry to have been such a foolish boy, yet having taken a prize or two, and expecting to enter now upon

some more serious business than cricket,—I am dismissed by the Master I hoped to serve, with a—“That’s all I want of you, sir.”

I imagine the sorrowfulness of these feelings must be abated, in the minds of most men, by a pleasant vanity in their hope of being remembered as the discoverers, at least, of some important truth, or the founders of some exclusive system called after their own names. But I have never applied myself to discover anything, being content to praise what had already been discovered ; and the only doctrine or system peculiar to me is the abhorrence of all that is doctrinal instead of demonstrable, and of all that is systematic instead of useful ; so that *no true* disciple of mine will ever be a “Ruskinian” !—he will follow, not me, but the instincts of his own soul, and the guidance of its Creator. Which, though not a sorrowful subject of contemplation in itself, leaves me none of the common props and crutches of halting pride. I know myself to be a true master, because my pupils are well on the way to do better than I have done ; but there is not always a sense of extreme pleasure in watching their advance, where one has no more strength, though more than ever the will, to companion them.

Not *always*—be it again confessed ; but when I first read the legend of St. George, which here follows, my eyes grew wet with tears of true delight ; first, in the knowledge of so many beautiful things, at once given to me ; and then in the surety of the wide good that the work thus begun would spring up into, in ways before wholly unconceived by me. It was like coming to the brow of some healthy moorland, where here and there one had watched, or helped, the reaper of some patch of thinly scattered corn ; and seeing suddenly a great plain white to the harvest, far as the horizon. That the first-fruits of it might be given in no manner of self-exaltation—Fors has determined that my young scholar should have his part of mortification as well as I, just in the degree in which either of us may be mortified in the success of others. For we both thought that the tracing of this chain of tradition in the story of St. George was ours alone ; and that we

had rather to apprehend the doubt of our result, than the dispute of our originality. Nor was it, indeed, without extreme discomfiture and vexation that after I had been hindered from publishing this paper for upwards of ten months from the time it was first put into my hands, I read, on a bright autumn morning at Brantwood, when I expected the author's visit, (the first he had made to me in my own house,) a paragraph in the "Spectator," giving abstract of exactly the same historical statements, made by a French antiquary, M. Clermont-Ganneau.

I am well assured that Professor Airey was not more grieved, though I hope he was more conscience-stricken, for his delay in the publication of Mr. Adams' calculations, than I was, for some days after seeing this anticipation of my friend's discoveries. He relieved my mind himself, after looking into the matter, by pointing out to me that the original paper had been read by M. Clermont-Ganneau, before the Académie des Inscriptions et Belles-lettres of Paris, two months before his own investigations had begun, and that all question of priority was, therefore, at an end. It remained for us only to surrender, both of us, what complacency we should have had in first announcing these facts; and to take a nobler pleasure in the confirmation afforded of their truth by the coincidence, to a degree of accuracy which neither of us had ever known take place before in the work of two entirely independent investigators, between M. Clermont-Ganneau's conclusions and our own. I therefore desired my friend to make no alterations in his paper as it then stood, and to make no reference himself to the French author, but to complete his own course of investigation independently, as it was begun. We shall have some bits all to ourselves, before we have done; and in the meantime give reverent thanks to St. George, for his help, to France as well as to England, in enabling the two nations to read together the truth of his tradition, on the distant clouds of Heaven and Time.

Mr. Anderson's work remains entirely distinct, in its interpretation of Carpaccio's picture by this tradition, and since at the mouth of two—or *three*, witnesses shall a word be estab-

lished, Carpaccio himself thus becomes the third, and the chief, witness to its truth ; and to the power of it on the farthest race of the Knights of Venice.

The present essay treats only of the first picture in the chapel of St. George. I hope it may now be soon followed by its author's consecutive studies of the other subjects, in which he has certainly no priority of effort to recognize, and has, with the help of the good Saints and no other persons, done all that we shall need.

J. RUSKIN.

BRANTWOOD,

26th January, 1878.

THE PLACE OF DRAGONS.

“Ἐνοήσας ὅτι τὸν ποιητὴν δεοί, εἶπερ μέλλει ποιητῆς αἶναι, ποιεῖν μύθους ἄλλ’ οὐ λόγους.”—*Plat. Phædo*, 61, B.

ON the eve of the Feast of the Annunciation, in the year of Christ 1452, the Council of Ten, by decree, permitted certain Dalmatians settled in Venice to establish a Lay Brotherhood, called of St. George and of St. Tryphonius. The brothers caused to be written in illuminated letters on the first pages of their minute book their “memorandum of association.” They desire to “hold united in sacred bonds men of Dalmatian blood, to render homage to God and to His saints by charitable endeavours and religious ceremonies, and to help by holy sacrifices the souls of brothers alive and dead.” The brotherhood gave, and continues to give, material support to the poor of Dalmatian blood in Venice; money to the old, and education to the young. For prayer and adoration it built the chapel known as St. George’s of the Slavonians. In this chapel, during the first decade of the sixteenth century, Carpaccio painted a series of pictures. First, three from the story of St. Jerome—not that St. Jerome was officially a patron of the brothers, but a fellow-countryman, and therefore, as it were, an ally;—then three from the story of St. George, one from that of St. Tryphonius, and two smaller from the Gospel History. Allowing for doorways, window, and altar, these nine pictures fill the circuit of the chapel walls.

Those representing St. George are placed opposite those of St. Jerome. In the anti-chapel of the Ducal Palace, Tintoret, who studied, not without result otherwise, these pictures of Carpaccio’s, has placed the same saints over against each other. To him, as to Carpaccio, they represented the two sides, practi-

cal and comtemplative, of faithful life. This balance we still, though with less completeness, signify by the linked names of Martha and Mary, and Plato has expressed it fully by the respective functions assigned in his ideal state to philosophers and guardians. The seer "able to grasp the eternal," "spectator of all time and of all existence,"—you may see him on your right as you enter this chapel,—recognizes and declares God's Law: the guardian obeys, enforces, and, if need be, fights for it.

St. George, Husbandman by name, and "*Τροπαιοφάρος*," Triumphant Warrior, by title, secures righteous peace, turning his spear into a pruning-hook for the earthly nature of man. He is also to be known as "*Μεγαλομάρτυρ*," by his deeds, the great witness for God in the world, and "*τῶν ἀθλητῶν ὁ μέγας Ταξιάρχης*," marshal and leader of those who strive to obtain an incorruptible crown.¹ St. Jerome, the seer, learned also in all the wisdom of the heathen, is, as Plato tells us such a man should be. Lost in his longing after "the universal law that knits human things with divine,"² he shows himself gentle and without fear, having no terror even of death.³ In the second picture on our right here we may see with how great quiet the old man has laid himself down to die, even such a pillow beneath his head as was under Jacob's upon that night of vision by the place which he thenceforward knew to be the "House of God," though "the name of it was called 'Separation' "⁴ at the first."⁵ The fantastic bilingual inter-

¹ These titles are taken from the earliest (Greek) records of him. The last corresponds to that of Baron Bradwardine's revered "Mareschal-Duke."

² Plat. Rep., VI. 486 A.

³ Plat. Rep., VI. 486 B.

⁴ Luz. This word stands also for the almond tree, flourishing when desire fails, and "man goeth to his long home."

⁵ In the 21st and 22nd Cantos of the "Paradise," Dante, too, connects the Dream of Jacob with the ascetic, living where "e consecrato un ermo, Che suole esser disposto a sola latria." This is in a sphere of heaven where "la dolce sinfonia del Paradiso" is heard by mortal ears only as overmastering thunder, and where the pilgrim is taught that no created vision, not the seraph's "che in Dio piu l'occhio ha fisso" may read that eternal statute by whose appointment spirits of the saints go forth upon their Master's business and return to Him again.

pretation of Jerome's name given in the "Golden Legend," standard of mediæval mythology, speaks to the same effect: "Hieronymus, quod est Sanctum Nemus," Holy Grove, "a nemore ubi aliquando conversatus est," from that one in which he sometimes had his walk—"Se dedit et sacri ne moris perpalluit umbra,"¹ but not beneath the laurels of "l'un giogo de Parnaso,"² to whose inferior summit, only, Dante in that line alludes, nor now under olive boughs—

"where the Attick bird

Trills her thick-warbled notes the summer long,"

but where, once on a winter night, shepherds in their vigil heard other singing, where the palm bearer of burdens, witness of victorious hope, offers to every man, for the gathering, fruit unto everlasting life. "Ad Bethleem oppidum remeavit, ubi, prudens animal, ad præsepe Domini se obtulit permansurum." "He went, as though home, to the town of Bethlehem, and like a wise domestic creature presented himself at his Master's manger to abide there."

After the pictures of St. George comes that of St. Tryphonius, telling how the prayer of a little child shall conquer the basilisk of earthly pride, though the soldier's spear cannot overthrow *this* monster, nor maiden's zone bind him. After the picture of St. Jerome we are given the Calling of Matthew, in which Carpaccio endeavours to declare how great joy fills the fugitive servant of Riches when at last he does homage as true man of another Master. Between these two is set the central picture of the nine, small, dark itself, and in a dark corner, in arrangement following pretty closely the simple tradition of earlier Venetian masters. The scene is an untilled garden—the subject, the Agony of our Lord.

The prominent feature of the stories Carpaccio has chosen—setting aside at present the two gospel incidents—is that, though heartily Christian, they are historically drawn quite as much from Greek as from mediæval mythology. Even in the scenes from St. Jerome's life, a well-known classical tale,

¹ Dante, "Eclogues," i. 30.

² Dante, "Par." I. 16.

which mingled with his legend, is introduced, and all the paintings contain much ancient religious symbolism. St. Tryphonius' conquest of the basilisk is, as we shall see, almost purely a legend of Apollo. From the middle ages onwards it has been often remarked how closely the story of St. George and the Dragon resembles that of Perseus and Andromeda. It does not merely resemble,—it is that story.

The earliest and central shrine of St. George,—his church, famous during the crusades, at Lydda,—rose by the stream which Pausanias, in the second century, saw running still "red as blood," because Perseus had bathed there after his conquest of the sea monster. From the neighbouring town of Joppa, as Pliny tells us, the skeleton of that monster was brought by M. Scaurus to Rome in the first century B.C. St. Jerome was shown on this very coast a rock known by tradition as that to which Andromeda had been bound. Before his day Josephus had seen in that rock the holes worn by her fetters.

In the place chosen by fate for this the most famous and finished example of harmony between the old faith and the new there is a strange double piece of real mythology. Many are offended when told that with the best teaching of the Christian Church Gentile symbolism and story have often mingled. Some still lament vanished dreams of the world's morning, echo the

"Voice of weeping heard, and loud lament,"

by woodland altar and sacred thicket. But Lydda was the city where St. Peter raised from death to doubly-marvellous service that loved garment-maker, full of good works, whose name was Wild Roe—Greek¹ type of dawn with its pure visions. And Lydda "was nigh unto Joppa,"² where was let down from heaven the mystic sheet, full of every kind of liv-

¹ The Hebrew poets, too, knew "the Hind of the glow of dawn."

² Near Joppa the Moslem (who also reverences St. George) sees the field of some great final contest between the Evil and the Good, upon whom the ends of the world shall have come—a contest surely that will require the presence of our warrior-marshal.

ing creature, (this, centuries before, a symbol familiar to the farthest east,¹) for lasting witness to the faithful that through his travailing creation God has appointed all things to be helpful and holy to man, has made nothing common or unclean.

There is a large body of further evidence proving the origin of the story of St. George and the Dragon from that of Perseus. The names of certain of the persons concerned in both coincide. Secondary, or later variations in the place of the fight appear alike in both legends. For example, the scene of both is sometimes laid in Phœnicia, north of Joppa. But concerning this we may note that a mythologist of the age of Augustus,² recounting this legend, is careful to explain that the name of Joppa had since been changed to Phœnice. The instance of most value, however—because connected with a singular identity of local names—is that account which takes both Perseus and St. George to the Nile delta. The Greek name of Lydda was Diospolis. Now St. Jerome speaks strangely of Alexandria as also called Diospolis, and there certainly was a Diospolis (later Lydda) near Alexandria, where “alone in Egypt,” Strabo tells us, “men did not venerate the crocodile, but held it in dishonour as most hateful of living things.” One of the “Crocodile towns” of Egypt was close by this. Curiously enough, considering the locality, there was also a “Crocodile-town” a short distance north of Joppa. In Thebes, too, the greater Diospolis, there was a shrine of Perseus, and near it another *Κροκοδείλων Πόλις*. This persistent recurrence of the name Diospolis probably points to Perseus’ original identity with the sun—noblest birth of the Father of Lights. In its Greek form that name was, of course, of comparatively late imposition, but we may well conceive it to have had reference³ to a local terminology and worship much more ancient. It is not unreasonable to connect too the Diospolis of Cappadocia, a region so

¹ Compare the illustrations on p. 44 of Didron’s “*Iconographie Chrétienne*” (English translation, p. 41).

² Conon. Narr., XL.

³ Compare the name Heliopolis given both to Baalbeck and On.

frequently and mysteriously referred to as that of St. George's birth.

Further, the stories both of Perseus and of St. George are curiously connected with the Persians; but this matter, together with the saint's Cappadocian nationality, will fall to be considered in relation to a figure in the last of Carpaccio's three pictures, which will open up to us the earliest history and deepest meaning of the myth.

The stories of the fight given by Greeks and Christians are almost identical. There is scarcely an incident in it told by one set of writers but occurs in the account given by some member or members of the other set, even to the crowd of distant spectators Carpaccio has so dwelt upon, and to the votive altars raised above the body of the monster, with the stream of healing that flowed beside them. And while both accounts say how the saved nations rendered thanks to the Father in heaven, we are told that the heathen placed, beside His altar, altars to the Maiden Wisdom and to Hermes, while the Christians placed altars dedicated to the Maiden Mother and to George. Even Medusa's head did not come amiss to the mediæval artist, but set in the saint's hand became his own, fit indication of the death by which he should afterwards glorify God. And here we may probably trace the original error—if, indeed, to be called an error—by which the myth concerning Perseus was introduced into the story of our soldier-saint of the East. From the fifth century to the fifteenth, mythologists nearly all give, and usually with approval, an interpretation of the word "gorgon" which makes it identical in meaning and derivation with "George." When comparatively learned persons, taught too in this special subject, accepted such an opinion and insisted upon it, we cannot be surprised if their contemporaries, uneducated, or educated only in the Christian mysteries, took readily a similar view, especially when we consider the wild confusion in mediæval minds concerning the spelling of classical names. Now just as into the legend of St. Hippolytus there was introduced a long episode manifestly derived from some disarranged and misunderstood series of paintings or sculptures concerning

the fate of the Greek Hippolytus,—and this is by no means a singular example, the name inscribed on the work of art being taken as evidence that it referred to the only bearer of that name then thought of—so, in all probability, it came about with St. George. People at Lydda far on into Christian times would know vaguely, and continue to tell the story, how long ago under that familiar cliff the dragon was slain and the royal maid released. Then some ruined fresco or vase painting of the event would exist, half forgotten, with the names of the characters written after Greek fashion near them in the usual superbly errant caligraphy. The Gorgon's name could scarcely fail to be prominent in a series of pictures from Perseus's history, or in this scene as an explanation of the head in his hand. A Christian pilgrim, or hermit, his heart full of the great saint, whose name as "Triumphant" filled the East, would, when he had spelt out the lettering, at once exclaim, "Ah, here is recorded another of my patron's victories." The probability of this is enhanced by the appearance in St. George's story of names whose introduction seems to require a similar explanation. But we shall find that the battle with the dragon, though not reckoned among St. George's deeds before the eleventh or twelfth century, is entirely appropriate to the earliest sources of his legend.

One other important parallel between Perseus and St. George deserves notice, though it does not bear directly upon these pictures. Both are distinguished by their burnished shields. The hero's was given him by Athena, that, watching in it the reflected figure of the Gorgon,¹ he might strike rightly with his sickle-sword, nor need to meet in face the mortal horror of her look. The saint's bright shield rallied once and again a breaking host of crusaders, as they seemed to see it blaze in their van under Antioch² wall, and by the breaches of desecrated Zion. But his was a magic mirror; work of craftsmen more cunning than might obey the Queen of Air. Turned to visions of terror and death, it threw back by law

¹ The allegorising Platonists interpret Medusa as a symbol of man's sensual nature. This we shall find to be Carpaccio's view of the dragon of St. George.

² Acts xi. 26.

of diviner optics an altered image—the crimson blazon of its cross.¹ So much for the growth of the dragon legend, fragment of a most ancient faith, widely spread and variously localised, thus made human by Greek, and passionately spiritual by Christian art.

We shall see later that Perseus is not St. George's only blood-relation among the powers of earlier belief; but for Englishmen there may be a linked association, if more difficult to trace through historic descent, yet, in its perfect harmony, even more pleasantly strange. The great heroic poem which remains to us in the tongue of our Anglo-Saxon ancestors—intuitive creation and honourable treasure for ever of simple English minds—tells of a warrior whose names, like St. George's, are "Husbandman" and "Glorious," whose crowning deed was done in battle with the poisonous drake. Even a figure very important in St. George's history—one we shall meet in the third of these pictures—is in this legend not without its representative—that young kinsman of the Saxon hero, "among the faithless" earls "faithful only he," who holds before the failing eyes of his lord the long rusted helm and golden standard, "wondrous in the grasp," and mystic vessels of ancient time, treasure redeemed at last by a brave man's blood from the vaulted cavern of the "Twilight Flyer." For Beowulf indeed slays the monster, but wins no princess, and dies of the fiery venom that has scorched his limbs in the contest. Him there awaited such fires alone—seen from their bleak promontory afar over northern seas—as burned once upon the ridge of Ceta, his the Heraklean crown of poplar leaves only, blackened without by the smoke of hell, and on the inner side washed white with the sweat of a labourer's brow.² It is a wilder form of the great story told by

¹ Compare the strange reappearance of the Æginetan Athena as St. John on the Florin. There the arm that bore the shield now with pointed finger gives emphasis and direction to the word "Behold."

² There was in his People's long lament for Beowulf one word about the hidden future, "when he must go forth from the body to become" What to become we shall not know, for fate has struck out just the four letters that would have told us.

seers¹ who knew only the terror of nature and the daily toil of men, and the doom that is over these for each of us. The royal maiden for ever set free, the sprinkling of pure water unto eternal life,—this only such eyes may discern as by happier fate have also rested upon tables whose divine blazon is the law of heaven; such hearts alone conceive, as, trained in some holy city of God, have among the spirits of just men made perfect, learned to love His commandment.

Such, then, was the venerable belief which Carpaccio set himself to picture in the Chapel of St. George. How far he knew its wide reign and ancient descent, or how far, without recognising these, he intuitively acted as the knowledge would have led him, and was conscious of lighting up his work by Gentile learning and symbolism, must to us be doubtful. It is not doubtful that, whether with open eyes, or in simple obedience to the traditions of his training, or, as is most likely, loyal as well in wisdom as in humility, he did so illumine it, and very gloriously. But painting this glory, he paints with it the peace that over the king-threatened cradle of another Prince than Perseus, was proclaimed to the heavy-laden.

The first picture on the left hand as we enter the chapel shows St. George on horseback, in battle with the Dragon. Other artists, even Tintoret,² are of opinion that the Saint rode a white horse. The champion of Purity must, they hold, have been carried to victory by a charger ethereal and

¹ "Beowulf" was probably composed by a poet nearly contemporary with Bede. The dragon victory was not yet added to the glories of St. George. Indeed, Pope Gelasius, in Council, more than a couple of centuries before, had declared him to be one of those saints "whose names are justly revered among men, but whose deeds are known to God only." Accordingly the Saxon teacher invokes him somewhat vaguely thus:—

"Invicto mundum qui sanguine temnis
Infinita refers, Georgi Sancte, trophæa!"

Yet even in these words we see a reverence similar to Carpaccio's for St. George as patron of purity. And the deeds "known to God alone" were in His good time revealed to those to whom it pleased Him.

² In the ante-chapel of the Ducal Palace.

splendid as a summer cloud. Carpaccio believed that his horse was a dark brown. He knew that this colour is generally the mark of greatest strength and endurance ; he had no wish to paint here an ascetic's victory over the flesh. St. George's warring is in the world, and for it ; he is the enemy of its desolation, the guardian of its peace ; and all vital force of the lower Nature he shall have to bear him into battle ; submissive indeed to the spur, bitted and bridled for obedience, yet honourably decked with trappings whose studs and bosses are fair carven faces. But though of colour prosaically useful, this horse has a deeper kinship with the air. Many of the ancient histories and vase-paintings tell us that Perseus, when he saved Andromeda, was mounted on Pegasus. Look now here at the mane and tail, swept still back upon the wind, though already the passionate onset has been brought to sudden pause in that crash of encounter. Though the flash of an earthly fire be in his eye, its force in his limbs—though the clothing of his neck be Chthonian thunder—this steed is brother, too, to that one, born by farthest ocean wells, whose wild mane and sweeping wings stretch through the firmament as light is breaking over earth. More ; these masses of billowy hair tossed upon the breeze of heaven are set here for a sign that this, though but one of the beasts that perish, has the roots of his strong nature in the power of heavenly life, and is now about His business who is Lord of heaven and Father of men. The horse is thus, as we shall see, opposed to certain other signs, meant for our learning, in the dream of horror round this monster's den.¹

St. George, armed to his throat, sits firmly in the saddle. All the skill gained in a chivalric youth, all the might of a soldier's manhood, he summons for this strange tourney, stooping slightly and gathering his strength as he drives the spear-point straight between his enemy's jaws. His face is very fair, at once delicate and powerful, well-bred in the fullest bear-

¹ This cloudlike effect is through surface rubbing perhaps more marked now than Carpaccio intended, but must always have been most noticeable. It produces a very striking resemblance to the Pegasus or the Ram of Phrixus on Greek vases.

ing of the words ; a Plantagenet face in general type, but much refined. The lower lip is pressed upwards, the brow knit, in anger and disgust partly, but more in care—and care not so much concerning the fight's ending, as that this thrust in it shall now be rightly dealt. His hair flows in bright golden ripples, strong as those of a great spring whose up-welling waters circle through some clear pool, but it breaks at last to float over brow and shoulders in tendrils of living light.¹ Had Carpaccio been aware that St. George and Perseus are, in this deed, one ; had he even held, as surely as Professor Müller finds reason to do, that at first Perseus was but the sun in his strength—for very name, being called the “Brightly-Burning”—this glorious head could not have been, more completely than it is, made the centre of light in the picture. In Greek works of art, as a rule, Perseus, when he rescues Andromeda, continues to wear the peaked Phrygian cap, dark helmet of Hades,² by whose virtue he moved, invisible, upon Medusa through coiling mists of dawn. Only after victory might he unveil his brightness. But about George from the first is no shadow. Creeping thing of keenest eye shall not see that splendour which is so manifest, nor with guile spring upon it unaware, to its darkening. Such knowledge alone for the dragon—dim sense as of a horse with its rider, moving to the fatal lair, hope, pulseless,—not of heart, but of talon and maw—that here is yet another victim, then only between his teeth that keen lance-point, thrust far before the Holy Apparition at whose rising the Power of the Vision of Death waxes faint and drops those terrible wings that bore under their shadow, not healing, but wounds for men.

The spear pierces the base of the dragon's brain, its point penetrating right through and standing out at the back of the head just above its junction with the spine. The shaft breaks in the shock between the dragon's jaws. This shivering of St. George's spear is almost always emphasized in pictures of him—sometimes, as here, in act, oftener by position of the splintered fragments prominent in the foreground. This is no tra-

¹ At his martyrdom St. George was hung up by his hair to be scourged.

² Given by Hermes (Chthonios).

dition of ancient art, but a purely mediæval incident, yet not, I believe, merely the vacant reproduction of a sight become familiar to the spectator of tournaments. The spear was type of the strength of human wisdom. This checks the enemy in his attack, subdues him partly, yet is shattered, having done so much, and of no help in perfecting the victory or in reaping its reward of joy. But at the Saint's "loins, girt about with truth," there hangs his holier weapon—the Sword of the Spirit, which is the Word of God.

The Dragon¹ is bearded like a goat,² and essentially a thorny³ creature. Every ridge of his body, wings, and head, bristles with long spines, keen, sword-like, of an earthy brown colour or poisonous green. But the most truculent-looking of all is a short, strong, hooked one at the back of his head, close to where the spear-point protrudes.⁴ These thorns are partly the same vision—though seen with even clearer eyes, dreamed by a heart yet more tender—as Spenser saw in the troop of urchins coming up with the host of other lusts against the Castle of Temperance. They are also symbolic as weeds whose deadly growth brings the power of earth to waste and chokes its good. These our Lord of spiritual husbandmen must for preliminary task destroy. The agricultural process consequent on this first step in tillage we shall see in the next picture, whose subject is the triumph of the ploughshare sword, as the subject of this one is the triumph of the pruning-hook spear.⁵ To an Italian of Carpaccio's time, further, spines—etymologically connected in Greek and

¹ It should be noticed that St. George's dragon is never human-headed, as often St. Michael's.

² So the Theban dragon on a vase, to be afterwards referred to.

³ The following are Lucian's words concerning the monster slain by Perseus, "Καὶ τὸ μὲν ἔπεισι πεφρικὸς τὰς ἀκαθὰς καὶ δεδιττόμενον τῷ χάσματι."

⁴ I do not know the meaning of this here. It bears a striking resemblance to the crests of the dragon of Triptolemus on vases. These crests signify primarily the springing blade of corn. That, here, has become like iron.

⁵ For "pruning-hooks" in our version, the Vulgate reads "ligones" --tools for preparatory clearance.

Latin, as in English, with the backbone—were an acknowledged symbol of the lust of the flesh, whose defeat the artist has here set himself to paint. The mighty coiling tail, as of a giant eel,¹ carries out the portraiture. For this, loathsome as the body is full of horror, takes the place of the snails ranked by Spenser in line beside his urchins. Though the monster, half-rampant, rises into air, turning claw and spike and tooth towards St. George, we are taught by this grey abomination twisting in the slime of death that the threatened destruction is to be dreaded not more for its horror than for its shame.

Behind the dragon lie, naked, with dead faces turned heavenwards, two corpses—a youth's and a girl's, eaten away from the feet to the middle, the flesh hanging at the waist in loathsome rags torn by the monster's teeth. The man's thigh and upper-arm bones snapped across and sucked empty of marrow, are turned to us for special sign of this destroyer's power. The face, foreshortened, is drawn by death and decay into the ghastly likeness of an ape's.² The girl's face—seen in profile—is quiet and still beautiful; her long hair is heaped as for a pillow under her head. It does not grow like St. George's, in living ripples, but lies in fantastic folds, that have about them a savour, not of death only, but of corruption. For all its pale gold they at once carry back one's mind to Turner's Pytho, where the arrow of Apollo strikes him in the midst, and, piercing, reveals his foulness. Round her throat cling a few torn rags, these only remaining of the white gar-

¹ The eel was Venus' selected beast-shape in the "Flight of the Gods." Boccaccio has enlarged upon the significance of this. Gen. Deor. IV. 68. One learns from other sources that a tail was often symbol of sensuality.

² In the great Botticelli of the National Gallery, known as Mars and Venus, but almost identical with the picture drawn afterwards by Spenser of the Bower of Acrasia, the sleeping youth wears an expression, though less strongly marked, very similar to that of this dead face here. Such brutish paralysis is with scientific accuracy made special to the male. It may be noticed that the power of venomously wounding, expressed by Carpaccio through the dragon's spines, is in the Botticelli signified by the swarm of hornets issuing from the tree-trunk by the young man's head.

ment that clothed her once. Carpaccio was a diligent student of ancient mythology. Boccaccio's very learned book on the Gods was the standard classical dictionary of those days in Italy. It tells us how the Cyprian Venus—a mortal princess in reality, Boccaccio holds—to cover her own disgrace led the maidens of her country to the sea-sands, and, stripping them there, tempted them to follow her in shame. I suspect Carpaccio had this story in his mind, and meant here to reveal in true dragon aspect the Venus that once seemed fair, to show by this shore the fate of them that follow her. It is to be noticed that the dead man is an addition made by Carpaccio to the old story. Maidens of the people, the legend-writers knew, had been sacrificed before the Princess; but only he, filling the tale—like a cup of his country's fairly fashioned glass—full of the wine of profitable teaching, is aware that men have often come to these yellow sands to join there in the dance of death—not only, nor once for all, this Saint who clasped hands with Victory. Two ships in the distance—one stranded, with rigging rent or fallen, the other moving prosperously with full sails on its course—symbolically repeat this thought.¹

Frogs clamber about the corpse of the man, lizards about the woman. Indeed for shells and creeping things this place where strangers lie slain and unburied would have been to the good Palissy a veritable and valued potter's field. But to every one of these cold and scaly creatures a special symbolism was attached by the science—not unwisely dreaming—of Carpaccio's day. They are, each one, painted here to amplify and press home the picture's teaching. These lizards are born of a dead man's flesh, these snakes of his marrow:² and adders, the most venomous, are still only lizards ripened witheringly from loathsome flower into poisonous fruit. The frogs³—symbols, Pierius tells us, of imperfection and shame-

¹ "The many fail, the one succeeds."

² "The silver cord" not "loosed" in God's peace, but thus devilishly quickened.

³ Compare the "unclean spirits come out of the mouth of the dragon," in Revelation.

lessness—are in transfigured form those Lycian husbandmen whose foul words mocked Latona, whose feet defiled the wells of water she thirsted for, as the veiled mother painfully journeyed with those two babes on her arm, of whom one should be Queen of Maidenhood, the other, Lord of Light, and Guardian of the Ways of Men.¹ This subtle association between batrachians and love declining to sense lay very deep in the Italian mind. In “Ariadne Florentina” there are two engravings from Botticelli of Venus, as a star floating through heaven and as foam-born rising from the sea. Both pictures are most subtly beautiful, yet in the former the lizard likeness shows itself distinctly in the face, and a lizard’s tail appears in manifest form as pendulous crest of the chariot, while in the latter not only contours of profile and back,² but the selected attitude of the goddess, bent and half emergent, with hand resting not over firmly upon the level shore, irresistibly recall a frog.

In the foreground, between St. George and the Dragon, a spotted lizard labours at the task set Sisyphus in hell for ever. Sisyphus, the cold-hearted and shifty son of Æolus,³ stained in life by nameless lust, received his mocking doom of toil, partly for his treachery—winning this only in the end,—partly because he opposed the divine conception of the Æacid race; but above all, as penalty for the attempt to elude the fate of death “that is appointed alike for all,” by refusal for his own body of that “sowing in corruption,” against which a deeper furrow is prepared by the last of husbandmen with whose labour each of us has on earth to do. Then, finding that Carpaccio has had in his mind one scene of Tartarus, we may believe the corpse in the background, torn by carrion-birds, to be not merely a meaningless incident of horror, but a reminiscence of enduring punishment avenging upon Tityus⁴ the insulted purity of Artemis.⁵

¹ Ἀγνεύς.

² Compare the account of the Frog’s hump, “Ariadne Florentina,” p.93.

³ Compare Pindar’s use of ἀλόος as a fit adjective for ψεῦδος, Nem. viii.43.

⁴ “Terræ omniparentis alumnum.”

⁵ Or, as the story is otherwise given, of the mother of Artemis, as in the case of the Lycian peasants above.

The coiled adder is the familiar symbol of eternity, here meant either to seal for the defeated their fate as final, or to hint, with something of Turner's sadness, that this is a battle not gained "once for ever" and "for all," but to be fought anew by every son of man, while, for each, defeat shall be deadly, and victory still most hard, though an armed Angel of the Victory of God be our marshal and leader in the contest. A further comparison with Turner is suggested by the horse's skull between us and Saint George. A similar skeleton is prominent in the corresponding part of the foreground in the "Jason" of the *Liber Studiorum*. But Jason clammers to victory on foot, allows no charger to bear him in the fight. Turner, more an antique¹ Hellene than a Christian prophet, had, as all the greatest among the Greeks, neither vision nor hope of any more perfect union between lower and higher nature by which that inferior creation, groaning now with us in pain, should cease to be type of the mortal element, which seems to shame our soul as basing it in clay, and, with that element, become a temple-platform, lifting man's life towards heaven.²

With Turner's adder, too, springing immortal from the Python's wound, we cannot but connect this other adder of Carpaccio's, issuing from the white skull of a great snake. Adders, according to an old fancy, were born from the jaws of their living mother. Supernatural horror attaches to this symbolic one, writhing out from between the teeth of that ophidian death's-head. And the plague, not yet fully come forth, but already about *its* father's business, venomously fastens on a frog, type of the sinner whose degradation is but the beginning of punishment. So soon the worm that dies not is also

¹ Hamlet, V. ii. 352.

² Pegasus and the immortal horses of Achilles, born like Pegasus by the ocean wells, are always to be recognized as spiritual creatures, not—as St. George's horse here—earthly creatures, though serving and manifesting divine power. Compare too the fate of Argus (Homer, *Od.* XVII.) In the great Greek philosophies, similarly, we find a realm of formless shadow eternally unconquered by sacred order, offering a contrast to the modern systems which aim at a unity to be reached, if not by reason, at least by what one may not inaccurately call an act of faith.

upon him—in its fang Circean poison to make the victim one with his plague, as in that terrible circle those, afflicted, whom “vita bestial piacque e non humana.”

Two spiral shells¹ lie on the sand, in shape related to each other as frog to lizard, or as Spenser’s urchins, spoken of above, to his snails. One is round and short, with smooth viscous-looking lip, turned over, and lying towards the spectator. The other is finer in form, and of a kind noticeable for its rows of delicate spines. But, since the dweller in this one died, the waves of many a long-fallen tide rolling on the shingle have worn it almost smooth, as you may see its fellows to-day by hundreds along Lido shore. Now such shells were, through heathen ages innumerable and over many lands, holy things, because of their whorls moving from left to right² in some mysterious sympathy, it seemed, with the sun in his daily course through heaven. Then as the open clam-shell was special symbol of Venus, so these became of the Syrian Venus, Ashtaroth, Ephesian Artemis, queen, not of purity but of abundance, Mylitta, ἡ τις ποτ’ ἐστίν, the many named and widely worshipped.³ In Syrian figures still existing she bears just such a shell in her hand. Later writers, with whom the source of this symbolism was forgotten, accounted for it, partly by imaginative instinct, partly by fanciful invention concerning the nature and way of life of these creatures. But there is here yet a further reference, since from such shells along the Syrian coast was crushed out, sea-purple and scarlet, the juice of the Tyrian dye. And the power of sensual delight throned in the chief places of each merchant city, decked her “stately bed” with coverings whose tincture was the stain of that baptism.⁴ The shells are

¹ Ovid associates shells with the enemy of Andromeda, but regarding it as a very ancient and fish-like monster, plants them on its back—

“terga cavis super obsita conchis.”—*Or. Met.*, IV. 724.

² In India, for the same reason, one of the leading marks of the Buddha’s perfection was his hair, thus spiral.

³ Compare the curious tale about the Echeneis. Pliny, *Hist. Nat.*, IX. 25. “De echeneide ejusque naturâ mirabili.”

⁴ The purple of Lydda was famous. Compare Fors Clavigera, April, 1876, p. 2, and Deucalion, § 39.

empty now, devoured—lizards on land or sea-shore are ever to such “inimicissimum genus”¹—or wasted in the deep. For the ripples² that have thrown and left them on the sand are a type of the lusts of men, that leap up from the abyss, surge over the shore of life, and fall in swift ebb, leaving desolation behind.

Near the coiled adder is planted a withered human head. The sinews and skin of the neck spread, and clasp the ground—as a zoophyte does its rock—in hideous mimicry of an old tree’s knotted roots. Two feet and legs, torn off by the knee, lean on this head, one against the brow and the other behind. The scalp is bare and withered. These things catch one’s eye on the first glance at the picture, and though so painful are made thus prominent as giving the key to a large part of its symbolism. Later Platonists—and among them those of the fifteenth century—developed from certain texts in the *Timæus*³ a doctrine concerning the mystical meaning of hair, which coincides with its significance to the vision of early (pre-Platonic) Greeks. As a tree has its roots in earth, and set thus, must patiently abide, bearing such fruit as the laws of nature may appoint, so man, being of other family—these dreamers belonged to a very “pre-scientific epoch”—has his roots in heaven, and has the power of moving to and fro over the earth for service to the Law of Heaven, and as sign of his free descent. Of these diviner roots the hair is visible type. Plato tells us,⁴ that of innocent, light-hearted men, “whose thoughts were turned heavenward,” but who “imagined in their simplicity that the clearest demonstration of things above was to be obtained by sight” the race of birds had being, by change of external shape into due harmony with the soul (“*μετερροθυμίζετο*”)—such persons growing feathers instead of hair.⁵ We have in

¹ Pliny, *Hist. Nat.*, VIII. 39.

² Under the name of *Salacia* and *Venilia*. See St. August., *Civ. Dei*, VII. 22.

³ Plato, *Tim.*, 75, 76.

⁴ *Ibid.* 91, D. E.

⁵ The most devoid of wisdom were stretched on earth, becoming footless and creeping things, or sunk as fish in the sea. So, we saw *Venus*

Dante, ' too, an inversion of tree nature parallel to that of the head here. The tree, with roots in air, whose sweet fruit is, in Purgatory, alternately, to gluttonous souls, temptation, and purifying punishment—watered, Landino interprets, by the descending spray of Lethe—signifies that these souls have forgotten the source and limits of earthly pleasure, seeking vainly in it satisfaction for the hungry and immortal spirit. So here, this blackened head of the sensual sinner is rooted to earth, the sign of strength drawn from above is stripped from off it, and beside it on the sand are laid, as in hideous mockery, the feet that might have been beautiful upon the mountains. Think of the woman's body beyond, and then of this head—"instead of a girdle, a rent; and instead of well-set hair, baldness." The worm's brethren, the Dragon's elect, wear such shameful tonsure, unencircled by the symbolic crown; prodigal of life, "risurgeranno," from no quiet grave, but from this haunt of horror, "co crin mozzi"²—in piteous witness of wealth ruinously cast away. Then compare, in light of the quotation from Plato above, the dragon's thorny plumage; compare, too, the charger's mane and tail, and the rippling glory that crowns St. George. It is worth while, too, to have in mind the words of the "black cherub" that had overheard the treacherous counsel of Guido de Montefeltro. From the moment it was uttered, to that of the sinner's death, the evil spirit says, "stato gli sono a crini"³—lord of his fate. Further, in a Venetian series of engravings illustrating Dante (published 1491), the firebreathings of the Dragon on Cacus' shoulders transform themselves into the Centaur's femininely flowing hair, to signify the inspiration of his forceful fraud. This "power on his head" he has because of such an angel.⁴ When we consider the Princess we shall find this symbolism yet further carried, but just now have to notice how the closely connected franchise of graceful motion,

chosen transmigration was into the form of an eel—other authorities say, of a fish.

¹ Dante, Purg., XXII., XXIII.

² *Ibid.* Inf., VII. 57. Purg., XXII. 46.

³ *Ibid.* Inf., XXVII.

⁴ *Ibid.* XXV.

lost to those dishonoured ones, is marked by the most carefully-painted bones lying on the left—a thigh-bone dislocated from that of the hip, and then thrust through it. Curiously, too, such dislocation would in life produce a hump, mimicking fairly enough in helpless distortion that one to which the frog's leaping power is due.¹

Centrally in the foreground is set the skull, perhaps of an ape, but more probably of an ape-like man, "with forehead villanous low." This lies so that its eye-socket looks out, as it were, through the empty eyehole of a sheep's skull beside it. When man's vision has become oviné merely, it shall at last, even of grass, see only such bitter and dangerous growth as our husbandman must reap with a spear from a dragon's wing.

The remaining minor words of this poem in a forgotten tongue I cannot definitely interpret. The single skull with jaw-bone broken off, lying under the dragon's belly, falls to be mentioned afterwards. The ghastly heap of them, crowned by a human mummy, withered and brown,² beside the coil of the dragon's tail, seem meant merely to add general emphasis to the whole. The mummy (and not this alone in the picture) may be compared with Spenser's description of the Captain of the Army of Lusts:—

"His body lean and meagre as a rake,
And skin all withered like a dried rook,
Thereto as cold and dreary as a snake.

* * * * *

Upon his head he wore a helmet light,
Made of a dead man's skull, that seemed a ghastly sight."

The row of five palm trees behind the dragon's head perhaps refers to the kinds of temptation over which Victory must be gained, and may thus be illustrated by the five troops that in Spenser assail the several senses, or beside Chaucer's five fingers of the hand of lust. It may be observed that

¹ 'Ariadne Florentina,' Lect. III., p. 93.

² The venom of the stellio, a spotted species of lizard, emblem of shamelessness, was held to cause blackening of the face.

Pliny speaks of the Essenes—predecessors of the Christian Hermits—who had given up the world and its joys as “*gens socia palmarum.*”¹

Behind the dragon, in the far background, is a great city. Its walls and towers are crowded by anxious spectators of the battle. There stands in it, on a lofty pedestal, the equestrian statue of an emperor on horseback, perhaps placed there by Carpaccio for sign of Alexandria, perhaps merely from a Venetian's pride and joy in the great figure of Colleone recently set up in his city. In the background of the opposite (St. George's) side of the picture rises a precipitous hill, crowned by a church. The cliffs are waveworn, an arm of the sea passing between them and the city.

Of these hieroglyphics, only the figure of the princess now remains for our reading. The expression on her face, ineffable by descriptive words,² is translated into more tangible symbols by the gesture of her hands and arms. These repeat, with added grace and infinitely deepened meaning, the movement of maidens who encourage Theseus or Cadmus in their battle with monsters on many a Greek vase. They have been clasped in agony and prayer, but are now parting—still just a little doubtfully—into a gesture of joyous gratitude to this captain of the army of salvation and to the captain's Captain. Raphael³ has painted her running from the scene of battle. Even with Tintoret⁴ she turns away for flight; and if her hands are raised to heaven, and her knees fall to the earth, it is more that she stumbles in a woman's weakness, than that she abides in faith or sweet self-surrender. Tintoret sees the scene as in the first place a matter of fact, and paints accord-

¹ Pliny, *Hist. Nat.*, V. 17.

² Suppose Caliban had conquered Prospero, and fettered him in a fig-tree or elsewhere; that Miranda, after watching the struggle from the cave, had seen him coming triumphantly to seize her; and that the first appearance of Ferdinand is, just at that moment, to her rescue. If we conceive how she would have looked then, it may give some parallel to the expression on the princess's face in this picture, but without a certain light of patient devotion here well marked.

³ Louvre.

⁴ National Gallery.

ingly, following his judgment of girl nature.¹ Carpaccio sees it as above all things a matter of faith, and paints mythically for our teaching. Indeed, doing this, he repeats the old legend with more literal accuracy. The princess was offered as a sacrifice for her people. If not willing, she was at least submissive; nor for herself did she dream of flight. No chains in the rock were required for the Christian Andromeda.

“And the king said, . . . ‘Daughter, I would you had died long ago rather than that I should lose you thus.’ And she fell at his feet, asking of him a father’s blessing. And when he had blessed her once and again, with tears she went her way to the shore. Now St. George chanced to pass by that place, and he saw her, and asked why she wept. But she answered, ‘Good youth, mount quickly and flee away, that you die not here shamefully with me.’ Then St. George said, ‘Fear not, maiden, but tell me what it is you wait for here, and all the people stand far off beholding.’ And she said, ‘I see, good youth, how great of heart you are; but why do you wish to die with me?’ And St. George answered, ‘Maiden, do not fear; I go not hence till you tell me why you weep.’ And when she had told him all, he answered, ‘Maiden, have no fear, for in the name of Christ will I save you.’ And she said, ‘Good soldier,—lest you perish with me! For that I perish alone is enough, and you could not save me; you would perish with me.’ Now while she spoke the dragon raised his head from the waters. And the maiden cried out, all trembling, ‘Flee, good my lord, flee away swiftly.’”² But our “very loyal chevalier of the faith” saw cause to disobey the lady.

Yet Carpaccio means to do much more than just repeat this story. His princess, (it is impossible, without undue dividing of its substance, to put into logical words the truth

¹ And perhaps from a certain ascetic feeling, a sense growing with the growing license of Venice, that the soul must rather escape from this monster by flight, than hope to see it subdued and made serviceable, (vide p. 14).

² *Legenda Aurea*.

here "embodied in a tale,")—but this princess represents the soul of man. And therefore she wears a coronet of seven gems, for the seven virtues; and of these, the midmost that crowns her forehead is shaped into the figure of a cross, signifying faith, the saving virtue.¹ We shall see that in the picture of Gethsemane also, Carpaccio makes the representative of faith central. Without faith, men indeed may shun the deepest abyss, yet cannot attain the glory of heavenly hope and love. Dante saw how such men—even the best—may not know the joy that is perfect. Moving in the divided splendour merely of under earth, on sward whose "fresh verdure," eternally changeless, expects neither in patient waiting nor in sacred hope the early and the latter rain,² "*Sembianza avevan nè trista nè lieta.*"

This maiden, then, is an incarnation of spiritual life, mystically crowned with all the virtues. But their diviner meaning is yet unrevealed, and following the one legible command she goes down to such a death for her people, vainly. Only by help of the hero who slays monstrous births of nature, to sow and tend in its organic growth the wholesome plant of civil life, may she enter into that liberty with which Christ makes His people free.

The coronet of the princess is clasped about a close red cap which hides her hair. Its tresses are not yet cast loose, inasmuch as, till the dragon be subdued, heavenly life is not secure for the soul, nor its marriage with the great Bridegroom complete. In corners even of Western Europe to this day, a maiden's hair is jealously covered till her wedding. Compare now this head with that of St. George. Carpaccio,

¹ St. Thomas Aquinas, putting logically the apostle's "substance of things hoped for," defines faith as "a habit of mind by which eternal life is begun in us" (*Summa* II. III. IV. 1).

² Epistle of James, v., Dante selects (and Carpaccio follows him) as heavenly judge of a right hope that apostle who reminds his reader how man's life is even as a vapour that appeareth for a little time and then vanisheth away. For the connection—geologically historic—of grass and showers with true human life, compare Genesis ii. 5—8, where the right translation is, "And no plant of the field was yet in the earth, and no herb yet sprung up or grown," etc.

painting a divine service of mute prayer and acted prophecy, has followed St. Paul's law concerning vestments. But we shall see how, when prayer is answered and prophecy fulfilled, the long hair—"a glory to her," and given by Nature for a veil—is sufficient covering upon the maiden's head, bent in a more mystic rite.

From the cap hangs a long scarf-like veil. It is twisted once about the princess's left arm, and then floats in the air. The effect of this veil strikes one on the first glance at the picture. It gives force to the impression of natural fear, yet strangely, in light fold, adds a secret sense of security, as though the gauze were some sacred ægis. And such indeed it is, nor seen first by Carpaccio, though probably his intuitive invention here. There is a Greek vase-picture¹ of Cadmus attacking a dragon, Ares-begotten, that guarded the sacred spring of the warrior-god. That fight was thus for the same holy element whose symbolic sprinkling is the end of this one here. A maiden anxiously watches the event; her gesture resembles the princess's; her arm is similarly shielded by a fold of her mantle. But we have a parallel at once more familiar and more instructively perfect than this. Cadmus had a daughter, to whom was given power upon the sea, because in utmost need she had trusted herself to the mercy of its billows. Lady of its foam, in hours when "the blackening wave is edged with white," she is a holier and more helpful Aphrodite, —a "water-sprite" whose voice foretells that not "wreck" but salvation "is nigh." In the last and most terrible crisis of that long battle with the Power of Ocean, who denied him a return to his Fatherland, Ulysses would have perished in the waters without the veil of Leucothea wrapped about his breast as divine life-buoy. And that veil, the "immortal" κρήδεμνον,² was just such a scarf attached to the head-dress as this one o-

¹ Inghirami gives this (No. 239).

² In pursuance of the same symbolism, Troy walls were once literally called "salvation," this word, with, for certain historical reasons, the added epithet of "holy," being applied to them. With the κρήδεμνον Penelope shielded her "tender" cheeks in presence of the suitors.

the princess's here.¹ Curiously, too, we shall see that Leucothea (at first called Ino), of Thebes' and Cadmus' line, daughter of Harmonia, is closely connected with certain sources of the story of St. George.² But we have first to consider the dragon's service.

¹ Vide Nitsch ad Od., V. 346.

² λεγοντι δ' ἐν καὶ θαλάσση

. . . βίστον ἄφθιτον

Ἴνοι τετάχθαι τὸν ἔλον ἄμυρ χρόνον.

(Pind. Ol., II. 51.)

The Editor had hope of publishing this book a full year ago. He now in all humility, yet not in uncertainty, can sum the causes of its delay, both with respect to his friend and to himself, in the words of St. Paul,

καὶ ἐνεκοψεν ἡμᾶς ὁ Σατανᾶς.

BRANTWOOD,

6th March, 1879.

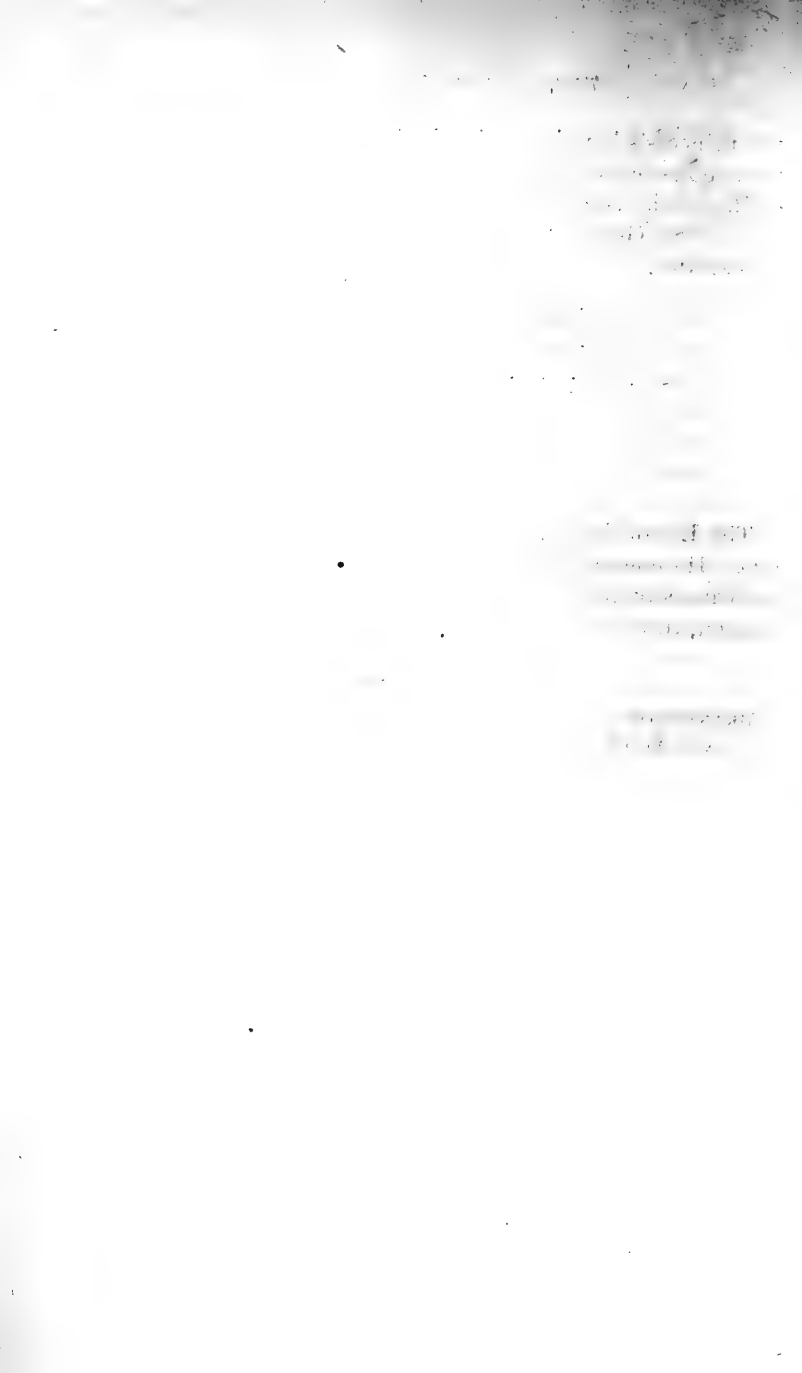

APPENDIX TO CHAPTER VIII

APPENDIX

SANCTUS, SANCTUS, SANCTUS.

AN ACCOUNT OF THE MOSAICS IN THE BAPTISTERY OF ST. MARK'S.

“The whole edifice is to be regarded less as a temple wherein to pray than as itself a Book of Common Prayer, a vast illuminated missal, bound with alabaster instead of parchment.”

Stones of Venice, ii. 4, 46.

“We must take some pains, therefore, when we enter St Mark's, to read all that is inscribed, or we shall not penetrate into the feeling either of the builder or of his times.”

Stones of Venice, ii. 4, 64.

THE following catalogue of the mosaics of the Baptistery of St. Mark's was written in the autumn of 1882, after a first visit to Venice, and was then sent to Mr. Ruskin as a contribution to his collected records of the church. It was not intended for publication, but merely as notes or material for which he might possibly find some use; and if the reader in Venice will further remember that it is the work of no artist or antiquarian, but of a traveller on his holiday, he will, it is hoped, be the more ready to pardon errors and omissions which his own observation can correct and supply. The mosaics of the Baptistery are, of course, only a small portion of those to be seen throughout the church, but that portion is one complete in itself, and more than enough to illustrate the vast amount of thought contained in the scripture legible on the walls of St. Mark's by every comer who is desirous of taking any real interest in the building.

The reader, then, who proposes to make use of the present guide can, by reference to the following list, see at a glance

the subjects with which these mosaics deal, and the order in which his attention will be directed to them. They are, in addition to the altar-piece, these :—

- I. The Life of St. John the Baptist.
- II. The Infancy of Christ.
- III. St. Nicholas.
- IV. The Four Evangelists.
- V. The Four Saints.
- VI. The Greek Fathers.
- VII. The Latin Fathers.
- VIII. Christ and the Prophets.
- IX. Christ and the Apostles.
- X. Christ and the Angels.

The subject of the altar-piece is the Crucifixion. In the centre is Christ on the cross, the letters $\overline{IC. \overline{XC.}}$ on either side. Over the cross are two angels, veiling their faces with their robes ; at its foot lies a skull,—Golgotha,—upon which falls the blood from Christ's feet, whilst on each side of the Saviour are five figures, those at the extreme ends of the mosaic being a doge and dogress, probably the donors of the mosaic.

To the left is St. Mark— $\overline{S \overline{M} \overline{A} \overline{R} \overline{C} \overline{V} \overline{S}}$ —with an open book in his hand, showing the words, “In illo tempore Maria mater” “In that hour Mary his mother” She stands next the cross, with her hands clasped in grief ; above her are the letters $\overline{M} \overline{P} \odot \overline{V} \overline{\mu} \overline{\eta} \overline{\tau} \overline{\eta} \overline{\rho} \overline{\Theta} \overline{\epsilon} \overline{\upsilon} \overline{\nu}$ —Mother of God.

To the right of the cross is St. John the Evangelist— $\overline{S. \overline{I} \overline{O} \overline{H} \overline{E} \overline{S} \overline{E} \overline{V} \overline{G}}$ —his face covered with his hands, receiving charge of the Virgin : “When Jesus, therefore, saw his mother, and the disciple standing by, whom he loved, he saith unto his mother, Woman, behold thy son ! Then saith he to the disciple, Behold thy mother ! And from that hour the disciple took her unto his own home” (St. John xix. 26, 27).

Lastly, next St. John the Evangelist is St. John the Baptist, bearing a scroll, on which are the words :

“ECCE AGNUS DEI ECE”

“Ecce agnus Dei, ecce qui tollit peccatum mundi.”

“Behold the Lamb of God which taketh away the sin of the world”
(St. John i. 29).¹

I. THE LIFE OF ST. JOHN THE BAPTIST.—Leaving the altar and turning to the right, we have the first mosaic in the series which gives the life of the Baptist, and consists in all of ten pictures. (See plan, p. 160.)

- a. His birth is announced.
- b. He is born and named.
- c. He is led into the desert.
- d. He receives a cloak from an angel.
- e. He preaches to the people.
- f. He answers the Pharisees.
- g. He baptizes Christ.
- h. He is condemned to death.
- i. He is beheaded.
- j. He is buried.

a. *His birth is announced.*—This mosaic has three divisions.

1. To the left is Zacharias at the altar, with the angel appearing to him. He swings a censer, burning incense “in the order of his course.” He has heard the angel’s message, for his look and gesture show clearly that he is already struck dumb. Above are the words :

INGRESSO ZACHARIA TĒPLV̄ DŪI
P̄RVIT EI AGL̄S DŪI STAS
A DEXTRIS ALTARIS

“Ingresso Zacharia templum domini aparuit ei angelus domini stans a dextris altaris.”

“When Zacharias had entered the temple of the Lord there appeared to him an angel of the Lord standing on the right side of the altar”
(St. Luke i. 9-11).

¹The scriptural references in this appendix are, first, to the Vulgate, which most of the legends in the Baptistery follow, and, secondly, to the English version of the Bible. The visitor will also notice that throughout the chapel the scrolls are constantly treated by the mosaicists literally as scrolls, the text being cut short even in the middle of a word by the curl of the supposed parchment.

PLAN OF THE BAPTISTERY.

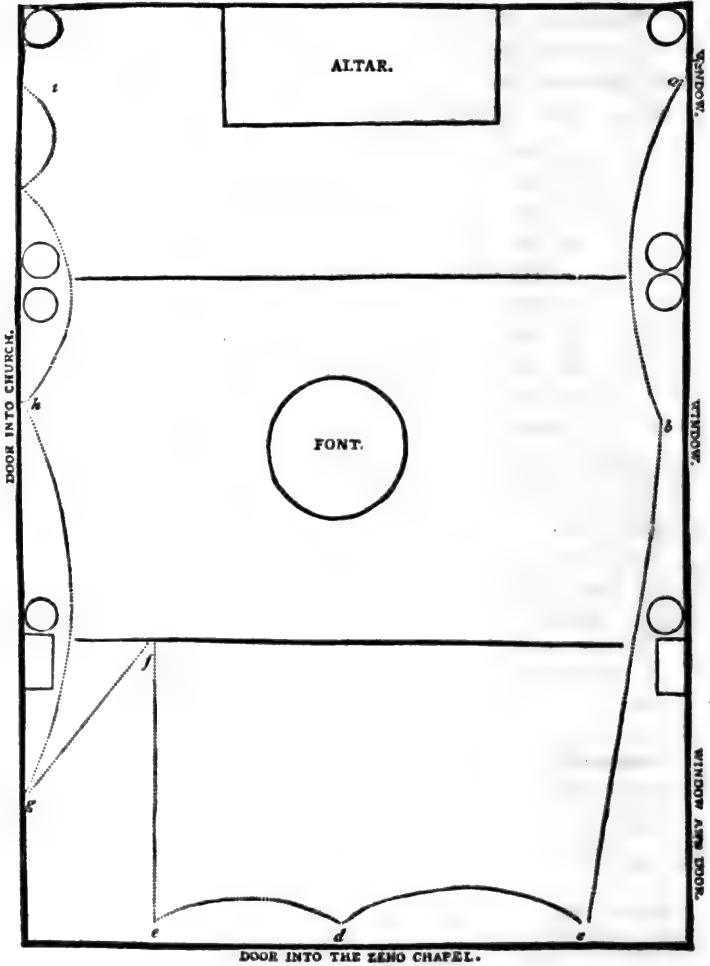

2. "And the people waited for Zacharias, and marvelled that he tarried so long in the temple. And when he came out, he could not speak unto them: and they perceived that he had seen a vision in the temple: for he beckoned unto them, and remained speechless" (St. Luke i. 21, 22).

✠ H. S. ZAHARIAS EXIT
TUTUS AD PPLM

"*He sanctus Zacharias exit tutus ad populum.*"

"*Here saint Zacharias comes out safe to the people.*"

3. "He departed to his own house" (St. Luke i. 23).
Zacharias embracing his wife Elizabeth.

✠ S. ZAH
RIAS. S. ELI
SABETA

b. He is born and named (opposite the door into the church).
—Zacharias is seated to the left¹ of the picture, and has a book or "writing table" in front of him, in which he has written "*Johannes est nomen ejus*"—"His name is John" (Luke i. 63). To the right an aged woman, Elizabeth, points to the child inquiringly, "How would you have him called?"; further to the right, another and younger woman kneels, holding out the child to his father. At the back a servant with a basket in her arms looks on. Unlike the other two women, she has no glory about her head. Above is a tablet inscribed:—



NATIVITAS
SANCTI JOHANNIS
BAPTISTÆ

and below another tablet, with the date and artist's name—

FRAN' TURESSIUS V. F. MDCXXVIII.

¹ By "right" and "left" in this appendix is meant always the right and left hand of the spectator as he faces his subject.

Turning now to the west wall, and standing with the altar behind us, we have the next three mosaics of the series, thus—

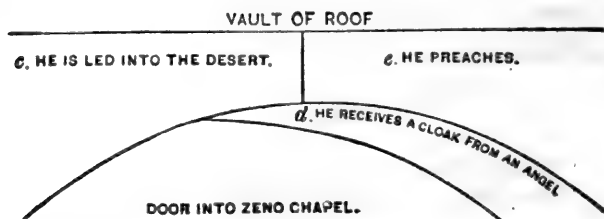

c. *He is led into the desert.*—The words of the legends are:—

✠ QVOM ANGELV' SEDOVXAT S. IOHAN.

I. DESERTUM.

“ Quomodo angelus seduxit (?) sanctum Johannem
in desertum.”

“ How an angel led away saint John into the desert.”

This is not biblical. “ And the child grew and waxed strong in spirit, and was in the deserts till the day of his showing unto Israel ” is all St. Luke (i. 80) says. Here the infant Baptist is being led by an angel, who points onward with one hand, and with the other holds that of the child, who, so far from being “ strong in spirit,” looks troubled, and has one hand placed on his heart in evident fear. His other hand, in the grasp of the angel's, does not in any way hold it, but is held by it; he is literally *being led* into the desert somewhat against his will. The word *sedouaxat* (? mediæval for *seduxit*) may here well have this meaning of persuasive leading. It should also be noted that the child and his guide are already far on their way: they have left all vegetation behind them; only a stony rock and rough ground, with one or two tufts of grass and a leafless tree, are visible.

d. *He receives a cloak from an angel.*—This is also not biblical. The words above the mosaic are—

HC ANGELUS REPRESENTAT VESTE BTO IOHI

“ Hic angelus representat vestem be to Johanni.”

“ Here the angel gives (back ?) a garment to the blessed John.”

John wears his cloak of camel's hair, and holds in one
 MT hand a scroll, on which is written an abbreviation
 NO of the Greek "μετανοείτε"—"Repent ye."
 ΔT
 E

e. He preaches to the people.

HIC PREDICAT.¹

"Here he preaches" [or "predicts the Christ"].

The Baptist is gaunt and thin; he wears his garment of camel's hair, and has in his hand a staff with a cross at the top of it. He stands in a sort of pulpit, behind which is a building, presumably a church; whilst in front of him listen three old men, a woman, and a child. Below are three more women.

f. He answers the Pharisees (on the wall opposite e).—

To the right are the priests and Levites sent from Jerusalem, asking, "What says he of himself?" They are four in number, a Rabbi and three Pharisees. To the left is St. John with two disciples behind him. Between them rolls the Jordan, at the ferry to which (Bethabara) the discussion between the Baptist and the Jews took place, and across the river the Rabbi asks:

QVOM . ERGO . BAPT
 ZAS . SI NQE . XPS . NE
 Q̄ . HELLA.,. NEQ' PHA

"Quomodo ergo baptizas si neque Christus, neque Elia, neque Propheta?"²

"Why baptizest thou, then, if thou be not that Christ, nor Elias, neither that prophet?" (John i. 25).

St. John does not, however, give the answer recorded of him in the Gospel, but another written above his head thus:—

¹ The mark of abbreviation over the C shows the omission of an h in the mediæval "predichat."

² The Vulgate has "Quid ergo baptizas si tu non es," etc.

✠ EGO BAPTIZO IÑO
MIE PATRIS
ET . FILII . 7. SP'
SCI

"Ego baptizo in nomine patris et filii & Spiritus sancti."

"I baptize in the name of the Father, and Son, and Holy Spirit."

g. He baptizes Christ.

HICE BAPTISMV' XPI

On the left is a tree with an axe laid to its root. In the centre stands St. John, with his hand on the head of Christ, who stands in the midst of the river. Three angels look down from the right bank into the water; and in it are five fishes, over one of which Christ's hand is raised in blessing. Below is a child with a golden vase in one hand, probably the river god of the Jordan, who is sometimes introduced into these pictures. From above a ray of light, with a star and a dove in it, descends on the head of Christ: "And Jesus when he was baptized, went up straightway out of the water: and, lo, the heavens were opened unto him, and he saw the Spirit of God descending like a dove, and lighting upon him: and, lo, a voice from heaven, saying, This is my beloved Son, in whom I am well pleased" (Matt. iii. 16, 17).

h. His death is commanded by Herod (over the door into the main body of the church).

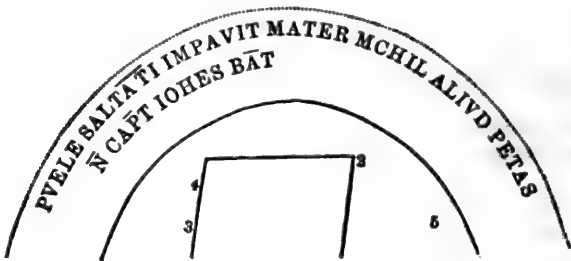

The mosaic is (according to the sacristan) entirely restored, and the letters of the legend appear to have been incorrectly treated. The words are "Puellæ saltanti imperavit mater

nihil (? nichil) aliud petas nisi caput Johannis Baptistæ"—
 "And as the girl danced her mother commanded her, saying,
 Ask for nothing else, but only for the head of John the Baptist."

Five figures are seen in the mosaic :—

1. Herod with his hands raised in horror and distress, exceeding sorry" (Mark vi. 26).
2. Herodias, pointing at him, with a smile of triumph.
3. Herodias' daughter dancing, with the charger on her head.
4. Another figure with regard to which see *ante*, p. 67, § 8, where it is suggested that the figure is St. John at a former time, saying to Herod, "It is not lawful for thee to have her." If this is not so, it may be that the figure represents the "lords, high captains, and chief estates of Galilee" (Mark vi. 21) who were at the feast.
5. A servant in attendance.

i. *He is beheaded.*

✠ DECHOLACIO SCI IOHIS BAT.

"The beheading of St. John the Baptist."

To the left is the headless body of St. John, still in prison. "And immediately the king sent an executioner (or 'one of his guard'), and he went and beheaded him in prison." The Baptist has leant forward, and his hands are stretched out, as if to save himself in falling. A Roman soldier is sheathing his sword, and looks somewhat disgusted at the daughter of Herodias as she carries the head to her mother, who sits enthroned near. (See *ante*, p. 69, § 10.)

j. *He is buried.*—"And when his disciples heard of it they came and took up his corpse and laid it in a tomb" (Mark vi. 29).

II. SEPELITVR . CO
 RPVS . S . IOHIS . BAT
 (See *ante*, p. 69, § 10.)

"Hic sepelitur corpus sancti Johannis Baptistæ"—"Here is being buried the body of St. John the Baptist."

The headless body of the Baptist is being laid in the grave by two disciples, whilst a third swings a censer over it.

II. THE INFANCY OF CHRIST.—Going back now to the west end of the chapel, we have four mosaics representing scenes in the infancy of Christ.

- | | | |
|---------------------------------|---|--|
| 1. The wise men before Herod. | } | Above <i>c</i> and <i>e</i> in the Life of St. John. |
| 2. The wise men adoring Christ. | | |
| 3. The flight into Egypt. | } | Opposite 1 and 2. |
| 4. The Holy Innocents. | | |

1. *The wise men before Herod.*

Herod is seated on his throne, attended by a Roman soldier; he looks puzzled and anxious. Before him are the three kings in attitudes of supplication; and above are the words—

✠ VBIE . QVINATU' . EST . REX . JUDÆORUM

“Ubi est qui natus est rex Judæorum?”
 “Where is he that is born king of the Jews?” } St. Matt. ii. 2.

2. *The wise men adoring Christ.*

✠ ADORABVT EV̄ ONS REGES TĒRE ET OMS GĒTES SER-
 VIENT EI

“Adorabunt eum omnes reges terræ, (et) omnes gentes servient ei.”

“Yea, all kings shall fall down before him; all nations shall serve him” (Psalm lxxii. 10, 11).

In the centre is the Madonna seated on a throne, which is also part of the stable of the inn. On her knees is the infant Christ, with two fingers of his right hand raised in benediction. The Madonna holds out her hand, as if showing the Child to the kings, who approach Him with gifts and in attitudes of devout worship. To the left is a man leading a camel out of a building; whilst to the right of the stable lies Joseph asleep, with an angel descending to him: “Arise and take the young child.” (See the next mosaic.) The rays from the central figure of the vaulted roof fall, one on the second of the three kings, and another, the most brilliant of them,—upon which, where it breaks into triple glory, the star of Bethlehem is set,—upon the Madonna and the Christ.

3. *The flight into Egypt.*

✠ SVRGE ET ACCIPE PUERVUM ET MATREM EU' ET FUGE
IN EGYPTUM . ET ESTO IBI USQ' DVM DICAM TIBI

“Surge et accipe puerum et matrem ejus et fuge in Egyptum et esto ibi usque dum dicam tibi.”

“Arise and take the young child and his mother, and flee into Egypt, and be there until I bring thee word” (St. Matt. ii. 13).

A youth carrying a gourd leads into a building with a mosque-like dome a white ass, on which is seated the Madonna, holding the infant Christ. Joseph walks behind, carrying a staff and cloak. The fact of the journey being sudden and hasty is shown by the very few things which the fugitives have taken with them—only a cloak and a gourd; they have left the presents of the three kings behind.

4. *The Holy Innocents.*

✠ TUNC . HERODE' VIDE' Q'MILVSV' EËT AMAGI' IRATV'E . RE,
DE. 7. MIT
TES OCCIDIT. OMS PUERO' QVI. ERANT . BETHLEEM QM. OIRUS
FINIBUS . EIVS.¹

“Tunc Herodes videns quoniam illusus esset a magis iratus est valde, et mittens occidit omnes pueros qui erant in Bethlehem et in omnibus finibus ejus.”

“Then Herod, when he saw that he was mocked of the wise men, was exceeding wroth, and sent forth, and slew all the children that were in Bethlehem, and in all the coasts thereof” (Matt. ii. 16).

Three Roman soldiers are killing the children, some of whom already lie dead and bleeding on the rocky ground. To the right is a mother with her child in her arms, and near her another woman is holding up her hands in grief.

III. ST. NICHOLAS.

Just below the mosaic of the Holy Innocents is one of S. NICOLAU'—St. Nicholas—with one hand raised in benedic-

¹ The letters underlined are unintelligible, as otherwise the legend follows the Vulgate. Possibly the words have been retouched, and the letters incorrectly restored.

tion whilst the other holds a book. He is here, close to the small door that opens on to the Piazzetta, the nearest to the sea of all the saints in St. Mark's, because he is the sea saint, the patron of all ports, and especially of Venice. He was, it is well known, with St. George and St. Mark, one of the three saints who saved Venice from the demon ship in the storm when St. Mark gave to the fishermen the famous ring.

There now remain for the traveller's examination the three vaults of the Baptistery, the arches leading from one division of the chapel to another, and the spandrils which support the font and altar domes. In the arch leading from the west end of the chapel to the front are the four evangelists; in that leading from the dome over the font to that over the altar are four saints, whilst in the spandrils of the two last-named domes are, over the font, the four Greek, and over the altar the four Latin fathers.

IV. THE FOUR EVANGELISTS.

S. LUCAS EŪG.

St. Luke is writing in a book, and has written a letter and a half, possibly QV, the first two letters of Quonium—"Forasmuch"—which is the opening word of his Gospel.

S. MARCVS EŪG.

St. Mark is sharpening his pencil, and has a pair of pincers on his desk.

S. IOHES EVG.

St. John is represented as very old,—alluding of course to his having written his Gospel late in life.

S. MATHEV' EVG.

St. Matthew is writing, and just dipping his pen in the ink.

V. FOUR SAINTS—*St. Anthony, St. Pietro Urseolo, St. Isidore, St. Theodore.*

a. *St. Anthony* (on the left at the bottom of the arch).

IL B EA
TO AN
TON IO
DI BR
E SA

“Il beato Antonio di Bresa.”

St. Anthony is the hermit saint. He stands here with clasped hands, and at his side is a skull, the sign of penitence. He wears, as in many other pictures of him, a monk's dress, in allusion to his being “the founder of ascetic monachism.” “His temptations” are well known.

b. *St. Pietro Urseolo* (above *St. Anthony*).

✠ BEA TUS
PETER V'VRSI
O DUXS
LO VENED

“Beatus Petrus Ursiolo dux s) Vened.”

“The blessed Pietro Urseolo, Doge of the Venetians.”

This Doge turned monk. Influenced by the teaching of the abbot Guarino, when he came to Venice from his convent in Guyenne, Pietro left his ducal palace one September night, fled from Venice, and shut himself up in the monastery of Cusano, where he remained for nineteen years, till his death in 997.

Here he is represented as a monk in a white robe, with a black cloak. He holds in his hand the Doge's cap, which he has doffed for ever, and as he looks upwards, there shines down on him a ray of light, in the centre of which is seen the Holy Dove.

c. *St. Isidore* (opposite the Doge).

S. ISIDORVS MARTIR (?)

This is *St. Isidore* of Chios, a martyr saint, who perished during the persecutions of the Christians by the Emperor Decius, A.D. 250. He appears to have been much worshipped at Venice, where he is buried. Here he is seen dressed as a warrior, and bearing a shield and a lily, the symbol of purity.¹

¹ See *Stones of Venice*, vol. ii. chap. viii § 127, and vol. iii. chap. ii. § 61. His body was brought to Venice with that of *St. Donato* in 1126 by the Doge Domenico Michiel. See *ante* p. 14.

d. St. Theodore. S. THEODOR. M.

He is with St. George, St. Demetrius, and St. Mercurius, one of the four Greek warrior saints of Christendom, besides being, of course, the patron saint of Venice. He is martyr as well as warrior, having fired the temple of Cybele, and perished in the flames, A.D. 300.

The four saints upon this arch thus represent two forms of Christian service; St. Anthony and the Doge being chosen as types of asceticism, and the other two as examples of actual martyrdom.

VI. THE FOUR GREEK FATHERS—*St. John Chrysostom, St. Gregory Nazianzenus, St. Basil the Great, and St. Athanasius* (on the spandrils of the central dome).

a. S. IOHES CRISOSTOMOS PATKA (patriarch). on the right of the door leading into the church.

He has no mitre, being one of the Greek Fathers, who are thus distinguished from the Latin Fathers, all of whom, except St. Jerome (the cardinal), wear mitres.

He bears a scroll—

✠ REG
NVM.I
NTRA
BIT.Q
VE.NON
S.PVR
VS ART
E.LAV
ABIT

“Regnum intrabit, quem non sit purus arte lavabit.”

“He shall enter the kingdom: who is not clean, him shall he thoroughly wash.”

b. S. GREGORIVS NAZIANZENUS (to the right of St. John Chrysostom). He is represented, as he usually is, as old and worn with fasting. On his scroll is written—

✠ QVO
DNA
TURA
TULI
T XPS
BAPTI
SMAT
ECV
RAT

“Quod natura tulit Christus baptismate curat.”

“What nature has brought, Christ by baptism cures.”

c. s. BASIL (to the right of his friend St. Gregory). St. Basil the Great, the founder of monachism in the East, began his life of devotion in early youth, and is here represented as a young man. The order of the Basilicans is still the only order in the Greek Church. His scroll has—

✠ UT SO
LE EST
PRIMUM
LUX)MU
RIRIDE
BATAIS
MUM

“Ut sole est primum lux” (as by the sun first we have light). The rest is unintelligible, except the last word, which suggests that the comparison is between the light of the sun and the spiritual light of baptism.

d. s. ATHANASIUS, old and white-haired. His scroll runs—

✠ UT UN
UM EST
NUM
EN SI
C SACR
NERE
OMU
ALV
MEN

“Ut unum est numen, sic sacro munere a lumen (? atque lumen).”

“As the Godhead is one, so also by God’s gift is light” (?)

VII. THE FOUR LATIN FATHERS—*St. Jerome, St. Ambrose, St. Augustine, and St. Gregory the Great* (on the spandrils of the altar dome).

The light here is very bad; and even after accustoming himself to it, the reader will hardly be able to do more than see that all four figures have books before them, in which they are writing, apparently in Greek characters. What they have written—in no case more than a few letters—is impossible to decipher from the floor of the chapel. St. Jerome wears his cardinal’s hat and robes, and St. Ambrose has his bee-hive near him, in allusion to the story that when in his cradle a swarm of bees once lighted on his lips and did not sting him.

The visitor has thus examined all the mosaics except those of the three domes. He must now, therefore, return from near the altar to the further end of the chapel, and take the first vaulting (for accurately this is not a dome) of that part of the roof.

VIII. CHRIST AND THE PROPHETS.

In the centre is Christ, surrounded by the prophets and patriarchs of the Old Testament, each of whom unfolds a scroll and displays on it a portion of his own prophecy.

Standing with his back to the altar, the visitor will thus see to the left of the Christ, Zephaniah and Elisha, and to his right Isaiah and Hosea.

1. ZEPHANIAH. SOPHONIAH PHA (propheta).

His scroll runs thus:—

EXPE
TA ME
IN DIE
RESU
RECT
IONIS
MEE
QUO
NIMA
IU

“Expecta me in die resurrectionis mee quoniam iudicium meum ut congregem gentes).”

See Zeph. iii. 8. This legend is shortened, and not quite accurately quoted, from the Vulgate. Our version is:—

“Wait ye upon me until the day that I rise up . . . for my determination is to gather the nations. . . .”

2. ELISHA.

ELISEAS PHA

Scroll:—PATER

MI PA
TER MI
CURBU'
ISRAEL
ETAU
RIGA
EIVS

“Pater mi, pater mi, currus Israel et auriga ejus.”

“My father, my father, the chariot of Israel and the horsemen thereof.”

2 Kings ii. 12.

3. ISALIAH

ISAIAS

PHA

Scroll:—ECCE V

IRGOc
CIPIET
ET PAR
IET FILI
UM ET V
OCABIT
UR NOM

“Ecce virgo concipiet et pariet filium et vocabitur nom (en ejus Emmanuel).”

“Behold a virgin shall conceive and bear a son, and shall call his name Immanuel.”¹

Isa. vii. 14.

¹ Isaiah is constantly represented with these words on his scroll, as, for example, on the roof of the Arena Chapel at Padua, and on the western porches of the cathedral of Verona.

4. HOSEA.

OSIA
PHA

Scroll:—VENIT

EET RE
VERTA
MURAD
DOMINŪ
QVIA
IPSE CE
PIT ET
SANA“Venit̄ et revertamur ad dominum
quia ipse cepit et sana (bit nos).”“Come and let us return unto the
Lord, for he has torn and he will heal
us.”

Hosea vi. 1.

Then turning around and facing the altar, we have, to the left of the Christ, Jeremiah and Elijah; to the right, Abraham and Joel.

5. JEREMIAH.

JEREMIAS
PHA

Scroll:—HIC EST

DEVS
NOSTER
ET NON
EXTIMA
BITUR
ALIVS“Hic est Deus noster et non extima-
bitur alius.”“This is our God, and none other
shall be feared.”

6. ELLIAH.

ELIA
PHA

Scroll:—DOMIN

ESICO
NUER
SUS
AVEN
IT PO
PVLVS
TV
VS“Domine si(c) conversus avenit pop-
ulus tuus.”“Lord, thus are thy people come
against thee.”

This is not biblical. It is noticeable that Elijah, unlike the other prophets, who look at the spectator, is turning to the Christ, whom he addresses.

7 ABRAHAM.

ABRAN
PHA.

Scroll:—VISITA

VIT DO
MINUS
SARAM
SICUT
PROMI
SERAT“Visitavit (autem) dominus Saram
sicut promiserat.”“The Lord visited Sarah as he had
said.”

Gen. xxi. 1.

8. JOEL.

JOEL

P̄HA

Scroll:—SUPER

SERVO(S)

MEOSET

SUPERA

NCILAS

ERUNEA

MDES

P̄VMEO

“Super servos meos et super ancillas
effundam de spiritu meo.”¹

“Upon my men servants and hand-
maids will I pour out (of) my spirit.”

Joel ii. 29.

Then, still facing the altar, there are on the wall to the right David and Solomon; on that to the left, above the Baptism of Christ, Obadiah and Jonah.

9. DAVID.

DAVID

P̄HA

Scroll:—FILIUS

MEV.E

STŪ.E

GO.H

ODIE

GEN

ULT

E

“Filius meus es tu, ego hodie genui
te.”

“Thou art my son, this day have I be-
gotten thee.”

Psalms ii. 7.

10. SOLOMON.

SALOMON

P̄HA

Scroll:—QVESI

VI.ILLV

M.ETNO

NINVEN

I.IUENE

RUT.IN

ME.VIGI

LE.QVI

CUTO

DIUT

CIUI

TA

TEM

“Quaesivi illum et non inveni-inven-
erunt in me vigiles qui custodiunt civi-
tatem.”

“I sought him, but I found him not.
The watchmen that go about the city
found (or ‘came upon’) me.”

Song of Solomon, iii. 2, 3.

¹The mosaic has apparently “erundam” for “effundam,” possibly a restorer’s error. The Vulgate has “spiritum neum,” for “de spiritu meo.”

11. OBADIAH.

Scroll:—ECCE
 PARV
 ULVM
 DEDI
 TTE
 INGE
 NTI
 BV
 8

ABDIAS
 P̄HA

“Ecce parvulum dedit te in gen-
 tibus.”

“Behold he has made thee small
 among the heathen.”

Obadiah 2.

(Vulgate has “dedi:” and so has
 our Bible “I have.”)

12. JONAH.

Scroll:—CLAMA
 VIADD
 OMINU
 MEEEX
 AUDI
 VITME
 DETR
 IBULA
 TIO
 MEA N̄

JONAS
 P̄HA

“Clamavi ad dominum et exaudivit
 me de tribulatione mea.”

“I cried by reason of my affliction
 to the Lord, and he heard me.”

Jonah ii. 2.

IX. CHRIST AND THE APOSTLES. (See *ante*, p. 67. § 8.)

Passing now to under the central dome, Christ is again seen enthroned in the midst, no longer, however, of the prophets, but of his own disciples. He is no longer the Messiah, but the risen Christ. He wears gold and red, the emblems of royalty; his right hand is raised in blessing; his left holds the resurrection banner and a scroll. The marks of the nails are visible in the hands and feet here only; they are not to be seen, of course, in the previous vaulting, nor are they in the third or altar dome where he sits enthroned triumphant as the Heavenly King.

Scroll:—EVNTES
 INMVDV
 UNIVES
 VM. PRE
 DICHAT
 EEVAN
 GELIV
 MOMIC
 REATU
 REQI
 CREDI
 DERI
 TEBA
 PTIS
 ATU

“Euntes in mundum universum
 prædicate evangelium omni creaturæ.
 Qui crediderit et baptizatu(s fuerit sal-
 vus erit).”

“Go ye into all the world, and
 preach the Gospel to every creature.
 He that believeth and is baptized shall
 be saved.”

St. Mark xvi. 15, 16.

Below, right round the dome, are the twelve Apostles, baptizing each in the country with which his ministry is actually or by tradition most associated. A list of them has been already given (*ante*, p. 67, § 8), with their countries, except that of St. Bartholomew, which is there noted as “indecipherable.” It is, however, legible as India.

Each Apostle is the centre of a similar group, consisting of the Apostle himself, his convert, in the moment of baptism, and a third figure whose position is doubtful. He may be awaiting baptism, already baptized, or merely an attendant: in the group of St. James the Less, he holds a towel; in that of St. Thomas, a cross; and in every case he wears the costume of the country where the baptism is taking place. Thus, to take the most striking instances, St. Philip's Phrygian has the red Phrygian cap; St. Peter's Roman is a Roman soldier; the Indians of St. Thomas and St. Bartholomew are (except for some slight variety of colour) both dressed alike, and wear turbans. Behind the figures is in each group a building, also characteristic architecturally of the given country. In two instances there is seen a tree growing out of this building, namely, in the case of Palestine and in that of Achaia; but whether or no with any special meaning or allusion may be doubtful.

The inscriptions are as follows (see *ante*, p. 67):

| | |
|-----------------------|---------------|
| SCS IOHES EVG BAPTIZA | I EFESO |
| S. IACOB MINOR | I JUDEA |
| S. PHVLIP | I FRIGIA |
| S. MATHEV' | I ETHIOPIA |
| S. SIMEON | I EGIPTV |
| S. TOMAS | IN INDIA |
| S. ANDRE | I ACHAIA |
| S. PETRV' | IN ROMA |
| S. BARTOLOMEV' | I INDIA |
| S. TADEV' | I MESOPOTAMIA |
| S. MATIAS | I PALESTIN |
| SCS MARCTS EVS | I ALESANDRIA |

In this list, most careful reference is made, as has been said, to the various traditions concerning the places of each Apostle's special ministry, the main tradition being always followed in cases of doubt. Thus St. John was bishop of Ephesus; St. James the Less bishop of Jerusalem, where he received St. Paul, and introduced him to the Church; St. Philip labored in Phrygia, and is said to have died at Hierapolis; St. Matthew chiefly in Ethiopia; St. Simeon in Egypt; and St. Thomas (though this may be by confusion with another Thomas) is said to have preached in India and founded the Church at Malabar, where his tomb is shown, and "Christians of St. Thomas" is still a name for the Church. So, again, St. Andrew preached in Achaia, and was there crucified at Patræ; the connection of St. Peter with Rome needs no comment; both Jerome and Eusebius assign India to St. Bartholomew; St. Thaddæus or Jude preached in Syria and Arabia, and died at Eddessa; the first fifteen years of the ministry of St. Matias were spent in Palestine; and lastly, St. Mark is reported to have been sent by St. Peter to Egypt, and there founded the Church at Alexandria.

X. CHRIST AND THE ANGELS.

We pass lastly to the altar-dome, already partly described in the "Requiem" chapter of this book (p. 68, § 9).

In the centre is Christ triumphant, enthroned on the stars, with the letters \overline{IC} \overline{XC} once more on either side of him. In

the circle with him are two angels, whose wings veil all but their faces ; round it are nine other angels, ruby-coloured for love, and bearing flaming torches. "He maketh his angels spirits, and his ministers a flaming fire."

Lower down round the dome are the "angels and arch-angels and all the company of heaven," who "laud and magnify His glorious name." These heavenly agencies are divided into three hierarchies, each of three choirs, and these nine choirs are given round this vault.

| | |
|----------------------|--------------------------------|
| Hierarchy I. . . . | Seraphim, Cherubim, Thrones. |
| Hierarchy II. . . . | Dominations, Virtues, Powers. |
| Hierarchy III. . . . | Princedom, Archangels, Angels. |

"The first three choirs receive their glory immediately from God, and transmit it to the second ; the second illuminate the third ; the third are placed in relation to the created universe and man. The first hierarchy are as councillors ; the second as governors ; the third as ministers. The Seraphim are absorbed in perpetual love and adoration immediately round the throne of God ; the Cherubim know and worship ; the Thrones sustain the seat of the Most High. The Dominations, Virtues, Powers, are the regents of the stars and elements. The last three orders—Princedom, Archangels, and Angels—are the protectors of the great monarchies on earth, and the executors of the will of God throughout the universe."¹

The visitor can see for himself how accurately this statement is borne out by the mosaics of the altar-dome. Immediately over the altar, and nearest therefore to the presence of God, is the Cherubim, "the Lord of those that know," with the words "fulness of knowledge," "*plenitudo scientiæ*," on his heart ; to the left is the Seraphim ; to the right the Thrones, "sustaining the seat of the Most High." Further to the right come the Dominations—an armed angel, holding in one hand a balance, in the other a spear. In one scale of the balance is a man, in the other the book of the law ; and this latter scale is being just snatched at by a winged demon, who, grovelling on the ground, turns round to meet the spear

¹ Mrs. Jameson's "Legendary Art," p. 45.

of the angel. Opposite the Dominations are the Princedoms or Principalities, another armed angel, wearing a helmet and calmly seated among the stars; and the Powers ("potestates") with a black devil chained at his feet. The Virtues come next, with a skeleton in a grave below, and at the back a pillar of fire; and, lastly, the Angels and Archangels, "the executors of the will of God throughout the universe," are seen nearest to the gospel-dome, standing above a rocky cave, in which are three figures. They appear to have various functions in the resurrection; the angel holds out a swathed man to the archangel, who holds a man (perhaps the same man), from whom the grave-clothes are falling. Between them they thus complete the resurrection of the dead.

It remains only for the visitor to observe, before leaving the chapel, the manner in which its different parts are related to each other. Upon the arch at the entrance to the gospel-dome are the Four Evangelists; on that which prefaces the altar-dome, with its display of heavenly triumph, are four saints "militant here on earth." But it is the domes themselves whose meaning is most evidently connected. In all, the same Figure is seen in the centre, surrounded in the first by the prophets of the Old Testament, in the second by the Apostles, in the third by the heavenly choirs, the three together thus proclaiming the promise, the ministry, and the triumph of the prophesied, crucified and glorified Christ.

SANCTUS, SANCTUS, SANCTUS,
 DOMINUS, DEUS, OMNIPOTENS,
 QUI ERAT, QUI EST, ET QUI VENTURUS EST.

Rev. iv. 8.

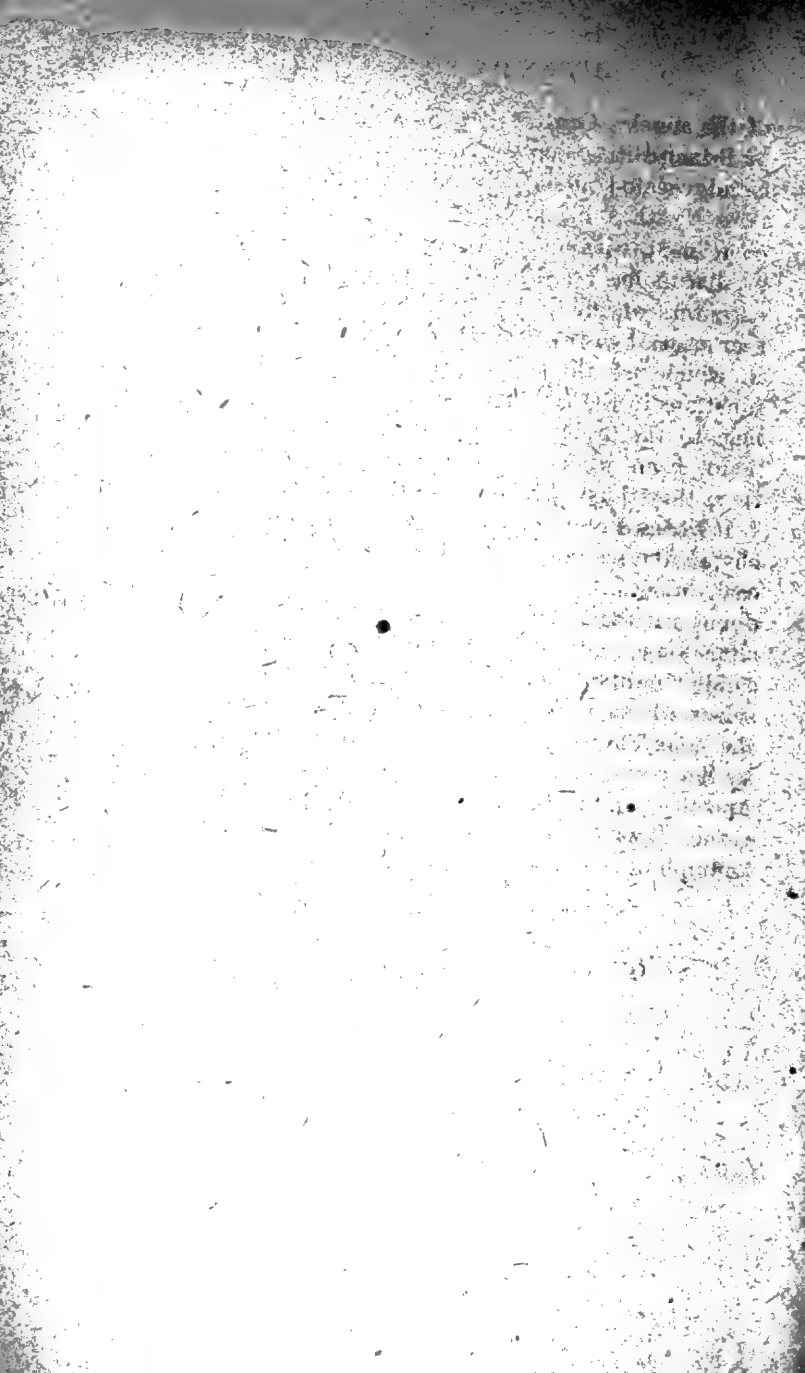

INDEX.

- Abraham, St. Mark's Baptistery, mosaic, 173.**
Adams' "Venice Past and Present," quoted, 20 n.
Adder coiled, symbolical of eternity, 144.
Age, feelings of old, 125.
Alexis, Emperor, and Venice, 56.
Altinum, Bishop of, founds early Venetian churches, 52.
Anderson, J. R., on Carpaccio, 1 S. pref. ; St. George, 1 S. 96 ; 2 S. 128 ; St. Jerome, 1 S. 104, seq.
Angelico, his religion sincere, pref., 3.
Angels, the hierarchies of, 68, 178 ; sculpture of, 39.
Animals, place of, in European Chivalry, 8 ; Venetian love of, 53.
Apostles, baptizing (St. Mark's Baptistery), 67 seq., 176 seq.
 " scenes of their ministry, 176.
Arabesques, of Carpaccio, 1 S., 99.
Architecture, an 'order' of, 15.
Art, great, combines grace and fitness, 15.
 " always instinctive, pref. 3
 " depends on national sympathy, pref. 3.
 " as material of history, pref. 4 seq.
 " the faithful witness, pref. 3.
Ascalon, not attacked by Venice, 10.
Ascension, mosaic of the, St. Mark's, 87.
Assisi, Giotto's chapel at, 1 S. 111.
Assyria, gods of, 83.
Athena, 70.
Athens and Ion, 61.
Author, the—
 diary quoted on Carpaccio's at Milan (Sept. 6, 1876), 1 S. 114.
 drawings of St. George's viper (1872), 1 S. 97.
 " of Carpaccio's parrot, 1 S., 98.
 " earliest, of St. Mark's, 62.
 errors of his early teaching, 43.
 feelings of, in advancing years, not disabled but enabled, 2 S. 125.
 knowledge of Greek myths, 62 n.
 plan for collecting records of St. Mark's, 87 n.
 protestantism of (see "religion").
 religion and early religious teaching, 21, 62-63.
 " its effect on his early work in Venice, 48.
 teaching of, not a discoverer, 2 S. 126, 127.
 " abhors doctrine for proof, system for usefulness, 2 S. 126.
 " a "true master," *ib.*

teaching his disciples not "Ruskinians," but free, 126.
books of, referred to—

Ariadne Florentina, p. (203) 70.

Examples of Venetian Architecture, 71.

Fors Clavigera, purchasable in Venice, 36 n.

" " iii. Feb. (on St. George), 36 n.

" " iv., p. 125 ('Punch'), 60 n.

" " vi. 110, 178-203 (on Psalm lxxvi.), 23.

" " vii. 75, gondolier and dog, 53.

" " vii. 68, on St. Theodore, 24.

Michael Angelo and Tintoret, pref. 4.

St. Mark's Rest, delay in issue of 2d Supplement, 2 S. 155 n.

" " scheme of and plans for, iv., 8 n.

" " sold in Venice, 36 n.

" " style of, pref. 3.

" " Supplement I., why issued, 1 S. pref. 91, 92.

Stones of Venice, errors of, and Author's Protestantism, 64.

" " quoted, 129, 147, 44 n.

" " republication of, planned, pref. 4.

" " "St. Mark's, description of, 62.

Baldwin, king of Jerusalem, 9.

Baptism of Christ (St. Mark's mosaic), 164.

Baptist, the, Life of (St. Mark's mosaic), 159.

Bari, William of, at siege of Tyre, 12.

Baruch's roll, pref. 3.

Basilicans, the only order of the Greek Church, 171.

Basilisk, Carpaccio's, 1 S. 98.

Bellini, Gentile, picture of Venice, 47.

Bellini, Gentile, picture of St. Mark's façade, 69, 70, 73.

Bellini Giovanni, vaults of, 69, 70.

" " Correr Museum (Transfiguration), 1 S. 120 n.

" " pictures by in the Frari, St. Zaccaria, 1 S. 117.

Bewick, 1 S. 117.

Bible quoted—

| | | | |
|---|----------|------------------------------|----------|
| Genesis xxi. | 173 | Zephaniah iii. 8. | 173 |
| Numbers xvi. 13. | 56 | St. Matthew ii. 2. | 166 |
| 2 Kings ii. 12. | 172 | " " ii. 16. | 167 |
| " " xxv. 7. | 55 | " " iii. 16, 17. | 165 |
| Proverbs iii. 17. | 1 S. 106 | " " v. 8-11. | 86 |
| " " vii. 5, 17. | 61 | " " x. 22. | 85 |
| Psalms ii. 7. | 174 | St. Mark vi. 21, 26. | 165 |
| " " xiv. 8. | 61 | " " xvi. 15, 16. | 176 |
| " " lxxii. 10, 11. | 166 | St. Luke i. 9, 11. | 160 |
| " " lxxvi. (Vulgate and Italian versions). | 7 | " " 21-22. | 160 |
| Song of Solomon iii. 2, 3. | 174 | " " 63. | ib. |
| Isaiah vii. 14. | 172 | " " 80. | 163 |
| " " xi. 8. | 84 | " " xiv. 33. | 1 S. 100 |
| " " xxiii. 2. | 32 | " " xix. 8. | 1 S. 101 |
| Jeremiah xvii. 9. | 49 | " " xix. 17. | 1 S. 103 |
| Ezekiel i. | 79 acq. | St. John i. 25. | 163 |
| " " xi. 16, 19, 22. | 80 | " " i. 29. | 159 |
| Hosea vi. 1. | 173 | " " xix. 26-27. | ib. |
| Joch ii. 29. | 174 | Romans v. 12. | 1 S. 106 |
| Obadiah 2. | 175 | Galatians ii. 20. | 84 |
| Jonah ii. 2. | 175 | 1 Thess. ii. 18. | 2 S. 153 |
| | | Rev. iv. 8. | 83, 170 |

- Birds, chased by Venetian boys, 54; legend of, and churches of Venice, 8.
- Bolton Abbey, 30.
- Bribery, 60.
- Brides of Venice, 1 S. 95.
- British Museum, Cotton MS., pref. 3.
- Buckle's civilization, 26.
- Byzantine art, mythical, 74.
- " " St. Mark's typical of, 65.
- Byzantium conquered by Venice, 65.
- Camerlenghi, treasurers of Venice, 26.
- Cape of Good Hope, discovery of, ruins Venice, 27.
- Capitals, laws of their treatment, 17, 19
- " of twelfth to fourteenth centuries, 17, 20.
- Cardinals, Carpaccio's satire on, 1 S. 118.
- Carlyle, Thomas, R.'s master, 1 S. 123.
- " " "Early Kings of Norway" quoted, 56 n.
- " Sterling, Life of, 1 S. 103; and of Werner, 103.
- Carpaccio: (1) General Characteristics of his Art, 1 S. 113; Its Characteristics, 115; (2) Details of his pictures; (3) Particular pictures.
- (1) *General Characteristics of his Art* :—
- composition of, 1 S. 99.
- details have important meanings with, 1. S. 107.
- and Luini, 1 S. 116.
- religion, as animating the present world, 1 S. 122 n.
- satire of, 1 S. 118, 121.
- sense of humour, and power of seriousness, 1 S. 102.
- simplicity, strength, and joy, 1 S. 96-97.
- study of, feelings requisite to the, 1 S. 113.
- symbolism, 1 S. 121.
- (2) *Details of his Pictures* :—
- arabesques (S. Tryphonius), i. S. 99.
- dogs, i. S. 99.
- parrot, i. S. 99.
- signatures of, lovely, i. S. 106.
- vaults of, 69, 70.
- (3) *Particular Pictures of* :—
- Agony in the Garden, i. S. 100.
- St. George and Dragon series, 24; 1 S. 98 seq., 108; 2 S. 138 seq.
- St. Jerome, 1 S. 104, 106, 108.
- St. Mary and Elizabeth (Correr Museum), 1 S. 119.
- St. Matthew, calling of (St. Giorgio dei Schiavoni), 1 S. 100.
- St. Stephen (Brera Gallery, Milan), 1 S. 114.
- St. Tryphonius (St. Giorgio dei Schiavoni), 1 S. 99.
- St. Ursula series (Accademia, Venice), 1 S. 119, 121.
- Venetian ladies and their pets (Correr Museum), in what sense the best existing picture, 1 S. 116.
- Virgin (Brera Gallery, Milan), 1 S. 114.
- youthful sketches by, St. Alvisè, i. S. 111.

- Carpets, Eastern, 1 S. 96.
 Catholicism, mediæval, as shown by Carpaccio, 1 S. 120.
 Ceilings painted, Venice, 1 S. 111.
 Cephalonia, taken by Venice, 1 S. 99.
 Cerberus, Dante's, 24.
 Charity, St Mark's mosaic, 85.
 Cheese, lessons in capital carving, by use of, 18 seq.
 Cherubim, the St. Mark's Baptistery, 66.
 Chivalry, places of animals in, 24.
 " of Venice and the West, A.D. 1100, 56.
 Chomley, Countess Isabel, legend translated by, 52 n.
 Christ and the Angels, St. Mark's Baptistery, 163.
 " and the Apostles, " " 67.
 " baptism of, " " 164.
 " infancy of, " " 166.
 " and the Prophets, " " 173.
 " modern lives of, 84.
 " "saves the *lost*," 1 S. 101.
 Christianity, development of, 50.
 Churches of Venice, legend of their foundation, 52.
 " " guide to points of compass in, 35 n.
 See 'Venice,' and under names of particular churches, 28.
 Churchyards, 53.
 Cimabue, 68.
 Classical learning and Venice, 46.
 Clermont-Ganneau on St. George, S. 127.
 Cockneyism, 9, 64, 86, 99.
 Coinage, leathern of Doge Domenico, Michiel, 8.
 Colour, Venetian feeling for, 58.
 Corner, Flaminio, on St. Giorgio dei Schiavoni, 1 S. 93.
 Correr Museum, woodcut maps of Venice (1480) in, 21.
 " " Carpaccio's "Venetian Ladies," 1 S. 117.
 Cotton MS., British Museum, pref. vi. 51.
 Creusa (Euripides' "Ion"), 62 n.
 Croiset's office of the B. V. M., 22.
 Crowe and Cavalcasella, 1 S. 105, 112, 113.
 Crucifixion, St. Mark's Baptistery, 98.
 Crusades, Venice and the, 44.
 Customs, blinding of deposed Doges, 55.
 " pillage of palace on election of Doge, 59 n.
 Cybele, temple of, 169.

 Dalmatia, attacked by Byzantium, 13.
 Damascus, and siege of Tyre, 12, 10.
 Dandolo, Doge Andrea, chronicle of, 11, 12, 65 n.
 " " legend of Venetian Churches, 51, 52.
 " " his tomb, St. Mark's Baptistery, 52 n.
 " Henry, 70; adorns church of St. James of the Rialto, 28.
 Dante's grasp of theology, 24.
 " Cerberus (Canto vi.), 24.
 Darwinism, 17, 1 S. 99.
 Dates, recollection of, 25, 43.
 David, piety and soldiership of, 60.

- David, mosaic of, St. Mark's Baptistery, 157.
 " " " , eastern dome, 74.
 Death, commonplace about blessedness of, 1 S. 106.
 Decoration, not 'a superficial merit,' 19.
 De-Hooghe, chiaroscuro of, 1 S. 117.
 Delphi, oracle of, pref. 4.
 Dogs, Carpaccio's, St. George's, 1 S. 99.
 " " St. Jerome's, 24, 1 S. 104.
 Doges, blinding of five deposed, 421-1100, 55.
 " election of (Doge Selvo), 58 seq.
 " See under Domenico Michiel St. Pietro Urseolo, Selvo.
 Doge's palace, pillage of, on election of Doge, 59, 60 n.
 Domenico, Michiel, Doge, 13.
 " " and conquest of Tyre, 8 seq.
 " " dismantles his ships 12 n.
 " " leathern coinage of 12.
 " " seizes Egean isles and Cephalonia, 13.
 " " closing years and death, 14.
 " " tomb of (San Giorgio Maggiore), 14.
 Doubt, religious feeling of, 50 seq.
 Dragon, Carpaccio's, 1 S. 101, 2 S. 132.
 Drapery, good and bad, 37.
 Ducal Palace, see 'Venice—Ducal Palace,' 16.
 Dumas, 1 S. 112.
 Dürer's engraving of St. Mark's Lion, 20.
 Durham Cathedral, 20.
- Edinburgh, Prince's street, asphalted, 31 n.
 Egean islands, seized by Venice, 13.
 Egypt, dragon of, 23, 26.
 " flight into, 167.
 Egypt, gods of, 121.
 " and siege of Tyre, 11, 12.
 Eliab, sons of, 55.
 Elijah, mosaic of, St. Mark's Baptistery, 173.
 Emerson referred to, 35.
 England, abbeys of, their quiet peace, 1 S. 96.
 " classical architecture of, 40.
 " commerce, 36, 64.
 " " and greed of money, 8.
 " religion of, 1200-1400, 50.
 Euripides' 'Ion' quoted, 61 n.
 Europe, course of history, 46.
 Evangelical doctrine of salvation, 1 S. 101.
 Evangelion and prophecy, 78.
 Evangelists, the, beasts of the, 83.
 " " (St. Mark's mosaics), 82, 164.
 " gospels of, 1 S. 100.
 " sculpture of (St. Mark's), 35.
 Executions, between Piazzetta pillars, 17.
 Eyes, putting out the, 55.
 Ezekiel's vision, 78.

- Faith and reason, 50.**
Fathers, the Greeks and Latin, 168 seq.
Fawn in Carpaccio's 'Virgin,' Brera, Milan, 1 S. 115.
Fishing in early Venice, 51.
Florence, sacred pictures of, 1 S. 122.
 " Spezieria of S. M. Novella, 61.
Forks, thought a luxury, 61.
'Fors' and the author, 54.
 " ordering of events by, S. 127.
Foscarini, on Doge Selvo's election, 59 n.
France, religion of, 1150-1350, 50.
- Gabriel, Archangel, St. Mark's bas-reliefs, 34.**
Geryon, 1 S. 97.
Gesta Dei, quoted, 10, 11 n.
Giotto's chapel at Assisi, 1 S. 111.
Giocondo, Fra, makes designs for Venice after 1513 fire, 28.
Giorgione's frescoes, 26 ; arrangement of masses, 1 S. 109.
Giustina, church to S., founded, 53.
Gordon, Rev. O., on Ps. lxxxvi., 23.
Goschen, Mr., 1 S. 101.
Gothic, foliage, origin of Venetian, 43.
Greek acanthus, 71.
 " art, but one school of, 65.
 " " its aim, first instruction, then beauty, 66.
 " capitals, 18.
 " harpy, 68.
 " myths (Euripides and Pindar), 61 n.
 " temple of the Dew, 60.
 " Thronos on St. Mark's, 35.
 " work on St. Mark's, 42, 43, 61, 65.
- Guiscard, and Doge Selvo, 57 seq.**
 " " the soldier par excellence of the Middle Ages," 60.
- Gunpowder, 51.**
- Heraclea, Venetian villas at, 51.**
Hercules, 42 ; labours of, St. Mark's bas-relief, 33.
Herod and St. John Baptist, 67, 165 ; and the wise men, 166.
Herodias, type of evil womanhood, 69.
Historians, sectarianism of, 48.
History, the course of European, 46.
 " transitional period of, 32.
 " the materials of, a nation's acts, words, and art, pref. p. 4.
 " how to read, 50.
- Holbein's jewel-painting, 1 S. 118.**
Horses of St. Mark, 69, 70.
Hunt, William, 31.
- Idleness, evils of, 51.**
Infidelity, signs of, in art, 38.
 " modern, 50.
- Innocents, Holy (St. Mark's Mosaics), 168.**
Inscription on St. James di Rialto, 27.

- Inscription on St. Mark's mosaics, 84.
 " " Baptistry, 157-179 *passim*.
 Inscription on tomb of Doge Domenico Michiel, 14.
 Inspiration and the Church, 1 S. 121.
 Ion and Athens, 65.
 Irish decoration, 71.
 " savagery, 56.
 Italian revolution and Venice, 13.
- Jameson, Mrs. 'Legendary Art,' quoted, 178.
 Jeremiah, St. Mark's Baptistry, 173.
 Jerusalem, Holy Sepulchre, arches of the, 71.
 " Baldwin, king of, at Venice, 8.
 Johnson, Dr., penance of, 64
 Jones, E Burne, helps R. *re* St. Mark's mosaics, 87.
 Jordan, river god of the, 164.
- Kensington schools, 1 S. 99.
 Knight, a, of the 15th century, 37.
- Landseer, Sir E., 7.
 Latrator Anubis, 15 *seq.*; meaning of, 22.
 Legenda Aurea, the, on St. George, 2 S. 149.
 Legend of foundation of Venetian churches, 52.
 Leucothea, 54.
 Lindsay, Lord, 'Christian Art' of, 63.
 Lion, St. Jerome's, 24.
 " St. Mark's, Venice (see St. Mark's).
 London, fire of, 7; the Monument, 8; Nelson column, 8.
 Longhena's tomb of Doge Dom. Michiel, 14.
 Lord's Prayer, the, and mediæval chivalry, 49.
 Lorenzi, M., helps R., 59 n.
 Lotteries in old and new Venice, 17 n.
 Luini and Carpaccio, 1 S. 114, 115, 116.
 Luxury, mediæval, how symbolized, 1 S. 118.
 " of Venice, and her fate, 44.
 Lydda, church of St. George at, 2 S. 132.
- Madonna on St. James di Rialto, 28, 29.
 Mantegna's "Transfiguration," Correr Museum, 1 S. 119.
 " St. Sebastian, 1 S. 121.
 Mariogola, of St. Theodore, 21, 24.
 Mazorbo, 54.
 Memnon, 35.
 Merlin, 60.
 M. Angelo, *pref.* 4.
 Milan, Monasterio Maggiore, Luini's St. Stephen, 1 S. 114.
 Milan, Brera Gallery, Carpaccio's in, 1 S. 114.
 Modesty, St. Mark's mosaic, 95.
 Monasticism, as explained by Carpaccio's St. Jerome, 1 S. 86, 105, 106.
 Mosaics, of St. Mark's (see under "Venice—St. Mark's"), 157.
 Muratori's edition of Sanuto, 8 n.
 Murray, C. F., 1 S. 102, 1 S. 115, 1 S. 119.

- Murray, John, Guide to Venice, on Piazzetta pillars, 7.
 " " " St. James di Rialto, 29, 30.
 " " " St. Mark's Lion, 78.
 " " Sketches of Venetian History, 8.

Napoleon I., 8.

Natalis Regia, rebuilds St. James di Rialto, 1531, 29.

Nelson column, 8.

Nicholas of the-Barterers, sets up Piazzetta pillars, 17.

Norman architecture, savagery of, 18.

Northumbrian architecture, clumsy work in, 18.

Oath of Venetian magistrates at Tyre, 13.

Olaf, blinds King Rærik, 56 n.

Oxford schools, author's drawings at, 1 S. 96, 97.

Pall Mall, 51.

Palladio, 14.

Palm trees, in Carpaccio's St. George, meaning of, 2 S. 148.

Paris, Vendôme column, 7.

Parliament, English, party politics, 8.

Parrot, Carpaccio's, 1 S. 97.

Parthenon bas-reliefs, 35.

Perfumes, use of, 61; manufacture of by Florentine monks, *ib.*

Perseus and St. George, 2 S. 133.

Persia and St. George, 2 S. 124.

Perugia, canopy at, 69.

Perugino, 1 S. 102.

Petroleum, 50.

Piazzetta pillars (see under "Venice—Piazzetta pillars"), 7.

Pindar, and Greek myths, 61 n.

Political Economy, 50.

Practice with fingers teaches eyes, 18.

Prayer Book, quoted, 83.

Printing, discovery of, 50; and Venice, 41.

Progress, modern, in Venice, 30; and inventions, 46.

Prophets, mosaics of, St. Mark's altar-dome, 81; baptistery, 168.

Proportion and propriety, distinct, 15.

Protestantism, 'private judgment,' 21, 22, 62, 63, 1 S. 103, 120.

'Punch,' on Bishop Wilberforce, 60; March 15, 1879, 64.

Purple, Byzantine, 82.

Rahab, meaning of in Ps. lxxxvi., 23.

Raphael, teaching of in art, 39 (see "S. Raphael").

Reason and Faith, 50.

'Red and White Clouds,' chap. vi.

Religion, of early Christian chivalry, 49.

" and doubt, 47 seq.

" stage between faith and reason, 50.

" of Venice, 40 seq.; the keynote (with art) of her history, 41.

Renaissance, and revival of learning, 42.

Restoration, evil of, illustrated, 70.

Rialto, meaning of, 30, 31.

- Rivers, named from colour or clearness, rarely from depth, 30.
 Roman Empire and Venice, 43.
 Romanin, 5 n. 13 ; on Rialto, 30, 31 ; on Selvo's election, 59 n.
 Rosamond and her father's skull, 50.
 Rubens, 1 S. 104.
 Ruskin, Mr. *See* "Author."
- Sabra and St. George, 37.
 " her symbolical meaning, 2 S. 151.
- Saint Alvise, Venice, ceiling of, 1 S. 111.
 " Ambrose, St. Mark's Baptistery, 171.
 " Anthony " " 168.
 " Athanasius " " 170.
 " Augustine " " 171.
 " Basil " " 171.
 " Cuthbert's book, pref. 3.
 " Demetrius, St. Mark's bas-relief, 42 ; warrior saint, 170.
 " Donato's body brought to Venice, 14.
 " Francis and the birds, 54.
 " Gabriel, St. Mark's bas-relief, 42.
 " George, his function and meaning, 21, 170 ; 2 S. 138.
 " " history of, 2 S. 126 seq.
 " " and the princess, legend quoted, 2 S. 150.
 " " connection with Perseus, and Persia, 2 S. 134.
 " " horse of, its colour, by Carpaccio and Tintoret, 2 S. 138.
 " " pictures of, Carpaccio's, 23, 1 S. 96 seq., 97.
 " " Porphyrio, " Bird of Chastity," 24.
 " " sculptures of, in Venice, 33, 35, 37, 38, 42.
 " " "sheathing his sword," 35.
 " " shield of, burnished, 2 S. 12.
 " George's Museum, Sheffield, casts of St. Mark's, 70.
 " Giorgio dei Schiavoni (*see* "Carpaccio," and "Venice").
 " ——— Maggiore, 8.
 " Giovanni in Bragola, church to, founded, 57.
 " ——— e Paolo, tombs in church of, 14.
 " Giustina, church to, founded, 53.
 " Gregory the Great, St. Mark's Baptistery, 171.
 " ——— Nazianzen " " 170.
 " Isidore's body brought to Venice, 14.
 " " (St. Mark's mosaic), 158 and n.
 " James di Rialto, history of, 26 seq., chap. iii.
 " " inscription on, 28, 87.
 " " " discovered by author, 76.
 " " interior of, 28.
 " Jerome, no good biography of, 1 S. 104.
 " " Carpaccio's pictures of, 1 S. 101 seq. (lion) ; 106 (burial) ;
 107 (in Heaven).
 " " his lion and dog, 24.
 " " mosaic of St. Mark's Baptistery, 170.
 " " teaching of, 22 ; 1 S. 104.
 " John Chrysostom (mosaic), 170.
 " Louis' part of Venice, 1 S. 111.
 " Maria Formosa, church to, founded, 52.

- Saint Mark, recovery of his body (mosaic of), 76.
- “ Mark’s church, etc., Venice (see “Venice, St. Mark’s”).
 - “ Matthew, calling of, 1 S. 100; gospel of, 1 S. 100.
 - “ Mercury, 122.
 - “ Nicholas of the Lido, 57; mosaic of, 167.
 - “ Pietro Urseolo, Doge, 169.
 - “ Raphael, church of, founded, 52.
 - “ Stephen, Carpaccio’s, Brera, Milan, 1 S. 114.
 - “ Theodore, 7.
 - “ “ his body at Venice, 1450, 24.
 - “ “ “the chair seller,” 33, iv.; meaning of, 42.
 - “ “ church to, on site of St. Mark’s, 83.
 - “ “ mosaic of, St. Mark’s, 170.
 - “ “ patron of Venice, 21.
 - “ “ statue of, Piazzetta pillar, 15.
 - “ “ “ St. Salvador, 39.
 - “ “ his teaching, 21, 24.
 - “ Tryphonius and the Basilisk, Carpaccio’s, 1 S. 99; 2 S. 120.
 - “ Zaccaria, church of, founded, 52.
- Salt-works of early Venice, 51.
- Samplers, English, 1 S. 96.
- Samson and Delilah, 61.
- ‘Sanctus, Sanctus, Sanctus,’ 157, 179.
- Sand, George, 1 S. 103, 112.
- Sansovino, on election of Doge Selvo, 58.
- “ rebuilds at Venice, 1513, 27.
- Sanuto, Marin, 2-5.
- Scarpagnino rebuilds at Venice, 1513, 27.
- Scepticism, modern, 79.
- Science, modern, its effect on belief, 48-51.
- Sclavonians and Venice, 1 S. 95.
- Scott, Sir. W., “Fortunes of Nigel,” its moral, 17 n.
- “ “Talisman,” its errors, 65.
- Sculpture above Ponte dei Baratteri, 36.
- “ rise and fall of Venetian, chap. iv., 37.
- Selvo, Doge, history of, 56 seq. (see St. George, sculpture of).
- “ mosaics of St. Mark’s, 78.
 - “ rebuilds St. James di Rialto, 1073, 28.
 - “ wife of, Greek, 60.
- ‘Shadow on the Dial,’ the, chap. 5.
- Shatts and capitals, relations of, 15.
- Shakspere, Hamlet, 48.
- “ King Lear, blinding of Gloster in, 55.
 - “ Merchant of Venice (Shylock), 25.
 - “ Midsummer Night’s Dream, ‘If I should as lion,’ 1 S. 102.
 - “ Much Ado about Nothing (Dogberry), 36.
 - “ Romeo and Juliet, ‘Ask for him to-morrow,’ 1 S. 102.
- Sheffield, author’s plans for, 11.
- Shells, in Carpaccio’s ‘St. George,’ 2 S. 145.
- Ships, dismantling of Venetian, 12.
- Skull, in Carpaccio’s ‘St. George,’ 2 S. 148.
- Smoke pestilence, modern, 54.
- Snyders, 1 S. 104.

- Solomon, love of fine things, 60.
 " St. Mark's mosaics, 82, 174.
 " Queen of Sheba and, Carpaccio's, 35, 1 S. 116.
- Sorrow, feeling under, 47 seq.
- Spirals, Greek and Northern, 71.
- Spoon, story of child's love for a wooden, 76.
- Symbolism, growth of, in art, 37, 38.
- Tempera, use of, 1 S. 117 ; by Carpaccio and Tintoret, *ib.*
- Temptation, the, mosaic of, St. Mark's, 75.
- Thrones, of the world, 38.
- Theories of belief, 47, 48 seq.
- Tiepolo's ceiling, St. Alvise, 1 S. 111.
- Tintoret, 'mightiest of the Venetians,' pref. 4.
 " death of, and fall of Venice (1594), 44.
 " 'rushing force' of, 1 S. 102.
 " studied Carpaccio, 2 S. 129.
 " tempera used by, and R.'s praise of, 1 S. 117.
- Titian, color of, 1 S. 117.
 " frescoes of, 26.
 " religion of, assumed, pref. 3.
- Trade, modern, 50.
- Trades of Venice, St. Mark's mosaics, 74.
- Tree, removal of, from before Accademia, Venice (Feb., 1877), 31.
- Turner, could not beat Carpaccio's paroquet, 1 S. 119.
- Tyre, burden of, chap. i.
 " siege of, chap. i., p. 7, 10-12 ; surrender of, 12.
 " oath of Venetian magistrates at, 13.
- Upholstery, modern, 1 S. 112.
- Van Eyck, detail of, 1 S. 117.
- Venice : (1) Her Character and Art ; (2) Her History ; (3) Architecture, Painting, and Sculpture ; (4) Modern Venice.
- (1) *Her Character and her Art* :—
- Her ambition, its objects, 7, 10.
 " aristocracy, its growth, 46.
 " art, the best material for her history, pref. 4.
 " " its growth shown, 34 seq., 39, 41, 75 ; recapitulated, 42
 aspect of early, 63.
 change from Eastern to Western temper, 20.
 character, love of home, of animals, of colour, 53 seq.
 chivalry learnt from Normans, 43, 45.
 Christianity of, learnt from Greeks, 43.
 commerce, 24, 26.
 council, in deciding on war, 9.
 deliberateness of action, 56.
 doges, treatment of deposed, 55-8.
 fall of, 44, 46 ; and gambling, 17.
 intellectual death of, 41.
 modern debasement, 42.
 home life of early, 53.

Venice (*continued*)—

people of, mosaic of doge and, 77.
 piety and covetousness of, 8.
 religion of, 1300–1500, chap. v., 43 seq.; 1 S. prof.
 relics, at last despised by, 27.
 revival of learning and, 46.
 Rome's influence on, 46.
 understand, how to, 21–49.

(2) *Her History* :—

progressive, but its periods distinct, 32.
 four periods of, (a) formation, 421–1100, 43.
 (b) establishment, 1100–1301, 43–44.
 (c) meditation, 1301–1520, 44.
 (d) luxury and fall, 1520–1600.

tells her own story, 33.
 errors of her historians, 32.
 religion and arts, its keynotes, 44.
 alliance with Alexis against Guiscard, 57.
 conquers Byzantium, 13.
 colonies in Asia, 13.
 fire of 1513, 27.
 founded, 421, 25.
 war with Guiscard, 57 seq.
 mercenary army, 27.
 war with Saracens, 9 seq., 10.
 Serrar del Consiglio (period ii.), 44–47.
 conquers Tyre, 12.

(3) *Architecture, Painting, and Sculpture of* :—

Academy, Carpaccio's St. Ursula, 1 S. 119.
 Camerlenghi Palace, 26.
 Ducal Palace built, 45.
 ——— pillars of arcade baseless, and why, 15, 16.
 ——— capitals of upper arcade, 16.
 Foscari Palace, sunset, 31.
 Gobbo di Rialto, 28 n.
 Grand Canal at sunset, 31.
 Jean d'Acre pillars, 71.
 Labia, palace, 40.
 Merceria, 26–36,
 Piazzetta, pillars of the, 7.
 “ “ the most beautiful in the world, 7 ; and why, 15.
 “ “ capitals and bases of, 16, 17 (history of not
 known).
 “ “ date of (12th century), 18.
 “ “ famous and why, 7 seq.
 “ “ history of, 15, 17.
 “ “ match each other, and how, 16.
 “ “ St. Theodore and St. Mark's Lion, on, 20, 21.
 “ “ space between, how used, 17.
 “ “ steps of restored, 16 n.

Venice (continued)—

- Ponte de' Barrateri, sculpture near the, 36.
 St. Alvise, ceiling of, 1 S. 111.
 St. Antonin, campo di, 1 S. 93.
 St. Bartholomew's Square, 26.
 St. Giorgio dei Schiavoni, 24.
 " " foundation of, 1, S. 94; S. 1.
 " " interior of, 1, S. 95, and see "Car
 paccio."
 ——— Maggiore, 8, 14, 15.
 St. James di Rialto, 42 seq.; history of, 27.
 St. John Eleemosynario, campanile, 28.
 St. Julian, 36.
 St. Louis' Quarter, 1 S. 111.
 St. Margaret's Campo, 31.
 St. Mark's Church, built, 45.
 " " baptistery of, 67 seq.; plan of, 160; mosaics,
 157 seq.
 " " campanile, lotteries beneath, 17 n.
 " " façade of, 34.
 " " " temp. Gentile Bellini, 69.
 " " horses of, 69.
 " " northwest corner of, sculpture of apostles, 35.
 " " porches of, bas-reliefs on, 42.
 " " tomb of Doge A. Dandolo, 52.
 " " mosaics of, 82.
 " " " designs of Veronese, 73.
 " " " collection of records of, 157.
 " " " central archivolt, bad, 71.
 " " " baptistery, 67 seq., 158.
 " " " " their connection and
 meaning, 179.
 " " " central dome, 74, 101.
 " " " east dome, 84.
 " " " north transept, 75.
 " " " south transept, 76.
 " " " sculptures, central archivolt, 70 seq.
 " " " of foliage, 70.
 " " " of sheep and lamb, northwest cor-
 ner, 38.
 " " " left of central arch, 34.

——— Lion, 78.

——— Place, nowadays, 59.

- St. Pantaleone, ceiling, 1 S. 112.
 St. Pietro Castello, cathedral church of Venice, 52.
 St. Raphael, church of, founded, 52.
 St. Salvatore, church of, founded, 52; piazza of, 39.

(4) *Modern Venice*:—

- church, and campo, 53.
 destruction of old by new, 26, pref. 6.
 dirt of, 26.
 hotels of, 26.

Venice (*continued*)—

- lighting of, 14.
- lotteries of, 17 and n.
- progress of, 59.
- restaurants of 10 n.
- sails of, 10 n.
- steamers in, 10.
- tree cut down before Academy (Feb. 26, 1877), 31.
- Veronese, P., designs some of St. Mark's mosaics, 75, 1 S. 98-103.
- “ mischief done by, 1 S. 111.
- Virgil, quoted, Aen., viii. 698, 23.
- Virgin, Carpaccio's Brera Gallery, Milan, 1 S. 114.
- “ St. Mark's bas-reliefs, 42.
- Virtues, on St. Mark's central dome mosaics, 96.
- “ and the seven gems, Carpaccio's St. George, 2 S. 150.
- “ Venetian, 95.
- Vivarini, 76.
- Wealth, evils of, 50.
- Wise men, the, 166.
- Wordsworth's 'White Doe of Rylstone,' 53.
- Zacharias, mosaic, St. Mark's, 161.
- Zara, siege of, 8.
- Zedekiah, blinding of, 56

LECTURES ON ART

DELIVERED BEFORE THE UNIVERSITY OF OXFORD IN
HILARY TERM, 1870



LECTURES ON ART.

LECTURE I.

INAUGURAL.

THE duty which is to-day laid on me, of introducing, among the elements of education appointed in this great University, one not only new, but such as to involve in its possible results some modification of the rest, is, as you well feel, so grave, that no man could undertake it without laying himself open to the imputation of a kind of insolence; and no man could undertake it rightly, without being in danger of having his hands shortened by dread of his task, and mistrust of himself.

And it has chanced to me, of late, to be so little acquainted either with pride, or hope, that I can scarcely recover so much as I now need of the one for strength, and of the other for foresight, except by remembering that noble persons, and friends of the high temper that judges most clearly where it loves best, have desired that this trust should be given me; and by resting also in the conviction that the goodly tree, whose roots, by God's help, we set in earth to-day, will not fail of its height because the planting of it is under poor auspices, or the first shoots of it enfeebled by ill gardening.

2. The munificence of the English gentleman to whom we owe the founding of this Professorship at once in our three great Universities, has accomplished the first great group of a series of changes now taking gradual effect in our system of public education; and which, as you well know, are the sign of a vital change in the national mind, respecting both the principles on which that education should be conducted, and

the ranks of society to which it should extend. For, whereas it was formerly thought that the discipline necessary to form the character of youth was best given in the study of abstract branches of literature and philosophy, it is now thought that the same, or a better, discipline may be given by informing men in early years of things it cannot but be of chief practical advantage to them afterwards to know ; and by permitting to them the choice of any field of study which they may feel to be best adapted to their personal dispositions. I have always used what poor influence I possessed in advancing this change ; nor can any one rejoice more than I in its practical results. But the completion—I will not venture to say, correction—of a system established by the highest wisdom of noble ancestors, cannot be too reverently undertaken : and it is necessary for the English people, who are sometimes violent in change in proportion to the reluctance with which they admit its necessity, to be now oftener than at other times reminded that the object of instruction here is not primarily attainment, but discipline ; and that a youth is sent to our Universities, not (hitherto at least) to be apprenticed to a trade, nor even always to be advanced in a profession ; but, always, to be made a gentleman and a scholar.

3. To be made these,—if there is in him the making of either. The populace of all civilized countries have lately been under a feverish impression that it is possible for all men to be both ; and that having once become, by passing through certain mechanical processes of instruction, gentle and learned, they are sure to attain in the sequel the consummate beatitude of being rich.

Rich, in the way and measure in which it is well for them to be so, they may, without doubt, *all* become. There is indeed a land of Havilah open to them, of which the wonderful sentence is literally true—‘The gold of *that* land is good.’ But they must first understand, that education, in its deepest sense, is not the equalizer, but the discerner, of men ; and that, so far from being instruments for the collection of riches, the first lesson of wisdom is to disdain them, and of gentleness, to diffuse.

It is not therefore, as far as we can judge, yet possible for all men to be gentlemen and scholars. Even under the best training some will remain too selfish to refuse wealth, and some too dull to desire leisure. But many more might be so than are now; nay, perhaps all men in England might one day be so, if England truly desired her supremacy among the nations to be in kindness and in learning. To which good end, it will indeed contribute that we add some practice of the lower arts to our scheme of University education; but the thing which is vitally necessary is, that we should extend the spirit of University education to the practice of the lower arts.

4. And, above all, it is needful that we do this by redeeming them from their present pain of self-contempt, and by giving them rest. It has been too long boasted as the pride of England, that out of a vast multitude of men confessed to be in evil case, it was possible for individuals, by strenuous effort, and singular good fortune, occasionally to emerge into the light, and look back with self-gratulatory scorn upon the occupations of their parents, and the circumstances of their infancy. Ought we not rather to aim at an ideal of national life, when, of the employments of Englishmen, though each shall be distinct, none shall be unhappy or ignoble; when mechanical operations acknowledged to be debasing in their tendency, shall be deputed to less fortunate and more covetous races; when advance from rank to rank, though possible to all men, may be rather shunned than desired by the best; and the chief object in the mind of every citizen may not be extrication from a condition admitted to be disgraceful, but fulfilment of a duty which shall be also a birthright?

5. And then, the training of all these distinct classes will not be by Universities of all knowledge, but by distinct schools of such knowledge as shall be most useful for every class: in which, first the principles of their special business may be perfectly taught, and whatever higher learning, and cultivation of the faculties for receiving and giving pleasure, may be properly joined with that labour, taught in connection with it. Thus, I do not despair of seeing a School of Agriculture, with its fully-endowed institutes of zoology, botany,

and chemistry ; and a School of Mercantile Seamanship, with its institutes of astronomy, meteorology, and natural history of the sea : and, to name only one of the finer, I do not say higher, arts, we shall, I hope, in a little time, have a perfect school of Metal-work, at the head of which will be, not the ironmasters, but the goldsmiths ; and therein, I believe, that artists, being taught how to deal wisely with the most precious of metals, will take into due government the uses of all others ; having in connection with their practical work splendid institutes of chemistry and mineralogy, and of ethical and imaginative literature.

And thus I confess myself more interested in the final issue of the change in our system of central education, which is to-day consummated by the admission of the manual arts into its scheme, than in any direct effect likely to result upon ourselves from the innovation. But I must not permit myself to fail in the estimate of my immediate duty, while I debate what that duty may hereafter become in the hands of others ; and I will therefore now, so far as I am able, lay before you a brief general view of the existing state of the arts in England, and of the influence which her Universities, through these newly-founded lectureships, may, I think, bring to bear upon it for good.

6. And first, we have to consider the impulse which has been given to the practice of all the arts of which the object is the production of beautiful things, by the extension of our commerce, and of the means of intercourse with foreign nations, by which we now become more familiarly acquainted with their works in past and in present times. The immediate result of this new knowledge has been, I regret to say, to make us more jealous of the genius of others, than conscious of the limitations of our own ; and to make us rather desire to enlarge our wealth by the sale of art, than to elevate our enjoyments by its acquisition.

Now, whatever efforts we make, with a true desire to produce, and possess, as themselves a constituent part of true wealth, things that are intrinsically beautiful, have in them at least one of the essential elements of success. But efforts

having origin only in the hope of enriching ourselves by the sale of our productions, are assuredly condemned to dishonourable failure ; not because, ultimately a well-trained nation may not profit by the exercise of its peculiar art-skill ; but because that peculiar art-skill can never be developed with a view to profit. The right fulfilment of national power in art depends always on the direction of its aim by the experience of ages. Self-knowledge is not less difficult, nor less necessary for the direction of its genius, to a people than to an individual, and it is neither to be acquired by the eagerness of unpractised pride, nor during the anxieties of improvident distress. No nation ever had, or will have, the power of suddenly developing, under the pressure of necessity, faculties it had neglected when it was at ease ; nor of teaching itself in poverty, the skill to produce, what it has never in opulence had the sense to admire.

7. Connected also with some of the worst parts of our social system, but capable of being directed to better result than this commercial endeavour, we see lately a most powerful impulse given to the production of costly works of art by the various causes which promote the sudden accumulation of wealth in the hands of private persons. We have thus a vast and new patronage, which, in its present agency, is injurious to our schools ; but which is nevertheless in a great degree earnest and conscientious, and far from being influenced chiefly by motives of ostentation. Most of our rich men would be glad to promote the true interests of art in this country ; and even those who buy for vanity, found their vanity on the possession of what they suppose to be best.

It is therefore in a great measure the fault of artists themselves if they suffer from this partly unintelligent, but thoroughly well-intended patronage. If they seek to attract it by eccentricity, to deceive it by superficial qualities, or take advantage of it by thoughtless and facile production, they necessarily degrade themselves and it together, and have no right to complain afterwards that it will not acknowledge better-grounded claims. But if every painter of real power would do only what he knew to be worthy of himself,

and refuse to be involved in the contention for undeserved or accidental success, there is indeed, whatever may have been thought or said to the contrary, true instinct enough in the public mind to follow such firm guidance. It is one of the facts which the experience of thirty years enables me to assert without qualification, that a really good picture is ultimately always approved and bought, unless it is wilfully rendered offensive to the public by faults which the artist has been either too proud to abandon, or too weak to correct.

8. The development of whatever is healthful and serviceable in the two modes of impulse which we have been considering, depends however, ultimately, on the direction taken by the true interest in art which has lately been aroused by the great and active genius of many of our living, or but lately lost, painters, sculptors, and architects. It may perhaps surprise, but I think it will please you to hear me, or (if you will forgive me, in my own Oxford, the presumption of fancying that some may recognize me by an old name) to hear the author of 'Modern Painters' say, that his chief error in earlier days was not in over-estimating, but in too slightly acknowledging the merit of living men. The great painter whose power, while he was yet among us, I was able to perceive, was the first to reprove me for my disregard of the skill of his fellow-artists; and, with this inauguration of the study of the art of all time,—a study which can only by true modesty end in wise admiration,—it is surely well that I connect the record of these words of his, spoken then too truly to myself, and true always more or less for all who are untrained in that toil,—'You don't know how difficult it is.'

You will not expect me, within the compass of this lecture, to give you any analysis of the many kinds of excellent art (in all the three great divisions) which the complex demands of modern life, and yet more varied instincts of modern genius, have developed for pleasure or service. It must be my endeavour, in conjunction with my colleagues in the other Universities, hereafter to enable you to appreciate these worthily; in the hope that also the members of the Royal Academy, and those of the Institute of British Architects, may

be induced to assist, and guide, the efforts of the Universities, by organizing such a system of art education for their own students as shall in future prevent the waste of genius in any mistaken endeavours; especially removing doubt as to the proper substance and use of materials; and requiring compliance with certain elementary principles of right, in every picture and design exhibited with their sanction. It is not indeed possible for talent so varied as that of English artists to be compelled into the formalities of a determined school; but it must certainly be the function of every academical body to see that their younger students are guarded from what must in every school be error; and that they are practised in the best methods of work hitherto known, before their ingenuity is directed to the invention of others.

9. I need scarcely refer, except for the sake of completeness in my statement, to one form of demand for art which is wholly unenlightened, and powerful only for evil;—namely, the demand of the classes occupied solely in the pursuit of pleasure, for objects and modes of art that can amuse indolence or satisfy sensibility. There is no need for any discussion of these requirements, or of their forms of influence, though they are very deadly at present in their operation on sculpture, and on jewellers' work. They cannot be checked by blame, nor guided by instruction; they are merely the necessary results of whatever defects exist in the temper and principles of a luxurious society; and it is only by moral changes, not by art-criticism, that their action can be modified.

10. Lastly, there is a continually increasing demand for popular art, multipliable by the printing-press, illustrative of daily events, of general literature, and of natural science. Admirable skill, and some of the best talent of modern times, are occupied in supplying this want; and there is no limit to the good which may be effected by rightly taking advantage of the powers we now possess of placing good and lovely art within the reach of the poorest classes. Much has been already accomplished; but great harm has been done also,—first, by forms of art definitely addressed to depraved tastes; and, secondly, in a more subtle way, by really beautiful and useful

engravings which are yet not good enough to retain their influence on the public mind ;—which weary it by redundant quantity of monotonous average excellence, and diminish or destroy its power of accurate attention to work of a higher order.

Especially this is to be regretted in the effect produced on the schools of line engraving, which had reached in England an executive skill of a kind before unexampled, and which of late have lost much of their more sterling and legitimate methods. Still, I have seen plates produced quite recently, more beautiful, I think, in some qualities than anything ever before attained by the burin : and I have not the slightest fear that photography, or any other adverse or competitive operation, will in the least ultimately diminish,—I believe they will, on the contrary, stimulate and exalt—the grand old powers of the wood and the steel.

11. Such are, I think, briefly the present conditions of art with which we have to deal ; and I conceive it to be the function of this Professorship, with respect to them, to establish both a practical and critical school of fine art for English gentlemen : practical, so that if they draw at all, they may draw rightly ; and critical, so that they may both be directed to such works of existing art as will best reward their study ; and enabled to make the exercise of their patronage of living artists delightful to themselves by their consciousness of its justice, and, to the utmost, beneficial to their country, by being given only to the men who deserve it ; and, to those, in the early period of their lives, when they both need it most, and can be influenced by it to the best advantage.

12. And especially with reference to this function of patronage, I believe myself justified in taking into account future probabilities as to the character and range of art in England ; and I shall endeavour at once to organize with you a system of study calculated to develop chiefly the knowledge of those branches in which the English schools have shown, and are likely to show, peculiar excellence. Now, in asking your sanction both for the nature of the general plans I wish to adopt, and for what I conceive to be necessary limitations of

them, I wish you to be fully aware of my reasons for both: and I will therefore risk the burdening of your patience while I state the directions of effort in which I think English artists are liable to failure, and those also in which past experience has shown they are secure of success.

13. I referred, but now, to the effort we are making to improve the designs of our manufactures. Within certain limits I believe this improvement may indeed take effect: so that we may no more humour momentary fashions by ugly results of chance instead of design; and may produce both good tissues, of harmonious colours, and good forms and substance of pottery and glass. But we shall never excel in decorative design. Such design is usually produced by people of great natural powers of mind, who have no variety of subjects to employ themselves on, no oppressive anxieties, and are in circumstances, either of natural scenery or of daily life, which cause pleasurable excitement. We cannot design because we have too much to think of, and we think of it too anxiously. It has long been observed how little real anxiety exists in the minds of the partly savage races which excel in decorative art; and we must not suppose that the temper of the middle ages was a troubled one, because every day brought its danger or its changes. The very eventfulness of the life rendered it careless, as generally is still the case with soldiers and sailors. Now, when there are great powers of thought, and little to think of, all the waste energy and fancy are thrown into the manual work, and you have as much intellect as would direct the affairs of a large mercantile concern for a day, spent all at once, quite unconsciously, in drawing an ingenious spiral.

Also, powers of doing fine oramental work are only to be reached by a perpetual discipline of the hand as well as of the fancy; discipline as attentive and painful as that which a juggler has to put himself through, to overcome the more palpable difficulties of his profession. The execution of the best artists is always a splendid tour-de-force, and much that in painting is supposed to be dependent on material is indeed only a lovely and quite inimitable legerdemain. Now, when

powers of fancy, stimulated by this triumphant precision of manual dexterity, descend uninterruptedly from generation to generation, you have at last, what is not so much a trained artist as a new species of animal, with whose instinctive gifts you have no chance of contending. And thus all our imitations of other people's work are futile. We must learn first to make honest English wares, and afterwards to decorate them as may please the then approving Graces.

14. Secondly—and this is an incapacity of a graver kind, yet having its own good in it also—we shall never be successful in the highest fields of ideal or theological art. For there is one strange, but quite essential, character in us: ever since the Conquest, if not earlier:—a delight in the forms of burlesque which are connected in some degree with the foulness in evil. I think the most perfect type of a true English mind in its best possible temper, is that of Chaucer; and you will find that, while it is for the most part full of thoughts of beauty, pure and wild like that of an April morning, there are even in the midst of this, sometimes momentarily jesting passages which stoop to play with evil—while the power of listening to and enjoying the jesting of entirely gross persons, whatever the feeling may be which permits it, afterwards degenerates into forms of humour which render some of quite the greatest, wisest, and most moral of English writers now almost useless for our youth. And yet you will find that whenever Englishmen are wholly without this instinct, their genius is comparatively weak and restricted.

15. Now, the first necessity for the doing of any great work in ideal art, is the looking upon all foulness with horror, as a contemptible though dreadful enemy. You may easily understand what I mean, by comparing the feelings with which Dante regards any form of obscenity or of base jest, with the temper in which the same things are regarded by Shakespeare. And this strange earthly instinct of ours, coupled as it is, in our good men, with great simplicity and common sense, renders them shrewd and perfect observers and delineators of actual nature, low or high; but precludes them from that specialty of art which is properly called sub-

lime. If ever we try anything in the manner of Michael Angelo or of Dante, we catch a fall, even in literature, as Milton in the battle of the angels, spoiled from Hesiod : while in art, every attempt in this style has hitherto been the sign either of the presumptuous egotism of persons who had never really learned to be workmen, or it has been connected with very tragic forms of the contemplation of death,—it has always been partly insane, and never once wholly successful.

But we need not feel any discomfort in these limitations of our capacity. We can do much that others cannot, and more than we have ever yet ourselves completely done. Our first great gift is in the portraiture of living people—a power already so accomplished in both Reynolds and Gainsborough, that nothing is left for future masters but to add the calm of perfect workmanship to their vigour and felicity of perception. And of what value a true school of portraiture may become in the future, when worthy men will desire only to be known, and others will not fear to know them for what they truly were, we cannot from any past records of art influence yet conceive. But in my next address it will be partly my endeavour to show you how much more useful, because more humble, the labour of great masters might have been, had they been content to bear record of the souls that were dwelling with them on earth, instead of striving to give a deceptive glory to those they dreamed of in heaven.

16. Secondly, we have an intense power of invention and expression in domestic drama ; (King Lear and Hamlet being essentially domestic in their strongest motives of interest). There is a tendency at this moment towards a noble development of our art in this direction, checked by many adverse conditions, which may be summed in one,—the insufficiency of generous civic or patriotic passion in the heart of the English people ; a fault which makes its domestic affections selfish, contracted, and, therefore, frivolous.

17. Thirdly, in connection with our simplicity, and good-humour, and partly with that very love of the grotesque which debases our ideal, we have a sympathy with the lower animals which is peculiarly our own ; and which, though it has already

found some exquisite expression in the works of Bewick and Landseer, is yet quite undeveloped. This sympathy, with the aid of our now authoritative science of physiology, and in association with our British love of adventure, will, I hope, enable us to give to the future inhabitants of the globe an almost perfect record of the present forms of animal life upon it, of which many are on the point of being extinguished.

Lastly, but not as the least important of our special powers, I have to note our skill in landscape, of which I will presently speak more particularly.

18. Such, I conceive, to be the directions in which, principally, we have the power to excel; and you must at once see how the consideration of them must modify the advisable methods of our art study. For if our professional painters were likely to produce pieces of art loftily ideal in their character, it would be desirable to form the taste of the students here by setting before them only the purest examples of Greek, and the mightiest of Italian, art. But I do not think you will yet find a single instance of a school directed exclusively to these higher branches of study in England, which has strongly, or even definitely, made impression on its younger scholars. While, therefore, I shall endeavour to point out clearly the characters to be looked for and admired in the great masters of imaginative design, I shall make no special effort to stimulate the imitation of them; and, above all things, I shall try to probe in you, and to prevent, the affectation into which it is easy to fall, even through modesty,—of either endeavouring to admire a grandeur with which we have no natural sympathy, or losing the pleasure we might take in the study of familiar things, by considering it a sign of refinement to look for what is of higher class, or rarer occurrence.

19. Again, if our artisans were likely to attain any distinguished skill in ornamental design, it would be incumbent upon me to make my class here accurately acquainted with the principles of earth and metal work, and to accustom them to take pleasure in conventional arrangements of colour and form. I hope, indeed, to do this, so far as to enable them to discern the real merit of many styles of art which are at pres-

ent neglected ; and, above all, to read the minds of semi-barbaric nations in the only language by which their feelings were capable of expression : and those members of my class whose temper inclines them to take pleasure in the interpretation of mythic symbols, will not probably be induced to quit the profound fields of investigation which early art examined carefully, will open to them, and which belong to it alone ; for this is a general law, that, supposing the intellect of the workman the same, the more imitatively complete his art, the less he will mean by it ; and the ruder the symbol, the deeper is his intention. Nevertheless, when I have once sufficiently pointed out the nature and value of this conventional work, and vindicated it from the contempt with which it is too generally regarded, I shall leave the student to his own pleasure in its pursuit ; and even, so far as I may, discourage all admiration founded on quaintness or peculiarity of style ; and repress any other modes of feeling which are likely to lead rather to fastidious collection of curiosities, than to the intelligent appreciation of work which, being executed in compliance with constant laws of right, cannot be singular, and must be distinguished only by excellence in what is always desirable.

20. While, therefore, in these and such other directions, I shall endeavour to put every adequate means of advance within reach of the members of my class, I shall use my own best energy to show them what is consummately beautiful and well done, by men who have past through the symbolic or suggestive stage of design, and have enabled themselves to comply, by truth of representation, with the strictest or most eager demands of accurate science, and of disciplined passion. I shall therefore direct your observation, during the greater part of the time you may spare to me, to what is indisputably best, both in painting and sculpture ; trusting that you will afterwards recognize the nascent and partial skill of former days both with greater interest and greater respect, when you know the full difficulty of what it attempted, and the complete range of what it foretold.

21. And with this view, I shall at once endeavour to do

what has for many years been in my thoughts, and now, with the advice and assistance of the curators of the University Galleries, I do not doubt may be accomplished here in Oxford, just where it will be pre-eminently useful—namely, to arrange an educational series of examples of excellent art, standards to which you may at once refer on any questionable point, and by the study of which you may gradually attain an instinctive sense of right, which will afterwards be liable to no serious error. Such a collection may be formed, both more perfectly, and more easily, than would commonly be supposed. For the real utility of the series will depend on its restricted extent,—on the severe exclusion of all second-rate, superfluous, or even attractively varied examples,—and on the confining the student's attention to a few types of what is insuperably good. More progress in power of judgment may be made in a limited time by the examination of one work, than by the review of many; and a certain degree of vitality is given to the impressiveness of every characteristic, by its being exhibited in clear contrast, and without repetition.

The greater number of the examples I shall choose will at first not be costly; many of them, only engravings of photographs: they shall be arranged so as to be easily accessible, and I will prepare a catalogue, pointing out my purpose in the selection of each. But in process of time, I have good hope that assistance will be given me by the English public in making the series here no less splendid than serviceable; and in placing minor collections, arranged on a similar principle, at the command also of the students in our public schools.

22. In the second place, I shall endeavour to prevail upon all the younger members of the University who wish to attend the art lectures, to give at least so much time to manual practice as may enable them to understand the nature and difficulty of executive skill. The time so spent will not be lost, even as regards their other studies at the University, for I will prepare the practical exercises in a double series, one illustrative of history, the other of natural science. And whether you are drawing a piece of Greek armour, or a hawk's beak, or a lion's paw, you will find that the mere necessity of

using the hand compels attention to circumstances which would otherwise have escaped notice, and fasten them in the memory without farther effort. But were it even otherwise, and this practical training did really involve some sacrifice of your time, I do not fear but that it will be justified to you by its felt results : and I think that general public feeling is also tending to the admission that accomplished education must include, not only full command of expression by language, but command of true musical sound by the voice, and of true form by the hand.

23. While I myself hold this professorship, I shall direct you in these exercises very definitely to natural history, and to landscape ; not only because in these two branches I am probably able to show you truths which might be despised by my successors ; but because I think the vital and joyful study of natural history quite the principal element requiring introduction, not only into University, but into national, education, from highest to lowest ; and I even will risk incurring your ridicule by confessing one of my fondest dreams, that I may succeed in making some of you English youths like better to look at a bird than to shoot it ; and even desire to make wild creatures tame, instead of tame creatures wild. And for the study of landscape, it is, I think, now calculated to be of use in deeper, if not more important modes, than that of natural science, for reasons which I will ask you to let me state at some length.

24. Observe first ;—no race of men which is entirely bred in wild country, far from cities, ever enjoys landscape. They may enjoy the beauty of animals, but scarcely even that : a true peasant cannot see the beauty of cattle ; but only the qualities expressive of their serviceableness. I waive discussion of this to-day ; permit my assertion of it, under my confident guarantee of future proof. Landscape can only be enjoyed by cultivated persons ; and it is only by music, literature, and painting, that cultivation can be given. Also, the faculties which are thus received are hereditary ; so that the child of an educated race has an innate instinct for beauty, derived from arts practiced hundreds of years before its birth. Now

farther note this, one of the loveliest things in human nature. In the children of noble races, trained by surrounding art, and at the same time in the practice of great deeds, there is an intense delight in the landscape of their country as *memorial*; a sense not taught to them, nor teachable to any others; but, in them, innate; and the seal and reward of persistence in great national life;—the obedience and the peace of ages having extended gradually the glory of the revered ancestors also to the ancestral land; until the Motherhood of the dust, the mystery of the Demeter from whose bosom we came, and to whose bosom we return, surrounds and inspires, everywhere, the local awe of field and fountain; the sacredness of landmark that none may remove, and of wave that none may pollute; while records of proud days, and of dear persons, make every rock monumental with ghostly inscription, and every path lovely with noble desolateness.

25. Now, however checked by lightness of temperament, the instinctive love of landscape in us has this deep root, which, in your minds, I will pray you to disencumber from whatever may oppress or mortify it, and to strive to feel with all the strength of your youth that a nation is only worthy of the soil and the scenes that it has inherited, when, by all its acts and arts, it is making them more lovely for its children.

And now, I trust, you will feel that it is not in mere yielding to my own fancies that I have chosen, for the first three subjects in your educational series, landscape scenes;—two in England, and one in France,—the association of these being not without purpose:—and for the fourth, Albert Dürer's dream of the Spirit of Labour. And of the landscape subjects, I must tell you this much. The first is an engraving only; the original drawing by Turner was destroyed by fire twenty years ago. For which loss I wish you to be sorry, and to remember, in connection with this first example, that whatever remains to us of possession in the arts is, compared to what we might have had if we had cared for them, just what that engraving is to the lost drawing. You will find also that its subject has meaning in it which will not be harmful to you. The second example is a real drawing by Turner, in the

same series, and very nearly of the same place; the two scenes are within a quarter of a mile of each other. It will show you the character of the work that was destroyed. It will show you, in process of time, much more; but chiefly, and this is my main reason for choosing both, it will be a permanent expression to you of what English landscape was once;—and must, if we are to remain a nation, be again.

I think it farther right to tell you, for otherwise you might hardly pay regard enough to work apparently so simple, that by a chance which is not altogether displeasing to me, this drawing, which it has become, for these reasons, necessary for me to give you, is—not indeed the best I have, (I have several as good, though none better)—but, of all I have, the one I had least mind to part with.

The third example is also a Turner drawing—a scene on the Loire—never engraved. It is an introduction to the series of the Loire, which you have already; it has in its present place a due concurrence with the expressional purpose of its companions; and though small, it is very precious, being a faultless, and, I believe, unsurpassable example of water-colour painting.

Chiefly, however, remember the object of these three first examples is to give you an index to your truest feelings about European, and especially about your native landscape, as it is pensive and historical; and so far as you yourselves make any effort at its representation, to give you a motive for fidelity in handwork more animating than any connected with mere success in the art itself.

26. With respect to actual methods of practice I will not incur the responsibility of determining them for you. We will take Lionardo's treatise on training for our first text-book; and I think you need not fear being misled by me if I ask you to do only what Lionardo bids, or what will be necessary to enable you to do his bidding. But you need not possess the book, nor read it through. I will translate the pieces to the authority of which I shall appeal; and, in process of time, by analysis of this fragmentary treatise, show you some characters not usually understood of the simplicity

as well as subtlety common to most great workmen of that age. Afterwards we will collect the instructions of other undisputed masters, till we have obtained a code of laws clearly resting on the consent of antiquity.

While, however, I thus in some measure limit for the present the methods of your practice, I shall endeavour to make the courses of my University lectures as wide in their range as my knowledge will permit. The range so conceded will be narrow enough ; but I believe that my proper function is not to acquaint you with the general history, but with the essential principles of art ; and with its history only when it has been both great and good, or where some special excellence of it requires examination of the causes to which it must be ascribed.

27. But if either our work, or our enquiries, are to be indeed successful in their own field, they must be connected with others of a sterner character. Now listen to me, if I have in these past details lost or burdened your attention ; for this is what I have chiefly to say to you. The art of any country is the exponent of its social and political virtues. I will show you that it is so in some detail, in the second of my subsequent course of lectures ; meantime accept this as one of the things, and the most important of all things, I can positively declare to you. The art, or general productive and formative energy, of any country, is an exact exponent of its ethical life. You can have noble art only from noble persons, associated under laws fitted to their time and circumstances. And the best skill that any teacher of art could spend here in your help, would not end in enabling you even so much as rightly to draw the water-lilies in the Cherwell (and though it did, the work when done would not be worth the lilies themselves) unless both he and you were seeking, as I trust we shall together seek, in the laws which regulate the finest industries, the clue to the laws which regulate *all* industries, and in better obedience to which we shall actually have henceforward to live, not merely in compliance with our own sense of what is right, but under the weight of quite literal necessity. For the trades by which the British people has believed it to be

the highest of destinies to maintain itself, cannot now long remain undisputed in its hands ; its unemployed poor are daily becoming more violently criminal ; and a searching distress in the middle classes, arising partly from their vanity in living always up to their incomes, and partly from their folly in imagining that they can subsist in idleness upon usury, will at last compel the sons and daughters of English families to acquaint themselves with the principles of providential economy ; and to learn that food can only be got out of the ground, and competence only secured by frugality ; and that although it is not possible for all to be occupied in the highest arts, nor for any, guiltlessly, to pass their days in a succession of pleasures, the most perfect mental culture possible to men is founded on their useful energies, and their best arts and brightest happiness are consistent, and consistent only, with their virtue.

28. This I repeat, gentlemen, will soon become manifest to those among us, and there are yet many, who are honest-hearted. And the future fate of England depends upon the position they then take, and on their courage in maintaining it.

There is a destiny now possible to us—the highest ever set before a nation to be accepted or refused. We are still un-degenerate in race ; a race mingled of the best northern blood. We are not yet dissolute in temper, but still have the firmness to govern, and the grace to obey. We have been taught a religion of pure mercy, which we must either now finally betray, or learn to defend by fulfilling. And we are rich in an inheritance of honour, bequeathed to us through a thousand years of noble history, which it should be our daily thirst to increase with splendid avarice, so that Englishmen, if it be a sin to covet honour, should be the most offending souls alive. Within the last few years we have had the laws of natural science opened to us with a rapidity which has been blinding by its brightness ; and means of transit and communication given to us, which have made but one kingdom of the habitable globe. One kingdom ;—but who is to be its king ? Is there to be no king in it, think you, and every man to do that which is right in his own eyes ? Or only

kings of terror, and the obscene empires of Mammon and Belial? Or will you, youths of England, make your country again a royal throne of kings; a sceptred isle, for all the world a source of light, a centre of peace; mistress of Learning and of the Arts;—faithful guardian of great memories in the midst of irreverent and ephemeral visions;—faithful servant of time-tried principles, under temptation from fond experiments and licentious desires; and, amidst the cruel and clamorous jealousies of the nations, worshipped in her strange valour, of goodwill towards men?

29. 'Vexilla regis prodeunt.' Yes, but of which king? There are the two oriflammes; which shall we plant on the farthest islands—the one that floats in heavenly fire, or that hangs heavy with foul tissue of terrestrial gold? There is indeed a course of beneficent glory open to us, such as never was yet offered to any poor group of mortal souls. But it must be—it *is* with us, now, 'Reign or Die.' And if it shall be said of this country, 'Fece per viltate, il gran rifiuto;' that refusal of the crown will be, of all yet recorded in history, the shamefullest and most untimely.

And this is what she must either do, or perish: she must found colonies as fast and as far as she is able, formed of her most energetic and worthiest men;—seizing every piece of fruitful waste ground she can set her foot on, and there teaching these her colonists that their chief virtue is to be fidelity to their country, and that their first aim is to be to advance the power of England by land and sea: and that, though they live on a distant plot of ground, they are no more to consider themselves therefore disfranchised from their native land than the sailors of her fleets do, because they float on distant waves. So that literally, these colonies must be fastened fleets, and every man of them must be under authority of captains and officers, whose better command is to be over fields and streets instead of ships of the line; and England, in these her motionless navies (or, in the true and mightiest sense, motionless churches, ruled by pilots on the Galilean lake of all the world) is to 'expect every man to do his duty;' recognising that duty is indeed possible no less in peace than

war ; and that if we can get men, for little pay, to cast themselves against cannon-mouths for love of England, we may find men also who will plough and sow for her, who will behave kindly and righteously for her, who will bring up their children to love her, and who will gladden themselves in the brightness of her glory, more than in all the light of tropic skies.

But that they may be able to do this, she must make her own majesty stainless ; she must give them thoughts of their home of which they can be proud. The England who is to be mistress of half the earth cannot remain herself a heap of cinders, trampled by contending and miserable crowds ; she must yet again become the England she was once, and in all beautiful ways more ; so happy, so secluded, and so pure, that in her sky—polluted by no unholy clouds—she may be able to spell rightly of every star that heaven doth show ; and in her fields, ordered and wide and fair, of every herb that sips the dew ; and under the green avenues of her enchanted garden, a sacred Circe, true Daughter of the Sun, she must guide the human arts, and gather the divine knowledge, of distant nations, transformed from savageness to manhood, and redeemed from despairing into Peace.

30. You think that an impossible ideal. Be it so ; refuse to accept it if you will ; but see that you form your own in its stead. All that I ask of you is to have a fixed purpose of some kind for your country and yourselves ; no matter how restricted, so that it be fixed and unselfish. I know what stout hearts are in you, to answer acknowledged need ; but it is the fatallest form of error in English youth to hide their best hardihood till it fades for lack of sunshine, and to act in disdain of purpose, till all purpose is vain. It is not by deliberate, but by careless selfishness ; not by compromise with evil, but by dull following of good, that the weight of national evil increases upon us daily. Break through at least this pretence of existence ; determine what you will be, and what you would win. You will not decide wrongly if you resolve to decide at all. Were even the choice between lawless pleasure and loyal suffering, you would not, I believe, choose basely.

But your trial is not so sharp. It is between drifting in confused wreck among the castaways of Fortune, who condemns to assured ruin those who know not either how to resist her, or obey ; between this, I say, and the taking your appointed part in the heroism of Rest ; the resolving to share in the victory which is to the weak rather than the strong ; and the binding yourselves by that law, which, thought on through lingering night and labouring day, makes a man's life to be as a tree planted by the water-side, that bringeth forth his fruit in his season ;—

'ET FOLIUM EJUS NON DEFLUET,
ET OMNIA, QUÆCUNQUE FACIET, PROSPERABUNTUR.'

LECTURE II.

THE RELATION OF ART TO RELIGION.

31. It was stated, and I trust partly with your acceptance, in my opening lecture, that the study on which we are about to enter cannot be rightly undertaken except in furtherance of the grave purposes of life with respect to which the rest of the scheme of your education here is designed. But you can scarcely have at once felt all that I intended in saying so ;—you cannot but be still partly under the impression that the so-called fine arts are merely modes of graceful recreation, and a new resource for your times of rest. Let me ask you, forthwith, so far as you can trust me, to change your thoughts in this matter. All the great arts have for their object either the support or exaltation of human life,—usually both ; and their dignity, and ultimately their very existence, depend on their being '*μετὰ λόγου ἀληθοῦς*,' that is to say, apprehending, with right reason, the nature of the materials they work with, of the things they relate or represent, and of the faculties to which they are addressed. And farther, they form one united system from which it is impossible to remove any part without harm to the rest. They are founded first in mastery, by

strength of *arm*, of the earth and sea, in agriculture and seamanship; then their inventive power begins, with the clay in the hand of the potter, whose art is the humblest, but truest type of the forming of the human body and spirit; and in the carpenter's work, which probably was the early employment of the Founder of our religion. And until men have perfectly learned the laws of art in clay and wood, they can consummately know no others. Nor is it without the strange significance which you will find in what at first seemed chance, in all noble histories, as soon as you can read them rightly,—that the statue of Athena Polias was of olive-wood, and that the Greek temple and Gothic spire are both merely the permanent representations of useful wooden structures. On these two first arts follow building in stone,—sculpture,—metal work,—and painting; every art being properly called 'fine' which demands the exercise of the full faculties of heart and intellect. For though the fine arts are not necessarily imitative or representative, for their essence is being 'περὶ γένεσιν'—occupied in the actual production of beautiful form or colour—still, the highest of them are appointed also to relate to us the utmost ascertainable truth respecting visible things and moral feelings: and this pursuit of fact is the vital element of the art power;—that in which alone it can develop itself to its utmost. And I will anticipate by an assertion which you will at present think too bold, but which I am willing that you should think so, in order that you may well remember it,—the highest thing that art can do is to set before you the true image of the presence of a noble human being. It has never done more than this, and it ought not to do less.

32. The great arts—forming thus one perfect scheme of human skill, of which it is not right to call one division more honourable, though it may be more subtle, than another—have had, and can have, but three principal directions of purpose:—first, that of enforcing the religion of men; secondly, that of perfecting their ethical state; thirdly, that of doing them material service.

33. I do not doubt but that you are surprised at my saying the arts can in their second function only be directed to

the perfecting of there ethical state, it being our usual impression that they are often destructive of morality. But it is impossible to direct fine art to an immoral end, except by giving it characters unconnected with its fineness, or by addressing it to persons who cannot perceive it to be fine. Whosoever recognises it is exalted by it. On the other hand, it has been commonly thought that art was a most fitting means for the enforcement of religious doctrines and emotions; whereas there is, as I must presently try to show you, room for grave doubt whether it has not in this function hitherto done evil rather than good.

34. In this and the two next following lectures, I shall endeavour therefore to show you the grave relations of human art, in these three functions, to human life. I can do this but roughly, as you may well suppose—since each of these subjects would require for its right treatment years instead of hours. Only, remember, I have already given years, not a few, to each of them; and what I try to tell you now will be only so much as is absolutely necessary to set our work on a clear foundation. You may not, at present, see the necessity for *any* foundation, and may think that I ought to put pencil and paper in your hands at once. On that point I must simply answer, ‘Trust me a little while,’ asking you however also to remember, that—irrespective of what you do last or first—my true function here is not that of your master in painting, or sculpture, or pottery; but my real duty is to show you what it is that makes any of these arts fine, or the contrary of fine; essentially good, or essentially base. You need not fear my not being practical enough for you; all the industry you choose to give me I will take; but far the better part of what you may gain by such industry would be lost, if I did not first lead you to see what every form of art-industry intends, and why some of it is justly called right, and some wrong.

35. It would be well if you were to look over, with respect to this matter, the end of the second, and what interests you of the third book of Plato’s Republic; noting therein these two principal things, of which I have to speak in this

and my next lecture : first, the power which Plato so frankly, and quite justly, attributes to art, of falsifying our conceptions of Deity : which power he by fatal error partly implies may be used wisely for good, and that the feigning is only wrong when it is of evil, ' *εάν τις μὴ καλῶς ψεύδεται* ; ' and you may trace through all that follows the beginning of the change of Greek ideal art into a beautiful expediency, instead of what it was in the days of Pindar, the statement of what ' could not be otherwise than so. ' But, in the second place, you will find in those books of the Polity, stated with far greater accuracy of expression than our English language admits, the essential relations of art to morality ; the sum of these being given in one lovely sentence, which, considering that we have to-day grace done us by fair companionship, you will pardon me for translating. ' Must it be then only with our poets that we insist they shall either create for us the image of a noble morality, or among us create none ? or shall we not also keep guard over all other workers for the people, and forbid them to make what is ill-customed, and unrestrained, and ungentle, and without order or shape, either in likenesses of living things, or in buildings, or in any other thing whatsoever that is made for the people ? and shall we not rather seek for workers who can track the inner nature of all that may be sweetly schemed ; so that the young men, as living in a wholesome place, may be profited by everything that, in work fairly wrought, may touch them through hearing or sight—as if it were a breeze bringing health to them from places strong for life ? '

36. And now—but one word, before we enter on our task, as to the way you must understand what I may endeavour to tell you.

Let me beg you—now and always—not to think that I mean more than I say. In all probability, I mean just what I say, and only that. At all events I do fully mean that, and if there is anything reserved in my mind, it will be probably different from what you would guess. You are perfectly welcome to know all that I think, as soon as I have put before you all my grounds for thinking it ; but by the time I have done so, you

will be able to form an opinion of your own ; and mine will then be of no consequence to you.

37. I use then to-day, as I shall in future use, the word 'religion' as signifying the feelings of love, reverence, or dread with which the human mind is affected by its conceptions of spiritual being ; and you know well how necessary it is, both to the rightness of our own life, and to the understanding the lives of others, that we should always keep clearly distinguished our ideas of religion, as thus defined, and of morality, as the law of rightness in human conduct. For there are many religions, but there is only one morality. There are moral and immoral religions, which differ as much in precept as in emotion ; but there is only one morality, which has been, is, and must be forever, an instinct in the hearts of all civilized men, as certain and unalterable as their outward bodily form, and which receives from religion neither law, nor peace ; but only hope, and felicity.

38. The pure forms or states of religion hitherto known, are those in which a healthy humanity, finding in itself many foibles and sins, has imagined, or been made conscious of, the existence of higher spiritual personality, liable to no such fault or stain ; and has been assisted in effort, and consoled in pain, by reference to the will or sympathy of such more pure spirits, whether imagined or real. I am compelled to use these painful latitudes of expression, because no analysis has hitherto sufficed to distinguish accurately, in historical narrative, the difference between impressions resulting from the imagination of the worshipper, and those made, if any, by the actually local and temporary presence of another spirit. For instance, take the vision, which of all others has been since made most frequently the subject of physical representation—the appearance to Ezekiel and St. John of the four living creatures, which throughout Christendom have been used to symbolize the Evangelists.* Supposing such interpretation just, one of those figures was either the mere symbol to St. John of himself, or it was the power which inspired him man-

* Only the Gospels, 'IV. Evangelia,' according to St. Jerome

ifesting itself in an independent form. Which of these it was, or whether neither of these, but a vision of other powers, or a dream, of which neither the prophet himself knew, nor can any other person yet know, the interpretation, I suppose no modestly-tempered and accurate thinker would now take upon himself to decide. Nor is it therefore anywise necessary for you to decide on that, or any other such question; but it is necessary that you should be bold enough to look every opposing question steadily in its face; and modest enough, having done so, to know when it is too hard for you. But above all things, see that you be modest in your thoughts, for of this one thing we may be absolutely sure, that all our thoughts are but degrees of darkness. And in these days you have to guard against the fatallest darkness of the two opposite Prides: the Pride of Faith, which imagines that the Nature of the Deity can be defined by its convictions; and the Pride of Science, which imagines that the Energy of Deity can be explained by its analysis.

39. Of these, the first, the Pride of Faith, is now, as it has been always, the most deadly, because the most complacent and subtle;—because it invests every evil passion of our nature with the aspect of an angel of light, and enables the self-love, which might otherwise have been put to wholesome shame, and the cruel carelessness of the ruin of our fellow-men, which might otherwise have been warmed into human love, or at least checked by human intelligence, to congeal themselves into the mortal intellectual disease of imagining that myriads of the inhabitants of the world for four thousand years have been left to wander and perish, many of them everlastingly, in order that, in fulness of time, divine truth might be preached sufficiently to ourselves; with this farther ineffable mischief for direct result, that multitudes of kindly-disposed, gentle, and submissive persons, who might else by their true patience have alloyed the hardness of the common crowd, and by their activity for good, balanced its misdoing, are withdrawn from all such true service of man, that they may pass the best part of their lives in what they are told is the service of God; namely, desiring what they cannot

obtain, lamenting what they cannot avoid, and reflecting on what they cannot understand.

40. This, I repeat, is the deadliest, but for you, under existing circumstances, it is becoming daily, almost hourly, the least probable form of Pride. That which you have chiefly to guard against consists in the overvaluing of minute though correct discovery ; the groundless denial of all that seems to you to have been groundlessly affirmed ; and the interesting yourselves too curiously in the progress of some scientific minds, which in their judgment of the universe can be compared to nothing so accurately as to the woodworms in the panel of a picture by some great painter, if we may conceive them as tasting with discrimination of the wood and with repugnance of the colour, and declaring that even this unlooked-for and undesirable combination is a normal result of the action of molecular Forces.

41. Now, I must very earnestly warn you, in the beginning of my work with you here, against allowing either of these forms of egotism to interfere with your judgment or practice of art. On the one hand, you must not allow the expression of your own favourite religious feelings by any particular form of art to modify your judgment of its absolute merit ; nor allow the art itself to become an illegitimate means of deepening and confirming your convictions, by realizing to your eyes what you dimly conceive with the brain ; as if the greater clearness of the image were a stronger proof of its truth. On the other hand, you must not allow your scientific habit of trusting nothing but what you have ascertained, to prevent you from appreciating, or at least endeavouring to qualify yourselves to appreciate, the work of the highest faculty of the human mind,—its imagination,—when it is toiling in the presence of things that cannot be dealt with by any other power.

42. These are both vital conditions of your healthy progress. On the one hand, observe that you do not wilfully use the realistic power of art to convince yourselves of historical or theological statements which you cannot otherwise prove, and which you wish to prove :—on the other hand, that you

do not check your imagination and conscience while seizing the truths of which they alone are cognizant, because you value too highly the scientific interest which attaches to the investigation of second causes.

For instance, it may be quite possible to show the conditions in water and electricity which necessarily produce the craggy outline, the apparently self-contained silvery light, and the sulphurous blue shadow of a thunder-cloud, and which separate these from the depth of the golden peace in the dawn of a summer morning. Similarly, it may be possible to show the necessities of structure which groove the fangs and depress the brow of the asp, and which distinguish the character of its head from that of the face of a young girl. But it is the function of the rightly-trained imagination to recognise, in these, and such other relative aspects, the unity of teaching which impresses, alike on our senses and our conscience, the eternal difference between good and evil : and the rule, over the clouds of heaven and over the creatures in the earth, of the same Spirit which teaches to our own hearts the bitterness of death, and strength of love.

43. Now, therefore, approaching our subject in this balanced temper, which will neither resolve to see only what it would desire, nor expect to see only what it can explain, we shall find our enquiry into the relation of Art to Religion is distinctly threefold : first, we have to ask how far art may have been literally directed by spiritual powers ; secondly, how far, if not inspired, it may have been exalted by them ; lastly, how far, in any of its agencies, it has advanced the cause of the creeds it has been used to recommend.

44. First: What ground have we for thinking that art has ever been inspired as a message or revelation? What internal evidence is there in the work of great artists of their having been under the authoritative guidance of supernatural powers ?

It is true that the answer to so mysterious a question cannot rest alone upon internal evidence ; but it is well that you should know what might, from that evidence alone, be concluded. And the more impartially you examine the phe-

nomena of imagination, the more firmly you will be led to conclude that they are the result of the influence of the common and vital, but not, therefore, less Divine, spirit, of which some portion is given to all living creatures in such manner as may be adapted to their rank in creation ; and that everything which men rightly accomplish is indeed done by Divine help, but under a consistent law which is never departed from.

The strength of this spiritual life within us may be increased or lessened by our own conduct ; it varies from time to time, as physical strength varies ; it is summoned on different occasions by our will, and dejected by our distress, or our sin ; but it is always equally human, and equally Divine. We are men, and not mere animals, because a special form of it is with us always ; we are nobler and baser men, as it is with us more or less ; but it is never given to us in any degree which can make us more than men.

45. Observe :—I give you this general statement doubtfully, and only as that towards which an impartial reasoner will, I think, be inclined by existing data. But I shall be able to show you, without any doubt, in the course of our studies, that the achievements of art which have been usually looked upon as the results of peculiar inspiration, have been arrived at only through long courses of wisely-directed labour, and under the influence of feelings which are common to all humanity.

But of these feelings and powers which in different degrees are common to humanity, you are to note that there are three principal divisions : first, the instincts of construction or melody, which we share with lower animals, and which are in us as native as the instinct of the bee or nightingale ; secondly, the faculty of vision, or of dreaming, whether in sleep or in conscious trance, or by voluntarily exerted fancy ; and lastly, the power of rational inference and collection, of both the laws and forms of beauty.

46. Now the faculty of vision, being closely associated with the innermost spiritual nature, is the one which has by most reasoners been held for the peculiar channel of Divine teaching : and it is a fact that great part of purely didactic art has

been the record, whether in language, or by linear representation, of actual vision involuntarily received at the moment, though cast on a mental retina blanched by the past course of faithful life. But it is also true that these visions, where most distinctly received, are always—I speak deliberately—*always*, the sign of some mental limitation or derangement; and that the persons who most clearly recognise their value, exaggeratedly estimate it, choosing what they find to be useful, and calling that ‘inspired,’ and disregarding what they perceive to be useless, though presented to the visionary by an equal authority.

47. Thus it is probable that no work of art has been more widely didactic than Albert Dürer’s engraving, known as the ‘Knight and Death.’* But that is only one of a series of works representing similarly vivid dreams, of which some are uninteresting, except for the manner of their representation, as the ‘St. Hubert,’ and others are unintelligible; some, frightful, and wholly unprofitable; so that we find the visionary faculty in that great painter, when accurately examined, to be a morbid influence, abasing his skill more frequently than encouraging it, and sacrificing the greater part of his energies upon vain subjects, two only being produced, in the course of a long life, which are of high didactic value, and both of these capable only of giving sad courage.† Whatever the value of these two, it bears more the aspect of a treasure obtained at great cost of suffering, than of a directly granted gift from heaven.

48. On the contrary, not only the highest, but the most consistent results have been attained in art by men in whom the faculty of vision, however strong, was subordinate to that of deliberative design, and tranquillised by a measure, continual, not feverish, but affectionate, observance of the quite unvisionary facts of the surrounding world.

And so far as we can trace the connection of their powers

* Standard Series, No. 9.

† The meaning of the ‘Knight and Death,’ even in this respect, has lately been questioned on good grounds. See note on the plate in Catalogue.

with the moral character of their lives, we shall find that the best art is the work of good, but of not distinctly religious men, who, at least, are conscious of no inspiration, and often so unconscious of their superiority to others, that one of the very greatest of them, deceived by his modesty, has asserted that 'all things are possible to well-directed labour.'

49. The second question, namely, how far art, if not inspired, has yet been ennobled by religion, I shall not touch upon to-day; for it both requires technical criticism, and would divert you too long from the main question of all,—How far religion has been helped by art?

You will find that the operation of formative art—(I will not speak to-day of music)—the operation of formative art on religious creed is essentially twofold; the realisation, to the eyes, of imagined spiritual persons; and the limitation of their imagined presence to certain places. We will examine these two functions of it successively.

50. And first, consider accurately what the agency of art is, in realising, to the sight, our conceptions of spiritual persons.

For instance. Assume that we believe that the Madonna is always present to hear and answer our prayers. Assume also that this is true. I think that persons in a perfectly honest, faithful, and humble temper, would in that case desire only to feel so much of the Divine presence as the spiritual Power herself chose to make felt; and, above all things, not to think they saw, or knew, anything except what might be truly perceived or known.

But a mind imperfectly faithful, and impatient in its distress, or craving in its dulness for a more distinct and convincing sense of the Divinity, would endeavour to complete, or perhaps we should rather say to contract, its conception, into the definite figure of a woman wearing a blue or crimson dress, and having fair features, dark eyes, and gracefully arranged hair.

Suppose, after forming such a conception, that we have the power to realise and preserve it, this image of a beautiful figure with a pleasant expression cannot but have the tendency

of afterwards leading us to think of the Virgin as present, when she is not actually present, or as pleased with us, when she is not actually pleased ; or if we resolutely prevent ourselves from such imagination, nevertheless the existence of the image beside us will often turn our thoughts towards subjects of religion, when otherwise they would have been differently occupied ; and, in the midst of other occupations, will familiarise more or less, and even mechanically associate with common or faultful states of mind, the appearance of the supposed Divine person.

51. There are thus two distinct operations upon our mind : first, the art makes us believe what we would not otherwise have believed ; and secondly, it makes us think of subjects we should not otherwise have thought of, intruding them amidst our ordinary thoughts in a confused and familiar manner. We cannot with any certainty affirm the advantage or the harm of such accidental pieties, for their effect will be very different on different characters : but, without any question, the art, which makes us believe what we would not have otherwise believed, is misapplied, and in most instances very dangerously so. Our duty is to believe in the existence of Divine, or any other, persons, only upon rational proofs of their existence ; and not because we have seen pictures of them. And since the real relations between us and higher spirits are, of all facts concerning our being, those which it is most important to know accurately, if we know at all, it is a folly so great as to amount to real, though most unintentional, sin, to allow our conceptions of those relations to be modified by our own undisciplined fancy.

52. But now observe, it is here necessary to draw a distinction, so subtle, that in dealing with facts it is continually impossible to mark it with precision, yet so vital, that not only your understanding of the power of art, but the working of your minds in matters of primal moment to you, depends on the effort you make to affirm this distinction strongly. The art which realises a creature of the imagination is only mischievous when that realisation is conceived to imply, or does practically induce a belief in, the real existence of the im-

agined personage, contrary to, or unjustified by the other evidence of its existence. But if the art only represents the personage on the understanding that its form is imaginary, then the effort at realisation is healthful and beneficial.

For instance. I shall place in your Standard series a Greek design of Apollo crossing the sea to Delphi, which is an example of one of the highest types of Greek or any other art. So far as that design is only an expression, under the symbol of a human form, of what may be rightly imagined respecting the solar power, the art is right and ennobling; but so far as it conveyed to the Greek the idea of there being a real Apollo, it was mischievous, whether there be, or be not, a real Apollo. If there is no real Apollo, then the art was mischievous because it deceived; but if there is a real Apollo, then it was still more mischievous, for it not only began the degradation of the image of that true god into a decoration for niches, and a device for seals; but prevented any true witness being borne to his existence. For if the Greeks, instead of multiplying representations of what they imagined to be the figure of the god, had given us accurate drawings of the heroes and battles of Marathon and Salamis, and had simply told us in plain Greek what evidence they had of the power of Apollo, either through his oracles, his help or chastisement, or by immediate vision, they would have served their religion more truly than by all the vase-paintings and fine statues that ever were buried or adored.

53. Now in this particular instance, and in many other examples of fine Greek art, the two conditions of thought, symbolic and realistic, are mingled; and the art is helpful, as I will hereafter show you, in one function, and in the other so deadly, that I think no degradation of conception of Deity has ever been quite so base as that implied by the designs of Greek vases in the period of decline, say about 250 B.C.

But though among the Greeks it is thus nearly always difficult to say what is symbolic and what realistic, in the range of Christian art the distinction is clear. In that, a vast division of imaginative work is occupied in the symbolism of virtues, vices, or natural powers or passions; and in the repre-

sentation of personages who, though nominally real, become in conception symbolic. In the greater part of this work there is no intention of implying the existence of the represented creature ; Dürer's *Melencolia* and Giotto's *Justice* are accurately characteristic examples. Now all such art is wholly good and useful when it is the work of good men.

54. Again, there is another division of Christian work in which the persons represented, though nominally real, are treated only as *dramatis-personæ* of a poem, and so presented confessedly as subjects of imagination. All this poetic art is also good when it is the work of good men.

55. There remains only therefore to be considered, as truly religious, the work which definitely implies and modifies the conception of the existence of a real person. There is hardly any great art which entirely belongs to this class ; but Raphael's *Madonna della Seggiola* is as accurate a type of it as I can give you ; Holbein's *Madonna at Dresden*, the *Madonna di San Sisto*, and the *Madonna of Titian's Assumption*, all belong mainly to this class, but are removed somewhat from it (as I repeat, nearly all great art is) into the poetical one. It is only the bloody crucifixes and gilded virgins and other such lower forms of imagery (by which, to the honour of the English Church, it has been truly claimed for her, that 'she has never appealed to the madness or dulness of her people,') which belongs to the realistic class in strict limitation, and which properly constitute the type of it.

There is indeed an important school of sculpture in Spain, directed to the same objects, but not demanding at present any special attention. And finally, there is the vigorous and most interesting realistic school of our own, in modern times, mainly known to the public by Holman Hunt's picture of the *Light of the World*, though, I believe, deriving its first origin from the genius of the painter to whom you owe also the revival of interest, first here in Oxford, and then universally, in the cycle of early English legend,—Dante Rossetti.

56. The effect of this realistic art on the religious mind of Europe varies in scope more than any other art power ; for in its higher branches it touches the most sincere religious

minds, affecting an earnest class of persons who cannot be reached by merely poetical design; while, in its lowest, it addresses itself not only to the most vulgar desires for religious excitement, but to the mere thirst for sensation of horror which characterises the uneducated orders of partially civilised countries; nor merely to the thirst for horror, but to the strange love of death, as such, which has sometimes in Catholic countries showed itself peculiarly by the endeavour to paint the images in the chapels of the Sepulchre so as to look deceptively like corpses. The same morbid instinct has also affected the minds of many among the more imaginative and powerful artists with a feverish gloom which distorts their finest work; and lastly—and this is the worst of all its effects—it has occupied the sensibility of Christian women, universally, in lamenting the sufferings of Christ, instead of preventing those of His people.

57. When any of you next go abroad, observe, and consider the meaning of, the sculptures and paintings, which of every rank in art, and in every chapel and cathedral, and by every mountain path, recall the hours, and represent the agonies, of the Passion of Christ: and try to form some estimate of the efforts that have been made by the four arts of eloquence, music, painting, and sculpture, since the twelfth century, to wring out of the hearts of women the last drops of pity that could be excited for this merely physical agony: for the art nearly always dwells on the physical wounds or exhaustion chiefly, and degrades, far more than it animates, the conception of pain.

Then try to conceive the quantity of time, and of excited and thrilling emotion, which have been wasted by the tender and delicate women of Christendom during these last six hundred years, in thus picturing to themselves, under the influence of such imagery, the bodily pain, long since passed, of One Person;—which, so far as they indeed conceived it to be sustained by a Divine Nature, could not for that reason have been less endurable than the agonies of any simple human death by torture: and then try to estimate what might have been the better result, for the righteousness and felicity

of mankind, if these same women had been taught the deep meaning of the last words that were ever spoken by their Master to those who had ministered to Him of their substance: 'Daughters of Jerusalem, weep not for me, but weep for yourselves, and for your children.' If they had but been taught to measure with their pitiful thoughts the tortures of battle-fields;—the slowly consuming plagues of death in the starving children, and wasted age, of the innumerable desolate those battles left;—nay in our own life of peace, the agony of unnurtured, untaught, unhelped creatures, awaking at the grave's edge to know how they should have lived; and the worse pain of those whose existence, not the ceasing of it, is death; those to whom the cradle was a curse, and for whom the words they cannot hear, 'ashes to ashes,' are all that they have ever received of benediction. These,—you who would fain have wept at His feet, or stood by His cross, —these you have always with you, Him you have not always.

58. The wretched in death you have always with you. Yes, and the brave and good in life you have always;—these also needing help, though you supposed they had only to help others; these also claiming to be thought for, and remembered. And you will find, if you look into history with this clue, that one of quite the chief reasons for the continual misery of mankind is that they are always divided in their worship between angels or saints, who are out of their sight, and need no help, and proud and evil-minded men, who are too definitely in their sight, and ought not to have their help. And consider how the arts have thus followed the worship of the crowd. You have paintings of saints and angels, innumerable;—of petty courtiers, and contemptible or cruel kings, innumerable. Few, how few you have (but these, observe, almost always by great painters) of the best men, or of their actions. But think for yourselves,—I have no time now to enter upon the mighty field, nor imagination enough to guide me beyond the threshold of it,—think, what history might have been to us now;—nay, what a different history that of all Europe might have become, if it had but been the object both of the people to discern, and of their arts to honour and bear record of, the

great deeds of their worthiest men. And if, instead of living, as they have always hitherto done, in a hellish cloud of contention and revenge, lighted by fantastic dreams of cloudy sanctities, they had sought to reward and punish justly, wherever reward and punishment were due, but chiefly to reward ; and at least rather to bear testimony to the human acts which deserved God's anger or His blessing, than only in presumptuous imagination to display the secrets of Judgment, or the beatitudes of Eternity.

59. Such I conceive generally, though indeed with good arising out of it, for every great evil brings some good in its backward eddies—such I conceive to have been the deadly function of art in its ministry to what, whether in heathen or Christian lands, and whether in the pageantry of words, or colours, or fair forms, is truly, and in the deep sense, to be called idolatry—the serving with the best of our hearts and minds, some dear or sad fantasy which we have made for ourselves, while we disobey the present call of the Master, who is not dead, and who is not now fainting under His cross, but requiring us to take up ours.

60. I pass to the second great function of religious art, the limitation of the idea of Divine presence to particular localities. It is of course impossible within my present limits to touch upon this power of art, as employed on the temples of the gods of various religions ; we will examine that on future occasions. To-day, I want only to map out main ideas, and I can do this best by speaking exclusively of this localising influence as it affects our own faith.

Observe first, that the localisation is almost entirely dependent upon human art. You must at least take a stone and set it up for a pillar, if you are to mark the place, so as to know it again, where a vision appeared. A persecuted people, needing to conceal their places of worship, may perform every religious ceremony first under one crag of the hill-side, and then under another, without invalidating the sacredness of the rites or sacraments thus administered. It is, therefore, we all acknowledge, inessential, that a particular spot should be surrounded with a ring of stones, or enclosed within walls

of a certain style of architecture, and so set apart as the only place where such ceremonies may be properly performed ; and it is thus less by any direct appeal to experience or to reason, but in consequence of the effect upon our senses produced by the architecture, that we receive the first strong impressions of what we afterwards contend for as absolute truth. I particularly wish you to notice how it is always by help of human art that such a result is attained, because, remember always, I am neither disputing nor asserting the truth of any theological doctrine ;—that is not my province ;—I am only questioning the expediency of enforcing that doctrine by the help of architecture. Put a rough stone for an altar under the hawthorn on a village green ;—separate a portion of the green itself with an ordinary paling from the rest ;—then consecrate, with whatever form you choose, the space of grass you have enclosed, and meet within the wooden fences often as you desire to pray or preach ; yet you will not easily fasten an impression in the minds of the villagers, that God inhabits the space of grass inside the fence, and does not extend His presence to the common beyond it : and that the daisies and violets on one side of the railing are holy,—on the other, profane. But, instead of a wooden fence, build a wall ; pave the interior space ; roof it over, so as to make it comparatively dark ;—and you may persuade the villagers with ease that you have built a house which Deity inhabits, or that you have become, in the old French phrase, a ‘logeur du Bon Dieu.’

61. And farther, though I have no desire to introduce any question as to the truth of what we thus architecturally teach, I would desire you most strictly to determine what is intended to be taught.

Do not think I underrate—I am among the last men living who would underrate—the importance of the sentiments connected with their church to the population of a pastoral village. I admit, in its fullest extent, the moral value of the scene, which is almost always one of perfect purity and peace ; and of the sense of supernatural love and protection, which fills and surrounds the low aisles and homely porch. But the question I desire earnestly to leave with you is, whether all the

earth ought not to be peaceful and pure, and the acknowledgment of the Divine protection as universal, as its reality? That in a mysterious way the presence of Deity is vouchsafed where it is sought, and withdrawn where it is forgotten, must of course be granted as the first postulate in the enquiry: but the point for our decision is just this, whether it ought always to be sought in one place only, and forgotten in every other.

It may be replied, that since it is impossible to consecrate the entire space of the earth, it is better thus to secure a portion of it than none: but surely, if so, we ought to make some effort to enlarge the favoured ground, and even look forward to a time when in English villages there may be a God's acre tenanted by the living, not the dead; and when we shall rather look with aversion and fear to the remnant of ground that is set apart as profane, than with reverence to a narrow portion of it enclosed as holy.

62. But now, farther. Suppose it be admitted that by enclosing ground with walls, and performing certain ceremonies there habitually, some kind of sanctity is indeed secured within that space,—still the question remains open whether it be advisable for religious purposes to decorate the enclosure. For separation the mere walls would be enough. What is the purpose of your decoration?

Let us take an instance—the most noble with which I am acquainted, the Cathedral of Chartres. You have there the most splendid coloured glass, and the richest sculpture, and the grandest proportions of building, united to produce a sensation of pleasure and awe. We profess that this is to honour the Deity; or, in other words, that it is pleasing to Him that we should delight our eyes with blue and golden colours, and solemnise our spirits by the sight of large stones laid one on another, and ingeniously carved.

63. I do not think it can be doubted that it is pleasing to Him when we do this; for He has Himself prepared for us, nearly every morning and evening, windows painted with Divine art, in blue and gold and vermilion; windows lighted from within by the lustre of that heaven which we may assume, at least with more certainty than any consecrated

ground, to be one of His dwelling-places. Again, in every mountain side, and cliff of rude sea shore, He has heaped stones one upon another of greater magnitude than those of Chartres Cathedral, and sculptured them with floral ornament,—surely not less sacred because living?

64. Must it not then be only because we love our own work better than His, that we respect the lucent glass, but not the lucent clouds; that we weave embroidered robes with ingenious fingers, and make bright the gilded vaults we have beautifully ordained—while yet we have not considered the heavens the work of His fingers; nor the stars of the strange vault which He has ordained. And do we dream that by carving fonts and lifting pillars in His honour, who cuts the way of the rivers among the rocks, and at whose reproof the pillars of the earth are astonished, we shall obtain pardon for the dishonour done to the hills and streams by which He has appointed our dwelling-place;—for the infection of their sweet air with poison;—for the burning up of their tender grass and flowers with fire, and for spreading such a shame of mixed luxury and misery over our native land, as if we laboured only that, at least here in England, we might be able to give the lie to the song, whether of the Cherubim above, or Church beneath—‘Holy, holy, Lord God of all creatures; Heaven—and Earth—are full of Thy glory?’

65. And how much more there is that I long to say to you; and how much, I hope, that you would like to answer to me, or to question me of! But I can say no more to-day. We are not, I trust, at the end of our talks or thoughts together; but, if it were so, and I never spoke to you more, this that I have said to you I should have been glad to have been permitted to say; and this, farther, which is the sum of it,—That we *may* have splendour of art again, and with that, we may truly praise and honour our Maker, and with that set forth the beauty and holiness of all that He has made: but only after we have striven with our whole hearts first to sanctify the temple of the body and spirit of every child that has no roof to cover its head from the cold, and no walls to guard its soul from corruption, in this our English land.

One word more.

What I have suggested hitherto, respecting the relations of Art to Religion, you must receive throughout as merely motive of thought; though you must have well seen that my own convictions were established finally on some of the points in question. But I must, in conclusion, tell you something that I *know*;—which, if you truly labour, you will one day know also; and which I trust some of you will believe, now.

During the minutes in which you have been listening to me, I suppose that almost at every other sentence those whose habit of mind has been one of veneration for established forms and faiths, must have been in dread that I was about to say, or in pang of regret at my having said, what seemed to them an irreverent or reckless word touching vitally important things.

So far from this being the fact, it is just because the feelings that I most desire to cultivate in your minds are those of reverence and admiration, that I am so earnest to prevent you from being moved to either by trivial or false semblances. *This* is the thing which I *know*—and which, if you labour faithfully, you shall know also,—that in Reverence is the chief joy and power of life;—Reverence, for what is pure and bright in your own youth; for what is true and tried in the age of others; for all that is gracious among the living, great among the dead,—and marvellous in the Powers that cannot die.

LECTURE III.

THE RELATION OF ART TO MORALS.

66. You probably recollect that, in the beginning of my last lecture, it was stated that fine art had, and could have, but three functions: the enforcing of the religious sentiments of men, the perfecting their ethical state, and the doing them material service. We have to-day to examine the mode of its action in the second power, that of perfecting the morality or ethical state of men.

Perfecting, observe—not producing.

You must have the right moral state first, or you cannot have the art. But when the art is once obtained, its reflected action enhances and completes the moral state out of which it arose, and, above all, communicates the exaltation to other minds which are already morally capable of the like.

67. For instance, take the art of singing, and the simplest perfect master of it, (up to the limits of his nature) whom you can find—a skylark. From him you may learn what it is to 'sing for joy.' You must get the moral state first, the pure gladness, then give it finished expression; and it is perfected in itself, and made communicable to other creatures capable of such joy. But it is incommunicable to those who are not prepared to receive it.

Now, all right human song is, similarly, the finished expression, by art, of the joy or grief of noble persons, for right causes. And accurately in proportion to the rightness of the cause, and purity of the emotion, is the possibility of the fine art. A maiden may sing of her lost love, but a miser cannot sing of his lost money. And with absolute precision from highest to lowest, the fineness of the possible art is an index of the moral purity and majesty of the emotion it expresses. You may test it practically at any instant. Question with yourselves respecting any feeling that has taken strong possession of your mind, 'Could this be sung by a master, and sung nobly, with a true melody and art?' Then it is a right feeling. Could it not be sung at all, or only sung ludicrously? It is a base one. And that is so in all the arts; so that with mathematical precision, subject to no error or exception, the art of a nation, so far as it exists, is an exponent of its ethical state.

68. An exponent, observe, and exalting influence; but not the root or cause. You cannot paint or sing yourselves into being good men; you must be good men before you can either paint or sing, and then the colour and sound will complete in you all that is best.

And this it was that I called upon you to hear, saying, 'listen to me at least now,' in the first lecture, namely, that no

art-teaching could be of use to you, but would rather be harmful, unless it was grafted on something deeper than all art. For indeed not only with this, of which it is my function to show you the laws, but much more with the art of all men, which you came here chiefly to learn, that of language, the chief vices of education have arisen from the one great fallacy of supposing that noble language is a communicable trick of grammar and accent, instead of simply the careful expression of right thought. All the virtues of language are, in their roots, moral; it becomes accurate if the speaker desires to be true; clear, if he speaks with sympathy and a desire to be intelligible; powerful, if he has earnestness; pleasant, if he has sense of rhythm and order. There are no other virtues of language producible by art than these: but let me mark more deeply for an instant the significance of one of them. Language, I said, is only clear when it is sympathetic. You can, in truth, understand a man's word only by understanding his temper. Your own word is also as of an unknown tongue to him unless he understands yours. And it is this which makes the art of language, if any one is to be chosen separately from the rest, that which is fittest for the instrument of a gentleman's education. To teach the meaning of a word thoroughly is to teach the nature of the spirit that coined it; the secret of language is the secret of sympathy, and its full charm is possible only to the gentle. And thus the principles of beautiful speech have all been fixed by sincere and kindly speech. On the laws which have been determined by sincerity, false speech, apparently beautiful, may afterwards be constructed; but all such utterance, whether in oration or poetry, is not only without permanent power, but it is destructive of the principles it has usurped. So long as no words are uttered but in faithfulness, so long the art of language goes on exalting itself; but the moment it is shaped and chiselled on external principles, it falls into frivolity, and perishes. And this truth would have been long ago manifest, had it not been that in periods of advanced academical science there is always a tendency to deny the sincerity of the first masters of language. Once learn to write gracefully in the

moment of an ancient author, and we are apt to think that he also wrote in the manner of some one else. But no noble nor right style was ever yet founded but out of a sincere heart.

No man is worth reading to form your style, who does not mean what he says; nor was any great style ever invented but by some man who meant what he said. Find out the beginner of a great manner of writing, and you have also found the declarer of some true facts or sincere passions; and your whole method of reading will thus be quickened, for, being sure that your author really meant what he said, you will be much more careful to ascertain what it is that he means.

69. And of yet greater importance is it deeply to know that every beauty possessed by the language of a nation is significant of the innermost laws of its being. Keep the temper of the people stern and manly; make their associations grave, courteous, and for worthy objects; occupy them in just deeds; and their tongue must needs be a grand one. Nor is it possible, therefore—observe the necessary reflected action—that any tongue should be a noble one, of which the words are not so many trumpet-calls to action. All great languages invariably utter great things, and command them; they cannot be mimicked but by obedience; the breath of them is inspiration because it is not only vocal, but vital; and you can only learn to speak as these men spoke, by becoming what these men were.

70. Now for direct confirmation of this, I want you to think over the relation of expression to character in two great masters of the absolute art of language, Virgil and Pope. You are perhaps surprised at the last name; and indeed you have in English much higher grasp and melody of language from more passionate minds, but you have nothing else, in its range, so perfect. I name, therefore, these two men, because they are the two most accomplished *Artists*, merely as such, whom I know in literature; and because I think you will be afterwards interested in investigating how the infinite grace in the words of the one, the severity in those of the other, and the precision in those of both, arise wholly out of the moral elements of their minds:—out of the deep tenderness in Virgil

which enabled him to write the stories of Nisus and Lausus; and the serene and just benevolence which placed Pope, in his theology, two centuries in advance of his time, and enabled him to sum the law of noble life in two lines which, so far as I know, are the most complete, the most concise, and the most lofty expression of moral temper existing in English words:—

*'Never elated, while one man's oppress'd;
Never dejected, while another's bless'd.'*

I wish you also to remember these lines of Pope, and to make yourselves entirely masters of his system of ethics; because, putting Shakespeare aside as rather the world's than ours, I hold Pope to be the most perfect representative we have, since Chaucer, of the true English mind; and I think the *Dunciad* is the most absolutely chiselled and monumental work 'exacted' in our country. You will find, as you study Pope, that he has expressed for you, in the strictest language and within the briefest limits, every law of art, of criticism, of economy, of policy, and, finally, of a benevolence, humble, rational, and resigned, contented with its allotted share of life, and trusting the problem of its salvation to Him in whose hand lies that of the universe.

71. And now I pass to the arts with which I have special concern, in which, though the facts are exactly the same, I shall have more difficulty in proving my assertion, because very few of us are as cognizant of the merit of painting as we are of that of language; and I can only show you whence that merit springs from, after having thoroughly shown you in what it consists. But, in the meantime, I have simply to tell you, that the manual arts are as accurate exponents of ethical state, as other modes of expression; first, with absolute precision, of that of the workman, and then with precision, disguised by many distorting influences, of that of the nation to which he belongs.

And, first, they are a perfect exponent of the mind of the workman; but, being so, remember, if the mind be great or complex, the art is not an easy book to read; for we must ourselves possess all the mental characters of which we are to

read the signs. No man can read the evidence of labour who is not himself laborious, for he does not know what the work costs : nor can he read the evidence of true passion if he is not passionate ; nor of gentleness if he is not gentle : and the most subtle signs of fault and weakness of character he can only judge by having had the same faults to fight with. I myself, for instance, know impatient work, and tired work, better than most critics, because I am myself always impatient, and often tired :—so also, the patient and indefatigable touch of a mighty master becomes more wonderful to me than to others. Yet, wonderful in no mean measure it will be to you all, when I make it manifest ;—and as soon as we begin our real work, and you have learned what it is to draw a true line, I shall be able to make manifest to you,—and indisputably so,—that the day's work of a man like Mantegna or Paul Veronese consists of an unflinching, uninterrupted succession of movements of the hand more precise than those of the finest fencer : the pencil leaving one point and arriving at another, not only with unerring precision at the extremity of the line, but with an unerring and yet varied course—sometimes over spaces a foot or more in extent—yet a course so determined everywhere that either of these men could, and Veronese often does, draw a finished profile, or any other portion of the contour of a face, with one line, not afterwards changed. Try, first, to realise to yourselves the muscular precision of that action, and the intellectual strain of it ; for the movement of a fencer is perfect in practised monotony ; but the movement of the hand of a great painter is at every instant governed by direct and new intention. Then imagine that muscular firmness and subtlety, and the instantaneously selective and ordi- nant energy of the brain, sustained all day long, not only without fatigue, but with a visible joy in the exertion, like that which an eagle seems to take in the wave of his wings ; and this all life long, and through long life, not only without failure of power, but with visible increase of it, until the actually organic changes of old age. And then consider, so far as you know anything of physiology, what sort of an ethical state of body and mind that means !—ethic through ages

past! what fineness of race there must be to get it, what exquisite balance and symmetry of the vital powers! And then, finally, determine for yourselves whether a manhood like that is consistent with any viciousness of soul, with any mean anxiety, any gnawing lust, any wretchedness of spite or remorse, any consciousness of rebellion against law of God or man, or any actual, though unconscious, violation of even the least law to which obedience is essential for the glory of life, and the pleasing of its Giver.

72. It is, of course, true that many of the strong masters had deep faults of character, but their faults always show in their work. It is true that some could not govern their passions; if so, they died young, or they painted ill when old. But the greater part of our misapprehension in the whole matter is from our not having well known who the great painters were, and taking delight in the petty skill that was bred in the fumes of the taverns of the North, instead of theirs who breathed empyreal air, sons of the morning, under the woods of Assisi and the crags of Cadore.

73. It is true however also, as I have pointed out long ago, that the strong masters fall into two great divisions, one leading simple and natural lives, the other restrained in a Puritanism of the worship of beauty; and these two manners of life you may recognise in a moment by their work. Generally the naturalists are the strongest; but there are two of the Puritans, whose work if I can succeed in making clearly understandable to you during my three years here, it is all I need care to do. But of these two Puritans one I cannot name to you, and the other I at present will not. One I cannot, for no one knows his name, except the baptismal one, Bernard, or 'dear little Bernard'—Bernardino, called, from his birthplace, (Luino, on the lago Maggiore,) Bernard of Luino. The other is a Venetian, of whom many of you probably have never heard, and of whom, through me, you shall not hear until I have tried to get some picture by him over to England.

74. Observe then, this Puritanism in the worship of beauty, though sometimes weak, is always honourable and amiable, and the exact reverse of the false Puritanism, which consists

in the dread or disdain of beauty. And in order to treat my subject rightly, I ought to proceed from the skill of art to the choice of its subject, and show you how the moral temper of the workman is shown by his seeking lovely forms and thoughts to express, as well as by the force of his hand in expression. But I need not now urge this part of the proof on you, because you are already, I believe, sufficiently conscious of the truth in this matter, and also I have already said enough of it in my writings; whereas I have not at all said enough of the infallibleness of fine technical work as a proof of every other good power. And indeed it was long before I myself understood the true meaning of the pride of the greatest men in their mere execution, shown, for a permanent lesson to us, in the stories which, whether true or not, indicate with absolute accuracy the general conviction of great artists;—the stories of the contest of Apelles and Protogenes in a line only, (of which I can promise you, you shall know the meaning to some purpose in a little while),—the story of the circle of Giotto, and especially, which you may perhaps not have observed, the expression of Dürer in his inscription on the drawings sent him by Raphael. These figures, he says, ‘Raphael drew and sent to Albert Dürer in Nürnberg, to show him’—What? Not his invention, nor his beauty of expression, but ‘sein Hand zu weisen,’ ‘To show him his *hand*.’ And you will find, as you examine farther, that all inferior artists are continually trying to escape from the necessity of sound work, and either indulging themselves in their delights in subject, or pluming themselves on their noble motives for attempting what they cannot perform; (and observe, by the way, that a great deal of what is mistaken for conscientious motive is nothing but a very pestilent, because very subtle, condition of vanity); whereas the great men always understand at once that the first morality of a painter, as of everybody else, is to know his business; and so earnest are they in this, that many, whose lives you would think, by the results of their work, had been passed in strong emotion, have in reality subdued themselves, though capable of the very strongest passions, into a calm as absolute as that of a deeply sheltered mountain lake, which reflects every agi-

tation of the clouds in the sky, and every change of the shadows on the hills, but is itself motionless.

75. Finally, you must remember that great obscurity has been brought upon the truth in this matter by the want of integrity and simplicity in our modern life. I mean integrity in the Latin sense, wholeness. Everything is broken up, and mingled in confusion, both in our habits and thoughts; besides being in great part imitative: so that you not only cannot tell what a man is, but sometimes you cannot tell whether he is, at all!—whether you have indeed to do with a spirit, or only with an echo. And thus the same inconsistencies appear now, between the work of artists of merit and their personal characters, as those which you find continually disappointing expectation in the lives of men of modern literary power;—the same conditions of society having obscured or misdirected the best qualities of the imagination, both in our literature and art. Thus there is no serious question with any of us as to the personal character of Dante and Giotto, of Shakespeare and Holbein; but we pause timidly in the attempt to analyse the moral laws of the art skill in recent poets, novelists, and painters.

76. Let me assure you once for all, that as you grow older, if you enable yourselves to distinguish, by the truth of your own lives, what is true in those of other men, you will gradually perceive that all good has its origin in good, never in evil; that the fact of either literature or painting being truly fine of their kind, whatever their mistaken aim, or partial error, is proof of their noble origin: and that, if there is indeed sterling value in the thing done, it has come of a sterling worth of the soul that did it, however alloyed or defiled by conditions of sin which are sometimes more appalling or more strange than those which all may detect in their own hearts, because they are part of a personality altogether larger than ours, and as far beyond our judgment in its darkness as beyond our following in its light. And it is sufficient warning against what some might dread as the probable effect of such a conviction on your own minds, namely, that you might permit yourselves in the weaknesses which you imagined to be allied to genius,

when they took the form of personal temptations ;—it is surely, I say, sufficient warning against so mean a folly, to discern, as you may with little pains, that, of all human existences, the lives of men of that distorted and tainted nobility of intellect are probably the most miserable.

77. I pass to the second, and for us the more practically important question, What is the effect of noble art upon other men ; what has it done for national morality in time past ; and what effect is the extended knowledge or possession of it likely to have upon us now ? And here we are at once met by the facts, which are as gloomy as indisputable, that, while many peasant populations, among whom scarcely the rudest practice of art has ever been attempted, have lived in comparative innocence, honour, and happiness, the worst foulness and cruelty of savage tribes have been frequently associated with fine ingenuities of decorative design ; also, that no people has ever attained the higher stages of art skill, except at a period of its civilisation which was sullied by frequent, violent, and even monstrous crime ; and, lastly, that the attaining of perfection in art power, has been hitherto, in every nation, the accurate signal of the beginning of its ruin.

78. Respecting which phenomena, observe first, that although good never springs out of evil, it is developed to its highest by contention with evil. There are some groups of peasantry, in far-away nooks of Christian countries, who are nearly as innocent as lambs ; but the morality which gives power to art is the morality of men, not of cattle.

Secondly, the virtues of the inhabitants of many country districts are apparent, not real ; their lives are indeed artless, but not innocent ; and it is only the monotony of circumstances, and the absence of temptation, which prevent the exhibition of evil passions not less real because often dormant, nor less foul because shown only in petty faults, or inactive malignities.

79. But you will observe also that *absolute* artlessness, to men in any kind of moral health, is impossible ; they have always, at least, the art by which they live—agriculture or seamanship ; and in these industries, skilfully practised, you will

find the law of their moral training; while, whatever the adversity of circumstances, every rightly-minded peasantry, such as that of Sweden, Denmark, Bavaria, or Switzerland, has associated with its needful industry a quite studied school of pleasurable art in dress; and generally also in song, and simple domestic architecture.

80. Again, I need not repeat to you here what I endeavoured to explain in the first lecture in the book I called 'The Two Paths,' respecting the arts of savage races: but I may now note briefly that such arts are the result of an intellectual activity which has found no room to expand, and which the tyranny of nature or of man has condemned to disease through arrested growth. And where neither Christianity, nor any other religion conveying some moral help, has reached, the animal energy of such races necessarily flames into ghastly conditions of evil, and the grotesque or frightful forms assumed by their art are precisely indicative of their distorted moral nature.

81. But the truly great nations nearly always begin from a race possessing this imaginative power; and for some time their progress is very slow, and their state not one of innocence, but of feverish and faultful animal energy. This is gradually subdued and exalted into bright human life; the art instinct purifying itself with the rest of the nature, until social perfectness is nearly reached; and then comes the period when conscience and intellect are so highly developed, that new forms of error begin in the inability to fulfil the demands of the one, or to answer the doubts of the other. Then the wholeness of the people is lost; all kinds of hypocrisies and oppositions of science develop themselves; their faith is questioned on one side, and compromised with on the other; wealth commonly increases at the same period to a destructive extent; luxury follows; and the ruin of the nation is then certain: while the arts, all this time, are simply, as I said at first, the exponents of each phase of its moral state, and no more control it in its political career than the gleam of the firefly guides its oscillation. It is true that their most splendid results are usually obtained in the swiftness of the

power which is hurrying to the precipice ; but to lay the charge of the catastrophe to the art by which it is illumined, is to find a cause for the cataract in the hues of its iris. It is true that the colossal vices belonging to periods of great national wealth (for wealth, you will find, is the real root of all evil) can turn every good gift and skill of nature or of man to evil purpose. If, in such times, fair pictures have been misused, how much more fair realities? And if Miranda is immoral to Caliban, is that Miranda's fault?

82. And I could easily go on to trace for you what, at the moment I speak, is signified, in our own national character, by the forms of art, and unhappily also by the forms of what is not art, but ἀτεχνία, that exist among us. But the more important question is, What *will* be signified by them ; what is there in us now of worth and strength which, under our new and partly accidental impulse towards formative labour, may be by that expressed, and by that fortified?

Would it not be well to know this? Nay, irrespective of all future work, is it not the first thing we should want to know, what stuff we are made of—how far we are ἀγαθὸν or κακὸν—good, or good for nothing? We may all know that, each of ourselves, easily enough, if we like to put one grave question well home.

83. Supposing it were told any of you by a physician whose word you could not but trust, that you had not more than seven days to live. And suppose also that, by the manner of your education it had happened to you, as it has happened to many, never to have heard of any future state, or not to have credited what you heard ; and therefore that you had to face this fact of the approach of death in its simplicity : fearing no punishment for any sin that you might have before committed, or in the coming days might determine to commit ; and having similarly no hope of reward for past, or yet possible, virtue ; nor even of any consciousness whatever to be left to you, after the seventh day had ended, either of the results of your acts to those whom you loved, or of the feelings of any survivors towards you. Then the manner in which you would spend the seven days is an exact measure of the morality of your nature.

84. I know that some of you, and I believe the greater number of you, would, in such a case, spend the granted days entirely as you ought. Neither in numbering the errors, or deploring the pleasures of the past; nor in grasping at vile good in the present, nor vainly lamenting the darkness of the future; but in instant and earnest execution of whatever it might be possible for you to accomplish in the time, in setting your affairs in order, and in providing for the future comfort, and—so far as you might by any message or record of yourself, for the consolation—of those whom you loved, and by whom you desired to be remembered, not for your good, but for theirs. How far you might fail through human weakness, in shame for the past, despair at the little that could in the remnant of life be accomplished, or the intolerable pain of broken affection, would depend wholly on the degree in which your nature had been depressed or fortified by the manner of your past life. But I think there are few of you who would not spend those last days better than all that had preceded them.

85. If you look accurately through the records of the lives that have been most useful to humanity, you will find that all that has been done best, has been done so;—that to the clearest intellects and highest souls,—to the true children of the Father, with whom a thousand years are as one day, their poor seventy years are but as seven days. The removal of the shadow of death from them to an uncertain, but always narrow, distance, never takes away from them their intuition of its approach; the extending to them of a few hours more or less of light abates not their acknowledgment of the infinitude that must be known to remain beyond their knowledge,—done beyond their deeds: the unprofitableness of their momentary service is wrought in a magnificent despair, and their very honour is bequeathed by them for the joy of others, as they lie down to their rest, regarding for themselves the voice of men no more.

86. The best things, I repeat to you, have been done thus, and therefore, sorrowfully. But the greatest part of the good work of the world is done either in pure and unvexed instinct

of duty, 'I have stubbed Thornaby waste,' or else, and better, it is cheerful and helpful doing of what the hand finds to do, in surety that at evening time, whatsoever is right, the Master will give. And that it be worthily done, depends wholly on that ultimate quantity of worth which you can measure, each in himself, by the test I have just given you. For that test, observe, will mark to you the precise force, first of your absolute courage, and then of the energy in you for the right ordering of things, and the kindly dealing with persons. You have cut away from these two instincts every selfish or common motive, and left nothing but the energies of Order and of Love.

87. Now, where those two roots are set, all the other powers and desires find right nourishment, and become to their own utmost, helpful to others and pleasurable to ourselves. And so far as those two springs of action are not in us, all other powers become corrupt or dead; even the love of truth, apart from these, hardens into an insolent and cold avarice of knowledge, which unused, is more vain than unused gold.

88. These, then, are the two essential instincts of humanity: the love of Order and the love of Kindness. By the love of order the moral energy is to deal with the earth, and to dress it, and keep it; and with all rebellious and dissolute forces in lower creatures, or in ourselves. By the love of doing kindness it is to deal rightly with all surrounding life. And then, grafted on these, we are to make every other passion perfect; so that they may every one have full strength and yet be absolutely under control.

89. Every one must be strong, every one perfect, every one obedient as a war horse. And it is among the most beautiful pieces of mysticism to which eternal truth is attached, that the chariot race, which Plato uses as an image of moral government, and which is indeed the most perfect type of it in any visible skill of men, should have been made by the Greeks the continual subject of their best poetry and best art. Nevertheless, Plato's use of it is not altogether true. There is no black horse in the chariot of the soul. One of the driver's worst faults is in starving his horses; another, in not break-

ing them early enough ; but they are all good. Take, for example, one usually thought of as wholly evil—that of Anger, leading to vengeance. I believe it to be quite one of the crowning wickednesses of this age that we have starved and chilled our faculty of indignation, and neither desire nor dare to punish crimes justly. We have taken up the benevolent idea, forsooth, that justice is to be preventive instead of vindictive ; and we imagine that we are to punish, not in anger, but in expediency ; not that we may give deserved pain to the person in fault, but that we may frighten other people from committing the same fault. The beautiful theory of this non-vindictive justice is, that having convicted a man of a crime worthy of death, we entirely pardon the criminal, restore him to his place in our affection and esteem, and then hang him, not as a malefactor, but as a scarecrow. That is the theory. And the practice is, that we send a child to prison for a month for stealing a handful of walnuts, for fear that other children should come to steal more of our walnuts. And we do not punish a swindler for ruining a thousand families, because we think swindling is a wholesome excitement to trade.

90. But all true justice is vindictive to vice as it is rewarding to virtue. Only—and herein it is distinguished from personal revenge—it is vindictive of the wrong done, not of the wrong done *to us*. It is the national expression of deliberate anger, as of deliberate gratitude ; it is not exemplary, or even corrective, but essentially retributive ; it is the absolute art of measured recompense, giving honour where honour is due, and shame where shame is due, and joy where joy is due, and pain where pain is due. It is neither educational, for men are to be educated by wholesome habit, not by rewards and punishments ; nor is it preventive, for it is to be executed without regard to any consequences ; but only for righteousness' sake, a righteous nation does judgment and justice. But in this, as in all other instances, the rightness of the secondary passion depends on its being grafted on those two primary instincts, the love of order and of kindness, so that indignation itself is against the wounding of love. Do you think the *μηδης Ἀχιλλῆος* came of a hard heart in Achilles, or

the 'Pallas te hoc vulnere, Pallas,' of a hard heart in Anchises' son?

91. And now, if with this clue through the labyrinth of them, you remember the course of the arts of great nations, you will perceive that whatever has prospered, and become lovely, had its beginning—for no other was possible—in the love of order in material things associated with true *δικαιοσύνη*, and the desire of beauty in material things, which is associated with true affection, *charitas*; and with the innumerable conditions of true gentleness expressed by the different uses of the words *χάρις* and *gratia*. You will find that this love of beauty is an essential part of all healthy human nature, and though it can long co-exist with states of life in many other respects unvirtuous, it is itself wholly good;—the direct adversary of envy, avarice, mean worldly care, and especially of cruelty. It entirely perishes when these are wilfully indulged; and the men in whom it has been most strong have always been compassionate, and lovers of justice, and the earliest discerners and declarers of things conducive to the happiness of mankind.

92. Nearly every important truth respecting the love of beauty in its familiar relations to human life was mythically expressed by the Greeks in their various accounts of the parentage and offices of the Graces. But one fact, the most vital of all, they could not in its fulness perceive, namely, that the intensity of other perceptions of beauty is exactly commensurate with the imaginative purity of the passion of love, and with the singleness of its devotion. They were not fully conscious of, and could not therefore either mythically or philosophically express, the deep relation within themselves between their power of perceiving beauty, and the honour of domestic affection which found their sternest themes of tragedy in the infringement of its laws;—which made the rape of Helen the chief subject of their epic poetry, and which fastened their clearest symbolism of resurrection on the story of Alcestis. Unhappily, the subordinate position of their most revered women, and the partial corruption of feeling towards them by the presence of certain other singular states of in-

ferior passion which it is as difficult as grievous to analyse, arrested the ethical as well as the formative progress of the Greek mind ; and it was not until after an interval of nearly two thousand years of various error and pain, that, partly as the true reward of Christian warfare nobly sustained through centuries of trial, and partly as the visionary culmination of the faith which saw in a maiden's purity the link between God and her race, the highest and holiest strength of mortal love was reached ; and, together with it, in the song of Dante, and the painting of Bernard of Luino and his fellows, the perception, and embodiment for ever of whatsoever things are pure, whatsoever things are lovely, whatsoever things are of good report ;—that, if there be any virtue, and if there be any praise, men might think on those things.

93. You probably observed the expression I used a moment ago, the *imaginative* purity of the passion of love. I have not yet spoken, nor is it possible for me to-day to speak adequately, of the moral power of the imagination : but you may for yourselves enough discern its nature merely by comparing the dignity of the relations between the sexes, from their lowest level in moths or mollusca, through the higher creatures in whom they become a domestic influence and law, up to the love of pure men and women ; and, finally, to the ideal love which animated chivalry. Throughout this vast ascent it is the gradual increase of the imaginative faculty which exalts and enlarges the authority of the passion until, at its height, it is the bulwark of patience, the tutor of honour, and the perfectness of praise.

94. You will find farther, that as of love, so of all the other passions, the right government and exaltation begins in that of the Imagination, which is lord over them. For to *subdue* the passions, which is thought so often to be the sum of duty respecting them, is possible enough to a proud dulness ; but to *excite* them rightly, and make them strong for good, is the work of the unselfish imagination. It is constantly said that human nature is heartless. Do not believe it. Human nature is kind and generous ; but it is narrow and blind ; and can only with difficulty conceive anything but what it imme-

diately sees and feels. People would instantly care for others as well as themselves if only they could *imagine* others as well as themselves. Let a child fall into the river before the roughest man's eyes ;—he will usually do what he can to get it out, even at some risk to himself ; and all the town will triumph in the saving of one little life. Let the same man be shown that hundreds of children are dying of fever for want of some sanitary measure which it will cost him trouble to urge, and he will make no effort ; and probably all the town would resist him if he did. So, also, the lives of many deserving women are passed in a succession of petty anxieties about themselves, and gleaning of minute interests and mean pleasures in their immediate circle, because they are never taught to make any effort to look beyond it ; or to know anything about the mighty world in which their lives are fading, like blades of bitter grass in fruitless fields.

95. I had intended to enlarge on this—and yet more on the kingdom which every man holds in his conceptive faculty, to be peopled with active thoughts and lovely presences, or left waste for the springing up of those dark desires and dreams of which it is written that ‘ every imagination of the thoughts of man's heart is evil continually.’ True, and a thousand times true it is, that, here at least, ‘ greater is he that ruleth his spirit, than he that taketh a city.’ But this you can partly follow out for yourselves without help, partly we must leave it for future enquiry. I press to the conclusion which I wish to leave with you, that all you can rightly do, or honourably become, depends on the government of these two instincts of order and kindness, by this great Imaginative faculty, which gives you inheritance of the past, grasp of the present, authority over the future. Map out the spaces of your possible lives by its help ; measure the range of their possible agency ! On the walls and towers of this your fair city, there is not an ornament of which the first origin may not be traced back to the thoughts of men who died two thousand years ago. Whom will *you* be governing by your thoughts, two thousand years hence ? Think of it, and you will find that so far from art being immoral, little else except art is moral ; that life

without industry is guilt, and industry without art is brutality; and for the words 'good' and 'wicked,' used of men, you may almost substitute the words 'Makers' or 'Destroyers.' Far the greater part of the seeming prosperity of the world is, so far as our present knowledge extends, vain: wholly useless for any kind of good, but having assigned to it a certain inevitable sequence of destruction and of sorrow. Its stress is only the stress of wandering storm; its beauty the hectic of plague: and what is called the history of mankind is too often the record of the whirlwind, and the map of the spreading of the leprosy. But underneath all that, or in narrow spaces of dominion in the midst of it, the work of every man, 'qui non accepit in vanitatem animam suam,' endures and prospers; a small remnant or green bud of it prevailing at last over evil. And though faint with sickness, and encumbered in ruin, the true workers redeem inch by inch the wilderness into garden ground; by the help of their joined hands the order of all things is surely sustained and vitally expanded, and although with strange vacillation, in the eyes of the watcher, the morning cometh, and also the night, there is no hour of human existence that does not draw on towards the perfect day.

96. And perfect the day shall be, when it is of all men understood that the beauty of Holiness must be in labour as well as in rest. Nay! *more*, if it may be, in labour; in our strength, rather than in our weakness; and in the choice of what we shall work for through the six days, and may know to be good at their evening time, than in the choice of what we pray for on the seventh, of reward or repose. With the multitude that keep holiday, we may perhaps sometimes vainly have gone up to the house of the Lord, and vainly there asked for what we fancied would be mercy; but for the few who labour as their Lord would have them, the mercy needs no seeking, and their wide home no hallowing. Surely goodness and mercy shall *follow* them, *all* the days of their life; and they shall dwell in the house of the Lord—FOR EVER

LECTURE IV.

THE RELATION OF ART TO USE.

97. OUR subject of enquiry to-day, you will remember, is the mode in which fine art is founded upon, or may contribute to, the practical requirements of human life.

Its offices in this respect are mainly twofold ; it gives Form to knowledge, and Grace to utility ; that is to say, it makes permanently visible to us things which otherwise could neither be described by our science, nor retained by our memory ; and it gives delightfulness and worth to the implements of daily use, and materials of dress, furniture, and lodging. In the first of these offices it gives precision and charm to truth ; in the second it gives precision and charm to service. For, the moment we make anything useful thoroughly, it is a law of nature that we shall be pleased with ourselves, and with the thing we have made ; and become desirous therefore to adorn or complete it, in some dainty way, with finer art expressive of our pleasure.

And the point I wish chiefly to bring before you to-day is this close and healthy connection of the fine arts with material use ; but I must first try briefly to put in clear light the function of art in giving Form to truth.

98. Much that I have hitherto tried to teach has been disputed on the ground that I have attached too much importance to art as representing natural facts, and too little to it as a source of pleasure. And I wish, in the close of these four prefatory lectures, strongly to assert to you, and, so far as I can in the time, convince you, that the entire vitality of art depends upon its being either full of truth, or full of use ; and that, however pleasant, wonderful, or impressive it may be in itself, it must yet be of inferior kind, and tend to deeper inferiority, unless it has clearly one of these main objects,—either *to state a true thing*, or *to adorn a serviceable one*. It must never exist alone,—never for itself ; it exists rightly only

when it is the means of knowledge, or the grace of agency for life.

99. Now, I pray you to observe—for though I have said this often before, I have never yet said it clearly enough—every good piece of art, to whichever of these ends it may be directed, involves first essentially the evidence of human skill, and the formation of an actually beautiful thing by it.

Skill, and beauty, always then ; and, beyond these, the formative arts have always one or other of the two objects which I have just defined to you—truth, or serviceableness ; and without these aims neither the skill nor their beauty will avail ; only by these can either legitimately reign. All the graphic arts begin in keeping the outline of shadow that we have loved, and they end in giving to it the aspect of life ; and all the architectural arts begin in the shaping of the cup and the platter, and they end in a glorified roof.

Therefore, you see, in the graphic arts you have Skill, Beauty, and Likeness ; and in the architectural arts Skill, Beauty, and Use ; and you *must* have the three in each group, balanced and co-ordinate ; and all the chief errors of art consist in losing or exaggerating one of these elements.

100. For instance, almost the whole system and hope of modern life are founded on the notion that you may substitute mechanism for skill, photograph for picture, cast-iron for sculpture. That is your main nineteenth-century faith, or infidelity. You think you can get everything by grinding—music, literature, and painting. You will find it grievously not so ; you can get nothing but dust by mere grinding. Even to have the barley-meal out of it, you must have the barley first ; and that comes by growth, not grinding. But essentially, we have lost our delight in Skill ; in that majesty of it which I was trying to make clear to you in my last address, and which long ago I tried to express, under the head of ideas of power. The entire sense of that, we have lost, because we ourselves do not take pains enough to do right, and have no conception of what the right costs ; so that all the joy and reverence we ought to feel in looking at a strong man's work have ceased in us. We keep them yet a little in

looking at a honeycomb or a bird's-nest ; we understand that these differ, by divinity of skill, from a lump of wax or a cluster of sticks. But a picture, which is a much more wonderful thing than a honeycomb or a bird's-nest,—have we not known people, and sensible people too, who expected to be taught to produce that, in six lessons?

101. Well, you must have the skill, you must have the beauty, which is the highest moral element ; and then, lastly, you must have the verity or utility, which is not the moral, but the vital element ; and this desire for verity and use is the one aim of the three that always leads in great schools, and in the minds of great masters, without any exception. They will permit themselves in awkwardness, they will permit themselves in ugliness ;—but they will never permit themselves in uselessness or in unverity.

102. And farther, as their skill increases, and as their grace, so much more, their desire for truth. It is impossible to find the three motives in fairer balance and harmony than in our own Reynolds. He rejoices in showing you his skill ; and those of you who succeed in learning what painters' work really is will one day rejoice also, even to laughter—that highest laughter which springs of pure delight, in watching the fortitude and the fire of a hand which strikes forth its will upon the canvas as easily as the wind strikes it on the sea. He rejoices in all abstract beauty and rhythm and melody of design ; he will never give you a colour that is not lovely, nor a shade that is unnecessary, nor a line that is ungraceful. But all his power and all his invention are held by him subordinate,—and the more obediently because of their nobleness,—to his true leading purpose of setting before you such likeness of the living presence of an English gentleman or an English lady, as shall be worthy of being looked upon for ever.

103. But farther, you remember, I hope—for I said it in a way that I thought would shock you a little, that you might remember it—my statement, that art had never done more than this, never more than given the likeness of a noble human being. Not only so, but it very seldom does so much

as this ; and the best pictures that exist of the great schools are all portraits, or groups of portraits, often of very simple and nowise noble persons. You may have much more brilliant and impressive qualities in imaginative pictures ; you may have figures scattered like clouds, or garlanded like flowers ; you may have light and shade, as of a tempest, and colour, as of the rainbow ; but all that is child's play to the great men, though it is astonishment to us. Their real strength is tried to the utmost, and as far as I know it is never elsewhere brought out so thoroughly, as in painting one man or woman, and the soul that was in them ; nor that always the highest soul, but often only a thwarted one that was capable of height ; or perhaps not even that, but faultful and poor, yet seen through, to the poor best of it, by the masterful sight. So that in order to put before you in your Standard series the best art possible, I am obliged, even from the very strongest men, to take the portraits, before I take the idealism. Nay, whatever is best in the great compositions themselves has depended on portraiture ; and the study necessary to enable you to understand invention will also convince you that the mind of man never invented a greater thing than the form of man, animated by faithful life. Every attempt to refine or exalt such healthy humanity has weakened or caricatured it ; or else consists only in giving it, to please our fancy, the wings of birds, or the eyes of antelopes. Whatever is truly great in either Greek or Christian art, is also restrictedly human ; and even the raptures of the redeemed souls who enter, ' celestemente ballando,' the gate of Angelico's Paradise, were seen first in the terrestrial, yet most pure, mirth of Florentine maidens.

104. I am aware that this cannot but at present appear gravely questionable to those of my audience who are strictly cognizant of the phases of Greek art ; for they know that the moment of its decline is accurately marked, by its turning from abstract form to portraiture. But the reason of this is simple. The progressive course of Greek art was in subduing monstrous conceptions to natural ones ; it did this by general laws ; it reached absolute truth of generic human form, and

if its ethical force had remained, would have advanced into healthy portraiture. But at the moment of change the national life ended in Greece; and portraiture, there, meant insult to her religion, and flattery to her tyrants. And her skill perished, not because she became true in sight, but because she became vile in heart.

105. And now let us think of our own work, and ask how that may become, in its own poor measure, active in some verity of representation. We certainly cannot begin by drawing kings or queens; but we must try, even in our earliest work, if it is to prosper, to draw something that will convey true knowledge both to ourselves and others. And I think you will find greatest advantage in the endeavour to give more life and educational power to the simpler branches of natural science: for the great scientific men are all so eager in advance that they have no time to popularise their discoveries, and if we can glean after them a little, and make pictures of the things which science describes, we shall find the service a worthy one. Not only so, but we may even be helpful to science herself; for she has suffered by her proud severance from the arts; and having made too little effort to realise her discoveries to vulgar eyes, has herself lost true measure of what was chiefly precious in them.

106. Take Botany, for instance. Our scientific botanists are, I think, chiefly at present occupied in distinguishing species, which perfect methods of distinction will probably in the future show to be indistinct;—in inventing descriptive names of which a more advanced science and more fastidious scholarship will show some to be unnecessary, and others inadmissible;—and in microscopic investigations of structure, which through many alternate links of triumphant discovery that tissues are composed of vessels, and that vessels are composed of tissue, have not hitherto completely explained to us either the origin, the energy, or the course of the sap; and which, however subtle or successful, bear to the real natural history of plants only the relation that anatomy and organic chemistry bear to the history of men. In the meantime, our artists are so generally convinced of the truth of the Darwinian theory, that

they do not always think it necessary to show any difference between the foliage of an elm and an oak ; and the gift-books of Christmas have every page surrounded with laboriously engraved garlands of rose, shamrock, thistle, and forget-me-not, without its being thought proper by the draughtsmen, or desirable by the public, even in the case of those uncommon flowers, to observe the real shape of the petals of any one of them.

107. Now what we especially need at present for educational purposes is to know, not the anatomy of plants, but their biography—how and where they live and die, their tempers, benevolences, malignities, distresses, and virtues. We want them drawn from their youth to their age, from bud to fruit. We ought to see the various forms of their diminished but hardy growth in cold climates, or poor soils ; and their rank or wild luxuriance, when full-fed, and warmly nursed. And all this we ought to have drawn so accurately, that we might at once compare any given part of a plant with the same part of any other, drawn on the like conditions. Now, is not this a work which we may set about here in Oxford, with good hope and much pleasure ? I think it so important, that the first exercise in drawing I shall put before you will be an outline of a laurel leaf. You will find in the opening sentence of Lionardo's treatise, our present text-book, that you must not at first draw from nature, but from a good master's work, '*per assuefarsi a buone membra,*' to accustom yourselves, that is, to entirely good representative organic forms. So your first exercise shall be the top of the laurel sceptre of Apollo, drawn by an Italian engraver of Lionardo's own time ; then we will draw a laurel leaf itself ; and little by little, I think we may both learn ourselves, and teach to many besides, somewhat more than we know yet, of the wild olives of Greece, and the wild roses of England.

108. Next, in Geology, which I will take leave to consider as an entirely separate science from the zoology of the past, which has lately usurped its name and interest. In geology itself we find the strength of many able men occupied in debating questions of which there are yet no data even for the

clear statement ; and in seizing advanced theoretical positions on the mere contingency of their being afterwards tenable ; while, in the meantime, no simple person, taking a holiday in Cumberland, can get an intelligible section of Skiddaw, or a clear account of the origin of the Skiddaw slates ; and while, though half the educated society of London travel every summer over the great plain of Switzerland, none know, or care to know, why that is a plain and the Alps to the south of it are Alps ; and whether or not the gravel of the one has anything to do with the rocks of the other. And though every palace in Europe owes part of its decoration to variegated marbles, and nearly every woman in Europe part of her decoration to pieces of jasper or chalcedony, I do not think any geologist could at this moment with authority tell us either how a piece of marble is stained, or what causes the streaks in a Scotch pebble.

109. Now, as soon as you have obtained the power of drawing, I do not say a mountain, but even a stone, accurately, every question of this kind will become to you at once attractive and definite ; you will find that in the grain, the lustre, and the cleavage-lines of the smallest fragment of rock, there are recorded forces of every order and magnitude, from those which raise a continent by one volcanic effort, to those which at every instant are polishing the apparently complete crystal in its nest, and conducting the apparently motionless metal in its vein ; and that only by the art of your own hand, and fidelity of sight which it developes, you can obtain true perception of these invincible and inimitable arts of the earth herself : while the comparatively slight effort necessary to obtain so much skill as may serviceably draw mountains in distant effect will be instantly rewarded by what is almost equivalent to a new sense of the conditions of their structure.

110. And, because it is well at once to know some direction in which our work may be definite, let me suggest to those of you who may intend passing their vacation in Switzerland, and who care about mountains, that if they will first qualify themselves to take angles of position and elevation with correctness, and to draw outlines with approximate fidelity, there

are a series of problems of the highest interest to be worked out on the southern edge of the Swiss plain, in the study of the relations of its molasse beds to the rocks which are characteristically developed in the chain of the Stockhorn, Beatenberg, Pilate, Mythen above Schwytz, and High Sentis of Appenzell; the pursuit of which may lead them into many pleasant, as well as creditably dangerous, walks, and curious discoveries; and will be good for the discipline of their fingers in the pencilling of crag form.

111. I wish I could ask you to draw, instead of the Alps, the crests of Parnassus and Olympus, and the ravines of Delphi and of Tempe. I have not loved the arts of Greece as others have; yet I love them, and her, so much, that it is to me simply a standing marvel how scholars can endure for all these centuries, during which their chief education has been in the language and policy of Greece, to have only the names of her hills and rivers upon their lips, and never one line of conception of them in their mind's sight. Which of us knows what the valley of Sparta is like, or the great mountain vase of Arcadia? which of us, except in mere airy syllabing of names, knows aught of 'sandy Ladon's liliated banks, or old Lycaeus, or Cyllene hoar?' 'You cannot travel in Greece?'—I know it; nor in Magna Græcia. But, gentlemen of England, you had better find out why you cannot, and put an end to that horror of European shame, before you hope to learn Greek art.

112. I scarcely know whether to place among the things useful to art, or to science, the systematic record, by drawing, of phenomena of the sky. But I am quite sure that your work cannot in any direction be more useful to yourselves, than in enabling you to perceive the quite unparalleled subtilities of colour and inorganic form, which occur on any ordinarily fine morning or evening horizon; and I will even confess to you another of my perhaps too sanguine expectations, that in some far distant time it may come to pass, that young Englishmen and Englishwomen may think the breath of the morning sky pleasanter than that of midnight, and its light prettier than that of candles.

113. Lastly, in Zoology. What the Greeks did for the horse, and what, as far as regards domestic and expressional character, Landseer has done for the dog and the deer, remains to be done by art for nearly all other animals of high organisation. There are few birds or beasts that have not a range of character which, if not equal to that of the horse or dog, is yet as interesting within narrower limits, and often in grotesqueness, intensity, or wild and timid pathos, more singular and mysterious. Whatever love of humour you have,—whatever sympathy with imperfect, but most subtle, feeling,—whatever perception of sublimity in conditions of fatal power,—may here find fullest occupation : all these being joined, in the strong animal races, to a variable and fantastic beauty far beyond anything that merely formative art has yet conceived. I have placed in your Educational series a wing by Albert Dürer, which goes as far as art yet has reached in delineation of plumage ; while for the simple action of the pinion, it is impossible to go beyond what has been done already by Titian and Tintoret ; but you cannot so much as once look at the ruffings of the plumes of a pelican pluming itself after it has been in the water, or carefully draw the contours of the wing either of a vulture or a common swift, or paint the rose and vermilion of that of a flamingo, without receiving almost a new conception of the meaning of form and colour in creation.

114. Lastly. Your work, in all directions I have hitherto indicated, may be as deliberate as you choose ; there is no immediate fear of the extinction of many species of flowers or animals ; and the Alps, and valley of Sparta, will wait your leisure, I fear too long. But the feudal and monastic buildings of Europe, and still more the streets of her ancient cities, are vanishing like dreams : and it is difficult to imagine the mingled envy and contempt with which future generations will look back to us, who still possessed such things, yet made no effort to preserve, and scarcely any to delineate them : for, when used as material of landscape by the modern artist, they are nearly always superficially or flatteringly represented, without zeal enough to penetrate their character, or patience enough to render it in modest harmony. As for places of

traditional interest, I do not know an entirely faithful drawing of any historical site, except one or two studies made by enthusiastic young painters in Palestine and Egypt : for which, thanks to them always ; but we want work nearer home.

115. Now it is quite probable that some of you, who will not care to go through the labour necessary to draw flowers or animals, may yet have pleasure in attaining some moderately accurate skill of sketching architecture, and greater pleasure still in directing it usefully. Suppose, for instance, we were to take up the historical scenery in Carlyle's 'Friederick.' Too justly the historian accuses the genius of past art, in that, types of too many such elsewhere, the galleries of Berlin—are made up, like other galleries, of goat-footed Pan, Europa's Bull, Romulus's She-Wolf, and the Correggiosity of Correggio, and contain, for instance, no portrait of Friedrich the Great,—no likeness at all, or next to none at all, of the noble series of Human Realities, or of any part of them, who have sprung, not from the idle brains of dreaming *dilettanti*, but from the head of God Almighty, to make this poor authentic earth a little memorable for us, and to do a little work that may be eternal there.' So Carlyle tells us—too truly ! We cannot now draw Friedrich for him, but we can draw some of the old castles and cities that were the cradles of German life—Hohenzollern, Hapsburg, Marburg, and such others ;—we may keep some authentic likeness of these for the future. Suppose we were to take up that first volume of 'Friedrich,' and put outlines to it ? shall we begin by looking for Henry the Fowler's tomb—Carlyle himself asks if he has any—at Quedlinburg, and so downwards, rescuing what we can ? That would certainly be making our work of some true use.

116. But I have told you enough, it seems to me, at least to-day, of this function of art in recording fact ; let me now finally, and with all distinctness possible to me, state to you its main business of all ;—its service in the actual uses of daily life.

You are surprised, perhaps, to hear me call this its main business. That is indeed so, however. The giving brightness to picture is much, but the giving brightness to life more.

And remember, were it as patterns only, you cannot, without the realities, have the pictures. You cannot have a landscape by Turner, without a country for him to paint; you cannot have a portrait by Titian, without a man to be portrayed. I need not prove that to you, I suppose, in these short terms; but in the outcome I can get no soul to believe that the beginning of art is in getting our country clean and our people beautiful. I have been ten years trying to get this very plain certainty—I do not say believed—but even thought of, as anything but a monstrous proposition. To get your country clean, and your people lovely;—I assure you, that is a necessary work of art to begin with! There has indeed been art in countries where people lived in dirt to serve God, but never in countries where they lived in dirt to serve the devil. There has indeed been art where the people were not all lovely,—where even their lips were thick—and their skins black, because the sun had looked upon them; but never in a country where the people were pale with miserable toil and deadly shade, and where the lips of youth, instead of being full with blood, were pinched by famine, or warped with poison. And now, therefore, note this well, the gist of all these long prefatory talks. I said that the two great moral instincts were those of Order and Kindness. Now, all the arts are founded on agriculture by the hand, and on the graces, and kindness of feeding and dressing, and lodging your people. Greek art begins in the gardens of Alcinous—perfect order, leeks in beds, and fountains in pipes. And Christian art, as it arose out of chivalry, was only possible so far as chivalry compelled both kings and knights to care for the right personal training of their people; it perished utterly when those kings and knights became *δημοβόροι*, devourers of the people. And it will become possible again only, when, literally, the sword is beaten into the ploughshare, when your St. George of England shall justify his name, and Christian art shall be known, as its Master was, in breaking of bread.

117. Now look at the working out of this broad principle in minor detail; observe how, from highest to lowest, health of art has first depended on reference to industrial use. There

is first the need of cup and platter, especially of cup ; for you can put your meat on the Harpies', or any other, tables ; but you must have your cup to drink from. And to hold it conveniently, you must put a handle to it ; and to fill it when it is empty you must have a large pitcher of some sort ; and to carry the pitcher you may most advisably have two handles. Modify the forms of these needful possessions according to the various requirements of drinking largely and drinking delicately ; of pouring easily out, or of keeping for years the perfume in ; of storing in cellars, or bearing from fountains ; of sacrificial libation, of Pan, athenaic treasure of oil, and sepulchral treasure of ashes—and you have a resultant series of beautiful form and decoration, from the rude amphora of red earth up to Cellini's vases of gems and crystal, in which series, but especially in the more simple conditions of it, are developed the most beautiful lines and most perfect types of severe composition which have yet been attained by art.

118. But again, that you may fill your cup with pure water, you must go to the well or spring ; you need a fence round the well ; you need some tube or trough, or other means of confining the stream at the spring. For the conveyance of the current to any distance you must build either enclosed or open aqueduct ; and in the hot square of the city where you set it free, you find it good for health and pleasantness to let it leap into a fountain. On these several needs you have a school of sculpture founded ; in the decoration of the walls of wells in level countries, and of the sources of springs in mountainous ones, and chiefly of all, where the women of household or market meet at the city fountain. There is, however, a farther reason for the use of art here than in any other material service, so far as we may, by art, express our reverence or thankfulness. Whenever a nation is in its right mind, it always has a deep sense of divinity in the gift of rain from heaven, filling its heart with food and gladness ; and all the more when that gift becomes gentle and perennial in the flowing of springs. It literally is not possible that any fruitful power of the Muses should be put forth upon a people

which disdains their Helicon ; still less is it possible that any Christian nation should grow up ‘*tanquam lignum quod plantatum est secus decursus aquarum,*’ which cannot recognise the lesson meant in their being told of the places where Rebekah was met ;—where Rachel,—where Zipporah,—and she who was asked for water under Mount Gerizim by a Stranger, weary, who had nothing to draw with.

119. And truly, when our mountain springs are set apart in vale or craggy glen, or glade of wood green through the drought of summer, far from cities, then it is best let them stay in their own happy peace ; but if near towns, and liable therefore to be defiled by common usage, we could not use the loveliest art more worthily than by sheltering the spring and its first pools with precious marbles : nor ought anything to be esteemed more important, as a means of healthy education, than the care to keep the streams of it afterwards, to as great a distance as possible, pure, full of fish, and easily accessible to children. There used to be, thirty years ago, a little rivulet of the Wandel, about an inch deep, which ran over the carriage-road and under a foot-bridge just under the last chalk hill near Croydon. Alas ! men came and went ; and it—did *not* go on for ever. It has long since been bricked over by the parish authorities ; but there was more education in that stream with its minnows than you could get out of a hundred pounds spent yearly in the parish schools, even though you were to spend every farthing of it in teaching the nature of oxygen and hydrogen, and the names, and rate per minute, of all the rivers in Asia and America.

120. Well, the gist of this matter lies here then. Suppose we want a school of pottery again in England, all we poor artists are ready to do the best we can, to show you how pretty a line may be that is twisted first to one side, and then to the other ; and how a plain household-blue will make a pattern on white ; and how ideal art may be got out of the spaniel’s colours, of black and tan. But I tell you beforehand, all that we can do will be utterly useless, unless you teach our peasant to say grace, not only before meat, but before rink ; and having provided him with Greek cups and plat-

ters, provide him also with something that is not poisoned to put into them.

121. There cannot be any need that I should trace for you the conditions of art that are directly founded on serviceableness of dress, and of armour ; but it is my duty to affirm to you, in the most positive manner, that after recovering, for the poor, wholesomeness of food, your next step towards founding schools of art in England must be in recovering, for the poor, decency and wholesomeness of dress ; thoroughly good in substance, fitted for their daily work, becoming to their rank in life, and worn with order and dignity. And this order and dignity must be taught them by the women of the upper and middle classes, whose minds can be in nothing right, as long as they are so wrong in this matter as to endure the squalor of the poor, while they themselves dress gaily. And on the proper pride and comfort of both poor and rich in dress, must be founded the true arts of dress ; carried on by masters of manufacture no less careful of the perfectness and beauty of their tissues, and of all that in substance and in design can be bestowed upon them, than ever the armourers of Milan and Damascus were careful of their steel.

122. Then, in the third place, having recovered some wholesome habits of life as to food and dress, we must recover them as to lodging. I said just now that the best architecture was but a glorified roof. Think of it. The dome of the Vatican, the porches of Rheims or Chartres, the vaults and arches of their aisles, the canopy of the tomb, and the spire of the belfry, are all forms resulting from the mere requirement that a certain space shall be strongly covered from heat and rain. More than that—as I have tried all through ‘The Stones of Venice’ to show—the lovely forms of these were every one of them developed in civil and domestic building, and only after their invention employed ecclesiastically on the grandest scale. I do not know whether you have noticed, but I think you cannot but have noticed, here in Oxford, as elsewhere, that our modern architects never seem to know what to do with their roofs. Be assured, until the roofs are right, nothing else will be ; and there are just two ways of keepi-

them right. Never build them of iron, but only of wood or stone; and secondly, take care that in every town the little roofs are built before the large ones, and that everybody who wants one has got one. And we must try also to make everybody want one. That is to say, at some not very advanced period of life, men should desire to have a home, which they do not wish to quit any more, suited to their habits of life, and likely to be more and more suitable to them until their death. And men must desire to have these their dwelling-places built as strongly as possible, and furnished and decorated daintily, and set in pleasant places, in bright light and good air, being able to choose for themselves that at least as well as swallows. And when the houses are grouped together in cities, men must have so much civic fellowship as to subject their architecture to a common law, and so much civic pride as to desire that the whole gathered group of human dwellings should be a lovely thing, not a frightful one, on the face of the earth. Not many weeks ago an English clergyman, a master of this University, a man not given to sentiment, but of middle age, and great practical sense, told me, by accident, and wholly without reference to the subject now before us, that he never could enter London from his country parsonage but with closed eyes, lest the sight of the blocks of houses which the railroad intersected in the suburbs should unfit him, by the horror of it, for his day's work.

123. Now, it is not possible—and I repeat to you, only in more deliberate assertion, what I wrote just twenty-two years ago in the last chapter of the 'Seven Lamps of Architecture'—it is not possible to have any right morality, happiness, or art in any country where the cities are thus built, or thus, let me rather say, clotted and coagulated; spots of a dreadful mildew spreading by patches and blotches over the country they consume. You must have lovely cities, crystallised, not coagulated, into form; limited in size, and not casting out the scum and scurf of them into an encircling eruption of shame, but girded each with its sacred pomœrium, and with garlands of gardens full of blossoming trees, and softly guided streams.

That is impossible, you say! It may be so. I have nothing to do with its possibility, but only with its indispensability. More than that must be possible, however, before you can have a school of art; namely, that you find places elsewhere than in England, or at least in otherwise unserviceable parts of England, for the establishment of manufactories needing the help of fire, that is to say, of all the τέχνη βαρυντικὴ and ἐπίρρητοι, of which it was long ago known to be the constant nature that 'ἀσχολίας μάλιστα ἔχουσι καὶ φίλως καὶ πόλεως συνεπιμελείσθαι,' and to reduce such manufactures to their lowest limit, so that nothing may ever be made of iron that can as effectually be made of wood or stone; and nothing moved by steam that can be as effectually moved by natural forces. And observe, that for all mechanical effort required in social life and in cities, water power is infinitely more than enough; for anchored mills on the large rivers, and mills moved by sluices from reservoirs filled by the tide, will give you command of any quantity of constant motive power you need.

Agriculture by the hand, then, and absolute refusal or banishment of unnecessary igneous force, are the first conditions of a school of art in any country. And until you do this, be it soon or late, things will continue in that triumphant state to which, for want of finer art, your mechanism has brought them;—that, though England is deafened with spinning wheels, her people have not clothes—though she is black with digging of fuel, they die of cold—and though she has sold her soul for gain, they die of hunger. Stay in that triumph, if you choose; but be assured of this, it is not one which the fine arts will ever share with you.

124. Now, I have given you my message, containing, as I know, offence enough, and itself, it may seem to many, unnecessary enough. But just in proportion to its apparent non-necessity, and to its certain offence, was its real need, and my real duty to speak it. The study of the fine arts could not be rightly associated with the grave work of English Universities, without due and clear protest against the misdirection of national energy, which for the present renders all good results of such study on a great scale, impossible. I can easily

teach you, as any other moderately good draughtsman could, how to hold your pencils, and how to lay your colours ; but it is little use my doing that, while the nation is spending millions of money in the destruction of all that pencil or colour have to represent, and in the promotion of false forms of art, which are only the costliest and the least enjoyable of follies. And therefore these are the things that I have first and last to tell you in this place :—that the fine arts are not to be learned by Locomotion, but by making the homes we live in lovely, and by staying in them ;—that the fine arts are not to be learned by Competition, but by doing our quiet best in our own way ;—that the fine arts are not to be learned by Exhibition, but by doing what is right, and making what is honest, whether it be exhibited or not ;—and, for the sum of all, that men must paint and build neither for pride nor for money, but for love ; for love of their art, for love of their neighbour, and whatever better love may be than these, founded on these. I know that I gave some pain, which I was most unwilling to give, in speaking of the possible abuses of religious art ; but there can be no danger of any, so long as we remember that God inhabits cottages as well as churches, and ought to be well lodged there also. Begin with wooden floors ; the tessellated ones will take care of themselves ; begin with thatching roofs, and you shall end by splendidly vaulting them ; begin by taking care that no old eyes fail over their Bibles, nor young ones over their needles, for want of rush-light, and then you may have whatever true good is to be got out of coloured glass or wax candles. And in thus putting the arts to universal use, you will find also their universal inspiration, their universal benediction. I told you there was no evidence of a *special* Divineness in any application of them ; that they were always equally human and equally Divine ; and in closing these inaugural series of lectures, into which I have endeavoured to compress the principles that are to be the foundations of your future work, it is my last duty to say some positive words as to the Divinity of all art, when it is truly fair, or truly serviceable.

125. Every seventh day, if not oftener, the greater number

of well-meaning persons in England thankfully receive from their teachers a benediction, couched in these terms:—‘The Grace of our Lord Christ, and the Love of God, and the Fellowship of the Holy Ghost, be with you.’ Now I do not know precisely what sense is attached in the English public mind to those expressions. But what I have to tell you positively is, that the three things do actually exist, and can be known if you care to know them, and possessed if you care to possess them; and that another thing exists, besides these, of which we already know too much.

First, by simply obeying the orders of the Founder of your religion, all grace, graciousness, or beauty and favour of gentle life, will be given to you in mind and body, in work and and in rest. The Grace of Christ exists, and can be had if you will. Secondly, as you know more and more of the created world, you will find that the true will of its Maker is that its creatures should be happy;—that He has made everything beautiful in its time and its place, and that it is chiefly by the fault of men, when they are allowed the liberty of thwarting His laws, that Creation groans or travails in pain. The Love of God exists, and you may see it, and live in it if you will. Lastly, a Spirit does actually exist which teaches the ant her path, the bird her building, and men, in an instinctive and marvellous way, whatever lovely arts and noble deeds are possible to them. Without it you can do no good thing. To the grief of it you can do many bad ones. In the possession of it is your peace and your power.

And there is a fourth thing, of which we already know too much. There is an evil spirit whose dominion is in blindness and in cowardice, as the dominion of the Spirit of wisdom is in clear sight and in courage.

And this blind and cowardly spirit is for ever telling you that evil things are pardonable, and you shall not die for them, and that good things are impossible, and you need not live for them; and that gospel of his is now the loudest that is preached in your Saxon tongue. You will find some day, to your cost, if you believe the first part of it, that it is not true; but you may never if you believe the second part of it

find, to your gain, that also, untrue ; and therefore I pray you with all earnestness to prove, and know within your hearts, that all things lovely and righteous are possible for those who believe in their possibility, and who determine that, for their part, they will make every day's work contribute to them. Let every dawn of morning be to you as the beginning of life, and every setting sun be to you as its close :—then let every one of these short lives leave its sure record of some kindly thing done for others—some goodly strength or knowledge gained for yourselves ; so, from day to day, and strength to strength, you shall build up indeed, by Art, by Thought, and by Just Will, an Ecclesia of England, of which it shall not be said, ‘ See what manner of stones are here,’ but, ‘ See what manner of men.’

LECTURE V.

LINE.

126. You will, I doubt not, willingly permit me to begin your lessons in real practice of art in words of higher authority than mine (I ought rather to say, of *all* authority, while mine are of none),—the words of the greatest of English painters ; one also, than whom there is indeed no greater, among those of any nation, or any time,—our own gentle Reynolds.

His says in his first discourse :—‘ The Directors’ (of the Academy) ‘ ought more particularly to watch over the genius of those students, who being more advanced, are arrived at that critical period of study, on the nice management of which their future turn of taste depends. At that age it is natural for them to be more captivated with what is brilliant, than with what is solid, and to prefer splendid negligence to painful and humiliating exactness.

‘ A facility in composing,—a lively and, what is called, a masterly handling of the chalk or pencil, are, it must be confessed, captivating qualities to young minds, and become of course the objects of their ambition. They endeavour to imitate these dazzling excellences, which they will find no great

labour in attaining. After much time spent in these frivolous pursuits, the difficulty will be to retreat ; but it will then be too late ; and there is scarce an instance of return to scrupulous labour, after the mind has been debauched and deceived by this fallacious mastery.'

127. I read you these words, chiefly that Sir Joshua, who founded, as first President, the Academical schools of English painting, in these well-known discourses, may also begin, as he has truest right to do, our system of instruction in this University. But secondly, I read them that I may press on your attention these singular words, 'painful and humiliating exactness.' Singular, as expressing the first conditions of the study required from his pupils by the master, who, of all men except Velasquez, seems to have painted with the greatest ease. It is true that he asks this pain, this humiliation, only from youths who intend to follow the profession of artists. But if you wish yourselves to know anything of the practice of art, you must not suppose that because your study will be more desultory than that of Academy students, it may therefore be less accurate. The shorter the time you have to give, the more careful you should be to spend it profitably ; and I would not wish you to devote one hour to the practice of drawing, unless you are resolved to be informed in it of all that in an hour can be taught.

128. I speak of the practice of *drawing* only ; though elementary study of modelling may perhaps some day be advisably connected with it ; but I do not wish to disturb or amuse you with a formal statement of the manifold expectations I have formed respecting your future work. You will not, I am sure, imagine that I have begun without a plan, nor blame my reticence as to the parts of it which cannot yet be put into execution, and which there may occur reason afterwards to modify. My first task must unquestionable be to lay before you right and simple methods of drawing and colouring.

I use the word 'colouring' without reference to any particular vehicle of colour, for the laws of good painting are the same, whatever liquid is employed to dissolve the pigments. But the technical management of oil is more difficult than

that of water-colour, and the impossibility of using it with safety among books or prints, and its unavailableness for note-book sketches and memoranda, are sufficient reasons for not introducing it in a course of practice intended chiefly for students of literature. On the contrary, in the exercises of artists, oil should be the vehicle of colour employed from the first. The extended practice of water-colour painting, as a separate skill, is in every way harmful to the arts: its pleasant slightness and plausible dexterity divert the genius of the painter from its proper aims, and withdraw the attention of the public from excellence of higher claim; nor ought any man, who has the consciousness of ability for good work, to be ignorant of, or indolent in employing, the methods of making its results permanent as long as the laws of Nature allow. It is surely a severe lesson to us in this matter, that the best works of Turner could not be shown to the public for six months without being destroyed,—and that his most ambitious ones for the most part perished, even before they could be shown. I will break through my law of reticence, however, so far as to tell you that I have hope of one day interesting you greatly (with the help of the Florentine masters), in the study of the arts of moulding and painting porcelain; and to induce some of you to use your future power of patronage in encouraging the various branches of this art, and turning the attention of the workmen of Italy from the vulgar tricks of minute and perishable mosaic to the exquisite subtilties of form and colour possible in the perfectly ductile, afterwards unalterable clay. And one of the ultimate results of such craftsmanship might be the production of pictures as brilliant as painted glass,—as delicate as the most subtle water-colours, and more permanent than the Pyramids.

129. And now to begin our own work. In order that we may know how rightly to learn to draw, and to paint, it will be necessary, will it not, that we know first what we are to aim at doing;—what kind of representation of nature is best?

I will tell you in the words of Lionardo. ‘That is the most praiseworthy painting which has most conformity with the thing represented,’ ‘*quella pittura e piu laudabile, la quale*

ha piu conformita con la cosa imitata,' (chap. 276). In plain terms, 'the painting which is likest nature is the best.' And you will find by referring to the preceding chapter, 'come lo specchio e maestro de' pittori,' how absolutely Lionardo means what he says. Let the living thing, (he tells us,) be reflected in a mirror, then put your picture beside the reflection, and match the one with the other. And indeed, the very best painting is unquestionably so like the mirrored truth, that all the world admit its excellence. Entirely first-rate work is so quiet and natural that there can be no dispute over it; you may not particularly admire it, but you will find no fault with it. Second-rate painting pleases one person much, and displeases another; but first-rate painting pleases all a little, and intensely pleases those who can recognise its unostentatious skill.

130. This, then, is what we have first got to do—to make our drawing look as like the thing we have to draw as we can.

Now, all objects are seen by the eye as patches of colour of a certain shape, with gradations of colour within them. And, unless their colours be actually luminous, as those of the sun, or of fire, these patches of different hues are sufficiently imitable, except so far as they are seen stereoscopically. You will find Lionardo again and again insisting on the stereoscopic power of the double sight: but do not let that trouble you; you can only paint what you can see from one point of sight, but that is quite enough. So seen, then, all objects appear to the human eye simply as masses of colour of variable depth, texture, and outline. The outline of any object is the limit of its mass, as relieved against another mass. Take a crocus, and put it on a green cloth. You will see it detach itself as a mere space of yellow from the green behind it, as it does from the grass. Hold it up against the window—you will see it detach itself as a dark space against the white or blue behind it. In either case its outline is the limit of the space of colour by which it expresses itself to your sight. That outline is therefore infinitely subtle—not even a line, but the place of a line, and that, also, made soft by texture. In the finest painting, it is therefore slightly softened; but it is necessary to be able to draw

it with absolute sharpness and precision. The art of doing this is to be obtained by drawing it as an actual line, which art is to be the subject of our present enquiry ; but I must first lay the divisions of the entire subject completely before you.

131. I have said that all objects detach themselves as masses of colour. Usually, light and shade are thought of as separate from colour ; but the fact is that all nature is seen as a mosaic composed of graduated portions of different colours, dark or light. There is no difference in the quality of these colours, except as affected by texture. You will constantly hear lights and shades spoken of as if these were different in nature, and to be painted in different ways. But every light is a shadow compared to higher lights, till we reach the brightness of the sun ; and every shadow is a light compared to lower shadows, till we reach the darkness of night.

Every colour used in painting, except pure white and black, is therefore a light and shade at the same time. It is a light with reference to all below it, and a shade with reference to all above it.

132. The solid forms of an object, that is to say, the projections or recessions of its surface within the outline, are, for the most part, rendered visible by variations in the intensity or quantity of light falling on them. The study of the relations between the quantities of this light, irrespectively of its colour, is the second division of the regulated science of painting.

133. Finally, the qualities and relations of natural colours, the means of imitating them, and the laws by which they become separately beautiful, and in association, harmonious, are the subjects of the third and final division of the painter's study. I shall endeavour at once to state to you what is most immediately desirable for you to know on each of these subjects, in this and the two following lectures.

134. What we have to do, then, from beginning to end, is, I repeat once more, simply to draw spaces of their true shape, and to fill them with colours which shall match their colours ; quite a simple thing in the definition of it, not quite so easy in the doing of it.

But it is something to get this simple definition ; and I wish you to notice that the terms of it are complete, though I do not introduce the terms 'light' or 'shadow.' Painters who have no eye for colour have greatly confused and falsified the practice of art by the theory that shadow is an absence of colour. Shadow is, on the contrary, necessary to the full presence of colour ; for every colour is a diminished quantity or energy of light ; and, practically, it follows, from what I have just told you (that every light in painting is a shadow to higher lights, and every shadow a light to lower shadows) that also every colour in painting must be a shadow to some brighter colour, and a light to some darker one—all the while being a positive colour itself. And the great splendour of the Venetian school arises from their having seen and held from the beginning this great fact—that shadow is as much colour as light, often much more. In Titian's fullest red the lights are pale rose-colour, passing into white—the shadows warm deep crimson. In Veronese's most splendid orange, the lights are pale, the shadows crocus colour ; and so on. In nature, dark sides, if seen by reflected lights, are almost always fuller or warmer in colour than the lights ; and the practice of the Bolognese and Roman schools, in drawing their shadows always dark and cold, is false from the beginning, and renders perfect painting for ever impossible in those schools, and all that follow them.

135. Every visible space, then, be it dark or light, is a space of colour of some kind, or of black or white. And you have to enclose it with a true outline, and to paint it with its true colour.

But before considering how we are to draw this enclosing line, I must state to you something about lines in general, and their use by different schools. I said just now that there was no difference between the masses of colour of which all visible nature is composed, except in *texture*.

1. Textures are principally of three kinds :—

- (1) Lustrous, as of water and glass.
- (2) Bloomy, or velvety, as of a rose-leaf or peach.
- (3) Linear, produced by filaments or threads, as in feathers, fur, hair, and woven or reticulated tissues.

All the three sources of pleasure to the eye in texture are united in the best ornamental work. A fine picture by Fra Angelico, or a fine illuminated page of missal, has large spaces of gold, partly burnished and lustrous, partly dead ;—some of it chased and enriched with linear texture, and mingled with imposed or inlaid colours, soft in bloom like that of the rose-leaf. But many schools of art depend for the most part on one kind of texture only, and a vast quantity of the art of all ages rests for great part of its power especially on texture produced by multitudinous lines. Thus, wood engraving, line engraving properly so called, and countless varieties of sculpture, metal work, and textile fabric, depend for great part of the effect of their colors, or shades, for their mystery, softness, and clearness, on modification of the surfaces by lines or threads ; and even in advanced oil painting, the work often depends for some part of its effect on the texture of the canvas.

136. Again, the arts of etching and mezzotint engraving depend principally for their effect on the velvety, or bloomy texture of their darkness, and the best of all painting is the fresco work of great colourists, in which the colours are what is usually called dead ; but they are anything but dead, they glow with the luminous bloom of life. The frescoes of Correggio, when not repainted, are supreme in this quality ; and you have a lovely example in the University Galleries, in the untouched portion of the female head by Raphael, partly restored by Lawrence.

137. While, however, in all periods of art these different textures are thus used in various styles, and for various purposes, you will find that there is a broad historical division of schools, which will materially assist you in understanding them. The earliest art in most countries is linear, consisting of interwoven, or richly spiral and otherwise involved arrangements of sculptured or painted lines, on stone, wood, metal, or clay. It is generally characteristic of savage life, and of feverish energy of imagination. I shall examine these schools with you hereafter, under the general head of the 'Schools of Line.'

Secondly, even in the earliest periods, among powerful nations, this linear decoration is more or less filled with chequered or barred shade, and begins at once to represent animal or floral form, first in mere outline, and then by outlines filled with flat shadow, or with flat colour. And here we instantly find two great divisions of temper and thought. The Greeks look upon all colour first as light; they are, as compared with other races, insensitive to hue, exquisitely sensitive to phenomena of light. And their linear school passes into one of flat masses of light and darkness, represented in the main by four tints,—white, black, and two reds, one brick colour, more or less vivid, the other dark purple; these two representing their favourite πορφύρεος colour, in its light and dark powers. On the other hand, many of the Northern nations are at first entirely insensible to light and shade, but exquisitely sensitive to colour, and their linear decoration is filled with flat tints, infinitely varied, having no expression of light and shade. Both these schools have a limited but absolute perfection of their own, and their peculiar successes can in no wise be imitated, except by the strictest observance of the same limitations.

138. You have then, Line for the earliest art, branching into—

- (1) Greek, Line with Light.
- (2) Gothic, Line with Colour.

Now, as art completes itself, each of these schools retain their separate characters, but they cease to depend on lines, and learn to represent masses instead, becoming more refined at the same time in all modes of perception and execution.

And thus there arise the two vast mediæval schools; one of flat and infinitely varied colour, with exquisite character and sentiment added, in the forms represented; but little perception of shadow. The other, of light and shade, with exquisite drawing of solid form, and little perception of colour: sometimes as little of sentiment. Of these, the school of flat colour is the more vital one; it is always natural and simple, if not great;—and when it is great, it is very great.

The school of light and shade associates itself with that of engraving; it is essentially an academical school; broadly di-

viding light from darkness, and begins by assuming that the light side of all objects shall be represented by white, and the extreme shadow by black. On this conventional principle it reaches a limited excellence of its own, in which the best existing types of engraving are executed, and ultimately, the most regular expressions of organic form in painting.

Then, lastly,—the schools of colour advance steadily till they adopt from those of light and shade, whatever is compatible with their own power,—and then you have perfect art, represented centrally by that of the great Venetians.

The schools of light and shade, on the other hand, are partly, in their academical formulas, too haughty, and partly, in their narrowness of imagination, too weak, to learn much from the schools of colour; and they pass into a decadence, consisting partly in proud endeavours to give painting the qualities of sculpture, and partly in the pursuit of effects of light and shade, carried at last to extreme sensational subtlety by the Dutch school. In their fall, they drag the schools of colour down with them; and the recent history of art is one of confused effort to find lost roads, and resume allegiance to violated principles.

139. That, briefly, is the map of the great schools, easily remembered by this form:—

LINE.

Early Schools.

LINE AND LIGHT.

Greek clay.

LINE AND COLOUR.

Gothic glass.

MASS AND LIGHT.

(Represented by Lionardo,
and his schools.)

MASS AND COLOUR.

(Represented by Giorgione,
and his schools.)

MASS, LIGHT, AND COLOUR.

(Represented by Titian,
and his schools.)

I will endeavour hereafter to show you the various relations of all these branches; at present, I am only concerned with your own practice. My wish is that you should with your

own eyes and fingers trace, and in your own progress follow, the method of advance traced for you by these great schools. I wish you to begin by getting command of line, that is to say, by learning to draw a steady line, limiting with absolute correctness the form or space you intend it to limit; to proceed by getting command over flat tints, so that you may be able to fill the spaces you have enclosed, evenly, either with shade or colour; according to the school you adopt; and finally to obtain the power of adding such fineness of drawing within the masses, as shall express their undulation, and their characters of form and texture.

140. Those who are familiar with the methods of existing schools must be aware that I thus nearly invert their practice of teaching. Students at present learn to draw details first, and to colour and mass them afterwards. I shall endeavour to teach you to arrange broad masses and colours first; and you shall put the details into them afterwards. I have several reasons for this audacity, of which you may justly require me to state the principal ones. The first is that, as I have shown you, this method I wish you to follow, is the natural one. All great artist nations *have* actually learned to work in this way, and I believe it therefore the right, as the hitherto successful one. Secondly, you will find it less irksome than the reverse method, and more definite. When a beginner is set at once to draw details, and make finished studies in light and shade, no master can correct his innumerable errors, or rescue him out of his endless difficulties. But in the natural method, he can correct, if he will, his own errors. You will have positive lines to draw, presenting no more difficulty, except in requiring greater steadiness of hand, than the outlines of a map. They will be generally sweeping and simple, instead of being jagged into promontories and bays; but assuredly, they may be drawn rightly (with patience), and their rightness tested with mathematical accuracy. You have only to follow your own line with tracing paper, and apply it to your copy. If they do not correspond, you are wrong, and you need no master to show you where. Again; in washing in a flat tone of colour or shade, you can always see yourself if it is flat, and

kept well within the edges ; and you can set a piece of your colour side by side with that of the copy ; if it does not match, you are wrong ; and, again, you need no one to tell you so, if your eye for color is true. It happens, indeed, more frequently than would be supposed, that there is real want of power in the eye to distinguish colours ; and this I even suspect to be a condition which has been sometimes attendant on high degrees of cerebral sensitiveness in other directions : but such want of faculty would be detected in your first two or three exercises by this simple method, while, otherwise you might go on for years endeavouring to colour from nature in vain. Lastly, and this is a very weighty collateral reason, such a method enables me to show you many things, besides the art of drawing. Every exercise that I prepare for you will be either a portion of some important example of ancient art, or of some natural object. However rudely or unsuccessfully you may draw it (though I anticipate from you neither want of care nor success), you will nevertheless have learned what no words could have as forcibly or completely taught you, either respecting early art or organic structure ; and I am thus certain that not a moment you spend attentively will be altogether wasted, and that, generally, you will be twice gainers by every effort. There is, however, yet another point in which I think a change of existing methods will be advisable.

141. You have here in Oxford one of the finest collections in Europe of drawings in pen, and chalk, by Michael Angelo and Raphael. Of the whole number, you cannot but have noticed that not one is weak or studentlike—all are evidently master's work.

You may look the galleries of Europe through, and so far as I know, or as it is possible to make with safety any so wide generalization, you will not find in them a childish or feeble drawing, by these, or by any other great master.

And farther :—by the greatest men—by Titian, Velasquez, or Veronese—you will hardly find an authentic drawing at all. For the fact is, that while we moderns have always learned, or tried to learn, to paint by drawing, the ancients learned to

draw by painting—or by engraving, more difficult still. The brush was put into their hands when they were children, and they were forced to draw with that, until, if they used the pen or crayon, they used it either with the lightness of a brush or the decision of a graver. Michael Angelo uses his pen like a chisel; but all of them seem to use it only when they are in the height of their power, and then for rapid notation of thought or for study of models; but never as a practice helping them to paint. Probably exercises of the severest kind were gone through in minute drawing by the apprentices of the goldsmiths, of which we hear and know little, and which were entirely a matter of course. To these, and to the exquisiteness of care and touch developed in working precious metals, may probably be attributed the final triumph of Italian sculpture. Michael Angelo, when a boy, is said to have copied engravings by Schöngauer and others with his pen, in facsimile so true that he could pass his drawings as the originals. But I should only discourage you from all farther attempts in art, if I asked you to imitate any of these accomplished drawings of the gem-artificers. You have, fortunately, a most interesting collection of them already in your galleries, and may try your hands on them if you will. But I desire rather that you should attempt nothing except what can by determination be absolutely accomplished, and be known and felt by you to be accomplished, when it is so. Now, therefore, I am going at once to comply with that popular instinct which, I hope, so far as you care for drawing at all, you are still boys enough to feel, the desire to paint. Paint you shall: but remember, I understand by painting what you will not find easy. Paint you shall; but daub or blot you shall not: and there will be even more care required, though care of a pleasanter kind, to follow the lines traced for you with the point of the brush than if they had been drawn with that of a crayon. But from the very beginning (though carrying on at the same time an incidental practice with crayon and lead pencil), you shall try to draw a line of absolute correctness with the point, not of pen or crayon, but of the brush, as Apelles did, and as all coloured lines are drawn on Greek vases. A line of absolute cor-

rectness, observe. I do not care how slowly you do it, or with how many alterations, junctions, or retouchings; the one thing I ask of you is, that the line shall be right, and right by measurement, to the same minuteness which you would have to give in a Government chart to the map of a dangerous shoal.

142. This question of measurement is, as you are probably aware, one much vexed in art schools; but it is determined indisputably by the very first words written by Lionardo: 'Il giovane deve prima imparare prospettiva, per le misure d'ogni cosa.'

Without absolute precision of measurement, it is certainly impossible for you to learn perspective rightly; and as far as I can judge, impossible to learn anything else rightly. And in my past experience of teaching, I have found that such precision is of all things the most difficult to enforce on the pupils. It is easy to persuade to diligence, or provoke to enthusiasm; but I have found it hitherto impossible to humiliate one student into perfect accuracy.

It is, therefore, necessary, in beginning a system of drawing for the University, that no opening should be left for failure in this essential matter. I hope you will trust the words of the most accomplished draughtsman of Italy, and the painter of the great sacred picture which, perhaps beyond all others, has influenced the mind of Europe, when he tells you that your first duty is 'to learn perspective by the *measures* of everything.' For perspective, I will undertake that it shall be made, practically, quite easy to you; but I wish first to make application to the Trustees of the National Gallery for the loan to Oxford of Turner's perspective diagrams, which are at present lying useless in a folio in the National Gallery; and therefore we will not trouble ourselves about perspective till the autumn; unless, in the meanwhile, you care to master the mathematical theory of it, which I have carried as far as is necessary for you in my treatise written in 1859, of which copies shall be placed at your disposal in your working room. But the habit and dexterity of measurement you must acquire at once, and that with engineer's accuracy. I hope that in our now gradually developing system of education, elementary

architectural or military drawing will be required at all public schools ; so that when youths come to the University, it may be no more necessary for them to pass through the preliminary exercises of drawing than of grammar : for the present, I will place in your series examples simple and severe enough for all necessary practice.

143. And while you are learning to measure, and to draw, and lay flat tints, with the brush, you must also get easy command of the pen ; for that is not only the great instrument for the finest sketching, but its right use is the foundation of the art of illumination. In nothing is fine art more directly connected with service than in the close dependence of decorative illumination on good writing. Perfect illumination is only writing made lovely ; the moment it passes into picture-making it has lost its dignity and function. For pictures, small or great, if beautiful, ought not to be painted on leaves of books, to be worn with service ; and pictures, small or great, not beautiful, should be painted nowhere. But to make writing *itself* beautiful,—to make the sweep of the pen lovely,—is the true art of illumination ; and I particularly wish you to note this, because it happens continually that young girls who are incapable of tracing a single curve with steadiness, much more of delineating any ornamental or organic form with correctness, think that the work which would be intolerable in ordinary drawing becomes tolerable when it is employed for the decoration of texts ; and thus they render all healthy progress impossible, by protecting themselves in inefficiency under the shield of a good motive. Whereas the right way of setting to work is to make themselves first mistresses of the art of writing beautifully ; and then to apply that art in its proper degrees of development to whatever they desire permanently to write. And it is indeed a much more truly religious duty for girls to acquire a habit of deliberate, legible, and lovely penmanship in their daily use of the pen, than to illuminate any quantity of texts. Having done so, they may next discipline their hands into the control of lines of any length, and, finally, add the beauty of colour and form to the flowing of these perfect lines. But it is only after

years of practice that they will be able to illuminate noble words rightly for the eyes, as it is only after years of practice that they can make them melodious rightly, with the voice.

144. I shall not attempt, in this lecture, to give you any account of the use of the pen as a drawing instrument. That use is connected in many ways with principles both of shading and of engraving, hereafter to be examined at length. But I may generally state to you that its best employment is in giving determination to the forms in drawings washed with neutral tint; and that, in this use of it, Holbein is quite without a rival. I have therefore placed many examples of his work among your copies. It is employed for rapid study by Raphael and other masters of delineation, who, in such cases, give with it also partial indications of shadow; but it is not a proper instrument for shading, when drawings are intended to be deliberate and complete, nor do the great masters ever so employ it. Its virtue is the power of producing a perfectly delicate, equal, and decisive line with great rapidity; and the temptation allied with that virtue is to licentious haste, and chance-swept instead of strictly-commanded curvature. In the hands of very great painters it obtains, like the etching needle, qualities of exquisite charm in this free use; but all attempts at imitation of these confused and suggestive sketches must be absolutely denied to yourselves while students. You may fancy you have produced something like them with little trouble; but, be assured, it is in reality as unlike them as nonsense is unlike sense; and that, if you persist in such work, you will not only prevent your own executive progress, but you will never understand in all your lives what good painting means. Whenever you take a pen in your hand, if you cannot count every line you lay with it, and say why you make it so long and no longer, and why you drew it in that direction and no other, your work is bad. The only man who can put his pen to full speed, and yet retain command over every separate line of it, is Dürer. He has done this in the illustrations of a missal preserved at Munich, which have been fairly facsimiled; and of these I have placed several in your copying series, with some of Tur-

ner's landscape etchings and other examples of deliberate pen work, such as will advantage you in early study. The proper use of them you will find explained in the catalogue.

145. And, now, but one word more to-day. Do not impute to me the impertinence of setting before you what is new in this system of practice as being certainly the best method. No English artists are yet agreed entirely on early methods; and even Reynolds expresses with some hesitation his conviction of the expediency of learning to draw with the brush. But this method that I show you rests in all essential points on his authority, on Lionardo's, or on the evident as well as recorded practice of the most splendid Greek and Italian draughtsmen; and you may be assured it will lead you, however slowly, to a great and certain skill. To what degree of skill, must depend greatly on yourselves; but I know that in practice of this kind you cannot spend an hour without definitely gaining, both in true knowledge of art, and in useful power of hand; and for what may appear in it too difficult, I must shelter or support myself, as in beginning, so in closing, this first lecture on practice, by the words of Reynolds: 'The impetuosity of youth is disgusted at the slow approaches of a regular siege, and desires from mere impatience of labour to take the citadel by storm. They must therefore be told again and again that labour is the only price of solid fame, and that, whatever their force of genius may be, there is no easy method of becoming a good painter.'

LECTURE VI.

LIGHT.

146. THE plan of the divisions of art-schools which I gave you in last lecture is of course only a first germ of classification, on which we are to found farther and more defined statement; but for this very reason it is necessary that every term of it should be very clear in your minds.

And especially I must ask you to note the sense in which I use the word 'mass.' Artists usually employ that word to

express the spaces of light and darkness, or of colour, into which a picture is divided. But this habit of theirs arises partly from their always speaking of pictures in which the lights represent solid form. If they had instead been speaking of flat tints, as, for instance, of the gold and blue in this missal page (S. 7), they would not have called them 'masses,' but 'spaces' of colour. Now both for accuracy and convenience' sake, you will find it well to observe this distinction, and to call a simple flat tint a space of colour; and only the representation of solid or projecting form a mass.

At all events, I mean myself always to make this distinction; which I think you will see the use of by comparing the missal page (S. 7) with a piece of finished painting (Edu. 2). The one I call space with colour; the other, mass with colour; I use however the word 'line' rather than 'space' in our general scheme, because you cannot limit a flat tint but by a line, or the locus of a line: whereas a gradated tint, expressive of mass, may be lost at its edges in another, without any fixed limit; and practically is so, in the works of the greatest masters.

147. You have thus, in your hexagonal scheme, the expression of the universal manner of advance in painting: Line first; then line enclosing flat spaces coloured or shaded; then the lines vanish, and the solid forms are seen within the spaces. That is the universal law of advance:—1, line; 2, flat space; 3, massed or solid space. But, as you see, this advance may be made, and has been made, by two different roads; one advancing always through colour, the other through light and shade. And these two roads are taken by two entirely different kinds of men. The way by colour is taken by men of cheerful, natural, and entirely sane disposition in body and mind, much resembling, even at its strongest, the temper of well-brought-up children:—too happy to think deeply, yet with powers of imagination by which they can live other lives than their actual ones; make-believe lives, while yet they remain conscious all the while that they *are* making believe—therefore entirely sane. They are also absolutely contented; they ask for no more light than is immediately

around them, and cannot see anything like darkness, but only green and blue, in the earth and sea.

148. The way by light and shade is, on the contrary, taken by men of the highest powers of thought, and most earnest desire for truth; they long for light, and for knowledge of all that light can show. But seeking for light, they perceive also darkness; seeking for truth and substance, they find vanity. They look for form in the earth,—for dawn in the sky; and seeking these, they find formlessness in the earth, and night in the sky.

Now remember, in these introductory lectures I am putting before you the roots of things, which are strange, and dark, and often, it may seem, unconnected with the branches. You may not at present think these metaphysical statements necessary; but as you go on, you will find that having hold of the clue to methods of work through their springs in human character, you may perceive unerringly where they lead, and what constitutes their wrongness and rightness; and when we have the main principles laid down, all others will develop themselves in due succession, and everything will become more clearly intelligible to you in the end, for having been apparently vague in the beginning. You know when one is laying the foundation of a house, it does not show directly where the rooms are to be.

149. You have then these two great divisions of human mind: one, content with the colours of things, whether they are dark or light; the other seeking light pure, as such, and dreading darkness as such. One, also, content with the coloured aspects and visionary shapes of things; the other seeking their form and substance. And, as I said, the school of knowledge, seeking light, perceives, and has to accept and deal with obscurity; and seeking form, it has to accept and deal with formlessness, or death.

Farther, the school of colour in Europe, using the word Gothic in its broadest sense, is essentially Gothic-Christian; and full of comfort and peace. Again, the school of light is essentially Greek, and full of sorrow. I cannot tell you which is right, or least wrong. I tell you only what I know—

this vital distinction between them : the Gothic or colour school is always cheerful, the Greek always oppressed by the shadow of death ; and the stronger its masters are, the closer that body of death grips them. The strongest whose work I can show you in recent periods is Holbein ; next to him is Lionardo ; and then Dürer : but of the three Holbein is the strongest, and with his help I will put the two schools in their full character before you in a moment.

150. Here is, first, an entirely characteristic piece of the great colour school. It is by Cima of Conegliano, a mountaineer, like Luini, born under the Alps of Friuli. His Christian name was John Baptist : he is here painting his name-Saint ; the whole picture full of peace and intense faith and hope, and deep joy in light of sky, and fruit and flower and weed of earth. The picture was painted for the church of Our Lady of the Garden at Venice, *La Madonna dell' Orto* (properly Madonna of the *Kitchen Garden*), and it is full of simple flowers, and has the wild strawberry of Cima's native mountains gleaming through the grass.

Beside it I will put a piece of the strongest work of the school of light and shade—strongest, because Holbein was a colourist also ; but he belongs, nevertheless, essentially to the *chiaroscuro* school. You know that his name is connected, in ideal work, chiefly with his 'Dance of Death.' I will not show you any of the terror of that ; only his deepest thought of death, his well-known 'Dead Christ.' It will at once show you how completely the Christian art of this school is oppressed by its veracity, and forced to see what is fearful, even in what it most trusts. You may think I am showing you contrasts merely to fit my theories. But there is Dürer's 'Knight and Death,' his greatest plate ; and if I had Lionardo's 'Medusa' here, which he painted when only a boy, you would have seen how he was held by the same chain. And you cannot but wonder why, this being the melancholy temper of the great Greek or naturalistic school, I should have called it the school of light. I call it so because it is through its intense love of light that the darkness becomes apparent to it, and through its intense love of truth and form that all mystery becomes at-

tractive to it. And when, having learned these things, it is joined to the school of colour, you have the perfect, though always, as I will show you, pensive, art of Titian and his followers.

151. But remember, its first development, and all its final power, depends on Greek sorrow, and Greek religion.

The school of light is founded in the Doric worship of Apollo and the Ionic worship of Athena, as the spirits of life in the light, and of life in the air, opposed each to their own contrary deity of death—Apollo to the Python, Athena to the Gorgon—Apollo as life in light, to the earth spirit of corruption in darkness, Athena as life by motion, to the Gorgon spirit of death by pause, freezing, or turning to stone: both of the great divinities taking their glory from the evil they have conquered; both of them, when angry, taking to men the form of the evil which is their opposite—Apollo slaying by poisoned arrow, by pestilence; Athena by cold, the black ægis on her breast. These are the definite and direct expressions of the Greek thoughts respecting death and life. But underlying both these, and far more mysterious, dreadful, and yet beautiful, there is the Greek conception of spiritual darkness; of the anger of fate, whether foredoomed or avenging; the root and theme of all Greek tragedy; the anger of the Erinnyes, and Demeter Erinnyes, compared to which the anger either of Apollo or Athena is temporary and partial:—and also, while Apollo or Athena only slay, the power of Demeter and the Eumenides is over the whole life; so that in the stories of Bellerophon, of Hippolytus, of Orestes, of Œdipus, you have an incomparably deeper shadow than any that was possible to the thought of later ages, when the hope of the Resurrection had become definite. And if you keep this in mind, you will find every name and legend of the oldest history become full of meaning to you. All the mythic accounts of Greek sculpture begin in the legends of the family of Tantalus. The main one is the making of the ivory shoulder of Pelops after Demeter has eaten the shoulder of flesh. With that you have Broteas, the brother of Pelops, carving the first statue of the mother of the gods; and you have his sister, Niobe, weeping herself to

stone under the anger of the deities of light. Then Pelops himself, the dark-faced, gives name to the Peloponnesus, which you may therefore read as the 'isle of darkness;' but its central city, Sparta, the 'sown city,' is connected with all the ideas of the earth as life-giving. And from her you have Helen, the representative of light in beauty, and the *Fratres Helenæ*—'lucida sidera;' and, on the other side of the hills, the brightness of Argos, with its correlative darkness over the *Atreidæ*, marked to you by Helios turning away his face from the feast of Thyestes.

152. Then join with these the Northern legends connected with the air. It does not matter whether you take Dorus as the son of Apollo or the son of Helen; he equally symbolizes the power of light: while his brother Æolus, through all his descendants, chiefly in Sisyphus, is confused or associated with the real god of the winds, and represents to you the power of the air. And then, as this conception enters into art, you have the myths of Dædalus, the flight of Icarus, and the story of Phrixus and Helle, giving you continual associations of the physical air and light, ending in the power of Athena over Corinth as well as over Athens. Now, once having the clue, you can work out the sequels for yourselves better than I can for you; and you will soon find even the earliest or slightest grotesques of Greek art become full of interest to you. For nothing is more wonderful than the depth of meaning which nations in their first days of thought, like children, can attach to the rudest symbols; and what to us is grotesque or ugly, like a little child's doll, can speak to them the loveliest things. I have brought you to-day a few more examples of early Greek vase painting, respecting which remember generally that its finest development is for the most part sepulchral. You have, in the first period, always energy in the figures, light in the sky or upon the figures;* in the second period, while the conception of the divine power remains the same, it is thought of as in repose, and the light is in the god, not in the sky; in the time of decline, the divine power is gradually disbelieved, and all form and light are lost together.

* See Note in the Catalogue on No. 201.

With that period I wish you to have nothing to do. You shall not have a single example of it set before you, but shall rather learn to recognise afterwards what is base by its strangeness. These, which are to come early in the third group of your Standard series, will enough represent to you the elements of early and late conception in the Greek mind of the deities of light.

153. First (S. 204), you have Apollo ascending from the sea ; thought of as the physical sunrise : only a circle of light for his head ; his chariot horses, seen foreshortened, black against the day-break, their feet not yet risen above the horizon. Underneath is the painting from the opposite side of the same vase : Athena as the morning-breeze, and Hermes as the morning cloud, flying across the waves before the sunrise. At the distance I now hold them from you, it is scarcely possible for you to see that they are figures at all, so like are they to broken fragments of flying mist ; and when you look close, you will see that as Apollo's face is invisible in the circle of light, Mercury's is invisible in the broken form of cloud : but I can tell you that it is conceived as reverted, looking back to Athena ; the grotesque appearance of feature in the front is the outline of his hair.

These two paintings are excessively rude, and of the archaic period ; the deities being yet thought of chiefly as physical powers in violent agency.

Underneath these two are Athena and Hermes, in the types attained about the time of Phidias ; but, of course, rudely drawn on the vase, and still more rudely in this print from Le Normant and De Witte. For it is impossible (as you will soon find if you try for yourself) to give on a plane surface the grace of figures drawn on one of solid curvature, and adapted to all its curves : and among other minor differences, Athena's lance is in the original nearly twice as tall as herself, and has to be cut short to come into the print at all. Still, there is enough here to show you what I want you to see—the repose, and entirely realized personality, of the deities as conceived in the Phidian period. The relation of the two deities is, I believe, the same as in the painting above, though probably there is another added of more definite kind. But the phys-

ical meaning still remains—Athena unhelmeted, as the *gentle* morning wind, commanding the cloud Hermes to slow flight. His petasus is slung at his back, meaning that the clouds are not yet opened or expanded in the sky.

154. Next (S. 205), you have Athena, again unhelmeted and crowned with leaves, walking between two nymphs, who are crowned also with leaves ; and all the three hold flowers in their hands, and there is a fawn walking at Athena's feet.

This is still Athena as the morning air, but upon the earth instead of in the sky, with the nymphs of the dew beside her ; the flowers and leaves opening as they breathe upon them. Note the white gleam of light on the fawn's breast ; and compare it with the next following examples :—(underneath this one is the contest of Athena and Poseidon, which does not bear on our present subject).

Next (S. 206), Artemis as the moon of morning, walking low on the hills, and singing to her lyre ; the fawn beside her, with the gleam of light of sunrise on its ear and breast. Those of you who are often out in the dawn-time know that there is no moon so glorious as that gleaming crescent ascending before the sun, though in its wane.

Underneath, Artemis and Apollo, of Phidian time.

Next (S. 207), Apollo walking on the earth, god of the morning, singing to his lyre ; the fawn beside him, again with the gleam of light on its breast. And underneath, Apollo, crossing the sea to Delphi, of the Phidian time.

155. Now you cannot but be struck in these three examples with the similarity of action in Athena, Apollo, and Artemis, drawn as deities of the morning ; and with the association in every case of the fawn with them. It has been said (I will not interrupt you with authorities) that the fawn belongs to Apollo and Diana because stags are sensitive to music ; (are they ?). But you see the fawn is here with Athena of the dew, though she has no lyre ; and I have myself no doubt that in this particular relation to the gods of morning it always stands as the symbol of wavering and glancing motion on the ground, as well as of the light and shadow through the leaves, chequering the ground as the fawn is dappled. Similarly the spots

on the nebris of Dionysus, thought of sometimes as stars (*ἀπὸ τῆς τῶν ἄστρων ποικιλίας*, Diodorus, II. I), as well as those of his panthers, and the cloudings of the tortoise-shell of Hermes, are all significant of this light of the sky broken by cloud-shadow.

156. You observe also that in all the three examples the fawn has light on its ears, and face, as well as its breast. In the earliest Greek drawings of animals, bars of white are used as one means of detaching the figures from the ground; ordinarily on the under side of them, marking the lighter colour of the hair in wild animals. But the placing of this bar of white, or the direction of the face in deities of light, (the faces and flesh of women being always represented as white), may become expressive of the direction of the light, when that direction is important. Thus we are enabled at once to read the intention of this Greek symbol of the course of a day (in the centre-piece of S. 208, which gives you the types of Hermes). At the top you have an archaic representation of Hermes stealing Io from Argus. Argus is here the Night; his grotesque features monstrous; his hair overshadowing his shoulders; Hermes on tiptoe, stealing upon him, and taking the cord which is fastened to the horn of Io out of his hand without his feeling it. Then, underneath, you have the course of an entire day. Apollo first, on the left, dark, entering his chariot, the sun not yet risen. In front of him Artemis, as the moon, ascending before him, playing on her lyre, and looking back to the sun. In the centre, behind the horses, Hermes, as the cumulus cloud at mid-day, wearing his petasus heightened to a cone, and holding a flower in his right hand; indicating the nourishment of the flowers by the rain from the heat-cloud. Finally, on the right, Latona, going down as the evening, lighted from the right by the sun, now sunk; and with her feet reverted, signifying the unwillingness of the departing day.

Finally, underneath, you have Hermes of the Phidian period, as the floating cumulus cloud, almost shapeless (as you see him at this distance); with the tortoise-shell lyre in his hand, barred with black, and a fleece of white cloud, not level, but

oblique, under his feet. (Compare the ‘*διὰ τῶν κοίλων—πλάγαι,*’ and the relations of the ‘*αἰγίδος ἡνίοχος Ἀθήνα,*’ with the clouds as the moon’s messengers, in Aristophanes; and note of Hermes generally, that you never find him flying as a Victory flies, but always, if moving fast at all, clambering along, as it were, as a cloud gathers and heaps itself: the Gorgons stretch and stride in their flight, half kneeling, for the same reason, running or gliding shapelessly along in this stealthy way.)

157. And now take this last illustration, of a very different kind. Here is an effect of morning light by Turner (S. 301), on the rocks of Otley-hill, near Leeds, drawn long ago, when Apollo, and Artemis, and Athena, still sometimes were seen, and felt, even near Leeds. The original drawing is one of the great Farnley series, and entirely beautiful. I have shown, in the last volume of ‘*Modern Painters,*’ how well Turner knew the meaning of Greek legends:—he was not thinking of them, however, when he made this design; but, unintentionally, has given us the very effect of morning light we want: the glittering of the sunshine on dewy grass, half dark; and the narrow gleam of it on the sides and head of the stag and hind.

158. These few instances will be enough to show you how we may read in early art of the Greeks their strong impressions of the power of light. You will find the subject entered into at somewhat greater length in my ‘*Queen of the Air;*’ and if you will look at the beginning of the 7th book of Plato’s ‘*Polity,*’ and read carefully the passages in the context respecting the sun and intellectual sight, you will see how intimately this physical love of light was connected with their philosophy, in its search, as blind and captive, for better knowledge. I shall not attempt to define for you to-day the more complex but much shallower forms which this love of light, and the philosophy that accompanies it, take in the mediæval mind; only remember that in future, when I briefly speak of the Greek school of art with reference to questions of delineation, I mean the entire range of the schools, from Homer’s days to our own, which concern themselves with the representation of light, and the effects it produces on material

form—beginning practically for us with these Greek vase paintings, and closing practically for us with Turner's sunset on the Temeraire ; being throughout a school of captivity and sadness, but of intense power ; and which in its technical method of shadow on material form, as well as in its essential temper, is centrally represented to you by Dürer's two great engravings of the 'Melencolia' and the 'Knight and Death.' On the other hand, when I briefly speak to you of the Gothic school, with reference to delineation, I mean the entire and much more extensive range of schools extending from the earliest art in Central Asia and Egypt down to our own day in India and China :—schools which have been content to obtain beautiful harmonies of colour without any representation of light ; and which have, many of them, rested in such imperfect expressions of form as could be so obtained ; schools usually in some measure childish, or restricted in intellect, and similarly childish or restricted in their philosophies or faiths : but contented in the restriction ; and in the more powerful races, capable of advance to nobler development than the Greek schools, though the consummate art of Europe has only been accomplished by the union of both. How that union was effected, I will endeavour to show you in my next lecture ; to-day I shall take note only of the points bearing on our immediate practice.

159. A certain number of you, by faculty and natural disposition,—and all, so far as you are interested in modern art,—will necessarily have to put yourselves under the discipline of the Greek or chiaroscuro school, which is directed primarily to the attainment of the power of representing form by pure contrast of light and shade. I say, the 'discipline' of the Greek school, both because, followed faithfully, it is indeed a severe one, and because to follow it at all is, for persons fond of colour, often a course of painful self-denial, from which young students are eager to escape. And yet, when the laws of both schools are rightly obeyed, the most perfect discipline is that of the colourist ; for they see and draw everything, while the chiaroscurists must leave much indeterminate in mystery, or invisible in gloom : and there are therefore many

licentious and vulgar forms of art connected with the *chiaroscuro* school, both in painting and etching, which have no parallel among the colourists. But both schools, rightly followed, require first of all the absolute accuracy of delineation. This you need not hope to escape. Whether you fill your spaces with colours, or with shadows, they must equally be of the true outline and in true gradations. I have been thirty years telling modern students of art this in vain. I mean to say it to you only once, for the statement is too important to be weakened by repetition.

Without perfect delineation of form and perfect gradation of space, neither noble colour is possible, nor noble light.

160. It may make this more believable to you if I put beside each other a piece of detail from each school. I gave you the *St. John of Cima da Conegliano* for a type of the colour school. Here is one of the sprays of oak which rise against the sky of it in the distance, enlarged to about its real size (Edu. 12). I hope to draw it better for you at Venice; but this will show you with what perfect care the colourist has followed the outline of every leaf in the sky. Beside it, I put a *chiaroscuro* drawing (at least, a photograph of one), *Dürer's*, from nature, of the common-wild wall-cabbage (Edu. 32). It is the most perfect piece of delineation by flat tint I have ever seen, in its mastery of the perspective of every leaf, and its attainment almost of the bloom of texture, merely by its exquisitely tender and decisive laying of the colour. These two examples ought, I think, to satisfy you as to the precision of outline of both schools, and the power of expression which may be obtained by flat tints laid within such outline.

161. Next, here are two examples of the gradated shading expressive of the forms within the outline, by two masters of the *chiaroscuro* school. The first (S. 12) shows you *Lionardo's* method of work, both with chalk and the silver point. The second (S. 302), *Turner's* work in mezzotint; both masters doing their best. Observe that this plate of *Turner's*, which he worked on so long that it was never published, is of a subject peculiarly depending on effects of mystery and conceal-

ment, the fall of the Reuss under the Devil's Bridge on the St. Gothard ; (the *old* bridge ; you may still see it under the existing one, which was built since Turner's drawing was made). If ever outline could be dispensed with, you would think it might be so in this confusion of cloud, foam, and darkness. But here is Turner's own etching on the plate, (Edu. 35 F), made under the mezzotint ; and of all the studies of rock outline made by his hand, it is the most decisive and quietly complete.

162. Again ; in the Lionardo sketches, many parts are lost in obscurity, or are left intentionally uncertain and mysterious, even in the light ; and you might at first imagine some permission of escape had been here given you from the terrible law of delineation. But the slightest attempts to copy them will show you that the terminal lines are inimitably subtle, unaccusably true, and filled by gradations of shade so determined and measured, that the addition of a grain of the lead or chalk as large as the filament of a moth's wing, would make an appreciable difference in them.

This is grievous, you think, and hopeless. No, it is delightful and full of hope : delightful, to see what marvellous things can be done by men ; and full of hope, if your hope is the right one, of being one day able to rejoice more in what others are, than in what you are yourself, and more in the strength that is for ever above you, than in that you can ever attain.

163. But you can attain much, if you will work reverently and patiently, and hope for no success through ill-regulated effort. It is, however, most assuredly at this point of your study that the full strain on your patience will begin. The exercises in line-drawing and flat laying of colour are irksome ; but they are definite, and within certain limits, sure to be successful if practised with moderate care. But the expression of form by shadow requires more subtle patience, and involves the necessity of frequent and mortifying failure, not to speak of the self-denial which I said was needful in persons fond of colour, to draw in mere light and shade. If, indeed, you were going to be artists, or could give any great length

of time to study, it might be possible for you to learn wholly in the Venetian school, and to reach form through colour. But without the most intense application this is not possible ; and practically, it will be necessary for you, as soon as you have gained the power of outlining accurately, and of laying flat colour, to learn to express solid form as shown by light and shade only. And there is this great advantage in doing so, that many forms are more or less disguised by colour, and that we can only represent them completely to others, or rapidly and easily record them for ourselves, by the use of shade alone. A single instance will show you what I mean. Perhaps there are few flowers of which the impression on the eye is more definitely of flat colour than the scarlet geranium. But you would find, if you were to try to paint it,—first, that no pigment could approach the beauty of its scarlet ; and secondly, that the brightness of the hue dazzled the eye, and prevented its following the real arrangement of the cluster of flowers. I have drawn for you here (at least this is a mezzotint from my drawing), a single cluster of the scarlet geranium, in mere light and shade (Edu. 32 B.), and I think you will feel that its domed form, and the flat lying of the petals one over the other, in the vaulted roof of it, can be seen better thus than if they had been painted scarlet.

164. Also this study will be useful to you, in showing how entirely effects of light depend on delineation, and gradation of spaces, and not on methods of shading. And this is the second great practical matter I want you to remember to-day. All effects of light and shade depend not on the method or execution of shadows, but on their rightness of place, form, and depth. There is indeed a loveliness of execution *added* to the rightness, by the great masters, but you cannot obtain that till you become one. Shadow cannot be laid thoroughly well, any more than lines can be drawn steadily, but by a long practised hand, and the attempts to imitate the shading of fine draughtsmen, by dotting and hatching, are just as ridiculous as it would be to endeavour to imitate their instantaneous lines by a series of re-touchings. You will often indeed see in Lionardo's work, and in Michael

Angelo's, shadow wrought laboriously to an extreme of fineness ; but when you look into it, you will find that they have always been drawing more and more form within the space, and never finishing for the sake of added texture, but of added fact. And all those effects of transparency and reflected light, aimed at in common chalk drawings, are wholly spurious. For since, as I told you, all lights are shades compared to higher lights, and lights only as compared to lower ones, it follows that there can be no difference in their quality as such ; but that light is opaque when it expresses substance, and transparent when it expresses space ; and shade is also opaque when it expresses substance, and transparent when it expresses space. But it is not, even then, transparent in the common sense of that word ; nor is its appearance to be obtained by dotting or cross hatching, but by touches so tender as to look like mist. And now we find the use of having Lionardo for our guide. He is supreme in all questions of execution, and in his 28th chapter, you will find that shadows are to be 'dolce e sfumose,' to be tender, and look as if they were exhaled, or breathed on the paper. Then, look at any of Michael Angelo's finished drawings, or of Correggio's sketches, and you will see that the true nurse of light is in art, as in nature, the cloud ; a misty and tender darkness, made lovely by gradation.

165. And how absolutely independent it is of material or method of production, how absolutely dependent on rightness of place and depth,—there are now before you instances enough to prove. Here is Dürer's work in flat colour, represented by the photograph, in its smoky brown ; Turner's, in washed sepia, and in mezzotint ; Lionardo's, in pencil and in chalk ; on the screen in front of you a large study in charcoal. In every one of these drawings, the material of shadow is absolutely opaque. But photograph-stain, chalk, lead, ink, or charcoal,—every one of them, laid by the master's hand, becomes full of light by gradation only. Here is a moonlight (Edu. 31 B.), in which you would think the moon shone through every cloud ; yet the clouds are mere single dashes of sepia, imitated by the brown stain of a photograph ; simi-

larly, in these plates from the *Liber Studiorum* the white paper becomes transparent or opaque, exactly as the master chooses. Here, on the granite rock of the St. Gothard (S. 302), is white paper made opaque, every light represents solid bosses of rock, or balls of foam. But in this study of twilight (S. 303), the same white paper (coarse old stuff it is, too!) is made as transparent as crystal, and every fragment of it represents clear and far away light in the sky of evening in Italy. From which the practical conclusion for you is, that you are never to trouble yourselves with any questions as to the means of shade or light, but only with the right government of the means at your disposal. And it is a most grave error in the system of many of our public drawing-schools that the students are permitted to spend weeks of labour in giving attractive appearance, by delicacy of texture, to chiaroscuro drawings in which every form is false, and every relation of depth untrue. A most unhappy form of error; for it not only delays, and often wholly arrests, their advance in their own art; but it prevents what ought to take place co-relatively with their executive practice, the formation of their taste by the accurate study of the models from which they draw. I do not doubt but that you have more pleasure in looking at the large drawing of the arch of Bourges, behind me, (Ref. 1), than at common sketches of sculpture. The reason you like it is, that the whole effort of the workman has been to show you, not his own skill in shading, but the play of the light on the surfaces of the leaves, which is lovely, because the sculpture itself is first-rate. And I must so far anticipate what we shall discover when we come to the subject of sculpture, as to tell you the two main principles of good sculpture: first, that its masters think before all other matters of the right placing of masses; secondly, that they give life by flexure of surface, not by quantity of detail; for sculpture is indeed only light and shade drawing in stone.

166. Much that I have endeavoured to teach on this subject has been gravely misunderstood, by both young painters and sculptors, especially by the latter. Because I am always urging them to imitate organic forms, they think if they carve quantities of flowers and leaves, and copy them from the life,

they have done all that is needed. But the difficulty is not to carve quantities of leaves. Anybody can do that. The difficulty is, never anywhere to have an unnecessary leaf. Over the arch on the right, you see there is a cluster of seven, with their short stalks springing from a thick stem. Now, you could not turn one of those leaves a hair's-breadth out of its place, nor thicken one of their stems, nor alter the angle at which each slips over the next one, without spoiling the whole, as much as you would a piece of melody by missing a note. That is disposition of masses. Again, in the group on the left, while the placing of every leaf is just as skilful, they are made more interesting yet by the lovely undulation of their surfaces, so that not one of them is in equal light with another. And that is so in all good sculpture, without exception. From the Elgin marbles down to the lightest tendril that curls round a capital in the thirteenth century, every piece of stone that has been touched by the hand of a master, becomes soft with under-life, not resembling nature merely in skin-texture, nor in fibres of leaf, or veins of flesh; but in the broad, tender, unspeakably subtle undulation of its organic form.

167. Returning then to the question of our own practice, I believe that all difficulties in method will vanish, if only you cultivate with care enough the habit of accurate observation, and if you think only of making your light and shade true, whether it be delicate or not. But there are three divisions or degrees of truth to be sought for, in light and shade, by three several modes of study, which I must ask you to distinguish carefully.

I. When objects are lighted by the direct rays of the sun, or by direct light entering from a window, one side of them is of course in light, the other in shade, and the forms in the mass are exhibited systematically by the force of the rays falling on it; (those having most power of illumination which strike most vertically); and note that there is, therefore, to every solid curvature of surface, a necessarily proportioned gradation of light, the gradation on a parabolic solid being different from the gradation on an elliptical or spherical one. Now when your purpose is to represent and learn the anat-

omy, or otherwise characteristic forms, of any object, it is best to place it in this kind of direct light, and to draw it as it is seen when we look at it in a direction at right angles to that of the ray. This is the ordinary academical way of studying form. Lionardo seldom practises any other in his real work, though he directs many others in his treatise.

168. The great importance of anatomical knowledge to the painters of the 16th century rendered this method of study very frequent with them; it almost wholly regulated their schools of engraving, and has been the most frequent system of drawing in art-schools since (to the very inexpedient exclusion of others). When you study objects in this way,—and it will indeed be well to do so often, though not exclusively,—observe always one main principle. Divide the light from the darkness frankly at first: all over the subject let there be no doubt which is which. Separate them one from the other as they are separated in the moon, or on the world itself, in day and night. Then gradate your lights with the utmost subtilty possible to you; but let your shadows alone, until near the termination of the drawing: then put quickly into them what farther energy they need, thus gaining the reflected lights out of their original flat gloom; but generally not looking much for reflected lights. Nearly all young students (and too many advanced masters) exaggerate them. It is good to see a drawing come out of its ground like a vision of light only; the shadows lost, or disregarded in the vague of space. In vulgar chiaroscuro the shades are so full of reflection that they look as if some one had been walking round the object with a candle, and the student, by that help, peering into its crannies.

169. II. But, in the reality of nature, very few objects are seen in this accurately lateral manner, or lighted by unconfused direct rays. Some are all in shadow, some all in light, some near, and vigorously defined; others dim and faint in aerial distance. The study of these various effects and forces of light, which we may call aerial chiaroscuro, is a far more subtle one than that of the rays exhibiting organic form (which for distinction's sake we may call 'formal' chiaro-

scuro), since the degrees of light from the sun itself to the blackness of night, are far beyond any literal imitation. In order to produce a mental impression of the facts, two distinct methods may be followed ;—the first, to shade downwards from the lights, making everything darker in due proportion, until the scale of our power being ended, the mass of the picture is lost in shade. The second, to assume the points of extreme darkness for a basis, and to light everything above these in due proportion, till the mass of the picture is lost in light.

170. Thus, in Turner's sepia drawing 'Isis' (Edu. 31), he begins with the extreme light in the sky, and shades down from that till he is forced to represent the near trees and pool as one mass of blackness. In his drawing of the Greta (S. 2), he begins with the dark brown shadow of the bank on the left, and illuminates up from that, till, in his distance, trees, hills, sky, and clouds, are all lost in broad light, so that you can hardly see the distinction between hills and sky. The second of these methods is in general the best for colour, though great painters unite both in their practice, according to the character of their subject. The first method is never pursued in colour but by inferior painters. It is, nevertheless, of great importance to make studies of chiaroscuro in this first manner for some time, as a preparation for colouring ; and this for many reasons, which it would take too long to state now. I shall expect you to have confidence in me when I assure you of the necessity of this study, and ask you to make good use of the examples from the *Liber Studiorum* which I have placed in your Educational series.

171. III. Whether in formal or aerial chiaroscuro, it is optional with the student to make the local colour of objects a part of his shadow, or to consider the high lights of every colour as white. For instance, a chiaroscuroist of Lionardo's school, drawing a leopard, would take no notice whatever of the spots, but only give the shadows which expressed the anatomy. And it is indeed necessary to be able to do this, and to make drawings of the forms of things as if they were sculptured, and had no colour. But in general, and more espe-

cially in the practice which is to guide you to colour, it is better to regard the local colour as part of the general dark and light to be imitated ; and, as I told you at first, to consider all nature merely as a mosaic of different colours, to be imitated one by one in simplicity. But good artists vary their methods according to their subject and material. In general, Dürer takes little account of local colour ; but in woodcuts of armorial bearings (one with peacock's feathers I shall get for you some day) takes great delight in it ; while one of the chief merits of Bewick is the ease and vigour with which he uses his black and white for the colours of plumes. Also, every great artist looks for, and expresses, that character of his subject which is best to be rendered by the instrument in his hand, and the material he works on. Give Velasquez or Veronese a leopard to paint, the first thing they think of will be its spots ; give it to Dürer to engrave, and he will set himself at the fur and whiskers ; give it a Greek to carve, and he will only think of its jaws and limbs ; each doing what is absolutely best with the means at his disposal.

172. The details of practice in these various methods I will endeavour to explain to you by distinct examples in your Educational series, as we proceed in our work ; for the present, let me, in closing, recommend to you once more with great earnestness the patient endeavour to render the *chiaroscuro* of landscape in the manner of the *Liber Studiorum* ; and this the rather, because you might easily suppose that the facility of obtaining photographs which render such effects, as it seems, with absolute truth and with unapproachable subtlety, superseded the necessity of study, and the use of sketching. Let me assure you, once for all, that photographs supersede no single quality nor use of fine art, and have so much in common with Nature, that they even share her temper of parsimony, and will themselves give you nothing valuable that you do not work for. They supersede no good art, for the definition of art is 'human labour regulated by human design,' and this design, or evidence of active intellect in choice and arrangement, is the essential part of the work ; which, so long as you cannot perceive, you perceive

no art whatsoever ; which, when once you do perceive, you will perceive also to be replaceable by no mechanism. But, farther, photographs will give you nothing you do not work for. They are invaluable for record of some kinds of facts, and for giving transcripts of drawings by great masters ; but neither in the photographed scene, nor photographed drawing, will you see any true good, more than in the things themselves, until you have given the appointed price in your own attention and toil. And when once you have paid this price, you will not care for photographs of landscape. They are not true, though they seem so. They are merely spoiled nature. If it is not human design you are looking for, there is more beauty in the next wayside bank than in all the sun-blackened paper you could collect in a lifetime. Go and look at the real landscape, and take care of it ; do not think you can get the good of it in a black stain portable in a folio. But if you care for human thought and passion, then learn yourselves to watch the course and fall of the light by whose influence you live, and to share in the joy of human spirits in the heavenly gifts of sunbeam and shade. For I tell you truly, that to a quiet heart, and healthy brain, and industrious hand there is more delight, and use, in the dappling of one wood-glade with flowers and sunshine, than to the restless, heartless, and idle could be brought by a panorama of a belt of the world, photographed round the equator.

LECTURE VII.

COLOUR.

173. TO-DAY I must try to complete our elementary sketch of schools of art, by tracing the course of those which were distinguished by faculty of colour, and afterwards to deduce from the entire scheme advisable methods of immediate practice.

You remember that, for the type of the early schools of

colour, I chose their work in glass ; as for that of the early schools of chiaroscuro, I chose their work in clay.

I had two reasons for this. First, that the peculiar skill of colourists is seen most intelligibly in their work in glass or in enamel : secondly, that Nature herself produces all her loveliest colours in some kind of solid or liquid glass or crystal. The rainbow is painted on a shower of melted glass, and the colours of the opal are produced in vitreous flint mixed with water ; the green and blue, and golden or amber brown of flowing water is in surface glossy, and in motion, 'splendidior vitro.' And the loveliest colours ever granted to human sight—those of morning and evening clouds before or after rain—are produced on minute particles of finely-divided water, or perhaps sometimes, ice. But more than this. If you examine with a lens some of the richest colours of flowers, as, for instance, those of the gentian and dianthus, you will find their texture is produced by a crystalline or sugary frost-work upon them. In the lychnis of the high Alps, the red and white have a kind of sugary bloom, as rich as it is delicate. It is indescribable ; but if you can fancy very powdery and crystalline snow mixed with the softest cream, and then dashed with carmine, it may give you some idea of the look of it. There are no colours, either in the nacre of shells, or the plumes of birds and insects, which are so pure as those of clouds, opal, or flowers ; but the *force* of purple and blue in some butterflies, and the methods of clouding, and strength of burnished lustre, in plumage like the peacock's, give them more universal interest ; in some birds, also, as in our own kingfisher, the colour nearly reaches a floral preciousness. The lustre in most, however, is metallic rather than vitreous ; and the vitreous always gives the purest hue. Entirely common and vulgar compared with these, yet to be noticed as completing the crystalline or vitreous system, we have the colours of gems. The green of the emerald is the best of these ; but at its best is as vulgar as house-painting beside the green of birds' plumage or of clear water. No diamond shows colour so pure as a dewdrop ; the ruby is like the pink of an ill-dyed and half-washed-out print, compared to the dianthus :

and the carbuncle is usually quite dead unless set with a foil, and even then is not prettier than the seed of a pomegranate. The opal is, however, an exception. When pure and uncut in its native rock, it presents the most lovely colours that can be seen in the world, except those of clouds.

We have thus in nature, chiefly obtained by crystalline conditions, a series of groups of entirely delicious hues; and it is one of the best signs that the bodily system is in a healthy state when we can see these clearly in their most delicate tints, and enjoy them fully and simply, with the kind of enjoyment that children have in eating sweet things. I shall place a piece of rock opal on the table in your working room: if on fine days you will sometimes dip it in water, take it into sunshine, and examine it with a lens of moderate power, you may always test your progress in sensibility to colour by the degree of pleasure it gives you.

174. Now, the course of our main colour schools is briefly this:—First, we have, returning to our hexagonal scheme, line; then *spaces* filled with pure colour; and then *masses* expressed or rounded with pure colour. And during these two stages the masters of colour delight in the purest tints, and endeavour as far as possible to rival those of opals and flowers. In saying ‘the purest tints,’ I do not mean the simplest types of red, blue, and yellow, but the most pure tints obtainable by their combinations.

175. You remember I told you, when the colourists painted masses or projecting spaces, they, aiming always at colour, perceived from the first and held to the last the fact that shadows, though of course darker than the lights with reference to which they *are* shadows, are not therefore necessarily less vigorous colours, but perhaps more vigorous. Some of the most beautiful blues and purples in nature, for instance, are those of mountains in shadow against amber sky; and the darkness of the hollow in the centre of a wild rose is one glow of orange fire, owing to the quantity of its yellow stamens.

Well, the Venetians always saw this, and all great colourists see it, and are thus separated from the non-colourists or

schools of mere chiaroscuro, not by difference in style merely but by being right while the others are wrong. It is an absolute fact that shadows are as much colours as lights are; and whoever represents them by merely, the subdued or darkened tint of the light, represents them falsely. I particularly want you to observe that this is no matter of taste, but fact. If you are especially soberminded, you may indeed choose sober colours where Venetians would have chosen gay ones; that is a matter of taste: you may think it proper for a hero to wear a dress without patterns on it, rather than an embroidered one; that is similarly a matter of taste: but, though you may also think it would be dignified for a hero's limbs to be all black, or brown, on the shaded side of them, yet, if you are using colour at all, you cannot so have him to your mind, except by falsehood; he never, under any circumstances, could be entirely black or brown on one side of him.

176. In this, then, the Venetians are separate from other schools by rightness, and they are so to their last days. Venetian painting is in this matter always right. But also, in their early days, the colourists are separated from other schools by their contentment with tranquil cheerfulness of light; by their never wanting to be dazzled. None of their lights are flashing or blinding; they are soft, winning, precious; lights of pearl, not of lime; only, you know, on this condition they cannot have sunshine: their day is the day of Paradise; they need no candle, neither light of the sun, in their cities; and everything is seen clear, as through crystal, far or near.

This holds to the end of the fifteenth century. Then they begin to see that this, beautiful as it may be, is still a make-believe light; that we do not live in the inside of a pearl; but in an atmosphere through which a burning sun shines thwartedly, and over which a sorrowful night must far prevail. And then the chiaroscuroists succeed in persuading them of the fact that there is mystery in the day as in the night, and show them how constantly to see truly, is to see dimly. And also they teach them the brilliancy of light, and the degree in which it is raised from the darkness; and, instead of their sweet and pearly peace, tempt them to look for the strength of flame

and coruscation of lightning, and flash of sunshine on armour and on points of spears.

177. The noble painters take the lesson nobly, alike for gloom or flame. Titian with deliberate strength, Tintoret with stormy passion, read it, side by side. Titian deepens the hues of his Assumption, as of his Entombment, into a solemn twilight; Tintoret involves his earth in coils of volcanic cloud, and withdraws, through circle flaming above circle, the distant light of Paradise. Both of them, becoming naturalist and human, add the veracity of Holbein's intense portraiture to the glow and the dignity they had themselves inherited from the Masters of Peace: at the same moment another, as strong as they, and in pure felicity of art-faculty, even greater than they, but trained in a lower school,—Velasquez,—produced the miracles of colour and shadow-painting, which made Reynolds say of him, 'What we all do with labour, he does with ease;' and one more, Correggio, uniting the sensual element of the Greek schools with their gloom, and their light with their beauty, and all these with the Lombardic colour, became, as since I think it has been admitted without question, the captain of the painter's art as such. Other men have nobler or more numerous gifts, but as a painter, master of the art of laying colour so as to be lovely, Correggio is alone.

178. I said the noble men learnt their lesson nobly. The base men also, and necessarily, learn it basely. The great men rise from colour to sunlight. The base ones fall from colour to candlelight. To-day, '*non ragioniam di lor,*' but let us see what this great change which perfects the art of painting mainly consists in, and means. For though we are only at present speaking of technical matters, every one of them, I can scarcely too often repeat, is the outcome and sign of a mental character, and you can only understand the folds of the veil, by those of the form it veils.

179. The complete painters, we find, have brought dimness and mystery into their method of colouring. That means that the world all around them has resolved to dream, or to believe, no more; but to know, and to see. And instantly all knowledge and sight are given, no more as in the Gothic

times, through a window of glass, brightly, but as through a telescope-glass, darkly. Your cathedral window shut you from the true sky, and illumined you with a vision; your telescope leads you to the sky, but darkens its light, and reveals nebula beyond nebula, far and farther, and to no conceivable farthest—unresolvable. That is what the mystery means.

180. Next, what does that Greek opposition of black and white mean?

In the sweet crystalline time of colour, the painters, whether on glass or canvas, employed intricate patterns, in order to mingle hues beautifully with each other, and make one perfect melody of them all. But in the great naturalist school, they like their patterns to come in the Greek way, dashed dark on light,—gleaming light out of dark. That means also that the world round them has again returned to the Greek conviction, that all nature, especially human nature, is not entirely melodious nor luminous; but a barred and broken thing: that saints have their foibles, sinners their forces; that the most luminous virtue is often only a flash, and the blackest-looking fault is sometimes only a stain: and, without confusing in the least black with white, they can forgive, or even take delight in things that are like the *νεβρις*, dappled.

181. You have then—first, mystery. Secondly, opposition of dark and light. Then, lastly, whatever truth of form the dark and light can show.

That is to say, truth altogether, and resignation to it, and quiet resolve to make the best of it. And therefore, portraiture of living men, women, and children,—no more of saints, cherubs, or demons. So here I have brought for your standards of perfect art, a little maiden of the Strozzi family, with her dog, by Titian; and a little princess of the house of Savoy, by Vandyke; and Charles the Fifth, by Titian; and a queen, by Velasquez; and an English girl in a brocaded gown, by Reynolds; and an English physician in his plain coat, and wig, by Reynolds: and if you do not like them, I cannot help myself, for I can find nothing better for you.

182. Better?—I must pause at the word. Nothing stronger,

certainly, nor so strong. Nothing so wonderful, so inimitable, so keen in unprejudiced and unbiassed sight.

Yet better, perhaps, the sight that was guided by a sacred will; the power that could be taught to weaker hands; the work that was faultless, though not inimitable, bright with felicity of heart, and consummate in a disciplined and companionable skill. You will find, when I can place in your hands the notes on Verona, which I read at the Royal Institution, that I have ventured to call the æra of painting represented by John Bellini, the time 'of the Masters.' Truly they deserved the name, who did nothing but what was lovely, and taught only what was right. These mightier, who succeeded them, crowned, but closed, the dynasties of art, and since their day painting has never flourished more.

183. There were many reasons for this, without fault of theirs. They were exponents, in the first place, of the change in all men's minds from civil and religious to merely domestic passion; the love of their gods and their country had contracted itself now into that of their domestic circle, which was little more than the halo of themselves. You will see the reflection of this change in painting at once by comparing the two Madonnas (S. 37, John Bellini's, and Raphael's, called 'della Seggiola'). Bellini's Madonna cares for all creatures through her child; Raphael's, for her child only.

Again, the world round these painters had become sad and proud, instead of happy and humble;—its domestic peace was darkened by irreligion, and made restless by pride. And the Hymen, whose statue this fair English girl of Reynolds' thought must decorate (S. 43), is blind, and holds a coronet.

Again, in the splendid power of realization, which these greatest of artists had reached, there was the latent possibility of amusement by deception, and of excitement by sensualism. And Dutch trickeries of base resemblance, and French and English fancies of insidious beauty, soon occupied the eyes of the populace of Europe, too restless and wretched now to care for the sweet earth-berries and Madonna's ivy of Cima, and too ignoble to perceive Titian's colour, or Correggio's shade.

184. Enough sources of evil were here, in the temper and

power of the consummate art. In its practical methods there was another, the fatallest of all. These great artists brought with them mystery, despondency, domesticity, sensuality : of all these, good came, as well as evil. One thing more they brought, of which nothing but evil ever comes, or can come—
Liberty.

By the discipline of five hundred years they had learned and inherited such power, that whereas all former painters could be right only by effort, they could be right with ease ; and whereas all former painters could be right only under restraint, they could be right, free. Tintoret's touch, Luini's, Correggio's, Reynolds', and Velasquez's, are all as free as the air, and yet right. 'How very fine !' said everybody. Unquestionably, very fine. Next, said everybody, 'What a grand discovery ! Here is the finest work ever done, and it is quite free. Let us all be free then, and what fine things shall we not do also !' With what results we too well know.

Nevertheless, remember you are to delight in the freedom won by these mighty men through obedience, though you are not to covet it. Obey, and you also shall be free in time ; but in these minor things, as well as in great, it is only right service which is perfect freedom.

185. This, broadly, is the history of the early and late colour-schools. The first of these I shall call generally, henceforward, the school of crystal ; the other that of clay : potter's clay, or human, are too sorrowfully the same, as far as art is concerned. Now remember, in practice, you cannot follow both these schools ; you must distinctly adopt the principles of one or the other. I will put the means of following either within your reach ; and according to your dispositions you will choose one or the other : all I have to guard you against is the mistake of thinking you can unite the two. If you want to paint (even in the most distant and feeble way) in the Greek school, the school of Lionardo, Correggio, and Turner, you cannot design coloured windows, nor Angelican paradises. If, on the other hand, you choose to live in the peace of paradise, you cannot share in the gloomy triumphs of the earth.

186. And, incidentally note, as a practical matter of imme-

diate importance, that painted windows have nothing to do with chiaroscuro. The virtue of glass is to be transparent everywhere. If you care to build a palace of jewels, painted glass is richer than all the treasures of Aladdin's lamp ; but if you like pictures better than jewels, you must come into broad daylight to paint them. A picture in coloured glass is one of the most vulgar of barbarisms, and only fit to be ranked with the gauze transparencies and chemical illuminations of the sensational stage. Also, put out of your minds at once all question about difficulty of getting colour ; in glass we have all the colours that are wanted, only we do not know either how to choose, or how to connect them ; and we are always trying to get them bright, when their real virtue is to be deep, and tender, and subdued. We will have a thorough study of painted glass soon : meanwhile I merely give you a type of its perfect style, in two windows from Chalons sur Marne (S. 141).

187. You will have then to choose between these two modes of thought : for my own part, with what poor gift and skill is in me, I belong wholly to the chiaroscuro school ; and shall teach you therefore chiefly that which I am best able to teach : and the rather, that it is only in this school that you can follow out the study either of natural history or landscape. The form of a wild animal, or the wrath of a mountain torrent, would both be revolting (or in a certain sense invisible) to the calm fantasy of a painter in the schools of crystal. He must lay his lion asleep in St. Jerome's study beside his tame partridge and spare slippers ; lead the appeased river by alternate azure promontories, and restrain its courtly little streamlets with margins of marble. But, on the other hand, your studies of mythology and literature may best be connected with these schools of purest and calmest imagination ; and their discipline will be useful to you in yet another direction, and that a very important one. It will teach you to take delight in little things, and develope in you the joy which all men should feel in purity and order, not only in pictures but in reality. For, indeed, the best art of this school of fantasy may at last be in reality, and the chiaroscuroists, true

in ideal, may be less helpful in act. We cannot arrest sunsets nor carve mountains, but we may turn every English homestead, if we choose, into a picture by Cima or John Bellini, which shall be 'no counterfeit, but the true and perfect image of life indeed.'

188. For the present, however, and yet for some little time during your progress, you will not have to choose your school. For both, as we have seen, begin in delineation; and both proceed by filling flat spaces with an even tint. And therefore this will be the course of work for you, founded on all that we have seen.

Having learned to measure, and draw a pen line with some steadiness (the geometrical exercises for this purpose being properly school, not University work), you shall have a series of studies from the plants which are of chief importance in the history of art; first from their real forms, and then from the conventional and heraldic expressions of them; then we will take examples of the filling of ornamental forms with flat colour in Egyptian, Greek, and Gothic design; and then we will advance to animal forms treated in the same severe way, and so to the patterns and colour designs on animals themselves. And when we are sure of our firmness of hand and accuracy of eye, we will go on into light and shade.

189. In process of time, these series of exercises will, I hope, be sufficiently complete and systematic to show its purpose at a glance. But during the present year, I shall content myself with placing a few examples of these different kinds of practice in your rooms for work, explaining in the catalogue the position they will ultimately occupy, and the technical points of process into which it is of no use to enter in a general lecture. After a little time spent in copying these, your own predilections must determine your future course of study; only remember, whatever school you follow, it must be only to learn method, not to imitate result, and to acquaint yourself with the minds of other men, but not to adopt them as your own. Be assured that no good can come of your work but as it arises simply out of your own true natures and the necessities of the time around you, though in many respects an

evil one. You live in an age of base conceit and baser servility—an age whose intellect is chiefly formed by pillage and occupied in desecration; one day mimicking, the next destroying, the works of all the noble persons who made its intellectual or art life possible to it:—an age without honest confidence enough in itself to carve a cherry-stone with an original fancy, but with insolence enough to abolish the solar system, if it were allowed to meddle with it. In the midst of all this, you have to become lowly and strong; to recognise the powers of others and to fulfil your own. I shall try to bring before you every form of ancient art, that you may read and profit by it, not imitate it. You shall draw Egyptian kings dressed in colours like the rainbow, and Doric gods, and Runic monsters, and Gothic monks—not that you may draw like Egyptians or Norsemen, nor yield yourselves passively to be bound by the devotion or infected with the delirium of the past, but that you may know truly what other men have felt during their poor span of life; and open your own hearts to what the heavens and earth may have to tell you in yours.

Do not be surprised, therefore, nor provoked, if I give you at first strange things, and rude, to draw. As soon as you try them, you will find they are difficult enough, yet, with care, entirely possible. As you go on drawing them they will become interesting, and, as soon as you understand them, you will be on the way to understand yourselves also.

190. In closing this first course of lectures, I have one word more to say respecting the possible consequence of the introduction of art among the studies of the University. What art may do for scholarship, I have no right to conjecture; but what scholarship may do for art, I may in all modesty tell you. Hitherto, great artists, though always gentlemen, have yet been too exclusively craftsmen. Art has been less thoughtful than we suppose; it has taught much, but much, also, falsely. Many of the greatest pictures are enigmas; others, beautiful toys; others, harmful and corrupting toys. In the loveliest there is something weak; in the greatest there is something guilty. And this, gentlemen, if you will, is the new thing that may come to pass,—that the scholars of England may re-

solve to teach also with the silent power of the arts ; and that some among you may so learn and use them, that pictures may be painted which shall not be enigmas any more, but open teachings of what can no otherwise be so well shown ; which shall not be fevered or broken visions any more, but shall be filled with the indwelling light of self-possessed imagination ; which shall not be stained or enfeebled any more by evil passion, but glorious with the strength and chastity of noble human love ; and which shall no more degrade or disguise the work of God in heaven, but testify of Him as here dwelling with men, and walking with them, not angry, in the garden of the earth.

1870
1871
1872
1873
1874
1875
1876
1877
1878
1879
1880
1881
1882
1883
1884
1885
1886
1887
1888
1889
1890
1891
1892
1893
1894
1895
1896
1897
1898
1899
1900

THE
ELEMENTS OF PERSPECTIVE

ARRANGED FOR THE USE OF SCHOOLS

AND INTENDED TO BE READ IN CONNECTION WITH THE FIRST
THREE BOOKS OF EUCLID

ELEMENTS

OF

ARITHMETIC

PREFACE.

FOR some time back I have felt the want, among Students of Drawing, of a written code of accurate Perspective Law; the modes of construction in common use being various, and, for some problems, insufficient. It would have been desirable to draw up such a code in popular language, so as to do away with the most repulsive difficulties of the subject; but finding this popularization would be impossible, without elaborate figures and long explanations, such as I had no leisure to prepare, I have arranged the necessary rules in a short mathematical form, which any school-boy may read through in a few days, after he has mastered the first three and the sixth books of Euclid.

Some awkward compromises have been admitted between the first-attempted popular explanation, and the severer arrangement, involving irregular lettering and redundant phraseology; but I cannot for the present do more, and leave the book therefore to its trial, hoping that, if it be found by masters of schools to answer its purpose, I may hereafter bring it into better form.*

* Some irregularities of arrangement have been admitted merely for the sake of convenient reference; the eighth problem, for instance, ought to have been given as a case of the seventh, but is separately enunciated on account of its importance.

Several constructions, which ought to have been given as problems, are on the contrary given as corollaries, in order to keep the more directly connected problems in closer sequence; thus the construction of rectangles and polygons in vertical planes would appear by the Table of Contents to have been omitted, being given in the corollary to Problem IX.

An account of practical methods, sufficient for general purposes of sketching, might indeed have been set down in much less space, but if the student reads the following pages carefully, he will not only find himself able, on occasion, to solve perspective problems of a complexity greater than the ordinary rules will reach, but obtain a clue to many important laws of pictorial effect, no less than of outline. The subject thus examined becomes, at least to my mind, very curious and interesting; but, for students who are unable or unwilling to take it up in this abstract form, I believe good help will be soon furnished, in a series of illustrations of practical perspective now in preparation by Mr. Le Vengeur. I have not seen this essay in an advanced state, but the illustrations shown to me were very clear and good; and as the author has devoted much thought to their arrangement, I hope that his work will be precisely what is wanted by the general learner.

Students wishing to pursue the subject into its more extended branches will find, I believe, Cloquet's treatise the best hitherto published.*

* *Nouveau Traité Élémentaire de Perspective.* Bachelier, 1822.

THE ELEMENTS OF PERSPECTIVE.

INTRODUCTION.

WHEN you begin to read this book, sit down very near the window, and shut the window. I hope the view out of it is pretty ; but, whatever the view may be, we shall find enough in it for an illustration of the first principles of perspective (or, literally, of “looking through”).

Every pane of your window may be considered, if you choose, as a glass picture ; and what you see through it, as painted on its surface.

And if, holding your head still, you extend your hand to the glass, you may, with a brush full of any thick colour, trace, roughly, the lines of the landscape on the glass.

But, to do this, you must hold your head very still. Not only you must not move it sideways, nor up and down, but it must not even move backwards or forwards ; for, if you move your head forwards, you will see *more* of the landscape through the pane ; and, if you move it backwards, you will see *less* : or considering the pane of glass as a picture, when you hold your head near it, the objects are painted small, and a great many of them go into a little space ; but, when you hold your head some distance back, the objects are painted larger upon the pane, and fewer of them go into the field of it.

But, besides holding your head still, you must, when you try to trace the picture on the glass, shut one of your eyes. If

you do not, the point of the brush appears double ; and, on farther experiment, you will observe that each of your eyes sees the object in a different place on the glass, so that the tracing which is true to the sight of the right eye is a couple of inches (or more, according to your distance from the pane), to the left of that which is true to the sight of the left.

Thus, it is only possible to draw what you see through the window rightly on the surface of the glass, by fixing one eye at a given point, and neither moving it to the right nor left nor up nor down, nor backwards nor forwards. Every picture drawn in true perspective may be considered as an upright piece of glass,* on which the objects seen through it have been thus drawn. Perspective can, therefore, only be quite right, by being calculated for one fixed position of the eye of the observer ; nor will it ever appear *deceptively* right unless seen precisely from the point it is calculated for. Custom, however, enables us to feel the rightness of the work on using both our eyes, and to be satisfied with it, even when we stand at some distance from the point it is designed for.

Supposing that, instead of a window, an unbroken plate of crystal extended itself to the right and left of you, and high in front, and that you had a brush as long as you wanted (a mile long, suppose), and could paint with such a brush, then the clouds high up, nearly over your head, and the landscape far away to the right and left, might be traced, and painted, on this enormous crystal field.† But if the field were so vast (suppose a mile high and a mile wide), certainly, after the picture was done, you would not stand as near to it, to see it, as you are now sitting near to your window. In order to trace the upper clouds through your great glass, you would have had to stretch your neck quite back, and nobody likes to bend their neck back to see the top of a picture. So you would

* If the glass were not upright, but sloping, the objects might still be drawn through it, but their perspective would then be different. Perspective, as commonly taught, is always calculated for a vertical plane of picture.

† Supposing it to have no thickness ; otherwise the images would be distorted by refraction.

walk a long way back to see the great picture—a quarter of a mile, perhaps,—and then all the perspective would be wrong, and would look quite distorted, and you would discover that you ought to have painted it from the greater distance, if you meant to look at it from that distance. Thus, the distance at which you intend the observer to stand from a picture, and for which you calculate the perspective, ought to regulate to a certain degree the size of the picture. If you place the point of observation near the canvas, you should not make the picture very large: *vice versa*, if you place the point of observation far from the canvas, you should not make it very small; the fixing, therefore, of this point of observation determines, as a matter of convenience, within certain limits, the size of your picture. But it does not determine this size by any perspective law; and it is a mistake made by many writers on perspective, to connect some of their rules definitely with the size of the picture. For, suppose that you had what you now see through your window painted actually upon its surface, it would be quite optional to cut out any piece you chose, with the piece of the landscape that was painted on it. You might have only half a pane, with a single tree; or a whole pane, with two trees and a cottage; or two panes with the whole farmyard and pond; or four panes, with farmyard, pond, and foreground. And any of these pieces, if the landscape upon them were, as a scene, pleasantly composed, would be agreeable pictures, though of quite different sizes; and yet they would be all calculated for the same distance of observation.

In the following treatise, therefore, I keep the size of the picture entirely undetermined. I consider the field of canvas as wholly unlimited, and on that condition determine the perspective laws. After we know how to apply those laws without limitation, we shall see what limitations of the size of the picture their results may render advisable.

But although the size of the *picture* is thus independent of the observer's distance, the size of the *object represented* in the picture is not. On the contrary, that size is fixed by absolute mathematical law; that is to say, supposing you have to draw a tower a hundred feet high, and a quarter of a mile distant

from you, the height which you ought to give that tower on your paper depends, with mathematical precision, on the distance at which you intend your paper to be placed. So, also, do all the rules for drawing the form of the tower, whatever it may be.

Hence, the first thing to be done in beginning a drawing is to fix, at your choice, this distance of observation, or the distance at which you mean to stand from your paper. After that is determined, all is determined, except only the ultimate size of your picture, which you may make greater, or less, not by altering the size of the things represented, but by *taking in more, or fewer* of them. So, then, before proceeding to apply any practical perspective rule, we must always have our distance of observation marked, and the most convenient way of marking it is the following.

PLACING OF THE SIGHT-POINT, SIGHT-LINE, STATION-POINT, AND STATION-LINE.

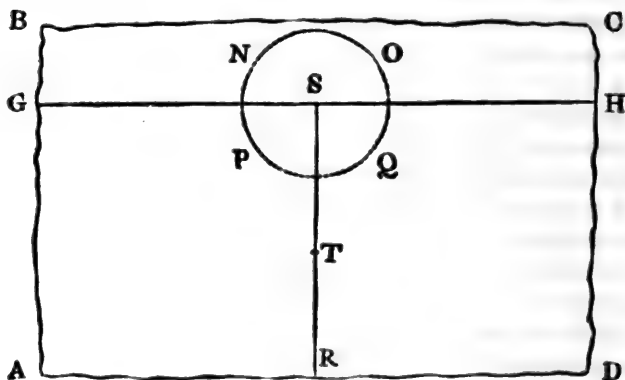

FIG. 1.

I. THE SIGHT-POINT.—Let $A B C D$, Fig. 1., be your sheet of paper, the larger the better, though perhaps we may cut out of it at last only a small piece for our picture, such as the dotted circle $N O P Q$. This circle is not intended to limit either the size or shape of our picture: you may ultimately

have it round or oval, horizontal or upright, small or large, as you choose. I only dot the line to give you an idea of whereabouts you will probably like to have it; and, as the operations of perspective are more conveniently performed upon paper underneath the picture than above it, I put this conjectural circle at the top of the paper, about the middle of it, leaving plenty of paper on both sides and at the bottom. Now, as an observer generally stands near the middle of a picture to look at it, we had better at first, and for simplicity's sake, fix the point of observation opposite the middle of our conjectural picture. So take the point s , the centre of the circle $N O P Q$;—or, which will be simpler for you in your own work, take the point s at random near the top of your paper, and strike the circle $N O P Q$ round it, any size you like. Then the point s is to represent the point *opposite* which you wish the observer of your picture to place his eye, in looking at it. Call this point the "Sight-Point."

II. THE SIGHT-LINE.—Through the Sight-point, s , draw a horizontal line, $G H$, right across your paper from side to side, and call this line the "Sight-Line."

This line is of great practical use, representing the level of the eye of the observer all through the picture. You will find hereafter that if there is a horizon to be represented in your picture, as of distant sea or plain, this line defines it.

III. THE STATION-LINE.—From s let fall a perpendicular line, $s R$, to the bottom of the paper, and call this line the "Station-Line."

This represents the line on which the observer stands, at a greater or less distance from the picture; and it ought to be *imagined* as drawn right out from the paper at the point s . Hold your paper upright in front of you, and hold your pencil horizontally, with its point against the point s , as if you wanted to run it through the paper there, and the pencil will represent the direction in which the line $s R$ ought to be drawn. But as all the measurements which we have to set upon this line, and operations which we have to perform with

it, are just the same when it is drawn on the paper itself, below s , as they would be if it were represented by a wire in the position of the levelled pencil, and as they are much more easily performed when it is drawn on the paper, it is always in practice so drawn.

IV. THE STATION-POINT.—On this line, mark the distance $s\tau$ at your pleasure, for the distance at which you wish your picture to be seen, and call the point T the “Station-Point.”

In practice, it is generally advisable to make the distance $s\tau$ about as great as the diameter of your intended picture; and it should, for the most part, be more rather than less; but, as I have just stated, this is quite arbitrary. However, in this figure, as an approximation to a generally advisable distance, I make the distance $s\tau$ equal to the diameter of the circle $n o p q$. Now, having fixed this distance, $s\tau$, all the dimensions of the objects in our picture are fixed likewise, and for this reason:—

Let the upright line AB , Fig. 2., represent a pane of glass placed where our picture is to be placed; but seen at the side

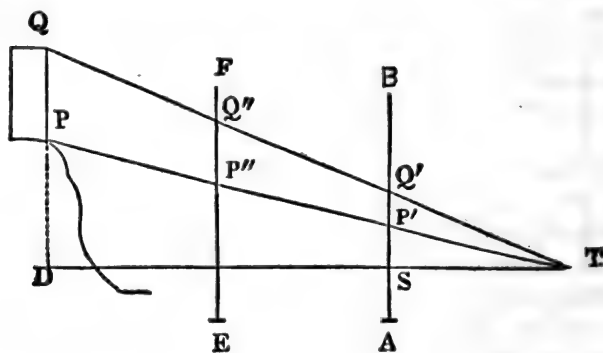

FIG. 2.

of it, edgewise; let s be the Sight-point; $s\tau$ the Station-line, which, in this figure, observe, is in its true position, drawn out from the paper, not down upon it; and τ the Station-point.

Suppose the Station-line $s\tau$ to be continued, or in mathematical language "produced," though s , far beyond the pane of glass, and let $p\ q$ be a tower or other upright object situated on or above this line.

Now the *apparent* height of the tower $p\ q$ is measured by the angle $q\ \tau\ p$, between the rays of light which come from the top and bottom of it to the eye of the observer. But the *actual* height of the *image* of the tower on the pane of glass $a\ b$, between us and it, is the distance $p'\ q'$, between the points where the rays traverse the glass.

Evidently, the farther from the point τ we place the glass, making $s\ \tau$ longer, the larger will be the image; and the nearer we place it to τ , the smaller the image, and that in a fixed ratio. Let the distance $d\ \tau$ be the direct distance from the Station-point to the foot of the object. Then, if we place the glass $a\ b$ at one third of that whole distance, $p'\ q'$ will be one third of the real height of the object; if we place the glass at two thirds of the distance, as at $e\ f$, $p''\ q''$ (the height of the image at that point) will be two thirds the height* of the object, and so on. Therefore the mathematical law is that $p'\ q'$ will be to $p\ q$ as $s\ \tau$ to $d\ \tau$. I put this ratio clearly by itself that you may remember it:

$$p'\ q' : p\ q :: s\ \tau : d\ \tau$$

or in words:

$$p\ \text{dash}\ q\ \text{dash is to } p\ q\ \text{as } s\ \tau\ \text{to } d\ \tau.$$

In which formula, recollect that $p'\ q'$ is the height of the appearance of the object on the picture; $p\ q$ the height of the object itself; s the Sight-point; τ the Station-point; d a point at the direct distance of the object; though the object is seldom placed actually on the line $\tau\ s$ produced, and may be far to the right or left of it, the formula is still the same.

For let s , FIG. 3., be the Sight-point, and $a\ b$ the glass—

* I say "height" instead of "magnitude," for a reason stated in Appendix I., to which you will soon be referred. Read on here at present.

here seen looking *down* on its *upper edge*, not sideways;— then if the tower (represented now, as on a map, by the dark square), instead of being at *D* on the line *s T* produced, be at *E*, to the right (or left) of the spectator, still the apparent height of the tower on *AB* will be as *s' T* to *E T*, which is the same ratio as that of *s T* to *D T*.

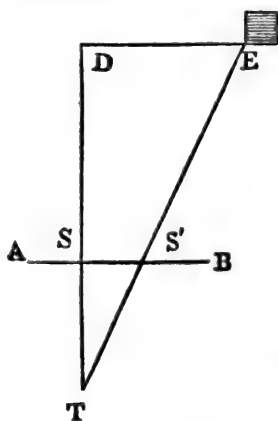

FIG. 3.

Now in many perspective problems, the position of an object is more conveniently expressed by the two measurements *D T* and *D E*, than by the single oblique measurement *E T*.

I shall call *D T* the “direct distance” of the object at *E*, and *D E* its “lateral distance.” It is rather a license to call *D T* its “direct” distance,

for *E T* is the more direct of the two; but there is no other term which would not cause confusion.

Lastly, in order to complete our knowledge of the position of an object, the vertical height of some point in it, above or below the eye, must be given; that is to say, either *D P* or *D Q* in Fig. 2.*: this I shall call the “vertical distance” of the point given. In all perspective problems these three distances, and the dimensions of the object, must be stated, otherwise the problem is imperfectly given. It ought not to be required of us merely to draw a room or a church in perspective; but to draw *this* room from *this* corner, and *that* church on *that* spot, in perspective. For want of knowing how to base their drawings on the measurement and place of the object I have known practised students represent a parish church, certainly in true perspective, but with a nave about two miles and a half long.

It is true that in drawing landscapes from nature the sizes

* *P* and *Q* being points indicative of the place of the tower's base and top. In this figure both are above the sight-line; if the tower were below the spectator both would be below it, and therefore measured below *D*.

and distances of the objects cannot be accurately known. When, however, we know how to draw them rightly, if their size were given, we have only to *assume a rational approximation* to their size, and the resulting drawing will be true enough for all intents and purposes. It does not in the least matter that we represent a distant cottage as eighteen feet long when it is in reality only seventeen ; but it matters much that we do not represent it as eighty feet long, as we easily might if we had not been accustomed to draw from measurement. Therefore, in all the following problems the measurement of the object is given.

The student must observe, however, that in order to bring the diagrams into convenient compass, the measurements assumed are generally very different from any likely to occur in practice. Thus, in Fig. 3., the distance DS would be probably in practice half a mile or a mile, and the distance TS , from the eye of the observer to the paper, only two or three feet. The mathematical law is however precisely the same, whatever the proportions ; and I use such proportions as are best calculated to make the diagram clear.

Now, therefore, the conditions of a perspective problem are the following.

The Sight-line GH given, Fig. 1.;

The Sight-point s given ;

The Station-point t given ; and

The three distances of the object,* direct, lateral, and vertical, with its dimensions, given.

The size of the picture, conjecturally limited by the dotted circle, is to be determined afterwards at our pleasure. On these conditions I proceed at once to construction.

* More accurately, "the three distances of any point, either in the object itself, or indicative of its distance."

PROBLEM I.

TO FIX THE POSITION OF A GIVEN POINT.*

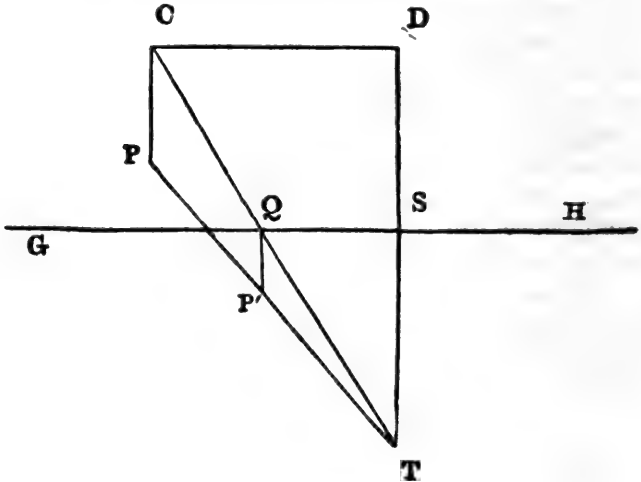

FIG. 4.

LET P , Fig. 4., be the given point.

Let its direct distance be DT ; its lateral distance to the left, DC ; and vertical distance *beneath* the eye of the observer, CP .

[Let GH be the Sight-line, s the Sight-point, and T the Station-point.] †

* More accurately, "To fix on the plane of the picture the apparent position of a point given in actual position." In the headings of all the following problems the words "on the plane of the picture" are to be understood after the words "to draw." The plane of the picture means a surface extended indefinitely in the direction of the picture.

† The sentence within brackets will not be repeated in succeeding statements of problems. It is always to be understood.

It is required to fix on the plane of the picture the position of the point P.

Arrange the three distances of the object on your paper, as in Fig. 4.*

Join $c T$, cutting $G H$ in q .

From q let fall the vertical line $q P'$.

Join $P T$, cutting $q P$ in P' .

P' is the point required.

If the point P is *above* the eye of the observer instead of below it, $c P$ is to be measured upwards from c , and $q P'$ drawn upwards from q . The construction will be as in Fig. 5.

And if the point P is to the right instead of the left of the observer, $D C$ is to be measured to the right instead of the left.

The Figures 4. and 5., looked at in a mirror, will show the construction of each, on that supposition.

Now read very carefully the examples and notes to this problem in Appendix I. (page 63). I have put them in the Appendix in order to keep the sequence of following problems more clearly traceable here in the text ; but you must read the first Appendix before going on.

* In order to be able to do this, you must assume the distances to be small ; as in the case of some object on the table : how large distances are to be treated you will see presently ; the mathematical principle, being the same for all, is best illustrated first on a small scale. Suppose, for instance, P to be the corner of a book on the table, seven inches below the eye, five inches to the left of it, and a foot and a half in advance of it, and that you mean to hold your finished drawing at six inches from the eye ; then $T S$ will be six inches, $T D$ a foot and a half, $D C$ five inches, and $C P$ seven.

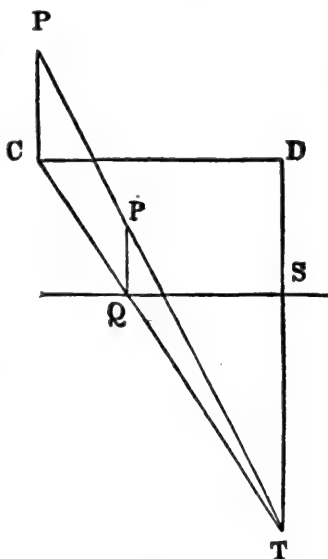

FIG. 5.

PROBLEM II.

TO DRAW A RIGHT LINE BETWEEN TWO GIVEN POINTS.

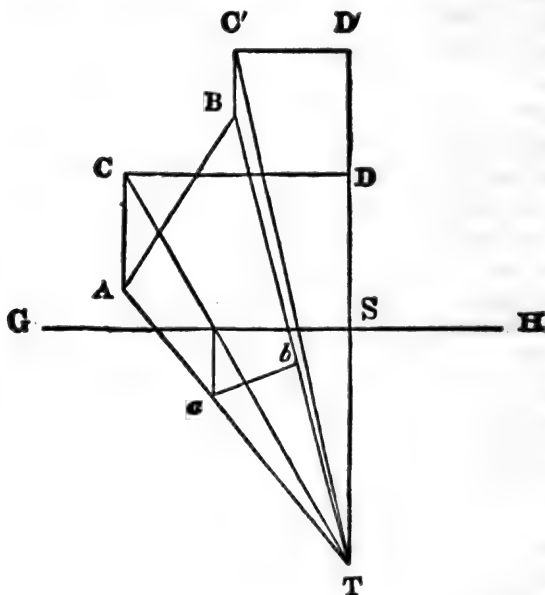

FIG. 6.

LET AB , Fig. 6., be the given right line, joining the given points A and B .

Let the direct, lateral, and vertical distances of the point A be TD , DC , and CA .

Let the direct, lateral, and vertical distances of the point B be TD' , $D'C'$, and $C'B$.

Then, by Problem I, the position of the point A on the plane of the picture is a .

And similarly, the position of the point B on the plane of the picture is b .

Join ab .

Then ab is the line required.

COROLLARY I.

If the line AB is in a plane parallel to that of the picture, one end of the line AB must be at the same direct distance from the eye of the observer as the other.

Therefore, in that case, DT is equal to $D'T$.

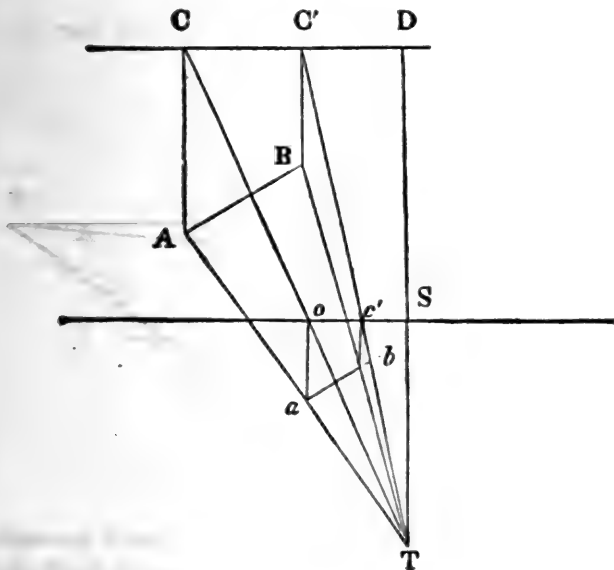

FIG. 7.

Then the construction will be as in Fig. 7.; and the student will find experimentally that ab is now parallel to AB .*

And that ab is to AB as TS is to TD .

Therefore, to draw any line in a plane parallel to that of the picture, we have only to fix the position of one of its extremities, a or b , and then to draw from a or b a line parallel to the given line, bearing the proportion to it that TS bears to TD .

* For by the construction $AT : aT :: BT : bT$; and therefore the two triangles ABT , abT , (having a common angle ATB), are similar.

COROLLARY II.

If the line $A B$ is in a horizontal plane, the vertical distance of one of its extremities must be the same as that of the other.

Therefore, in that case, $A c$ equals $B c'$ (Fig. 6.).

And the construction is as in Fig. 8.

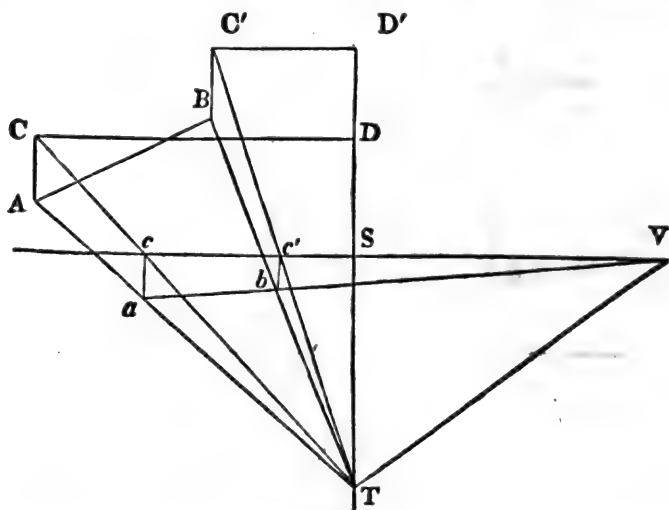

FIG. 8.

In Fig. 8. produce ab to the sight-line, cutting the sight-line in v ; the point v , thus determined, is called the VANISHING-POINT of the line $A B$.

Join $T v$. Then the student will find experimentally that $T v$ is parallel to $A B$.*

COROLLARY III.

If the line $A B$ produced would pass through some point beneath or above the station-point, $c D$ is to $D T$ as $c' D'$ is to $D' T$; in which case the point c coincides with the point c' , and the line ab is vertical.

* The demonstration is in Appendix II. Article I.

Therefore every vertical line in a picture is, or may be, the perspective representation of a horizontal one which, produced, would pass beneath the feet or above the head of the spectator.*

PROBLEM III.

TO FIND THE VANISHING-POINT OF A GIVEN HORIZONTAL LINE.

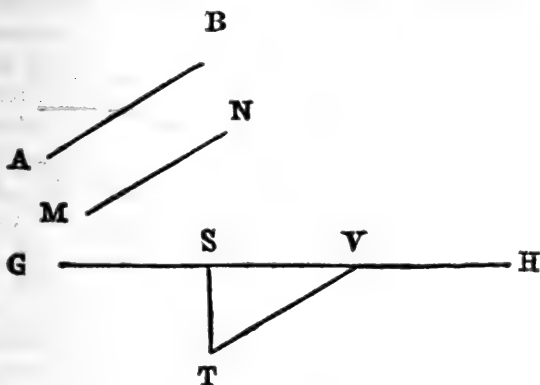

FIG. 9.

LET *AB*, Fig. 9., be the given line.

From *t*, the station-point, draw *tv* parallel to *AB*, cutting the sight-line in *v*.

v is the Vanishing-point required. †

* The reflection in water of any luminous point or isolated object (such as the sun or moon) is therefore, in perspective, a vertical line; since such reflection, if produced, would pass under the feet of the spectator. Many artists (Claude among the rest) knowing something of optics, but nothing of perspective, have been led occasionally to draw such reflections towards a point at the centre of the base of the picture.

† The student will observe, in practice, that, his paper lying flat on the table, he has only to draw the line *TV* on its horizontal surface, parallel to the given horizontal line *AB*. In theory, the paper should be vertical, but the station-line *ST* horizontal (see its definition above,

COROLLARY I.

As, if the point b is first found, v may be determined by it, so, if the point v is first found, b may be determined by it. For let $A B$, Fig. 10., be the given line, constructed upon the

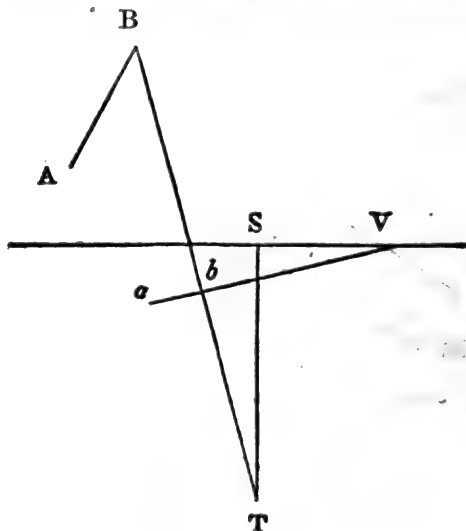

FIG. 10.

paper as in Fig. 8. ; and let it be required to draw the line $a b$ without using the point c' .

Find the position of the point A in a . (Problem I.)

page 13.) ; in which case $T v$, being drawn parallel to $A B$, will be horizontal also, and still cut the sight-line in v .

The construction will be seen to be founded on the second Corollary of the preceding problem.

It is evident that if any other line, as $M N$ in Fig. 9., parallel to $A B$, occurs in the picture, the line $T v$, drawn from T , parallel to $M N$, to find the vanishing-point of $M N$, will coincide with the line drawn from T , parallel to $A B$, to find the vanishing-point of $A B$.

Therefore $A B$ and $M N$ will have the same vanishing-point.

Therefore all parallel horizontal lines have the same vanishing-point.

It will be shown hereafter that all parallel *inclined* lines also have the

Find the vanishing-point of AB in v . (Problem III.)

Join $a v$.

Join $b t$, cutting $a v$ in b .

Then $a b$ is the line required.*

COROLLARY II.

We have hitherto proceeded on the supposition that the given line was small enough, and near enough to be actually drawn on our paper of its real size; as in the example given in Appendix I. We may, however, now deduce a construction available under all circumstances, whatever may be the distance and length of the line given.

From Fig. 8. remove, for the sake of clearness, the lines $c' d'$, $b v$, and $t v$; and, taking the figure as in Fig. 11., draw from a , the line $a r$ parallel to AB , cutting BT in r .

Then $a r$ is to AB as $a t$ is to AT .

— — as ct is to CT .

— — as ts is to TD .

That is to say, $a r$ is the sight-magnitude of AB . †

Therefore, when the position of the point A is fixed in a , as in Fig. 12., and $a v$ is drawn to the vanishing-point; if we draw a line $a r$ from a , parallel to AB , and make $a r$ equal to the sight-magnitude of AB , and then join $r t$, the line $r t$ will cut $a v$ in b .

same vanishing-point; the student may here accept the general conclusion—"All parallel lines have the same vanishing-point."

It is also evident that if AB is parallel to the plane of the picture, $t v$ must be drawn parallel to GH , and will therefore never cut GH . The line AB has in that case no vanishing-point: it is to be drawn by the construction given in Fig. 7.

It is also evident that if AB is at right angles with the plane of the picture, $t v$ will coincide with ts , and the vanishing-point of AB will be the sight-point.

* I spare the student the formality of the *reductio ad absurdum* which would be necessary to prove this.

† For definition of Sight-Magnitude, see Appendix I. It ought to have been read before the student comes to this problem; but I refer to it in case it has not.

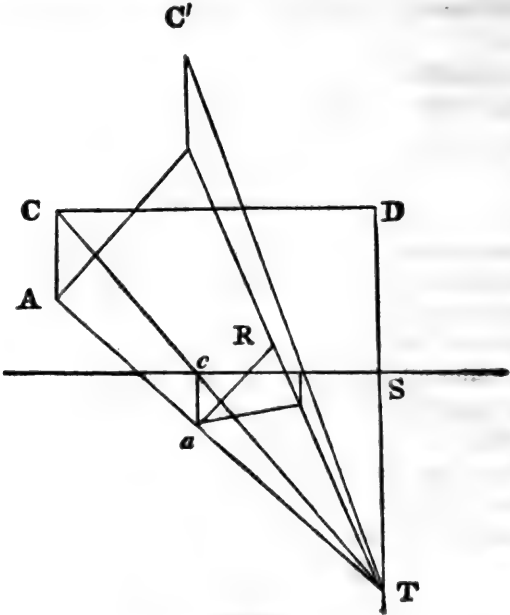

FIG. 11.

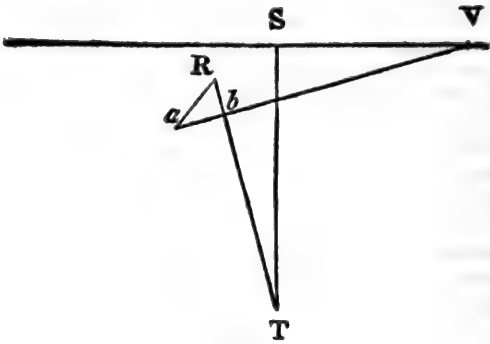
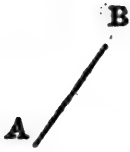

FIG. 12.

So that, in order to determine the length of $a b$, we need not draw the long and distant line $A B$, but only $a R$ parallel to it, and of its sight-magnitude; which is a great gain, for the line $A B$ may be two miles long, and the line $a R$ perhaps only two inches.

COROLLARY III.

In Fig. 12., altering its proportions a little for the sake of clearness, and putting it as here in Fig. 13., draw a horizontal line $a R'$ and make $a R'$ equal to $a R$.

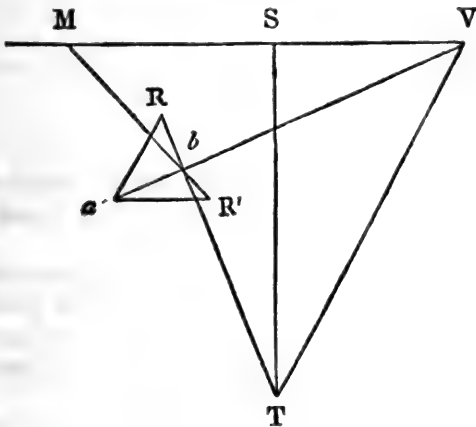

FIG. 13.

Through the points R and b draw $R'M$, cutting the sight-line in M . Join TV . Now the reader will find experimentally that VM is equal to VT .*

Hence it follows that, if from the vanishing-point v we lay off on the sight-line a distance, VM , equal to VT ; then draw through a a horizontal line aR' , make aR' equal to the sight-magnitude of AB and join $R'M$; the line $R'M$ will cut av in b . And this is in practice generally the most convenient way of obtaining the length of ab .

* The demonstration is in Appendix II. Article II. p. 90

COROLLARY IV.

Removing from the preceding figure the unnecessary lines, and retaining only $r'm$ and av , as in Fig. 14., produce the line ar' to the other side of a , and make ax equal to ar' .

Join xb , and produce xb to cut the line of sight in n .

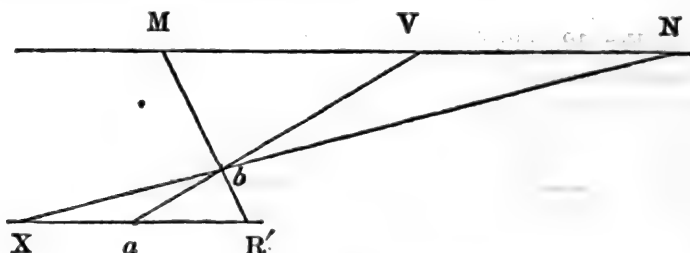

FIG. 14.

Then as xr' is parallel to mn , and ar' is equal to ax , vn must, by similar triangles, be equal to vm (equal to vt in Fig. 13.).

Therefore, on whichever side of v we measure the distance vt , so as to obtain either the point m , or the point n , if we measure the sight-magnitude ar' or ax on the opposite side of the line av , the line joining $r'm$ or xn will equally cut av in b .

The points m and n are called the "DIVIDING-POINTS" of the original line ab (Fig. 12.), and we resume the results of these corollaries in the following three problems.

PROBLEM IV.

TO FIND THE DIVIDING-POINTS OF A GIVEN HORIZONTAL LINE.

LET the horizontal line ab (Fig. 15.) be given in position and magnitude. It is required to find its dividing-points.

Find the vanishing-point v of the line ab .

With centre v and distance $v t$, describe circle cutting the sight-line in m and n .

Then m and n are the dividing-points required.

In general, only one dividing-point is needed for use with any vanishing-point, namely, the one nearest s (in this case the point m). But its opposite n , or both, may be needed under certain circumstances.

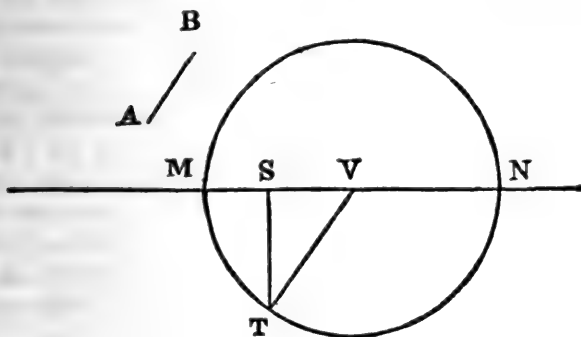

FIG. 15.

PROBLEM V.

TO DRAW A HORIZONTAL LINE, GIVEN IN POSITION AND MAGNITUDE, BY MEANS OF ITS SIGHT-MAGNITUDE AND DIVIDING-POINTS.

LET AB (Fig. 16.) be the given line.

Find the position of the point a in a .

Find the vanishing-point v , and most convenient dividing-point, m , of the line AB .

Join av .

Through a draw a horizontal line ab' and make ab' equal to the sight-magnitude of AB . Join $b'm$, cutting av in b .

Then ab is the line required.

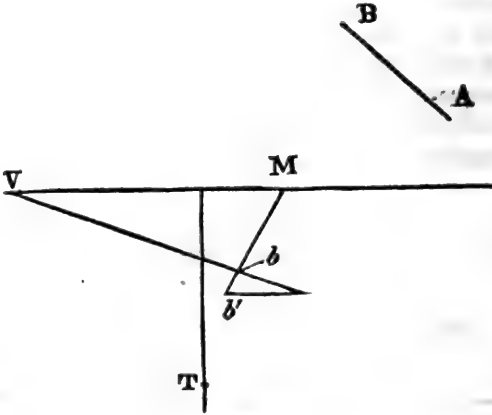

FIG. 16.

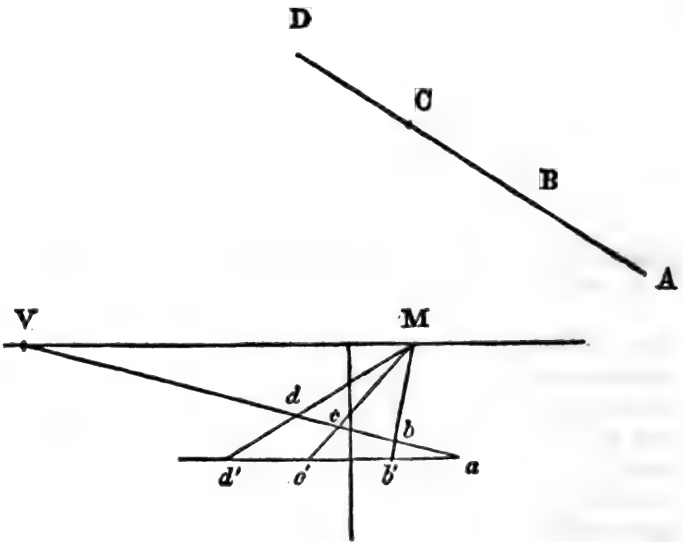

FIG. 17.

COROLLARY I.

Supposing it were now required to draw a line ΛC (Fig. 17.) twice as long as ΛB , it is evident that the sight-magnitude $a c'$ must be twice as long as the sight-magnitude $a b'$; we have, therefore, merely to continue the horizontal line $a b'$, make $b c'$ equal to $a b'$, join $c m'$, cutting $a v$ in c , and $a c$ will be the line required. Similarly, if we have to draw a line ΛD , three times the length of ΛB , $a d'$ must be three times the length of $a b'$, and joining $d' m$, $a d$ will be the line required.

The student will observe that the nearer the portions cut off, $b c$, $c d$, &c., approach the point v , the smaller they become; and, whatever lengths may be added to the line ΛD , and successively cut off from $a v$, the line $a v$ will never be cut off entirely, but the portions cut off will become infinitely small, and apparently "vanish" as they approach the point v : hence this point is called the "vanishing" point.

COROLLARY II.

It is evident that if the line ΛD had been given originally, and we had been required to draw it, and divide it into three equal parts, we should have had only to divide its sight-magnitude, $a d'$, into the three equal parts, $a b'$, $b' c'$, and $c' d'$, and then, drawing to m from b' and c' , the line $a d$ would have been divided as required in b and c . And supposing the original line ΛD be divided *irregularly into any number* of parts, if the line $a d'$ be divided into a similar number in the same proportions (by the construction given in Appendix I.), and, from these points of division, lines are drawn to m , they will divide the line $a d$ in true perspective into a similar number of proportionate parts.

The horizontal line drawn through a , on which the sight-magnitudes are measured, is called the "MEASURING-LINE."

And the line $a d$, when properly divided in b and c , or any

other required points, is said to be divided "IN PERSPECTIVE RATIO" to the divisions of the original line A D.

If the line $a v$ is above the sight-line instead of beneath it, the measuring-line is to be drawn above also: and the lines $b' m$, $c' m$, &c., drawn down to the dividing-point. Turn Fig. 17. upside down, and it will show the construction.

PROBLEM VI.

TO DRAW ANY TRIANGLE, GIVEN IN POSITION AND MAGNITUDE, IN A HORIZONTAL PLANE.

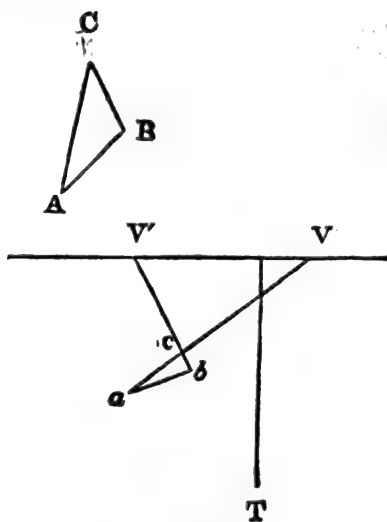

FIG. 18.

LET A B C (Fig. 18.) be the triangle.

As it is given in position and magnitude, one of its sides, at least, must be given in position and magnitude, and the directions of the two other sides.

Let A B be the side given in position and magnitude.

Then AB is a horizontal line, in a given position, and of a given length.

Draw the line AB . (Problem V.)

Let ab be the line so drawn.

Find v and v' , the vanishing-points respectively of the lines AC and BC . (Problem III.)

From a draw av , and from b , draw bv' , cutting each other in c .

Then abc is the triangle required.

If AC is the line originally given, ac is the line which must be first drawn, and the line $v'b$ must be drawn from v' to c and produced to cut ab in b . Similarly, if BC is given, bc must be drawn to c and produced, and ab from its vanishing-point to b , and produced to cut ac in a .

PROBLEM VII

TO DRAW ANY RECTILINEAR QUADRILATERAL FIGURE, GIVEN IN POSITION AND MAGNITUDE, IN A HORIZONTAL PLANE.

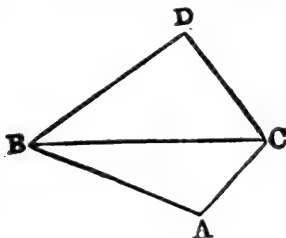

FIG. 19.

LET $ABCD$ (Fig. 19.) be the given figure.

Join any two of its opposite angles by the line BC .

Draw first the triangle ABC . (Problem VI.)

And then, from the base BC , the two lines BD , CD , to their vanishing-points, which will complete the figure. It is unnecessary to give a diagram of the construction, which is merely that of Fig. 18. duplicated; another triangle being drawn on the line AC or BC .

COROLLARY.

It is evident that by this application of Problem VI any given rectilinear figure whatever in a horizontal plane may be drawn, since any such figure may be divided into a number of triangles, and the triangles then drawn in succession.

More convenient methods may, however, be generally found, according to the form of the figure required, by the use of succeeding problems; and for the quadrilateral figure which occurs most frequently in practice, namely, the square, the following construction is more convenient than that used in the present problem.

PROBLEM VIII.

TO DRAW A SQUARE, GIVEN IN POSITION AND MAGNITUDE, IN A HORIZONTAL PLANE.

LET $A B C D$ (Fig. 20.) be the square.

As it is given in position and magnitude, the position and magnitude of all its sides are given.

Fix the position of the point A in a .

Find v , the vanishing-point of $A B$; and m , the dividing-point of $A B$, nearest s .

Find v' , the vanishing-point of $A C$; and n , the dividing-point of $A C$, nearest s .

Draw the measuring-line through a , and make $a b'$, $a c'$, each equal to the sight-magnitude of $A B$.

(For since $A B C D$ is a square, $A C$ is equal to $A B$.)

Draw $a v'$ and $c' n$, cutting each other in c .

Draw $a v$, and $b' m$, cutting each other in b .

Then $a c$, $a b$, are the two nearest sides of the square.

Now, clearing the figure of superfluous lines, we have $a b$, $a c$, drawn in position, as in Fig. 21.

And because $A B C D$ is a square, $C D$ (Fig. 20.) is parallel to $A B$.

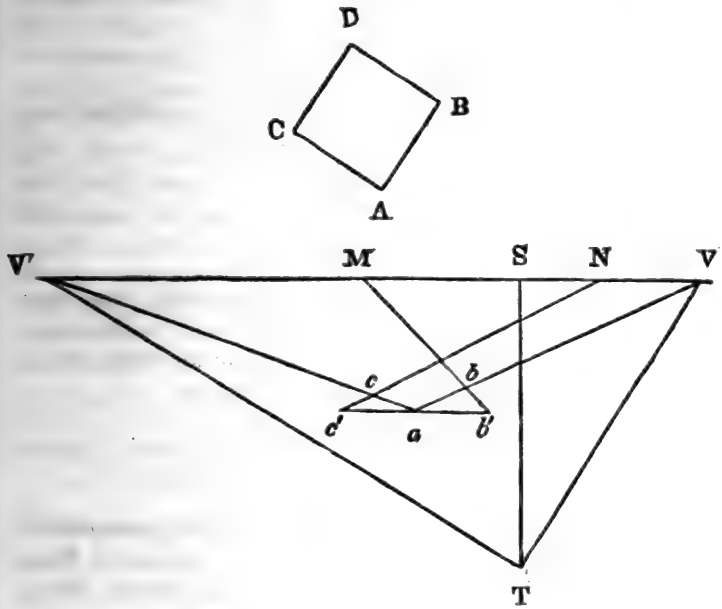

FIG. 20.

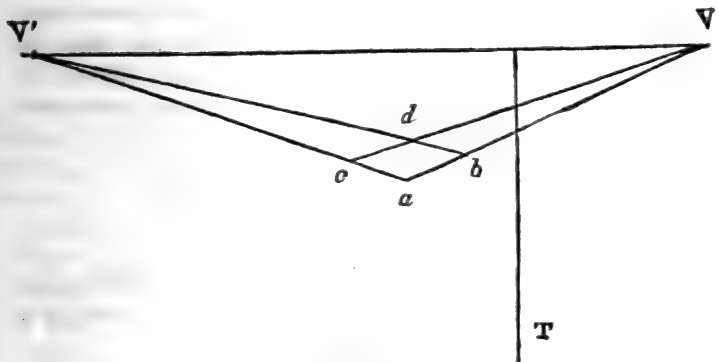

FIG. 21.

And all parallel lines have the same vanishing-point. (Note to Problem III.)

Therefore, v is the vanishing-point of $c d$.

Similarly, v' is the vanishing-point of $b d$.

Therefore, from b and c (Fig. 22.) draw $b v'$, $c v$, cutting each other in d .

Then $a b c d$ is the square required.

COROLLARY I.

It is obvious that any rectangle in a horizontal plane may be drawn by this problem, merely making $a b'$, on the measuring-line, Fig. 20., equal to the sight-magnitude of one of its sides, and $a c'$ the sight-magnitude of the other.

COROLLARY II.

Let $a b c d$, Fig. 22., be any square drawn in perspective. Draw the diagonals $a d$ and $b c$, cutting each other in c . Then

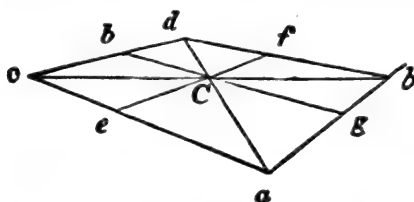

FIG. 22.

c is the centre of the square. Through c , draw $e f$ to the vanishing-point of $a b$, and $g h$ to the vanishing-point of $a c$, and these lines will bisect the sides of the square, so that $a g$ is

the perspective representation of half the side $a b$; $a e$ is half $a c$; $c h$ is half $c d$; and $b f$ is half $b d$.

COROLLARY III.

Since $A B C D$, Fig. 20., is a square, $B A C$ is a right angle; and as $T V$ is parallel to $A B$, and $T V'$ to $A C$, $V' T V$ must be a right angle also.

As the ground plan of most buildings is rectangular, it constantly happens in practice that their angles (as the corners

of ordinary houses) throw the lines to the vanishing-points thus at right angles ; and so that this law is observed, and $v r v'$ is kept a right angle, it does not matter in general practice whether the vanishing-points are thrown a little more or a little less to the right or left of s ; but it matters much that the relation of the vanishing-points should be accurate. Their position with respect to s merely causes the spectator to see a little more or less on one side or other of the house, which may be a matter of chance or choice ; but their rectangular relation determines the rectangular shape of the building, which is an essential point.

PROBLEM IX.

TO DRAW A SQUARE PILLAR, GIVEN IN POSITION AND MAGNITUDE, ITS BASE AND TOP BEING IN HORIZONTAL PLANES.

LET $A H$, Fig. 23, be the square pillar.

Then, as it is given in position and magnitude, the position and magnitude of the square it stands upon must be given (that is, the line $A B$ or $A C$ in position), and the height of its side $A E$.

Find the sight-magnitudes of $A B$ and $A E$. Draw the two sides $a b, a c$, of the square of the base, by Problem VIII., as in Fig. 24. From the points a, b , and c , raise vertical lines $a e, c f, b g$.

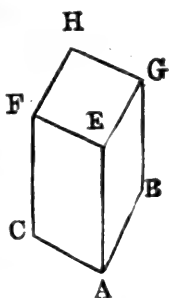

FIG. 23.

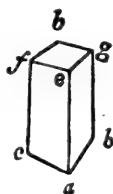

FIG. 24.

Make $a e$ equal to the sight-magnitude of $A E$.

Now because the top and base of the pillar are in horizontal planes, the square of its top, $F G$, is parallel to the square of its base, $B C$.

Therefore the line $E F$ is parallel to $A C$, and $E G$ to $A B$.

Therefore $E F$ has the same vanishing-point as $A C$, and $E G$ the same vanishing-point as $A B$.

From e draw ef to the vanishing-point of ac , cutting cf in f .

Similarly draw eg to the vanishing-point of ab , cutting bg in g .

Complete the square gf in h , drawing gh to the vanishing-point of ef , and fh to the vanishing-point of eg , cutting each other in h . Then $aghf$ is the square pillar required.

COROLLARY.

It is obvious that if AE is equal to AC , the whole figure will be a cube, and each side, $aecf$ and $agfb$, will be a square in a given vertical plane. And by making AB or AC longer or shorter in any given proportion, any form of rectangle may be given to either of the sides of the pillar. No other rule is therefore needed for drawing squares or rectangles in vertical planes.

Also any triangle may be thus drawn in a vertical plane, by enclosing it in a rectangle and determining, in perspective ratio, on the sides of the rectangle, the points of their contact with the angles of the triangle.

And if any triangle, then any polygon.

A less complicated construction will, however, be given hereafter.*

PROBLEM X.

TO DRAW A PYRAMID, GIVEN IN POSITION AND MAGNITUDE, ON A SQUARE BASE IN A HORIZONTAL PLANE.

LET AB , Fig. 25., be the four-sided pyramid. As it is given in position and magnitude, the square base on which it stands must be given in position and magnitude, and its vertical height, CD .†

* See page 86 (note), after you have read Problem XVI.

† If, instead of the vertical height, the length of AD is given, the vertical must be deduced from it. See the Exercises on this Problem in the Appendix, p. 71.

Draw a square pillar, $A B G E$, Fig. 26., on the square base of the pyramid, and make the height of the pillar $A F$ equal to the vertical height of the pyramid $C D$ (Problem IX.). Draw

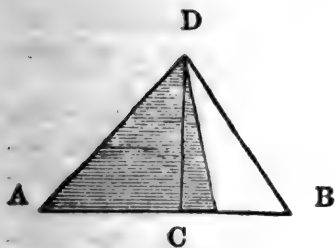

FIG. 25.

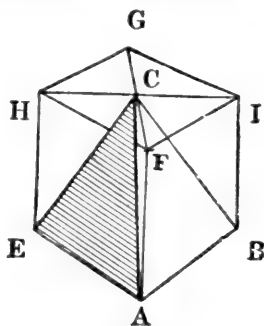

FIG. 26.

the diagonals $G F, H I$, on the top of the square pillar, cutting each other in c . Therefore c is the centre of the square $F G H I$. (Prob. VIII. Cor. II.)

Join $C E, C A, C B$.

Then $A B C E$ is the pyramid required. If the base of the pyramid is above the eye, as when a square spire is seen on the top of a church-tower, the construction will be as in Fig. 27.

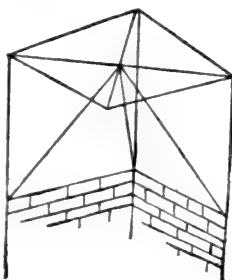

FIG. 27.

PROBLEM XI

TO DRAW ANY CURVE IN A HORIZONTAL OR VERTICAL PLANE.

Let $A B$, Fig. 28., be the curve.

Enclose it in a rectangle, $C D E F$.

Fix the position of the point c or d , and draw the rectangle. (Problem VIII. Coroll. I.)*

* Or if the curve is in a vertical plane, Coroll. to Problem IX. As a rectangle may be drawn in any position round any given curve, its position with respect to the curve will in either case be regulated by convenience. See the Exercises on this Problem in the Appendix, p. 76.

Let $C D E F$, Fig. 29., be the rectangle so drawn.

If an extremity of the curve, as A , is in a side of the rectangle, divide the side $C E$, Fig. 29., so that $A C$ shall be (in perspective ratio) to $A E$ as $A C$ is to $A E$ in Fig. 28. (Prob. V. Cor. II.)

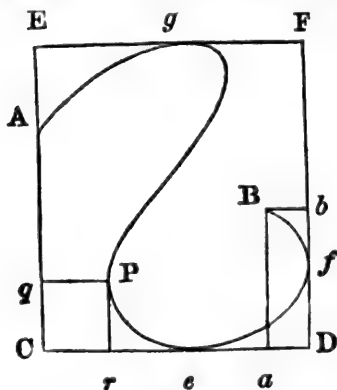

FIG. 28.

Similarly determine the points of contact of the curve and rectangle, e, f, g .

If an extremity of the curve, as B , is not in a side of the rectangle, let fall the perpendiculars $B a, B b$ on the rectangle sides. Determine the correspondent points a and b in Fig. 29., as you have already determined A, B, e , and f .

From b , Fig. 29., draw $b B$ parallel to $C D$,* and from a draw $A B$ to the vanishing-point of $D F$, cutting each other in B . Then B is the extremity of the curve.

Determine any other important point in the curve, as P , in the same way, by letting fall $P q$ and $P r$ on the rectangle's sides.

Any number of points in the curve may be thus determined, and the curve drawn through the series; in most cases, three or four will be enough. Practically, complicated curves may be better drawn in perspective by an experienced eye than by rule, as the fixing of the various points in haste involves too many chances of error; but it is well to draw a good many by rule first, in order to give the eye its experience. †

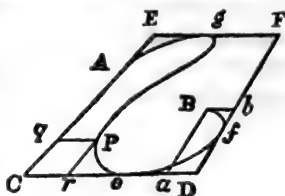

FIG. 29.

* Or to its vanishing-point, if $C D$ has one.

† Of course, by dividing the original rectangle into any number of equal rectangles, and dividing the perspective rectangles similarly, the curve may be approximately drawn without any trouble; but, when accuracy is required, the points should be fixed, as in the problem.

COROLLARY.

If the curve required be a circle, Fig. 30., the rectangle which encloses it will become a square, and the curve will have four points of contact, $A B C D$, in the middle of the sides of the square.

Draw the square, and as a square may be drawn about a circle in any position, draw it with its nearest side, $E G$, parallel to the sight-line.

Let $E F$, Fig. 31., be the square so drawn.

Draw its diagonals $E F$, $G H$; and through the centre of the square (determined by their intersection) draw $A B$ to the vanishing-point of $G F$, and $c d$ parallel

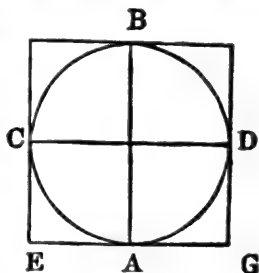

FIG. 30.

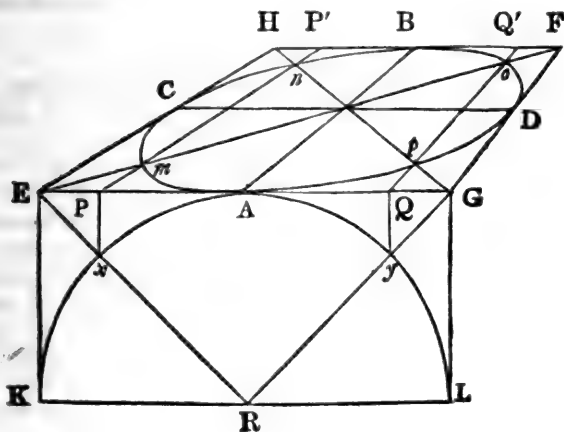

FIG. 31.

to $E G$. Then the points $A B C D$ are the four points of the circle's contact.

On $E G$ describe a half square, $E L$; draw the semicircle $E A L$; and from its centre, B , the diagonals $R E$, $R G$, cutting the circle in x , y .

From the points $x y$, where the circle cuts the diagonals, raise perpendiculars, $P x$, $Q y$, to $E G$.

From P and Q draw $P P'$, $Q Q'$, to the vanishing-point of $G F$, cutting the diagonals in m , n , and o , p .

Then m , n , o , p are four other points in the circle.

Through these eight points the circle may be drawn by the hand accurately enough for general purposes ; but any number of points required may, of course, be determined, as in Problem XL

The distance $E P$ is approximately one seventh of $E G$, and may be assumed to be so in quick practice, as the error involved is not greater than would be incurred in the hasty operation of drawing the circle and diagonals.

It may frequently happen that, in consequence of associated constructions, it may be inconvenient to draw $E G$ parallel to the sight-line, the square being perhaps first constructed in some oblique direction. In such cases, $Q G$ and $E P$ must be determined in perspective ratio by the dividing-point, the line $E G$ being used as a measuring-line.

[*Obs.* In drawing Fig. 31. the station-point has been taken much nearer the paper than is usually advisable, in order to show the character of the curve in a very distinct form.

If the student turns the book so that $E G$ may be vertical, Fig. 31. will represent the construction for drawing a circle in a vertical plane, the sight-line being then of course parallel to $G L$; and the semicircles $A D B$, $A C B$, on each side of the diameter $A B$, will represent ordinary semicircular arches seen in perspective. In that case, if the book be held so that the line $E H$ is the top of the square, the upper semicircle will represent a semicircular arch, *above* the eye, drawn in perspective. But if the book be held so that the line $G F$ is the top of the square, the upper semicircle will represent a semicircular arch, *below* the eye, drawn in perspective.

If the book be turned upside down, the figure will represent a circle drawn on the ceiling, or any other horizontal plane above the eye; and the construction is, of course, accurate in every case.]

PROBLEM XII.

TO DIVIDE A CIRCLE DRAWN IN PERSPECTIVE INTO ANY GIVEN NUMBER OF EQUAL PARTS.

LET AB , Fig. 32., be the circle drawn in perspective. It is required to divide it into a given number of equal parts; in this case, 20.

Let KAL be the semicircle used in the construction. Divide the semicircle KAL into half the number of parts required; in this case, 10.

Produce the line EG laterally, as far as may be necessary.

From o , the centre of the semicircle KAL , draw radii through the points of division of the semicircle, p, q, r , &c., and produce them to cut the line EG in P, Q, R , &c.

From the points PQR draw the lines PP', QQ', RR' , &c., through the centre of the circle AB , each cutting the circle in two points of its circumference.

Then these points divide the perspective circle as required.

If from each of the points p, q, r , a vertical were raised to the line EG , as in Fig. 31., and from the point where it cut EG a line were drawn to the vanishing-point, as qq' in Fig. 31., this line would also determine two of the points of division.

If it is required to divide a circle into any number of given unequal parts (as in the points A, B, C , Fig. 33.), the shortest way is thus to raise vertical lines from A and B to the side of the perspective square XY , and then draw to the vanishing-point, cutting the perspective circle in a and b , the points required. Only notice that if any point, as A , is on the nearer side of the circle ABC , its representative point, a , must be on the nearer side of the circle abc , and if the point B is on the farther side of the circle ABC , b must be on the farther side of abc . If any point, as c , is so much in the lateral arc of the circle as not to be easily determinable by the vertical line, draw the horizontal cp , find the correspondent p in the side of the per-

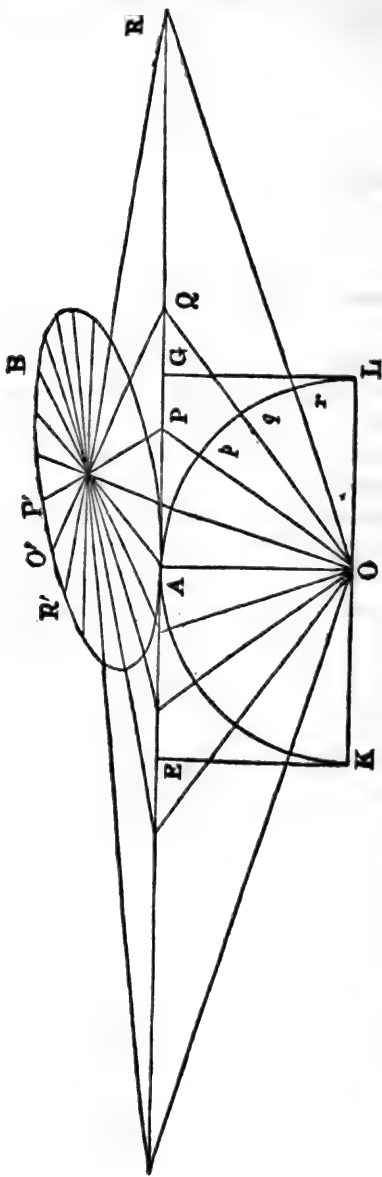

FIG. 32.

pective square, and draw $p c$ parallel to $x y$, cutting the perspective circle in c .

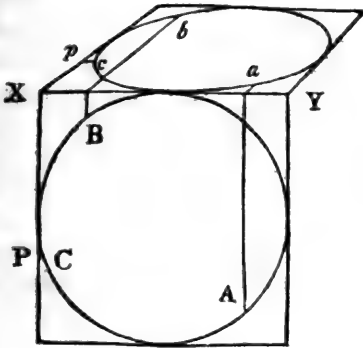

FIG. 33.

COROLLARY.

It is obvious that if the points P' , Q' , R , &c., by which the circle is divided in Fig. 32., be joined by right lines, the resulting figure will be a regular equilateral figure of twenty sides inscribed in the circle. And if the circle be divided into given unequal parts, and the points of division joined by right lines, the resulting figure will be an irregular polygon inscribed in the circle with sides of given length.

Thus any polygon, regular or irregular, inscribed in a circle, may be inscribed in position in a perspective circle.

PROBLEM XIII.

TO DRAW A SQUARE, GIVEN IN MAGNITUDE, WITHIN A LARGER SQUARE GIVEN IN POSITION AND MAGNITUDE; THE SIDES OF THE TWO SQUARES BEING PARALLEL.

LET $A B$, Fig 34., be the sight-magnitude of the side of the smaller square, and $A c$ that of the side of the larger square.

Draw the larger square. Let $D E F G$ be the square so drawn

Join $E G$ and $D F$.

On either $D E$ or $D G$ set off, in perspective ratio, $D H$ equal to one-half of $B C$.

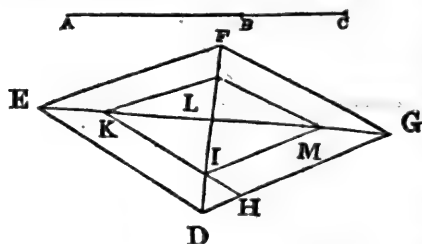

FIG. 34.

Through H draw $H K$ to the vanishing-point of $D E$, cutting $D F$ in I and $E G$ in K . Through I and K draw $I M$, $K L$, to vanishing-point of $D G$, cutting $D F$ in L and $E G$ in M . Join $L M$.

Then $I K L M$ is the smaller square, inscribed as required.*

COROLLARY.

If, instead of one square within another, it be required to draw one circle within another, the dimensions of both being given, enclose each circle in a square. Draw the squares first, and then the circles within, as in Fig. 36.



FIG. 36.

* If either of the sides of the greater square is parallel to the plane of the picture, as $D G$ in Fig. 35. $D G$ of course must be equal to $A C$, and $D H$ equal to $\frac{B C}{2}$, and the construction is as in Fig. 35.

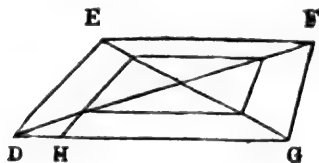

FIG. 35.

PROBLEM XIV.

TO DRAW A TRUNCATED CIRCULAR CONE, GIVEN IN POSITION AND MAGNITUDE, THE TRUNCATIONS BEING IN HORIZONTAL PLANES, AND THE AXIS OF THE CONE VERTICAL.

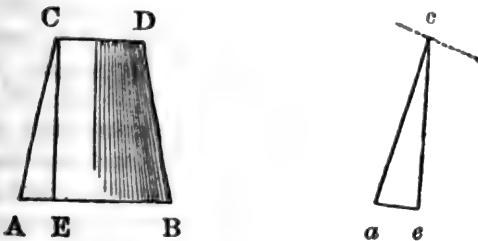

FIG. 37.

LET $A B C D$, Fig. 37., be the portion of the cone required.

As it is given in magnitude, its diameters must be given at the base and summit, $A B$ and $c D$; and its vertical height, $c E$.*

And as it is given in position, the centre of its base must be given.

Draw in position about this centre,† the square pillar $a f d$, Fig. 38., making its height, $b g$, equal to $c E$; and its side, $a b$, equal to $A B$.

In the square of its base, $a b c d$, inscribe a circle, which therefore is of the diameter of the base of the cone, $A B$.

* Or if the length of its side, $A C$, is given instead, take $a e$, Fig. 37., equal to half the excess of $A B$ over $C D$; from the point e raise the perpendicular $c e$. With centre a , and distance $A C$, describe a circle cutting $c e$ in c . Then $c e$ is the vertical height of the portion of cone required, or $C E$.

† The direction of the side of the square will of course be regulated by convenience.

In the square of its top, $efgh$, inscribe concentrically a circle whose diameter shall equal cd . (Coroll. Prob. XIII.)

Join the extremities of the circles by the right lines kl, nm . Then $klnm$ is the portion of cone required.

COROLLARY I.

If similar polygons be inscribed in similar positions in the circles kn and lm (Coroll. Prob. XII.), and the corresponding angles of the polygons joined by right lines, the resulting

figure will be a portion of a polygonal pyramid. (The dotted lines in Fig. 38., connecting the extremities of two diameters and one diagonal in the respective circles, occupy the position of the three nearest angles of a regular octagonal pyramid, having its angles set on the diagonals and diameters of the square ad , enclosing its base.)

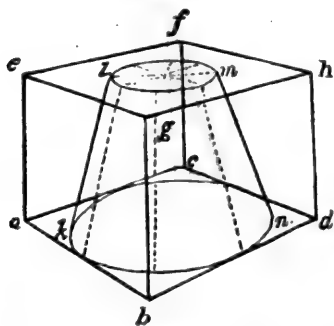

FIG. 38.

If the cone or polygonal pyramid is not truncated, its apex will be the centre of the upper square, as in Fig. 26.

COROLLARY II.

If equal circles, or equal and similar polygons, be inscribed in the upper and lower squares in Fig. 38., the resulting figure will be a vertical cylinder, or a vertical polygonal pillar, of given height and diameter, drawn in position.

COROLLARY III.

If the circles in Fig. 38., instead of being inscribed in the squares bc and fg , be inscribed in the sides of the solid figure

$b e$ and $d f$, those sides being made square, and the line $b d$ of any given length, the resulting figure will be, according to the constructions employed, a cone, polygonal pyramid, cylinder, or polygonal pillar, drawn in position about a horizontal axis parallel to $b d$.

Similarly, if the circles are drawn in the sides $g d$ and $e c$, the resulting figures will be described about a horizontal axis parallel to $a b$.

PROBLEM XV.

TO DRAW AN INCLINED LINE, GIVEN IN POSITION AND MAGNITUDE.

WE have hitherto been examining the conditions of horizontal and vertical lines only, or of curves enclosed in rectangles.

We must, in conclusion, investigate the perspective of inclined lines, beginning with a single one given in position. For the sake of completeness of system, I give in Appendix II. Article III. the development of this problem from the second. But, in practice, the position of an inclined line may be most conveniently defined by considering it as the diagonal of a rectangle, as $A B$ in Fig. 39., and I shall therefore, though at some sacrifice of system, examine it here under that condition.

If the sides of the rectangle $A C$ and $A D$ are given, the slope of the line $A B$ is determined; and then its position will depend on that of the rectangle. If, as in Fig. 39., the rectangle is parallel to the picture plane, the line $A B$ must be so also. If, as in Fig. 40., the rectangle is inclined to the picture plane, the line $A B$ will be so also. So that, to fix the position of $A B$, the line $A C$ must be given in position and magnitude, and the height $A D$.

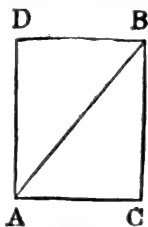

FIG. 39.

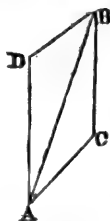

FIG. 40.

If these are given, and it is only required to draw the single line AB in perspective, the construction is entirely simple; thus:—

Draw the line AC by Problem I.

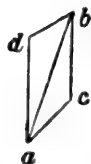

FIG. 41.

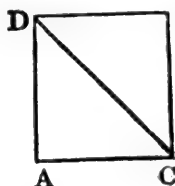

FIG. 42.

Let AC , Fig. 41., be the line so drawn. From a and c raise the vertical lines ad , cb . Make ad equal to the sight-magnitude of AD . From d draw db to the vanishing-point of ac , cutting bc in b .

Join ab . Then ab is the inclined line required.

If the line is inclined in the opposite direction, as DC in Fig. 42., we have only to join dc instead of ab in Fig. 41., and dc will be the line required.

I shall hereafter call the line AC , when used to define the position of an inclined line AB (Fig. 40.), the "relative horizontal" of the line AB .

OBSERVATION.

In general, inclined lines are most needed for gable roofs, in which, when the conditions are properly stated, the vertical height of the gable, XY , Fig. 43., is given, and the base line,

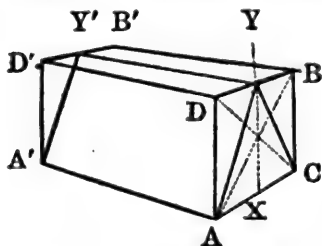

FIG. 43.

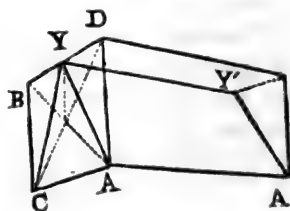

FIG. 44.

AC , in position. When these are given, draw AC ; raise vertical AD ; make AD equal to sight, magnitude of XY ; complete the perspective-rectangle $ADBC$; join AB and DC (as by dotted lines in figure); and through the intersection of the

dotted lines draw vertical $\kappa \gamma$, cutting DB in γ . Join $A \gamma$, $C \gamma$; and these lines are the sides of the gable. If the length of the roof $A A'$ is also given, draw in perspective the complete paralleliped $A' D' B C$, and from γ draw $\gamma \gamma'$ to the vanishing-point of $A A'$, cutting $D' B'$ in γ' . Join $A' \gamma'$, and you have the slope of the farther side of the roof.

The construction above the eye is as in Fig. 44; the roof is reversed in direction merely to familiarize the student with the different aspects of its lines.

PROBLEM XVI.

TO FIND THE VANISHING-POINT OF A GIVEN INCLINED LINE.

If, in Fig. 43. or Fig. 44., the lines $A \gamma$ and $A' \gamma'$ be produced, the student will find that they meet.

Let P , Fig. 45., be the point at which they meet.

From P let fall the vertical $P v$ on the sight-line, cutting the sight-line in v .

Then the student will find experimentally that v is the vanishing-point of the line $A c$.*

Complete the rectangle of the base $A c'$, by drawing $A' c'$ to v , and $c c'$ to the vanishing-point of $A A'$.

Join $\gamma' c'$.

Now if γc and $\gamma' c'$ be produced downwards, the student will find that they meet.

Let them be produced, and meet in P' .

Produce $P v$, and it will be found to pass through the point P' .

Therefore if $A \gamma$ (or $C \gamma$), Fig 45., be any inclined line drawn in perspective by Problem XV., and $A c$ the relative horizontal ($A c$ in Figs. 39., 40.), also drawn in perspective.

Through v , the vanishing-point of $A c$, draw the vertical $P P'$ upwards and downwards.

Produce $A \gamma$ (or $C \gamma$), cutting $P P'$ in (P or P').

* The demonstration is in Appendix II. Article III.

Then P is the vanishing-point of AY (or P' of CY).

The student will observe that, in order to find the point P by this method, it is necessary first to draw a portion of the

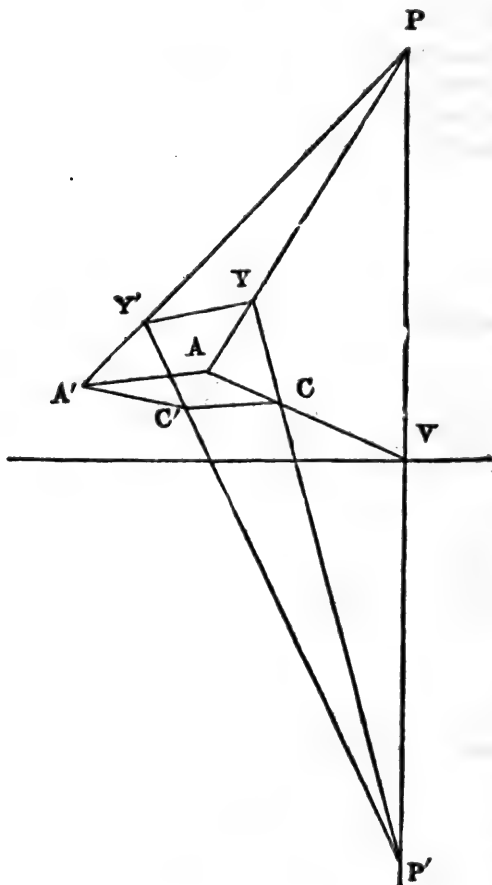

FIG. 45.

given inclined line by Problem XV. Practically, it is always necessary to do so, and, therefore, I give the problem in this form.

Theoretically, as will be shown in the analysis of the prob-

lem, the point *p* should be found by drawing a line from the station-point parallel to the given inclined line; but there is no practical means of drawing such a line; so that in whatever terms the problem may be given, a portion of the inclined line (*A Y* or *C Y*) must always be drawn in perspective before *p* can be found.

PROBLEM XVII.

TO FIND THE DIVIDING-POINTS OF A GIVEN INCLINED LINE.

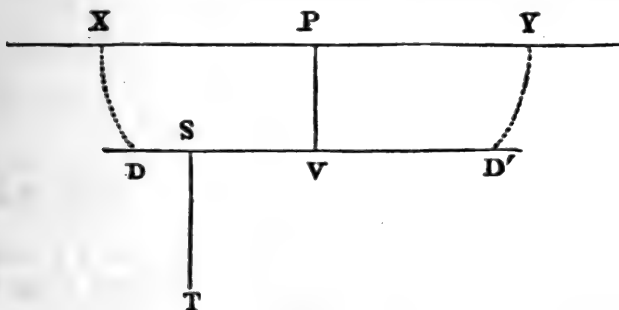

FIG. 46.

LET *P*, Fig. 46., be the vanishing-point of the inclined line, and *v* the vanishing-point of the relative horizontal.

Find the dividing-points of the relative horizontal, *D* and *D'*.

Through *P* draw the horizontal line *x y*.

With centre *P* and distance *D P* describe the two arcs *D X* and *D' Y*, cutting the line *x y* in *x* and *y*.

Then *x* and *y* are the dividing-points of the inclined line.*

Obs. The dividing-points found by the above rule, used with the ordinary measuring-line, will lay off distances on the retiring inclined line, as the ordinary dividing-points lay them off on the retiring horizontal line.

* The demonstration is in Appendix II., p. 91.

Another dividing-point, peculiar in its application, is sometimes useful, and is to be found as follows :

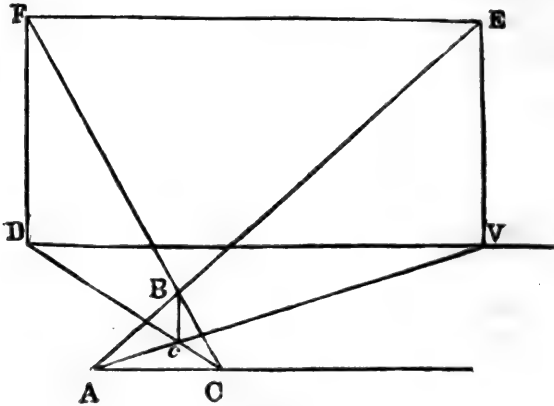

FIG. 47.

Let AB , Fig. 47., be the given inclined line drawn in perspective, and Ac the relative horizontal.

Find the vanishing-points, v and E , of Ac and AB ; D , the dividing-point of Ac ; and the sight-magnitude of Ac on the measuring-line, or Ac .

From D erect the perpendicular DF .

Join CB , and produce it to cut DE in F . Join EF .

Then, by similar triangles, DF is equal to EV , and EF is parallel to DV .

Hence it follows that if from D , the dividing-point of Ac , we raise a perpendicular and make DF equal to EV , a line CF , drawn from any point c on the measuring-line to F , will mark the distance AB on the inclined line, AB being the portion of the given inclined line which forms the diagonal of the vertical rectangle of which Ac is the base.

As they are given in position, the relative horizontals $\Lambda \mathfrak{N}$ and $c \mathfrak{D}$ must be given.

Then by Problem XVI. the vanishing-point of $\Lambda \mathfrak{B}$ is v , and of $c \mathfrak{D}$, v' .

Join $v v'$ and produce it to cut the sight-line in x .

Then $v x$ is the sight-line of the inclined plane.

Like the horizontal sight-line, it is of indefinite length; and may be produced in either direction as occasion requires, crossing the horizontal line of sight, if the plane continues downward in that direction.

x is the vanishing-point of all horizontal lines in the inclined plane.

PROBLEM XIX.

TO FIND THE VANISHING-POINT OF STEEPEST LINES IN AN INCLINED PLANE WHOSE SIGHT-LINE IS GIVEN.

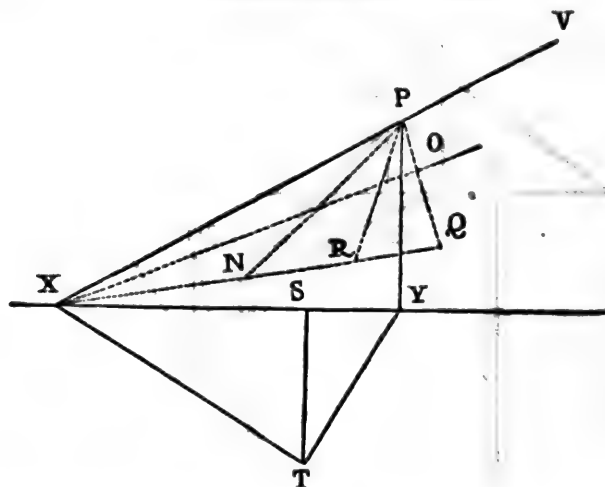

FIG. 49.

LET $v x$, Fig. 49., be the given sight-line.

Produce it to cut the horizontal sight-line in x .

Therefore x is the vanishing-point of horizontal lines in the given inclined plane. (Problem XVIII.)

Join rx , and draw ty at right angles to rx .

Therefore y is the rectangular vanishing-point corresponding to x .*

From y erect the vertical yp , cutting the sight-line of the inclined plane in p .

Then p is the vanishing-point of steepest lines in the plane.

All lines drawn to it, as qp , rp , np , &c., are the steepest possible in the plane; and all lines drawn to x , as qx , ox , &c., are horizontal, and at right angles to the lines pq , pr , &c.

PROBLEM XX.

TO FIND THE VANISHING-POINT OF LINES PERPENDICULAR TO THE SURFACE OF A GIVEN INCLINED PLANE.

As the inclined plane is given, one of its steepest lines must be given, or may be ascertained.

Let ab , Fig. 50., be a portion of a steepest line in the given plane, and v the vanishing-point of its relative horizontal.

Through v draw the vertical gf upwards and downwards.

From a set off any portion of the relative horizontal ac , and on ac describe a semicircle in a vertical plane, adc , cutting ab in e .

Join ec , and produce it to cut gf in f .

Then f is the vanishing-point required.

For, because aec is an angle in a semicircle, it is a right angle; and therefore the line ef is at right angles to the line ab ; and similarly all lines drawn to f , and therefore parallel to ef , are at right angles with any line which cuts them, drawn to the vanishing-point of ab .

And because the semicircle adc is in a vertical plane, and its diameter ac is at right angles to the horizontal lines traversing the surface of the inclined plane, the line ec , being in this semicircle, is also at right angles to such traversing lines.

* That is to say, the vanishing-point of horizontal lines drawn at right angles to the lines whose vanishing-point is x .

And therefore the line ec , being at right angles to the steepest lines in the plane, and to the horizontal lines in it, is perpendicular to its surface.

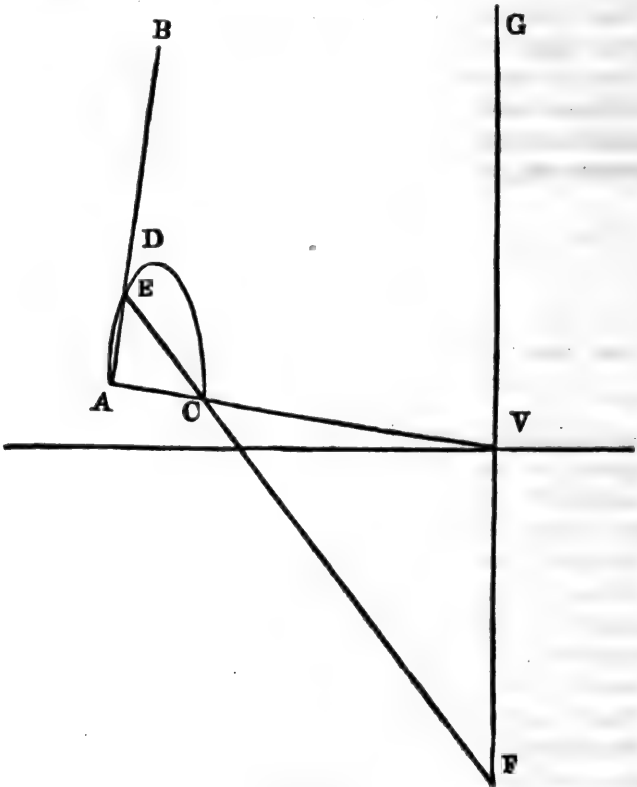

FIG. 50.

THE preceding series of constructions, with the examples in the first Article of the Appendix, put it in the power of the student to draw any form, however complicated,* which does

* As in algebraic science, much depends, in complicated perspective, on the student's ready invention of expedients, and on his quick sight of the shortest way in which the solution may be accomplished, when there are several ways.

not involve intersection of curved surfaces. I shall not proceed to the analysis of any of these more complex problems, as they are entirely useless in the ordinary practice of artists. For a few words only I must ask the reader's further patience, respecting the general placing and scale of the picture.

As the horizontal sight-line is drawn through the sight-point, and the sight-point is opposite the eye, the sight-line is always on a level with the eye. Above and below the sight-line, the eye comprehends, as it is raised or depressed while the head is held upright, about an equal space ; and, on each side of the sight-point, about the same space is easily seen without turning the head ; so that if a picture represented the true field of easy vision, it ought to be circular, and have the sight-point in its centre. But because some parts of any given view are usually more interesting than others, either the uninteresting parts are left out, or somewhat more than would generally be seen of the interesting parts is included by moving the field of the picture a little upwards or downwards, so as to throw the sight-point low or high. The operation will be understood in a moment by cutting an aperture in a piece of pasteboard, and moving it up and down in front of the eye, without moving the eye. It will be seen to embrace sometimes the low, sometimes the high objects, without altering their perspective, only the eye will be opposite the lower part of the aperture when it sees the higher objects, and *vice versâ*.

There is no reason, in the laws of perspective, why the picture should not be moved to the right or left of the sight-point, as well as up or down. But there is this practical reason. The moment the spectator sees the horizon in a picture high, he tries to hold his head high, that is, in its right place. When he sees the horizon in a picture low, he similarly tries to put his head low. But, if the sight-point is thrown to the left hand or right hand, he does not understand that he is to step a little to the right or left ; and if he places himself, as usual, in the middle, all the perspective is distorted. Hence it is generally unadvisable to remove the sight-point laterally, from the centre of the picture. The Dutch painters,

however, fearlessly take the license of placing it to the right or left ; and often with good effect.

The rectilinear limitation of the sides, top, and base of the picture is of course quite arbitrary, as the space of a landscape would be which was seen through a window ; less or more being seen at the spectator's pleasure, as he retires or advances.

The distance of the station-point is not so arbitrary. In ordinary cases it should not be less than the intended greatest dimension (height or breadth) of the picture. In most works by the great masters it is more ; they not only calculate on their pictures being seen at considerable distances, but they like breadth of mass in buildings, and dislike the sharp angles which always result from station-points at short distances.*

Whenever perspective, done by true rule, looks wrong, it is always because the station-point is too near. Determine, in the outset, at what distance the spectator is likely to examine the work, and never use a station-point within a less distance.

There is yet another and a very important reason, not only for care in placing the station-point, but for that accurate calculation of distance and observance of measurement which have been insisted on throughout this work. All drawings of objects on a reduced scale are, if rightly executed, drawings of the appearance of the object at the distance which in true perspective reduces it to that scale. They are not *small* drawings of the object seen near, but drawings the *real size* of the object seen far off. Thus if you draw a mountain in a landscape, three inches high, you do not reduce all the features of the near mountain so as to come into three inches of paper. You could not do that. All that you can do is to give the appearance of the mountain, when it is so far off that three inches of paper would really hide it from you. It is precisely

* The greatest masters are also fond of parallel perspective, that is to say, of having one side of their buildings fronting them full, and therefore parallel to the picture plane, while the other side vanishes to the sight-point. This is almost always done in figure back-grounds, securing simple and balanced lines.

the same in drawing any other object. A face can no more be reduced in scale than a mountain can. It is infinitely delicate already ; it can only be quite rightly rendered on its own scale, or at least on the slightly diminished scale which would be fixed by placing the plate of glass, supposed to represent the field of the picture, close to the figures. Correggio and Raphael were both fond of this slightly subdued magnitude of figure. Colossal painting, in which Correggio excelled all others, is usually the enlargement of a small picture (as a colossal sculpture is of a small statue), in order to permit the subject of it to be discerned at a distance. The treatment of colossal (as distinguished from ordinary) paintings will depend therefore, in general, on the principles of optics more than on those of perspective, though, occasionally, portions may be represented as if they were the projection of near objects on a plane behind them. In all points the subject is one of great difficulty and subtlety ; and its examination does not fall within the compass of this essay.

Lastly, it will follow from these considerations, and the conclusion is one of great practical importance, that, though pictures may be enlarged, they cannot be reduced, in copying them. All attempts to engrave pictures completely on a reduced scale are, for this reason, nugatory. The best that can be done is to give the aspect of the picture at the distance which reduces it in perspective to the size required ; or, in other words, to make a drawing of the distant effect of the picture. Good painting, like nature's own work, is infinite, and unreduceable.

I wish this book had less tendency towards the infinite and unreduceable. It has so far exceeded the limits I hoped to give it, that I doubt not the reader will pardon an abruptness of conclusion, and be thankful, as I am myself, to get to an end on any terms.

The first of these is the
 fact that the population
 has increased rapidly
 since the year 1850
 and that the number of
 persons engaged in
 agriculture has
 decreased correspondingly
 The second is the
 fact that the amount of
 land cultivated has
 increased in proportion
 to the increase in
 population
 The third is the
 fact that the amount of
 land cultivated has
 increased in proportion
 to the increase in
 population
 The fourth is the
 fact that the amount of
 land cultivated has
 increased in proportion
 to the increase in
 population
 The fifth is the
 fact that the amount of
 land cultivated has
 increased in proportion
 to the increase in
 population
 The sixth is the
 fact that the amount of
 land cultivated has
 increased in proportion
 to the increase in
 population
 The seventh is the
 fact that the amount of
 land cultivated has
 increased in proportion
 to the increase in
 population
 The eighth is the
 fact that the amount of
 land cultivated has
 increased in proportion
 to the increase in
 population
 The ninth is the
 fact that the amount of
 land cultivated has
 increased in proportion
 to the increase in
 population
 The tenth is the
 fact that the amount of
 land cultivated has
 increased in proportion
 to the increase in
 population

APPENDIX.

I.

PRACTICE AND OBSERVATIONS ON THE PRECEDING PROBLEMS.

PROBLEM I.

An example will be necessary to make this problem clear to the general student.

The nearest corner of a piece of pattern on the carpet is $4\frac{1}{2}$ feet beneath the eye, 2 feet to our right and $3\frac{1}{2}$ feet in direct distance from us. We intend to make a drawing of the pattern which shall be seen properly when held $1\frac{1}{2}$ foot from the eye. It is required to fix the position of the corner of the piece of pattern.

Let AB , Fig. 51., be our sheet of paper, some 3 feet wide. Make ST equal to $1\frac{1}{2}$ foot. Draw the line of sight through S . Produce TS , and make DS equal to 2 feet, therefore TD equal to $3\frac{1}{2}$ feet. Draw DC , equal to 2 feet; CP , equal to 4 feet. Join TC (cutting the sight-line in Q) and TP .

Let fall the vertical QP' , then P' is the point required.

If the lines, as in the figure, fall outside of your sheet of paper, in order to draw them, it is necessary to attach other

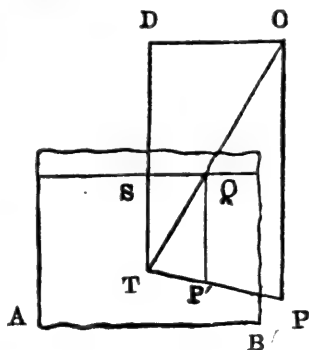

FIG. 51.

sheets of paper to its edges. This is inconvenient, but must be done at first that you may see your way clearly; and sometimes afterwards, though there are expedients for doing without such extension in fast sketching.

It is evident, however, that no extension of surface could be of any use to us, if the distance TD , instead of being $3\frac{1}{2}$ feet, were 100 feet, or a mile, as it might easily be in a landscape.

It is necessary, therefore, to obtain some other means of construction; to do which we must examine the principle of the problem.

In the analysis of Fig. 2., in the introductory remarks, I used the word "height" only of the tower, QP , because it was

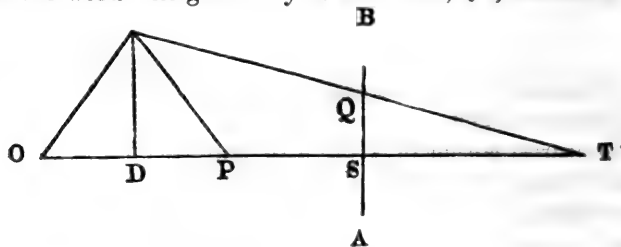

FIG. 52.

only to its vertical height that the law deduced from the figure could be applied. For suppose it had been a pyramid, as OQP , Fig. 52., then the image of its side, QP , being, like every other magnitude, limited on the glass AB by the lines coming from its extremities, would appear only of the length $Q'S$; and it is not true that $Q'S$ is to QP as TS is to TP . But if we let fall a vertical QD from Q , so as to get the vertical height of the pyramid, then it is true that $Q'S$ is to QD as TS is to TD .

Supposing this figure represented, not a pyramid, but a triangle on the ground, and that QD and QP are horizontal lines, expressing lateral distance from the line TD , still the rule would be false for QP and true for QD . And, similarly, it is true for all lines which are parallel, like QD , to the plane of the picture AB , and false for all lines which are inclined to it at an angle.

Hence generally. Let PQ (Fig. 2. in Introduction, p. 14) be any magnitude parallel to the plane of the picture; and $P'Q'$ its image on the picture.

Then always the formula is true which you learned in the Introduction: $P'Q'$ is to PQ as ST is to DT .

Now the magnitude P dash Q dash in this formula I call the "SIGHT-MAGNITUDE" of the line PQ . The student must fix this term, and the meaning of it, well in his mind. The "sight-magnitude" of a line is the magnitude which bears to the real line the same proportion that the distance of the picture bears to the distance of the object. Thus, if a tower be a hundred feet high, and a hundred yards off; and the picture, or piece of glass, is one yard from the spectator, between him and the tower; the distance of picture being then to distance of tower as 1 to 100, the sight-magnitude of the tower's height will be as 1 to 100; that is to say, one foot. If the tower is two hundred yards distant, the sight-magnitude of its height will be half a foot and so on.

But farther. It is constantly necessary, in perspective operations, to measure the other dimensions of objects by the sight-magnitude of their vertical lines. Thus, if the tower, which is a hundred feet high, is square, and twenty-five feet broad on each side; if the sight-magnitude of the height is one foot, the measurement of the side, reduced to the same scale, will be the hundredth part of twenty-five feet, or three inches: and accordingly, I use in this treatise the term "sight-magnitude" indiscriminately for all lines reduced in the same proportion as the vertical lines of the object. If I tell you to find the "sight-magnitude" of any line, I mean, always, find the magnitude which bears to that line the proportion of ST to DT ; or, in simpler terms, reduce the line to the scale which you have fixed by the first determination of the length ST .

Therefore, you must learn to draw quickly to scale before you do anything else; for all the measurements of your object must be reduced to the scale fixed by ST before you can use them in your diagram. If the object is fifty feet from you, and your paper one foot, all the lines of the object must be reduced to a scale of one fiftieth before you can use them;

if the object is two thousand feet from you, and your paper one foot, all your lines must be reduced to the scale of one two-thousandth before you can use them, and so on. Only in ultimate practice, the reduction never need be tiresome, for, in the case of large distances, accuracy is never required. If a building is three or four miles distant, a hairbreadth of accidental variation in a touch makes a difference of ten or twenty feet in height or breadth, if estimated by accurate perspective law. Hence it is never attempted to apply measurements with precision at such distances. Measurements are only required within distances of, at the most, two or three hundred feet. Thus, it may be necessary to represent a cathedral nave precisely as seen from a spot seventy feet in front of a given pillar; but we shall hardly be required to draw a cathedral three miles distant precisely as seen from seventy feet in advance of a given milestone. Of course, if such a thing be required, it can be done; only the reductions are somewhat long and complicated; in ordinary cases it is easy to assume the distance $s\tau$ so as to get at the reduced dimensions in a moment. Thus, let the pillar of the nave, in the

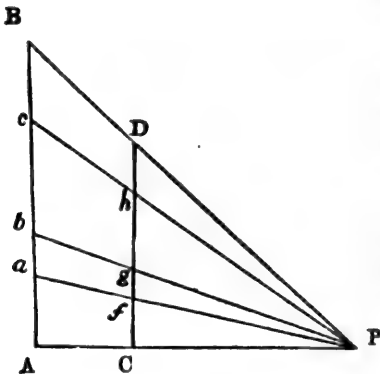

FIG. 53.

case supposed, be 42 feet high, and we are required to stand 70 feet from it: assume $s\tau$ to be equal to 5 feet. Then, as 5 is to 70 so will the sight-magnitude required be to 42; that is to say, the sight magnitude of the pillar's height will be 3 feet. If we make $s\tau$ equal to $2\frac{1}{2}$ feet, the pillar's height will be $1\frac{1}{2}$ foot and so on.

And for fine divisions into irregular parts which cannot be measured, the ninth and tenth problems of the sixth book of Euclid will serve you: the following construction is, however I think, more practically convenient:—

The line AB (Fig. 53.) is divided by given points, $a, b, c,$

into a given number of irregularly unequal parts: it is required to divide any other line, CD , into an equal number of parts, bearing to each other the same proportions as the parts of AB , and arranged in the same order.

Draw the two lines parallel to each other, as in the figure.

Join AC and BD , and produce the lines AC , BD , till they meet in P .

Join aP , bP , cP , cutting CD in f , g , h .

Then the line CD is divided as required, in f , g , h .

In the figure the lines AB and CD are accidentally perpendicular to AP . There is no need for their being so.

Now, to return to our first problem.

The construction given in the figure is only the quickest mathematical way of obtaining, on the picture, the sight-magnitudes of DC and PC , which are both magnitudes parallel with the picture plane. But if these magnitudes are too great to be thus put on the paper, you have only to obtain the reduction by scale. Thus, if TS be one foot, TD eighty feet, DC forty feet, and CP ninety feet, the distance QS must be made equal to one eightieth of DC , or half a foot; and the distance $Q'P$, one eightieth of CP , or one eightieth of ninety feet; that is to say, nine eighths of a foot, or thirteen and a half inches. The lines CT and PT are thus *practically* useless, it being only necessary to measure QS and $Q'P$, on your paper, of the due sight-magnitudes. But the mathematical construction, given in Problem I, is the basis of all succeeding problems, and, if it is once thoroughly understood and practised (it can only be thoroughly understood by practice), all the other problems will follow easily.

Lastly. Observe that any perspective operation whatever may be performed with reduced dimensions of every line employed, so as to bring it conveniently within the limits of your paper. When the required figure is thus constructed on a small scale, you have only to enlarge it accurately in the same proportion in which you reduced the lines of construction, and you will have the figure constructed in perspective on the scale required for use.

how far off In such case draw the line $A B$, as nearly as you can guess, about the part of the picture it ought to occupy, and on such a scale as you choose. Divide it into any convenient number of equal parts, according to the height you presume it to be. If you suppose it to be twenty feet high, you may divide it into twenty parts, and let each part stand for a foot; if thirty feet high, you may divide it into ten parts, and let each part stand for three feet; if seventy feet high, into fourteen parts, and let each part stand for five feet; and so on, avoiding thus very minute divisions till you come to details. Then observe how high your eye reaches upon this vertical line; suppose, for instance, that it is thirty feet high and divided into ten parts, and you are standing so as to raise your head to about six feet above its base, then the sight-line may be drawn, as in the figure, through the second division from the ground. If you are standing above the house, draw the sight-line above B ; if below the house, below A ; at such height or depth as you suppose may be accurate (a yard or two more or less matters little at ordinary distances, while at great distances perspective rules become nearly useless, the eye serving you better than the necessarily imperfect calculation). Then fix your sight-point and station-point, the latter with proper reference to the scale of the line $A B$. As you cannot, in all probability, ascertain the exact direction of the line $A V$ or $B V$, draw the slope $B V$ as it appears to you, cutting the sight-line in v . Thus having fixed one vanishing-point, the other, and the dividing-points, must be accurately found by rule; for, as before stated, whether your entire group of points (vanishing and dividing) falls a little more or less to the right or left of s does not signify, but the relation of the points to each other *does* signify. Then draw the measuring-line $B G$, either through A or B , choosing always the steeper slope of the two; divide the measuring-line into parts of the same length as those used on $A B$, and let them stand for the same magnitudes. Thus, suppose there are two rows of windows in the house front, each window six feet high by three wide, and separated by intervals of three feet, both between window and window and between tier and tier; each

of the divisions here standing for three feet, the lines drawn from $B G$ to the dividing-point D fix the lateral dimensions, and the divisions on $A B$ the vertical ones. For other magnitudes it would be necessary to subdivide the parts on the measuring-line, or on $A B$, as required. The lines which regulate the inner sides or returns of the windows ($a, b, c, \&c.$) of course are drawn to the vanishing-point of $B F$ (the other side of the house), if $F B V$ represents a right angle; if not, their own vanishing-point must be found separately for these returns. But see Practice on Problem XL.

Interior angles, such as $E B C$, Fig. 55. (suppose the corner

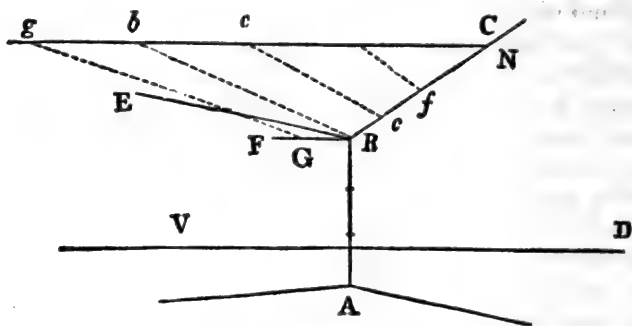

FIG. 55.

of a room), are to be treated in the same way, each side of the room having its measurements separately carried to it from the measuring-line. It may sometimes happen in such cases that we have to carry the measurement *up* from the corner B , and that the sight-magnitudes are given us from the length of the line $A B$. For instance, suppose the room is eighteen feet high, and therefore $A B$ is eighteen feet; and we have to lay off lengths of six feet on the top of the room-wall, $B C$. Find D , the dividing-point of $B C$. Draw a measuring-line, $B F$, from B ; and another, $g C$, anywhere above. On $B F$ lay off $B G$ equal to one third of $A B$, or six feet; and draw from D , through g and B , the lines $g g, B b$, to the upper measuring-line. Then $g b$ is six feet on that measuring-line. Make $b c, c h, \&c.$, equal to

bg ; and draw ce , hf , &c., to D , cutting BC in e and f , which mark the required lengths of six feet each at the top of the wall.

PROBLEM X.

This is one of the most important foundational problems in perspective, and it is necessary that the student should entirely familiarize himself with its conditions.

In order to do so, he must first observe these general relations of magnitude in any pyramid on a square base.

Let AGH' , Fig. 56., be any pyramid on a square base.

The best terms in which its magnitude can be given, are the length of one side of its base, AH , and its vertical altitude (GD in Fig. 25.); for, knowing these, we know all the other magnitudes. But these are not the terms in which its size will be usually ascertainable. Generally, we shall have given us, and be able to ascertain by measurement, one side of its base AH , and either AG the length of one of the lines of its angles, or BG (or $B'G$) the length of a

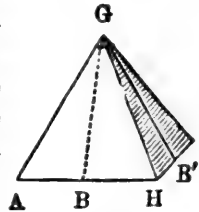

FIG. 56.

line drawn from its vertex, G , to the middle of the side of its base. In measuring a real pyramid, AG will usually be the line most easily found; but in many architectural problems BG is given, or is most easily ascertainable.

Observe therefore this general construction.

Let $ABDE$, Fig. 57., be the square base of any pyramid.

Draw its diagonals, AE , BD , cutting each other in its centre, C .

Bisect any side, AB , in F .

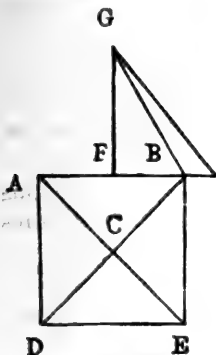

FIG. 57.

From F erect vertical FG .

Produce FB to H , and make FH equal to AC

Now if the vertical altitude of the pyramid (CD in Fig. 25.) be given, make FG equal to this vertical altitude.

Join GB and GH .

Then GB and GH are the true magnitudes of GB and GH in Fig. 56.

If GB is given, and not the vertical altitude, with centre B , and distance GB , describe circle cutting FG in G , and FG is the vertical altitude.

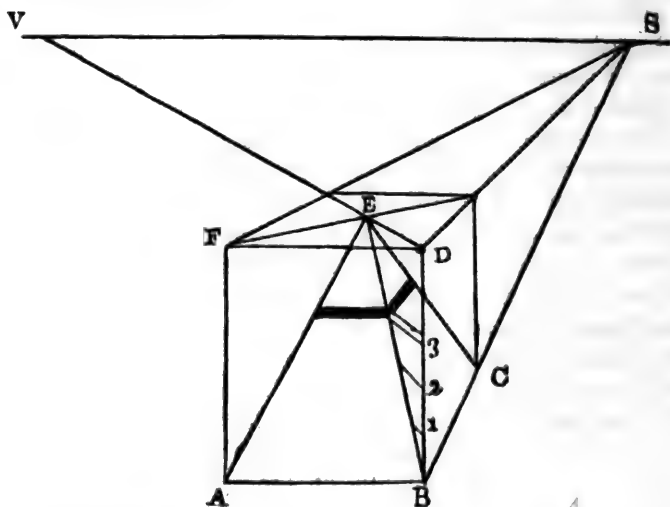

FIG. 58.

If GH is given, describe the circle from H , with distance GH , and it will similarly cut FG in G .

It is especially necessary for the student to examine this construction thoroughly, because in many complicated forms of ornaments, capitals of columns, &c., the lines GB and GH become the limits or bases of curves, which are elongated on the longer (or angle) profile GH , and shortened on the shorter (or lateral) profile GB . We will take a simple instance, but must previously note another construction.

It is often necessary, when pyramids are the roots of some ornamental form, to divide them horizontally at a given ver-

tical height. The shortest way of doing so is in general the following.

Let $A E C$, Fig 58., be any pyramid on a square base $A B C$, and $A D C$ the square pillar used in its construction.

Then by construction (Problem X.) $B D$ and $A F$ are both of the vertical height of the pyramid.

Of the diagonals, $F E$, $D E$, choose the shortest (in this case $D E$), and produce it to cut the sight-line in v .

Therefore v is the vanishing-point of $D E$.

Divide $D B$, as may be required, into the sight-magnitudes of the given vertical heights at which the pyramid is to be divided.

From the points of division, 1, 2, 3, &c., draw to the vanishing-point v . The lines so drawn cut the angle line of the pyramid, $B E$, at the required elevations. Thus, in the figure, it is required to draw a horizontal black band on the pyramid at three fifths of its height, and in breadth one twentieth of its height. The line $B D$ is divided into five parts, of which three are counted from B upwards. Then the line drawn to v marks the base of the black band. Then one fourth of one of the five parts is measured, which similarly gives the breadth of the band. The terminal lines of the band are then drawn on the sides of the pyramid parallel to $A B$ (or to its vanishing-point if it has one), and to the vanishing-point of $B C$.

If it happens that the vanishing-points of the diagonals are awkwardly placed for use, bisect the nearest base line of the pyramid in B , as in Fig. 59.

Erect the vertical $D B$ and join $G B$ and $D G$ (G being the apex of pyramid).

Find the vanishing-point of $D G$, and use $D B$ for division, carrying the measurements to the line $G B$.

In Fig. 59., if we join $A D$ and $D C$, $A D C$ is the vertical profile of the whole pyramid, and $B D C$ of the half pyramid, corresponding to $F G B$ in Fig. 57.

We may now proceed to an architectural example.

Let $A H$, Fig. 60., be the vertical profile of the capital of a pillar, $A B$ the semi-diameter of its head or abacus, and $F D$ the semi-diameter of its shaft.

Let the shaft be circular, and the abacus square, down to the level E.

Join B D, E F, and produce them to meet in G.

Therefore E C G is the semi-profile of a reversed pyramid containing the capital.

Construct this pyramid, with the square of the abacus, in the required perspective, as in Fig. 61.; making A E equal to A E in Fig. 60., and A K, the side of the square, equal to twice

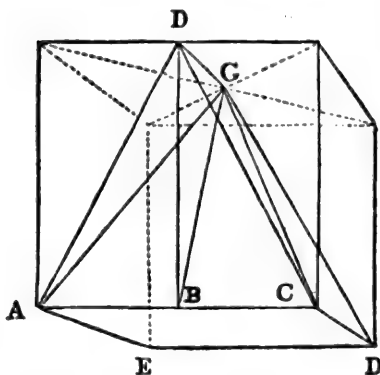

FIG. 59.

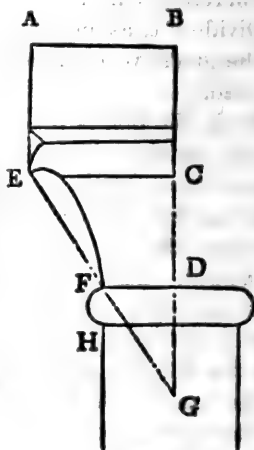

FIG. 60.

A B in Fig. 60. Make E G equal to C G, and E D equal to C D. Draw D F to the vanishing-point of the diagonal D V (the figure is too small to include this vanishing-point), and F is the level of the point F in Fig. 60., on the side of the pyramid.

Draw F m, F n, to the vanishing-points of A H and A K. Then F n and F m are horizontal lines across the pyramid at the level F, forming at that level two sides of a square.

Complete the square, and within it inscribe a circle, as in Fig. 62., which is left unlettered that its construction may be clear. At the extremities of this draw vertical lines, which will be the sides of the shaft in its right place. It will be found to be somewhat smaller in diameter than the entire shaft in Fig. 60., because at the centre of the square it is

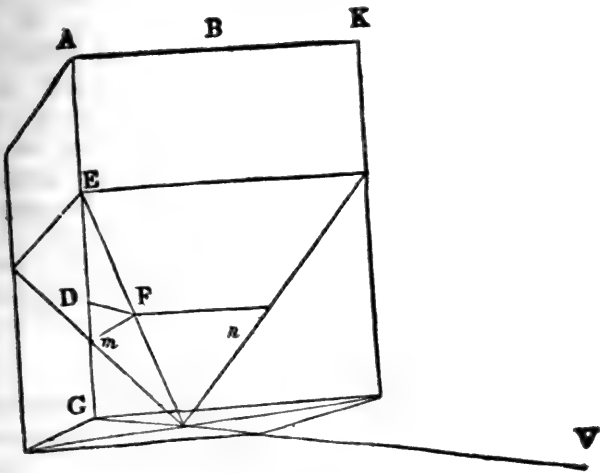

FIG. 61.

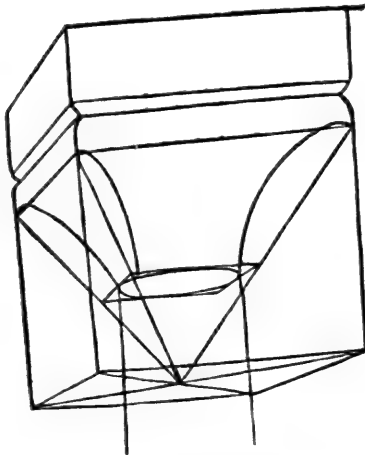

FIG. 62.

more distant than the nearest edge of the square abacus. The curves of the capital may then be drawn approximately by the eye. They are not quite accurate in Fig. 62., there being a subtlety in their junction with the shaft which could not be shown on so small a scale without confusing the student; the curve on the left springing from a point a little way round the circle behind the shaft, and that on the right from a point on this side of the circle a little way within the edge of the shaft. But for their more accurate construction see Notes on Problem XIV.

PROBLEM XI

It is seldom that any complicated curve, except occasionally a spiral, needs to be drawn in perspective; but the student will do well to practise for some time any fantastic shapes which he can find drawn on flat surfaces, as on wall-papers, carpets, &c., in order to accustom himself to the strange and great changes which perspective causes in them.

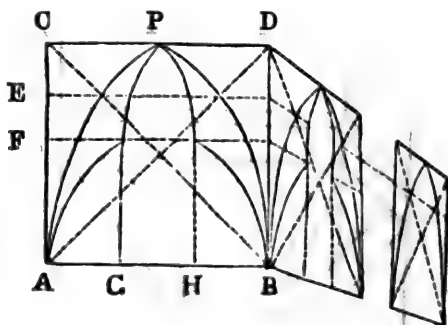

FIG. 63.

The curves most required in architectural drawing, after the circle, are those of pointed arches; in which, however, all that will be generally needed is to fix the apex, and two points in the sides. Thus if we have to draw a range of pointed arches, such as $A P B$, Fig. 63, draw the measured arch

to its sight-magnitude first neatly in a rectangle $A B C D$; then draw the diagonals $A D$ and $B C$; where they cut the curve draw a horizontal line (as at the level E in the figure), and carry it along the range to the vanishing-point, fixing the points where the arches cut their diagonals all along. If the arch is cusped, a line should be drawn at F to mark the height of the cusps, and verticals raised at G and H , to determine the interval between them. Any other points may be similarly determined, but these will usually be enough. Figure 63. shows the perspective construction of a square niche of good Veronese Gothic, with an uncusped arch of similar size and curve beyond.

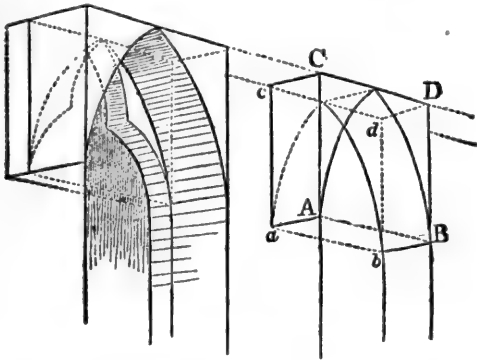

FIG. 64.

In Fig. 64. the more distant arch only is lettered, as the construction of the nearest explains itself more clearly to the eye without letters. The more distant arch shows the general construction for all arches seen underneath, as of bridges, cathedral aisles, &c. The rectangle $A B C D$ is first drawn to contain the outside arch; then the depth of the arch, $A a$, is determined by the measuring-line, and the rectangle, $a b c d$, drawn for the inner arch.

$A a$, $B b$, &c., go to one vanishing-point; $A B$, $a b$, &c., to the opposite one.

In the nearer arch another narrow rectangle is drawn to determine the cusp. The parts which would actually come into sight are slightly shaded.

PROBLEM XIV.

SEVERAL exercises will be required on this important problem.

I. It is required to draw a circular flat-bottomed dish, narrower at the bottom than the top; the vertical depth being given, and the diameter at the top and bottom.

Let $a b$, Fig. 65., be the diameter of the bottom, $a c$ the diameter of the top, and $a d$ its vertical depth.

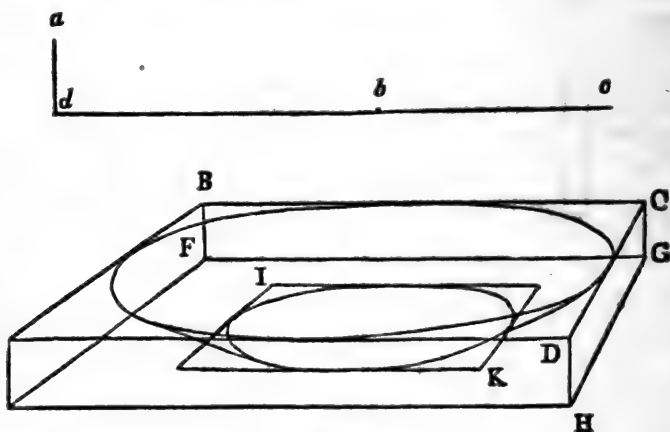

FIG. 65.

Take $A D$ in position equal to $a c$.

On $A D$ draw the square $A B C D$, and inscribe in it a circle.

Therefore, the circle so inscribed has the diameter of the top of the dish.

From A and D let fall verticals, $A E$, $D H$, each equal to $a d$.

Join $E H$, and describe square $E F G H$, which accordingly will be equal to the square $A B C D$, and be at the depth $a d$ beneath it.

Within the square $E F G H$ describe a square $I K$, whose diameter shall be equal to $a b$.

Describe a circle within the square $I K$. Therefore the circle so inscribed has its diameter equal to $a b$; and it is in the

centre of the square $EFGH$, which is vertically beneath the square $ABCD$.

Therefore the circle in the square IK represents the bottom of the dish.

Now the two circles thus drawn will either intersect one another, or they will not.

If they intersect one another, as in the figure, and they are below the eye, part of the bottom of the dish is seen within it.

To avoid confusion, let us take then two intersecting circles without the enclosing squares, as in Fig. 66.

Draw right lines, $a b, c d$, touching both circles externally. Then the parts of these lines which connect the circles are the sides of the dish. They are drawn in Fig. 65. without any prolongations, but the best way to construct them is as in Fig. 66.



FIG. 66.

If the circles do not intersect each other, the smaller must either be within the larger or not within it.

If within the larger, the whole of the bottom of the dish is seen from above, Fig. 67., *a*.

If the smaller circle is not within the larger, none of the bottom is seen inside the dish, *b*.

If the circles are above instead of beneath the eye, the bottom of the dish is seen beneath it, *c*.

If one circle is above and another beneath the eye, neither the bottom nor top of the dish is seen, *d*. Unless the object be very large, the circles in this case will have little apparent curvature.

II. The preceding problem is simple, because the lines of the profile of the object (*a b* and *c d*, Fig. 66.) are straight. But if these lines of profile are curved, the problem becomes much more complex: once mastered, however, it leaves no farther difficulty in perspective.

Let it be required to draw a flattish circular cup or vase, with a given curve of profile.



FIG. 67.

The basis of construction is given in Fig. 68., half of it only being drawn, in order that the eye may seize its lines easily.

Two squares (of the required size) are first drawn, one above the other, with a given vertical interval, λc , between them, and each is divided into eight parts by its diameters and diagonals. In these squares two circles are drawn: which are, therefore, of equal size, and one above the other. Two smaller circles, also of equal size, are drawn within these larger circles in the construction of the present problem; more may be necessary in some, none at all in others.

It will be seen that the portions of the diagonals and diame-

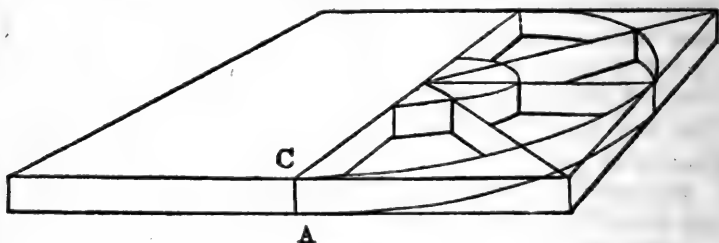

FIG. 68.

ters of squares which are cut off between the circles represent radiating planes, occupying the position of the spokes of a wheel.

Now let the line $\lambda E B$, Fig. 69., be the profile of the vase or cup to be drawn.

Enclose it in the rectangle $c D$, and if any portion of it is not curved, as λE , cut off the curved portion by the vertical line $E F$, so as to include it in the smaller rectangle $F D$.

Draw the rectangle $\lambda C B D$ in position, and upon it construct two squares, as they are constructed on the rectangle $\lambda C D$ in Fig. 68.; and complete the construction of Fig. 68., making the radius of its large outer circles equal to λD , and of its small inner circles equal to λE .

The planes which occupy the position of the wheel-spokes will then each represent a rectangle of the size of $F D$. The construction is shown by the dotted lines in Fig. 69; c being the centre of the uppermost circle.

Within each of the smaller rectangles between the circles, draw the curve EB in perspective, as in Fig. 69.

Draw the curve xy , touching and enclosing the curves in the rectangles, and meeting the upper circle at y .*

Then xy is the contour of the surface of the cup, and the upper circle is its lip.

If the line xy is long, it may be necessary to draw other rectangles between the eight principal ones; and, if the curve of profile AB is complex or retorted, there may be several lines corresponding to xy , enclosing the successive waves of the

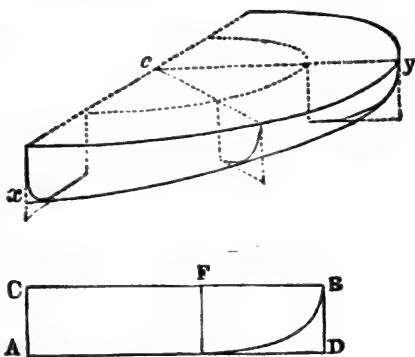

FIG. 69.

profile; and the outer curve will then be an undulating or broken one.

III. All branched ornamentation, forms of flowers, capitals of columns, machicolations of round towers, and other such arrangements of radiating curve, are resolvable by this problem, using more or fewer interior circles according to the conditions of the curves. Fig. 70. is an example of the construction of a circular group of eight trefoils with curved stems. One outer or limiting circle is drawn within the square $EDCF$, and the extremities of the trefoils touch it at the extremities of its diagonals and diameters. A smaller circle is

* This point coincides in the figure with the extremity of the horizontal diameter, but only accidentally.

at the vertical distance BC below the larger, and A is the angle of the square within which the smaller circle is drawn ; but the square is not given, to avoid confusion. The stems of the trefoils form drooping curves, arranged on the diagonals and diameters of the smaller circle, which are dotted. But no perspective laws will do work of this intricate kind so well as the hand and eye of a painter.

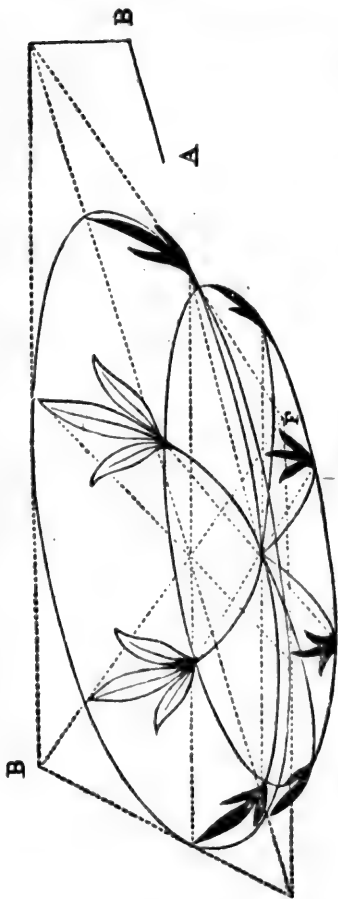

FIG. 70.

IV. There is one common construction, however, in which, singularly, the hand and eye of the painter almost always fail, and that is the fillet of any ordinary capital or base of a circular pillar (or any similar form). It is rarely necessary in practice to draw such minor details in perspective ; yet the perspective laws which regulate them should be understood, else the eye does not see their contours rightly until it is very highly cultivated.

Fig. 71 will show the law with sufficient clearness ; it represents the perspective construction of a fillet whose profile is a semicircle, such as FH in Fig. 60., seen above

the eye. Only half the pillar with half the fillet is drawn, to avoid confusion.

q is the centre of the shaft.

$p q$ the thickness of the fillet, sight-magnitude at the shaft's centre.

Round p a horizontal semicircle is drawn on the diameter of the shaft $a b$.

Round q another horizontal semicircle is drawn on diameter $c d$.

These two semicircles are the upper and lower edges of the fillet.

Then diagonals and diameters are drawn as in Fig. 68., and at their extremities, semicircles in perspective, as in Fig. 69.

The letters A, B, C, D, and E, indicate the upper and exterior

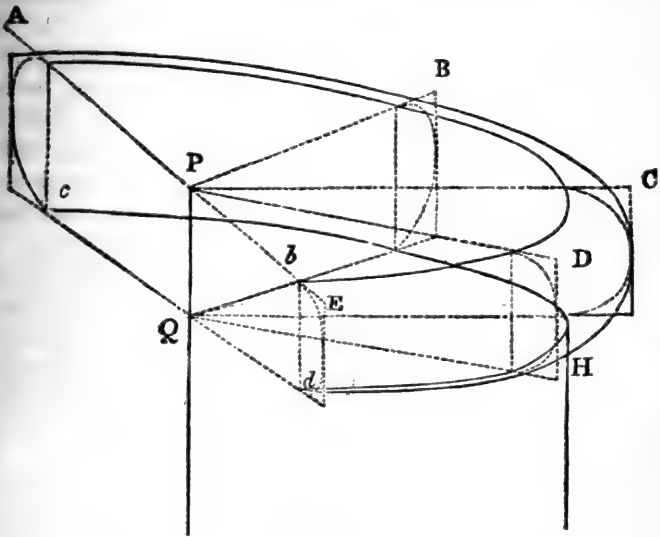

FIG. 71.

angles of the rectangles in which these semicircles are to be drawn; but the inner vertical line is not dotted in the rectangle at c , as it would have confused itself with other lines.

Then the visible contour of the fillet is the line which encloses and touches * all the semicircles. It disappears behind the shaft at the point h , but I have drawn it through to the opposite extremity of the diameter at d .

* The engraving is a little inaccurate; the enclosing line should touch the dotted semicircles at A and B . The student should draw it on a large scale.

Turned upside down the figure shows the construction of a basic fillet.

The capital of a Greek Doric pillar should be drawn frequently for exercise on this fourteenth problem, the curve of its echinus being exquisitely subtle, while the general contour is simple.

PROBLEM XVI.

It is often possible to shorten other perspective operations considerably, by finding the vanishing-points of the inclined lines of the object. Thus, in drawing the gabled roof in Fig. 43., if the gable $A Y C$ be drawn in perspective, and the vanishing-point of $A Y$ determined, it is not necessary to draw the two sides of the rectangle, $A' D'$ and $D' B'$, in order to determine the point Y' ; but merely to draw $Y Y'$ to the vanishing-point of $A A'$ and $A' Y'$ to the vanishing-point of $A Y$, meeting in Y' , the point required.

Again, if there be a series of gables, or other figures produced by parallel inclined lines, and retiring to the point v , as in Fig. 72.*, it is not necessary to draw each separately, but merely to determine their breadths on the line $A v$, and draw the slopes of each to their vanishing-points, as shown in Fig. 72. Or if the gables are equal in height, and a line be drawn from Y to v , the construction resolves itself into a zigzag drawn alternately to p and q , between the lines $Y v$ and $A v$.

The student must be very cautious, in finding the vanishing-points of inclined lines, to notice their relations to the horizontals beneath them, else he may easily mistake the horizontal to which they belong.

Thus, let $A B C D$, Fig. 73., be a rectangular inclined plane, and let it be required to find the vanishing-point of its diagonal $B D$.

Find v , the vanishing-point of $A D$ and $B C$.

Draw $A E$ to the opposite vanishing-point, so that $D A E$ may represent a right angle.

Let fall from B the vertical $B E$, cutting $A E$ in E .

* The diagram is inaccurately cut. $Y v$ should be a right line,

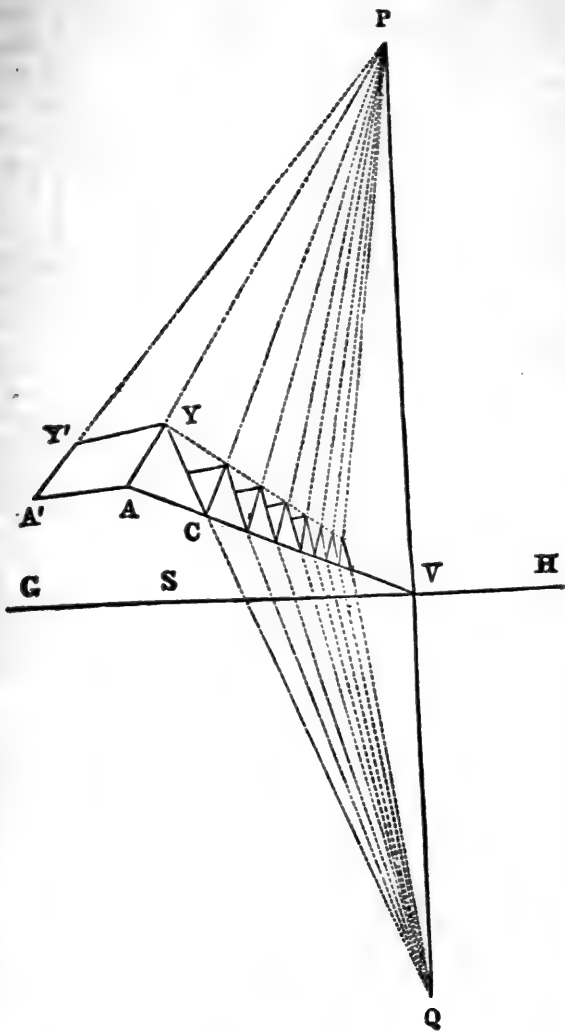

FIG. 72.

Join $E D$, and produce it to cut the sight-line in v' .

Then, since the point E is vertically under the point B , the horizontal line $E D$ is vertically under the inclined line $B D$. So that if we now let fall the vertical $v' P$ from v' , and produce

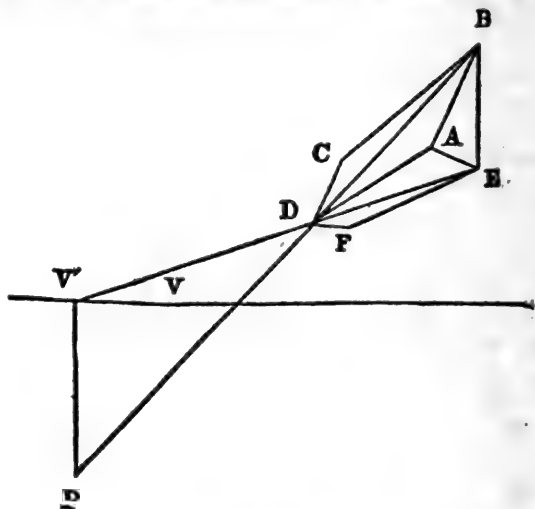

FIG. 78.

$B D$ to cut $v' P$ in P , the point P will be the vanishing-point of $B D$, and of all lines parallel to it.*

* The student may perhaps understand this construction better by completing the rectangle $A D F E$, drawing $D F$ to the vanishing-point of $A E$, and $E F$ to v . The whole figure, $B F$, may then be conceived as representing half the gable roof of a house, $A F$ the rectangle of its base, and $A C$ the rectangle of its sloping side.

In nearly all picturesque buildings, especially on the Continent, the slopes of gables are much varied (frequently unequal on the two sides), and the vanishing-points of their inclined lines become very important, if accuracy is required in the intersections of tiling, sides of dormer windows, &c.

Obviously, also, irregular triangles and polygons in vertical planes may be more easily constructed by finding the vanishing-points of their sides, than by the construction given in the corollary to Problem IX.; and if such triangles or polygons have others concentrically inscribed within them, as often in Byzantine mosaics, &c., the use of the vanishing-points will become essential.

PROBLEM XVIII.

BEFORE examining the last three problems it is necessary that you should understand accurately what is meant by the position of an inclined plane.

Cut a piece of strong white pasteboard into any irregular shape, and dip it in a sloped position into water. However you hold it, the edge of the water, of course, will always draw a horizontal line across its surface. The direction of this horizontal line is the direction of the inclined plane. (In beds of rock geologists call it their "strike.")

Next, draw a semicircle on the piece of pasteboard; draw its diameter, AB , Fig. 74., and a vertical line from its centre, CD , and draw some other lines, CE , CF , &c., from the centre to any points in the circumference.

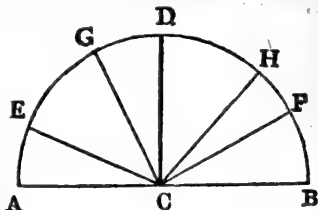

FIG. 74.

Now dip the piece of pasteboard again into water, and holding it at any inclination and in any direction you choose, bring the surface of the water to the line AB . Then the line CD will be the most steeply inclined of all the lines drawn to the circumference of the circle; GC and HC will be less steep, and EC and FC less steep still. The nearer the lines to CD , the steeper they will be; and the nearer to AB , the more nearly horizontal.

When, therefore, the line AB is horizontal (or marks the water surface), its direction is the direction of the inclined plane, and the inclination of the line DC is the inclination of the inclined plane. In beds of rock geologists call the inclination of the line DC their "dip."

To fix the position of an inclined plane, therefore, is to determine the direction of any two lines in the plane, AB and CD , of which one shall be horizontal and the other at right angles to it. Then any lines drawn in the inclined plane, parallel to AB , will be horizontal; and lines drawn parallel to

$c d$ will be as steep as $c' d'$, and are spoken of in the text as the "steepest lines" in the plane.

But farther, whatever the direction of a plane may be, if it be extended indefinitely, it will be terminated, to the eye of the observer, by a boundary line, which, in a horizontal plane, is horizontal (coinciding nearly with the visible horizon);—in a vertical plane, is vertical;—and, in an inclined plane, is inclined.

This line is properly, in each case, called the "sight-line" of such plane; but it is only properly called the "horizon" in the case of a horizontal plane: and I have preferred using always the term "sight line," not only because more comprehensive, but more accurate; for though the curvature of the earth's surface is so slight that practically its visible limit always coincides with the sight line of a horizontal plane, it does not mathematically coincide with it, and the two lines ought not to be considered as theoretically identical, though they are so in practice.

It is evident that all vanishing-points of lines in any plane must be found on its sight-line, and, therefore, that the sight-line of any plane may be found by joining any two of such vanishing-points. Hence the construction of Problem XVIII.

II.

DEMONSTRATIONS WHICH COULD NOT CONVENIENTLY BE INCLUDED IN THE TEXT.

I.

THE SECOND COROLLARY, PROBLEM II.

In Fig. 8. omit the lines $c d$, $c' d'$ and $d s$; and, as here in Fig. 75., from a draw $a d$ parallel to $A B$, cutting $B T$ in d ; and from d draw $d e$ parallel to $B C$.

Now as $a d$ is parallel to $A B$ —

$$A C : a c :: B C : d e;$$

but $A C$ is equal to $B C'$ —

$$\therefore a c = d e.$$

Now because the triangles $a c v$, $b c' v$, are similar—

$$a c : b c' :: a v : b v;$$

and because the triangles $d e T$, $b c' T$ are similar—

$$d e : b c' :: d T : b T.$$

But $a e$ is equal to $d e$ —

$$\therefore a v : b v :: d T : b T.$$

\therefore the two triangles $a b d$, $b T v$, are similar, and their angles are alternate :

$$\therefore T v \text{ is parallel to } a d.$$

But $a d$ is parallel to $A B$ —

$$\therefore T v \text{ is parallel to } A B.$$

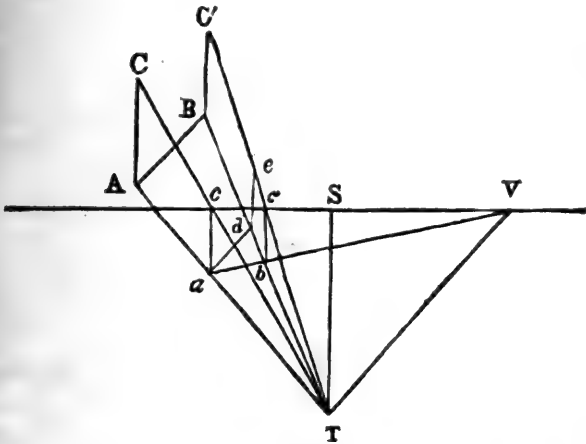

FIG. 75.

II

THE THIRD COROLLARY, PROBLEM III.

In Fig. 13, since $a R$ is by construction parallel to $A B$ in Fig. 12., and $T V$ is by construction in Problem III. also parallel to $A B$ —

$$\begin{aligned} \therefore a R \text{ is parallel to } T V, \\ \therefore a b R \text{ and } T b V \text{ are alternate triangles,} \\ \therefore a R : T V :: a b : b V. \end{aligned}$$

Again, by the construction of Fig. 13., $a R'$ is parallel to $M V$ —

$$\begin{aligned} \therefore a b R' \text{ and } M b V \text{ are alternate triangles,} \\ \therefore a R' : M V :: a b : b V. \end{aligned}$$

And it has just been shown that also

$$\begin{aligned} a R : T V :: a b : b V— \\ \therefore a R' : M V :: a R : T V. \end{aligned}$$

But by construction, $a R' = a R$ —

$$\therefore M V = T V.$$

 III

ANALYSIS OF PROBLEM XV.

We proceed to take up the general condition of the second problem, before left unexamined, namely, that in which the vertical distances $B C'$ and $A C$ (Fig. 6. page 20), as well as the direct distances $T D$ and $T D'$ are unequal.

In Fig. 6., here repeated (Fig. 76.), produce $C' B$ downwards, and make $C' E$ equal to $C A$.

Join $A E$.

Then, by the second Corollary of Problem II., $A E$ is a horizontal line.

Draw TV parallel to AE , cutting the sight-line in v .

$\therefore v$ is the vanishing-point of AE .

Complete the constructions of Problem II. and its second Corollary.

Then by Problem II. ab is the line AB drawn in perspective; and by its Corollary ae is the line AE drawn in perspective.

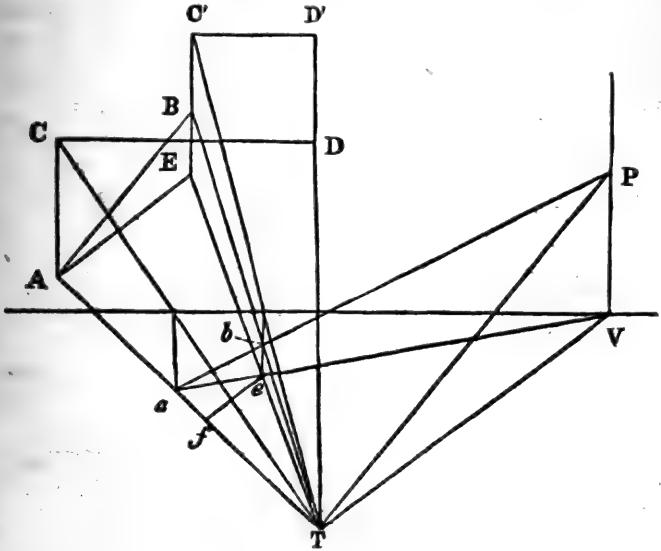

FIG. 76.

From v erect perpendicular VP , and produce ab to cut it in P .

Join TP , and from e draw ef parallel to AE , and cutting AT in f .

Now in triangles EBT and AET , as eb is parallel to EB and ef to AE ; $-eb : ef :: EB : AE$.

But TV is also parallel to AE and PV to eb .

Therefore also in the triangles APV and AVT ,

$$eb : ef :: PV : VT,$$

Therefore $PV : VT :: EB : AE$.

And, by construction, angle $TPV = \angle AEB$.

Therefore the triangles TVP , AEB , are similar; and TP is parallel to AB .

Now the construction in this problem is entirely general for any inclined line AB , and a horizontal line AE in the same vertical plane with it.

So that if we find the vanishing-point of AE in v , and from v erect a vertical VP , and from T draw TP parallel to AB , cut-

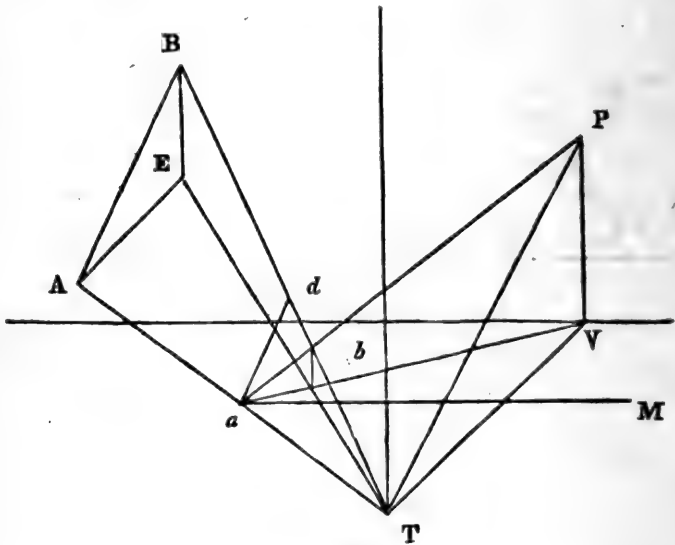

FIG. 77.

ting vP in P , P will be the vanishing-point of AB , and (by the same proof as that given at page 21.) of all lines parallel to it.

Next, to find the dividing-point c of the inclined line.

I remove some unnecessary lines from the last figure and repeat it here, Fig. 77., adding the measuring-line, aM , that the student may observe its position with respect to the other lines before I remove any more of them.

Now if the line AB in this diagram represented the length of the line AB in reality (as AB does in Figs. 10. and 11.), we

should only have to proceed to modify Corollary III. of Problem II. to this new construction. We shall see presently that AB does not represent the actual length of the inclined line AB in nature, nevertheless we shall first proceed as if it did, and modify our result afterwards.

In Fig. 77, draw ad parallel to AB , cutting BT in d .

Therefore ad is the sight-magnitude of AB , as ar is of AR in Fig. 11.

Remove again from the figure all lines except PV , VT , PT , ab , ad , and the measuring-line.

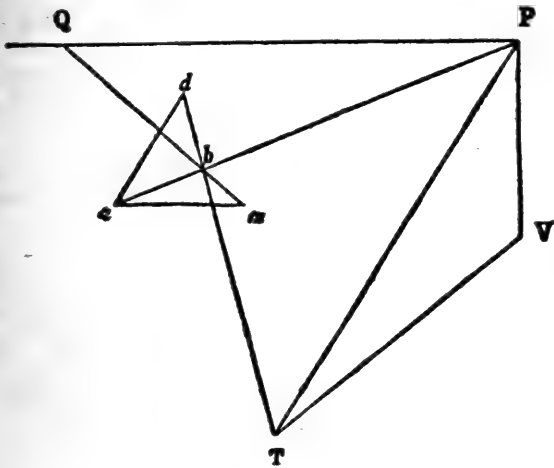

FIG. 78.

Set off on the measuring-line am equal to ad .

Draw Bq parallel to am , and through b draw m q , cutting PQ in q .

Then, by the proof already given in page 25, $Pq = PT$.

Therefore if P is the vanishing-point of an inclined line AB , and qP is a horizontal line drawn through it, make Pq equal to PT , and am on the measuring-line equal to the sight-magnitude of the line AB in the diagram, and the line joining m q will cut aP in b .

We have now, therefore, to consider what relation the length of the line AB in this diagram, Fig. 77., has to the length of the line AB in reality.

Now the line AE in Fig. 77. represents the length of AB in reality.

But the angle AEB , Fig. 77., and the corresponding angle in all the constructions of the earlier problems, is in reality a right angle, though in the diagram necessarily represented as obtuse.

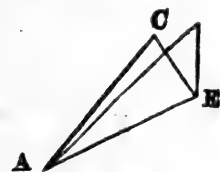

FIG. 79.

Therefore, if from E we draw EC , as in Fig. 79., at right angles to AE , make $EC = EB$, and join AC , AC will be the real length of the line AB .

Now, therefore, if instead of am in Fig. 78., we take the real length of AB , that real length will be to am as AC to AB in Fig. 79.

And then, if the line drawn to the measuring-line PQ is still to cut AP in b , it is evident that the line PQ must be shortened

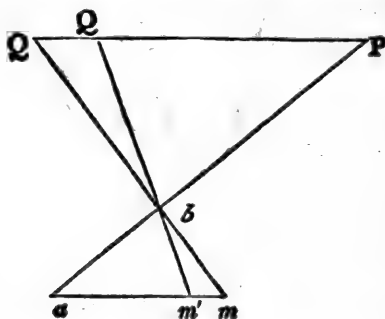

FIG. 80.

in the same ratio that am was shortened, and the true dividing-point will be q' in Fig. 80., fixed so that $q'P'$ shall be to $Q'P$ as am' is to $am : am$, representing the real length of AD .

But am' is therefore to am as AC is to AB in Fig. 79.

Therefore $P'Q'$ must be to PQ as AC is to AB .

But PQ equals PT (Fig. 78.); and PV is to VT (in Fig. 78.) as BE is to AE (Fig. 79.).

Hence we have only to substitute $p v$ for ec , and $v r$ for az , in Fig. 79., and the resulting diagonal ac will be the required length of $p q'$.

It will be seen that the construction given in the text (Fig. 46.) is the simplest means of obtaining this magnitude, for vd in Fig. 46. (or vm in Fig. 15.) = vr by construction in Problem IV. It should, however, be observed, that the distance $p q'$ or px , in Fig. 46., may be laid on the sight-line of the inclined plane itself, if the measuring-line be drawn parallel to that sight-line. And thus any form may be drawn on an inclined plane as conveniently as on a horizontal one, with the single exception of the radiation of the verticals, which have a vanishing-point, as shown in Problem XX.

THE END.







PLEASE DO NOT REMOVE
CARDS OR SLIPS FROM THIS POCKET

UNIVERSITY OF TORONTO LIBRARY

PR Ruskin, John
5261 Proserpina
P7
18--

