

UNIV. OF  
TORONTO  
LIBRARY







Digitized by the Internet Archive  
in 2007 with funding from  
Microsoft Corporation

<http://www.archive.org/details/psychobiology01baltuoft>





~~Philos  
P.~~

111

# PSYCHOBIOLOGY

EDITED BY  
**KNIGHT DUNLAP**  
*Johns Hopkins University*

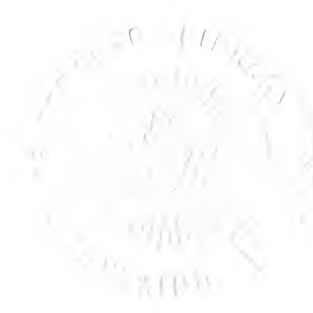

## VOLUME I

156949  
2/11/20

BALTIMORE, MD.  
1918



BF  
1  
PG  
v.1

~~1111~~  
1111



Y

## CONTENTS

### NUMBER 1—JULY, 1917

Announcement.....	1
The retention of habits by the rat after destruction of the frontal portion of the cerebrum. S. I. Franz and K. S. Lashley.....	3
Action of some opium alkaloids on the psychological reaction time. D. I. Macht and Schachne Isaacs.....	19
On cerebral motor control: the recovery from experimentally produced hemiplegia. Robert Oden and S. I. Franz.....	33
The effect of delayed feeding upon learning. John B. Watson.....	51
Internal secretion in learning. (Discussion) Knight Dunlap.....	61

### NUMBER 2—SEPTEMBER, 1917

Continuous stimulations versus continuous shock in the phototactic response. S. J. Holmes.....	65
The effects of cerebral destruction upon habit-formation and retention in the albino rat. H. S. Lashley and S. I. Franz.....	71
The effects of strychnine and caffeine upon the rate of learning. K. S. Lashley.....	141
The stop-watch and the association test. Knight Dunlap.....	171

### NUMBER 3—NOVEMBER, 1917

On the motor functions of the cerebral cortex of the cat. Joseph Duerson Stout.....	177
Relative values of reward and punishment in habit formation. J. D. Dodson	231

### NUMBER 4—JANUARY, 1918

A classification of groups. Carl W. Bock.....	277
A synchronous motor kymograph. Knight Dunlap.....	319
Dunlap's method for the mean variation. Buford Johnson.....	325
Action of some antipyretic analgesics on psychological reaction time. D. I. Macht, S. Isaacs and J. Greenburg.....	327

### NUMBER 5—MARCH, 1918

Some notes on the auditory sensitivity of the white rat. Walter S. Hunter...	339
A simple maze: With data on the relation of the distribution of practice to the rate of learning. K. S. Lashley.....	353

### NUMBER 6—MAY, 1918

Methods of studying controlled word associations. Mildred West Loring..	369
Word-lists for adjective and noun reactions. Mildred West Loring.....	429
Methods of using balanced magnet chronoscopes. Knight Dunlap.....	445
Discriminative responses to visual stimuli. H. M. Johnson.....	459
Index.....	495

STATE OF NEW YORK  
IN SENATE

January 15, 1907.

REPORT  
OF THE  
COMMISSIONERS OF THE LAND OFFICE  
IN ANSWER TO A RESOLUTION PASSED BY THE SENATE  
MAY 15, 1906.

## ANNOUNCEMENT

PSYCHOBIOLOGY is established for the publication of research bearing on the interconnection of mental and physiological functions. It will include in its volumes therefore, not only investigations of what is sometimes called "psychological physiology" but also investigations in pharmacology, physiology, anatomy, neurology and psychiatry in so far as the results of these investigations have explicit bearing on problems of mental life, or mental factors are included in the essential conditions of the investigation.

We would emphasize the fact that in spite of the increasing tendency in the several sciences represented, especially in psychology, to seek practical results, and formulate as quickly as possible conclusions having immediate application, it has been our purpose to establish another journal devoted to pure science, in which the ideals of those whose primary interests are in sound scientific progress shall be represented as fully as possible. In pursuance of this purpose, we urge contributors to pay attention to the details of method and technique which alone can give their conclusions value, and we set no arbitrary limit of length. Papers submitted will be accepted in so far as space permits, if they conform to the following standards. (1) They must be in the proper field of the journal. (2) They must possess sufficient importance. (3) They must be adequately written. Unnecessary length and brevity are alike excluded by this last criterion.

Manuscript may be sent directly to the editor-in-chief. When an article lies in the special field of one of the associate editors, it may be sent to him.



# THE RETENTION OF HABITS BY THE RAT AFTER DESTRUCTION OF THE FRONTAL PORTION OF THE CEREBRUM

S. I. FRANZ AND K. S. LASHLEY

*From the Government Hospital for the Insane and the Psychological Laboratory of  
The Johns Hopkins University*

Much has been written regarding the neurology of learning and especial attention has been directed to the cerebrum. Comparatively little evidence has been adduced to show what cerebral elements are used in the formation of habits, although recent experimental investigations show that the frontal positions of the cerebrum are utilized by monkeys, dogs, and cats.<sup>1</sup> In only those animals with a highly developed brain is there a distinct differentiation of the frontal (as an association area) from the central (so-called motor and sensory-kinesthetic) area, and in fact the possibility of the histological differentiation of numerous areas of the brains of many of the lower animals is slight. The relatively simple and homogeneous character of the cerebral cortex in the rodents makes their cerebral physiology worthy of study, and there is the added advantage that the animals acquire habits rapidly and much information is at hand regarding their normal reactions.

At the same time, on account of their low cost and ease of housing, many different experiments on the brain may be made which are not possible with animals having larger and more highly developed brains. Such experiments on rats may be expected to give results of at least suggestive value respecting the functions of corresponding parts of more highly evolved brains. Thus, if it is found that these animals can acquire habits after the removal of certain small or large parts of the cerebrum,

<sup>1</sup> For most of the evidence: S. I. Franz, *The Frontal Lobes*, New York: Science Press, 1907, pp. 64.

but not after the removal of other parts, or if they can retain but can not acquire habits after certain cerebral destructions, there will exist a basis for further extensive and intensive work on the so-called higher animals. The present work was undertaken with these objects in view.

Several questions were posed, although the facts to answer only a few parts of these questions are now available. Some of the questions are: Do rats retain habits of recent formation after the destruction of certain cerebral regions? Do they retain habits of long standing, or those in which there has been an overtraining or over-learning? Can rats learn after the removal of the whole cortex? If learning and retention are possible after destruction of parts of the cortex, how much and what parts of the brain are necessary for, and what parts are normally used in the formation and the retention of habits? At the present time there are available results of experiments in which the frontal portions of the brain have been destroyed, and in which there have been destructions of two-thirds or more of the whole cortex (that of the cerebral convexity), but only those experiments dealing with the effects of frontal destructions will be reported here.

When the experiments were undertaken there was available a large number of rats which has been trained in a simple maze for other purposes and it was decided to use them in preliminary tests. The maze was built after the pattern of the Yerkes discrimination box (fig. 1). It consists of a starting compartment (*a*) leading by a sliding door to a central alley (*b*), which at its outer end offers the alternatives of the cul de sac (*c*) and the alley (*d*) leading directly to the food (*e*). A maze of this character had decided advantages for the training of large numbers of animals but is not altogether suitable for tests on retention on account of the speed with which it is learned and the degree of probability that any given correct trial is the result of chance. Incidental observations on the behavior of the animals in the maze are therefore of great importance for the determination of the retention of the habit.

Two activities of the animals in the maze are to be especially

noted, as their characteristics are evidences of learning or lack of learning, and of retention of the maze habits. These activities relate to the reactions at the door of the starting box and to the shortening of the path to the food. When first introduced into the starting compartment of the maze the rat sniffs at the wire cover, sides, and corners of the compartment and pays no particular attention to the door. When the door is first raised he almost always stands erect and sniffs at its lower edge before venturing into the first alley. With practice his reactions become centered on the door; he tries to push it up or sniffs at the

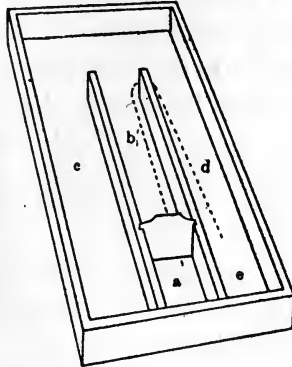

FIG. 1. SIMPLE MAZE

*a* Starting compartment; *e*, food. The dotted line shows the path taken by well trained animals, keeping close to the right-hand partition and cutting close around the corner.

crack under it. The moment that the experimenter touches the door to open it the rat turns with his head in the right front corner of the starting compartment and as soon as the door is raised high enough to admit his body crawls out into the alley. This behavior is noted in the records of the different animals as "normal orientation to opening door." In his first trials in the maze the rat spends much time in sniffing at the wire cover, the walls, and particularly the corners of the maze. The trained rat can go from the starting compartment to the food in 1.2 seconds. The minimum time on the first trial for any of the sixty rats that have been trained has been eight seconds and

the modal time is about thirty seconds, most of which is spent in exploratory sniffing. With practice these exploratory movements disappear and the animal runs to the food without a pause. Many animals come to follow the path marked by the dotted line in figure 1. That is, they keep close to the right-hand wall of the middle alley and keep close to the end of the partition in rounding the turn. This cutting down of excess distance and absence of exploratory sniffing are characteristic of the later stages of learning and when they appear in retention tests are therefore conclusive evidence for at least a partial retention of the motor habits of the maze.

In training, ten successive errorless trials were taken as evidence for learning (rarely more than six errors are made in the hundred trials following the achievement of this record). Some of the rats were then given an overtraining of from one to two hundred trials before the destruction of the frontal lobes. Others were operated upon on the day following that on which learning was completed.

The operations were performed under ether anesthesia, and at the end the cut scalp was closed with sutures and was covered with a cotton and collodion dressing.

In some cases a transverse opening about 4 by 8 mm. was made in the skull just back of the fronto-parietal suture and the frontal area of the brain was destroyed by passing a narrow scalpel diagonally forward to the region of the olfactory bulbs and thence cutting out to the sides of the cranial cavity. In other cases two small trephine holes were made in the region of the suture and a spear-pointed needle was inserted through these, pushed through the frontal area and drawn to the sides to cut away the frontal regions. Owing to the small operative field it is not possible to determine the exact extent of the lesion at the time of operation but the possibility of using a large number of animals and of later determination of the extent of the destruction of tissue makes it possible to obtain records of some animals in which the exact lesion desired has been produced.

Most of the animals have been kept for two weeks or more after the operation and in many cases the absorption of the clot



has progressed to such an extent that it seems advisable to wait until histological examinations of the brains can be made before describing the lesions in detail. Fourteen animals have been operated upon for destruction of the frontal lobes and of these eight have been autopsied. In these the gross lesion has been in every case as extensive as that indicated in figure 2, and in three of the animals has extended back so as to involve the anterior two-thirds of the cortex.

Brief records of the animals studied are given below. Whenever possible, fifteen trials in the maze were obtained from each animal on the day following the operation. The time con-

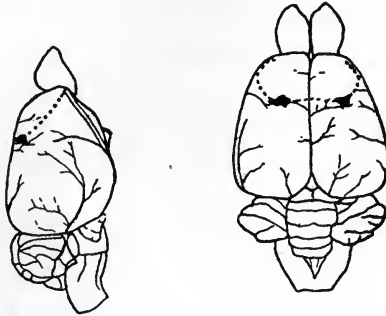

FIG. 2. DIAGRAM OF THE EXTENT OF THE LESION IN RAT H1 ♀, AS DETERMINED BY GROSS DISSECTION

sumed in each of these trials in going from the starting compartment to the food dish and the number of errors, either of entering the cul de sac or of turning back upon the true pathway, was recorded. In the following records the total time consumed in these fifteen trials and the total number of errors are compared with the total time and errors of the first fifteen trials made by the same rat in its first training in the maze. The time and number of errors of the rat's first trial in the maze at the beginning of training are also compared with those of the first trial of the retention tests. In addition to this observations are reported on the general behavior of the animals in the maze.

*Animals tested for retention without overtraining*

*Experiment 1.* G2 ♀. Ninety-four days old at the beginning of training. Learning was completed in 54 trials at 10 trials per day. No overtraining.

Operation through two trephine holes, followed by extensive hemorrhage. Retention was tested twenty-five hours after the operation. The animal was constantly irritated by inflammation of the nasal sinuses but was otherwise in good condition. Orientation in starting compartment was normal. In every trial except the second the animal kept close to the right-hand wall of the middle alley and cut close to the end of the partition. On the second trial she turned into the entrance of the cul de sac but did not advance more than two inches. Various tests suggest that she was anosmic. A comparison of the records of learning and retention follows.

		LEARNING	RETENTION
First 15 trials	{ Total time.....	188 seconds	54 seconds
	{ Errors.....	5	1 (?)
First trial	{ Time.....	15 seconds	2.6 seconds
	{ Errors.....	0	0

*Experiment 2.* G1 ♀. Ninety-four days old. Learning was completed in 23 trials with 2 trials per day. No overtraining.

Operation through large transverse opening, followed by considerable hemorrhage but with recovery of motor coördination within half an hour. Retention was tested twenty-six hours after the operation. The rat was very weak, falling over when attempting to make quick turns or to scratch the dressing on her head. She oriented in the starting compartment and gave no evidence of exploratory sniffing in the maze. On the first trial she turned into the cul de sac and wandered back and forth for a few seconds, then went directly to the food. A second error was made on the eleventh trial. The other trials were made correctly but at a rather slow rate. The rat made frequent long stuporous pauses and spent a good bit of time also in scratching at the dressing on her head. On the following day she was given 20 trials in the maze and in every case reached the food without error and in less than four seconds. The records of learning and retention follow.

		LEARNING	RETENTION
First 15 trials	Total time.....	117 seconds	159 seconds
	Errors.....	8	2
First trial	Time.....	10 seconds	45 seconds
	Errors.....	1	1

*Experiment 3.* H1 ♀. Ninety-two days old. Learning was completed in 21 trials with 2 trials per day. No overtraining.

Operation through two trephine holes, with little hemorrhage. Retention was tested twenty-two hours after the operation. The rat oriented in the starting compartment, ran promptly and without exploratory smelling, and never explored the maze in a way comparable to that of normal animals in their first trials. She entered the cul de sac on the first, fifth, eleventh, and thirteenth trials but turned back promptly before reaching the end of it. On the errorless trials she followed the path marked in figure 1. The records of learning and retention were the following.

		LEARNING	RETENTION
First 15 trials	Total time.....	85 seconds	64 seconds
	Errors.....	2	4
First trial	Total time.....	10 seconds	8 seconds
	Errors.....	1	1

*Animals tested after overtraining*

*Experiment 4.* G1 ♂. Seventy-three days old. Learning was completed in 21 trials with 10 trials per day. Training was continued for 170 trials.

Destruction of frontal lobes through large transverse opening, followed by little hemorrhage. Retention was tested twenty hours after the operation. The rat oriented correctly in the starting compartment and advanced promptly when the door was opened. On the first trial he turned into the cul de sac and stopped with his head in the first corner, then backed out and went directly to the food. He made a second error on the fourteenth trial. The other trials were correct but were delayed by a peculiar reaction. When he reached the

first corner after passing the turn he would pause with his nose close in the corner (but without apparent sniffing), then back away and turn down the alley to the food. Tests made by pulling his vibrissae while he was eating indicated that these organs were lacking in tactile sensitivity. The records of learning and retention were the following.

		LEARNING	RETENTION
First 15 trials	Total time.....	1018 seconds	92 seconds
	Errors.....	21	2
First trial	Time.....	34 seconds	12 seconds
	Errors.....	1	1

*Experiment 5.* F1 ♀. Seventy-five days old. Learning was completed in 90 trials with 10 trials per day. Training was continued for 120 trials.

Operation through a single small trephine hole on the left with little hemorrhage. Retention was tested twenty-six hours later. The rat oriented in the starting compartment, and in the majority of trials followed the path indicated in figure 1. On the third and fifth trials she retraced a part of the direct pathway to the food and on the tenth trial she swerved so that her head was in the cul de sac but she never ventured entirely off the direct pathway. The records of learning and retention were the following.

		LEARNING	RETENTION
First 15 trials	Total time.....	640 seconds	44 seconds
	Errors.....	19	2
First trial	Time.....	15 seconds	4 seconds
	Errors.....	2	0

*Experiment 6.* F2 ♂. Sixty-nine days old. Learning was completed in 24 trials with 2 trials per day. Training was continued for 170 trials.

Operation through large transverse opening with very severe hemorrhage. Retention was tested twenty-three hours after the operation. The rat was active and oriented correctly in the starting compartment. In four trials the rat returned to the starting compartment after ad-

vancing for his own length into the middle alley, but he did not leave the pathway once in fifteen trials. The records of learning and retention follow.

		LEARNING	RETENTION
First 15 trials	Total time.....	93 seconds	68 seconds
	Errors.....	7	0
First trial	Time.....	13 seconds	6 seconds
	Errors.....	1	0

*Experiment 7.* G3♂. Seventy-three days old. Learning was completed in 24 trials with 10 trials per day. Training was continued for 170 trials.

Operation through two trephine holes with little hemorrhage. Retention was tested twenty hours after the operation. He oriented correctly to the opening of the door, ran quickly and followed the path of figure 1 in all but the first and second trials. In the first trial he entered the cul de sac but turned back without exploratory sniffing. In the second trial he put his head into the entrance of the cul de sac, but did not enter it. He appeared to be anosmic. The records of learning and retention follow.

		LEARNING	RETENTION
First 15 trials	Total time.....	359 seconds	55 seconds
	Errors.....	11	1
First trial	Time.....	11 seconds	8 seconds
	Errors.....	0	1

*Experiment 8.* F2♀. Seventy-five days old. Learning was completed in 25 trials with 2 trials per day. Training was continued for 200 trials.

Operation by transverse opening with severe hemorrhage. Retention was tested twenty-six hours after the operation. The rat was very weak and her movements were as a rule, slow and hesitating but without marked pauses at the entrance of the cul de sac. On the first trial she explored the cul de sac quickly, but without exploratory sniffing, and had some difficulty in finding the food in the dish. On the

tenth and thirteenth trials she again entered the cul de sac but did not go to the end. On the other trials she followed the most direct path and cut close around the end of the partition. The records of learning and retention were the following.

		LEARNING	RETENTION
First 15 trials	Total time.....	203 seconds	115 seconds
	Errors.....	7	3
First trial	Time.....	60 seconds	18 seconds
	Errors.....	1	1

*Experiment 9.* D1 ♀. Sixty-nine days old. Learning was completed in 48 trials with 10 trials per day. Training was continued for 200 trials.

The frontal lobes were destroyed by a transverse incision. Retention was tested twenty-four hours after the operation. The rat oriented correctly in the starting compartment, attempting to lift the door by thrusting her nose under it. Two errors were made on the fifth trial. The others were run correctly and by the shortest possible path. There was no exploratory sniffing. The records of learning and retention follow.

		LEARNING	RETENTION
First 15 trials	Total time.....	566 seconds	57 seconds
	Errors.....	23	2
First trial	Time.....	18 seconds	1.8 seconds
	Errors.....	1	0

*Experiment 10.* B1 ♂. Sixty-seven days old. Learning was completed in 70 trials with 10 trials per day. Training was continued for 200 trials.

The frontal lobes were destroyed by a transverse incision. Retention was tested twenty-eight hours after operation. On the first trial the rat explored the maze hurriedly without pausing to sniff. In the later trials he usually paused and swayed back and forth at the end of the first passage but entered the cul de sac only once, on the

seventh trial. He oriented in the starting compartment. The records of learning and retention follow.

		LEARNING	RETENTION
First 15 trials	{ Total time.....	1797 seconds	137 seconds
	{ Errors.....	33	2
First trial	{ Time.....	32 seconds	12 seconds
	{ Errors.....	1	1

*Experiment 11.* F3♂. Sixty-nine days old. Learning was completed in 60 trials with ten trials per day. Training was continued for 200 trials.

The anterior third of the cortex was destroyed. Little hemorrhage. Retention was tested twenty-two hours after the operation. On the first trial the rat turned into the cul de sac and ran half way to the end, then turned back and went directly to the food. He made no other error in the fifteen trials of the test, and followed the most direct route to the food. His records for learning and retention follow.

		LEARNING	RETENTION
First 15 trials	{ Total time.....	428 seconds	50 seconds
	{ Errors.....	11	1
First trial	{ Total time.....	175 seconds	11 seconds
	{ Errors.....	4	1

*Experiment 12.* G4♂. Seventy-three days old. Learning was completed in 16 trials with 2 trials per day. Training was continued for 200 trials.

Frontal lobes were removed by a transverse incision in the region of the fronto-parietal suture. Retention was tested twenty hours after the operation. The animal was very weak and spastic. He reacted promptly to the maze, however, orienting in the starting compartment and never hesitating at the turn in the maze. He had some little difficulty in finding the food, pushing under instead of above the edge of the dish. After 10 trials he began to show evidence of fatigue so the remaining trials for retention were postponed for two days when he had regained almost normal strength. The records of learning and retention follow.

		LEARNING	RETENTION
First 15 trials	Total time.....	135 seconds	51 seconds
	Errors.....	2	0
First trial	Time.....	20 seconds	2 seconds
	Errors.....	1	0

*Experiment 13.* G2♂. Sixty-nine days old. Learning was completed in 24 trials with 2 trials per day. Training was continued for 200 trials.

Frontal lobes destroyed by a transverse incision. Retention was tested twenty-two hours after the operation. The animal was very weak and spastic. He had great difficulty in finding the food and gnawed at the edge of the dish as much as at the bread. Nevertheless he followed the direct path to the food with never a suggestion of reaction to the entrance to the cul de sac. During the trials there were many stuporous pauses (one of fifty seconds duration, which accounts for the long time consumed in the fifteen trials recorded below) so, after five trials the rat was returned to the home cage and the tests continued two days later when he had recovered strength. The records of learning and retention follow.

		LEARNING	RETENTION
First 15 trials	Total time.....	134 seconds	123 seconds
	Errors.....	3	0
First trial	Time.....	21 seconds	8 seconds
	Errors.....	1	0

*Experiment 14.* F4♂. Sixty-nine days old. Learning was completed in 18 trials with 2 trials per day. Training was continued for 120 trials.

Frontal lobes destroyed by a transverse incision through a small trephine hole on the left. Retention tested 20 hours after operation. The animal had developed a left hemi-paresis and failed to leave the starting compartment of the maze in an hour on each of three consecutive days. Autopsy showed an extensive clot over the orbital surface of the right hemisphere, extending back to the pons.



## SUMMARY OF RESULTS OF EXPERIMENTS

The records of time and errors have been summarized in table 1. From the averages it appears that the rats which were not overtrained required 29 per cent less time for the first 15 trials after the destruction of the frontal lobes and made 53 per cent

TABLE 1

*The time required for reaching the food and the number of errors made by rats in learning the maze and in the retention tests after the destruction of the frontal lobes*  
*Animals without overtraining.*

NUMBER	TRAINING			RETENTION		
	First 15 trials		First trial	First 15 trials		First trial
	Time	Errors		Time	Errors	
G2 ♀ .....	188	5	15	54	1(?)	2.6
G1 ♀ .....	117	8	10	159	2	45
H1 ♀ .....	85	2	10	64	4	8
	390	15	35	277	7	55.6

*Animals overtrained*

G1 ♂ .....	1018	21	34	92	2	12
F1 ♀ .....	640	19	15	44	2	4
F2 ♂ .....	93	7	13	68	0	6
G3 ♂ .....	359	11	11	55	1	8
F2 ♀ .....	203	7	60	115	3	18
D1 ♀ .....	566	23	18	57	2	1.8
B1 ♂ .....	1797	33	32	137	2	12
F3 ♂ .....	428	11	175	50	1	11
G4 ♂ .....	135	2	20	51	0	2
G2 ♂ .....	134	3	31	123	0	8
	5408	137	399	791	13	82.8

fewer errors than they did in learning the maze. This in itself is evidence for a partial retention of the habit. When considered in connection with the data on their behavior in the maze it shows that there was little if any loss that can not be accounted for by the distracting effects of the head bandages and the general shock effects of the operation. None of the animals showed

the exploratory sniffing at cracks and corners which is so characteristic of the untrained rat in the maze. All were tested immediately after the retention tests by being placed in a strange cage with food and all spent at least thirty seconds in exploring the cage before pausing at the food, so that the lack of exploratory activities in the maze must be looked upon as due to retention of the habit and not to a general sluggishness resulting from the operations. The three rats which were not overtrained oriented in the starting compartment and two regularly followed the path marked in figure 1. The abnormality of behavior of the third (G1 ♀) was probably due to loss of sensitivity of the vibrissae.

The animals which were overtrained required 87 per cent less time for the first fifteen trials after operation and made 90 per cent fewer errors than in their initial learning. This, in addition to the data on individual behavior in the maze shows that there was practically no loss of the habit resulting from the destruction of the frontal lobes.

There is an apparent difference in the amount of retention between animals which were over-trained and those which were trained only until they had learned the problem. This difference is probably not so great as is indicated by the averages because the long time spent by the non-overtrained group is the result of the inclusion of the rat G1 ♀ which spent a great deal of time in trying to remove the dressing from its head.

Only one animal did not show evidence of the maze habit after removal of the frontal portions of the brain. This animal showed such an amount of muscular weakness, or apathy, that the running of the maze was not attempted by it even after the fashion of an untrained animal. With this exception the tests gave indisputable evidence of the retention of the habit after the frontal portions of both hemispheres has been excised. Moreover, the evidence is more compelling because of some obvious behavior disturbances in a number of the animals. Thus, it has been reported of the second animal, G1 ♀ that, although the time for running the maze after the operation was greater than in the training series, its other behavior relating directly to the

maze was retained. The time variation (lengthening) was due entirely to changes in its physical condition other than those necessarily related to its maze activities. That this is so will be realized when it is remembered that the delays were made up of periods of scratching its head-dressing and of long stuporous or apathetic pauses. In the fourth animal the sensibility of the vibrissae was decreased, perhaps they were anesthetic, and the short times for running the maze after the operation are especially noteworthy. The twelfth and thirteenth animals were weak and spastic, and exhibited abnormal reactions in connection with the food dish, but both managed to find the correct path quite promptly. The time for the first fifteen trials of the thirteenth animal, G2 ♂, after operation was only slightly less than that of the corresponding period of training, but the long stuporous pauses account for much of the time that was taken.

As a whole, therefore, the experiments show that in the white rat the removal of large parts of the frontal portions of the brain does not greatly interfere with a learned reaction. This is the more remarkable since it seems probable that the so-called motor area is in that region and that in most, if not all, of the cases there was a destruction or abolition of the motor connections. While it can not be concluded with certainty, it seems likely that the motor derangements which were exhibited by many of the rats were due to the interference with the normal efferent impulses and not to the general anemia (from the hemorrhage of the operation). Some of the animals also showed obvious disturbances of sensibility, the observations indicating that in some the stimuli to the vibrissae and olfactory stimuli did not give normal effects. In view of the importance of these two forms of sensibility in the rat's reactions, we are led to wonder whether these retain their predominance in the animal's learned activities, or are replaced by other forms of sensibility, such as the general kinesthetic. Although the results give plain evidence of non-interference (relative, to be sure) with learned reactions when the frontal portions of the brain have been destroyed they also suggest that the habit reaction is not neces-

sarily cortical in these animals. Other experiments which have been performed bear out this conclusion, but it seems best to reserve the account of these other tests until careful cerebral examinations have been completed.

## ACTION OF SOME OPIUM ALKALOIDS ON THE PSYCHOLOGICAL REACTION TIME

DAVID I. MACHT AND SHACHNE ISAACS

*From the Pharmacological and Psychological Laboratories of the Johns Hopkins University*

While a large number of drugs either in therapeutic or in toxic doses exert a profound effect on the brain, some as excitants or delirifacients, others as sedatives, and still others in other ways, it is surprising and remarkable how little experimental work, with one or two exceptions, is found on the relation of psychology to pharmacology. The two important exceptions to this statement are alcohol and caffeine. Owing to the economic importance of coffee, tea and alcoholic beverages, the effects of alcohol and caffeine have been the subjects of extensive investigations both by older and by more recent authorities. A review of the work on alcohol up to 1903 is found in Professor Abel's Monograph on the Pharmacological Action of Alcohol (1). Of the newer work we need only mention the recent elaborate and exhaustive studies on the psychological effects of alcohol by Benedict and Dodge (2), and on the effects of caffeine by Hollingsworth (3). With the exception of these two drugs, only occasional and sporadic contributions, such as that of Loewald (4) on bromides, and that of Poffenberger (5) on strychnin are met with in this field. Even in the case of the most important group of narcotic drugs, namely the opium alkaloids, very little definite and accurate experimental data as to their influence on the psychic functions, are to be found in the literature.

In connection with an extensive and intensive study of the pharmacological effects of opium and its principal alkaloids, which have for some years been carried on by one of the present authors (M.), it was deemed very desirable to investigate more carefully the effects of morphin and opium on the psychological

processes and more particularly on the reaction time in man. Accordingly the present investigation was undertaken

A search through the literature revealed but two contributions of any importance on the subject. In 1878 Dietl and Vintschgau (6) studied the effects of wine and coffee on the reaction time; observations were made on the authors themselves and in connection with the effects of alcohol and caffeine, a few experiments were made with morphin. The apparatus for measuring time used by the authors was a rapidly revolving kymograph—an obviously inadequate instrument for the purpose. These authors concluded that morphin prolongs the reaction time, but that the effect is of short duration.

E. Kraepelin (7) in 1892 made some observations on the effects of a number of poisons including alcohol and morphin on the reaction time, and that author found that morphin produced a primary quickening and secondary prolongation of the reaction time in his subjects.

The present investigation was undertaken with two purposes in view. In the first place, it was desired to ascertain the effect of morphin alone on simple and complex or association reaction time. In the second place, it was desired also to ascertain the effect on the reaction time of the same quantities of morphin when given in combination with other opium alkaloids. Recent pharmacological work has emphasized the importance of what is spoken of as "synergism" of drugs. It has been found that by combining two different substances, a pharmacological effect can be produced which is different from the arithmetical summation of the effects of its two components, as known from their action when administered separately. The two drugs in such a case are said to "potentiate" each other. Thus, for instance, one of the present authors (M.) has shown that morphin administered in the form of opium (i.e., in combination with the so-called minor opium alkaloids) is much less depressing to the respiration than when given in the same quantity alone (8). Again, Macht, Herman and Levy (9) have shown that the analgesic power of morphin is potentiated or enhanced by combining it with the otherwise inert opium alkaloid, narcotin.

## METHOD

The experiments were made on the authors themselves and on ten colleagues, making twelve normal subjects in all.

The reaction time was measured by means of an improved chronoscope devised by Prof. Knight Dunlap, which is a far more accurate and convenient instrument than the old Hipp instrument. The apparatus is to be described by Professor Dunlap elsewhere (10). It consists essentially of a synchronous motor, run on a tuning fork vibrating fifty times per second, and registering the time in units of  $2\sigma$  or  $1/500$  of a second, the dial-hand of the chronoscope being controlled by an electro-magnetic clutch.

The simple sound reaction was obtained by the experimenter calling out a word or number into the speaking disc which started the chronoscope and the subject responding with a set answer as soon as possible through another speaking disc, thus stopping the clock. The results were then recorded in terms of  $2\sigma$  or  $1/500$  of a second. It is needless to state that the subject and experimenter were separated by a curtain in order to prevent their seeing each other.

The simple touch reaction was obtained in a similar manner. The experimenter touched the hand of the subject behind a curtain, the pressure of the touch starting the chronoscope going. The subject responded as soon as he perceived the touch sensation by pressing a bulb or touching a key which immediately stopped the clock.

The simple light reflex was tested by the experimenter's pressing a key and thus lighting an incandescent lamp behind a white screen, the subject responding by pressing another key which extinguished the light and stopped the chronoscope.

In order to determine the more complex reaction time or association reaction time, various devices were tried, such as response to certain words (noun and adjective, subject and predicate, etc.), but none of these were found satisfactory for the purpose in view. The most convenient and satisfactory method was finally found to be the calculation of a mathematical problem. Two sets of problems were submitted to the subjects in

all experiments. In one series the subject was requested to add 17 mentally to a two-figure number, such as those given in the following table (table 1), and to announce the sum as quickly as possible through a telephone arrangement which breaks the circuit and stops the clock. In the second series a more difficult task was given to the subject. The experimenter in this case

TABLE 1

*Exercise: Add 17 mentally and respond*

22	35
71	58
68	41
46	75
33	38
64	67
51	54
32	28
59	47
73	26
29	43
56	31
48	66
34	57
62	42
78	24
25	55
39	27
74	79
52	45
77	21
49	63
44	23
72	37
53	61
76	65
36	64

TABLE 2

*Exercise: Multiply by 3 and add 4 and respond*

29	64
76	27
55	46
48	23
24	69
79	33
54	65
47	22
58	53
75	67
49	39
68	52
35 <sup>a</sup>	61
71	36
37	28
66	73
45	44
34	31
21	25
78	74
51	77
26	43
72	59
32	63
41	56
38	42
57	62

announced a two-figure number and the subject was required to multiply the same by 3 and add 4 to the product, and then announce the result through the speaking disc, thus recording the reaction time (table 2).

In each test twenty numbers were generally employed at each sitting. This method furnished quite a complicated asso-



ciation test and at the same time eliminated as much as possible memory and habituation or familiarity. The subject in every case was expected to go through the mathematical process in his mind and not to rely on his memory at all. Great attention was paid in the association tests to the number of errors made, and these were recorded for comparison of the normal reaction time with that obtained after the administration of a drug.

After the normal simple and complex reaction times were established in any one experiment, the subject was given a drug. All the drugs were given under the supervision of Dr. Macht by subcutaneous or intramuscular injection, which insured their prompt and complete absorption in a few minutes. The reaction times were then again measured in several series and the results tabulated and analyzed.

In testing simple reactions to sound, touch and light, the number of readings taken were generally from twenty to fifty or more in each series. In testing the association time, twenty problems were submitted by each method. An average reading was computed with the help of a calculating machine, thus saving an enormous amount of time, and the mean variations were also computed by means of an adding machine, in accordance with Dunlap's method (11).

Control experiments were occasionally made with injections of physiological saline solution, while the subject was under the impression that he was receiving a drug. It may be here stated that in such cases no definite change in the reaction time was noted.

#### SUMMARY OF EXPERIMENTS

Thirty experiments were made in all, each lasting from two to four hours.

Morphin sulphate was administered in seventeen experiments, the dosage varying from 4 mgm. ( $\frac{1}{16}$  grain) to 15 mgm. ( $\frac{1}{4}$  grain).

Narcotin hydrochloride was injected in three experiments, the doses being 10 mgm., 15 mgm. and 15 mgm. respectively.

Narcophin, which is a mixture of morphin and narcotin meconates in proportion of 1 to 2, was employed in three experiments, the doses being 12 mgm. and 20 mgm.

Pantopon or pantopium, which is a mixture of the hydrochlorides of all the opium alkaloids, containing 50 per cent of morphin, was administered in seven experiments, the doses employed being 8. 10 and 15 mgm. in different cases.

TABLE 3

*Dr. Macht; July 28, 1916; 2.30 p.m.; Morphin 4 mgm.*

SERIES		SOUND	TOUCH	LIGHT	TWO PLACE FIGURE + 17	TWO PLACE FIGURE × 3 + 4
Normal...	M.	0.282'' (21)	0.159''	0.130''	2.215''	(17) 4.357''
	m.v.	0.020''	0.014''	0.009''	0.278''	0.718''
	r.v.	7.3%	9.2%	7.4%	12.6%	16.5%
After in- jection first.....	Time	10'	27'	31'	14'	20'
	M.	(23) 0.255''	0.148''	0.136''	(21) 2.020''	(19) 4.065''
	m.v.	0.024''	0.009''	0.004''	0.300''	0.656''
	r.v.	10.0%	6.6%	3.3%	14.8%	16.1%
After in- jection second..	Time	36'	50'	53'	39'	44'
	M.	(23) 0.300''	(22) 0.158''	(24) 0.136''	(19) 2.300''	(19) 3.702''
	m.v.	0.025''	0.008''	0.008''	0.362''	0.592''
	r.v.	8.0%	5.7%	6.3%	15.7%	16.0%
After in- jection third....	Time	57'	77'	80'	60'	66'
	M.	(23) 0.280''	(23) 0.167	(26) 0.140''	(21) 2.401''	(21) 3.578''
	m.v.	0.022''	0.012	0.007''	0.535''	0.654''
	r.v.	8.0%	7.2%	5.5%	22.2%	18.3%
After in- jection fourth..	Time				84'	88'
	M.				(15) 2.018''	(14) 3.591''
	m.v.				0.244''	1.084''
	r.v.				12.1%	30.2%

*Key to tables:* M. = mean or average reading in seconds; m.v. = mean variation; r.v. = relative variation. The line marked Time, indicates the time after injection of the drug when the readings were begun. Figures in parentheses indicate the number of readings made.

Owing to the expense of publication, it is impossible in this paper to report in tabular form all the data obtained in the present investigation. Only the chief results will therefore be described here. Tables 3 and 4, however, are printed as examples of the manner in which the data were studied. In table 3 the

effect of 4 mgm. of morphin on one of the subjects is tabulated. In the first series of readings the normal reaction times are recorded, the first line indicating the average of a large number of readings; the second line the mean variation, and the third line the relative variation. The normal having been established, the drug was injected and four series of readings were made in the same order as above, as indicated in the table. In table 4 the effect of the same dose of morphin, 4 mgm., in the form of narcophin, i.e., in combination with 8 mgm. of the inert alkaloid narcotin, in the same subject is given. Here the number of errors are also given.

TABLE 4

*Dr. Macht, July 20, 1916; Narcophin 12 mgm. (= Morphin meconate 4 mgm.) at 3.15 p.m.*

SERIES		SOUND	TOUCH (VOICE REAC- TION)	LIGHT	ONE PLACE FIGURE × 3 + 4	ONE PLACE FIGURE × 4 - 3	
Before in- jection...	M	0.278''	0.248''	0.162''	1.154''	1.682''	1 error
	m.v.	0.020''	0.026''	0.011''	0.183''	0.321''	
	r.v.	7.2%	10.4%	6.7%	15.8%	19.1%	
After in- jection first.....	Time	15'	57'	62'	45'	49'	2 errors
	M.	0.308''	0.258''	(18) 0.150''	1.298''	1.686''	
	m.v.	0.023''	0.033''	0.015''	0.198''	0.386''	
	r.v.	7.6%	12.7%	10.0%	15.2%	22.8%	
After injec- tion second...	Time	80'	109'	114'	99'	104'	
	M.	(19) 0.300''	0.238''	(19) 0.136''	1.432''	1.644''	
	m.v.	0.030''	0.025''	0.008''	0.239''	0.491''	
	r.v.	10.2%	10.5%	6.1%	16.6%	29.9%	

NORMAL DATA

As might have been expected, the normal reaction time varied widely in the different subjects.

The normal reaction time for simple sound ranged from 0.172 to 0.340 of a second, the commonest figure lying between 0.250 and 0.300 of a second.

The simple reaction time for touch ranged from 0.120 to 0.280 of a second, the most frequent reading lying between 0.140 and 0.190 of a second.

The simple reaction time for light ranged from 0.112 to 0.220 of a second, the commonest figure lying between 0.120 and 0.160 of a second.

The reaction time for the addition test (+17) varied from 1.154 to 3.010 seconds, the commonest figure being a little over two seconds.

The reaction time for the multiplication and addition tests was much longer, the figures ranging from 2.456 to 6.810 seconds, the commonest figures being between three and five seconds.

It will be seen that of the simple reactions, that for light was the shortest and that for sound was the longest.

#### EFFECT OF MORPHIN

It was found that the effects of a morphin injection depends on the size of the dose and manifests itself in one or more of three ways. In the first place, the absolute reading of the reaction may be affected. In the second place, the mean variations in the readings may be greatly increased or decreased. In the third place, in the case of association reactions, there may be an effect noted on the accuracy with which the subject performs mental problems.

After small doses of morphin (4 to 6 mgm.) there was noted a distinct *primary effect*, which consisted in a stimulation or a shortening of the reaction time, or in a decrease in the mean variation of the readings, or sometimes in both, and furthermore in a lesser number of errors made in the computation of mathematical problems. This primary effect of morphin generally lasted half an hour or more and was followed by a secondary stage characterized by a depression, as indicated by the prolongation of the reaction time and greater variations in the readings or both. After very small doses of morphin, however, the depression was sometimes lacking.

After larger doses of morphin (8 to 15 mgm.), however, the primary stage of stimulation was very short and could be easily overlooked unless the readings were begun very soon after the injection of the drug. Depression, on the other hand, was

the predominant picture as could be seen by the prolongation of the reaction time readings and greater variations in the same and also, in case of associations, by a greater number of mistakes.

Although the two stages of morphin action above described were not always marked, a careful analysis of all the experiments indicated that they were present in almost all the cases. The primary stage of quickening or stimulation, in our opinion, probably corresponds to the stage of *euphoria* or well-being so well known to the pharmacologist and which occurs after small doses of opiates. It is this euphoria or sense of well-being which probably is responsible in a great measure for the greater accuracy in mathematical calculations, especially in subjects with a nervous temperament; inasmuch as the narcotic action of the drug is just sufficient to "take the edge out" of the subject's anxiety. The primary stage of increased efficiency noted agrees well with the results of some other tests of mental efficiency produced by opium *per os* or by mouth described by Münsterberg (12).

The ordinary therapeutic doses of morphin (8 to 15 mgm. or  $\frac{1}{8}$  to  $\frac{1}{4}$  grain) are generally too large to make the primary stage of quickened reaction in normal individuals very noticeable and it is for this reason often overlooked.

It may be remarked in this place that although the nauseating effect of morphin, so commonly met with, occurred in several of the subjects, the nausea had apparently no effect on the readings. Indeed, in the individual who was most markedly affected in this way (Dr. Kiang) the reaction time, if anything, was quickened.

#### EFFECT OF COMBINATIONS

Three experiments were made with injections of narcotin hydrochloride alone and have already been described. No definite change in the reaction time was produced by the drug.

Three experiments were made with a combination of morphin and narcotin in the ratio of one to two, by administering the drug called narcophin, which is a mixture of morphin and narcotin meconates. In two of the experiments there was a definite increase in narcosis and corresponding prolongation or depression of the reaction time noted as compared with morphin alone,

being very marked in one case, but of a lesser degree in the other. In the third case the narcosis was, anything, less than that produced by morphin alone.

Seven experiments were made with a combination of all the opium alkaloids in the form of pantopon, a mixture of hydrochlorides containing 50 per cent of morphin. In four of the experiments there was a very marked increase in narcosis and prolongation of the reaction time produced by pantopon as compared with that produced by the same amount of morphin when given alone. The greater narcosis in these cases was also shown by the greater number of errors in the association problems. In two other cases the greater narcosis was also present but not in so marked degree as in the preceding two, and in one experiment the result was doubtful.

On analyzing all the experiments with pantopon and narcophin, we may summarize by saying that out of ten experiments five showed a marked increase in narcosis and prolongation of the reaction time; three experiments showed also a definite but not so marked a prolongation of the reaction time as compared with morphin alone; one subject gave doubtful results although his accuracy was markedly affected in regard to association problems; and in one case the reaction time was quickened by the combination more than it was by morphin alone. It was also noted that in all experiments both with morphin alone and with its combinations, the simple reactions were less affected by the drugs than the association tests, thus showing that the narcotics exerted their influence especially upon the higher functions of the brain.

Tables 5 and 6 present a summary of most of the experiments performed in the present investigation. In these tables the figures for reaction time are expressed in terms of per cent as compared with the normal readings in each experiment. Only the primary and the maximum effects of each drug are shown in order to enable us to better analyze the effects of the drugs. The tables also indicate the time after the injection at which the readings were made, and in table 6 the run of errors is indicated by arrows.

TABLE 5

## Simple reactions

SUBJECT	DRUG	SOUND						TOUCH						LIGHT					
		Primary effect			Maximal effect			Primary effect			Maximal effect			Primary effect			Maximal effect		
		Time of reading after injection of drug	Relative readings	per cent	Time of reading after injection of drug	Relative readings	per cent	Time of reading after injection of drug	Relative readings	per cent	Time of reading after injection of drug	Relative readings	per cent	Time of reading after injection of drug	Relative readings	per cent	Time of reading after injection of drug	Relative readings	per cent
Mr. Herman.....	Morphin sulphate, 10 mgm.	10	97	96	58	110	131	26	115	244	48	128	213	30	102	144	74	114	112
Mr. Herman.....	Pantopon, 15 mgm.	10	112	92	52	140	286	23	121	119	23	121	119	27	106	106	47	87	208
Dr. Dunlap.....	Morphin sulphate, 8 mgm.	15	158	72	68	160	65	40	124	87	97	124	142	43	113	162	43	113	162
Dr. Dunlap.....	Narcophin, 20 mgm.	14	107	75	50	106	100	34	74	106	72	80	189	39	105	142	76	109	107
Dr. Dunlap.....	Pantopon, 15 mgm.	6	131	70	25	133	120	18	115	162	42	118	151	21	102	147	47	106	282
Dr. Macht.....	Morphin sulphate, 4 mgm.	10	90	137	36	106	110	27	93	71	77	105	80	31	104	46	53	104	74
Dr. Macht.....	Morphin sulphate, 8 mgm.	30	101	174	30	101	174	40	116	91	40	116	91	45	159	30	45	159	30
Dr. Macht.....	Morphin sulphate, 12 mgm.	15	111	106	80	108	142	57	105	112	57	105	112	62	93	150	62	93	150
Dr. Macht.....	Pantopon, 8 mgm.	7	75	136	30	85	(?)	20	97	99	88	111	83	24	97	100	92	97	175
Dr. Rouiller.....	Morphin sulphate, 5 mgm.	5	89	108	66	83	200	26	101	222	83	104	200	29	115	330	29	115	330
Dr. Rouiller.....	Pantopon, 10 mgm.	9	95	95	32	101	78	13	101	108	92	112	157	17	103	233	94	107	250
Dr. White.....	Morphin sulphate, 10 mgm.	6	98	89	53	121	147	19	104	63	87	114	83	22	90	69	68	98	131
Dr. White.....	Pantopon, 20 mgm.	11	72	103	11	72	103	33	114	87	76	141	115	36	110	78	79	114	187
Mr. Colson.....	Morphin sulphate, 5 mgm.	5	88	110	5	88	110	23	103	109	23	103	109	27	97	74	27	97	74
Mr. Colson.....	Pantopon, 10 mgm.	8	105	85	63	148	226	13	95	200	78	114	204	44	103	88	83	121	104
Mr. Miller.....	Morphin sulphate, 5 mgm.	10	122	199	10	122	199	30	121	193	30	121	193	34	103	118	34	103	118
Mr. Bagby.....	Morphin sulphate, 6 mgm.	10	104	80	59	133	322	24	100	133	76	106	162	27	90	176	79	98	135
Dr. Kiang.....	Morphin sulphate, 8 mgm.	10	96	54	42	112	72	28	72	160	63	93	153	31	117	120	65	116	146
Mr. Nachlas.....	Morphin sulphate, 8 mgm.	10	104	54	25	105	57	12	102	136	12	102	136	15	113	60	35	117	69
Mr. Nachlas.....	Morphin sulphate, 15 mgm.	10	100	111	88	129	109	45	84	80	73	93	103	50	92	70	75	105	89
Mr. Isaacs.....	Morphin sulphate, 6 mgm.	(?)	97	85	(?)	97	85	(?)	107	111	(?)	107	111	(?)	100	151	(?)	100	151
Mr. Isaacs.....	Morphin sulphate, 8 mgm.	10	108	48	10	108	48	18	94	170	18	94	170	25	82	138	25	82	138
Mr. Isaacs.....	Morphin sulphate, 10 mgm.	13	96	84	74	96	133	40	101	81	84	112	74	33	81	85	90	79	105
Mr. Isaacs.....	Morphin sulphate, 12 mgm.	15	91	83	45	94	89	35	88	70	66	101	125	40	98	70	40	98	70
Mr. Isaacs.....	Narcophin, 20 mgm.	10	93	96	41	112	60	31	93	150	61	102	130	34	100	93	65	112	66
Mr. Isaacs.....	Pantopon, 15 mgm.	7	104	142	17	101	154	24	119	121	76	110	151	27	101	123	80	112	160

TABLE 6  
Complex reactions

SUBJECT	DRUG	EXERCISE: ADDING 17 TO A TWO PLACE NUMBER						EXERCISE: MULTIPLYING TWO PLACE NUMBER BY 3 AND ADDING 4 TO PRODUCT											
		Primary effect			Maximal effect			Primary effect			Maximal effect								
		Time of reading after injection of drug	Relative change in readings	per cent	Time of reading after injection of drug	Relative change in readings	per cent	Time of reading after injection of drug	Relative change in readings	per cent	Time of reading after injection of drug	Relative change in readings	per cent						
Mr. Herman.....	Morphin sulphate, 10 mgm.	13	112	104	60	113	104	0	→ 2	18	109	92	54	104	155	1	→ 2		
Mr. Herman.....	Pantopon, 15 mgm.	13	105	130	56	115	147	1	→ 1	18	133	124	60	143	160	2	→ 4		
Dr. Dunlap.....	Morphin sulphate, 8 mgm.	33	139	199	33	139	199	1	→ 1	37	120	81	93	123	116	0	→ 1		
Dr. Dunlap.....	Narcophin, 20 mgm.	25	103	120	79	110	207	1	→ 2	30	88	71	85	111	70	0	→ 2		
Dr. Dunlap.....	Pantopon, 15 mgm.	28	110	131	59	122	96	1	→ 3	38	117	166	38	117	166	5	→ 6		
Dr. Macht.....	Morphin sulphate, 4 mgm.	14	91	117	60	108	176	2	→ 1	→ 0	20	93	97	88	82	182	3	→ 1	
Dr. Macht.....	Morphin sulphate, 8 mgm.	15	110	93	45	122	110												
Dr. Macht.....	Narcophin, 12 mgm.	45	112	96	99	124	105												
Dr. Macht.....	Pantopon, 8 mgm.	10	101	120	73	116	110	1	→ 1	49	101	119	104	98	156	1	→ 2		
Dr. Rouiller.....	Morphin sulphate, 5 mgm.	8	97	107	70	101	110	3	→ 3	→ 1	14	92	114	78	92	160	2	→ 2	
Dr. Rouiller.....	Pantopon, 10 mgm.	20	97	104	38	98	121	0	→ 1	18	87	132	74	81	162	9	→ 5		
Dr. White.....	Morphin sulphate, 10 mgm.	9	94	88	73	120	120	2	→ 1	→ 1	→ 3	23	86	105	42	87	106	4	→ 6
Dr. White.....	Pantopon, 20 mgm.	15	77	175	15	77	175	3	→ 4	15	93	87	77	120	103	4	→ 2		
Mr. Colson.....	Morphin sulphate, 5 mgm.	10	89	79	39	92	112	3	→ 1	→ 2	65	94	167	92	102	183	6	→ 2	
Mr. Colson.....	Pantopon, 10 mgm.	20	101	123	122	120	142	2	→ 2	56	104	120	72	101	127	7	→ 10		
Mr. Miller.....	Morphin sulphate, 5 mgm.	14	102	67	67	103	78	7	→ 4	→ 1	→ 2	21	103	120	75	127	120	9	→ 6
Mr. Bagby.....	Morphin sulphate, 6 mgm.	16	103	111	16	103	111	0	→ 1	→ 0	13	98	100	65	100	97	5	→ 1	
Dr. Kiang.....	Morphin sulphate, 8 mgm.	13	90	85	44	91	90	0	→ 3	→ 1	18	95	160	18	95	160	2	→ 1	
Mr. Nachlas.....	Morphin sulphate, 8 mgm.	10	132	134	25	130	146	0	→ 2	40	117	138	40	117	138				
Mr. Nachlas.....	Morphin sulphate, 15 mgm.	35	105	91	63	109	101	4	→ 1	→ 0	40	137	176	112	131	106	1	→ 4	
Mr. Isaacs.....	Morphin sulphate, 6 mgm.	(?)	88	78	(?)	107	101	4	→ 1	→ 0	(?)	90	119	(?)	90	119	5	→ 5	
Mr. Isaacs.....	Morphin sulphate, 8 mgm.	35	140	200	35	140	200	0	→ 1	→ 2	45	95	130	45	95	130			
Mr. Isaacs.....	Morphin sulphate, 10 mgm.	25	81	80	106	125	138	0	→ 1	→ 2									
Mr. Isaacs.....	Morphin sulphate, 12 mgm.	31	102	108	92	127	160	1	→ 0	→ 2									
Mr. Isaacs.....	Narcophin, 20 mgm.	13	96	120	68	153	150	3	→ 0	→ 4	19	99	82	76	111	200	5	→ 5	
Mr. Isaacs.....	Pantopon, 15 mgm.	11	113	116	59	150	120	0	→ 0	→ 2	16	122	107	65	127	118	1	→ 2	



It is interesting to note that in the case of both narcophin and pantopon, much less nausea was produced by those combinations than by the same amount of morphin which they contain, when given alone. This agrees perfectly with numerous other experiences of one of the authors (M.) recorded elsewhere (13).

#### SUMMARY

A careful analysis of all the experiments performed lead the authors to the following conclusions:

1. The effect of morphin alone and in combination with other opium alkaloids depends upon the dose used and may be manifested by a change in the mean reading, a change in the mean variation of the readings, or by both of these; and in case of association tests, by the number of errors made in performing a mathematical calculation.

2. After small doses of morphin, there is generally a primary stage of stimulation or quickened reaction time; this may or may not be followed by a secondary stage of depression, as indicated by narcosis and prolongation of the reaction time.

3. After larger doses of morphin, the primary stimulation stage is very short and may be overlooked, whereas the secondary or stage of depression is predominant.

4. From the experiments made with combinations of morphin with other opium alkaloids in the form of narcophin and pantopon, it appears that morphin given in such a form is more narcotic and correspondingly more depressant to the psychic functions than when the same dose of morphin is administered to the same subject by itself.

#### REFERENCES

- (1) ABEL: Physiological aspects of the liquor problem. 1903, ii, 1-169.
- (2) DODGE AND BENEDICT: Psychological effect of alcohol. Carnegie Institute, Washington, 1915.
- (3) HOLLINGWORTH: Arch. of Psychol., no. 22, April, 1912.
- (4) LOEWALD: Kraepelin's Psychologische Arbeiten, 1896, i, 489.
- (5) POFFENBERGER: Arch. of Psychol. Am. Jr. of Psych., 1914, xxv, 82.
- (6) DIETL AND VINTSCHGAU: Pflüger's Archiv, 1877, xvi, 316.

- (7) KRAEPELIN: Cited by Wundt, *Physiol. Psychol.*, 1903, iii, 446.
- (8) MACHT: *Journ. Pharmacol. and Exper. Therap.*, 1915, vii, 339.
- (9) MACHT, HERMAN AND LEVY: *Proc. Natl. Acad. of Sciences*, 1915, i, 582;  
and *Journ. Pharmacol. and Exper. Therap.*, 1915, viii, 1.
- (10) DUNLAP: *Jour. Exp. Psychol.* 1917, ii, June.
- (11) DUNLAP: *Psychological Review*, 1913, xx, 154.
- (12) MÜNSTERBERG: *Beiträge* 2, *Exp. Psychol.* 1892, iv, 121.
- (13) MACHT: *Trans. Assoc. of American Physicians*, 1916.

# ON CEREBRAL MOTOR CONTROL: THE RECOVERY FROM EXPERIMENTALLY PRODUCED HEMIPLEGIA<sup>1</sup>

ROBERT OGDEN AND SHEPHERD IVORY FRANZ

*From the Physiological Laboratory of the George Washington University, and the Government Hospital for the Insane*

Attention has recently been directed to the possibility of recovery of voluntary muscular control in human cases of cerebral hemiplegia.<sup>2</sup> The results which have been reported are so different from those which have been predicted by neurologists that the whole matter of cerebral control again comes to the fore as a problem of intense practical as well as theoretical interest. It has long been believed that if improvement in motor ability does not occur in man within a period of two years following the cerebral accident the paralysis is permanent. The series of cases which have been reported show that this is not true, because even in cases of paralysis of eight or more years' duration, considerable improvement follows suitable remedial measures of the nature of exercise, including massage.

It is well known that an animal which has had its so-called motor cortex destroyed or the pyramidal fibers cut on one side shows a condition similar to that of the human apoplectic hemiplegia. It is also known that, even though the hemiplegia be complete, recovery of (voluntary) motor function takes place. The beginning of this recovery in the dog comes in a day or two, and after a few weeks the dog can use the legs on the paralyzed side apparently as well as those on the non-paralyzed side. The animal does, however, use the legs of the non-paralyzed side

<sup>1</sup> This investigation was made possible by a grant to one of us (F.) by the Carnegie Institution of Washington, and we beg to express our sense of obligation for the assistance thus given.

<sup>2</sup> S. I. Franz, M. E. Scheetz, and A. A. Wilson: The possibility of recovery of motor function in long-standing hemiplegia. *Jour. of Amer. Med. Assn.*, 1915, vol. 65, 2150-2154.

in preference to those of the paralyzed side even though the latter be "recovered." And also, when the animal is under the influence of certain toxic agents, such as alcohol or ether, the previously paralyzed limbs exhibit motor disturbances even though prior to the administration of the alcohol or ether the animal appeared to be perfectly normal in a motor way. The recovery in the monkey and ape is less rapid than in the dog, although after nine to twelve months it may not be possible on casual inspection to notice any motor disturbances.<sup>3</sup>

The effect of suitable exercises in the long-standing human hemiplegics suggested that if the paralyzed segments of an animal with an experimentally produced hemiplegia were adequately dealt with the recovery would be more rapid and more complete than if the animal were permitted to recover by itself. The suggestion was tested and the results of the observations are given in the subsequent paragraphs.

Four male monkeys (*macacus rhesus*) about a year and a half old were successfully used as subjects. One other animal died too soon after the operation to make the results of value. The hemiplegia was produced under ether anesthesia by the destruction of the motor cortex with an electric thermocautery. The extent of the motor area was determined by faridization (bipolar), and the area destroyed corresponded with the electrical delimitation of the motor zone. After the destruction different parts of the destroyed area, and beyond, were stimulated to see if the electrical stimulations would then produce movements, and in one case in which movements were obtained the area of destruction was extended and the part already cauterized was gone over again with the cautery. To destroy the motor zone lying concealed within the central fissure the white hot cautery was pushed about 6 to 8 mm. into the brain substance and carried close to and parallel with the fissure.

The lesions which were produced were different from those produced by cerebral hemorrhage in man (apoplexy) in that they

<sup>3</sup> For a general account of the phenomena of recovery from cerebral paralysis in the dog and monkey see Luciani: *Human Physiology* (Trans. by F. A. Welby), vol. 3, pp. 581 ff. (dog) and pp. 586 ff. (monkey).

were cortical, and entirely so as far as this could be done. It will be remembered that most of the hemiplegia-producing cerebral hemorrhages in man are in the lenticulo-striate region, the cerebral insult producing in those cases interferences with or destructions of the pyramidal fibers. The lesions also differed from many in man in that in man a hemorrhage may act by pressure to produce a temporary alteration in conductivity or irritability which simulates the effect of destruction. This alteration in conductivity or irritability may partly or wholly disappear when the clot becomes organized or is absorbed. Since there is no regeneration of the cellular elements the experimental destruction may be regarded as the more complete and the more satisfactory.

Information regarding the methods of dealing with the animals are given in the brief accounts of the observations which follow. The post-operative management of the cases differed in order that the value of different procedures might be determined. Each animal was operated upon under a general anesthetic, and the later feeding and care was the same for all, except in those cases when it became necessary to feed the animal by hand.

#### *Experiment 1*

*Monkey 1.* Before operation this animal appeared to be right-handed, although the observations were not sufficient in number to make this perfectly certain. It was normal and lively. The left motor cortex was cauterized May 30, 1916. The animal was then obviously hemiplegic on the right side, the paralysis extending to the face as well as to the arm and leg segments. The right arm and leg were flaccid and the right side of the face drooped. The animal could not feed itself with the right hand and arm.

*Management and results.* The left (normal) arm was strapped to the trunk by means of a jacket so constructed that the arm could not be used for any of the important operations of feeding and climbing. The left leg could not be hampered in the same manner although it was thought to be desirable. The object of the restriction was to compel, if possible, the animal's use of the corresponding paralyzed segment. In addition to this passive method of treatment, efforts were made to get

the animal to move the paralyzed segments. The flaccid arm, for example, was dealt with in the following manner. The animal was held by a strap attached about the waist and the dorsal surface of the right hand was struck with a strap; this appeared to "anger" the animal and he endeavored to escape from the irritation (by the use of shoulder and arm muscles), and to lift the arm and hand to grasp the irritating stimulus; subsequent to the attempts to get the animal to move the arm muscles, the muscles which in human hemiplegic cases are those most difficult to recover (the extensors) and the nerves of those muscles were stimulated by friction and tapotement from five to ten minutes, the duration of the treatment depending upon the conditions of the involved muscles. The treatment of the leg was as follows: The animal was strapped to a table, the right leg was held and the sole of the foot was struck to cause the animal to withdraw it; friction was also applied to the nerves and to the muscles; reactions similar to those of the arm segment were obtained from the leg, the animal attempting to escape from the stimulus by drawing up and by abducting the leg. At the same time the animal was led around by its strap, and in this way the animal was encouraged to use its paralyzed leg in walking and its paralyzed arm for support as it went about the room.

At first little or no reaction was obtained from the stimulating treatment, but soon the application of the stimulus brought about slight appropriate or adequate responses, and after a few days the responses to the stimuli were almost equal to those of a normal animal. Soon also the animal began to use the arm for grasping food and in carrying it to the mouth, and the arm and the leg were used, but of course awkwardly at first, for climbing and holding.

At the end of fourteen days the animal could use its leg and arm very well, and three weeks after the operation the monkey was able to pick small objects from the floor and to convey them to his mouth; he was able to use the two legs, both individually and together, very well, and there was no observable disturbances in walking and climbing beyond that to be expected from an animal which had one arm (the left normal one) rendered useless by the restricting jacket. In three weeks the monkey's movements on the right side were as accurate, precise, and forceful as those of a normal animal, and when the left strapped-down arm was liberated it was found to be less accurate than the right (disuse phenomenon). About two months later this animal was observed to catch with the right hand a fly that had alighted

in the monkey's cage. The coordination and quickness for the performance of this act will readily be appreciated.

*Summary.* By preventing movement of the normal arm and then "compelling" the animal to move the paralyzed segments, and by mechanical stimulation of the peripheral nerves and of the muscles, in three weeks the animal recovered from its paralyzed condition to such an extent that the movements on the paralyzed side were judged to be normal.

### *Experiment 2*

*Monkey 1.* A week after this animal had thoroughly recovered the use of its right side a second similar operation was performed on the right hemisphere. The whole of the right stimuable cortex was destroyed under asepsis and general anesthesia, June 26, 1916. The paralysis involved the left side of the face as well as the arm and leg, and the paralysis was typical of the upper neuron type.

*Management and results.* The right (recovered from paralysis) side of the body was not restrained and the left half of the body was not given any special treatment. In this respect the animal was given the chance to recover by itself without interference. The animal usually lived in a cage (90 by 58 cm., and 114 cm. high) by itself so that it would not get the stimulus of combat, etc., with another animal, but it was let out into a large room for exercise each day for periods varying from one to four hours. Some forced exercise of the newly paralyzed parts could not be prevented, for it was necessary to compel the animal to come close for observation and for testing, and its solitary living had made it somewhat timorous although during the period of its former paralysis it had been handled with relative ease. The animal, therefore, cannot be said to have been entirely without some of the treatment which had been given to it following its first hemiplegia, although this kind of treatment was given as little as possible.

Even though the animal had received a small amount of forced exercise it has remained paralyzed and apparently without much capability of using its left arm and hand (December 24, 1916). It can walk and jump; it climbs on the wire netting of its cage, it uses the left arm for a prop, and with the left hand takes hold of its strap when the latter is pulled upon. It tends to fall towards the left side, when it jumps it does not always reach the cage or box which it apparently attempts to reach, when it climbs over its cage the right arm and hand

are used for pulling and the left is apparently used only for support. When food is given, even though the food be close to the left hand, the animal always reaches for the food with the right. Unlike a normal monkey which grasps and holds food with both hands and feet, this animal uses only the right hand and the right foot. When compelled to stand the animal holds the left arm limp at its side, the right grasps the strap to support itself. When standing the toes of the left foot are spread, the great toe is at times doubled under the foot, and the leg is used uncertainly. When excited, as by some special stimulation or when a stick is pointed at him, the monkey will jump away and in the excited condition the left arm and leg appear to be used to much better advantage than in the unexcited condition. This may be due to the predominance of reflex activity at these times. If swung from his strap above the floor he also attempts to grasp the strap with his left hand, but only a slight amount of force is necessary to disengage that hand, although the right hand holds very firmly and cannot be easily removed from the strap.

*Summary.* This experiment with a hemiplegic animal without special management and treatment shows that the animal may remain for a period of six months or more without very much improvement in voluntary control. This is in direct opposition to the results obtained with the right side of the same animal which, under treatment, recovered in three weeks.

### *Experiment 3*

*Monkey 2.* The left motor cortex was destroyed June 2, 1916, the operation being similar to those of the first two experiments. The animal then exhibited an upper neuron paralysis, involving the face and the upper and lower extremities. The right arm was at first completely useless, the right leg was limp. In coming out from the effects of the anesthetic the animal immediately used the left arm.

*Management and results.* The unparalyzed side of the animal was not restrained, and in this respect the experiment was the same as in experiment 2. The animal did, however, receive "general" massage of the affected limbs, the parts being rubbed daily and the muscles being carefully kneaded. No special effort was made to get the animal to use the paralyzed segments, and the stimulation exercises like those in experiment 1 with monkey 1 were not carried out. The treatment (general, instead of special types of, exercises and massage) was carried out regularly for twenty-six days, and at the end of that time the



monkey used the left hand exclusively for all operations. The right hand showed marked wrist drop, there was very little strength in either flexion or extension of the fingers, and the whole arm segment had not advanced much towards recovery during the period of the treatment. The leg showed a similar condition. There was a dragging of the foot when the animal crawled or attempted to walk over the floor, and the foot and leg could not be used with any facility for climbing or other kinds of operations which a normal monkey performs. It was evident, however, that some improvement was taking place, and that there would be a recovery in time seemed to be a justifiable conclusion.

*Summary.* General massage for twenty-six days of the paralyzed segments of an hemiplegic monkey did not bring about a recovery of motor ability, although there was some evidence of returning function, much more than that found in monkey 1 after six months' "laissez faire" treatment.

#### *Experiment 4*

*Monkey 2.* At the time of the second operation on this animal it was in the condition just described. The second operation was the cauterization of the right motor cortex on June 28, 1916. This resulted in a complete paralysis of the left side with characteristic flaccid condition of the arm, face and leg.

*Management and results.* The right (not completely recovered paralyzed) arm was bound closely to the body and only the left arm could be used by the animal for the purpose of feeding and climbing about its cage. In addition, active movements of the extensor muscles were invoked by mechanical stimulation, and massage was used for the muscle groups and for the nerves. The conditions of treatment were the same as in the first experiment with monkey 1.

The results of this treatment for twenty-six days were evidenced by great activity on the part of the animal, by its ability to use the newly paralyzed segments, and the movements could not be said to be different from those of a normal animal. The movements are accurate and of good force, and the animal dominated monkey 3 which had been in the same cage with him for some time. He now uses his legs very well in walking, he jumps more accurately than the other two animals which still survive, and he is very much more active. There is an apparent preference for the use of the left hand in feeding, but when food is withheld until the animal uses the right hand for grasping it, it is seen that the right is used apparently equally well. At the

present writing the animal appears in all respects to be normal, there having been a continued betterment of the right side since the special exercises on that side were stopped.

*Summary.* This animal with hemiplegia was given special exercises with massage and it was compelled to use the paralyzed segments; voluntary ability to move the paralyzed segments returned in twenty-six days, the recovery being present and apparently permanent five months after the operation.

#### *Experiment 5*

*Monkey 3.* On June 2, 1916, the left cerebral motor cortex was cauterized as completely as possible. The paralysis was the same as in the previous experiments in that there was an evident complete hemiplegia of the upper neuron type of the whole right side.

*Management and results.* The left arm was strapped to the body of the animal so that movements of the paralyzed right side would be necessary for feeding and climbing. No other kind of treatment was given, the animal being permitted to recover "spontaneously." After twenty-six days the amount of recovery was slight. Some movement of the paralyzed arm and leg was possible, but the animal was obviously incompetent on the right side. There was a characteristic wrist drop and there was some atrophy and an extreme weakness of the right arm. The leg was moved more than the arm, but it also was weak and the movements were uncertain and rather gross in nature. This was the condition on June 28, after which time active treatment of the right arm and leg was instituted, the treatment consisting in daily muscle and nerve stimulation by vibratory digital means, and in the stimulation of the animal by the special method already described. This treatment was continued for four weeks and in that period of time all evidence of the paralysis had disappeared, and the leg and arm had regained their normal power and precision.

*Summary.* The normal arm of a paralyzed monkey was restrained but no special treatment of the paralyzed segments was given for a period of about four weeks, and this management did not bring about a return of motor function. During the next four weeks the nerves and muscles were stimulated and the animal was encouraged by special stimulations to use the arm and leg. During the second month the treatment brought about a complete return of motor function so that the animal's movements became normal.

*Experiment 6*

*Monkey 3.* After the animal had recovered its normal motor ability on the right side following the destruction of the left cortical motor area, the right cerebral motor area was cauterized (July 28, 1916). This produced a left hemiplegic condition similar to those in the other experiments.

*Management and results.* Both arms and legs were permitted to be free to move, but the left paralyzed arm and leg were carefully massaged without, however, giving individual attention to the special muscle groups and to the nerves as had been done in the second part of the preceding experiment. This animal continued to use the right arm almost to the exclusion of the left, although both may now be used when it is necessary, the left more awkwardly than the right. The animal moves well, climbs and jumps, it has been seen to pick over its cage companion for parasites (?), but all of its movements are more awkward than those of monkey 2 which is in the same cage with it. There has been a slight deterioration of the right side in that the right hand cannot be used as well as at the end of the special training period, and at the present writing it exhibits a slight wrist drop on the right side, but a marked wrist drop on the left. When it handles food, which it usually takes in both hands at one time, it is noticeable that there is considerable weakness on the left, there is also a marked awkwardness. During December, 1916, this animal was noticed to have convulsions. One began December 18, 1916, at about 2.00 p.m., and the animal was under observation during the convulsive attack. The animal had been feeding, and was holding two bananas in his hands. The food was suddenly dropped, and the monkey tried to get it from the floor, but not being apparently able to do this with the hands, he lowered his head to where the bananas had fallen. In that position a series of clonic movements began. The animal fell to its side, and the convulsive movements were noticed to be especially (or entirely, it could not be said with certainty) of the right side, but the face area was not apparently involved. The leg was more active than the arm, although the arm shook all over and the fingers were also in alternate contraction and relaxation. When the convulsion had partly subsided the animal tried to crawl over a partition (about 35 cm. high) which separated the cage into two parts. This attempt was unsuccessful at first, but the monkey continued to try until it succeeded. Success was finally attained only with great effort of the left arm and leg, and the right

corresponding segments were dragged over. The animal returned to its food about a half minute after it had successfully negotiated the partition. For about four or five minutes subsequently the right side could be used only with great awkwardness, but at the end of that time there was an apparent return to its former ability. There was a facial cyanosis for fully half an hour subsequent to the convulsion. Another similar convulsion occurred the same evening, about 8 hours after the first one. Others have been noted repeatedly both by one of us and by an assistant, and they have appeared to be of the same character as that described. The monkey has not been able to use the right hand as well as he did previous to the occurrence of the convulsions, and some of the apparent deterioration in the proper use of that hand may reasonably be ascribed to the unknown convulsive-producing condition.<sup>4</sup>

*Summary.* In this experiment although general massage was given to the paralyzed segments there was less recovery than in those cases in which special attention was paid to the individual muscles and nerves. The recovery has been sufficient to enable the animal to feed himself, and to perform other necessary acts, but not sufficient to make the finer kinds of movements; the muscles remain weak. This case is complicated with a unilateral epileptiform condition, which may have been the reason for a slight deterioration in the use of the right hand.

<sup>4</sup> Since the above was written another convulsion has occurred in the presence of one of us, and its characters have been noted. The monkey had been eating a piece of carrot for about three minutes, when the food which he had been holding was dropped to the floor, the right hand was clenched to make a fist, then there was a tonic flexion of the forearm on the arm, and this was followed by a slow tonic abduction of the arm to about 75 degrees from the normal position. A sudden relaxation then occurred, followed by a series of clonic movements in the whole of the arm area, and at this time the monkey cried several times. From this time the convulsion was purely clonic, the right leg following the arm, and in a few seconds the left side followed the right in a series of severe and extensive movements. The convulsion ended in 27 or 28 seconds, with a gradual lessening of the rate and of the extension of the movements, and as soon as the clonic movements had stopped the animal took up the piece of carrot which it had been eating previous to the attack. The convulsions have been coming at longer intervals, and they have been observed chiefly after the animal begins his morning meal.

*Experiment 7*

*Monkey 4.* On July 25, 1916, the left motor cortex was destroyed in the manner previously described. This brought about a right-sided hemiplegia, with flaccidity of the arm and leg.

*Management and results.* The movements of the left arm were prevented by tightly bandaging that arm to the trunk. The special treatment consisted in the stimulation of the extensors of the arm, the shoulder muscles, and the muscles of the leg by friction, by the stimulating of the corresponding nerves, and by the irritating exercises to

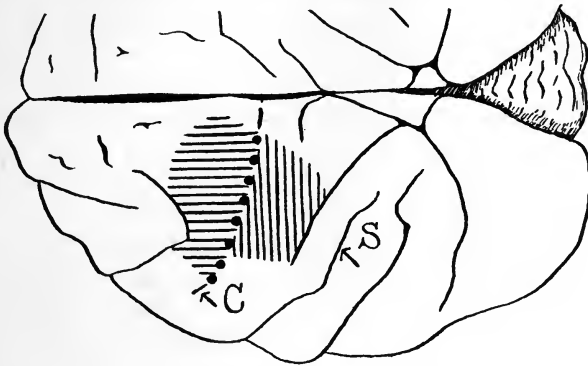

FIG. 1. PART OF THE SUPERIOR SURFACE OF THE BRAIN OF MONKEY 4

The obviously destroyed motor area is indicated by horizontal lines, and the apparently abnormal post-central area indicated by vertical lines. C, central fissure, partly indeterminate and indicated by the dotted line; S, fissure of Sylvius. About natural size.

cause the animal to make defensive and offensive movements. The recovery was rapid, after the first few days the improvement being marked. After three weeks of the treatment (August 18) it was not possible to notice any difference in the activities of the two sides of the body, the right arm being used as well as the left for such operations as feeding and climbing, and the right leg being perfectly controlled and coordinated in walking, running, climbing, and jumping.

This animal had been sent from Washington to New Hampshire, and on August 20 it was noticed to have coryza. This developed like an influenza with pulmonary symptoms, and the animal died three days later. The brain was removed and the accompanying diagram illus-

trates the condition of the left hemisphere. The microscopic examination has not been made at this writing, but the gross appearance shows that most, if not all, of the arm and leg areas of the left cortex had been destroyed. The precentral area which showed destruction is shown in the diagram by horizontal lines. Behind the central fissure there is another area (post-central and intermediate post-central, according to Campbell's histological differentiation) which appears to be affected. This area may have been involved because of changes in the blood supply in the application of the cautery to the precentral cortex, although it is not possible to determine the matter until the brain has been examined histologically. It also appears from the gross examination that some of the uppermost part of the leg area may have escaped destruction because of its proximity to the longitudinal sulcus, but this also cannot be definitely determined until the results of the microscopical examination are available. It has previously been noted that the cautery was pushed into the brain so as to destroy the parts not usually accessible, and it may be that the superficial normal appearance will not be borne out by further examination.

*Summary.* Monkey 4 was made hemiplegic on the right side, and after three weeks, treatment of the arm and leg muscles, and by compelling the animal to use the right side, it became able to use the right arm and leg as well as a normal animal. The brain showed extensive destruction of the precentral area on the left, with a possible complication of the post-central area on the same side.

#### GENERAL SUMMARY AND DISCUSSION

The seven cases of hemiplegia in the four animals were treated in different ways in order to determine some of the conditions favorable to the recovery of voluntary motor function. The second experiment shows that motor recovery after the production of an hemiplegia does not result if the animal is left to its own devices, and this management (or lack of management) it is almost unnecessary to remark is what is given to most human paralytic cases. Even though the animal be prevented from using the sound (unparalyzed) segments there is little difference in the improvement from that in which no treatment is given unless in addition to the limitation of the possibility of movement there be added some extra stimulation to the muscles

and nerves of the paralyzed side (experiment 5), although the recovery is rapid in such a case if treatment by muscle stimulation and nerve vibration be directed to the involved parts and if special stimulation exercises be given to the animal which will provoke the animal to move the paralyzed segments (final part of experiment 5). The method of treatment recommended by neurologists, general massage, does produce a slight amount of improvement but not to an extent to enable the animal to use the arm and hand properly for such ordinary operations as feeding and climbing, although these activities may be carried out after such treatment in an awkward manner. When, however, efforts are directed to the special nerves and muscles, and when the sound side of the animal is restrained so that movements of climbing and feeding must be made, if at all, by the use of the paralyzed segments the improvement is rapid and the recovery is practically complete (experiments 1, 4, and 7).

One fact that stands out prominently is that recovery from the hemiplegic state may be very rapid. It has long been known that an hemiplegic monkey left to its own devices will after a considerable period of time recover the ability to use the arm and leg, but this period is one of months and is well illustrated in the one of the experiments described (experiment 2), where the animal after six months has not recovered to any great extent the ability to use the paralyzed left side. The rapid recovery of the animals used in experiments 1, 4, and 7, and in the last part of experiment 5, is suggestive, and perhaps conclusion-compelling, that the continued paralysis of animals, and by analogy the persistence of motor incapacities in man, is due to lack of management rather than to a real inability.<sup>5</sup>

The results also suggest a reconsideration of the whole problem of cerebral motor control, and especially that of cortical motor control. It has long been believed and taught that the cerebral cortex is necessary for the production of a voluntary

<sup>5</sup> Each of the authors has in preparation a report of a series of cases of paralysis in man which will be published shortly, both showing that considerable improvement may result from properly directing the attack against certain muscle groups and their related nerves.

movement. While it would be too venturesome to say from the experiments on the monkeys that the power of purely "voluntary" movement was recovered, the experiments on man which have previously been cited, and those which will later be published, show conclusively that such "voluntary" movements may be produced even though the paralysis has been what neurologists call "residual," and in some cases even when it has persisted for a decade or more. It is, however, reasonable to suppose that not all of the "recovered" motor ability of the monkeys is of the nature of reflexes of a complicated type, and if we conclude that only a few of the recovered movements are "voluntary" it is sufficient to cause us to hesitate to accept the generally accepted view of cortical motor function.

Here also may be cited the results which have been reported by von Monakow regarding the pyramidal fibers, for he finds that after the complete destruction of the motor cortex there is approximately from 25 to 33 per cent of the pyramidal fibers intact, or rather undegenerated. This fact would point, assuming the pyramidal fibers to be purely motor, to the conclusion that other parts of the brain normally send impulses to the anterior horn cells, and that the control of the body musculature is not entirely from the so-called precentral region, and it may be not entirely cortical. There remains from this anatomical argument the question of "voluntary" and "involuntary" movements, but this is more completely answered by the results of the present series of experiments as well as by the results of the experiments with human paralytics to which reference has been made.

The results are of interest in another direction, in that they place in the hands of the experimenter the means for the rapid recovery of motor function so that the "vicarious" functions of other cerebral parts may be investigated. If there is a delay in the recovery for periods of six to twelve months the possibilities of experimentation are greatly reduced. With the possibility of producing such rapid recoveries as we have described in this paper there is opened up the means of investigating certain motor functions which were not feasible previously



on account of the long delays, in which there are numerous chances of intercurrent affections taking off some of the animals. Some of these problems have been planned and it is hoped that results will be obtained for a future article using at least two of the animals which have been reported upon here. It is because of this that the brains of the animals now alive have not been taken out and illustrated, but it is expected that a full report upon them will be made at a subsequent time.

The illustrations which are reproduced are selections of photographs of the animals at different stages. Some of the original photographs were small, and they were enlarged. To make the illustrations stand out well, the backgrounds on some of the negatives were "blocked out" and prints made from them in that condition. In other cases after prints had been made the figures of the animals were cut out. From the photographs without backgrounds the illustrations have been made. Although some of the fine detail at the edges of the prints are lost, the principal characteristics have been retained unchanged for there was no retouching of the negatives beyond the changes in the background.

## PLATE 1

Fig. A. Monkey 1, immediately after the second operation, after the recovery of the right side, showing the paralysis on the left. Note the manner in which the left hand is turned under and the left leg outspread.

Fig. B. Monkey 1, after the second operation. The left arm is now being used as a prop as the animal sits upright.

Figs. C. and D. Monkey 1, after second operation, showing the ability of the animal to use the right (recovered) hand for holding a strap which it is trying to chew. In both illustrations the animal is shown after the strap had been pulled upon so that the animal was irritated. Note the apparent helplessness of the left arm and leg, both of which members are flaccid.

Fig. E. Monkey 2, after the second operation. The left arm of the animal, which has been just paralyzed, was accidentally caught in the strap which was pulled upon to get the animal to sit upright. The right arm is bandaged to the body. Note the utter helplessness, there being no effort to get the left arm out from the restraining strap.

Fig. F. Monkey 2, after the second operation. Note that the animal has now recovered the ability to use the left hand and arm to a certain extent, since it holds the strap.

Fig. G. Monkey 2, after the second operation. Note that the animal now uses its left hand and arm with apparent ease to support itself in walking.

Fig. H. Monkey 2, 26 days after the second operation. The animal was photographed in the act of attempting to take hold of the irritating strap. Note that the left arm is now used in a normal manner.

Fig. J. Monkey 3, after the second operation. Note that the right side has recovered, but that the newly paralyzed left is badly used. The left arm shows wrist drop, and the small toe on the left foot is turned under.

Fig. K. Monkey 4, after first operation, 26 days. Note that the right arm is used well in holding to the strap and that the right leg takes a normal position when the animal is sitting.





## THE EFFECT OF DELAYED FEEDING UPON LEARNING

JOHN B. WATSON

*From the Psychological Laboratory of the Johns Hopkins University*

In the Psychological Bulletin of February, 1916, I gave the results of some experiments on the effect of delayed feeding upon rapidity of habit formation. The experiment there summarized was carried out in the psychological laboratory of the Johns Hopkins University in the winter and spring of 1915. Six male rats approximately one hundred days of age and six male rats approximately sixty days of age were required to learn the simple problem of entering the food box shown below (fig. 1).

The problem box and restraining cage were of the same general character as figured in my book.<sup>1</sup> Two modifications of the problem box there figured were essential: the first was to provide a means of keeping the animal from going back into the restraining cage after it had solved the problem by entering *b*. This was accomplished by means of a thin metal shutter held down by a light string. The shutter was made slightly larger than the opening. It was held open by the experimenter through the aid of a string passing to the outside of the restraining cage. After the animal's tail had cleared *b* the string was released and the spring closed the shutter. The time was taken from the moment the animal passed through *a* the opening into the restraining cage until its body had cleared *b*. The interval of time the animal spent in the under-floor space, passing through *c*, etc., was not recorded. The second modification was necessitated by the fact that a means had to be provided for restraining the animal from getting its food until a definite time interval had passed. This was accomplished by making a cylindrical

<sup>1</sup> Behavior, Henry Holt and Company, 1914, pp. 94 ff.

food box *d*, 5 cm. in diameter and 8 cm. high. This was supplied with a lid *e* perforated with several 1 mm. holes to allow the possibility of olfactory stimulation. A small vertical rod was screwed into the center of the lid. The rod passed up through a hole in the wire mesh of the problem box and restraining cage (the sleeve *f* was needed to keep the animals from attempting to push through the hole in the mesh). By means of this rod the experimenter could allow the animal to get food at the desired

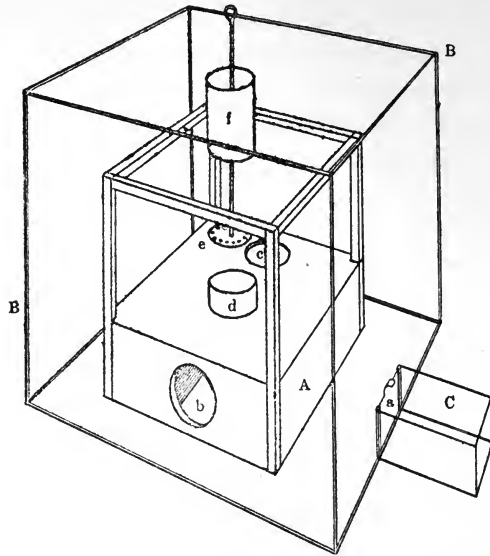

FIG. 1

time. The food cup had a raised bottom below which was cut an inside screw thread. A disc supplied with the same sized threads was screwed into the wooden floor of the problem box. The metal food box could thus be fastened securely into this floor plate. This device afforded a firm support for the food box and also made its removal for cleaning quite easy. The firm support was found to be necessary because when the animals were not fed immediately they attacked this box with the utmost vigor.

The twelve animals were divided into two groups. Six of these had to learn the problem by the usual method of immediate feeding. Six others were required to learn by the method of delayed feeding. The animals chosen were laboratory pets and exceedingly gentle. All twelve were bred from stock which had been in the laboratory for a long time.<sup>2</sup> The twelve animals were distributed at random into the two groups *before* the first trial. The only precaution taken was to see that each group contained three young animals and three of the older ones. The early trials (table 1) show that the initial ability (after the first trial, which need not enter our records because of the fact that it was not until after the first solution of the problem that any difference in procedure was introduced) of the two groups was not very different. All twelve animals were allowed to get their food in the box before the first trials were given. During this preliminary habituation stage the opening at *b* was closed so that the explorations of the animals were confined to the inside of the problem box proper. A hinged door in the top of the box permitted the animals to be lifted in and out. In the regular trials the problem box was banked up with sawdust on all four sides to a height of four inches. At all times (and with both groups) during the tests the lid to the food box was left on. After a given animal, working by the immediate feeding method, had scratched away the sawdust and entered *b*, the door was closed and the food box immediately opened. It was always opened by the time the animal could pass up through *c*. The rats were allowed to eat for five seconds and then they were lifted out and taken back to their living cages. Only one trial per day was given. Exactly the same method was adopted for the group working by the delayed feeding method except that in this case the *lid to the food box was held down for thirty seconds*.

The behavior of the animals working under the ordinary conditions offers nothing worthy of comment. The behavior of the group whose feeding was delayed for thirty seconds presents an unusually difficult problem to those who hold that the getting

<sup>2</sup> I wish to thank Dr. Helen Hubbert for supplying me with these animals.

of the food, following usually immediately upon the completion of the last ("successful") act, stamps in that movement. The successful act was to dig away the sawdust in exactly the right place and enter *b*. But these animals after entering *b* ran im-

TABLE 1

Showing complete records of the twelve animals used in the experiment. One trial per day given

TRIALS	DELAYED FEEDING						AVERAGE DELAYED FEEDING	AVERAGE IMMEDIATE FEEDING	IMMEDIATE FEEDING						AVERAGE BY 3'S DELAYED FEEDING	AVERAGE BY 3'S IMMEDIATE FEEDING
	60 days of age			100 days of age					60 days of age			100 days of age				
	1	2	3	1	2	3			1	2	3	1	2	3		
1	400	1190	160	360	177	25	385	923	2545	656	345	265	1680	40		
2	40	100	25	92	55	40	58	111	125	169	50	46	145	135		
3	155	40	20	11	42	240	84	89	193	93	18	105	85	40	176	374
4	40	15	11	25	29	63	30	24	27	25	10	25	55	6		
5	57	7	5	10	7	25	18	36	33	15	12	22	7	129		
6	36	4	25	5	20	12	17	23	7	7	65	26	4	30	22	28
7	27	12	7	18	7	5	13	9	7	4	13	12	6	11		
8	12	27	3	15	5	8	12	13	5	5	46	7	8	5		
9	25	10	5	9	3	5	9	8	4	21	10	4	5	5	11	10
10	20	3	11	7	3	12	9	15	42	19	7	15	4	5		
11	30	10	20	7	4	10	13	9	18	6	5	13	6	3		
12	20	4	16	3	4	9	8	13	13	11	6	6	5	9	10	11
13	3	7	3	7	6	20	8	9	5	5	4	20	6	13		
14	14	9	10	7	2	15	9	7	6	10	3	7	3	12		
15	15	30	10	6	2	3	11	24	13	70	47	7	3	5	9	13
16	10	15	8	5	3	3	7	8	7	25	2	4	4	3		
17	5	9	3	10	3	3	6	9	12	8	25	3	4	4		
18	3	8	23	7	5	3	8	6	17	6	3	5	3	3	7	8
19	18	16	10	7	4	5	10	5	6	8	4	8	3	3		
20	3	25	8	11	2	7	9	5	6	5	8	6	4	3		
21	10	15	7	10	2	5	8	6	6	6	3	10	6	4	9	5
22	3	12	12	5	3	2	6	6	5	6	3	6	6	12		
23	10	9	7	12	3	10	8	7	4	13	5	11	6	3		
24	8	9	7	7	4	4	6	7	7	18	4	7	4	4	7	7
25	8	11	3	7	3	4	6	8	10	21	4	5	4	3		
26	6	6	9	5	2	7	6	7	7	9	9	5	3	7		
27	7	7	17	7	5	2	7	6	5	7	14	5	3	4	6	7

mediately to the food box. Finding it closed they became frantic. They would fight the rod, tear at the box, then they would leave the neighborhood of the food box momentarily, pass back through *c* to the under-floor space, and then return to the food



box. Often considerable pressure had to be exerted upon the rod to keep the lid on. Their acts were very rapid—too rapid for the recording of accurate notes. Under such conditions thirty seconds is a long time and a great tax upon the experimenter. There is a strong tendency on his part to let the ani-

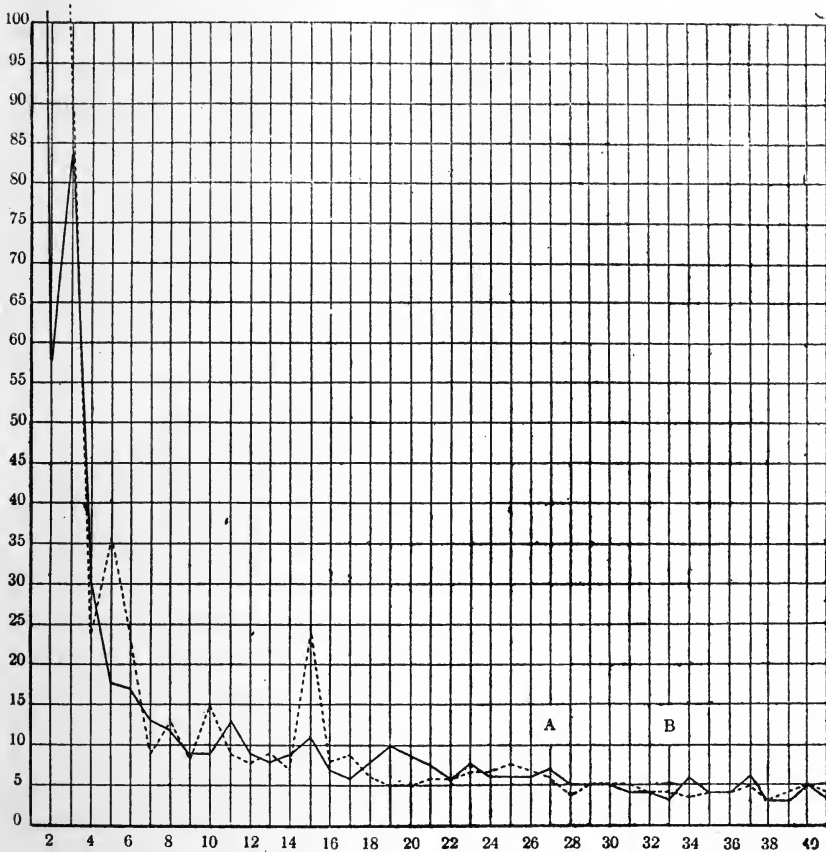

FIG. 2

imals have the food a bit too early. For this reason the experimental technique here is not ideal and automatic control for all the variable factors should have been introduced.

Notwithstanding this weakness in technique some interesting light is thrown upon this general problem. Below I give sepa-

rately the complete individual records of all twelve animals, the averages by trials, and the average of each succeeding three trials. The curve is plotted from the daily average.

After the above records had been obtained by the one trial a day method, it occurred to me that a disturbance might result if the animals were given two trials per day. I then gave the test for three days, each animal receiving two trials in immediate succession. For convenience in comparing the records, table 2 is plotted as a continuation of the graph of table 1. The graph of table 2 begins at A., figure 2.

TABLE 2  
*Showing effect of giving two trials daily*

TRIALS	DELAYED FEEDING GROUP						AVERAGE DELAYED FEEDING	AVERAGE IMMEDIATE FEEDING	IMMEDIATE FEEDING GROUP							
	60 day animals			100 day animals					60 day animals			100 day animals				
	1	2	3	1	2	3			1	2	3	1	2	3		
28	5	5	9	5	2	3	5	4	14	13	19	6	3	3		
29	5	3	9	6	2	4	5	5	5	6	5	5	4	5		
30	3	4	9	5	2	7	5	5	6	5	5	6	2	3	5	5
31	4	5	5	3	3	3	4	5	9	5	4	4	2	5		
32	3	3	5	6	2	4	4	4	3	3	3	4	2	7		
33	2	3	7	2	2	2	3	4	5	3	3	3	5	5	3.7	4

It will be seen that there was a steady continuation of the learning process and that no evil results followed from this short test. Attention is called to the fact that animals 1, 2, and 3 of the immediate feeding group were slow on the first trial on the first day. This was undoubtedly due to the fact that some wild rats ran over the problem box during the night. These three records were not included in the averages.

It occurred to me finally that it would be desirable to see what would happen if the feeding methods were reversed for a few trials. Accordingly three of the animals from the delayed feeding group (the three sixty day animals) were forced to run for eight trials receiving their food immediately at the end of each trial. On the other hand three of the animals from the immediate feeding group (the three sixty day animals) were forced to work by the delayed feeding method.

Table 3 gives the results of the first eight trials (table 3). The graph of table 3 begins at *B*, figure 2. It will be seen from the averages of these few trials that nothing significant appeared.

Looking at these records we see that no matter what our criterion or standpoint may be the fact remains that the delaying of the feeding for thirty seconds after the solving of the problem did not alter the learning process. I think it extremely unlikely that two groups working by the same method would ever show a more closely similar time record. It may be that experimentation with a larger number of animals and with automatic controls might show a significant difference. It is quite possible that a longer period of delay might give far different results.

TABLE 3  
*Showing effect of reversing the method of feeding*

TRIALS	DELAYED FEEDING GROUP WITH FEEDING RELATIONS REVERSED			AVERAGE	AVERAGE	IMMEDIATE FEEDING GROUP WITH FEEDING RELATIONS REVERSED		
	60 day animals					60 day animals		
	1	2	3			1	2	3
34	6	3	10	6.3	3.6	3	3	5
35	4	3	5	4.0	4.3	7	3	3
36	4	5	5	4.6	4.3	5	3	5
37	4	11	3	6.0	5.3	7	6	3
38	3	2	5	3.3	3.3	4	4	2
39	2	3	5	3.3	4.3	6	4	3
40	6	3	6	5.0	5.3	3	6	7
41	2	3	5	3.3	4.3	4	3	6

It would of course be desirable to have some system of recording the number of random movements and the type of these movements. This ought to be done especially during the delay period. So far as the experimenter can state, the animals were working as vigorously during the thirty seconds delay as at any other time and they were displaying the same type of movements, viz., exercising their instinctive and habitual repertoire.

I assume that what psychologists mean when they say that a movement is stamped in by reason of the "satisfaction" which it brings and that another movement is stamped out by reason

of the "dissatisfaction" it brings could be stated somewhat as follows: The getting of the food produces metabolism, increased circulation, changes the tone of the organism, supplies nutrition to the blood stream, etc. Now the whole system of neuro-muscular arcs exercised throughout the solving of the problem does not share equally in this bettered condition of the organism. The particular arc last functional (the one employed in the successful act) by reason of the fact that 'activity in it has not completely died down' will reap the greatest benefit from the bettered functional condition of the organism. This in the long run would tend to favor the successful arc at every trial. I do not mean to say that any of them would state it in just this way. As a matter of fact none of them has ever given even a fair presentation of just what they do mean. Swift has given the nearest approximation to this statement. Thorndike has advocated the satisfaction and dissatisfaction theory most consistently but he has not attempted to give even a crude physiological basis for his views.

While I have no solution to offer I cannot help but see in the experiment which I have just reported a serious objection to any such formulation. I think we may assume without exaggeration that there are from ten to fifteen complex acts performed during the thirty seconds delay. All of these acts come after the so-called successful act, i.e., the scratching away of the sawdust at the proper place and the entering of *b*. As an interesting speculative point one should consider the average total time of the solving of the problem. After the fourth trial the average time drops below thirty seconds. Thus from the fourth trial on *more useless movements occur in any given trial after the problem has been solved than occur prior to the actual solution of the problem!* Why should not the neuro-muscular arcs used in executing these later random movements be the ones to share in the bettered physiological condition of the organism?

I offer this experiment not as throwing any conclusive light on the learning process but as opening up the possibility of carrying out experimental work upon the fixation of arcs in habit and as showing the very great need there is for such study. The

control of habit is one of the most vital problems in every system of psychology. The answering of this question ought to enable us to attack the problem of habit control in a far more scientific manner than is now possible.

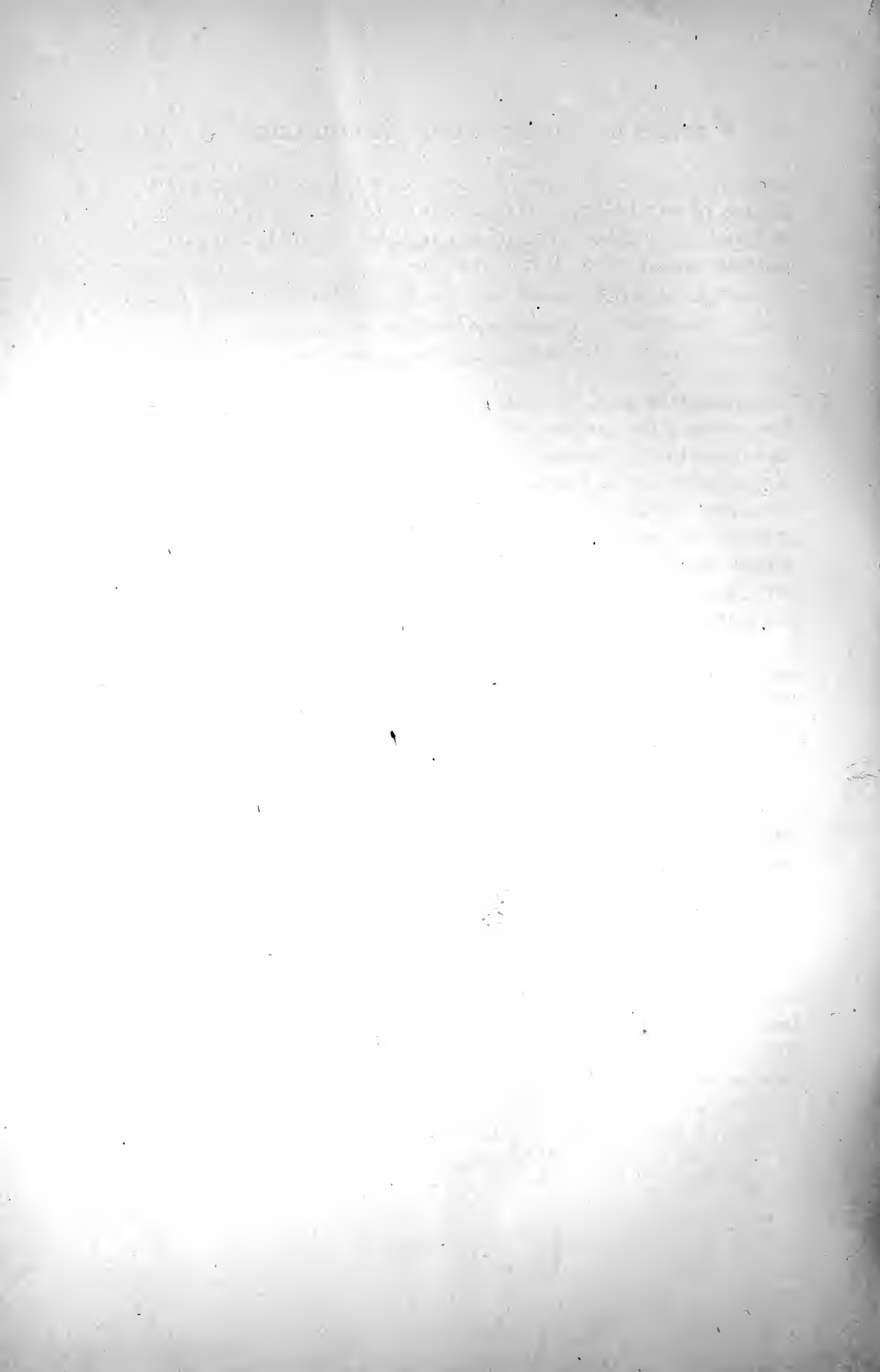

## DISCUSSION

### INTERNAL SECRETION IN LEARNING

KNIGHT DUNLAP

*The Johns Hopkins University*

Non-psychological writers, and many psychologists, assume that emotion has a direct influence on action, and in particular, that pleasure (or satisfaction) and pain (or dissatisfaction) are instrumental in the formation of habits. Certain writers, however, have objected to this assumption on various theoretical grounds, the most important of which, at the present time, is the alleged fact that no detailed mechanism is discoverable or has even been suggested, by which the effects of emotion on action might be mediated. This omission I have had in mind for several years to supply by a hypothesis which seems to offer grounds for experimental test: but as I shall be able to carry out the tests on only a few points, it seems proper to outline the hypothesis for the consideration of others who may be experimentally interested in the matter.

The hypothesis I have in mind is a logical outcome of the view to which some of us were earlier forced concerning the emotions, namely, that in the important bodily changes which are commonly called "expressions of emotion" (and which I, following Lange, would insist *are* the emotions), the activities of certain, probably all, of the endocrine glands play a part. Five years ago I assumed that this would be found true of the "major emotions" (or what are sometimes called "emotions" as distinguished from "feelings"), as Cannon has so admirably shown. At the present time, I have no hesitation in adopting it as a working hypothesis for the "feelings" of pleasure and pain, and all other definite affects.

There are certain cases in which the effect of pleasure in "fixing" a reaction can be explained by the immediate repeti-

tion of the act, or by the dwelling in thought on the act, which is probably physiologically equivalent to a repetition. These cases come under the heading of *repetition* or *frequency*, which, so far as I know, no one doubts to be an important factor in association or habit-formation. The cases which cannot be subsumed under this head are the ones in which the efficacy of pleasure has been challenged, and these are the ones with which we are at the present moment concerned.

If pleasure (to neglect pain for the moment) is directly connected with a change in internal secretions, and if internal secretions may act on the nervous mechanism (both of which conditions are possible), we have in this aspect of pleasure a possible means of influencing habit formation. Since the reaction which we suppose to be "fixed" by pleasure precedes rather than follows the pleasure; or at least precedes the hedonic secretory effects—as we must allow a time interval for the secretion to be carried in the blood stream to the effective locality—the influence of whatever hormone is involved is retroactive, i.e., it will act on a pathway over which discharge has occurred in such a way as to make discharge over that pathway more probable in the future than it was before.

In brief, the obviously suggested theory is that the nervous discharge leaves an arc or certain important points in the arc in such a condition chemically, that a certain substance (hormone) may a few moments later "fix" it. Artificial as this theory sounds at first, I believe it is worth putting to the test.

I might point out familiar observation, and data from the experimental investigations of learning, which fit this working hypothesis. There are many pertinent cases. I believe however that this procedure would not be legitimate, since the observations which support my hypothesis were not made with this hypothesis in view, and hence the strong backing they afford may be more apparent than real. The important thing is that experimenters should hereafter keep the hypothesis in mind, and observe specifically in future work the data which have direct bearing on it.

The particular efficacious hormone which is liberated in pleasure



is conjectural. It can hardly be adrenalin, for this, as Cannon's experiments seem to show, is the endocrinic correlate of excitement, which is not conducive to habit formation, but rather to the breaking down of habits. It must be a secretion, which like adrenalin, is discharged directly into the blood (not indirectly through the lymph channels), by which it is carried to the "centers" in which habits are formed, i.e., in which the critical synapses lie: unless indeed the route may be still more direct as seems hardly possible, even from the pituitary body. It may be, however, that the secretion is not formed in a "gland" proper, but in some tissue whose primary function is not secretion.

The effects of pain, in preventing the fixing of the preceding acts, may not be so specific as are the effects of pleasure. It is possible that adrenalin or some other active principle is the negating agent here, but it is also possible that the effects are produced by the setting up immediately of more powerful reactions which disturb the interconnections left by the preceding algesogenic reaction. By "pain" is here meant the affective content usually (and properly) described by this term, ignoring the unfortunate psychologists' confusion between this and certain specific sensations.

The implications of the theory which admit of experimental verification, or the reverse, are numerous. Those in which I have been most interested in are the following.

1. Actions performed shortly before the reaction which produces the "satisfying" result, and actions *immediately* following it, would be fixed, along with the act itself. The normal pause in activity following the "satisfying" reaction (where the reaction itself is not immediately repeated) is probably a useful phenomenon.

2. If an animal, in solving a simple "problem" makes a short series of reactions, including a number of "wrong" acts and terminating with the correct (satisfying) act the probability of repetition of the "wrong" acts is as great as that of the "right." But after the solving several times, the probability of the "right" act becomes greater than that of any "wrong" act unless a

“wrong” act has been in every series. In that case, the animal should eventually repeat the “right” act uniformly preceded by the “wrong” one.

3. If the apparatus is so disposed that satisfaction is not given to the animal until several “wrong” acts have been done after the act which really makes the satisfaction available, learning will be made especially difficult, unless the animal is able to make a conceptual analysis of the problem.

4. In a problem involving the necessity of a definite series of actions for its solution, and allowing the performance of “wrong” acts at various points, the elimination of wrong acts will follow no law except that of probability, based on a number of repetitions. Of the wrong acts which have been done up to a certain point in the learning, those which have been done the fewest times will be eliminated soonest.

5. In the human animal, in spite of the non-emotional factors which enter most learning problems, the hormone factor should be discernible.

65

## CONTINUOUS STIMULATIONS VERSUS TRANSITIONAL SHOCK IN THE PHOTOTACTIC RESPONSE

S. J. HOLMES

*From the Zoölogical Laboratory of the University of California*

In a paper by Miss K. W. McGraw and the writer (1) a description is given of several experiments which were designed to ascertain whether the phototactic response is due to the continuous stimulating effect of light or to the stimuli that result from changes in the intensity of light. The ordinary phototactic movements of animals afford an opportunity for both these forms of stimulation to come into play. An animal going toward or away from the light naturally deviates more or less from a straight path and hence subjects its photosensitive surfaces to more or less frequent changes of light intensity. In order to separate the effect of continuous stimulation from that of the shock of transition the attempt was made to eliminate the latter so far as possible and thus to observe the influence of constant stimulation alone.

In one set of experiments insects with one eye blackened over with asphalt varnish were placed within a small circular enclosure in the center of a cylindrical container whose sides were lined with uniformly colored paper. Light was admitted through the center of the upper side which was also uniformly colored, so that in whatever way the insect turned the amount of light entering the eye would be approximately the same. In general, insects that were positively phototactic performed circus movements toward the normal eye when placed in the enclosure, while negatively phototactic insects turned about in the reverse direction. The movements of the insect doubtless produced some changes in intensity of photic stimulation, but they were slight; nevertheless the behavior of the insects within the enclosure was practically the same as when they were outside and

exposed to the varying influence of lights and shadows from a multitude of objects.

In other experiments insects were held above an easy-running horizontal disk or turn-table which they could rotate with their feet. Light was made to fall upon the insect from one side. If the insect attempted to turn toward the light the movements of its feet would rotate the disk in the reverse direction. Butterflies proved to be very convenient forms to work with since by grasping them with their wings held together above the back they could be easily held above the disk so that their feet could move it in either direction. Under these conditions several species of butterflies were found to rotate the disk quite constantly away from the illuminated side in their efforts to turn toward the light. They would also promptly change the direction of rotation when the light was carried from one side of the insect to the other. Some species of Diptera gave results quite parallel to those obtained with the butterflies.

As was pointed out, the slight movements of one's hand, although these were minimized by the use of a hand rest, and the movements of the head of the insect due to its own activities in rotating the disk, would produce some fluctuation in the amount of stimulation received by the eye, but these changes were necessarily small. The general outcome of both sets of experiments was therefore favorable to the view that the continuous stimulating influence of light is a potent factor in effecting orientation.

In a paper on the reactions of *Euvanessa antiopa* to light Mr. W. L. Dolley (2) has questioned the conclusion just expressed, and has described some experiments whose results in his opinion justify a different interpretation. Dolley's work was done under the supervision of Prof. S. O. Mast whose views regarding the so-called "continuous action theory" he apparently shares. The apparatus that Dolley employed, consisting of an easy-running horizontal disk above which the insect could be held, was in principle the same as ours. The wings of the butterfly, however were held in a clamp, thus getting rid of one source of movement. In other respects the body and especially the head

were free to move and naturally changed in position somewhat as the insect became active. By observing the shadow of the head when the insect was moving its legs it could be seen that the head did in fact move up and down. Whenever the insects were active, however, "they attempted to turn toward the functional eye, never in the opposite direction." The results of the experiments, so far as the nature of the orienting stimulus is concerned, are regarded as not conclusive, "for the moment the animals become active, and before they attempt to turn, there is a change in the position of the eye owing to the vertical movements of the head, and this, no doubt, results in changes in the luminous intensity on the various ommatidia. Thus, it is evident that the attempt on the part of the animal to turn toward the illuminated eye may be due to stimuli dependent upon the time-rate of change of intensity." So far as the butterflies responded to light at all, their behavior, while rather spasmodic, was in essential agreement with what was described by Miss McGraw and myself, only as the creatures jiggled somewhat during the experiment it was held that the conclusions drawn in our paper were "not justified."

In order to test the question still further and to obtain results which would permit of only one possible conclusion, an apparatus was devised which would hold the eyes of the insect in a firmly fixed position. If the eyes could be maintained in a perfectly constant relation to the light the element of transitional shock or differential sensibility would of course be eliminated. To secure this end a piece of wood was fashioned into the shape of an L with a long and a short arm. The wings of the butterfly could be clamped on either side of the upper arm which was held horizontally, while the body lay below with the head pointed toward the shorter arm. Into the shorter arm a nail with a flat circular head was driven a short distance from the end. The butterfly was so placed that the front of its head abutted against the head of the nail. By means of a quick drying glue the butterfly's head was cemented to the head of the nail, and left there until the glue dried. With the wings firmly clamped above, and the head firmly glued to the head of the nail, the activities of the

insect could only produce a limited movement of the body, but no movement of the head. The wooden L was then clamped upon an iron frame so as to bring the insect in a horizontal position, and the feet of the insect were allowed to rest upon a light, horizontal disk capable of easy rotation. The light employed rested upon a firm stand so that no complication could arise from that source. Care was taken to see that the glue was firmly set and that the head made no motions during the struggles of the insect. Everything was made as rigid as could well be, so that one could be assured that eye and light must remain in a constant relation, however much the insect might move its legs or even its body.

Under these conditions, which would seem to insure the constant stimulating influence of light, how did the butterflies react? Specimens of *Vanessa caryæ* were chosen for experimentation since they were easily obtainable. The first individual selected was found to rotate the disk quite consistently away from the light. When the light was placed on the other side of the insect the disk was rotated in the reverse direction. Frequently the movements of the insect were soon discontinued, but when the foot or body was touched with a needle the rotation of the disk was generally resumed. The light was changed from one side of the insect to the other fifteen times and each time the disk was unmistakably rotated away from the light. After a rest in the dark for about an hour the light was changed from side to side twelve times with the same result as before. The insect which now gave evidence of exhaustion was liberated; the glue fastening its head to the apparatus was found to be well hardened.

Other butterflies of the same species were experimented with in the same manner and gave results equally decided. The responses of the butterflies were not quite so vigorous as in the experiments originally described. This is probably due to the unnatural stimulation caused by the head being firmly glued to a foreign object, and also to confinement in a fixed position during the time the glue was being dried. Nevertheless the results made it abundantly evident that the butterflies with the

head firmly fixed showed a marked tendency to rotate the disk away from the eye receiving the most light. Inasmuch as the conditions of the experiment were such as hardly to leave any room for fluctuations of light intensity to play any part, the only reasonable interpretation of the results is that they are due to the continuous action of the light.

REFERENCES

- (1) HOLMES, S. J. AND MCGRAW, K. W. : Jour. Animal Behavior, iii, 367-373, 1913.
- (2) DOLLEY, W. L. : Jour. Exp. Zoöl., xx, 357-420, 1916.

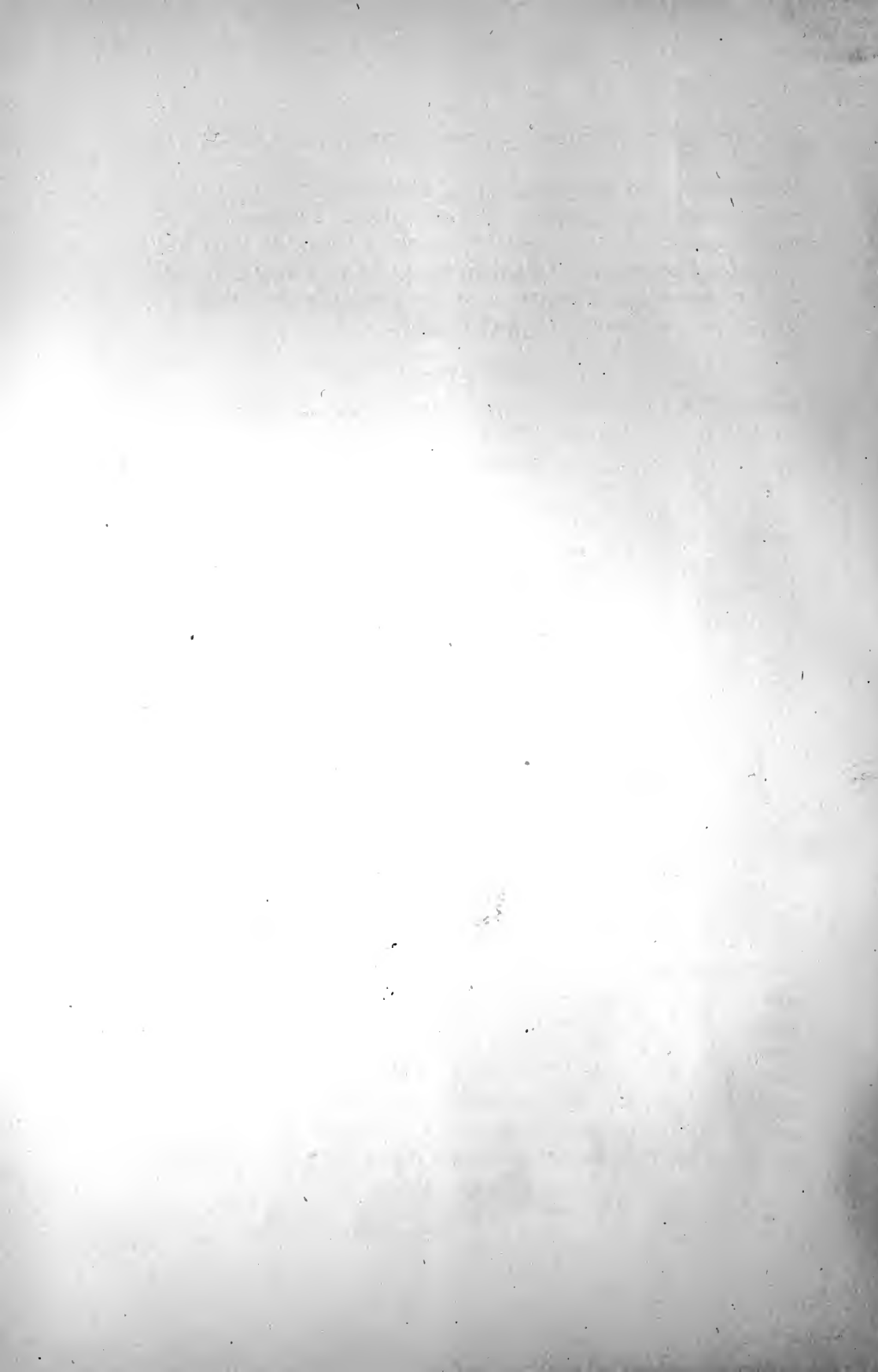



# THE EFFECTS OF CEREBRAL DESTRUCTION UPON HABIT-FORMATION AND RETENTION IN THE ALBINO RAT

K. S. LASHLEY AND S. I. FRANZ

*Department of Psychology of the Johns Hopkins University and the Government  
Hospital for the Insane*

## INTRODUCTION

It has long been known that the cerebrum is anatomically complex and it is recognized that its functions are diverse. There is also the appreciation of the failure to correlate the known anatomical facts with the functional observations. There are many reasons for the last. The variation in cerebral structure in different species of animals is one of the greatest of the difficulties in the correlation of the anatomical and the functional, for two animals with obviously dissimilar brain structures may appear in the main to be functionally similar, and conversely two animals with obviously dissimilar activities may have quite similar cerebral structural arrangements. The diversity of structures in the same brain has been more recently emphasized. Differences in the arrangements or in the method of combination of cells and fibers have been described as points of major importance, and many cortical areas, a score or more, have been described as different organs. They have also been assumed to represent equal functional differences. On the functional side, especially when man has been under consideration, the diversity has been exaggerated, and this has probably been carried over into modern neurology from the mental faculty aspect of Gall's phrenological system, although the anatomical part of Gall's work is totally discarded. The differences of emotions, hate, joy, fear, anger, of sensations such as color, tone, and the taste and smell qualities, of movement and of will, of desire, of interest, and of all mental states, have led to assump-

tions of uniqueness by the uncritical in psychological analysis. There followed the further belief that each one of the supposedly different mental states must have a corresponding anatomically distinct counterpart.

When these beliefs are looked at critically they are recognized to be logical from the standpoint of any of the current brain-mind hypotheses. But this logical conclusion applies only to the general and not to the particular way in which the differences are looked at. It is doubtless true that there are many arrangements of cells and fibers in different parts of the cortex, and these differences in arrangement may mean differences in function. That great differences in function are not necessary consequences of anatomical differences may be illustrated, but of course not proven, by an analogy. It is well recognized that a house may be built of wood, or of bricks, or of stone, and that it may be one or two or more stories in height, be narrow or broad, or with large windows and doors, or with Venetian blinds, or painted blue, or with a gable roof, or with any other characteristics. But, whatever these anatomical characteristics may be the structure remains a place of habitation. The differences in structure do not indicate fundamental functional differences of the collections, they are modifications of only certain minor elements, and point only to minor functional differences. The function of the habitation may, therefore, differ slightly because of its combinations of internal and external structures, for it may be more comfortable in winter, or be conducive to cleanliness, or the reverse. It still remains a house with the general functions which all such structures have. The windows let in light, the doors permit entry and exit, the walls protect, and the furnishings give comfort, to different degrees, but the same general functions pertain to the cottage, to the mansion and to the apartment house. The functional similarities are more pronounced than the structural differences.

Equally with mental states and the cerebral anatomical structures. We may discover by careful analysis that although the mental states differ they are not so divergent as a superficial observation would indicate. There are many similarities, many

common elements, in apparently dissimilar mental conditions. We also find that the cerebral structures do not differ widely in fundamentals. Many of the cells have the same general mass and appearance, but in one place may differ in number from those in another location. Their staining qualities are similar, the neurofibrils are much the same, the most marked differences are the direction and the length of the axones and the number of collaterals. Consequently, it should be obvious that great care should be taken that points of minor difference are not made the basis for major deductions.

At the same time care should be exercised that apparent similarities are not accepted as equalities and that a certain condition should not too hastily be assumed to point exclusively to one explanation. But this mistake is one of the most common in dealing with cerebral functions. Von Monakow has emphasized the distinctions which must be made in certain cases, and has pointed out some of the difficulties of interpretation. In one direction these difficulties are to be appreciated by the careful consideration of the temporary and the residual defects following a cerebral accident. But there are many more. For example, after the destruction of certain parts of the cerebrum of an animal, if a beam of light is thrown into the eye, or if an object crosses the visual field, and the eyes turn in the proper direction one cannot be certain whether the animal sees or the reaction is a reflex without vision.

For cases such as that just mentioned we have a means of more exact determination. This is the method of training which can be used both prior and subsequent to any experimental destructions. We may set such conditions to an operated animal which exhibits a reaction to light stimuli that the animal will be able to form a habit provided the cerebral sensory, associational (if they exist), and motor elements be intact. If a necessary part of the sensory-motor mechanism be out of order such a habit can not be acquired. By varying the end conditions, either the sensory or the motor or both, it is possible to deduce the effects of destructions if they be more than temporary, and only in this way is it possible to determine accu-

rately the character of a certain loss. Such a defect might apparently be motor. If this should be so we have reason to believe that a required movement could not be initiated from the cerebrum by any form of stimulus, whether light or sound or touch. If, however, the defect be sensory, let us say visual, the problem changes. A stimulus of that particular kind would not serve to produce a habit of any character, whereas other sensory stimuli (sound, touch, smell, etc.) could be used as the means to produce habits. By changing the conditions both on the sensory and motor sides it is also possible to discover what may be termed an "association" loss, although this is in some particulars more difficult than the sensory and motor losses.

After a cerebral accident in man there is also the possibility of determining the degree of retention, the characters of the retained habits, and the capability of formation of new habitual modes of reaction, i.e., behavior. In the clinical examinations of man chief, and frequently exclusive, use is made of the speech habits, although the exclusive employment of speech as the mode of reaction has certain disadvantages. They are not always obvious and they appear to be little appreciated. One of these is that an inability may be reported by speech which by other means it is possible to discover does not exist. This fact is recognized in certain well developed cases which in the past have been called hysterical. It is now admitted that in many other individuals similar "hysterical" symptoms may exist without there being easily recognized signs. Diverse mental states, such as dementia, great joy, or even a lack of understanding, may result in variations in speech habits which mask other effects. This being so, it is clear that to accept as final evidence of a defect a negation (by speech) is similar to the conclusion that an animal sees if the eyes are turned towards the stimulating light. The experimental method should be extended and the habit reaction method especially should be applied to the determination of defects in man after cerebral lesions. The limitation of clinical studies on cerebral functions to the consideration of speech reactions as the motor side of learned reactions can in many cases result only in superficial

knowledge. The adoption of methods looking toward the determination of other habit forms will result in more complete information.

Although it is commonly believed that habit formation is due to the functioning of cerebral parts, and especially those parts which are called cortical, it is by no means right to conclude that all habit reactions are due to cerebral, or more restrictedly cortical, activities. Leaving aside those reactions which must pass by way of subsidiary stations, like the thalamus, as part of the total reaction, it is doubtless the case that certain habits are carried out by the exclusive use of non-cortical, and exclusively also perhaps by non-cerebral parts. This is shown in the reactions of the so-called lower animals, and it has been contended that for the execution of some long-established habits in higher animals only non-cerebral parts are needed. There is reason to believe that in the brainless frog certain simple habits may be acquired. One of the urgent needs at the present time both in neurology and in the study of learning is the establishment of the parts played by the different portions of the nervous system. With these facts in hand it will not only be possible to understand something of learning and forgetting, but at the same time we shall be better able to appreciate that inadequately named condition which is called cerebral vicarious functioning.

Two main problems were in mind when the following work was begun. One was the effects of different lesions upon habit formation and retention, the second was the determination of the parts needed for habit formation. These problems are identical in some particulars, but they can also be considered to be independent. It may be that in a normal animal a habit is formed by the interaction of certain nervous elements, but that when any of these elements have been destroyed or even interfered with other elements may take their places. Or, it may be that in the process of learning many different elements are used at first, but that the number decreases as the habit is acquired.

The scope of the experiments described here has been limited to a determination of the relation of the frontal pole and dorsal

convexity of the cerebrum to the formation and retention of habits which involve chiefly responses to tactile and kinesthetic stimulation. After operation to destroy the frontal pole of both hemispheres (section III) or the entire dorsal convexity of the cortex (section V) the animals were trained on the inclined-plane box or maze and their rate of learning was compared with that of normal individuals. In other experiments (sections I, II, and IV) normal animals were trained upon the same problems and after the destruction of various areas of the cortex were tested to determine the degree of retention of the habits previously established and their ability to reform the habits in the cases where these had been lost.

In the carrying out of the operative procedures excessive hemorrhage was not infrequently encountered. To avoid this as much as possible the operations were performed rapidly. The sizes of the brain and skull are such that there is no space for packing to check a hemorrhage, and it was thought best to operate quickly even if some animals died because of the resulting hemorrhage from the cerebral lesion, rather than have an equal or greater number of deaths from hemorrhage from the longitudinal sinus. This was possible because of the number of animals which were available. Most of the cerebral operations were carried out through small skull openings, and partly because of this the lesions differed in all cases. Slightly different positions of the heads of two animals make the views of the small operative fields dissimilar, variations in the sharpness of the section knife make distinct variations in the ease, depth and completeness of the intended sections, and even slight variations in the relations of the brain to the skull sutures give difficulties that are not easily overcome. The complete removal of the top of the skull and the consequent full view of the superior surface of the brain would have been a more satisfactory procedure in some ways. The difficulty of controlling the hemorrhage from the skull is however added to the difficulty of controlling the hemorrhage from the cerebral section. At the same time even though the top part of the skull be removed without any ill effect other difficulties persist. The point of insertion of

the knife can be more accurately determined, but slight variations cannot be avoided and these would make the lesions dissimilar. In addition, the quantity and the extent of the hemorrhage cannot be controlled, and this hemorrhage acts as a superimposed lesion. In some cases the lateral ventricles were found to be filled with blood, and in other cases clots were found at the base and even at the cerebro-cerebellar junction. Mention may also be made here of the variations in the location of the stimuable areas (the motor areas), report of which will later be made by one of us (L). Whatever operative technique is used the destructions are varying, and the most that can be expected in these small animals is to operate on sufficient numbers, and to select and compare those cases which have relatively similar lesions. This we have done. In all cases the lesions will be described and the comparison of sets of animals will be made.

When the experimental part of the work was completed the animals were killed and their brains were removed, fixed in 10 per cent formaldehyde, dehydrated, and cut in celloidin. Horizontal sections 80  $\mu$ . in thickness were cut and every tenth section was stained in toluidin blue and mounted in balsam. Each brain was given an arbitrary number and the examination and description of the lesions were made without knowledge of the behavior data, except in the case of the extensive lesions which were recognizable in the sections.

For reconstruction of the lesions serial outline sketches of the sections were made under the projection microscope to show the extent of the lesion visible under low powers of the microscope. The sections were then examined under higher power and the parts which seemed certainly involved in the lesion, either through actual destruction of the cortex or severance from all connection with the descending fiber tracts, were filled in on the sketches. The plane of the sections was determined for each brain by reference to the corpora quadrigemina and knee of the corpus callosum, measurements of the extent of the lesion were made, and these were reduced to the dimensions of the diagram used in case the brain varied from the average. Finally the extent of the lesion was marked on the diagram in the planes of the sections and the areas so outlined were blocked in.

The brains were first turned over to a technician to be sectioned. As a result two brains were lost and several others so badly prepared that accurate reconstructions were impossible. Six brains were sectioned by the technician, the remainder by one of the writers. In the descriptions of the lesions reference is made to well defined land-marks, particularly the limits of the ventricles, the divisions of the corpus callosum, the gyrus hippocampus, and the subcortical ganglia. The relative positions of these structures are shown in the serial sections, figured in plate I, figure 22.

I. THE RETENTION OF A SIMPLE KINESTHETIC-MOTOR HABIT  
AFTER DESTRUCTION OF THE FRONTAL POLE OF  
THE CORTEX

In experiments described earlier (1) a number of animals were trained in the simple maze (fig. 1). An attempt was then

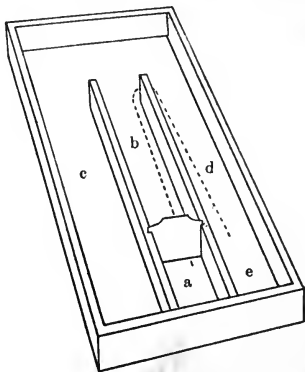

FIG. 1. THE SIMPLE MAZE

*a*, starting compartment; *b*, middle alley; *c*, *cul de sac*; *d*, alley leading to food.

made to destroy the frontal portion of the cortex by transverse incisions through small openings in the parietal bones and as soon as the animals had recovered sufficiently from the operation, usually within forty-eight hours, they were tested for retention of the habit. In thirteen of the fourteen animals that survived the operation there was demonstrated some reten-



tion of the habit, evidenced either by relatively few errors in the first trials of the retention tests or by survival of individual peculiarities of reaction to the maze. Details of these experiments have been given in the earlier paper. The extent of the cerebral lesion has now been determined for each animal and a report of the findings will be given in the first section of this paper.

The experiments are here given the same numbers as in the first article and page references for each experiment are given to facilitate reference to the original description. A brief estimate of the degree of retention is included for each animal with the record of the total number of errors made during the first fifteen trials of training and the first fifteen of the retention tests. This is followed by the description of the lesions.

In the diagrams prepared for this section of the paper we have figured only so much of the lesion as is obvious, either from the total separation of the injured parts from the remainder of the brain, the complete degeneration of the cortex, or the unmistakable section of the descending tracts. In every case it is probable that the lesion affected a much more extensive area than that indicated but it has seemed best to restrict the description to the obvious destructions.

After certain of the animals (experiments 8, 9, 10, 11, 12 and 13) had recovered from the effects of the operation and had given evidence of the retention of the habit a second operation, designed to destroy the temporal or occipital regions, was performed. The description of the second lesion is included with that of the first, in the animals which survived; the effects of the operation will be described in experiment 15.

*Experiment 1* (page 8). Almost perfect retention. Errors: learning 5, retention 1.

Lesion (plate II, fig. 1). There is a transverse cut extending diagonally across both cerebral lobes. From above the knee of the corpus callosum on each side it passes out along the forceps of the callosum to the external capsule and thence to the cortex, 1.5 mm. behind the base of the olfactory bulb. Below, on the left, the lesion extends to the floor of the lateral ventricle, on

the right to the base of the lobe behind the olfactory bulb. Practically all the cortex of both hemispheres lying in front of the knee of the corpus callosum is destroyed by the lesion.

*Experiment 2* (page 8). Partial retention. Errors: learning 8, retention 2.

Lesion. Not enough sections of the brain were preserved for an accurate determination of the extent of injury. Apparently the lesion was superficial, extending over the antero-dorsal surface of the frontal poles.

*Experiment 3* (page 9). Partial retention. Errors: learning 2, retention 4. Secondary evidence of retention.

Lesion (plate II, fig. 3). The brain was imperfectly sectioned. Right hemisphere. There is a transverse section of the hemisphere just in front of the forceps of the corpus callosum, extending from the inner margin of the mesial cortex through the lateral cortex. Left hemisphere. The lesion is similar to that on the right but involves the mesial cortex as well.

The posterior extent of the lesion could not be determined accurately. The destruction was certainly not less than that shown in the figure.

*Experiment 4* (page 9). Partial retention. Errors: learning 21, retention 2.

Lesion (plate II, fig. 4). Right hemisphere. There is a complete transection of the anterior pole in a vertical plane passing through the knee of the corpus callosum. Left hemisphere. The cut is in the same plane as that on the right but penetrates only from the mesial surface to the external capsule and ventrad to the fibers of the peduncle.

*Experiment 5* (page 10). Perfect retention. Errors: learning 19, retention 2.

Lesion (plate II, fig. 5). Right hemisphere. There is a small injury on the mesial surface above the knee of the corpus callosum. Left hemisphere. There is a small cylindrical cyst extending from the dorsal cortex through the knee of the corpus callosum and the cerebral peduncle, severing the fibers coming from the frontal pole.

*Experiment 6* (page 10). Perfect retention. Errors: learning 7, retention 0.

Lesion (plate II, fig. 6). The operation was by a single median opening. There is an extensive destruction of cortex at the opening in the skull and a transverse cut extending ventrad from it past the knee of the corpus callosum, destroying all the cortex lying between and in front of the forceps of the callosum.

*Experiment 7* (page 11). Retention nearly perfect. Errors: learning 11, retention 1.

Lesion (plate II, fig. 7). Right hemisphere. There is a transverse cut extending forward from over the knee of the corpus callosum, through the forceps to the fibers of the peduncle. There is a large cyst in the mesial cortex of the frontal pole. The destruction is probably limited to the dorso-medial surfaces of the lobe. Left hemisphere. The lesion extends from the tip of the frontal pole along the course of the fibers to the end of the forceps, then turns laterad along the external capsule for a short distance and finally out along the course of the radial fibers to the cortex.

*Experiment 8* (page 11). Partial retention. Errors: learning 7, retention 3. The brain was so damaged in sectioning that nothing could be made of the extent of the lesion.

*Experiment 9* (page 12). Nearly perfect retention. Errors: learning 23, retention 2.

Lesion (plate II, fig. 9). Right hemisphere. There is a section of the hemisphere from above the knee of the corpus callosum diagonally forward to the base of the olfactory bulb. The lesion is superficial, destroying chiefly the mesial cortex in front of the callosum and above the olfactory tracts. Left hemisphere. There is a complete transverse section similar to that on the right but extending around onto the orbital surface.

*Experiment 10* (page 12). Nearly perfect retention. Errors: learning 33, retention 2.

Lesion (plate II, fig. 10). Right hemisphere. *First operation.* There is a transverse incision extending ventrad in a plane passing through the end of the forceps of the corpus callosum to the base of the olfactory bulb, destroying all the frontal pole, which is filled by a large cyst, and cutting a part of the olfactory tract. *Second operation.* There is a small incision extending down

from the dorsal convexity through the fornix and internal capsule and penetrating the thalamus in the region of the lateral thalamic nucleus. Left hemisphere. *First operation.* The lesion is similarly placed to that on the right but more superficial, passing just under the cortex through the end of the forceps to the base of the olfactory bulb. It narrows at the base and does not involve the olfactory tracts. The entire pole exclusive of the mesial cortex is destroyed, however. *Second operation.* There is a transverse lesion extending down from the dorsal convexity just in front of the hippocampus, cutting through the fornix and penetrating the crux cerebri for one half its width.

*Experiment 11* (page 12). Perfect retention. Errors: learning 11, retention 1.

Lesion (plate II, fig. 11). Right hemisphere. *First operation.* There is a transverse section of the hemisphere just back of the knee of the corpus callosum and extending diagonally laterad to the cortex along the forceps of the callosum and ventrad to the floor of the lateral ventricle. The ventricle is distended until it occupies one-third of the width of the hemisphere. *Second operation.* There is a superficial incision extending from above the anterior end of the lateral ventricle to the posterior border of the corpus callosum and laterad along the external capsule to the level of the thalamus. There is a large cyst replacing the fibers of the external capsule in the occipital lobe. Left hemisphere. *First operation.* There is a transverse lesion just behind the knee of the corpus callosum extending downward to the level of the fornix. Internally it extends deeper, penetrating the olfactory fibers in the region of the anterior olfactory nucleus. *Second operation.* There is an incision passing in from the cortex to the external capsule near the posterior limit of the first lesion, thence extending backward along the external capsule for an indeterminate distance. The external capsule is largely replaced by a cyst extending into the occipital pole. The frontal poles of both hemispheres were completely severed from the rest of the brain by the first operation.

*Experiment 12* (page 12). Retention perfect. Errors: learning 2, retention 0.

Lesion (plate II, fig. 12). Right hemisphere. *First operation.* There is a transverse incision just in front of the forceps of the corpus callosum severing all of the anterior pole, except the mesial cortex, down to the olfactory tracts. *Second operation.* There is a lesion over the dorsal and orbital surfaces with completely degenerated cortex in the regions indicated in the figure. Left hemisphere. *First operation.* There is a lesion extending from the end of the forceps of the corpus callosum to the mesial cortex and ventrad into the olfactory fiber tracts. All of the mesial cortex anterior to the knee of the callosum is destroyed but little injury has been done to that of the lateral face of the anterior pole. *Second operation.* There is a lesion over the dorsal and orbital surfaces of the hemisphere extending along the fibers of the external capsule over the area indicated, with complete degeneration of the overlying cortex.

*Experiment 13* (page 12). Retention nearly perfect. Errors: learning 3, retention 0.

Lesion (plate II, fig. 13). Right hemisphere. *First operation.* There is a complete transverse section of the anterior pole through the end of the forceps of the corpus callosum to the level of the olfactory tracts. *Second operation.* There is a lesion extending from the first backward along the external capsule to the posterior border of the hippocampus, narrowing forward below at the level of the lateral ventricle. All the cortex overlying the lesion is completely degenerated. Left hemisphere. *First operation.* Transverse section of the anterior pole extending downward to just above the level of the olfactory tracts. *Second operation.* There is a longitudinal incision extending backward in the external capsule from the first lesion to the posterior edge of the hippocampus, covering the entire orbital surface down to the olfactory cortical funiculus. All the overlying cortex is degenerated.

*Experiment 14* (page 13). No retention. The animal developed hemiparesis and was stuporous.

Lesion. An invasion of the thalamus by an extensive clot was determined by gross dissection.

Of the fourteen animals described in this series thirteen gave

some evidence of the retention of the habit. An exact estimation of the individual degree of retention is precluded by the simplicity of the habit and the different extents to which the animals showed shock effects of the operation. Since all the animals with lesions restricted to the frontal regions retained the habit wholly or in part and since the lesions were for the most part incomplete the first question that arises is whether or not any particular area in the frontal region was left intact in all the animals. The combined extents of the lesions in this series are shown in figure 2. The entire frontal pole of each hemisphere extending down to the olfactory tracts was destroyed in one or another of the animals. No one part of the frontal pole remained undestroyed in all. It seems, then, that no particular part of the frontal pole of the rat's cortex is necessary for the

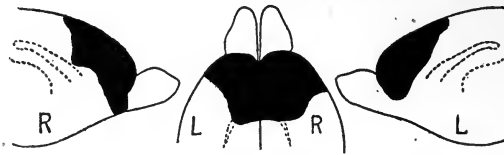

FIG. 2. TOTAL EXTENT OF INJURIES TO CORTEX IN ANIMALS DESCRIBED IN SERIES I

All parts of the cortex anterior to the knee of the corpus callosum have been destroyed.

retention of the maze-habit; there is no specialized region concerned with the maze-habit which has a uniform position for all animals. Furthermore, in some of the animals (experiments 1, 3, 4, 10 and 11), there was an almost complete destruction of all the cortex above and in front of the knee of the corpus callosum so that it seems very probable that no part of the frontal region of the rat's brain is concerned with the retention of the maze-habit.

A number of attempts have been made to find some correlation between the extent of lesion in these cases and the accuracy of performance in the retention tests but no such correlation seems to exist. Both animals with extensive and those with slight lesions made perfect records in the retention tests

and others with almost identical lesions made several errors. This lack of relation between the extent of frontal lesion and the degree of retention provides further evidence that the functioning of the maze-habit is independent of the frontal region of the cortex.

## II. THE RETENTION OF THE MAZE-HABIT AFTER FRONTAL AND TEMPORAL OR FRONTAL AND OCCIPITAL LESIONS

*Experiment 15.* After retention had been tested in the animals described in experiments 8, 9, 10, 11, 12 and 13 they were allowed to rest for two weeks and then were retrained for twenty-five trials, showing practically no loss of the habit in this time. They were next subjected to a second operation. In three, an incision was made from the locus of the first operation backward



FIG. 3. TOTAL EXTENT OF THE LESIONS IN ANIMALS OF SERIES II, WHICH RETAINED THE MAZE-HABIT AFTER THE SECOND OPERATION

on both sides for a distance of 5 mm. In the other three the scalpel was passed almost horizontally backward through the cortex of the dorsal convexity from the region of the first lesion to the tentorium. Three of these animals survived, one after occipital lesion (11) and two after temporal lesion (10 and 12). The lesions have been defined in the descriptions of these animals and figured in plate II, figures 10, 11, and 12. The combined extent of the lesions is shown in figure 3.

All three animals showed perfect retention of the habit after the second operation. They were each given fifteen trials in the maze on the day following the second operation, and ten trials on the second day. Number 10 averaged 2.5 seconds per trial in these twenty-five trials and made only one error. Number 12 averaged 2.6 seconds and made one error in the same number

of trials. Number 11 was slower and required an average of 9.0 seconds per trial but did not make a single error or react in any way to the entrance to the *cul de sac* in twenty-five trials.

After the first operation all these animals had shown a perfect retention of the habit, in spite of a practically complete destruction of the frontal poles of both hemispheres. The second operation probably did little additional harm to number 10 beyond cutting the fimbria on both sides. In number 12, however, large areas on the dorsal and orbital surfaces of both hemispheres were destroyed. In number 11 practically all the dorsal and lateral surfaces of the cortex overlying the gyri hippocampi and between them and the frontal poles was destroyed.

The effects of the first operation, taken in conjunction with the other experiments of the same series, indicate rather clearly that the persistence of the habit was not conditioned by the functional integrity of the frontal pole. The second operation resulted in the elimination of not less than half of the cortex of the dorsal convexity and the combined destruction resulting from all the operations performed on these animals, certainly includes not less than two thirds of the cortex, leaving only the occipital regions, the ventral surface, and the gyri hippocampi intact. We are justified in concluding therefore that no part of the cortex in front of the caudal end of the corpus callosum and above the level of the floor of the lateral ventricles is concerned with the retention of simple kinesthetic-motor habits.

#### *Experiments with the inclined-plane box*

The simple maze offered some disadvantages for a study of retention owing to the fact that it did not require a reaction that was sufficiently well defined to be certainly recognizable in the retention tests. It seemed best therefore to use some more complex habit in the later experiments for the sake of getting a more clearly defined series of activities and also with the possibility that the more complex habit, involving different types of reaction, might reveal a selective effect of the cerebral lesion upon certain types of activity. The inclined-plane box (2) was



finally selected as combining a fairly specific reaction to a definite series of stimulating objects with relatively complex kinesthetic-motor habits. In order to complicate the kinesthetic habits somewhat and allow of greater individual variation than is possible in the usual type of this problem-box, the design shown in figure 4 was adopted. The problem-box consists of a wire covered rectangular frame-work having a door (*D*), held open by a pair of flat brass springs, compressed between the door

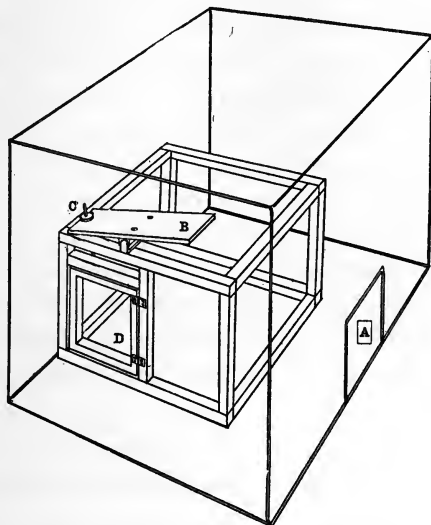

FIG. 4. THE INCLINED PLANE BOX

*A*, door of restraining cage; *B*, inclined plane; *C*, catch extending down to upper edge of door, *D*, door leading into food-box.

and its frame. On top of the box, above the door is a board (*B*), supported in the middle by a metal fulcrum and weighted so that the end *C* is slightly heavier than the other. From the board an adjustable metal rod (*C*) extends through the top of the box to the door and serves as a latch to hold it closed. A pressure of from 50 to 75 grams at the free end of the plane (*B*) is required to tilt it and release the door. This, the food-box, is enclosed in a larger restraining cage having a door at *A* and is pushed against the side of the restraining cage opposite

the door so that only three sides are exposed. The animal, introduced into the restraining cage through the door (*A*) must climb to the top of the food-box, push down the outer end of the plane (*B*) for a distance of half an inch until the door springs open, then climb down and enter the door to get food. A momentary pressure is not sufficient to depress the plane and the animal must maintain the full pressure while the plane is moving down. The fact that he must climb upon the food-box makes possible a variety of ways of approaching the plane and the development of individual peculiarities of reaction.

The methods of training were those generally employed in experiments with similar apparatus. The animals, unless much weakened by loss of blood, were fed only in the food-box after the conclusion of the day's tests. Five trials were given daily.

Records were made for each trial of the time required by the animals to reach and push down the plane, and separate records of the time taken in going from the plane to the food after the plane had been tripped. Extensive notes were made of individual peculiarities in the path followed to the plane, of the method of pushing it down, and of the path followed from the plane to the food.

### III. THE RATE OF LEARNING AFTER INJURY TO THE FRONTAL POLE

*Experiment 16* As a preliminary test of the ability of the animals to form complex habits after the destruction of the frontal pole of the cortex a group of six animals which had been used to experiments on the maze (experiments 1, 2, 3, 4, 6 and 7) and had fully recovered from the operation was trained on the inclined plane, described and figured above. Their behavior when placed in the restraining cage was in all respects normal and they learned the problem at a practically normal rate. Their rate of improvement in the average time required for tripping the latch is compared in figure 5 with that of an equal number of normal animals trained under identical conditions. The actual time consumed in learning was somewhat less than that required by normal animals; their methods of learning were the

same and their final efficiency was as great as that of any normals. Their quicker time on the first trials is probably due to the fact that they had been handled a great deal and were more accustomed to the experimenter than were the normal animals.

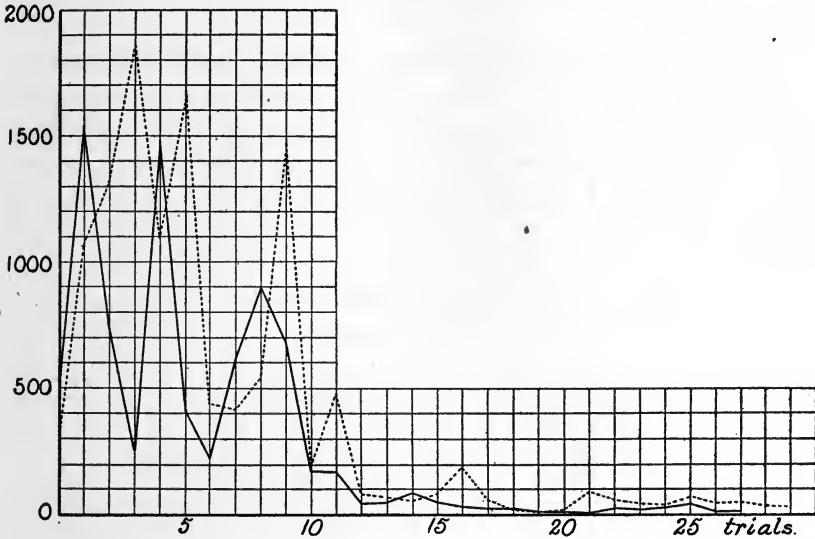

FIG. 5. A COMPARISON OF THE RATE OF LEARNING THE INCLINED PLANE BOX BY NORMAL ANIMALS AND BY ANIMALS AFTER INJURY TO THE FRONTAL AREAS

Six animals are included in each group. The average time in seconds per trial is plotted. Normal rats: - - - - -. Operated rats: \_\_\_\_\_.

The extent of the lesions in these animals is shown in plate II, figures 1, 3, 4, 6 and 7. The combined extent of the lesion is shown in figure 6. Practically every part of the anterior pole of the cortex in front of the knee of the corpus callosum



FIG. 6. TOTAL EXTENT OF LESIONS IN ANIMALS WHICH LEARNED THE INCLINED PLANE BOX AFTER OPERATION

was destroyed in one or another of these animals without interfering in any way with the formation of the relatively complex habit. In numbers 3, 6 and 7 the lesions were small but in numbers 1 and 4 there was a loss of practically the entire frontal pole of both hemispheres without a correlated reduction of the learning ability.

It seems quite certain, therefore, that no particular part of the anterior third of the cortex of the white rat is necessary for the formation of a complex kinesthetic-motor habit and, from the condition in numbers 1 and 4, that the entire frontal region of the cortex may be dispensed with without any reduction of the ability to learn.

#### IV. RETENTION OF THE INCLINED-PLANE HABIT AFTER CEREBRAL LESIONS

Earlier experiments with the higher mammals indicate that learning may take place in the absence of parts of the cortex which are normally functional in habit formation. Thus, Franz (3) has found that the destruction of the frontal lobes in the cat and monkey is followed by the loss of recently formed habits but that the habits can be immediately reacquired and that the rate of learning is practically the same as before the loss of these areas. The ability of the animals described in series III to learn the inclined plane problem does not, therefore, preclude the possibility that the frontal region of the cortex is normally functional when present. To test this a series of normal animals were trained on the inclined plane box, then operated upon to destroy the frontal areas, and tested for retention of the habit. Seventeen animals survived the operation and were tested thoroughly for retention or relearning of the habit.

In three animals the lesions were restricted to the dorsal and temporal regions, first to test the relation of these parts to the functioning of the habit, second, as a control of the effects of operative shock.

No final criterion of learning was adopted, but the animals

were not operated upon until they had several times tripped the plane and gone to the food without excess movements. This required from 25 to 45 trials. A part were overtrained for a time about equal to that required for learning, receiving a total of from 75 to 115 trials.

*Operation without injury to the brain*

*Experiment 17.* Two trephine holes were made in the skull of an old female just back of the fronto-parietal suture and these were enlarged with bone forceps to a diameter of about 5 mm. on either side. The scalp was then sewn up without further injury to the brain than was necessary in making the openings. In training the animal had been given 100 trials on the inclined box. Her average time per trial was for the first five trials; to plane, 1025 seconds; to door, 26 seconds. For the last five trials the averages were: to plane, 9.4 seconds; to door, 2.0 seconds.

Retention was tested on the second day after the operation. The average time per trial was: to plane, 46 seconds; to door, 9.2 seconds. Her reactions were unhesitating. The path followed from the door to the plane was direct and the plane was the only object in the restraining cage which excited more than a momentary reaction. In every trial the animal sprung the plane by standing beside it and pushing down upon its outer end with her fore feet. The slight increase in time over the last trials preceding the operation is due to a slower rate of movement and not to any increase of exploratory movements.

Autopsy showed small adhesions of the convexity of the hemispheres at the region of the trephine openings. The extent of the lesions is shown in plate III, figure 17.

*After opening of the skull and exposure of an area of the cortex as great as that involved in the greater number of the experiments here described, this animal showed perfect retention.*

*Temporal lobes destroyed*

*Experiment 18.* A large opening, 2 by 5 mm. was made on each side of the skull just back of the fronto-parietal suture of a medium sized female rat, 140 days old. Through these the scalpel was passed to destroy the temporal lobes. The animal had been trained on the inclined-plane box for 115 trials. The average time per trial for the first five trials was: to plane, 2719 seconds; to door, 61 seconds. That for the last five trials was: to plane, 34 seconds; to door, 2.2 seconds.

Retention was tested on the second day after the operation, when the animal was active and in good condition. The average time for the nine trials given on this day was: to plane, 22 seconds; to door, 11 seconds. Her specific reactions were wholly confined to the plane and door. On different trials she approached the plane from different directions, but always tripped it in the same way, by pushing down on its outer end with her fore feet, and in every trial except the first she went directly from the plane to the door of the food-box.

Extent of lesions (plate III, fig. 18). Right hemisphere. There is a large lesion on the dorsal convexity including almost all the cortex dorsal and lateral to the gyrus hippocampus, extending from near the longitudinal fissure, over the convexity and down over the temporal lobe to the level of the posterior horn of the lateral ventricle, following the course of the external capsule.

Left hemisphere. The lesion on the dorsal convexity is similar to that on the right. It extends downward around the antero-lateral face of the gyrus hippocampus and thence forward through the lateral face of the corpus striatum.

*After a bilateral lesion destroying most of the cortex lying dorsad and laterad to the gyri hippocampi the motor habit previously established was retained.*

*Experiment 19.* In the skull of a small female, 148 days old, two trephine holes were made about three millimeters back of the fronto-parietal suture. The scalpel was passed back from these to destroy the temporal lobes. The animal had been

trained on the inclined-plane box for 75 trials. The average time per trial for the first five trials of learning was: to plane, 916 seconds; to door, 85 seconds. The average for the last five trials was: to plane, 2.8 seconds, to door, 2.2 seconds.

Retention was tested on the second day after the operation. At this time the animal was active and showed no abnormal symptoms. She was given ten trials on this day with the following average time per trial: to plane, 51 seconds; to door, 14 seconds.

The animal's behavior toward the problem box was in all respects normal. Her exploratory movements were restricted to the plane and in seven of the trials she tripped the catch by pushing the plane down with her fore feet, a stereotyped method which she used before the operation.



FIG. 7. TOTAL EXTENT OF LESIONS IN THE CONTROL ANIMALS (EXPERIMENTS 17, 18 and 19)

Lesion (plate III, fig. 19). Right hemisphere. There is an extensive lesion of the cortex extending from the anterior border of the hippocampus to the knee of the corpus callosum and narrowing rapidly as it extends laterad on the orbital surface. It is continued over the orbital surface as a lesion of the external capsule around the upper half of the corpus striatum with degeneration of the overlying cortex.

Left hemisphere. There is a lesion similar to that on the right over the dorsal convexity but it is broader over the temporal region and extends downward only to the upper level of the lateral ventricle.

*This animal, after the destruction of the cortex over the temporal and a portion of the orbital surface of both hemispheres, showed no deterioration of the habit previously formed.*

The perfect retention of the habit by these three animals

shows that any loss of the habit shown in other animals is probably not the result of operative shock but must be ascribed to the actual brain injury acting either locally in the operative field or extending by hemorrhage or intracranial pressure to other regions. The extensive destruction of the temporal surfaces of the cortex in experiments 18 and 19 shows that these areas play no important part in the retention of the habit. Figure 7 shows the combined extent of the lesions in these animals.

*Frontal region destroyed: animals showing retention after operation*

*Experiment 20.* Two trephine holes were made through the calvarium of a large female rat, 140 days old, and a transverse incision was made through the frontal pole of each hemisphere. The animal had been trained for 35 trials on the inclined plane box. The average time required for the first five trials was: to plane, 123 seconds; to door, 42 seconds. The average time required for the last five trials was: to plane, 13 seconds; to door, 3 seconds.

Retention was tested twenty-four hours after the operation but the animal was stuporous and did not react to the problem box. On the following day she opened the food-box three times. Her movements were slow and much time was spent in scratching at the dressing on her scalp. There were, however, few random movements and except for the diversions incident to this scratching, she kept closely to the direct path from the door to the plane and from the plane to the food. Her method of tripping the catch before the operation had been to walk to the back of the plane and, standing either on or beside it with her hind feet, to reach out to its outer end with her fore feet and push down, gradually throwing her weight forward on her fore feet. This same method was used throughout the trials following the operation, but the movements involved were carried out with greater inaccuracy than before. In some trials she went from the plane to the door without making any attempt to push the former; in others she pushed, but did not wait for the catch to spring.



During the first days of the retention tests she frequently leaped into the air, whirled through 180 degrees, and snapped her jaws repeatedly, or at other times spun about in a similar manner and bit her own tail. Another movement which occurred frequently was a sort of scampering, a series of short leaps which did not carry her forward more than a few inches. These movements, as well as the inexactness of the reactions to the plane served to prolong the time and make it less comparable with the time of learning. Training was continued for 45 trials after the operation. The average time for the first five trials of the retention tests was: to plane, 63 seconds; to door, 23 seconds. The rate of improvement was more uniform and at first more rapid than that observed during learning, but the time required for springing the catch was not reduced so low as it had been before the operation. The rate of learning and of improvement in the retention tests are shown in figure 8, where the total time required for successive groups of five trials is plotted.

Lesions (plate III, fig. 20). Right hemisphere. There is a transverse lesion on the anterior convexity, passing forward along the fibers of the callosum and through the end of the forceps of the callosum to the base of the olfactory bulb, completely separating the frontal pole.

Left hemisphere. The lesion is quite similar to that on the right but does not extend quite to the olfactory bulb and preserves the greater part of the mesial face of the frontal pole.

*After nearly complete destruction of the frontal poles of both hemispheres this rat retained her previous method of tripping the catch. There was, however, some inaccuracy of movement indicating a partial loss of the habit.*

*Experiment 21.* The frontal pole of the cortex was destroyed in a small female, 130 days old. She had been trained for 40 trials on the inclined-plane box. The average time required for the first five trials was: to plane, 618 seconds; to door, 74 seconds. The average time required for the last five trials was: to plane, 5.2 seconds; to door, 1.8 seconds.

Retention was first tested on the day following the operation.

The animal was stuporous and did not react to the problem situation. On the following day she was active and gave evidence of hunger. She was given five trials on this day and five trials per day thereafter for 8 days. The average time per trial for the first five trials of the retention tests was: to plane, 81 seconds; to door, 42 seconds. In the tests on the first day she used no uniform method of springing the plane; she once pulled

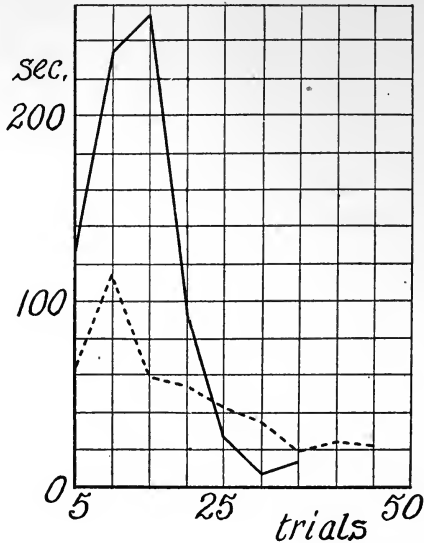

FIG. 8. RATE OF IMPROVEMENT IN TRAINING AND RETENTION TESTS. THE AVERAGE TIME PER SUCCESSIVE FIVE TRIALS IS PLOTTED FOR EXPERIMENT 20

Learning ———; Retention - - - -

it up from behind, once jumped up on it from in front of the food box, once walked straight across it from the back of the box, and twice walked out on it from the rear. After the fourth trial she adopted this latter method and used it uniformly in succeeding trials, varying the method only rarely by pushing down the plane with her fore feet. In the learning trials she had uniformly climbed up from the rear of the box and tripped the catch by pushing the plane down with her fore feet.

The curves of the learning and retention tests are given in figure 9. It is evident that very much less time was required for the solution of the problem at the beginning of the retention tests than at the beginning of learning, but that improvement was relatively slower. Apparently the plane retained a certain stimulatory value, much like that which it acquires in the early stages of learning, but did not at first call out the appropriate reactions for getting food.

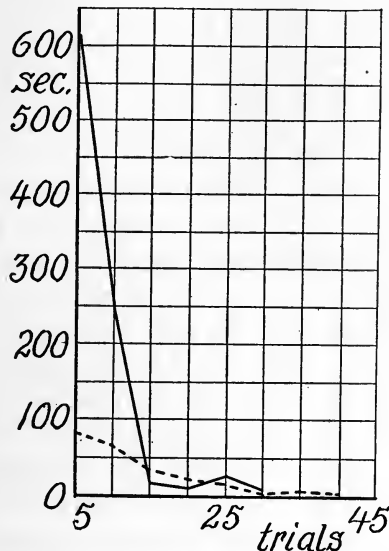

FIG. 9. RATE OF IMPROVEMENT IN TRAINING AND RETENTION TESTS FOR EXPERIMENT 21

Arranged as figure 8

Lesions (plate III, fig. 21). Right hemisphere. There is a transverse lesion extending from just behind the knee of the corpus callosum laterad to the cortex and diagonally ventrad through the base of the olfactory bulb. The greater part of the mesial face of the frontal pole is intact but there is a probable destruction of all the antero-lateral area.

Left hemisphere. There is a transverse lesion extending from the anterior horn of the lateral ventricle along the forceps of

the corpus callosum to the external capsule and downward to the floor of the ventricle. It probably involves very little destruction. There is also a lesion extending into the mesial cortex just back of the knee of the corpus callosum, destroying a small area. There is a partly absorbed clot in the third ventricle.

*In this animal three-fourths of the cortex on one frontal pole and about one-eighth on the other were destroyed. The habit was partly retained. The reactions after the operation resembled those appearing in the early stages of learning before a stereotyped mode of solving the problem has been acquired.*

*Experiment 22.* Transverse incisions were made in the frontal areas of the cortex of a large male, 140 days old, through two trephine holes in the temporal regions. The animal had been trained for 40 trials on the inclined plane box. The average time per trial required for the first five trials of training was: to plane, 330 seconds; to door, 38 seconds. The average time per trial for the last five trials was: to plane, 6.6 seconds; to door, 3.2 seconds.

Retention was tested on the day following the operation but the animal was stuporous and did not attempt to climb upon the food box. On the third day he climbed upon the box but got down immediately and remained quiet in a corner for 20 minutes. On the fourth day after the operation he climbed on the box and fell off, striking the back of his head and lying stunned for 30 seconds. When he recovered he climbed up on the box, walked out on the plane from the rear and then went directly to the food. The remaining trials were made quickly. The average time for the first five trials, exclusive of the one in which the fall occurred was: to plane, 45 seconds; to door, 5.6 seconds. The tests were continued for 30 trials, which are compared with the first practice series in figure 10. In the first tests he made frequent trips from the plane to the door and made few pauses at other parts of the restraining cage. In later practice he acquired the habit of jumping up from the door to the back of the plane, then walking out to the free end of the plane. This was not the most frequent method that he had employed during learning.

Like the animal in experiment 21 he seemed to retain a general response to the region of the plane but to have lost the specific reactions used in springing it.

Lesion (plate III, fig. 22). Right hemisphere. There is a vertical transverse lesion extending downward from the anterior horn of the lateral ventricle to the cerebral peduncle, without

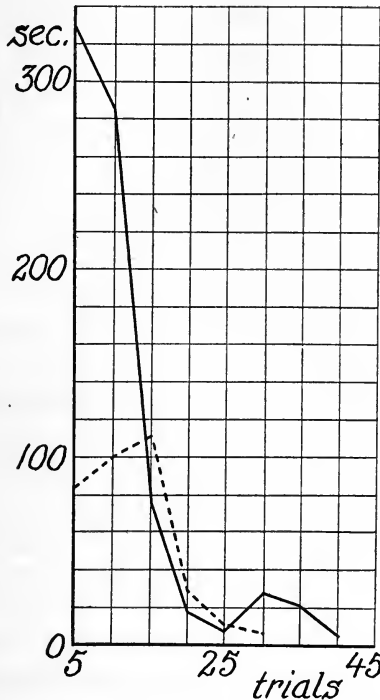

FIG. 10. RATE OF IMPROVEMENT IN TRAINING AND RETENTION TESTS FOR  
EXPERIMENT 22  
Arranged as figure 8

involving this, however. On the antero-dorsal convexity there is a lesion corresponding to the trephine opening, with the cortex cephalad to it somewhat degenerated. The deeper lesion involves little destruction, as the cut follows the course of the fibers.

Left hemisphere. The lesion on the dorsal convexity is somewhat larger than that on the right. There is a large cavity

in the region of the external capsule opposite the corpus striatum with degeneration of the fibers and cortex laterad to it, and invasion of the cerebral peduncle in the region receiving fibers from the mesial surface of the frontal pole.

*Bilateral destruction of the cortex above the knee of the corpus callosum with degeneration on the orbital and mesial surfaces of the left hemisphere was followed by a partial loss of the habit including the definite mode of depressing the plane.*

*Experiment 23.* The frontal areas of the cortex were transected through two trephine holes in a small male rat, 149 days old. He had been trained previously on the inclined-plane box for 100 trials. The average time for the first five trials of practice was: to plane, 332 seconds; to door, 48 seconds. The average time for the last five trials was: to plane, 10.2 seconds; to door, 2.2 seconds. During the training he developed an absolutely stereotyped method of tripping the plane. He ran first to the door, jumped up from there upon the food box in such a way as to alight upon the free end of the plane, turned and jumped down to the floor in front of the door and went in to the food.

Retention was first tested on the second day after the operation. The animal was fairly active, sniffed at the door of the food box and stood up and sniffed the plane repeatedly but made no effort to get upon the box in thirty minutes. On the fifth day after the operation he first showed marked activity comparable to that of a normal animal. For the first four trials he climbed to the top of the box always from the door, but gave no specific reaction to the plane, in each case pushing it down apparently by chance and using a different method each time. On the fifth trial he went first to the door, jumped up upon the lower end of the plane, then turned quickly and jumped down to the door. This was repeated five times before he alighted on the outer end of the plane. During the next ten trials he invariably jumped up from the front of the box to the plane, and then down to the door again, repeating this performance as often as fifteen times in a single trial before he alighted on the free end of the plane. This was due in part to

the fact that he was too weak to jump the full distance readily and usually jumped from near the side of the restraining cage, catching its wires if he fell short. In the repeated failures to open the door by jumping up at this place a new method of working the plane was gradually evolved; he came to scramble up over the lower end of the plane, turn and push down on its free end until the door opened.

The average time per trial for the first five trials of the retention tests was: to plane, 176 seconds; to door, 13 seconds. The relations of the practice curves of learning and retention are practically the same as for those shown in experiments 20, 21, and 22.

Lesion (plate III, fig. 23). Right hemisphere. There is a transverse incision extending cephalad from above the hippocampus through the lateral ventricle and caudal end of the corpus striatum to the peduncle. The internal capsule and the fibers of the peduncle are uninjured, so that the lesion probably involves little more than the superficial areas through which the knife passed. This includes the greater part of the cortex above the corpus callosum and a narrower band extending down over the orbital surface.

Left hemisphere. There is a transverse lesion extending from above the anterior border of the hippocampus to the base of the olfactory lobe, transecting the corpus striatum and completely severing the portion of the cortex lying cephalad to it.

*Destruction of all of the left frontal region and the temporal region of the right was followed by the retention of the stereotyped mode of reacting to the problem box but with inaccuracies of adjustment which resulted in the acquirement of a new mode of response.*

*Experiment 24.* The frontal poles of both hemispheres of a medium sized female rat, 147 days old, were incised through large trephine holes, well back of the fronto-parietal suture. She had been trained previously for 75 trials on the inclined-plane box. The average time per trial required for the first five trials of training was: to plane, 2422 seconds; to door, 23

seconds. The average time for the last five trials was: to plane, 15.4 seconds; to door, 2.4 seconds. Retention was tested on the second day after the operation. She reacted promptly to the problem-box situation, never pausing except at the door and at the plane. She tripped the plane by one of two methods; either she jumped up from in front of the door so that her hind feet struck the free end of the plane, or, this method failing, she turned and pushed the plane down with her fore feet. These were the methods used before the operation. The average time required for the first five trials of the retention tests was: to plane, 37.6 seconds; to door, 9.6 seconds.

Lesion (plate III, fig. 24). Right hemisphere. There is a small lesion on the antero-dorsal convexity corresponding to the extent of the opening of the skull. From this a transverse cut extends ventrad through the union of the forceps of the corpus callosum with the external capsule to the base of the olfactory bulb. Its effects are limited to the lateral face of the cortex where there is a narrow degenerated area along the edges of the cut, widening on the orbital surface.

Left hemisphere. The lesion is almost identical with that on the right but less extensive on the orbital surface.

*Destruction of the antero-lateral faces of the cortex in this animal resulted in practically no loss of the habit.*

*Frontal region destroyed: animals showing questionable retention after operation*

*Experiment 25.* The frontal poles of the cerebrum of a small male rat, 143 days old, were destroyed by incisions through two large openings in the parietal bones, 5 mm. back of the fronto-parietal suture. The animal had previously been given 45 trials in the inclined-plane box. The average time required for the first five trials was: to plane, 575 seconds; to door, 40 seconds. The average time for the last five trials of training was: to plane, 9.6 seconds; to door, 2.8 seconds.

Retention was first tested on the fourth day after the operation as the animal was quite stuporous up to this time and had to be fed by hand. On this and the following day he moved



slowly about the floor of the restraining cage but made no attempt to climb up to the plane in more than an hour. On the following day he was more active but gave marked fear reactions, squeaking and jumping blindly against the sides of the cage when touched and biting at the experimenter's hands or at his own feet when he was picked up. This behavior persisted for four days, then he became more normal and on the eighth day after the operation he solved the problem box five times. On the following day he was spastic and on the tenth day after the operation died. His average time per trial on the five successful trials was: to plane, 138 seconds; to door, 50 seconds. At no time in the retention tests did the plane seem to have any more intense stimulating value than other parts of the problem situation. The only evidence for retention is the short time required for solving the problem, and this may be merely a chance variation.

Lesion (plate III, fig. 25). Right hemisphere. There is a lesion over the dorsal surface of the gyrus hippocampus, extending cephalad along the roof of the lateral ventricle, then ventrad through the knee of the corpus callosum, transecting the corpus striatum and extending to the base of the hemisphere. A large cyst has been formed filling the greater part of the frontal pole and the anterior half of the corpus striatum is degenerated.

Left hemisphere. There is a large pit on the dorsal convexity, extending down around the gyrus hippocampus and a transverse incision extending from this through the anterior horn of the lateral ventricle to the base of the olfactory bulb, completely severing the anterior pole.

*After practically complete destruction of the anterior third of both hemispheres this animal succeeded in solving the inclined-plane problem in considerably less time than that usually required by normal individuals and in less than one fourth of the time which he took for an equal number of trials in the initial training.*

*Experiment 26.* The frontal poles of both hemispheres of a small male rat, 143 days old, were incised through large openings in the parietal bones. He had been trained on the inclined-plane box for 40 trials. The average time required per trial

for the first five trials was: to plane, 721 seconds; to door, 35 seconds. The average time per trial for the last five trials was: to plane, 5.4 seconds; to door, 2.4 seconds.

Retention was tested first four days after the operation. The animal was still stuporous and on this and the following day made no attempt to get upon the food box. On the seventh day after the operation he ran actively back and forth from the door to the back of the food box and tripped the plane twice by climbing up over it from the door. On the following day he was stuporous but on the ninth day he solved the problem five times quite rapidly. Thereafter he became progressively worse and died on the fourteenth day after the operation.

The average time per trial for the first five trials of the retention tests was: to plane, 179 seconds; to door, 26 seconds. This is less than one fourth of the time required for the first five trials of training and indicates some degree of retention although no specific habits of reaction to the plane which had been noted before the operation were observed to persist.

Lesion (plate III, fig. 26). Right hemisphere. There is a transverse lesion extending diagonally forward and downward from just above the hippocampus through the lateral ventricle to the base of the olfactory bulb. The corpus striatum is cut in two transversely. The entire frontal pole is probably non-functional.

Left hemisphere. The lesion is very similar in form to that on the right but penetrates less deeply toward the mesial surface and probably leaves the mesial cortex functional.

*After extensive destruction of the antero-lateral regions of both hemispheres this animal gave no indication of the retention of specific habits of reaction to the plane. However, even though he was stuporous for much of the time, he required only one fourth as much time for the retention tests as for corresponding tests in initial learning.*

*Frontal pole destroyed: animals in which the habit was lost but reacquired after operation*

*Experiment 27.* The frontal poles of the cortex were incised in a small female rat, 145 days old, through two trephine holes at the frontal-parietal suture. The animal had been given 30 trials on the inclined-plane box. The average time required for the first five trials was: to plane, 396 seconds; to door, 23 seconds. The average time per trial for the last five trials was: to plane, 24 seconds; to door, 4.0 seconds. The animal was very weak from the operation and could not be tested for eight days. On the ninth and tenth days she was very spastic and remained motionless in the restraining cage. On the eleventh day she first tripped the catch and on the following days improved considerably in the directness of her approach to the plane but never reached her previous efficiency. Throughout the period of retraining she remained spastic and lost weight rapidly. During the first trials of retraining there was never any indication of the retention of any specific mode of reacting to the problem box. The average time per trial for the first five trials of the retention tests was: to plane, 599 seconds; to door, 65 seconds.

Lesion (plate III, fig. 27). Right hemisphere. There is a transverse section passing over the anterior face of the gyrus hippocampus, through the lateral ventricle to the base of the hemisphere, separating all parts of the cortex in front of the anterior horn of the lateral ventricle. The corpus striatum is completely destroyed and the lesion extends caudad from it along the external capsule to the hippocampus, with degeneration of all the cortex laterad to it.

Left hemisphere. The lesion is less extensive, passing ventrad just behind the knee of the corpus callosum to the base of the olfactory bulb and out diagonally through the anterior end of the corpus striatum to the cortex, severing the anterior pole.

*The destruction of the anterior poles of both hemispheres, of part of the orbital surface of one hemisphere, and of all of one and part of the other corpus striatum was followed by a persistent spas-*

*ticity and by a complete loss of the motor habit. The habit was reacquired with normal rapidity at first but a normal degree of proficiency was not attained.*

*Experiment 28.* The frontal poles of the cortex were destroyed in a large male, 140 days old. He had been trained on the inclined-plane box for 30 trials. The average time per trial was for the first five trials: to plane, 2594 seconds; to door 224. That for the last five trials was: to plane, 22.0 seconds; to door, 1.6 seconds.

Retention was tested on the day following the operation but no approach to normal activity was obtained until the third day. He then tripped the plane three times, requiring an average time of: to plane, 493 seconds; to door, 79 seconds. For the following week he did not get upon the food box in a total of six hours spent in the restraining cage. He then became active again and eventually learned the problem, requiring about the same time as in the initial practice to reduce his average time to less than 30 seconds. In the early trials of the retention tests there was no uniformity in the method of tripping the plane and there was never any indication of the retention of a specific habit of reaction.

Lesion (plate III, fig. 28). Right hemisphere. There is a lesion of the dorsal convexity over the gyrus hippocampus and extending forward around the anterior surface of the hippocampus, along the roof of the lateral ventricle and ventrad in front of the knee of the corpus callosum through the peduncle, severing the frontal pole. The entire lobe in front of the corpus striatum is degenerated and filled by a large cyst.

Left hemisphere. The lesion is similar to that on the right, but extends farther back along the external capsule, with degeneration of a part of the orbital cortex. Only the outer half of the peduncle is injured so that the mesial surface of the lobe is probably functional.

*After almost total destruction of both anterior poles of the cortex in front of the corpora striata this animal completely lost the habit of the inclined-plane box, but acquired it again in about the same time as was required for initial learning.*

*Frontal pole destroyed: animals which lost the habit after operation and failed to acquire it again*

*Experiment 29.* The frontal poles of both hemispheres were incised in a large male rat, 155 days old. He had been trained for 85 trials on the inclined-plane box. The average time per trial for the first five trials was: to plane, 2311 seconds; to door, 51 seconds. That for the last five trials was: to plane, 8.9 seconds; to door, 2.8 seconds.

The animal was tested daily for a week after the operation but did not once get on top of the food box. His activity was equal to that of a normal animal but was confined to a few stereotyped movements. He spent a great deal of time in climbing up the sides of the restraining cage and pushing against the wire top with his nose. This was gradually replaced by a rapid pacing around the food box from the door to the back and to the door again, interspersed with long pauses in front of the door of the food box, which continued day after day without variation. There was no indication of the retention of any part of the habit.

Lesion (plate III, fig. 29). Right hemisphere. There is a lesion through the lateral ventricle, passing laterad through the posterior third of the corpus striatum to the cortex and ventrad through the peduncle. There is a second lesion over the frontal pole with complete degeneration of the cortex and formation of a cyst. It is probable that the section of the cerebral peduncle destroyed the lower connections of all the frontal region.

Left hemisphere. There is an extensive superficial lesion over the convexity of the frontal pole with a transverse cut extending laterad from the lateral ventricle to the cortex in front of the corpus striatum, following the course of the fibers and probably doing very little damage.

*After a complete section of one cerebral peduncle, destruction of the frontal pole on that side, and destruction of half the cortex of the frontal region on the other side this animal gave no evidence of retention of the habit, and failed to reacquire it within the limits of the experiment.*

*Experiment 30.* The frontal poles of the cortex of a medium sized male rat, 140 days old, were transected with a spear-pointed needle, introduced through small trephine holes in the parietal bones just behind the fronto-parietal suture. The animal had been trained for 25 trials on the inclined-plane box. The average time per trial for the first five trials was: to plane, 3382 seconds; to door, 39 seconds. That for the last five trials was: to plane, 43.0 seconds; to door, 10.4 seconds. During training the animal developed an easily recognizable method of springing the plane. He regularly placed his right fore foot on the end of the plane and kept it there while he thrust his nose under the plane. In this position his weight was supported largely by the right fore foot and the end of the plane was pulled down.

Retention was tested first on the second day after the operation while the animal was still weak and stuporous. He moved about slowly, smelling in the corners of the restraining cage and once crossed the top of the food box but gave no specific reaction to the plane. He was tested daily for thirty minutes thereafter for fourteen days. For the first three days he was very active and quite wild, squeaking and jumping whenever touched; later he became tame but rarely moved away from the door of the restraining cage.

Lesion (plate III, fig. 30). Right hemisphere. There is a lesion of the cortex above the dorsal and lateral surfaces of the gyrus hippocampus with prolongation of the lateral ventricle along the external capsule into the occipital lobe with probable degeneration of all the fibers in this region. There is a complete separation of the hippocampus from the external capsule with probable degeneration of the fibers in the capsule. There is a transverse lesion also extending forward along the corpus callosum, around the knee to the floor of the lateral ventricle, and laterad through the anterior end of the corpus striatum to the external capsule. This lesion does not penetrate far enough to injure the peduncle so that the ventro-lateral face of the frontal pole is probably intact.

Left hemisphere. There is a transverse lesion extending

from above the gyrus hippocampus, through the anterior end of the fornix and the corpus striatum to the base of the olfactory bulb, completely severing the anterior pole.

Both corpora striata were injured but show no sign of degeneration except along the edges of the cut.

*With almost complete destruction of the frontal poles of both hemispheres and a probable degeneration of much of the cortex on the orbital and occipital regions of the right hemisphere this animal showed a complete loss of the habit and a failure to relearn the problem.*

*Experiment 31.* The frontal poles of both hemispheres were incised in a small female rat, 148 days old. She had been given 100 trials on the inclined-plane box, requiring as an average time per trial for the first five trials: to plane, 591 seconds; to door, 67 seconds. For the last five trials these averages were: to plane, 5.4 seconds; to door, 3.2 seconds.

Retention was tested on the second day after the operation. The animal was very weak, but ran about actively in the restraining cage and twice crossed the plane without giving any specific reaction to it. On the following day she spent thirty minutes climbing up to the top of the restraining cage and falling back to the floor. She ran across the top of the food box several times and in each case pitched off on her head without making any attempts to catch the side of the box. For the next two days her activity in the restraining cage was greater than that of a normal rat, but was restricted wholly to attempts to climb around the sides of the restraining cage just below the top, with repeated heavy falls. On the sixth day after the operation she died.

Lesion. The brain of this animal was lost.

*Experiment 32.* The frontal pole of the cerebrum was transected through two large trephine holes in the parietal region of a small female rat, 146 days old. She had been trained on the inclined-plane box for 55 trials. The average time per trial for the first five trials was: to plane, 945 seconds; to door, 145 seconds. That for the last five trials was: to plane, 7.2 seconds; to door, 2.6 seconds.

Retention was first tested on the second day after the operation. The animal moved about the floor of the restraining cage for a few minutes, then settled down and remained motionless. The same thing happened on the next three days. On the sixth day she became very spastic and during the tests passed through a series of prolonged tonic spasms, exhibited in arching of the back, retraction of the head, and gradual extension of the legs and feet so that she came to stand only on the tips of her toes. This appeared after every rapid movement and persisted for sometimes as much as two minutes. On the following day she was still more spastic and the spasms intervened at every attempt to walk. On the ninth day after the operation she had partly recovered and succeeded in tripping the plane four times. The average time for these four trials was: to plane, 1117 seconds; to door, 70 seconds. On the following days she again became spastic and showed no further improvement in two weeks.

Lesion (plate III, fig. 32). There is a transverse lesion completely separating the frontal poles of both hemispheres from the remaining cortex, along a plane extending from the anterodorsal face of the hippocampus, through the forceps of the corpus callosum to the base of the olfactory bulbs. There is a separation of the left corpus striatum from the external capsule and a partial invasion of the nucleus by large blood vessels. There is a similar degeneration of the anterior end of the right corpus striatum.

*After complete destruction of the frontal poles of both hemispheres and partial destruction of the cerebral nuclei this animal gave no evidence of retention of the habit.*

*Experiment 33.* Operation on the frontal poles of the cerebrum in a large female rat, 142 days old. She had been trained for 120 trials on the inclined-plane box. The average time per trial for the first five trials was: to plane, 2970 seconds; to door, 28 seconds. That for the last five trials was: to plane, 34 seconds; to door, 2.2 seconds.

Retention was tested on the second day after the operation. The animal was seemingly in good condition, ran about actively



and seemed fairly normal in behavior. She was placed in the restraining cage and ran about actively for five minutes but did not get up to plane. She seemed suspicious and explored with neck extended. She then settled down at the back of the box and remained motionless for an hour. On the two days following this behavior was repeated. There was never any specific reaction to the situation and after the first five minutes there was no normal exploration; she did not get on top of the food box in three hours on three consecutive days. She also was abnormally wild and tried to escape when picked up.

Lesion (plate III, fig. 33). Right hemisphere. There is a lesion extending diagonally forward from above the hippocampus along the course of the external capsule over the corpus striatum to the base of the olfactory bulb, severing all the fibers laterad to the forceps of the corpus callosum but leaving the mesial surface of the pole intact. The lesion is filled by a large clot.

Left hemisphere. The lesion extends somewhat farther back than that on the right, passing down through the anterior third of the corpus striatum into the lateral half of the cerebral peduncle. The mesial surface of both hemispheres is probably intact.

*After destruction of the antero-lateral pole of both hemispheres this animal gave no evidence of retention.*

Seventeen animals are reported in this series. The extent of injury and the degree of retention is given in the following table.

LESION	RETAINED HABIT	LOST HABIT	RELEARNED HABIT
Slight injury on dorsal convexity.....	1	0	
Destruction of cortex on temporal and orbital surfaces.....	2	0	
Partial destruction of frontal region.....	5 (1?)	3	0
Complete destruction of frontal region.....	(1?)	4	2

After partial or complete destruction of the frontal poles of both hemispheres some of the animals retained the habit, others lost it, and of these some reacquired it after training and others

failed. What is the relation of these differences of behavior to the extent of the cerebral destructions? The figures of the brains are grouped on plate III for comparison. The first fact evident from the figures is that in every case where there was a clear retention of the habit the destruction of the anterior pole of one or both hemispheres was incomplete. In animals which showed a loss of the habit there is apparently a greater destruction of cortex, so that in most if not all cases the whole of both frontal poles is involved.

It is impossible to say how sharp is the distinction between these two groups when the extents of the lesions are compared. The maximum extent of the lesion has not been determined accurately in any case and the figures are based almost wholly upon the gross lesions. It is probable, however, that these are at least indices of the true extent of injury.

Among the animals which showed no retention there was a practically complete destruction of the frontal poles of both hemispheres in experiments 27, 30 and 32, with almost complete destruction in experiment 28. In two of the remaining a part of the mesial cortex was preserved; the extent of the lesion was not determined in the third. One animal which showed doubtful retention (experiment 25) was also found to have a complete destruction of the frontal region of both hemispheres. The only evidence for retention in this case was the solution of the problem in less than the normal learning time. There was no recognizable reaction to the plane which persisted after the operation and the successful movements were made as though by chance. The long average time (50 seconds) required by the animal to reach the food after tripping the plane gives further evidence that there was little or no retention of the habit. Allowing for the questionable nature of the retention in this last animal, we are justified in concluding that the complete destruction of the frontal region of the rat's brain results in the loss of the complex inclined-plane habit.

After partial destruction of the frontal pole five animals retained the habit, one gave questionable evidence of retention and two showed no retention of the habit. Of the latter, one

(experiment 29) developed an abnormal stereotyped reaction to the situation and the other (experiment 33) was stuporous during most of the tests so that the two animals scarcely provide data from which reliable conclusions can be drawn. With the exception of these two and the questionable case described in experiment 26, the animals with partial injuries to the frontal pole gave clear evidence of retention of the habit. Among them the one described in experiment 20 showed the most extensive lesion, only the left mesial region being left intact (plate III, fig. 20). In the others the lesions were more restricted, leaving the frontal pole of one or other hemisphere intact. This sug-



FIG. 11. TOTAL EXTENT OF LESION IN ANIMALS OF SERIES IV WHICH RETAINED THE HABIT

gests the question whether or not there is some particular part of the frontal region concerned with the retention of the habit. Figure 11 shows the combined extent of the lesions in the animals retaining the habit. Every part of the frontal region was destroyed in one or another of the operations.

It seems, then, that although some part of the frontal region ✓ must remain intact if the plane-box habit acquired by the normal animals is to be retained, the particular part preserved is immaterial. The different parts of the frontal region are, to adopt a term from experimental embryology, equipotential in the functioning of the habit.

#### V. HABIT FORMATION AFTER DESTRUCTION OF LARGE AREAS OF THE CORTEX

In spite of many dogmatic assertions concerning the function of the cerebrum in so-called associative memory we have not a single published account of any experiments which give con-

clusive evidence that the cerebrum is or is not necessary for habit formation. Burnett (4) failed to get decerebrate frogs to learn a simple maze but it is possible either that the operation resulted in such a disintegration of the animal's other habitual reactions that the incentive for learning the maze was no longer adequate, or that the maze presented a too complex habit and that a simpler habit might still have been acquired. The experiments certainly do not justify the author's sweeping conclusion that learning is not possible in the absence of the cerebral cortex. The statement in the introduction that learning is possible in the decerebrate frog is based upon unpublished results on the facilitation of the crossed reflex of the hind leg.<sup>1</sup> Goltz (5) made an attempt to train his decerebrate dog but gave up quickly for fear that the training methods would result in the animal's death. Rothman (6) reported the acquirement of new motor coördinations in his decerebrate dog but gave no details of the experiment. It is not possible to be certain that the changes in behavior noted by these authors were not concomitants of recovery from operative shock rather than true examples of habit formation.

It may be that no complex habits are acquired in the absence of the cerebral cortex but a fundamental point in the problem of the physiology of learning is involved in the possibility of the formation of simple habits wholly by the mechanisms of the spinal cord and brain stem. Is there any fundamental difference between the organization of the cerebrum and that of lower centers such as to give the former special functions which are lacking to the more primitive portions of the nervous system, or are the cerebral and spinal functions alike save for the possibility of greater complexities of reflex connections within the cortex? Failure or success in obtaining habit formation in

<sup>1</sup> Some may object to this as an example of learning, but it is undoubtedly true that any modification of an animal's behavior due to repeated stimulation (exclusive of fatigue phenomena) is properly called learning. The distinction between "associative memory" and other types of acquired reactions is by no means so clear as the exponents of this as a criterion of consciousness would have us believe.

decerebrate animals will furnish significant evidence for this problem.

As yet we have not been able to effect a complete decerebration of the rat but by the destruction of large and varied areas we have obtained evidence, perhaps not yet conclusive, that the cerebral cortex is not functional in the formation of simple habits.

A number of animals were operated upon to destroy the cortex over the dorsal, temporal, and frontal regions and such parts of the orbital and occipital surfaces as could be reached from above without lesion to the thalamus. Six of these survived and all have been trained successfully in the formation of simple habits. A record of the experiments is given below.

In the diagrams of the brains of this series of animals (plate II, figs 34 to 39) the solid black areas represent the parts from which the cortex has been completely absorbed, the stippled areas those in which there was degeneration or evident loss of function through destruction of fibers.

*Experiment 34.* A large opening was made in the calvarium of a large adult male rat and a scalpel (curved on the flat) was drawn around the frontal and temporal lobes on each side and thrust backward to the tentorium. On the day following the operation the animal began to walk about. He was very spastic, with back arched constantly, and occasionally remained motionless for long periods in contorted positions. He would not eat, but drank milk when it was placed in his mouth and when his short vibrissae were touched with a pipette filled with milk he grasped the end of it with his teeth. He would not do this in response to a stick unless it were wet with milk. This reaction suggests the retention of smell. He gave no detectable reactions to light, to light contact, or to aromatic odors which are avoided by normal rats. He reacted to loud sounds, to heavy contact or diffuse pressure, and to protopathic stimuli.

On the second day he ate when his lips were pressed against the food, but when his movements carried him away from the food he continued to gnaw at the edge of the food dish for some time. During the ten days that he was kept alive he never

learned to find food by himself and had to be fed, chiefly with milk given from a pipette.

*Training.* He was fed five or six times a day by placing the end of a pipette between his teeth and squirting milk into his mouth. He almost immediately began to reach for the pipette as soon as it was brought in contact with his short vibrissae. An attempt was made to train him to inhibit this reaction. He was first given a taste of milk, the pipette was then wiped off and brought in contact with his short vibrissae. He took hold of it but, getting no milk, let go immediately. This was repeated every five seconds for fifty-five times with the following results. He reacted every time in the first five trials, four

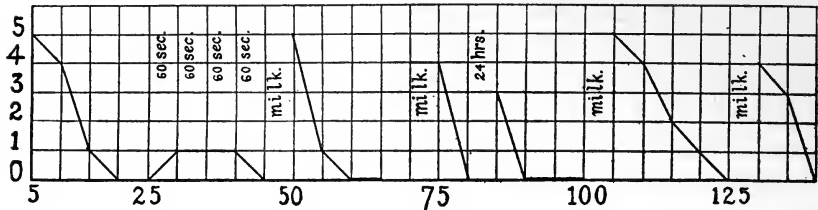

FIG. 12. RATE OF LEARNING TO REJECT EMPTY PIPETTE

The number of times that the pipette was taken in successive groups of five trials is plotted.

times in the second five, once in the third, and not once in the fourth and fifth. After a 60 second interval ten more trials were made. He reached for the pipette the first time but not again. After another 60 second interval he reached once again, then failed to reach for nine trials; so after a third interval. After the fourth interval of 60 seconds he did not reach once in ten trials. Milk was then placed in his mouth twice, the pipette was wiped and offered again. It was grasped five times in the first five trials, once in the second five, and not thereafter. Milk was given again and after this he reached for the pipette four times in the first five trials, four times in the second, and not in the third and fourth. Quite similar results were obtained on the following day. The complete series is given in figure 12.

On the following days he became more and more deteriorated and was finally killed as he could no longer be induced to eat.

An attempt was made to establish a conditioned reflex to contact with the foot. The animal was fastened in the container designed by Watson and the foot was fastened to a pointer in contact with a kymograph. The dorsal surface of the foot was then stimulated first by rubbing with the uncharged electrodes, then electrically. The first effect of electric stimulation is a quick jerk of the foot followed by an increased tonic contraction of the muscles for standing so that the animal, with repeated stimulation, rises gradually until he stands on the tips of his toes and maintains that position for as long as three minutes.

In the apparatus the animal's reactions became more and more violent until, after the fourteenth stimulation he began to bite his thigh and had to be taken out. For five minutes thereafter, when his right hind foot was touched he reacted by turning his head to the foot and squeaking. Fifteen minutes later no reaction to contact with the foot was given.

Lesion (plate II, fig. 34). The brain of this animal was one of those improperly sectioned so that an exact delimitation of the destroyed area has not been possible. As nearly as can be determined there is a total destruction or degeneration of all the cortex lying above and laterad to the third and lateral ventricles, a separation of the frontal pole from all underlying structures at the level of the cerebral peduncles, a great shrinkage of both corpora striata, and a destruction of the medial portion of the occipital lobes.

*This animal had probably the greatest destruction of cerebral tissue of any reported in this study. His instinctive exploratory reactions were so limited that training on the ordinary laboratory problems was impossible. He nevertheless showed an ability to form very simple habits quite rapidly.*

*Experiment 35.* Deep transverse and horizontal incisions were made in the cortex of a large male rat, 115 days old. He recovered rapidly from the operation and gave no evidence of motor disturbances or of other abnormality of behavior.

Training in the simple maze (fig. 1) was begun six days after

the operation. He required only thirty trials to learn to go to the right. He was then required to go to the left and the earlier habit was completely overcome in twenty trials. The records of time and errors are given in table 1.

TABLE 1

*Rate of learning for rat described in experiment 35. In this and the following tables the average time per trial and the total number of errors are given for successive groups of five trials*

TO RIGHT		TO LEFT	
Time	Errors	Time	Errors
43.0	3	28.0	4
35.5	3	8.0	1
16.5	1	7.5	0
8.5	0	6.5	0
7.5	0		
6.5	0		

He was killed 30 days after the operation. Microscopic examination of the brain showed (plate II, fig. 35):

Right hemisphere. A transverse lesion beginning above the posterior end of the corpus callosum and extending forward almost horizontally to the anterior pole, above the level of the corpus callosum. There is a superficial lesion of the lateral surface of the occipital lobe resulting from a knife cut which separated the cortex from the underlying fibers. A similar lesion extends over the orbital surface, separating nearly half of the lateral surface of the cortex from the underlying fibers and destroying the fibers of the external capsule back to the level of the hippocampus. The lateral ventricle was not reached by the injuries and the subcortical ganglia are intact.

Left hemisphere. The lesion on the dorsal convexity is similar to that on the right. There is a transverse lesion completely severing the frontal pole just in front of the caudate nucleus. A lesion on the orbital surface following the course of the external capsule to the anterior end of the hippocampus has completely destroyed a lens-shaped area on the orbital surface. The cerebral nuclei are intact.



After the destruction of somewhat more than the anterodorsal third of the cortex, together with a large area on the right occipital lobe, this animal showed no detectable abnormality in behavior or in the rate of habit formation.

*Experiment 36.* A transverse opening 10 by 8 mm. was made in the calvarium of a small female rat, 115 days old, and transverse and longitudinal incisions were made in the cortex to as great a depth as possible. Recovery was rapid and without appreciable motor disturbance. She ate alone from the first and seemed practically normal in behavior except for a complete indifference to other animals of the same or opposite sex.

Training in the simple maze was begun 12 days after the operation. The habit of going to the right was perfected in fifty trials. She had, apparently, an initial preference for the right side of the maze. Training to break up this and to establish the habit of going to the left was then started and one hundred and twenty trials were required before ten successive errorless trials were made. The records of time and errors are given in table 2.

TABLE 2  
*Rate of learning for rat described in experiment 36*

TO RIGHT		TO LEFT			
Time	Errors	Time	Errors	Time	Errors
86.0	0	137.0	6	27.0	3
97.2	2	29.0	1	53.0	5
29.0	0	35.0	3	43.0	3
76.2	2	65.5	2	37.0	1
62.0	1	16.5	2	17.0	1
52.0	2	18.5	1	21.5	1
51.0	2	31.0	4	12.5	1
263.0	3	34.0	3	23.0	1
19.0	0	12.5	1	20.5	2
12.5	0	42.0	4	23.0	1
		24.5	2	9.5	0
		15.0	0	8.5	0

The rat was autopsied 40 days after the operation. Microscopical examination of the brain shows (plates I and II, fig. 36):

Right hemisphere: Destruction of the entire corpus callosum including the knee and all cortical tissue above it and above the hippocampus. A transverse lesion extends laterad from the anterior end of the lateral ventricle along the forceps of the corpus callosum, through the external capsule to the cortex and ventrad to the cerebral peduncle. The fornix is severed with a slight injury to the adjacent thalamus. The lateral ventricle is much enlarged but the corpus striatum is seemingly intact.

Left hemisphere. The corpus callosum is destroyed as on the right with absorption of all cortical tissue above its level. There is a diagonal lesion from the anterior horn of the lateral ventricle to the base of the olfactory lobe, probably involving all the cortex laterad to it. Fornix destroyed and lateral ventricle enlarged until it occupies half of the horizontal area of the lobe. Corpus striatum and thalamus nearly completely destroyed.

*The animal shows destruction of the antero-dorsal half of the cerebrum without marked loss in ability to form simple habits.*

*Experiment 37.* A transverse opening, 11 by 6 mm. was made in the calvarium of a large male, 200 days old, just back of the frontal-parietal suture and through it a transverse frontal and longitudinal temporal incisions were made through the cortex, followed by great hemorrhage. Killed 30 days after operation.

The animal recovered quickly, moving about and reacting to other animals within four days after the operation. He was fed by hand for the first four days, then learned to find food for himself but would not eat with the experimenter near. An abscess developed on his neck (infection of the cerebral glands) but cleared up in 20 days. He showed fewer effects of the operation than any other rat in this group, being the only one which showed any responses to other animals. This did not extend to normal sexual reactions.

Training in the simple maze was begun twelve days after the operation. At this time the animal showed no motor disturbance and was normal in his reactions to the experimenter. He was first trained to go to the right in the maze and required fifty trials for learning. He was then required to go to the left

for food and again learned in fifty trials. The average time required and the total number of errors made in successive groups of five trials are given in table 3.

Microscopical examination of the brain showed (plate II, fig. 37):

TABLE 3  
*Rate of learning for the rat described in experiment 37*

TO RIGHT				TO LEFT			
Time	Errors	Time	Errors	Time	Errors	Time	Errors
<i>seconds</i>		<i>seconds</i>		<i>seconds</i>		<i>seconds</i>	
143.0	4	9.5	0	31.0	4	11.0	0
143.0	4	14.0	1	17.5	1	12.0	0
15.0	0	14.5	1	16.0	2	21.0	1
42.0	4	8.0	0	18.5	1	19.5	0
19.0	1	11.0	0	15.5	2	12.0	0

Right hemisphere. Destruction of the greater part of the convexity of the cortex from the occipital portion of the corpus callosum to the knee, involving the greater part of the corpus callosum and exposing the lateral ventricle and extending around the anterior face of the caudate nucleus to the cortex, separating the anterior pole to the level of the olfactory fibers. The fibers of the anterior pole have been absorbed, leaving a large cyst. The longitudinal incision extends backward from the transverse lesion to the middle of the caudate nucleus, then along the course of its fibers, through the external capsule to the cortex, producing, apparently, very little destruction.

Left hemisphere. The lesion on the dorsal convexity is similar to that on the right. The transverse lesion passes just in front of the knee of the corpus callosum and diagonally forward to the base of the olfactory lobe, severing the entire anterior pole to the level of the olfactory tracts. There is invasion of the anterior end of the caudate nucleus by hemorrhage. The longitudinal incision seems to have passed along in the lateral ventricle and to have done little damage. There is an extensive superficial lesion extending over the occipital lobe.

*Experiment 38.* Transverse frontal and longitudinal incisions were made in the cerebral cortex of an old male rat, through a circular trephine hole 8 mm. in diameter. After the operation he was very weak and emaciated rapidly. He was fed by hand for five days, then recovered the ability to eat alone. From the day after the operation he showed a pronounced spasticity of the left side, carrying his head rotated about 60 degrees to the right and walking with the left hind leg extended stiffly and only the tips of the toes set down on the ground. During the first few days he fell over at every third or fourth step and always made a complete rotation to the right in getting to his feet again, his behavior resembling that of an animal after unilateral destruction of the semicircular canals.

In the cage the animal was much more restless than any of the others in the group. He ran almost constantly around an oval path, bounded by the sides of the cage, and always in the same direction, clock-wise. On one day, 35 days after the operation, his activity was observed nearly continuously for 12 hours. During this time he ran around the same path at an average rate of twenty revolutions per minute, with a total of not more than one hour's interruption for rest and eating; a total distance of not less than seven miles. During the 40 days that he was kept under observation he showed very little improvement in motor control beyond that acquired in the first week after operation.

*Habit formation.* Training in the simple maze was begun 12 days after the operation. He was active, although his movements were very badly coördinated. On the first trial in the maze each day he had great difficulty in walking and his first passage of the central alley was usually a series of somersaults. After the first trial coördination was usually better. After sixty to seventy trials in the maze he learned to traverse it with a few falls but this was accomplished by supporting himself against the sides of the alleys and not by improvement in walking in a straight line. He always had great difficulty in turning around to his left and when he finally learned to go to the food in the left alley of the maze he accomplished

the turn at the end of the central alley by holding to the end of the partition with both left feet and pushing his body around with the right.

He learned to turn to the right for food after forty trials. The food was then placed in the left alley. The previous habit of turning to the right, reinforced by his motor difficulty in turning to the left made the new habit very difficult for him to acquire and eighty trials were required before he made ten in succession without error. The records of time and errors are given in table 4.

TABLE 4  
*Rate of learning for rat described in experiment 38*

TO RIGHT		TO LEFT			
Time	Errors	Time	Errors	Time	Errors
486.0	1	615.0	100	332.0	30
53.0	2	55.0	12	68.0	6
302.0	5	216.5	41	58.0	7
45.0	1	44.0	35	19.0	0
59.0	2	141.0	12	19.0	1
195.0	0	86.0	25	20.0	2
17.5	0	383.0	91	15.0	2
14.5	1	112.0	20	11.5	0
		408.0	31	10.0	0

He was killed 40 days after the operation. A small abscess filled with pus was found over the cranial opening but did not extend into the cortical tissues. There was a deep pit in the cortex, completely exposing the lateral and third ventricles. Microscopic examination showed a complete destruction of the convexity of the cortex including the whole of the corpus callosum to the knee (plates I and II, fig. 38). The lesion extends from just behind the corpus callosum diagonally forward to the base of the olfactory lobes, separating the entire frontal pole on either side. The longitudinal incisions extending down over the temporal and orbital surfaces of the cortex to the level of the ventricles with degeneration of neighboring areas. The right corpus striatum is degenerated and infiltrated by large blood

vessels. The right half of the fornix is severed and there is an extensive clot filling the third ventricle.

*There was in this animal a destruction of fully half the cortical tissue, including the frontal pole and nearly all of the dorsal convexity and embracing all of the excitable area and the area described as motor by the histologists; degeneration of the right corpus striatum and fornix; permanent spasticity confined to the left side; no loss of learning ability beyond that due to motor incoördination.*

*Experiment 39.* Transverse frontal and longitudinal incisions were made in the cortex of a small male rat, 126 days old. He was very weak after the operation and grew emaciated rapidly. A hemiparesis appeared immediately after the operation, giving him some difficulty in walking and making it impossible for him to sit up on his hind feet. In the home cage or in the maze when his nose came in contact with the food he at once swung his head to the left, away from the food and against the side of the food dish, which he then gnawed. In order to eat without constant help he had to be placed in a large dish of food. He then usually twisted his head around to the left until his nose was under his left hind leg and ate in that position, gradually straightening out if left to himself. This behavior persisted until the animal was killed, twelve weeks after the operation. During the first three weeks after the operation he had an almost constant erection of the penis and masturbated at frequent intervals. There was a gradual recovery from this but a seeming deterioration in other respects as he became more and more inactive and stuporous.

He was trained to go to the right in the simple maze 11 days after the operation. His paresis made it easier for him to turn to the left and he showed little improvement in accuracy after two hundred trials. The passage-way to the left was then blocked and he was given one hundred trials with only the direct way to the food open. He soon ceased to pause at the blocked entry and ran directly to the food, but when the left passage was again opened he at once entered it and did no better than before. In all, four hundred and fifty trials were given but he only once made five successive trials without error. An examina-

tion of the records of the first two hundred trials (table 5) shows, however, that he at first made some improvement both in time and in the number of errors and that this improvement was permanent. This is evidence for learning, though of a simple type. In the later part of training he developed a stereotyped reaction to the maze which must be classed as a habit, though it did not contribute to the getting of food. In the trials, day after day, he would first turn into the entrance of the right alley, advance for twice his body-length, then whirl about quickly, run to the

TABLE 5  
*Rate of learning in rat described in experiment 39*  
*To right*

TIME	ERRORS	TIME	ERRORS	TIME	ERRORS
149.0	3	19.5	2	63.0	8
159.0	6	25.0	3	39.0	2
88.0	4	62.0	2	48.0	6
111.0	5	47.0	1	37.0	6
111.0	7	60.0	6	28.0	1
99.0	6	28.0	2	19.0	0
70.0	4	66.5	7	69.0	8
95.0	6	44.0	3	76.0	5
96.0	6	48.0	5	31.0	3
58.0	3	37.0	3	23.0	2
75.0	6	37.0	3	49.0	4
59.0	5	79.0	3	19.0	1
65.0	5	59.0	3	29.0	4
62.0	2	61.0	4	33.0	4

end of the left alley, turn back to the right alley and go directly to the food. Records of time and errors for the first two hundred trials are given in table 5.

The rat was killed 71 days after the operation. Microscopical examination of the brain showed (plates I and II, fig. 39):

Right hemisphere. There is a destruction of tissue over the dorsal convexity of the cortex down to and including the corpus callosum. There is transverse lesion extending diagonally forward just behind the knee of the corpus callosum to the base of the olfactory bulb, completely cutting off the frontal pole. The fornix and gyrus dentatus are completely destroyed. The cor-

pus striatum is cut through in sagittal section for its full length and the lesion filled by a large clot which extends down into the cerebral peduncle, cutting through its fibers obliquely. The anterior portion of the caudate nucleus is replaced by a clot, the remainder is much shrunken. The antero-lateral surface of the thalamus shows indications of degeneration.

Left hemisphere. There is destruction of all tissues above and including the corpus callosum. A transverse lesion extends diagonally from behind the knee of the corpus callosum to the base of the olfactory bulb, severing the anterior pole. The lateral ventricle is collapsed and all the cortex laterad to it is replaced by scar tissue. The external capsule lies free in a cyst laterad to the corpus striatum and, in the occipital lobe, is replaced by a large cyst. The corpus striatum is degenerated. The fornix is largely destroyed. The thalamus is intact.

*In this animal the destruction of all the cortex above and in front of the corpus callosum and laterad to the left lateral ventricle with partial degeneration of the right and complete degeneration of the left caudate nuclei, destruction of the fornix and injury to the thalamus on the right was followed by inability to solve the simple maze but did not preclude the formation of simple habits as evidenced by the gradual appearance of stereotyped modes of response to the maze.*

The course of learning in these different animals is compared with the average of normal individuals trained under the same conditions in figure 13. The animals described in experiments 35 and 37 were apparently normal in behavior and learned in about the same amount of practice as is required by normal rats. The animals in experiments 36 and 38 learned to go to the right quite readily but had a great deal of difficulty in readjusting to the problem when they were required to overcome the first habit and learn to turn to the left. The rat in experiment 39 was unable to learn the problem in more than three hundred trials. However, even this animal showed marked improvement in the time required for running the maze during the early part of practice. In experiments 38 and 39 a part of the difficulty experienced by the animals was clearly due to a persistent hemi-



paresis which made it easier to turn to one side than to the other. They did show, however, some indications of abnormality in learning not due to the motor difficulty. The development of stereotyped errors in experiment number 39 and the large number of errors of the same type made by the rat in experiment

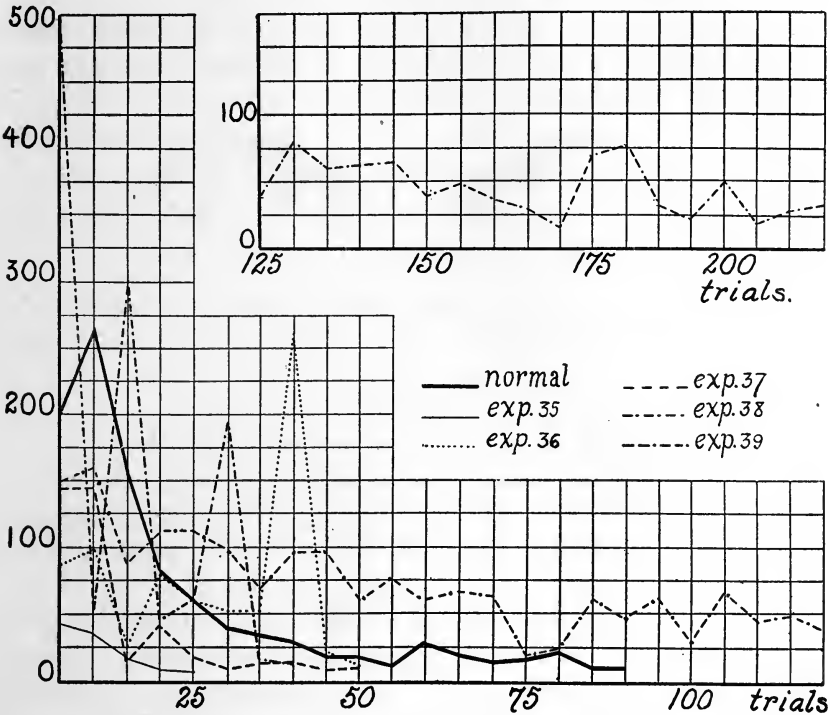

FIG. 13. A COMPARISON OF THE RATE OF LEARNING THE SIMPLE MAZE BY NORMAL ANIMALS AND BY ANIMALS AFTER DESTRUCTION OF THE ANTERIOR AND DORSAL SURFACES OF THE CORTEX

38 in the second training test (table 4) are without parallel in the behavior of normal animals. They indicate, perhaps, an abnormal predominance of kinesthetic-motor chain reflexes and a difficulty in inhibiting them in new situations. This is suggestive of the perseverations sometimes seen in human defectives.

In every one of the animals clear evidence of some degree of habit-formation was obtained. Whether or not the possible complexity of habit was limited by the destruction in these cases was not definitely determined by the experiments. No attempt was made to train the animals in more difficult tasks and until experiments can be carried out on a more extensive scale we can conclude only that somewhat more than the anterior half of the cerebral cortex in the white rat (fig. 14) is unnecessary for the formation of simple habits.



FIG. 14. THE TOTAL EXTENT OF THE COMBINED LESIONS IN THE ANIMALS WHICH LEARNED THE SIMPLE MAZE AFTER OPERATION. SERIES V

### *Discussion*

To the destruction of what structural elements may the loss of the plane-box habit be ascribed, and to what the retention in the cases of partial destruction? The lesions in many cases involve the motor area and the loss of the habitual reaction might be considered as primarily the result of the motor disturbances arising from injury to this region. However, such facts as we have at hand concerning the motor area in the rat do not support this view.

The cyto- and myelino-architecture of the brain of the rat has not been worked out but Isenschmid (7) has given a full account of the arrangement and composition of the cell-layers of the different regions of the cortex of the mouse and the similarity of the brains of the two species is probably sufficient to justify the application of his results to the rat. He finds three principle areas, fronto-medial, dorso-lateral, and sub-occipital, distinguished by the relative thickness of the cell-layers and the size of the elements, and within these distinguishes a number of subordinate areas. Those which have come within the scope of the present experiments are shown in figure 15.

The majority of writers agree that there is a frontal field, variously located in the region *l* which has not the characteristics of the motor areas, but no statements are made as to its relation to the frontal lobes of higher mammals. The stimulation experiments which we have carried out indicate that even the extreme pole of the cortex is excitable, that there is no silent area corresponding to the frontal lobes of higher mammals, but the small size of the brain and the difficulty of preventing some spreading of the current would make it difficult to detect such an area if it existed.

There is no experimental evidence concerning the function of these fields, although a part has been interpreted as motor,

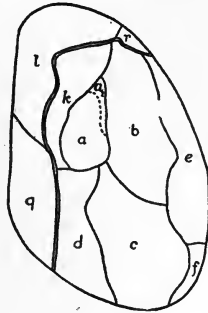

FIG. 15. THE CHIEF CYTOARCHITECTURAL AREAS OF THE BRAIN OF THE MOUSE.  
AFTER ISENSCHMID

another as sensori-motor. According to Isenschmid, who has summarized the literature of this subject the area described as motor differs considerably in the descriptions of different authors.

Upon purely histological grounds Cajal includes an area extending over *a*, *a<sub>1</sub>*, and *b*, in figure 15. Döllken (8) includes the areas *l*, *k*, *a*, *a<sub>1</sub>*, *b*, and the anterior portions of *q* and *d*. Brodmann (9) includes *k* and a part of field *l*.

Without physiological verification conclusions as to the function of histologically differentiated parts can have little value. The stimulative area has been found to correspond most closely to the anatomical field described by Döllken. The excitable areas thus far determined are shown in figure 16. They em-

brace the entire frontal pole and the areas *l*, *k*, *a*, *a*<sub>1</sub>, and a part of the anterior portions of *q* and *d* (fig. 15) including most of the area described by Döllken but not extending so far over the parietal surface as his figures indicate.

In the operative experiments this entire motor area was frequently destroyed completely without serious interference with the animal's ability to form kinesthetic-motor habits.

After purely cortical destruction we have never found any motor disturbance which has persisted for as much as eighteen hours after the operation; in particular there is no indication of localized disturbances in the front or hind limbs resulting from

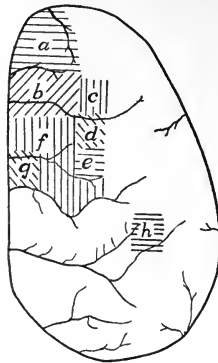

FIG. 16. THE DISTRIBUTION OF THE STIMULABLE AREAS IN THE BRAIN OF THE RAT

the destruction of corresponding regions of the stimulative area. In those cases where motor disturbances were observed there appears to have been always a very extensive injury to the corpus striatum. (The material is being reexamined with reference to this point.) It seems clear, then, that the loss of the habits was not due directly to motor paralysis.

In experiments 27, 30, 32, and 33 there was destruction of the frontal pole including at most only the stimulative area for the head and neck and, with this, complete loss of the habit. So it seems almost certain that in these cases the loss of the habit was due to the interruption of some other cortical reflex pathways than those included in the excitable area. The effects of

the operations upon retention can not be looked upon as the result of a motor insufficiency, nor, probably, as primarily the result of the destruction of the excitable area.

Previous work (10) on the function of the frontal portion of the cortex in higher mammals (cat and monkey) has given evidence that this part of the cortex is normally utilized in habit-formation, but that in its absence some other portion of the brain may usurp its function. Further, there is evidence that when the habits have been practiced for a long time by normal animals the preservation of the frontal lobes is no longer a condition of their correct functioning; they come to be carried out, probably, at a lower level of nervous organization. It was the primary purpose of this study to determine the amount of practice necessary for retention of a habit after ablation of the part of the cortex originally functional in its performance. This purpose has been largely defeated by the great variation in the extent of destruction in different animals. The results, however, verify for the rat the findings for higher mammals and suggest some additional possibilities of interest. The experiments of series I, II, and V indicate either that very simple habits such as that of turning in the simple maze may be acquired by normal animals without the utilization of the frontal portion of the cortex at any time during learning, or that the cortex very rapidly ceases to function in the performance of the habit. There is a little evidence, noted in the first paper, that the animals of series I which have been long overtrained retained the habit a little more perfectly than those which were trained to perfect performance. The irregular conditions of training incident to the use of the animals in other experiments and the great variation in the extent of the lesions makes the justice of such a conclusion questionable.

In the more complex habit of the inclined plane box the presence of some portion of the frontal pole is evidently a condition for the performance of the habit where this has been acquired with the frontal pole intact. Again, owing to the small number of animals tested and the variation in extent of the lesions the data on the relation of the amount of practice to the functions

of the cortex is inadequate. From experiments 29, 31, and 33 in which animals were overtrained it seems that an amount of overtraining equal to three or four times that required for learning is insufficient to reduce the habit to lower brain levels. The difference in the complexity of the maze and inclined-plane box habits and the apparent failure of the latter to be reduced to subcortical levels within the limits of these experiments suggest that the amount of practice necessary for the assumption of the cortical functions by subcortical ganglia is proportional to the complexity of the habit. Until further evidence is accumulated this can not be considered more than a probable assumption.

The data presented in section IV shows that complete destruction of the frontal pole results in the loss of the plane-box habit, whereas the loss of the temporal and parietal regions is without effect upon the habit. This indicates that conduction pathways involved in the performance of the habit pass through the frontal pole, but an attempt to localize these more accurately brings to light a complexity of function which has not before been suggested. Partial destruction of the frontal pole did not always result in the loss of the habit. An attempt to find a correlation between the part destroyed and the retention or loss of the habit revealed the further fact that no single part of the frontal pole escaped destruction in all the animals which retained the habit (fig. 14). It seems then that for retention some part of the frontal pole must be preserved but no particular part seems necessary. This is, perhaps, what might be expected if we abandon the purely diagrammatic concept of the reflex cortical arc as a single chain of neurones and consider that for the performance of even a simple movement a number of such arcs are required. With a vast number involved in complex habitual acts, it is very improbable that all would be projected on a restricted area of the cortex; the experimental results suggest rather that in their cortical relations these arcs are widely distributed over the frontal pole so that a partial lesion results in only the partial destruction of the arcs involved in the performance of any simple act.

The experiments of series V have shown that the rat may form

simple habits after the complete destruction of all the cortex of the frontal, temporal, and parietal regions and the greater part of that on the orbital surfaces. This includes all the regions to which the function of habit formation has been ascribed and leaves only those which have been thought to have visual, auditory, and olfactory functions. The destruction of cortical tissue has not been extensive enough to prove that learning may take place wholly at the level of the sub-cortical centers but the evidence at hand is sufficient to justify more extensive experiments upon this point. The ability of the animals to form habits after the loss of those parts of the brain which are normally used in learning, the reestablishment of motor control after the loss of the stimuable area of the cortex and of the corpus striatum, and the seeming equipotentiality of the different parts of the frontal pole in the functioning of complex habits go far toward establishing the complete functional interchangability of all parts of the cerebral cortex.

#### SUMMARY

Rats were trained after destruction of various parts of the cerebral cortex including the frontal, temporal, parietal, and a large part of the orbital surfaces and the influence of the cerebral destruction upon their ability to form and retain kinesthetic-motor habits was tested. It was found that:

1. The habit of turning correctly in the simple maze may be retained after the destruction of any part or all of the cortex lying in front of and above the knee of the corpus callosum and after the destruction of any part of the temporal and parietal regions.

2. The maze-habit may be acquired after the destruction of all the cortex included within these areas, and after the destruction of one, perhaps both, of the striate nuclei.

3. The more complex habits involved in opening the inclined-plane box are retained after destruction of the temporal regions of the cortex.

4. The complete destruction of the frontal regions of the cortex results in the loss of the inclined-plane box habit.

5. The partial destruction of the frontal region does not abolish this habit.

6. So long as the destruction of the frontal pole is not complete the habit is retained, apparently irrespective of what part of the frontal region has been destroyed.

7. No marked motor disturbances appear after the complete destruction of the stimulative areas of the cortex but in certain cases marked hemiparesis seemed to result from the destruction of the corpus striatum.

#### REFERENCES

- (1) This journal, 1917, i, 1-15.
- (2) WATSON, J. B.: Behavior, New York, 1914.
- (3) FRANZ, S. I.: On the functions of the cerebrum. American Journal of Physiol., 1902, viii, 1-22. Archives of Psychol., New York, 1907, no. 2, 1-64.
- (4) BURNETT, T. C.: Some observations on decerebrate frogs with especial reference to the formation of associations. Amer. J. of Physiol. 1912, xxx, 80-87.
- (5) GOLTZ, F.: Der Hund ohne Grosshirn. Arch. f. d. ges. Physiol., 1892, li, 570-615.
- (6) ROTHMAN, M.: Demonstration des Hundes ohne Grosshirn. (Ber. über d. V. Kongress f. exper. Psychol.) Leipzig, Barth, 1912, pp. 256-260.
- (7) ISENSCHMID, R.: Zur Kenntnis der Grosshirnrinde der Maus. Abh. d. Königl. Preuss. Akad. d. Wiss., 1911, 1-46.
- (8) DÖLLKEN, I.: Beiträge zur Entwicklung des Säugergehirns. Lage und Ausdehnung des Bewegungscentrums der Maus. Neurol. Centbl., 1907, xxvi, 50-59.
- (9) BRODMAN, K.: Vergleichende Lokalisationslehre der Grosshirnrinde. Leipzig, 1909.
- (10) FRANZ, S. I.: Opus cit.

#### PLATE I

FIG. 22. Serial horizontal sections, 1.6 mm. apart, of the brain of the rat described in experiment 22. The positions of the structures used as reference points in the descriptions of the lesions are noted on the figures. *C.ex.*, external capsule; *c.st.*, corpus striatum; *f.*, fornix; *f.c.*, forceps of the corpus callosum; *h.*, hippocampus; *n.c.*, anterior olfactory nucleus; *n.l.*, lateral thalamic nucleus; *o.*, base of olfactory bulb; *s.p.*, septum pellucidum; *v.l.*, lateral ventricle.

FIG. 38. Serial sections of the brain of the rat described in experiment 38. The method of reconstruction is shown in this and plate II, figure 38.

FIG. 36. Horizontal section through the brain of the rat described in experiment 36.

FIG. 39. Horizontal section of the brain of the rat described in experiment 39, showing a probable complete destruction of the left hemisphere.



CEREBRAL FUNCTION IN THE RAT  
 K. S. LASHLEY AND S. I. FRANZ

PLATE I

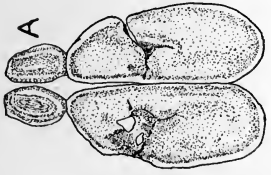

22

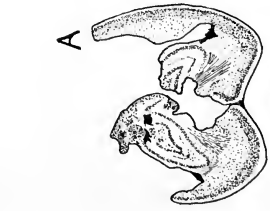
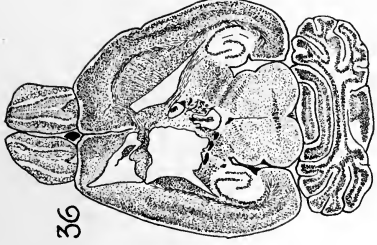
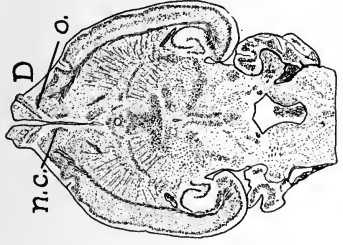
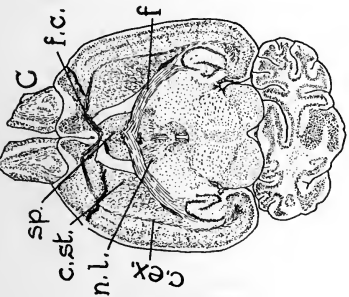
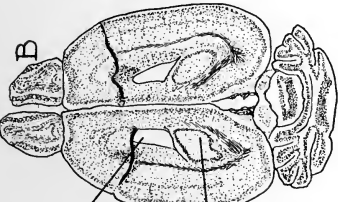

38

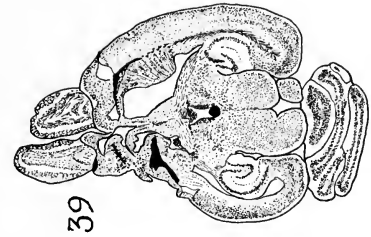
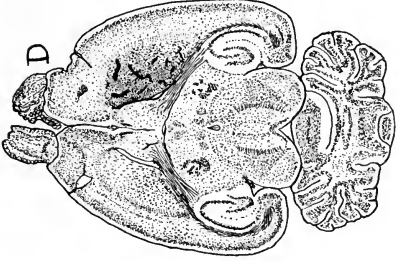
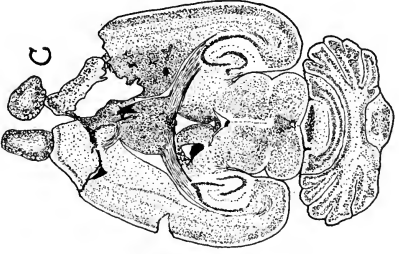
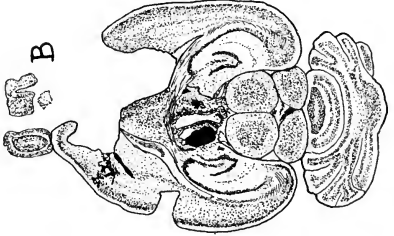

## PLATE II

FIGS. 1 to 14. The extent of the lesions in animals which retained the habit of the simple maze after cerebral destruction. The numbers of the figures correspond to the numbers of the experiments under which the animals are described. In figures 10, 11, and 12 the striated areas show the extent of the second operation.

FIGS. 34 to 39. The extent of the lesions in animals which formed simple habits after operation. The solid black areas are those in which the cortex was completely absorbed. The dotted areas are those in which the cortex was probably not functional as a result of the destruction of its descending fibers.

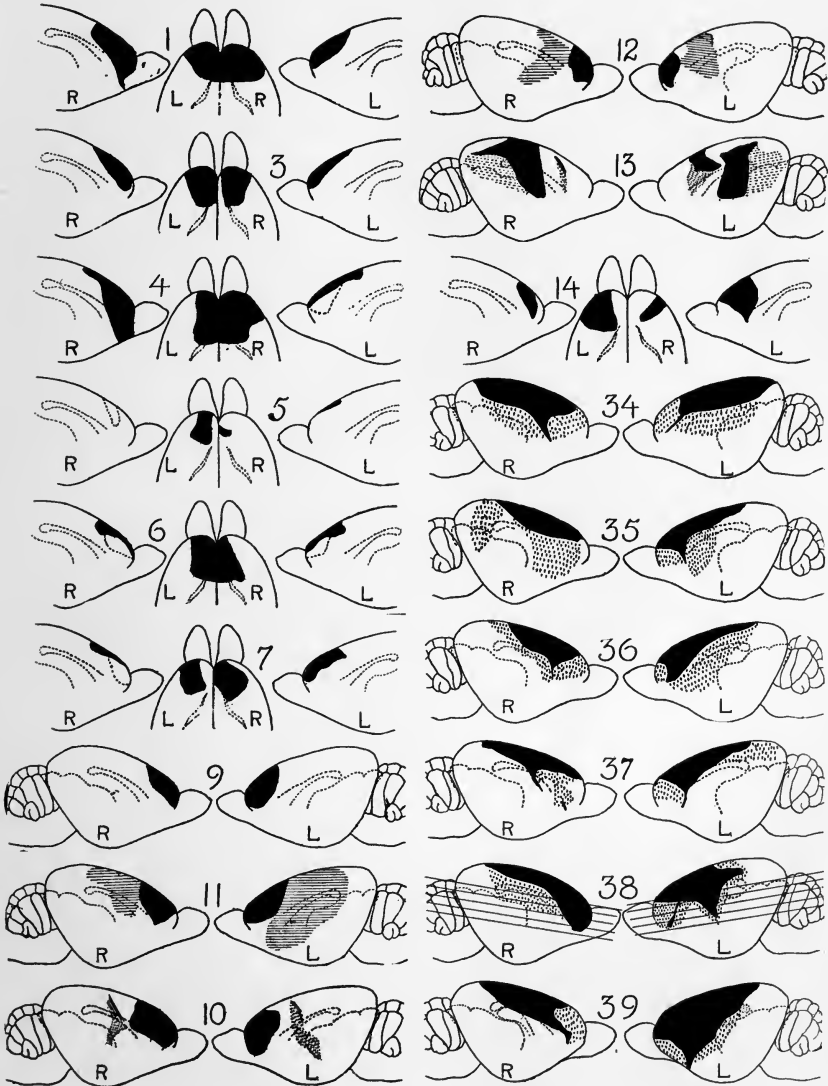



PLATE III

FIG. 17: Lesion in the control animal in which there was no operation on the brain.

FIGS. 18 and 19. Lesions in the control animals after operation on the temporal lobes.

FIGS. 20 to 24. The extent of the lesions in the animals which retained the inclined-plane box habit after operation.

FIGS. 25 and 26. The extent of the lesion in the animals which showed a doubtful retention of the habit.

FIGS. 27 to 33. The extent of the lesion in the animals which lost the inclined-plane box habit after operation.

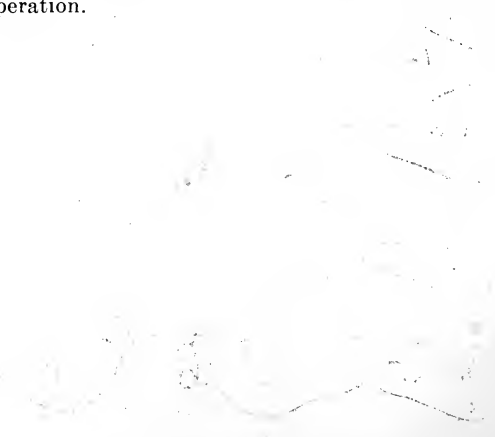

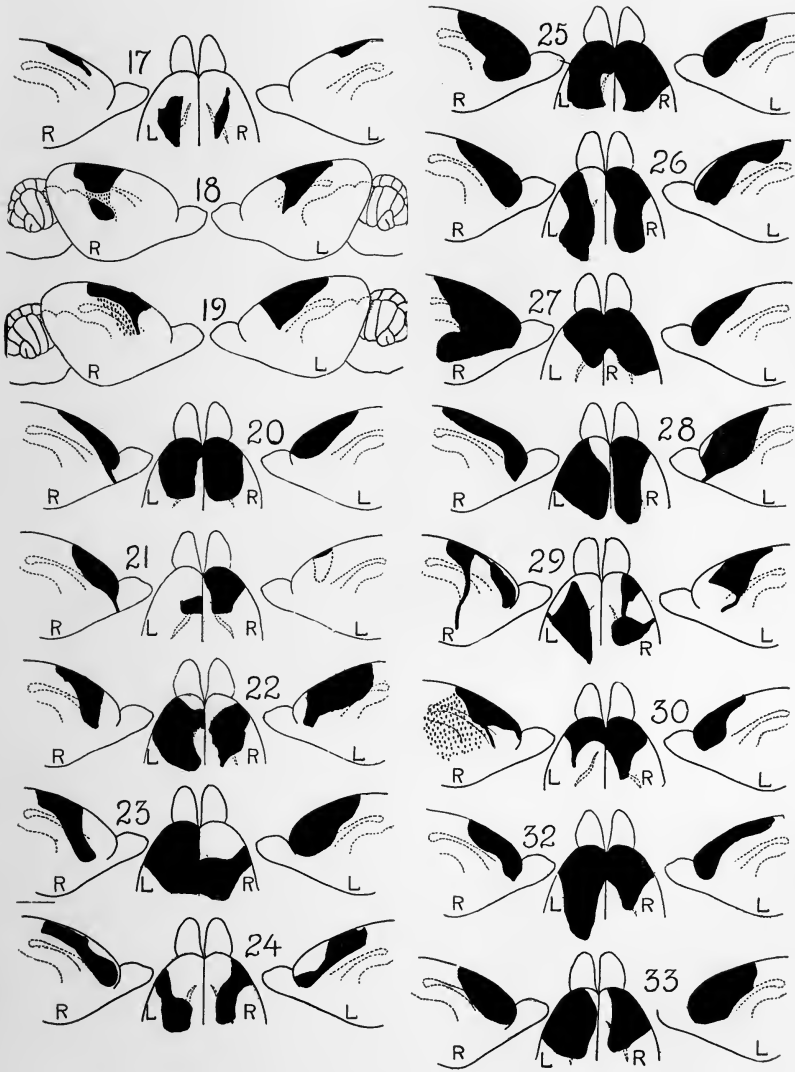

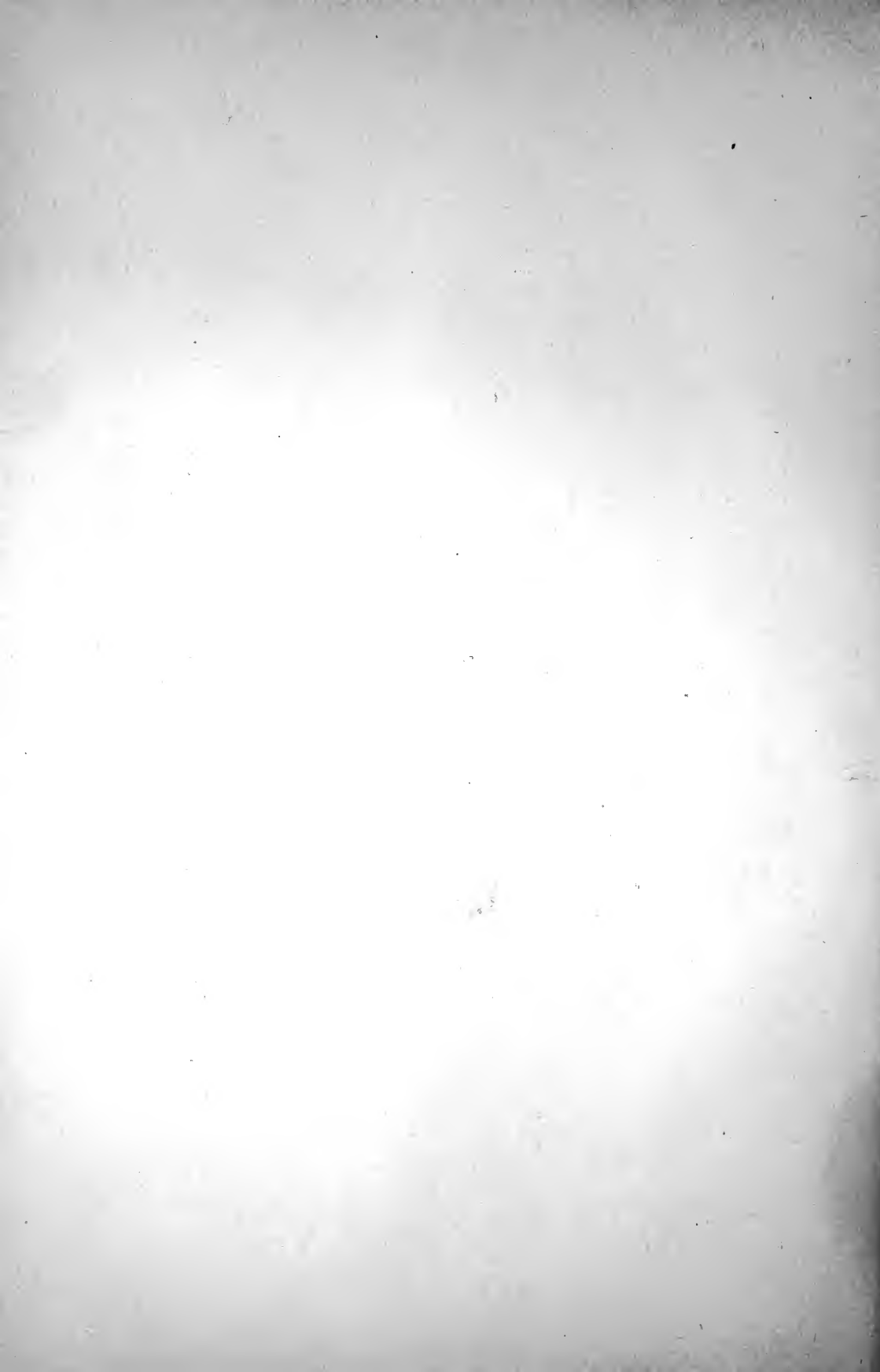

## THE EFFECTS OF STRYCHNINE AND CAFFEINE UPON THE RATE OF LEARNING

K. S. LASHLEY

*Department of Psychology of the Johns Hopkins University*

Among the hypotheses which have been advanced to account for the reintegration of conduction paths in learning three stand out as rather definitely opposed to one another in the neural processes which they imply. The hypothesis suggested by Ladd and Woodworth ('11) assumes inhibition of successive activities as the fundamental process which results in the selection and fixation of random activities. The second hypothesis assumes nervous reinforcement as the fundamental process by which successive acts become linked together in habit-formation. In its vaguest forms this hypothesis refers to pleasure and pain as the reinforcing agents without any attempt to analyze the way in which they act. Its most concrete expression is that given by Angell ('09), though the diagram which he gives has little correspondence with physiological facts. The third hypothesis depends chiefly upon the chance spreading of nervous excitation (Watson, '14 a), or the simultaneous activation of two afferent pathways in such a way that the final common path of one is able to divert the discharge of the other and so bring about a permanent connection between itself and this afferent path (Max Meyer, '11), (Pawlow, '14). If Sherrington's explanation of the spreading of nerve impulses as a result of fatigue of the final common path be accepted, the mechanism implied in this hypothesis is relatively independent of inhibitory and reinforcing activities of the nervous system.

The studies of Verworn and of Sherrington have shown that the primary action of strychnine upon the central nervous system is the reduction of inhibitory processes and their final conversion into processes of excitation. A means is thus pro-

vided for inducing functional changes in nerve conduction which may have a direct bearing upon the hypotheses mentioned above. It may serve, at least, to distinguish the first, the "inhibition theory," from the others, since, if this theory be true, the reduction of inhibitory processes should retard learning, while the resultant increase in the ease of spread of excitatory processes might be expected to accelerate learning, either by increasing the variety of activities available for selection by repetition (third hypothesis), or by increasing the effects of reinforcing agents such as are presupposed by the second hypothesis. Thus, if strychnine retards learning, it should lend some support to the first hypothesis, if it accelerates it, it will give evidence in favor of the second or third.

The interpretation of the results may be complicated, however, by the locus of attack of the drug. Experimental work has located this definitely only in the intercommunicating cells of the dorsal horn of the spinal cord, but the involvement of the entire body in the convulsions of acute strychnine poisoning indicates a similar reduction of inhibitory processes in the midbrain, or perhaps even in the cerebrum. The reduction of stimulus threshold found by Amantea ('15) after application of strychnine to restricted parts of the cortex also shows an increased excitability of the cortex and probably closely similar action of the drug upon cortical and spinal cells. This evidence seems sufficient to justify the interpretation of any effects of the drug found as due to its general reduction of synaptic resistances.

It was with essentially the above problem in mind that I began a study of the effects of strychnine upon habit-formation. Since caffeine is generally stated to have a physiological action similar to that of strychnine but confined to the cerebrum and since it is so generally used as a stimulant it was included with strychnine in this study of the effects of the central excitants.

The three hypotheses outlined above, while most widely accepted, by no means exhaust the possible explanations of the learning process and the results reported in the following pages have, perhaps, complicated rather than simplified the



problem. Accumulating evidence of the dependence of the direction of nerve conduction upon the relative refractory phases of the neurons involved (Forbes and Gregg, '15) and the growing acceptance of the all-or-none law of nerve action make it seem less and less probable that any of the current accounts of the neurological basis of habit is in any way adequate to account for the facts. The presentation of the problem in this form has nevertheless seemed of value in spite of the possible falsity of all the hypotheses which it is designed to test, if only as a means of emphasizing the strictly physiological nature of the problem of learning and the necessity for a more concrete formulation of this problem than has hitherto been made.

#### METHODS IN THE PRESENT EXPERIMENTS

For testing the effects of the central excitants, albino rats, approximately sixty-five days old, were used. They were trained in the circular graphic maze (Watson, '14 b), time, distance, errors, and number of trials required for learning being recorded. The technique of training was essentially that described by Hubbert ('15) with the difference that each animal was given five trials per day and that the training was continued until three successive errorless trials were made during one day's practice.

*Administration of drug.* The drugs given were strychnine sulphate (Powers and Weightman) and caffeine (pure alkaloid, Merck) in aqueous solution. They were injected subcutaneously in solutions of such strength that 0.10 cc. contained the desired dose. The minimum lethal dose of strychnine for an 150 gram rat was determined at the beginning of the experiments as about 0.50 mgm. This is usually fatal in about fifteen minutes but its effect varies somewhat with the concentration of the solution and with individual differences in the animals, one rat being killed by 0.10 mgm., others surviving 0.50 mgm. without convulsions. For study, two concentrations of the drug were used, 0.10 mgm. and 0.05 mgm. per 0.10 cc. of solution. These correspond by weight to doses of about 0.8 and 0.4

grains, respectively, for a 150 pound man, or sixteen and eight times the maximum therapeutic dose.

The caffeine was administered in doses of 0.50 mgm. and 1.00 mgm. These were chosen arbitrarily as corresponding by weight to 4 and 8 grain doses for man. The drugs were administered each day exactly ten minutes before the beginning of training. This time was chosen as the interval after which the first convulsion appears, following the minimum lethal dose of strychnine. Since Goldscheider and Flatau ('98) have found changes in the cells of the dorsal horn within three minutes after the subcutaneous injection of strychnine the ten minute interval seems ample time to assure the full effect of the drug during training. The absence of any easily recognizable effect of the caffeine made it impossible to note its time of action so the same interval between the administration of the drug and the beginning of training was used with it as with strychnine.

A Luer hypodermic syringe graduated in hundredths cubic centimeters was used for injection. Owing to the small quantity (0.10 cc.) of fluid injected some variation in the size of the dose from day to day was unavoidable. With care, however, it was possible to keep this well within 10 per cent of the total quantity injected.<sup>1</sup>

*Method of training.* The course of training was as follows. On three consecutive days the rat was confined for fifteen, ten, and five minutes respectively in the feeding compartment of the maze and was given no food except what was eaten there. On the fourth day training was begun. For the first trial the rat

<sup>1</sup> The technique devised for injection has proved so satisfactory that I believe it can be substituted advantageously for that used in many types of work. The usual methods of confining the animals for injection were found to excite them to an extent which threatened to interfere seriously with the experiments and it seemed necessary that the experimenter have both hands free to manipulate the animals. The hypodermic was therefore fastened by a clamp to project over the edge of a table above which was attached a long lever bearing upon the plunger of the syringe and extending below the table-top so that it could be moved by the experimenter's knee. His hands were thus left free to hold the animal without exciting it, and with careful handling, the animals rarely showed any sensitivity to the injection. With practice it is possible to control the quantity of solution injected by this method to within 0.005 cc.

was pushed out of the starting compartment and the door was closed behind him to avoid the long delay which usually occurs there. In all later trials he was allowed to take his time in starting unless the delay exceeded ten minutes. When he reached the food compartment he was not allowed to retrace the path but was returned to the starting box immediately, getting rarely more than one or two bites of food. After the fifth trial he was confined in the food compartment and allowed to eat for five minutes; then was not fed again until the completion of the next day's practice.

If the rat did not reach the food compartment within one hour after starting, he was returned to the home cage, without food, and the trial was continued on the following day. If the food compartment was not reached within less than three hours the animal was discarded. This occurred in the case of only one rat.

Throughout the experiments the animals were fed exclusively on bread and milk and of this only so much as was eaten during the five minutes' confinement in the feeding compartment of the maze. On this diet a few lost weight rapidly but the average loss of all the animals trained was only 5.1 grams, or about 4 per cent of their average weight at the beginning of the experiments. There was no apparent relation between the loss or gain in weight and the drug administered.

*Criteria of learning.* In computing the results the number of trials preceding the first run without error and also the number preceding three successive errorless runs on the same day have been used as the most dependable criteria of the respective abilities of the groups.<sup>2</sup>

In these experiments and probably in all others where differently treated groups of animals are studied, the rate of running is modified by the differential treatment so that the time consumed in learning, when considered alone, is not reliable as a criterion of the amount of practice. There is no evidence that the distance traversed is similarly influenced and this may be

<sup>2</sup> I have dealt with the relative reliability of these two criteria in another paper (Lashley, '17).

taken as the more trustworthy index to the amount of practice. Since the total distance traversed in learning is greatly influenced by the number of trials, irrespective of whether or not errors are made in all the trials, the total distance traversed during learning is not an accurate index to the number of errors made. The total distance in excess of the direct path through the maze is, on the contrary, closely correlated with the number of errors made, and may perhaps be looked upon as the most accurate measure of error available since we can in no other way evaluate the distances to which the animals penetrate the blind alleys before returning to the direct path.

The relative values of the number of trials and the number of errors made as indices of the effort consumed in learning cannot be determined at present. It is not necessary that a blind alley be entered in order that the alternative entering of the correct path be fixed in the habit. On the other hand it is possible that the failure to obtain food in the blind alley is an important factor in the fixation of the movements required for running over the true pathway. The data on excess distance are given therefore as contributory evidence, the value of which cannot be determined at present. Records were made, also, of the time taken on each trial and of the total distance traversed, thus giving an index of the relative activity of the different groups as determined by their rate of running, and also of the approximate number of errors made by the different rats.

*The rôle of chance in determining the results.* In every experiment where the course of learning is studied in groups of subjects trained under diverse conditions some control of chance variations in the subject and in the conditions of training is necessary. In very few of the recorded experiments of this type, whether performed on man or animals, have enough subjects been used to make the differences found significantly greater than their probable errors, computed by the usual formulae. Consequently, the results are suggestive rather than conclusive.

The significance of the results based upon few subjects may be increased by a careful control of possible variable factors

other than those which are intentionally varied in the experimental procedure. Careful selection of the subjects, and rigorous duplication of the experimental conditions may go far towards the elimination of chance variations in the results. The ideal control of small numbers of subjects is to train all at first in exactly the same activity and then with the results of this training as an index of individual variability, to introduce experimental modifications of the training methods in teaching a second activity. But where learning is relatively slow, as in the white rat, where the age of the subjects may be an important item, and where there may be unknown seasonal differences in the rate of learning, the demands upon the time of the experimenter become such that he cannot alone supply all the requisite controls. As I have pointed out in a previous paper (Lashley, '17), such experiments should be either carried out by the cooperation of several experimenters, or the subjects should be trained in the simplest possible tasks so that as many as possible may be trained.

In the present series of experiments the controls employed seem to cover most of the variable factors save that of individual differences in the animals. They were, briefly, the following:

(1) *Genotype*. The animals trained were all taken from large litters, one animal from each litter being assigned to each of the differentially treated groups. (2) *Sex*. The animals chosen from any given litter were all of the same sex so that each animal in any group was controlled by a sibling of the same sex in each of the other groups. (3) *Age*. Except in the second experiment, all animals were between sixty-five and seventy days of age at the beginning of training. In the second experiment they ranged from seventy-five to eighty-five days. Training was begun with all members of the same litter on the same day. (4) *Daily variations*. For convenience in injecting the drugs all members of each group were trained at about the same time of day, morning, afternoon, or night, but on successive days the order in which the different groups were taken up was varied so that there was no constant difference in the time

of day during which the different groups were trained. Hubert has shown, further, that the rate of learning is not influenced by the time of training. (5) *Seasonal variations*. No seasonal variation in the learning ability of the rat has been demonstrated, but to control possible variations the experiments were condensed into the shortest possible time and corresponding members of all groups were trained at the same time. (6) *Differences of weight*. Where differences in the weight of siblings existed their distribution to the different groups was left to chance. The actual differences in the average weights of the groups were very slight.

Individual differences in the rats other than those noted above were beyond control and may have played some part in determining the results obtained. A further argument, however, in favor of the validity of the differences found between the different groups as indices of the effects of the drugs is the internal agreement between the results of the different experiments which will be considered later.

In the training of animals the personal equation of the experimenter may be influential in deciding the rate of learning. I have sometimes thought that my methods of handling the animals influenced their behavior in the maze, but I have not been able to get any definite evidence of such an influence. Throughout the experiments I made every effort to keep the treatment of all the animals the same and to detect any involuntary favoring of one group or another. Furthermore, the most significant check upon the personal equation is the fact that the results obtained were wholly unexpected and by no means agreeable to my preconceived notion of the probable effects of the drugs.

#### THE EFFECT OF THE DRUGS UPON THE GENERAL ACTIVITY OF THE RATS

It is generally stated that large doses of strychnine increase the activity of animals, making them restless and increasing the extent of their reactions to stimuli. I have not found any

concentration of strychnine which notably increases the general activity of the rat. After the minimum lethal dose the animals crouch on the floor of the cage and remain unusually quiet, unless stimulated, until the onset of convulsions. At the same time the irritability to auditory stimuli is very much increased, and the slightest noise will make them leap high in the air.

The dose of 0.10 mgm., like the lethal dose, seems to reduce spontaneous activity and to lower the threshold to auditory stimuli.<sup>3</sup> After five to ten minutes a coarse tremor, which may be so marked as to resemble a scratching reflex, is visible when the rat raises one foot from the floor. At the same time a marked incoördination of movement appears. The animals are unable to leap accurately or to prevent themselves from falling from the experimenter's hands, and in walking their feet are set down heavily so that the sound may be heard at some distance. When they are frightened their movements become badly incoördinated and even convulsive.

The computation of the rate of running in the maze shows that they move slowly. Besides this they frequently show a characteristic slowing of movement and hesitation when approaching the turns in the maze, so that their progress is a series of quick dashes, alternating with pauses ten seconds or more in length at the turnings of the maze. This behavior may be present even when errors are no longer made.

This description applies to the majority of the animals in group A, experiment 1 (table 1). The animals in the second experiment (group E) rarely showed any such activities, and my notes on them reiterate from day to day "no perceptible effect of the drug." Tremor was sometimes noted but only two of the sixteen showed hesitation at the turns of the maze. The animals used in the second experiment were bred during the winter and were older and much larger than those used in the first experiment. Since in the two experiments the dose was not regulated to the weight of the animals it is almost certain that it was relatively smaller for the group E than for

<sup>3</sup> Probably the excitability to other stimuli is also increased, but this is more difficult to determine.

the group A and that the physiological effects were, on this account, less.

The dose of 0.05 mgm. had a much less pronounced effect on the animals than the larger one. Except for an occasional tremor they seemed in no wise different from those which had not received the drug.

Effects of the caffeine, in any quantity, were difficult to detect. In general, its administration seemed to be followed by some increase in timidity, exhibited in attempts to escape from the experimenter's hands, to run out of the food compartment of the maze at the experimenter's approach, and to hide in the corners of the maze. This did not seem to be present after the second or third day's practice. No tremor or inaccuracy of movement was noted after injection of caffeine.

There is some, though not very certain evidence of the establishment of tolerance to the drugs. After daily injections for two weeks no symptoms were noted in any of the animals following injections of 0.10 or even larger doses of strychnine, and the animals receiving caffeine seemed normal in behavior.

There were no deleterious after effects from the use of the drugs. In some cases 0.10 mgm. of strychnine was given daily for three months. At the end of this time the animals were well nourished and healthy. Practically all were mated, later, and produced large healthy litters.

#### THE INFLUENCE OF THE DRUGS UPON THE AMOUNT OF PRACTICE REQUIRED FOR LEARNING

*Program of experiments.* A preliminary experiment was carried out upon four groups of animals receiving respectively 0.10 mgm. of strychnine, 0.05 mgm. of strychnine, 0.50 mgm. of caffeine, and 0.10 cc. of distilled water. The animals were trained until a record of three successive errorless runs was reached, were then kept without practice for four weeks, and were finally retrained without the drugs to test the retention of the habit. When they were again able to thread the maze without error, their speed and accuracy under the influence



of the different drugs was tested. The experiment gave fairly clear results for the larger doses of strychnine and caffeine, but as a test of its validity two other experiments, one with strychnine and one with caffeine, were carried out. The program of the different experiments, with the number of animals trained, is given in table 1.

TABLE 1

*Synopsis of experiments. Data are given separately on three experiments in each of which the animals were trained simultaneously, with control of age, sex, genotype, etc.*

GROUP	DRUG	NUMBER OF RATS	AGE IN DAYS
Experiment 1. June-September, 1915. Learning, re-learning, and efficiency tested			
A	Strychnine, 0.10 mgm.	10	60-70
B	Strychnine, 0.05 mgm.	9	60-70
C	Caffeine, 0.50 mgm.	9	60-70
D	Water, 0.10 cc.	10	60-70
Experiment 2. October-December, 1915. Learning tested			
E	Strychnine, 0.10 mgm.	16	70-90
F	Water, 0.10 cc.	16	70-90
Experiment 3. February-April, 1916. Learning tested			
G	Caffeine, 0.50 mgm.	6	60-70
H	Caffeine, 1.00 mgm.	6	60-70
I	Water, 0.10 cc.	6	60-70
J	Strychnine, 0.10 mgm. (after training)	6	60-70

*The effects of strychnine on learning.* Three groups of animals, A, B, and E, were trained after injection of strychnine and control groups, D and F, receiving only water, were trained at the same time. The number of trials required by each of the animals in these five groups for reaching the standard of three successive errorless runs is shown in figure 1. The average numbers of trials required for the five groups to meet the two criteria of learning are given in table 2.

Groups A, B, and D were trained at the same time and under the same conditions. Among them it appears that the group

receiving the smaller dose of strychnine is not significantly different from that receiving water only. Judged by the standard of the first errorless run it, is superior, by that of three errorless runs it is inferior. In neither case is the difference enough greater than its probable error to be significant; there is no indication that the strychnine had any effect upon

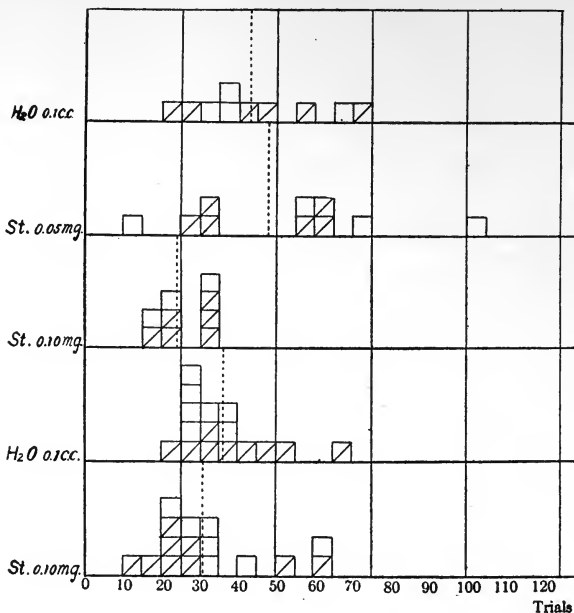

FIG. 1. A comparison of the number of trials required for learning by animals trained after injection of strychnine and normal animals (receiving injections of water only). The squares represent each one animal; the diagonal lines indicate females. For each group the number of animals making each score is shown on the ordinates, the number of trials required for learning on the abscissae. The dotted lines show the averages of the groups.

the learning of this group. The heavier dose of strychnine, on the contrary, seems to have reduced the number of trials required for learning. A comparison of group A with the control group D shows, as a probable result of the administration of the strychnine, a reduction of 36 to 44 per cent in the number of trials required to meet the two criteria of learning. Both

differences are at least three times their probable errors and therefore almost certainly the result of the differential treatment of the two groups. In the second strychnine experiment (groups E and F) the superiority of the drugged over the normal animals is less pronounced, amounting to only 18 per cent for the first errorless run and 11 per cent for three successive errorless runs. The differences also are not significantly greater

TABLE 2

*A comparison of the number of trials required for learning by rats after injections of strychnine and of water*

GROUP	DRUG	NUMBER OF TRIALS PRECEDING FIRST WITHOUT ERROR	PER CENT OF WATER CONTROL	NUMBER OF TRIALS PRECEDING THREE SUCCESSIVE WITHOUT ERROR	PER CENT OF WATER CONTROL
D	Water, 0.10 cc.	23.0 ± 2.4	100.0	43.5 ± 3.8	100.0
A	Strychnine, 0.10 mgm.	14.8 ± 1.2	64.3	24.5 ± 1.4	56.3
B	Strychnine, 0.05 mgm.	20.4 ± 2.3	88.7	48.6 ± 5.4	111.7
F	Water, 0.10 cc.	19.6 ± 1.5	100.0	35.1 ± 1.8*	100.0
E	Strychnine, 0.10 mgm.	16.1 ± 1.7	82.1	31.0 ± 2.4	88.3
<i>Differences</i>					
D-A		8.2 ± 2.7		19.0 ± 4.1	
D-B		2.6 ± 3.4		5.1 ± 6.6	
F-E		3.5 ± 2.2		4.1 ± 3.0	

\* In a previous discussion of these data (Lashley, '17) a mistake was made in computing the probable error of this average. The error was large but does not significantly affect the conclusions of that paper.

than their probable errors, so that from these data alone the second experiment lends little support to the first.

As has been brought out in the earlier discussion, however, the drugged animals in this experiment showed in other respects a lesser effect of the drug than did those used in the first experiment. The records of the behavior of the animals of group E in the maze give only two rats which showed tremor after injection of strychnine and these two animals required fewer trials for learning than any others in the group. It is

probable, then, that when the greater weight and age of the animals used in this experiment is taken into account, the group corresponds rather to group B of the first experiment, which also showed no tremor resulting from the drug and no superiority over the controls.

The number of trials as a measure of the amount of practice resulting in a given degree of efficiency is probably less dependable than the number of errors made during practice. The distance traversed during training in excess of the shortest path through the maze expresses the amount of practice fairly accurately and the average excess distance has been computed

TABLE 3

*A comparison of the distance traversed in excess of the true pathway during learning of the maze by rats after injections of strychnine sulphate and of water*

GROUP	DRUG	EXCESS DISTANCE	PER CENT OF WATER CONTROL
		<i>meters</i>	
D	Water, 0.10 cc.	266.8	100.0
A	Strychnine, 0.10 mgm.	159.8	59.8
A	Strychnine, 0.05 mgm.	265.7	99.6
F	Water, 0.10 cc.	211.8	100.0
C	Strychnine, 0.10 mgm.	146.1	68.9

for each of the groups trained. These averages are given in table 3, and the individual records in figure 2. In the first experiment there is practically no difference between the group receiving 0.05 mgm. of strychnine and the control group. In both experiments the groups receiving the larger dose of strychnine, 0.10 mgm., traversed a shorter distance in excess of the true pathway than did the control groups. In the first experiment this saving amounted to 41.2 per cent and in the second experiment to 31.1 per cent. This difference between the groups in the second experiment is greater than that revealed by the number of trials. It is probable that the excess distance, or number of errors represents more accurately than the

number of trials the actual amount of practice required for the attainment of a given degree of proficiency and, hence, that the results of the first and second experiments are more nearly in accord than could be determined from the data on the number of trials alone.

The results may be judged in yet another way and one which gives a still more reliable basis for comparison than the average

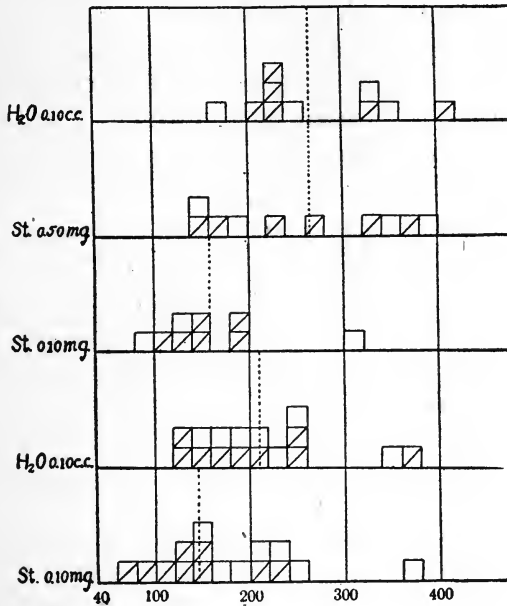

FIG. 2. A comparison of the total excess distance over the shortest path through the maze traversed during training by rats under the influence of strychnine and by normal animals. Arranged as figure 1, except that the abscissae represent meters.

number of trials required for learning. The method by which the animals were selected for training makes it possible to compare each animal with a sibling of the same sex trained under identical conditions. Table 4 gives the results of such a comparison of the rats with their individual controls. Of the animals which received 0.05 mgm. of strychnine 60 per cent were superior to their controls. Eighteen out of 25, or 72 per cent

of those receiving the larger dose of strychnine were superior to their controls. This comparison of individuals eliminates the excess weight given to extreme variates by the computation of averages and forms a basis for an estimation of the regularity of action of the drug. The results are consistent with those obtained from the averages of trials and distances and lend additional support to the view that the superiority of groups A and E over their controls is the result of the action of the drug and not merely a chance variation.

The evidence from various sources, when massed together, seems dependable. The animals receiving the smaller dose of strychnine were not affected by the drug. The larger animals showed little effects of the drug either upon their general tonic

TABLE 4

*The proportion of rats receiving strychnine which learned the maze in fewer trials than their individual controls*

GROUP	DRUG	NUMBER LEARNING IN FEWER TRIALS THAN THEIR CONTROLS	NUMBER LEARNING IN MORE TRIALS THAN THEIR CONTROLS	PER CENT SUPERIOR TO CONTROLS
B	Strychnine, 0.05 mgm.	6	4	60
A	Strychnine, 0.10 mgm.	8	1	88
E	Strychnine, 0.10 mgm.	10	6	62

condition or their rate of learning, with the exception of two which showed tremor and learned more rapidly than the other members of the group. The smaller rats, after the large dose of strychnine, showed a fine tremor and learned the maze in considerably less time than was required by the controls. The evidence points to an acceleration of learning resulting from the administration of strychnine, but only when it is given in doses large enough to produce observable alterations in muscular tonus.

*Time of action of the drug.* To test whether the acceleration is due to the immediate effects of the drug or to a general alteration in metabolism another series of rats was trained in which the strychnine was administered daily five minutes after training instead of before. The results of this test are given in table

5. Apparently the strychnine so given had a retarding effect upon learning, but while the difference between the strychninized animals and their controls is fairly great, the number of animals is so small that no dependence can be placed upon the difference. In this case the dose was graduated to the weight of the animals, 0.10 mgm. of strychnine to each hundred grams weight of the animal so that the immediate effects of the drug resembled those found in the first experiment. The test suggests that the acceleration of learning found for groups A and E is the result of the immediate action of the drug.

*The influence of caffeine on the rate of learning.* The tests of the effects of caffeine were made in the same way as those with strychnine. Three groups of rats were trained after doses

TABLE 5

*A comparison of the number of trials required for learning by rats after injection of water before training, and of 0.10 mgm. of strychnine after each day's practice*

GROUP	DRUG	NUMBER OF TRIALS PRECEDING FIRST ERRORLESS RUN	PER CENT OF WATER CONTROL	NUMBER OF TRIALS PRECEDING THREE SUCCESSIVE WITHOUT ERROR	PER CENT OF WATER CONTROL
I	Water, 0.10 cc.	14.3 $\pm$ 2.2	100.0	30.0 $\pm$ 2.8	100.0
J	Strychnine, 0.10 mgm.	18.0 $\pm$ 1.4	125.8	42.5 $\pm$ 4.2	141.6

of 0.50 mgm. and 1.00 mgm. of the drug and others receiving only water were trained at the same time. The average numbers of trials required for learning, as estimated from the first errorless run and from three successive errorless runs, are given in table 6. In groups G and H the dose was regulated to the weight of the different animals on the basis of the above doses for an hundred gram rat, so that these groups received relatively more of the drug than did group C.

In every case the rats receiving caffeine required a greater number of trials for learning than did their water controls. The differences are quite large, from one and one half to three times as many trials being required by the caffeinized animals as by normal ones. The differences between the groups are at least three times their probable errors and hence significant.

The drug seemed to affect all the animals that received it in the same way. Of the 21 animals trained after injection of caffeine only one required as few trials for learning as did his individual control. The results of the comparison of individual records are given in table 8. Further, no animal that was given caffeine learned in fewer trials than the average of the control animals, as appears from figure 3.

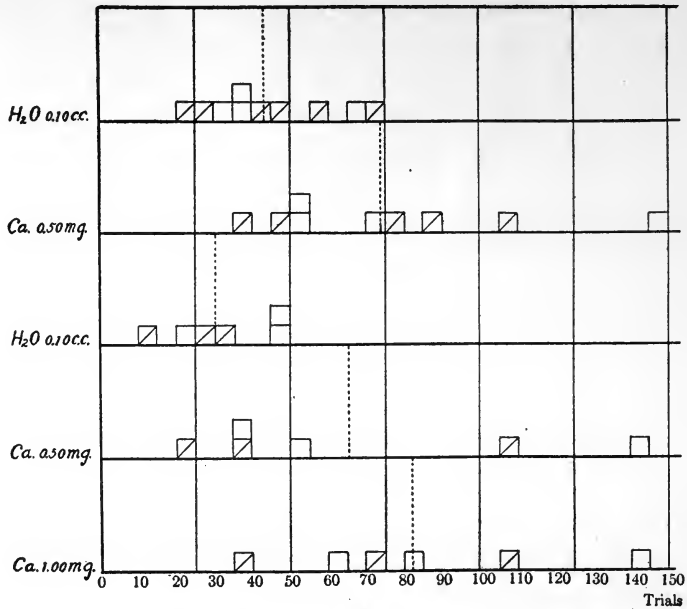

FIG. 3. A comparison of the number of trials required for learning by animals trained after injection of caffeine with that required by normal ones. Arranged as figure 1.

The distance traversed in excess of the true pathway, or approximately, the number of errors made, also shows the caffeinized animals inferior to the controls. The individual records of excess distance are given in figure 4 and the averages in table 7. The proportions are somewhat less than those given by the data on the number of trials but are still too large to be explicable as the result of chance.



TABLE 6

*A comparison of the number of trials required for learning by rats after injections of caffeine and of water*

GROUP	DRUG	NUMBER OF TRIALS PRECEDING FIRST WITHOUT ERROR	PER CENT OF WATER CONTROL	NUMBER OF TRIALS PRECEDING THREE ERRORLESS RUNS	PER CENT OF WATER CONTROL
D	Water, 0.10 cc.	23.0 ± 2.4	100.0	43.5 ± 3.8	100.0
C	Caffeine, 0.50 mgm.	32.4 ± 3.0	140.8	74.4 ± 7.5	171.0
I	Water, 0.10 cc.	14.3 ± 2.2	100.0	30.0 ± 2.8	100.0
G	Caffeine, 0.50	31.3 ± 6.3	218.8	65.3 ± 12.0	217.6
H	Caffeine, 1.00 mgm.	43.0 ± 5.1	300.7	82.6 ± 9.2	275.3

*Differences*

C-D	9.4 ± 3.8	30.9 ± 7.8
G-I	17.0 ± 2.9	35.3 ± 12.3
H-I	28.7 ± 5.6	52.6 ± 9.6

TABLE 7

*Distance in excess of true pathway traversed by rats after injections of caffeine and of water*

GROUP	DOSE	EXCESS DISTANCE	PER CENT OF WATER CONTROL
		<i>meters</i>	
D	Water, 0.10 cc.	266.8	100.0
C	Caffeine, 0.50 mgm.	436.1	163.8
I	Water, 0.10 cc.	205.9	100.9
G	Caffeine, 0.50 mgm.	373.7	181.5
H	Caffeine, 1.00 mgm.	455.9	221.4

TABLE 8

*The proportion of rats receiving caffeine which required a greater number of trials for learning the maze than did their individual controls*

GROUP	DRUG	NUMBER LEARNING IN FEWER TRIALS THAN CONTROLS	NUMBER LEARNING IN MORE TRIALS THAN CONTROLS	PER CENT INFERIOR TO CONTROLS
C	Caffeine, 0.50 mgm.	0	9	100
G	Caffeine, 0.50 mgm.	1	5	83
H	Caffeine, 1.00 mgm.	0	6	100

As in the case of the tests on strychnine, the number of animals trained is small, but the differences brought out are so pronounced in every case that we seem justified in concluding definitely that caffeine has a retarding effect upon the rate of learning the maze.



FIG. 4. A comparison of the total excess distance over the shortest path through the maze traversed by animals under the influence of caffeine and by normal animals. Arranged as figure 2.

#### THE EFFECT OF THE DRUGS UPON RETENTION

When each animal in experiment 1 had made a perfect record it was kept without further training for twenty days and was then tested for retention without further administration of the drugs. The criterion used in testing relearning was the same as that for learning: three successive trials without error. The average numbers of trials required by the different groups to reach this standard are given in table 9. The range of variation in each group was very great, from 1 to 30 or more trials

and the differences apparent in the table are, perhaps, not great enough to be significant. Seemingly, the rats which learned most quickly and consequently received the smallest amount of practice, required the most practice for re-acquirement of the habit, but the great variability within the groups makes such a conclusion doubtful.

EFFECTS OF THE DRUGS UPON THE RATE OF MOVEMENT IN THE MAZE

While the results seem precise enough to demonstrate an accelerating effect for strychnine and a retarding effect for caffeine upon the rate of learning it is by no means clear how these effects are brought about or whether they actually bear

TABLE 9

*The average number of trials required for relearning by the rats in experiment 1*

GROUP	DRUG	AVERAGE NUMBER OF TRIALS REQUIRED FOR LEARNING	AVERAGE NUMBER OF TRIALS REQUIRED FOR RELEARNING
A	Strychnine, 0.10 mgm.	24.5	18.8
B	Strychnine, 0.05 mgm.	48.6	12.9
C	Caffeine, 0.50 mgm.	74.4	12.1
D	Water, 0.10 cc.	43.5	9.9

upon the theories previously outlined. The maze habit is so complex and demands the formation of so many new functional conduction paths that failure or success in learning may be only indirectly or not at all the result of changes in the rate of formation of such pathways. Some indication of the mode of action of the drugs is given by the behavior of the animals in approaching the turns of the maze and by the data obtained upon the relative time required by the different groups and the rate of running at different stages of the learning process. The tracings of the paths followed by the animals in learning the maze have been measured and the average time, distance, and rate of running of the different groups have been computed. The results are summarized in table 10. The rate, determined by dividing the distance by the time, is subject to error from

the fact that no allowance could be made for the times during which the rats were inactive. In the earlier trials many of the animals remain quiet in the corners of the maze for rather long periods, so that the differences in rate recorded for the first trials represent differences in the amount of time spent in inactivity rather than differences in actual rate of running during activity. The periods of inactivity rarely, if ever, persist after the third trial, however, so that the averages for later trials express more nearly the true rate of movement.

TABLE 10

*The rate at which the animals ran in the maze at different periods during the learning process. The rate is expressed in centimeters per second. Average rates, for the first trial, the three successive errorless trials, and for the intervening trials, are given*

GROUP	DRUG	AVERAGE RATE OF RUNNING		
		First trial	Three perfect trials	All others
A	Strychnine, 0.10 mgm.	2.2	13.4	6.5
B	Strychnine, 0.05 mgm.	2.9	18.7	11.2
C	Caffeine, 0.50 mgm.	4.3	16.7	14.6
D	Water, 0.10 cc.	4.4	20.3	11.8
E	Strychnine, 0.10 mgm.	5.1	11.7	15.0
F	Water, 0.10 cc.	7.7	15.7	21.5
G	Caffeine, 0.50 mgm.	3.5	18.9	17.1
H	Caffeine, 1.00 mgm.	7.1	17.9	23.3
I	Water, 0.10 cc.	3.6	11.3	8.5
J	Strychnine, 0.10 mgm. (after training)	4.9	12.5	11.9

The table shows that both in the first trial and in the total of all succeeding trials including the three successive errorless ones the strychninized animals ran more slowly than their controls, that those which had received 0.5 mgm. of caffeine more closely approximated their controls than did any of the other groups, and that those which received a full milligram of caffeine ran most rapidly. It was impossible to keep accurate records of the amount of time spent by the animals in inactivity, but the longer periods were noted, and in so far as can be determined from these the strychninized rats were more continuously and the

caffeinated rats less continuously active than their controls, although the differences were not great. This is the inverse relation to the rates of running found and emphasizes the fact which appears most clearly in the averages of all trials, that the movements of the strychninized rats were retarded and those of the caffeinated rats were accelerated by the drugs.

When the averages of all trials, exclusive of the first one and the last three (table 10, last column) are considered the slow movements of the strychnine rats and the rapid movements of the caffeine appear unmistakably. If the records of the rate of running of the water-controls are taken as standard, the average rates of the strychninized animals are (B) 95, (A) 53, and (C) 72 per cent of this respectively; those of the caffeinated are (C) 123, (G) 200, and (H) 272 per cent of their controls.

I have already mentioned the characteristic behavior of the strychninized rats when approaching the turns in the maze (p. 149). Those rats which showed other effects of the drug, tremor, etc., usually slowed down and approached the entrance from one alley to the next cautiously, turning their heads from side to side and smelling the edges of the opening before going through. This behavior, which did not persist long after the maze-habit became automatized, was never apparent in the caffeinated rats or in the controls. With its disappearance the rate of running increased also to equal or exceed that of the controls. This is shown by the average speed of the rats during the tests for efficiency (table 11).

The caffeinated rats not infrequently seemed to be in a high state of excitement during training. Greater care was necessary in confining them in the food compartment of the maze than for the other groups, as a slight noise or jarring of the maze would bring them rushing from the food to hide in one of the blind alleys of the maze. Once they had begun to acquire the habit their behavior differed less from the strychninized rats and from the controls, but instead of approaching the turns of the maze cautiously, they frequently dashed ahead at a speed which carried them almost past the openings before they could turn. This behavior also became less noticeable as the habit became

fixed but never completely disappeared. The fact, brought out in table 11, that with long training their rate of running under the influence of the caffeine became less than without the drug is due to the fact that more errors were made under the former conditions and more time was lost in turning and other activities which did not increase the distance traversed.

THE EFFECT OF THE DRUGS UPON EFFICIENCY OF PERFORMANCE  
OF A MOTOR HABIT

For further information which might be of service in interpreting the data on learning a series of tests upon the effect of

TABLE 11

*Data on the effects of strychnine and caffeine on efficiency in the performance of a motor habit. The averages (except those marked first ten trials) are each based upon 180 trials*

GROUP	RECEIVING	AVERAGE DISTANCE PER TRIAL	AVERAGE EXCESS DISTANCE PER TRIAL	AVERAGE TIME PER TRIAL	TOTAL NUMBER OF ERRORS	AVERAGE RATE
		<i>meters</i>	<i>meters</i>	<i>seconds</i>		<i>m.p.s.</i>
1	Water 0.10 cc.	5.24	0.89	10.5	85	0.49
	Strychnine 0.10 mgm.	4.67	0.32	8.3	35	0.56
	First ten trials	5.16	0.81	10.6	33(99)	0.48
2	Water 0.10 cc.	5.30	0.95	10.9	76	0.48
	Strychnine 0.10 mgm.	5.04	0.69	9.7	68	0.52
	First ten trials	5.09	0.74	11.0	25(75)	0.46
3	Water 0.10 cc.	5.06	0.71	9.4	71	0.47
	Caffeine 0.50 mgm.	5.27	0.92	12.8	90	0.41
	First ten trials	5.39	1.04	10.8	38(114)	0.49

the drugs upon the established maze-habit was carried out. Eighteen rats which had learned and relearned the maze were divided into three groups and given five trials per day in the maze for fourteen successive days. On the first two days all were given subcutaneous injections of 0.10 cc. of water ten minutes before they were started in the maze. A comparison of their efficiency with and without the drugs was then made in the following way. For two consecutive days the drug was

given by subcutaneous injection; on the following two days only water was given; and again the drug on the next two days. To control the effects of practice during the test three rats in each group received the drug on the first two test days while the remaining three received water on these days and the alternations were continued regularly with each three. The three groups were given alternately (1) water, 0.10 cc. and strychnine sulphate, 0.10 mgm.; (2) water, 0.10 cc. and strychnine sulphate, 0.05 mgm.; (3) water, 0.10 cc., and caffeine, 0.50 mgm.

The data obtained in the experiment are summarized in table 11. In the table the averages of the first ten trials are based upon sixty trials, or ten for each rat. The remaining averages are based upon thirty trials for each rat or one hundred and eighty trials altogether. The significant figures for determining relative efficiency with and without the drugs are the rate of running and the number of errors. The differences in rate are not great: for group 1, the rate of running, under the influence of the drug is 114 per cent; for group 2, 108 per cent; and for group 3, 91 per cent of the water control. These differences are in inverse proportion to the number of errors made and are probably due to the time lost in stopping and turning when errors were made.

The superiority of the animals under strychnine as measured either by the excess distance traversed or by the counted number of errors is quite marked. Under strychnine group 1 made 59 per cent fewer errors and traversed 64 per cent less distance than when without strychnine. Under the same conditions group 2 made 11 per cent fewer errors and covered 28 per cent less distance.

Under caffeine the rats of group 3 made 26 per cent more errors and traversed a distance 29 per cent greater than without the drug.

All the rats, with one exception, in groups 1 and 3, in which the greatest effects of the drugs are evident, were affected in the same way by the drugs. The individual averages of the animals in these groups are given in table 12. In group 1 every one of the animals made fewer errors while under the

influence of strychnine than while normal. In group 3 only one of the rats (no. 4) made fewer errors when under the influence of caffeine than when normal and this rat totaled so many more errors than any of the others that his record may perhaps be regarded as abnormal. This result agrees with the data on learning. The animals which learned most rapidly, those under the influence of strychnine, also were most accurate in carrying out the learned activity. Those which required

TABLE 12

*Individual records of efficiency of performance in animals receiving doses of strychnine sulphate or caffeine alternately with water*

LABORATORY NUMBER OF ANIMAL	TOTAL EXCESS DISTANCE IN 30 TRIALS		TOTAL NUMBER OF ERRORS IN 30 TRIALS	
	Water	Strychnine	Water	Strychnine
<i>Group 1</i>	<i>meters</i>	<i>meters</i>		
14	35.5	20.7	16	9
13	6.3	2.5	4	3
16	21.5	7.4	14	6
17	40.0	10.0	16	4
27	1.7	0.0	3	0
28	57.7	17.9	32	13
<i>Group 3</i>		Caffeine		Caffeine
4	67.1	57.2	36	32
11	8.3	14.4	3	9
29	9.3	20.1	8	10
21	18.6	26.4	9	15
23	3.9	11.4	5	7
7	21.0	36.5	10	17

much practice for perfect learning were inaccurate even after having once acquired the required standard of proficiency. It seems that the same factors that resulted in increased or diminished accuracy in performance of the perfected habit were influential also in shortening or prolonging the learning process.

#### DISCUSSION

We may summarize the better established results of this work as follows: Strychnine sulphate, when administered in doses large enough to produce obvious changes in tonus, effects



a saving in the amount of practice necessary for learning. Caffeine in large doses markedly increases the amount of practice consumed in learning and the retardation of the rate of learning seems proportional to the amount of the drug administered.

During training the animals under the influence of strychnine move more slowly, and those under caffeine more rapidly than normal animals. Associated with these effects are a seeming caution in approaching the turns of the maze appearing in the strychninized animals and an exaggerated carelessness in those under caffeine. These effects largely disappear when the habits have become automatized. After the habit has been perfected strychnine increases and caffeine diminishes the accuracy of the animals' performance.

The results are complex and seemingly at variance with the similarity of action accredited to the drugs by pharmacologists, and, in view of our elementary knowledge of their effects upon various sense organs and upon the autonomic nervous system it is not possible to make any definite conjecture as to the way in which the drugs bring about their effects upon the learning process.

The most confusing point is the direct opposition of the effects of caffeine and strychnine. Until further data is accumulated upon the physiological action of these drugs it will not be possible to apply the present data to the question of the relation of inhibitory or excitatory nervous activity to learning. A significant suggestion concerning the difference of action of the drugs is given by Sajous ('12). He asserts that the first effects observed after the administration of both drugs result from the stimulation of suprarenal activity: Caffeine is more effective than strychnine in producing this result and its effects are almost wholly confined to this action: Strychnine, however, in large doses soon attacks the spinal centers and its more pronounced effects are due to its action on the central nervous system. I have not been able to find the original data upon which these statements are based and they are not in accord with the more generally accepted accounts of the action of the drugs, although there seems to be no conclusive evidence against

them. If correct, they go far toward clearing up the problem. The hyper-emotionalism of the caffeinized animals suggests an increased output of adrenalin in agreement with Sajous' conception. It is possible, then that the retarding effects of caffeine on learning are due to endocrine activity, which, in the case of strychnine is obscured by the action of the drug upon the central nervous system.

Since only the larger dose of strychnine affects learning and then only when other symptoms indicate its attack upon the central nervous system it seems probable that its acceleration of learning is correlated in some way with the reduction of synaptic resistances and the increased ease of spread of nerve impulses. This condition should result in a greater diversity of activity, a readier change from one type of action to another, than is possible in a normal nervous system, and might therefore militate against the appearance of stereotyped errors. As this is the sort of error appearing in the later stages of practice it seems possible that the acceleration of learning by strychnine may be effected in this way.

#### SUMMARY

Albino rats were trained in the circular maze after subcutaneous injection of strychnine sulphate and of caffeine. Others were trained after similar manipulations but without the drugs, as controls. Analysis of the data obtained gives the following results:

1. Small doses of strychnine sulphate are without effect upon the rate of habit-formation.
2. Large doses of strychnine sulphate, sufficient to produce tremor and incoördination of movement, accelerate learning.
3. Caffeine, in doses of 0.5 mgm. or more, retards learning in direct proportion to the size of the dose.
4. Strychnine sulphate in large doses increases the accuracy of performance of a perfected habit.
5. Large doses of caffeine result in increased activity and reduced accuracy of performance.

## REFERENCES

- AMANTEA, G. Sur les rapports entre les centres corticaux de la circonvolution sigmoïde et la sensibilité cutanée chez le chien. *Arch. ital. de biol.*, 1915, lxiii, 143-148.
- ANGELL, J. R. *Psychology*, 4th. edition, p. 70, 1909. New York. Holt.
- FORBES, A. AND GREGG, A. Electrical studies in mammalian reflexes. II. The correlation between strength of stimuli and the direct and reflex nerve response. *Amer. Jour. Physiol.*, 1915, xxxix, 172-235.
- GOLDSCHIEDER, A., UND FLATAU, E. *Normale und pathologische Anatomie der Nervenzellen auf Grund der neueren Forschungen*. 1898, Berlin.
- HUBBERT, H. B. The effect of age on habit formation in the albino rat. *Behav. Monog.*, 1915, ii, (No. 11), pp. v + 55.
- LADD, G. T., AND WOODWORTH, R. S. *Elements of Physiological Psychology*, p. 551. New York, 1911. Scribner.
- LASHLEY, K. S. The criterion of learning in experiments with the maze. *Jour. Animal Behav.*, 1917, vii, 66-70.
- MEYER, MAX. *The Fundamental Laws of Human Behavior*. Boston, 1911. Badger.
- PAWLOW. Cited from Babkin, B. P. *Die äussere Sekretion der Verdauungsdrüsen*. Berlin, 1914. Springer.
- SAJOUS, C. E. DE M. *The Internal Secretions and the Principles of Medicine*. Philadelphia, 1912, F. A. Davis Co.
- WATSON, J. B. a. *Behavior: An Introduction to Comparative Psychology*. New York, 1914. Holt.
- WATSON, J. B. b. A circular maze with camera lucida attachment. *Jour. Animal Behav.*, 1914, iv, 56-59.



## THE STOP-WATCH AND THE ASSOCIATION TEST

KNIGHT DUNLAP

*From the Psychological Laboratory of the Johns Hopkins University*

In performing the association test with groups of from three to five "suspects," using a reliable chronoscope, I have never had a failure, except from the attempt of some "innocent" person to appear "guilty." In the cases to which I refer, an assistant shows one member of the group a picture, or instructs him to commit a simple act which is not known in detail to the other "suspects;" then each in turn is put through a series of free association reactions to twenty or twenty-five\* words, containing from five to eight words referring to the picture or act; and from the response-words and the reaction-times, I determine which is the "guilty" person. In these cases the method is put to its severest test, because there is no strong desire on the part of the "guilty" person to escape detection, and, as above remarked, "innocent" persons sometimes deliberately disobey instructions thus making their reactions appear "guilty." This difficulty does not occur in real practice, hence its occurrence in these cases does not constitute failure. In practical work, given some details of the case which could be known only to the guilty person; and a lively aversion on the guilty person's part to being detected; there is small chance of failure with suspects of average intelligence.

It is true, nevertheless, that many experimenters report failure in application of the method, and these failures require explanation. In some cases, undoubtedly, improperly prepared word-lists are responsible: the preparation of the word-list is the chief part of the test requiring skill. In other cases, probably, the subject has not realized at the time of the test that he was suspected. This realization is of course indispensable. In still other cases it is possible that the technique of the reac-

tion-timing is at fault, and as the stop-watch is much used in this work, it has seemed to me worth while to investigate the possible errors in the use of the watch for association-timing.

Seven advanced students volunteered to carry out experiments by the following method. The chronoscope and voice-keys were set up with proper accessories for the association reaction. Sensitive voice keys, responding accurately, were used, set so that experimenter and reactor faced each other directly across an ordinary table. The experimenter spoke the stimulus-word in each case against the stimulus key, and manipulated the stop-watch. An assistant managed the chronoscope, and recorded the readings, which the experimenter did not see. In this way, for each reaction, we obtained a stop-watch record, and simultaneously, a chronoscope record of the same reaction. The six experimenters and several other persons served as reactors at different times.

The reactions were taken in series of fifty, using word-lists that had been prepared by Dr. Loring for other purposes. As the absolute reaction values are immaterial these word-lists are omitted from this account. Twenty series were obtained, with the results presented in Table 1.

In Table 1 we can readily discern certain general facts. (1) The average stop-watch time is in every case longer than the average chronoscope time. This would be expected from the tendency to start the watch approximately *with* the stimulus word (synchronizing reaction), and to stop it *after* the beginning of the response word (serial reaction). (2) The mean variations of the corresponding averages show considerable disagreement. Experimenters B, D, and E in each series reduce with the stop-watch the actual (chronoscope) variation. Experimenter G in each increases the variation. Experimenters A and C reduce it in three series and increase it in one. Experimenter F reduces the variation in one series and increases it in the other. The differences between the average times for stop-watch and chronoscope, and the divergences of mean variations, do not show in full measure the actual discrepancies between the individual chronoscope times and the stop-watch times, since,

as is obvious, the mean variations might in a given pair of series be identical, and the averages be identical, yet the discrepancies between corresponding times be large. As a matter of fact, the data from which Table 1 was compiled shows a measure of discrepancy far above that indicated in the table. Many long actual (chronoscope) reactions have short stop-watch records and vice versa, in every series. The tendency to reduce varia-

TABLE 1

EXPERIMENTER	STOP-WATCH		CHRONOSCOPE	
	Average	Mean variations	Average	Mean variations
	<i>seconds</i>	<i>per cent</i>	<i>seconds</i>	<i>per cent</i>
A	1.3	14	1.206	18
A	1.26	12	1.078	13
A	1.4	15	1.011	20
A	1.32	18	1.145	15
B	1.495	19	1.432	28
B	1.484	17	1.385	19
B	1.572	14	1.438	21
B	1.544	14	1.444	15
C	1.248	17	1.195	33
C	1.172	23	1.134	11
C	0.864	16	0.777	23
C	0.928	23	0.885	28
D	1.536	18	1.448	20
E	1.672	21	1.181	29
E	1.472	20	1.117	25
F	1.636	24	1.4	20
G	1.308	24	1.172	17
G	1.424	25	1.153	17
G	1.276	18	1.066	13
G	1.486	22	1.228	13

tions which is shown in Table 1 by almost all experimenters, is shown in the detailed data in even greater degree by everyone. This tendency to react automatically with the stop-watch after a relatively constant interval is somewhat masked in the averages by a number of erratic very long and very short reactions having little correspondence with the actual variations. While the presentation of the entire mass of data is not feasible, Table 2 gives a clear indication of the general nature of these data.

In the first column of Table 2 is given a stop-watch reading. In the second column the number of times that reading occurred in the series designated is given. In the third column is given the range of the chronoscope readings corresponding to the stop-watch readings, and in the fourth column is given the average of these chronoscope readings. For example: in the second series of Experiment E the reading 1.2 occurred 13 times; the chronoscope measures of the same 13 reactions ranged from 0.940 to 1.3; and the average of the 13 chronoscope readings was 1.083.

TABLE 2  
*Experimenter E; second series*

WATCH	NUMBER	CHRONOSCOPE RANGE	CHRONOSCOPE AVERAGE
1.2	13	940-1.300	1.083
1.4	13	1.000-1.898	1.279
1.6	5	1.100-1.624	1.360
1.8	7	1.260-1.764	1.418
2.0	6	1.480-2.114	1.704

*Experimenter A; fourth series*

1.0	10	752-1.310	997
1.2	18	640-1.398	1.140
1.4	14	860-1.412	1.151
1.6	5	966-1.866	1.325

#### CONCLUSIONS

Stop-watch records of association reactions are highly unreliable, when taken by experimenters who have not had long practice in such work. The experimenter tends (1) to lengthen the record (a matter of slight importance), and (2) to reduce the variations in the records by setting up a reaction-habit of relatively constant period. This latter is a highly important matter, especially in association tests of normal persons, for in these cases not only are the variations, (and not the absolute averages,) of importance, but also, these variations are small.

While these conclusions are so far valid for experimenters without long practice, *there is every reason to believe that with*



*the prolongation of training the unreliability becomes greater,* as the reaction tendency becomes more fixed. When, in addition to the error due to the reaction tendency, and the irregular errors due to incidental causes, is added the emotional effect on the experimenter due to knowledge of significant words, we may expect great difficulty in the stop-watch application of the association tests. It is not improbable that in many cases a significant set of results is obtained, not by actually measuring reaction-times, but by lengthening the time-records where the behavior (facial expression, tone of voice, etc.,) is suspicious. This would account for the divergence between recorded times for significant and non-significant terms in certain stop-watch series being greater than are normally obtained by methods more mechanically accurate. In other cases the experimenter (according to his statements) correctly identifies the culprit when the recorded times furnish no clue to one who has not witnessed the test. I have found in my laboratory that in many cases it is possible to pick out the guilty party from his subsidiary reactions to the test-words without paying any attention to the reaction-times and with little consideration of the response words. This method is however so obviously susceptible to the effects of prejudice and pre-conceptions that it ought not to be substituted for the true association method.



ON THE MOTOR FUNCTIONS OF THE CEREBRAL  
CORTEX OF THE CAT<sup>1</sup>

JOSEPH DUERSON STOUT

*From the Laboratory of Physiology of the George Washington University*

The results of the early experiments to determine the localization of the cerebral motor areas, by means of electrical stimulation were far from consistent. Some of the discrepancies may be accounted for on the ground of differences of experimental methods, but that other factors may be present has generally been lost sight of. Franz has recently shown that when a number of hemispheres are investigated by the same stimulation method considerable variations are discovered. These variations are chiefly: (1) Differences in the absolute amount of the stimuable areas; and (2) differences in the relative extents of the stimuable areas for individual segments (for the fore and hind limbs which he investigated). In the more highly developed brain of the monkey, on which he worked, and in man, such variations are, he has shown, indicated by the activities of the individual animals. In those animals in which the nervous system; and especially the cerebrum is simple, the routine and partly unvarying nature of the reactions suggests that there may be less variation in motor cerebral control. Franz has demonstrated what others had previously suggested, that the greater complexity of the brain in higher animals is associated with a greater variation in motor control.

<sup>1</sup> The investigation of the motor areas of the cat's brain was made because this animal is being generally utilized in experiments on the nervous system (cf. especially Sherrington's studies of reflexes), because of the ease with which it can be handled, because its general behavior is less complex than that of the monkey, and more variable than that of the rabbit and other rodents, because this animal has been used in a number of previous experiments and its capacity of learning (the possibility of motor adjustments) has been investigated, and because the motor area of the animal has not been carefully mapped out.

## DESCRIPTION OF THE CAT'S BRAIN

The accompanying diagram (fig. 1) illustrates the principal features of the anterior part of the cat's brain, and, as far as they refer to the present work, they may be described as follows: The approximate measurements of the cerebrum are: antero-posteriorly, 5 cm.; transversely, 4 cm.; and vertically, 3 cm. The sulcus cruciatus occupies a prominent position on the anterior portion of the superior surface, extending outwards from the median line about 5 mm. On the mesial surface of the hemisphere, it extends backwards and slightly downwards for

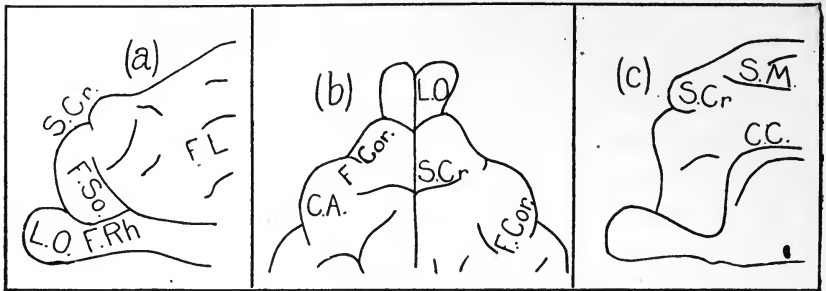

FIG. 1. Appearances of cat's brain from (a) the lateral aspect, (b) the superior aspect, and (c) the mesial aspect. *C.C.*, corpus callosum; *S.M.*, supra-marginal gyrus; *S.Cr.*, crucial fissure; *F.So.*, supraorbital fissure; *L.O.*, olfactory lobe; *F.Rh.*, rhinal fissure; *F.L.*, lateral fissure; *C.A.*, compensatory ansate fissure; *F.Cor.*, coronal fissure (adapted from Wilder and Gage).

the same distance. When the posterior bank is lifted backwards, the cortical structure, extending into the sulcus, is seen to have approximately the shape of a quadrant of a circle, the outer boundary curving downwards, backwards, and inwards from the superior surface to the mesial surface of the hemisphere. An artery is invariably found on the surface of the hemisphere at the junction of the margins of the sulcus, but with care the posterior bank of the sulcus may be lifted back, leaving the artery on the anterior bank, with slight injury and little hemorrhage. About 7.5 mm. in front of the crucial sulcus is the deep depression, marking the union of the olfactory and frontal lobes. The olfactory lobe is parallel to and extends downwards from the

median fissure and on the under surface of the hemisphere it almost meets the optic chiasm. Its outer margin, the fissura rhinalis, curves downwards, then gradually outwards, and reaches the supraorbital fissure. The latter begins 5 mm. underneath the middle of the crucial sulcus, and is directed downwards, and backwards, to meet the fissura rhinalis. (The description of other features of the cat's brain will be found in Wilder and Gage.)

Running parallel with the superior margin of the hemisphere, and about 5 mm. from it, is the fissura lateralis (*F.L.*), extending from the posterior portion of the superior surface forwards to a point about 7.5 mm. above the outer end of the crucial sulcus, then turning sharply inward toward the inner end of the crucial. At the point where it changes its direction, the ansate fissure arises and extends outwards and forwards for about 2.5 mm. At or near the outer end of this fissure the fissura coronalis starts and travels in a semi-circular course around the outer end of the crucial sulcus, having a radius of about 0.5 cm. from the end of the crucial. A small dimple, sometimes a short fissurette as it is called by Campbell, is found at a point about equally separated from the outer half of the sulcus cruciatus and the fissura lateralis. This it is that Campbell believes to be the "homologue of Rolando," i.e., the upper half of the fissure of Rolando, although it may be stated that this belief is not in keeping with the physiological findings of the present work. When distinguishable as a fissure, it is called the compensatory ansate fissure.

Histologically, Campbell and others have found that the so-called motor area contains fiber and cell arrangements, which map it off rather sharply from surrounding areas. Campbell's studies have led him to conclude that the motor area in the cat may be represented as in the accompanying figures (fig. 2). He describes this area as follows:

On the mesial surface, the area is confined to a small portion of the marginal gyrus, situated immediately behind the sulcus cruciatus, and it is worthy of mention that it does not reach quite to the hinder extremity of the sulcus. In a frontal view, the close relation to the sul-

cus cruciatus is better displayed. Then, anteriorly, the area extends downwards and outwards, to be limited in turn by the upper extremity of the orbital and the anterior extremity of the coronal sulcus. Laterally, the sulcus coronalis constitutes a bar, transverse sections showing that formation reaches to the floor of, but not beyond, the sulcus. Posteriorly, the field meets the post-crucial or sensory area medially, across the hinder line of the sigmoid gyrus, and it is most important to observe that the boundary line is constantly related to a shallow depression, placed equidistant from the cruciate and ansate sulci. This depression varies in representation in different brains and even in opposite hemispheres. It may appear as a short transverse fissurette, or merely as a dimple, but it is never entirely absent, and I have little doubt that it is the equivalent of a fissurette better developed in other animals and known as the *Compensatory Ansate*.

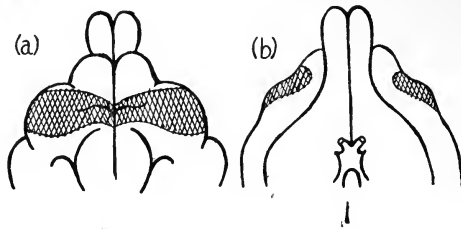

FIG. 2. Motor area of cat's cerebrum (cross-hatched), as differentiated by cyto- and myelo-architectonic methods (adapted from Campbell).

He makes further reference to the homology of this fissure.

There have been few satisfactory descriptions of the physiological conditions existing in the brain of the cat, which are available for the study of the motor control. The most satisfactory accounts are those published by Ferrier in 1886 and by François-Franck in 1887.

Ferrier made numerous investigations of the motor area in the cortex of the cat. In stimulation experiments he used the induced current of sufficient strength to cause "a pungent but quite bearable sensation when the electrodes were placed on the tip of the tongue." He states that

Though it is obviously advisable to use no stronger current than is sufficient to produce a definite result, the measure of the intensity of

the stimulus to be employed in each case is the degree of definite and decided localization of effects uniformly obtainable.

The results of Ferrier's experiments may be summarized as follows: Stimulation of the median area—the posterior portion of the sigmoid gyrus—is followed by movements of the hind limb; stimulation of the region immediately anterior to the posterior extremity of the coronal fissure, by movements of the fore limb; stimulation of the area immediately internal to the anterior extremity of the coronal fissure, by movements of the

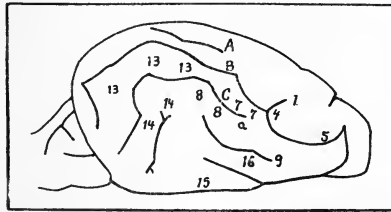

FIG. 3. Motor areas of the cat's cerebrum, determined by Ferrier (adapted). 1, advance of the hind leg; 4, retraction and adduction of the fore leg; 5, elevation of the shoulder, flexion of the fore arm and paw, sometimes clutching or grasping action of the paw, with protrusion of the claws; 7, elevation of the angle of the mouth and cheek, with closure of the eye; 8, retraction with some degree of elevation of the angle of the mouth, and drawing downward and forward of the ear; 9, opening of the mouth and movements of the tongue; 13, eyeballs moved to the opposite side; 14, pricking of the ear and eyes turned to the opposite side; 15, elevation of the lip and torsion of the nostril on the same side; 16, divergence of the lips.

fore limb and shoulder. Of the remaining lateral and superior regions of the cortical surface, stimulation of that portion, lying between the posterior halves of the lateral and the supra-Sylvian fissures, results in movements of the eyes and head. Stimulation of the region adjacent to the anterior extremity of the supra-Sylvian and extending to the coronal fissure results in movements of the mouth, tongue, lips, ear and paw. It is interesting to compare the results with those obtained in the present work. For purposes of comparison a diagram of Ferrier's localizations is here given (fig. 3).

The opinions of various investigators as to the equivalent in the brain of the cat of the fissure of Rolando in the brain of man and the higher monkeys, have varied considerably from time to time. To quote from Ferrier:

The crucial sulcus has been regarded by some as the homologue of the fissure of Rolando. Others (Meynert, Pansch) regard the coronal fissure as the true homologue; while Broca finds it the prae-Sylvian sulcus, or sulcus bounding the gyrus formed by the anterior extremities of the lower three external convolutions.<sup>2</sup>

Ferrier discards the prae-Sylvian sulcus and the crucial sulcus, but is inclined to accept the coronal fissure as the Rolandic analogue. This is contrary to the later opinion of Campbell, as has been indicated above, but the criteria of Campbell and of Ferrier are, it should be noted, not the same, the former depending upon anatomical examination, while Ferrier has taken the physiological point of view. The conclusions of Ferrier in this regard are to be compared with the results which are reported in later sections of this paper.

François-Franck has not definitely located the various points on the cortex which he stimulated other than to describe them as points for the movement of the crossed fore limb, etc., so it is necessary to deal with his results in some cases with much reserve in comparing them with the results from definitely located points.

### *Methods*

The animals used were adult cats. Each was first anaesthetized in a box and while unconscious strapped to an animal holder. Anaesthesia was then maintained throughout the experiment with the A. C. E. mixture.<sup>3</sup> In the animals first operated upon, two  $\frac{1}{2}$ -inch trephine openings were made in the skull and the openings were then enlarged with bone forceps, backward and to the front and side. By this method difficulty was ex-

<sup>2</sup> D. Ferrier: *Functions of the Brain*. 2d edit. 1886, p. 346.

<sup>3</sup> This is a mixture of 1 part alcohol, 2 parts chloroform and 3 parts ether, frequently used in animal experiments and sometimes as an anaesthetic for man.



perienced in exposing the anterior areas without considerable shock and hemorrhage, and in other animals the first trephine opening was made in the glabellar region, as far forwards as possible, without taking in the orbital margins. This exposed the upper portions of the two frontal bony sinuses. A second opening was then made in the median line sufficiently posterior to clear the posterior wall of the sinuses. The button, when removed, did not tear the vascular sinus, but considerable bleeding from the bone and small vessels followed. This was usually stopped with hot sponges and, if much blood appeared to be lost, the animal was given from 5 to 15 cc. of salt solution subcutaneously. The openings were enlarged with bone forceps on all sides and the plate of bone between the frontal bony sinuses and the brain cavity was removed. After all hemorrhage had been stopped, by means of hot sponges and bone wax, and the animal had rested a few minutes, the dura was slit and laid back, thus exposing the cerebral surface of one side. The brain tissue was kept moist and warm by frequent applications of cotton sponges, wet in warm salt solution. Bipolar stimulation was used in most experiments, monopolar in a few. The former method was found most convenient.

Stimulation was applied from an inductorium by means of platinum electrodes with the center of the points about 1.5 mm. apart. The secondary coil was kept at such a distance from the primary that the stimuli were supraminimal, but not maximal. After twenty or thirty tests, each stimulus being approximately two seconds in length, at intervals of one or two minutes, the brain was covered with warm, moist sponges and allowed to rest for a quarter of an hour.

The use of methods for keeping the body temperature at a normal line was found necessary. For this purpose the animal was kept throughout the tests on a metal box containing a lighted electric lamp, and when observations of reactions were not being made the animal was covered with cloths.

## LOCALIZATION AND LIMITATION OF THE MOTOR AREA

The first series of experiments was conducted with the object of locating the boundaries of the motor field of the cat's cerebral cortex. For this purpose twelve animals gave results of comparative value, although the details for all animals are not given in the present paper. All cases are omitted in which the experiments were not completed to the desired point, but the results in these omitted cases do not differ, except in minor detail, from those that are recorded here. The results indicate that the motor area is confined laterally to that portion of the cortical surface between the two coronal fissures and the median line. It extends posteriorly to the anterior extremity of the fissura lateralis, and anteriorly to a line about 0.5 cm. above the upper extremity of the olfactory lobe. It occupies both banks of the crucial sulcus, and, anteriorly to the crucial sulcus, it extends over to and upon the median surface of the hemisphere about 0.5 cm. The region thus marked off is fairly constant in different animals, and the stimulation of similarly located areas of it in the successive animals led to the production of movements which, in their general nature, are similar. These motor reactions are, for the purpose of study, divided into four groups, according to the portions of the body involved, and the location on the cortex of the points from which they were initiated was mapped out. These groups are (1) hind limb, (2) trunk and tail, (3) fore limb, and (4) head and neck.

*Total extents of motor area*

Cat 8 was the first one to offer sufficient results to be satisfactorily considered in this classification. The motor field of the right hemisphere extended from the fissura lateralis to a line 0.5 cm. above the superior margin of the olfactory lobe, and from a line 0.5 cm. from the median line outward, almost to the fissura coronalis. The movements of the hind limb were obtained from stimulation of the whole of this area, with the exception of a narrow strip on the outer side and a small area anteriorly. Movements of the trunk and tail were few in num-

ber and these were obtained only from the middle third of the field. Movements of the fore limb, which were numerous, followed stimulations within a field almost co-extensive with the field for hind limb movements. Movements of the head and neck were from stimulations of a field lying almost entirely in front of the crucial sulcus and at the outer part of the motor field.

Cat 9, right hemisphere. The motor field extended as a whole over an area similar to that of cat 8, and in addition reached the median line. The central portion of the field, lying posterior to the sulcus cruciatus, gave upon stimulation almost exclusively movements of the hind limb. Movements of the trunk and tail were initiated by stimulation of two small areas close to the median line. The larger of these areas is at the posterior portion of the motor field and the other on the posterior bank of the crucial sulcus. All movements of the fore limb were obtained from stimulation of a large area in front of the crucial sulcus. Movements of the head and neck were obtained from stimulation of two areas, a small area at the anterior portion of the motor field, near to the median line, and a large area posterior to the outer end of the crucial sulcus.

Cat 10, both hemispheres. The right hemisphere presented two distinct fields, one extending about 0.5 cm. in each direction from the sulcus cruciatus and to the median line. This gave upon stimulation only movements of the hind limb, except within a small area anterior to the outer end of the sulcus, which gave movements of the fore limb, trunk and tail. Movements of the head and neck were initiated by stimulation of a small field, extending from the upper end of the fissura rhinalis, almost to the median line. The left hemisphere of this animal presented an arrangement quite similar, except that the area for the hind limb extended further posteriorly.

Cat 11, left hemisphere. The total motor field extended from the middle third of the coronal fissure to the median line and from a line about 0.5 cm. above the upper end of the olfactory lobe to the anterior extremity of the fissura lateralis. Movements of the hind limb followed stimulation within an area ex-

tending from the median line to the outer end of the crucial sulcus and from the end of the fissura lateralis to a line 0.5 cm. anterior to the crucial sulcus. The fore limb movements were from an area with the same antero-posterior boundaries, but lying in the outer half of the motor field. The trunk and tail movements were from a narrow strip of the cortex, extending within the posterior part of the hind limb area. The head and neck movements were obtained from stimulations within a triangular area lying close to the median line, its apex at the inner end of the crucial sulcus and its base on a line 0.5 cm. posterior to the upper end of the olfactory lobe.

Cat 12, right hemisphere. All reactions were obtained from a crescent shaped area, about the sulcus cruciatus, the horns of the crescent extending forward. The area about the crucial sulcus, when stimulated, gave movements of the hind limb. The base of the outer horn gave movements of the fore limb. The portion of the field lying internal to the anterior end of the coronal fissure and the portion lying between the median line and the upper end of the fissura rhinalis gave movements of the head and neck.

Cat 14, left hemisphere. The extent of the stimuable area was almost identical with that of the field for cat 11, except at its inner boundary, which did not reach quite to the median line. The fore limb field extended from the middle third of the coronal fissure almost to the median line, and from a line half way between the anterior end of the fissura lateralis to a line 0.5 cm. above the upper end of the olfactory lobe. The area for the head and neck movements did not reach the median line, but was limited to an area about the superior end of the fissura rhinalis. The hind limb field, and that for the trunk and tail, had almost exactly the same location as the same fields in cat 11.

Cat 15, left hemisphere. The motor field was along the crucial sulcus, extending from the median line almost to the coronal fissure. Movements of the hind limb were from stimulations applied to the inner four-fifths of this field and movements of the fore limb from stimulations applied to the outer four-fifths

of the field. The portion of the field extending between the upper end of the fissura rhinalis and the outer half of the crucial sulcus gave movements of the head and neck only.

*Summary.* To make a generalized account of the fields, the total stimuable areas have been combined, and also the separate areas for the anatomically segmental movements, for the hemispheres of all animals (figs. 4, 5, 6, 7, and 8). It is found that the motor field as a whole, figure 4, extends from the anterior end of the fissura lateralis anteriorly to a line about 0.5 cm. above the olfactory lobe, and from the fissura coronalis inwards to the median line. In front of the crucial sulcus it extends over the median margin, a short distance on the median surface of the hemisphere. The areas for the movement of the several body segments are not distinct but overlap, the stimulation of the posterior one-fifth of the field giving almost entirely movements of the hind limb and tail, stimulation of the anterior, inner portion almost entirely movements of the head and neck. Between these areas the fields overlap, but it may be said that the cortical representations, for the different body areas, occupy the following fields:

(1) Movements of the hind limb (fig. 6), a field about four-fifths the size of the entire motor area and extending from the median line almost to the fissura coronalis, and from a line, slightly internal to the anterior end of the fissura lateralis, to a line half way from the sulcus cruciatus to the upper extremity of the olfactory lobe. This field is almost hexagonal in shape and only touches the median line adjacent to the sulcus cruciatus. The larger portion of this field is posterior to the sulcus cruciatus.

(2) Movements of the trunk and tail (fig. 8), small scattered areas lying within the posterior portion of the hind limb field.

(3) Movements of the fore limb (fig. 7), an octagonal shaped field almost as large as the hind limb field, and extending from a line half way between the anterior end of the fissura lateralis and the sulcus cruciatus anteriorly, to the upper end of the fissura rhinalis and laterally from the fissura coronalis to within a short distance of the median line. It approaches nearest to the median line anterior to the sulcus cruciatus, and from there

rapidly recedes anteriorly and posteriorly. (4) Movements of the head and neck (fig. 5) are obtained from stimulation of several fields, lying almost entirely within the anterior inner

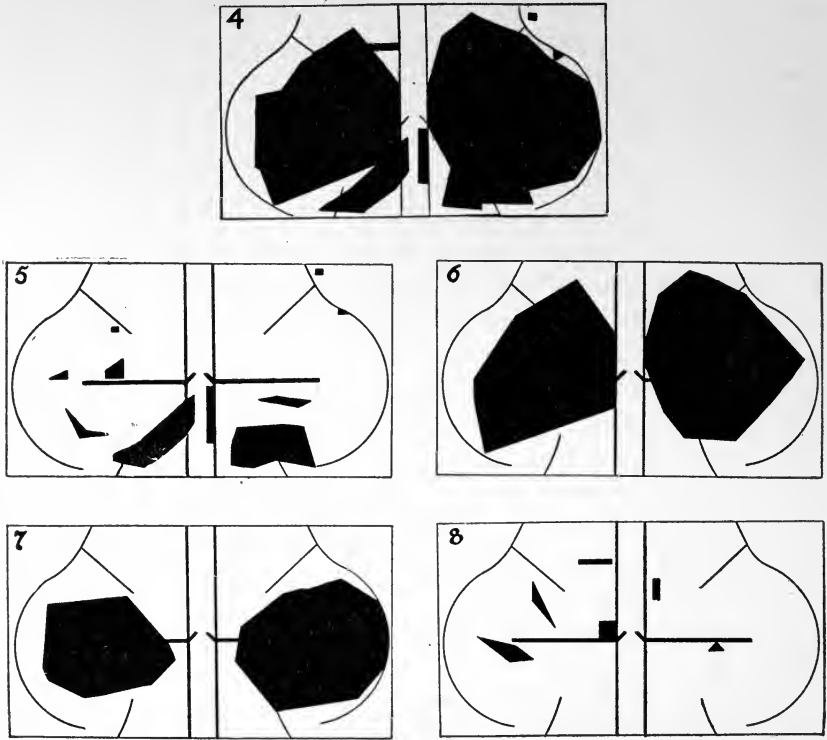

FIGS. 4, 5, 6, 7, and 8. Combined areas for movements in the cat's cerebral cortex. Each diagram is a composite of results obtained by stimulating the cortices of four hemispheres. The crucial sulcus is indicated in the diagrams by the heavy cross line. Figure 4 shows the combined area for all animals for the two hemispheres. Figure 5 shows the combined areas for movements of the head and neck. Figure 6 shows the areas for the hind limb. Figure 7 shows the areas for the fore limb. Figure 8 shows the areas for the trunk and tail.

quadrant of the motor area. The representation for these movements is richest at the anterior extremity of the precrucial area, adjacent to the median line. This area is almost entirely for movements of this type. It extends posteriorly to the crucial

sulcus and over on the adjacent median surface of the hemisphere, about 0.5 mm.

In cats 15 and 16 that portion of the cortex lying on the banks of the crucial sulcus was exposed either by cutting away one bank or by lifting the posterior bank backward. The surface thus exposed was in extent approximately one-third the size of the motor area lying on the exposed surface of the hemisphere. Stimulation of it gave results which were in every way similar to those obtained by stimulation of the exposed motor area previously described, and the movements, which were elicited, prove this area to be functionally merely an infolding of the cortical surface, for they involve the same body areas as the adjacent surface cortex. In addition there was a particularly rich representation for movements of the head and neck, especially for the tongue, lips, jaws, throat and eyes. The number of non-stimulable areas distributed among the stimuable areas, in the exploration of these banks, indicates that the results were true stimulations of the motor cells and not due to overflow of current into contiguous tissue. A fuller account of these fields will be given in a subsequent section and will there be illustrated by diagrams.

#### AREAS FOR DIFFERENT SEGMENTAL MEASUREMENTS

Figures 9 to 16 show graphically the distribution of the areas in the brains of the different animals upon which the tests were made; and the composite of localization in those animals on which complete series were obtained is given in figure 4. As has been noted above, the results on other animals, in which the exploration of one hemisphere was thought not to be sufficiently complete, are not included, because it is not sure that the results would have been strictly comparable. The results were plotted on diagrams of a size approximately 5 diameters of the original brains and from the enlarged diagrams the illustrations of the present work were reduced.

In these figures the longitudinal sulcus and the crucial sulcus are represented by heavy black lines, the other fissures by

lighter lines. The areas for movements of the body segments are dealt with as if they extended in straight lines mostly, but in this respect the figures are necessarily diagrammatic.

The reproduced illustrations are slightly larger than the original brains, and in the figures the fissural variations are shown.

Figures 9 to 12 show the respective distributions in cats 8, 9, 10 and 12 of the areas of the right hemispheres for the four anatomical groups which have been made, and figures 13 to 16 give similar results for the left hemisphere of cats 10, 11, 14 and 15 respectively. Figure 4 shows the total superficial area obtained by the summation of the areas in all animals. In each of the figures 9 to 16 are shown the distributions of the fields for head and neck, fore limb, hind limb and trunk and tail. The results, which are graphically represented, show a great amount of variation in location of the motor responsive cortex in the hemispheres of different animals. For one animal, cat 10, of which both hemispheres were investigated, a similar deviation was found (compare figs. 11 and 13). These variations are apparently greater than the gross anatomical variations in fissural arrangement, and the great differences in the relative sizes and overlappings of areas are readily noted.

The figures representing the combined fields (figs. 4 to 8) are not to be interpreted as the average field, but solely as the widest distribution of areas in which stimuli were found to result in movement in the animals which were sufficiently investigated. The compactness or solidity of the areas for the fore and hind limbs is in marked contrast with the wide and isolated distribution of the areas for the head and neck and the trunk and tail. In the individual hemispheres similar diffusion or separation of the areas was sometimes found, as is shown in figures 10, 12, 15, and 16.

Considering the field for the head and neck, on the right cortices, it is seen that in cat 8, figure 9, the field is slightly external to and mainly anterior to the outer end of the crucial sulcus. In cat 9, figure 10, it is again external to the end of the crucial sulcus, but not entirely posterior to it. In cat 10, figure 11, it



is at the anterior extremity of the motor field, near the median line, and about 0.5 cm. posterior to the upper part of the olfactory lobe. In cat 12, figure 12, it is in two portions, one near the anterior end of the coronal fissure and the other anterior to the inner end of the crucial sulcus, extending over the margin of the hemisphere onto the median surface. On the left cortices, the field for the head and neck is found as follows in the various animals. Cat 10, figure 13, a very small area about 0.5 cm.

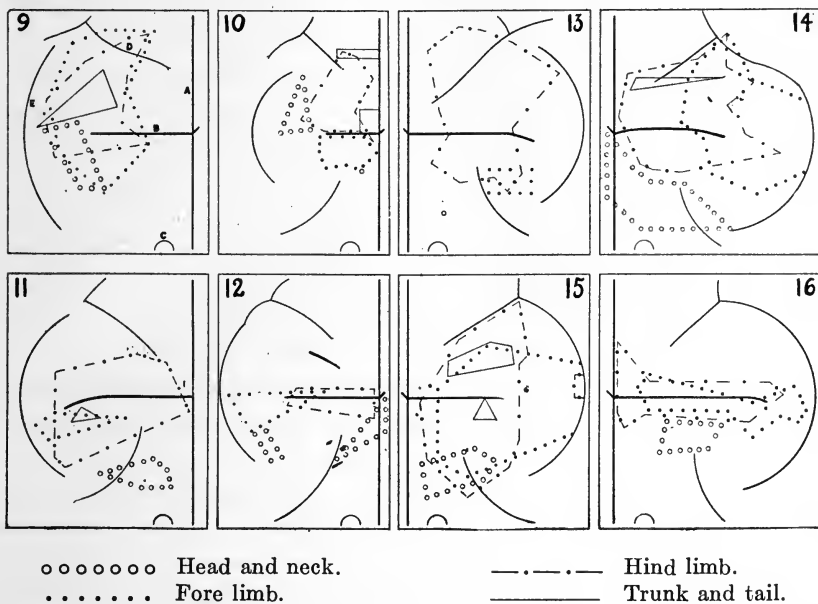

FIGS. 9, 10, 11, 12, 13, 14, 15, and 16. The illustrations show the extent of the cortical areas in the hemisphere of the individual cats over which movements of different segments were obtained. The parts inclosed by the full line show the areas for trunk and tail; those inclosed by circles show the areas for the head and neck, the dotted lines inclose the areas for the fore limb, and the lines of dots and dashes show the areas for the hind limb. The figures 9, 10, 11, and 12 give results from the right hemispheres of cats 8, 9, 10, and 12, respectively; figures 13, 14, 15, and 16 give the results from the left hemispheres of cats 10, 11, and 15.

In the figures, posterior is above, anterior is below; the left hemisphere is at the right of each figure, and the right hemisphere is at the left. The lines represent certain fissures. These are lettered in figure 9 as follows: A, longitudinal fissure; B, crucial fissure; C, olfactory lobe; D, lateral fissure; E, coronal fissure.

above the superior extremity of the olfactory lobe. In cat 11, figure 14, a very large area, extending from the anterior extremity of the coronal fissure to the inner end of the crucial sulcus and a short distance onto the median surface of the hemisphere and forward to within 0.5 cm. of the upper part of the olfactory lobe. In cat 14, figure 15, a moderate sized area, half way between the crucial sulcus and the olfactory lobe.

The fore limb field is likewise subject to considerable variation, though less than the head and neck field. On the right the following distribution is found. Cat 8 (fig. 9), a very large field, including practically all of the motor field demonstrated for this animal, and extending from the anterior angle of the lateral fissure to the upper end of the supraorbital fissure, from the middle of the crucial sulcus almost to the coronal fissure. Cat 9 (fig. 10), a small field immediately anterior to the crucial sulcus and extending almost to the median line. It is to be noted that this is the only animal in which the fields for the fore and hind limbs do not coincide at some point in their extent. Cat 10 (fig. 11) a small area immediately anterior to the outer half of the crucial sulcus. Cat 12 (fig. 12), a moderate sized field embracing both banks of the crucial sulcus and extending outward and forward to the coronal fissure. On the left cortices the fore limb field is as follows: Cat 10 (fig. 13), a small field lying between the anterior end of the coronal fissure and the posterior end of the supraorbital fissure. Cat 11 (fig. 14), a very large field extending from the posterior four-fifths of the coronal fissure to the middle of the crucial sulcus. Cat 14 (fig. 15), from the middle third of the coronal fissure inward to a line 0.5 cm. from the median line, and lying mostly in front of the crucial sulcus. Cat 15 (fig. 16), a narrow zone lying along the banks of the crucial sulcus and extending from the coronal fissure almost to the median line.

The fields for the hind limb are located as follows: Right cortices, cat 8 (fig. 9), from the anterior angle of the lateral fissure to a line half way between the crucial sulcus and the upper end of the supraorbital fissure, from the middle of the crucial sulcus to within 2 mm. of the posterior third of the coronal

fissure. Cat 9 (fig. 10), posterior to the crucial sulcus and extending from the median line opposite the anterior end of the *fissura lateralis* to a line half way between the outer end of the crucial sulcus and the posterior end of the coronal fissure. Cat 10 (fig. 11), a large field extending from the anterior end of the lateral fissure to the anterior end of the coronal fissure and from the median line to a line slightly external to the outer end of the crucial sulcus. Cat 12 (fig. 12), an area restricted to the bank of the crucial sulcus. On the left cortices the localizations are as follows: Cat 10 (fig. 13), a large area extending from the anterior angle of the lateral fissure to a line half way from the crucial sulcus to the olfactory lobe, and occupying the middle two-thirds of the area between the median line and the coronal fissure. Cat 11 (fig. 14), an area similarly located to that of cat 10. Cat 14 (fig. 15), from the anterior angle of the lateral fissure to a line 0.5 cm. above the olfactory lobe and from a line slightly external to the median line to a line continued forward from the body of the lateral fissure.

The fields for the trunk and tail may be said in a general way to occupy scattered areas mainly posterior to the crucial sulcus, but there is considerable variation in the different animals. The localizations in the individual animals, on the right side, are as follows: Cat 8 (fig. 9), an area posterior to the outer end of the crucial sulcus and extending almost to the middle of the coronal fissure. Cat 9 (fig. 10), two small areas, one immediately posterior to the inner end of the crucial sulcus and the other extending from the median line outward to the anterior end of the lateral fissure. Cat 10 (fig. 11), a small area immediately anterior to the outer end of the crucial sulcus. On the left side, the localizations are as follows: Cat 10 (fig. 13), none. Cat 11 (fig. 14), a narrow zone extending from the median line outward to a line drawn forward in continuation of the body of the lateral fissure and lying half way between the anterior portion of the lateral fissure and the crucial sulcus. Cat 14 (fig. 15), two small areas, one immediately anterior to the outer end of the crucial sulcus and the other midway between the anterior portion of the lateral fissure and the outer half of the crucial sulcus.

The comparison of the extent of the motor field as demonstrated by the present work, and the extent of the motor field as demonstrated by the methods of Campbell, brings out the following differences. The motor field, as given by Campbell, is bounded posteriorly by the ansate fissure. In the present work the motor field extends farther posteriorly to the point where the lateral fissure bends inward (sometimes outward). Campbell's field then approaches the inner end of the crucial sulcus and passes over onto the median surface of the hemisphere immediately posterior to the inner end of the crucial sulcus. In the present tests motor reactions were obtained by the stimulation of the area between the angle of the lateral fissure and the median line in many of the animals, although in a few the stimulative area did not reach quite to the median line posteriorly. In all animals there was a stimulative area internal to that portion of the lateral fissure lying anterior to the ansate fissure. No reactions were obtained from stimulation of the median surface of the hemisphere, posterior to the crucial sulcus, except in the case of cat 16, where a narrow stimulative area was found immediately adjacent to the posterior bank of the opened crucial sulcus. It did not reach to the margin of the hemisphere. Reactions were obtained from the stimulation of a narrow strip of cortex within the median line, anterior to the crucial sulcus, though, according to the description of Campbell, the motor area only extends to that portion of the median surface of the hemisphere lying posterior to the crucial sulcus. Anteriorly and laterally the extent of the motor field, as found in the present tests, is identical with the extent mentioned by Campbell.

#### MOTOR AREAS LYING WITHIN THE CRUCIAL SULCUS

The results obtained from the stimulation of the banks of the crucial sulcus, either after separation by lifting the posterior bank backwards or after the removal of the posterior bank, correspond with those which have been described for the superficial cortical areas.

The difficulties encountered in the investigation of the functions of the banks of the crucial sulci are considerable, owing

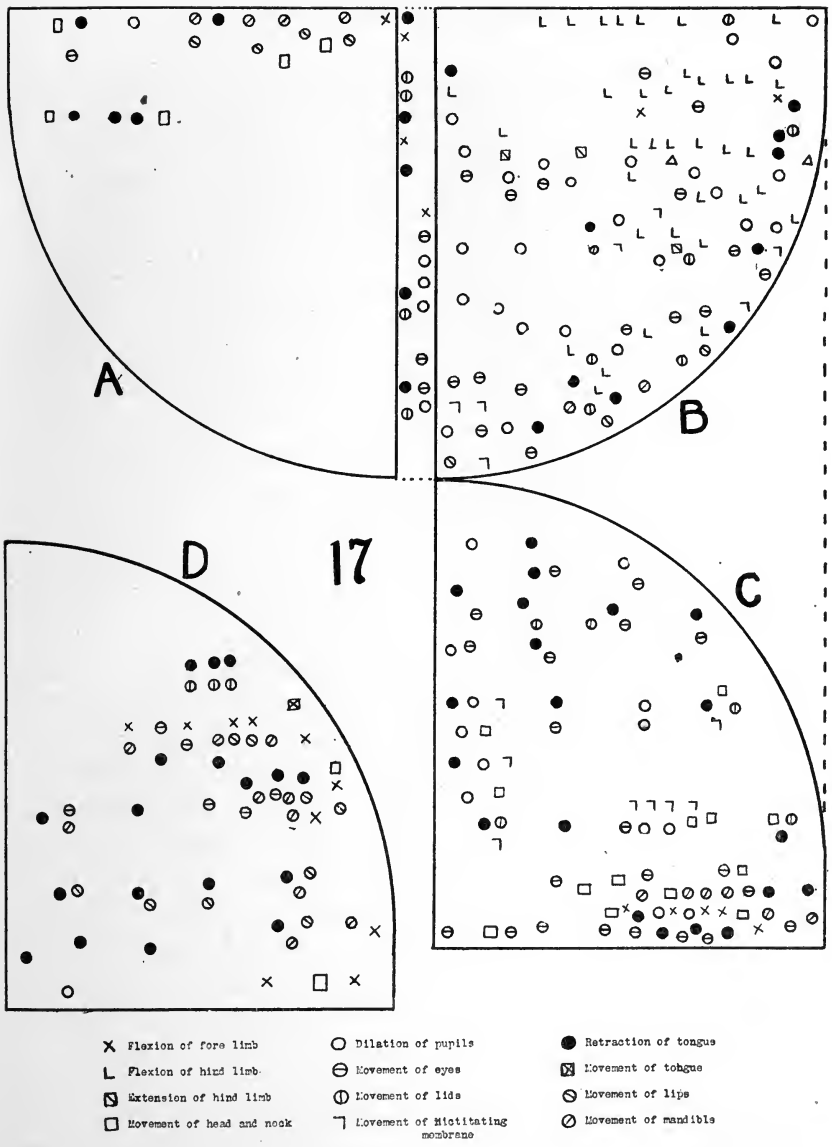

FIG. 17. Giving graphically the results of the stimulation of the usually concealed parts of the cortex within the crucial sulcus. The kinds of movements are indicated by small geometrical marks, the explanations of which are given below the figures. *A* shows the results obtained on the posterior bank of the right crucial sulcus of cat 16; *B* shows the results on the posterior bank of the sulcus on the left side, and *C* those on the anterior bank of the left side of the same animal. *D* shows the results of the stimulation of the anterior bank of the left crucial sulcus of the left side of cat 15.

both to the somewhat inaccessible position of the tissue and to the location of an artery of considerable size between the two lips of the sulcus, or, as it appears on inspection, in the sulcus. The removal of this artery is frequently followed by troublesome hemorrhage, but the results on two animals were sufficiently good to record.

Stimulations applied to that portion of the posterior bank lying immediately internal to the visible margin of the crucial sulcus resulted, in cat 16, on the left side, mainly in flexions of the crossed hind limb. Stimulation of the inner portion of this bank resulted mainly in movements of the eyes and pupils. Stimulations of the outer margin resulted in movements of the tongue, eyes, nictitating membranes, pupils, mandible and flexions of the hind limb. Stimulations of the portion of the field farthest removed from the surface resulted in movements of the eyes, nictitating membranes and lips. These results are shown in figure 17B.

The only results obtained from the posterior bank of the right crucial sulcus of this animal (fig. 17A) were from stimulation applied to the region immediately internal to the margin of the crucial sulcus and along that portion of the median surface immediately adjacent. The stimulation of the former area resulted in movements of the mandible, lips, tongue and neck. Stimulation of the latter area resulted in movements of the lids and tongue and flexion of the fore limb.

The anterior bank of the left crucial sulcus of cat 16 gave the following results (fig. 17C). Stimulation of that portion of the field lying immediately internal to the margin of the crucial sulcus resulted in movements of the eyes and neck from the inner half of the field, and, in addition to these, dilatation of the pupils, movements of the mandible, retraction of the tongue and flexion of the fore limb. Stimulations of the inner margin of the field, adjacent to the median line, resulted in dilatation of the pupils, movements of the lids, retraction of the tongue, and movements of the neck and nictitating membranes. Stimulations of the outer margin of the field resulted in dilatation of the

pupils, movements of the eyes, lids, nictitating membranes, retraction of the tongue, and movements of the head on the neck.

The anterior bank of the left crucial of cat 15 gave the following results (fig. 17D). Stimulation of the region lying immediately within the visible margin of the crucial sulcus, resulted in dilatation of the pupils, retraction of the tongue, movements of the lips. Stimulation of the outer margin of the field resulted in retraction of the tongue, movements of the lids, mandible, lips and flexion of the fore limb. Stimulation of the middle portion of the field resulted in movements of the eyes and mandible, retraction of the tongue and flexion of the fore limb.

The order of mention of the various types of movement following stimulation of the banks of the crucial sulci is the order of the frequency of their actual occurrence.

#### CHARACTERS OF MOVEMENTS FROM CORTICAL STIMULATION

The results obtained from the stimulation of the cortices of cats 8, 9, 10, 11, 12, 14 and 15 were analysed as to the types of the movements produced and the points on the cortex from which each type of movement originated. The accompanying table (table 1) gives a list of these movements and figures 18 to 61 illustrate the cortical locations for each type. Four right and four left hemispheres are included.

The total number of successful stimulations of the eight hemispheres was 467. Of these 154, or 33 per cent, were of the right, and 313, or 67 per cent, were of the left cortices. The number of the successful stimulation for each animal was as follows: right hemisphere—cat 8, 34; cat 9, 39; cat 10, 39; cat 12, 42; left hemisphere—cat 10, 31; cat 11, 99; cat 14, 131; cat 15, 52. It was found that a total of 903 segmental movements (i.e., movements relating to single segment) of all types resulted from these stimulations, of which 306, or 34 per cent, were from the right, and 597, or 66 per cent, from the left cortices. The number of these movements for the individuals was as follows: right—cat 8, 95, or 2.79 individualized movements per stimulation; cat 9, 70, or

TABLE 1  
*Analysis of movements from stimulation of the cerebral cortex*

NUMBERS OF FIGURES AND TYPES OF MOVEMENT	RIGHT HEMISPHERE					LEFT HEMISPHERE					GRAND TOTALS
	Cat 8	Cat 9	Cat 10	Cat 12	Totals	Cat 10	Cat 11	Cat 14	Cat 15	Totals	
18. Depression shoulder.....		2		1	(3)			7	1	(8)	11
19. Adduction fore limb.....				1	(1)					(0)	1
20. Lifting shoulder.....		2			(2)			2		(2)	4
21. Adduction fore limb.....	3				(3)		1	3		(4)	7
22. Inward rotation fore limb.....		1			(1)		1	4		(5)	6
23. Outward rotation fore limb.....	2				(2)		2	2		(4)	6
24. Retraction elbow.....	15	4	5		(24)	18	27	7		(52)	76
25. Forward extension fore limb....	3		4		(7)	1	5	11	4	(21)	28
26. Flexion fore knee.....	6	2		1	(9)		10	23	10	(43)	52
27. Extension fore knee.....	6		4	3	(13)	1	6	15	6	(28)	41
28. Rotation fore limb.....	2	1		1	(4)		2			(2)	6
29. Flexion fore ankle.....	6	4		1	(11)	1	1	18	2	(22)	33
30. Extension fore ankle.....	4	2	4		(7)	1	8	16		(25)	42
31. Flexion toes fore foot.....	3				(3)			3		(3)	6
32. Extension toes fore foot.....	2	2		7	(11)		5	4	1	(10)	21
33. Adduction thigh.....	2			8	(10)			1		(1)	11
34. Inward rotation thigh.....				2	(2)					(0)	2
35. Outward rotation thigh.....		4		1	(5)					(0)	5
36. Flexion thigh.....	1	6	1		(8)	1	6	6	1	(14)	22
37. Extension thigh.....	6	2			(8)			3		(3)	11
38. Flexion hind knee.....	12	10	10	9	(41)	7	22	41	24	(94)	135
39. Extension hind knee.....	1			1	(2)		1	1		(2)	4
40. Flexion hind ankle.....	8	6	20	3	(37)	19	23	40	35	(117)	154
41. Extension hind ankle.....	2		2	1	(5)		1	7		(8)	13
42. Rotation hind ankle.....	1	2	1	1	(5)		8		4	(12)	17
43. Flexion hind toes.....	4	5	3	1	(13)	4	13	8	1	(26)	39
44. Extension hind toes.....		1	2	1	(4)	3	4	2		(9)	13
45. Eye movements.....		1	2	8	(11)		9	2	1	(12)	23
46. Lid movements.....					(0)		4			(4)	4
47. Lip movements.....	1		4	1	(6)		3	4	1	(8)	14
48. Jaw movements.....		3			(3)		6	2		(8)	11
49. Face movements.....		1		2	(3)	1	1			(2)	5
50. Retraction tongue.....	1	3		2	(6)		2	4		(6)	12
51. Extraction tongue.....					(0)			2		(2)	2
52. Throat movements.....					(0)		6			(6)	6
53. Head bent to side.....			1	2	(3)					(0)	3
54. Head turned to side.....			2		(2)					(0)	2
55. Head forward.....			4	4	(4)		1	3	2	(6)	10
56. Head backward.....	1		4		(5)	3		5	2	(10)	15
57. Depression of tail.....			1		(1)		2	2		(4)	5
58. Lifting of tail.....	3				(3)			3		(3)	6
59. Sideward movement of tail.....		2	2		(4)			8		(8)	12
60. Unanalyzed movement.....		4			(4)		2			(2)	6
61. Movement of trunk.....					(0)			1		(1)	1
Total number of movements.....	95	70	72	69	(306)	42	173	280	102	(597)	903



1.79 per stimulation; cat 10, 72, or 1.85 per stimulation; cat 12, 69, or 1.64 per stimulation; left—cat 10, 42, or 1.36 per stimulation; cat 11, 173, or 1.75 per stimulation; cat 14, 280, or 2.14 per stimulation; cat 15, 102, or 1.96 per stimulation. Summarizing, there were from the right cortices a total of 154 successful stimulations and a total of 306 movements, or an average of 1.99 movements per stimulation, and from all left cortices a total of 397 successful stimulations and a total of 597 movements, or an average of 1.91 movements per stimulation. Combining the figures for the two sides, there were a total of 467 stimulations with a total of 903 movements, or an average of

TABLE 2

*Analysis of the motor results from the stimulation of the cortices of cats 8, 9, 10, 11, 12, 14 and 15*

	RIGHT					LEFT					TOTAL RIGHT AND LEFT
	Cat 8	Cat 9	Cat 10	Cat 12	Total right	Cat 10	Cat 11	Cat 14	Cat 15	Total left	
Total successful stimulations .....	34	39	39	42	154	51	99	131	52	313	467
Total movements produced.	95	70	72	69	306	42	173	280	102	597	903
Average number of movements per stimulation.	2.79	1.79	1.85	1.64	1.99	1.36	1.75	2.14	1.96	1.91	1.95

1.95 movements per stimulation. This indicates the complexity of the cortical motor relations, but shows an approximate similarity in the complexity of results for both hemispheres. Referring to the results for the individual animals, it is seen that the relation of movement to stimulation, as shown by the figures for the average number of simple movements following the various stimulations, is subject to considerable variation in the different individuals. The only animal presenting results from two hemispheres is cat 10. A marked variation is found in the results from the two sides of this brain, for while the right gave an average of 1.85 movements per stimulation, the left gave an average of only 1.36 movements per stimulation.

For further analysis we may consider the movements of flexion

and extension of the joints of the fore and hind limbs, including the hip, but excluding the shoulder owing to complexity of the movements of this latter joint. From stimulation of the eight cortices there was a total of 441 flexions, of which 122 were from stimulation of the right side and 319 from stimulation of the left side. Comparing these with the total number of movements of all types, the flexions are 40 per cent of the activity for the right cortices and 53 per cent for the left. There was a total of 145 extensions from the eight cortices, of which 60 were from the right side and 85 from the left. Comparing these with the total number of movements of all types, from these cortices, we see that the extensions are 20 per cent of the total activity of the right and 14 per cent of the activity of the left cortices. Average for the two sides 16 per cent.

Combining the two sets of figures we find that of the total number of movements of all kinds, following stimulation of the right cortices, a total of 60 per cent is either flexion or extension of some one of the joints considered, and of the left cortices a total of 65 per cent is either flexion or extension of these joints. The flexions are slightly over three times as numerous as are the extensions, being twice as numerous on the right side and nearly four times as numerous on the left side. In cat 10 the flexions were 47 per cent of the activity of the right cortex and 76 per cent of that of the left; average for the two sides, 58 per cent. The extensions were 17 per cent on the right, and 12 per cent on the left; average for the two sides 15 per cent. Flexions and extensions together were from the right cortex 64 per cent and from the left cortex 88 per cent, for the two cortices an average as compared with the total activity, of 74 per cent.

In tables 1, 4, and 5 the first columns show the numbers of the diagrams which refer to the other data on the corresponding lines on these tables. The remainders of the tables are almost self-explanatory.

The study of the actual distributions of the cortical points, the stimulation of which results in the production of various types of body movements, brings out several interesting facts.

TABLE 3

*Summary of movements of the fore and hind limbs*

MOVEMENTS	RIGHT HEMISPHERE					LEFT HEMISPHERE					TOTAL RIGHT AND LEFT
	Cat 8	Cat 9	Cat 10	Cat 12	Total right	Cat 10	Cat 11	Cat 14	Cat 15	Total left	
Total movements from cortex.....	95	70	72	69	306	42	173	280	102	597	903
Fore limb											
Total shoulder movements.....	23	9	9	2	43	1	27	56	12	96	139
Total fore knee movements.....	12	2	4	4	22	1	16	38	16	71	93
Total fore ankle movements.....	12	7	4	9	32	2	11	34	2	49	81
Total movements toes fore foot.....	5	2		7	14		5	7	1	13	27
Total movements fore limb.....	52	20	17	22	111	4	59	135	31	229	340
Percentages.....	55	29	24	32	36	10	34	48	31	38	38
Hind limb											
Total hip movements.....	9	12	1	11	33	1	6	10	1	18	51
Total hind knee movements.....	13	10	10	10	43	7	23	42	24	96	139
Total hind ankle movements.....	11	8	23	5	47	19	32	47	39	137	184
Total movements toes hind foot.....	4	6	5	2	17	7	17	10	1	35	52
Total movements hind limb.....	37	36	39	28	140	34	78	109	65	286	426
Percentages.....	39	51	54	41	46	81	45	39	64	48	47

The protocols of the experiments performed on cats 8, 9, 10, 11, 12, 14, and 15 were analysed, and a list was made of all movements of a certain types, such as flexion of the fore knee, extension of the hind knee, etc. In this consideration the complex activities were analysed into their components, as far as was possible, and the resultant simple movements are dealt with individually. Forty-four such types of simple movement had been recorded. A diagram of the locations of the motor points for each of these types of movement was made. These diagrams are presented in figures 18 to 61. Each one of these diagrams is a composite map of the localization of points which gave certain movements in the animals which have been dealt with. There were eight cortices, four right and four left. The principal features in the motor region are given as in the previous

diagrams. The dots indicate the locations of the areas on the several hemispheres which, on stimulation, gave rise to the movement under consideration. The numerals in parentheses placed immediately without the anterior end of the coronal fissure represent the total number of such movements from the

TABLE 4  
*Comparative frequency of movements of the various joints*

MOVEMENTS	RIGHT HEMISPHERE					LEFT HEMISPHERE					TOTAL RIGHT AND LEFT	
	Cat 8	Cat 9	Cat 10	Cat 12	Total right	Cat 10	Cat 11	Cat 14	Cat 15	Total left		
<b>Fore limb</b>												
<i>Shoulder</i>												
18. Depression.....		2		1	3				7	1	8	11
19. Adduction fore limb.....				1	1						0	1
20. Lifting of shoulder.....		2			2			2			2	4
21. Abduction fore limb.....	3				3		1	3			4	7
22. Inward rotation fore limb.....		1			1		1	4			5	6
23. Outward rotation fore limb.....	2				2		2	2			4	6
24. Retraction of fore knee.....	15	4	5		24	18	27	7	52		76	76
25. Forward extension fore limb.....	3		4		7	1	5	11	4	21	28	28
Total shoulder movements.....	23	9	9	2	43	1	27	56	12	96	139	139
<i>Fore knee</i>												
26. Flexion of fore knee.....	6	2		1	9	10	23	10	43		52	52
27. Extension of fore knee.....	6		4	3	13	1	6	15	6	28	41	41
Total fore knee movements.....	12	2	4	4	22	1	16	38	16	71	93	93
<i>Fore ankle</i>												
28. Rotation fore ankle.....	2	1		1	4	2				2	6	6
29. Flexion fore ankle.....	6	4		1	11	1	1	18	2	22	33	33
30. Extension fore ankle.....	4	2	4	7	17	1	8	16		25	42	42
Total fore ankle movements.....	12	7	4	9	32	2	11	34	2	49	81	81
<i>Toes of fore foot</i>												
31. Flexion toes fore foot.....	3				3			3		3	6	6
32. Extension toes fore foot.....	2	2		7	11		5	4	1	10	21	21
Total movements toes fore foot....	5	2	0	7	14	0	5	7	1	13	27	27
Total movements for fore limb.....	52	20	17	22	111	4	59	135	31	229	340	340

TABLE 4—Continued

MOVEMENTS	RIGHT HEMISPHERE					LEFT HEMISPHERE					TOTAL RIGHT AND LEFT
	Cat 8	Cat 9	Cat 10	Cat 12	Total right	Cat 10	Cat 11	Cat 14	Cat 15	Total left	
<b>Hind limb</b>											
<i>Hip</i>											
33. Abduction of thigh.....	2			8	10			1	0	1	11
34. Inward rotation of thigh.....				2	2					0	2
35. Outward rotation of thigh.....		4		1	5					0	5
36. Flexion of thigh.....	1	6	1		8	1	6	6	1	14	22
37. Extension of thigh.....	6	2			8			3		3	11
Total hip movements.....	9	12	1	11	33	1	6	10	1	18	51
<i>Hind knee</i>											
38. Flexion hind limb.....	12	10	10	9	41	7	22	41	24	94	135
39. Extension hind knee.....	1			1	2		1	1		2	4
Total hind knee movements.....	13	10	10	10	43	7	23	42	24	96	139
<i>Hind ankle</i>											
40. Flexion hind ankle.....	8	6	20	3	37	19	23	40	35	117	154
41. Extension hind ankle.....	2		2	1	5		1	7		8	13
42. Rotation hind ankle.....	1	2	1	1	5		8		4	12	17
Total hind ankle movements.....	11	8	23	5	47	19	32	47	39	137	184
<i>Toes of hind foot</i>											
43. Flexion toes hind foot.....	4	5	3	1	13	4	13	8	1	26	39
44. Extension toes hind foot.....			1	2	4	3	4	2		9	13
Total movements toes of hind foot	4	6	5	2	17	7	17	10	1	35	52
Total movements of hind limbs....	37	36	39	28	140	34	78	109	65	286	426
<b>Summary</b>											
Total movements of all types.....	95	70	72	69	306	42	173	280	102	597	903
Total movements of fore limb.....	52	20	17	22	111	4	59	135	31	229	340
Total movements of hind limb.....	37	36	39	28	140	34	78	109	65	286	426
Per cent for fore limb.....	55	29	24	32	36	10	34	48	30	38	38
Per cent for hind limb.....	39	51	54	41	46	81	45	39	64	48	47

four cortices The larger numerals correspond with those given in table 1, in which are enumerated the different types of movement, and the actual number of each type resulting from the stimulation of the brain of each animal as well as the totals.

TABLE 5  
Comparative frequency of flexions and extensions of the joints of the limbs

MOVEMENTS	RIGHT HEMISPHERE					LEFT HEMISPHERE					TOTAL RIGHT AND LEFT
	Cat 8	Cat 9	Cat 10	Cat 12	Total right	Cat 10	Cat 11	Cat 14	Cat 15	Total left	
26. Flexion fore knee.....	6	2		1	9		10	23	10	43	52
29. Flexion fore ankle.....	6	4		1	11	1	1	18	2	22	33
31. Flexion toes fore foot.....	3				3			3		3	6
Total flexion fore limb.....	15	6		2	23	1	11	44	12	68	91
36. Flexion thigh.....	1	6	1		8	1	6	6	1	14	22
38. Flexion hind knee.....	12	10	10	9	41	7	22	41	24	94	135
40. Flexion hind ankle.....	8	6	20	3	37	19	23	40	35	117	154
43. Flexion toes hind foot.....	4	5	3	1	13	4	13	8	1	26	39
Total flexion hind limb.....	25	27	34	13	99	31	64	95	61	251	350
Total flexions both limbs.....	40	33	34	15	122	32	75	139	73	319	441
27. Extension fore knee.....	6		4	3	13	1	6	15	6	28	41
30. Extension fore ankle.....	4	2	4	7	17	1	8	16		25	42
32. Extension toes fore foot.....	2	2		7	11		5	4	1	10	21
Total extensions fore limb.....	12	4	8	17	41	2	19	35	7	63	104
37. Extension thigh.....	6	2			8			3		3	11
39. Extension hind knee.....	1			1	2		1	1		2	4
41. Extension hind ankle.....	2		2	1	5		1	7		8	13
44. Extension toes hind foot.....		1	2	1	4	3	4	2		9	13
Total extensions hind limb.....	9	3	4	3	19	3	6	13		22	41
Total extensions both limbs.....	21	7	12	20	60	5	25	48	7	85	145
Total movements of all types.....	95	70	72	69	306	42	173	280	102	597	903
Percentage of extensions of fore and hind limbs.....	22	10	17	29	20	12	14	17	7	14	16
Percentage of flexions of fore and hind limbs.....	42	47	47	22	40	76	43	50	72	53	49

It is seen that there is considerable variation in the distribution, not only of the stimuable points in the composite map for the two sides, but even for the location of the general fields on the two sides. To a certain degree, the locations of the fields on the two sides do correspond for certain types of movement, but

for many of the types the fields on the two sides appear to have little relation to each other. An excellent example is given in figure 28, which shows the locations for rotation of the fore limb. On the left cortex, the field for outward rotation is adjacent to and external to the outer end of the crucial sulcus, while on the right side it is close to the anterior angle of the lateral fissure. The field for inward rotation of the fore limb, figure 22, is shown to be adjacent to and external to the end of the crucial sulcus on the left side, and near the upper end of the supraorbital fissure on the right side. The field for flexion of the toes of the hind foot, figure 43, on the right side, is in the region adjacent to the crucial sulcus, on the left in the region about the anterior end of the lateral fissure. The field for movements of the mandible, figure 48, is, on the right side, between the outer end of the crucial and the anterior end of the lateral fissure, on the left side it is internal to the upper end of the supraorbitalis. The field for retraction of the tongue, figure 50, has a distribution on the two sides similar to that for the movements of the mandible. The field for sideward movements of the tail, figure 59, is, on the right, immediately posterior to the inner end of the crucial sulcus and immediately anterior to the outer end, but on the left it is between the outer half of the crucial and the anterior limb of the lateral.

On the other hand, for certain types of movement, the cortical fields are quite symmetrically placed on the two sides. The following examples of such symmetrically placed fields may be mentioned: The field for retraction of the elbow, figure 24, occupies, on the right and left sides, the area bounded by the coronal, supraorbital and anterior limb of the lateral fissure. The field for extension of the fore knee, figure 27, from the middle of the crucial sulcus on both banks to the coronal fissure, in a wedge shaped area. The field for flexion of the toes of the hind foot, figure 43, adjacent to the crucial sulcus on both banks and to the anterior limb of the lateral fissure. The field for movements of the eye, figure 45, internal to the supraorbital fissure. The field for movements of the lips, figure 47, same as for movements of the eyes.

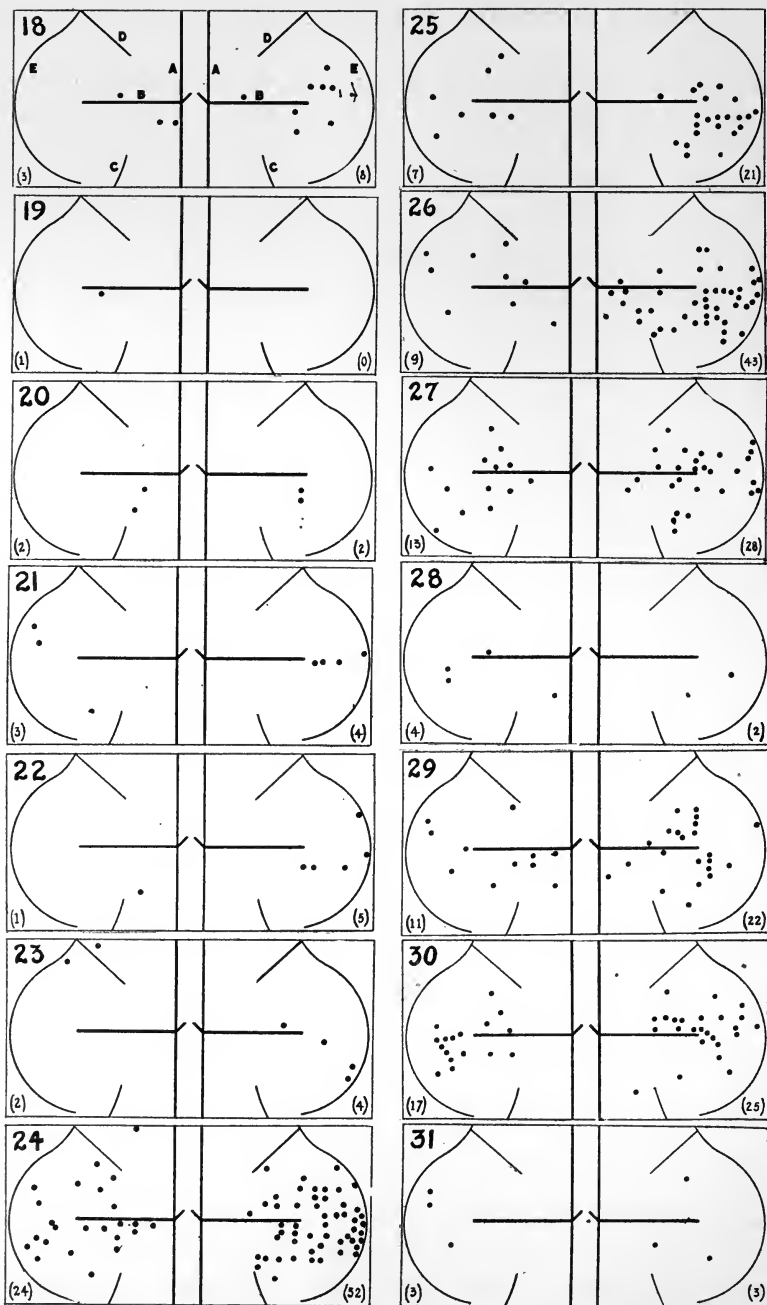

FIGS. 18 TO 31



The very wide distribution of the fields for certain types of movements is at once noted on inspection of the diagrams. For example, the field for flexion of the hind knee, figure 38, occupies

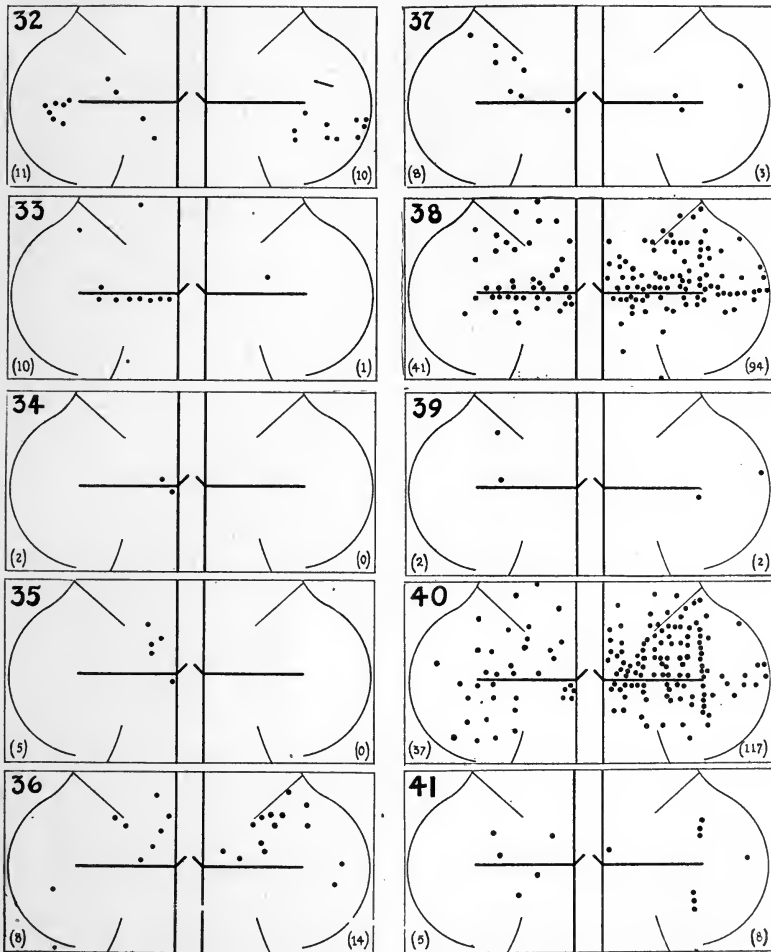

FIGS. 32 TO 41

practically the posterior three-fifths of the entire motor field on the left and the posterior two-fifths of the total motor field on the right. Flexion of the hind ankle, figure 40, is obtained from numerous points scattered thickly over the entire motor

field on either side. Retraction of the elbow, figure 24, is obtained from a field bounded by the coronal and supraorbital fissures and by the anterior limb of the lateral fissure.

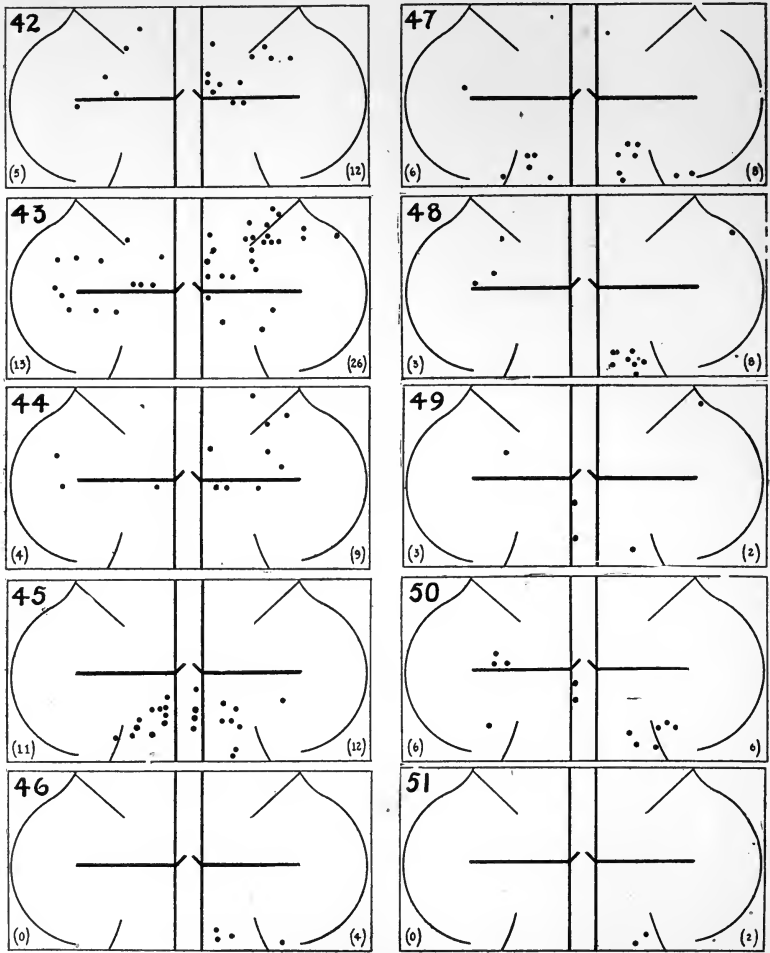

FIGS. 42 TO 51.

The great number of points producing reactions of certain kinds and the wide distribution of such points on the cerebral surface probably indicate the frequent demand for that particular type of movement in the daily life of the individual and the

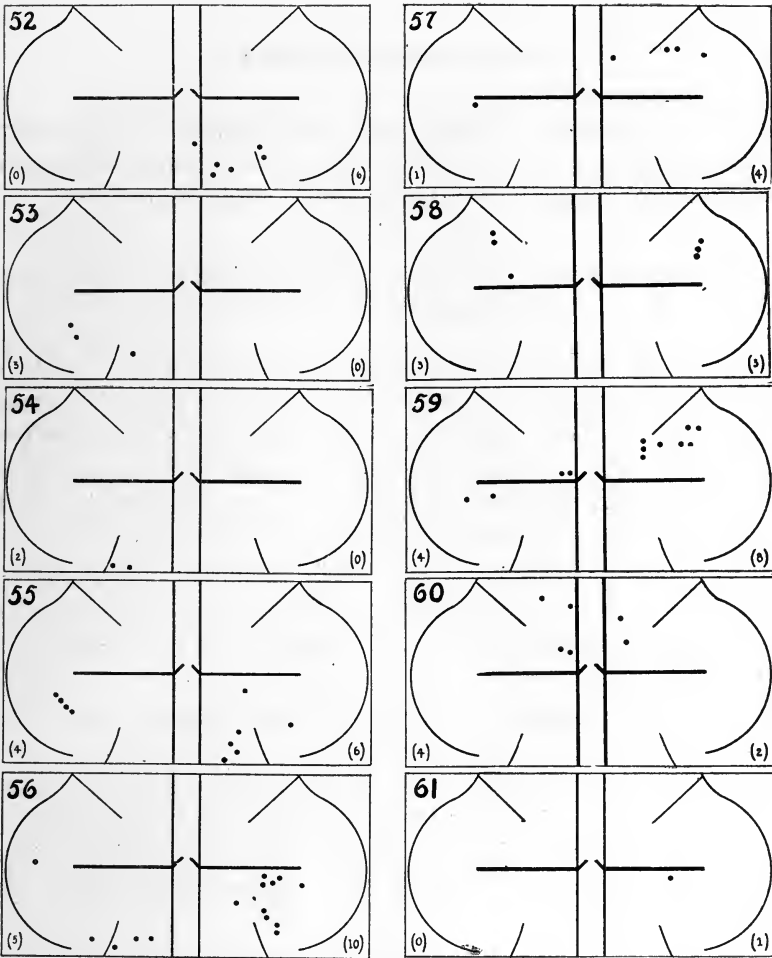

FIGS. 52 TO 61.

FIGS. 18 TO 61. These figures show the location of the individual points on the right and left cortices, each figure representing results from eight hemispheres. The complex movements were analyzed for this purpose into component segmental terms. For description of the method see the text. The movements are tabulated in table 1, to which reference is to be made for the determination of the kinds of movements which are localized in the diagrams. The large figure with each illustration is that referring to the diagram (and to a corresponding number in the first columns of tables, 4 and 5), the smaller figures in parentheses give the total number of movements of the particular type in the four hemispheres stimulated.

In the figures, posterior is above, anterior is below; the left hemisphere is at the right of each figure, and the right hemisphere is at the left. The lines represent certain fissures. These are lettered in figure 18 as a key, the designations being as follows: *A*, longitudinal fissure; *B*, crucial fissure; *C*, supraorbital fissure; *D*, lateral fissure, *E*, coronal fissure.

frequent combination of such types of movement in the production of certain forms of activity, which are in constant demand in the individual's reaction to his complex environment.

ANALYSIS OF THE RESULTS OBTAINED FROM STIMULATION OF THE  
EXTRA-MOTOR CORTEX

In each of the animals studied investigation was made of results of irritations of other portions of the cerebral cortex, lying outside of the boundaries of what we believe to be the true motor field. These extra-motor fields are the readily approached anterior, superior and lateral aspects. It was found that usually there was no response from stimulation with the ordinary strength of current for a moderate time. With an increased strength of current, or with an application for a longer time, a total of fifty-nine responses was obtained. From study of these the following observations are made:

1. A stronger current or longer application was required than for stimulation of the motor cortex.

2. The latent period of the movement, when a movement was obtained, was always longer than for cortical motor stimulation. Frequently the latent period was three or four times as long as that of movements resulting from the stimulation of the "primary" motor cortex.

3. As far as inspection could determine, the movements which were produced were as functionally perfect as were movements produced by stimulation of the motor cortex.

4. The movements involved more restricted portions of the body musculature than did movements from motor cortex stimulation, and they frequently were of a so-called vegetative nature, that is they involved mechanisms whose activities are for the carrying on of respiration, or jaw and tongue movements, such as are encountered in mastication.

5. When analysed, the fifty-nine responses were found to include a total of seventy-three simple movements, of which only twenty-eight involved the contra-lateral side of the body alone, one the homolateral side alone, and thirty-four involved

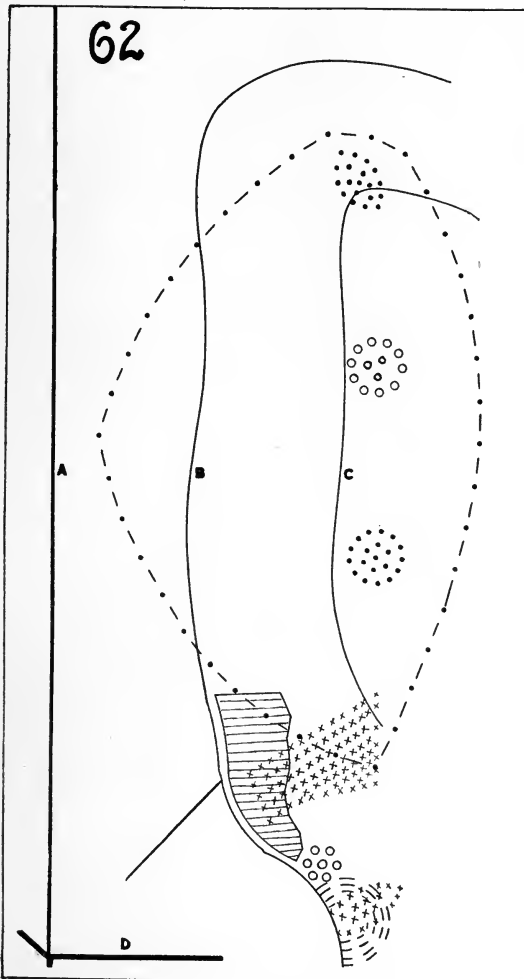

FIG. 62. The location of cortical areas outside of the crucial area which give motor results on prolonged or strong stimulation. Areas of circles correspond with movements of respiration acceleration, those of dots with respiration inhibition. The area of horizontal lines gave movements of the hind leg and tail. The area marked with crosses gave movements of the face. The area indicated by broken lines opposite the crucial sulcus gave movements of the fore leg.

In the figure, posterior is above, anterior below. The fissures are lettered as follows: A, longitudinal fissure; B, lateral fissure; C, supra-Sylvian fissure; D, crucial fissure.

both sides. This is a very high percentage of bilateral activity and can indicate either that the extra-motor areas are functionally in connection with the motor areas of both sides of the brain, in other words are bilateral in their control, or that the mechanisms which are involved are so intimately bilateral that control may be present in both sides of the cerebrum. The general distribution of the stimuable extra-motor areas is given in figure 62.

TABLE 6  
*Summary of movements obtained from extra-motor stimulations*

	CONTRA- LATERAL	HOMOLAT- ERAL	BILATERAL
Eye movements.....	10	1	8
Pupil changes.....			7
Fore foot movements.....	12		
Hind foot movements.....	5		
Hind knee movements.....	1		
Face movements.....			3
Lip movements.....			4
Jaw movements.....			2
Tail movements.....			2
Ear movements.....			1
Changes of respiration:			
Stoppage:			
Inspiratory.....			5
Expiratory.....			0
Hastening or deepening.....			2
	28	1	34

Figure 62 is a diagram presenting a record of the combined results obtained from the stimulation of the extra-motor regions of the cortices of cats 19, 20, 21, 24, 25, 26, and 27. The hemisphere investigated in each case, except that of cat 19, was the left, and since the results obtained from the investigation of cat 19 were similar to the results from the other animals they were included in the composite diagram of the left cortices of the other animals for the purpose of simplification. The areas represented in this diagram indicate only the total extent of the fields from which the various types of movement were initiated

by stimulation of the seven hemispheres. No attempt has been made to present the average field or to indicate the differences in the animals, which in this respect were very great.

The results of these tests may be compared with the results reported by Ferrier. It is seen that there is considerable similarity in the two series of results. For example, the field for the eye movements is almost coextensive in the two diagrams. Movements of the face region are from an area similarly located in the diagrams, immediately external to the anterior portion of the lateral fissure, though considerably more extensive according to Ferrier than is indicated by the present results. Ferrier's results from stimulation of the true motor region are, so far as they are given, identical with those here obtained.

Of the regions here referred to as "extra-motor," that lying adjacent to and between the longitudinal portion of the lateral and supra-Sylvian fissures give movements of the eyes in both Ferrier's and my experiments. Certain movements of respiration, which are found from stimulation of the banks of the supra-Sylvian region, are not mentioned by Ferrier. In both series, the region lying between the posterior portion of the coronal fissure and the anterior extremity of the supra-Sylvian fissure gives movements of the face area. Ferrier obtained no movements of the hind limb from the region external to the posterior portion of the coronal fissure, while in the present series of experiments such responses were frequently obtained. Ferrier secured a very extensive exposure of Sylvian area, and obtained motor responses of the lips, mouth and nose by stimulation in that region. No attempt was made in my experiments to expose this region and consequently a comparison cannot be made other than to say that the extra-motor field for these movements ran from the coronal fissure outward in such a direction that if further exposure had been made it seems probable that Ferrier's results would have been confirmed.

The probable reason for the consideration of these areas as truly motor by Ferrier, was his failure to recognize and distinguish between what we believe, as a result of careful and more recent histological and physiological methods, is a true motor

field, and what we believe are areas influencing the true motor fields. In the present series of experiments, note was taken of the comparative strengths of current and durations of stimulation needed in the various areas investigated. It was found, as previously mentioned, that from stimulation of points on the cortex outside of the sigmoid area either a longer application or a stronger current, or both, was required to obtain motor reaction than for successful stimulation of the sigmoid or true motor areas.

THE EFFECT OF SIMULTANEOUS OR SUCCESSIVE STIMULATIONS AT  
A MOTOR AND AN EXTRA-MOTOR POINT ON THE  
CEREBRAL CORTEX

On the brains of three animals there was investigated the effect of stimulating a point in the motor region of the cortex and, without discontinuing this stimulation, of adding a second stimulation at some point on the extra-motor cortex. A kymographic record was taken of the responses, and the following observations made: If a current of moderate strength is applied to the motor areas, and this stimulus be continued for a time, a clonic discharge is manifested in the appropriate muscles. If, while continuing stimulation at the point within the motor cortex, another current of similar strength is applied to some point in the extra-motor cortex, the clonus is at once steadied to a tonus (see figs. 63 and 68). Removal of the first current, while continuing the second current, is at once followed by commencing relaxation of the muscles involved, but the relaxation is very much retarded by the presence of the extra-motor stimulation (see fig. 65). In the relaxation following the removal of the stimulus to the motor region, when this stimulus has alone been applied, there is usually a slight tendency to after-movement. The after effect is likewise present, but to a less degree, when an extra-motor stimulus is kept applied, during the relaxation stage (see fig. 63).

The extra-motor stimulus, judging from these results, is able to exert a steady influence on the motor discharge, such as



would tend to make the movement more constant in its nature. It was unable, in the strength used, either to initiate movements of its own or to maintain activities initiated by direct stimulation of the motor cortex.

Examples of the myograms obtained by the above given methods of stimulation of the motor and extra-motor cortex, are presented in figures 63, 64, 65, 66, 67, 68, and 69.

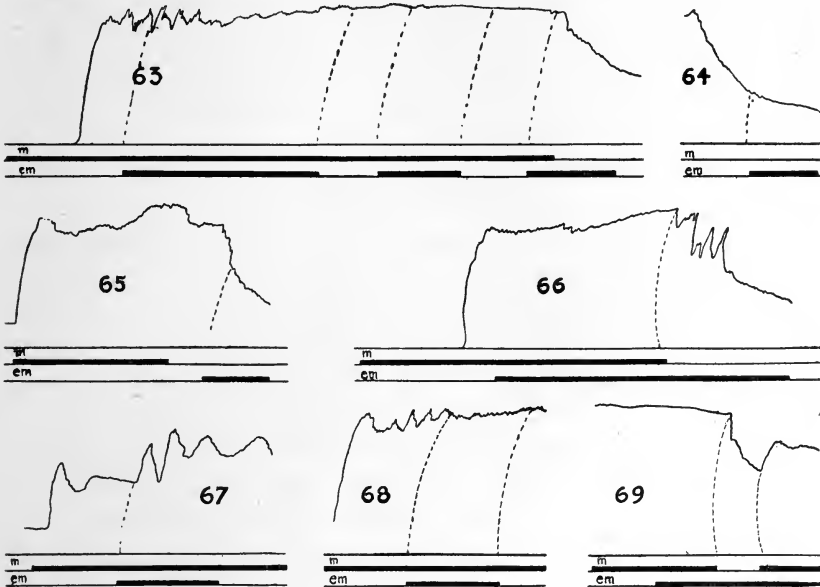

FIGS. 63, 64, 65, 66, 67, 68, and 69. Curves showing the effects of stimulating a "motor" point and the simultaneous or successive stimulation of a point within the so-called "extra-motor" region. The figures have been reproduced from tracings of the kymograph records. The broad black parts of the lower two lines of each figure show the time of application of the stimulus to the motor area (indicated by m) and to the extra motor region (indicated by em). For description of the results see the text.

The extra-motor regions investigated with regard to the effect of applying a stimulus to a point within them simultaneously with the application of a similar stimulus to some point on the motor cortex were those areas lying internal to the anterior half of the main limb of the lateral fissure and external to the ansate fissure in cat 36, and a similar location on the brain of

cat 37. From the stimulation of each of these fields positive motor results were obtained, though differing considerably, both in degree and in nature, for even successive tests of the same pair of points in the motor and extra-motor regions.

While in general the results have exhibited only controlling or steadying action by the simultaneous extra-motor stimulation, it should be mentioned that some of the results indicate the possibility, or even probability, of an augmenting influence by the addition of such an extra-motor stimulus. An example of such effect is presented in the tracing of the myogram for the stimulation applied to two such points on the cortex of cat 36, as shown in figure 67.

There is frequently a retardation of the muscular relaxation when there is present, or there is added, an extra-motor stimulation during the period immediately following the discontinuance of the stimulus to the motor cortex (figs. 63, 64, and 65). The addition of the extra-motor stimulus also frequently results in a decrease of clonic activity, resulting from the continuance of a motor stimulus (figs. 63, 66, and 68). The addition of, or the presence of, an extra-motor stimulus was never found to cause an abnormal continuance of activity initiated by a stimulation applied to a point within the motor cortex, although it was usually able to cause a retardation of the relaxation time, when the motor current was discontinued. In nearly all cases, the curves showed a commencing relaxation immediately following the removal of the motor current, even though a comparatively strong current was applied to some point of the extra-motor cortex.

A satisfactory explanation for the influence of the stimulation of the extra-motor regions, upon the activity of the motor regions, is not at hand. The actual explanation cannot be definitely stated until further work on the nervous system has been done, and until some of the at present imperfectly understood connections are definitely learned. It may, however, be stated that the exertion of an inhibiting, exaggerating, or steadying influence can be accounted for in one of several ways: (a) the extra-motor areas may exert such influence by direct connections with

the motor cortex by associational fibers; (b) there may be mutual connections of the two regions by means of fibers running to the basal ganglia, such as the lenticular, or the caudate nuclei, or the optic thalamus; (c) efferent fibers passing to the cerebellum, from the two regions, may mediate the control there; (d) efferent fibers, from the extra-motor regions, passing into the spinal cord to the spinal cell centers, may be responsible.

It seems most likely that the extra-motor influence is like that of the efferent elements in the spinal cord upon the activity and tonus of muscles, innervated by cells in corresponding spinal segments.

#### COMPARISON OF THE PERIOD OF LATENCY FROM STIMULATION OF POINTS ON THE CORTEX AND POINTS JUST UNDER THE CORTEX

In three animals stimuli were applied to various points on the cortex within the motor area, and records were made of the reactions. From these there were determined the times between the beginning of the stimulation and the resulting movements, i.e., the latent periods. After these records were made, for each of the points chosen, the cortex at that particular area was removed with a sharp pair of hair-pointed scissors and as soon as the slight hemorrhage was controlled, the tissue underneath was similarly stimulated to determine if there was a change in the duration of this period. The tissue removed was about 2 mm. square and of about the same thickness. The time interval was unfortunately not measured in terms of seconds or parts of seconds, but in terms of vibrations of the primary coil of the inductorium, which was used for stimulation. While it is not certain that this vibration remained constant in all tests, it is certain that it was reasonably constant for the tests on each animal. The comparison of the latencies is, therefore, possible although not in parts of a second. The following table (table 7) gives the results of these tests. On the brain of each animal the number of stimuable points differed, and at times more subcortical than cortical stimuli were given at one point. The table shows the number of stimuli, the aver-

age duration in vibration rate for the cortical and subcortical, and the percentage relations, i.e., the subcortical average divided by the longer cortical.

The results of this part of the work are not conclusive and are given at this time because of their suggestive value, rather than their power of explanation. In comparison with the results here recorded it is of interest to note that in cat 24 the average cortical latent period, in ten tests, was 30.9 vibrations.

TABLE 7  
*Comparison of latency of movement for cortical and subcortical points*

CAT	CORTICAL		SUBCORTICAL		PER CENT SUBCORTICAL
	Number of stimulations	Average latency	Number of stimulations	Average latency	CORTICAL
26	20	10.7 v.	45	6.3 v.	59
27	29	28.5 v.	30	22.1 v.	78
32	44	21.5 v.	51	18.9 v.	88

The table shows that the latency of the subcortical stimulations was approximately 75 per cent of the latency of the stimulations of the cortex. In addition to these relations the following observations were made of the cortical and the subcortical reactions. The amount of current needed for the stimulation of the cortical and of the subcortical tissue was approximately the same. The character of the reactions and the fatiguability of the two tissues was not noticeably different.

It will be observed that the latent periods for the cortical stimulation vary considerably in the different animals, the difference between the shortest and the longest periods being nearly 200 per cent. Similar variations in the latent periods for subcortical stimulations were also found, but a comparison of the results in cats 26, 27, and 32 shows that in every case the average subcortical latency is less than that of the cortical. The table gives the results in percentages and shows that the difference is not the same for all animals, in cat 26 the subcortical latency being about 40 per cent less than the cortical latency, while in cat 32 the difference is only about 12 per cent.

Whether or not the greater delay in cortical stimulation is due

to the extra space or to more synaptic connections which are traversed is not sure, but the great differences would rather indicate the latter condition. One other matter should be briefly considered, viz., the probability that the subcortical tissue may have become more excitable than the cortical, on account of the injury with its resultant loss of blood and washing with normal salt solution. This is a possible explanation for such results, but this explanation is not certainly warranted in view of the similarities in irritability, as measured by current strength necessary to produce a reaction, which were obtained. It should be noted that the subcortical stimuli were given always after the cortical (a condition imposed by the nature of the experiment) and the stimuli, if a fatigue effect for the first tests was present, should have resulted in a longer latent period for the subcortical stimuli. The time of the latent period for subcortical stimuli, even in view of a possible retarding fatigue effect, was shorter and this is a further indication that this is not a casual result. A comparison of the latencies for the corresponding cerebral points, cortical and subcortical, is also instructive with respect to the differences. In a few cases the subcortical latencies were greater than the corresponding cortical, but not frequently.

One further qualification should be made with respect to the method and results. Although an effort was made to stimulate the subcortical tissue immediately below a certain cortical point which was selected, it was (and is) impossible to be certain that this was accurately done. Assuming, however, that the tissue immediately below the cortex was stimulated, it is not possible to say that the fibers for the same overlying cells were stimulated. One fact is, however, especially noteworthy. This is that the subcortical stimulation, as a rule, resulted in a movement of the same muscles as those from the cortical stimulation.

It was noted that in many cases there is considerable after-movement following the discontinuance of the stimulation. This is true both for cortical and subcortical stimulation. Such a result for subcortical stimulation is rather surprising in view of the statement of François-Franck that stimulation of the corona radiata results in motor reactions which cease immediately after

the discontinuance of the stimulation and that stimuli at these points are not followed by after-movement. A condition similar to that mentioned by François-Franck would be expected from stimulation of the subcortical tissue. The absence of it indicates a very close (and, perhaps frequent) connection between the cortex and the immediately underlying tissue, a connection even closer than the connection between the cortex and the corona radiata.

The presence of after-movement in the contractions resulting from the stimulation of the subcortical tissues in the cat may, however, be due to the fact that the cat is lower in the scale than the monkeys with which François-Franck worked, and that in the cat the dependence of the lower centers is not so marked. It may then be that the lower centers once set into activity are capable of continuing their motor discharges for a certain time, in the form of after-movement in the cat while in the monkey the dependence of the lower centers is such that they cease activity immediately on the discontinuance of the discharges from the higher centers. This presupposes that the after-movement present from the stimulation of the intact cortex of the monkey is a purely cortical phenomenon. A somewhat similar amount of independence of the cortex and the subcortical parts in the dog, as compared with the monkey, is indicated in the relative ease of recovery of the dog and the relative difficulty of recovery in the monkey after the experimental production of a cortical hemiplegia.

#### MOTOR REACTIONS FROM STIMULATION OF THE CORPUS CALLOSUM AND THE CORONA RADIATA

Tests of the irritability of the corpus callosum and the corona radiata in cats 18, 21, 26, 27, and 32 were performed as follows: The superior surface of the cortex of the left hemisphere was removed in a long wedge-shaped strip, extending from the occipital pole to the superior end of the supraorbital fissure and from the lateral fissure to a line projected posteriorly from the outermost portion of the coronal fissure. The tissue re-

moved was sufficiently thick to include the roof of the lateral ventricle. This method of approach was adopted in order to secure as complete an exposure of the corpus callosum and corona radiata as possible. By such an approach the corpus callosum was severed antero-posteriorly throughout its whole extent. The portion of the corona radiata laid bare included most of the tissue underlying the motor cortex and a large part of that underlying the extra-motor regions of the superior and lateral portions of the hemisphere.

The tests of irritability were carried out as soon as the hemorrhage, which was sometimes considerable, was arrested by packing lightly with surgical gauze. The same method of recording

TABLE 8

*Results of stimulation of corpus callosum. General distribution of stimuable areas, the portions of the corpus callosum in the table being related to the movements mentioned*

CAT	MOVEMENTS			RESPIRATION	
	Hind limb	Fore limb	Head and neck	Inspiration	Expiration
18		Mid. $\frac{1}{3}$	Ant. $\frac{4}{5}$		
21	Ant. $\frac{1}{3}$	Ant. $\frac{1}{3}$	Ant. $\frac{1}{3}$		
26	Ant. $\frac{1}{2}$	Ant. $\frac{1}{2}$	Ant. $\frac{4}{5}$	Mid. $\frac{1}{3}$	
27		Ant. $\frac{1}{2}$	Ant. $\frac{1}{2}$		Ant. $\frac{2}{3}$
32	Ant. $\frac{1}{3}$	Ant. $\frac{2}{3}$	Ant. $\frac{1}{5}$	Post. $\frac{1}{3}$	M'd. $\frac{1}{3}$

results was used as in the tests of irritability of the surface. It may be said that most of the animals used for the investigations of the irritability of the corpus callosum and corona radiata were first used for a short time for the investigation of the surface irritability. The first stimulations applied to the exposed tissue of the corpus callosum were by means of a very weak current, which was gradually increased to an amount just sufficient to produce reaction, an effort being made to use as weak a current as possible to prevent unnecessary fatigue of the tissue.

The accompanying table (table 8) presents the summary of the results from the stimulation of the various portions of the corpus callosum and table 9 gives the summary of results ob-

tained from the stimulation of the corona radiata. In table 8 it is seen that the results from the stimulation of the corpus callosum are fairly constant in the different animals, although the extents of the area for the various types of muscular activity differ slightly from animal to animal. For example, movements of the hind limb resulted from stimulation of the anterior third of the corpus callosum in cats 21 and 32, and from the anterior half in cat 26. Movements of the fore limb resulted from the stimulation of the anterior third in cat 21, from the anterior half in cats 26 and 27, from the anterior two-thirds in cat 32, and from the middle third in cat 18.

The area most responsive to stimulation was the anterior half, although in cats 18, 26, and 32 reactions were obtained from all the structure, excepting the posterior fifth. The richness of reaction from stimulation of the anterior portion is to be accounted for by its nearness to the motor area and the consequent richer supply of fibers passing presumably between the motor areas of the two sides. It is to be noted that the most of the movements produced by stimulation of the corpus callosum were of the muscles of the right side of the body, while the left end of the corpus callosum was exposed. The explanation of this is not clear, but it is probably due to the fact that the fibers producing the reactions are not members of the usual motor efferent system, but are normally used to convey impulses from the left cortex to associated motor mechanisms of the right cortex. It is as yet impossible to say what their actual course is. Further study of the motor cerebral control of the cat is necessary to explain this matter.

The area of the exposed tissue of the corona radiata yielding the most satisfactory results was that portion of the structure underlying the motor cortex and extending posteriorly close to the anterior half of the corpus callosum. This is probably due to the passage of the previously mentioned motor associational fibers from the motor cortex to the corpus callosum, and thence to the other hemisphere. The actual forms of movement produced from the stimulation of the corona radiata were in many cases similar to the activity produced by stimulation of the



immediately overlying motor cells. A second area yielding motor reactions was found under that portion of the cortex in the region extending from the anterior bank of the postlateral fissure outwards and forwards to the superior extremity of the

TABLE 9

*Summary of results from the stimulation of the corona radiata. General distribution of stimuable areas*

CATS		
Movements of the hind limb		
18	None	
21	Close to the under portion of the middle third of corpus callosum, and anteriorly under the post-crucial area	
26	None	
27	None	
32	Close to the anterior third of the corpus callosum	
Movements of the fore limb		
18	None	
21	Close to the middle third of the corpus, and under all of the surface motor area	
26	Under the surface area about the crucial sulcus	
27	Same	
32	Under the post crucial area	
Movements of the head and neck		
18	None	
21	Close to the middle third of the corpus, and along the outer margin of the posterior one-third of the exposed field	
26	Close to the under surface of all the corpus and under the crucial area	
27	Under the inner part of the anterior section of the motor area	
32	Under the inner part of the motor area	
Movements of respiration		
	Inspiratory:	Expiratory:
18	None	None
21	A few points near the middle third of corpus	Numerous points opposite the middle third of the corpus
26	None	None
27	Under the anterior portion of the motor field	None
32	Above the posterior one-third of corpus	Above the posterior one-third of corpus

ecto-Sylvian fissure. A third and less frequently found field is situated under the region of the surface lying external to the median portion of the supra-Sylvian fissure. The movements obtained from stimulation within these fields were as functionally perfect as movements produced by stimulation of the motor areas of the surface. They involved movements of each side of the body and sometimes of both sides.

From stimulation both of the corpus callosum and of the corona radiata a large number of responses included a change in the depth or rate of the respiratory movements.

#### GENERAL SUMMARY

*Superficial motor cortex.* 1. The general area of motor control in the cortex of the cat extends from the fissura coronalis, on either side, to the mid-line, and about 5 cm. over the margin of the mid-line on to that portion of the mesial surface of the hemisphere back of the sulcus crucialis. It extends from a point about 0.5 cm. above the upper margin of the olfactory lobe backwards to the union of the posterior end of the fissura coronalis with the anterior end of the fissura lateralis. It extends well to the bottom of the sulcus crucialis on both banks.

2. The area for control of the hind-limb and tail extends over the posterior three-fourths of this area, being richest in the area from the sulcus crucialis backwards. The area between the ansate fissure and the median line is almost entirely for control of the hind-limb.

3. The area for motor control of the fore-limb includes that between the inner end of the ansate fissure and the sulcus coronalis, back of the sulcus crucialis, and the area immediately in front of the sulcus crucialis extending downwards to the anterior end of the fissura coronalis.

4. The area for control of the neck lies anterior to the sulcus crucialis and downward to a point about 0.5 cm. above the upper margin of the olfactory lobe.

5. The area for the control of the nose, mouth and tongue lies around the superior end of the fissura supraorbitalis. Stimula-

tion of the various points in the area for control of these latter movements give bilateral movements which are well coördinated and purposeful in nature. A similar result is found from scattered stimulations from various places controlling movements of the limbs.

6. The area outside of the fissura coronalis is practically barren of results from stimulation.

*Banks of the sulci cruciales.* 7. The anterior and posterior banks of the crucial sulci give reactions which are not quite so widespread over the body musculature as are those from stimulation of the surfaces of the hemispheres, but which are coördinated equally as well for those members which they do involve. The anterior bank controls movements of the tongue, mouth, throat, neck, eyes, pupils and fore feet. The posterior bank controls movements of the tongue, mouth, eyes, face and ears and fore and hind limbs.

*Variability of motor control.* 8. Analysis of the results from stimulation of the cortices of cats 8, 9, 10, 11, 12, 14, and 15 as to the types of movement included in the responses indicates a considerable degree of complexity in the cortical representations for the activities of the muscles. When analysed into their simpler component parts it is found that the average response to each stimulation applied to the right cortex included 1.99 simple movements, and of the left cortex 1.95 simple movements. This is subject to considerable variation in the individual animals, as shown by the results for cat 8, right hemisphere, of 2.79 and for cat 10, left hemisphere, of 1.36 movements per stimulation. It is subject to considerable variation even in the responses from the two hemispheres of the same animal, as shown in the case of cat 10. The average number of simple movements per stimulation of the right cortex of this animal was 1.85; and 1.36 for the left cortex.

9. Comparison of the frequency of the various types of movements of the joints of the limbs indicates that on the right side an average of 82 per cent and on the left side an average of 86 per cent of the total cortical responses were movements of some type of the joints of either fore or hind limb. As to the relative

frequency of the involvement of the two limbs, for the right side an average of 36 per cent, and for the left side an average of 38 per cent of the responses were movements of the fore limb. On the right side an average of 41 per cent and on the left side an average of 47 per cent were movements of the hind limb. This indicates, when the figures are combined, that there is a slightly greater cortical representation for movements of the hind limb than for movements of the fore limb.

10. Considering the frequency of movements, involving the various joints, it is seen that the joint most frequently involved is the right hind ankle (137 movements), and the next most frequent the right hind knee or right shoulder (each 96 movements). The most frequent type of movement is flexion of the right hind ankle (117).

*Extra-motor cortex.* From stimulation of the readily approachable portions of the cortical surface, outside the boundaries recognized for the motor area, the following conclusions may be drawn:

11. More current or longer application of current is required to produce motor activity than is required for successful stimulation of the motor area.

12. The movements so produced are as functionally perfect as are movements produced by stimulation of the motor area.

13. The latency is always longer with stimulation of these areas.

14. The movements involve more restricted portions of the body musculature, and are most apt to involve activity of such mechanisms as respiration, pupil changes, chewing, etc.

15. About 47 per cent of the movements so produced are bilateral in their distribution and the others contralateral.

16. The stimuable extra-motor field occupies a triangular area whose apex approaches the median line near the center of the fissura lateralis, and whose base extends from slightly external to the center of the fissura coronalis, to the point where the supra-Sylvian fissure bends downward posteriorly. Stimulation of the major portion of this field results in movements of the eyes and pupils. Several small areas along the supra-Sylvian

exert influence on the respiratory movements. The anterior portion of the field, adjacent to the motor field, gives movements of the face, hind leg and fore ankle. These are similar to the results of stimulation applied to the cortex within the adjacent motor field, and it may be thought that overflow of current into the motor cells might have been the cause of such reactions, but the occurrence of motor reactions of the face from the immediately adjacent field tends to discredit this, because the portion of the motor field which controls activity of the muscles of the face does not extend over this portion of the cortex, but is confined to that region lying mainly in front of the crucial sulcus.

*Simultaneous and successive stimulation of two different parts of cortex.* The application of two stimulations to the cortical surface, one within the limits of the motor field, and the other at some point on the cortex outside of the motor field, discloses the following facts.

17. If the motor current be applied first the muscular contractions usually assume a clonic form. If the extra-motor current be then applied, while continuing the motor current, the clonus is sometimes steadied to a tonus. If the motor current be now discontinued the phase of relaxation at once sets in, but is much prolonged as compared with the relaxation following the removal of stimulation applied to the motor cortex alone.

18. The stimulation of a point within the extra-motor area may be said to cause this area to exert a steadying influence on the motor discharge from stimulation of the motor field, so long as stimulation of the motor area is continued, but when stimulation of the motor field is discontinued the extra-motor stimulation is unable to cause a continuance of the motor discharge at full force for even a brief period. The influence of the extra motor-field is possibly such as to cause the motor discharge to assume a more purposeful nature.

*Cortical and subcortical reactions.* From comparison of the motor reactions from stimulation of the motor cortex at various points, and the reactions following the removal of small pieces of the cortex at these same points, and subsequent stimulation

of the immediately underlying tissue, i.e., the most peripheral portion of motor corona radiata, the following conclusions may be drawn:

19. The latency from the subcortical point is approximately 75 per cent of the latency of the overlying cortex.

20. The amount of the current needed to excite the subcortical point is not appreciably different with the apparatus used in these experiments.

21. The character of the reactions from the two regions is practically identical. The stimulation of the subcortical point usually reacts in activity of practically the same groups of muscles as does stimulation of the cortical point.

*Motor reactions from stimulations of corpus callosum and of corona radiata.* The results from stimulation of the exposed end of the corpus callosum may be summarized as follows:

22. The corpus callosum is irritable to electrical stimulation except at its posterior extremity.

23. Stimulation of the anterior one-third results in movements of the hind limb usually of the crossed side, but sometimes of the hind limb of the same side.

24. Stimulation of the anterior half results in movements of the fore limb of one or the other side, usually the crossed side.

25. Stimulations of the anterior four-fifths result in movements of the head and neck, of a bilateral nature.

26. Stimulations applied to the middle two-fourths result in changes of the respiratory activity, usually causing an increase in the intake.

27. The amount of current needed for the stimulation of the exposed tissue of the corpus callosum is practically the same as for stimulation of the surface of the cortex.

28. The movements produced are as functionally perfect as are those produced by stimulation of the cortical surface and are apt to involve several joints in the same manner as do the cortical responses.

The results from stimulation of the structure of the corona radiata, exposed by removal of a long wedge-shaped strip of the cortex, may be summarized by saying that (29) motor reac-

tions followed the application of a moderate strength of current to points widely scattered over the field so exposed. The most productive area was that underlying the motor cortex and adjacent to the anterior portion of the corpus callosum.

## REFERENCES

- CAMPBELL, A. W. 1905 Histological studies on the localization of cerebral function. Cambridge, University Press.
- FERRIER, D. 1886 Functions of the brain. 2d edit. New York, Putnams.
- FRANCOIS-FRANCK, C. E. 1887 Leçons sur les fonctions motrices du cerveau. Paris, Doin.
- FRANCOIS-FRANCK, C. E. and PITRES, J. A. 1878 Progrès méd., Paris, January 5.
- FRANZ, S. I. 1915 Variations in distribution of the motor centers. Psychol. Monog., xix, no. 81, pp. 80-161.
- MONAKOW, C. v. 1914 Die Lokalisation im Grosshirn und der Abbau der Funktion durch kortikale Herd. Wiesbaden, Bergmann.
- SCHÄFER, E. A. (EDITOR) 1900 Text-book of physiology., vol. ii. Edinburgh, Pentland. Article on The cerebral cortex, by E. A. Schäfer, pp. 697-782.
- WILDER, B. G. and GAGE, S. H. 1882 Anatomical technology as applied to the domestic cat. New York, Barnes.

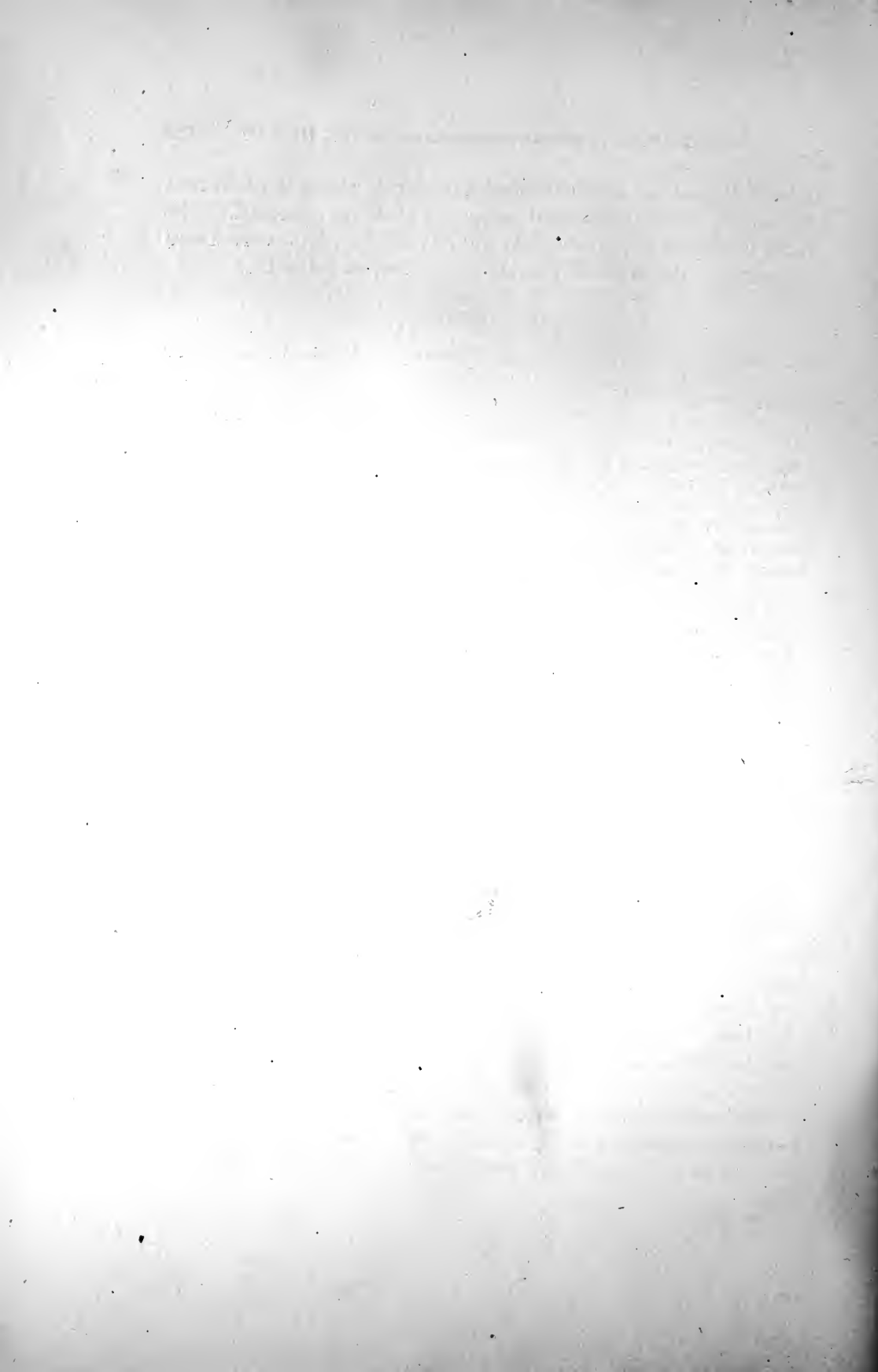



# RELATIVE VALUES OF REWARD AND PUNISHMENT IN HABIT FORMATION

J. D. DODSON

*From the Psychological Laboratory of the University of Minnesota*

## CONTENTS

History of problem.....	231
Present problem.....	237
Preliminary experiment.....	241
Conclusions.....	247
Experiment proper.....	247
Curves of learning.....	249
Summary of tables.....	256
Differences in learning in males and females.....	262
Interpretation of curves of relative values of hunger.....	262
Values of different strengths of electrical stimuli.....	266
Comparison with earlier results.....	268
Summary of facts to be explained.....	268
Some laws of learning which have been suggested.....	269
Relation of rate of learning to retention.....	274
Retraining.....	275
Conclusions.....	275

## HISTORY OF THE PROBLEM

For investigations of animal behavior under laboratory conditions, the first need is some form of stimulation which will serve as a motive for the proper performance of the required act. The forms of stimuli most commonly used are rewards and punishments. But there are differences of opinion among students of comparative behavior as to which of these two motives facilitate most the learning process. At the suggestion of Prof. R. M. Yerkes the writer has undertaken to answer, for at least a sensory habit in one species of animals, this important question.

The use of reward and punishment as motives for securing desired forms of behavior is as old as the companionship of human and infra-human organisms. Wherever man has at-

tempted to establish habits of subserviency in lower animals he has resorted primarily to one or both of these motives for action. But the close of the last century and the beginning of the present have seen an awakening of a broader interest in animal behavior than that of subserviency—an interest in the comparative behavior of living organisms. With the interest in comparative behavior and the use of laboratory methods naturally came the question of motive to secure the desired behavior.

If one ignores a few experiments done by Romanes, Lubbock, Graber, Preyer, Loeb and Verworn (1881 to 1890), whose interests were primarily physiological and not psychological, he may begin his history of comparative experimental behavior with E. L. Thorndike whose "Animal Intelligence" appeared in 1898. He reduced his subjects to a state of "utter hunger" and placed them in a box from which they might escape by working some form of simple door-fastener. The motive used to get the animal to react to this situation was the placing of food on the outside of the box. These experiments brought forth a considerable amount of adverse criticism. These criticisms were directed either against the placing the animal under abnormal conditions as a means of control or against reducing them to a condition of "utter hunger." But these objections did not seriously affect the interest in comparative behavior; and many valuable experiments have been performed in our psychological laboratories, especially at Harvard, Chicago, Johns Hopkins and Clark.

Within the next decade after the appearance of Thorndike's monograph, Yerkes, in the Harvard Psychological Laboratory, had devised a means of using punishment as a motive for the proper performance of a required act. He says (11):

My experiments with the dancer differ from those which have been made by most students of mammalian behavior in one important respect. I have used punishment instead of reward as the chief motive for the proper performance of the required act. Usually in experiments with mammals hunger has been the motive depended upon. The animals have been required to follow a certain devious path, to escape from a box by working a button, a bolt, a lever, or to gain entrance to a box by the use of the teeth, claws, hand, or body weight and thus

obtain food as a reward. There are two very serious objections to the use of the desire for food as a motive in animal behavior experiments—objections which in my opinion renders it almost worthless in the case of many animals. These are the discomfort of the animal and the impossibility of keeping the motive even fairly constant. However prevalent the experience of starvation may be in the life of the animal, it is not pleasant to think of subjecting it to extreme hunger in the laboratory for the sake of finding out what it can do to obtain food. Satisfactory results can be obtained in an experiment whose success depends chiefly upon hunger only when the animal is so hungry that it constantly does its best to obtain food, and when the desire for food is equally strong and equally effective as a spur to action in the repetitions of the experiment day after day. It is easy enough to get almost any mammal into a condition of utter hunger, but it is practically impossible to have the desire for food of the same strength day after day.

But the use of punishment as a motive for the performance of a required act did not escape adverse criticism. Watson (10) says,

It is not fair to talk of the cruelty and inhumanity of keeping the animals hungry, as has been done by several writers, until there is some factual support for the charge. There is not the slightest difficulty in keeping the animal in perfect condition and at the same time hungry enough to work properly. We have found no animal which does not work well when food is used as the general stimulus. . . . We repeated the maze experiment on the dancer with food as a stimulus. So far as we could judge the method was as satisfactory, from the standpoint of the rapidity of learning and from that of the well being of the animal, as the punishment of Yerkes. . . . This punishment method has not worked any too well. It has been criticised by Hamilton who found that it made his dogs restless and hesitant, by Lashley, who found it made rats, where association was difficult, after a time refuse to work.

In spite of the difficulties of using reward and punishment as stimuli for the performing of any desired act, there are many valuable experiments in animal behavior for which one or both of these are not only desirable but almost absolutely necessary for the performance. This being true, it is very profitable that

the experimenter know which is the most favorable to habit formation.

During the years, 1907 and 1908 Dr. Yerkes and the writer attempted to work out, in the Harvard Psychological Laboratory, the problem as to the relation of strength of stimulus to rapidity of habit formation (12). The subject used for this experiment was the dancing mouse; the habit for the dancer to acquire was a simple visual discrimination between two boxes of different light intensity. We used three degrees of difficulty of discrimination, easy, medium and difficult; and three strengths of stimuli, weak, medium and strong. The data secured led to the following conclusions:

1. In the case of the particular habit which we have studied, the rapidity of learning increases as the amount of difference in the brightness of the electric boxes between which the mouse is required to discriminate is increased. The limits within which this statement holds have not been determined.
2. The relation of the strength of electrical stimulus to rapidity of learning or habit-formation depends upon the difficulty of the habit, or, in the case of our experiments, upon the conditions of visual discrimination.
3. When the boxes which are to be discriminated between differ very greatly in brightness, and discrimination is easy, the rapidity of learning increases as the strength of electrical stimulus is increased from the threshold of stimulation to the point of harmful intensity. Our results do not represent, in this instance, the point at which the rapidity of learning begins to decrease, for we did not care to subject our animals to injurious stimulation. We therefore present this conclusion tentatively, subject to correction in the light of future research. Of its correctness we feel confident because of the results which the other sets of experiments gave.
4. When the boxes differ only slightly in brightness and discrimination is extremely difficult the rapidity of learning at first rapidly increases as the strength of stimulus is increased from the threshold, but, beyond an intensity of stimulation which is soon reached, it begins to decrease. Both weak stimuli and strong stimuli result in slow habit formation. A stimulus whose strength is nearer to the threshold than the point of harmful stimulation is most favorable to the acquisition of a habit.

5. As the difficultness of discrimination is increased the strength of that stimulus which is most favorable to the acquisition to habit formation approaches the threshold. This leads us to infer that an easily acquired habit, that is one which does not demand difficult sense discriminations or complex associations, may readily be formed under strong stimulation, whereas a difficult habit may be acquired readily only under relatively weak stimulation.

Prof. Lawrence W. Cole repeated the above experiment on the chick with the discriminatory conditions somewhat changed to fit the needs of his subjects (2). His results led him to the following conclusion:

In conclusion, it is evident that within the limits of the stimuli which I used, the number of trials required by the chick to learn to choose consecutively the darker of the two unequally illuminated screens, when discrimination is easy, decreases with an increase of stimulus. Under medium difficulty of discrimination the above law holds true only for the lower intensities of the stimuli which were used or, in other words, the optimal stimulus recedes towards the threshold from 590 to 480 (6). The above law for the condition of easy discrimination holds true for that of difficult discrimination if we consider only the record of the chicks which succeeded in learning to make the discrimination. If, however, we consider only the chicks which failed, the optimal stimulus recedes once more to a point nearer the threshold of stimulation than in case of medium discrimination. In other words, with difficult conditions of discrimination, strong stimuli divided the chicks into two groups, those which succeeded in learning to discriminate by reason of more right choices at the beginning of the training series and consequently fewer pain stimuli, and those which failed because of fewer right choices and more pain stimuli in the earlier trials. So far as I determined the sensitiveness of chicks, it may be said that on the average the more sensitive chicks learn more rapidly both for strong and weak stimuli.

Mildred A. Hogue and Ruth J. Stocking did some work in Johns Hopkins Psychological Laboratory on the relative values of punishment and reward as motives (4). Their subjects were a mixed breed of black-and-white rats. The problem for the rats was to learn to discriminate between two lights of different intensity, always choosing the one and avoiding the other. The

experimenters divided their subjects into three groups of two rats each and trained two with punishment, which was a "light electric shock," two with reward, which was "milk-soaked bread," and two with a combination of reward and punishment.

Of the two rats trained with reward and punishment one finished in 490 trials, or the 49th day, the other in 550 trials, or on the 55th day; but the first of these made a perfect record on the 30th, 31st, 34th, 37th, 40th, 43rd and 44th days; the latter made a perfect record on the 48th day. Of those trained with punishment one finished in 550 trials; the other had not finished when the experiment was discontinued on the 60th day; but the latter made a perfect record on the 37th, 50th and 51st days. Neither of the animals used with reward finished or made a perfect record during the entire series. From these results the experimenters came to the following conclusions:

It seems evident from this experiment that a combination of punishment and reward-motives is more effective in bringing about visual discrimination in the rat than is either punishment or reward used alone. It seems evident, also that punishment is more effective than reward, at least in so far as the rate of learning is concerned.

Whatever else the above experiments may or may not have proved, they demonstrate beyond a question of doubt that no experimenter can arbitrarily choose a single strength of stimulus or degree of hunger and say he has the most favorable condition for training any living organism. The experiment on the relative value of punishment and reward as motives shows almost nothing of the relative value of these two motives. The strength of electrical shock used may have been the most unfavorable to the learning process while the degree of hunger was the most favorable, or the strength of shock may have been the most favorable while the degree of hunger was the most unfavorable. It seems likely from the results that both the electrical shock and the degree of hunger were too weak to keep the animals up to their greatest capacity.

## PRESENT PROBLEM

The problem of the relative values of reward and punishment is of importance both for practical experimentation and for its bearing upon the question of the rôle of 'incentives' in determining the fixation of arcs in habit. Its solution demands the discovery of the most effective methods of employing both incentives and the comparing of these two. In order to avoid the error of comparing a degree of hunger to a strength of electric shock which might in no way be comparable, we have attempted to work out a curve of relative values of different degrees of hunger and a curve of the relative values of different strengths of electrical shock. We found the relative values for each for four different conditions using in all some 80 subjects. While we do not contend that we found absolutely the most favorable condition of hunger and the most favorable strength of electric shock for the learning process we do contend that the most favorable condition in each case lies somewhere within the limits used and that we approached fairly close to that condition.

The writer at this time desires to acknowledge his indebtedness to Major Robert M. Yerkes for his supervision and many valuable suggestions in carrying out this experimental study.

*Subject used.* As the white rat possesses the desirable qualities of lending itself readily to laboratory methods and treatment, and of breeding rapidly we chose it as our subject. All individuals used in this experiment were bred in the Harvard Laboratory for Animal Psychology from a pure albino "pet rat stock" secured from Miss A. E. C. Lathrop, Granby, Massachusetts. They were fed, when not being used as subjects, at 8.30 in the forenoon and at 5.00 in the afternoon each day. The morning meal consisted of mixed grains and the afternoon meal of bread soaked in milk. A constant supply of water was provided by means of automatically feeding bottles which also served as weights to keep the doors closed.

*Apparatus.* The control box, figure 1, was 55 cm. long by 39 cm. wide by 20 cm. deep. It was divided into a nest box, *A*, 15 cm. long by 21 cm. wide, an entrance chamber, *B*, 20 cm. long

by 21 cm. wide, two electric boxes, *D, D*, each 15 cm. long by 10 cm. wide and two alleys, *E, E*, each 55 cm. long by 8 cm. wide. The nest box opened into the entrance chamber by a small doorway, *F*, closed by a vertically sliding door. The right electric

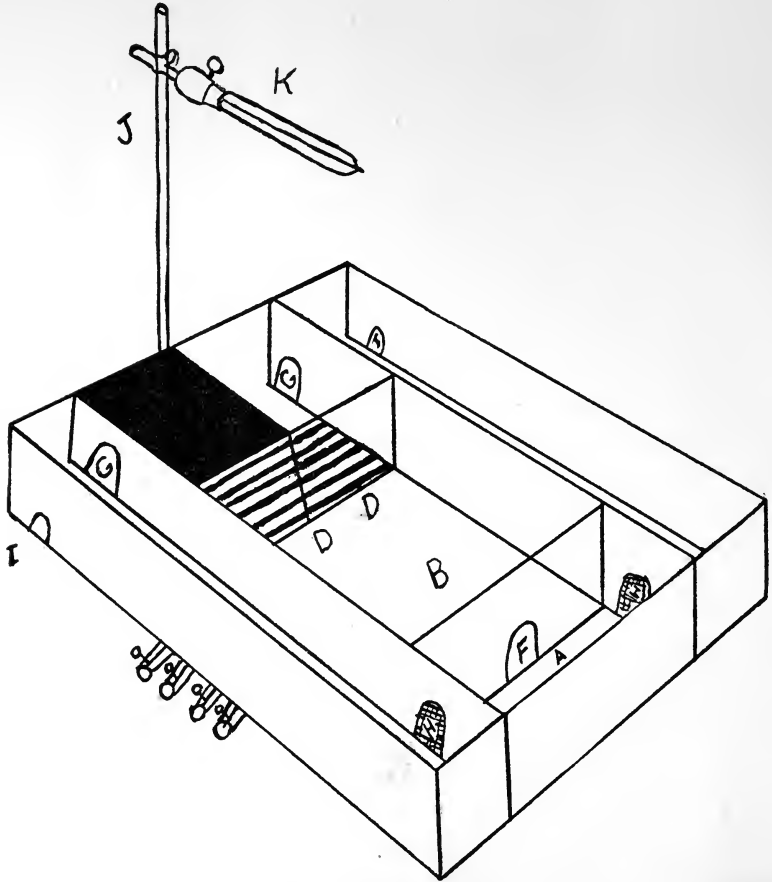

FIG. 1. CONTROL BOX

*A*, nest box; *B*, entrance chamber; *D, D*, electric boxes; *E, E*, alleys; *F, G, G, H, H*, doorways; *I, I*, food receptacles; *J, K*, lamp stand and lamp.

box opened into the right alley and the left into the left alley by the doorways, *G, G*, which were closed by colorless glass doors. The alleys opened into the nest box by means of swinging wire



doors, *H, H*, which a rat could easily push open after which it would enter the nest box but could not pass back into the alley. Small food receptacles, *I, I*, were inserted into the side at the rear of the control box. These receptacles could be removed and the openings closed by small metal doors. On the floors of the electric boxes were series of copper plates connected in a circuit with a no. 6 Columbia dry cell and a calibrated Porter inductorium. The current was kept constant at 1.5 amperes by means of a resistance coil. Fastened to the rear of the control box was a lamp stand, *J*.

*Room and light.* The experiment was done in a dark room lighted by a "Champion" 16 watt ground glass tubular lamp *K*, figure 1, the lighting capacity of which was reduced by a resistance coil to 0.61 candle power. The lamp was attached to the stand at a distance of 80 cm. from the bottom of the control box and so placed that the front of the electric boxes cast a perpendicular shadow. One of the electric boxes was made dark by placing a cardboard just the size of the top of the box over the box. This cardboard was shifted from one box to the other in irregular order, not remaining on one side for more than two trials at one time. Thus the problem for the rat was to learn to discriminate between a box the lighting of which was 0.95 candle-meter and a box the lighting of which was such as was reflected from the dark surface of the control box through an opening 10 cm. by 15 cm. at the front of the electric box, and to choose the light box.

*Time and number of trials.* Each subject was given ten trials every third day. This unusually long time between training periods was necessary to make it possible to use a hunger period of forty-eight hours. In order to eliminate differences due to tendencies of varied activity of the rat at different hours of the day, all experiments were done between three and five o'clock in the afternoon. The animals trained with electrical shock were given their trials from three to four o'clock and those with hunger from four to five. The habit was considered perfected when the subject made ten correct choices on the same day. While this is a smaller number of correct choices than is usually required

in like experiments we did not care to require an animal to retain the habit for so long a time as six or nine days.

*Care of subjects.* Subjects which were trained with electric shock were fed twice daily just as were the animals which were not being used. The subjects which were trained with hunger were fed in the same way except during the period of training. The group trained with twenty-four hours of hunger was fed the last time, before the experiment, at three-thirty in the afternoon of the day prior to the day of the experiment. Thirty minutes after feeding the rats were transferred to a cage in which no food was ever put and kept there until the time of the experiment. The group trained with thirty-one hours of hunger was fed at eight-thirty a.m. and transferred at nine a.m. of the day prior to the day of the experiment. The group trained with forty-one hours of hunger was fed last at ten and transferred at ten-thirty p.m. two days before the day of the experiment. The fourth group, trained with forty-eight hours hunger was fed at three-thirty and transferred at four p.m. two days before the day of the experiment.

*Training with electric shock.* At the beginning of each experiment all doors of the control box were closed except the one at the exit of the light box. The food receptacle had been removed on the day before and all food cleaned off the box and the openings closed. The subject was placed in the nest box and allowed to pass into the choice box where it faced the dual possibility of entering the light or dark electric box. If it chose the light box it could pass out at the exit and through the alley to the nest box without receiving any shock; but if it chose the dark box it received an electric shock and it had to return through the entrance chamber and the light box in order to get to the nest box. The shock was given to the animal after it had entered the electric box instead of as it entered as is the usual method. This was to make the place of punishment as nearly comparable to the place of food as was possible.

*Training with food.* At the beginning of the series of experiments with food, food was placed in the receptacles and all doors closed as in case of the training with electric shock. If the sub-

ject chose the light box it found toasted corn flakes soaked in cream in the food receptacle. The rat was given about ten seconds in which to eat, then the experimenter made it pass on through the alley into the nest box ready for another trial. If the animal chose the dark box it found the door closed and had to return into the entrance chamber and pass out through the light box.

*Timing of subject.* The experimenter kept the time in seconds that the subject took from the moment it entered the entrance chamber until it entered one of the electric boxes.

*Selecting of subjects.* In order to eliminate family differences each litter of rats was divided equally; and one group trained with hunger and the other with electric shock.

#### PRELIMINARY EXPERIMENT

At the beginning of this experiment certain preliminary questions still remained to be answered. The most important of these were (1) The advisability of giving light-dark preference series and (2) the earliest age at which rats are sufficiently well developed to undergo periods of starvation as long as forty-eight hours without being reduced to physically unfit conditions for experimentation.

Subjects used for this series of experiments were fifty-six days old on the day the experiment began. Each rat was given one-half hour a day for five days preceding the experiment proper in the control box with doors opened, with the cover of the electric box removed and food in the receptacles. This gave the animals an acquaintance with the box and the place where food might be found in case of hunger.

*Special conditions of series I.* A series of experiments as here used includes all subjects, both hunger and electric shock, which were trained at the same time. The electric shock used for the first series was seventy-five units (6); and the length of the period of hunger was twenty-four hours. The difficultness of discrimination was the same in all experiments—being fairly easy.

TABLE 1  
Results with punishment of seventy-five units

NO. OF SERIES	MALES										
	No. 34		No. 38		No. 42		No. 44		No. 46		Av. E.
	W.	Av. T.	W.	Av. T.	W.	Av. T.	W.	Av. T.	W.	Av. T.	
		<i>seconds</i>		<i>seconds</i>		<i>seconds</i>		<i>seconds</i>		<i>seconds</i>	
1	5	17.9	7	4.7	6	1.6	4	3.4	6	3.6	5.6
2	4	11.5	6	1.5	4	2.0	3	3.1	4	2.0	4.2
3	1	3.4	4	1.6	1	1.7	3	2.0	5	2.1	2.8
4	0	6.0	0	2.1	0	1.6	2	2.0	4	1.8	1.2
5							1	2.0	1	2.0	0.4
6							1	1.6	0	2.0	0.2
7							0	3.8			0.0
	Retraining										
1	1	3.4	5	1.3	7	3.6	3	3.0	0	1.5	3.2
2	1	2.5	3	1.5	2	2.8	0	2.1			1.2
3	0	2.0	0	2.2	0	1.4					0.0
	FEMALES										
	No. 35		No. 39		No. 41		Av. E.	GEN. AV.	TOTAL AV. T.		
	W.	Av. T.	W.	Av. T.	W.	Av. T.					
		<i>seconds</i>		<i>seconds</i>		<i>seconds</i>			<i>seconds</i>		
1	6	15.0	6	4.7	5	5.2	5.6	5.62	6.9		
2	3	11.7	4	2.1	6	6.9	4.2	4.33	4.6		
3	0	6.7	5	3.3	4	4.0	3.0	3.88	3.1		
4			0	4.5	5	6.0	1.4	1.36	4.0		
5					6	2.0	2.0	1.5	3.3		
6					3	8.0	1.0	0.5	3.8		
7					4	4.2	1.33	0.5	4.7		
8					0	5.0	0.0	0.0	4.4		
	Retraining										
1	0	3.6	1	3.4	0	3.2	0.33	2.13	2.8		
2			0	4.5			0.0	0.75	2.2		
3								0.0	1.8		

TABLE 2  
Results with hunger of twenty-four hours

NO. OF SERIES	MALES										
	No. 36		No. 40		No. 48		Av. E.				
	W.	Av. T.	W.	Av. T.	W.	Av. T.					
		<i>seconds</i>		<i>seconds</i>		<i>seconds</i>					
1	6	2.7	5	3.7	6	3.0	5.66				
2	3	2.1	5	2.5	6	2.0	4.66				
3	5	1.3	2	3.0	6	1.2	4.33				
4	4	1.9	2	1.3	2	0.9	2.66				
5	2	1.6	2	1.0	1	1.1	1.66				
6	4	1.1	2	1.1	2	1.0	2.66				
7	3	1.2	1	1.2	2	1.1	2.0				
8	2	1.1	3	1.0	6	1.5	3.66				
9	3	1.2	0	1.0	2	1.1	1.66				
10	2	1.1			4	1.4	2.0				
11	2	1.0			1	1.0	1.0				
12	1	1.2			2	1.0	1.0				
13	2	1.2			2	1.0	1.33				
14	1	1.0			3	1.2	1.33				
15	0	1.0			2	1.0	0.66				
16					0	1.0	0.0				
	Retraining										
1	2	1.0	2	1.0	4	1.4	2.66				
2	1	1.1	0	1.0	1	1.2	0.66				
3	6	1.1			0	1.1	2.0				
4	4	1.0					1.66				
5	0	1.2									
	FEMALES										
	No. 37		No. 43		No. 45		No. 47		Av. E.	GEN. AV.	Av. T.
	W.	Av. T.	W.	Av. T.	W.	Av. T.	W.	Av. T.			
		<i>seconds</i>		<i>seconds</i>		<i>seconds</i>		<i>seconds</i>			<i>seconds</i>
1	4	7.0	5	1.5	5	2.4	4	1.8	4.5	5.0	3.2
2	8	2.5	3	1.6	2	1.4	2	1.2	3.75	4.14	1.8
3	5	1.3	2	3.0	6	1.2	1	1.1	4.0	4.14	1.4
4	3	2.5	4	1.7	3	1.5	2	0.8	3.0	2.88	1.5
5	5	1.7	4	1.0	6	1.0	0	1.0	3.75	2.86	1.0
6	5	2.4	4	2.0	2	1.0			2.75	2.71	1.6
7	3	2.0	3	2.0	6	1.0			3.0	2.57	1.6
8	3	2.5	5	1.5	5	1.2			2.75	3.45	1.6
9	2	1.2	6	1.0	2	1.0			2.5	2.14	1.1
10	0	1.5	4	1.0	5	1.1			2.25	2.14	1.2
11			0	1.0	1	1.0			0.25	0.57	1.0
12					2	1.1			0.5	0.71	1.1
13					2	1.0			0.5	0.86	1.0
14					1	1.1			0.25	0.71	1.1
15					1	1.1			0.25	0.43	1.0
16					2	1.0			0.5	0.28	1.1
17					0	1.0			0.0	0.0	1.0

TABLE 2—Continued

NO. OF SERIES	FEMALES								AV. E.	GEN. AV.	AV. T.
	No. 37		No. 43		No. 45		No. 47				
	W.	Av. T.	W.	Av. T.	W.	Av. T.	W.	Av. T.			
	Retraining										
		<i>seconds</i>		<i>seconds</i>		<i>seconds</i>		<i>seconds</i>			<i>seconds</i>
1	5	1.3	3	1.2	0	1.0	2	1.0	2.5	2.57	1.1
2	1	1.0	3	1.0			0	1.0	0.75	0.71	1.0
3	2	1.2	3	1.2					1.0	1.43	1.2
4	0	1.2	1	1.4					0.25	0.71	1.2
5			3	1.1					0.75	0.43	1.2
6			0	1.0					0.0	0.00	1.0

*Special conditions of series II.* The strength of the electric shock used for the second series was two hundred and fifty units; and the length of period of hunger was thirty-one hours.

*Results.* Detailed results of the above series of experiments are given in tables 1 to 4. These tables also give the results of the retraining of the same subjects after a period of twenty-one days from the day on which each animal perfected the habit. The retraining of each group of rats was done under the same conditions as the training, and the habit was considered re-established when the subject made ten successive right choices.

*Construction of tables.* At the top of each table are the numbers of the subjects (even numbers refer to males and odd to females) trained under the conditions stipulated in the heading of the table. The first vertical column gives the number of the training series; the vertical columns marked W give the number of errors made by the subjects in each training series; columns marked Av. T. give the average time for the choice of the individuals; columns marked Av. E. give the average number of errors made by males and females (according to which the column follows); the column marked Gen. Av. in each table gives the general average of both males and females; and the column marked total Av. T. gives the general average time for choice of both males and females in each table.

TABLE 3

Results with electrical shock of two hundred and fifty units

NO. OF SERIES	MALES										
	No. 60				No. 62				Av. Er.		
	W.		Av. T.		W.		Av. T.				
	<i>seconds</i>		<i>seconds</i>		<i>seconds</i>		<i>seconds</i>				
1	6		6.1		7		1.5		6.6		
2	2		1.6		2		2.1		2.0		
3	5		2.0		1		1.0		3.0		
4	3		1.6		1		2.1		2.0		
5	2		1.1		0		1.2		1.0		
6	3		1.2						1.5		
7	0		1.4						0.0		
Retraining											
1	3		1.0		0		1.0		1.5		
2	1		1.0						0.5		
3	3		1.1						1.5		
4	0		1.6						0.0		
	FEMALES										
	No. RO		No. 51		No. 53		No. 61		Av. E.	GEN. AV.	AV. T.
	W.	Av. T.	W.	Av. T.	W.	Av. T.	W.	Av. T.			
	<i>seconds</i>		<i>seconds</i>		<i>seconds</i>		<i>seconds</i>				<i>seconds</i>
1	4	3.5	5	4.0	4	6.0	5	4.0	4.5	5.16	4.2
2	4	3.2	4	3.7	2	2.8	3	1.6	3.0	2.83	2.5
3	5	2.0	1	1.0	4	3.0	2	2.4	2.75	2.83	2.6
4	3	1.6	4	1.8	1	1.3	0	1.9	2.0	2.0	2.1
5	0	3.0	3	1.5	0	1.1			1.0	0.87	1.4
6			3	1.4					0.75	1.0	1.3
7			0	2.6					0.00	0.0	2.0
Retraining											
1	4	1.0	2	1.3	5	1.0	1	1.8	3.0	2.5	1.2
2	2	1.1	1	1.3	6	1.0	2	1.3	2.75	1.0	1.1
3	0	1.1	0	1.1	0	1.2	0	1.1	0.0	0.5	1.1
4										0.0	1.6

TABLE 4  
Results with hunger of thirty-one hours

NO. OF SERIES	MALES										
	No. 64				NO. 70				Av. E.		
	W.		Av. T.		W.		Av. T.		.		
	<i>seconds</i>		<i>seconds</i>		<i>seconds</i>		<i>seconds</i>		.		
1	6		1.0		2		1.3		4.0		
2	4		0.9		1		1.3		2.5		
3	7		1.4		0		0.9		3.5		
4	3		0.8						1.5		
5	1		0.7						0.5		
6	3		0.8						1.5		
7	1		0.6						0.5		
8	0		0.7						0.0		
Retraining											
1	1		0.8		1		0.8		1.0		
2	2		1.1		0		1.0		1.0		
3	1		0.9						0.5		
4	2		0.8						1.0		
5	1		1.0						0.5		
6	0		1.0						0.0		
	FEMALES										
	No. 55		No. 57		No. 63		No. 65		Av. E.	GEN. AV.	AV. T.
	W.	Av. T.	W.	Av. T.	W.	Av. T.	W.	Av. T.			
	<i>seconds</i>		<i>seconds</i>		<i>seconds</i>		<i>seconds</i>				<i>seconds</i>
1	6	2.5	3	1.3	6	1.0	4	1.0	4.75	4.5	1.3
2	5	1.4	6	1.0	4	1.0	4	1.0	4.75	4.0	1.1
3	5	0.8	1	0.7	5	1.3	6	1.3	4.25	4.0	0.9
4	3	0.8	2	0.8	2	0.7	1	0.7	1.5	1.5	0.7
5	0	0.7	1	0.8	4	0.7	2	0.7	1.75	1.33	0.7
6			0	0.7	4	0.7	2	0.9	1.5	1.5	0.7
7					3	0.6	1	0.7	1.0	0.83	0.7
8					4	0.6	4	0.8	2.0	1.33	0.7
9					2	0.6	1	0.7	0.75	0.5	0.7
10					5	0.7	0	0.7	1.25	0.83	0.7
11					2	0.7			0.5	0.32	0.6
12					0	0.6			0.0	0.0	0.6
Retraining											
1			2	1.0	5	1.0	5	1.0	4.0	2.6	0.9
2			1	1.4	2	0.9	0	0.7	1.5	1.0	1.2
3			5	1.2	1	0.8			2.0	1.4	0.9
4			4	1.0	0	0.8			1.66	1.2	0.8
5			0	0.9					0.0	0.2	0.9
6									0.0	0.0	1.0



## CONCLUSIONS

1. On the whole subjects showed no marked preference between the light and the dark box but the experimenter found four rats, all belonging to the same litter, which were decidedly positive phototropic. Two of these animals always chose the light box and the other two took the light box eight out of ten trials. But this must not be taken to have any bearing on the question of light or dark preference in rats under ordinary light conditions, for the light used in this experiment was not only very weak, being 0.61 candle power, but was softened by the ground glass bulb.

2. When the experimenter attempted to use a period of hunger of forty-eight hours he found that rats fifty-six days old could not undergo so long a period of starvation but were by the third or fourth series physically unfit for use.

3. The above facts led us to establish two preference series of ten trials each and to use subjects older than fifty-six days.

## EXPERIMENT PROPER

Subjects used in the experiment proper were seventy-eight days old on the day that the training series began. Each animal was given one-half hour daily in the control box for five days preceding the training series in order that the subject might become familiar with the box and the place where food might be found. In addition to this each subject was given two preference series of ten trials each on the two days preceding the training series.

*Special conditions of the experiments.* The experiments were done in four sets, each set consisting of a group of animals trained with electric shock and a group trained with hunger. For the first set the strength of electric shock was one hundred and fifty units and the length of the period of hunger was forty-eight hours. For the second set the strength of electric shock was one hundred and fifteen units and the period of hunger was thirty-one hours. For the third set the strength of electric shock was seventy-five units and period of hunger twenty-four hours. For the fourth set the strength of electric shock was sixty units and the period of

TABLE 5  
Results with electric shock of one hundred and fifty units

NO. OF SERIES	MALES										Av. E.
	No. 74		No. 76		No. 82		No. 84		No. 86		
	W.	Av. T.	W.	Av. T.	W.	Av. T.	W.	Av. T.	W.	Av. T.	
A	5		4		4		8		6		5.4
B	7		6		5		6		5		5.6
Q	6	3.0	5	4.0	5	1.8	5	3.0	4	2.0	5.0
2	4	3.6	4	6.0	3	1.9	4	2.4	4	4.5	4.2
3	4	2.1	1	4.5	5	1.2	5	2.2	6	1.9	4.2
4	4	1.6	1	4.0	2	1.3	5	1.9	2	1.6	2.8
5	2	1.0	3	3.8	0	1.1	5	6.8	3	2.2	2.6
6	2	1.0	0	5.5			2	9.0	0	3.0	0.8
7	2	2.5					3	5.0			1.0
8	3	3.7					2	5.0			1.0
9	3	4.5					2	5.8			1.0
10	0	3.0					0	13.7			0.0
Retention											
1	4	3.0	0	4.6	6	2.4	1	9.0	1	3.5	3.4
Retraining											
1	3	2.6			4	1.9	2	4.4	1	4.5	2.0
2	4	3.1			1	1.1	0	4.8	2	3.6	1.4
3	2	2.8			1	1.6			0	3.0	0.6
4	0	4.6			0	1.6					
FEMALES											
	No. 71		No. 73		No. 81		No. 85		Av. E.	GEN. AV.	Av. T.
	W.	Av. T.	W.	Av. T.	W.	Av. T.	W.	Av. T.			
		seconds		seconds		seconds		seconds			
A	7		6		3		6		5.5	5.44	
B	7		4		6		6		5.75	5.77	
1	5	5.0	7	1.8	4	2.0	7	3.0	5.75	5.33	2.8
2	4	2.0	2	2.0	3	1.5	3	3.1	3.0	3.33	3.8
3	2	6.5	2	2.0	3	1.2	4	1.2	2.75	3.58	2.2
4	3	1.7	1	1.4	1	1.3	1	1.6	1.5	2.11	2.3
5	1	1.4	2	3.0	2	1.1	0	2.2	1.25	2.0	2.2
6	0	4.0	2	6.0	0	1.0			0.5	0.66	2.2
7			0	4.2					0.0	0.56	2.6
8										0.56	1.0
9										0.56	8.3
10										0.0	5.0
P. E. 3.9											

TABLE 5—Continued

NO. OF SERIES	FEMALES									GEN. AV.	AV. T. <i>seconds</i>
	No. 71		No. 73		No. 81		No. 85		Av. E.		
	W.	Av. T.	W.	Av. T.	W.	Av. T.	W.	Av. T.			
	<i>seconds</i>		<i>seconds</i>		<i>seconds</i>		<i>seconds</i>				
	Retention										
1	0	1.2	1	4.5	2	1.2	2	1.2	1.25	1.88	2.5
	Retraining										
1			1	4.5	0	2.1	0	3.9	0.25	1.22	3.4
2			0	3.1						0.77	2.2
3										0.33	3.1
4										0.0	3.1

hunger forty-one hours. Detailed results are given in tables 5 to 12 inclusive. These tables are constructed on the same plan as tables in the preliminary experiments.

*Retention.* On the twenty-first day after the subject had perfected the habit a retention series of ten trials was given. This series was given under the same conditions and in the same manner as the training series except that the subject was neither given food for right choice nor electric shock for wrong choice.

*Retraining.* Three days after the retention test retraining was begun and each individual was retrained in the same way that it had been trained. The habit was considered perfected, as it was in the training series, when the rat made a perfect series of ten successive trials.

CURVES OF LEARNING

Figures 2 and 3 show the characteristic differences in the curves of learning and curves of re-learning with electric shock and hunger. These curves represent the average number of errors made in each training series as given in next to the last column of tables 5 to 12 inclusive. The curve marked one hundred and fifty units is based on the average number of errors for the sub-

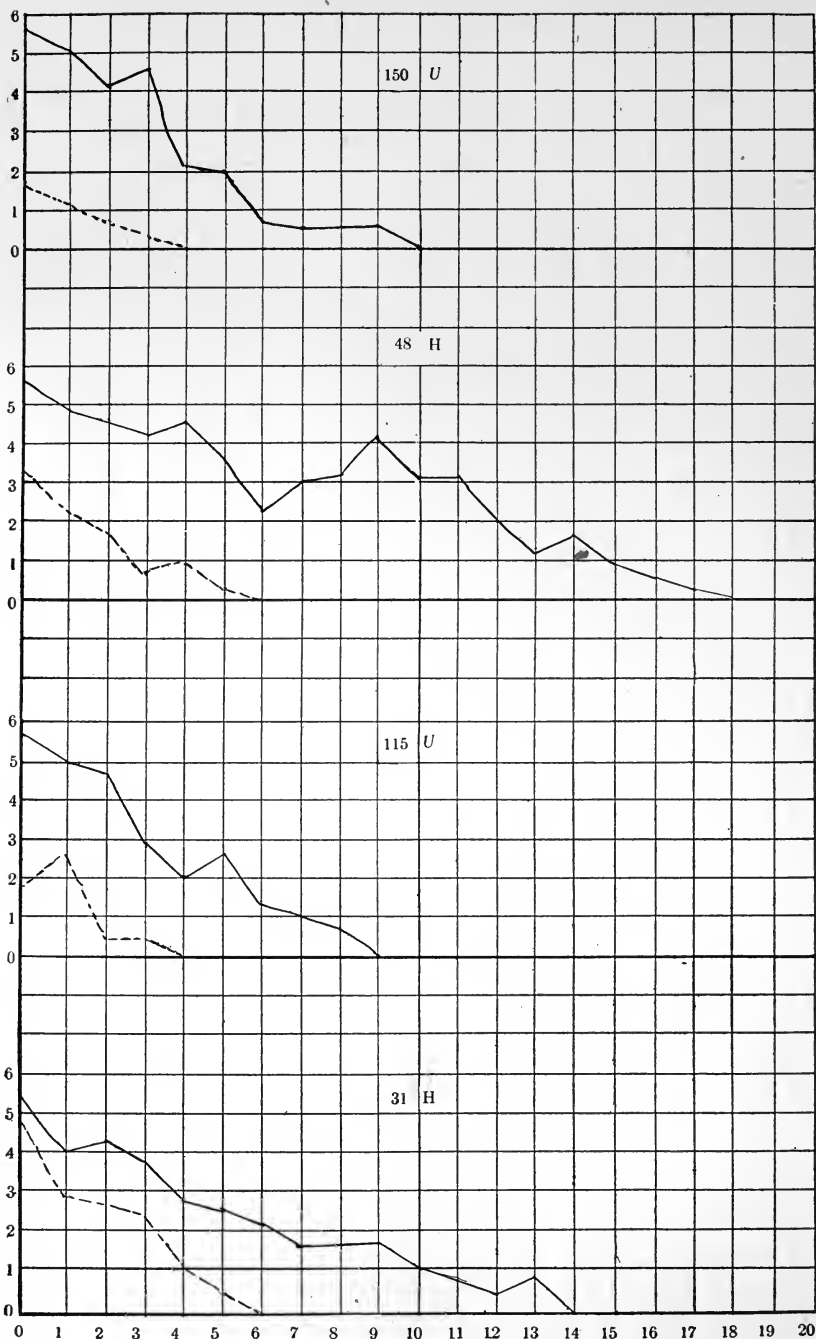

FIG. 2. CURVES OF LEARNING AND RELEARNING

Abscissae represent series of ten tests given every third day; ordinates the average number of errors. Solid line in each case is the learning and the broken line the relearning curve. The first point on ordinates is an average of the preference tests in case of learning curve and of the retention test in case of the relearning curve.

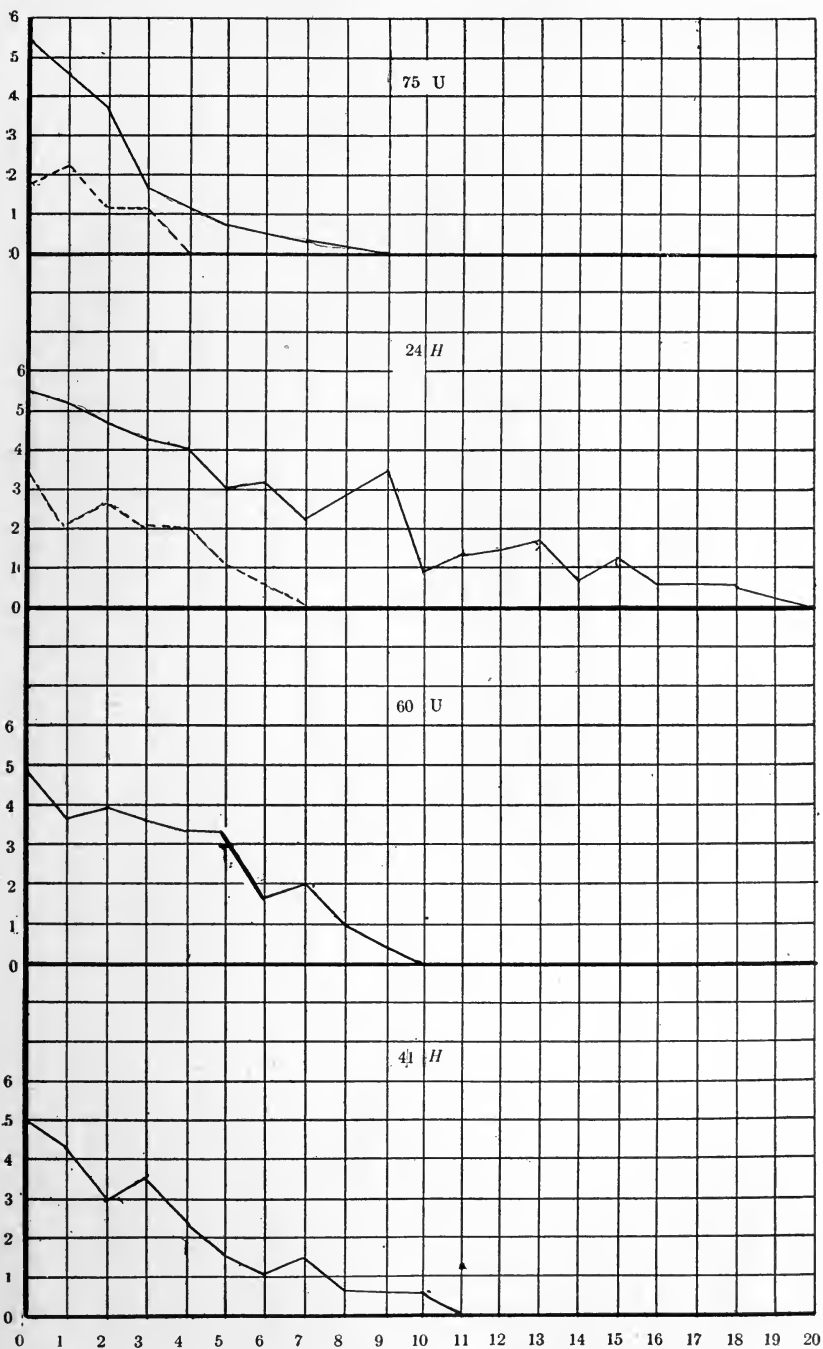

FIG. 3. CURVES OF LEARNING AND RELEARNING

Abscissae represent series of ten tests given every third day; ordinates the average number of errors. Solid line in each case is the learning and the broken line the relearning curve. The first point on ordinates is an average of the preference tests in case of learning curve and of the retention test in case of the relearning curve.

TABLE 6  
*Results with hunger of forty-eight hours*

NO. OF SERIES	MALES										Av. Er.
	No. 72		No. 78		No. 80		No. 88		No. 90		
	W.	Av. T.	W.	Av. T.	W.	Av. T.	W.	Av. T.	W.	Av. T.	
		<i>seconds</i>		<i>seconds</i>		<i>seconds</i>		<i>seconds</i>		<i>seconds</i>	
A	6		4		6		8		6		6.0
B	4		4		5		5		5		4.6
1	3	1.4	6	5.0	9	4.0	5	1.0	5	1.0	5.6
2	7	1.0	7	1.4	3	1.2	3	0.7	7	1.0	5.4
3	5	1.4	4	1.1	3	1.0	5	1.0	2	1.0	3.8
4	5	1.0	3	1.4	5	1.0	4	1.0	6	1.0	4.6
5	5	1.4	3	1.5	5	0.8	3	0.8	4	1.6	4.0
6	2	0.8	2	1.1	4	1.0	2	1.1	3	1.1	2.6
7	3	2.0	5	1.6	4	1.0	2	0.8	6	1.0	4.0
8	3	1.3	2	2.3	5	1.0	2	0.9	3	1.0	3.0
9	6	1.3	2	2.0	4	0.9	5	1.0	6	1.2	4.6
10	5	1.2	9	1.5	3	0.7	2	0.9	4	1.8	4.6
11	4	1.3	4	1.6	3	0.8	2	0.7	4	1.4	3.4
12	6	2.5	2	6.2	0	1.5	3	0.8	3	1.8	2.8
13	2	1.2	2	1.4			1	0.9	4	1.3	1.8
14	1	1.3	3	1.2			4	0.7	4	1.1	2.4
15	0	1.0	2	1.0			4	0.7	4	1.0	2.0
16			0	1.0			1	0.8	4	1.4	1.0
17							1	1.0	0	1.0	0.2
18							0	0.6			0.0
Retention											
	1	1.3	4	1.1	5	1.1	0	0.5	6	0.9	3.2
Retraining											
1	0	0.5	2	0.6	3	0.3			3	0.7	1.6
2			3	0.7	4	0.7			2	0.7	1.8
3			1	0.6	0	0.6			2	0.5	0.6
4			3	0.7					1	0.6	0.8
5			0	0.7					0	0.5	0.0
P. E. 5.9											

TABLE 6—Continued

NO. OF SERIES	FEMALES									GEN. AV.	AV. T
	No. 75		No. 77		No. 87		No. 89		Av. E.		
	W.	Av. T.	W.	Av. T.	W.	Av. T.	W.	Av. T.			
		<i>seconds</i>		<i>seconds</i>		<i>seconds</i>		<i>seconds</i>			
A	4		5		7		5		5.25	5.66	
B	6		7		6		7		6.5	5.44	
1	3	1.5	5	1.4	4	1.0	2	3.0	3.5	4.99	2.1
2	5	1.1	5	1.2	5	1.3	2	1.2	4.25	4.79	1.2
3	1	1.2	6	1.1	6	1.1	5	1.3	4.5	4.11	1.1
4	3	1.8	4	1.1	6	1.0	6	1.0	4.75	4.66	1.2
5	3	1.7	3	2.1	3	1.1	4	0.7	3.25	3.66	1.3
6	1	2.5	2	1.2	3	1.3	1	0.8	1.75	2.22	1.2
7	3	1.2	4	1.2	2	0.9	1	0.8	1.75	3.0	1.1
8	5	1.7	4	1.6	2	1.1	2	0.7	3.25	3.11	1.2
9	4	1.1	4	1.0	3	1.0	5	1.0	4.0	4.33	1.2
10	4	2.0	6	1.1	2	1.1	2	0.8	3.75	3.11	1.2
11	4	1.2	3	1.5	4	1.0	0	0.8	2.75	3.11	1.2
12	0	1.0	2	1.0	2	1.6			1.0	2.0	2.0
13			0	0.8	3	1.7			0.75	1.33	1.7
14					3	0.7			0.75	1.66	1.0
15					4	1.1			1.00	0.88	1.0
16					1	1.1			0.25	0.66	1.0
17					1	0.8			0.25	0.22	1.0
18					0	0.6			0.0	0.0	0.6
Retention											
1	2	1.0	5	1.2	1	0.6	7	1.0	3.75	3.44	0.9
Retraining											
1	3	1.1	5	0.6	3	0.6	2	0.6	3.25	2.33	0.7
2	1	0.9	0	0.7	2	0.5	4	0.6	1.75	1.77	0.6
3	0	0.6			0	0.5	3	0.7	0.75	0.66	0.6
4							4	0.6	1.0	0.88	0.6
5							3	0.7	0.75	0.33	0.7
6							0	0.7	0.00	0.00	0.7

TABLE 7

Results with electric shock of one hundred and fifteen units

NO. OF SERIES	MALES								Av. E.
	No. 92				No. 98				
	W.	Av. T.	W.	Av. T.	W.	Av. T.	W.	Av. T.	
		<i>seconds</i>		<i>seconds</i>		<i>seconds</i>		<i>seconds</i>	
A	5		4						4.5
B	8		5						6.5
1	5	1.5	5	1.5					5.0
2	4	3.0	5	2.3					4.5
3	2	5.5	1	3.5					1.5
4	3	4.5	0	3.6					1.5
5	3	3.3							1.5
6	0	4.8							0.0
Retention									
	2	2.4	0	4.0					1.0
Retraining									
1	3	3.5							1.5
2	2	1.9							1.0
3	2	2.4							1.0
4	0	4.0							0
	FEMALES								Av. T.
	No. 91		No. 95		No. 99		Av. E.	GEN. AV.	
	W.	Av. T.	W.	Av. T.	W.	Av. T.			
		<i>seconds</i>		<i>seconds</i>		<i>seconds</i>		<i>seconds</i>	
A	3		7		6		5.3	5.0	
B	7		5		7		6.3	6.2	
1	5	3.5	5	1.1	5	2.3	5.0	5.0	2.3
2	5	4.2	5	3.4	4	1.8	4.6	4.6	3.1
3	3	2.9	4	3.2	4	1.5	3.66	2.8	2.1
4	0	2.6	3	2.0	4	1.1	2.33	2.0	1.9
5			7	2.0	3	1.9	3.33	2.6	1.9
6			3	6.3	4	2.9	2.33	1.4	4.2
7			2	2.0	3	1.8	1.66	1.0	1.9
8			2	3.2	2	1.7	1.33	0.8	2.4
9			0	2.1	0	1.8	0.0	0.0	1.9
Retention									
1	3	2.0	2	2.8	2	2.3	2.33	1.8	2.5
Retraining									
1	4	2.4	3	3.6	3	2.0	3.0	2.6	2.4
2	1	2.0	0	1.6	0	1.9	0.33	0.4	1.9
3	0	2.0					0.0	0.4	2.0
4								0.0	4.0
P. E. 6.8									



jects trained with an electric shock of one hundred and fifty units and the curve marked forty-eight hours is based on the average number of errors for subjects trained with hunger of forty-eight hours, and-so-on for the other curves. Figure 4 shows the relative values of different strengths of electric shock, the relative values of different degrees of hunger and the relative values of both electric shock and hunger in the learning process.

TABLE 8  
*Results with hunger of thirty-one hours*

NO. OF SERIES	MALES						Av. E.
	No. 94		No. 96		No. 100		
	W.	Av. T. <i>seconds</i>	W.	Av. T. <i>seconds</i>	W.	Av. T. <i>seconds</i>	
A	6		5		5		5.3
B	4		7		7		6.0
1	5	1.0	4	1.0	5	1.8	4.66
2	4	0.6	5	0.6	4	1.1	4.33
3	6	0.7	5	0.8	3	1.0	4.66
4	2	0.8	1	0.8	3	0.9	2.0
5	3	0.6	0	1.0	4	0.9	2.3
6	3	0.7			4	0.8	2.3
7	2	0.9			4	1.0	2.0
8	4	0.6			2	1.2	2.0
9	4	1.1			2	1.0	2.0
10	4	0.9			0	1.0	1.3
11	4	1.0					1.3
12	2	0.8					0.66
13	3	1.0					1.0
14	0	0.8					
Retention							
1	3	0.5	7	1.4	4	0.9	4.6
Retraining							
1	3	0.7	2	0.8	3	0.8	2.6
2	3	0.6	3	0.8	1	0.7	2.3
3	3	0.5	4	0.9	0	0.7	2.3
4	0	0.6	2	0.8			0.6
5			0	0.9			0.0

TABLE 8—Continued

NO. OF SERIES	FEMALES					GEN. AV.	AV. T.
	No. 93		No. 97		Av. E.		
	W.	Av. T.	W.	Av. T.			
A	5	<i>seconds</i>	5	<i>seconds</i>	5.0	5.2	
B	3		6		4.5	5.4	
1	3	1.0	3	1.0	3.0	4.0	1.1
2	4	0.5	4	0.6	4.0	4.2	0.7
3	1	0.7	4	0.5	2.5	3.8	0.7
4	3	0.7	5	0.6	4.0	2.8	0.8
5	2	0.7	2	0.6	3.0	2.6	0.7
6	2	0.7	2	0.6	2.0	2.2	0.7
7	1	0.6	1	1.2	1.0	1.6	0.9
8	2	0.7	0	0.6	1.0	1.6	0.7
9	2	0.6			1.0	1.6	0.9
10	1	0.7			0.5	1.0	0.9
11	0	0.7			0.0	0.8	0.8
12						0.4	0.8
13						0.6	1.0
14						0.0	0.8
Retention							
1	5	0.8	5	0.8	5.0	4.8	0.8
Retraining							
1	0	0.7	6	0.7	3.0	2.8	0.7
2			6	0.6	3.0	2.6	0.6
3			5	1.1	2.5	2.4	0.8
4			3	1.0	1.5	1.0	0.8
5			2	0.7	1.0	0.4	0.8
6			0	1.0	0.0	0.0	1.0
P. E. 6.							

## SUMMARY OF TABLES

Table 13 contains the summary results of the experiment proper. It gives (1) the average number of trials and the probable error made by males, by females and the general average and probable error for both males and females in the formation of a perfect habit in case of four strengths of electric shock and four degrees of hunger, and the average time for choice in each

TABLE 9  
Results with electric shock of seventy-five units

NO. OF SERIES	MALES								AV. E.				
	No. 102		No. 106		No. 108		No. 110						
	W.	Av. T.	W.	Av. T.	W.	Av. T.	W.	Av. T.					
	<i>seconds</i>		<i>seconds</i>		<i>seconds</i>		<i>seconds</i>						
A	5		7		6		5		5.75				
B	5		5		6		6		5.5				
1	4	3.2	5	1.8	4	4.7	4	4.2	4.25				
2	4	2.1	3	2.2	2	4.2	5	2.7	3.5				
3	1	3.0	1	5.2	1	2.7	0	2.0	0.75				
4	3	5.5	0	3.5	0	1.9			0.75				
5	0	4.0							0.0				
Retention													
1	5	2.7	0	8.0	0	1.1	2	3.9	1.75				
Retraining													
1	4	3.0					0	2.3	1.0				
2	0	4.0							0.0				
	FEMALES										GEN. AV.	AV. T.	
	No. 101		No. 103		No. 105		No. 107		No. 115				Av. E.
	W.	Av. T.	W.	Av. T.	W.	Av. T.	W.	Av. T.	W.	Av. T.			
	<i>seconds</i>		<i>seconds</i>		<i>seconds</i>		<i>seconds</i>		<i>seconds</i>		<i>seconds</i>		
A	5		6		6		4		6		5.4	5.55	
B	6		5		7		8		4		6.0	5.33	
1	7	2.6	5	2.5	5	2.6	6	2.3	4	3.3	5.4	4.88	2.82
2	4	5.0	4	3.0	5	2.5	6	2.0	1	2.4	4.0	3.77	1.1
3	2	6.5	1	2.4	5	1.9	3	3.5	1	3.3	2.4	1.66	1.2
4	0	1.3	0	5.4	4	5.6	5	2.3	0	1.4	1.8	1.33	1.7
5					3	1.6	5	4.0			1.6	0.88	4.0
6					3	1.9	4	3.7			1.4	0.77	1.1
7					0	2.2	5	3.2			1.0	0.55	2.7
8							2	3.9			0.4	0.22	3.9
9							0	2.8			0.0	0.00	2.8
Retention													
1	2	5.4	3	4.5	2	1.7	4	2.5	2	3.0	2.6	1.88	3.6
Retraining													
1	6	2.0	6	2.1	1	1.6	3	2.7	1	2.6	4.4	2.4	2.8
2	2	2.6	2	1.8	4	1.5	2	1.4	0	1.9	2.2	1.1	2.2
3	1	4.3	0	2.1	0	1.3	0	1.8			0.2	1.1	2.4
4	0	4.8									0.0	0.0	2.8
P. E. 2.9													

TABLE 10  
*Results with hunger of twenty-four hours*

NO. OF SERIES	MALES								AV. E.
	No. 104		No. 112		No. 114		No. 116		
	W.	Av. T. <i>seconds</i>	W.	Av. T. <i>seconds</i>	W.	Av. T. <i>seconds</i>	W.	Av. T. <i>seconds</i>	
A	6		5		7		5		5.75
B	5		4		5		5		4.75
1	5	3.3	4	1.5	7	1.7	4	4.2	5.0
2	5	2.7	4	3.2	5	1.7	4	3.2	4.5
3	6	2.7	4	1.4	4	1.4	6	2.4	5.0
4	6	3.1	6	1.9	1	1.4	5	2.0	4.5
5	4	1.1	5	1.4	3	1.3	3	1.6	3.25
6	4	1.2	4	1.1	4	1.2	3	1.8	3.25
7	4	0.8	2	1.1	3	1.2	4	1.9	2.5
8	4	1.6	2	1.2	3	1.3	2	1.4	2.75
9	2	1.6	5	1.7	6	1.6	5	1.6	4.5
10	1	0.9	1	1.1	1	1.4	1	1.1	1.0
11	1	0.8	1	1.2	0	1.1	5	2.0	1.75
12	0	0.9	3	1.1			3	1.5	1.5
13			4	1.0			3	1.8	1.75
14			3	1.0			4	1.2	1.75
15			5	1.8			4	2.2	2.25
16			1	1.3			2	1.3	0.75
17			0	1.0			2	1.1	0.5
18							2	1.0	0.5
19							0	1.0	0.0
Retention									
1	3	1.1	4	1.5	2	1.6	6	1.1	3.75
Retraining									
1	1	1.2	2	1.5	4	1.2	1	0.9	2.0
2	3	1.2	3	1.0	4	1.2	3	0.9	3.25
3	2	1.2	1	0.9	4	1.2	2	0.8	2.25
4	1	1.3	1	1.1	2	1.1	3	1.0	1.75
5	0	1.0	2	1.2	2	1.0	2	1.0	1.5
6			0	1.0	1	0.8	0	1.0	0.25
7					0	0.8			0.0

TABLE 10—Continued

NO. OF SERIES	FEMALES											GEN. AV.	AV. T. sec- onds
	No. 109		No. 111		No. 113		No. 117		No. 119		Av. E.		
	W.	Av. T.	W.	Av. T.	W.	Av. T.	W.	Av. T.	W.	Av. T.			
		sec- onds		sec- onds		sec- onds		sec- onds		sec- onds			
A	5		4		5		5		4		4.6	5.11	
B	6		5		5		6		6		5.6	5.77	
1	6	4.0	6	2.2	6	5.5	4	4.3	6	3.4	5.6	5.33	3.3
2	4	2.0	7	2.1	3	0.7	5	1.9	6	1.3	5.0	4.77	2.1
3	3	3.5	4	1.7	1	1.2	3	2.3	3	4.0	2.8	4.33	2.2
4	2	6.0	5	3.0	4	1.5	2	2.2	5	1.8	3.6	4.0	2.5
5	5	1.6	4	2.5	1	0.9	1	2.1	3	1.5	2.8	3.0	1.4
6	3	1.6	2	2.9	3	0.8	2	3.0	5	1.4	3.0	3.11	1.7
7	2	1.1	2	1.9	2	1.0	1	1.9	3	1.1	2.0	2.22	1.3
8	2	1.9	6	1.7	1	1.1	3	1.5	4	1.4	3.2	3.0	1.4
9	1	1.2	4	1.7	1	0.7	4	2.0	3	2.0	2.4	3.33	1.4
10	1	1.2	1	0.6	0	0.6	1	0.8	1	1.0	0.8	0.88	1.0
11	0	0.7	2	0.9			0	0.6	3	1.2	1.0	1.33	1.0
12			3	1.3					4	3.0	1.4	1.44	1.5
13			4	1.1					2	1.2	1.2	1.55	1.2
14			1	1.9					0	0.9	0.2	0.88	1.2
15			3	1.7							0.6	1.33	1.9
16			4	1.9							0.8	0.77	1.5
17			2	1.4							0.4	0.66	1.2
18			4	1.1							0.8	0.66	1.2
19			1	1.2							0.2	0.11	1.1
20			0	1.0							0.0	0.0	1.0
Retention													
1	0	1.0	3	1.2	5	1.0	2	1.4	6	1.0	3.2	3.44	1.2
Retraining													
1			4	1.5	1	0.8	4	2.0	3	1.0	2.4	2.22	1.2
2			5	2.0	1	0.7	5	1.8	3	1.0	2.8	2.77	1.2
3			5	1.8	0	0.7	5	1.8	2	0.9	2.4	2.22	1.3
4			4	1.2			3	1.4	4	0.7	2.2	2.0	1.0
5			3	1.1			3	1.7	2	1.2	1.6	1.44	1.0
6			2	1.0			2	1.1	1	1.0	1.0	0.66	1.3
7			0	0.8			0	1.0	0	1.0	0.0	0.00	0.9
P. E. 7.6													

TABLE 11  
Results with electric shock of sixty units

NO. OF SERIES	MALE		FEMALES				Av. E.	GEN. AV.	AV. T.
	No. 118		No. 121		No. 123				
	W.	Av. T.	W.	Av. T.	W.	Av. T.			
		<i>seconds</i>		<i>seconds</i>		<i>seconds</i>			
A	5		3		3		3.0	3.66	
B	4		8		6		7.0	6.00	
1	4	1.2	4	1.5	3	1.3	3.5	3.6	1.5
2	6	1.1	2	2.7	4	1.6	3.0	4.0	1.8
3	5	1.7	1	3.1	4	1.3	2.5	3.6	1.3
4	4	1.7	1	2.8	5	1.5	3.0	3.3	2.0
5	4	3.0	2	4.5	4	1.6	3.0	3.33	3.0
6	2	4.5	0	3.6	3	1.9	1.5	1.66	3.3
7	2	2.3			4	2.1	2.0	2.0	2.2
8	1	4.3			2	1.9	1.0	1.0	3.1
9	0	3.6			1	2.0	0.5	0.33	2.8
10					0	1.8	0.0	0.0	1.8
P. E. 5.7									

TABLE 12  
Results with hunger of forty-one hours

NO. OF SERIES	MALES				FEMALES				GEN. AV.	AV. T.		
	No. 124		No. 126		Av. E.	No. 125		No. 127				
	W.	Av. T.	W.	Av. T.		W.	Av. T.	W.			Av. T.	
		<i>seconds</i>		<i>seconds</i>		<i>seconds</i>		<i>seconds</i>				
A	7		2		4.5	6		3		4.5	4.5	
B	5		5		5.0	6		5		5.5	5.25	
1	5	1.1	4	1.1	4.5	3	1.0	6	1.2	4.5	4.5	1.1
2	5	0.7	5	0.7	5.0	2	0.8	4	0.8	3.0	4.0	0.7
3	4	0.5	5	0.6	4.5	5	0.5	2	0.6	3.5	4.0	0.6
4	4	0.6	3	0.5	3.5	4	0.6	1	0.6	2.5	3.0	0.6
5	2	0.5	6	0.5	4.0	2	0.5	1	0.5	1.5	2.75	0.5
6	2	0.5	3	0.5	2.5	2	0.5	0	0.5	1.0	1.75	0.5
7	4	0.5	2	0.5	3.0	3	0.6			1.5	1.75	0.5
8	0	0.5	1	0.6	0.5	1	0.8			0.5	0.5	0.7
9			1	0.6	0.5	1	0.8			0.5	0.5	0.7
10			0	0.7	0.0	0	0.7			0.0	0.0	0.7
P. E. 5.6												

TABLE 13  
*Summary of results of experiments*  
 Original training

	AVERAGE NUMBER OF TRIALS				GEN. AV.	P. E.	TOTAL AV. T.
	Males	P. E.	Females	P. E.			
Reward hours							<i>seconds</i>
24	137.5	11.6	122.0	11.6	128.89	7.6	1.5
31	86.6	13.6	85.0	7.1	86.0	6.0	0.8
41	80.0	4.8	70.0	9.7	75.0	5.6	0.66
48	146.7	7.0	125.0	9.2	136.67	5.9	1.2
Punishment in units							
60	80.0	9.0	70.0	8.8	73.33	5.7	2.3
75	30.0	2.3	46.0	4.9	38.88	2.9	2.4
115	40.0	4.8	63.33	9.7	54.00	6.8	2.6
150	64.0	6.3	50.0	2.3	57.77	3.9	3.6

Retention tests

	NUMBER OF INDIVIDUALS MAKING PERFECT RECORD			AV. ER.		GEN. AV. ER.	TOTAL AV. T.
	Males	Females	Total	Males	Females		
Reward							<i>seconds</i>
24	0	1	1	3.75	3.2	3.44	1.2
31	0	0	0	4.6	5.0	4.8	0.8
48	1	0	1	3.2	3.7	3.44	0.9
Punishment							
75	2	0	2	1.75	2.6	1.88	3.6
115	1	0	1	1.0	2.33	1.8	2.5
150	1	1	2	2.4	1.25	1.88	2.5

Retraining

	AVERAGE NUMBER OF TRIALS		GEN. AV.	TOTAL AV. T.
	Males	Females		
Reward				<i>seconds</i>
24	50.0	40.0	44.4	1.1
31	30.0	26.0	28.0	0.9
48	20.0	25.0	22.2	0.6
Punishment				
75	2.5	20.0	12.2	2.5
115	15.0	13.3	14.0	2.6
150	20.0	2.5	12.2	2.9

case; (2) it gives the number of males and the number of females and the total number of subjects which made a perfect retention test after twenty-one days, the average number of errors made by males and the average made by females and the general average for both males and females in the retention test, and the average time for choice; (3) it gives the average number of trials required by males, the average number of trials by females and the general average for both males and females for the relearning of the habit, and the average number of choices in the relearning process.

#### DIFFERENCES IN LEARNING IN MALES AND FEMALES

As may be seen in table 13 there is a difference in the rate of learning with males and females but this difference is neither consistent nor conclusive. In all cases with hunger the average number of trials required for perfecting the habit is less for females than for males but with electric shock the average with seventy-five units and one hundred and fifteen units was less for males. The retention tests show no difference in retention of males and females when trained with different degrees of hunger but a difference in favor of the males four to one when trained with electric shock. The retraining results are even less consistent than in case of training. But having observed rather closely the behavior of all subjects the experimenter would hesitate to say that there is no sex difference. This difference, however, is not necessarily a difference in the capacity of the two sexes to profit by experience but probably a difference in physiological make-up which causes the most favorable condition of learning to vary in a characteristic manner for the two sexes. Females on the whole seemed more anxious for food than the males in all four sets of experiments. This may account for the difference for the rate of learning with hunger.

#### INTERPRETATION OF CURVES OF RELATIVE VALUES OF HUNGER

If the reader will examine the curve of learning (fig. 4) for different degrees of hunger he will find that there is a constant increase in the rate of habit formation up to forty-one hours of



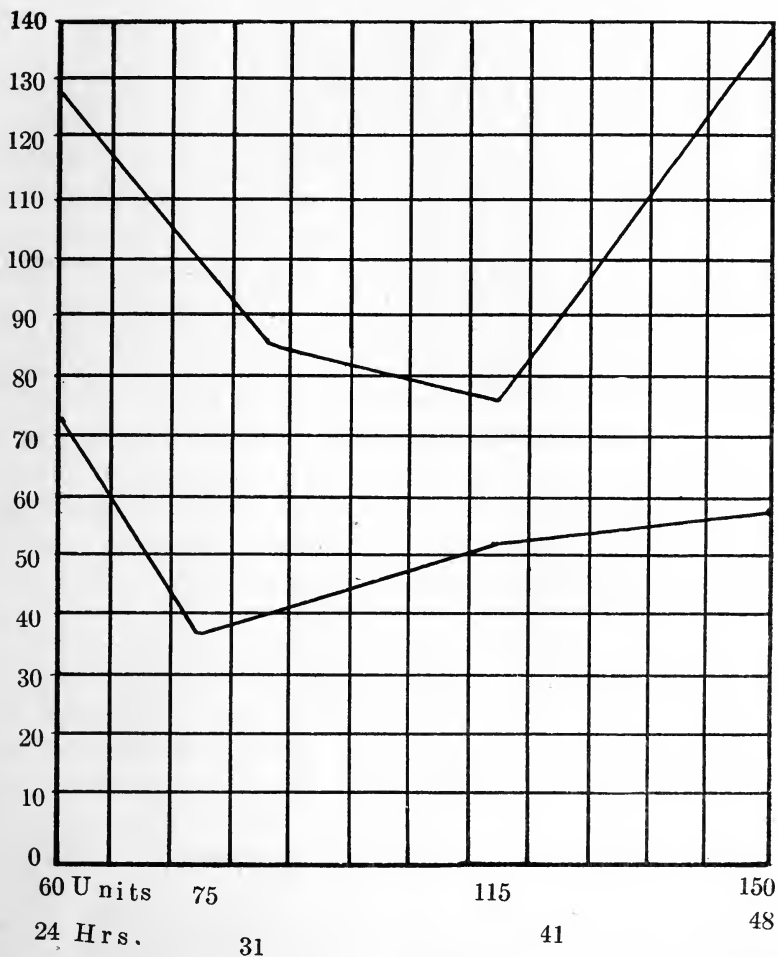

FIG. 4. CURVE OF RELATIVE VALUES OF HUNGER AND ELECTRIC SHOCK

Abscissa represents the strength of stimuli and the degrees of hunger; ordinate represents the average total number of trials required for the perfecting of the habit. The upper curve represents the relative values of the four different degrees of hunger and the lower the relative values of the four strengths of electric shock.

hunger but a sudden decrease from forty-one to forty-eight hours of hunger. The first part of the curve needs no explanation, for the difference in the rate of habit formation when a subject is putting its whole energy in the accomplishment of the act and when it is more or less indifferent towards the performance is fairly well established. Rats which pass from the door between the entrance chamber and nest box in sixty-six hundredths of a second were making about the greatest speed possible for such animals. The scratching reflex or any other distracting influence seldom interfered with their choosing. But the rats which took one and five-tenths seconds had time to scratch occasionally or explore the entrance chamber. But the cause of the rapid decrease in the rate of learning for animals of forty-eight hours of hunger is not so apparent. Nor can this decrease be accounted for in terms of poor physical condition of the subjects. At the end of the series of experiments all these animals were in good physical condition though they had somewhat less flesh than their mates which had been trained with electric shock.

Had one who did not know their physical condition been observing the manner of choice of this group of rats he would have immediately come to the conclusion that they were not hungry. They neither rushed to get food nor ate eagerly when they had reached it. Their behavior was very much the same as that of subjects which had gone for only twenty-four hours without food. It is true that the carriage of the rat was somewhat different. Dr. J. A. Carlson's careful experiments on hunger in man and dogs account for the behavior of this group of animals in a most satisfactory manner (1). Dr. Carlson has demonstrated rather conclusively that the sense of hunger is due to "certain types of contractions in the empty or nearly empty stomach. That these contractions stimulate nerves in the sub-mucosa or muscularis." He demonstrated experimentally that these contractions persist almost constantly after the first day of hunger in man: and in young dogs until a short time before death from starvation. In describing his own experience for a period of five days of hunger he says,

The sensation of hunger was almost constant after the first day of starvation—somewhat more severe during the first two or three days. The most severe sensations were at periods of gastric contractions. Appetite ran practically parallel with sensation of hunger. It increased during the first two or three days and diminished on the fourth and fifth days. Instead of an eagerness for food there was an almost indifference to food despite the persistent hunger call of the empty stomach.

The writer could not give a more exact description of the behavior of these rats after forty-eight hours of hunger than the above. As the average time of choosing indicates, this group of subjects was slightly more active than the group which was trained with twenty-four hours of hunger but they were not eager for food. Still their behavior was indicative of some disturbing factor: they assumed the hump of a starving animal. They largely abandoned it immediately after eating but assumed it again as the hunger period advanced. This disturbing element was due, no doubt, to the continued contractions of the empty stomach. It seems probable from Dr. Carlson's description of his sensations during a starving period, that these rats had sensations of hunger but were not eager for food. As may be seen from next to the last column, table 7, and from the curve of learning representing this column, this disturbing factor was so great that it seemed most probable even as late as the hundredth trial that these animals would never finish the learning process. But from the hundredth trial on the animals were more eager for food. There are two possible explanations for this change: (1) As the subjects grew older they were better able to stand long periods of starvation; (2) the organism doubtless tended to adapt itself to its conditions.

Dr. Carlson says, "That the young and growing individual experiences greater hunger than the adult or aged individual is common knowledge." This being the case it is most likely that the period of eagerness for food ends earlier in the young than in the adult individual. When one examines the retraining of the group of animals trained with forty-eight hours of hunger he finds this most interesting fact, that this group retrained more rapidly than the other groups. That it made better average time

in choosing than any other group used throughout the experiments is, also, to be noticed. During the retraining these subjects showed great eagerness for food. These facts go to substantiate the indications in the latter part of the training series: viz., That rats as they grow older are better able to undergo long starving periods and that the period of eagerness for food is extended; and that the organism may tend to adapt itself to its conditions. While the first of these is sufficient to account for the facts it is very probable that the second entered into the situation.

#### VALUES OF DIFFERENT STRENGTHS OF ELECTRICAL STIMULI

The experimenter determined roughly the minimum stimulus to which the white rat would respond with the control box used in this experiment. Six males and six females of the same age as the subjects for the experiment were used for this purpose. With eighteen units these rats gave no observable signs of response but with twenty-five units all animals tested gave slight movements indicative of feeling the shock. Thus it is fairly certain that with well developed rats the threshold of sensation for subjects of seventy-eight days of age is between eighteen and twenty-five units with the apparatus used in this experiment. This is from ten to fifteen units below the threshold for the experimenter.

As may be seen from table 13, subjects trained with an electric shock of sixty units perfected the learning process on an average of 73.33 trials; subjects trained with seventy-five units on an average of 38.89 trials; subjects trained with one hundred and fifteen units on an average of 54 trials; and those trained with one hundred and fifty units perfected the process on an average of 57.77 trials. Thus seventy-five units proved to be the most favorable strengths of stimulus for the learning process in rats of seventy-eight days of age. This is also a very favorable strength of stimulus for animals of fifty-six days of age.

Individual differences were very marked with the two weaker strengths of stimuli. All subjects reacted to a stimulus of seventy-five units very vigorously with the exceptions of numbers 105 and

107. Number 105 would get out of the electric box fairly rapidly but 107 did not seem much disturbed by the shock and took its time in getting off the electric plates. The experimenter is convinced that the difference in time taken for 107 to perfect the habit and the time taken for 110 to perfect the same habit is not primarily a difference in the learning capacities of the two subjects but a difference in favorableness of the conditions of learning. With a stimulus of one hundred and fifty units probably number 107 would have even surpassed 110 in the learning process. There is little doubt that a stronger stimulus would have been more favorable to the learning of both 107 and 105. Both of these subjects were slightly lighter than the other rats of this group, but the runt of the entire series was trained with hunger of twenty-four hours and surpassed any of the other animals trained with this degree of hunger. The fairly weak stimuli were more favorable to the observation of individual differences than stronger stimuli, as the stronger stimuli called forth vigorous reaction in the least sensitive subjects.

How may we account for the increase in the number of trials required for the habit formation as the strength of stimulus increased from about seventy-five units up to one hundred and fifty units? One hundred and fifty units is far below the point of injury to the subject. The only thing to account for this difference that was observable to the experimenter was less nervousness on the part of subjects trained with seventy-five units than subjects trained with the stronger stimuli. Subjects trained with seventy-five units approached the electric box more cautiously and sometimes put their noses into the dark box, then withdrew and entered the light box, while subjects trained with stronger shock would rush into one of the boxes seemingly trying to escape from the situation by running over the grill. Thus it seems that the primary cause for the differences in length of time required for rats to perfect the habit of always choosing the light box when trained with a rather weak stimulus and when trained with stronger stimuli is due to the disturbing factor of excitation.

## COMPARISON WITH EARLIER RESULTS

Do the above results agree with the results found in previous experiments on the relative values of different strengths of stimuli in habit formation? Were one to examine the results given by the different experiments without taking into consideration the nature of the subjects used he would conclude that the results are almost diametrically opposed. But when one takes into consideration the differences in the natures of the animals it seems that the results point to a common principle. As everyone who is acquainted with the dancing mouse knows, this animal is not especially sensitive to its environment. It dances in the presence of danger with the same indifference to its environment that it does in its cage. It enters an electric box where it may receive a strong shock almost as readily as it does a box where there is no form of punishment. Ordinary changes in its environment affect its behavior very little. On the other hand the rat is extremely sensitive to its environment. The slightest movement in its presence may call forth the native tendency of flight with the suddenness of a simple reflex. Subjects trained with electric shock had to be forced through the door between the nest box and the entrance chamber, and here in the presence of the electric boxes the primary motive for choice seemed to be to escape from the situation. If, as all these experiments indicate, there is a point of interference as the strength of stimulus is increased this point should be reached much sooner with the rat than the dancer. And the interference due to excitement will appear much earlier in the series of difficultness with the rat than with the dancer. Thus the most favorable strength of stimulus for habit formation in the rat should be weaker than the most favorable strength of stimulus for the dancer and interference due to excitation should be more noticeable in the rat than in the dancer.

## SUMMARY OF FACTS TO BE EXPLAINED

The above results present certain obvious facts which need interpretation. Why should rats of similar heredity and environment perfect a like habit in so widely different lengths of

time when trained with different degrees of hunger? Why should subjects of similar heredity and environment perfect a like habit in so widely different lengths of time when trained with different strengths of electric shock? Why should subjects with the same heredity and similar environment perfect a like habit in so widely different lengths of time when trained with hunger and when trained with electric shock as motives? Subjects trained with the most favorable condition of hunger perfected the habit in very nearly one-half the number of trials that subjects trained with the least favorable conditions of hunger did. Subjects trained with a shock of seventy-five units perfected the habit in slightly more than one-half the number of trials that subjects trained with one hundred and fifty units did. Subjects trained with the most favorable electric shock perfected the habit in about thirty-nine trials while it took subjects trained with the most favorable condition of hunger seventy-five trials.

#### SOME LAWS OF LEARNING WHICH HAVE BEEN SUGGESTED

Thorndike in his *Educational Psychology* gives three primary laws of learning (8).

(1) Exercise. To the situation, "a modifiable connection being made by him between a situation S and a response R," man responds originally, other things being equal, by an increase in the strength of that connection. To a situation, "a modifiable connection not being made by him between a situation S and a response R, during a length of time T," man responds originally, other things being equal, by a decrease in the strength of that connection.

Corollary to the first part of the law of exercise:

the degree of strengthening of a connection will depend upon the vigor and duration as well as the frequency of its making.

(2) Effect. To the situation, "a modifiable connection being made by him between an S and an R and being accompanied or followed by a satisfying state of affairs" man responds, other things being equal, by an increase in the strength of that connection. To a connection similar, save that an annoying state of affairs goes with or follows it, man responds, other things being equal, by a decrease in the strength of the connection.

(3) Readiness. By original nature a certain situation starts a behavior series: this involves not only actual conduction along certain neurones and across certain synapses, but also the readiness of others to conduct.

Watson criticizes the conception that pleasure tends to stamp-in desirable acts and pain to stamp-out the undesirable acts, and offers two principles, "recency" and "frequency" as possible explanation for the mechanical process in learning. He says (10),

It is our aim to combat the idea that pleasure or pain has anything to do with habit formation or that harmfulness or harmlessness has anything more to do with the situation.

Again,

We may confess at once that we have no new principles to offer in solving the problems involved in learning, but we hope that by stating our problem carefully and by clearing away the misconceptions referred to, we shall be able to show in a convincing way that the mechanical principles with which we are already familiar and which can experimentally be shown to act in the way we maintain are sufficient to yield the solution of those problems. We shall call these principles (1) frequency and (2) recency.

Holmes says (5):

Profiting by experience in an animal of primitive type of intelligence we conceive, then, to take place as follows: The creature is endowed with the capacity for responding to beneficial stimuli by aggressive, outstretching movements, and to injurious stimuli by movements of withdrawal, retreat and avoidance. All these are matters of pure instinct. Given the power of forming associations between responses, the animal acquires new habits of action by repeating those responses which arouse instinctive acts of a congruous, and discontinuing those responses which arouse instinctive acts of an incongruous kind.

Peterson has recently suggested "completeness of response" as a fundamental principle in the explanation of the learning process. He says (7),



That the animal in the performance of an act is constantly in a state of muscular tension due to mutually reinforcing, mutually inhibiting tendencies and that these tensions are released only when the proper reactions have been made and the desired act been performed.

Haggerty gives a physiological interpretation of the learning process in the following law (3):

A physiological state is not self-contained but tends to radiate to other physiological states both those which form with it a series of states like a habit chain and also to other physiological states which have never formed a series.

*Frequency.* That the frequency of repetition of a desired act is of value in perfecting the habit may hardly be successfully denied, but that it is a dynamic factor may be doubted. Its importance varies with the nature of the habit and the motive used for promoting the learning process. That it fails to offer anything like a complete explanation for habit formation is shown by the following facts: (1) It took rats trained with a shock of seventy-five units an average frequency of 24 right choices to 14 wrong while it took rats trained with twenty-four hours of hunger a frequency of 85 right choices to 42 wrong to perfect the same habit. (2) It required subjects trained with a shock of sixty units an average frequency of 51 right choices to 23 wrong choices while it took subjects trained with seventy-five units an average frequency of 24 right to 14 wrong choices to perfect the same habit. (3) It required subjects trained with forty-one hours of hunger an average frequency of 45 right choices to 23 wrong while it required those subjects trained with twenty-four hours of hunger an average frequency of 85 right to 42 wrong choices to perfect the habit. Thus we see that the proportion of right to wrong choices is greater in all cases where it took the subject a greater number of trials to complete the learning process.

*Recency.* The importance of recency as a factor in the formation of a habit, varies like that of frequency, with the nature of the habit. But it does not help to explain the differences in the results in this experiment. The recency in all series of ex-

periments was the same and as to the recency between trials there was practically no difference.

*Vigor.* The importance of the vigor with which an animal performs an act has been underestimated by some students of behavior. The more nearly the whole active organism is directed towards the accomplishment of the act the more rapidly will the act be perfected. The subjects which chose most quickly and made the greatest effort to reach the food learned in about one half the time that it took for those subjects which did not seem anxious to get to the food. This is evidently an important factor in accounting for the difference in the time taken for animals trained with twenty-four hours hunger and animals trained with forty-one hours hunger to perfect the same habit. It also has its bearing in the interpretation of the difference in the average number of trials taken by animals trained with sixty units and those trained with seventy-five units. The former stimulus was too weak to keep the subjects up to their greatest efficiency. The directing of all energy in a single channel means efficiency in acquiring any habit. Animals trained with the more favorable conditions were not often interfered with by the scratch reflex and like inhibitory processes.

*Satisfyingness and annoyingness.* Thorndike tells us "that improvement is the addition or subtraction of bonds or the addition or subtraction of satisfyingness and annoyingness." But how the satisfaction of eating of food after an animal has performed an act can lap back and in some way stamp in the act is not very easy to understand. Likewise it would be a hazardous science that would say that the satisfaction an animal gets from eating after forty-one hours of hunger is more effective in stamping in a desired act than eating after forty-eight hours of hunger, or that the annoyingness of an electric shock of one hundred and fifty units is less effective in stamping out an undesirable act than that of seventy-five units. The above illustrations are sufficient to show that the principles of satisfyingness and annoyingness are of no significance in an explanation of the results of this experiment.

*Other principles.* Though the principles of congruity and incongruity, completeness of response and the law of irradiation

are suggestive and are doubtless of importance in the explanation of the learning process, the writer is unable to give a satisfactory interpretation of this experiment on the basis of one or all of these principles.

The seeming simplicity of the mechanical principles of a simple type of learning grows into complexity when one attempts to account for habit formation under different conditions. The writer does not hope to give a set of principles which will explain the mechanics of all types of habit formation, nor does he care to add another guess as to the physiological changes which take place, but desires some kind of interpretation for the results obtained in the above experiments. Any part or even all of the principles which have been mentioned do not give a satisfactory explanation of the facts. There are at least two other factors which seem of importance.

*Native tendencies.* Something of the importance of the native tendencies of the organism in the learning process has been recognized in a very general way by a number of students of behavior, but the writer here refers to specific tendencies. The specific native tendency with which the learning process is linked seems of vital importance in determining the length of time for perfecting any habit. Subjects trained with the most favorable strength of electric shock perfected the same habit in slightly over half the time that subjects trained with the most favorable degree of hunger. Most probably this is due not to a difference in the values of pleasant and unpleasant stimuli but to the fact that in one case the process is tied-up with the tendency of flight and in the other it is tied-up with the food seeking tendency. The tendency of flight is a very strong tendency and takes predominance over the food seeking tendency when both are stimulated. The rat which is seeking food, on the approach of an enemy takes to flight and ceases the search of food for the time being. Were these comparisons between sex and flight tendencies the results might be very different. The stronger the pull or drive of the tendency with which an act is linked-up the less likely is the individual to be attracted from the performance of the act. The subject which is very hungry is seldom inter-

ferred with by the scratch reflex while the subject which is only slightly hungry is frequently interfered with by it; but the subject trained with electric shock is less frequently interfered with than is the very hungry subject. This means that the native tendency of flight holds the subject up to a more efficient performance of the act than does the food seeking tendency.

*Disintegration.* The physiological process which takes place in the nervous system in the learning process is not definitely known but whatever it is it may be interfered with, or there may be a tearing down process taking place along with the building up process. It is in this rather broad sense that the writer uses the term disintegration. The factors which cause disintegration may vary from a minimum to a point where the tearing down process is equal to the building up process. Subjects trained with a shock of one hundred and fifty units learned less rapidly than subjects trained with a shock of seventy-five units, doubtless because of disintegration due to too great excitement of the situation. That is, the disintegrating and integrating processes were more nearly equal in the former case than in the latter. Subjects trained with twenty-four hours hunger would not infrequently be headed directly towards the light box when the scratch reflex would predominate over the food seeking tendency and the animal would stop and scratch and then go in the direction which it might be headed regardless of right or wrong. Subjects trained with forty-eight hours of hunger were more active than subjects trained with twenty-four hours of hunger but learned less rapidly, probably because of the interfering effect of the strong contractions of the stomach. The physiological disturbance during the first 80 trials was so great that it seemed that the animals would never finish with forty-eight hours of hunger, but about this time the subjects seemed to adapt themselves to the condition.

#### RELATION OF RATE OF LEARNING TO RETENTION

Our results show no marked difference in the three groups tested for retention in the relative values of different degrees of hunger for the retention of the habit. Of the nine subjects trained with forty-eight hours hunger one made a perfect retention test; of

those trained with twenty-four hours hunger one made a perfect retention test; and of those trained with thirty-one hours hunger there was no perfect retention test. Likewise groups trained with electric shock showed no special difference in retention. Two subjects for each of the strengths of electric shock, one hundred and fifty and seventy-five units, made perfect records for retention and one subject for the strength of one hundred and fifteen units of electric shock made a perfect retention test. These facts indicate that subjects trained with electrical stimuli retained better than subjects trained with hunger. Thus it seems that the time required for the formation of a habit has little to do with the retention of the habit but the strength of the native tendency with which the habit is linked is of some importance.

#### RETRAINING

The retraining series are on the whole in harmony with the training series. Animals trained with twenty-four hours of hunger relearned the habit on an average in 44.4 trials; those trained with thirty-one hours retrained on an average in 28 trials; subjects trained with forty-eight hours retrained on an average in 22.2 trials; subjects trained with seventy-five units of shock retrained on an average in 12.2 trials; those trained with one-hundred and fifteen units retrained on an average in 14 trials; and subjects trained with one hundred and fifty units retrained on an average in 12.2 trials. The fact that subjects trained with forty-eight hours of hunger relearned more rapidly than any of the other groups is due to the increased age and adaptation of the organism to long periods of starvation. Just as one should expect, there is no significant difference in the time taken for the three groups trained with electric shock to relearn the process, for the retraining time was too short.

#### CONCLUSIONS

1. In case of hunger the rapidity of learning increases as the hunger increases but the maximum hunger is reached in rats of seventy-eight days of age some where between forty-one and forty-eight hours. After the maximum hunger is reached there is a rapid decrease in the rate of learning as the period of starvation is increased.

2. With a discrimination problem of the difficultness used in this experiment the rate of learning increases as the strength of stimulus increases from the threshold up to about seventy-five units, which is a comparatively weak stimulus, and gradually decreases as the strength of stimulus is increased beyond this point.

3. The electric shock is more favorable to the learning process in the white rat than is hunger in case of a simple discrimination problem.

4. The important factors in accounting for the differences in rate of learning in this experiment are: vigor of performance, frequency of repetition, native tendency with which the process is linked, and the disintegration due to interfering tendencies.

5. The time taken for forming a habit has but little to do with its retention but the tendency with which it is linked may be of considerable importance.

#### REFERENCES

- (1) CARLSON, J. A.: The control of hunger in health and disease. 1916, Univ. Chicago Press.
- (2) COLE, L. W. The relation of strength of stimulus to rate of learning in the chick. *Journal of Animal Behavior*, 1911, i, 111-124.
- (3) HAGGERTY, M. E. The laws of learning. *Psychol. Rev.*, 1912, xx, 411-422.
- (4) HOGUE, MILDRED AND STOCKING, RUTH. A note on the relative values of punishment and reward as motives. *Journal of Animal Behavior*, 1912, ii, 43-50.
- (5) HOLMES, S. J. *Studies in animal behavior*. Boston, 1916, R. G. Badger.
- (6) MARTIN, E. G. A quantitative study of faradic stimulation. *Amer. Jour. of Physiol.*, xxii.
- (7) PETERSON, J. Completeness of response as an explanatory principle in learning. *Psychological Rev.*, 1915, xxiii.
- (8) THORNDIKE, E. L. *Educational psychology, briefer course*. Teachers College, N. Y.
- (9) WASHBURN, MARGARET F. *The animal mind*. 2d Edit., N. Y. 1917. Macmillan Co.
- (10) WATSON, J. B. *Behavior—an introduction to comparative psychology*. New York, 1914, Henry Holt & Co.
- (11) YERKES, R. M. *The dancing mouse*. New York, 1907, Henry Holt & Co.
- (12) YERKES, R. M., AND DODSON, J. D. The relation of strength of stimulus to rapidity of habit formation. *The Journal of Comparative Neurology and Psychology*, 1908, xviii, 457-491.

# A CLASSIFICATION OF GROUPS<sup>1</sup>

CARL W. BOCK

Introductory and historical.....	277
I. The general series: a-G, b-G, c-G.....w-G, x-G, y-G, z-G.....	281
1. Groups as stable activities.....	281
2. The coefficients <i>a</i> , <i>b</i> , <i>c</i> , etc.....	285
3. The coefficient <i>w</i> .....	295
4. The coefficient <i>x</i> .....	297
5. The coefficient <i>a</i> .....	298
6. The coefficient <i>y</i> .....	300
7. The coefficient <i>z</i> .....	312
8. Other analytical methods.....	313
II. Conclusions.....	318

## INTRODUCTION

The present study is based upon the work of Swindle<sup>2</sup> who described and defined certain very simple and characteristic movement complexes to which he gave the name *groups*. As a provisional definition of a *group* he says as follows: "The simplest conceivable instinctive movement (Bewegungsinstinkt) is the result of the capability of an organism to react so many times with a given member of the body (Koerperglied) until a definite number of movements have been made"—that is to say, until a *group* of similar movements have been beat in a particular tempo, amplitude, and direction.

<sup>1</sup> Submitted in partial fulfillment of the requirements for the degree of Doctor of Philosophy in the Graduate School of the Ohio State University under the title, "The Association of Voluntary Movements."

The writer wishes to take the opportunity of expressing his obligations to his observers, namely, his wife, Dr. Karl Dallenbach of Cornell University, Dr. Geo. F. Arps of Ohio State University, and to Miss Ruth Miller, graduate student of the latter institution; to Dr. A. P. Weiss who read the manuscript and whose constant help and guidance made this work possible; more particularly, however, to Dr. G. F. Arps whose liberality of thought and action and constant interest and attention may not be overestimated.

<sup>2</sup> Swindle, P. F. *Zeitschrift für Psychologie u. Physiologie der Sinnesorgane*, 1915, Bd. 49.

In amplification of the above, Swindle's observations on certain animals may well be cited. He observed that certain owls (*Glaucidium whitelei* Lws.) made characteristic periodic to and fro movements with the tail. More concretely stated, the owls moved the tail to and fro a certain number of times and then stopped; after a pause of variable duration they made similar movements and rested, and so on throughout longer periods of observation. Other animals behaved similarly, some using this, others that member of the body, or limb, for the performance of these group movements.

By definition any series of periodic movements of the same body members is called a *group*, and any single to and fro movement, a *beat* or an *element* of a group. Moreover, if the group consists of 5 elements or 8 elements, or 23 elements, etc., it is respectively known as the 5-group, 10-group, 23-group, etc., to distinguish it from groups which contain any other number of elements.

The term *group* had however another justification than that of merely defining or describing a series of similar periodic movements. It had a functional or behavioral justification which was based upon the fact that certain groups recurred very frequently in the same animal, and indeed far more frequently than would be expected, were the frequency of recurrence only a matter of chance. In consequence of the apparent stability of these activities the term *group* carries with it the implication that groups are entities of some kind,—functional units of perhaps the same order as the more traditional functional units commonly called reflexes, instincts, and habits. Indeed, Swindle identifies groups with instincts and habits accordingly as they are inborn or acquired.

The observers whose data constitute the basis of the present study were human beings. They were instructed by the writer to beat periodically on the button of a tambour as long as they desired to do so: to rest as long as they had previously beat: and finally, so to alternate beating and resting until instructed to cease. No limitations were placed on the periodicity of their



beating nor upon the duration except that the periodicity of any given group was to remain constant.<sup>3</sup>

This procedure gave as its data (1) an alternate series of groups and rests, and (2) a series of discrete but contiguous durations, i.e., durations of groups, and durations of rest periods. Generalized the data would appear as follows:

- (1) Group, Rest, Group; Rest, G, R, G, R, G, R, etc.
- (2) G-Dur., R-Dur., G-Dur., R-Dur., G-D, R-D, G-D, R-D, etc.

Quantitatively expressed, the above two series may be expressed:

- (3) a-G, R, b-G, R, c-G, R, . . . . . w-G, R, x-G, R, y-G, R, z-G
- (4) a-sec., b-sec., c-sec., d-sec., e-sec., f-sec., g-sec., etc.

where *a, b, c, d, etc.*, in (3) stand for simple numbers, each describing and defining the group to which it has reference from the point of view of the number of elements contained in it; and where the corresponding coefficients in (4) qualify the durations of both groups and rests in seconds. Inasmuch as the rest periods are not otherwise quantitatively described in series (1) and (3), they may be entirely disregarded in these equations or series, and the latter may be written as follows:

- (5) a-G, b-G, c-G, d-G, . . . . . w-G, x-G, y-G, z-G

The above series only describes groups as to the number of elements or beats contained in them; it says nothing regarding the other characteristic properties of groups, such as their periodicities, or their durations; it disregards entirely the rests and their durations, but it is the fundamental series of this paper, which seeks to answer the following questions:

- (a) What groups are beat by any observer?
- (b) Is a general classification possible?

Our observers were seated in one of the standard tablet chairs, the right fore-arm resting on the tablet, the index finger crooked

<sup>3</sup>It goes without saying that observers were not permitted to count either silently or aloud while beating.

and resting upon the button of a *cardio-tambour*. The said tambour was fastened to the extreme front of the tablet in a convenient place for tapping, and was connected to a more complicated recording tambour by a rubber tube, as ordinarily in such cases. Records of the excursions of the pointer of the recording tambour were made upon smoked paper which was stretched between two horizontal drums. One of the latter

TABLE I  
Observer R

- 1.) 44, 24, 44, 47, 22, 46, 52, 48, 68, 32, 104, 47, 7, 45, 10.
- 2.) 36, 54, 27, 36, 96, 115, 174, 130, 49, 12, 17, 16, 24, 52, 45, 21, 18, 130.
- 3.) 23, 28, 42, 45, 46, 46, 46, 22, —, 19, 44, 68, 44, 44, 70, 143, 190, 10, 10.
- 4.) 22, 115, 22, 22, 45, 24, 32, 8, 93, 156, 106, 99, 47, 31, 79.
- 5.) 77, 46, 22, 76, 393, 18, 22, 22, 46, 156, 7, 7, 7, 19, 22, 46, 68, 46, 46, 8.
- 6.) 20, 43, 45, 22, 94, 6, 7, 7, 7, 7, 6, 7, 50, 3, 3, 3, 3, 45, 45, 22, 46, 46, 46, 46, 46.
- 7.) 44, 10, 49, 68, 50, 48, 48, 46, 46, 46, 46, 68, 71, 22, 22, 46, 46.
- 8.) 22, 75, 70, 46, 46, 70, 115, 96, 108, 71, 71, 22, 46, 46, 46, 46, 46, 46, 46, 46.
- 9.) 46, 70, 46, 117, 22, 70, 70, 333, 22, 22, 22, 22, 22, 70.
- 10.) 29, 31, 31, 15, 15, 22, 22, 22, 21, 22, 47, 46, 70, 22, 22, 22, 46, —, —, 75, 22, 47, 60
- 11.) 46, 46, 47, 45, 46, 8, 8, 46, 22, 22, 22, 22, 22, 22, 22, 22, 22, 22, 96, 94, 46, 98, 47, 46, 46.
- 12.) 48, 136, 118, 94, 100, 47, 174, 94, 70, 46, 46, 94, 94.
- 13.) 22, 22, 22, 23, 22, 46, 46, 46, 24, 22, 46, 45, 142, 146, 95, 60, 66, 46, 70, 95.
- 14.) 46, 94, 94, 68, 95, 46, 46, 47, 416, 48, 94.
- 15.) 22, 22, 46, 94, 46, 68, 94, 94, 94, 48, 46, 46, 49, 94, 70, 32, 44.
- 16.) 43, 3, 3, 3, 3, 3, 3, 3, 13, 12, 12, 10, 10, 14, 20, 22, 22, 44, 74, 46, 46.
- 17.) 47, 47, 46, 133, 94, 79, 94, 118, 95, 94, 70, 46, 46.

formed part of an electrically driven kymograph, the other was simple and revolved upon a fixed axis which was supported on two stands by clamps. The two drums were placed on separate tables which were some 15 to 20 feet apart. The recording tambour as also the time signal were fixed in front of one of the drums to a platform movable in the direction of the axes of the drums. Consequently it was possible by simply shifting the platform and thereby the recording apparatus to secure from 4 to 6 complete *turns* of a *continuous* series of groups, which, with a distance of 15 to 20 feet between the tables, amounted to about

100 feet of groups and rests, requiring from thirty minutes to as much as five hours to secure, depending upon the speed of the drums.

Observers were given no other instructions than those given above. In other respects, and in so far as it was compatible with beating groups, they were left to their own devices, free to perform such other activities as studying their lessons, talking, singing, reading, or thinking, and free to have whatever ideas occurred to or in them, of whose nature no record was made or desired.

I. THE GENERAL SERIES:  $a-G, b-G, c-G, \dots w-G, x-G, y-G, z-G$

1. *Groups as stable activities.* In order to show that groups are stable or recurrent activities it is only necessary to show that the coefficients  $a, b, c, d$ , etc. are identical, or, that some of them are, and in numbers sufficient to exclude chance identities. In its ideal, i.e. extreme form, the above general series would reduce itself to one of the following forms:

$$\begin{cases} (6) & a-G, a-G, a-G, a-G, a-G, a-G, \text{ etc.} \\ (7) & c-G, c-G, c-G, c-G, c-G, c-G, \text{ etc.} \\ (8) & \text{etc.} \end{cases}$$

This would imply, what rarely happens except under extremely well controlled conditions, and certainly never under the conditions under which our observers worked, that the same group was always beat.

Table 1 contains a record of 17 series of groups beat on approximately seventeen succeeding days by observer R. A glance at this table will show that, considering any given series, there are groups which recur several times within that series; and considering the 17 series, that the above groups likewise occur and recur in practically all series. These facts are more conveniently shown in table 2, which constitutes a table of the frequencies of the several different groups beat by this observer for each of the seventeen days of experimentation and which give also (lower row) the total frequencies of all groups for the total of the seventeen days.



Considering the latter first, it is evident that there are several groups which are beat with frequencies above the average frequency of all other groups, because:

- (a) the total number of groups beat = 303
- (b) the total number of different groups beat = 69
- (c) the average frequency = 4.4

The numbers 47, 62, 13, and 18 which represent the frequencies of the four groups 22, 46, 70, and 94 give the following percentage frequencies: 15.5 per cent, 22.1 per cent, 4.2 per cent and 6 per cent. These percentages are, with one exception, quite above the average frequency of all groups, and still greater than 2.4 per cent which represents the average frequency of all groups, the above four excepted. Clearly there are certain groups that are beat more often than others and more often than they would be beat, were their distribution a matter of chance. Graphically this is shown on graph 1 from which it appears that the groups 3, 7, 22, 46, 70 and 94 have maxima that are perceptibly greater than the average for all groups.

It will have to be asked and answered how often a group must be beat or must recur in any given series before it can be said that its frequency of recurrence is significant. Clearly, but only generally, this is the case when its frequency rises appreciably over the average frequency of all other groups. In this it is assumed that on a chance basis all groups are equally likely to occur. If certain groups occur more frequently and particularly when these same groups recur on different days of experimentation, or indeed in different observers, then such recurrence must have some significance. On this principle the groups 22, 46, 70 and 94 are significant, whatever the nature of the significance, and speaking generally again, the 303 groups of observer R may presently be divided into the two classes, those that are significant and those that are insignificant by the frequency criterion. Obviously no hard and fast line can be drawn between the members of the two classes of groups, and consequently the frequency principle cannot be considered as the sole or as an abso-

lute measure. Moreover this criterion would exclude from consideration those groups whose frequencies fall below that of the average of all groups and which include groups that are very significant on the bases of other criteria. For instance the group 416 occurs but a single time; yet it *can* be predicted that if the observer beats a group in the 400's, it ought to be precisely the 416 and no other 400 group. The frequency of this group is given by the fraction  $1/303$ .

As a matter of fact the terms *significant* and *insignificant* have only a present convenience and no real justification at all except relatively speaking. Organisms do not behave on the chance basis; all their activities are significant, only some are for present purposes more so than others. There are many factors which tend to maximize the difficulties of a rigorous application of the frequency criterion, of which but one can properly be discussed at this time. Assuming that the group 416 (vide table 2) is significant for present purposes and of the same order of significance as the 22 group or the 46 group of the same observer, it might be asked how it happens that the latter groups are beat so frequently and the former only once? The answer is simple enough. The frequency criterion can only apply where or when all groups have an equal chance of recurrence, which is not in accord with either fact or theory in the present instance. In the first place, the duration of the 416 group is relatively much greater than the durations of the groups 22 and 46. In the second, the 416 is a much longer group. Theoretically it ought to be expected that animals or humans that have a relatively large repertoire of groups, some short, others of medium size, and still others that are long, will beat the medium sized groups most frequently. This is of course on the assumption that the organism in question has received no special training. A long group, or one whose duration is long, has not the same chance of recurrence, just because it takes longer for its performance, and consequently the same measure does not apply for these groups as apply for the shorter groups, and particularly for the medium sized groups.

In the light of the above the general series,

$$(5) \quad a-G, b-G, c-G, d-G, e-G, \dots w-G, x-G, y-G, z-G$$

can be transformed into the series,

$$(6) \quad a-G, b-G, a-G, b-G, a-G, \dots w-G, x-G, y-G, z-G$$

in which the coefficients  $a, b$ , etc., represent groups of the order of the 22, 46, 70, and 94 of observer R, and the coefficients  $w, x, y$ , and  $z$  represent groups that are for the present insignificant on the basis of the frequency criterion. The stability of the groups 22, 46, 70, and 94 is established by virtue of the possibility of the above transformation.

2. *The coefficients  $a, b, c$ , etc.* The coefficients  $a, b, c, d$ , etc., of general series (5) have been shown to be recurrent or stable in the previous section. Substituting for  $a, b$ , etc., in (6) the particular values as found for observer R by the frequency criterion,

$$a = 22; \quad b = 46; \quad c = 70; \quad d = 94.$$

The facts are these: a certain individual R beats 17 series of groups on seventeen consecutive days, and of the 303 groups beat, amongst which there are 69 different groups, he beats four groups, the 22, 46, 70, and 94 relatively very frequently. The question to be asked is this; have the abnormally high frequencies of the four groups 22, 46, 70, and 94 four causes or less than four causes?

A glance at graph 1 will reveal a certain regularity or even periodicity in the maxima for the groups 22, 46, 70, and 94. It is true that the maxima for these several groups do not have even approximately the same values, which is explicable by the discussion of a previous section and also by certain facts about to be discussed. To the apparent periodicity of the above four maxima, the following other singularities may be added: considered day by day (table 2) these four groups do not have their maxima on the same days. Consider the 22 group; for whatever reason, observer R beats the 22 group with increasing frequency

as the experiment progresses up to and including the eleventh day. On the twelfth day he does not beat the 22 group at all, although he beats it again on the thirteenth day and on succeeding days. Apparently the factor which makes for the production of the 22 group, and with progressively increasing frequency, ceases for some reason to be operative on the twelfth day. The factors that make for the production of a group in general are either environmental or internal, but the former cannot enter into the discussion because the general conditions

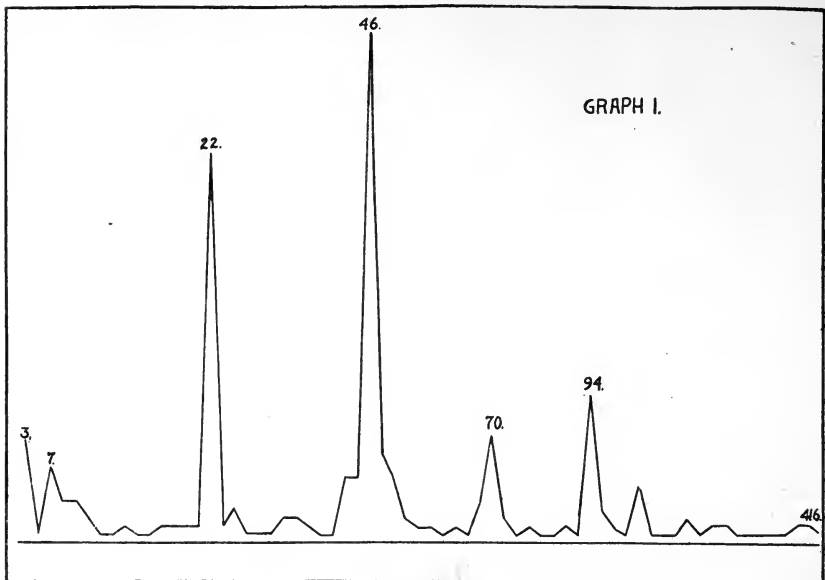

under which the observer worked were practically identical throughout the seventeen days of experimentation. Moreover the observer's general health remained the same, and indeed there is no way in which the observer's acts on the twelfth day are explicable except on the assumption that some very radical change had taken place within his organization, which is contrary to fact. Consequently it must be assumed that observer *did* beat the 22 group, appearances to the contrary notwithstanding, on the twelfth day. On this day observer beat



the 94 group four times, one of the maxima for this group which is not beat on the thirteenth day. Similarly, the maxima for the 70 group occurs one day later, i.e., on a different day from that of the 46 group on which day the frequency of the latter group approaches a minimum. On the tenth day a maximum of 7 obtains for the 22 group while the 70 group is beat but once and the 46 group twice. On the fifteenth when the 94 group has a maximum, all other groups practically have minimums.

Apparently an inverse correlation of some kind obtains between the frequency maxima of these four groups, and in this case some kind of a relationship must exist among the four groups. Consider finally the four *numbers* 22, 46, 70, and 94: the following numerical relations obtain:

$$\begin{aligned} 22 &= 22 \\ 46 &= 22 + 22 + 2 \\ 70 &= 46 + 22 + 2 \\ 94 &= 70 + 22 + 2 \end{aligned}$$

These relations are the counterpart of the apparent periodicities previously referred to on the graph. If the above numerical relations correspond to actual facts it would mean that

$$\begin{aligned} 22-G &= 22-G \\ 46-G &= 22-G + 22-G + 2-G \\ 70-G &= 46-G + 22-G + 2-G \\ 94-G &= 70-G + 22-G + 2-G \end{aligned}$$

and it would explain the periodicity of the maxima that obtain on graph 1 for the frequencies of the above four groups as well as the otherwise inexplicable fact that an organism can beat a certain group with progressively increasing frequency, or perform an activity of any kind in the same manner and suddenly for no apparent reason cease to perform it at all. The explanation is that the observer does not cease to beat the 22 group—he merely beats it several times in succession, hiding thereby its identity as such in the guise of an apparently new or different group. The above equations explain also why the frequencies of such groups as the 70 and 94 is relatively so small. They do not represent frequencies of different groups but rather the fre-

quency of the 22 group, and since the 70 and 94 groups each contain several 22 groups, they must recur less frequently, other things being equal.

Fortunately the proofs for the above equations were found in the records of the observer, but for reasons to be explained, only by chance. Before the records in question (containing the proofs) were made, during the last four days of experimentation, the facts as stated above were well known to the writer, who searched in vain among those records that had been made up to this time for some objective evidence which might support the conclusions to which considerations of frequency, inverse correlations, and numerical relations pointed. At present, after three years' experience the writer prefers not to refer to records for proof except under very particular circumstances because he knows that a record cannot normally contain the facts of analysis unless accidentally or incidentally,—not because the facts of numerical analyses do not correspond to behavioral actualities, but because they do not *necessarily* correspond as would be expected by ordinary habits of thought. The writer will call attention to the facts and reasons of the above at its proper time.

Consider figure 5 (first part) a fac-simile of one of the many 46 groups.

Figure 5 shows 46 beats of varying amplitudes given in a practically constant tempo. Numerical and other reasons point to the conclusion that the 46 group above consists of two 22 groups and a 2 group. Examination of the figure will show that there exist in this figure absolutely no evidence for the assumption. It cannot, except very arbitrarily be said, that here (on say the 22d beat) the first 22 group ends, and there (on say the 23d beat) the second 22 group begins, and that the last two beats constitute the above 2 group. Not only is it impossible to see in this figure the desired relationship, but any other relationships are equally invisible. The above 46 group corresponds to the generality of the 46 groups which observer R made and yet it can otherwise be shown beyond all possibility of doubt that the relation,

$$46 = 22 + 22 + 2$$

must correspond in some way and somehow to actualities of function. Consider figure 1:

A close examination of figure 1, reading it from right to left, i.e., in the order in which it was made, will reveal 21 beats of varying amplitudes followed by the 22d beat whose amplitude greatly exceeds those of its immediate neighbors. These first 22 beats may be said to constitute a 22 group. The 23d and 24th beats are relatively small and are followed by 22 beats of greater amplitude, the 22d, being again clearly larger than the 21 preceding beats. Clearly a 2 group and two 22 groups are outlined in the 46 beats which together constitute the 46 group. The

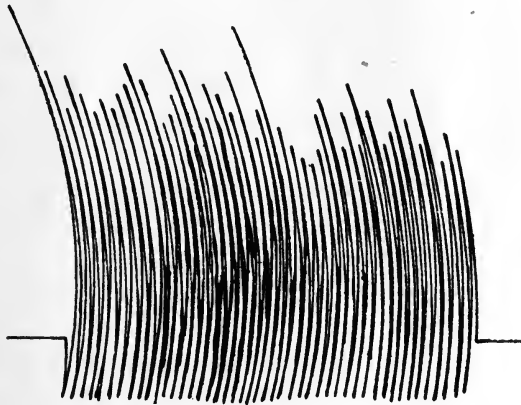

FIG. 1

technique of this delineation is by the method of "amplitude variation," but no particular significance would have attached to such variations did they not so closely correspond to prediction, or had they occurred but once. Both the latter facts indicate that the variations are not accidental, and this being so, there must exist some logical grounds for their occurrence, which cannot be other than the grounds contained in the prediction.

In his work Swindle noted and commented on the fact that the final beat of a group was often accented, that is, larger than the others. He referred to the fact by the term *final accent*. He sought to identify the accentuation with the occurrence of the

subjective positive after-image, and did actually re-discover the so-called positive after-image of long duration because he had noted the final accentuation of groups. Specifically he noted that certain animals often accompanied the final beat of a group by a simultaneous beat with another member of the body. Thus certain bears that made peculiar up and down movements of their bodies accompanied the last of the movements by simultaneously slapping the walls of the cage against which they supported themselves with one of their front paws. This slap, or movement corresponds, so Swindle believes, to the final accent as shown in the above figure except that in the figure the extra movement is shown as made by the same body member and not by an extraneous one. The writer has made similar observations. *Generally* the last beat is accented. Ordinarily he could not observe however that the final beat of a group was accompanied by any particularly pronounced movement of any other body member. As a matter of fact *every beat* of the finger was accompanied by slight movements of *every other part* of the body and very close observations showed that these slight movements were not necessarily mechanical effects of the moving arm or finger, but actual physiological contractions. These movements were given in the same tempo as that of the main activity, and they could be well felt by simply grasping the limbs in question by the hand and feeling the contractions. And generally the final accent of the main activity was *accompanied* by a slight increase in the amplitudes of the accessory movements. The writer wishes here merely to call attention to the principle of the *final accent* and such other observations which he made in this connection as well as those of Swindle. They are theoretically very important and their discussion will be referred to in a separate section of this study. The fact of the final accent establishes the significance of the discussion of figure 2, and therefore the constitution of the 46 group above. Consider figure 2:

Figure 2 is entirely similar to figure 2 except that the separate components of the 46 group are not as well delineated as in the preceding figure. Consider figure 3.

Figure 3 differs from the preceding figures in one essential manner—a small rest period ensues on the completion of the first 22 beats of the group which is followed by 22 more beats. This interval is *not* of the kind called for by the instructions to the observers; it occurred or was made without the knowledge

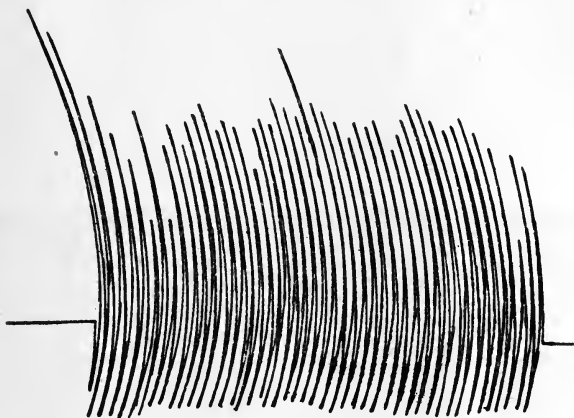

FIG. 2

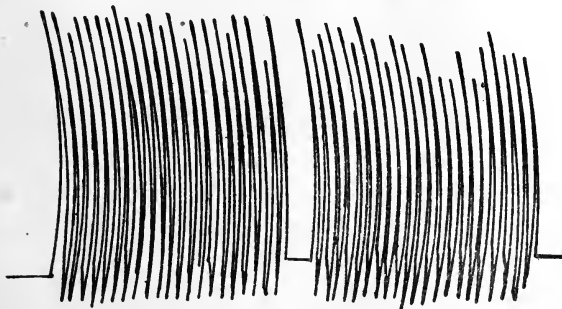

FIG. 3

of observer R, and under external conditions that cannot be held accountable for it. Whatever the causes for the interval, it is significant that it occurs after the completion of a 22 group and that it is followed by another 22 group. As it stands figure 4 represents a 44 group, or two 22 groups plus the small interval. The interval measures at its base exactly 3 mm. The intervals

between any four beats and between every four beats measure 3 mm. Between four elements or beats, there can be inserted 2 beats and three of the smaller intervals that normally occur between any two successive elements of a group. Consequently the above intervals is *precisely* long enough to permit the interpolation of 2 beats given in the *same* tempo as that of the other beats of this group; the interpolation made in the above figure corresponds to a 46 group and is in accord with all preceding figures as well as with the prediction made with respect to the composition of the 46 group. Consider figure 4.

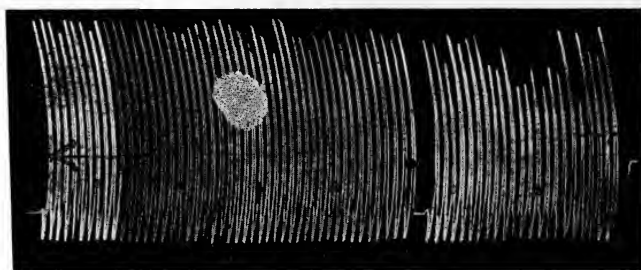

FIG. 4

Figure 4 is similar to figure 3 with the exception that a 46 group and a 22 group are concerned plus a small interval with precisely the same implications as above; two beats and only two can be interpolated, thus making a total of 70 beats which agrees with the predictions made in regard to the composition of the 70 group. Consider figure 5.

Figure 5 is an example of the same kind as the preceding. The small interval permits the interpolation of a 2 group given in the tempo of the other beats but there is a significant difference between the intervals, which significance attaches also to all the other intervals of the same kind already mentioned and to be given. Relatively the intervals are all equivalent in that they permit the interpolation of exactly 2 beats, yet absolutely the intervals are not equivalent because they have different durations.

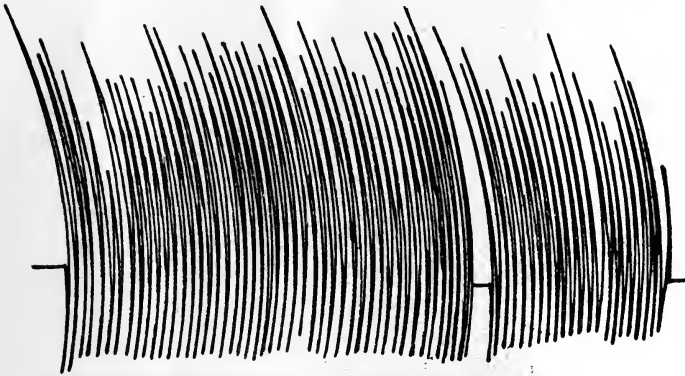

FIG. 5

Figure 6 agrees with the preceding figures except respecting the particular groups concerned. The groups are the 22 and 71 ( $70 + 1$ ) plus the usual interval for the interpolation of a 2 group. It is therefore an attempted synthesis of a 95 group ( $94 + 1$ ).

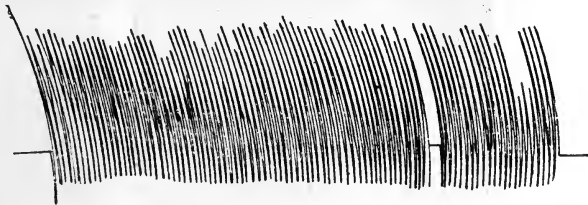

FIG. 6

Figure 7 corresponds to two groups 46 and 71 ( $70 + 1$ ) plus an interval into which but one beat may be interpolated. Consequently it represents an attempted synthesis of a 118 group, a group which is beat *as such* twice by this observer.

The above are examples selected from 15 occurrences of the same kind in the work of observer R. In a certain sense they must be regarded as quite accidental because they occur relatively infrequently and consequently they cannot always be relied upon, except under pre-arranged conditions, to furnish objective evidence and proof for conditions that might be indi-



FIG. 7



cated by other circumstances. However since they have been found, they do in the present instance furnish the necessary proof for the conclusions that analysis has pointed out, and warrant the assumption that the 46, 70, and 94 groups are compounds of a single group, the 22, and that the several maxima of these groups are therefore conditioned by a common factor and not by four separate factors. The general series (6) thereby suffers the following further modification:

$$(7) a-G, (2a+k)-G, (3a+2k)-G, (na+(n-1)k)-G \dots w-G, x-G, y-G, z-G.$$

3. *The coefficient w.* A glance at table 2 and graph 1 will reveal the interesting fact that there occur in the vicinity of the maxima for the groups 22, 46, 70, and 94, groups that are beat relatively more frequently than the average of all other groups, but yet not nearly with the abnormally high frequencies of the above four groups. Their occurrence as such is not significant; their occurrence with the said frequencies is not significant; but their occurrence with their particular frequencies in *association* with the groups 22, 46, 70, and 94 is significant and raises the question whether the high frequencies of the associated groups is in any manner conditioned by the frequencies of the groups to which they are associated?

The groups to which reference is made here are the 24, 44, 45, 47, 48, 68, 71, and 95. Considering only the 46 group and its *associated* groups 44, 45, 47, and 48, the facts are as follows: the group 46 occurs with abnormal frequency; the four neighboring (in the numerical sense) groups 44, 45, 47, and 48 occur in far greater numbers than the average of all other groups, but yet with not nearly the exaggerated frequencies of the group 46. Each of the four groups 22, 46, 70, and 94 have one or more such exceptional neighbors, and with the exception of the groups 3 and 7 of which special mention will presently be made, no other group has a frequency that lies above the average. The question that logically follows is this: why are groups like the 44, 45, 47, and 48, that have relatively high frequencies associated with groups like the 46 group that has an abnormally high frequency?

When it was shown that the groups 22, 46, 70, and 94 were stable activities by virtue of their recurrence, it was assumed that this implied that the said groups were functional units, or behavioral entities of some kind, such units as reflexes, etc. Now it is well known of these more traditional units that they vary within very wide limits from time to time in their temporal and spatial attributes and in the number and sequence of their elements, as well as in their amplitudes and directions. Such variability is to be expected. Groups like the 46 above do indeed vary. Of the 62 different 46 groups no two are exactly alike except in the number of their elements from which they all derive their common name. In their other attributes they vary very widely. Particularly do they vary with respect to the amplitudes of their individual beats. The latter are obviously minor variations which, consequently, ought to occur, as they do, very frequently on grounds of probability. But variations of 1, 2, 3, or more beats cannot be said to be minor variations and therefore would not occur as often as amplitude variations, not necessarily because they are essentially different kinds of variations but because they imply greater variations of the same kind. Thus a variation of one beat from the typical 46 group implies theoretically only that the 46th beat has an amplitude 0 which is a greater deviation from the 46 group than 45 beats with a normal amplitude plus one beat with an amplitude of about one-third of the average of the other beats would be.

Since amplitude variations do occur very frequently and since variations of one beat or more are of the same nature as these, differing in degree only, and since they therefore imply relatively large variations of amplitude, it is to be expected on purely a priori grounds that a typical group, as the 46 group, will have associated with it groups like itself and of the same species whose frequencies will in general be the greater, the greater the frequency of the type group; and the less, the farther the individual members of the same species are numerically removed from the type group. This is obviously the case in the present instance where the above conditions are sufficiently fulfilled as on graph 1.

Accordingly groups like the 44, 45, 47, and 48 will be considered as varieties of the group species 46, and it will be predicted that in any similar investigation such varieties will occur. The coefficient  $w$  thereby suffers the following transformations:

$$w_1 = a \neq n, \quad w_2 = (2a + k) \neq n; \quad w_3 = (3a + 2k) \neq n; \\ w_4 = (na + (n-1)k) \neq n.$$

4. *The coefficient  $x$ .* The general series (6) contains the undefined coefficient  $x$  whose nature it is the purpose of this section to discover. The simple facts upon which the discussion is based are as follows: an organism beats a certain group  $a$  very often; it was also shown that he beats groups of the order  $2a$ ,  $3a$ ,  $4a$ , etc. The question to be asked is whether any other multiples of  $a$  might be expected to occur which cannot be demonstrated to be such by an appeal to simple frequency criteria?

The following numerical equations obtain between those groups that have been shown to be multiples of the group 22:

$$22 = 22 \\ 46 = 22 + 22 + 2 \\ 70 = 46 + 22 + 2 \\ 94 = 70 + 22 + 2$$

Continuing these equations with their numerical implications, the following expressions can be obtained:

$$\begin{array}{ll} 118 = 94 + 22 + 2 & 262 = 238 + 22 + 2 \\ 142 = 118 + 22 + 2 & 286 = 262 + 22 + 2 \\ 166 = 142 + 22 + 2 & 310 = 286 + 22 + 2 \\ 190 = 166 + 22 + 2 & 334 = 310 + 22 + 2 \\ 214 = 190 + 22 + 2 & 358 = 334 + 22 + 2 \\ 238 = 214 + 22 + 2 & 382 = 358 + 22 + 2 \\ & 416 = 382 + 22 + 2 \end{array}$$

In the above equations the numbers on the left hand side represent groups that might be expected to be beat by this observer in view of the fact that he beats the 46, 70, and 94 groups. Of these, the following groups are beat with the indicated frequency by this observer:

118	2 times,	333 (334-1)	1 time,
142	1 time,	416	1 time,
190	1 time,		

It is hardly necessary to comment on the remarkable accuracy of the above predictions and it is believed that the concurrence that obtains between prediction and fact is sufficiently great to warrant the belief that the groups 118, 142, 190, 333, and 416 are of the same order as the 46, 70, and 94, and therefore of the nature of the 22 group. It should be pointed out however that frequency criteria cannot be invoked in the cases of these groups to establish the said relations partly because they are very large groups and partly also for reasons later to be considered. Since the general series suffers no radical modification by the above discussion, no transformations will be made; the general coefficient  $x$  may be taken to stand for all multiples of the type group  $a$  that can be predicted as in the above.

5. *The coefficient a.* With the exception of the general coefficients  $y$  and  $z$ , all other coefficients have been shown to be definable in terms of the coefficient  $a$ . It is interesting to examine whether  $a$  can be expressed in terms other than itself. A rigorous application of the mathematical law of *no exception* would lead to the conclusion that such groups as the 22 might be analyzed and expressed in terms of groups smaller than itself in much the same manner as the groups 46, 70, and 94 have been expressed in terms of the 22 group.

The application of the above principle however carries with it the necessity for giving to its results a very clear meaning which may not be simply conventional or arbitrary, but which must have some relation to, and which will square with, the morphology and physiology of the organism which has produced the groups in question. In consequence thereof analyses may be carried out only so far as they are possible of interpretation, the limits and meanings of which we are about to examine.

The facts or data on which an analysis of the 22 group might be possible are these: the hypothetical components must necessarily be smaller than the 22 group; of the smaller groups which

observer R beat, there must be some definite reason for the selection of a given set of groups as the components, i.e., the selection may not be arbitrary; with a possible exception there are no objective proofs to guide in the selection of these components; the frequency criterion is the sole remaining guide, which points out the groups 3, 7, 8, and 10 as componential possibilities of the 22 group because of their recurrence.

The groups 3, 7, 8, and 10 have relatively high frequencies. This cannot be due to chance and inasmuch as all other groups whose frequencies are above the average have been shown to be related to the 22 group there can be little question that the latter

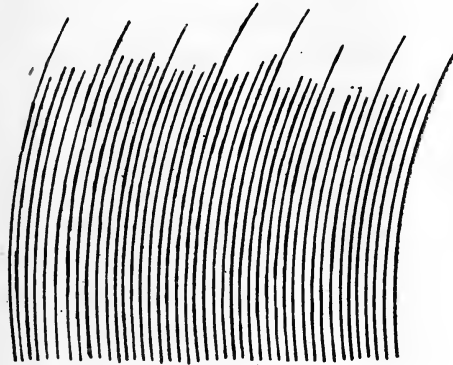

FIG. 8

is related in some way to one or more of the groups 3, 7, 8, and 10. A bit of objective evidence which may be offered in support of the conclusion is the fact that the 416 group which has been shown to be a multiple of the 22 group, is made up of fifty-seven 6 groups and two 7 groups. A portion of the 416 group is shown in fac-simile in figure 8.

Whether or not the coefficient  $a$  or as in the present example, the 22 group, can be reduced to lower terms is in a certain sense not important. The most important fact about the 22 group is that it is obviously a functional unit and a functional entity of a very definite kind in terms of which many other groups may be expressed. If reducible, the same importance would attach

to the then resulting group as now attaches to the 22 group, and since for present purposes analysis must cease at some point, it might as well be at the 22 group as elsewhere. The importance that attaches to the 22 group, as it stands at present for the reasons cited, does not depend upon the fact whether the 22 group is or is not an ultimate functional unit, if such exist; it depends solely on the fact that the 22 group is a functional entity and that it is related to other groups in very definite ways. For that reason the question as to its composition will be left open for the present with this additional remark, that it is without doubt, or *was* at some time a complex activity, compounded of smaller units whose precise nature is at this time indeterminable.

6. *The coefficient  $y$ .* The general series (6) contains a coefficient  $y$  which represents a class of groups whose description and analysis have not been possible thus far. It is the purpose of this section to consider this class of groups and to this end the data of observer S will be studied (table 3).

The question must first be raised and answered on what assumptions it is possible to attempt a description and definition of a general series of groups such as series (6) by means of an appeal to the data of *several* different observers, defining certain of the coefficients of this series on the basis of the groups of one observer and others on that of different observers. The question contains the implication that different observers beat such radically different groups or classes of groups that no generalizations are possible, or otherwise it ought to be possible to completely define *every* coefficient of the general series (6) by the data of a single observer, such as R.

It is not the same to say that different observers beat different groups and different observers beat different classes of groups. Different observers do beat different groups, though they often also beat similar or even identical groups. On probability grounds this is to be expected considering the large number of possible observers. But the statement that observers beat different classes of groups contains the contrary to fact implication that members of the same species differ very widely in structure and function, i.e., that they differ more than they are alike.

Since members of the same species are more alike than they are different, it must be true, or expected, that the laws governing their habits of behavior, and the combination of these, and their succession will generally be the same, particularly when good reasons can be assigned for *apparent* deviations from the above assumption.

TABLE 3  
Observer S

- 1.) 24, 33, 57, 73, 76, 45, 11, 55, 52, 38, 24, 35, 40, 5, 38, —, 21, 113, 11, 48, 78, 23, 79, 198, 53, 77, 66, 20, 131, 22, 37, 10, 143, 80, 20, 11, 36, 32, 38.
- 2.) 33, 27, 74, 87, 83, 45, 128, 23, 258, 27, 256, 39, 54, 240, 15, 176, 124, 58, 22, 154, 57, 20, 248.
- 3.) 33, 162, 32, 56, 180, 53, 55, 282, 105, 55, 238, 41, 220, 207, 37, 100, 95, 30, 31, 97, 338, 146, 144, 337, 199, 18, 47, 264, 73, 126, 237, 32, 176.
- 4.) 44, 51, 480, 380, 170, 153, 98, 207, 435, 120, 176, 209, 404, 45, 84, 81, 85, 39, 80, 105, 58, 32, 141, 120, 110, 18, 141, 174, 17, 161, 103, 982.
- 5.) 64, 112, 62, 173, 75, 83, 279, 118, 65, 148, 144, 47, 144, 144, 192, 142, 38, 163, 134, 59, 137, 156, 115, 27, 93, 277, 90, 132, 111.
- 6.) 57, 103, 89, 29, 125, 145, 246, 65, 256, 61, 197, 96, 163, 368, 176, 212.
- 7.) 33, 129, 50, 84, 80, 89, 180, 94, —, 68, 137, 193, 57, 156, 96, 80, 59, 167, 60, 194, 190, 124, 34, 110, 43.
- 8.) 65, 100, 35, 116, 162, 46, 162, 120, 171, 90, 38, 63, 233, 42, 75, 35, 147, 92, 94, 102, 127, 151, 156, 47, 128, 97, 235, 34, 45.
- 9.) 28, 69, 90, 131, 41, 107, 255, 47, 96, 87, 183, 60, 169, 49, 141, 156, 188, 94, 299, 167, 57, 225, 52, 95.
- 10.) 92, 101, 113, 57, 196, 190, 47, 337, 57, 254, 103, 77, 277, 60, 245, 15, 41, 60, 240, 41, 67, 46, 99.

For purposes of convenience the second record of observer S is reproduced below in the order in which it was made or beat.

33, 27, 74, 87, 83, 45, 128, 23, 258, 27, 256, 39, 54, 240, 15, 176, 124, 58, 22, 154, 57, 20, 248

The following facts are of interest in connection with the work of observer R. Observer S beats the 27 group twice and its double, the 54 once; the 128 group and its double, the 256 group, and also the group 258 which differs from the double of the 128 by two beats, making it very likely a variety of the 128 or 256 group species; the 22 group and the multiples 176 and 154; the 124 group and its double, the 248 group. In this respect then, the present observer does not differ from ob-

server R at all, except that he does not seem to beat groups of type *a* and their *multiples* as frequently as R. This difference however is very significant as will appear hereafter, and it is precisely such differences which make generalizations or group classifications on the basis of a single observer difficult.

Consider the first four groups of the above series of groups, namely:

33, 27, 74, 87,

and the corresponding *numerical* equation:

$$(1) \quad 33 + 27 + 27 = 87.$$

and the next four groups of this series,

83, 45, 128, 23,

and the corresponding *numerical* equation:

$$(2) \quad 83 + 45 = 128.$$

and the following seven groups:

258, 27, 256, 39, 54, 240, 15,

and the corresponding *numerical* equations:

$$\begin{aligned} (3) \quad (9 \times 27) + 15 &= 258 \\ (4) \quad 39 + 54 + 39 + 54 + 54 &= 240 \\ (5) \quad 27 + 27 &= 54 \\ (6) \quad 39 + 15 &= 54 \\ (7) \quad (16 \times 15) &= 240 \end{aligned}$$

and finally the series:

176, 124, 58, 22, 154, 57, 20, 248,

and the corresponding *numerical* equations:

$$\begin{aligned} (8) \quad (8 \times 22) &= 176 \\ (9) \quad 58 + 22 + 22 + 22 &= 124 \\ (10) \quad 57 + 20 + 57 + 20 &= 154 \\ (11) \quad (7 \times 22) &= 154 \\ (12) \quad 124 + 124 &= 248 \\ (13) \quad 57 + 57 + 57 + 57 + 20 &= 248 \end{aligned}$$



The question to be answered is this: what relations exist between any of the above short series of groups and the corresponding *numerical* equations? It must be noticed first that all the numbers which occur in equations (1) to (13) occur also in that part of the series to which they correspond, and that no other number which does not occur in the corresponding part of the series occurs in the equations. Two possible conclusions can be drawn from these correspondences; either we are concerned with a remarkable set of coincidences or the above numerical relations have some significance. The first conclusion is untenable from the fact that such numerical relations as between the coefficients of groups are by far too common to be regarded as accidents, and secondly from the fact that in principle the above equations do not differ from similar equations obtained in the case of observer R except that in the latter case the equations involved the addition of *identical* coefficients whereas here they involve the addition of *non-identical* coefficients. From this it is obvious that the general coefficient  $y$  may be taken to represent groups whose coefficients are obtainable by the addition of two or more *different* groups which latter groups must occur in the temporal vicinity of the groups whose components they may be said to be.

An extension of the arithmetical principles involved in the above equations is possible when they are obtained not only as between neighboring groups of the same record, but also between any groups at all within the said record. Below are given in categorical form a list of the more important equations obtainable from among the several groups of the series under discussion. With certain exceptions, the equations *do* not contain any numbers that are *not* found as such among the coefficients of the groups of the above series. The exception mentioned above consists of the use of the *half* of the coefficient of groups in the case of even numbered groups, and approximate *halves* or so-called *physiological halves* of odd numbered groups. The only justification for the use of said numbers in the making of analytical equations as above comes from the fact that it is so generally possible to do so, and from the obvious relation that

exists as between halves and the multiples of a number. Thus we may consider the 46 group the *physiological double* of the 22 group, or we may consider the 22 group the *physiological half* of the 46 group.

A partial list of such equations follows:

$$\begin{aligned} 74 &= 33 + 27 + 27/2 \text{ (14)} \\ &= 27 + 27 + 20 \\ &= 54 + 20 \\ &= 39 + 15 + 20 \end{aligned}$$

$$\begin{aligned} 87 &= 33 + 27 + 27 \\ &= 33 + 54 \\ &= 33 + 39 + 15 \\ &= 57 + 15 + 15 \\ &= 27 + 45 + 15 \\ &= 27 + 15 + 15 + 15 + 15 \end{aligned}$$

$$\begin{aligned} 83 &= 33 + 27 + 23 \\ &= 33 + 33 + 33/2 \\ &= 23 + 45 + 15 \\ &= 23 + 23 + 22 + 15 \\ &= 23 + 15 + 15 + 15 + 15 \end{aligned}$$

$$\begin{aligned} 45 &= 15 + 15 + 15 \\ &= 23 + 22 \end{aligned}$$

$$\begin{aligned} 128 &= 83 + 45 \\ &= 74 + 54 \\ &\text{and all substitution products.} \end{aligned}$$

$$23 = 23$$

$$\begin{aligned} 258 &= (128 + 1) + (128 + 1) \\ &= 83 + 23 + 23 + 83 + 23 + 23 \\ &= 45 + 45 + 45 + 45 + 45 + 33 \\ &= 33 + 33 + 33 + 33 + 33 + 33 + 33 + 27 \\ &= 27 + 27 + 27 + 27 + 27 + 27 + 27 + 27 + 27 + 27 + 15 \\ &\text{and all substitution products.} \end{aligned}$$

$$27 = 27$$

$$\begin{aligned}
 256 &= 83 + 45 + 83 + 45 \\
 &= 128 + 128 \\
 &= 54 + 74 + 54 + 74 \\
 &\text{and all substitution products.}
 \end{aligned}$$

$$39 = 39$$

$$\begin{aligned}
 54 &= 27 + 27 \\
 &= 39 + 15
 \end{aligned}$$

$$\begin{aligned}
 240 &= 39 + 54 + 39 + 54 + 54 \\
 &= 33 + 27 + 33 + 27 + 33 + 27 + 33 + 27 \\
 &= 176 + 27 + 15 + 22 \\
 &= 124 + 83 + 33 \\
 &= 124 + 39 + 23 \\
 &= 124 + 74 + 27 + 15 \\
 &= 128 + 58 + 54 \\
 &= 128 + 27 + 45 + 20 + 20 \\
 &= 83 + 83 + 74 \\
 &= 74 + 87 + 57 + 22 \\
 &= 74 + 87 + 39 + 20 + 20 \\
 &= 45 + 45 + 45 + 45 + 45 \\
 &\text{and all substitution products.}
 \end{aligned}$$

$$15 = 15$$

$$\begin{aligned}
 176 &= 22 + 22 + 22 + 22 + 22 + 22 + 22 + 22 \\
 &= 154 + 22 \\
 &= 124 + 15 + 15 + 22 \\
 &= 57 + 22 + 45 + 15 + 22 + 15 \\
 &= 58 + 58 + 15 + 15 + 15 + 15 \\
 &= 128 + 33 + 15 \\
 &= 33 + 33 + 33 + 33 + 22 + 22 \\
 &= 33 + 33 + 33 + 57 + 20 \\
 &= 33 + 33 + 45 + 45 + 20 \\
 &= 27 + 27 + 27 + 27 + 27 + 27 + 27/2 \\
 &= 27 + 27 + 27 + 27 + 33 + 15 + 20 \\
 &= 74 + 57 + 45 \\
 &= 74 + 87 + 15 \\
 &= 39 + 39 + 39 + 39 + 20 \\
 &= 39 + 54 + 83 \\
 &\text{and all substitution products.}
 \end{aligned}$$

$$\begin{aligned}
 124 &= 248/2 \\
 &= 58 + 22 + 22 + 22 \\
 &= 15 + 15 + 15 + 15 + 15 + 20 + 20 + 22 \\
 &= 39 + 39 + 23 + 23 \\
 &= 45 + 57 + 22 \\
 &= 20 + 20 + 20 + 20 + 22 + 22 \\
 &= 33 + 33 + 58 \\
 &= 27 + 27 + 27 + 20 + 23 \\
 &= 74 + 27 + 23 \\
 &= 58 + 33 + 33
 \end{aligned}$$

$$\begin{aligned}
 154 &= 22 + 22 + 22 + 22 + 22 + 22 + 22 \\
 &= 57 + 20 + 57 + 20 \\
 &= 33 + 33 + 33 + 33 + 22 \\
 &= 27 + 27 + 27 + 27 + 23 + 23 \\
 &= 58 + 58 + 15 + 23 \\
 &= 45 + 45 + 22 + 22 + 20 \\
 &= 74 + 33 + 27 + 20 \\
 &= 74 + 27 + 23 + 15 + 15 \\
 &= 124 + 15 + 15 \\
 &= 87 + 45 + 22 \\
 &= 39 + 27 + 39 + 27 + 22 \\
 &= 58 + 22 + 74 \\
 &= 58 + 57 + 39
 \end{aligned}$$

$$\begin{aligned}
 248 &= 124 + 124 \\
 &= 154 + 54 + 20 + 20 \\
 &= 154 + 74 + 20 \\
 &= 124 + 74 + 20 + 15 + 15 \\
 &= 176 + 20 + 20 + 22 \\
 &= 128 + 45 + 45 + 15 + 15 \\
 &= 128 + 33 + 33 \\
 &= 87 + 87 + 74 \\
 &= 57 + 57 + 57 + 57 + 20 \\
 &= 57 + 57 + 57 + 22 + 20 + 15
 \end{aligned}$$

and all substitution products.

Close scrutiny of the above tables will lead to the conclusion that it is generally possible to express any of the coefficients of the larger groups in terms of combinations of the coefficients of

the smaller groups; and that it is not only possible to find one combination of coefficients to satisfy any of the larger groups but frequently very many, the coefficients being so intimately related numerically.

To discuss thoroughly one of the above groups, consider the 240. Before it was beat by observer S, he beat the two groups 39 and 54; then he beat the 240 and after it the 15. Now the sum of two 39 groups and three 54 groups equals 240, a number which agrees precisely with the coefficient of the 240 group, and from this it *might* be concluded (and under conditions properly though not *necessarily* so) that the 240 group is actually a succession of 39 and 54 groups each the requisite number of times. And the relation between the 54 and 39 groups itself would strengthen this conclusion for, together with the 15 group which the observer beat immediately after the 240, the 39 equals the 54 ( $39 + 15 = 54$ ) indicating a relationship between these two groups which enter apparently into combination to form the 240, the more so since 240 is also a multiple of 15.

Consider also the 154 group: it is evidently a multiple of the 22 group beat immediately before i.e.,  $7 \times 22 = 154$ ; but following it are the groups 57 and 20 which in the combination  $57 + 20 + 57 + 20$  also equals 154. A question of considerable significance arises, for it may at once be asked how it is possible for a group to have more than one set of components, particularly where there is no apparent relation between the several members of the two or more sets? Thus, while seven times 22 is equal to 154, it is difficult to see how this same 22 group can be a component seven times of the groups 57 and 20 which are also components of the 154 groups. Without entering into a discussion of this question at this time, it may be said that it is for this reason that the writer does not expect to find his analytical results objectified in the records themselves, for, of the many analytical possibilities, which ought one necessarily find? are some of these possibilities actualities and others not? and if so, what criteria are to be used in establishing the identity of the right combination?

Below are given in a convenient form a few other examples of the same kind from the records of observer T and S. In every case the group to be analyzed is starred and below it under the horizontal line are given the several sets of components found for the group above the line:

*Résumé of record 3, observer S*

$$\begin{array}{r} 97^* \\ \hline 47 + 32 + 18 \end{array}$$

$$\begin{array}{r} 338^* \\ \hline \begin{array}{ccc} \frac{97}{47 + 32 + 18} & + & \frac{144}{47 + 47 + 32 + 18} & + & \frac{97}{47 + 32 + 18} \end{array} \end{array}$$

$$\begin{array}{r} 146^* \\ \hline 73 + 73 \end{array}$$

$$\begin{array}{r} 144^* \\ \hline 47 + 47 + 32 + 18 \end{array}$$

$$\begin{array}{r} 337^* \\ \hline \begin{array}{ccc} \frac{146 + 47}{73 + 73} & + & \frac{144}{47 + 47 + 32 + 18} \end{array} \end{array}$$

$$\begin{array}{r} 199^* \\ \hline \begin{array}{ccc} 73 & + & 126 \\ \hline 47 + 47 + 32 \end{array} \end{array}$$

$$18^*$$

$$47^*$$

$$\begin{array}{r} 264^* \\ \hline \begin{array}{ccc} 199 + 18 + 47 \\ \hline 126 + 73 \\ \hline 47 + 47 + 32 \end{array} \end{array}$$

$$\begin{array}{r} 73^* \\ \hline 18 + 18 + 18 + 18(?) \end{array}$$

$$\begin{array}{r} 126^* \\ \hline 47 + 32 + 47 \end{array}$$

$$32^*$$

$$\begin{array}{r} 176^* \\ \hline 144 \quad + \quad 32 \\ \hline 47 + 47 + 32 + 18 \end{array}$$

*Résumé of record 8, observer S*

$$\begin{array}{r} 65^* \\ \hline 100^* \\ 35 + 65 \\ \hline 35^* \\ \hline 116^* \\ 35 + 46 + 35 \\ \hline 162^* \\ 116 + 46 \\ \hline 35 + 46 + 35 \\ \hline 46^* \\ 120^* \\ 90^* \\ 38^* \\ 63^* \\ \hline 233^* \\ \hline 90 + 38 + 63 + 42 \\ \hline 42^* \end{array}$$

*Résumé of record 4, observer T*

(To be read from left to right.)

$$\begin{array}{r} 12,* \quad 71^* \quad 81^* \quad 22^* \quad 29^* \\ \hline 12 + 59 \quad 22 + 59 \\ \hline 12 + 47 \quad 47 + 12 \\ \hline 110^* \quad 47^* \quad 103^* \\ \hline 29 + 81 \quad 59 + 22 + 22 \\ \hline 22 + 59 \quad 47 + 12 \\ \hline 12 + 47 \end{array}$$





the use of the technique, presently the number of accented beats increases so that not only is it impossible to use the data obtained in this way, but it "spoils" an otherwise good observer whose habits become continually modified by the instructions given. This condition no doubt obtains generally, particularly in introspections, and it was for this reason that the writer not only did not require introspections, assuming them to have value, but hesitated to mention the word *introspection* lest the habits of his observers might become too radically changed either by actual instructions or by casual references to it.

Observer Q beat the following series of groups under conditions as above:

166    81    225    148    170

The 166 group was accented on the 83 beat and on the 137th beat. The 83d beat divides the 166 group into two equal parts, namely, two 83 groups. Thus the present observer agrees with others cited in this work. The 137th beat is the 54th beat of the second hypothetical 83 group, thereby dividing this group into the two groups 54 and 29. The 81 group following, which differs only by 2 from the two 83 components of the 166 group is accented on the 54 beat, i.e., thereby separating out another 54 group, and dividing it into the groups 54 and 27 which latter group equals  $54/2$ . The 225 group was accented only on the 54th beat, and the rest of the series is unanalyzable.

The same observer beat the following series:

66    86    161    117    42

The group 66 was accented on the 43d beat, i.e., on the  $86/2$  beat, which 86 group follows the 66 group. The group 161 was accented on the 57th beat, thereby dividing it into the groups 75 and 86. The 86 groups actually preceded the 161. The 117 was accented on the 75th beat, dividing it into the groups 75 and 42. The 75 was shown to be a similar component of the preceding group, and the 42 group actually follows the 117 group.

From the above it would seem possible to conclude that the coefficient  $y$  of the general series (6) is definable in terms of

the sum of two or more coefficients of the type  $a_1, a_2, a_3, \text{etc.}$ , where  $a_1, a_2, a_3, \text{etc.}$ , are of the order  $a$  and definable as this one has been defined. Thus a peculiar difference obtains between the observers R and S. Where R beats but a single type group  $a$ , (22) and its multiples or physiological multiples, and beats these relatively very frequently, S beats several of the type  $a$ , as  $a_1, a_2, a_3, \text{etc.}$  but does not beat any of these with nearly the high frequencies obtainable in R. Whether or not the coefficients  $a_1, a_2, a_3, \text{etc.}$ , can themselves be defined in lower terms, or in terms of a coefficient  $a$  is insignificant for present purposes. It is only significant that such coefficients exist, and that the groups they represent are functional entities in terms of which a large number of other groups can be defined. As previously stated, there can be but little question that if a present relation does not obtain between the above type groups, a genetic relationship does obtain which would mean that these groups perhaps once had a common ancestor functionally considered.

7. *The coefficient z.* The general coefficient  $z$  will usually represent all groups that are not capable of analysis as indicated in the previous sections of this study. It may be interesting to point out why it will not always be possible to analyze the totality of any given series of groups, and why there will be found certain individuals whose groups will be generally not capable of analysis.

The chief reason why this must be so is that the environment even in the best controlled experiments will play its customary rôle in modifying behavior of any kind and particularly the habits under present discussion. The present writer took only the most general precautions to insure a more or less constant environment for the reason that it is generally quite impossible to realize even the faintest approximation to this ideal except where observers are totally devoid of all senses and memory, which would make them worthless for our purposes, but more so because such conditions, whether realized either wholly or in part, are so unnatural and so unusual that they themselves constitute one of the gravest sources of stimulation, and constantly condition corresponding modifications of their habits,

a very undesirable goal in investigations like the present one. The habits in the possession of an organism have generally been acquired under every-day conditions and they are therefore least liable to change under the conditions under which they were developed than under any other conditions.

Since an observer cannot, in general, be entirely removed from sources of environmental stimulation, it must happen now and then, depending on the one hand on the degree of the constancy of the environment or on the "habitualness" of the environment, and on the other on the constitution of the organism itself, that groups will be beat whose nature depends essentially on the environment and not on the organization of the organism, which, if it could be accurately measured and defined, would establish the identity of *every* group of any observer.

8. *Other analytical methods.* It occurred to the writer to extend the methods so generally successful in the consideration of a single series of groups of any given observer to a comparative study of several records of the same observer for the purpose of ascertaining whether the same general relations obtained for the same group in different series. For this purpose, records of the same observer (beat on different days) which contained a common group were selected and compared. The comparisons were effected between the groups that immediately preceded or followed the group common to the several series.

In records 3 and 10, observer S beat the following series:

$$\left\{ \begin{array}{cccccc} 57 & 196 & 47 & 337 & 57 & 354 \\ 199 & 18 & 47 & 264 & 73 & 126 \end{array} \right.$$

The common group in the two records or parts of records is the 47. If a simple relation obtains between any pair of groups that have about the same temporal positions with respect to the common group 47, or any common group, or any groups that are known to be related, then the significance of the relations that obtain for the groups of any single series is thereby strengthened because the corresponding probability problem becomes more restricted. Another condition or another set of conditions

enter into the problem to which the coefficients of the series must conform.

Subtract the number 264 from the number 337 and a *number* 73 obtains. But this *number* is identical with the coefficient of the group 73 which follows the 264 group. From this it appears, that while observer S follows the 47 group by the 337 in record 3, he also follows this group by the 337 group in record 10 with this difference only, that in 10 he beats the 337 group in two parts, while in 3 he beats the 264 and 73 groups in strict succession.

Records 3 and 4, observer S, give the following series:

$$\left\{ \begin{array}{cccccc} 18 & 47 & 264 & 73 & 126 & 237 \\ 18 & 141 & 174 & 17 & 161 & 103 \end{array} \right.$$

The following equations indicate some of the relations here found:

$$\begin{array}{ll} (1) \quad 141 = 47 + 47 + 47 & (3) \quad 174 = 73 + 47 + 18 + 18 + 18 \\ (2) \quad 264 = 174 + 73 + 17 & (4) \quad 161 = 126 + 17 + 18 \end{array}$$

The complex may therefore be written in the convenient form:

$$\left\{ \begin{array}{l} 18^* \quad 47^* \quad \frac{264^*}{174 + 17 + 73} \quad 73^* \quad 126^* \\ \frac{47 + 73 + 18 + 18 + 18}{47 + 47 + 47} \quad \frac{174^*}{47 + 73 + 18 + 18 + 18} \quad \frac{17^* \quad 161^*}{17 + 128 + 18} \\ \frac{73 + 17 + 17 + 18 + 18 + 18}{47 + 47 + 47} \end{array} \right.$$

The following series are taken from the Records of Ob. T.:

$$\left\{ \begin{array}{ccccc} 8 & 12 & 16 & 12 & 13 \\ 25 & 56 & 16 & 72 & 36 \\ 12 & 38 & 16 & 174 & 89 \\ 89 & 94 & 16 & 108 & — \\ 15 & 13 & 16 & 25 & 11 \end{array} \right.$$

Analyzed, the following relations are found:

$$\left. \begin{array}{l}
 8^* \qquad \qquad \qquad 12^* \qquad \qquad \qquad \frac{16^*}{8+8} \quad 12^* \qquad \qquad \qquad 13^* \\
 \\
 \frac{25^*}{12+13} \qquad \frac{56^*}{12+12+12+12+8} \quad \frac{16^*}{8+8} \quad \frac{72^*}{6 \times 12} \quad \frac{36^*}{12+12+12} \\
 \\
 12^* \qquad \frac{38^*}{12 \times 13 + 13} \quad \frac{16^*}{8+8} \quad \frac{174^*}{108+25+(13 \times 3)} \quad \frac{89^*}{(5 \times 13) + (2 \times 12)} \\
 \\
 \frac{89^*}{(5 \times 13) + (2 \times 12)} \qquad \frac{94^*}{56+38} \qquad \frac{16^*}{8+8} \quad \frac{108^*}{(9 \times 12)} \\
 \\
 15^* \qquad \qquad \qquad 13^* \qquad \qquad \qquad \frac{16^*}{8+8} \quad \frac{25^*}{12+13} \qquad \qquad \qquad 11^*
 \end{array} \right\}$$

The following series are taken from the records of S:

$$\left\{ \begin{array}{cccc}
 33 & 162 & 32 & 56 \\
 33 & 129 & 50 & 84 \\
 33 & 27 & 74 & 87 \\
 24 & 33 & 57 & 73 & 76
 \end{array} \right.$$

Analyzed, they take the following form:

$$\left\{ \begin{array}{l}
 33^* \qquad \qquad \qquad \frac{162^*}{33 \quad + \quad 129} \qquad \qquad \qquad 32^* \\
 \qquad \qquad \qquad \frac{57+24+24+24}{33+24} \\
 \qquad \qquad \qquad \frac{96}{32+32+32} \\
 \\
 33^* \qquad \qquad \qquad \frac{129^*}{57+24+24+24} \qquad \qquad \qquad \frac{50^*}{33+33/2} \\
 \frac{33+24}{96(1)} \\
 \frac{32+32+32}{27+27+27+24+24} \\
 \\
 33^* \qquad \qquad \qquad 27^* \qquad \qquad \qquad \frac{74^*}{33+27+27/2} \\
 \\
 24^* \quad 33^* \qquad \qquad \qquad \frac{57^*}{24+33} \qquad \qquad \qquad \frac{73^*}{33+27+27/2}
 \end{array} \right.$$

(1) The 96 group appears further on in the first series and therefore cannot be shown.

In records 2, 7, and 9, observer S beat the following series whose common group, the 57, does not appear for want of space:

{	—	33	129	50	84	80	89
	48	96	86-7	$\frac{183 (2)}{182 + 1}$	60	$\frac{169 (2)}{142 + 27}$	49
	—	258	27	$\frac{134 + 48}{256}$	39	54	240

(2) These groups were objectively analyzed into the indicated groups by the method of accents; without instructions.

Analyzed, they take the following form:

—	33*	$\begin{array}{r} 129^* \\ 33 + 96 \\ \hline 48 + 48 \\ 33/2 + 27 + 86 \\ \hline 27 + 27 + 32 \\ \hline 54 \end{array}$	$\begin{array}{r} 50^* \\ 33 + 33/2 \end{array}$
48*	$\begin{array}{r} 96^* \\ 48 + 48 \end{array}$	$\begin{array}{r} 87^* \\ 1 + 86 \\ \hline 32 + 27 + 27 \\ \hline 33 \end{array}$	$\begin{array}{r} 183^* \\ 182 + 1 \\ \hline 48 + 134 \\ \hline 48 + 86 \\ \hline 96 + 87 \\ \hline 48 + 134 + 1 \\ \hline 84 + 50 \\ \hline 60 + 84 + 39 \\ \hline 33 + 27 \end{array}$
—	$\begin{array}{r} 258^* \\ 129 + 129 \\ \hline 33 + 96 \\ \hline 48 + 48 \end{array}$	$27^*$	$\begin{array}{r} 256^* \\ 138 + 128 \\ \hline 45 + 83 + 74 + 54 \\ \hline 134 + 50 + 27 \\ \hline 86 + 48 \\ \hline 33 + 27 + 27 \end{array}$

(Continued.)

$\begin{array}{r} 84^* \\ \hline 27 + 57 \\ \hline 33 + 24 \end{array}$	$\begin{array}{r} 80^* \\ \hline 15 + 50 + 15 \\ \hline 33 + 33/2 \end{array}$	$\begin{array}{r} 89^* \\ \hline 39 + 50 \\ \hline 33 + 33/2 \end{array}$
$\begin{array}{r} 60^* \\ \hline 33 + 27 \end{array}$	$\begin{array}{r} 169^* \\ \hline 80 + 89 \\ \hline 15 + 50 + 15 \quad 50 + 39 \end{array}$	$\begin{array}{r} 49^* \\ \hline 33 + 33/2 \end{array}$
$39^*$	$\begin{array}{r} 54^* \\ \hline 39 + 15 \\ \hline 27 + 27 \end{array}$	$\begin{array}{r} 240^* \\ \hline 80 + 80 + 80 \\ \hline 60 + 60 + 60 + 60 \\ \hline 89 + 54 + 49 + 48 \end{array}$

The examples cited above seem to indicate that there exists a quasi-stability in the order or succession in which groups are beat at different times, which is manifested in the fact that groups which have the same or about the same place in the temporal order of the series with respect to a group common to the several records can be expressed in terms of each other, or in terms of common groups, or by the sum of two or more groups of the same set, or by the sum of two or more groups of different but neighboring sets. This may be perhaps interpreted that the above relations merely express the simple fact that an observer like S beats several typical groups of the order  $a_1, a_2, e_3, a_4$ , etc., and their many combinations, and tends to beat them from day to day without their suffering any radical modifications of any kind, whether from environmental causes or internal causes, thereby giving to these series of groups the appearance of *associations* akin to the associations of the subjective field, and doubtless of the same kind. Thus the several different series, oriented with respect to a common group, may be regarded as a number of different modifications which one of them, or an entirely different one have from time to time suffered from various causes. Genetically there are several interesting problems contained herein which are capable of experimental treatment, but which the writer will defer for later consideration.

## CONCLUSIONS

Quite apart from attempts at interpretation, and considering groups only from their behavioral or functional aspects, independent of the organisms which have produced them, or the morphology and physiology of these, the following specific conclusions are warranted from the facts of the preceding pages:

1. The totality of all group activities beat by organisms may be represented in a generalized form, as follows:

$$a-G, b-G, c-G, d-G, e-G, \dots \dots \dots w-G, x-G, y-G, z-G$$

2. The coefficients of this series may generally be substituted for,

*a.* By one, several, or very many groups of the order  $a_1, a_2, a_3, a_4$ , etc., these being functional units of varying degrees of stability, the degree varying inversely with their numbers, and themselves being generally incapable of further description except in a hypothetical genetic sense.

*b.* by simple multiples of such type groups of the order  $a_1, a_2, a_3$ , etc., and their halves, or by physiological multiples or halves.

*c.* by varieties of such type groups whose frequencies will generally be in inverse ratio to their deviation from their type form.

*d.* by the sums of such type groups, or by the sums of their multiples, each taken any number of times.

*e.* by modifications of the above kinds of types of groups due to environmental factors, or to internal causes, in which case such modified groups are not generally capable of analysis without a complete description of the modifying factors.

3. Generally the same analytical methods are applicable to the group activities of all observers, who differ only in the number of type groups of the order  $a_1 a_2 a_3$  which they beat, and their respective frequencies.



## A SYNCHRONOUS MOTOR KYMOGRAPH

KNIGHT DUNLAP

*From the Psychological Laboratory of the Johns Hopkins University*

The instrument herein described was constructed in the physics workshop of the Johns Hopkins University from my specifications, and has been in successful operation. It will probably be put on the market, as soon as arrangements can be made therefor, by C. H. Stoelting.

The instrument consists essentially of a horizontal cast iron base, *M*, on which are mounted a ten-pole synchronous motor, of the type used in the chronoscope previously described<sup>1</sup> by me; a drum, *L*, with magnetic clutches, *F*<sub>1</sub> and *F*<sub>2</sub>, of the type designed by me and used on the chronoscope; and a worm-wheel, *E* mounted on a short shaft.

The motor is mounted with the armature, *C*, in the horizontal plane, a worm, *D*, is cut on the armature shaft, which is of steel, and this worm engages the worm-wheel, *E*. The shaft of the worm wheel carries the core of the clutch-magnet *F*<sub>1</sub>, the core having at its outer end an expansion *G*<sub>1</sub>, with flat annular external surface. The armature, and worm wheel and shaft are intended to rotate continuously, the drum remaining at rest until electric current is sent through the windings of the clutch-magnet, *F*<sub>1</sub>, from the terminals *O*<sub>1</sub>, whereupon the expansion of the core, *G*<sub>1</sub>, adheres to the disc, *H*<sub>1</sub>, mounted on the drum-shaft, and the drum-shaft and drum rotate with the worm-shaft. Upon the breaking of the circuit through the windings of the clutch-magnet, the drum comes to rest, without disturbing the rotation of the armature and the worm-shaft.

If desired, current may be applied to the breaking clutch-magnet, *F*<sub>2</sub>, at the moment in which the current through *F*<sub>1</sub> is

<sup>1</sup> Journal of Experimental Psychology.

interrupted, causing the drum to be positively arrested and rigidly held, through the attraction of the disc  $H_2$  to the non-rotating magnet core  $G_2$ .

The worm-wheel on the present instrument has 150 teeth, and hence when the motor is driven by a 25 vibration fork, the drum makes one rotation in one minute, if the fork and motor are in simple step. However, by starting the motor at double speed (either speed may be secured by a twist given to the armature-shaft by the thumb and finger) it may be made to run at that rate, two poles passing for each current-interruption, and the drum makes one rotation in thirty seconds. Forks of different rates may be used, up to 100 vibrations per second, although ordinary forks above 50 in frequency do not make good contact. Driven by the 60 cycle alternating current, without fork, but with suitable resistance, the drum makes one rotation in twelve and a half seconds. If a rectifier, of the "Tungar" type be used instead of resistance, the drum makes one rotation in twenty-five seconds. The motor runs well on alternating current of frequencies of from 15 to 120 per second.

At the slower speeds: with 25 and 50 vibration forks, or with the 60 cycle A. C. with rectifier, or 25 cycle A. C. without rectifier: the method of starting the motor described above (thumb and finger) is the best. For the higher speeds; with 60 cycle A. C. without rectifier: a different method must be used. A single layer of adhesive tape (electricians, or surgeon's, is wrapped smoothly around the armature shaft, and the motor is started by drawing the fingers smartly across the shaft. This method of starting is easier if the current is off the motor-field, and is put on by closing a switch at the moment when the right speed is obtained. In any case, the starting is a "knack" which should be readily learned, after which the process is simple.

With any method of motor drive, any speed within reasonable limits may be obtained by using a worm wheel of the requisite number of teeth. Each size of wheel requires, of course, a specific location of the motor on the base, so that the kymograph should be built for the speed of drum required. It is

entirely feasible, however, to design a base with slots for bolting the motor to it, and mount a series of worm-wheels on the horizontal shaft, so that by sliding the proper wheel into position, and moving the motor into its proper position for that wheel, any of the speeds corresponding to the series of worm-wheels may be employed.

The kymograph may also be designed to run with a vertical drum, but in this case the drum could not be so simply removed and replaced as in the present instrument.

The drum-shaft rotates on bearings  $J_1$  and  $J_2$ , which I have designed especially for this mechanism. Each bearing consists of three screws with polished hardened ends on which the shaft rests. By adjusting these screws, which are provided with lock-nuts, the drum-shaft may be lined up accurately with the worm-wheel shaft. When the current is off the clutch magnets, the drum may be lifted out of the bearings without the unfastening of any catch, and it is as easily replaced.

The writing levers used with the present kymograph are mounted on a heavy iron block, with planed self-cleaning grooves sliding on planed guides on the base (not shown in the cut). For work where records occupying not more than one drum-rotation are required, this is the ideal system. The block may be slid to any desired lateral position, which it will keep without fastening: and it may be slid to the left far enough to remove the writing from the drum, and allow the latter to be lifted out. A mechanical shift of the carrier, for spiral records on the drum, could be arranged. The instrument can also be designed to use continuous paper.

For the satisfactory driving of a small synchronous motor of the type used in this kymograph, platinum contacts should not be used on the fork. Dental wire, of gold hardened by alloy with platinum, is best for the moving part of the contact, attached to the fork tine, and a plate or stud of the same alloy should be used for the fixed part of the contact (although platinum is satisfactory for this part). I have found that a short section of large gauge wire, set in the end of the adjusting screw, is a satisfactory arrangement for the fixed part of the contact.

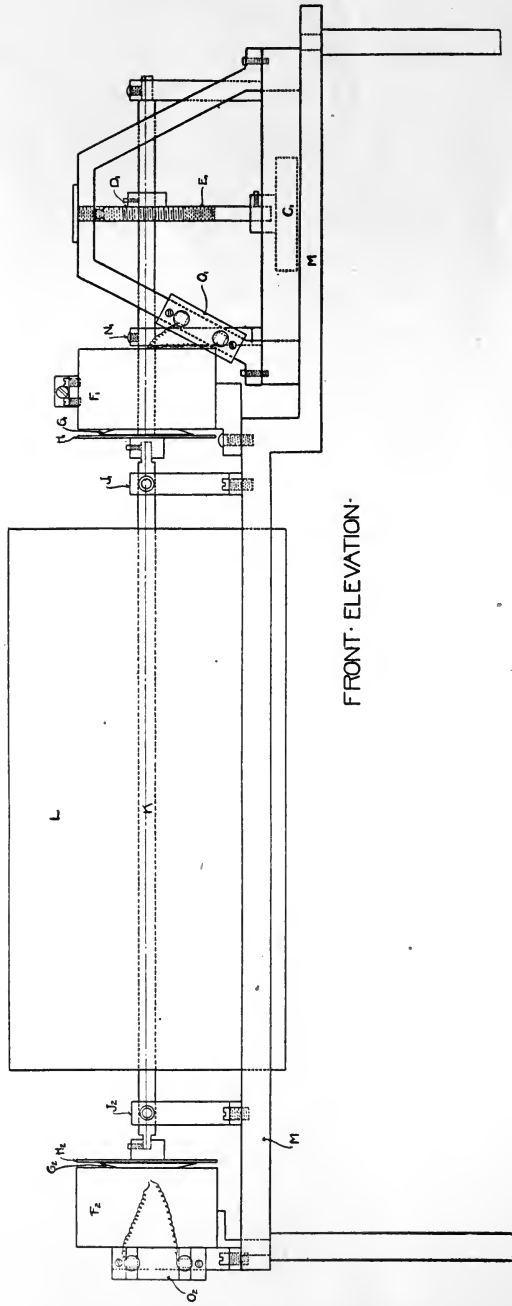

FRONT ELEVATION

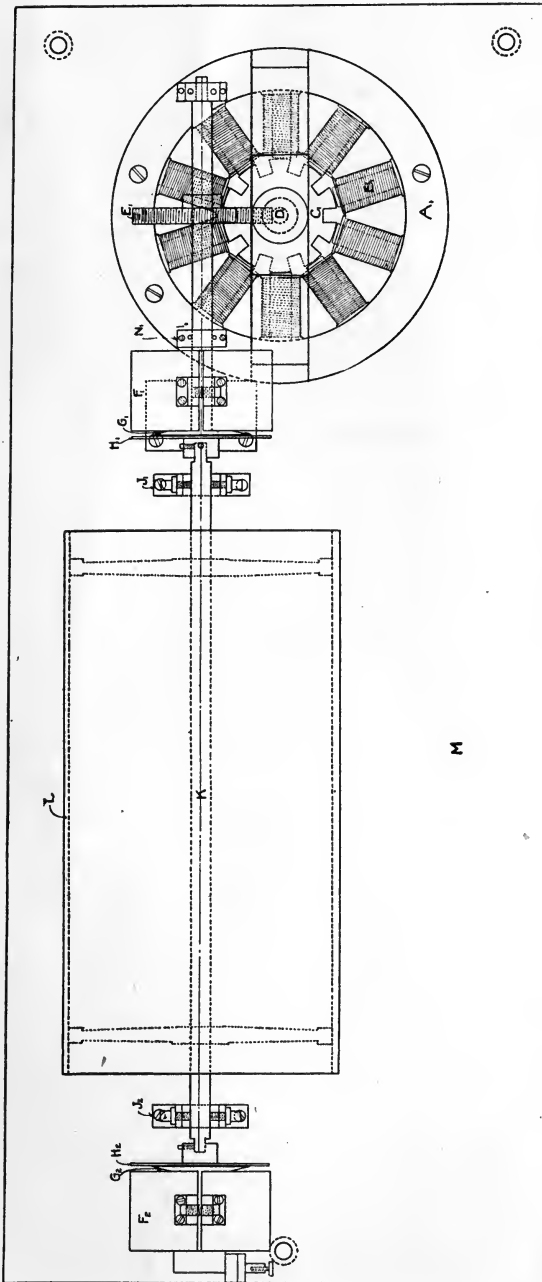

PLAN VIEW

The practical advantages of this kymograph are:

1. Simplicity of construction. There are few parts, and these are of simple and strong design.

2. Comparative noiselessness. If desired, the master fork may be placed in another room, or in a sound proof box. The motor itself makes little noise when operated on a fork-interrupted current. Driven by A. C., the noise is a little greater.

3. Ease of operation. The motor being in continuous rotation, the drum may be started and stopped at will, by manipulating a switch anywhere in the room or in another room.

4. Economy of writing surface. Full speed, and complete stop are attained by the drum in a very small fraction of a second, so that the usual waste of surface due to the "picking up" in speed of the usual spring or motor drive is eliminated.

5. Simplicity of time measurement. The rate of the fork being known, the rate of the drum is known and is invariable. The clutch is so efficient, that in tests which I have made, a fork-tracing taken several times around the drum has given but a single line, the writing point following the same path on the first, second, third, and following tracings. In making this test, a recording fork must be used which is in exact tune (synchronous or even multiple) with the fork driving the motor; or a magnetic recorder may be driven from the same fork. In the latter case there may be slight temporary disturbances of the superposition due to changes in the latency of the magnet, but these may be detected, as may also aberrations due to change in amplitude or in form of the vibration.

Knowing the rate of the drum, and its diameter, the relation between seconds and millimeters may be established, and hence no time-line on the drum is needed in most cases, since the records may be read by the aid of a millimeter scale.

## DUNLAP'S METHOD FOR THE MEAN VARIATION

BUFORD JOHNSON

*From the Psychological Laboratory of the Bureau of Educational Experiments*

In the Psychological Review for March, 1913, Knight Dunlap described a simple method developed by him, of obtaining the mean variation of a series of values, together with the necessary operations for carrying out the process on a calculating machine.

In the derivation of the formulae there is one obvious misprint in writing  $(\Sigma P + PM)$  for  $(\Sigma P - PM)$ , but this is correctly printed when the same expression is used in the succeeding line.

The formulae derived are as follows:

$$MV = (\Sigma P - PM) \div 1/2 N = (RM - \Sigma R) \div 1/2 N, \text{ when}$$

$N$  = total number of measures

$M$  = average or mean

$MV$  = mean variation

$P$  = number of terms greater in value than the average

$R$  = number of terms less in value than the average

$\Sigma P$  = sum of the terms greater in value than the average

$\Sigma R$  = sum of the terms less in value than the average

These same formulae are reproduced, with a slightly different symbolization, in Whipple's<sup>1</sup> Manual of Mental and Physical Tests, Part I: Simpler Processes, which was published in 1914.

The following substitutes are used:

$N_{+M}$  for  $P$

$N_{-M}$  for  $R$

$\Sigma_{+M}$  for  $\Sigma P$

$\Sigma_{-M}$  for  $\Sigma R$

.5 for  $1/2$

<sup>1</sup>Whipple's Manual of Mental and Physical Tests, Part I: Simpler Processes, p. 22. Dunlap developed the method itself and not merely the application of the calculating machine technique, as Whipple's footnote (p. 21) might imply. We are not acquainted with any previous development of the method.

Two alternative rules, based on the formulae, are given by Dunlap. In cases where all of the original terms employed are either positive or negative in sign, either of these two rules may be used. The second is a simpler one for operation on the machine. However, there are cases in which some of the terms averaged are positive and some are negative, the average being based on the algebraic sum of the terms. In these cases there may be difficulty in the application of rules (1) and (2). A third rule should be added which makes the procedure in such a case unmistakable. The procedure indicated in this third rule will avoid all danger of errors which may otherwise be serious.

The three rules which satisfy all the cases arising are as follows:

1. Add together the terms greater than the average; from the sum subtract the product of the number of terms ( $P$ ) so added, multiplied by the average ( $M$ ); and divide the remainder by half the total number of terms in the series ( $1/2 N$ ).

2. Add together the terms which are less than the average; subtract the sum from the product of the number of terms ( $R$ ) so added, multiplied by the average ( $M$ ); and divide the remainder by half the number of terms in the total series ( $1/2 N$ ).

3. In cases where the average is based on the algebraic sum of positive and negative terms, if this average is positive, compute the mean variation in accordance with Rule (1) from the positive terms which are numerically greater than the average. If the average is negative in sign, compute the mean variation in accordance with Rule (2) from the negative terms which are numerically greater than the average.



## ACTION OF SOME ANTIPYRETIC ANALGESICS ON PSYCHOLOGICAL REACTION TIME

D. I. MACHT, S. ISAACS AND J. GREENBERG

*From the Pharmacological Laboratory of the Johns Hopkins University*

In a preceding communication by Macht and Isaacs published in this Journal (1), the authors reported the results of their investigations on the effect of opium and its principal alkaloid, morphin on the psychological reaction time. Opium and morphin are the most effective analgesic or pain-relieving drugs at the disposal of the pharmacologists. There is, however, another class of drugs which is also very efficient in the relief of pain, especially of a neuralgic character. This is the group of so-called antipyretics which derive their name from the other very interesting property which they possess, namely that of reducing temperature in cases of fever. This group of drugs includes a large number of substances widely employed by physicians and laymen for the relief of headaches, neuralgias, rheumatic pains, etc. Following the investigations on the effects of opium and morphin on psychological reaction time, it was interesting to inquire into the effect of the antipyretics in this respect. Accordingly, the present research was undertaken.

The only previous work of importance on the subject worth considering is that of Münsterberg (2). That author reported some experiments on the effect of three antipyretics—quinin, antipyrin, and phenacetin—on some mental efficiency tests. The tests employed by him were the reproduction of consonants or digits read to the subject, the counting of letters in a given text within a given period of time, the time taken to name ten colors presented in a row, etc. Münsterberg found marked impairment following antipyrin and quinin. From the pharmacological point of view, however, the doses of the drugs employed in his experiments were entirely too large or toxic. Thus, for instance, the

dose of antipyrin administered by him to his subjects was 1 gram or 15 grains; whereas the ordinary therapeutic dose of that drug employed at present is a quarter of a gram or about 4 grains. In the present investigation, the doses of all the drugs employed were *therapeutic doses*.

#### METHOD

The method of investigation was the same as that followed in the opium experiments.

The reaction time was measured by means of an improved chronoscope devised by Prof. Knight Dunlap, which is a far more accurate and convenient instrument than the old Hipp instrument. The apparatus is described by Professor Dunlap elsewhere (3). It consists essentially of a synchronous motor, run on a tuning fork vibrating fifty times per second, and registering the time in units of  $2\sigma$  or  $1/500$  of a second, the dial-hand of the chronoscope being controlled by an electro-magnetic clutch.

The simple sound reaction was obtained by the experimenter calling out a word or number into the speaking disc which started the chronoscope and the subject responding with a set answer as soon as possible through another speaking disc, thus stopping the clock. The results were then recorded in terms of  $2\sigma$  or  $1/500$  of a second. It is needless to state that the subject and experimenter were separated by a curtain in order to prevent their seeing each other.

The simple touch reaction was obtained in a similar manner. The experimenter touched the hand of the subject behind a curtain, the pressure of the touch starting the chronoscope going. The subject responded as soon as he perceived the touch sensation by pressing a bulb or touching a key which immediately stopped the clock.

The simple light reflex was tested by the experimenter's pressing a key and thus lighting an incandescent lamp behind a white screen, the subject responding by pressing another key which extinguished the light and stopped the chronoscope.

In order to determine the more complex reaction time or association reaction time, various devices were tried, such as response to certain words (nouns and adjective, subject and predicate,

etc.), but none of these were found satisfactory for the purpose in view. The most convenient and satisfactory method was finally found to be the calculation of a mathematical problem. Two sets of problems were submitted to the subjects in all experiments. In one series the subject was requested to add 17 mentally to a two-figure number, such as those given in the following table (table A) and to announce the sum as quickly as possible through a telephone arrangement which breaks the circuit and stops the clock. In the second series a more difficult task was given to the subject. The experimenter in this case announced a two-figure number and the subject was required to multiply the same by 3 and add 4 to the product, and then announce the result through the speaking disc, thus recording the reaction time (table B).

TABLE A

*Exercise: Add 17 mentally  
and respond*

22	35
71	58
68	41
46	75
33	38
64	67
51	54
32	28
59	47
73	26
29	43
56	31
48	66
34	57
62	42
78	24
25	55
39	27
74	79
52	45
77	21
49	63
44	23
72	37
53	61
76	65
36	64

TABLE B

*Exercise: Multiply by 3 and  
add 4 and respond*

29	64
76	27
55	46
48	23
24	69
79	33
54	65
47	22
58	53
75	67
49	39
68	52
35	61
71	36
37	28
66	73
45	44
34	31
21	25
78	74
51	77
26	43
72	59
32	63
41	56
38	42
57	62

In each test twenty numbers were generally employed at each sitting. This method furnished quite a complicated association test and at the same time eliminated as much as possible memory and habituation or familiarity. The subject in every case was expected to go through the mathematical process in his mind and not to rely on his memory at all. Great attention was paid in the association tests to the number of errors made, and these were recorded for comparison of the normal reaction time with that obtained after the administration of a drug.

#### SUBSTANCES STUDIED

After the normal simple and complex reaction times were established in any one experiment, the subject was given a drug, and the reaction time was then again measured repeatedly at intervals in order to determine the effect of the substance. The effect of the drug was indicated by changes either in the mean reading or by changes in the mean variation between the readings, or by both. In case of association tests the number of errors made in computations, before and after the drug was administered, was also taken into account. Inasmuch as the antipyretic drugs do not lend themselves well to administration by injection, all the drugs were given by mouth under the supervision of Dr. Macht.

In testing simple reactions to sound, touch and light, the number of readings taken were generally from twenty to fifty or more in each series. In testing the association time, twenty problems were submitted by each method. An average reading was computed with the help of a calculating machine, thus saving an enormous amount of time, and the mean variations were also computed by means of an adding machine, in accordance with Dunlap's method (4).

The experiments were performed for the most part on the authors themselves, and occasionally on other subjects. About forty experiments were made in all, each lasting from two to five or more hours. The drugs studied were the following: quinin, acetanilid, acetphenetid (phenacetin), antipyrin, phenyl salicylate (salol), acetyl-salicylic acid (aspirin), and pyramidon. In

order to ascertain whether these drugs produced a synergistic effect or not, the following combinations were also studied: acetanilid and salol, phenacetin and salol, acetanilid and phenacetin, aspirin and salol, and antipyrin and aspirin. The doses of the drugs never exceeded those employed by conservative therapists.

#### SUMMARY OF EXPERIMENTS

Owing to the expense of publication, it is impossible in this paper to report in tabular form all the data obtained in the present investigation. An analysis of the results obtained will therefore be only given, and a few tables illustrating the method of carrying on the experiments. Tables 1, 2, and 3 exemplify three of the experiments which have been performed. As will be seen, upon examining them, they indicate the drug and the dose employed, the reaction time readings before the administration of the drug, and several series of readings after the drug had been taken. In each case the mean reading (M.), the mean variation (m.v.), and in case of a complex reaction the number of errors committed are indicated. Furthermore, after the administration of the drug, the relative change in the mean readings and the relative change in the mean variations have been also computed and expressed in terms of percentages of the normal. In table 4, an attempt was made to summarize the results of all the experiments. In this table the drugs used and their dosage are indicated and the most striking or maximal effect of the drugs is expressed in terms of percent of the normal reading. Furthermore, the time at which that effect was noticed is indicated and in the case of the mathematical problems the run of errors is expressed.

TABLE I  
*Greenberg; July 12, 1917, at 12.50; acetanilid—7 grains*

		SOUND	LIGHT	TOUCH	+17	×3+4
I. Normal began at 12.20	m.....	172	140	156	1486	2504
	mv.....	10	8	11	339	791
	Errors.....				3	
II. Began at 12.50, then dinner	m.....	162	140	168	1356	2180
	mv.....	10	15	11	235	394
	Errors.....				1	
	Relative change in m.....	94%	100%	107%	91%	86%
	Relative change in mv.....	100%	187%	100%	67%	49%
I. After drug at 1.50	Time.....	1 hr.	1 hr. 2'	1 hr. 38'	1 hr. 41'	1 hr. 44'
	m.....	180	154	194	1256	2212
	mv.....	11	9	16	173	533
	Errors.....				4	
	Relative change in m.....	104%	110%	135%	87%	88%
	Relative change in mv.....	110%	112%	145%	51%	67%
II. After drug at 2.56	Time.....	2 hr. 6'	2 hr. 8'	2 hr. 10'	2 hr. 10'	2 hr. 15'
	m.....	190	140	170	1316	2196
	mv.....	15	21	19	250	494
	Errors.....				3	2
	Relative change in m.....	110%	100%	108%	88%	86%
	Relative change in mv.....	150%	271%	172%	73%	62%
III. After drug at 3.22	Time.....	2 hr. 32'	2 hr. 34'	2 hr. 35'	2 hr. 37'	2 hr. 40'
	m.....	184	142	160	1354	2334
	mv.....	12	11	13	246	727
	Errors.....				1	3
	Relative change in m.....	107%	101%	102%	91%	93%
	Relative change in mv.....	120%	150%	111%	72%	91%

TABLE 2

*Dr. Macht; July 19, 1917, at 11.05 a.m.; pyramidon—6 grains*

		SOUND	LIGHT	TOUCH	+17	×3+4
Before at 10.40 a.m.	m.....	156	142	138	2088	2816
	m.v.....	11	7	10	333	692
	Errors.....				2	2
I. After drug at 11.40	Time.....	35'				
	m.....	158	140	144	1870	2718
	m.v.....	11	11	7	232	591
	Errors.....				1	0
	Relative change in m.....	100%	98%	104%	89%	99%
	Relative change in m.v.....	100%	156%	70%	69%	85%
II. After drug at 12.06	Time.....	1 hr. 1'				
	m.....	174	150	152	2028	3168
	m.v.....	20	9	17	322	705
	Errors.....				0	2
	Relative change in m.....	111%	105%	110%	97%	113%
	Relative change in m.v.....	181%	128%	170%	96%	110%
III. After drug at 1.00	Time.....	1 hr. 55'				
	m.....	208	152	152	1968	2658
	m.v.....	18	11	11	377	737
	Errors.....				0	2
	Relative change in m.....	133%	107%	110%	94%	94%
	Relative change in m.v.....	163%	157%	110%	113%	106%
IV. After drug at 2.09 (after lunch)	Time.....	3 hr. 4'	3 hr. 7'	3 hr. 11'	3 hr. 13'	3 hr. 17'
	m.....	170	136	150	2282	2838
	m.v.....	17	10	12	426	639
	Errors.....				3	2
	Relative change in m.....	109%	95%	108%	109%	100%
	Relative change in m.v.....	154%	142%	120%	128%	92%
V. After drug at 3.10	Time.....	4 hr. 5'	4 hr. 8'	4 hr. 10'	4 hr. 12'	4 hr. 16'
	m.....	180	140	140	2014	3102
	m.v.....	25	12	13	257	765
	Errors.....				0	0
	Relative change in m.....	115%	98%	101%	96%	114%
	Relative change in m.v.....	229%	145%	130%	77%	110%

TABLE 3.

*Isaacs; July 27, 1917, at 2.58 p.m.; antipyrin—600 mgm.*

		SOUND	LIGHT	TOUCH	+17	×3+4
Before	m.....	168	132	144	1484	4786
	m.v.....	13	8	9	320	1437
	Errors.....				1	2
I. After drug at 3.13	Time.....	15'	16'	18'	20'	22'
	m.....	170	124	140	1412	4994
	m.v.....	15	15	15	214	1636
	Errors.....				1	5
	Relative change in m.....	101%	93%	97%	95%	104%
	Relative change in m.v.....	115%	187%	166%	66%	113%
II. After drug at 4.12	Time.....	1 hr. 14'	1 hr. 16'	1 hr. 18'	1 hr. 20'	1 hr. 23'
	m.....	162	136	162	1620	5036
	m.v.....	18	12	14	426	1786
	Errors.....				3	2
	Relative change in m.....	96%	103%	112%	109%	105%
	Relative change in m.v.....	136%	150%	155%	133%	124%

## ANALYSIS

A careful study and analysis of all the data obtained has led the authors to the following conclusions. The results obtained with antipyretics are quite different from those found after morphin or opium. No primary stage of stimulation or shortened reaction time was noted after administration of antipyretics, except possibly after small doses of quinin. It was found that in all cases the ordinary doses of antipyretics produced either very little effect on the reaction time, or if affecting it at all, they always impaired it as indicated by the prolongation of the mean readings, by the increase in the mean variations of readings, or by both. The most powerful or depressant drug in this respect was found to be pyramidon. This is not entirely surprising inasmuch as pyramidon in the author's (M.) experience and in the experience of many physicians is one of the most efficient anal-



gesics—its effect coming closer to that of the narcotics than that of most other antipyretics. It was furthermore interesting to note that when the antipyretics exerted an influence on the reaction time, the simple reflexes or reactions to sound, light, and touch were more prolonged or impaired than the more complex association tests. Of the three simple reactions that of touch was more generally retarded than of sound or light. The association tests were also depressed or impaired, but usually in a distinctly lesser degree than the simple reactions or reflexes. Thus, for instance, the absolute readings in case of the mathematical calculations were sometimes even actually improved and the depressant effect of the drug revealed itself only through the greater number of errors committed.

Experiments with combinations of the various antipyretics gave results which could be explained by a simple summation or addition of the individual effects of the components. No so-called synergism or potentiation of one drug by another was observed.

The curious difference in the effect of the drugs on the simple reactions as compared with that on the more complex ones is the direct opposite of the results obtained after administration of opium or morphin. In the latter case, the simple reactions were always less impaired than the more complex association tests. A comparison of the findings obtained with the two groups of analgesics, the opiates or narcotics, and the antipyretic analgesics, seems to point to some lower synapse as the seat of action of the coal tar derivatives.

TABLE 4

SUBJECT	DRUG	DOSE	SOUND		LIGHT		TOUCH		ADD 17			MULTIPLY BY 3 AND ADD 4		
			Time when Relative change in mean reading per cent	Relative change in mean variation per cent	Time when Relative change in mean reading per cent	Relative change in mean variation per cent	Time when Relative change in mean reading per cent	Relative change in mean variation per cent	Time when Relative change in mean reading per cent	Relative change in mean variation per cent	Time when Relative change in mean reading per cent	Relative change in mean variation per cent	Time when Relative change in mean reading per cent	Relative change in mean variation per cent
Greenberg.....	Acetamid	5	40'	115 117	1° 30'	113 140	1° 32'	116 250	40'	131 124	2-4-3	40'	94 108	3-2-4
Greenberg.....	Acetamid	7	1° 16'	110 150	1° 18'	100 271	1° 20'	108 172	1° 22'	88 73	3-1-4-3-1	1° 25'	86 62	0-40-1-2-3
Isaacs.....	Acetamid	5	42'	112 106	44'	111 84	50'	110 120	55'	95 119	1-1	1°	107 108	3-9
Isaacs.....	Acetamid	7	1° 38'	105 100	1° 40'	97 130	1° 42'	107 190	1° 17'	135 266	0-1-3-2-1	1° 20'	119 209	4-8-10-8-8
Macht.....	Acetamid	5	45'	105 83	50'	92 127	54'	88 92	57'	125 108	3-2-2	1° 2'	96 83	5-3-1
Macht.....	Acetamid	5	1° 29'	83 60	1° 31'	96 115	1° 32'	112 136	1° 34'	107 120	2-40-1	1° 38'	100 164	2-3-5
Macht.....	Acetamid	8	43'	105 106	45'	107 77	47'	103 162	48'	97 94	2-2-0	53'	94 77	4-5-3
Greenberg.....	Salol	10	20'	114 68	22'	113 90	24'	110 114	26'	102 130	1-40-1	30'	96 68	1-1-2
Isaacs.....	Salol	10	31'	111 92	33'	98 88	37'	101 107	39'	109 174	0-2	43'	110 92	0-1
Macht.....	Salol	10	24'	97 94	26'	112 126	28'	110 114	29'	91 189	0-0	31'	90 114	0-1
Greenberg.....	Antipyrin	5	54'	101 75	55'	97 81	57'	93 111	59'	112 117	1-2-0	1° 1'	106 55	2-2-2
Isaacs.....	Antipyrin	10	1° 14'	96 138	1° 16'	103 150	1° 18'	112 155	1° 20'	104 133	1-1-3	1° 23'	105 124	2-5-2
Macht.....	Antipyrin	5	50'	94 100	52'	100 76	54'	91 75	56'	95 74	1-40-0	59'	121 183	2-2-2
Greenberg.....	Aspirin	10	34'	98 137	35'	107 78	36'	98 225	38'	128 174	1-1-2	40'	126 181	1-1-0
Dr. R.....	Aspirin	10	30'	109 106	32'	79 84	34'	106 200	36'	92 65	5-1	40'	94 86	3-8
Macht.....	Aspirin	10	21'	101 141	23'	103 85	24'	90 50	26'	100 145	0-1-0	30'	113 91	1-3-1
Greenberg.....	Pyramidin	6	1° 1'	104 137	1° 3'	112 155	1° 10'	114 106	1° 12'	112 112	2-2-2-2-2	2° 4'	92 155	2-1-2-2-2
Isaacs.....	Pyramidin	9	1° 48'	109 100	56'	110 107	1° 52'	105 125	1° 56'	103 105	3-2-40-2	2° 6'	116 143	2-10-5-3
Macht.....	Pyramidin	6	1° 55'	133 163	1° 57'	107 157	1° 59'	110 110	3° 13'	109 128	2-1-0-3	3° 17'	100 92	2-0-2-2-2
Greenberg.....	Quinine S.	7	1° 37'	96 84	1° 39'	106 137	1° 41'	106 128	1° 41'	94 105	0-40-1	1° 45'	104 178	0-40-1
Isaacs.....	Quinine S.	5	1° 5'	91 112	1° 7'	83 118	1° 9'	90 133	1° 11'	94 85	4-3-3-0	1° 15'	94 83	2-1-1-3
Greenberg.....	Acetphenetid	5	1° 28'	94 107	1° 30'	95 116	1° 32'	106 150	1° 34'	94 70	0-1-1	1° 38'	91 84	1-4-1
Isaacs.....	Acetphenetid	5	40'	116 88	42'	96 112	44'	117 133	45'	112 200	2-2	48'	124 136	2-2
Macht.....	Acetphenetid	5	35'	109 71	37'	105 81	39'	110 175	41'	109 118	2-40	1° 41'	124 104	0-1-0

Isaacs.....	Antipyrin Aspirin	3 5	26' 106142	28' 120	80	30' 107 90	33' 84 42	2→0→3	37' 103104	2→3→2
Greenberg...	Antipyrin Aspirin	3 5	1°29' 101 75	1°33' 103 78	1°36' 110 73	1°38' 95151	1→1→1→1	1°43' 103100	1→1	
Isaacs.....	Salol Aspirin	5 5	40' 97160	42' 103 57	44' 104 82	46' 106120	1→0	50' 110156	3→4	
Greenberg...	Salol Aspirin	5 5	1°13' 118160	1°14' 96 63	1°16' 111 210	1°17' 107136	1→1	1°19' 105108	2→1	
Macht.....	Acetanilid Salol	2.5 2.5	17' 100 91	19' 88100	20' 100100	21' 101 67	0→0	24' 125210	1→0	
Greenberg...	Acetanilid Salol	2.5 2.5	1°18' 117110	1°20' 113 77	1°22' 114135	1°25' 94 84	0→0	1°27' 97 97	1→1	
Isaacs.....	Acetanilid Salol	2.5 2.5	1° 93108	1° 2' 108154	1° 4' 105109	1° 6' 110103	2→1	1°10' 101118	5→4	
Macht.....	Acetphenetidin Salol	5 5	1°10' 92 56	1°12' 99144	1°14' 91133	1°16' 104 97	0→2	1°20' 88 60	1→0	
Greenberg...	Acetphenetidin Salol	5 5	1°21' 103110	1°22' 104200	1°24' 108138	1°37' 108 90	2→1→1	1°40' 117149	1→0→1	
Isaacs.....	Acetphenetidin Salol	5 5	2°51' 102 64	2°53' 106 81	2°55' 104120	2°56' 88 92	0→0→1	2°58' 111121	6→4→4	
Greenberg...	Acetphenetidin Acetanilid	3 3	1° 1' 103125	1° 2' 103 91	1° 3' 106 84	1° 5' 110 75	0→1→1	1° 7' 89 73	0→0→0	

## SUMMARY

1. All the antipyretics with the possible exception of quinin tend to impair or retard the psychological reaction time.

2. The simple reactions to sound, light, and touch, if anything are more affected than the more complex or association reaction times.

3. Combinations of antipyretics give results explainable by simple addition of the effects of the components.

4. The greater change in the simple reactions as compared with the more complex ones seems to point to the seat of action of the antipyretic analgesics as being on some lower synapse than that which is affected by morphin or opium.

## REFERENCES

- (1) MACHT AND ISAACS: *Psychobiology*, 1917, i, 19.
- (2) MÜNSTERBERG: *Beiträge zur Exp. Psych.*, 1892, iv, 121-146.
- (3) DUNLAP: *Journal Exp. Psych.*, 1917, ii, June.
- (4) DUNLAP: *Psychological Review*, 1913, xx, 154.

SOME NOTES ON THE AUDITORY SENSITIVITY OF THE WHITE RAT

WALTER S. HUNTER  
*University of Kansas*

Since the publication of the earlier work on the auditory sensitivity of the white rat (1), it has been possible to secure additional data that merit publication. Inasmuch as the material, however, comes from several diverse lines of work rather than from one systematic study, it is thought best to present it in the form of notes.

I

Mr. Otto Weir tested the sensitivity of eight rats to the tone 4096 d.v. sounded on a tuning fork. Of the eight rats, six (rats 1 to 6) were adults and two (rats 7 and 8) were young rats. Rat 6 was a female; the sex of rat 4 was undetermined; and the others were males. All of the rats were untrained save rats 1 and 2 who had mastered the Watson circular maze. Ten trials daily with punishment and reward were given using a varying presentation to prevent the formation of position habits. The apparatus was the same as that used in the earlier experiments, consisting of the T-shaped discrimination box wired for the administration of an electric shock when errors were made. This box is illustrated in figure 1. The tuning fork was securely clamped by the shank about 12 inches above the center of the apparatus. Contact with the apparatus was possible through the clamps, rods and table upon which latter the apparatus rested. Pads of cotton were placed between the shank of the fork and the clamps partly in order to reduce accessory vibrations and partly to produce a clearer tone. No resonator was used. The tuning fork was activated by striking with a metallic hammer especially constructed for the purpose by the instrument maker.

The attempt was made to compel the rats to associate turning to the right through the box with the tone produced by striking the fork. In the six older rats, turning to the left was to be associated with a noise produced by striking the fork with the hammer while holding the prongs of the fork between the thumb and finger. In this case the fork was struck at the same tempo as when a tone was produced. Noises of two slightly different kinds were present, although at one time the tone was absent and at another it was absent. In the two younger rats (rats 7 and 8), turning to the left was to be associated with silence.

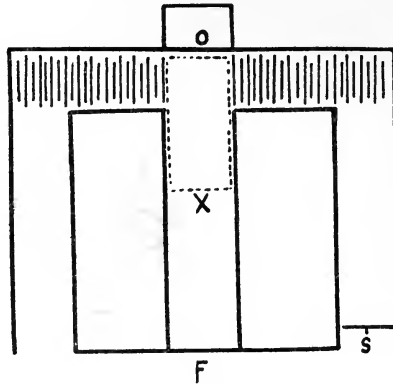

FIG. 1. T-SHAPED DISCRIMINATION BOX

*O*, the box containing the light; *F*, food bowl; *S*, alley stop; *X*, point above which tuning forks and whistles were clamped. The dotted area indicates the position of the sandpaper in certain tests.

Table 1 gives the percentage of correct responses made by each rat for each successive fifty trials of the learning period. It will be seen from an examination of this table that rat 3 was the only one who made significant progress toward the establishment of the required habit. This rat made better than 70 per cent of correct reactions for the last three groups of fifty trials. It was therefore given certain control tests in order to determine the nature of the cue guiding its response.

It did not prove practical to eliminate noise by using electrically driven forks because of the fork's small amplitude of vibra-

TABLE 1

*Percentage of correct responses in each succeeding 50 trials*

TRIALS	RATS							
	1	2	3	4	5	6	7	8
50	32	40	28	36	58	42	60	54
100	44	58	52	58	54	42	50	56
150	26	44	60	42	56	54	64	56
200	52	52	72	50	54	52	56	50
250	48	52	65	68	60	54	56	64
300	38	44	65	53	64	58	54	50
350	24	52	50	42	52	48	48	52
400	58	48	45	50	57	54	60	64
450	34	42	54	42	44	36	74	48
500	62	48	28	48	48	36	56	56
550	50	56	80	60	60	52	50	34
600	46	56	74	60	60	40	54	56
640	48	47	70	56	50	50	54	58

tion. The controls are therefore not conclusive, although the indication is that tone sensitivity is absent. The following controls were used with rat 3:

*Control 1.* The noise stimulus ordinarily used only for turning to the left was used for all trials. This substituted a certain "thud" for the "tone and thud" previously used as a cue for turning to the right. No tone therefore was given. All other conditions normal. The response was counted correct if it coincided with the order of presentation.

*Control 2.* The supports of the tuning fork were fastened to tripods resting upon the floor and in some cases upon two adjacent tables. This control ruled out the possibility of contact cues due to the transmission of vibrations through the table to the discrimination box.

*Control 3.* Cotton was forced between the prongs of the fork. Striking the fork now produced a faint tone of high pitch as well as a noise of new quality. The same stimulus from striking the fork was given in each trial. The reactions were counted as correct if they fitted the series of presentations.

Control 1 caused a breakdown in the rat's high percentage of correct responses. When this control was alternated with normal conditions on intervening days, correct responses did not

exceed 60 per cent, although the normal conditions gave 73 to 80 per cent correct response. Clearly something was eliminated that had served to determine the rats responses. The results, however, do not prove tone sensitivity because the "thud" caused by the free fork was different from the "thud" of the fork when held and may have served as the basis of the original discrimination.

Control 2 did not disturb the accuracy of the rat's responses.

Control 3 was given one day with an accuracy of 50 per cent; two days, with 70 per cent; and one day each with 60, 50, and 40 per cent. In this control the stimulus used for each trial was the same. The results of this control indicate, therefore, that a high percentage may be made without using an auditory cue. They are also partly in harmony with the view that the original response was influenced by the differences in the noises involved.

These three controls have not determined the exact basis of the response during the normal tests. Inasmuch as the percentage of correct responses was not stable during those tests, and was not particularly high, it seems probable in the light of these controls and of other published work, that rat 3 was not reacting to tone stimulation.

## II

The experiments on audition to be reported in this section were made in the summer of 1914 and again in the spring of 1915 at the University of Texas. In the course of some correspondence, Professor Carr of the University of Chicago described some of the work then being carried out at that university by Mr. Harry Wylie on transfer of training. At that time the present writer was making a study of auditory sensitivity and of habit interference as published in the 1915 and 1917 articles listed above. The methods and apparatus employed were peculiarly adapted to the study of Wylie's method dealing with transfer between sense fields. The method of inter-sense transfer was therefore employed with the result that valuable data bearing upon tone sensitivity were secured. This data was not made public until Wylie presented his report at the 1915 meeting of



the American Psychological Association (2), when a verbal report of the present finding was made.

The apparatus used was the T-shaped discrimination box of the earlier experiments, figured above. A hole about 1 inch in diameter was cut in the box at the point marked *O* in the figure. Outside of the apparatus and directly in front of this hole was placed a 10 candle power light enclosed in a covered box. This light could be turned off and on as desired. The hole in the box was closed with a square of clear glass over which a layer of bond typewriter paper was placed. The result was a diffused light of good intensity (somewhat less than 10 candle power).

The first rats used were rats 46 and 47 of the 1915 paper. These rats were about six months old at the time of the present observations. They had been trained to discriminate a piston whistle tone of 3906.17 d.v. from silence by running to the right when the tone was given and to the left for silence. Controls had been used which indicated that the rats would substitute for the whistle either: "rush of air" sound made by the whistle without the tone; a "rush of air" sound made with the experimenter's lips; or handclapping of medium intensity. In other words, the rat would run to the right when either of the above stimuli were given, and to the left for silence. On the other hand when the following tonal stimuli were substituted for the whistle the rat failed to discriminate them from silence: one 1280 d.v. fork; a 1152 d.v. and a 1280 d.v. fork sounding simultaneously; and the normal whistle when it was removed to a distance, thus eliminating the usual noise accompaniment. Transfer was therefore possible without training from one noise (that of the whistle) to various others; but not possible from the noise in question to tonal stimuli.

It was at this point that the suggestion derived from Wylie's work was applied. The rat was placed in the apparatus and stimulated with a light in place of the whistle in order to see if a transfer would be made between the two sense fields in spite of the fact that the previous transfer within the auditory sense field had not occurred. The results for the two animals are given in table 2. The rats were given the regular whistle test in a dark

room on the first day in order to be certain that the darkness would not disturb the reaction. On the following day the rat was placed in the apparatus with the room dark and the light at *O* turned on. A correct response consisted either of running to the right for the light or to the left for darkness. As the table indicates, rat 46 failed to make the substitution, making only 5 correct reactions out of 10 on each of two days with the light. This was mere chance. Rat 47, on the other hand, made the substitution on each of three days, making 9, 8, and 9 correct reactions respectively.

TABLE 2  
*Data on light substitution*

	TRIALS	TRIALS CORRECT
Rat 46:		
Normal whistle in dark.....	10	9
Light.....	10	5
Light.....	10	5
Normal whistle in dark.....	10	8
Rat 47:		
Normal whistle in dark.....	10	9
Light.....	10	9
Light.....	10	8
Light.....	10	9
Normal whistle in the dark.....	10	9

These results indicate clearly a greater similarity, for the behavior of rat 47, between noise and light than was found between noise and tone. This is harmonious with the apparent fact of insensitivity to the tones as indicated in the earlier papers.

Five rats, 1, 7, 9, and 11, had been trained in 1915 to discriminate handclapping from silence, using the same apparatus, by running to the right for handclaps and to the left for silence. (A description of this work is published in the 1917 article.) No direct tests were made on their ability to substitute tones for the noise. It is legitimate to assume that, like all of the many rats heretofore tested, they would have failed. They were tested however upon their ability to substitute a tactual and a visual stimulus for the noise. For the tactual stimulus a piece of coarse

sandpaper was laid in the alley at the point indicated in dotted lines in the figure. (The rat was to run right for the contact and left for its absence.) The visual stimulus was the same used with the two rats above described.

The results secured are given in table 3. It will be seen from this that rat 1 failed to substitute the light for the noise. The sandpaper gave 70 per cent correct reactions, which is slightly better than chance but which does not demonstrate clearly that the substitution was made. Rat 7 clearly failed on the sandpaper, but gave slight evidences of substituting the light. The same statements are true of rat 9. Rat 11 failed to substitute the sandpaper. On the other hand, the data on light indicate a clear-cut and all but perfect substitution similar to that in the case of rat 47 described above.

It is perhaps a safe conclusion that light and noise are more similar for the behavior of rat 11 than are noise and tone, although no direct tests of tone sensitivity were made. The justification for such a conclusion would rest upon the lack of evidence for tone sensitivity in the white rat, and upon the behavior of rat 47 above. With all of these rats careful controls indicated that they were not dependent upon the series of presentations, but were guided, normally, by auditory stimuli.

### III

In the 1917 paper, tests were described in which three rats, 7, 15, and 23, acquired the habit of running to the right for handclaps and to the left for silence. They were then trained to run to the left for a buzzer and to the right for silence. At the close of this second training, when retested on the first habit, no one of the three fell below 80 per cent correct responses for 30 trials. Rat 27 also acquired the two habits serially. Rats 7 and 27 were continued in the experiments, to be described in this section, for the purpose of determining additional features underlying their reactions.

Each of these rats could respond correctly in either of the two following three ways: run right for handclaps (h.c.) and left for

TABLE 3

*Data on the substitution of light and sandpaper*

RAT	CONDITION OF TEST	NUMBER OF TRIALS	NUMBER CORRECT
1	Normal handclaps.....	10	8
	Sandpaper.....	10	7
	Handclaps.....	10	8
	Sandpaper.....	10	8
	Sandpaper.....	10	7
	Sandpaper.....	10	7
	Sandpaper.....	10	7
	Handclaps.....	20	17
	Light.....	10	5
	Handclaps.....	10	5
	Handclaps.....	10	7
	Handclaps.....	20	18
	Light.....	10	6
	Handclaps.....	10	6
Handclaps.....	20	16	
7	Normal handclaps.....	20	20
	Sandpaper.....	10	5
	Handclaps.....	10	10
	Sandpaper.....	10	6
	Handclaps.....	10	7
	Handclaps.....	10	8
	Sandpaper.....	10	6
	Handclaps.....	30	26
	Light.....	10	7
	Handclaps.....	10	10
	Light.....	10	5
	Handclaps.....	10	7
	Handclaps.....	10	8
	Light.....	10	7
Handclaps.....	20	16	
9	Normal handclaps.....	20	16
	Sandpaper.....	10	5
	Handclaps.....	10	10
	Sandpaper.....	10	5
	Handclaps.....	10	6
	Handclaps.....	10	10
	Sandpaper.....	10	5
	Handclaps.....	20	14
	Handclaps.....	10	8
	Light.....	10	7
	Handclaps.....	10	10
Handclaps.....	20	17	

TABLE 3—Continued

RAT	CONDITION OF TEST	NUMBER OF TRIALS	NUMBER CORRECT
9	Light.....	10	8
	Handclaps.....	10	8
	Light.....	10	6
	Handclaps.....	10	8
	Normal handclaps.....	10	8
	Sandpaper.....	10	5
	Handclaps.....	10	8
	Sandpaper.....	10	8
11	Sandpaper.....	10	6
	Sandpaper.....	10	6
	Handclaps.....	10	8
	Sandpaper.....	10	5
	Handclaps.....	30	24
	Light.....	10	10
	Handclaps.....	10	10
	Light.....	10	9
	Handclaps.....	10	9
	Light.....	10	10

silence; run left for buzzer and right for silence; or run right for h.c. and left for buzzer. Each day's work was begun with either of the auditory stimuli. This determined the right or left turn and silence was then treated accordingly. Controls were now instituted in an attempt to determine just wherein the difference between the two noises lay. Illness in the animals finally prevented an entirely satisfactory solution. The data are presented in their present fragmentary form because it will probably rarely happen that an experimenter will have rats possessed of these two habits, thus making possible the extension of the work.

The work on auditory sensitivity in the white rat has indicated an insensitivity to tones in the lower portion of the scale and also to some as high as the pitch 4096 d.v. on the fork. It has also demonstrated that the rat can hear noises. In the case of rats 7 and 27, the opportunity was offered to extend these previous observations on noise. *Are noises for the rat grouped into the three classes of continuous, intermittent and beat noises as Hensen claims for man?* The buzzer used in the tests with rats 7 and 27 gave a continuous sound and the handclaps constituted an inter-

mittent noise of about 150 interruptions per minute. The experimenter had been using handclaps for a noise stimulus for many months and had reduced the clapping to an automatism which varied but slightly in rate.

The following are the controls used in the analysis of the two habits described. (In the formation of the habits, punishment and reward were used. In the controls, punishment was never used for fear of breaking up the association.)

*K* = turn right for h.c. and left for buzzer.

h.c. = turn right for h.c. and left for silence.

*B* = turn left for buzzer and right for silence.

Control 1. Hissing through the teeth, turn left.

Control 2. Hissing through teeth, turn right.

Control 3. "Rush of air" sound with lips, turn right.

Control 4. "Rush of air" sound with lips, turn left.

Control 5. Buzzer sounded for two seconds, at intervals of one second, turn left.

Control 6. Buzzer sounded normally, turn right.

Control 7. Metronome beating 120 per minute, turn right.

Control 8. Metronome beating 120 per minute, turn left.

Control 9. Metronome beating 200 per minute, turn right.

Control 10. Metronome beating 200 per minute, turn left.

Control 11. Metronome beating 160 per minute, turn right.

Control 12. Metronome beating 176 per minute, turn right.

Control 13. Motor knocking 180 per minute, turn right.

Control 14. Motor knocking 232 per minute, turn left.

Control 15. Motor knocking 140 per minute, turn left.

Control 16. Motor knocking 240 per minute, turn right.

Control 17. Motor knocking 250 per minute, turn left.

Control 18. Motor knocking 500 per minute, turn left.

Control 19. Beats 120 per minute with 512 v.s. forks, turn right.

Control 20. Beats 142 per minute with 512 v.s. forks, turn right.

Control 21. Beats 174 per minute with 512 v.s. forks, turn right.

Control 22. Beats 3840 per minute with 512 v.s. and 576 v.s. forks, turn left.

Not all of these controls could be used with each rat, and the limitations of time prevented their being exhaustively applied. The buzzer used was an ordinary commercial one and was sus-

pended above the apparatus in a manner which prevented the transmission of vibrations directly to the box. When the metronome was used, it was placed upon a ledge just to the back and above the apparatus and entirely separated from direct connection with the experimental table. The forks used (mounted upon resonance boxes) were suspended in the same manner as the buzzer. In controls 13 to 18 a strip of metal was fastened to the spindle of a motor in such a manner that the rotations of the motor caused it to strike at a definite rate against a cardboard. This gave an excellent noise of medium intensity and of volume and quality different from the handclaps. The motor (a silent one) was placed upon a nearby table.

The results secured are summarized in table 4. Rat 7, who was tested with the beats from the forks, ignored them and would not class them either with the continuous or with the interrupted noises. Hissing and the "rush of air" sound were substituted readily for the buzzer, *i.e.*, at least 80 per cent correct reactions were made going to the left for these noises and to the right for silence. The metronome beating at 120 and at 176 were substituted for the handclap successfully; whereas the rat persistently refused to run to the right for the metronome at 200 and to the left for silence. Two 512 v.s. forks mistuned to give beats of 142 and 174 per minute were ignored as were the beats from the forks 512 v.s. and 576 v.s. sounding together. *The evidence suggests that the rat was insensitive to the beats, which is very interesting inasmuch as beats are periodic variations in intensity and the rats seem insensitive to tone.* The evidence also indicates that the transition between continuous and intermittent noises occurs in the region of 200 interruptions per minute.

Rat 27 ran to the left for hissing, and for the motor knocking at the rate of 500 per minute. It refused to go to the left for the motor knocking at the rate of 232 per minute and for the metronome at 200 per minute (right for silence). The motor rate of 250 was neither clearly rejected from nor clearly included with the continuous sounds. The rates of 120 and 180 per minute were definitely substituted for the handclaps, whereas hissing, the buzzer, and the metronome at 160, 200 and the motor at 240 were

TABLE 4  
*Controls used with rats in analysis of buzzer-h.c. habit*

RAT 7		RAT 27	
Control	Number correct in 10	Control	Number correct in 10
K	9	K	9
1	9	2	7
5	3 of 7	1	7
K	18 of 20	B	6
5	9	B	9
3	4	1	8
4	9	B	8
7	8	2	6
9	5	B	7
K	9	K	7
7	8	K	9
9	5	K	35 of 40
K	9	1	8
K	10	1	8
20	6	2	4
7	7	B	8
7	8	7	8
9	4	9	4
K	10	6	4
20	6	16	5
19	7	17	10
K	10	17	7
19	6	9	7
19	5	K	10
19	5	9	8
K	9	10	6
12	9	K	7
9	5	K	9
K	10	h.c.	16 of 20
22	5	11	5
22	4	11	6
B	8	11	19 of 30
		9	5
		B	9
		10	6
		h.c.	7
		h.c.	10
		9	6
		B	7
		h.c.	9
		1	9
		9	4
		h.c.	16 of 20
		9	6
		h.c.	9
		11	7
		h.c.	18 of 20
		9	6
		h.c.	9
		9	31 of 50



clearly rejected from the class of interrupted noises. Because of the rat's refusal to class the metronome at 160 with the intermittent noises, the results are not so clear cut as might be desired. However, as with rat 7, the indication is that the frequencies around 200 are the critical ones.

It seems probable that the discriminations here made by the two animals were discriminations of "qualities" rather than of "rates." The difference between the noise group of hissing, buzzing and "rush of air" and the noise group of handclaps and slow metronome beats is the qualitative difference of continuous and intermittent pointed out by Hensen. The indications are, therefore, that for the white rat there are two classes of noises—beats are apparently not sensed.

#### REFERENCES

- (1) HUNTER, W. S.: The auditory sensitivity of the white rat. *Jr. Animal Behav.*, 1914, 4, 215-222; and 1915, v, 312-329.  
HUNTER, W. S., and YARBROUGH, JOS. U.: The interference of auditory habits in the white rat. *Jr. Animal Behav.*, 1917, vii, 49-65.  
BARBER, A. G.: The localization of sound in the white rat. *Jr. Animal Behav.*, 1915, v, 292-311.
- (2) WYLIE, H. H.: Some experiments on transfer of training. *Psych. Bull.*, 1916, xiii, 78-79.



# A SIMPLE MAZE: WITH DATA ON THE RELATION OF THE DISTRIBUTION OF PRACTICE TO THE RATE OF LEARNING

K. S. LASHLEY

*The Johns Hopkins University and the University of Minnesota*

## I. A TEST OF THE VALIDITY OF RESULTS OBTAINED WITH THE SIMPLE MAZE

The use of complicated mazes for the study of learning in animals originated in an effort to determine the limits of educability of the lower mammals. The problem of habit-formation in animals soon expanded, however, to include the more general problem of the mechanism of learning and this led to a search for a method of comparing individual differences in learning ability and average differences for groups trained under diverse conditions. The application of the complicated maze to the determination of individual differences followed as a matter of course, since it provided a practicable technique for the training of animals. But in none of the pioneer work, nor, indeed, in any of the studies thus far recorded, has there been a thorough test of the applicability of the maze technique to the particular problems studied by its aid. This is true also of the various problem boxes and other apparatus used for training animals in complex habits.

The study of habit formation in animals has now advanced to a stage where accurate work is possible and where statistical methods can and should be employed for the evaluation of data. Many problems require the comparison of the rates of learning of numerous animals trained under diverse conditions, as in studies of the action of drugs. If the animals are trained in complex habits the experiment frequently requires an expenditure of time out of proportion to the results obtained, and the necessary

restriction of the data to a few subjects leaves the experimental results inconclusive. A simpler technique is therefore desirable; one by which the subjects may be trained rapidly and data gathered upon a large number within a reasonable time. The training of larger numbers might, perhaps, be accomplished by the use of automatic training and recording apparatus but the apparatus of this character that has been devised is bulky, expensive, and not altogether dependable. Further, many animals seem to be much more disturbed by mechanical contrivances in the training box than by manipulation in the hands of the experimenter and the preliminary training necessary to accustom them to moving doors, and the like, nearly counterbalances the advantages of automatic training. The alternative method for gathering larger amounts of data involves the training of the animals in some easily acquired habit for which no great expenditure of time will be required by any one animal.

A widely accepted objection to the use of simpler habits arises, however, from the possibility that these may fail to demonstrate individual differences which would appear in more complex forms of learning. This is perhaps true where the primary interest of the study is in the comparative intelligence of the animals but where the problem is primarily that of the mechanism of learning, the nervous changes involved in the reintegration of conduction paths, the phenomena resulting from the complexities of the habit only serve to confuse the data and make it impossible to distinguish between the effects of simple reintegration and those resulting from the simultaneous formation of a number of habits. This confusion is illustrated by the results of studies of the effects of the distribution of practice upon the rate of learning. Such results, as I have shown in previous articles (Lashley, '15 and '17) are due at least in part to the interference of simultaneously formed habits and, as the present study indicates, are probably always due to the complexity of the habit and not to any fundamental character of the learning process. The failure of a simple habit to reveal a difference which appeared when more complex habits were studied should indicate, therefore, that the difference found was due to some factor introduced by the formation of

several habits simultaneously, rather than that training in the simple habit failed to reveal any fundamental differences in the processes of learning.

In view of the need for a simpler technique it seemed that a study of the adaptability of some simple habit to a comparative study of the rate of learning in diverse groups of animals would be of value. Since the rat is the animal most studied and perhaps best fitted for laboratory study it was chosen for a test of technique. Various attempts were made to adapt the methods of study of the conditioned reflex to the rat, but without much

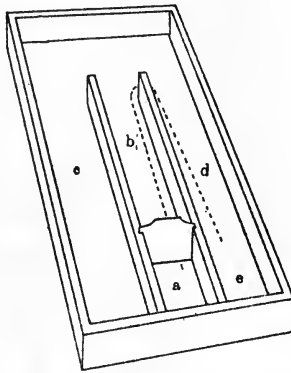

FIG. 1. THE SIMPLE MAZE

*a*, Starting compartment; *c*, cul de sac; *d*, food compartment; *e*, position of food dish.

success, and finally a simple maze was adopted as offering a possible technique for comparative work. It was modeled after the Yerkes discrimination box, offering a choice between a single cul de sac and an alley leading to food (fig. 1).

The questions to be answered by the study were: When differentially treated animals learn the simple maze are differences in the rate of learning as evident as in the formation of complex habits? If such differences appear, are they of the same character as those revealed in complex habits? How great an economy of the experimenter's time is made possible by the use of the simple maze?

It seemed advisable to use some conditions of training which have been tested already in complicated mazes, and of these the use of practice periods of diverse length was selected as a condition whose general results are well established and whose details are capable of wide variation.

Twenty-five rats were trained in the simple maze with 10 trials per day and 24 with 2 trials per day. Entering the cul de sac or turning back along the true path was counted as an error and ten successive trials without error were required as a criterion of learning. The general precautions to secure uniformity in the groups compared were those which I have described in an earlier study of the circular maze (Lashley, '17b). The conditions or feeding were varied somewhat within the groups: details of this will be considered in the second part of this paper.

The average number of trials required for learning by the animals having 2 trials per day was  $21.5 \pm 0.81$ . The average number for the animals having 10 trials per day was  $57.8 \pm 4.70$ . The difference is  $36.3 \pm 4.76$  trials in favor of the group practicing with fewer trials per day; a saving of about 60 per cent as a result of the distributed practice. This result is in accord with the data obtained by Ulrich ('15) in his study with the circular maze and indicates that the simple maze is as well adapted to bring out group differences of this character as is the more complicated apparatus.

When the animals had learned the maze they were used in operative experiments. Portions of the cerebral cortex were destroyed and retention of the maze habit was tested after the operation. In this type of work also the simple maze proved useful (Lashley and Franz, '17).

With respect to the time consumed in training, the simple maze offers a great advantage over the more complicated apparatus. The average time consumed by each of the 49 animals in actual practice in the maze was 7.4 minutes. The average time required in practice by a group of 32 normal animals trained previously in the circular maze was 47.1 minutes. That is, more than six times as much time must be spent in training animals in the circular maze as in the simple maze, yet the results of the former method are in no way more reliable than those of the latter.

The saving of time is probably of less importance than these figures suggest, for a great deal of time is consumed in placing the animals in the starting compartment, in waiting for them to enter the maze, in recording their behavior, and in caring for them between training periods, so that the time spent in actual training is only a small per cent of that demanded by experimental work. Even so, the item of 40 minutes saved in the training of each animal is not to be neglected.

It seems then that the simple maze offers a dependable method of comparing individual differences in learning ability, not inferior to that provided by training in more complex habits, and that it affords a significant economy of the experimenter's time.

## II. DATA ON THE EFFECTS OF THE TEMPORAL DISTRIBUTION OF PRACTICE

The relative simplicity of the habits that must be formed for the accurate running of the simple maze has made it possible to distinguish certain types of behavior which seem correlated with the effects of the temporal distribution of practice and may contribute something to our knowledge of the way in which long practice periods retard habit-formation in the rat. The experiment was originally planned to test the effects of a variety of methods of training other than variations in the distribution of practice. The unexpected result appeared that the diverse methods of training produced different effects, conditioned by the distribution of practice, and it is in these different effects that the chief interest of the experiment lies.

For training the animals were divided into four groups with which diverse methods of training were used. With one of the groups (A) the customary methods of training were employed. Food was placed in the end of one alley (fig. 1, *e*). The animals were confined in the end of this alley and fed there on three days preceding training. During training they were allowed to reach the food at every trial; that is, to correct errors made in the cul de sac.

The second group (B) received similar training except that the animals were allowed to explore the entire maze, without food, for 20 minutes on the day before training was begun.

The third group (C) was treated like the first except that the animals were not allowed to correct their errors but were returned immediately to the starting compartment if they entered the cul de sac or turned back along the correct path. Each time that they were returned to the starting compartment a trial was recorded, whether or not they had reached the food.

The fourth group (D) was trained like the first except that a dish of food, covered with fine wire netting so that the food could not be reached, was placed in the end of the cul de sac.

Each of these groups was subdivided into two, one of which received ten, the other two trials per day. A summary of the groups is given in table 1.

TABLE 1  
*Conditions of training for animals tested in the simple maze*

GROUP	VARIATIONS FROM CUSTOMARY METHODS OF TRAINING	NUMBER OF ANIMALS	
		Two trials per day	Ten trials per day
A	Normal.....	10	9
B	Preliminary exploration.....	5	5
C	Errors not corrected.....	5	5
D	Screened food in cul de sac.....	5	5

Training was continued until the animals made ten successive trials without error. In some cases training was continued beyond this point for as much as 200 trials. None of the animals so trained made more than 5 per cent of errors in these later trials, so that the criterion may be looked upon as indicating practically perfect learning.

The average numbers of trials per day required by the different groups are given in table 2. Under all the various conditions of training the animals which were trained with only two trials per day learned more rapidly, per unit of practice, than those which were trained with ten trials per day. The average difference for all the groups resulting from the different distributions of practice



TABLE 2

*The average number of trials required for learning the simple maze by animals trained under diverse conditions*

GROUP	AVERAGE TRIALS AT 2 PER DAY		NUMBER OF RATS	AVERAGE TRIALS AT 10 PER DAY		NUMBER OF RATS	DIFFERENCE (TRIALS)	
A	21.1	0.8	10	51.7	4.3	9	30.6	4.4
B	19.2	1.9	5	29.4	3.6	5	10.2	4.1
C	22.6	1.7	5	44.6	2.7	5	22.0	3.2
D	25.2	2.4	5	110.4	9.7	5	85.2	9.9
All	21.5	0.8	25	57.8	4.7	24	36.3	4.8

is  $36.3 \pm 4.8$ , and as this is nearly eight times its probable error indicates a real effect of the distribution of practice.

But among the groups trained by different methods the effects of distribution of practice vary enormously, from a minimum of 53 per cent to a maximum of 338 per cent increase in practice required for learning following equal lengthening of the practice periods. The relatively slight individual variation within the groups, indicated by the small probable errors, makes the differences significant.

The methods of training most effective in producing variations from the rate of learning determined in the customary way were preliminary exploration of the maze without food and presence of screened food in the cul de sac. The significant differences found are:

	TWO TRIALS PER DAY		TEN TRIALS PER DAY	
A-B.....	1.9	2.0	22.3	5.6
D-A.....	4.1	2.5	58.7	10.6

(C and A are practically identical.)

The influence of these different methods of training was in the same direction for both concentrated and distributed practice, but only in concentrated practice were marked effects produced.

The simplicity of the movements involved in traversing the maze made it possible to record the behavior of the animals in detail and to distinguish characteristic differences in the behavior of the different groups which seem to be correlated with the rate

of learning. The variations in behavior relate chiefly to two instinctive modes of response to the maze problem.

1. When given food in a somewhat unfamiliar environment the rat will almost invariably explore the neighborhood of the food before eating. In the circular maze the exploration usually includes the food compartment and the alley surrounding it. If the animal is not restrained after reaching the food it is almost certain to go through this exploration on the first trial of each day's practice. Once the exploration is completed the animal will go directly to the food in the succeeding trials. The same tendency appears in the simple maze with an extension of the area explored to include almost the entire maze. This is shown by the following analysis of the path followed by the animals during their first and second trials in the simple maze.

The data are taken from 52 animals with which training was begun in the simple maze. Three of these were discarded because of illness; the remaining 49 are those described above. Of the 52, 25 avoided the cul de sac on the first trial. This is one less than the expectation from chance, since only two alternative paths were offered. Of these 25, chance should have led one half to enter the cul de sac and one half to avoid it on the second trial and, if the principle of recency were an important factor in learning, more than half should have gone directly to the food. Instead of this, however, 17 of the animals entered the cul de sac on the second trial and only eight went directly to the food. This result seems to indicate an instinctive tendency to varied activity, or to a thorough exploration of the environment.

The tendency to explore the maze becomes much more pronounced if the animals are frightened at any time during training and this leads to additional errors and an apparently increased learning time.

2. The second factor of importance in prolonging the learning process in concentrated practice is emotional disturbance in the food compartment. Unless the animals have been handled a great deal they will give avoiding reactions when the experimenter attempts to pick them up and readily learn to avoid places where they have been caught. The following behavior is

typical of the animals in the groups which showed marked retardation in concentrated practice.

The animal reaches the food and begins to eat. The experimenter puts his hand into the food compartment to transfer the rat to the starting box. The rat retreats and is caught. On the next trial he advances toward the food, pauses, extends his head upward toward the place whence the hand came before, makes several false starts, and finally advances timidly to the food, giving evidence of increased tonus and readiness for flight. Under the usual conditions of training (group A) this behavior rarely appears on the first trial, becomes marked on the third to fifth, and disappears by the end of the practice period. It seems as though several trials were required to set up the association between the food compartment and the avoiding reaction, in each day's practice, and several more to fatigue the conditioned emotional reflex so established. This is shown clearly by the following average times required for successive trials on the second day of training by the animals in group A.

Trial.....	1	2	3	4	5	6	7	8	9	10
Seconds.....	18	22	57	37	28	15	13	13	17	16

The increased time in the second to fifth trials is characteristic of many of the records and is correlated with the flight reactions near the food compartment.

The chief importance of these two factors in favoring distributed practice lies in the fact that their effects are shown in the later trials of each day's practice. When only two trials are given there is not time for the summation of the exploratory and flight impulses and so fewer errors due to these causes are made. That they were important factors in determining the effects of distribution of practice is shown by the differences in the behavior of the animals in the three groups which differed in the number of trials required for learning. The rats in group B, which had been allowed to become thoroughly familiar with the maze, rarely gave the flight reactions in the food compartment and there was slight indication of a summation of emotional disturbance such as appeared in group A. Familiarity with the maze

reduced the tendency to emotional disturbance. This is shown by the following averages times for successive trials in group B (ten trials per day) on the second day of practice.

Trial.....	1	2	3	4	5	6	7	8	9	10
Seconds.....	38	22	20	17	22	8	5	5	5	13

The time of successive trials falls steadily throughout the practice period. The rats in group D, on the contrary, showed a much more marked tendency to flight reactions in the food compartment than did those in the other groups. They would frequently advance to the food dish, then turn, run quickly into the cul de sac, and gnaw for some time at the wire cover of the food dish there. Apparently owing to the presence of the screened food in the cul de sac, as offering the stimulus of food without associated handling, these animals frequently persisted in their avoidance of the food compartment and in their efforts to get at the food in the cul de sac throughout the practice period. This is shown by the following average times for successive trials in the second day's practice.

Trial.....	1	2	3	4	5	6	7	8	9	10
Seconds.....	14	34	33	11	27	22	35	20	36	154

The prolonged time toward the end of the day's practice is characteristic of the early days of practice of this group.

The summation of the exploratory impulse and of emotional disturbance thus seems to be characteristic of the groups showing marked retardation of learning in concentrated practice. Further, the extent to which such summation occurred varied with the different conditions of training and resulted in corresponding variations in the amount of retardation. It thus seems clear that a great part of the retardation resulting from concentrated practice is due to this summation of instinctive reactions. Even in group B, which showed the least loss of efficiency in ten trials practice per day, there was some indication of a tendency for the animals to avoid the place where they had been caught and it seems probable that a large part of the retardation shown by this group is due also to the interfering effect of this emotional factor. The

greater retardation shown by the other groups (in excess of 53 per cent) is due, almost certainly, to this one factor of summation of instinctive reactions.

### III. THE BEARING OF THE RESULTS UPON THEORIES OF THE NEUROLOGICAL BASIS OF LEARNING

Experimental work upon the effects of the distribution of effort in learning has given uniform results for practically every process studied. Within limits as yet undetermined concentrated practice is less efficient than distributed. But no satisfactory explanation of this seemingly universal phenomenon has yet been advanced. In an earlier paper (Lashley, '15) I have listed seven different possible explanations for the superiority of distributed practice found in archery, between which it is not possible to choose on the basis of the existing evidence, and the list then given was certainly not exhaustive.

The universality of the phenomenon might be taken to indicate that it is due to some fundamental process in the formation of new functional connections in the nervous system and this is the view which seems to be most generally held. For example, Starch says ('12): "Why are shorter and more numerous periods economical? The main reason, no doubt, is the well known fact that a period of rest after newly formed associations gives them a chance to become settled and fixed." Colvin ('11) makes much of this hypothesis, also, and gives it the rank of a general law that "it takes a certain amount of time for associations to fix themselves," and this is used to explain not only the effects of distribution of practice but also retroactive inhibition and the facts included under Jost's law.

From the standpoint of neurological theory the truth or falsity of this hypothesis is of extreme importance. If there is a gradual strengthening of associations during periods of non-practice there is implied a continuation of chemical changes within the nerve cells, initiated by the passage of a neural impulse through new channels and persisting for hours or even days without the influence of continued impulses. If, on the contrary, no such

gradual fixation occurs, the problem of the neuro-chemistry of learning is simplified by admission of the hypothesis that the effects of the passage of the neural impulse upon later conductivity are direct and immediate. This hypothesis is more in accord with such facts as are known concerning the alteration of conductivity in regions of decrement (Lucas, '17), where the learning process may, perhaps, be located ultimately, and with the generally established facts of the deterioration of function through disuse.

The experimental evidence upon which the belief in a gradual fixation of associations is based is far from convincing. It consists primarily of the facts expressed in Jost's law, of occasional records of improvement in complex functions during periods of non-practice, and of the data upon the effects of distribution of practice. All of this can be explained equally well by other hypotheses and, in view of the extreme importance of the point for physiological explanation, we should be careful not to accept the assumption of a 'gradual setting' of new functional connections until some real evidence is advanced in support of it.

In studies of the mechanism of learning the processes of adjustment and of fixation must be distinguished as absolutely independent variables. The former is, in lower animals and probably in primates also, solely the production of varied random activity, through which the first adjustment to a new situation is brought about; the latter is a process by which the recurrence of certain of the random activities in future trials is rendered more probable. Slow improvement in any function may result either from difficulty in discovering efficient methods of performance or from failure to fix as habits the methods which have been hit upon by chance. In an earlier paper (Lashley, '17a) I have shown that a part of the superiority of short over long practice periods is due to the fact that distributed practice permits of greater variability of response and hence greater probability of discovering new and successful modes of attacking the problem, than does concentrated practice. The influence of the distribution of practice is here exerted upon the process of adjustment to the new situation and not upon that of fixation of the random acts.

In the study cited it was not possible to determine the extent to which this one factor was responsible for the effects of the distribution of practice. The present study makes it possible to estimate the importance of conflicting habits under different distributions of practice a little more accurately, although the conflicting reactions are of a somewhat different character from those dealt with in the first study. The retardation in concentrated practice in group D amounted to 338 per cent, that in group B to only 53 per cent of the effort required for learning in distributed practice. The difference, 285 per cent, is clearly due to conflicting habits which affect the efficiency of performance and not the formation of associations. The animals of group B gave some evidence of avoiding reactions in the neighborhood of the food dish, and since a slight exaggeration of this reaction was able to increase the retarding effects of concentrated practice to 145 per cent in group A, we are justified in assuming that a large part of the 53 per cent retardation found in group B is due to the same factors which were effective in groups A and D.

When allowance is made for the influence of stereotyped reactions upon random activity and for the establishment of habits which actively interfere with efficient performance, there may yet remain a slight reduction in efficiency in concentrated practice which is due to the influence of the distribution of effort upon the process of fixation of new functional nervous connections. Such a remainder can be demonstrated only by a process of elimination of agents which modify behavior in problem-solving or efficiency of performance and this can be done only by a more complete control of experimental methods than has yet been undertaken. In the existing evidence there is no reason for the belief that any such remainder will be found, at least in maze-learning. The agents acting upon other processes than those of fixation are adequate to account for all the effects of concentrated practice revealed by experiments and there is no foundation for the assumption that there is any "gradual process of fixation" which is influenced by the distribution of practice. Whether or not the concept is more applicable to other forms of learning, such as those involving implicit activity, is a matter for

experimental investigation. The existing studies demonstrate the superior efficiency of distributed practice but give no clue to the reason for it.

The inferences drawn from studies of the rat in the maze can not be extended to embrace learning of other types without further study. But the studies with the maze are the only ones in which definite evidence as to the mode of action of the distribution of practice has been obtained. The experiments reported here and in the previous study seem to demonstrate that the greater part, if not all, of the effect of concentrated practice in maze-learning is due to the development of habits which interfere with efficient performance, either by limiting trial movements or by causing actual avoidance of the correct path. In both cases the interference is with the process of adjustment and not with that of fixation.

In other forms of learning there are many agents which such as fatigue and loss of interest in long practice periods which may interfere with efficient performance and so prolong the apparent learning time, while with verbal habits the possibility of practice outside of the experimental practice periods has not been altogether eliminated where short practice periods were used. There is thus a possibility that in all forms of learning the results of distribution of practice are due, not to any fundamental principle in the fixation of nervous integrations, but to wholly incidental factors arising from the particular conditions of training in each case studied. The evidence obtained with the maze lends some probability to this view; sufficient, at least, to preclude the use of such a blanket explanation as the gradual 'setting' of new nervous connection before the influence of other factors has been investigated.

#### SUMMARY

1. The simple maze, including a single cul de sac, provides as reliable an index to the rate of fixation of habit in differentially treated groups of animals as does the more complicated circular maze.



2. The use of the simple maze makes it possible to train larger numbers of animals and so gain a better control of individual variations.

3. In the formation of the maze-habit distributed practice is more efficient than concentrated.

4. This is due to factors which arise from the particular methods of training used, peculiar to the maze problem, and not to the influence of the time relations upon the process of fixation of new functional nervous connections.

5. The same is probably true of all cases where the distribution of effort has been found to influence the rate of learning. There is no reliable evidence for a gradual "setting" of the nervous connections formed during learning.

#### REFERENCES

- COLVIN, S. S.: The learning process. New York, 1911.
- LASHLEY, K. S.: The acquisition of skill in archery. Carnegie Inst. of Washington. Pub. no 211, 1915, 105-128.
- LASHLEY, K. S.: A causal factor in the relation of the distribution of practice to the rate of learning. Journ. Animal behav., 1917a, vii, 139-142.
- LASHLEY, K. S.: The effects of strychnine and caffeine upon the rate of learning. Psychobiology, 1917b, i, 141-169.
- LASHLEY, K. S.: AND FRANZ, S. I.: The effects of cerebral destruction upon habit-formation and retention in the albino rat. Psychobiology, 1917, i, 71-139.
- LUCAS, KEITH: The conduction of the nervous impulse. London, 1917.
- STARCH, D.: Periods of work in learning. Jour. Educational Psychol., 1912, iii, 209-213.
- ULRICH, J. L.: Distribution of effort in learning in the white rat. Behav. Monogr. 1915, ii, no. 10, 1-51.



# METHODS OF STUDYING CONTROLLED WORD ASSOCIATIONS

MILDRED WEST LORING

*From the Psychological Laboratory of the Johns Hopkins University*

[The work reported here by Dr. Loring supplies the necessary ground for a series of investigations in which it is proposed to use the association method, and especially the method of controlled associative recall for the study of psychobiological problems. In addition to the data presented in this paper, Dr. Loring has accumulated a magazine of 10,888 words which have been selected on an experimental basis and classified, and from which future selections for any desired type of work may be made with great efficiency. Such a comprehensive list is essential if working lists are to be selected in scientific way, avoiding the associative sequences and preferences of the compiler. In accumulating and testing this list a labor of considerable magnitude has been performed, by methods which can scarcely be improved upon.

The experimental work reported was done in the light of a comprehensive survey of the literature of the association reaction from Francis Galton's in 1879 to authors of 1916, in which year the paper was completed. The historical survey and word lists are omitted from present publication, but the bibliography is included.]

Early in the history of the word association method it was observed that this method had distinct possibilities for practical application, especially in pathological fields, both because of its simplicity and because of its intrinsic diagnostic character. Very soon it began to be applied to the insane, the feeble-minded, and the delinquent with the hope that different types of association could be determined for each of these and their subgroups, and so provide one more aid to a critical diagnosis. The method was later used with great success in the detection of guilty knowledge. And with normal subjects there has been some study of the effect

of age, sex, environment and the like on the character of the associations, and lengthy efforts on the part of many authors to find satisfying classifications of the associations. But it will be noted though that comparatively little investigation has been done where the chief end in view was an examination into the actual technic of the method. The work of some of the earlier German investigators, it is true, does show considerable effort to regulate the length and type of stimulus words, but many have neglected these factors entirely. Many, too, have been content to use the stop watch to measure reaction time, and it may be for this reason that important variations in reaction time with different types of stimulus words and controls have been overlooked, inasmuch as the watch method introduces into the total reaction time three reaction times instead of one. The unreliability of the Hipp chronoscope without considerable modification and standardization, and its operating difficulties, doubtless caused many to abandon a careful determination of the reaction time.

A second fact which the history of the word association method discloses is that most of the conclusions have been drawn from free associations. In some of the early work continuous associations were studied but the obvious disadvantages of this method prevented its extended use. The controlled word association method, on the other hand, has had little investigation, except by some of the German investigators, probably because of the prevalent opinion that free associations represent more truly the natural course of ideas in the individual. And yet the controlled word association method has an advantage worthy of consideration. Because the free association method leads necessarily to a heterogeneous mixture of types of response, nearly every investigator has been forced to expend a great deal of effort in classifying the responses. Nevertheless they have reached no uniformity in their classifications. This difficulty is avoided in the controlled word association method, where the stimulus words are uniform, and the response words by virtue of the instruction to the subject are likewise uniform, so that the problem of classification is obviated.

The purpose of this investigation then was to consider the following points in the procedure of the controlled word association method, to determine to what extent these factors must be taken into account in a precise use of this method.

1. Does the length of the reaction time in controlled associations differ for the normal and inverse order of nouns and adjectives in the English language? That is, will the reaction time be longer or shorter when the stimulus words are adjectives to be responded to with nouns, than for the opposite, when the stimulus words are nouns to be responded to with adjectives? Is there any such relation between the verb-object and the verb-subject associations?

2. Does the length of the reaction time vary systematically, if the stimulus words are nouns and the response words are adjectives, according to the logical categories in which these nouns fall?

3. Does the length of the reaction time vary according to the number of syllables in the stimulus word, for the adjective-noun, noun-adjective, verb-object, and verb-subject associations?

4. Does the length of the reaction time vary according to the position of the accent in the stimulus word for the adjective-noun and noun-adjective associations?

5. If the same lists of adjectives and noun stimulus words are given for three successive days, requiring noun and adjective reactions, respectively, and with no additional instruction, will there be a systematic change in the reaction time from day to day?

6. Is there any variation in the length of the reaction time for normal and inverse directions of controlled double associations? If the stimulus word is an adjective, for an association to be made first to a noun (not spoken) and then to a verb as response word with this noun as its subject, will the reaction time be longer or shorter than when the control is reversed and the stimulus word is a verb to associate back through a noun subject to an adjective modifying this subject?

A consideration of these questions will indicate whether such factors are important in a precise use of the controlled word association method. Without any apparent knowledge of their rôle many investigators have drawn conclusions from variations

in reaction time which might well be within the normal limits of variation for the kind of stimulus word used, the length of the word, the position of its accent, and the type of control required.

#### APPARATUS

The Johns Hopkins chronoscope, designed by Dr. Dunlap, was used in this experiment to record the reaction times, and in connection with it Dunlap voice keys of the small model (97). The auditory method of presentation was employed, both stimulus and response words being spoken. The chronoscope is essentially a synchronous motor driven by a 50 D. V. tuning fork. The motor has 10 poles so that the armature rotates five times per second. Attached to the shaft of the armature is an electromagnet which rotates with the shaft; anterior to this magnet is a fixed magnet facing the rotating one. A light soft iron disc lies between the two magnets, attached at its center to a light shaft perpendicular to it which passes through a brass bearing to the anterior face of the clock, where it is attached to the index-hand. This sliding shaft moves back and forth according as the iron disc is attracted to the rotating or fixed magnet. When the master key of the voice key circuit (140) is closed, current flows first through the fixed magnet, which is in the branch of the circuit of the stimulus voice key, causing the disc to be attracted to this magnet, and then also through the rotating magnet. Since the current through both magnets is equal, the disc remains in the initial position. Speaking into the stimulus voice key breaks the current through the fixed magnet so that the disc is attracted to the rotating magnet. It then rotates with the armature shaft, causing the hand of the clock to turn at the rate of the armature, 5 rotations per second. Speaking into the reaction voice key breaks the current through the rotating magnet so that the disc jumps back again to the fixed magnet, and the hand stops. A spur gear on the shaft of the index-hand meshes with a larger cogwheel on the dial, serving as a rotation-counter. The dial itself is divided into 100 units, so that each unit measures 2 sigma. In using the chronoscope it is only necessary to set the hand at zero, press the master key before speaking the stimulus word.

keep it down until after the response word is spoken, and then read the reaction time directly.

The superiority of this chronoscope lies in the fact that it has no significant error, is extremely simple in operation, and runs continuously and noiselessly. It can run neither slow nor fast by the smallest fraction of time, else the motor gets out of step with the fork and stops. The only possible elements of error lie in (a) a possible change of vibration rate of the fork due to temperature changes, which can be obviated by enclosing it in a box with a thermostat, but which for this work is a negligible factor, (b) a possible error in the divisions of the dial, and (c) in a possible difference in reluctance of the disc between the magnets, in passing in opposite directions, due to a possible difference in the strength of the two fields. This last was found to be negligible in the chronoscope used.

The chronoscope will run continuously if care is taken to keep the fork contact properly adjusted. By experimenting, platinum wire was found impracticable for this; it burns up too quickly and has not enough spring to give the optimum length of period of contact for the motor to "catch." A gold alloy wire was tried, the wire used in dental work, and found extremely satisfactory. The gauge of the wire and its length are important, but these two factors must be determined empirically. As the wire burns back, the contact must be readjusted to keep the optimum period of contact for the motor. Only when this fails does the motor stop. Adjusting and cleaning the contact about twice a day when it is being used continuously all day has usually been found sufficient. The motor was run on the following voltage and amperage:

*Voltage:* 10.0 volts, closed fork contact, but not vibrating.

*Voltage:* 30.0 volts, broken fork contact.

*Voltage:* 25.4 volts, fork running on optimum contact for motor; motor dead.

*Voltage:* 25.4 volts, fork running, motor running.

*Amperage:* 1.3 amperes, closed fork contact, but not vibrating.

*Amperage:* 0.3 amperes, fork running on optimum contact for motor; motor dead.

*Amperage:* 0.3 amperes, fork running, motor running.

The motor is started by hand. It is equipped with a stroboscope if a higher rate is required, but for the low rate of 5 rotations per second a slight twist of the axle which soon gets to be a knack causes the motor to get in step with the fork.

The experimenter and subject sat on opposite sides of a small table with a large black curtain stretched between so that the subject could see neither the experimenter nor any of the apparatus. The experimenter sat with the master key and the chronoscope on his right and the fork on his left, each on separate stands, so that neither could affect the voice keys, which are so sensitive that the passing wagons or a moving chair in an adjacent room stops the clock. With this arrangement too, the experimenter could record results and regulate the fork contact without moving from his chair. The subject was given his instructions in regard to the type of response required and then the list of words. The experimenter signalled the subject before each word by saying "ready." Since the motor was practically noiseless, the only possible distracting noise was the low hum of the fork, which might have been eliminated by enclosing it in a padded box, or placing it in another room. This was a constant, however, throughout the experiment and apparently was not noticed to any appreciable extent except by one subject who worked at night when the building was absolutely quiet and all outside noises were at a minimum.

#### EXPERIMENT I

The general plan of the whole problem was to secure a large number of stimulus words—nouns, adjectives and verbs—to be given to a group of subjects, in order first of all that eliminations might be made of unsuitable stimulus words on the basis of the reactions to them. This was called experiment I. Final conclusions were not to be based on these results because the subjects were few in number and also because the lists of stimulus words contained many words unfitted for the association experiment. The primary object then was to detect these unsuitable words by means of the reaction time and the response word, and to omit



them in a later experiment. In experiment II these revised lists were given to a new group of subjects to make possible a more careful examination into the problems of technic under consideration.

To this end a complete survey of an abridged Standard Dictionary of 300,000 words was made and all one, two, and three syllable adjectives, nouns, and verbs (transitive and intransitive separately) were listed. A verb having both a v.t. and v.i. meaning was classed as v.t., so that the two verb lists comprised verbs which, respectively, can take objects and which cannot. A large number of all these words were necessarily omitted. These fell into three classes, (a) *technical words*, such as *modulus*, *titrates*, (b) *unfamiliar and archaic words*, such as *moil*, *bosky*, (c) obviously *vulgar words*. In this last list are included only such words as actually occur in the dictionary, and not words having their vulgar meaning only in a subtle and secondary sense. Separate consideration of these was made later. This made twelve lists, which altogether totaled 10,888 words, with the words of each in alphabetical order. To get them in random order, each list was cut up so that one word was on each slip. The words of each list separately were put in a box, shaken thoroughly and drawn out one by one for relisting into groups of 40 words each. When the words were in final form there were found to be the following number in each class.

	ADJECTIVES	NOUNS	VERBS (TR.)	VERBS (INTR.)
1 syllable.....	262	1806	792	219
2 syllable.....	973	2643	1028	231
3 syllable.....	791	1726	365	52
Totals.....	2026	6175	2185	502

These in groups of 40 each, were now ready for use. Two groups of subjects were chosen, one to work on adjectives and nouns, the other on both classes of verbs. The associations were controlled as follows,

STIMULUS	RESPONSE
Adjectives	Nouns
Nouns	Adjectives
Verbs (tr.)	Nouns (objects)
Verbs (intr.)	Nouns (subjects)

As the words at this time were not yet completely catalogued, the several groups of words were given in serial order, the adjective-noun group of subjects going through the whole series of adjectives, in the successive order of one, two, and three syllables, and on their completion going through the whole series of nouns in the same way. The verb group likewise first did the transitive verbs and then the intransitive verbs. As noted above, the various classes of stimulus words were in lists of 40 each in this preliminary work, and four lists were given per hour on a twelve minute schedule—that is, twelve minutes were allowed to a list, any time left over being given up to a rest period, during which the subject was allowed to do anything he pleased, converse with the experimenter, walk around or sit quietly. It was usually spent in irrelevant conversation. The remainder of the hour was allowed for preparation of material, breakdown of apparatus, and other details. Each day 160 words were given. In this experiment all subjects worked one hour per day for three days each week, as far as possible at the same hour of the day. The one exception was subject I who reported only twice a week. He fell far behind the others of his group, and for this reason subject IV was secured to supplement his work. It will be observed therefore that the results of these two are not capable of intra-comparison to the extent of the others; subject I finished all adjectives, part of the one syllable nouns, and all the two syllable nouns; subject IV did part of the one syllable nouns, and all the two and three syllable nouns.

Subjects were instructed as to the required type of response word, and told to speak the first word occurring to them that fitted this requirement as quickly as possible, even though the response word was not exactly precise. Subjects were frequently reminded

not to inhibit reactions that they might think foolish or vulgar; that the emphasis in this experiment was being put on the reaction time, not the reaction word, so they must feel free to react without inhibition. As thorough a spirit of informality as possible outside the working period was encouraged. All reaction times over twelve seconds were rejected arbitrarily as failures. The results for adjectives and nouns will be considered first, the results for verbs later, as the former were investigated in greater detail than were the verbs.

Four subjects were used in the adjective-noun experiment, to give three complete sets of reactions for all the adjectives and nouns. All the adjectives were completed by each of subjects I, II, and III, three syllable nouns by subjects II, III, and IV, two syllable nouns completely by subjects I and IV, about half each by subjects II and III, one syllable nouns completely by subjects II and III, almost all by subject I and the rest by subject IV. The exact relation of the numbers of words done by each will be seen in the number of cases given in tables 1, 2, 3, 4, 5, 6, 7, remembering that these figures represent the number of successful responses, not the entire number of stimulus words given to the subject. Subjects I, II, and IV were men students, a Senior, a Sophomore and a graduate respectively. Subject III was a woman graduate in the Department of Psychology.

*Results for the adjective-noun and noun-adjective association*

The results for adjectives and nouns in experiment I are shown in tables 1, 2, 3, 4, and 5, and in figures 1, 2, 3, and 4.

*Table 1.* Here are shown the number of cases, the average reaction times, and the mean variations for each of the six groups of stimulus words, one, two, and three syllable stimulus adjectives and nouns, for each of four subjects. There are no results on three syllable nouns for subject I nor on any adjectives for subject IV. The order in which these words were given is to be kept in mind. This was serially through one, two, and three syllable adjectives, and the nouns then in the same way. For subjects II and III the results are uniform. There is a definite

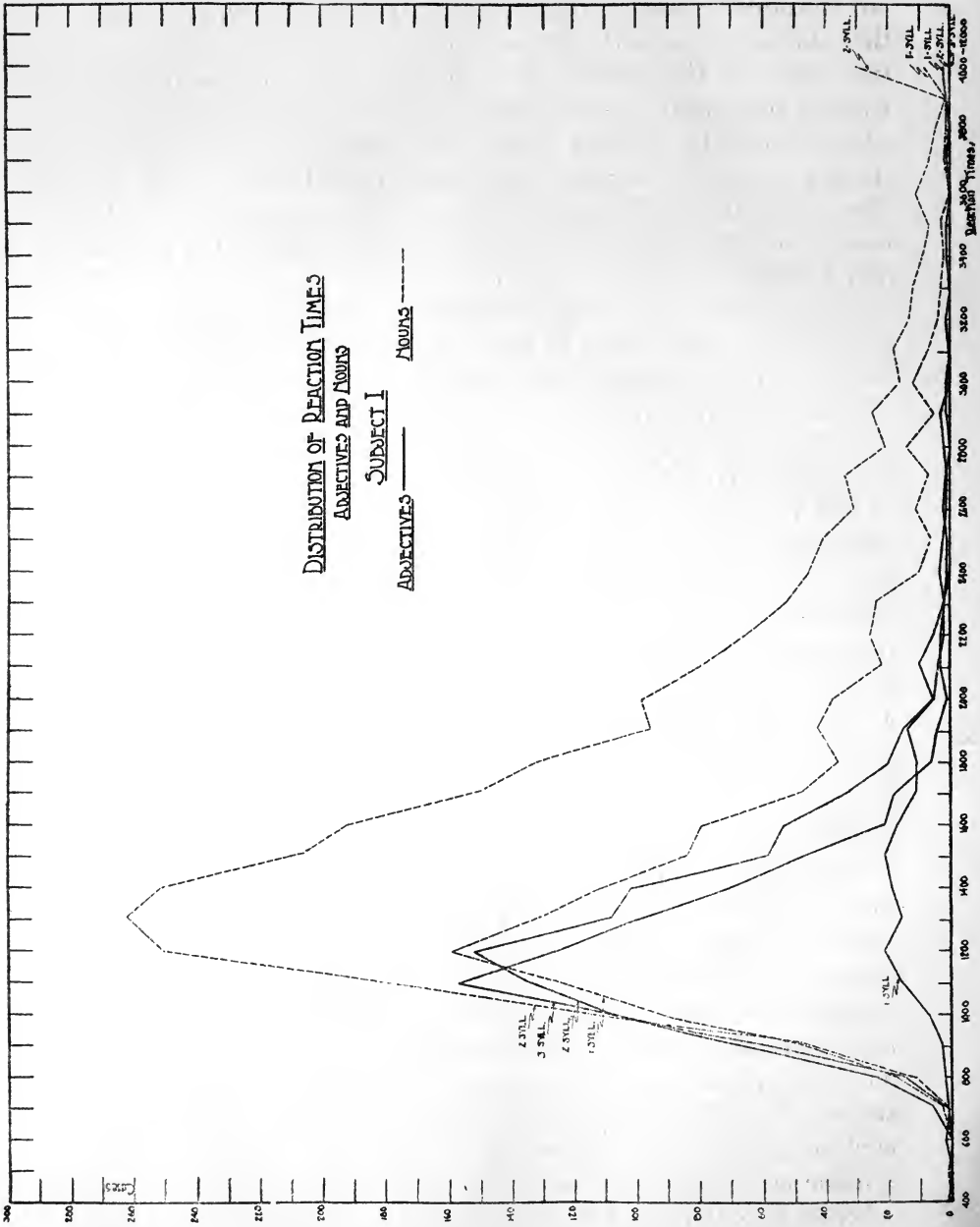

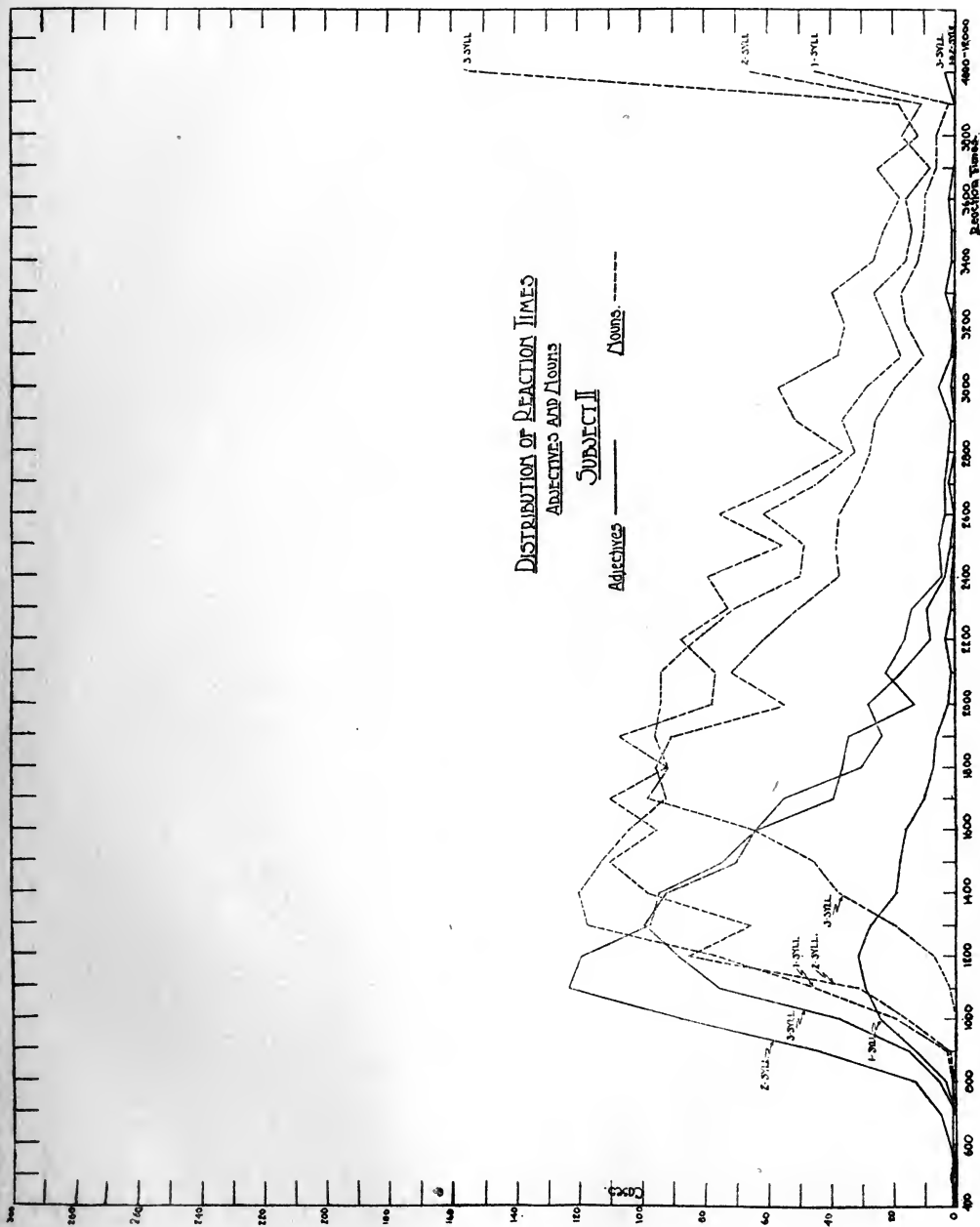

DISTRIBUTION OF REACTION TIMES  
ADJECTIVES AND NOUNS

SUBJECT II

Adjectives \_\_\_\_\_ Nouns \_\_\_\_\_

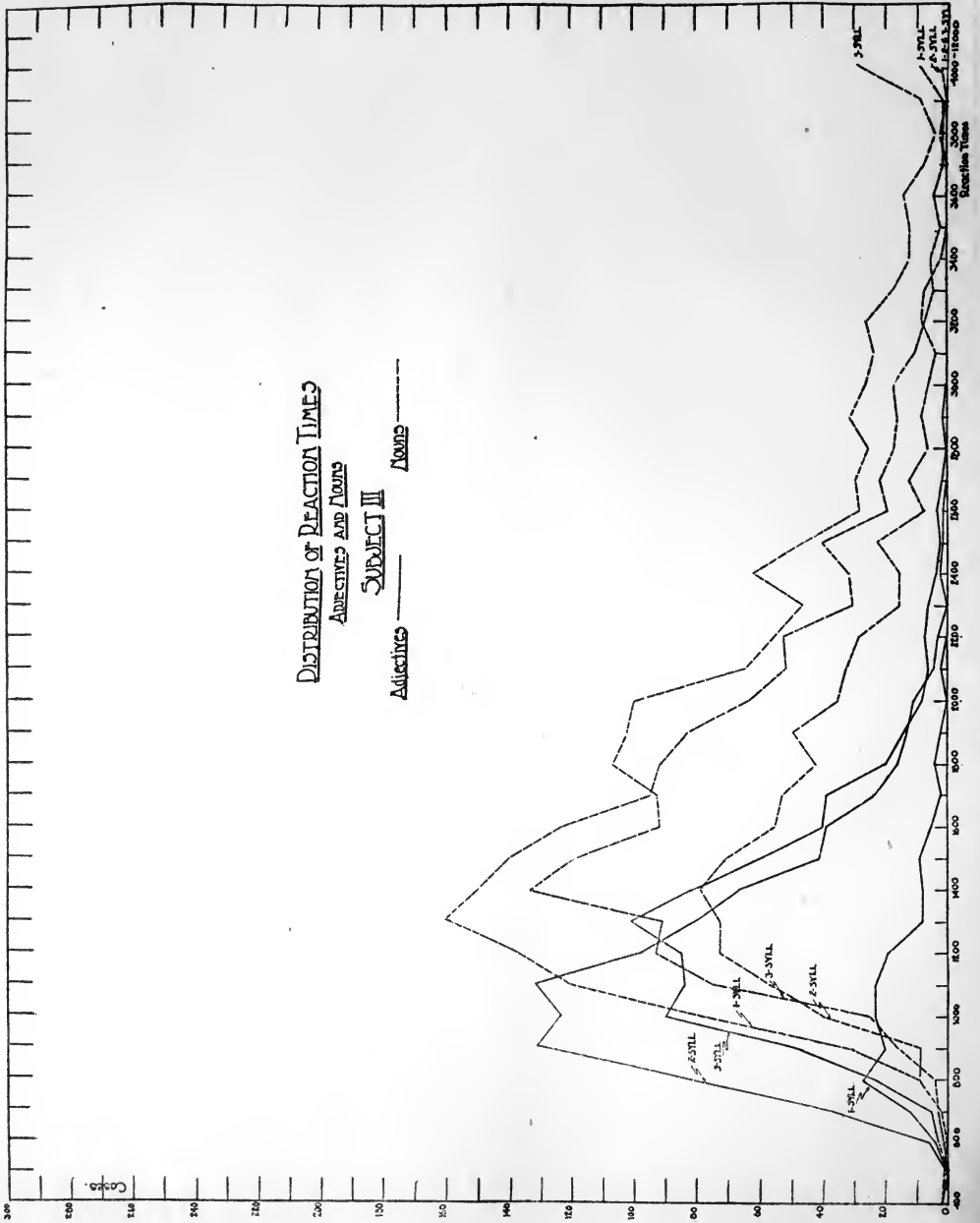

DISTRIBUTION OF REACTION TIMES  
GROUP  
SUBJECT IV

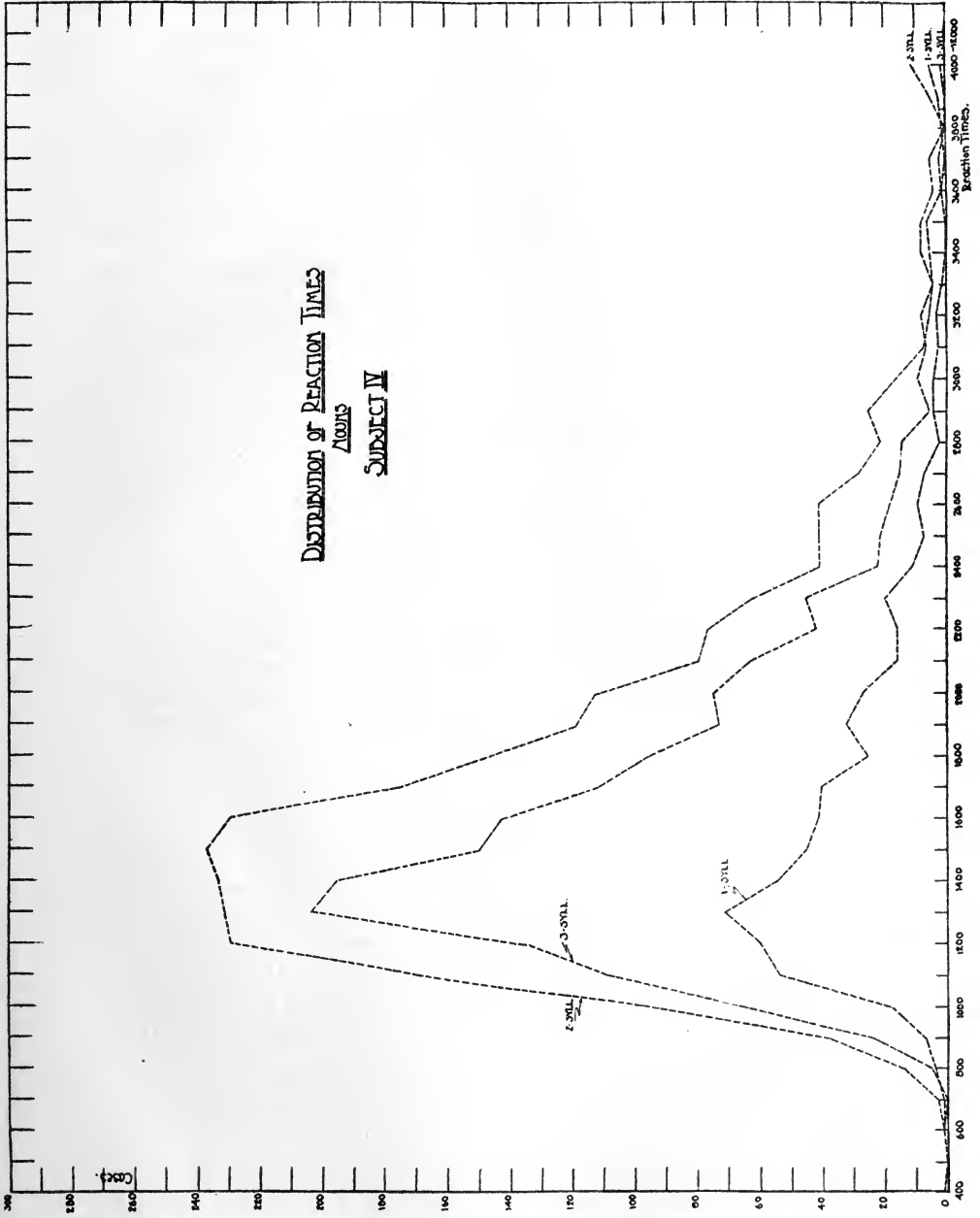

increase in reaction time with the number of syllables for both nouns and adjectives, and a uniformly larger reaction time for any group of nouns over adjectives of the same number of syllables. For subject IV no conclusions can be drawn; the reaction time for nouns of one, two, and three syllables is practically constant. Since this subject did none of the adjectives no comparison is possible between the reaction times for adjectives and nouns. The vocabulary of subject IV was very wide; there were only two or three failures during the whole series due to unfamiliarity with the word. This may indicate that the increase in reaction time with the number of syllables is not dependent

TABLE 1  
*Reaction times for unselected adjectives and nouns\* (totals)*

SUBJECT	ONE SYLLABLE						TWO SYLLABLE						THREE SYLLABLE					
	Adjectives			Nouns			Adjectives			Nouns			Adjectives			Nouns		
	Cases	Av.	M. V.	Cases	Av.	M. V.	Cases	Av.	M. V.	Cases	Av.	M. V.	Cases	Av.	M. V.	Cases	Av.	M. V.
	I	164	1912	282	1190	1580	404	918	1324	240	2522	1744	470	749	1268	192		
II	211	1378	248	1461	2014	598	901	1396	284	1649	2210	630	755	1592	302	1581	2542	828
III	168	1138	218	1617	1730	442	907	1328	176	817	1750	414	728	1380	268	1608	2018	554
IV				591	1708	414				2527	1718	412				1674	1692	370

\* Adjectives and nouns refer to the stimulus words in all tables.

on the actual increase in length of time for the stimulus word to be spoken, but rather because words increase in complexity of meaning and strangeness with their length. This would account for the increase in reaction time with the increase in the number of syllables for subjects II and III, and for the constancy in reaction time for subject IV whose interests were chiefly literary. The results for subject I are peculiar but thoroughly explainable. It will be noticed that for the adjectives, which were completed before the nouns were begun, there was a steady decrease in reaction time in progressing from one syllable to two syllables and then to three syllables, the averages being respectively 1912, 1324, and 1268 sigma. The



results for nouns, in regard to the increase in reaction time with increase in the number of syllables, agrees with those for subjects II and III. The reverse order for adjectives is to be explained by the fact that at the beginning of the work the subject was not in good health. This was not realized by the experimenter until the subject was well started in the work, and then it was thought interesting to see the effect of improvement in health on the reaction time. It will be observed how slow his reaction time is for one syllable adjectives as compared to the other subjects, and how much it dropped for the two syllable adjectives. It was in the middle of this group of words that his poor health, which manifested itself in extreme nervousness, suddenly improved after being treated by a physician. This continued throughout the remainder of the adjectives; it could hardly be said that his reactions were perfectly normal until this time, which was about a month later. From then on during the noun series there was nothing conspicuous in his behavior or reactions. Notes taken during his period of disturbance may prove of interest in emphasizing the dependence of the reverse order of reaction times upon his health at the time.

*Subject I. November 18.* A tendency today to respond to an adjective with a noun cognate to it, e.g., *awkward-awkwardness*. When questioned in regard to this, says he has a feeling of going along the line of least resistance, which he can not control. Went to see Dr. X. last Friday about his nervousness. Dr. X. gave him some bitter medicine and it made him better the next day, and he has felt better ever since. Subject I looks better and is much less nervous. Face not so scratched—scratches it when nervous. Has, he says, especially hard attacks twice a year. Has been playing heretofore during experiment with a collection of clamps, bars, wire, etc., collected from what is within his reach. No such behavior today.

*November 19.* Some tendency to react as on yesterday, e.g., *peevish, peevishness*. Some tendency to repeat the response of the previous stimulus word. Much repetition of "*being*" as reaction word. Nervousness present again today. Medicine taken last Friday was nuxvomica—has been taking it every day, but not today, because "effect

wearing off." Now attributes his well-being of yesterday to the good weather, and vice versa for today which is cloudy.

*November 26.* Reactions of this type no longer occur: *awkward-awkwardness*, but new type has appeared—the same reaction word is given many times in the same list. "*Spirit*" was given 15 times in today's work (160 words). Other responses of this type were "*mean,*" "*money,*" "*mood.*"

*December 2.* Reaction types occurred like those of November 26. The repeated responses were,

List I—Occasion	3 times
Gift	3 times
Condition	5 times
List II—Occasion	2 times
Gift	2 times
Condition	1 time
List III—Occasion	1 time
Gift	5 times
Condition	0 time
Spirit	6 times

It may be that "*spirit*" in the last list was substitution, voluntary or involuntary, for the word "*condition.*" In the middle of list III, subject said that when he gave a reaction that was being duplicated so often, it was not the word that first came to *mind*, but to his *lips*, i.e.,

Maternal—gift (spoken reaction)  
Maternal—care (thought reaction)

After being told that hereafter on such reactions the *thought* word as well as the *spoken* word would be called for, these reactions began immediately to fall off, i.e.,

List IV—Occasion	1 time
Gift	0 time
Condition	0 time
Spirit	2 times
<i>but</i> Mind	5 times

as if a new word were being introduced to avoid the anticipated questioning. There was still some evidence of the first type of odd reaction, i.e., *awkward—awkwardness.*

*December 3.* Duplicate responses continue.

List II—Conduct	8 times
List III—Conduct	1 time
Spirit	5 times
Action	5 times
List IV—Conduct	2 times
Spirit	4 times
Action	2 times
Condition	1 time
Man	7 times
Mind	5 times

*Nouns—first day.* Likes adjectives better than nouns; nouns call up an object with no particular emphasis on its qualities, while the adjective can not appear without an object. Subject feels that the nouns are going faster however.

*Tables 2 and 3.* These tables show the total distribution of reaction times for each of the four subjects who acted in the adjective noun experiment. The reaction time has been divided into steps of 100 sigma, and opposite each reaction time is recorded the number of cases for a particular group of words in which the reaction time had a value lying between this particular number of sigma and 100 sigma more. For instance, in table 2, subject I, there are 16 reaction times of values between 1100 and 1200 sigma, for one syllable adjectives. All reaction times greater than twelve seconds were arbitrarily discarded as failures, and since the number of cases of very long reaction times was few for most subjects, it was decided to bunch all cases of reaction times lying between 4000 and 12,000 sigma. This accounts for the number of cases listed opposite 4000 sigma sometimes being much greater than the adjacent number of cases.

These distribution tables bear out the results in table 1. On the whole for any given subject, the maximum number of cases for any group of nouns is at a higher reaction time than for adjectives of the same number of syllables. The syllable variation is not so perfect, but with greater uniformity among the number of cases, the modes would probably follow the averages.

These results have also been plotted into distribution curves, which are shown in figures 1, 2, 3, 4. In each figure are given

TABLE 2

*Distribution of reaction times, adjectives and nouns*

SIGMA	SUBJECT I						SUBJECT II					
	ONE SYLLABLE		TWO SYLLABLE		THREE SYLLABLE		ONE SYLLABLE		TWO SYLLABLE		THREE SYLLABLE	
	Adjectives	Nouns	Adjectives	Nouns	Adjectives	Nouns	Adjectives	Nouns	Adjectives	Nouns	Adjectives	Nouns
400	0	0	0	0	1	0	0	1	0	1	0	
500	0	1	1	0	0	0	2	0	0	1	1	
600	0	0	0	0	2	0	0	2	0	0	1	
700	1	3	6	1	1	0	0	5	0	0	1	
800	2	18	24	11	15	3	1	13	1	5	1	
900	3	50	70	48	59	13	3	44	2	15	0	
1000	7	91	108	113	108	24	19	87	16	37	0	
1100	16	128	136	185	157	29	45	123	31	75	2	
1200	21	159	152	250	126	31	76	119	85	88	7	
1300	16	131	108	262	100	27	117	97	65	99	19	
1400	19	112	102	251	71	19	120	94	98	92	37	
1500	21	84	59	206	49	18	113	74	112	70	45	
1600	17	80	54	192	21	16	104	64	95	64	64	
1700	11	48	33	150	18	10	92	55	110	39	98	
1800	11	36	20	132	6	7	95	30	91	36	92	
1900	14	43	15	96	4	6	90	23	95	34	106	
2000	5	38	5	99	1	2	54	28	93	13	77	
2100	4	22	10	80	3	1	71	17	93	22	76	
2200	2	26	5	66	3	3	61	8	82	16	87	
2300	2	24	2	53	2	1	50	9	70	14	72	
2400	3	10	1	46	0	1	37	3	49	4	79	
2500	2	6	1	41	0	0	38	1	48	5	55	
2600	1	11	2	31	0	0	37	0	61	3	75	
2700	1	7	1	34	0	0	31	2	44	3	54	
2800	2	14	0	21	0	0	27	0	32	2	36	
2900	3	5	1	25	0	0	25	0	36	1	51	
3000	0	12	1	16	0	0	19	1	28	5	56	
3100	0	7	0	18	0	0	10	0	17	1	37	
3200	0	4	1	13	0	0	16	1	21	0	35	
3300	0	3	0	12	0	0	17	0	26	3	39	
3400	1	2	0	9	0	0	12	0	16	1	26	
3500	1	3	0	7	0	0	10	0	14	1	23	
3600	0	0	0	11	0	0	10	0	16	2	18	
3700	0	2	1	7	1	0	6	0	8	0	25	
3800	0	1	0	5	0	0	6	0	17	0	12	
3900	1	1	0	1	0	0	2	0	11	0	18	
4000 to 12,000	2	8	0	30	0	0	45	0	66	3	156	
Total cases.....	164	1190	918	2522	749	211	1461	901	1649	755	1581	
Average R. T.....	1912	1580	1324	1744	1268	1378	2014	1396	2210	1592	2542	
M. V.....	282	404	240	470	192	248	598	284	630	302	828	

TABLE 3

*Distribution of reaction times, adjectives and nouns*

SIGMA	SUBJECT III						SUBJECT IV					
	ONE SYLLABLE		TWO SYLLABLE		THREE SYLLABLE		ONE SYLLABLE		TWO SYLLABLE		THREE SYLLABLE	
	Adjectives	Nouns	Adjectives	Nouns	Adjectives	Nouns	Adjectives	Nouns	Adjectives	Nouns	Adjectives	Nouns
400	0	2	1	0	0	0		0		1		0
500	0	1	0	0	0	0		0		0		0
600	4	0	6	0	3	1		1		1		1
700	12	2	36	2	5	3		1		3		0
800	27	9	82	9	23	4		4		14		5
900	20	31	131	9	48	16		7		38		24
1000	23	77	123	39	89	25		18		97		66
1100	23	120	131	57	83	74		54		169		109
1200	19	137	97	72	84	92		60		229		134
1300	8	160	80	72	100	90		71		231		203
1400	8	149	66	78	81	132		54		233		195
1500	9	139	41	70	60	118		45		237		150
1600	5	122	39	55	40	91		41		229		143
1700	2	94	23	53	39	92		40		175		112
1800	4	91	16	42	20	106		25		148		96
1900	2	82	13	49	14	101		32		119		73
2000	0	63	11	35	8	99		27		113		75
2100	2	51	4	32	6	64		16		80		63
2200	0	52	3	28	7	55		16		77		42
2300	0	30	0	15	6	46		20		63		46
2400	0	31	2	15	3	62		11		41		22
2500	0	40	1	22	2	46		7		41		21
2600	0	19	1	7	3	28		9		41		18
2700	0	21	0	12	1	29		7		28		15
2800	0	17	0	6	0	25		2		21		14
2900	0	16	0	8	3	31		4		25		5
3000	0	17	0	6	0	26		4		16		9
3100	0	10	0	3	0	23		2		7		6
3200	0	7	0	8	0	26		3		5		8
3300	0	4	0	7	0	17		1		4		4
3400	0	5	0	2	0	12		0		8		5
3500	0	2	0	0	0	12		0		8		6
3600	0	4	0	0	0	14		1		4		1
3700	0	1	0	0	0	7		0		5		2
3800	0	1	0	2	0	3		1		0		0
3900	0	1	0	0	0	9		2		5		0
4000 to 12,000	0	9	0	2	0	29		5		11		1
Total cases.....	168	1617	907	817	728	1608		591		2527		1674
Average R. T.....	1138	1730	1328	1750	1380	2018		1708		1718		1692
M. V.....	218	442	176	414	268	554		414		412		370

six curves, a one, two, and three syllable curve each for adjectives and nouns. Full lines represent the adjectives and dotted lines the nouns. The number of syllables is indicated on the curve itself. Smoother curves might have been obtained if larger steps in the reaction time had been chosen, and if the number of cases for the various groups of words had been more uniform. It is worth while emphasizing the fact that reaction times do not follow the error curve of mathematics. Whereas the error curve is perfectly symmetrical, the reaction time curve is very much skewed, with the maximum of the curve lying at a much lower value than the mean of the extreme reaction times. The reason for this is obvious. There is a physiological limit for the lowest value of a series of reaction times, below which no reaction time can fall, while on the other hand there is no such limit put upon high reaction times. Reaction times may be expected to be of any increasingly greater value beyond the minimum, up to infinity (which we call failure) depending on the ability of the subject. The curve then takes the form indicated here. It should be noticed therefore that only such mathematical formulae should be applied to the data of such curves as have been developed for this type of measurements. For this reason only the number of cases, averages and mean variations are given in the data presented here. There has been an unfortunate tendency to apply formulae that refer exclusively to the mathematical curve of error to such curves as are given here.

The reaction times may at first sight appear abnormally long. Likewise the mean variations may seem high. But this is not so however. In the first place no conclusion is valid unless based on a sufficiently large number of cases. In a great many investigations only a short list of words has been used and sweeping conclusions are made on the basis of their results. In this experiment over 8000 adjectives and nouns have been used for stimulus words, so that a fairer indication is given of the true nature of the reaction time under the conditions laid down in the experiment. In the second place no attempt has been made in this work to choose "easy" words for stimulus words. In much of the association work easy words have been chosen

because they are more suitable for educational and pathological tests. It is to be expected that the average reaction time on such a list of words given to normal subjects would be considerably lower than when the list of stimulus words is maximally inclusive as is the case here. The aim here was to retain as many words as possible both difficult and easy, rather than to choose a select, homogeneous list. But aside from these two reasons which might justify unduly long reaction times, it must still be concluded here that these reaction times are not long at all. A careful gleaning of the literature shows that where any considerable number of stimulus words has been used, reaction times running up to four and five seconds are not uncommon even for normal subjects. To what extent these high reaction times have been found is difficult to determine because in most cases detailed results are not given, and mean variations are invariably omitted which might afford a clue to this point. The chief interest has been concerning the nature of the associations themselves and this has helped to minimize a discussion of the length of the reaction time. For this reason detailed results are given here showing the number of cases, averages, mean variations, and distributions. All computations were made on the Burroughs electric adding machine. Mean variations were obtained with the Dunlap formula, which is especially adapted for use on a calculating machine.

*Table 4.* This table shows the variation in reaction time according to the position of the accent in three syllable adjectives and nouns. It was not considered worth while or valid to make comparisons on accent for two syllable words inasmuch as the percentage of these with the accent on the second syllable is extremely small in comparison with those having the accent on the first syllable. And likewise for three syllable adjectives and nouns, comparison is really valid only between words having the accent on the first and on the second syllable, inasmuch as the number of words with the accent on the third syllable is very small. No conclusion can be drawn at all in regard to the effect of accent on reaction time. The variations in reaction time with change of accent for either adjective or nouns follow

no consistent sequence for the various subjects. It is interesting to note though that with both groups of words here subdivided into three classes each, the conclusion drawn from table 1 still holds, that is, that the reaction time is greater for stimulus nouns than for stimulus adjectives.

*Table 5.* Here are shown the results of separating the stimulus nouns into seven logical categories and one unclassified group.

Considerable difficulty was experienced in finding a scheme for classification. It was intended at first to classify them into two groups only, abstract and concrete, but when an actual classification under these simple headings was tried it was found utterly

TABLE 4

*Variation of reaction time with accent; three syllable unselected adjectives and nouns*

SUBJECT	ACCENT ON FIRST SYLLABLE						ACCENT ON SECOND SYLLABLE						ACCENT ON THIRD SYLLABLE					
	Adjectives			Nouns			Adjectives			Nouns			Adjectives			Nouns		
	Cases	Av.	M. V.	Cases	Av.	M. V.	Cases	Av.	M. V.	Cases	Av.	M. V.	Cases	Av.	M. V.	Cases	Av.	M. V.
I	363	1232	272				374	1294	198				12	1458	144			
II	368	1604	356	950	2508	768	371	1540	322	579	2594	700	16	1576	204	42	2674	586
III	352	1358	158	981	2034	558	365	1388	270	582	1992	286	11	1624	248	45	1948	566
IV				1014	1700	382				611	1686	368				49	1568	282

impossible. There is no hard and fast line between these two classes. There are, of course, nouns which are obviously concrete, and others undeniably abstract, from a certain point of view, but between these and including a very large percentage of all nouns are a great horde which are really of widely varying degrees of concreteness and abstractness. The terms are only relative. From one point of view everything is concrete and from another everything is equally abstract. Even the stock illustrations of abstract nouns, such as *triangularity* or *virtue*, may be thought of as being just as concrete as *furniture* or *walking*. The words that gave the greatest difficulty were those of a lower level of abstractness than those which are usually used as illustrations of abstracts (nouns ending in *ity*, *hood*, *ness*),



TABLE 5

*Reaction times for classified nouns (unselected)*

	SUBJECT I			SUBJECT II			SUBJECT III			SUBJECT IV		
	Cases	Av.	M. V.	Cases	Av.	M. V.	Cases	Av.	M. V.	Cases	Av.	M. V.
<i>One syllable group*</i>												
In.....	554	1518	364	673	2022	544	725	1700	422	266	1708	452
An.....	144	1720	436	188	2198	804	212	1774	472	73	1656	400
Ac.....	152	1530	452	198	1964	526	216	1674	390	74	1730	408
Vg.....	34	1554	372	54	2078	648	63	1604	352	28	1594	372
Pb.....	46	1622	390	63	1782	410	63	1782	322	28	1610	410
Em.....	17	1630	268	18	2244	888	23	1774	496	6	2068	368
Ab.....	68	1654	380	78	2142	618	103	1900	622	52	1730	390
Un.....	175	1664	492	189	2238	574	212	1702	544	64	1776	364
Total.....	1190	1580	404	1461	2014	598	1617	1730	442	591	1708	414
<i>Two syllable group*</i>												
In.....	1051	1644	396	659	2148	588	348	1702	414	1024	1666	418
An.....	541	1822	382	354	2282	612	169	1998	488	539	1698	384
Ac.....	248	1892	530	161	2264	624	88	1732	392	263	1826	436
Vg.....	78	1600	424	49	2080	376	28	1546	356	76	1606	440
Pb.....	37	1654	486	30	2290	558	8	1480	450	46	1696	320
Em.....	24	1990	558	16	2334	472	11	1758	264	23	1802	630
Ab.....	213	1836	552	186	2302	732	54	1664	396	246	1840	426
Un.....	312	1794	486	194	2198	678	111	1664	366	310	1768	440
Total.....	2522	1744	470	1649	2210	630	817	1750	414	2527	1718	412
<i>Three syllable group*</i>												
In.....				434	2538	680	440	1956	524	446	1670	334
An.....				322	2716	682	325	2092	514	343	1674	356
Ac.....				222	2698	722	234	2060	648	236	1764	390
Vg.....				38	2338	704	42	1600	410	39	1404	268
Pb.....				12	2334	596	14	2540	536	20	1708	402
Em.....				23	2774	710	25	1750	518	26	1758	426
Ab.....				275	2864	614	279	2038	606	293	1702	420
Un.....				255	2656	694	249	2040	554	271	1694	414
Total.....				1581	2542	828	1608	2018	554	1674	1692	370

\*In, inanimate objects; An, animate objects; Ac, nouns of action; Vg, vegetable kingdom; Pb, parts of body; Em, feelings and emotions; Ab, abstract nouns; Un, unclassified.

but which are not of the level of concreteness of *apple* or *book*. Such words are *cost*, *fate*, *style*, *skill*. Do we mean *costness*, *fatehood*, *styleness*, *skillness*, or the actual *money*, the actual *happening*, *short skirts and high boots*, and *manipulation of figures*? Or can we say that we are ever precise at all in just what we do mean, is now one meant, now the other? For this reason a new classification was sought. Seven categories with an additional unclassified group was the smallest number found possible to use. They were chosen as follows:

1. *Inanimate objects*. This class is self-explanatory.
2. *Animate objects*. Here are included all nouns denoting *living* objects in the animal kingdom. A *corpse* or a *salt herring* was classified as inanimate. The noun must also denote the whole organism, not just one of its parts, e.g. *arm* and *knuckle* come under a later category.
3. *Actions*. These nouns express pure action, such as *leap*, *riding*, for their existence lasts only during the *leaping* or *riding*. After the *leap* has been *leaped* there is no *leap* left. This was taken as the test for this class. There are a good many nouns which may express either pure action or the result of the action. The adjective given by the subject was taken as criterion of which interpretation has been made by the subject, and it was so classified. If ambiguous, it was relegated to the unclassified group. Such an example of possible double meaning is the noun *crack*. This may mean the actual space in the side of the broken object, as in the reaction *jagged-crack*, or it may mean the action of cracking itself as in the reaction *sudden-crack*. The former and others of its kind were classified as inanimate objects.
4. *Vegetable kingdom*. This class is self-explanatory.
5. *Parts of the body*. This class is self-explanatory. It was of course not possible to list them under animate objects with words denoting a complete organism. Besides it was thought that a separate classification of these might through a possible increased reaction time throw some light on the emotional reaction, inasmuch as many parts of the body are of especial erotic significance.

6. *Feeling and emotions.* These are nouns actually denoting the feelings and emotion themselves, such as *love, anger, distress*. In this list were not included words having an emotional connotation, such as *mistletoe*.

7. *Abstracts.* These have been partly discussed above. It was decided to include not only the orthodox abstracts which usually end in *ity, hood, ness*, but also that lower hierarchy of abstracts including words like *vogue, needs, and loss*.

8. *Unclassified.* Here were put the days, months, seasons, sounds, diseases, weights and measures, collective nouns, directions of the compass, times of day, parts of speech, the sciences and arts, and others.

The result of this classification as indicated in table 5 shows nothing. There is no greater variation in the average reaction time for the eight classes of nouns for any given subject than would be expected from the large variation in the number of words per group. This of course was not controllable. This uniformity may indicate that emotional disturbances, from what ever cause—the meaning of the word, its relative unfamiliarity, etc.—do not necessarily manifest themselves in an increased reaction time but through some physiological mechanism other than the vocal apparatus, such as respiration, heart rate, blood pressure. This problem is already under investigation in this laboratory. Certainly nothing was indicated by this laborious classification to give any clue to a possible difference in types of response according to the intrinsic nature of the stimulus noun. Because of these negative findings it was decided not to compile reaction time results on the classification of adjectives. These adjectives had already been classified under the same heads as the nouns, the criterion of classification being the noun cognate with the adjective.

#### *Results for the verb-object and verb-subject association*

The results for verbs in experiment I, given in table 6 are analogous to those for adjectives and nouns. The reaction time for the verb-subject association is longer than for the verb-object

association, and the reaction time for both types of association increases directly with the number of syllables in the stimulus word. On the basis of these verb associations further eliminations in the verb stimulus words were made. It was only lack of time that prevented a more detailed investigation into these types of controlled associations by giving the selected words to a new and larger group of subject in a more systematic manner. This was done only with the selected adjectives and nouns.

TABLE 6  
*Reaction times for verb-object and verb-subject associations*

SUBJECT	ONE SYLLABLE						TWO SYLLABLE						THREE SYLLABLE					
	Verb-object			Verb-subject			Verb-object			Verb-subject			Verb-object			Verb-subject		
	Cases	Av.	M. V.	Cases	Av.	M. V.	Cases	Av.	M. V.	Cases	Av.	M. V.	Cases	Av.	M. V.	Cases	Av.	M. V.
V	435	1308	432	213	1536	506	985	1420	444	220	1898	598	369	1516	388	50	2124	438
VI	281	1708	606	194	1760	410	941	1756	544	219	1742	432				41	2118	542
VII	718	2026	808				960	2250	902				366	2490	926			
VIII	437	1614	520	195	2284	806				215	2690	906	351	2140	782	47	2990	1154

*Conclusions for the adjective-noun and noun-adjective association*

1. The reaction time for the noun-adjective association is very definitely longer than for the adjective-noun association, for stimulus words having the same number of syllables. The amount of this increase varies with the number of syllables in the groups compared and with the subject. The difference varied from 420 sigma to 950 sigma, but not in any fixed way in passing from words of one syllable to those of two and three syllables. The reason for this definitely longer reaction time for nouns than for adjectives is *probably* to be sought in the normal order of nouns and adjectives in the English language. With the exception of a few set phrases such as "durance vile" and "choir invisible" the universal order in the English language is adjective-noun. Because of this the habit of reaction in this direction is very stable and as mechanised as is possible with the permutation of adjectives and nouns occurring in language.

The reverse reaction therefore always requires greater effort and gives a longer reaction time. In connection with this possible explanation an experiment is under way in this laboratory to test out the same reactions on French, Italian, and Spanish subjects where the order of adjectives and nouns is on the whole the reverse from the English order. If this language explanation has validity, we will expect to find that the adjective-noun reaction is longer than the noun-adjective reaction.

A contributory reason for the reaction time being longer for nouns than for adjectives lies in the fact that many nouns are commonly never used with a modifying adjective, e.g., *rote* and *ounce*, and it is relatively difficult to find adjectives to modify them. This lengthens the reaction time. This was no factor however in Experiment II which follows, where all such words were eliminated. Subjects invariably stated that it is more difficult to respond with adjectives to noun stimulus words than with nouns to adjective stimulus words. They were questioned in regard to this and their naïve explanations all fell into this general scheme; an adjective always suggests some object having that quality, but a noun suggests no particular aspect of itself, making it necessary to "feel" for an attribute. Some notes taken of comments by different subjects may be of interest here.

*Subject II.* November 17 (first day on nouns). Nouns much harder than adjectives. Have to think backwards then forwards to see if adjective fits. Have to think harder but time seems to go much faster for a list. (This is not so—time really much longer.)

*Subject I.* December 10 (first day on nouns). Likes adjectives better than nouns, because nouns call up an object with no particular emphasis on its qualities, while the adjective can not appear without an object. It feels as if the nouns were going faster.

*Subject IV.* November 22 (first day on nouns). Felt as if doing poorly. Ought to be able to think of better adjectives—less commonplace ones.

2. The reaction time for these types of controlled associations increases directly with the number of syllables in the stimulus word. This holds for both adjectives and nouns. The one

exception found for adjectives was in the results for subject I and for nouns in the results for subject IV. These have already been explained. This increase varies for adjectives from 18 sigma to 196 sigma and for nouns from 10 sigma to 332 sigma.

3. The position of the accent in stimulus nouns and stimulus adjectives has no systematic effect on the reaction time.

4. There is no interpretable variation in reaction time according to a logical classification of the stimulus nouns for the noun-adjective association. The reaction time remains relatively constant within the limits of word length. The variations can be attributed to a difference in the number of cases in the various groups.

5. From observations of the subjects during the course of the experiments is to be concluded that two or three separate hours of work are sufficient for the subject to become adapted to the experiment, to lose any emotional disturbance due to sex difference between experimenter and subject, as far as this last can ever be reached. Inhibition of associations from such a cause we are persuaded was at its minimum during the whole experiment for all subjects.

6. It is impossible for a subject to keep at the top notch of tension throughout the whole of one session, and necessarily not for the whole experiment, to the same extent that this is possible in getting reaction times on a few words. That which we call "tension," whatever its physiological mechanism, was evident for the first two or three words of each list. It was indicated by a distinctly shorter reaction time and an observable muscular rigidity in the subject. The reaction time then suddenly became longer and remained more or less uniform throughout the list. It is probable that this later uniformity is due to an adjustment to a certain comfortable physiological tension that can be maintained through the course of one hour's work at a time, for three days a week, throughout several months.

#### *Conclusions for the verb-object and verb-subject associations*

1. The reaction time for the verb-subject association is longer on the average than for the verb-object association for stimulus words having the same number of syllables. This is *probably*

due to the word order in the English language. Since the normal sequence for subject, verb, object is seldom varied, it is natural that associations between them should be in the order of subject-verb and verb-object. If the reaction time should prove to be equal for these associations in their normal order, it would follow that by reversing one association, for instance the subject-verb to the verb-subject, this reaction time would be longer than for the verb-object association. This is what the results here show. It is probable therefore that the English word order accounts for the relative value of the reaction times for the verb-subject and verb-object associations.

2. For both types of verb associations the reaction time on the average increases directly with the number of syllables in the stimulus word. The explanation for this is probably the same as for the same finding for adjective-noun and the noun-adjective associations, that is, it is due to the increasing unfamiliarity and complexity of meaning of a word with the increase in the number of its syllables, rather than to the actual increase in the time taken to speak the longer words.

#### EXPERIMENT II

##### *A more detailed study of the adjective-noun and noun-adjective association*

From the results of the previous experiment it was possible to secure a revised list of adjectives, nouns, and verbs, forming a lexicon of words suitable to the types of associations outlined above; to take an equal number of each group for further trial on a large number of subjects and investigate in greater detail the same problems studied in experiment I. The lexicon was compiled for each of the four groups of words and will be later published separately but lack of time prevented any further investigation into the verb-subject and verb-object associations. The first task was to eliminate unsuitable words. These were found to fall into the following classes:

1. Unfamiliar words beyond those already eliminated in making up the original lists. Throughout experiment I there was a

growing conviction that it is necessary to distinguish between the reading and the conversational vocabulary. In making the original lists the experimenter had unwittingly but naturally chosen words which are familiar as *read*. Many of these were pronounced unfamiliar when heard by the subject, though his judgment changed when the word was spelled for him.

2. Words difficult to pronounce intelligibly to the subject, such as *leak*, which was taken variously as *leap*, *link*, etc.

3. Words having an emotional value either obviously or subtly; in the first case words like *pregnant*, *corset*, etc., and in the latter case that rather large group of words almost entirely confined to the masculine vocabulary whose dictionary meaning is perfectly unemotional, but in everyday use have also a subtle sexual meaning. The elimination of these words was made by several men in the department. Since however, many of these words seem to be purely colloquial, there are doubtless many still in the revised lists.

4. Homonyms in the narrow sense. A difference of spelling and identity of pronunciation in words of the same part of speech was made the criterion. *Fate* and *fete* are homonyms for this experiment, but not *great* and *grate*. It was considered sufficient control that the subject knew what part of speech he was being given. Furthermore most homonyms actually do exist in the narrow sense taken. Two of these homonyms escaped detection and got into the revised lists. These are *chaste*, *chased*, and *dessert*, *desert*.

5. Words that are intrinsically difficult to respond to with the required type of response, such as the nouns *nothing* and *ounce*. Adjectives are not commonly used with these nouns.

6. A small group of words eliminated for various unclassified reasons, long reaction times or absurd responses attributable to none of the above reasons.

After these rejections were completed, special lists were made up from the selected words for ten days' work. Each list contained 30 words and six lists were given in an hour making 180 words per session. Whereas the two types of stimulus words were run through serially in experiment I, in this experiment one,



two, and three syllable nouns and adjectives were run in parallel so that comparison between the groups would be entirely valid. Therefore each day's series was made up of one list each of the following words and give in this order:

- (1) One syllable adjectives
- (2) One syllable nouns
- (3) Two syllables adjectives
- (4) Two syllable nouns
- (5) Three syllable adjectives
- (6) Three syllable nouns

The adjectives and nouns alternated on successive days in occupying the first position in the series. Nouns occurred first on odd days and adjectives on even days. It was discovered unfortunately that there were not enough selected one syllable adjectives to cover ten days' work, in fact there were only 194 of them, enough for six days' work (180) and a few over. For this reason it was possible to carry out the above procedure for only six of the ten days. The remaining days' work was made up only of two and three syllable adjectives and nouns. It was necessary to drop one syllable nouns for the remainder of the series in order that there might be an equal number of one syllable adjectives and nouns for the comparison of their reaction times. To make the number of two and three syllable adjectives and nouns come out even for the remaining four days' work the following schedule was adopted:

<i>Days 7 and 9</i> .....	{	Two lists each of 2 syllable nouns and adjectives
		One list each of 3 syllable nouns and adjectives
<i>Days 8 and 10</i> .....	{	Two lists each of 3 syllable nouns and adjectives
		One list each of 2 syllable nouns and adjectives

This gave the following distribution of the 1800 stimulus words:

1 syllable adjectives and nouns, each 180.....	360
2 and 3 syllable adjectives and nouns, each 360.....	1440

In addition to the regular ten days' work, three days' practise work was given beforehand on the basis of the conclusion in experiment I that the length of time required to become adapted

to the experimental situation is two or three sessions. For stimulus words, were taken whatever material was available from the rejected words of various kinds, and as nearly as possible the scheme of parallelism and alternation was carried out. No three syllable nouns were included in these practise words. Rejections had not been quite completed on them at the time experiment II began, inasmuch as the three syllable nouns formed the last material for experiment I. The actual three days' practise words, totalling 540 nouns and adjectives, were distributed as follows:

	ONE SYLLABLE	TWO SYLLABLE	THREE SYLLABLE
Adjectives.....	30	180	60
Nouns.....	120	150	0

It was also intended that the results for the practise period and the regular ten days' work should be compared to see directly the effect of excluding unsuitable words of different kinds.

Eight subjects were used in this experiment, four of whom had acted as subjects in the experiment on verbs, subjects V, VI, VII, VIII and four who were entirely new to the whole procedure. All eight subjects took the practise work, for there was no reason for thinking necessarily that the first four might be adapted to adjective and noun associations merely because they had been working on verb associations. Of course practically all emotional disturbance in the first four subjects had already been eliminated. At the beginning of the regular ten days' work it may be said that all subjects had lost as much of any emotional disturbance as they would ever lose, and for all except one subject perhaps we would say that any remaining emotional upset was practically nil. This one exception, subject XII, was of a naturally shy disposition. Subjects VII, VI, VIII, IX, X and XII were all university men, the first of these being a Ph.D., the second a graduate student, the next two sophomores and the last three freshmen. Subject XI was a junior at a woman's college. In all there were seven men and one woman. It had been hoped to have an equal number of men and women but the difficulty of getting women subjects prevented this.

*Results for experiment II*

*Table 7.* This is similar to table 1, experiment I. It shows the number of cases, averages, and mean variations for one, two, and three syllable selected adjectives and nouns for the total regular ten days' work. The results are consistent throughout for each observer in corroborating the conclusion in experiment I that the noun-adjective reaction is longer than the adjective-noun reaction. These results also substantiate the earlier conclusion that the reaction time increases directly with the number of syllables in the stimulus word for these two types of associations.

TABLE 7

*Reaction times for selected adjectives and nouns, regular ten days' work (totals)*

SUBJECT	ONE SYLLABLE						TWO SYLLABLE						THREE SYLLABLE					
	Adjectives			Nouns			Adjectives			Nouns			Adjectives			Nouns		
	Cases	Av.	M. V.	Cases	Av.	M. V.	Cases	Av.	M. V.	Cases	Av.	M. V.	Cases	Av.	M. V.	Cases	Av.	M. V.
	V	179	1196	236	176	1584	418	347	1382	278	352	1666	408	350	1616	450	348	1852
VI	176	1196	356	176	1602	386	351	1290	358	344	1836	598	352	1466	414	350	1910	580
VII	177	1640	478	177	2380	928	350	1856	636	346	2660	1014	351	2130	758	344	2902	1046
VIII	168	1766	548	169	2434	730	341	1962	652	334	2752	624	344	2318	920	347	2978	1042
IX	174	1738	634	172	1918	586	347	1830	604	337	2338	804	340	2022	612	349	2568	814
X	173	1332	300	174	1532	294	349	1508	240	334	1714	346	344	1790	546	340	1958	358
XI	174	1694	676	177	2300	886	350	1998	812	348	2860	1286	332	2396	1078	339	3002	1334
XII	172	1736	622	166	1920	562	343	2038	710	344	2336	798	332	2460	810	344	2518	840

*Table 8.* This table shows the reaction times for the regular ten days, giving the numbers of cases, average reaction times, and mean variations for each of the ten days separately. The conclusions drawn from the previous table, where, the same reaction times of each class were treated en masse for the ten days, are on the whole borne out here. An examination into the relative length of the average reaction time for adjective and noun stimulus words for each subject for each of the ten days shows the following number of cases where the noun stimulus word gives a longer average reaction time than the adjective stimulus word. Of course, only the average reaction times for the same

TABLE 8  
*Reaction times for selected adjectives and nouns regular ten days' work (by days)*

STIMULI	DAY 1			DAY 2			DAY 3			DAY 4			DAY 5																	
	Adjectives			Nouns			Adjectives			Nouns			Adjectives			Nouns														
	Cases	M. V.	Av.	Cases	M. V.	Av.	Cases	M. V.	Av.	Cases	M. V.	Av.	Cases	M. V.	Av.	Cases	M. V.	Av.												
Subject V																														
1	30	1190	206	28	1602	360	30	1416	332	30	1416	332	29	1786	502	30	1130	256	29	1388	244	30	1288	286	30	1592	502			
2	28	1174	150	29	1540	294	30	1326	278	30	1476	252	29	1744	442	30	1318	270	29	1390	234	29	1420	192	30	1712	376			
3	29	1348	252	30	1558	132	30	1702	370	29	1538	344	28	1586	300	27	1618	506	29	1718	338	30	1350	242	29	1908	350			
Subject VI																														
1	30	1158	288	28	1636	360	30	1436	274	29	1376	310	29	1746	530	30	1214	236	30	1862	448	30	1108	212	30	1502	362			
2	28	1278	256	30	1710	542	29	1266	236	27	2012	722	30	1838	598	29	1186	442	29	1794	518	28	1184	284	29	2012	534			
3	30	1540	440	28	2100	568	27	1648	464	30	1998	670	28	1528	358	30	2510	932	29	1548	300	30	1830	402	30	1422	412	29	2004	620
Subject VII																														
1	28	1742	524	29	2546	994	30	1568	524	30	2358	998	30	1682	452	30	2112	526	30	1372	346	30	2230	722	30	1890	560	29	3042	1154
2	28	1884	660	27	2664	1226	29	1920	598	30	2608	992	29	1918	590	29	2628	1208	29	1760	622	30	3002	1318	30	2102	490	30	2988	1412
3	28	1698	572	26	3234	964	28	1892	752	20	2416	632	30	1852	594	30	2918	852	29	2168	414	29	3196	1292	29	2650	1006	28	3002	1328
Subject VIII																														
1	25	2112	588	26	2458	576	27	2128	546	29	2840	732	27	1628	450	26	2476	836	30	1350	262	29	2280	804	30	1570	662	30	2250	646
2	27	2274	642	26	2624	664	28	2784	1108	30	3520	1484	27	2024	574	25	2238	690	29	2176	720	29	2594	830	28	1690	530	28	2846	1142
3	26	2600	828	27	3042	1126	26	2926	1238	29	3212	906	28	2390	670	29	2644	744	28	2358	738	30	2514	724	29	2102	788	28	2690	650
Subject IX																														
1	30	1072	638	30	2018	552	29	1560	442	29	1742	484	30	1406	362	29	2214	820	30	1634	662	26	1916	522	26	2010	876	29	1740	472
2	29	1698	572	29	2268	778	27	1914	664	26	2142	632	30	1720	636	28	2412	884	30	1440	394	28	2140	710	29	1946	702	27	2352	660
3	29	1072	480	28	2202	584	27	1818	480	28	2320	1218	28	1946	604	29	2684	722	28	2008	730	30	2370	640	28	2192	632	29	2590	660

Subject X

1	28	1472	384	27	1360	268	29	1324	332	28	1496	266	30	1232	218	30	1546	270	29	1192	210	29	1422	300	27	1441	170	30	1718	354
2	28	1522	508	27	1690	312	30	1616	390	28	1546	252	29	1482	348	29	1642	234	29	1384	318	28	1678	364	29	1572	196	26	1780	350
3	30	1628	418	28	1676	278	28	1682	376	29	1634	254	29	1658	372	29	1716	306	27	1738	308	29	1778	268	28	1942	344	26	2022	348

Subject XI

1	30	1656	586	29	2012	718	30	1872	812	29	2660	1110	29	1722	636	30	2436	814	27	1768	728	29	2520	1222	30	1656	638	30	2106	768
2	30	1836	696	30	3054	1480	30	1646	512	29	2920	1106	28	2664	1268	29	2682	1266	30	1766	592	29	2532	1046	28	2016	668	29	2604	1312
3	30	1824	748	27	2680	1204	26	2480	982	28	2360	1294	27	2660	946	27	2680	1536	27	2976	1790	30	2378	598	28	1828	670	30	2564	1018

Subject XII

1	30	1730	440	25	1930	428	29	1914	558	29	1660	464	29	1766	434	29	2078	668	28	1620	566	28	2394	704	30	1726	612	29	1876	374
2	30	1908	792	28	1958	554	27	1640	374	29	2038	760	26	2116	678	29	2642	1016	28	1982	720	27	2566	824	30	2162	938	29	2026	540
3	27	2136	494	29	2328	680	27	2138	620	30	2312	754	28	3256	1300	27	2902	782	28	2532	974	28	2504	764	26	2332	904	29	2482	638

TABLE 8—Continued

STYLABLES	DAY 6			DAY 7			DAY 8			DAY 9			DAY 10																	
	Adjectives		Nouns	Adjectives		Nouns	Adjectives		Nouns	Adjectives		Nouns	Adjectives		Nouns															
	Cases	Av.	M. V.	Cases	Av.	M. V.	Cases	Av.	M. V.	Cases	Av.	M. V.	Cases	Av.	M. V.															
Subject V																														
1	30	1218	218	30	1666	454	30	1358	390	59	1640	392	29	1190	214	28	1854	286	56	1674	458	59	1994	502	29	1400	266	30	1788	346
2	30	1282	162	30	1854	640	59	1358	390	59	1640	392	29	1190	214	28	1854	286	56	1674	458	59	1994	502	29	1400	266	30	1788	346
3	30	1638	540	29	1738	326	28	1704	572	30	2038	618	58	1748	592	55	1748	268	29	1844	438	29	2212	534	60	1674	432	59	2046	484
Subject VI																														
1	29	1164	196	29	1370	246	58	1280	332	56	1944	596	30	1086	240	26	1412	466	59	1266	338	60	1704	464	30	1066	184	30	1708	482
2	29	1410	306	28	1884	614	58	1280	332	56	1944	596	30	1086	240	26	1412	466	59	1266	338	60	1704	464	30	1066	184	30	1708	482
3	29	1650	184	28	1896	516	30	1230	276	29	1540	324	59	1346	420	58	1660	510	30	1382	304	29	1780	308	60	1436	362	59	1916	592
Subject VII																														
1	29	1592	342	29	2014	526	60	1832	560	58	2544	768	30	1562	884	29	2644	1070	57	1832	546	55	2378	790	29	1884	420	29	2688	996
2	29	2016	928	29	2426	738	60	1832	560	58	2544	768	30	1562	884	29	2644	1070	57	1832	546	55	2378	790	29	1884	420	29	2688	996
3	30	2142	754	30	2528	890	30	1938	550	28	2800	986	59	2316	710	60	2590	984	30	1946	668	29	2632	836	58	2154	754	55	2902	1226
Subject VIII																														
1	29	1604	520	29	2314	734	60	2080	678	55	2728	882	29	1396	380	26	2646	884	55	1860	518	57	2784	970	30	1350	318	30	2374	714
2	28	1946	750	28	3008	982	60	2080	678	55	2728	882	29	1396	380	26	2646	884	55	1860	518	57	2784	970	30	1350	318	30	2374	714
3	30	2440	914	29	3074	644	29	2414	940	30	3016	962	59	2216	740	59	2974	1024	30	2102	800	29	3004	928	59	2044	658	57	3106	1032
Subject IX																														
1	29	1816	636	29	1946	520	58	1780	596	57	2106	586	30	1554	406	25	2302	794	55	2166	794	57	2642	1104	30	1562	504	30	2210	840
2	29	1642	404	30	2562	998	58	1780	596	57	2106	586	30	1554	406	25	2302	794	55	2166	794	57	2642	1104	30	1562	504	30	2210	840
3	30	2220	880	30	2782	902	27	2142	736	30	2212	480	57	2028	572	57	2712	966	30	2230	724	30	2756	824	56	1776	398	58	2518	736

Subject X

1	30	1884	312	30	1630	284	1458	314	57	1606	214	29	1456	376	26	1694	356	58	1484	284	57	1810	370	30	1644	368	28	1946	360	
2	29	1540	481	28	1764	442	58	1608	214	29	1632	344	59	1810	474	59	2022	394	29	1604	344	28	1942	412	55	1936	516	55	2146	542
3	29	1852	416	28	1820	358	30	1690	348	29	1932	344	59	1810	474	59	2022	394	29	1604	344	28	1942	412	55	1936	516	55	2146	542

Subject XI

1	28	1558	590	30	2082	666	1766	712	58	2504	1376	28	1480	410	29	2388	896	60	2458	1104	56	3014	1562	29	1930	910	30	3698	1842	
2	28	1692	572	29	2382	830	59	1766	712	58	2504	1376	28	1480	410	29	2388	896	60	2458	1104	56	3014	1562	29	1930	910	30	3698	1842
3	29	2394	1216	30	3682	1988	28	1934	624	30	2700	1168	52	2284	994	58	2850	1184	29	2234	630	26	3758	1826	56	2732	1356	53	3214	1320

Subject XII

1	29	1660	402	26	1640	394	1964	644	56	2404	802	29	1886	616	28	2552	812	59	2356	796	60	2568	886	30	1760	676	30	1998	738	
2	25	1532	416	28	2246	678	59	1964	644	56	2404	802	29	1886	616	28	2552	812	59	2356	796	60	2568	886	30	1760	676	30	1998	738
3	28	2242	622	29	2240	706	29	2366	646	29	2568	742	56	2422	894	58	3058	1152	29	2984	1536	27	2638	1030	59	2086	708	58	2098	566

day are compared, and therefore the maximum number of cases following the rule for one syllable stimulus words is six and for two and three syllable stimulus words is ten.

TABLE A

*Number of cases following the rule for the relation between the reaction times for adjective-noun and noun-adjective associations*

SUBJECT	ONE SYLLABLE STIMULUS WORDS	TWO SYLLABLE STIMULUS WORDS	THREE SYLLABLE STIMULUS WORDS
V.....	6	10	10
VI.....	6	10	10
VII.....	6	10	10
VIII.....	6	10	10
IX.....	5	10	10
X.....	5	9	8
XI.....	6	10	9
XII.....	4	9	7
Totals.....	44	78	74
Maximum total.....	48	80	80

Likewise the conclusion drawn from experiment I and from the previous table of experiment II, concerning the variation in the average length of reaction time with the number of syllables in the stimulus word, is confirmed here, although not so thoroughly as is the previous conclusion. In most cases throughout the ten days the reaction time increases with the number of syllables in the stimulus word. This holds true for both adjectives and nouns. If on a given day adjectives of one, two, and three syllables are given, and if we are looking for a continuous increase in reaction time for one to two, and from two to three syllable words, there will be two steps in this increase, either of which may break down. On those days where only two and three syllable words were given there is only one step. Therefore according to the rule previously established there should be 16 successful increases in the reaction time for both adjectives and nouns, during the whole ten days' work. The following table shows to what extent the rule is substantiated when the results are taken by days.



TABLE B

Number of cases following the rule for increase in reaction time directly with the number of syllables

SUBJECT	ADJECTIVES	NOUNS
V.....	14	12
VI.....	13	13
VII.....	13	13
VIII.....	16	12
IX.....	11	15
X.....	16	15
XI.....	11	11
XII.....	14	15
Totals.....	108	106
Maximum totals.....	128	128

*Table 9.* Here are shown the results for the practise period. The same conclusions hold here as for the regular period; the reaction time for the noun-adjective association is longer than for the adjective-noun association, and the reaction time for both adjectives and nouns increases directly with the number of syllables in the stimulus word. There are two exceptions for adjectives, one for subject VII and one for subject X. It will be observed that all the averages for subject X compared with the others are relatively low. This was due to an actual narrowness of vocabulary, which instead of hampering him actually hastened his reaction. He was a university freshman from a preparatory school where little attention was given to English. As a result his reactions lay within a narrow range and duplicates were common. This was true particularly for the adjective responses to nouns. They were made up largely of what Kent and Rosanoff call non-specific reactions, such as *large, small, good, bad, tall, short*, etc. Few if any adjectives were of more subtle or connotative significance. Nouns that were reacted to by the other subjects with such adjectives as *horrible, ghastly* or *beautiful, wonderful* got merely *bad* or *good* from this subject for a response. Necessarily these stock adjectives occurred many times in one list and allowed of a relatively short reaction time. The noun responses were meager in their con-

71. B.

notation and variety, though to a less degree than the adjectives. Owing to the dearth of words in his vocabulary a good many words of common knowledge were unknown to him and their reactions had to be recorded as failures. These reasons may account for the break in the results. For this subject as well as for all the others the reaction times for the rejected words of this practise series are much longer than for the selected words of the regular series.

TABLE 9

*Reaction times for practise adjectives and nouns, preliminary three days' practise (totals)*

SUBJECT	ONE SYLLABLE						TWO SYLLABLE						THREE SYLLABLE					
	Adjectives			Nouns			Adjectives			Nouns			Adjectives			Nouns		
	Cases	Av.	M. V.	Cases	Av.	M. V.	Cases	Av.	M. V.	Cases	Av.	M. V.	Cases	Av.	M. V.	Cases	Av.	M. V.
	V	29	1534	432	115	2072	588	174	1638	412	138	2082	572	55	1802	354		
VI	29	1316	336	103	2128	572	159	1774	618	131	2554	784	50	2118	662			
VII	28	1866	416	103	3720	1560	156	2620	1050	128	3776	1426	50	2538	988			
VIII	26	1938	532	97	3302	1060	157	2634	1030	124	3722	1332	45	3094	1040			
IX	27	1834	848	105	3186	1378	147	2638	840	114	3518	1462	47	3004	956			
X	23	1726	494	96	1750	448	149	1664	370	118	1968	508	49	1842	466			
XI	28	1636	522	94	3006	1146	154	2132	778	133	3168	1360	50	2456	1234			
XII	25	1704	556	98	2976	1204	155	2566	950	131	3720	1288	37	3128	944			

*Table 10.* This table shows the results by days for the practise period. There is only one case where the noun series gave a shorter reaction time than the adjective series. There are six exceptions however to the rule for syllable variation, three for adjectives and three for nouns.

*Tables 11 to 14 (inclusive).* These give respectively the distribution of reaction times for each of the eight subjects for the regular ten days' work, with the average reaction time, mean variation, and the total number of cases given at the foot of each column. It is to be noted that the difference between the actual number of cases recorded and the number of stimulus words given in each group (180 or 360) is due to various causes:

1. Failure to respond at all, or with a suitable word.
2. Stopping of the motor.

TABLE 10

*Reaction times for practise adjectives and nouns, preliminary three days' practise (by days)*

SYLLABLE	DAY 1						DAY 2						DAY 3					
	Adjectives			Nouns			Adjectives			Nouns			Adjectives			Nouns		
	Cases	Av.	M. V.	Cases	Av.	M. V.	Cases	Av.	M. V.	Cases	Av.	M. V.	Cases	Av.	M. V.	Cases	Av.	M. V.
Subject V																		
1	29	1534	432	28	1878	680				29	2052	664				58	1120	572
2	58	1772	348	56	2164	620	57	1650	410	54	2012	504	59	1502	344	28	2052	400
3							25	1662	350				30	1920	370			
Subject VI																		
1	29	1316	336	25	1920	414				25	1830	402				53	2322	574
2	50	1720	550	48	2474	780	56	1996	772	56	2488	728	53	1592	424	27	2846	992
3							26	1976	542				23	2372	816			
Subject VII																		
1	28	1866	416	27	3686	1622				25	2954	702				51	4160	1308
2	52	2784	1194	50	3818	1492	53	2420	906	52	3702	1248	51	2666	776	26	3762	1198
3							24	3034	1460				26	2080	540			
Subject VIII																		
1	26	1938	532	25	3534	1178				26	2962	874				46	3374	950
2	53	2612	1136	45	4352	1276	58	2742	1128	52	3200	1276	46	2520	780	27	3752	1386
3							23	3186	1154				22	2996	804			
Subject IX																		
1	27	1834	848	24	2524	974				25	2398	794				56	3824	1550
2	49	2036	636	38	2658	1038	49	2866	1318	55	3664	1472	49	2958	1216	21	4690	1442
3							23	2804	820				24	3198	1278			
Subject X																		
1	23	1726	494	21	1708	476				24	1512	394				51	1878	410
2	48	1760	420	42	2100	694	51	1608	338	49	1870	422	50	1624	358	27	1938	332
3							25	1896	516				24	1784	410			
Subject XI																		
1	28	1636	522	20	2864	980				25	2704	1226				49	3240	1230
2	55	2132	840	50	3004	1296	52	2096	652	56	2954	1308	47	2176	808	27	3840	1384
3							24	2644	1482				26	2282	982			
Subject XII																		
1	25	1704	556	24	2584	1104				26	3050	1308				48	3128	1174
2	57	2410	872	51	4174	1398	53	2688	1078	56	3514	1190	45	2640	914	24	3320	1084
3							18	3176	976				19	3080	938			

TABLE 11  
*Distribution of reaction times, adjectives and nouns*

SIGMA	SUBJECT V						SUBJECT VI					
	One syllable		Two syllables		Three syllables		One syllable		Two syllables		Three syllables	
	Adjectives	Nouns	Adjectives	Nouns	Adjectives	Nouns	Adjectives	Nouns	Adjectives	Nouns	Adjectives	Nouns
400	0	0	0	0	0	0	0	0	0	0	0	0
500	0	0	0	0	0	0	0	0	0	0	0	1
600	0	0	0	0	0	0	0	0	3	0	1	0
700	6	1	2	0	0	0	6	1	18	1	5	2
800	12	6	6	2	2	0	13	1	37	2	11	0
900	25	9	26	4	13	0	40	6	49	15	33	4
1000	42	13	52	16	31	1	34	14	50	19	32	16
1100	26	18	53	26	37	19	18	17	43	29	51	18
1200	18	17	43	41	45	21	17	19	27	19	37	24
1300	11	24	48	37	37	27	13	16	36	36	40	32
1400	13	13	33	40	32	25	11	22	19	22	27	30
1500	10	13	20	33	33	39	7	16	13	24	21	24
1600	5	11	15	18	12	46	3	9	10	29	14	25
1700	2	11	10	29	18	26	2	12	8	22	17	22
1800	2	5	6	25	16	22	6	7	7	16	8	18
1900	4	9	8	15	8	16	0	6	8	10	12	19
2000	2	6	6	8	12	13	3	5	3	15	5	19
2100	0	4	5	10	9	20	1	3	0	11	9	9
2200	0	3	3	9	5	16	1	5	7	6	3	11
2300	0	0	2	5	8	11	0	4	0	9	2	10
2400	0	1	1	1	5	8	0	2	2	5	3	7
2500	1	0	3	7	3	6	0	0	0	7	1	8
2600	0	2	1	2	2	7	1	2	5	3	1	3
2700	0	1	0	0	3	7	0	1	0	1	2	4
2800	0	1	0	4	3	1	0	1	2	7	4	8
2900	0	2	0	7	2	3	0	0	1	4	4	3
3000	0	0	1	1	2	0	0	1	1	5	1	8
3100	0	0	0	4	0	4	0	1	0	3	1	4
3200	0	0	1	1	2	3	0	2	1	0	0	1
3300	0	1	1	2	0	3	0	2	0	2	2	6
3400	0	1	0	1	1	0	0	0	0	3	0	2
3500	0	1	0	0	1	1	0	0	0	3	0	2
3600	0	0	0	1	0	0	0	0	0	1	2	1
3700	0	0	0	0	0	0	0	0	0	4	0	0
3800	0	0	0	2	2	0	0	0	0	1	1	1
3900	0	0	0	0	1	1	0	0	0	0	0	1
4000 to 12,000	0	3	0	1	5	2	0	1	2	10	1	8
Total cases.....	179	176	347	352	350	348	176	176	351	344	352	350
Average R. T.....	1196	1584	1382	1666	1616	1852	1196	1602	1290	1836	1466	1910
M. V.....	236	418	278	408	450	424	356	386	358	598	414	580

TABLE 12

*Distribution of reaction times, adjectives and nouns*

SIGMA	SUBJECT VII						SUBJECT VIII					
	One syllable		Two syllables		Three syllables		One syllable		Two syllables		Three syllables	
	Adjectives	Nouns	Adjectives	Nouns	Adjectives	Nouns	Adjectives	Nouns	Adjectives	Nouns	Adjectives	Nouns
400	0	0	0	0	0	0	0	0	0	0	0	0
500	0	0	0	0	0	0	0	0	0	0	0	0
600	0	0	0	0	0	0	0	0	0	0	0	0
700	0	0	1	0	0	1	1	0	1	0	0	0
800	3	1	3	0	2	0	5	1	4	0	0	0
900	9	3	18	0	1	0	10	0	9	1	1	0
1000	13	2	21	2	14	0	17	1	16	1	6	0
1100	21	3	32	9	26	2	12	1	19	6	15	1
1200	15	9	29	12	21	3	12	5	29	8	11	1
1300	16	9	27	16	25	8	15	9	29	3	25	0
1400	16	8	22	10	23	13	7	8	23	11	20	7
1500	21	12	23	21	23	14	11	10	23	17	27	14
1600	3	15	13	17	17	10	9	6	18	13	24	15
1700	10	6	20	30	26	19	10	6	17	22	21	13
1800	7	8	17	12	20	13	11	7	24	15	13	16
1900	8	6	11	10	12	18	9	10	12	14	15	18
2000	6	13	11	13	8	24	6	9	13	16	16	7
2100	3	7	12	19	14	14	1	5	11	7	15	20
2200	1	11	11	12	9	11	6	9	14	15	12	16
2300	7	3	12	11	7	16	3	7	7	13	10	6
2400	1	4	6	8	6	13	1	7	4	11	8	17
2500	1	2	9	17	9	11	3	4	8	13	7	9
2600	2	5	4	8	13	16	2	10	5	15	7	16
2700	2	3	7	6	7	10	0	5	8	13	4	12
2800	1	4	5	7	9	8	1	6	3	8	8	11
2900	1	1	6	9	8	7	1	5	7	5	12	7
3000	1	4	3	4	6	9	2	7	7	7	9	14
3100	0	3	4	10	5	7	2	4	0	4	6	9
3200	0	2	3	8	2	5	3	2	0	8	3	7
3300	2	3	3	2	3	3	1	2	2	9	5	7
3400	2	3	1	3	2	6	1	1	2	7	2	13
3500	3	3	1	7	0	5	0	1	2	2	4	12
3600	0	3	2	1	3	4	1	2	3	7	4	4
3700	1	1	1	4	1	3	0	2	2	4	0	8
3800	0	2	1	6	2	5	0	3	1	2	0	5
3900	0	2	2	2	2	7	0	1	3	9	3	4
4000 to 12,000	1	16	9	50	25	59	5	13	15	48	30	58
Total cases.....	177	177	350	346	351	344	168	169	341	334	344	347
Average R. T.....	1640	2380	1856	2660	2130	2902	1766	2434	1962	2752	2318	2978
M. V.....	478	928	636	1014	758	1046	548	730	652	624	920	1042

TABLE 13

*Distribution of reaction times, adjective and nouns*

SIGMA	SUBJECT IX						SUBJECT X					
	One syllable		Two syllables		Three syllables		One syllable		Two syllables		Three syllables	
	Adjectives	Nouns	Adjectives	Nouns	Adjectives	Nouns	Adjectives	Nouns	Adjectives	Nouns	Adjectives	Nouns
400	0	0	0	0	0	0	0	0	0	0	0	0
500	0	0	0	0	0	0	0	0	0	0	0	0
600	0	0	0	0	0	0	0	0	0	0	0	0
700	3	0	1	0	0	0	2	1	0	0	0	0
800	9	1	4	0	0	0	7	2	5	0	1	0
900	12	5	15	2	3	0	20	8	16	1	4	0
1000	12	7	31	4	6	2	28	13	33	3	10	3
1100	15	14	43	6	16	2	25	9	39	11	21	6
1200	16	4	28	21	23	8	24	19	37	34	24	14
1300	12	15	28	24	29	18	15	20	36	40	45	23
1400	8	11	23	16	26	13	9	18	46	34	22	26
1500	10	12	19	20	23	14	10	18	26	42	30	32
1600	9	10	15	17	29	16	7	23	20	30	27	33
1700	4	9	26	20	20	16	6	12	10	30	19	35
1800	8	18	16	17	26	15	4	4	14	19	19	25
1900	8	8	10	16	15	20	5	7	13	21	16	22
2000	1	8	11	13	12	16	5	4	12	9	13	17
2100	4	6	13	12	13	14	0	1	13	8	15	25
2200	6	4	6	9	10	14	0	2	5	10	15	20
2300	3	6	12	16	10	21	1	6	8	13	10	11
2400	3	4	7	11	11	15	2	1	5	9	17	13
2500	3	3	6	10	5	7	1	3	0	4	8	6
2600	5	0	2	8	3	14	0	2	2	2	6	5
2700	3	3	3	10	6	12	1	0	2	4	2	5
2800	3	4	3	5	6	14	1	0	1	4	5	0
2900	4	4	5	10	7	14	0	0	1	2	4	5
3000	1	1	4	6	5	9	0	0	1	2	6	5
3100	3	0	1	8	3	4	0	0	1	0	1	1
3200	0	1	0	4	3	11	0	0	1	0	0	2
3300	2	4	2	7	4	4	0	0	0	0	0	1
3400	1	2	3	4	4	1	0	0	1	0	0	3
3500	0	1	3	8	6	2	0	0	0	1	1	0
3600	3	0	1	3	1	2	0	0	0	0	0	0
3700	0	1	2	3	2	4	0	0	0	1	2	0
3800	0	0	1	1	3	5	0	0	0	0	0	0
3900	0	1	2	2	0	2	0	1	0	0	1	1
4000 to 12,000	3	5	10	24	11	40	0	0	1	0	0	1
Total cases.....	174	172	347	337	340	349	173	174	349	334	344	340
Average R. T.....	1738	1918	1830	2338	2022	2568	1338	1532	1508	1714	1790	1958
M. V.....	634	586	604	804	612	814	300	294	240	346	546	358

TABLE 14

*Distribution of reaction times, adjectives and nouns*

SIGMA	SUBJECT XI						SUBJECT XII					
	One syllable		Two syllables		Three syllables		One syllable		Two syllables		Three syllables	
	Adjectives	Nouns	Adjectives	Nouns	Adjectives	Nouns	Adjectives	Nouns	Adjectives	Nouns	Adjectives	Nouns
400	0	0	0	0	0	0	0	0	0	0	0	0
500	0	0	0	0	0	0	0	0	0	0	0	0
600	0	0	0	0	0	0	1	0	0	0	0	0
700	2	0	0	0	1	1	2	0	2	0	0	0
800	5	0	9	0	1	0	4	3	4	0	3	1
900	13	1	19	2	8	1	7	4	10	4	7	2
1000	17	5	24	5	16	5	13	4	25	8	5	4
1100	21	9	39	9	24	1	14	9	27	13	13	6
1200	25	13	31	15	22	9	11	10	17	16	16	10
1300	14	13	28	22	23	13	16	12	23	18	16	11
1400	11	13	21	19	19	11	15	13	24	16	11	19
1500	5	14	19	19	15	15	3	9	22	12	17	13
1600	8	8	11	23	16	17	11	9	19	19	11	10
1700	9	6	13	16	17	22	11	14	15	20	17	17
1800	3	8	10	12	10	18	7	7	12	19	17	23
1900	3	3	13	8	15	12	5	8	17	6	23	14
2000	0	3	7	10	12	8	8	12	9	21	9	12
2100	2	11	9	16	10	16	8	9	16	10	12	15
2200	5	6	12	10	10	17	8	4	7	14	13	13
2300	2	7	11	7	12	17	5	9	9	16	11	20
2400	0	7	4	5	8	11	1	0	8	7	12	16
2500	0	3	2	5	6	7	1	3	10	14	11	14
2600	4	7	1	9	6	7	4	3	4	8	9	8
2700	3	3	5	8	8	7	4	2	9	6	8	9
2800	2	5	8	6	2	5	1	5	7	9	11	8
2900	0	0	3	9	1	4	1	2	3	7	8	10
3000	2	1	3	7	8	4	3	1	3	8	9	10
3100	2	1	6	5	2	8	1	3	6	10	9	8
3200	4	5	5	6	2	7	2	1	2	5	1	8
3300	1	1	3	4	2	4	0	1	2	5	6	8
3400	1	3	0	4	2	6	0	1	3	4	4	6
3500	1	3	1	4	3	7	1	1	2	3	1	3
3600	1	1	5	3	1	3	0	1	2	10	3	4
3700	2	1	2	6	1	4	0	2	3	3	3	6
3800	1	2	3	5	4	0	1	0	3	3	5	0
3900	0	0	0	5	3	4	0	1	0	1	1	2
4000 to 12,000	5	14	23	64	42	68	3	3	18	29	30	34
Total cases.....	174	177	350	348	332	339	172	166	343	344	332	344
Average R. T.....	1694	2300	1998	2860	2396	3002	1736	1920	2038	2336	2460	2518
M. V.....	676	886	812	1286	1078	1334	622	562	710	798	810	840

3. Failure of the subject to speak into the voice key so as to make the clock stop.

4. A few cases where 3 occurred for the experimenter.

These results corroborate the conclusions drawn from the averages. It will be noticed that to a great extent the modes bear out the same conclusions as do the averages, especially for the increase in reaction time for nouns over adjectives.

The relatively large number of reaction times of four seconds and over, for some of the subjects, must indicate either that the stimulus words need further elimination or that these subjects had particularly slow reaction times, therefore bringing a larger percentage of reactions into this four second group. Both conclusions are true to some extent. Some further elimination is still necessary to accommodate the lists to the vocabularies of even university freshmen. On the other hand subjects VII, VIII, and XI were naturally slow in reaction no matter how simple the stimulus word.

#### *Conclusions for experiment II*

1. The reaction time for the noun-adjective association is longer than for the adjective-noun association.

2. The reaction time for both adjective and noun stimulus words increases directly with the number of syllables in the stimulus word.

3. The above conclusions agree with those made in experiment I. They hold also for a group of difficult adjectives and nouns such as were used in the practise period of this experiment, although the reaction times in this case are greatly increased above those obtained on the large mixed group used in experiment I or the selected group of this experiment.

4. Distribution curves plotted from the results for adjective and noun stimulus words indicate that the modes for the reaction times follow in general the laws of the averages.



## EXPERIMENT III

This experiment was carried out in its present brief scope merely to get some indication of the probable course of the experiment on a large scale. It consisted in repeating for two successive days the identical lists of day 10 of the regular series. The purpose was to see the course of the reaction time. For this reason the subject was not told that these lists were repetitions, but merely that he might possibly recognize some words as having been given before, to take no note of this but to react as usual with the first adjective or noun thought of, and to make no effort to duplicate his response for the same stimulus word. This work was done immediately at the close of the regular ten days' work by the same eight subjects.

*Results for experiment III*

The results are shown in table 15. On the whole there is a decrease in reaction time with each repetition of the same stimulus words, both adjectives and nouns. Subject V, however, did not conform to this type of reaction except in two out of a possible eight drops in reaction time. Unfortunately we have no note of any unusual behavior during these three days that might account for his eccentricity. If we exclude his results entirely the exceptions are few, only 1 increase as against 27 decreases for nouns and only 5 increases as against 23 decreases in reaction time for adjectives.

The response words given were usually repetitions in spite of the fact that most of the subjects did not recognize on the second day that the words were duplicates of those of the previous day, and in spite of the instructions given them in regard to recognizing a duplicate word. The subjects all "caught on" by the third day that the lists were duplicates; if one of them gave a new response word he usually commented on the fact to himself.

TABLE 15  
*Reaction times for repetitions of day 10*

SUBJECT	TWO SYLLABLE ADJECTIVES									THREE SYLLABLE ADJECTIVES								
	Day 10			Day 11			Day 12			Day 10			Day 11			Day 12		
	Cases	Av.	M. V.	Cases	Av.	M. V.	Cases	Av.	M. V.	Cases	Av.	M. V.	Cases	Av.	M. V.	Cases	Av.	M. V.
	V	29	1400	266	29	1630	414	30	1458	220	60	1674	432	58	1932	380	59	1638
VI	30	1066	184	29	954	122	30	994	170	60	1436	362	59	1200	292	60	1214	248
VII	29	1884	520	29	1318	290	29	1166	266	58	2154	754	56	1666	504	59	1356	432
VIII	30	1350	318	29	1604	402	30	1172	312	59	2044	658	59	1848	652	59	1488	420
IX	30	1562	504	30	1570	408	30	1372	314	56	1776	398	59	1566	416	60	1678	476
X	30	1644	368	26	1398	174	30	1120	156	55	1956	516	59	1376	264	60	1228	230
XI	29	1930	910	30	1758	446	29	1310	400	56	2732	1356	58	2260	806	57	1758	716
XII	30	1760	676	30	1348	546	30	1040	346	59	2086	708	60	1680	692	60	1328	462
	TWO SYLLABLE NOUNS									THREE SYLLABLE NOUNS								
V	30	1758	346	30	2210	502	30	1878	426	59	2046	484	59	2200	380	60	2072	364
VI	30	1708	482	30	1198	216	30	1108	140	59	1916	592	57	1500	408	58	1438	358
VII	29	2688	996	29	1922	746	28	1366	332	55	2902	1226	55	2024	688	57	1610	488
VIII	30	2374	714	30	2262	802	29	1808	556	57	3106	1032	60	2582	810	57	2124	702
IX	30	2210	840	29	1848	484	30	1536	360	58	2518	736	57	2162	824	60	2088	688
X	28	1946	360	27	1512	298	30	1198	218	55	2146	542	59	1470	252	58	1204	174
XI	30	3698	1842	30	2806	1226	30	1858	612	53	3214	1320	54	3224	1364	58	2120	850
XII	30	1998	738	30	1628	550	30	1154	360	58	2098	566	53	1784	612	60	1540	418

*Conclusion for experiment III*

1. Successive repetitions of a list of stimulus words cause successive decreases in the reaction times when the subject is not informed of the fact of repetition. These reaction times would ultimately reach a physiological level.

EXPERIMENT IV. DOUBLE ASSOCIATIONS

This experiment like experiment III was made only on a small scale in order to get an indication of the probable course of the results on a larger scale. It comprised one hour's work only for each of four subjects, V, VI, VII, VIII. Six lists of stimulus words were given, 20 each of one, two and three syllable adjectives and intransitive verbs, run in parallel as in experiment II.

Double associations were required. For an adjective stimulus word, the subject must think of a noun applicable to the adjective and respond orally with a verb having this noun as subject. In this way the first association was silent, the second spoken. The verb given might be either transitive or intransitive, but auxiliaries were prohibited. With the transitive verbs, the association was made in the reverse order, back to a noun as its subject (silent) and then to an adjective (spoken) modifying this noun. Intransitive verbs were chosen for this type of reaction as a check on the backward direction of the association, otherwise the association might be made forward to an object of the verb and its modifier.

*Results for experiment IV*

The results are shown in table 16. With the two exceptions in the three syllable words, there is a uniformly large reaction time

TABLE 16  
*Reaction times for double associations*

SUBJECT	ONE SYLLABLE						TWO SYLLABLE						THREE SYLLABLE					
	Adjectives			Verbs			Adjectives			Verbs			Adjectives			Verbs		
	Cases	Av.	M. V.	Cases	Av.	M. V.	Cases	Av.	M. V.	Cases	Av.	M. V.	Cases	Av.	M. V.	Cases	Av.	M. V.
	V	20	2236	696	20	2466	618	20	2466	466	20	2498	546	19	3054	496	20	2892
VI	19	1740	400	20	2576	556	19	2458	762	20	2958	852	20	2428	668	20	2658	516
VII	20	2844	764	18	3954	1496	19	4112	1008	20	4690	1674	20	4378	1720	20	5202	1492
VIII	20	2894	626	20	4206	1230	20	4546	1924	19	4606	1566	20	4382	1290	19	4256	1116

for the backward association from verbs to adjectives. This results agrees with the comments of the subjects when asked which was the easier. The backward association with some exceptions was felt to require the greater effort. The increase in reaction time varies, to be sure, between wide limits among the different subjects and for stimulus words of different lengths, from 32 sigma to 1312 sigma, with an average increase of 571 sigma. For the two exceptions for subjects V and VIII,

respectively, the decrease in reaction time for the backward association is small compared to the average increase for other cases. It amounts only to 162 sigma and 126 sigma. A larger number of cases would probably throw these results in the same direction as the others.

#### *Conclusion for experiment IV*

1. The reaction time is longer for "backward" than for "forward" double associations, using these terms to refer to the normal language order. The reaction time is longer in associating from intransitive verbs back through noun subjects to modifying adjectives than from adjectives forward through noun subjects to verbs.

#### SUMMARY

One of the most important results of this investigation has been the preparation of lists of stimulus words suitable for use in the word association reaction. These lists total 10,888 words and are classified into groups of adjectives, nouns, transitive verbs, and intransitive verbs, each list arranged in chance order alphabetically and further subdivided into groups of one, two, and three syllables. Furthermore each of these groups has been once tested for the suitability of its words to the word association reaction and separated into selected words, rejected words, homonyms. It is insisted that this evaluation of the stimulus words can by no means be considered final or of universal fitness, but will surely serve greatly in a proper selection of words for a particular purpose in view.

The complete lists without eliminations were used once with four subjects to study the adjective-noun, noun-adjective, verb-object and verb-subject controlled associations, and to obtain data for the selection and rejection of words.

The adjective-noun and noun-adjective controlled association was more intensively studied on eight new subjects using 1800 words from the revised lists, keeping the number of stimulus nouns and adjectives equal, and constant for all subjects at each

of the ten sessions, and preserving an exact balance in the order of presentation of the various groups. In both parts of the experiment the associations were recorded, also the reaction times, which were measured with the Johns Hopkins chronoscope. Averages and mean variations were calculated on the Burroughs adding machine, using the Dunlap adding machine formula for the mean variations. From this data it was purposed to observe whether there is any definite time relation between the adjective-noun and the noun-adjective associations, or between the verb-object and verb-subject association and whether the reaction time has any fixed relation to the number of syllables in the stimulus word, the position of the accent or the logical category to which the stimulus word belongs. Some data was secured on double associations and associations to repeated stimulus words, and the emotional adaptation of the subject to the experiment is discussed.

The following conclusions were drawn from the results:

1. The normal order for adjectives and nouns in the English language gives on the average a shorter association time than the inverse order, when the number of syllables in the compared groups is the same. That is, the reaction time for the adjective-noun association is shorter than for the the noun-adjective association. This holds when the groups are made up of carefully selected words, or when the stimulus words are all difficult, i.e., the words rejected from the revised lists, or when the stimulus words are still unevaluated and therefore include both difficult and easy words.

2. The reaction time for both the adjective-noun and noun-adjective associations increases on the average directly with the number of syllables in the stimulus word, and as in (1) holds for carefully selected stimulus words, or difficult words, or mixed groups of words containing both selected and difficult words.

3. The position of the accent in the stimulus word has no systematic effect on the reaction time for either the adjective-noun or noun-adjective association.

4. There is no interpretable variation in reaction time on the average according to the grouping of stimulus nouns into

logical categories. The reaction time remains relatively constant within the limits of word length when large groups of stimulus words are used.

5. The reaction time for the verb-subject association is longer on the average than for the verb-object association for stimulus words having the same number of syllables. As with the nouns and adjectives the normal order for the English language gives the shorter reaction time.

6. For both the verb-subject and verb-object associations the reaction time on the average increases directly with the number of syllables in the stimulus word.

7. Two or three separate hours of work are sufficient for the subject to become adapted to the procedure of the word association experiment, and to lose as much as is possible of any emotional disturbance resulting from the novelty of his environment or from sex difference between subject and experimenter.

8. The beginning of each list of words is usually marked by three or four reaction times faster than the average. There is then a sudden increase which persists throughout the list, and which may be due to the adjustment of the subject to a comfortable steady muscular "tension" adapted to a long period of work.

9. Successive repetitions of a list of stimulus words for both the adjective-noun and the noun-adjective associations, cause successive decreases in the reaction time when the subject is not informed that the stimulus words are words that have been given before. These reaction times would no doubt ultimately reach a physiological level.

10. The reaction time for double associations is longer on the average for the inverse order than for the normal order in the English language. That is, the reaction time is longer in associating from intransitive verbs backward through noun subjects to adjectives than forward from adjectives through noun subjects to verbs.

11. In all controlled word association experiments, any interpretation of reaction times must surely take into consideration the type of control put upon the associations, and the

number of syllables in the stimulus word. It is further insisted that conclusions are valid only when drawn from extended data using large groups of words as have been used in this investigation.

#### FURTHER TECHNICAL PROBLEMS IN THE WORD ASSOCIATION METHOD

In connection with the application of the Association Method to practical problems, and for the further understanding of the associative processes and conditions themselves, a considerable number of special points remain to be investigated. Obviously, the accurate use of the association-reaction as a tool for the investigation of mental conditions demands the fullest possible knowledge of the laws of the reaction itself. The problems included in the following list have been formulated in this laboratory for experimental attack, and it is hoped that work on some of them may be under way before long.

1. A more detailed study of the course of the reaction time for repetitions of a group of stimulus words of different types, as suggested in Experiment III.
2. A more detailed study of double and triple associations along the line suggested in Experiment IV.
3. The effect of suggestion on the reaction time variation for different types of forward and backward controlled associations.
4. Comparison of visual and auditory methods of presentation of stimulus words in the word association method.
5. A comparison of spoken and written types of reaction in the word association method.
6. The variation in reaction time for the adjective-noun and noun-adjective reaction in French, Italian, and Spanish subjects.
7. A study of the emotions in the word association method, when supplemented by plethysmographic, cardiographic, sphygmographic, pneumographic, and galvanometric controls.
8. Sex differences in various types of controlled word associations.
9. Investigation into the comparative length of reaction times for the following types of controlled word associations;
  - (1) noun subject—intransitive verb
  - noun subject—transitive verb
  - noun subject—verb (either v.i. or v.t.)

- (2) intransitive verb—noun subject  
transitive verb—noun subject  
verb (either v.i or v.t)—noun subject
  - (3) transitive verb—noun object  
nouns object—transitive verb
  - (4) noun subject—verb  
verb—noun subject
  - (5) Comparison of English and German subjects for (3) and (4).
  - (6) noun subject—(verb)—noun object  
noun object—(verb)—noun subject
  - (7) noun (cause)—verb (effect)  
verb (effect)—noun (cause)
  - (8) verb—adverb  
adverb—verb
  - (9) class (genus)—member (species)  
member (species)—class (genus)
  - (10) opposites for verbs
  - (11) opposites for adjectives
  - (12) opposites for adverbs
  - (13) coordinate members.
10. A study of preferential associations.
- (1) to observe whether transitive or intransitive verbs occur more often in the *noun subject—verb* reaction.
  - (2) to observe whether noun subjects or noun objects occur more often in the *verb—related noun* reaction
  - (3) to observe whether noun subjects or noun objects occur more often in the *noun—noun (related through action)* reaction
  - (4) to observe which type of reaction occurs more often in the *noun—logically related word (other than verb)* reaction; adjective, subordinate, supraordinate, or co-ordinate.
  - (5) to observe which type of reaction occurs more often in the *adjective—logically related word* reaction; substantive or opposite.

## REFERENCES

- (1) GALTON, F.: Psychometric experiments. *Brain*, ii, 1879.  
GALTON, F.: Psychometric experiments. *Inquiries into human faculty*. 1883.
- (2) WUNDT, W.: Ueber psychologische Methoden. *Phil. Stud.*, i, 1883.



- (3) TRAUTSCHOLDT, M.: Experimentelle Untersuchung ueber die Association der Vorstellungen. *Phil. Stud.*, i, 1883.
- (4) WAHLE, R.: Bemerkung zur Beschreibung und Eintheilung der Ideen-association. *V.-schr. f. wiss. Phil.*, ix, 1885.
- (5) CATTELL, J. M.: The time it takes to see and name objects. *Mind*, xi, 1886.
- (6) CATTELL, J. M.: Psychometrische Abtheilungen, I und II. *Phil. Stud.*, iii, 1886.
- (7) CATTELL, J. M.: Experiments on the association of ideas. *Mind*, xii, 1887.
- (8) CATTELL, J. M., AND BRYANT, S.: Mental association investigated by experiment. *Mind*, xiv, 1889.
- (9) SCRIPTURE, E. W.: Ueber den associativen Verlauf der Vorstellungen. *Phil. Stud.*, vii, 1892.
- (10) MÜNSTERBERG, H.: Studien zur Associationslehre. Beiträge zur experimentellen Psychologie. Heft. iv.
- (11) TITCHENER, E. B.: The Leipsic School of Experimental Psychology. *Mind*, N. S. I, 1892.
- (12) WUNDT, W.: Bemerkungen zur Associationslehre. *Phil. Stud.*, vii, 1892.
- (13) BOURDON, B.: Recherches sur la succession des phénomènes psychologiques. *Rev. Phil.* xxxv, 1893.
- (14) HOWE, H. H.: Mediate association. *Am. J. Psych.*, vi, 1893.
- (15) BERGSTRÖM, J. A., Relation of the interference to the practise effect of an association. *Am. J. Psych.*, vi, 1894.
- (16) CALKINS, M. W.: Association. Studies from the Harvard Psychological Laboratory. *Psych. Rev.* i, 1894.
- (17) JASTROW, J.: Community and association of ideas. *Psych. Rev.* i, 1894.
- (18) JERUSALEM, W.: Ein Beispiel von Association durch unbewusste Mittelglieder. *Phil. Stud.* x, 1894.
- (19) SMITH, W. G.: Mediate association. *Mind*, N. S., iii, 1894.
- (20) WARD, J.: Assimilation and association. *Mind*, N. S., iii, 1894.
- (21) WUNDT, W.: Sind die Mittelglieder einer mittelbaren Association bewusst oder unbewusst? *Phil. Stud.*, x, 1894.
- (22) ALLIN, A.: Ueber die Grundprincip der Association. *Diss.* Berlin, Mayer und Mueller, 1895.
- (23) DUMONT, C.: De la ressemblance et de la contiguité dans l'association. *Rev. de Métaph. et de Mor.*, iii, 1895.
- (24) ASCHAFFENBURG, G.: Experimentelle Studien ueber Associationen. *Psych. Arbeiten*, i, 1896, ii, 1899, iv, 1904.
- (25) CALKINS, M. W.: Association. Studies from the Harvard Psych. Laboratory. *Psych. Rev.*, iii, 1896.
- (26) CALKINS, M. W.: Association: An essay analytic and experimental. *Psych. Rev. Monog. Suppl.*, i, 1896.
- (27) KRAEPELIN, E.: Der psychologische Versuch in der Psychiatrie. *Psych. Arbeiten*, i, 1896.
- (28) ZIEHEN, T.: Die Ideenassoziation des Kindes. 1 u. 2 Abh. *Sammlung v. Abh. aus dem Geb. der päd. Psych. u. Phys.*, i, 1896, iii, 1900.
- (29) JOST, A.: Die Assoziationsfestigkeit in ihrer Abhängigkeit der Verteilung der Wiederholungen. *Ztschr. f. Psych.*, xiv, 1897.

- (30) REGNAULT, F.: Des associations d'idées dans le génie. *Medicine Mod.*, viii, 1897.
- (31) CALKINS, M. W.: Short studies in memory and in association from the Wellesley College Laboratory. *Psych. Rev.*, v, 1898.
- (32) DEFFNER, K.: Die Aehnlichkeitsassociation (Diss. Munich., 1898). *Ztschr. f. Psych.*, xviii, 1898.
- (33) GOBLOT, E.: Sur la theorie physiologique de l'association. *Rev. Phil.*, xlvi, 1898.
- (34) VAN DER PLAATS, N.; Vrije Woord-Associatie. *Akademische Proefschrift*, Amsterdam, 1898.
- (35) SOMMER, R.: Lehrbuch der psychopathologischen Untersuchungsmethoden, 1899.
- (36) VAN ERP TAALMAN KIP, M. J.: Psychiatrische en neurologische Bladen, vi, 1899.
- (37) BOURDON, B.: Le type grammatical dans les associations verbales. *C. R. IVe Congrès Int. de Psychol.*, 1900 (1901).
- (38) WRESCHNER, A.: Eine experimentelle Studie ueber die Assoziation in einem Fall von Idiotie. *Allgem. Ztschr. f. Psychiatrie*, 1900.
- (39) CORDES, G.: Experimentelle Untersuchungen ueber Associationen. *Phil. Stud.*, xvii, 1901.
- (40) KELLOR, F. A.: The association of ideas. *Pedag. Sem.*, viii, 1901.
- (41) THUMB A., UND MARBE, K.: Experimentelle Untersuchungen ueber die psychologischen Grundlagen, der sprachlichen Analogiebildung. Leipzig, 1901.
- (42) MAYER, A., UND ORTH, J.: Zur qualitativen Untersuchung der Association. *Ztschr. f. Psych.*, xxvi, 1901.
- (43) BOURDON, B.: Contribution à l'étude de l'individualité dans les associations verbales. *Phil. Stud.* xix, 1902 (Festsch.).
- (44) SCHMIDT, F.: Experimentelle Untersuchungen zur Associationslehre. *Ztschr. f. Psych.*, xxviii, 1902.
- (45) CLAPARÈDE, E.: L'association des Idées. *Bibliothèque Internationale de Psychologie Experimental.* Paris. O. Doin. 1903.
- (46) FUHRMANN: Diagnostik und Prognostik der Geisteskrankheiten. Leipzig, 1903
- (47) PIÉRON, H.: L'association médiate. *Rev. Phil.*, lvi, 1903.
- (48) PIÉRON, H.: Les expériences sur l'association des idées. *Rev. de Psychiat.*, 3e S., vii, 1903.
- (49) SMITH, W. G.: The range of immediate association and memory in normal and pathological individuals. *Arch. Neur.*, ii, 1903.
- (50) WUNDT, W.: Grundzüge. 5te Auflage, S. 526, Leipzig, 1903.
- (51) BLEULER, E.: Diagnostischestudien Vorwart ueber die Bedeutung von Assoziationsversuchen. *J. f. Psych. u. Neur.*, iii, 1904.
- (52) FÉRÉ, C.: Note sur le rôle des conditions somatiques dans l'association des idées. *Année Psych.*, xi, 1904 (1905).
- (53) JUNG, C. G., UND RIKLIN, F.: Diagnostische Assoziationen. *J. f. Psych. Neur.*, iii, 1904.
- (54) JUNG, C. G.: Analyse der Assoziationen eines Epileptikers. *J. f. Psych. und Neur.*, v, 1904.

- (55) GROSS, A.: Zur psychologische Tatbestandsdiagnostik. Mon. schr. f. Kriminalpsychologie und Strafrechtsreform, 1904.
- (56) LIPMANN, O.: Die Wirkung der einzelnen Wiederholungen auf verschieden starke und verschieden alte Assoziationen.
- (57) RIKLIN, F.: Ueber die diagnostischen Bedeutung von Assoziationsversuchungen bei Hysterischen. Centbl. f. Nervenhl. u. Psychiat., 1904.
- (58) WATT, H. J.: Ueber Assoziationsreaktionen, die auf optische Reizworte erfolgen. Ztschr. f. Psych. u. Phys. d. Sinnesorgane., xxxvi, 1904.
- (59) WEHRLIN, K.: Ueber die Assoziationen von Imbecilen und Idioten. J. f. Psych. u. Neur., iv, 1904-1905.
- (60) WERTHEIMER, M., UND KLEIN, J.: Psychologische Tatsbestandsdiagnostik. Arch. f. Kriminalanthropologie, xv, 1904.
- (61) EDGELL, B.: Experiments on association. J. of Phys., xxxii, 1905.
- (62) GROSS, A.: Die Assoziationsmethode im Strafprocess. Ztschr. f. d. gesamte Strafrechtswissenschaft, xxvi, 1905-1906.
- (63) GROSS, A.: Zur psychologischen Tatbestandsdiagnostik. Beiträge zur Psych. der Aussage, ii, 1905-1906.
- (64) GRABOWSKY, A.: Psychologische Tatbestandsdiagnostik. Sonderabdruck, 1905.
- (65) GROSS, H.: Zur psychologischen Tatbestandsdiagnostik. Arch. f. Kriminalanthropologie u. Kriminalistik., xix, 1905.
- (66) ISSERLIN, M.: Zur psychologischen Tatbestandsdiagnostik. Monatsschr. f. Psychiatrie u. Neur., xviii, 1905.
- (67) JUNG, C. G.: Uber das Verhalten der Reaktionszeit beim Assoziationsexperimente. J. f. Psychiatrie u. Neur., vi, 1905
- (68) JUNG, C. G.: Experimentelle Beobachtungen ueber das Erinnerungsvermögen. Centbl. f. Nervenhl. u. Psychiat., 1905.
- (69) JUNG, C. G.: Zur psychologischen Tatbestandsdiagnostik. Centbl. f. Nervenhl. u. Psychiat., 1905.
- (70) KRAMER, F., UND STERN, W.: Selbstverrath durch Association. Beiträge zur Psychologie der Aussage., ii, 1905-1906.
- (71) PETERS, W.: Ueber Erinnerungsassoziationen. Ber. d. III Kongress f. Exper. Psych., 1905.
- (72) RIKLIN, F.: Analytische Untersuchungen der Symptome und Assoziationen eines Fall von Hysteria. Psychiatrisch-neurol. Woch., 46-52, 1905.
- (72a) WATT, H. J.: Experimentelle Beiträge zur einer theorie des Denkens. Arch. f. d. ges. Psych., iv, 1905.
- (73) ARNOLD, F.: The psychology of association. Columbia Univ. Contributions to Philos. and Psych., 1906.
- (74) BALDWIN, B. T.: Association under the influence of difference ideas. Harvard Psych. Studies, ii, 1906.
- (75) HAHN, R.: Ueber die Beziehung zwischen Fehlreaktionen und Klangassoziationen. (Dis.) Zürich, 1906.
- (76) JUNG, C. G.: Diagnostische Assoziationsstudien. Bd. I. Leipzig, Barth, 1906.
- (77) JUNG, C. G.: Die psychologische Diagnose des Tatbestandes. Juristisch-Psychiatrische Grenzfragen. Halle, 1906.

- (78) JUNG, G. C.: Ueber die Bedeutung des Associations experimentes f. d. Psychopathologie. *Gross Arch. f. Kriminalanthr. u. Kriminalistik*, 1906.
- (79) KIESOW, F.: Ueber sogenannte frei steigende Vorstellungen usw. *Arch. f. d. gesamte Psych.*, vi, 1906.
- (80) LEDERER, M.: Die Verwendung der psychologischen Tatbestandsdiagnostik in der Strafrechtspraxis. *Mon. Schr. f. Kriminalpsych*, 1906.
- (81) LEVY, M.: Studien über die experimentelle Beeinflussung des Vorstellungsverlaufs. I u. II, *Ztschr. f. Psych.*, xlii-xliv, 1906-1907.
- (82) MESSER, A.: Experimentell-psychologische Untersuchungen über das Denken. *Arch. f. d. ges. Psych.*, viii, 1906.
- (83) PICK, A.: Rückwirkung sprachlicher Perseveration auf den Associationsvorgang. *Ztschr. f. Psych.*, xlii, 1906.
- (84) WERTHEIMER, M.: Experimentelle Untersuchungen zur Tatbestandsdiagnostik. *Arch. f. d. ges. Psych.*, vi, 1906.
- (85) DROMARD.: De la "Plasticité" dans l'association des idées. *Rev. Phil.*, lxiv, 1907.
- (86) FÜRST, E.: Statistische Untersuchungen über Wortassoziationen und über familiäre Uebereinstimmung. usw. *J. f. Psych u. Neur.*, ix, 1907.
- (87) JUNG, C. G.: On psychophysical relations of the associative experiment. *J. of Abnorm. Psych.*, i, 1907.
- (88) NEUMANN, E.: Über Assoziationsexperimente mit Beeinflussung der Reproduktionszeit. *Arch. f. d. ges. Psych.*, ix, 1907.
- (89) SEVERANCE, E., AND WASHBURN, M. F.: Loss of associative power in words after long fixation. *Am. J. Psych.*, 1907.
- (90) WATT, H. J.: Ueber den Einfluss der Geschwindigkeit der Aufeinanderfolge von Reizen auf Wortreaktionen. *Arch. f. d. ges. Psych.*, ix, 1907.
- (91) WRESCHNER, A.: Die Produktion und Assoziation von Vorstellungen. *Zts. f. Psych. u. Phys. Ergänzungsband*, iii, Theil I u. II, 1907-1909.
- (92) SALING, G.: Associative Massenversuche. *Ztschr. f. Psych.*, xlix, 1908.
- (93) SCHOLL, K.: Versuche über die Einführung von Komplexen in Assoziationen von gesunden und Geisteskranken. *Klin. f. psych. u. Nerv. Krankh.*, iii, 1908.
- (94) ACH, N.: Ueber eine Methode zur Untersuchung der simultanen Assoziationen. *Bericht d. III Kongress f. Exper. Psych.*, Leipzig, 1909.
- (95) DUNLAP, K.: A new key for reaction time work. *Psych. Monog*, x, 1909.
- (96) SCHULTZE, F. E. O.: Bericht über Assoziationsversuche des psych. Inst. der Frankfurter Akad. *Ber. d. III Kongress f. Exper. Psych.*, 1909.
- (97) THUMB, A.: Assoziationsversuche im Dienste der Sprachwissenschaft. *Ber. d. III Kongress f. Exper. Psych.*, 1909.
- (98) STEIN, P.: Tatbestandsdiagnostische Versuche bei Untersuchungsgefangen. *Ztschr. f. Psych.*, iii, 1909.
- (99) YERKES, R. M., AND BERRY, C. S.: Association reaction method of mental diagnosis. *Am. J. Psych.*, xx, 1909.
- (100) BOVET, P.: L'originalité et la banalité dans les expériences collectives d'association. *Arch. de Psych.*, x, 1909.
- (101) EASTMANN, M.: To reconsider the association of ideas. *J. of Psych.*, etc., vii, 1910.

- (102) FRANZ, S. I.: Some considerations of the association word experiment. *Bull. Gov. Hops. for Insane.*, ii, 1910.
- (103) FREUD, S.: Origin and development of psycho-analysis. *Am. J. Psych.*, xxi, 1910.
- (104) GEISSLER, L. R.: A preliminary introspective study of the association-reaction consciousness. *Am. J. Psych.*, xxi, 1910.
- (105) JOUSSAIN, A.: Le cours de nous idées. *Rev. Philos.*, lxx, 1910.
- (106) JUNG, C. G.: The association method. *Am. J. Psych.*, xxi, 1910.
- (107) KENT, G. H. AND ROSANOFF, A. J.: A study of association in insanity. *Am. J. of Insanity.*, lxvii, 1910.
- (108) LANGFELD, H. S.: Suppression with negative instruction. *Psych. Bull.*, vii, 1910.
- (109) LEACH, H. M., AND WASHBURN, M. F.: Some tests by the association reaction method of mental diagnosis. *Am. J. Psych.*, xxi, 1910.
- (110) NUNBERG, H.: Diagnostische Assoziationsstudien. *J. f. Psych. u. Neur.*, xvi, 1910.
- (111) OHMS, H.: Untersuchung unterwertiger Assoziationen mittels des Worterkennungsvorgangs. *Ztschr. f. Psych.*, lvi, 1910.
- (112) REINHOLD, F.: Beiträge sur Assoziationslehre auf Grund von Massenversuchen. *Ztschr. f. Psych.*, liv, 1910.
- (113) RITTERHAUS, R.: Die Komplexforschung. *J. f. Psych. u. Neur.*, xv, 1910.
- (114) RUSK, R. R.: Experiments on mental association in children. *Brit. J. Psych.*, iii, 1910.
- (115) WHIPPLE, G. M.: Manual of mental and physical tests. Baltimore, 1910.
- (116) DAUBER, J.: Über bevorzugte Assoziationen und verwandte Phänomene. *Ztschr. f. Psych.*, lix, 1911.
- (117) DUNLAP, K.: The fall-hammer, chronoscope and chronograph. *Brit. J. of Psych.*, iv, 1911.
- (118) FOUCAULT, M.: Etude expérimentale sur l'association de ressemblance. *Arch. de Psych.*, x, 1911.
- (119) GOETT, T.: Assoziationsversuche an Kindern. *Ztschr. f. Kinderhkl.*, cv, 1911.
- (120) HUBER, E.: Assoziationsversuche an Soldaten. *Ztschr. f. Psych.*, lix, 1911.
- (121) LANGFELD, H. S.: Suppression with negative instruction. *Psych. Rev.*, xviii, 1911.
- (122) LEVY-SUHL, M.: Studien über die experimentelle Beeinflussung des Vorstellungsverlaufes. *Ztschr. f. Psych.*, lix, 1911.
- (123) LEY AND MENZERATH: L'étude expérimentale de l'association des idées dans les maladies mentales. Gand: Van der Haeghen, 1911.
- (124) WELLS, F. L.: Some properties of the free association time. *Psych. Rev.*, xviii, 1911.
- (125) WELLS, F. L.: A preliminary note on the categories of association reactions. *Psych. Rev.*, xviii, 1911.
- (126) WELLS, F. L.: Practice effect in free associations. *Am. J. Psych.*, xxii, 1911.
- (127) WELLS, F. L., AND FORBES, A.: On certain electrical processes in the human body and their relation to emotional reactions. *Arch. of Psych.*, xvi, 1911.

- (128) WHITLEY, M. T.: An empirical study of certain tests for individual differences. *Arch. of Psych.*, xix, 1911.
- (129) WOODWORTH, R. S., AND WELLS, F. L.: Association tests. *Psych. Rev. Monog. Supp.*, xiii, 1911.
- (130) APTEKMANN, E.: Experimentelle Beiträge zur Psychologie des psychogalvanischen Phänomens. *Jahr. f. Psychonanal. u. psychopath. Forsch.*, 1912.
- (131) ATHERTON, M. V., AND WASHBURN, M. F.: Mediate associations studies by the method of inhibiting associations. *Am. J. Psych.*, xxiii, 1912.
- (132) CULLER, A. J.: Interference and adaptability: an experimental study of their relation, etc. *Arch. of Psych.*, xxiv, 1912.
- (133) DUNLAP, K.: Hipp chronoscope without armature springs. *Brit. J. Psych.*, v, 1912.
- (134) EASTMANN, F. C., AND ROSANOFF, A. J.: Association in feeble-minded and delinquent children. *Am. J. of Insanity*, lxix, 1912.
- (135) NAGLE, F.: Experimentelle Untersuchungen über Grundfragen der Assoziationslehre. *Arch. f. d. ges. Psych.*, xxiii, 1912.
- (136) PFENNINGER, W.: Untersuchungen über die Konstanz und den Wechsel der psych. Konstellation bei normalen und Frühdementen. *Jahr. f. Psychoanal. u. psychopath. Forsch.*, 1912.
- (137) PFERSDORFF: *Monat. f. Psychiat. u. Neur.*, xxxi, 1912.
- (138) WELLS, F. L.: The question of association types. *Psych. Rev.*, xix, 1912.
- (139) WOHLGEMUTH, A.: Ueber die Richtung der Assoziationen. *Ber. über d. V Kongress f. Exper. Psych.*, Leipzig, 1912.
- (140) DUNLAP, K.: Apparatus for association timing. *Psych. Rev.*, xx, 1913.
- (141) KELLEY, T. L.: The association experiment: Individual differences and correlations. *Psych. Rev.*, xx, 1913.
- (142) ROSANOFF, I. R., AND A. J.: A study of associations in children. *Psych. Rev.*, xx, 1913.
- (143) SUTHERLAND, A. H.: Critique of word association reactions. *Banta Pub. Co., Menasha, Wis.*, 1913.
- (144) WELLS, F. L.: The personal factor in Association reactions. *Am. J. of Insanity*, lxix, 5, 1913.
- (145) WELLS, F. L.: Professor Cattell's relation to the association method. *Columbia Contribs. to Phil and Psych.*, xxii, 1914.
- (146) CLAPARÈDE, E.: Experiences sur la mémoire des associations spontanées. *Arch. de Psych.*, lxix, 1915.
- (147) CRANE, H. W.: A study in association reaction and reaction time. *Psych. Rev., Monog. Supp.*, xviii, 1915.
- (148) DOOLEY, L.: A study in correlation of normal complexes by means of the association method. *Am. J. Psych.*, xxvii, 1916.

## WORD-LISTS FOR ADJECTIVE AND NOUN REACTIONS

MILDRED WEST LORING

*University of Washington, Seattle*

The following word lists, were employed by Dr. Loring in experiments II, III and IV of "Methods of Studying Controlled Word Associations (this journal, current volume, pages 369-428). Each day's work is given in the order in which it was presented, and the order of days is preserved. The method of selecting the words is described on pages 374-376, and 397-400. The consideration of these lists in connection with the range of distribution of reaction times is important, as it is impossible to obtain the necessarily long lists of words of equal familiarity. These lists being the results of two successive elimination processes, furnish a good basis for further reduction for work where shorter lists may be used, and greater uniformity, with a certain grade of average familiarity, may be desirable. The complete lexicon of verbs, nouns and adjectives which remained after the two eliminations will be issued later: but in the mean time these lists may be useful as sources. The necessity of making up lists of stimulus words by methodical selection from longer, mechanically prepared, lists, and so avoiding the associative processes of the one who makes up the lists, is obvious.

*Double associations (120)*

ONE SYLLABLE ADJECTIVES	ONE SYLLABLE VERBS INTRANSITIVE	TWO SYLLABLE ADJECTIVES	TWO SYLLABLE VERBS INTRANSITIVE	THREE SYLLABLE ADJECTIVES	THREE SYLLABLE VERBS INTRANSITIVE
white huge nice sweet lame thin late swift blue rich loud gay round young free good clean numb dark dry	stoop chime toil think doze laugh talk blush yawn skate rise live cease wait come faint swim grunt sneer fret	ragged human snowy greedy frantic quiet graceful polite modern sullen ready shallow yellow single famous pleasant hungry crooked deadly heavy	abscond rejoice tarry collide succumb loiter sparkle repent elapse compete stumble rebel arise relent with chatter suffer appear labor quarrel	contented delightful elastic immortal excellent desolate ponderous indolent eventful tenacious unhappy envious conceited talkative penniless tremulous dangerous ambitious humorous devoted	deviate disappear oscillate endeavor overhang correspond meditate sympathize condescend hesitate disagree justify coincide testify persevere emigrate undulate interfere moralize culminate



## Practise day 1

ONE SYLLABLE NOUNS	ONE SYLLABLE NOUNS	TWO SYLLABLE ADJECTIVES	TWO SYLLABLE NOUNS	TWO SYLLABLE ADJECTIVES	TWO SYLLABLE NOUNS
mere first nude two next west jet back six sparse most worse prime rank third much one east ninth sound three eighth nine hind tenth dire dank chaste few each	scrap month creed lick grace trend nine five pork cowl rot snare fluff hop mash hulk puss slack writ beam pot spoke rut volt breast trump norm kind sop Czar	formless Belgian mushy aglow hairy ribald spongy frugal latent southeast snappish fourteen abject forty gluey adept obscure eighteen alpine lovesick racy unborn German any verbal noiseless morose sooty fifteenth Prussian	cobble telltale chilblain nothing bigness Sabbath elect intent booby asset comma falseness thousand slattern mining docket million acme total drier cosmos friction wobble badness fifty scion bastard semblance mystic doomsday	unlike putrid snowwhite measly fourfold hidebound pliant entire phonic massy sinless Norman mawkish elfish gitty thousand better inert exempt loathsome untoward Roman agape advance obscene frstrate intact tactile obese lucid	saddler object suckling pedant quickstep felder Psalter Tuesday stammer specie eighty flexor sector middle wallow sorghum extent surplus liter ratio ditto quadroon outskirt truism Bacchus midway seven lovefeast crossroad thorax

## Practise day 2

ONE SYLLABLE NOUNS	TWO SYLLABLE ADJECTIVES	TWO SYLLABLE NOUNS	TWO SYLLABLE ADJECTIVES	TWO SYLLABLE NOUNS	THREE SYLLABLE ADJECTIVES
banc length prick fjord slang spunk clap smith clog asp whist drab mile front buck hemp ounce lea haunch pew verb smut shrimp whey Dutch flick boss foal stool fizz	bizarre erect fifty sinful downhill alike overcast Cuban ducal dormant potent seventh rotund doubtless fury edgewise unfit British ashen Grecian fifteen second flagrant earthy tasty pitchy nineteen piquant afraid neuter	Savior ninety fichu ozone something Babel midnight lovelock scruple dicky Bastille wallop flashlight Japan chicken event reverse evil subscript axis remnant Spartan prefect quotient auburn tangent feeler funky gazette flagging	unctuous thirteen downright bastard lovelorn billionth cyclic eighteenth afire hundred vapid abstruse defunct crimpy Hebrew brassy hundredth unused careful convex nickel causal tangent twenty spiny cogent dozy seven hybrid outright	prefix flora weasel outfield proverb nineteen cutworm cyclist Stoic Quaker drawer Cossack workhouse outset flyspeck amour stanchion shortage cockney zero Cyclops fraction mister goitre trio harlot forceps item Saturn eighteen	shortsighted presumptive flagellant votable insipid apropos flamboyant inherent didactic thirtieth seventy fiftieth eclectic tractable adipose unfailing opulent emergent disruptive probable synchronous prolific recreant tendinous insurgent debonair politic affecting sixtieth veracious

*Practise day 3*

TWO SYLLABLE ADJECTIVES	ONE SYLLABLE NOUNS	TWO SYLLABLE ADJECTIVES	ONE SYLLABLE NOUNS	THREE SYLLABLE ADJECTIVES	TWO SYLLABLE NOUNS
virile sixty thirsty monthly cognate toxic lustful pendant undress merry direful languid devoid dulcet Chinese upstairs extra crisscross crystal fetid northwest innate hindmost flacid neither smutty astral duplex fivefold hirsute	Turk shank screw watt gland sup flip batch seed warp spawn dump vogue Mars strain tan Greek back Swede stint ten Swiss lymph dune Norse lust sylph verge drake ace	nutty squeamish lustrous farther viscous moody prudish focal limpid ninety effete Irish sixteen eighty loveless eastern conclave Danish eastward eighteen highflown English agog million overt Christian Swedish northeast futile thirty	dross thrall huff noun whit skin manx wasp tryst heaves gram Celt grist foil pint eaves young spank tab rick stud deuce sling six two dram oat crimp twelve cock	niggardly culpable composite licentious conjugal sardonic nocturnal seductive volatile sagacious eleven aquiline erotic succulent erosive disparate solvable quiescent provident dissonant posthumous ecstatic ungodly illicit Arabic seventeen requisite pellucid sensual another	maggot filler mistress egress storage spectrum killer spearmint bottom dictum amends today concord adverb Christian Virgin caller Spaniard alto default autumn Irish public flapper affray inquest dissent upstairs respect sequence

*Regular day 1*

ONE SYLLABLE NOUNS	ONE SYLLABLE ADJECTIVES	TWO SYLLABLE NOUNS	TWO SYLLABLE ADJECTIVES	THREE SYLLABLE NOUNS	THREE SYLLABLE ADJECTIVES
hat	hot	anchor	muddy	apparel	domestic
clam	wet	grinder	upper	preference	receptive
sneer	ill	muffler	murky	cuticle	crystalline
share	true	statement	ragged	transition	descriptive
pulp	huge	incense	flimsy	hypocrite	heavenly
crunch	rude	cudgel	sleepy	embassy	scandalous
swish	large	rigor	vivid	tallyho	deductive
freak	weird	skipper	partial	creamy	scholastic
blight	sweet	keepsake	human	uprising	lucrative
leap	close	beeswax	heedful	forefather	recumbent
clue	faint	bracelet	foxy	muskmelon	luminous
splash	dense	peacock	skittish	disclosure	ruinous
league	strange	revel	Gothic	stadium	savory
gain	live	bugle	snowy	exertion	pitiless
dike	kind	vortex	gory	overalls	usual
slaw	stale	column	soggy	management	baptismal
mound	crude	inroad	golden	pretender	counterfeit
key	strict	sermon	robust	landholder	lineal
lad	thin	pageant	warlike	skeleton	usable
risk	mute	helmet	rival	matinee	roundabout
earl	raw	popcorn	gorgeous	beverage	intrinsic
wing	stern	fellow	ablaze	pineapple	decimal
tar	tight	social	greedy	orient	contented
wreck	swift	esquire	unknown	incision	portable
drove	glad	jasper	shaky	peppermint	construction
scream	soft	diction	graceful	nursery	unfaithful
pump	curt	resource	senior	lavender	consistent
snob	rich	folksong	unjust	bobolink	dominant
chop	loud	restraint	shaggy	republic	unrighteous
scoop	wild	snowstorm	hazy	insurance	delightful

## Regular day 2

ONE SYLLABLE ADJECTIVES	ONE SYLLABLE NOUNS	TWO SYLLABLE ADJECTIVES	TWO SYLLABLE NOUNS	THREE SYLLABLE ADJECTIVES	THREE SYLLABLE NOUNS
brusque wide scarce white nice scant moist bold lame big high best gaunt lost tough harsh calm dull shy gray shrill blue short gay round broad deft shrewd tart just	crash span badge niche boast curve leech splotch log paint ink cane point trot nurse drudge bead deal morgue sway bud fringe corn siege mop cow steam clerk tribe soup	unread middle glossy many fervid frantic recent afame flaky tiresome maudlin unreal marshy quiet maple verdant magic flabby polite formal velvet marine stubby funny porous fatal mental puny graphic ornate	creature poster stanza hatchet melon orphan ending ostrich shekel plenty journal ally account bluebell absence crowbar peddler relish pallor lagoon colic margin rubbish horseshoe wedlock reward outrage membrane nuisance cafe	dignified consequent aqueous cardinal elastic immortal lovable incoming contingent respective suggestive resplendent unbalanced excellent legible unwilling envious loquacious desolate unweary erudite substantial esthetic tubular possessive conjugate destitute incumbent angelic downhearted	orchestra example molasses tendency barricade reception lookingglass assessment vocation cinnamon rattlesnake magistrate acceptance caramel onlooker survivor raspberry stiletto hobgoblin agency monarchy delegate rebellion museum direction postmaster scorpion pharisee avowal subtlety

*Regular day 3*

ONE SYLLABLE NOUNS	ONE SYLLABLE ADJECTIVES	TWO SYLLABLE NOUNS	TWO SYLLABLE ADJECTIVES	THREE SYLLABLE NOUNS	THREE SYLLABLE ADJECTIVES
bank	green	apron	typhoid	negligence	prosaic
crowd	young	serpent	former	accident	daughterly
twist	cool	lockjaw	tardy	division	audacious
store	tan	proctor	opaque	solution	ponderous
fish	mad	dismay	impish	opening	adequate
owl	numb	sweater	sultry	sentinel	strenuous
judge	black	moment	hectic	mystery	rapturous
fact	full	sentence	frisky	vanilla	affective
clan	bleak	lather	tricky	preferment	initial
lash	spry	woman	polar	testament	paramount
aid	damp	eclipse	aged	encounter	indolent
sex	still	usher	piggish	allowance	abundant
void	wrong	arbor	needful	entreaty	evident
wag	vague	gooseflesh	metric	precaution	atrocious
float	free	nature	outside	benefit	melodic
twinge	dumb	lever	manlike	ejection	eventful
scar	fond	banking	soppy	suspension	proficient
barn	bent	caution	worthless	johannycake	harmonious
care	deaf	slaughter	leaky	rosary	narcotic
school	grand	belfry	adroit	victory	capable
warmth	rear	ramrod	novel	salary	tenacious
clump	blind	abode	shabby	penalty	overdue
brain	brown	essay	naked	selection	titanic
rye	rash	index	patient	apprentice	contrary
bill	blunt	taboo	floating	professor	abysmal
spy	flat	pooodle	ideal	emigrant	unhappy
net	good	fouder	sumptuous	quotation	generous
tent	choice	plateau	insane	manager	durable
scrape	brave	toaster	uncouth	usurer	masculine
voice	clean	ruby	uncouth	graphophone	decrepit

## Regular day 4

ONE SYLLABLE ADJECTIVES	ONE SYLLABLE NOUNS	TWO SYLLABLE ADJECTIVES	TWO SYLLABLE NOUNS	THREE SYLLABLE ADJECTIVES	THREE SYLLABLE NOUNS
tall stout loose straight false tame drunk slim fair sleek vast brief tense long spare clear deep fast blond meek new fresh thick hard cold left light cheap dead burnt	bump clang turn map pill thrift bull verse gout bird din proof sap truce drug breath grunt trance van poise firm ship tuft cheek squaw mule foam lord sponge frost	sullen intense sulky aghast slender tepid bitter sudden unformed legal rabid naughty level nasty modern leaden ghastly anxious savage rapid stingy ample skilful antique lenient plucky trusty scanty inner ready	martyr sherry jackal handwork romance sanction relic blister coupling outfit antler detour squalor pencil sapphire eyepiece surrey merman triumph discourse menace fable razor traffic sonnet landlord output prairie adjunct penknife	arrogant payable submissive exotic efficient conceited roseate unruly reluctant inherent absorbent congested dramatic affected dissolute essential spurious impulsive incisive subjunctive talkative ordinal tremulous becoming connective resultant penniless defiant accursed redundant	forbearance advancement digestion excitement domicile bitterness typewriter oriole pedigree utterance stratagem sunbonnet constancy enmity dividend alliance immigrant eminence conundrum offering manikin chickenpox brewery arena theater protection embankment admiral retinue attention

*Regular day 5*

ONE SYLLABLE NOUNS	ONE SYLLABLE ADJECTIVES	TWO SYLLABLE NOUNS	TWO SYLLABLE ADJECTIVES	THREE SYLLABLE NOUNS	THREE SYLLABLE ADJECTIVES
tact	slick	contour	lively	sycamore	dolorous
depth	prompt	tribune	intent	avalanche	acoustic
churn	glum	hockey	august	furbelow	temporal
gap	dry	crevasse	perfect	quandary	classical
blur	crisp	homestead	matchless	telegraph	dangerous
slab	odd	return	superb	carpenter	ignoble
zinc	low	applause	arid	upheaval	taciturn
sky	coy	insect	faithless	tradition	emphatic
hilt	blank	solder	baneful	diffusion	federal
ranch	old	camel	supreme	formula	repulsive
club	keen	vaudeville	homesick	ambition	barbaric
salt	dim	truant	oral	election	unconscious
beef	fine	insight	subtle	proceeding	expressive
arch	bad	prelude	purple	employee	grammatic
slash	swell	harness	lifelong	remembrance	unwritten
hope	bright	guitar	wooly	strategy	easterly
car	frail	clearance	likely	mineral	almighty
fad	lank	runner	tidal	etiquette	negative
drill	bluff	meaning	further	sensation	comical
shack	droll	counter	stringent	cranium	unholy
flesh	sour	drawbridge	modest	inflexion	ethical
lot	bald	viasnd	final	prejudice	positive
sip	trite	pinion	mellow	abstinence	duteous
loam	steep	satin	stony	government	ambitious
class	dark	railroad	woody	acrobat	seclusive
stilt	brisk	miller	balmy	kerosene	whimsical
cave	safe	splinter	frigid	nominee	insolent
shad	prim	champagne	splendid	canteloupe	magnetic
bit	sane	pottage	linen	oasis	organic
war	late	knuckle	jagged	hollyhock	shortwinded



## Regular day 6

ONE SYLLABLE ADJECTIVES	ONE SYLLABLE NOUNS	TWO SYLLABLE ADJECTIVES	TWO SYLLABLE NOUNS	THREE SYLLABLE ADJECTIVES	THREE SYLLABLE NOUNS
blithe apt buff ripe pure staid queer poor quick stiff sad plump sharp fierce mild firm sick neat snug pink rare sore lone stray warm red staunch terse vile frank	couch sob pate rat gun sprig ache muff bun roof sow feud tile hill lamp crest splint thrill prude lake pond blame pile skunk soot haste veal line yelp hell	listless random icy unkempt shallow mangy ashy scarlet flashy soapy offhand wary rotten wakeful lofty beastly spiteful yellow wonderous shameless facile sovereign fateful single postal wicker redhot wooden heinous frequent	downfall oven gymnast bonnet tenure gizzard mummy poultry dotage paddle huckster crevice regime upset cousin exile charter painter circuit harelip entrance mandate parlance uplift gauntlet freezer wicket being upshot steward	responsive inventive unrivaled humorous tremendous rational devoted intimate conversant studious national corporal contracted inclusive negligent numerous general hesitant judicial intrepid delicious resolute clamorous destructive infectious outlying undoubted onerous unfeeling retentive	compassion mockery suicide abundance wayfarer creator privacy dimension fugitive dishonor susponder colony parachute institute construction official doggerel treachery boulevard possessor hickory aurora molecule telescope opinion committee animal cathedral nightingale

*Regular day 7*

TWO SYLLABLE NOUNS	TWO SYLLABLE ADJECTIVES	TWO SYLLABLE NOUNS	TWO SYLLABLE ADJECTIVES	THREE SYLLABLE NOUNS	THREE SYLLABLE ADJECTIVES
access	grateful	ivy	rugged	folio	haphazard
measles	exact	harem	foggy	elector	exclusive
body	social	permit	sturdy	mechanics	authentic
matron	liquid	raffle	dusty	sonata	virtuous
passage	worthy	fodder	boundless	November	coherent
robin	famous	thunder	sleety	countenance	repentant
herring	hilly	plaza	latest	slavery	absolute
culvert	lonesome	hobby	drowsy	location	imperfect
painting	hoary	poison	homelike	assistant	external
effect	fearsome	riot	fervent	mulatto	affable
mouthpiece	spacious	decrease	severe	piazza	accurate
primer	festive	partner	florid	eyewitness	elusive
roaster	pleasant	decade	scrawny	affluence	odious
trooper	dying	swallow	oblong	receiver	secretive
granite	hateful	dormer	urgent	balcony	various
felon	useless	archway	prostrate	archery	tentative
standstill	healthy	snowdrift	hungry	favorite	quarterly
volume	able	hardtack	stately	torpedo	unpleasant
physique	hearty	esteem	haughty	emotion	palatial
churchyard	double	pantry	draughty	overshoe	desirous
footprint	harmless	virtue	unwise	dramatist	financial
outpost	curly	conquest	flossy	hobbyhorse	offensive
speaker	ruddy	turtle	open	advantage	previous
deceit	paltry	walrus	crooked	vaseline	corpulent
nickname	rocky	parlor	haunted	semester	infernal
sago	proper	coffin	endless	invasion	piteous
dummy	handy	tincture	vagrant	handywork	ludicrous
pinkeye	grotesque	hedgehog	fertile	courier	extensive
candle	seasick	porthole	sordid	bungalow	horrible
ringworm	brutal	era	hasty	authoress	integral

## Regular day 8

TWO SYLLABLE ADJECTIVES	TWO SYLLABLE NOUNS	THREE SYLLABLE ADJECTIVES	THREE SYLLABLE NOUNS	THREE SYLLABLE ADJECTIVES	THREE SYLLABLE NOUNS
humane gracious sickly filthy occult local swampy solid tranquil lonely honest sincere portly outer secure deadly frosty profuse inside lazy stupid torrid firstclass vocal solemn floral wistful heavy sorry artful	statue dogma filter courtship journey sweeper pivot poet lotus trial illness saber table shaver tremor member accused zither pilot kingdom solo goodwill negress landscape bluefish supply outlaw portrait sardine parole	barbarous paternal movable ungracious aggressive repellent untidy convulsive granular spiritless inconstant decorous unlikely objective insular negligee scrupulous filial merciless discordant covetous sufficient changeable delinquent colossal attentive apparent dutiful consummate personal	salvation robbery assemblage congestion Puritan hemisphere dynasty crockery highwayman nicotine palmistry invention sunflower conjecture gallery difference assortment innkeeper canopy history volunteer decision happiness grasshopper advocate edible adjective underworld submission physician	vertical pertinent corrosive pernicious existent penitent dastardly possible exhaustion magical sensible untimely sonorous ostensive insolvent acquittal cowardice descendant radiant disloyal prominent religious powerless pertinent bountiful jovial formative compliant physical pretentious courageous	disaster narrator utensil conductor horsepower oration absorbent detention rhetoric mayonnaise carrousal tenement bandit hippodrome acquittal cowardice descendant perspective merchandise corpuscule appendage caravan davenport microscope discontent agony property castiron arsenic supplement

*Regular day 9*

TWO SYLLABLE NOUNS	TWO SYLLABLE ADJECTIVES	TWO SYLLABLE NOUNS	TWO SYLLABLE ADJECTIVES	THREE SYLLABLE NOUNS	THREE SYLLABLE ADJECTIVES
rabbit duchess nocturn mischance forcepump postscript boycott adder forger garnet parley faction scripture gypsy embrace relay cologne request finance idler harebell dodger libel baseball motive plumbing mirage pennant girdle outlet	tireless misty divine corrupt docile eager chilly devout clumsy dorsal tasteless darling breathless cursed nervy ashamed crucial hurtful windy fragile distant plaintive livelong native finite southern massive little youthful minus	foeman result August process brigade pedal neighbor writing minute tumor summons broncho culture platter caucus trapeze bridegroom player cabin dessert goblet amber college soda pittance Sultan anguish lawsuit donor outcome	outdoor pious unclean pasty orange lifeless clammy optic simple wiry humble chunky feeble dandy regal mealy nervous jolly airy obtuse luckless drizzly frothy certain lower jealous busy wormy alert dowdy	proviso exclusion toboggan deception consciousness athletics commencement whiporwill attainment handicap existence collection rectitude mackintosh decimal guardian baronet centipede instructor disciple paradise albatross explosion talisman position earthenware irritant precipice mimicry intellect	implicit feminine obnoxious singular expensive mercantile inductive erratic reticent halfhearted creative enormous illnatured maternal ultimate unequal miscranean despondent criminal deficient timorous readable typical primary thunderous untraveled obdurate annual radical evergreen

## Regular day 10

TWO SYLLABLE ADJECTIVES	TWO SYLLABLE NOUNS	THREE SYLLABLE ADJECTIVES	THREE SYLLABLE NOUNS	THREE SYLLABLE ADJECTIVES	THREE SYLLABLE NOUNS
future charming frightful complex bloody content common buxom childless flippant upright impure gaudy colored blissful pungent faulty conscious bossy younger needy tiny cruel irksome friendly triple sundry noble fearless bogus	descent hemstitch bloodhound contempt greenhouse tortoise ladder divorce tassel rawhide author repair cocaine affront reason pursuit abyss ransom alien wizard epic mixture charade apling collie mammy hornpipe silver genius havoc	rickety watery outrageous terrific natural unlawful plebeian secular malignant intensive sporadic unwitting tortuous ungainly evasive passable miserly ungrateful defensive contagious impolite tangible productive overland fantastic illegal mutual uniform relative sinister	veteran afterthought midshipman prominence egoist heritage humorist runaway audience trickery barrier preamble orator alternate funeral terrier eventide foliage domino circumstance nutcracker retention provision cabinet retirement conclusion assistance fantasy coyote dismissal	benevolent rebellious musical autumnal orthodox edible immodest specific respectful sensitive exultant compulsive bodily maximum feverish copious corrective extrinsic unwholesome maritime temperate momentous passionate effective terminal abusive orderly infinite fraternal marvelous	occurrence period politics hyena reticence lunatic collision lethargy countryman subscription pestilence midwinter retrospect honesty felony coverlet temptation sisterhood vinegar sentiment rattletrap tornado stimulant premium signature vehicle exhibit impression formation gelatine



## METHODS OF USING BALANCED-MAGNET CHRONOSCOPES

KNIGHT DUNLAP

*The Johns Hopkins University*

The following schemes may be used equally well for installing the Johns Hopkins chronoscope<sup>1</sup> or the Hipp as used by my method<sup>2</sup> without armature springs. The diagrams (figs. 1 and 2) are given for the former instrument: in setting up the latter, the circuits which operate the synchronous motor of the Johns Hopkins chronoscope are of course to be omitted.

The Johns Hopkins chronoscope operates either on (1) direct current, with tuning fork interruption for the motor circuit, or (2) alternating current for the motor circuit, without fork, and direct current for the clutch circuits. The alternating current of the usual house lighting circuit is 60 cycle, and power circuits are sometimes 25 cycle: it will be assumed that one or the other of these frequencies is to be employed. The first system is represented in figure 1: the second system in figure 2.

### THE MOTOR CIRCUIT

The motor circuit and the clutch circuit may be drawn from the same direct current source, which may be the 110 to 120 volt power circuit as indicated in figure 1, or may be storage battery or rotary transformer circuit. Otherwise, the motor circuit and the clutch circuit are entirely distinct, and may be usefully described separately.

In using alternating current 110 to 120 volts (the potential

<sup>1</sup> Dunlap: The Johns Hopkins chronoscope. 1917, *Jour. of Exper. Psychol.*, ii, 299-252.

<sup>2</sup> Dunlap: The Hipp chronoscope without springs. 1912, *Brit. Jour. of Psychol.*, v, 1-7.

Poffenberger and Morgan: The Hipp chronoscope: its use and adjustments. 1916, *Jour. of Exper. Psychol.*, i, 185-199.

of the usual house lighting circuits), lamp resistance or a rheostat may be used to control the current; or a rectifier of the proper type may be used without resistance. The scheme with resistance is shown in figure 2. The standard four-receptacle voltage-reducing lamp board (lamp board no. 1) is here represented, but

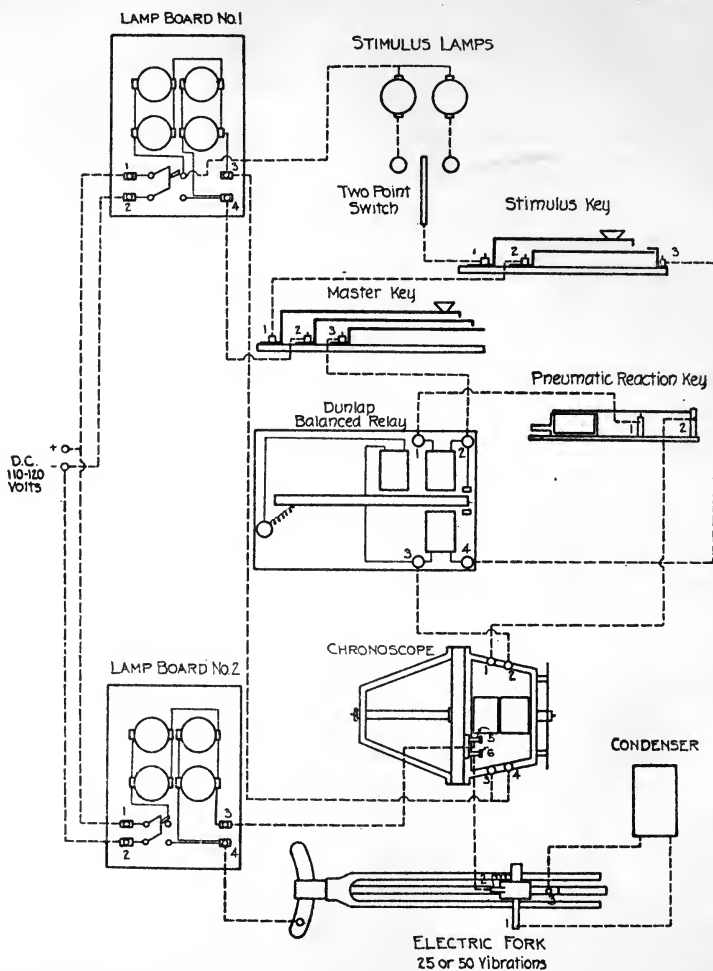

FIG. 1. CHRONOSCOPE OPERATED ON DIRECT CURRENT; THROUGH TUNING-FORK INTERRUPTER

Set up for visual discrimination reaction utilizing same current source.



lamps are to be used in the two primary receptacles (the left-hand ones in the cut) only. Obviously a two-receptacle lamp board is all that is necessary, since the motor circuit is closed. One receptacle is sufficient if a single lamp of appropriate wattage fits the requirements, but two receptacles connected in parallel is better, since it makes possible lamp combinations to fit all cases.

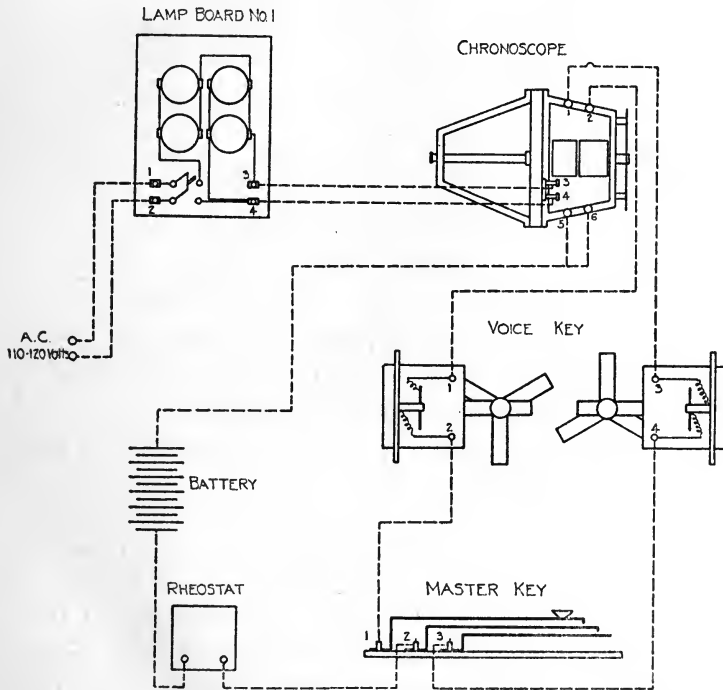

FIG. 2. CHRONOSCOPE OPERATED ON ALTERNATING CURRENT

Set up with voice keys for association reaction, with battery for clutch connections.

Two 100 to 120 watt lamps (of the voltage of the circuit), or one 100 to 120 watt lamp and one 50 to 60 watt lamp, will be found satisfactory. There is considerable latitude in amount of current permissible in any case, since the speed of the motor is not dependent on the current, but on the frequency. Enough

current to give sure operation, and not enough to heat the motor seriously, or make starting difficult, is the easy requirement. The motor will run on a single 60 watt lamp, although hard to start on so small current, and easily put out of phase and stopped by the slight jar of the clutch action. The current practically needed depends on the adjustment of the clutch, and the amount of current in the clutch circuit. On the average, lamps totaling 150 watts will do very well; 100 watts may be satisfactory; more than 240 should never be used; and more than 180 will heat the motor if used continuously.

Lamp resistance is advised, because of its safety. The lamps act as tell-tales, showing clearly whether the current is on or off, and there is no danger of damage from accidentally putting on too much current, as is apt to happen in moving a rheostat handle in the wrong direction. By having the connections at the lamp board covered, all danger from shock is eliminated.

If a rheostat be used instead of lamp resistance, one of 120 ohms total resistance, and 2 amperes continuous capacity is advised. The Jagabi 1506, James G. Biddle, fills these specifications. The resistance should never be allowed to fall below 50 ohms; hence a stop should be put on the slide, a little less than half way from the zero end.

The motor has been run experimentally on the whole range of frequencies between 15 and 120 per second: the conditions for this test were arranged by M. W. Pullen of the Department of Electrical Engineering, and I have not standardized the resistances to be used with the 25 cycle circuit. The determination of the proper resistance is very simple, but there are probably few places where this frequency would be available.

The speed of the motor, when operated on the unrectified 60 cycle current may be too great. Since there are ten poles to the motor, and the 60 cycle current has 120 impulses per second, the armature will make 12 revolutions per second and the measuring unit of the dial will be one twelve-hundredth of a second. Not only is this unit needlessly small, even for the measurement of simple reaction times, but the difficulty in starting the motor is high (see below). With 25 cycle unrectified current the arma-

ture speed is 5 rotations per second, the measuring unit of the dial is 2 sigma—which is small enough for all purposes—and the motor is easily started. If a rectifier is used with the 60 cycle current the impulses are reduced to 60 per second, the measuring unit is one six-hundredth of a second, the motor starts easily and runs well without heating. I have found the small size "Tungar" rectifier, General Electric Company, very satisfactory when connected directly in the circuit without resistance.

A small transformer may be used directly in the circuit, reducing the voltage to the point required to force the proper amount of current through the field coils. This has the advantage of economizing current, a large proportion of which is wasted in the resistance of the above described arrangements. The transformer should step the voltage down one-half; i.e., should reduce the 120 volt potential to 60, or the 110 to 55.

It is necessary to bear in mind that the nominal cycles per second of a lighting or power circuit are only approximate, and that there is a slight variation from the standard from time to time. The alternating current can be used for demonstration purposes, and for practise work where accuracy is not essential, without check. But, for research purposes it is necessary to use a frequency-meter from time to time to determine the actual frequency; or else to obtain from the power house data on the diurnal variations in frequency. In many situations it will be found that the variations at the hours at which the apparatus is used are small enough to be neglected in the calculations. Since the frequency determines the value of the units of measurement of the chronoscope, reaction times obtained while running the motor on a current of uncertified frequency are not worth much.

For the above reasons, it is recommended that the motor be operated on direct current, with tuning fork interruption wherever possible.

In using direct current in the motor circuit, an electric fork is necessary to interrupt the circuit periodically. If the 120 or 110 volt current is used, a voltage-reducing lamp board should

be introduced. This set-up is shown in figure 1. In this lamp-board four 100 or 120 watt lamps are satisfactory, and all are left permanently screwed down. Four 120 watt lamps reduce the voltage to about 50, when the circuit is broken.

Storage cells may be used as a source of direct current, the voltage of the battery depending on the fork somewhat. In some cases a standard 12 volt battery will serve, but a twenty to twenty-five volt set, with adjustable resistance capable of carrying 1 to 1.5 amperes and a maximum of 12 to 18 ohms is preferable. Edison storage cells are recommended on account of their requiring less care; and they may be used in the same room with the apparatus, as they have no fumes deleterious to steel as do the acid cells. The variations in voltage of the Edison cells do not affect the measurements.

If the fork-magnet is high-wound, it may be necessary to arrange a shunt around it, to provide sufficient current for the motor field without forcing too much through the fork. I have not found this necessary with any of the standard wound forks.

The fork contacts should be of dental gold alloy (gold and platinum), which is cheaper than platinum and far more satisfactory. Tungsten contacts might possibly be employed, but I am unable to say definitely that tungsten is satisfactory. Much trouble will be found if platinum be used and I do not find that the motor operates satisfactorily with a platinum contact fork. I find dental wire of 18 gauge (Brown and Sharpe) works well: 19 or 20 might perhaps be used. The table on which the wire strikes should be surfaced with a section (disc) of large gauge wire.

With any fork interrupting a large current (more than a small fraction of an ampere) a condenser ought to be used. The small size 2 microfarad condenser made by the Western Electric Company is cheap in price and quite satisfactory. The condenser must be connected across the gap of the fork contact, and must not include the electro-magnet (of the fork) between its terminals. In other words, when the fork-contact is broken, the circuit must be traceable unbroken from one contact of the condenser through the magnet windings. For convenience, an

extra pair of binding posts should be mounted, one on the shank of the fork itself, or, as in the figure, on the metal mounting (base) of the fork (fig. 1, electric fork, 3); the other on the metal support of the fixed part of the contact. If the fork be connected as described, and then, while it is in operation, one of the condenser connections be momentarily broken, the large increase in the spark at the break of the fork-contact will demonstrate the value of the condenser in preventing burning up of the contact and consequent loss of adjustment.

The adjustment of the fork-contact is a matter of trial and error. I find it best to adjust to the smallest amplitude of vibration which gives uniform vibration. The contact should be broken when the fork is at rest. It should be hardly necessary to warn against touching the steel of the fork with the hand in starting the fork, but with students this is always necessary.

Once in operation, the motor should run for hours with no adjustments. If the motor stops, it may be due to one of several causes. (1) Insufficient current. (2) Bad adjustment of the fork-contact, so that the break of the circuit is not sufficiently long. (3) Too tight adjustment of the bearing of the motor shaft. The adjustment is a delicate matter, but once made should be good for a long time. The shaft should not be loose, but should yet spin freely. (4) Too much current in the clutch circuit. Under this condition the jar of the clutch sets the armature "hunting" and it kills itself. The fact is to be emphasized that the variations in current and contact do not affect the speed of the motor unless they stop it completely.

#### STARTING THE MOTOR

A simple synchronous motor will not start itself: the armature must first be put in rotation at the speed required by the frequency of the current, or the frequency of the interruption, and must "get in step" with the current phases. Given this start, the motor will continue to run as long as the current is adequate, until it is overloaded, or until a jar starts it "hunting."

On the 25 or 50 vibration fork, on 25 cycle alternating current

with resistance, or 60 cycle alternating current with rectifier, starting the motor is simple. With the thumb and forefinger the armature shaft is given a spin in the proper direction. Wrapping a string around the shaft, to get a pull, is not satisfactory. On first trial with the thumb and finger method, a great many spins will perhaps be necessary before the proper knack is acquired. The commonest error is spinning too fast. Another common error is taking hold of the shaft for a fresh spin, before noting whether the preceding one was effective; thus spoiling a good start. After a little practise facility is acquired, so that the motor may be started with little difficulty; usually on the first, second or third spin.

On the 60 cycle unrectified current, since the speed of rotation is relatively high, the finger and thumb method may be difficult. In that case, wrap a strip of adhesive tape—electrician's or surgeon's—around the shaft spirally to make a smooth single thickness, and start by drawing the fingers across the wrapped part of the shaft. It may be easier to spin the armature with current off, closing the main switch as the fingers leave the shaft.

#### THE CLUTCH CIRCUIT

The clutch circuit must always be direct current, and should have an amperage just sufficient to give sharp, not violent, action to the clutch. The exact voltage will necessarily vary with the accessory instruments used, and it is well to have a rheostat in the circuit, as in figure 2, so that the current may be properly controlled.

The essential feature of the Johns Hopkins chronoscope, and the Hipp without armature springs is, that within certain limits, variations in the current strength do not alter the measurements, since the clutch is moved in by one electromagnet, and moved out by another which is the exact mate of the first in core and windings. The two magnets are connected in parallel so that variations in the current affect both equally. In consequence of this feature, it is necessary to avoid differences in resistance and in inductance between the two branches of the clutch circuit.

This requirement is to be borne in mind in connection with the details which follow.

For the set-up in figure 2, with voice keys<sup>3</sup> for the association reaction, storage cells connected in series to give over four volts will operate the clutch. The higher voltage with resistance, as in figure 1, is more desirable. In the arrangement shown in figure 1, a voltage-reducing lamp-board is used, with one 100 watt lamp and one 60 watt lamp in the primary (left-hand) pair of receptacles, and two 100 watt lamps in the secondary (right-hand) pair. With this arrangement the total current in the two branches of the clutch circuit, the master key being completely closed, is approximately 0.6 ampere.

The current is divided through the two branches of the circuit through the master key (refer to figure 2: figure 1 is more complicated), which, as will be noticed, completes the circuit through the anterior magnet (the non-rotating magnet) a moment before completing the circuit through the posterior (rotating) magnet in the other branch. This is necessary in order that the clutch shall always be locked in the non-rotating position when the key is pressed. The master key is a two-contact key of new design, involving three strips of spring brass, or better, or phosphor bronze, so arranged as to be self-scouring, and therefore needing no gold contacts. When the master key is released, current is "off" both branches of the clutch circuit, thus permitting resetting of the register hand, and making the clutch circuit perfectly safe.

#### OPERATION IN THE ASSOCIATION REACTION

The set-up of figure 2 has now been completely described, with indication of alternatives in both motor circuit and clutch circuit. The method of operation will now be described before proceeding to the more complicated set up of figure 1.

Operator and reactor being in position before their respective

<sup>3</sup> For description of the voice key, see *Psychological Review*, 1913, xx, 250-253. The Ewald chronoscope described there as satisfactory proved later very unsatisfactory, it got out of adjustment and could not be put in repair again.

voice keys, the operator commands "ready:" the master key being open, his voice has no effect on the mechanism. Next he closes the master key: current now flows through both branches of the clutch circuit, the armature automatically taking its position against the non-rotating magnet. Holding the key closed, the operator speaks the stimulus word against the diaphragm of the voice-key at the right of the cut: the vibrations of which cause the current through the anterior magnet to be interrupted momentarily, allowing the armature disc to be attracted to the posterior magnet. The armature shaft and the register hand thereupon commence to rotate, and continue until the reactor, by speaking the response-word against the diaphragm of the other (left-hand in cut), voice key, interrupts the current through the posterior magnet, thus allowing the anterior magnet to attract the armature disc and stop its rotation. With good adjustment, there is nearly perfect balance both of the latent periods of the two magnets, and of the slip of the armature on the pole of each, so that the time between the beginning of the interruption of the first branch and the beginning of the interruption of the second branch, is accurately registered on the dial. The operator releases the master key as soon as the register hand stops, takes the reading, and sets the hand for the next reaction.

#### SET-UP AND OPERATION FOR MEASUREMENT OF SIMPLE AND DISCRIMINATION REACTIONS

It is essential that the circuit through the anterior magnet, after being opened by the stimulus, shall be reclosed before the circuit through the posterior magnet is opened, or else the registration will fail. In the association set-up, this reclosure is automatically effected by the voice key, and the time-relations of the reaction are such that this is always effective. For reactions employing a different sort of stimulation, such as light or faint sound, provision must be made for reclosure. A variety of devices are possible for this purpose. Where a pendulum or shutter is employed to control a light stimulus, the breaking and remaking



of the stimulus branch of the clutch circuit may be arranged with a precise interval between. In other cases, a simple relay of low resistance and inductance has been employed with no appreciable error resulting, the unbalancing of the two branches being slight. In general, the use of a simple relay is not safe, and hence the balanced relay shown in figure 1 has been developed. As shown in the diagram, the closure of the master key will automatically set the armature lever of the relay against the stop on the side of magnet 3-4, and when the master key is completely closed, current will flow equally through this magnet and through magnet 1-2: and since these magnets are duplicates, and one is in the circuit of each of the clutch magnets, the two branches of the circuit are perfectly balanced. On depressing the stimulus key, contact is made between 1 and 2 (of the stimulus key), thus giving the stimulus, at the same moment that contact is broken between 2 and 3, interrupting the circuit through the anterior chronoscope magnet. The armature lever of the relay being released from magnet 3-4, moves over to the opposite stop, and recompletes the circuit through the anterior clutch magnet, through the third relay magnet, thus again balancing the circuits, and assuring also that the armature lever of the relay will be held in the new position even after the current through magnet 1-2 is interrupted by the movement of the reactor. In the diagram, the pneumatic reaction key which has been found most reliable, is shown, without the rubber bulb which the reactor squeezes. The stimuli are schematically shown as flashes of two low-wattage mazda lamps, either one being switched in before the measurement. For discrimination, lamps of two colors might be used, enclosed both in the same box with a milk glass window, so that the color would always appear in the same place.

In the set-up of figure 1 both master key and stimulus key must be held down from the time each is pressed until the end of the registration. The balanced relay is self-setting, so that the actual procedure is simple. The time of action of the relay must be well inside of the reaction limit, and must be over 15 sigma, in order to allow leeway for the chronoscope clutch.

Action time between 20 sigma and 90 sigma may readily be secured, or if pathological or anticipatory reactions are to be measured, the action may be made within the limits of 20 and 50 sigma.

For other types of stimulus, variations in the above scheme are required, but the balanced relay will in almost all cases be the main accessory. For the reaction circuit, no special apparatus or wiring are needed on account of the balanced circuit, since the reaction circuit does not have to be reclosed.

#### GENERAL CAUTIONS

The Johns Hopkins chronoscope, like the Hipp, requires careful testing to assure balance of the magnet latencies and of the armature slips, but once set up and thoroughly tested, no further checks are needed unless the instrument is allowed to get badly out of condition. We have found that chronoscopes which were properly balanced, have become unbalanced in shipment, either through bending of the armature disc or other injury. The anterior clutch magnet (or in later designs, the magnet-core) has so far been made so that it can be rotated by hand; an adjustment which is not needed in most work, and can be dispensed with. This magnet bearing must be tight enough so that the magnet will not creep under the torsion of the armature disc at stopping. Oil on the magnet face or armature disc will cause clinging. The clutch must be kept clean.

The chronoscope should be set on a square of thick harness felt. If the tuning fork is in the reaction room, it also should be set on harness felt. The hum of the apparatus is then reduced to a negligible intensity. In using voice keys, they should be supported on a heavy, solid table, to avoid their being susceptible to the jar of the master key and movements of the operator's hand.

To remove the most probable source of error in the Johns Hopkins chronoscope, I propose to replace the friction clutch by a modification of the Hipp toothed clutch. It seems advisable also in the next model to gear back the register hand so that

the units of measurement will be larger. Five sigma units are small enough for any work, and 10 sigma units are most satisfactory for association reactions. A chronoscope arranged to read five sigma units on a 50 vibration fork will read ten sigma units on a 25 vibration fork.

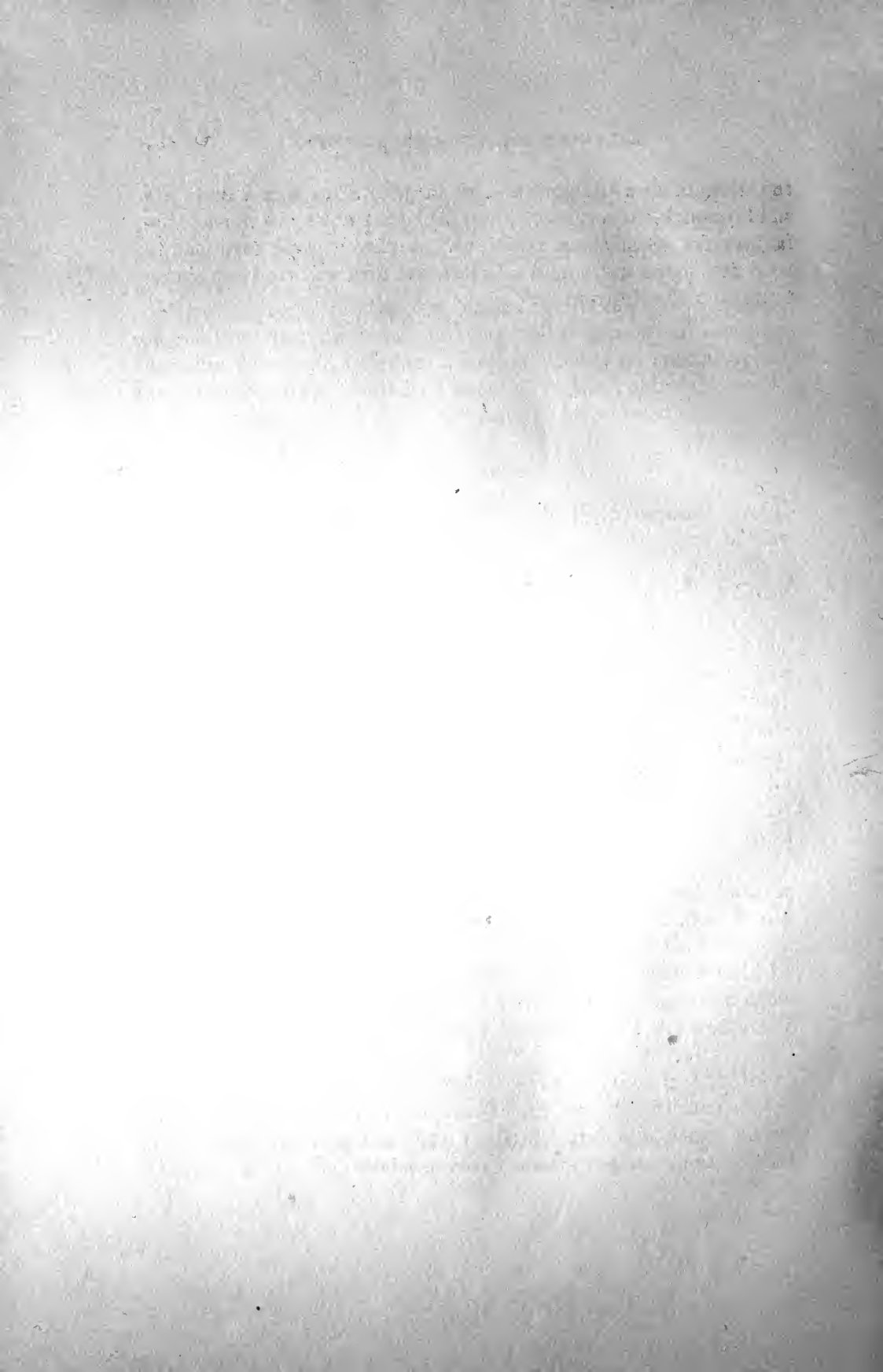

# THE INFLUENCE OF THE DISTRIBUTION OF BRIGHTNESSES OVER THE VISUAL FIELD ON THE TIME REQUIRED FOR DISCRIMINATIVE RESPONSES TO VISUAL STIMULI<sup>1</sup>

H. M. JOHNSON

*Captain, Sanitary Corps, U. S. A., Air Service Medical Research Laboratory,  
Hazelhurst Field, Mineola, Long Island, New York*

## INTRODUCTION

The following pages contain a report of a study which was undertaken as a methodological preliminary to an extensive study of the influence on visual performance of the distribution of brightnesses over the visual field.

The primary purpose was two-fold: (1) To ascertain whether the method employed is sufficiently sensitive to demonstrate the effects of such moderate differences in distribution of lighting as might be encountered under installations which are voluntarily used; and (2) to train the subjects so thoroughly that their diurnal performance under a given condition would be free of important fluctuations due to the variable effects of fatigue and practice. This was to permit of their economical use in the more extensive work, which was designed to include a wide range of distributions of brightnesses and variable sizes of the test-field, under such controls as would justify direct intercomparison of the data obtained under the various external conditions.

As the author has been prevented from carrying out the complete study, the results of the preliminary investigation are presented without apology, as indicating definitely the sensitivity and reliability of the method employed, and the differential effects of the particular environmental conditions under which

<sup>1</sup> This paper from the Nela Research Laboratory, National Lamp Works of General Electric Company, Nela Park, Cleveland, Ohio.

the work was done. Reference to the primary purpose of the experiment will make it clear why the range of stimulus-variables was narrow, and why certain refinements of control were not employed.

#### PRELIMINARY CONSIDERATIONS

The problem of ascertaining suitable methods of investigating such questions was referred to the writer in the winter of 1915-16 by the director of the Nela Research Laboratory. Except for the excellent work of Cobb<sup>2</sup> on the thresholds for detail and for differences in brightness, the field had been scarcely touched. Cobb's results, while interesting in themselves, are perhaps more important in that they demonstrate to the illuminating engineer (1) that sensory thresholds are exceedingly unstable and uncertain things, even when the external situation and the physiological factors are optimal; so that large numbers of observations are necessary to satisfactory evaluation of the results; and (2) that an objective check on the reports of the observer is absolutely essential to intelligent interpretation. These facts have long been known to the psychologists, and they can be readily appreciated by any other scientists who may be brought to consider them.

#### EXPLORATORY EXPERIMENTATION

For *ad hominem* reasons it was inexpedient to adopt as highly "artificial" a method as that of determining discrimination-times without first testing the adequacy of some "simpler, easier and more natural" method. Accordingly the first exploratory work was in the attempt to locate such a method.

The most obvious of the possible types of test was first selected for study. It was proposed to assign the subject some definite task, to the performance of which vision is indispensable; and,

<sup>2</sup> Cobb, P. W. and Geissler, L. R.: The effect on foveal vision of bright surroundings. *Psychological Review*, xx, 1913, pp. 425-447; also Cobb, P. W.: same title, *ibid.*, xxi, 1914, pp. 23-32; and *Journ. Exper. Psychol.*, i, 1916, pp. 419-425, and pp. 540-566.

after establishing control of other variables than vision, to use the speed and accuracy of the work done under a given lighting condition as an indicator of the appropriateness of the condition to visual performance.

Such a method, while simple in principle, demands the fulfilment of certain requirements, which I may be pardoned for enumerating for the benefit of non-technical readers:

1. The work done under the different lighting conditions must be of equal intrinsic difficulty. Otherwise, differences in speed and accuracy might wrongfully be attributed to the influences of differences in lighting.

2. The work done under the different lighting conditions must be distributed among them so that the effects of fatigue and practice are evenly distributed. Otherwise, differential effects of these variables may be erroneously interpreted as effects of the differences in lighting; or they may serve to distort or to obscure genuine effects of differences in lighting.

3. The measure of the subject's performance must be obtainable independently of his own reports or description. This point was mentioned in the comment on Cobb's work, but it cannot be too strongly emphasized.

4. A sufficiently large number of observations must be obtained from each subject to insure that such effects as may be obtained are not accidental. In other words, enough results must be accumulated to justify statistical treatment, and the application of standard measures of reliability to them.

In the past ten years, the pages of American lighting journals have been burdened by reports of tests which fail to satisfy certain of the above requirements, especially the third and fourth. In the judgment of the writer—which at this point accords with that of the best psychological authorities—a proper regard for economy of time would not justify one in reading such reports farther than to verify the description of the defective methods employed.

In the beginning of the present work, several types of work-material were examined and found unsatisfactory. The most promising material was arithmetical, compiled by Prof. Knight

Dunlap, for use with the Burroughs adding machine in studies of habit-formation. This material had been derived by subjecting a constant to a certain systematic treatment which insured an even distribution of difficulties among the several sets of material, and minimized and regulated the occurrence of repetitions. The amount of this material available was too small for our purposes. Several weeks were therefore spent in the compilation of additional material according to a key furnished by Professor Dunlap, and a fair amount of satisfactory material was thus obtained.

A lighting booth was then constructed; various types of distribution of illumination were procured, and an adding machine installed. As the machine is large, and under the conditions of operation fills a large part of the visual field with surfaces of varying types and degrees of reflectivity—some being black, others nickelled, and most of them highly polished—it was necessary to screen the machine from view of the subject, and require him to learn to operate it by the "touch" method.

Six subjects were employed, five being undergraduate students in the college for women of Western Reserve University. The college is located several miles from the laboratory, and it proved impossible to maintain a regular or satisfactory schedule. It became evident after some weeks that the subjects would not master the "touch" system of operation in time to complete the preliminary experiment according to plan within the academic year. The diurnal variations in performance under a single lighting condition were too great to justify the expectation that the various lighting conditions would show differential effects, unless the lighting conditions under comparison were extreme, unless an enormous amount of work material was provided and used, or unless the preliminary training period was to be indefinitely prolonged. It was therefore decided to abandon the experiment in favor of a method which involved a less intricate muscular coördination, until more favorable conditions for the use of the "simpler" method could be obtained. The work method under fair conditions of operation may be valuable.



## DESCRIPTION OF THE METHOD ADOPTED

The use of the time required for visual discrimination as an index of the appropriateness of a lighting condition implies that the time required for this form of reaction will be shorter and the dispersion of the individual reactions will be smaller under the more favorable lighting conditions than under the less favorable ones. As some students of illuminating engineering may not immediately see the justification for this assumption, certain elementary physiological doctrines will be recalled.

When a stimulus adequate to excite a sensory-motor response is presented to an organism, certain physiological changes occur, which for simplicity's sake are described as if they occurred within the fictitious "reflex arc." These changes are:

1. An electrical or chemical process is excited in the end-organ, or receptor.
2. An afferent neural impulse is transmitted to some selective ganglion. This may lie in the brain, the spinal cord, or some plexus.
3. An efferent neural impulse is transmitted to an effector, i.e., a muscle or gland.
4. The effector responds by secretion, contraction or change in tonicity.
5. An afferent neural impulse, originating in receptors contiguous to the effector, is transmitted to some center, and thence, as an efferent impulse, to the same or some other effector.

All except possibly the last of the above series of physiological changes are regarded as a necessary condition of a change in "consciousness." The most satisfactory hypothesis of mind-body relationship, namely, the hypothesis of "functional correlation," assumes that these physiological changes occur simultaneously with the changes in "consciousness."

In the special case of responses to visual stimuli, the excitability of the receptors—i.e., the rods and cones of the retina—is greatly modified by the character of fixation, of accommodation and of adaptation. All these factors may be influenced by the distribution of brightnesses over the visual field. If the distri-

bution is unfavorable, the "receptiveness" of the sense-organ is diminished, and its latent period is increased.

The rate of transmission of a neural impulse along a single axone is fairly constant under constant conditions and is not affected by continued repetition of the stimulus, provided the intervening period is not excessively short.<sup>3</sup>

A relatively large, and variable, portion of the time required for completing a neural arc is consumed in the synapses (i.e., the connections between single neurones) and especially in the central synapses, where the efferent pathways for a given afferent impulse are selected or blocked. If the stimulation of the sense-organ is not sufficiently intense—and inadequacy may be due either to insufficient intensity of the stimulus or to an unfavorable condition of receptiveness of the sense-organ—the first afferent impulse reaching a given center from the sense-organ may be too weak to be transmitted across the surfaces of separation of the connected neurones until it is reinforced by succeeding impulses.<sup>4</sup> The latter may be transmitted over the same afferent pathway, or over a different one. The concept of "intensity" of an impulse may be formulated so as to accord with the "all or nothing" principle, on the assumption that the intensity of stimulation of a set of ganglionic synapses is determined, other factors being constant, by the number of afferent neurones excited; that the receptors belonging to the several afferent neurones may have different thresholds or different latent periods; that their activity is intermittent; and that the more favorable the receptiveness of the sense-organ the greater will be the number of receptors excited at the same instant by a given stimulus. If a neural impulse is conveyed to a synapse and not discharged across it, the energy may be stored for a time in the synapse instead of being immediately dissipated. Thus, the afferent impulse, though inadequate at first, may become adequate by reinforcement. Any factor, therefore, which may tend to reduce

<sup>3</sup> Howell, W. H.: A textbook of physiology (6th ed.). Philadelphia, W. B. Saunders Company, 1915.

<sup>4</sup> Sherrington, C. S.: Integrative action of the nervous system. New Haven, Yale University Press, 1906.

the sensitivity of the sense-organ would also operate to increase the latency of the synapses, and thus to increase the time required for reaction.

In the special case of vision it has been shown that the retina is anaesthetic during rotational eye-movement,<sup>5</sup> so that if fixation is disturbed, a longer time of exposure to the stimulus may be required for the accumulation of enough energy in the various synapses involved to overcome the resistance of the surfaces of separation.

Increased difficulty of maintaining fixation under a lighting condition which does not permit of stability of adaptation, has been hypostasized by Cobb,<sup>6</sup> and seems to be supported by the self-observation of a number of subjects, although objective evidence, such as photographic records, is lacking. There is a well-established tendency to frequent and excessive changes in the size of the pupil, as the various parts of the retina are successively exposed to brightnesses to which they are not adapted. Great relative instability of the pupillary size may be a source of much discomfort, and it may certainly operate to reduce the sensitivity of the retina.

Disturbances of accommodation operate in the same way, by tending to equalize the differences in brightness of the various portions of the stimulus as imaged on the retina.

The latent period of muscular tissue is subject to important modifications from temperature-changes, toxins, etc., especially the toxins resulting from "fatigue." In work such as the present one, these variables can be minimized, as the muscular responses involved are relatively simple, easy and not sustained.

Inasmuch as discriminative reactions involve more numerous synaptic connections than simple ones, it was assumed that the time required for executing them would be the more sensitive indicator of the influence of external variables. The fact that

<sup>5</sup> Holt, E. B.: *Psychol. Rev. Monogr. Supp.*, iv, 1903; pp. 3-45.

<sup>6</sup> Cobb, P. W.: *Physiological points bearing on glare. Tr. Illum. Eng. Soc.*, vi, 1911, pp. 153 ff.; also, *Physiological aspects of illuminating engineering. (Two lectures.) In: Lectures on illuminating engineering, vol. 2. Baltimore, The Johns Hopkins Press, 1911, pp. 559 ff.*

the correctness or incorrectness of the reaction furnished an objective check on the subject's mode of response, also influenced the choice of this type of determination.

#### APPARATUS AND PROCEDURE

In the present work the conditions of Cobb's studies were imitated as far as was practicable. A photometric field, in sensibly perfect balance, is viewed monocularly<sup>7</sup> by the subject from *E* (fig. 1) through the limiting rectangular window *W* of a hollow polyhedron *C*, the interior surfaces of which fill the remainder of the visual field. The brightnesses of the latter are practically unity with respect to each other, but may be varied at will with respect to the brightness of the photometric field, the two illuminations being almost completely independent.

The photometric field is formed as follows: A milk-glass surface *MG*<sub>3</sub>, illuminated by a tungsten incandescent lamp *L*<sub>3</sub>, is viewed directly by the subject through a 10 degree double prism *P*. Two similar surfaces, *MG*<sub>1</sub> and *MG*<sub>2</sub>, illuminated by lamps *L*<sub>1</sub> and *L*<sub>2</sub>, respectively, are viewed by reflection from the silvered mirrors *M*<sub>1</sub> and *M*<sub>2</sub> respectively, and by partial reflection from the front surfaces of *P*. The silvered mirrors are used on account of the limited area of *P* and the limited distance *WP*. If *L*<sub>1</sub> and *L*<sub>2</sub> are properly placed, the result is a balanced photometric field projected in the plane of *P*, 150 cm. from the eye, and limited by the dimensions of *W*. These, in terms of visual angle subtended by them, are approximately 1.96 degrees vertically and 2.65 degrees horizontally; so that when properly fixated, the image of the test field covers the fovea and extends but little beyond it. The distribution of intensities among the wavelengths of the visible spectrum is approximately that of a black body at 2400°K.

The stimulus to reaction is the darkening of one-half of the photometric field to the extent of the brightness added by *L*<sub>1</sub>

<sup>7</sup> The unused eye is covered by a sheet of ground glass, through which light from the interior of *C* is diffusely transmitted with little reduction by absorption. This tends to stabilize the relative adaptation of the two retinas, and reduces the pupillary fluctuation which might otherwise result.

or  $L_2$  as the case may be. The subject holds in either hand a rubber bulb, which when quickly pressed, actuates a Dunlap pneumatic reaction key, to which it is attached by a rubber tube.<sup>8</sup> The reaction consists in pressing the bulb corresponding to the side of the field which is darkened, as soon as the darkening is perceived. A warning signal, made by an electrical buzzer, is given by hand from 1 to 1.5 seconds before the stimulus is

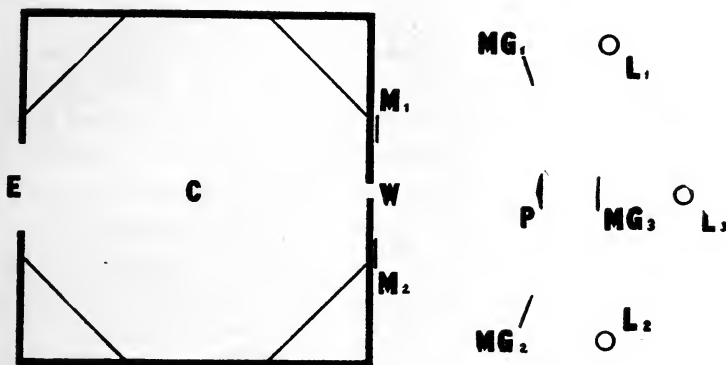

FIG. 1

*C*, integrating polyhedron; *E*, position of eye of observer; *W*, limiting window. *P*, 10 degree double prism; *MG*<sub>3</sub>, milk glass surface forming standard portion of photometric field; *L*<sub>3</sub>, tungsten lamp illuminating *MG*<sub>3</sub>; *M*<sub>1</sub> and *M*<sub>2</sub>, silvered mirrors; *MG*<sub>1</sub> and *MG*<sub>2</sub>, milk-glass surfaces viewed from *E* by reflection from *M*<sub>1</sub> and *M*<sub>2</sub> and by partial reflection from *P*; *L*<sub>1</sub> and *L*<sub>2</sub> auxiliary tungsten lamps, illuminating *MG*<sub>1</sub> and *MG*<sub>2</sub> respectively, the extinction of which is the stimulus to reaction. Sundry protective screens used to arrest scattered light, are not shown.

presented, the time depending on the desire of the subject, and being kept as nearly constant as possible.

In ten to fifteen cases, irregularly distributed within each series of 100 reactions, the warning signal is not followed by the darkening of either side of the field, and the subject is instructed

<sup>8</sup> The keys used in this work were modified so as to constitute double-throw switches. Thus, if the wrong key was actuated, it momentarily closed a signal circuit (shown in figure 2). The range of movement of the common connector in the reaction switch was made less than 1 mm., in order to insure closing of the signal circuit.

to inhibit reaction in such cases. If reaction is not inhibited, the fact is recorded; but false reactions are not included in the averaged results.

A Johns Hopkins chronoscope,<sup>9</sup> operated in an adjacent room, records the time elapsing between the opening of the circuit through  $L_1$  or  $L_2$ , and the subject's reaction. A part of the latent period of the lamp is thus added to the subject's reaction-time. Correction for this constant was not made in the results as presented. From data furnished by my colleague in physics, Dr. A. G. Worthing, it appears that with the lamps used, and under the conditions of the experiment, the added brightness would be reduced to 0.5 per cent of the brightness of the test-field and thus become completely effective, in 0.022 second after the current is interrupted; but it would be reduced to 90 per cent of its own original value, and begin to be effective, in 0.0006 second. I am uncertain what correction should be applied. It is clear, however, that the correction is constant and relatively small with respect to the variable to which it belongs.

The method of presenting the stimuli is simple, and is readily ascertained from inspection of the wiring diagram in figure 2. The wiring of the pendulum magnet, and of the warning buzzer and the buzzer with which the subject, when necessary, signalled the experimenter, are not shown, but are independent of the rest of the system.

The chosen supplementary lamp  $L_1$  or  $L_2$  is cut out, and the chronoscope started by the pendulum breaking the lamp circuit and the circuit through the stationary magnet of the chronoscope at  $PS_1$ . The lamp circuit is broken a second time at  $PS_2$  so that the lamp is not re-lighted when  $PS_3$  is closed an instant later to restore the circuit through  $CC_1$  before the subject reacts. On its return swing, the pendulum closes  $PS_2$  and  $PS_1$  in the order given, but does not re-open  $PS_3$ , which is opened by hand after the chronoscope is read.

Inspection of figure 2 will make it apparent that if the switch  $ES_1$  is open and if the bank of double-throw switches  $ES_2$ ,  $ES_3$ ,

<sup>9</sup> Dunlap, Knight: The Johns Hopkins Chronoscope. Journ. Exper. Psychol., ii, 1917; pp. 249-252.

$ES_4$  and  $ES_5$  are thrown to the left, the left side of the field, partially illuminated by  $L_1$ , will be darkened when  $PS_1$  is opened, and that the subject will stop the chronoscope if he actuates the reaction key  $SS_1$ , and flash the signal lamp  $RL_4$  and sound

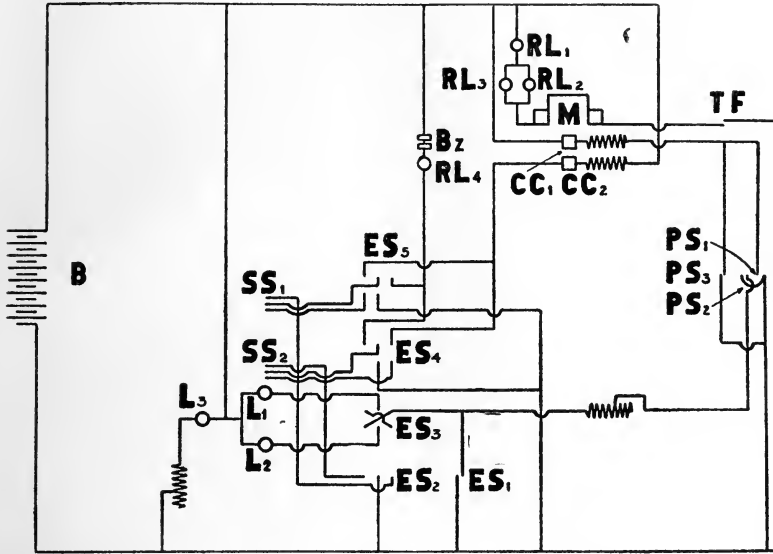

FIG. 2

$B$ , 50-ampere storage battery (120 volts);  $M$ , coils of field of chronoscope motor;  $TF$ , 100 d.v. tuning fork;  $CC_1$ , coil of stationary magnet of chronoscope;  $CC_2$ , coil of rotating magnet of chronoscope;  $PS_1$ ,  $PS_2$ ,  $PS_3$ , switches actuated by pendulum;  $ES_1$ ,  $ES_2$ ,  $ES_3$ ,  $ES_4$ ,  $ES_5$ , switches operated by experimenter;  $SS_1$ ,  $SS_2$ , reaction-keys, pneumatic type, modified to form two-way switches, operated by subject;  $L_3$ , principal source of photometric field;  $L_1$ ,  $L_2$ , auxiliary lamps, whose extinction is the stimulus to reaction;  $Bz$ , buzzer actuated by subject in event of incorrect reaction;  $RL_1$ ,  $RL_2$ ,  $RL_3$ ,  $RL_4$ , lamps operated as resistances. The lamps illuminating the interior of  $C$  are not shown. They were wired in multiple with the rest of the system shown in figure 2, but were otherwise independently controlled.

the signal buzzer  $B$  if he actuates the right hand reaction switch  $SS_2$ . If the bank of switches is thrown to the right, the functions of  $L_1$  and  $L_2$  and of  $SS_1$  and  $SS_2$  are reversed. If  $ES_1$  is closed, the chronoscope is started by the breaking of  $PS_1$  but the circuit is not opened through either  $L_1$  or  $L_2$ . If the subject, from over-

expectancy, should react in such case, the fact will be registered by the chronoscope, or by the lamp-buzzer combination, or both, according as  $SS_1$ ,  $SS_2$ , or both are actuated.

Each daily sitting consists of three series of 100 reactions each, one series being given at each sitting under each of the three experimental conditions under study. The order of arrangement of the three series is varied from day to day so as to distribute the effects of fatigue and practice uniformly among them.

Each series of 100 presentations of the stimulus contains an equal number of right-hand and left-hand presentations. The order is predetermined by shuffling a pack of 100 cards. The stimuli to which reaction is to be inhibited are interpolated irregularly.

Each series of 100 presentations is subdivided into four groups of 25 presentations each. Each group requires from 4.5 to 6 minutes, and a rest of about 2 minutes is allowed between groups.

For adaptation to the condition in which the interior of  $C$  is not illuminated, 15 minutes is allowed; for the other conditions, 5 minutes. In the latter cases, the subject keeps the head at the opening in  $C$  and looks at any part of the interior, or at the photometric field, as he may elect. Intent fixation during adaptation is not encouraged or practiced. For adaptation to darkness the subject turns away his body so that the photometric field is not in view. The rest of the room is not illuminated.

During a series of presentations the subject keeps his head in place. This is rendered fairly easy by the use of a mouthpiece containing a wax impression of the teeth. He is instructed to fixate the center of the photometric field as soon as the warning signal is given.

The three conditions the reactions under which were compared are defined in table 1.

All the measurements given are in terms of candles per square meter.

The brightness of the interior of  $C$  under condition  $D_1$  is too low to be measurable with a Beckstein portable photometer, which is of the Lummer Brodhun type.

The measurements given below are those made near the end



of the work. The absolute brightnesses of the various surfaces can not be perfectly maintained without frequent photometry, as the lamps deteriorate gradually with use. The variation in this case was slight, as the lamps were not actually operated over 100 hours after being seasoned, and those illuminating the interior of *C* were operated at subnormal voltage. The relative brightnesses were easily kept very constant, as the lamps were connected in multiple on a steady circuit from large accumulator cells, and the variations in potential after the resistances had reached a stable temperature were not detectable with the ordinary voltmeter.

It will be noted that the absolute brightness of the test field (measured with  $L_1$  and  $L_2$  in operation) varied between 23 and

TABLE 1

NAME OF CONDITION	BRIGHTNESS OF TEST FIELD	BRIGHTNESS OF SURROUNDINGS	RATIO $B_{TF} : B_s$	RATIO $B_s : B_{TF}$
$B_1$	24.37	18.19	1.34	0.746
$D_1$	23.09	>0.00	< $\infty$	>0.00
$B_2$	27.42	61.60	0.45	2.25

27 candles per square meter with the different brightnesses of surroundings. This is due to light from the interior of *C* being reflected into the eye of the observer from  $MG_1$ ,  $MG_2$  and  $MG_3$ . This could have been avoided by varying the distance between  $L_3$  and  $MG_3$  to compensate, and it would have been done had the purpose of the experiment been a test of the conditions rather than a test of the method itself. The mounting of  $L_3$  which was used did not permit of convenient and accurate adjustment.

The absolute brightness contributed by  $L_1$  and  $L_2$  to their respective halves of the photometric field was 1.14 candles per square meter. This, with respect to the total brightness of the field was as follows: For condition  $B_1$ , 4.68 per cent; for condition  $D_1$ , 4.94 per cent; for condition  $B_2$ , 4.16 per cent. This constitutes a variability in the intensity of the stimulus to reaction, which in the most precise work might not be desired, but which

is not as important as it might seem to the novice. The brightness-difference created by cutting out one of the supplementary lamps is several times as large as a threshold value, and it certainly appeared to be no smaller under one condition than under another. It had been pretty well established that when the absolute intensities of the stimuli are well above the threshold, differences of this magnitude do not appreciably affect the time required for reaction; and none of the subjects used in the present work gave differences in reaction-time under the several conditions corresponding to the direction of the differences given above.

#### THE SUBJECTS USED

Certain information regarding the subjects is of interest in connection with the results which they yielded.

Subject C was an unmarried woman, twenty years old, a junior in the college for women of Western Reserve University. She is exceptionally intelligent, and prior to this work had served as a laboratory subject for several months. Her reactions which are presented below were preceded by only 400, distributed over four days, but she made few errors in the regular work. She showed considerable improvement with practice, however, and this tends to increase the dispersion of the averaged reaction-times, and thus to reduce the apparent reliability of the differences among the several sets. The differences, however, are for the most part quite definite. Her academic schedule and vacation-plans prevented the allowance of more training and the accumulation of as many reactions as were desired. A fact of considerable interest is that in some earlier work she showed a definitely higher tactile sensitivity in "total" darkness than in an illuminated room, most of the other subjects used in that experiment showing a contrary effect. In the present experiment she "preferred to work in the dark," asserting that she found it "easier to pay attention" in the dark than in the light. She maintained this preference throughout the work, and expressed herself as being certain that her reactions under condition  $D_1$  were shorter

than those given under either of the other conditions. The results show that this estimate was unreliable.

Subject E was twenty-three years old, unmarried, a senior in the college for women, Western Reserve University. She had had no previous training in photometric observation or in other laboratory work, and required 4500 reactions, equally distributed among the three conditions, to reduce the percentage of incorrect responses to an acceptable minimum. The reactions accumulated in this period of training are not included in the averages.

Subject M was an unmarried woman, twenty-one years old, and a high school graduate. Her principal occupation was the manufacture of a trousseau. This with activities incidental thereto occupied most of her interest as well. She was trained with some little difficulty but after 2400 reactions, equally distributed among the three conditions, she gave the results which are presented below. In the 5400 reactions which are presented, a considerable improvement with practice is noticeable.

Subject A was a left-handed, unmarried man, twenty-two years old, with high school training. He was employed as an assistant in the laboratory. He exhibited definite psychotic traits which would be regarded by some psychiatrists as definite symptoms of an overcompensated inferiority-complex, having a sexual basis. He collected tickets at evening performances in a cinematographic house in order to supplement his salary, and also to study the actors, some of whom he imitated quite creditably as to mannerisms of pose and dress. Despite repeated explanations of the uses of reaction-time determinations, he persisted in regarding the experiment as a test of his "mind" and therefore exerted himself to the utmost in order to give the shortest possible reaction. The result was 289 incorrect or anticipatory reactions given with the 5400 correct ones which are presented. The averaged series were preceded by 1000 reactions obtained for purposes of training. All except the first 100 were equally distributed among the three external conditions.

None of the subjects required refractive correction in the eye used in observation.

## RESULTS: AVERAGES

The distributions and averages are presented in tables 2 to 5 inclusive. They are given for the benefit of any reader who may wish to subject them to different treatment than the one employed.

It will be noted that the reaction-times of subject C are distributed in classes of  $\frac{1}{127}$  second, while the other subjects' reactions are in classes of 0.01 second. The records of subject C were made first of all, with the chronoscope motor operated at 720 revolutions per minute. Later, the speed was reduced for the other subjects, to 600 revolutions per minute to give a decimal unit of measurement.

In all these tables the time values are given in classes of ten units each, the designation of the class being the numerical value of the median of the class. For example, the class of 0.31 includes all the reactions between 0.305 and 0.314 inclusive. The unit of 0.001 second is smaller than is useful. The chronoscope is accurate to only 1 per cent, in the average, of the magnitude of the times measured in this work, as was shown by the daily checks with the pendulum.

Table 6 gives a summary of the averages and the probable errors of the averages for each subject under each of the three conditions; also, the differences between the compared averages, and the probable error of the differences. The latter is computed from the formula

$$PE_{M_1-M_2} = 0.6745 \sqrt{\frac{\sigma_1^2}{N_1} + \frac{\sigma_2^2}{N_2}}$$

in which  $\sigma$  represents the root mean square deviation from the mean, and  $N$  the number of terms included in the average  $M$ . From inspection it will be noted that this formula is equivalent to

$$PE_{M_1-M_2} = \sqrt{PE_{M_1}^2 + PE_{M_2}^2}$$

which is given by Davenport,<sup>10</sup> after Pearson, as the formula

<sup>10</sup> Davenport, C. B.: Statistical methods, with special reference to biological variation. 3d ed. New York, J. Wiley & Sons, 1904, p. 15.

TABLE 2  
*Frequency-distribution of reactions according to time-classes. Subject C*

CLASS (UNIT = $\frac{1}{10}$ SECOND)	LEFT HAND. CONDITION:			RIGHT HAND. CONDITION:		
	B <sub>1</sub>	D <sub>1</sub>	B <sub>2</sub>	B <sub>1</sub>	D <sub>1</sub>	B <sub>2</sub>
57		1*			1*	
56						
55						
54	1*					
53						
52						3*
51		1*				1*
50						1*
49		1			1*	
48					2*	2*
47	1*	2	2	1*		2
46		5	4		3	3
45	1	3	4		3	1
44	2	6	2	1*	2	6
43	4	10	8	1	1	8
42	4	19	17	2	10	6
41	6	14	15	9	9	15
40	20	27	25	8	9	21
39	18	36	33	7	20	27
38	21	33	32	15	30	25
37	41	38	51	31	31	35
36	50	72	59	37	43	45
35	53	50	64	55	48	49
34	74	39	50	53	41	41
33	49	50	44	46	43	43
32	41	29	40	60	43	37
31	38	36	29	52	52	36
30	54	33	30	60	56	53
29	37	19	15	39	37	42
28	22	18	11	36	31	22
27	13	4	9	21	19	16
26	3	2	4	7	8	6
25	1		1	3	3	3
24	1				3	1
<i>N</i> .....	553	546	549	542	545	543
<i>M</i> .....	33.64	35.32	35.18	32.62	33.28	33.98
<i>M</i> (units of 0.01 sec- onds).....	28.03	29.43	29.32	27.18	27.73	28.32
<i>PE<sub>M</sub></i> .....	0.087	0.100	0.097	0.084	0.099	0.106

\* Excluded from average by Chauvenet's criterion.

TABLE 3

*Frequency-distribution of reactions according to time-classes. Subject E*

CLASS (UNIT = 0.01 SECOND)	LEFT HAND. CONDITION:			RIGHT HAND. CONDITION:		
	B <sub>1</sub>	D <sub>1</sub>	B <sub>2</sub>	B <sub>1</sub>	D <sub>1</sub>	B <sub>2</sub>
49	1*	2	2		1*	2*
48	1*	2	1	2*	2*	
47	1*	8	2	1*	3*	2*
46	2*	4	1	1*	1	4*
45	2*	5	12	1*	3	4
44		9	6		2	3
43	1	18	12		2	
42	2	17	11	1*	1	4
41	4	31	26	1*	8	1
40	7	28	24	1*	10	3
39	11	36	34	3	18	7
38	9	44	47	2	20	18
37	12	46	44	5	14	17
36	28	70	56	4	14	18
35	55	68	70	20	37	29
34	54	53	60	13	30	26
33	76	79	81	23	43	47
32	75	50	59	37	71	57
31	101	38	40	45	63	64
30	60	31	26	45	64	54
29	52	24	25	65	55	55
28	63	13	18	68	48	82
27	26	11	11	72	41	59
26	24	4	14	68	44	48
25	15	5	6	81	43	36
24	10	2	4	40	23	22
23	6	2	3	40	22	20
22			1	34	10	14
21	1			23	6	6
20	1			6	1	
19						
<i>N</i> .....	693	700	696	694	694	694
<i>M</i> .....	31.44	35.18	34.66	27.53	30.76	29.98
<i>PE<sub>M</sub></i> .....	0.091	0.115	0.116	0.096	0.117	0.115

\* Excluded from average by Chauvenet's criterion.

TABLE 4

Frequency-distribution of reaction according to time-classes. Subject M

CLASS (UNIT = 0.01 SECOND)	LEFT HAND. CONDITION:			RIGHT HAND. CONDITION:		
	B <sub>1</sub>	D <sub>1</sub>	B <sub>2</sub>	B <sub>1</sub>	D <sub>1</sub>	B <sub>2</sub>
59						
58		2*				
57						
56		2*			2*	
55		2*			1*	
54						
53		1*				
52		2			1	
51						
50		6			2	
49		2	1*	1*		1*
48		5	1*	1*	4	1*
47	2*	3	2*		4	
46		7	2		5	3*
45	1*	12	3		6	6
44		13	4		16	2
43	2*	11	3		19	3
42		22	5	1*	13	3
41	2*	17	6	2*	19	5
40	3	21	9	1*	27	8
39	3	37	18	1	40	5
38	5	44	26	5	47	15
37	14	60	25	7	61	23
36	17	70	45	9	61	21
35	19	62	52	16	65	37
34	26	64	43	21	55	54
33	34	78	69	28	62	49
32	47	73	73	46	70	79
31	57	67	91	55	70	82
30	78	72	83	82	58	89
29	88	42	92	92	49	84
28	97	32	80	100	35	77
27	114	22	65	101	44	76
26	99	18	29	92	25	58
25	75	14	37	86	19	48
24	55	7	16	56	10	31
23	28	4	12	36	4	19
22	21	4	2	38	2	11
21	11	2	6	18	2	10
20	1			4	2	
19	1			1		
<i>N</i> .....	893	893	896	894	897	895
<i>M</i> .....	28.37	34.17	31.21	27.82	33.76	30.15
<i>PE<sub>M</sub></i> .....	0.076	0.118	0.097	0.079	0.117	0.096

\* Excluded from average by Chauvenet's criterion.

TABLE 5

Frequency-distribution of reactions according to time-classes. Subject A

CLASS (UNIT = 0.01 SECOND)	LEFT HAND. CONDITION:			RIGHT HAND. CONDITION:		
	B <sub>1</sub>	D <sub>1</sub>	B <sub>2</sub>	B <sub>1</sub>	D <sub>1</sub>	B <sub>2</sub>
57						1*
56						
55						
54						
53					3*	1*
52					1*	
51			1*			
50						1*
49		1*	1*		1*	1*
48			1*		2	2
47		2*	1*		2	2
46					5	4
45		6	2*		4	3
44		2	1		10	4
43		5	1	1*	3	6
42	1*	6	3	1*	9	7
41	1*	7	6	1	12	7
40		12	9	1	15	16
39	1	15	4	3	17	19
38	2	23	12	7	29	23
37	5	37	19	11	36	37
36	7	17	37	5	46	39
35	7	50	36	14	44	47
34	14	51	37	33	54	39
33	28	83	56	49	52	57
32	40	70	62	73	66	60
31	62	73	66	86	86	60
30	88	99	102	117	102	98
29	121	106	102	100	84	78
28	100	77	100	97	66	77
27	118	63	76	94	57	62
26	93	42	70	56	37	50
25	82	31	40	56	25	33
24	52	10	24	51	14	33
23	38	6	17	15	8	13
22	32	7	11	14	4	6
21	6	2	3	6	3	6
20	3		2	6	1	1
19	1			1		
18	1					
17						1
<i>N</i> .....	901	900	896	896	893	890
<i>M</i> .....	27.80	31.22	29.96	28.96	31.83	31.15
<i>PE<sub>M</sub></i> .....	0.072	0.095	0.094	0.077	0.107	0.111

\*Excluded from average by Chauvenet's criterion.



TABLE 6  
Averages, probable errors, and differences between compared averages

SUBJECT	LEFT HAND						RIGHT HAND					
	$M_{B_1}$		$M_{D_1}$		$M_{B_2}$		$M_{B_1}$		$M_{D_1}$		$M_{B_2}$	
	Rel.	Abs. (0.01 sec.)	PE	Rel.	Abs. (0.01 sec.)	PE	Rel.	Abs. (0.01 sec.)	PE	Rel.	Abs. (0.01 sec.)	PE
C.....	1.000	28.03	0.087	1.050	29.43	0.101	1.046	29.32	0.097	1.000	27.18	0.084
E.....	1.000	31.44	0.091	1.118	35.18	0.115	1.102	34.66	0.116	1.000	27.53	0.096
M.....	1.000	28.37	0.079	1.205	34.17	0.118	1.101	31.21	0.097	1.000	27.82	0.079
A.....	1.000	27.83	0.075	1.123	31.22	0.095	1.074	29.96	0.090	1.000	28.96	0.077
	$M_{D_1} - M_{B_1}$			$M_{B_2} - M_{D_1}$			$M_{B_2} - M_{B_1}$			$M_{D_1} - M_{B_1}$		
	Dif	PE	Dif	Dif	PE	Dif	Dif	PE	Dif	Dif	PE	Dif
C.....	1.40	0.132	10.6	-0.11	0.140	0.79	1.29	0.130	9.93	0.55	0.130	4.23
E.....	3.74	0.147	25.4	-0.52	0.163	3.19	3.22	0.147	21.9	3.23	0.151	21.4
M.....	5.80	0.142	40.8	-2.96	0.152	19.5	2.84	0.125	22.7	5.94	0.141	42.1
A.....	3.39	0.118	28.7	-1.26	0.131	9.6	2.13	0.115	18.5	2.85	0.132	21.7
	$M_{B_2} - M_{D_1}$			$M_{B_2} - M_{D_1}$			$M_{B_2} - M_{D_1}$			$M_{B_2} - M_{D_1}$		
	Dif	PE	Dif	Dif	PE	Dif	Dif	PE	Dif	Dif	PE	Dif
C.....							0.59	0.145	4.07	1.14	0.135	10.4
E.....							-0.78	0.164	4.75	2.45	0.150	16.3
M.....							-3.61	0.151	23.9	2.33	0.124	18.8
A.....							-0.68	0.154	4.41	2.19	0.135	16.2

of the "probable difference" between  $M_1$  and  $M_2$ . This designation may be due to a typographical elision, although its use might be justified.

The ratio of the magnitude of the difference to the probable error of the difference is given as a means of ascertaining from the probability integral table of the function  $x \div PE_x$  what is the probability for and against the difference being due to chance.

Certain extreme reactions, indicated by asterisks in tables 2 to 5 inclusive, were not included in the averages. Their exclusion was accomplished by the use of Chauvenet's criterion.<sup>11</sup> Its application to an asymmetrical distribution is not wholly justifiable, but the calculation of a theoretically perfect one is rather tedious and the gain in accuracy is not sufficient to justify the labor. The arbitrary use of a standard criterion of exclusion is evidently better than rendering judgment from simple inspection. In any set of data of this type a number of stray determinations will be found which clearly do not belong to the same distributions as the others and probably were not obtained under comparable conditions. To admit them to a distribution containing a *limited number of cases* may tend to distort comparisons with other distributions in which, owing to the limited number of observations, similar strays had not yet appeared. And yet, it is evidently unfair to apply an arbitrary criterion of exclusion which may not apply uniformly to all the compared distributions.

The distributions, reduced to a percentage basis, are also shown graphically in figures 3 to 6 inclusive. From inspection of the graphs it is evident that all the distributions are multimodal. This is characteristic of all the reaction-time distributions which the author has seen. His attention was called to the fact some five years ago by Professor Dunlap, who asserted at the time that this form of distribution is typical, and does not disappear with greater accumulation of data. This was corroborated in an interesting manner in tallying the daily records of the present work, according to classes of time-values.

<sup>11</sup> Cf. Davenport, C. B.: *op. cit.*, pp. 12 f.

All the prominent modes were prominent throughout the process of tallying, although their relative values might shift as a result of practice.

This fact indicates that a given curve of this type is really compounded from several separate distributions, more or less widely separated; each of which, if isolated, might be a normal

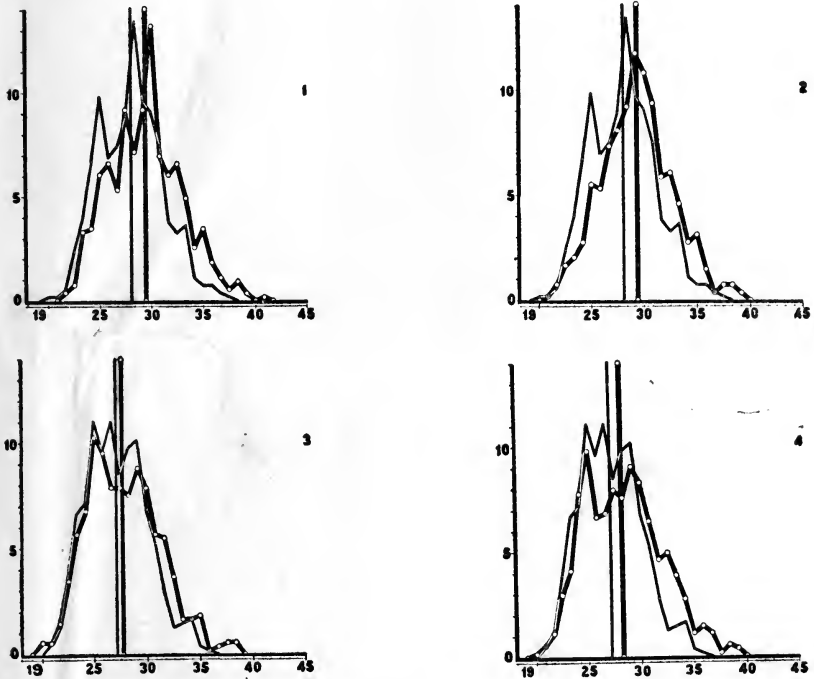

FIG. 3. PERCENTAGE DISTRIBUTION OF REACTION-TIMES OF SUBJECT C

Ordinates, percentages of reactions. Abscissae, time in units of 0.01 second.  
 Graph 1. Light line, 553 left hand reactions under condition  $B_1$ .  
 Graph 1. Heavy line, 546 left hand reactions under condition  $D_1$ .  
 Graph 2. Light line, 553 left hand reactions under condition  $B_1$ .  
 Graph 2. Heavy line, 549 left hand reactions under condition  $B_2$ .  
 Graph 3. Light line, 542 right hand reactions under condition  $B_1$ .  
 Graph 3. Heavy line, 545 right hand reactions under condition  $D_1$ .  
 Graph 4. Light line, 542 right hand reactions under condition  $B_1$ .  
 Graph 4. Heavy line, 543 right hand reactions under condition  $B_2$ .  
 Vertical lines indicate averages.

curve. The analysis of such a curve is said by Davenport to be very laborious, and I have not yet found time to attempt it. Meantime, the constants of dispersion and of reliability which are presented are not to be regarded as the closest possible approximations to the true values.

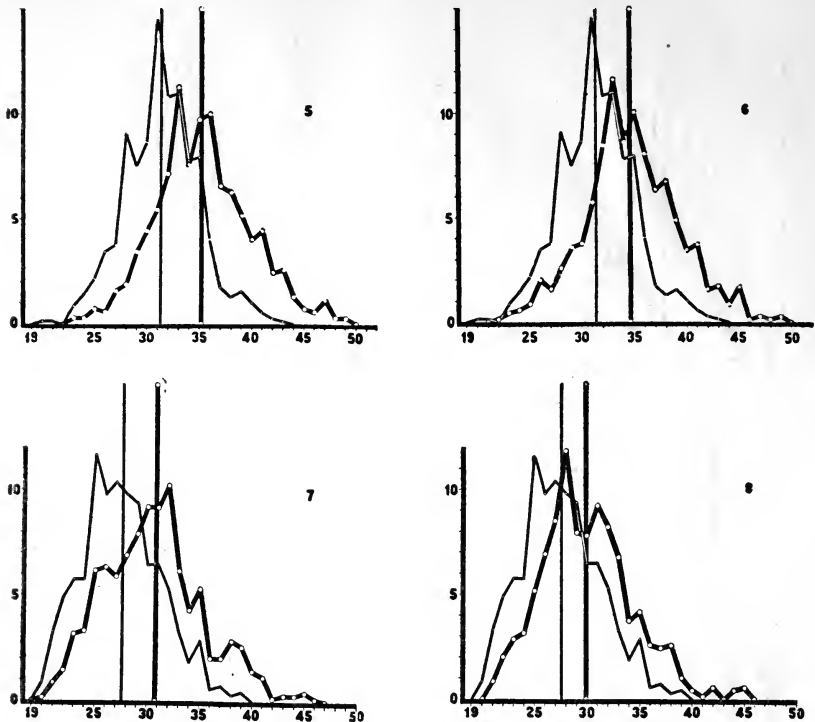

FIG. 4. PERCENTAGE DISTRIBUTION OF REACTION-TIMES OF SUBJECT

Ordinates, percentages of reactions. Abscissae, time in units of 0.01 second.

Graph 5. Light line, 693 left hand reactions under condition  $B_1$ .

Graph 5. Heavy line, 700 left hand reactions under condition  $D_1$ .

Graph 5. Light line, 693 left hand reactions under condition  $B_1$ .

Graph 5. Heavy line, 696 left hand reactions under condition  $B_2$ .

Graph 7. Light line, 694 right hand reactions under condition  $B_1$ .

Graph 7. Heavy line, 694 right hand reactions under condition  $D_1$ .

Graph 8. Light line, 694 right hand reactions under condition  $B_1$ .

Graph 8. Heavy line, 694 right hand reactions under condition  $B_2$ .

Vertical lines indicate averages.

This type of distribution may be explained on the hypothesis that between the retina and the muscles of the hand are several distinct systems of neural arcs of varying "length," and that under favorable conditions of receptiveness of the organism, the "shorter" ones may be brought into operation; while under less favorable conditions the impulse must pass over certain of

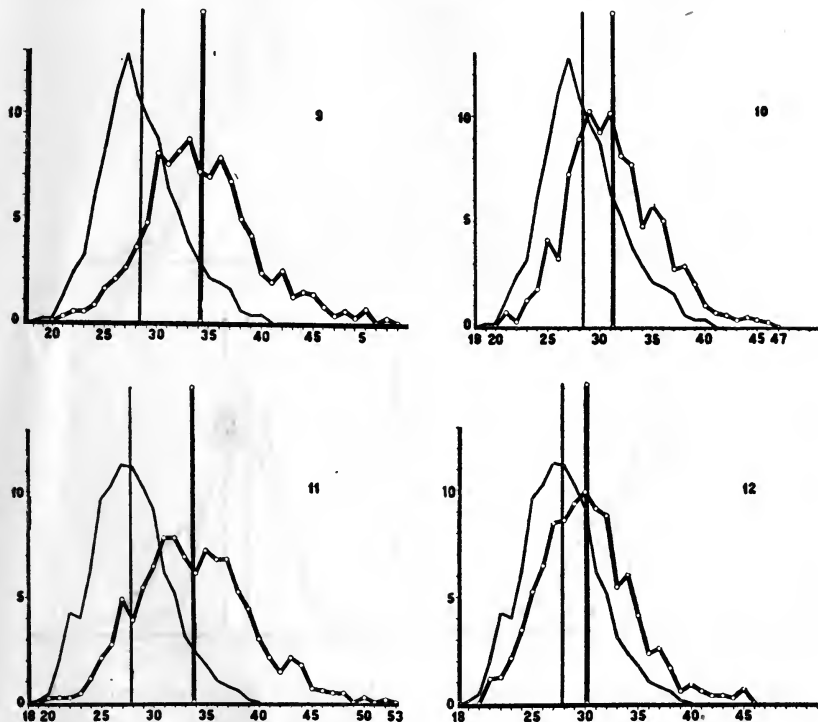

FIG. 5. PERCENTAGE DISTRIBUTION OF REACTION-TIMES OF SUBJECT M

Ordinates, percentages of reactions. Abscissae, time in units of 0.01 second.

Graph 9. Light line, 893 left hand reactions under condition  $B_1$ .

Graph 9. Heavy line, 893 left hand reactions under condition  $D_1$ .

Graph 10. Light line, 893 left hand reactions under condition  $B_1$ .

Graph 10. Heavy line, 896 left hand reactions under condition  $B_2$ .

Graph 11. Light line, 894 right hand reactions under condition  $B_1$ .

Graph 11. Heavy line, 897 right hand reactions under condition  $D_1$ .

Graph 12. Light line, 894 right hand reactions under condition  $B_1$ .

Graph 12. Heavy line 895 right hand reactions under condition  $B_2$ .

Vertical lines indicate averages.

the "longer" pathways. The expressions "short" and "long" do not refer to geometric distances, but to the relative degree to which the paths retard the propagation of the impulse over them. (Cf. the roughly analogous expression "optical distance.")<sup>12</sup>

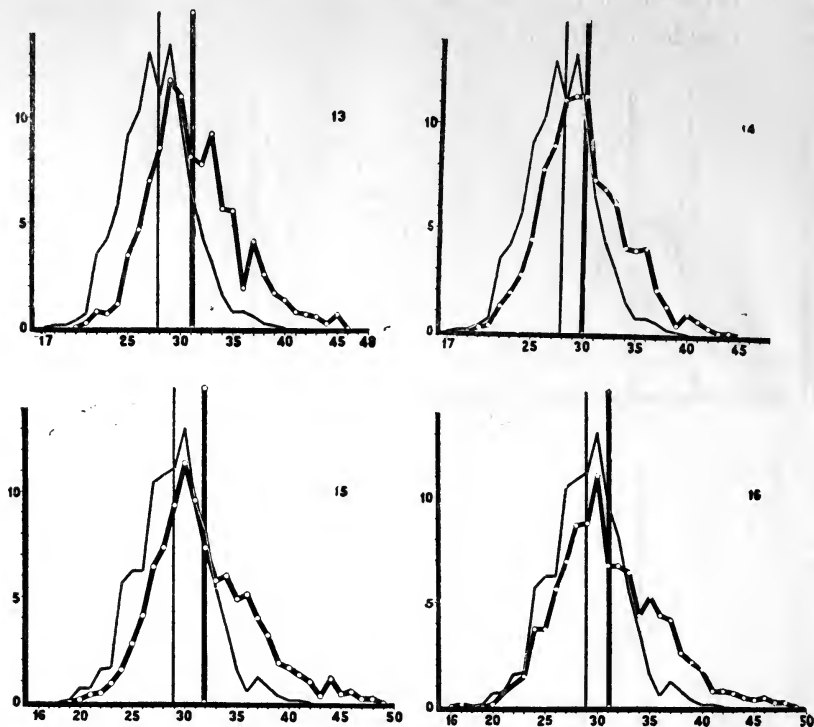

FIG. 6. PERCENTAGE DISTRIBUTION OF REACTION-TIMES OF SUBJECT A

Ordinates, percentages of reactions. Abscissae, time in units of 0.01 second.

Graph 13. Light line, 901 left hand reactions under condition  $B_1$ .

Graph 13. Heavy line, 900 left hand reactions under condition  $D_1$ .

Graph 14. Light line, 901 left hand reactions under condition  $B_1$ .

Graph 14. Heavy line, 896 left hand reactions under condition  $B_2$ .

Graph 15. Light line, 896 right hand reactions under condition  $B_1$ .

Graph 15. Heavy line, 893 right hand reactions under condition  $D_1$ .

Graph 16. Light line, 896 right hand reactions under condition  $B_1$ .

Graph 16. Heavy line, 890 right hand reactions under condition  $B_2$ .

Vertical lines indicate averages.

<sup>12</sup> This paragraph was inspired by oral discussion of the question with Professor Dunlap, but it does not purport to be an accurate presentation of his views.

A similar concept, formulated in accordance with the "all or nothing" principle might be substituted for the above. Under favorable conditions the impulse conveyed to the effector over the first system of neural arcs excited might be adequate to arouse reaction. Under less favorable conditions the "intensity" of the first impulse alone might be inadequate, but might have to await reinforcement by succeeding impulses conveyed over other pathways which were excited later. Or, a part of the delay may be assumed to have taken place in the central synapses, rather than in the muscle, as was suggested above (p. 464).

A study of the distribution-curves of the reaction-times, not only of one subject, but of several subjects compared with each other, suggests strongly that there are several definite time-values, more or less widely separated, about which the reactions tend to group rather closely. Under the more favorable conditions, the preponderance is among the smaller values.

The foregoing discussion should make it clear that the practice of smoothing curves of distribution of reaction-times by averaging the ordinates in overlapping groups of threes is illegitimate, and may also serve to obscure some very instructive features.

#### DISPERSION

The averages of reaction-times obtained under different conditions are much more significant when the dispersion of the reaction-times is considered. This measured by the "standard deviation," or quadratic mean of the deviations from the mean. In table 7 is given the standard deviation  $\sigma$ , for each subject under each lighting-condition, with the probable error of the standard deviation; also the differences between the standard deviations of the compared distributions and the probable errors of the differences. The probable error of the standard deviation is derived from the formula

$$PE_{\sigma} = 0.6745 \frac{\sigma}{\sqrt{2N}}$$

and the probable error of the difference between the standard deviations of the compared distributions, from the formula

TABLE 7  
Comparison of dispersions of reaction times

SUBJECT	LEFT HAND						RIGHT HAND											
	$\sigma_{B_1}$		$\sigma_{D_1}$		$\sigma_{B_2}$		$\sigma_{B_1}$		$\sigma_{D_1}$		$\sigma_{B_2}$							
	Rel.	Abs. (0.01 sec.)	Rel.	Abs. (0.01 sec.)	Rel.	Abs. (0.01 sec.)	Rel.	Abs. (0.01 sec.)	Rel.	Abs. (0.01 sec.)	Rel.	Abs. (0.01 sec.)						
C.....	1.000	3.04	0.062	1.150	3.50	0.071	1.111	3.38	0.068	1.000	2.88	0.059	1.194	3.44	0.071	1.263	3.64	0.075
E.....	1.000	3.51	0.063	1.290	4.53	0.082	1.292	4.54	0.082	1.000	3.76	0.068	1.220	4.59	0.083	1.191	4.48	0.081
M.....	1.000	3.51	0.056	1.475	5.18	0.082	1.227	4.31	0.069	1.000	3.50	0.056	1.488	5.21	0.083	1.221	4.31	0.068
A.....	1.000	3.19	0.050	1.325	4.23	0.067	1.251	3.99	0.064	1.000	3.43	0.055	1.384	4.75	0.071	1.439	4.90	0.078
	$\sigma_{D_1} - \sigma_{B_1}$		$\sigma_{B_2} - \sigma_{D_1}$		$\sigma_{B_2} - \sigma_{B_1}$		$\sigma_{D_1} - \sigma_{B_1}$		$\sigma_{B_2} - \sigma_{B_1}$		$\sigma_{D_1} - \sigma_{B_1}$		$\sigma_{B_2} - \sigma_{B_1}$					
SUBJECT	Diff	$\frac{D_{\text{Diff}}}{PE_{\text{Diff}}}$	Diff	$\frac{D_{\text{Diff}}}{PE_{\text{Diff}}}$	Diff	$\frac{D_{\text{Diff}}}{PE_{\text{Diff}}}$	Diff	$\frac{D_{\text{Diff}}}{PE_{\text{Diff}}}$	Diff	$\frac{D_{\text{Diff}}}{PE_{\text{Diff}}}$	Diff	$\frac{D_{\text{Diff}}}{PE_{\text{Diff}}}$	Diff	$\frac{D_{\text{Diff}}}{PE_{\text{Diff}}}$				
C.....	0.46	0.094	4.9	-0.12	0.132	0.91	0.34	0.127	2.68	0.56	0.092	6.1	-0.20	0.100	2.0	0.76	0.096	7.9
E.....	1.02	0.106	9.53	-0.01	0.116	0.09	1.03	0.132	9.10	0.83	0.107	7.75	-0.11	0.116	0.95	0.72	0.106	6.79
M.....	1.67	0.099	16.81	-0.87	0.107	8.13	0.80	0.89	9.01	1.71	0.100	17.0	-0.90	0.107	8.8	0.81	0.088	9.2
A.....	1.04	0.084	12.4	-0.24	0.092	2.61	0.80	0.081	9.89	1.32	0.090	14.6	0.15	0.105	1.43	1.47	0.095	15.5



$$PE_{\sigma_1-\sigma_2} = \sqrt{PE_{\sigma_1}^2 + PE_{\sigma_2}^2}$$

The results show in general that the condition which yielded the shortest average reaction-time for all the subjects, gave also the most narrow distribution of the individual reaction-times about the mean. This fact is inferable from a comparison of the probable errors of the compared averages.

#### DISTRIBUTION OF ERRORS

In the course of accumulating the averaged reaction-times, a number of wrong or anticipatory reactions were also obtained on each subject. The distribution of these errors according to the lighting condition under which they were given, is of considerable interest. The data are summarized in table 8.

TABLE 8

SUBJECT	CONDITION B <sub>1</sub> , NUMBER ERRORS		CONDITION D <sub>1</sub> , NUMBER ERRORS		CONDITION B <sub>2</sub> , NUMBER ERRORS	
	Absolute	Relative	Absolute	Relative	Absolute	Relative
C.....	22	1.00	23	1.04	23	1.04
E.....	9	1.00	24	2.66	23	2.55
M.....	47	1.00	70	1.44	54	1.15
A.....	57	1.00	129	2.26	103	1.89

The results follow the same general tendencies as the reaction-times. Those of subjects M and A suggest that discrimination was more difficult under conditions  $D_1$  and  $B_2$  than under  $B_1$  and that the subjects sometimes attempted to compensate by an excessive strain of "attention;" i.e., that they were sometimes set for a "motor" type of reaction, in the expectation that a given side would be darkened; and that this expectancy was so strong that when the stimulus finally appeared they reacted without regard to its direction. The same tendency is very clear in the results of subject E, but errors appeared much less frequently than in the results of subjects M and A. I do not regard the differences in the distribution of the errors of subject C as significant.

## SUMMARY

In all 18,300 discriminative reactions are presented as obtained on four subjects under three lighting conditions.

For all the subjects, the time required for making a discriminative reaction is longer for the condition under which the surroundings are dark than for the condition under which the surroundings are three-fourths as bright as the stimulus. The differences between the averages vary between 2 per cent and 20 per cent for the several reactors; and in seven sets out of eight the probability is many billion to one against the differences being due to chance. The one exception is one series given by subject C, whose preference is for the dark. In this case there was no reversal of the effect, but merely a reduction of the difference to a value which is four times its probable error.

All the subjects required a longer time for discriminative reaction when the surroundings were 2.25 times as bright as the stimulus than when they were 0.75 times as bright as the stimulus. The magnitude of the difference varies between 4 per cent and 10 per cent for the different subjects and in every case its value with respect to its probable error indicates a probability of many billion to one against the difference being due to chance.

For three of the four subjects the retardation due to excessively bright surroundings is less than that due to dark surroundings. The difference for subject E is between 3 and 5 times its probable error, and therefore reasonably probable; for subject M it is from 19 to 24 times its probable error, and therefore almost absolutely certain; while for subject A it varies between 5 and 9 times its probable error. One set of subject C shows a reversal of this effect and the other set is ambiguous.

For all the subjects, the dispersion of the results is greater when the surroundings are dark than when they are 75 per cent as bright as the stimulus. The magnitude of the difference varies between 15 per cent and 54 per cent for the different subjects. For subject C the difference is approximately 5 to 6 times its probable error; and for the other subjects, from 8 to 17 times its probable error.

For all the subjects the dispersion of the results is greater when the surroundings are 2.25 times as bright as the stimulus, than when they are 0.75 times as bright as the stimulus. The magnitude of the difference varies between 11 per cent and 44 per cent for the different subjects, and in seven sets out of eight it is 8 to 15 times its probable error.

For one subject, M, the dispersion of the results is about twice as great when the surroundings are dark as when they are excessively bright; and the differences are large with respect to their probable errors. For the other three subjects the differences are small and their significance is doubtful.

Three of the four subjects made a much smaller number of incorrect or anticipatory reactions when the surroundings were 75 per cent of the brightness of the stimulus, than when they were dark or excessively bright. Subject C is an exception, exhibiting no significant difference. She made few errors under any condition after the first few days of practice.

#### DISCUSSION

The results show that while individual differences exist among the subjects used, visual performance was more accurate and certain when the surroundings were of the same order of brightness as the stimulus than when they were dark or when they were considerably though not excessively brighter. If the latent period of the muscular tissue involved, and the latent period of the retina were added and the sum taken from the time required for the type of reaction given by the subjects, the small absolute differences obtained would appear relatively much larger than they do when added to a larger quantity. If moderate differences in the distribution of brightnesses have in general the effect of speeding and retarding visual performance to the extent indicated by the results obtained under these special conditions, the matter of appropriate distribution of brightnesses would seem to be of greater importance than has been attributed to it by illuminating engineers. So far, they have concerned

themselves chiefly with eliminating extreme conditions of "glare."<sup>13</sup>

While the preliminary experiment was not planned to ascertain what is the optimal distribution of brightnesses, certain definite results were incidentally obtained. The author believes these results to be susceptible of misinterpretation unless certain facts are especially considered. It will be recalled that the area of the stimulus was small, its image barely covering the fovea. Under this condition the brightness of the surroundings determined the state of adaptation of the retina. In such case, therefore, one may suspect that the brightness of the surroundings which best adapts the retina to the brightness of the stimulus will always be the optimal condition. This has been borne out by the work of Cobb and of Cobb and Geissler on the thresholds for pattern and for difference of brightness, and has been corroborated by the present work to the extent of the limited range of distributions of brightnesses employed.

Under ordinary lighting conditions, however, as in the home or office, the page which one may be reading, or the sewing on one's lap, may cover a large part of the visual field. The paper on which this report was written subtended a visual angle of 40 degrees in one dimension and 60 degrees in the other, at the distance from the eye at which it lay during the work. The writer has tried several "uniform" distributions of illumination in the home and office, and has discarded all of them in favor

<sup>13</sup> For the benefit of any student of illuminating engineering who may still be puzzled by the significance of differences of a few thousandths of a second in the time required for recognition, I have the kind permission of Capt. P. W. Cobb to refer to a suggestion of his, contained in a paper which, I trust, will soon be published. The suggestion is that the normal resting period of the eye is but momentary; and that any condition which increases the time required for perception, even by a small amount, may tend to retard the normal rate of eye-movement and hence to induce excessive fatigue of the extrinsic muscles. The case is somewhat analogous to the movements in walking. If one is compelled to walk more slowly than is one's wont, or to adopt an irregular gait, the added exertion is at once noticeable. It is often noted that the reading of unfamiliar subject-matter is much more fatiguing than the reading of familiar matter—for the reason that the eye must rest for a longer period on the words or group of words comprehended in a single observation.

of a floor-lamp or desk-lamp, placed so as to give a comfortable brightness over a large central area, leaving the extreme peripheral field fairly dark.

In the present experiment, if the area of the test-object had been sufficiently increased, a value would have been found at which the stimulus-surface, instead of the surroundings, determined the state of adaptation. In such a situation, the influence of the surroundings might have been nullified or even reversed. The results as reported are therefore to be regarded as holding under the special conditions of the experiment, and not necessarily holding otherwise.

The plan of experimentation required next an application of the method to a wide range of relative brightnesses of field and surroundings, to find the optimal relation between them with the original area of the stimulus; and next, a variation of the area of the stimulus to ascertain whether the effects already found are general or not. The work, however, was interrupted by the national emergency of 1917; and not long afterwards, the experimenter's relations with the laboratory were terminated upon his entering the military service. The problem is therefore abandoned, with the following comment on method:

Threshold-determinations as a measure of the influence of external conditions are meaningless unless a time-limit is placed on the period of observation, or unless the time required for observation is considered. If the observer maintains—as in an ideal case—a constant criterion, the difference between the threshold readings made under different external conditions need give no indication of the relative facility of observation. Under a relatively difficult condition the better observer tends to compensate by making a greater effort, and extending the period of observation; the less reliable observer, if he fails, may fail by shifting his criterion or by declining to make the necessary increase of effort.

A special form of threshold-determination consists in requiring the observer to keep an instrument continuously in threshold adjustment for a considerable period of time. This method is unsatisfactory, as the subject's attention is variable, and the

settings made during the lapses of attention are not necessarily related to the subject's instructions or intention. In other words, the setting of the instrument at a given instant does not necessarily measure the subject's threshold. The method was thoroughly tried recently in the work on low oxygen at the Air Service Medical Research Laboratory, and had to be discarded.

Work-tests are unimpeachable in principle, and the difficulties in the way of applying them are not insuperable. But the preparation of an adequate amount of uniformly difficult material is a task which many students would find appalling; and the use of such material is an absolutely indispensable condition of getting interpretable results. If the type of work chosen for the test involves a high degree of muscular coördination, a very long period of preliminary training is necessary. And, since the time required to execute a coördinated muscular response may be highly variable in comparison with the short time required for simpler registration of the act of discrimination, such a work-test will require the accumulation of a larger quantity of data than most students would consider to be worth the expense.

The reaction-time method requires a simple muscular response, which is usually stabilized within a few weeks of training so that further improvement is slow and gradual. The determination of discrimination-time is probably sufficiently sensitive to show the effects of any condition which tends to increase the difficulty of sensory response. The price of definite results, especially if the effect is small, is threefold: (1) adequate control of the external conditions so that secondary stimulus-variables are not effective; (2) adequate training of the subjects, to stabilize effects of fatigue and practice, and insure an approximation to uniformity in methods of observing and reacting; and (3) the accumulation of a sufficient number of reactions to make the results reliable.

The number of reactions necessary to demonstrate a differential effect depends, obviously on the magnitude of the effect and the dispersion of the results. For example, the last 600 left-hand reactions of subject A, equally distributed among the three lighting conditions described above, show a difference in favor of condition  $B_1$  over  $D_1$  which is 14 times the probable

error of the difference; and a difference in favor of condition  $B_1$  over  $B_2$  which is 13 times its probable error. This number of reactions is evidently enough to demonstrate the direction and the relative certainty of these differences. The same data show a difference in favor of condition  $B_2$  over condition  $D_1$  of 3 times the probable error of the difference. This means that in a large number of repetitions of the experiment a reversal of the effect would be expected once in each 22 times. Whether this difference is sufficiently reliable is of course a matter of opinion. I should consider it desirable to quadruple the number of data, since if the effect is persistent this procedure would halve the probable error and would increase nine hundred fold the probability against the difference being due to chance.

Obviously the most economical procedure is to tally the results daily as they are accumulated; summate and average them from time to time, and obtain the constants of dispersion and reliability; and stop work under any compared conditions when the results show a sufficiently definite effect, as judged by the degree of precision which may be demanded.

The number of reactions necessary for definite results from a trained subject is of course far smaller than from an untrained subject, as the effect of training is to enable the subject to reduce the dispersion of his results very greatly. The most economical method therefore requires the subjects to be thoroughly trained before the external variables whose effects are to be compared, are introduced.

#### CONCLUSION

I wish to acknowledge the technical assistance of Mr. George Hathaway in the experimental work; and the aid and counsel of a number of colleagues, especially of the following: Dr. W. Weniger, in planning the electrical system; Captain P. W. Cobb, in the photometry of the various surfaces and in criticism of the paper; Dr. C. F. Lorenz and Dr. A. G. Worthing, in the selection of flashing lamps and in valuable criticism of technical methods; and Captain J. E. Coover, who acquainted me with the valuable abbreviations of statistical procedure which he has

used so fruitfully in his work in psychical research at Stanford. Major William MacLake, of the department of psychiatry in this laboratory, favored me by a careful and critical perusal of the paper, with special reference to the neurological questions involved. My general indebtedness to the work of Professor Dunlap will be readily recognized by psychological readers, although I have seen fit to deviate rather widely from his published opinions on the treatment of data,<sup>14</sup> which I understand he is now willing to modify somewhat.

<sup>14</sup> Dunlap, Knight: Some experiments with reactions to visual and auditory stimuli. *Psychol. Rev.*, xvii, 1910; pp. 319-335. Cf. p. 323.



## AUTHOR AND SUBJECT INDEX

- A**NALGESICS, Action of some anti-pyretic, on psychological reaction time. D. I. Macht, S. Isaacs and J. Greenburg, 327-338
- Announcement, 1
- Associations, Method of studying controlled word. M. W. Loring, 369-428
- Association test, The stop-watch and the. Knight Dunlap, 339-352
- B**OCK, CARL W. A classification of groups, 277-318
- C**EREBRAL cortex of the cat, On the motor functions of the. J. D. Stout, 177-230
- Cerebral destruction, The effects of, upon habit formation and retention in the albino rat. K. S. Lashley and S. I. Franz, 71-140
- Cerebral motor control: The recovery from experimentally produced hemiplegia. R. Oden and S. I. Franz, 33-50
- Chronoscopes, Methods of using the balanced-magnet. Knight Dunlap, 445-458
- Continuous stimulations versus transitional shock, in the phototactic response. S. J. Holmes, 65-70
- D**ESTRUCTION of the frontal portion of the cerebrum, The retention of habits by the rat after. S. I. Franz and K. S. Lashley, 3-18
- Discriminative responses to visual stimuli. H. M. Johnson, 459-494
- Distribution of practice to the rate of learning, A simple maze: with data on the relation of, 353-368
- DODSON, J. D. Relative values of reward and punishment in habit formation, 231-276
- DUNLAP, KNIGHT. Internal secretion in learning. (Discussion), 61-64
- DUNLAP, KNIGHT. The stop-watch and the association test, 171-176
- DUNLAP, KNIGHT. A synchronous motor kymograph, 319-324
- DUNLAP, KNIGHT. Methods of using balanced-magnet chronoscopes, 445-458
- Dunlap's method for the mean variation. Buford Johnson, 325-326
- F**RANZ, S. I. AND LASHLEY, K. S. The retention of habits by the rat after destruction of the frontal portion of the cerebrum, 3-18
- FRANZ, S. I. AND ODEN, R. On cerebral motor control; the recovery from experimentally produced hemiplegia, 33-50
- FRANZ, S. I. AND LASHLEY, K. S. The effects of cerebral destruction upon habit formation and retention in the albino rat, 71-140
- Feeding, Effects of delayed upon learning. J. B. Watson, 51-60
- G**ROUPS, A classification of. Carl W. Bock, 277-318
- GREENBURG, J., MACHT, D. I. and ISAACS, S. Action of some anti-pyretic analgesics on psychological reaction time, 327-338
- H**ABIT formation and retention in the albino rat, Effects of cerebral destruction upon. K. S. Lashley and S. I. Franz, 71-140

- Habit formation, Relative values of reward and punishment in. J. D. Dodson, 231-276
- Hemiplegia, the recovery from experimentally produced: On cerebral motor control. R. Oden and S. I. Franz, 33-50
- HOLMES, S. J. Continuous stimulations versus transitional shock in the phototactic response, 65-70
- HUNTER, WALTER S. Some notes on the auditory sensitivity of the white rat, 339-352
- I**SAACS, SCHACHNE AND MACHT, D. I. The action of some opium alkaloids on the psychological reaction time, 19-32
- ISAACS, SCHACHNE, MACHT, D. I. AND GREENBURG, J. Action of some antipyretic analgesics on psychological reaction time, 327-338
- Internal secretion in learning. (Discussion.) Knight Dunlap, 61-64
- J**OHNSON, BUFORD. Dunlap's method for the mean variation, 325-326
- JOHNSON, H. M. Discriminative responses to visual stimuli, 459-494
- K**YMOGRAPH, A synchronous motor. Knight Dunlap, 319-324
- L**ASHLEY, K. S. AND FRANZ, S. I. The retention of habits by the rat after destruction of the frontal portion of the cerebrum, 3-18
- LASHLEY, K. S. AND FRANZ, S. I. The effects of cerebral destruction upon habit-formation and retention in the albino rat, 71-140
- LASHLEY, K. S. The effects of strychnine and caffeine upon the rate of learning, 141-170
- Learning, Internal secretion in. Knight Dunlap, 61-64
- Learning, The effects of strychnine and caffeine upon the rate of. K. S. Lashley, 141-170
- Learning, The effects of delayed feeding upon. J. B. Watson, 51-60
- LORING, MILDRED WEST. Methods of studying controlled word associations, 369-428
- LORING, MILDRED WEST. Word-lists for adjectives and noun reactions, 429-444
- M**ACHT, D. I., ISAACS, S. AND GREENBURG, J. Action of some antipyretic analgesics on psychological reaction time, 327-338
- MACHT, D. I. AND ISAACS, S. Action of some opium alkaloids on the psychological reaction time, 19-32
- Mean variation, Dunlap's method for the. Buford Johnson, 325-326
- Methods of using balanced-magnet chronoscopes. Knight Dunlap, 445-458
- Methods of studying controlled word associations. M. W. Loring, 369-428
- Motor functions of the cerebral cortex of the cat, On the. J. D. Stout, 177-230
- O**DEN, ROBERT AND FRANZ, S. I. On cerebral motor control: the recovery from experimentally produced hemiplegia, 33-50
- Opium alkaloids on the psychological reaction time, Action of some. D. I. Macht and S. Isaacs, 19-32
- P**HOTOTACTIC response, Continuous stimulations versus transitional shock in the. S. J. Holmes, 65-70.
- Psychological reaction time, Action of some antipyretic analgesics on. D. I. Macht, S. Isaacs and J. Greenburg, 327-338

- Psychological reaction time, Action of some opium alkaloids on. D. I. Macht and S. Isaacs, 19-32
- R**EACTION time, Action of some antipyretic analgesics on psychological. D. I. Macht, S. Isaacs and J. Greenburg, 327-338
- Reaction time, Action of some opium alkaloids on psychological. D. I. Macht and S. Isaacs, 19-32
- Reactions, Word-lists for adjective and noun. M. W. Loring, 429-444
- Retention of habits by the rat after destruction of the frontal portion of the cerebrum, The. S. I. Franz and K. S. Lashley, 3-18
- Retention, The effects of cerebral destruction upon habit-formation and. K. S. Lashley and S. I. Franz, 71-140
- Reward and punishment in habit formation, Relative value of. J. D. Dodson, 231-276
- S**ENSITIVITY, of the white rat, Some notes on the auditory. W. S. Hunter, 339-352
- Stop-watch and the association test, The. Knight Dunlap, 171-176
- STOUT, JOSEPH DUERSON.** On the motor functions of the cerebral cortex of the cat, 177-230
- Strychnine and caffeine, The effects of upon the rate of learning. K. S. Lashley, 141-170
- V**ISUAL stimuli, Discriminative responses to. H. M. Johnson, 459-494
- W**ATSON, JOHN B. The effect of delayed feeding upon learning, 51-60
- Word-lists for adjective and noun reactions. Mildred W. Loring, 429-444



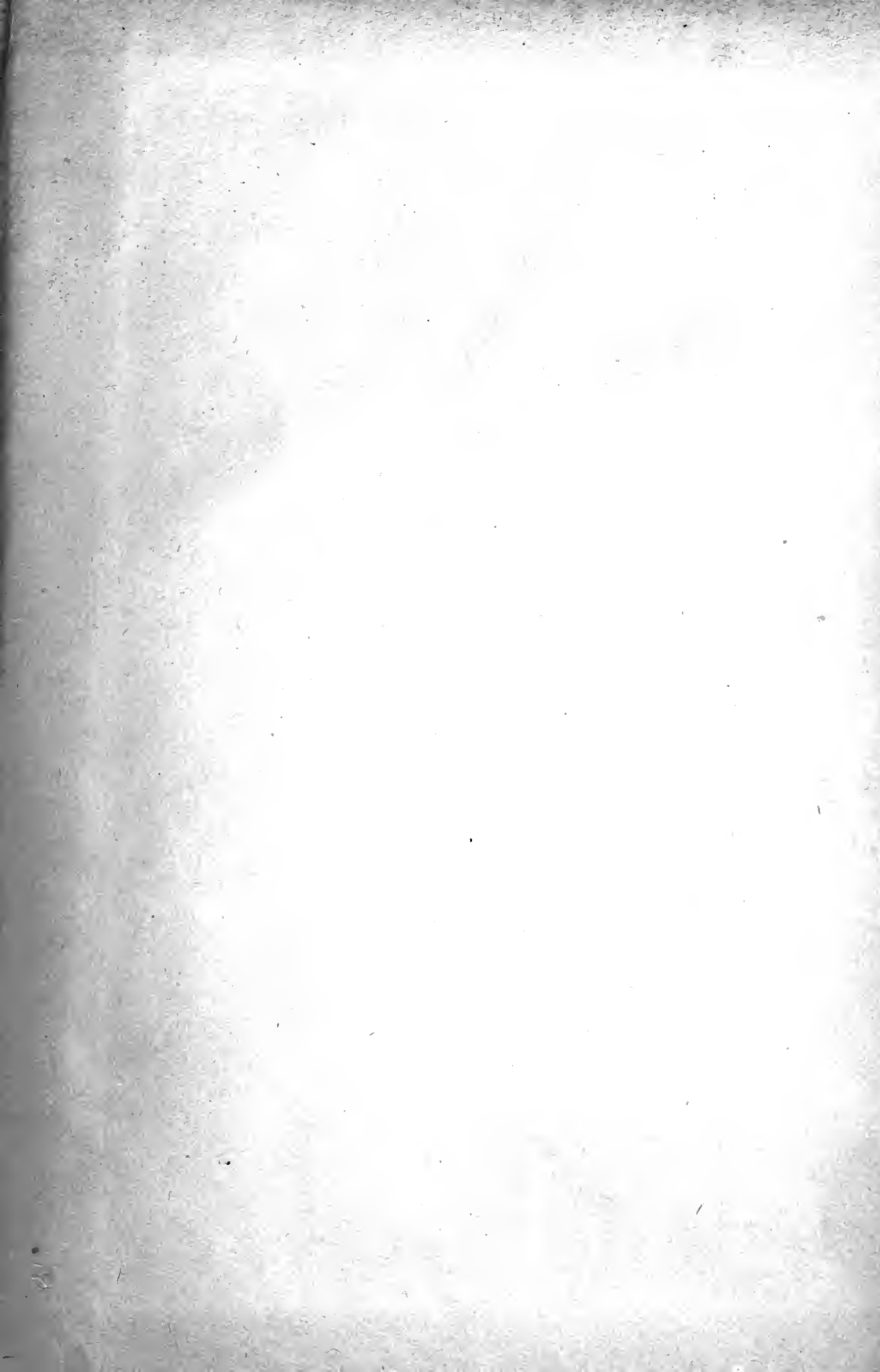

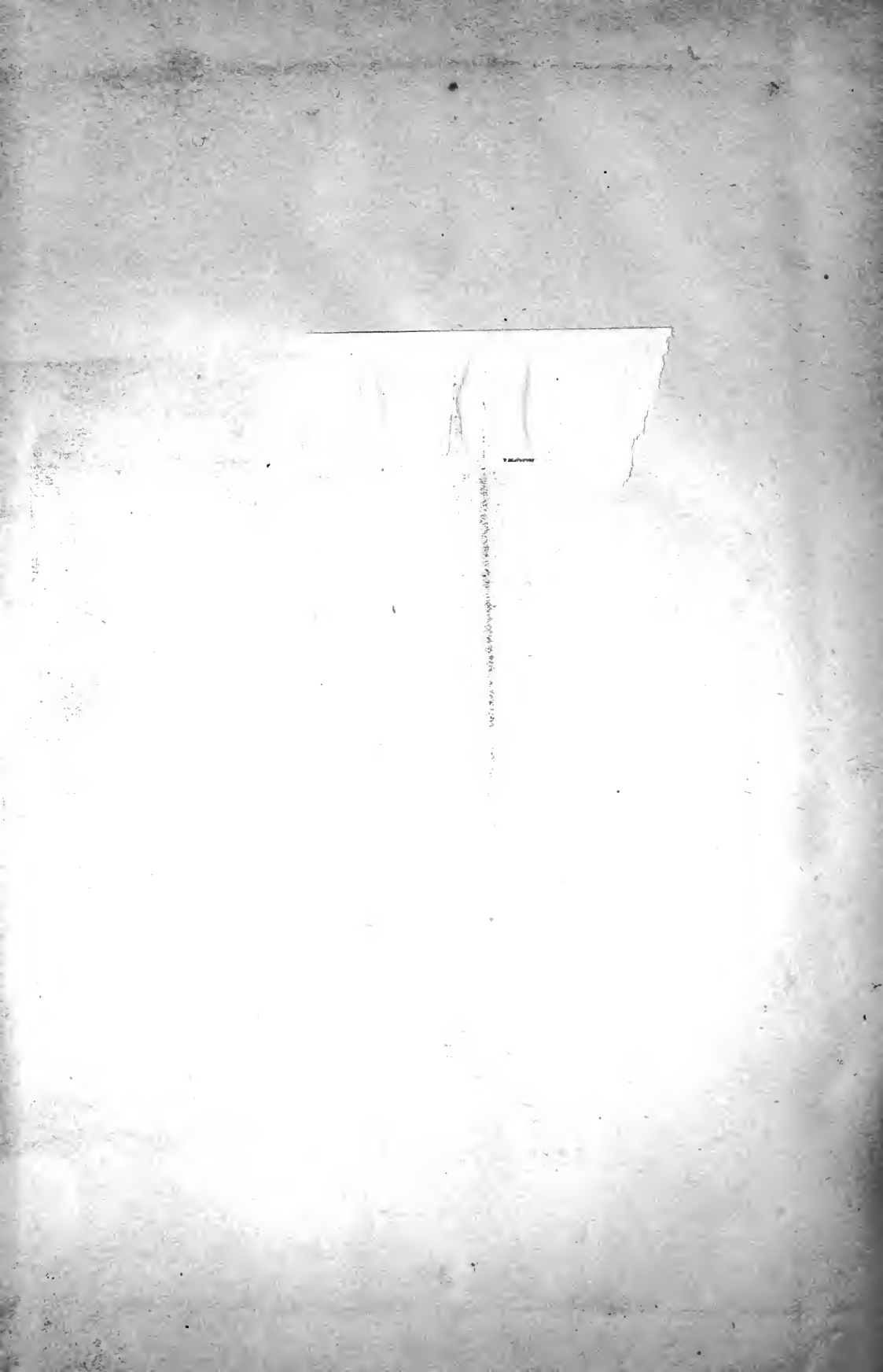

BF  
1  
P6  
v.1

Psychobiology

---

**PLEASE DO NOT REMOVE  
SLIPS FROM THIS POCKET**

---

**UNIVERSITY OF TORONTO  
LIBRARY**

