

QUA 6204

266.2

Alex. Agassiz.

Library of the Museum

OF

COMPARATIVE ZOÖLOGY,

AT HARVARD COLLEGE, CAMBRIDGE, MASS.

Founded by private subscription, in 1861.



Deposited by **ALEX. AGASSIZ.**

No. 7527.

Alfred Ayassir







QUARTERLY JOURNAL
OF
MICROSCOPICAL SCIENCE :

EDITED BY
EDWIN LANKESTER, M.D., F.R.S., &c.,

AND
E. RAY LANKESTER, B.A. Oxon., F.R.M.S.

VOLUME XI.—NEW SERIES.

With Illustrations on Wood and Stone.



LONDON
J. & A. CHURCHILL, NEW BURLINGTON STREET.

1871.

UNIVERSITY OF CAMBRIDGE

LIBRARY
MUSEUMS DEPARTMENT
CAMBRIDGE MA

THE UNIVERSITY OF CAMBRIDGE

LIBRARY

UNIVERSITY OF CAMBRIDGE

LIBRARY

LONDON :

J. E. ADLARD, PRINTER, BARTHOLOMEW CLOSE.

MEMOIRS.

RESEARCHES *on the ERRORS of MICROSCOPICAL VISION, and on NEW METHODS of CORRECTING THEM.* By G. W. ROYSTON-PIGOTT, M.A., M.D. Cantab., M.R.C.P., Fellow of the Cambridge Philosophical Society, of the Royal Astr. and Mic. Soc. of London; formerly Fell. St. Pet. Coll., Cambridge.

(Part I, with Plate I.)

It would be unjust to the memory of Mr. Lister to omit the statement here that microscopical science is more deeply indebted to his discovery of "two *aplanatic foci*" than to any other, except the principles of achromatism. Published originally by the Royal Society in their 'Transactions,' this discovery of practical APLANATIC FOCI acquired a world-wide celebrity, and in a comparatively short space of time the microscope took gigantic strides from the power represented by 200 linear to one fivefold greater, with a corresponding increase of brilliancy and sharpness of definition. The aperture, raised from 30 degrees to 170, conferred new powers of resolution. Objectives were gradually constructed from one quarter to the fiftieth of an inch focal length. Proposed by him also was a method of correcting the aberration introduced in a well corrected objective by covering the object with a thin lamina of glass. The powers of the best constructed microscope depend, unlike the telescope, upon the variable distance between the eye and object-glass, and are a function of this distance and the product of the Herschelian powers of the eye-piece and objective.¹

¹ It may be convenient here to repeat that, 10 inches being taken as the standard distance of distinct vision, $\frac{10}{E}$ is the power of an eye-piece of focal length E , $\frac{10}{F}$ that of an objective of focal length F , so that the magnifying power at a distance of 10 inches is

$$M = \frac{10}{E} \times \frac{10}{F} = \frac{100}{EF}.$$

It will be necessary to allude to several points in this paper of paramount interest in microscopical observations at the present moment, and I venture here to rapidly glance at the issues which must now be undertaken (it is hoped) by physicists better qualified in every way for the difficult task, where, in the cause of science, "to rest and be thankful" amounts to disloyalty to nature and her bountiful revelations.

These researches, more or less significant according as they may affect future microscopical interpretation, have been patiently followed out during a considerable period, as against the general belief in the perfection of modern instruments, which have commanded the award of the highest honours in international exhibitions; and but for the concurrence of some able observers, formerly opponents, the writer could, perhaps, hardly have dared to traverse established views almost fundamental.

I propose, therefore, to establish the following points by careful experiments and calculation.

That whilst the microscope far exceeds the telescope in amplifying power, its various appliances introduce unsuspected sources of error; that many of its showings are the result of a toilsome complicated system of illumination, dependent upon the degree of individual experience in hitting, as it were by hazard, upon the best defining pencil of transmitted rays suitable to produce the desired features and conceal the lenticular imperfections of special glasses; that residuary aberration (hitherto ignored) plays an important part in producing delusive appearances, either within, without, or at the best or aristocratic focus; that it may be readily detected by the aberrameter; that aperture produces very remarkable results upon the visibility of eidolic appearances; that the residuary aberration is capable of ready detection and mea-

With an eye-piece of $\frac{1}{10}$ th focal length (inches being understood throughout this paper as the unit) and a focal length $\frac{1}{20}$ th, corresponding to the increased effect of the most celebrated objectives now constructed by Messrs. Powell and Lealand, capable of resolving Nobeit's 19th band of lines ruled on glass, 112,668 lines per inch, it will be seen

$$M = \frac{100}{EF} = 20,000 \text{ linear.}$$

The powers of the glasses calculated by this formula precisely correspond to the list of powers of the different combinations with a C or third eye-piece of one inch focal length.

Objective .	2 in.	1 in.	$\frac{1}{2}$ in.	$\frac{1}{4}$ in.	$\frac{1}{8}$ th in.	$\frac{1}{16}$ th in.	$\frac{1}{25}$ th in.	$\frac{1}{50}$ th in.
Power . . .	—	100	200	400	800	1600	2500	5000

and four times these powers for a deep eye-piece of $\frac{1}{4}$ focal length.

surement. I propose also to give some striking examples of true, false, and natural definition.

In the second part of this paper I hope to have the honour of laying before the readers of this Journal an account of new modes of correcting the objective by additional lenses, which, by traversing the axis of the instrument, operates as a searcher for aplanatism to detect the most perfect aristocratic locus for producing the finest final focal image, a contrivance which changes the state of the aberrations, both spherical and chromatic, and introduces the new colour-test for high-power definition, at the same time that it very considerably deepens focal perspective and enhances magnifying power and increases the intensity of illumination.

The same instrument also furnishes a means, in many cases, of applying a correction to objectives unfurnished with a screw-collar adjustment.

Lastly, some researches in the effect of the immersion system, and its further improvement.

The superiority of the immersion system, so much used on the Continent—it being far more easy to construct a good immersion objective than our English first-class glasses—should stimulate the inquiry into the causes of defect in aëro-objectives; indeed, notwithstanding the greater brilliance of the hydro-lens, it is still highly desirable to adhere to the dry form. It appears to the writer that the latter is far preferable as regards general utility and adaptability, as the immersion lens is necessarily inconvenient, in some cases impracticable, and in many destructive.

I may be permitted here to remark that the most important part of the instrumental adjustments is the minute interval by which the front sets of glasses are separated. Commonly employed to compensate for varying thickness of the usual "glass cover" applied to protect and secure minute objects upon the "slide," a screw collar, divided into fifty parts, regulates to the 10,000th of an inch this important interval, upon a novel co-operation, of which these researches are intended principally to bear.

The prospect of further advancement in the power and precision of the microscope is now bright and full of encouragement. It is, however, almost necessary to start *de novo*. Many accredited facts must be relinquished. Several of the most trustworthy tests have now become antiquated and delusive. But considering the relations of this instrument to the arts, science, and jurisprudence, too much importance can hardly be attached to the uniformity, constancy, and fidelity of its readings.

It is thought that the new order of facts regarding an accepted but transitional definition opens a very wide field of inquiry. The present paper is rather intended to be suggestive than exhaustive.

§ I. *Residuary Spherical Aberration.*

Dividing the area of the surface of a lens into concentric rings, it is known that, for spherical surfaces in general, each ring transmits its rays differently, and intersecting the axis at variable points. In but a few instances can each shell of conical rays be made to intersect at one and the same point, whether the rays be homogeneous or chromatic. The image of a window, for instance, formed by a plano-convex lens upon white paper, it is well known, is four times more indistinct with the plane side turned towards the light than when the convex surface is so turned. Spherical aberration is here clearly apparent. In the same way, if an objective be employed on the stage, and images formed by it be carefully examined by a microscope of excellent correction, it will be found that these images are more or less distinct according to the variation of the interval regulated by the screw collar (Pl. I, fig. 4). If a brilliant disc be thus observed, the errors of the objective, tested, will show a variety of characters. Irradiation, nebulous light, bright or coloured haloes, haze, yellow fog, absence of a decided focal point, no certain evanishment of form just within and without the best point of definition. Such are some of the more glaring appearances of either spherical or chromatic aberration, the yellow fog being the worst fault of all. In minor cases, passing muster with inaccurate observers, a faint mist overspreads the field; outlines appear considerably adumbrated, they want sharpness, decision, and point; adjacent structures more or less coalesce (fig. 1 *f*).

Experiments on Residuary Aberration and Aperture.

The ordinary optical formulæ show that spherical aberration for a convexo-plane lens diminishes rapidly for parallel rays as the aperture and focal length is smaller, and the same will happen with minute spherical lenses or spheres. For the latter the focal point of ordinary glass is placed at a point one fourth the diameter distant from the surface and without it, and the same happens with cylindrical lenses, supposing the refractive index be $\mu = 1.500$.

Another interesting form of lens, in some cases exceedingly perfect, is of accidental manufacture during the process of

rolling melted glass. The best are found in the thickest patent plate glass, caused by the expansion of minute quantities of incandescent gas or impacted vapour. Some curious phenomena are connected with these spherical cavities, of a physical character, which, however, are out of place here. It suffices to state that enclosed between the surfaces of glass, ground to such accuracy as to show Newton's rings under slight pressure, or only under the weight of a second layer, some of these exquisite little gaseous lenses exhibit images of great precision and clearness. They differ, however, essentially from the solid spherical lenses by the focal point being placed within the sphere, instead of without it, as in glass sphericles; and in the enormous aperture embraced in the focal picture (nearly 180° , the limit).

Remembering that when a pencil of parallel rays passes through a denser into a rarer medium (supposing common air were enclosed), the focal point for a refractive index $\mu = \frac{3}{2}$ would be found to lie upon the posterior curvature of the minute hollow sphericle, *i.e.* on the surface furthest from the eye of the observer. If the contained gas or air were more attenuated or μ diminished, it would approach the centre. This appears from the formula

$$-\frac{2 \cdot \overline{\mu - 1}}{\mu r} = \frac{1}{f} \quad (\text{writing here } \frac{1}{\mu} \text{ for } \mu):$$

The field of view presented is generally three fifths of the diameter of the gaseous sphericle, and is independent of the aperture of the objective, whilst change of aperture has a very surprising effect upon the visual characters of the *solid* glass sphericle, however small, as also upon cylindrical refracting fibres. This change, so decided and important in minute research, has been a cause of much surprise and pleasure to the writer, as it appears to open a new mode of changing and selecting definition under novel conditions.

Experiment 1.—Placing minute glass sphericles 1-1000th of an inch in diameter, no black outline is visible with an aperture exceeding 83° . As the aperture is reduced a black annulus appears and broadens continually (figs. *a, b, c, d, e*), and for rows of sphericles in contact and very small their outlines are similar, obscure or developed according to the aperture and obliquity of light used.

Experiment 2.—Spun glass threads 1-3000th in diameter. Jet black bands, similarly, are developed, only with an aperture of 83° and under, and their breadth increases rapidly as the aperture is reduced (figs. 2, 3, 5).

Remarkable is the result that large aperture destroys the

black ring outline of refracting spherules and black borders of cylindrical fibres. In innumerable instances the only possibility of distinguishing the molecules of organized particles depends upon shadow. It will be seen, further on, that the visibility of this shadow is entirely governed by *aperture* and refractive index in the observed substance. The human eye, in natural vision, sees an object 10 inches' distance under a less aperture than 2° , and for distant objects it becomes less than a second of arc. The gaseous lenticle just described presents to ordinary vision a delicate jet black ring, and glass sphericles and cylindricles give a black boundary. A fundamental defect of excessive aperture is the disappearance of these invaluable characters of minute sphericles and fibres capable of refracting light. An extraordinary variety of objects, critically examined, develop a new order of appearances under reduced aperture totally invisible with the same uniform aperture generally employed by the observer, yet the advantage of changing telescopic aperture has been long appreciated and acted upon.¹

It also appears that very large aperture is incompatible with any considerable depth of focal vision or with focal perspective (if a new term may be allowed). Intense definition combined with a deeper perspective are qualities which now form the great desideratum of histological research.

Under high power focal perspective is almost inappreciably shallow, and until this can be deepened only a mere skeleton section or plane of the object can appear in the field of the microscope at once. As no attempts have been made to measure this visual range for different powers, it may not be uninteresting to record an experiment made in the spring of 1869 with a very small pencil of parallel solar rays illuminating obliquely some beautiful spherules (of a scale of "azure blue"), lying in close contact, $\frac{1}{30000}$ th of an inch in diameter. With the highest power used (4000), the point of distinct vision appeared palpably to travel through the beading, and by estimation (as near as could be done) the visual perspective extended only one fourth through the bead, or $\frac{1}{12000}$ th of an inch. In other words, nothing above or beneath a plate of that thickness was visible with the same focus. The *focal plate*, if I may so name it, may be roughly estimated, from the results of several experiments, as follows:

¹ It has already been observed angular aperture of microscopes varies from 15° to 170° , unlike the telescopic aperture measured by inches.

Objectives	$\frac{1}{20}$ th in.	$\frac{1}{16}$ th in.	$\frac{1}{8}$ th in.	$\frac{1}{4}$ in.	$\frac{1}{2}$ in.	1 in.
Thickness of focal plate } or depth of prospective }	$\frac{1}{150000}$	$\frac{1}{120000}$	$\frac{1}{60000}$	$\frac{1}{20000}$	$\frac{1}{6000}$	$\frac{1}{2600}$.

It appears that perspective deepens with a given objective as the aperture is reduced.

Dr. Goring first laid down the principle that "penetration" is always as the angle of aperture directly. This appears to the writer as the very opposite of the truth, and this principle is still entertained and applied as an obstacle to progress. *By penetration he meant the resolving power of large aperture.*

The "resolution" of difficult structures can only depend upon sharp and distinct outlines, *i.e.* the exhibition of structure as it really exists, without the false halo of aberration and the false shadows of complex illumination. If it were possible to construct an instrument that could imitate natural vision (as an object appears to the eye) under a small aperture, much vagueness of terms would disappear. It was found that only by large apertures could difficult test-objects be resolved. It was therefore thought essential to a fine definition. Other causes, however, promoted the success, at that time unsuspected.

Experiment 3.—A glass bead ($\frac{1}{1000}$ th diameter), formed by fusing a spun thread ($\frac{1}{3000}$ th), is examined with an aperture of 120° objective. No black border appears till the aperture is reduced to 80° . It then increases in breadth as it is diminished; the image of waving foliage glistening in the sunbeams becomes more distinct as the black band broadens; and the light up to a certain point *increases*.

Experiment 4.—Very fine hairs acquire a distinct sharp and black outline as the aperture is reduced; penumbra vanishes, and the terminal central spectrum of intersection becomes gradually visible (9 a).

Experiment 5.—The spines of the Podura scale were resolved into three or four jet black beads with a reduced aperture (fig. 6) and a solar beam with careful corrections and oblique light incident in the direction of the longest diameter of the scale. During the reduction of the aperture in each of these cases the perspective evidently deepens.

§ II.—*On the Use of a New Aberrameter for Testing Aberration and the Effects of Aperture.*

From the preceding and similar experiments it would appear that an instrument contrived to vary at will the

angular aperture might possibly bring out some new points; and provided particular rings or annular areas of the objective surfaces could be instantaneously compared, a further application might be made in the direction of testing the comparative aberrations of special areas. For the whole question of aberration hinges upon the unequal effects of these rings of surface. Such an instrument has been adapted by the writer, which gives apertures from one thirtieth to half an inch, twelve in number, and has three central stops for cutting off the central pencils. The aberrameter being applied to the nose of the microscope, into this the objective to be critically examined is inserted; various areas are successively cut off and the effects noted. The unbalanced state of the aberrations in general, with proper tests, become at once apparent, and no adjustment of focus or "screw collar" gets rid of the defects.

Experiment 8.—Objective one inch focal length, quality "good." The definition of the central pencil is obscure. As aperture increases, so does the definition improve up to No. 9 (full aperture). Striæ of azure blue, finest scales visible, best with outer ring of pencil; invisible with central rays, aperture No. 6 (600 diameters).

Result.—Outer and inner rays are not in aplanatic co-operation. Aberration uncorrected.

Experiment 9.—Dots on "battledore scales" intensely black with No. 7 aperture; *the black annuli are developed.*

Experiment 10.—Same object. Fine $\frac{1}{4}$, full aperture, power 400. Battledore bulbs translucent and ill-defined. Aperture reduced to No. 1. The surface starts out in full relieve, shaded black and sharply marked. *Direct light.*

All the perspective of *an inch objective* is obtained; the focal plate gains extraordinary depth; the surface resembles rather an *intaglio* than a flat-drawn picture; reduced to a flat surface, as usual, with one-fourth objective and full aperture.

From repeated experiments of this kind it appears that the concentric areas or rings of the objective surfaces seldom exhibit equal defining powers, that an even quality in the corrections is infrequent, and that careful focussing does not correct the definition. The contrivances of the aberrameter readily detect the aberrating annulus, if it is provided with a sufficient number of graduated stops to obliterate either the central or excentric pencils; and it affords a new means of examining an object, so as to bring out its details in strong relief. No. 2 aperture evolves relieve details even

with a one-eighth, and studs the same object with *black points* (in addition to the bulbs).

This is a fair example of deeply shaded, sharply cut definition. All microscopic observation is a question of light and shadow, and the facility of changing at will the shading of spherical and cylindrical forms is a new avenue to truth.

From these *effects of aperture* it may now be assumed that *with a small aperture a spherical refractive particle exhibits a dark, even jet black, terminal annulus*. If a body be studded with such beading it will necessarily appear dark from an assemblage of shadows; when the definition is exalted these beads, considered as lenses, exhibit in general too small a point of central illumination to be detected with ordinary glasses. Even if perfectly refracting and unembarrassed with other substrata, beads so small as $\frac{1}{30000}$ th form an image of a radiant source of light inconceivably minute.¹ In some cases, therefore, they appear jet black with a small aperture, but most frequently invisible with an excess of aperture.

Supposing the glasses free from annular aberration, greater depth of vision with black outlines is given by a reduced aperture with direct light. But if the central pencils aberrate incorrigibly, then the outline will be blurred and ill-defined, thick and dark.

On the other hand, enlarged aperture appears to illuminate a dark object, if transparent; it converts, apparently, in many cases, opacity into translucence, transforms a reddish-brown scale into a brilliant object, reveals interstitial sparkling, and developes new, but often delusive, appearances in eidolic forms.

It may now be stated more generally, and geometrically explained:—If the aperture of the objective of a microscope be reduced below a certain angle ($83^{\circ} 48'$ for ordinary glass) spherical particles of a refractive character assume black annular shadows, the breadth of which is increased as the

aperture is diminished. Assuming for a sphere $f = -\frac{\mu r}{2(\mu - 1)}$ (fig. 1), let BC be a refracting particle of radius r , F the principal focus for parallel rays; then, if $\mu = \frac{3}{2}$, HF = $\frac{1}{2} r$. Draw FN a tangent to the spherule touching it at N. Then it is manifest—

¹ The minute image of a brilliant flame is, in all such cases, swelled out by the imperfection of the glasses into an exaggerated spurious disc.

$$\sin NFH = \frac{ON}{OF} = \frac{r}{\frac{3}{2}r} = \frac{2}{3}.$$

Hence,

$$\theta \text{ or } \angle NFH = 41^\circ . 48' \text{ nearly.}$$

$$2 NFH = 83^\circ . 36' \text{ nearly.}^1$$

If L represent the front lens of the objective, it appears that the spherule of glass (when $\mu = \frac{3}{2}$) cannot transmit a greater divergent pencil than $83^\circ 36'$. That all objective aperture above this is useless for *sphericular* definition. That as the aperture of L is diminished by a stop at KK, the transmitted pencil of rays is contracted to EDHFK, and a black shadow of obliterated rays is developed, represented by the segment HNCD, the visual angle of which is NFH. That

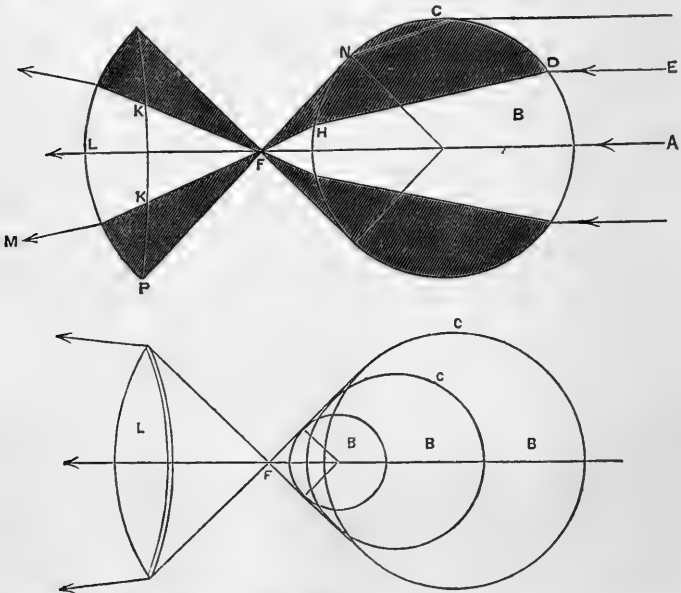

as KK is diminished the black annuli broadens. That this effect is independent of the size of the globule, as shown at BBB.

Black outlines of cylindrical refracting bodies follow the same law, the breadth of black outline being determined by the smallness of the objective aperture. And a system of such bodies, whether distributed in cylinders or beads, present similar phenomena.

¹ For any other refractive body, $\sin NFH = r \div \frac{\mu r}{2(\mu - 1)} = \frac{2(\mu - 1)}{\mu}$ for the sine of the semi-limiting aperture.

It appears from the expression for θ that the black annulus of different refracting spherules commences at various values of the objective aperture, readily found by the expression

$$2\theta = 2 \sin^{-1} \frac{2(\mu - 1)}{\mu},$$

and no black outline can be developed at a higher angle of aperture. Thus, taking Sir J. Herschel's tables for mean rays, the following values of μ being substituted, and 2θ tabulated, the limiting apertures to correctly define spherules of the following substances are given in the third column.

Substance.	Index of refraction.	Objective aperture.
Tabasheer or bamboo silica	1·182	25°·40'
Water	1·336	60°·16'
Olive oil	1·470	79°·18'
Plate glass	1·500	83°·36'
Canada balsam	1·532	87°·16'
Cairngorm topaz	1·624	100°·44'
Oil of cassia	1·635	101°·36'
Blue sapphire	1·794	124°·30'
Heavy glass (lead 2, flint 1 part)	1·988	164°·6'

To correctly define a spherule of water the aperture should be reduced below 60°, for olive oil less than 80°, for oil of cassia less than 100°, and for a spherule of heavy glass the definition will bear 160° of aperture; whilst in observing bamboo silica spherules, no black annulus should be developed in spherules of this substance at a greater angular aperture than 25°. It is evident that a coarse measure of the refracting index of a given spherule can be at once obtained by measuring the aperture at which the jet annulus begins to be developed.

But as it has been the fashion to employ objectives of the largest attainable aperture, these nice distinctions of the optical definition, as depending on the relation of the refractive index to objective aperture, have been completely overlooked. Precisely the same experiments may be evolved from observing cylindrical fibres of a refracting character.

The kind of definition obtained is therefore frequently an unknown function of the aperture and refractive index of the substance observed.

An interesting confirmation of this principle is to be seen in the behaviour of various siliceous bodies, as those found in sponges, the spherules and cylindricles of which display very different characters of a much paler definition at their intersections and at their general edges than ordinary glass threads, and their refractive index probably approaches the low value of that of tabasheer of bamboo. Apart from this

law of shadow being governed by the combined effects of aperture and refracting power, no trustworthy interpretation can be given of comparative appearances or of approximate form, and, consequently, the analysing effects of changing the angular aperture by means of such a contrivance as the aberrameter are in many delicate observations of considerable interest and value.

§ III. *In selecting Standards of Definition, known Objects are greatly preferable to the Conjectural.*

The development of the powers of the microscope have been mainly owing to the selection of natural objects as tests, chiefly of the striated character. But as quality is raised, striation recedes and beads appear in almost every test object of a striated character. The wavy Podura—that celebrated object—is no longer the finest test. The spines give way to beads. It would appear that such objects for the highest powers are a kind of *mirage*, deluding the observer. For forty years this object has been the chief guide to the opticians, and the chief standard by which to value the glasses and perfect their performance.

Known objects are therefore to be preferred, and if a very perfect image can be formed of suitable objects of familiar properties, sufficiently minute and accurate to test the defects in question, observers may proceed with confidence in their researches. The watch-dial used for testing Lord Rosse's leviathan mirror, as being a *known* object, acted perfectly. An object of a highly conjectural structure would have been of little avail for a refined testing.

It is well known that the aberration rapidly diminishes at a conjugate focus as it moves up to the lens. If, therefore, an excellent objective be reversed, and an image of a distant object be formed in the focus of the microscope, the aberration of this image will in a high degree be less than that produced at the longer conjugate focus, the aberration in general¹ being found to increase with the distance at which the image is formed from the objective, as in the case of lengthening the draw-tube of the microscope. Hence if a very fine objective be used to form a *miniature* of an object placed at ten inches' distance, the aberration of a point in the image is very considerably less than when the objective is used in the ordinary way.

Experiment 11.—A small watch-dial strongly illuminated

¹ Subject to the special and fundamental compensations of the objective glass.

is placed ten inches from the stage, and forms an image of itself in the focus of the instrument by transmitting a pencil of rays through a fine $\frac{1}{16}$ th objective secured to the stage. It is viewed with $\frac{1}{8}$ th and C eye-piece of one inch focal length (power of 800 diameters), *both objectives having been previously adjusted for viewing an uncovered object.*

Result.—Nebulous field. Graduation (minutes) invisible. No index corrections of objectives removed the nebulosity. The $\frac{1}{8}$ th observing glass was of average quality. Residuary aberration most decided.

Experiment 12.—The positions of the two objectives are reversed. The image formed by the $\frac{1}{8}$ th is viewed by the $\frac{1}{16}$ th with equal power.

Result.—Nebulosity is diminished greatly.

Deduction.—Aberration of the $\frac{1}{16}$ th better corrected than that of the $\frac{1}{8}$ th.

Experiment 13.—Mercurial globules of various sizes placed on black cloth now replace the watch-dial at ten inches from stage.

Result.—Beautiful sharp images of the window visible in the particles of mercury *miniatured* by the $\frac{1}{16}$ th stage objective arranged as in Experiment 11 like a condenser.

Deduction.—The difficulty of observing minute globules placed upon the stage entirely avoided. A new order of tests is secured of any degree of minuteness and brilliance. This method is recommended as avoiding the inconvenience and practical difficulty of viewing the image of a brilliant disc upon a globule of mercury almost touching the objective, and *impossible with the immersion lens.*

For ordinary purposes of testing, nothing can be more simple than employing artificial spectra formed by either objectives or lenses. If the former are selected, then the observing lenses must be of known character and quality. If the latter, then their especial qualities must also be known.

Achromatism, so-called, with spherical error or planatism, gives a pale grey-yellowish hue and a perspective resembling a view through horn or any slightly opaline medium. The details of the dial or other object cannot be distinguished. The stage image of a watch resembles fig. 10.

Chromatism with fine aplanatism is in every case better seen by using a bright flame or solar rays. If a small, brilliant camphine lamp be placed a few feet from the stage and in the instrumental axis, when the apertures are very large, a gorgeous halo of rich colouring in the order of dispersion irradiates the outline of the flame imaged by the objective used as a condenser.

§ IV. *On Provisional Definition.*

There is abundant reason for supposing that there may be, and probably are, a good many, microscopic appearances, even those regarded as tests, which must be considered as merely provisional until better modes of observation are established.

Erroneous readings may generally be treated under the effects of eidola, interference, mixed shadows, and the shadows or false images of a lower structure confusing the outline of the upper focal plane of vision; diffraction and chromatism also bear their part in the rôle of delusive definition. In this way black lines, black and white chequers, rows of spherules (provisionally offering the signs of cylindrical bodies), and crescentic shadows, are all confused into angular, triangular, and hexagonal markings, false lights and bright points, the resultant focal images of coincident sphericular lenses in contact. In fact, it appears many of the long-established readings of the best microscopes require re-reading. There remains work for a generation of new observers.

It has been considered that the greatest obliquity of illumination practicable is necessary to bring out minute structure, and therefore the greatest possible aperture (170°) is absolutely indispensable to define properly. On this principle all modern microscopes are now constructed. A further insight into the superior effects of a finer definition will, perhaps, remove this obstacle to successful research. A more brilliant, intenser display of outline, shadow, and coexistent colouring—a more natural picture *in relief*, resembling ordinary vision, in which the relations of upper and lower planes are better appreciated by the eye at one glance—prominences and hollows, elevations and depressions—in short, a finer prospect altogether, deeper and more finely cut in its tracery, such are the improvements demanded. In low powers the binocular arrangement has effected much of this. But in the high powers the old defects are continually embarrassing the observer. At one and the same instant he can only perceive a true sectional picture, just as we see sectional plates of an engine cut through the middle. Continually fresh sections are focussed down upon, and the memory must now aid the brain as well as the eye to decipher continually dissolving views.

Erroneous Readings.

Experiment 14.—If wire gauze be folded and viewed against the light at ten inches' distance, innumerable varied

patterns of interference are exhibited. The waves of interference depend upon—

- (1) The angles of intersection of the superimposed wefts ;
- (2) The fineness of the meshes ; and
- (3) If two layers of different coarseness are used, a new order of waves are introduced.

The patterns are endless ; irregular weaving of the gauze enhances their beautiful effects. There will be seen endless examples of patterns—squares, wavy plaid, Scotch plaid, tidal sand ripples, short black lines, &c. &c.

Examining the latter with a fine three-inch focus crossed lens, bright lines of light appear on the black background of contiguous wires parallel in the same plane.

Now, it cannot be doubted that what can be seen in the coarse way must take place in the microscopic field. Many objects are striated longitudinally and at the same time obliquely, forming veritable meshes and delicate waves.

Again, it is known that light issuing through fine gratings suffers diffraction, and, permeating attenuated films, suffers physical changes (due, it is supposed, to collision or interference waves), generating the most gorgeous colouring, sparkling with a peculiar prismatic beauty according to the thinness of the structure. These phenomena happen both by refraction through films and reflection, and by reflection also from a surface broken up with fine lines, as in Barton's buttons, diatoms, and the more resplendent butterflies. Without further expansion of this subject (a rich field of research), I may be allowed to pass on to a few examples of false reading from various causes.

Error A.—The provisional appearance of a row of spherical beads too minute to be defined by our glasses is a cylindrical figure. For the same reason as the last the shadows coalesce.

The penumbrae of spherical error overlap and produce the provisional cylinder, as in the conventional form of the striated *Lepisma saccharina*. And when a substratum of beading exists, their compound shadows render the delicate beading difficult of observation.¹

Error B.—The intersection of minute cylindrical bodies in general produces no spectra or black bands, nor prismatic colours, in the best modern objectives.

If minute threads of spun glass be carefully examined,

¹ Inferior glasses still show the diatom *lines* as *ribs* or cylindrical appearances, and the Podura markings as corrugations! grooves, hollows, and ridges : often seen when, with immersion lenses and a cracked cover, the water is insinuated between the glass and the structure.

according to the diminution of the aperture intensely black bands or borders are surmounted at their intersections with brilliant lozenge-shaped spectra, which rotate slightly as the focus is changed.

The same thing should happen in the microscopic appearance of minute intersecting hairs. But this is never seen, except the corrections be of a very high order. On the contrary, every fine hair appears obscured with a blurred edging, under inferior optical treatment.

The rhomboidal spectra of the finest hairs seen crossing at a very acute angle of 10° are remarkable; the black shadow is prolonged as seen at *a*, fig. 9. The hairs observed were about $\frac{1}{60000}$ th of an inch in diameter, tapering to a fine point, nearly invisible.

Error C.—When there is a complex structure in adjacent strata, the images of the substrata interfere with those of the upper, and false appearances result.

Experiment 15.—If two pieces of fine wire gauze superimposed be placed under the microscope, with a low power of twenty-five diameters, a series of false spectra appear, according to the plane of focal vision.

Example.—Wefts being inclined about 5° , to see the interference lines a low four-inch power should be used. Extraordinary spectra exhibit false black dots, perfectly well defined. The distant bars vanish and form dots in the front. Crescentic lights and shadows, round dots, and a variety of appearances, present themselves, all of which possibly explain many false micro-spectra (fig. 12).

A careful arrangement of spider lines would doubtless give some interesting results, as the “*blue band*” of the web described by Sir D. Brewster.

Error D.—Nothing is more striking than the change of the markings produced by intersecting rouleaux, according as they are opaque or transparent, and the aperture and aberration are changed. Thus, in the great standard test, on which much will doubtless yet be written, the Podura, the bodies¹ of whose “spines” form waves, are themselves spectral; under correct adjustment they appear provisionally as elongated narrow cylinders, exquisitely distinct. Then, if the light be made sufficiently oblique, and the concave mirror be reduced in aperture, these cylinders show a double set of black lines of interference, alternate portions fade away, and a new appearance is put in—a very interesting example of interference rays. The lines do not correspond to the black

¹ The standard form still clung to by the old school of microscopists.

boundary bands. This total evanishment of the Podura markings is, perhaps, one of the most extraordinary phenomena of its kind ever observed.¹ It will be seen that the more *acutely* the substrata of ribbing or beading cross the upper, the longer are the black lines of interference, and the more prolonged are the false spectra or spurious spines (fig. 7).

§ III. *On the possibility of searching the Axis for the most favorable Position of the Conjugate Focus to form an Image with a Minimum Aberration.*

I have already remarked that objectives are usually constructed to give the most beautiful (I might say finished) image for the eye-lens at a final distance of eight or nine inches, beyond and within which the performance is not guaranteed.

But it appears, from a discussion of the equations of aberration of a series of lenses separated or in contact, that the conditions of aplanatism may be satisfied by an indefinite number of solutions, especially, *cæteris paribus*, by fortunate selections of the values of u and v , the distances of the object and final image from the front lens. A search, therefore, along the axis of a given instrument may be rewarded with the discovery of an aplanatic focal point even better than the conventional distance. And, supposing that point can be found, the residuary aberration may in many cases be further ameliorated by introducing a new compensation of *position* and *separation*.

Together with these acquisitions it is desirable to combine, as well for the immersion as ordinary objectives—

(1) A more convenient distance of the front lens from the covering glass.

(2) To increase depth of perspective.

(3) To use low power and least aberrating lenses for the eye-glasses.

(4) To exalt magnifying power.

I venture to hope that the aplanatic searcher used under the conditions to be specified will be found to accomplish some, if not all, these desiderata.

¹ First observed with $\frac{1}{16}$ th immersion lens, aplanatic searcher, and oblique illumination at right angles to markings, July, 1868.

(To be continued.)

*On a MODE of REPRODUCTION by SPONTANEOUS FISSION in
the HYDROIDA.* By Prof. ALLMAN, F.R.S.
(Plate II.)

THE hydroid which presents the remarkable mode of reproduction about to be described was obtained in Loch Long, on the west coast of Scotland. It is a Campanularidan, profusely branched with its trophosome, bearing considerable resemblance to that of *Obelia didiotoma*. No gonosome, however, was present in any of the specimens collected; and though I believe that there are sufficient grounds for regarding it as generically distinct from all previously described hydroids, its exact systematic position cannot, in the absence of a gonosome, be assigned otherwise than provisionally.

It is in the possession of certain peculiar appendages—the morphological condition of the phenomenon which physiologically distinguishes it from other hydroids—that I find the grounds for assigning to it a distinct generic rank. I would propose for it the name of *Schizocladium ramosum*, with the following diagnosis.

Family—CAMPANULARIDÆ.

Genus—SCHIZOCLADIUM.

Trophosome.—Hydrocaulus rooted, branching, carrying besides the hydranth-bearing ramuli others (fissiparous appendages) which spring from various parts of the hydrocaulus, are of a cylindrical form, simple, and never give support either to a hydranth¹ or to a generative bud. Hydrothecæ with inoperculate orifice.

Gonosome unknown.

Name from σχίζω, to divide, and κλαδίον, a branchlet.

S. ramosum.

(Pl. II, figs. 1 and 2.)

Trophosome.—Hydrocaulus attaining a height of about an inch, much and irregularly branched, distinctly annulated at the origin of the branches and for some distance from their distal extremities; fissiparous appendages equal to, or slightly surpassing in length, the hydranth-bearing ramuli,

¹ For reasons given elsewhere I use the term "hydranth" to signify the proper alimentary zooid of the hydroid colony.

annulated, generally distributed over the hydrocaulus; hydranth with about twenty-four tentacles, alternately elevated and depressed in extension; hydrothecæ rather wide, with even margin.

Attached to buoys, Loch Long, Scotland.

It is in the possession of the appendages destined for fissiparous reproduction that the chief peculiarity of *Schizocladium* is to be found. These (figs. 2, *a*, *b*, *c*) are developed in abundance from all parts of the hydrocaulus. They are in the form of cylindrical or slightly club-shaped ramuli, and commence just like the ordinary branchlets, as offshoots from the hydrocaulus, consisting, like these, of a continuation of the cœnosarc invested by a chitinous perisarc, but differing from them in a very important point by never carrying hydranths. Their cœnosarc becomes somewhat thickened towards the distal extremity, where it is, as elsewhere, invested by the perisarc, here very delicate and destitute of the annulation which exists on all the rest of the appendage.

After the fissiparous branchlet has attained its complete length the contained cœnosarc still continues to elongate itself. In doing so it ruptures the delicate pellicle of chitine which closes the extremity of the branchlet, and extends itself quite naked into the surrounding water (fig. 2, *b*).

It is now that the process of fission commences. A constriction takes place in the cœnosarc at some distance below its free extremity, and in the part still covered by the chitinous perisarc (fig. 2, *b*). The constriction rapidly deepens, and ultimately cuts off a piece (fig. 2, *c*), which slips entirely out of the perisarc tube, and becomes a free zooid (fig. 2, *d*), while the surface of dissection soon heals over, and the axial cavity of the free frustule becomes here as completely closed as at the opposite end.

The detached frustule is now about $\frac{3}{100}$ of an inch in length, with distinct endoderm and ectoderm, and strikingly resembles a *planula* in all points except in the total absence of vibratile cilia (fig. 3). It attaches itself by a mucous excretion from its surface to the sides of the vessel, and exhibits slight and very sluggish changes of form.

After a few hours it will be found that the mucous excretion has formed round the fission-frustule a tube of great tenuity and transparency. The frustule moves slowly along the sides of the vessel, and in doing so withdraws itself from the first-formed portion of its sheath, which now remains behind, adhering to the vessel as an extremely delicate tubular pellicle (fig. 4), while the frustule continues the excretion from its surface, thus reminding us of the mode in

which certain tubicolous Annelides may be seen to form their cases.

In tracing the further history of the fission-frustule, the important and unexpected fact became apparent that the frustule never becomes directly developed into a hydranth. After a time a bud springs from its side, and it is from this bud alone that the first hydranth of the new colony is developed (figs. 5—8). The bud which thus becomes developed into the primordial hydranth remains attached to the fission-frustule, which forms for it a sort of hydrorhiza, but which would seem ultimately to perish and give place to true hydrorhiscal filaments. In the mean time the primary bud emits others (fig. 8), and a compound branching colony is the result.

In about four days after I had noticed the formation of fission-frustules some hundreds of these bodies had been thrown off from a single specimen of *Schizocladium* in my jar, and the sides and bottom of the vessel had become covered with a whole forest of young hydroids which had been developed from the frustules,

From the account now given it will be seen that the fission-frustule admits of comparison with the free medusoid element of other hydroids. It agrees with this in never becoming directly developed into a new trophosome, but differs from it in the very important fact of taking no part in the true generation of the hydroid, and in giving origin to a new colony only by a simple non-sexual multiplication.

The fission of *Schizocladium* presents us with an alternation, though, inasmuch as there is no sexual zooid in the series, it is of a kind essentially different from the true or Chamissoian alternation. The following series will express the succession of zooids in the fissiparous reproduction of *Schizocladium*:

Hydranth + fissiparous ramulus (formed by gemmation)
+ fission-frustule (formed by fission) + hydranth.

Here, as in a true alternation, we have a succession of heteromorphic zooids forming a series, whose last term gives origin to a zooid which is a simple repetition of the first term, and which thus becomes the starting point for a second series exactly repeating the first, and so on indefinitely. There is, however, in no part of this process any sexual reproduction, and the indefinitely recurring series are always connected to one another by non-sexual art.

The fissiparous multiplication of *Schizocladium* would seem to throw light on the nature of certain bodies which I have elsewhere described as making their appearance in a jar con-

taining living specimens of *Corymorpha nutans*. These bodies presented a close resemblance to the fission-frustules of *Schizocladium*, and were seen to become developed into hydranths, which it is almost certain are ultimately destined to repeat the form of the adult *Corymorpha*. Their origin was, at the time I noticed them, very enigmatical, but I now regard it as highly probable that they are produced by a process of spontaneous fission from the filaments which are emitted near the base of the stem in *Corymorpha*. They would seem, however, to differ from the fission-frustules of *Schizocladium* in becoming directly developed into a trophosome.

On some NEW SPECIES of the GENUS AMPHIPRORA. By
REV. EUGENE O'MEARA, M.A., Rector of Newcastle
Lyons, Co. Dublin. Plate III.

SOME of the Diatoms which are the subject of this paper have been brought under notice from time to time at our club meetings. And now I desire to present them in regular form, adding such species as have come under my observation in the interval. The material which furnished them was collected by our respected club member, Dr. E. Perceval Wright, during his sojourn in the Seychelles. This very active member of our circle has contributed largely to the interest of our meetings, and to the value of our 'Proceedings,' by various communications in his own speciality, arising out of his researches in that hitherto unexplored district, and has placed me under a debt of gratitude for the material with which he has supplied me, containing in abundance diatomaceous forms of the greatest beauty and rarity.

The Seychelles group of islands is situated in the Indian Ocean, between $3^{\circ} 42'$ and $5^{\circ} 50'$, lat. S., and between $55^{\circ} 15'$ and $56^{\circ} 50'$ long. E.

The matter was from four distinct sources :

1. The contents of large Holothurians, such as *Mulleria nobilis* and *Holothuria fulva*.
2. The washings of a beautiful coral, *Tubipora musica*.
3. The washings of some echinoderms.
4. The sediment of vessels in which various Crustacea, Annelids, and Mollusca, were conveyed to this country.

The subject of this paper is limited to certain forms of the genus *Amphiprora*. As occasion serves I hope to collect

the forms belonging to other genera, and present them to your notice in connected groups.

Amphiprora rimosa, n. s., Pl. III, fig. 1.—Valve constricted; length $\cdot 0070$, greatest breadth $\cdot 0035$, breadth at the constriction $\cdot 0026$. The central line consists of two distinct portions; one, starting from the left margin at the middle point, passes inwards towards the centre, turning thence at right angles; gradually narrowing, it proceeds towards the apex; at a point about three fifths of its length, measuring from the centre, it throws off a branch to the right at right angles to its main course, thence it verges slightly to the left and at a short distance throws off another branch shorter than the former, and in an opposite direction; then turning, it pursues a course in a line parallel to its original direction towards the apex, at a little distance from which it divaricates into two branches of unequal length, the shorter towards the right and the longer towards the left, both ending in a sharp point. The same description applies to the course of the other portion of the median line, starting from the right margin and running towards the other apex, except that the longer and shorter ramifications are alternate to those in the opposite lobe of the valve. The striæ are very fine, linear, partly disposed in nearly parallel curves around the extreme points of the several ramifications of the median line, and partly arranged in straight lines parallel to each other. The margin is adorned with a single row of large moniliform puncta.

Several efforts were made to obtain different aspects of this form, but to no purpose, at the slightest touch of the bristle the valve being reduced to fragments.

Amphiprora Nitzschia, n. s., fig. 2.—Length $\cdot 0067$, breadth in front view $\cdot 0013$; valve slightly constricted on side view; ends produced and narrow, perfectly pellucid, the keel or median line presenting the appearances of a rope, broad and running to the apices. On first inspection this form was supposed to belong to the genus *Nitzschia*, but on turning it over it became obvious that it was an *Amphiprora*. On the front view this species is slightly constricted, without any markings, except a few rows of dots at the extremities (fig. 2 b).

Amphiprora sulcata, n. s., fig. 3.—Valve deeply constricted, length $\cdot 0054$; the lobes formed somewhat like a bill-hook, the margin of the inner boundary line jagged, each lobe pervaded by four jagged furrow-like bands nearly parallel to the outer margin of the valve. These bands are easily resolved into short parallel lines, disposed at right angles to the length. A small space towards the apex, in-

cluded between the inner boundary line and the innermost of the jagged bands, is occupied by two or three rows of large, rather linear puncta. Several complete frustules were observed, but in that form which the figure was drawn the jagged bands, which were nearly complete in the one lobe, appeared to have been abraded from the other; the latter was marked with nearly parallel rows of puncta. In one case the inner margin, when brought more prominently to view, presented the outline indicated in fig. 3 *b*.

Amphiprora biseriata, n. s., fig. 4.—Valve in front view deeply constricted; length $\cdot 0024$, very narrow; striæ costate. On side view (fig. 4 *b*) the keel greatly bowed, and dipping deeply in the centre. Striæ consisting of two nearly parallel rows of short costæ separated by a blank interspace.

Amphiprora diadema, n. s., fig. 5.—Valve deeply constricted in front view; length $\cdot 0038$, its lobes greatly rounded, the inner margin rounded, striate, striæ costate; striæ on lobes costate, fine and waved. All my efforts to obtain a front view of this form were ineffectual.

On an OPEN COMPRESSORIUM. By JOHN BARKER, M.D.
(Described at a recent meeting of the Dublin Microscopical Club.)

It is often a great help to microscopic research to be able to apply compression to any object which may present itself on a slide while still remaining in the field of view; and in spite of the many and various appliances (very ingenious and excellent in their way) most workers prefer to press down the cover on slide with the point of a porcupine's quill, the handle of a fine paint-brush, &c., to removing the object from the stage and from under view of the observer, and in many cases the object is too much crushed, the cover broken, or, more likely still, it slips out of the field, and it is often impossible to find it again. The compressorium here represented will, I think, be found to possess many advantages, and its use will get rid of all the difficulties indicated above. It consists of two parts, the stage and the compressor. The stage (A, B, C, D) is a flat brass plate, with a circular opening, bevelled beneath so as to allow any kind of condenser to be applied below, and with two small short pins projecting below at A and B (not seen in the diagram), and

which fit tightly into the small holes usually made in the upper part of the movable stage of all microscopes, so as to keep the plate firmly fixed to the stage of the microscope. The compressor (κ , ι , H , M , N) is turned off the stage,

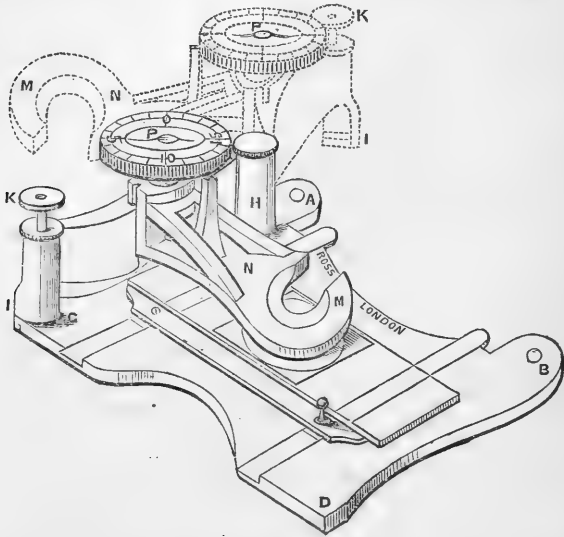

and remains in that position when not in use. It consists of a stout arch of brass terminating in two feet, one (H) on which it pivots and which should be made stout and strong, the other foot (κ , ι) ends in a shoe with a spring catch (I), and which, when the compressor is turned round on the pillar (H), fits into the notch (C), and can be released by the finger acting on the pin (κ); the compressing plate (m , n) is acted upon by the milled head (P), and can be lowered and raised to any extent required by a micrometer screw to which it is attached.

With the compressor fixed on the stage of the microscope (the compressor turned off as in the dotted lines) every kind of microscopic work can go on just as if the compressor were off the stage; in fact, it is not at all in the way; however, when anything requiring compression turns up in microscopic research the compressor part can be pivoted round the pillar (H) so as to occupy the position indicated in the continuous lines, and that without disturbing the slide, cover, or object-glass (although a little retraction of the object-glass may be made in order to see what you are about), and then by turning the milled head (P) the plate m , n , is

lowered gradually parallel to the stage, and the object is proportionally compressed; the inner part of plate (H, N) is bevelled off, to enable the observer to follow the object to a considerable degree, should it be inclined to slip from under view. When the compression is ended the milled head (P) is worked back to raise the compressing plate clear of the slide, and the compressor can be again turned aside on releasing the catch with the finger at K.

I have found this instrument particularly useful in the examination of Entomostraca, which are fragile, and if injured obscure the view, also in researches on Rhizopoda and Rotatoria; in fact, in almost every department of microscopic work it will save a vast amount of trouble, and, I trust, meet with the approbation of microscopists. The compressorium represented in these diagrams has been beautifully constructed by Mr. Thomas Ross, of London.

NOTES on AMPHIDOTUS CORDATUS (*Penn*).

By DAVID ROBERTSON, F.G.S.¹

IN the early part of 1868, on the shores at Cumbræ, my attention was attracted to many holes occurring in the sand. In tracing them to a depth of four or five inches, I found an *Amphidotus cordatus* under each hole. The diameter of the hole was about equal to that of a crowquill, and often irregular, and rose straight over the long spines surrounding the dorsal impression of the test. By placing one of the animals in a glass jar with two or three inches of sand below and over it, and covering the whole with water, an opportunity was afforded of seeing how the holes were produced and kept open. Long contractile processes, with tentaculated heads—described by Forbes as “long ringed worm-like suckers,” and by John Johannes Müller as “locomotive feet”—were thrust up through the sand, and were seen slowly, and apparently searchingly, wandering over its surface, then grasping particles of the sandy matter in their tentacles, and finally dragging them rapidly down into the hole. As these holes extend from four to five inches into the sand, and I have seen these prehensile tentacles stretch between two and three inches over its surface, the length of these instruments cannot be less than six or seven inches.

¹ Communicated by Dr. Anthon Dohrn, of Jena.

Two or three of them are occasionally seen issuing from the same opening in the sand at a time.

The question arose, where was the sand carried to, and for what purpose? It was at first suspected that these long prehensile filaments might convey the particles down the anterior groove of the test directly into the mouth, as no means appeared more suitable for the conveyance of the sand which is found so abundantly in the stomach, the mouth being a calcareous aperture without movable lips or jaws. It was also observed that a clear open space filled with water is constantly maintained between the mouth and the sand to the extent of the long post-oral spines; hence it is improbable that the mouth itself is capable of being brought closely into contact with the sand; besides I failed to see any current going in or out the oral aperture.

Although the parts were kept well in view and carefully watched, the long dorsal prehensile filaments were never seen to reach down the anterior groove, but numerous particles of sand at short intervals were observed descending, and the particles flowed down freely when sand was dropped over the hole from above.

In order to ascertain whether the material descending along the anterior groove was the same as that which was put in from above, coal was pulverized, washed, and applied with the same result.

These observations would lead to the belief that the long prehensile filaments convey the sandy material that they gather from the surface to the dorsal impressions only, and that it is then passed along chiefly, if not wholly, by the action of the narrow linear series of small spines stretching from the ovarian holes down the anterior groove, and is at last dropped on the sand below.

The mouth is irregularly surrounded by processes which Forbes calls "short tentacula, with discs surrounded by clavate filaments." These I have seen on several occasions descend and grasp the sand or other material dropped from the anterior groove, and conveying it into the mouth. This operation, however, appears to be seldom performed, and will only be observed by the exercise of patient attention.

There can be little doubt that the office of these organs is to transmit to the mouth the food material thus brought by the agency of the long dorsal filaments together with the small spines of the anterior groove.

Being led to inquire how the hole between the animal and the surface of the sand was kept open with the tide rolling over it, I found that it was effected by a glutinous secretion

exuded from the body of the animal ; and, further, by the same exudation the animal keeps the particles of fine sand in which it lies imbedded from getting down amongst the spines by this substance forming a thin covering of the mucous matter incorporated with sand, which envelopes the body of the animal, and when a portion of the sand by accident gets down amongst the spines it is thrown out by a fresh discharge of the glutinous matter.

That the animal possesses a supply of this substance adequate to any exigency is seen by putting the *Amphidotus* in fresh water for a short time, when it will be found surrounded by a mass of slime.

The digestive organs appear to be somewhat intricate. There is a peculiar process situated within the test on the left side of the oral opening which serves as a point of attachment for the gullet as it bends round to the left side of the body.

The intestines, for there is no stomach proper, is extremely thin and delicate, and is ruptured by the slightest attempt to remove it. It is of considerable calibre, and packed with sand ; from the above attachment it proceeds onwards, making one and a half convolutions, abutting against the internal projection of the anterior groove ; here it turns upon itself and makes two thirds of a convolution, reaching the left side, whence it turns inwards and a little backwards. At this point it contracts considerably (and here it contains no sand, but a small quantity of black pasty matter), rising in an arching form to the roof of the test behind the madreporiform tubercle, and thence passing down to the anus.

From the fact of no sand being found in the small gut near the anus, and little black pellets being the only matter seen to be ejected, it appears most probable that the sand does not pass through the animal, but is disgorged, although this I have never seen.

Observations on LICHENICOLOUS MICRO-PARASITES. By
W. LAUDER LINDSAY, M.D., F.R.S.E., F.L.S.

THE following fragmentary "Observations" refer to the Microscopic Anatomy of certain Parasites—of microscopic size—that affect the thallus or apothecia of living Lichens, or both their thallus and apothecia. These parasites are partly referable to the family of Lichens, and partly to the Fungi: but mostly to a nondescript group intermediate between Lichens and Fungi, partaking of the characters of both.¹ This group of Lichenicolous Microscopic Parasites has been little studied, and is little known. My present "Observations" are a mere Contribution to the Natural History of the Parasites in question; serving, however, to illustrate some of their prominent general features. Sometimes the parasite occurs in the form of asciferous or sporidiferous apothecia or perithecia, with or without spermogonia or pycnidia; or the latter secondary or complementary forms of reproductive organs occur alone.

1. On *Cladonia uncialis*, Hffm.²

Top of Birnam Hill, Dunkeld; collected by myself in September, 1858. The podetia frequently terminate in large, irregular, bullose dilatations—which constitute deformities or anamorphoses of the thallus. From these bullosities, sometimes, one or more small ramuscles pass off at right angles, or strike downwards at an acute angle. At other times bullosities are scattered over the whole length of the podetia, which then acquire a very irregular deformed aspect. The anamorphoses of this *Cladonia*—in the Birnam plant—are quite analogous to those of *Cetraria glauca* and *Parmelia conspersa*, when the seat of the parasitic *Lecidea oxyspora* Tul.³ Wherever, on the Birnam *Cladonia*, such bullosities occur, they are studded over with the minute, brown, immersed, punctiform concep-

¹ The so-called *Fungo-lichens*, whose general characters I have pointed out in the following papers:

1. "Otago Lichens and Fungi," 'Trans. of Royal Society of Edinburgh,' vol. xxiv, p. 434.
2. "*Arthonia melaspermella*," 'Journal of Linnean Society,' vol. ix (Botany), p. 268.
3. "Parasitic Micro-lichens," 'Quart. Journal of Microscopical Science,' January, 1869.

² Vide "Observations on W. Greenland Lichens," 'Trans. Linnean Society,' vol. xxvii, p. 364, plate xlvi, fig. 14.

³ In *P. conspersa*, these parasite-infected bullosities appear to constitute variety *abortiva*, Déglise.

tacles of parasitic *Pycnidia*. Their basal cellular tissue is brown. The basidia are '00050" to '00066" long, simple, linear, or filiform and flexuose as in *Dichæna rugosa*, Fr. The stylospores are '00033" long, '00020" broad; simple, colourless, oval, pyriform or irregular—frequently containing one or more long nucleiform oil-globules, besides other oily or granular matter. These pycnidia and their contents have a much more *fungoid* than lichenoid character—especially as regards the length and form of the basidia, and the character of the stylospores. In my 'Memoir on Spermogones' (pp. 163 & 285, and plate vii, fig. 14—16) I have regarded them as probably referable to a parasitic *Lecidea*, *L. Cladoniaria* of Nylander ('Enumération générale,' Supplém., p. 339). Neither pycnidia nor spermogonia are, however, described by Nylander as belonging to his *L. Cladoniaria*: neither apothecia nor spermogonia occur in connexion with the Birnam parasite; and I have not seen authenticated specimens of Nylander's *L. Cladoniaria*.

2. On *Cladonia bellidiflora*, Ach.¹

Kelly's Green, Dublin; collected by Dr. Moore, of Glasnevin, in August, 1853, and sent me by Mr. Carroll in 1858. The squamules of the horizontal thallus of the *Cladonia* are deformed by becoming convex and sub-bullose, the anamorphoses in question resembling those of the thallus of *Cetraria glauca*, *Parmelia saxatilis*, and *P. conspersa*, produced by the growth of *L. oxyspora*; similar, moreover, to those immediately before described as occurring in *Cl. uncialis*. In *Cl. bellidiflora* the parasite² is scattered over the whole horizontal thallus: generally, however, on separate squamules from those bearing apothecia of the *Cladonia*. Apothecia and pycnidia³ of the parasite are intermixed, the former being black, discoid bodies, the latter minute brown, punctiform conceptacles. The apothecia are black throughout; sub-convex on the upper surface—like a double convex lens on section—generally sub-immersed, seldom sessile, and less seldom altogether immersed; their surface being usually level with that of the thallus of the *Cladonia*. In their young state the parasitic apothecia are small, black, flattened verrucarioid cones, which

¹ Vide "Observations on W. Greenland Lichens," p. 364, plate xlviii, fig. 9.

² Further described in my paper on "New Lichenicolous Micro-Fungi," p. 545.

³ In my 'Mem. Spermog.' (p. 164), I refer to them as *spermogonia*; and my only reason for change of designation is—as I have explained in my paper on "Polymorphism in the Fructification of Lichens" ('Quart. Journal of Microscopical Science,' January, 1868)—the *form* of the contained corpuscles, which are to be regarded as *stylospores* rather than as spermata.

gradually burst through the cortical layer of the thallus. The pycnidia have the outward aspect of spermogonia; they are immersed, become pale and sub-gelatinous under moisture, vary in size and shape, are sometimes confluent and sometimes have a depressed surface; their cavity is simple, and their walls of brown cellular tissue. The stylospores are ellipsoid, resembling in form and size those of *Lecidea abietina*; about $\cdot 00033''$ long and $\cdot 00014''$ broad, borne on short, simple basidia. Neither the apothecia nor pycnidia of the parasite can be confounded with the apothecia or spermogonia of the *Cladonia*. The spermogonia of *Cl. bellidiflora* are figured and described in my 'Mem. Spermog.' (pl. vii, figs. 1—3 & 5—10, p. 162). The parasite now described may be the *Lecidea Cladoniaria*¹ of Nylander ('Enum. génér.,' Supplém., p. 339). The structure of the latter has not yet, however, been satisfactorily ascertained or described, e.g. the colour and character of its sporidia; while the pycnidia of the Kelly's Green parasite differ greatly from the spermogonia of *L. Cladoniaria*.

3. On *Cetraria Islandica*, L.

(a) Braemar, collected by Admiral Jones in June, 1858: form *platyna*: thallus sterile. The apothecia of the parasite are scattered over the thallus: they are black, convex, becoming sub-spherical: superficial, their base only being immersed or sunk in a hollow of the thallus; regular in form and smooth on the surface, having a general resemblance to the apothecia of *Abrothallus microspermus*;² surrounded sometimes by a slight, irregular, darker brown thalline ring, varying in size. Paraphyses indistinct, obscured by much brown colouring matter, especially at their tips; asci blue with iodine, $\cdot 00133''$ long, $\cdot 0008''$ broad. Sporidia not distinctly seen, but apparently simple, ellipsoid and very small, $\cdot 00025''$ long and $\cdot 000083''$ broad.

If the reaction with iodine is to be accepted as a sufficient criterion, this parasite is to be considered a *Lichen*, a conclusion to which the form and structure of the apothecia and the character of the paraphyses also point. It has certain characters in common with *Biatora Heerii*, Hepp (= *Scutula Wallrothii*, Tul.=var. *Wallrothii* of *Lecidea anomala*, Fr. according to Nylander's 'Scand,' p. 703), which grows on *Peltigera canina* and *rufescens*. The sporidia of the *Biatora* are, however, sometimes 2-locular,³ though also simple. The

¹ Which appears to have certain prints of resemblance to *L. oxyspora*, Tul.

² Vide author's "Monograph of Abrothallus," 'Quart. Journal of Microscopical Science,' January, 1857.

³ Körber ('Parerga,' p. 454) describes its sporidia as *only 2 locular*, and its apothecia as brownish-red, passing into black.

Braemar parasite also resembles *Lecidea oxysporella*, Nyl. (Prodr., p. 145), which affects *Cladonia digitata*, Hffm.

(b) Fogstuen (3150 ft.), Dovrefjeldt, Norway; collected by myself in August, 1857. The parasite is scattered generally over the thalline surface, sometimes on its margins, as very black Lecidine apothecia of most variable size and form. Its apothecia are quite different from those of the *Cetraria*, which are terminal and marginal, never black. Frequently—in the young state apparently—the parasitic apothecia are mere tubercles or warts. In maturity they become discoid, larger and flattened, usually with a round outline, but frequently with a very rough or granular surface. Sometimes the disk is girt by a very ragged, raised thalline exciple, or by a raised thickened edge; at other times the surface of the disk is concave, and there is no exciple or margin of any kind. Sometimes, in age, the disk falls out, leaving a white saucer-like hollow in the thallus. The apothecia of the parasite here bear a general resemblance to the diseased apothecia of *Sticta pulmonacea*, Ach., var. *pleurocarpa* Ach., caused by the growth of the parasitic *Celidium Stictarum*, Tul.; or to degenerate apothecia in some forms of *Lecidea parasema*, Ach. The apothecia parasitic on the *Cetraria* are themselves apparently degenerate, exhibiting no distinct structure.

Probably it is the same parasite that affects the Braemar and Dovrefjeldt plants, which further may belong to *Lecidea Cetraricola*, Linds.¹ *Abrothallus Smithii*, Tul. sometimes also occurs on *C. Islandica*, according to Körber (Parerga, p. 456); but its sporidia at once separate it from *L. Cetraricola*.

4. On *Lecanora ventosa*, Ach.

Sphæria ventosaria, Linds.

(a) Summit of Lochnagar; collected by myself in August, 1856. The thallus of the *Lecanora* exhibits a series of anamorphoses in the form of globular excrescences—large round warts—similar to those that occur sometimes also on *L. tartarea*, and in a somewhat less degree resembling the thalline deformities of *Parmelia saxatilis* produced by *Abrothallus*. These wart-like tumours are sometimes much smoother and of more uniform surface than the general thallus: at other times, however, quite as verrucose and irregular, or more so. Sometimes they bear nothing but the parasitic *Sphæria*, at other times they are quite sterile: they are always devoid of apothecia of the *Lecanora*. The *Sphæria* is very

¹ "Observations on W. Greenland Lichens," p. 364, plate xlvi, fig. 16.

abundant and very protean, scattered sometimes over the general surface of the thallus, but more frequently and more especially affecting the cushion-like thalline deformities just described. The variable forms under which the parasite occurs are mostly referable either to a Verrucarioid or Lecidioid type. The former typical condition is represented by punctiform or papillæform perithecia, crowning thalline warts, and more or less immersed therein: round and black—sometimes girt with a more or less distinct or faint thalline ring, which resembles an exciple. Sometimes these perithecia are agglomerated in largish masses: or they are confluent in compound, verrucæform conceptacles, irregular in shape and surface. Forms referable to the Lecidioid type are still more variable, especially as to size and shape. Sometimes they are large, scattered, round, flat, with a black smooth disk and a thalline (spurious) margin; at other times the outline is irregular, the disk convex, granular or rough—occasionally slightly pruinose—with a glaucous or bluish-white bloom covering or obscuring the varying depth of its blackness. The size is sometimes small; they are immarginate, and confluent or crowded in large irregular masses.¹

In Lochnagar specimens of *L. ventosa* the apothecia are frequently small and abortive, but they cannot be confounded with the *Sphæria*: the latter, however, is more apt to be confounded with the *spermogonia* of the *Lecanora*. These *spermogonia* are never Lecidioid: they are more distinctly verrucæform: more frequently compound: of a paler, bluer hue: more superficial: and elevated on ordinary thalline papillæ.

Intermingled with the sporidiferous perithecia of the *Sphæria*, on the thalline anamorphoses before described, are certain black papillæform conceptacles,² which are, perhaps—seeing that they contain no normal reproductive structure, of the nature of pycnidia or *spermogonia*, or both—referable probably (should this supposition prove correct) to the *Sphæria*. But other conceptacles of similar external character are apparently referable to *Torula lichenicola*, Linds.,³ or at least to a parasitic *Torula*. They contain the characteristic spore-chains or filaments of *Torula*, here, however, colourless: associated with other, much more delicate, more articulated,

¹ *Sphæria ventosaria* is further described or figured in the following papers:

1. "Otago Lichens and Fungi," p. 439.

2. "Observations on W. Greenland Lichens," pp. 346, 366, plate I, fig. 10.

3. "New Lichenicolous Micro-Fungi," p. 537.

² Vide "Observations on W. Greenland Lichens," p. 366, plate I, fig. 9.

³ "New Lichenicolous Micro-Fungi," 'Trans. Royal Society of Edinburgh,' vol. xxv, pp. 515 and 530.

colourless filaments—resembling the delicate colourless paraphyses of *Verrucaria*—the analogues probably of the sterile sterigmata or filaments of the spermogonia of many true Lichens, *e.g.* the *Parmeliæ*. The terminal articulation of the spore-filaments generally contains one or more granular nuclei.

(*b*) On roadside walls, between Spittal of Glenshee and Braemar; also collected by myself in August, 1856. Here the parasite is mostly punctiform, seated on the apices of the cones or papillæ of the thallus, intermingled with the apothecia. The perithecia of the *Sphæria* exhibit comparative uniformity of size and shape, appearing on the summits of the thalline cones as black, round, or stellate points or spots, girt by a sort of thalline exciple, which is variously regular or irregular, thin, or tumid and pertusarioid. The sporidia are brown, 2-locular or simple, broadly ellipsoid, oval, sub-spherical or figure-8-shaped, from constriction of the outer wall opposite the central septum.¹ This form of the parasite agrees well with Mudd's description of his *Microthelia ventosicola* (British Lichens, p. 307), which is undoubtedly the same Fungus.

I found the *spermogonia* of *L. ventosa* more or less abundantly in my copy (1840, original edition) of Schærer's *Exsiccati*,² No. 320, sub nom. *Parmelia ventosa*, on left-hand specimen: and also in the following specimens in the Kew Herbarium—(1) Braemar, 1844; (2) Clova (on rocks), 1843 and 1846, collected by Gardiner: (3) the Hartz mountains, Germany (on rocks), collected by Hampe, 1846; (4) Mount Susten, Switzerland; and (5) Devonshire. In all these cases they occurred as flattish, irregular, compound verrucæ, with sinuous cavities, and more or less numerous ostioles: generally as warts of considerable size, bluish or black on their surface, composed apparently—by confluence or union—of several simple perithecia. The sterigmata frequently branch sub-digitately from the base, though they are often also simple or nearly so. Nylander describes them, however, as only or always simple. They are often '001" to '00066" long. Sometimes in age (*e.g.* in Schærer's Exs. No. 320) they assume an *indigo* colour, which is that also of the envelope or spermogonal walls. The spermata are always straight, and often about '00020" long.

¹ *Vide* "Observations on W. Greenland Lichens," p. 366, plate I, figs. 11 and 12.

² *Ibid.*, fig. 13.

5. On *Lecanora tartarea*, Ach.

(a) Var. *frigida*, Sm. "Highlands of Scotland, 1807," in the Kew Herbarium. The parasite has the characters of a *Lecidea*, and is probably referable to *L. parasitica*, Flk. (Nyl. Prodr., p. 144). The apothecia are small, black, thin, with a wavy outline. The paraphyses are indistinct in their filaments, with, however, very dark brown tips. The asci are $\cdot 0010''$ to $\cdot 0013''$ long, and $\cdot 00033''$ to $\cdot 00050''$ broad. The sporidia are 2—4-locular, brown, $\cdot 0004''$ long, and $\cdot 00014''$ broad. *L. parasitica* is better known on the continent, as it occurs on the thallus of various *Pertusariæ*: but it also grows on *Lecanora parella*, and on *L. Turneri*, Ach., which is now generally assigned, as Nylander assigns it (Prod., p. 85), to *L. tartarea*. Its sporidia are described as 8 in each ascus, small, oblong-cylindrical, or narrowly ellipsoid, sometimes curved, 4-sometimes 2-locular, brown. Evidently closely allied to *L. parasitica*, if they are not all referable to a single type, are the parasitic *Buellia urceolata* and *B. convexa* of Th. Fries (L. Arct., pp. 233-4, and L. Spitsberg, p. 45): and the various species of Massalongo's genus *Leciographa*, as given in Körber's Parerga (p. 463) e.g. *L. Neesii*, Fw., and *L. parasitica*, Mass.

(b) Igloolik; collected during Sir Edward Parry's polar expedition in 1823: in the Kew Herbarium. Parasite bluish-black, very irregular in form and size, seldom round in outline, generally angulose or radiate: crowning the thalline warts, semi-immersed therein. There is no definite structure; but it differs apparently in its characters from any of the Greenland parasites on the same Lichen, as I have examined and described them.¹

(c) Morchone, Braemar; collected by myself in August, 1856. Parasite very minute, black, punctiform, scattered on the pale glaucous surface of wartlike deformities of the thallus, and on the tumid margins of the apothecia; with difficulty seen, from its extreme minuteness, even under the lens.² It exhibits, however, no normal structure.

I have occasionally found *Coniothecium lichenicolum*, Linds.,³ parasitic on the sterile thallus of *L. tartarea*, e.g. on an isidioid state, collected on Morchone, Braemar, in August, 1856, and on another specimen collected during the same excursion and month on Scur-na-gillean, Skye. The reproductive structure of this fungus readily distinguishes

¹ "Observations on W. Greenland Lichens," p. 342-4.

² *Ibid.*, p. 366, plate 1, fig. 3.

³ "New Lichenicolous Micro-Fungi," pp. 518 and 534.

it, however, from the other more common parasites of *L. tartarea*.

Leighton has recently recorded¹ the occurrence of a new *Sphæria*, *S. tartaricola*, Nyl., on the thallus of *L. tartarea*, or its var. *palescens*, L., on Cader Idris, Wales. In Spitzbergen the thallus of *L. tartarea* is infested by the parasitic *Lecidea associata*, Th. Fries (L. Spitsb., p. 42) which has simple, ellipsoid, or sub-globose, colourless sporidia.

6. On *Lecanora parella*, Ach.

In British specimens, on the sterile isidioid or variolarioid—more or less tartareous—thallus, I have frequently met with *Coniothecium lichenicolum*—more frequently than on *L. tartarea*. Thus it occurs in my Herbarium on specimens from Glen Dee and Morchone, Braemar, collected in August, 1856, and from Blackcairn Hill, Fifeshire, collected in May, 1858. On New Zealand forms of *L. parella*, Leighton records the occurrence of *Lecidea parasitica*; while in France its apothecia are sometimes the seat of *Pseudographis elatina*, Nyl. (Prod., p. 171).²

7. On *Lecanora cinerea*, L.

(a) Scur-na-gillean (3200 feet), Skye, August, 1856. The parasite here appears to be *Endococcus erraticus*, Mass.³ (Nyl. Scand., p. 283 = *Microthelia pygmæa*, Körb., Mudd., p. 307). The hymenial gelatine becomes rose-coloured with iodine: the paraphyses are delicate, discrete, short, wavy, not coloured nor knobbed at tips: the asci '006" long, and '00066" to '0010" broad, saccate, as in *Arthonia*, not blue with iodine, myriad-spored: the sporidia broadly ellipsoid, 2-locular, becoming figure-8-shaped, brown, '00025" long, and '00011" broad. This *Endococcus* occurs in Greenland and Spitzbergen, on various species of *Placodium*, *Lecanora*, and *Lecidea*.⁴

(b) Leighton's Exsiccati, No. 81 (in my copy), bears the parasitic *Verrucaria gemmifera*, Tayl. (Mudd., Brit. Lich., p. 307). It differs from *Endococcus erraticus* in its larger perithecia and sporidia, and in its asci being only 8-spored. In Leighton's plant the asci became violet under iodine:

¹ 'Annals of Nat. History,' vol. xix, p. 408; and in the 'Transactions of the Linnean Society,' vol. xxvii, p. 159, and plate xxxv; the locality in the latter case being near Dolgelly, North Wales.

² Another parasite, on *L. parella*, is mentioned among my "New Lichenicolous Micro-Fungi," p. 549.

³ Vide "Observations on W. Greenland Lichens," p. 367, plate li, fig. 4.

⁴ Th. Fries, 'L. Arct.,' p. 275, and 'L. Spitsberg,' p. 51.

the sporidia are olive, ellipsoid-oblong in the young state, containing 2 polar nuclei instead of regular loculi and septa. It appears to me absurd to separate these parasites in different *genera*, or from the genus *Verrucaria*; nor am I satisfied as to the propriety of distinguishing them even as *species*. It would be quite as scientific, and much more convenient, to regard *E. erraticus* as a mere polysporous variety of *V. gemmifera*.

8. On *Lecanora polytropa*, Ehrh.

Summit of Ben Lawers; gathered by myself in June, 1856. The apothecia are studded over with a parasite, which is probably *Thelidium epipolytropum*, Mudd. (Brit. Lich., p. 298).¹ It occurs as microscopic, black, punctiform, conceptacles, externally resembling *Torula lichenicola*. The asci are, however, 4-spored, while in Mudd's plant they are 8-spored. Sporidia variable in form and size: generally ellipsoid, 2-locular, pale yellow, becoming *pale blue under iodine*. They cannot be confounded with the sporidia of the *Lecanora*, which are simple, oval, and colourless.²

9. On *Lecanora subfusca*, Ach.

(a) Var. *albella*, Pers. Corticolous, collected on Morchone, Braemar, in August, 1856. Next to *Torula lichenicola*, the most interesting of many parasites I have found on *L. subfusca* are the following. In the Morchone plant two parasites³ produce deformity or disease of the apothecia of the *Lecanora*, sometimes rendering them quite black, and their surface rough or verrucose, by the close aggregation of numerous minute papillæform conceptacles. Externally the two series of parasitic perithecia are alike, but their internal structure is very different. One series contains asci that give a *blue with iodine*, and are therefore presumably referable to a *Lichen*. The sporidia are 2-locular, pale yellow,⁴ pyriform, sometimes resembling those of certain forms of *Verrucaria epidermidis*. This parasite causes only partial discoloration of the apothecia on which they grow. The other parasite deeply and wholly blackens the apothecia, which it affects. Its sporidia are brown, 2-locular, and figure-8-shaped.

(b) Corticolous form of type: growing on birch, Corra-

¹ Vide "Observations on W. Greenland Lichens," p. 366, plate 1, fig. 23.

² *Ibid.*, p. 366, plate 1, figs. 22, 23, 24, and 25.

³ *Ibid.*, p. 366, plate 1, fig. 16.

⁴ Another parasite, with somewhat similar sporidia, affecting var. *atrynea*, Ach., is mentioned among my "New Lichenicolous Micro-Fungi," p. 541.

mulzie Linn, Braemar; collected by myself in August, 1856. The apothecia of the *Lecanora* are studded over with microscopic black papillæ, having a simple cavity, and an envelope of deep brown hexagonal cellular tissue, lined internally by a series of short, simple, filiform sterigmata, which give off spherical (atomic) corpuscles of the character of *spermatia*, colourless when young, but *becoming brown in age*; a character (the acquisition of a brown colour) at least unusual in *spermatia* and rare even in stylospores. The conceptacles in question must apparently be regarded as *spermogonia*¹ referable to some parasite, but not to *Sphæria epicymatia*, Wallr. (Nyl., Prodr., p. 85; Syn., p. 42 = *S. lichenicola*, Smrf. pr. p. = *S. lichenicola*, DR.,² whose *spermogonia* and *pycnidia* are quite different, unless we are to regard them as a secondary form of its *spermogonia*.

(c) Var. *albella*, Auctt.: corticolous:³ Kinnoull Hill, Perth; collected in April, 1855. *Pycnidia* are sparingly scattered over the thallus as minute black points, containing short, ellipsoid, narrow or broadish stylospores, about '00025" long, variable both in form and size; sometimes cohering in couples (concatenate), and then resembling portions of the spore-chains of *Torula lichenicola*: seated on very short, simple, inconspicuous basidia.⁴

(d) Var. *albella*, Pers., Hepp's Exsiccati, No. 187. *Pycnidia* occur as small brown points scattered about the periphery of the thallus. Externally they closely resemble some forms of the *spermogonia* of the *Lecanora*, from which their internal structure alone distinguishes them. The stylospores are small, short, linear-oblong, straight, sometimes irregular as to size and form, generally 2-locular; seated on very short simple basidia. The wall of the receptacles is cellular, and deep brown.⁵ Here the *pycnidia* have quite as much the appearance of belonging to the *Lecanora* as its ordinary *spermogonia* have.

(e) Corticolous form of type: Yester House, Haddingtonshire; collected in July, 1856, by Dr. Murray Lindsay.

¹ Vide "Observations on W. Greenland Lichens," p. 366, plate 1, fig. 15.

² It affects the apothecia of the *Lecanora*, and possesses both *spermogonia* and *pycnidia*. Probably, identical with it is *S. apotheciorum* Mass. ('Berk. Brit. Fungology,' p. 396). It is impossible to confound either of these *Sphæria* (if they are separate species or forms) with *Torula lichenicola*, whose spore-chains, and brown or otherwise coloured spores, at once distinguish it.

³ *Lecanora intumescens* of Hepp's Exs., No. 614, is only a similar, if not the same, condition of *L. subfusca*.

⁴ Vide "Observations on W. Greenland Lichens," p. 366, plate 1, fig. 17.

⁵ *Ibid.*, p. 366, plate 1, fig. 18.

Scattered over the thallus are numerous black point-like bodies, quite superficial, and easily detachable—not at all immersed in the thalline warts. There is no normal reproductive structure, so that their true character cannot be determined. Probably, however, they are referable to some *Fungus*.

(*f*) In certain other Scotch specimens of the type, I have met with corpuscles of a more anomalous kind than any of those above mentioned, viz. bodies apparently of the character of *stylospores*;¹ regarding which, however, there is no evidence as to their origin, whether contained in asci or produced from basidia. They are oblong or ellipsoid, rounded at the ends, brown, frequently finely granular, often also containing two largish sub-polar nuclei, or three or more nuclei more central in their position.

(*g*) On old bark, Carrigaloe, near Cork, collected by Carroll. On the same piece of bark, and associated with the *Lecanora*, but not parasitic on it, and perhaps having no necessary connection with it, occur certain black, very minute conceptacles, containing spermatia that are spherical (atomic), in myriads, about '000033" in diameter, borne on short, simple sterigmata.² These *spermogonia* are unassociated with other perithecia or apothecia than those of *L. subfusca*; so that it is impossible to assign to them a proper position amongst either Fungi or Lichens.

Also parasitic on *L. subfusca* are the following Fungo-lichens or lichens:

1. *Pharcidia congesta*, Körb. (Parerga, p. 470 *L. subfusca*, var. *Pharcidia*, Ach.) on the disk of *L. subfusca* and *intumescens*.³ Sporidia 8, clavate, 2—4-locular, hyaline.

2. *Arthonia varians*, Dav. (Nyl. Scand., p. 260): apothecia flat or sub-convex; sporidia ovoid, 3—4-locular; hymenial gelatine wine-red with iodine.

3. *Lecidea parasitica*, Flk.

The foregoing illustrations suffice to show that this single cosmopolite species—*L. subfusca*—with its varieties or forms, is the seat of a considerable number and variety of parasites—partly Fungi, partly Fungo-lichens, and partly Lichens. These parasites include generally the following:

I. Certain true *Fungi*—sporiferous or sporidiferous—*e. g.*, *Sphaeria epicymatia* and *Torula lichenicola*.

¹ Vide "Observations on W. Greenland Lichens," p. 366, plate 1, fig. 20.

² *Ibid.*, p. 366, plate 1, fig. 21.

³ Vide foot-note on previous page.

II. Certain organisms that are probably Fungi, but are indeterminate by reason of defective structure (= rudimentary and young, or old, abortive and degenerate).

III. Certain true *Lichens*, sporidiferous, and giving lichenic reactions with iodine—*e.g.* *Lecidea parasitica*, *Arthonia varians*, and form 1 under head (a), which may, for distinction, bear appropriately the provisional designation *Microthelia subfuscicola*.

IV. Certain *spermogonia* that may be referable to the *Lecanora* itself, though more probably, perhaps, to Parasites of the class either of Fungi, Fungo-lichens, or Lichens, whose sporiferous or sporidiferous perithecia are absent.

V. Certain *pycnidia*, which are in the same position, in regard to our knowledge of their true character, as the isolated *spermogonia* above mentioned.

VI. Certain other organisms, without normal reproductive structure, whose true character cannot even be properly guessed at.

Many of these parasites or conceptacles seated on or associated with the thallus or apothecia of *L. subfusca* have the same external aspect, being minute, black, punctiform bodies, resembling, and often apt to be confounded with, certain microscopic *Sphæriæ*, *Microtheliæ*, *Verrucariæ*, or their *spermogonia* or *pycnidia*. Those containing spermatia or stylospores would probably have been referred by the earlier lichenologists to the pseudo-genus *Pyrenothæa* among *Lichens*, and by fungologists to *Septoria* or some similar pseudo-genus among *Fungi*. And such a classification might afford convenient *provisional* position, though the ambiguity as to their real nature would thereby remain unaffected. In some cases it is quite possible we really have to do with *two or three forms of the spermogonia or pycnidia* of the *Lecanora* itself.¹ In other cases the *spermogonia* or *pycnidia* in question are referable to parasites that seldom exhibit all forms of their reproductive organs in association on the same specimen; while in some instances, again, it defies the systematist to determine with any degree of preferential probability the true character or position of the anomalous parasitic organisms in question.

¹ *Vide* author's paper on "Polymorphism in the Fructification of Lichens," 'Quart. Journal of Microscopical Science,' January, 1868; "Report of British Association, 1867, Transactions of Sections," p. 89. Illustrations of *multiple forms of spermogonia and pycnidia* will further be given in a memoir in preparation on "The Spermogonia and Pycnidia of Crustaceous Lichens" [for the Transactions of the Linnean Society, vol. xxvii].

10. On *Lecidea petræa*, Flot.

(a)—On basalt, the Wrekin, Shropshire, in Leighton's Exs., No. 783 (sub num. *Lichen rimosus*, Dicks). The parasitic *Verrucaria rimosicola*, Leight. (Mudd, Brit. Lich., p. 308, pl. 5, fig. 179), which Körber describes as affecting the thallus of var. *sub-concentrica*, Fr. (Parerga, p. 467), is scattered over the whole thallus as a series of very minute, black papillæ, quite like those of many spermogonia externally. It has, however, dark olive or brown, oval, 4-locular sporidia; while the spermogonia of *L. petræa*, according to Tulasne, are small, black, punctiform conceptacles scattered among the apothecia, containing very delicate, straight spermatia about '000043" long, borne on small, irregularly ramose, sterigmata. In Leighton's Exs. No. 184 I found these *spermogonia* as minute, black papillæ scattered on some of the small, sterile thalline areolæ. The spermatia were linear-oblong, borne on long, very slender, linear, filiform, sterigmata, branching simply at base, and varying greatly in length. The basal cellular tissue was scarcely coloured brown.

(b) On what appears to be merely a form of *L. petræa* (*Lecidea calcaria*, Weiss, Hepp's Exs., No. 147; *Diplotomma calcareum*, Mudd, Brit. Lich., p. 219), on limestone from Yorkshire, collected by Dr. Carrington in 1857, are scattered *Pycnidia*,¹ which may be referable to *Verrucaria rimosicola*. Mudd (Brit. Lich., p. 308) describes the said *Verrucaria* as occurring on his *Diplotomma calcareum*, but he makes no reference to pycnidia. The pycnidia of the Yorkshire Lichen are small, black, punctiform conceptacles scattered here and there on the thallus, containing stylospores, which are oblong-oval, borne on short, simple basidia. The same pycnidia appear to occur in my copy of Leighton's Exs., No. 17 (var. *concentrica*), on sandstone, Llangollen, Denbighshire. In Schærer's Exs., No. 184, *Lecidea calcaria* is accompanied by what appears to be the same *Verrucaria*, which here occurs, however, *on the bare rock*. The sporidia are those of *V. rimosicola*—brown when old.

(c) With, or on, *L. petræa* in Schærer's Exs., No. 183,² occurs a series of small papillæ, externally resembling spermogonia. But they contain sporidia that are brown in maturity, normally 4- though sometimes 2-locular, ellipsoid, colourless in the young state (in the asci). Both asci and

¹ *Vide* "Observations on W. Greenland Lichens," p. 368, plate lii, fig. 37.

² *Ibid.*, p. 367, plate l, fig. 18.

sporidia are smallish. The perithecia and sporidia alike are so different from the apothecia and sporidia of the *Lecidea* that the former are probably to be regarded as parasitic, holding a similar relation to *L. petræa* that (e.g.) *Pertusaria paradoxa*, Linds.,¹ does to *Lecanora oculata*. In this case the parasite may be provisionally distinguished as *Microthelia petræicola*. The only other permissible conclusion is that the perithecia in question are a secondary form of sporidiferous fructification belonging to the *Lecidea*, in which event the phenomenon would be physiologically and morphologically even more interesting.

11. On *Lecidea geographica*, L.

(a) Var. *atro-virens*, Sch., on granite, St. Moritz, in Hepp's Exs., No. 153. Some of the thalline areolæ are studded over with a parasite, which is probably *Tichothecium stigma*, Körb. (Parerga, p. 468).² It occurs as microscopic, black, round, punctiform conceptacles, generally immersed, sometimes sub-papillar, containing a hymenium and asci that give a *blue or violet colour with iodine*, the said blue being more easily and rapidly developed in the hymenial gelatine than in the asci. Paraphyses indistinct. Asci, 8-spored. Sporidia intermixed, as usual, with oil-globules; colourless, or nearly so, in the young state (in the asci) gradually assuming an olive or brown colour; oval or ellipsoid, in maturity 2-locular, sometimes with a constriction opposite the septum; in the young state sometimes simple, or the septum obscure; in all stages of growth granular. In this parasite the sporidia are much larger than those of some forms at least of *L. alpicola*.³ There can generally be no confusion with the sporidia of *L. geographica*, which in its common form are very large and muriform.⁴

The *spermogonia*, however, of *L. geographica* (var. *atro-virens*, as I have examined them in Hepp's Exs., No. 153, Schaerer's Exs., No. 623, and Mougeot and Nestler's Exs., No. 640) are externally indistinguishable from the parasite above described. They are of less common occurrence, generally very rare, and are scattered (when they do occur) in groups over some of the sterile thalline areolæ, as black, punctiform conceptacles, conspicuous from the contrast of colour. Their walls consist of brown cellular tissue. The

¹ "Observations on W. Greenland Lichens," pp. 344 and 366, plate I, fig. 5.

² *Ibid.*, p. 367, plate lii, fig. 12.

³ *Ibid.*, p. 367, plate lii, figs. 4, 5, 6, and 13.

⁴ *Ibid.*, pp. 367-8, plate lii, figs. 7, 8, and 9.

spermatia are very short and rod-shaped, borne on sterigmata that are short, simple, or branching (bifurcating) at base, and indistinct.

(b) Var. *conglomerata*, Sch., on granitic rocks, Mount Susten, in Schærer's Exs., No. 577.¹ The thallus, which consists of pulviniform scales or areolæ, sterile and frequently soresiferous, is sparingly studded over with the minute, black, punctiform, sub-sessile, prominent perithecia of a parasite having the characters of *Endococcus erraticus*, Mass. It contains myriad-spored asci .0020" long and .00083" broad. There are no distinct paraphyses. The sporidia are .00016" to .00020" long, .00014" broad, oval, 2-locular, and deep brown in maturity, colourless or pale in the young state (within the asci.)

(c) Var. *alpicola*, Sch., on granite (associated with *Lecanora polytropa*, Sch., var. *alpigena*, Sch.), on the higher Alps, in Schærer's Exs., No. 322. The parasite is similar externally to that which occurs in (b), microscopic, black, and round, here immersed; and it has similar very small sporidia. But my notes do not record whether the asci were 8- or poly-spored, so that it is impossible to determine whether it is referable to *E. erraticus*² or *Verrucaria gemmifera*. I have not met with the spermogonia of *alpicola*, but Nylander describes its spermatia as short, straight, and cylindrical, like those of *geographica*. It is impossible, therefore, on microscopical examination, to confound the spermogonia of either *geographica* or its var. *alpicola* with the parasites above described, which externally so closely resemble them.

12. On *Peltigera aphthosa*, Hffm.

Falls of the Garrawalt, Braemar; collected by myself in Aug., 1856. The thallus is the seat of a *Cladosporium*, which, if it is entitled to specific distinction, may be fitly denominated *C. lichenicolum*. Mr. M. C. Cooke, to whom it was submitted, describes it as "imperfect," and as "common on everything vegetable," though I do not quite understand whether this expression refers to the *genus* only, or to the particular *species* or form in question. The only structure visible under power 380 of Nacet's microscope consists of brown articulated tubuli—the constituent cells of which are oblong, and either empty or contain atomic granules in roelike masses—with difficulty visible.³

¹ Vide "Observations on W. Greenland Lichens," p. 367, plate lii, fig. 7.

² *Ibid.*, p. 367, plate lii, fig. 11.

³ *Ibid.*, p. 365, plate xlvi, fig. 28.

NEUMANN'S THEORY *of the* DEVELOPMENT *of*
BLOOD-CORPUSCLES.¹

THE development of the blood is certainly one of the least understood physiological processes, and especially is this true of its cellular elements. The most diverse opinions have been held respecting the origin of the white cells, their transformation into red, and the ultimate fate of the latter.

In the first place, the embryonal development of blood was regarded as the key to the mystery; and since in the embryo the development of red corpuscles takes place from the white or lymph cells, through the intermediate form of a coloured nucleated cell, a similar process was assumed to take place in the adult body. Since, however, the intermediate form—a coloured nucleated cell—could not be found in the blood of the adult organism, it was supposed by one party (Kölliker) either that these forms might exist in some part of the body not examined, or else that the absence of transitional forms was to be explained by the rapidity of the transformation. Another party gave up the theory of transformation of white into red corpuscles, and sought another mode of origin for the latter. Thus, according to Wharton Jones and Bennett it was the nuclei of the lymph cells which were transformed into the red corpuscles. According to H. Müller, the latter arose from a fusion of nucleus and cell in the smaller lymph-cells. Gerlach, Funke and others believed in an endogenous formation of red corpuscles in larger cells, while Zimmermann had recourse to some entirely different elements of the blood itself. Since, however, none of the latter views could be satisfactorily established, the tendency has been to fall back upon the hypothesis of a formation of red corpuscles out of the white corpuscles of the blood itself. There is no greater unanimity of opinion respecting the ultimate fate of the red corpuscles, though, in spite of the doubts of Kölliker, it seems probable that there is a continual dying off and new production of these elements; and it has been thought that a greater or less power of resistance to the action of water is a sign of the age of particular corpuscles. The origin of the white corpuscles has been pretty generally assigned to the

¹ 'Untersuchungen über die Verschiedenen Theorie'n der Entwicklung der Blutkörperchen, besonders über die neueste, von Neumann.' Inaugural Dissertation; von Charles W. Eales, M.B., Leipzig, 1870.

'Investigations on the Different Theories of the Development of the Blood-corpuscles, and especially on the latest, that of Neumann.' A Graduation-Thesis, by C. W. Eales. (Abstract by J. F. Payne, M.B.)

spleen and lymphatic glands, for which the abundance of those elements in the vessels leading from these glands is a weighty argument. It has, however, always been a matter of the greatest difficulty to determine in what part of the body the metamorphosis of the blood-corpuscles takes place. This process also has been referred to the spleen, and especially on the strength of two peculiar structures met with there—(1) cells resembling the white blood-cells, but with a yellowish colour; (2) cells said to contain red blood-corpuscles. The first form undoubtedly exists, as confirmed by Eales, in the rabbit's spleen, but loses in importance when compared with the more characteristic transitional forms observed by Neumann. The second form of cell at first excited great interest, but its occurrence is so very variable and uncertain that it is probably correct to regard it, with Virchow, as a more or less pathological structure.

It has also been supposed that the metamorphosis of blood-cells may take place in the liver, and this because the red corpuscles of the hepatic vein are thought to show, by their greater resistance to the action of water, that they are younger than those of the portal vein, which are not only swollen up, but completely destroyed, by the addition of water. There are also many crenated and withered red corpuscles to be seen in the portal vein, but very few in the hepatic. These facts, if they prove anything, rather tend to show that the corpuscles in the portal vein are old and worn out, than that those in the hepatic vein are new; and the well-known solvent power of the biliary acids for the red corpuscles makes it probable that these may be destroyed in the liver and help in the formation of bile. But there is no proof that any new corpuscles are formed in the liver.

This enumeration is sufficient to show that, as regards the adult organism, no single point in the development of blood-corpuscles is yet satisfactorily established. Even that for which the most cogent arguments may be brought forward, namely, the origin of white blood-cells in the spleen, has recently met with the renewed opposition of Henle; who suggests, however, no other theory in its stead.

Professor Neumann, of Königsberg, deserves the credit, not only of having, more or less, overthrown the theories hitherto proposed of the development of the blood-corpuscles, but also of having successfully inaugurated investigations on this point which lead in an entirely new direction. He has pointed out, as Henle did, that the organs which have been up till now considered are comparatively unimportant, and has most successfully filled up the gap thus produced in

microscopical anatomy by bringing the blood changes into relation with a structure to which such a function has never been ascribed. Kölliker had, many years ago, with a sort of divination, expressed the opinion that the origin of the red blood-corpuscles from the white in the adult organism would never be demonstrated until nucleated coloured cells should be discovered. It was reserved for Neumann, not only to discover the long-sought cell, but also to establish, on several grounds, its character as a transitional form.

The views of Neumann are published in the 'Archiv der Heilkunde,' vol. x. (1869), p. 63, *et seq.*, under the title, "The Significance of the Marrow of Bones in the Formation of Blood." He there lays down two propositions:

1. There takes place in the vessels of the bone-marrow, favoured by a considerable retardation of the blood-current, a transformation of abundantly-accumulated white cells into red.

2. A continuous passage of medullary cells into the vessels contributes to this accumulation of white cells in the blood-vessels of the marrow.

This whole theory, for which a considerable number of more or less reliable arguments can be urged, gains at once a large amount of probability from the discovery, first, of the coloured nucleated cells, and, secondly, of a remarkable accumulation of lymph cells in the marrow, in virtue of which the latter acquires an importance with regard to the formation of blood, not only equal, but greater than that formerly ascribed to the spleen. Other important arguments are, however, alleged. Neumann has found beside those nucleated and coloured cells, which he regards as the true intermediate form between the white and the red corpuscles, other transitional forms which, on the one hand, form a passage from the white blood cells to the red nucleated cells, on the other hand, from these to the red non-nucleated corpuscles.

Neumann meets the objection that these coloured transitional cells may be merely lymph-corpuscles tinged with blood colouring matter, by showing that their general character is quite different from that of lymph-cells, and further, that they are limited to the osseous marrow. He accordingly compares them, as well as similar forms met with in the frog, to the nucleated red cells of the embryo.

The detailed description given by Neumann of the marrow refers especially to the marrow of the bones of rabbits, and he regards the existence of similar relations in the human body as a matter of probability rather than of certainty.

Eales also has found these minute structural characters of

the marrow to hold good only in the case of rabbits, and has not succeeded in detecting them in the human body. This difference he regards as possibly explicable by the fact that the human structures examined were those of persons enfeebled by disease, and also that they were not examined till some hours after death. Besides that, the human marrow, even that of children, is very different in appearance, even to the naked eye, from that of young rabbits, which may often be separated completely from the surrounding bone in the form of a red cylinder. The *à priori* probability that similar relations exist in the human marrow will, very possibly, be confirmed by researches conducted in some different method.

Eales also insists upon the fact admitted by Neumann, that the yellow fatty marrow which fills all the long bones in adults plays, at best, a very subordinate part in blood formation; and that the observations must be understood to apply only to the red vascular marrow which is found in all bones in young animals, but in adults, in the spongy bones only.

This structure is minutely described by Neumann, whose account is confirmed in the main by Eales. It consists of a remarkably developed capillary network, and of a special tissue, called by Neumann the medullary tissue, contained in the meshes of this network. The capillaries have this peculiarity, that their calibre is much greater than, on the average, four times as great as that of the small arterial branches immediately supplying them, and this sudden enlargement of the blood channel must cause a considerable diminution in the velocity of the blood. The capillary network is also very close, its meshes being only about half-again as large, or less than twice as large as the diameter of the capillaries. Within these vessels, especially in the wider portions, is seen a great accumulation of white cells, as well as "transitional forms" in variable proportion, and it is these which especially mark out the locality as the seat of blood metamorphosis. The tissue contained in the meshes of the vascular network consists of a stroma of delicate stellate cells, anastomosing by means of fine prolongations, and thus forming a reticulation within which are contained, in the red marrow, a large number of lymphoid cells; but these do not occur in the yellow marrow. To this tissue Neumann gives the name of *medullary tissue*; and to the red form, *lymphoid medullary tissue*; it bears most resemblance to the cytogenous connective tissue of Kölliker, or adenoid tissue of His. The yellow marrow being without lymphoid cells, and having its anastomosing cells filled with fat, resembles ordinary adipose tissue.

Since it is precisely in the red marrow, with its numerous lymphoid cells, that an accumulation of white or lymphoid cells is seen within the blood-vessels, the question at once arises—What is the connection between these facts? Are the lymphoid cells in the blood derived from those in the medullary tissue, or *vice versá*? Neumann supposes that the lymphoidal cells of the blood are formed in the medullary tissue, and find their way into the vessels by a process of immigration similar to, but the converse of, that of emigration observed by Cohnheim; though, of course, not in this case susceptible of direct observation. The difference is, however, very considerable between a cell finding its way out of a vessel in the direction of the blood pressure and into a vessel against the blood pressure. In order to make it probable that the medullary cells do find their way into the vessels, it would be important to show they exhibit amœboid movements. Neumann has observed that a small number only of the lymphoid cells pressed out of the medulla in a rapid investigation are without these movements, and concludes that it would be impossible to regard this small number as the only medullary cells; so that some of those showing amœboid movements must be medullary.

More important support is given to the theory by various facts which point to a multiplication of medullary cells, since these, as they must go somewhere, Neumann concludes must find their way into the vessels. He also draws attention to the variations in size of the medullary cells, laying down the proposition that great differences in the size of similar elements in a tissue must depend upon processes of growth going on in them. Moreover, he draws attention to the myeloid cells or '*myeloplaxes*' found in the marrow of bones, which cells, according to Kölliker, arise from a proliferative increase of the small medullary cells, and finally divide again into a large number of small cells. If, then, according to Neumann, such a multiplication of small cells does really take place as these facts point to, there is no other exit for them than into the vessels; the nutritive changes in so stable a substance as bone being far too small to need so copious a supply of organisable material. The hypothesis of an *emigration* of white cells from the capillaries into the medullary tissue, and a consequent accumulation of them here, is rejected by Neumann on the ground that a tissue, like the medulla, enclosed in a hard shell of bone, is especially unfavorable for the emigration of cells, and that it is difficult to see what would become of the emigrated white cells, their return to the vessels being improbable, and their exit through

the very scanty or almost deficient lymphatics of bone being equally so.

An unprejudiced consideration of all these circumstances must lead to the conclusion, that though the theory of Neumann is hardly susceptible of direct proof, it has, at all events, a great deal to say for itself; and that the marrow deserves, if any tissue of the body does, special notice with respect to the question of the transformation of blood-cells.

Eales's own researches have been especially directed to the ribs, but he has obtained similar results from the apophyses of the long bones, the sternum, and the diploe of the skull.

The method of investigation, which is substantially that of Neumann, is as follows:—A sawn-off piece of bone is gently pressed between a vice or pair of pincers till a thick reddish fluid oozes out from the cut surface. This is removed with a pipette and examined under the microscope without any addition, and is most advantageously covered with small fragments of covering glass. An enormous abundance of lymphoid cells, of the most various size, at once strikes the eye; true red corpuscles are present, but in very small number. The peculiar cell forms, designated as transitional, which are here so important, have been repeatedly observed to occur in varieties which may be arranged in the series described below; a series forming a perfect chain of connection without any important break from the white to the red cells; or at least hardly admitting of any other equally satisfactory interpretation. Beginning with the white or lymph-cell the series is as follows:—

1. Colourless granular cells without a visible nucleus (ordinary lymph-corpuscles.)

2. Smaller cells of the same kind, without more irregular outline, and without a visible nucleus.

3. Cells almost of the same size, with a large granulated nucleus; and in its neighbourhood a few scattered granules; and also with an annular or crescentic slightly yellowish border.

4. Cells of the same size, with a similar border, a somewhat smaller nucleus; no granules.

5. Cells of about the same size, with a sharp outline, a somewhat more distinct yellow colour, and a still smaller granulated nucleus in the middle (halfway or middle stage.)

6. The same with a more or less homogeneous, sometimes slightly concave nucleus.

7. The same, with scattered irregular granules (remains of the nucleus).

8. More decidedly yellow, somewhat smaller; without nucleus.

9. Yet smaller; more intensely coloured, without nucleus (ordinary red blood-corpuscles).

It will be seen from this short description of the different cell forms, that they constitute so unbroken a series that one might be tempted on this basis alone to refer the metamorphosis of blood-elements without hesitation to the marrow; if, however, there were no confirmatory grounds, the author would not venture to draw this conclusion, since the cells in question might be susceptible of another interpretation.

The process of transformation appears to be, judging from the series of forms above described, as follows:—The lymph-corpuscles diminish from the periphery, next they lose near the centre some scattered granulations, while the remaining hyaline substance begins to be coloured yellow so soon as the granulations have quite disappeared, though with little general diminution in the size of the cell; the nucleus, previously granular, becomes small and homogeneous—while the whole cell is still but little diminished in size,—and it is not till the nucleus has first broken up and then quite disappeared that the size of the cell is materially diminished.

Neumann, who refers to this process only in the following words, “The protoplasm becoming coloured and at the same time homogeneous;—after that disappearance of the nucleus,” does not seem to understand the process of transformation quite in the way here sketched out, and draws especial attention to cells which are more or less homogeneous in the centre, but retain their granular character at the periphery. If, however, these represented transitional forms on their way to become red corpuscles, there should be also forms with a yellow coloration in the centre, which is not the case. Hence these forms described by Neumann may perhaps not be transitional forms at all, but rather modifications of the ordinary lymph-cells which are on their way to perish altogether. The probability that some do thus perish before conversion into red corpuscles has already been pointed out by Virchow.

With respect to the frequency of these transitional forms, they may be found in larger or smaller numbers in the fluid from all *red* marrow; at least the characteristic nucleated coloured cells have never been found entirely wanting. Examinations have been made of the bodies of new-born children and adults of every age, including, in one case, a

woman of ninety-eight years of age. The assertion of Neumann, that the number of transitional forms diminishes with increased age, was found to be confirmed in the extreme cases; but for intermediate cases, or generally for any universal conclusions, the number of cases (twenty or thirty) seemed insufficient. Four special cases seemed worth more detailed notice:—

1. In a case of Addison's disease, the medullary fluid containing, properly speaking, *nothing but* white cells, and the transitional forms were fewer and less distinct than in any of the other cases.

2. In a woman who died of puerperal hæmorrhage, transitional forms in all stages of development were extremely numerous and well-defined.

3. In a woman who had committed suicide (poisoning with hydrochloric acid), transitional forms were more distinct and somewhat more numerous than in the case of individuals dying of a long or short illness.

4. In phthisical patients, about as many transitional forms as in the second case. The constant occurrence of coloured cells with two nuclei was very noticeable; in one case there was a cell with three nuclei.

It should be mentioned that almost always more transitional forms were found in rabbits than in the human subject.

Cases of leukæmia were also investigated. In a case of Neumann's, he had previously observed that the vascular network, generally so richly developed in the medulla, was absent. The medullary cells were not only extremely numerous, but showed very remarkable differences in size. The few vessels which remained contained almost entirely red corpuscles. These very interesting results agree perfectly with the view that the abundance of white cells in the blood, which characterises this disease, may be due to a diminished conversion of white cells into red, as well as to an increased production of the former. It is, however, clear from the occasional occurrence of coloured nucleated cells in the blood of leukæmic persons, that the blood metamorphosis cannot be entirely suspended, the probable explanation being that these cells have left the marrow before their complete transformation.

Eales had the opportunity of examining a femur and a rib of a leukæmic person, but not till they had been long preserved in spirit. In these specimens he found the medullary cells well developed and numerous, the vessels containing what looked like white and red corpuscles. No transitional forms were seen, but the weight of these observations was

diminished by the fact that they were not made, as Neumann's were, on fresh specimens.

On the MINUTE STRUCTURE *of* CERTAIN HARD PARTS *of the*
GENUS CIDARIS. By CHARLES STEWART, F.L.S., F.R.M.S.
(With Plate IV.)

If we regard a natural classification of echinoderms as an indication of their genetic relationships, it requires all points of their development and structure to be known; but as so complete a knowledge as this is rarely attained, some feature, whose modifications are easily recognised, generally has undue importance attached to it. In the hope of contributing to a more satisfactory classification of the recent regular Echinoidea, I have devoted some time to the minute anatomy of this group of Echinoderms, and have found a remarkable constancy in their minute structure, by which species appearing closely allied can readily be distinguished, and groups as clearly indicated as by their more marked features. But I should wish it to be thoroughly understood that I in no way underrate the value of those parts of their anatomy which have long been used in determining the families genera and species: my object is rather to direct attention to some characters whose importance has not I think been fully recognised.

The suborder of recent Echinoidea Regularia is divided into four families, namely, Cidaridæ, Diademidæ, Echinidæ, and Echinometridæ. These are, however, not of equal importance, and leave many groups of associated genera, of which one may speak as sub-families.

I have selected for the present paper *Cidaris annulata* to represent the restricted genus *Cidaris* (*C. Thouarsii*, *C. tribuloides*, *C. baculosa*, *C. annulata*), this being a leading example of the first family, hoping to give the remaining genera on a future occasion.

Spines.—The spines of the Cidaridæ are of two sorts, primary and secondary. The primary spines, by far the larger, are arranged one on each plate of the interambulacral areas, to which they articulate by a ball-and-socket joint. The joint is surrounded by a muscle to move the spine; there is also a small muscle or ligament, extending from a pit on the ball to a pit on the concave articular surface of the spine. The secondary spines are much more numerous, and are

thickly scattered over the shell in the intervals between the primaries on the peristomal and anal membranes, and on the ambulacral areas. They converge around the bases of the primary spines and over the ambulacra, apparently for the protection of the more delicate structures found there. They articulate by a simple ball-and-socket joint, without a central ligament.

The minute structure of the primary spines is peculiar to all existing members of the family. These spines may be described as of terminate growth; that is, having arrived at a certain size, an end is put to the growth, and probably also to the life, of their upper portion, by a dense crust; this crust commences abruptly a short distance above the collar, into which the muscle which moves the spine is inserted, and extends over all the upper parts of the spine. The crust is extremely liable to parasitic incrustations, and in no part of the spine so invested is there any evidence of repair after injury: this renders it probable that the soft animal membrane (perisoma), which invests the shells of all echinoderms, dies after the formation of this dense layer, as no other echinoderms are subject to similar attacks.

On examining a transverse section of a primary spine, three layers may be recognised (Plate IV, fig. 1)—a central pith, formed of a loose sponge-like reticulation of calcareous fibres, which take in the main a longitudinal direction (this is seen better in longitudinal sections). Outside this pith is found a layer, which constitutes the greater part of the spine; it is composed of radiating plates, extremely thin where they arise from the pith, and gradually increasing in thickness as they approach the external crust, immediately below which the spaces between them are about equal to their own thickness; they are regularly and closely perforated, the holes being arranged in rows, which are oblique to the direction of the spine. These plates, when closely approximated, are simply united by bars, but if further apart, the bars branch and form the usual spongy network, which is so characteristic of the echinoderm skeleton. The external crust, although very dense, is perforated by minute tubes, which arise from the intervals between the plates of the middle layer, and terminate upon the free surface of the spine. The thickening of the crust forms the spinules, ridges, &c., which are so constantly found on the spines of the *Cidaridæ*. When these ridges are much marked, as frequently occurs near the tips of the spines, the plates of the middle layer commonly do not radiate from the pith to the crust, but certain of them converge to plates which retain their normal position, the

latter corresponding to the most prominent part of the several ridges.

The secondary spines are much more simple in structure, no external dense crust being found on them, the pith having the longitudinal fibres very strongly developed, and these fibres passing gradually towards the surface into an ill defined layer, which corresponds with the middle layer of the primary spines.

The articular surfaces of both descriptions of spines, together with the tubercles on which they articulate, are consolidated by the deposition of calcareous matter between the reticulate fibres which primitively compose them. This condition of greater density is probably brought about by the friction to which these parts are exposed.

Pedicellariæ (figs. 2, 3, 4, 5).—The structure of the *Pedicellariæ* is peculiar to the *Cidaridæ*. They are commonly of but one essential form, modified only to a slight extent in the various genera, and in the different parts of the shell of the same species. They consist of a head formed of three jaw-like pieces supported on a stem; the size of the head and the length of the stem vary considerably in the different parts of the shell. Each spoon-like jaw is in contact throughout the entire length of its serrated edge with both its fellows. They differ from those of all other *Echinoidea* in having a large chamber in their outer wall occupying a third of the diameter of the jaw, and extending for about two thirds of its length from the apex; it is closed at the end nearest the stem, but has a large triangular opening near the point, the margins of which are thickened and armed with strong teeth. The jaws of the *Pedicellariæ* articulate at their base, as in the other *Echinoidea*, by a strong, broad, triangular and grooved process, which projects inwards and slightly forwards; from this articular process arises a flat triangular keel, having its outer edge attached to the mesial line of the jaw to nearly its middle. The muscles which close the jaws arise and are inserted on either side of the keel, where it is attached externally; their combined action can readily be seen by referring to fig. 5. The muscles which open the jaws arise from that part of the articular process and base of the head which faces the stem; they run in part from jaw to jaw, and in part are inserted into the stem. The stem also presents peculiarities confined to this family. It is composed of two calcareous rods continuous with one another; the upper one is very short and smooth, and is in close contact with the base of the head, to which it is united by the opening muscles of the jaws; the lower one composes the greater part of the stem, is twice the

diameter of the upper one, and has its surface roughened by small tuberculations, but for a very short distance below the upper rod resembles it in character.

Ambulacral tubes.—The ambulacra bearing their tubes are prolonged on the peristomal membrane to the opening in its centre, through which the teeth of the animal project; these ambulacral tubes are well developed here and on the under surface of the shell generally, but on the upper or dorsal region are reduced to a rudimentary state, and probably only assist in the process of respiration. The free sucker-like extremity of the tube is kept distended by a system of plates similar to those found in other Echinoidea, but as its structure can be demonstrated more readily in some of the larger forms, I shall for the present reserve its description. The general body of the tube is strengthened and supported by numerous spicula (fig. 6), the form of which is peculiar to the Cidaridæ; they are found as cylindrical, rough fibres, curved to adapt them to the form of the tubes, to which they give a ringed appearance when *in situ*; they are roughened by numerous short spinules, which are most abundant on their convex or outer border; the length of each spiculum is about equal to a quarter the circumference of the tube.

The various parts whose minute structure has been now described are confined to, or are appendages of, the external surface of the corona or shell; the characters they furnish are constant to, and only found in members of the family Cidaridæ. They vary only to a slight extent in the different genera and species.

The soft viscera, &c., found in the interior of the Echinoidea are in Cidaris supported and rendered firm and rigid by the formation of numerous spicula in the delicate membrane which lines the interior of the shell, and is reflected over them.

Their forms present features by which genera and species seem clearly to be indicated. This condition is, with the exception of one genus, constant to the family, but must not be considered as peculiar to it, as some members of the Echinometridæ show a similar structure. The spicula of the ovary are, I believe, the most important as furnishing a character which, though modified considerably in the different genera, is, as far as I have yet seen, essentially the same in each genus. The spicula of the other viscera are more varied in their forms, and would probably be of assistance in determining species.

Ovary.—In dried specimens of Cidaris the branched tubes composing the ovary do not retain their individuality, but the ovary appears as a flattened cake, adhering to the

inner surface of the inter-ambulacral region of the shell. Its spicula (fig. 7) are in the form of triangular perforated plates, derived from the enlargement of a tri-radiate spiculum, which first forms and subsequently has its angles filled up, leaving the holes, which are so constantly found lightening the otherwise dense shells of these animals. Mixed with these are a few spicula, which from the greater size and length of one of their radii, have assumed more the character of spines.

The spicula of other internal parts vary greatly in the species; as a rule, they are coarser and more numerous where the fibrous membranes are themselves thickest, but I will not describe their varieties, as the object of the present paper is only to indicate the value of the minute structure of these animals as an aid to their generic distinctions.

Briefly in summing up one may say that:

a. The spines of the recent *Cidaridæ* are characterised by the dense crust which terminates their growth.

b. The pedicellariæ, by the special chamber found in each jaw, and by the calcareous stem divided into two parts, the upper being in immediate contact with the head.

c. The ambulacral tubes, by being surrounded by the concentrically curved spicula, which give them a ringed appearance.

These three characters are common to, and only found in, all recent *Cidaridæ* (the fossil forms are not alluded to, as they do not admit of a complete and satisfactory examination).

d. The ovary, strengthened by triangular plate-like or tri-radiate spicula (the former most abundant), but not retaining the form of its component tubules, in the dry state affords a feature constant and peculiar to this genus.

NOTES *on the METHOD of APPLICATION of NITRATE of SILVER and CHLORIDE of GOLD in the PREPARATION of CERTAIN TISSUES for MICROSCOPIC INVESTIGATION.*
By HENRY N. MOSELEY, B.A. Oxon., Radcliff Travelling Fellow.

It is hoped that the following notes may be of service to some of the readers of the *Quart. Journal of Microscopical Science*. I have this year spent six months in the laboratories of Professor Stricker in Vienna, and have worked with the microscopes under his assistant Dr. Klein, to whom I am indebted for the greater part of my knowledge of the methods here described.

NITRATE OF SILVER.—Cornea.—For the investigation of the stellate bodies in the cornea, known as “Negative images,” it is best to use nitrate of silver in the solid form. The surface of the cornea, if possible whilst still *in situ*, must first be scraped all over with a scalpel, so as to remove the conjunctival epithelium. This requires considerable force, as the epithelium is closely adherent. The exposed surface is then rubbed with a piece of caustic for a few seconds, and further action of the silver is suddenly stopped by a stream of common salt solution (about 2 per cent.). The cornea, which should now appear white and almost opaque, should be well washed in water and immediately put up in glycerine. If it be a small one from a frog, *e.g.*, it can be mounted whole, radial cuts being made in it to allow of its lying flat. If it be large and thick, small sections parallel to the surface should be made with a razor. The stellate bodies will be visible almost immediately, but at the present time of the year, when a strong sunlight cannot be obtained, from twelve to twenty-four hours are necessary to darken the back-ground nicely, and throw them properly into relief.

The writer has thus prepared the cornea of the ox, cat, rabbit, pigeon, and various amphibia. The latest account of the appearances presented in such preparations will be found in a paper by Schweigger-Seidel in the ‘*Bericht der mathem. phys. Classe der Königl. Sächs. Gesellschaft der Wissenschaften*,’ 1869 (see also the Chronicle in the present number of this Journal).

Stomata in lymph sac of Frog.—For thin membranes a solution of nitrate of silver, $\frac{1}{2}$ per cent. is used. The stomata in the wall of the large abdominal lymph sac of the frog, and which are of great interest, may be thus prepared:—The abdomen of a frog just killed is opened, and the intestines are raised up; on one side a very fine membrane will then be seen stretching across horizontally from the median line to the abdominal wall, and forming a sac filled with a perfectly transparent fluid. As much of this membrane as possible should be removed and instantly plunged into the silver solution. It should be held by one corner with forceps, and agitated in the solution for about two minutes, so that all parts may be equally impregnated. It should then be placed in distilled water and remain there till it assumes a light brown tint, when it should be carefully spread out on a slide and mounted in glycerine. The stomata are figured in Kölliker’s ‘*Handbuch der Gewebelehre*,’ p. 602. For a method of staining the nuclei of the cells and mounting in Canada balsam, see p. 283 of this Journal, vol. x, new series.

Lymphatics in Central tendon of diaphragms.—This is most conveniently prepared from a rabbit. The tendon is cut out whole from the animal, which must be still quite hot, care being taken not to stretch or scratch it, and that as little blood as possible falls on it. To ensure these conditions, I find it best to kill by decapitation, and allow the blood to drain for a short time. The thorax and abdomen are both laid open rapidly. The tendon can then be easily cut out without injury. The tendon is removed to a saucer-full of distilled water, at about blood-heat, and is rapidly brushed pretty hard with a large camel's hair pencil on both sides for about a quarter of a minute. It is then removed to the silver solution, in which it should be treated as the membrane from the frog just described. The writer generally cuts a tendon into three pieces, and allows one piece to remain in the solution two minutes, another two and a half, and the third three, thus obtaining preparation of various tints; and making sure of at least one good one. As soon as the tendon has become of a light brown colour, if the process has been successful, the larger lymph vessels should be plainly visible to the naked eye white on a dark ground. It adds very much to the beauty of the preparation to remove the fibrous layer of the pleura, and that of the peritoneum from their respective surfaces of the tendon after the staining. This may be done with care under water with a pair of forceps. I have found that these preparations may be well stained with a solution of carmine in ammonia, to which a few drops of acetic acid have been added, so as partly to precipitate it; and I have such preparations mounted in glycerine, which are now nine months' old, and not in the least impaired.

CHLORIDE OF GOLD.—*Auerbach's plexus.*—For making gold preparations of Auerbach's plexus, a rabbit should be taken, the intestines of which are still contracting peristaltically. A slight transverse cut, as shallow as possible, should be made on the outside of a loop of intestine, and one lip of this cut should be taken hold of with a pair of forceps, and torn away. If this operation be properly performed, a narrow strip, consisting of a longitudinal muscular coat and peritoneum will be obtained, and, after some practice, it is possible to obtain such strips a foot or more in length. The process is rendered easier by blowing up the intestine first; but this step is not necessary. The strip should be plunged, with haste, for fear of drying, into a solution of gold chloride in distilled water ($\frac{1}{4}$ th per cent.), and allowed to remain in the solution from ten to fifteen minutes, by which time it will have assumed a pale straw colour. It should then be

transferred to distilled water, acidified with acetic acid, so as to be just acid to the taste. It is better to prepare several strips at once, and give them various amounts of exposure to the gold solution. The vessel containing the acidified water should be placed in the strongest light possible for about twenty-four hours, or till the tissue has become of a purple colour, and the nerve plexus distinctly visible to the naked eye. Glycerine should be used for mounting.

Cornea.—The cornea of frogs and animals up to the size of a rabbit may be cut out whole, and so treated with the gold solution. Larger corneæ, such as those of the ox, it is better first to render more permeable to the reagent by cutting them into thick sections parallel to the surface. The cornea should remain in the solution till it assumes a pale straw colour, and should then be treated in the same manner as Auerbach's plexus. The frog's cornea can be mounted whole, but from the thickest mammalian corneæ sections must be cut with a razor.

Before mounting the frog's corneæ, the epithelium of the conjunctiva and of Descemet's membrane should be scraped off as clean as possible. In mammalian corneæ, if it be wished to show the finest nerves among the epithelium, the corneæ may be imbedded in pith, or a mixture consisting of about half white wax, and half olive oil, and vertical sections made of it. Or the epithelium may be partly removed and partly left *in situ*, and a thin section made parallel to the surface, so as to be viewed from above.

The results of gold preparation of the cornea are very uncertain; sometimes the nerves only are stained, sometimes the connective-tissue-corpuscles; sometimes, again, though the corneæ assumes a beautiful purple colour, neither of these structures are to be seen at all. Again, a remarkable fact, the two corneæ from the same frog may be removed at the same time, and treated together all through; and yet one may show the corpuscles, and scarcely any nerves; the other, all the nerves, and no corpuscles. At all events, the two always differ considerably. Whether this arises from some slight difference in the physiological state of the tissues of the two corneæ, or perhaps from slight differences in the amount of light which they receive, though exposed together in the same vessel, it would be interesting, if possible, to determine. It is difficult to give any exact time for exposure to the action of the gold solution. A healthy frog's cornea requires to remain in the solution about half an hour. A cornea that has been inflamed by means of a thread or caustic, with a view to Stricker's observations on inflammation, requires only about

half that time. In order to stain the nerves, the exposure should be longer than for the connective-tissue-corpuscles. After some practice, the proper straw-yellow colour of the tissue is readily recognised.

Tails of Tadpoles.—A very fine network of nerves, first described by Dr. Klein, may be obtained by staining the tails of tadpoles with gold in the same manner as the cornea. When the tail has assumed the proper tint, it must be placed in absolute alcohol, with a few drops of acetic acid in it, for about five minutes, when the skin of the two surfaces of the tail can be separated from one another, by tearing, with forceps, from above downwards. Half may then be mounted in glycerine.

In conclusion, it must be borne in mind, that in preparation with both gold and silver, constant failures occur, particularly when these reagents are used for the first few times. That, however, they are worth trying, will be at once confessed by any one who has seen a good silver preparation of the central tendon of the diaphragm of the rabbit, and a good gold preparation of the cornea of the common frog, showing both the nerves and corpuscles. Moreover, these methods are, of course, applicable in many other lines of research, these special cases being chosen for description only because the writer has paid most attention to them. The great thing to remember is, that the tissues used in these preparations must be absolutely fresh, in fact, living.

Dammar-lac.—It may not be out of place to mention here an unfortunate error which has crept into the translation of 'Stricker's Handbook,' published by the Sydenham Society. The word, "Dammar-firniss," has been translated, "Canada balsam." Dammar varnish is recommended by Stricker in his work for mounting histological preparations. It is always used in his laboratory, and in those of Brücke and Rokitansky, and has there entirely supplanted Canada balsam.

Well-made Dammar varnish has many advantages over Canada balsam. It is clearer, more free from colour, and when used cold, as it always is, it dries quicker, though it is much thinner and more limpid. It is to be hoped that this mistake will be corrected in a future edition, as any one who has used really good Dammar varnish for histological purposes will not be likely to try Canada balsam again.

I have not been able to obtain, as yet, any good Dammar varnish in London, though the Gum Dammar is, of course, common enough. I have, however, given a sample of Vienna varnish to Messrs. Baker, of Holborn, who have promised to procure it as soon as possible.

REVIEWS.

Biologische Studien. Von Dr. ERNST HAECKEL, Erstes Heft. Studien ueber Moneren und andere Protisten. (See Plate V.)

THE volume which Dr. Haeckel has just published contains reprints of several papers already put out by him in the 'Jenaische Zeitschrift,' together with two additional notices of new forms of Monera which we have not previously seen. The monograph of the Monera is already well known to our readers, since it was reproduced in full in this Journal during the year 1869. Succeeding this in the present volume is a series of papers entitled "Contributions to the Plastid Theory." In the first of these Haeckel points out what he means by the 'Plastid theory,' which he discusses in connection with the generally received 'Cell theory.' Just as at one time the cell was conceived to be the simplest living form, as seen in the ovum and unicellular organisms, and just as it was conceived that organisms are built up by aggregations of these simplest morphological units, so must we now admit the existence of still simpler units—the simplest conceivable—mere bits of protoplasm, undifferentiated, without nucleus, living freely as Monera, and possibly also becoming aggregated also to form tissue. That such units should exist is what we were gradually led to expect by the researches of Max Schultze and others, resulting in the abandoning of the cell-wall, and the rise of the all-important protoplasm-theory. It is Haeckel who has discovered them. He calls these simplest units Cytods, and classes Cytods and Cells together under the head Plastids. The cytod being the simplest possible form of life, it is this form under which life first appeared, and it is this which we should look to see formed by so-called spontaneous generation. In the course of development the cytod has given rise to the cell by internal differentiation of a nucleus. Since the development of the individual (Ontogeny) is a more or less complete epitome of the development of the species (Phylogeny), we should expect such Plastids as are cells to pass through the cytod condition in their life-cycle, and we find that they

actually do. Since the cytod is the earliest form, all organic beings have sprung from it, but all but Monera have passed through the cell stage also, and hence in all the higher forms the cytod condition in the development of the individual is obscure, the ovum appearing first as a cell, though Amœbæ, Gregarinæ, and Radiolaria reproduce by cytods. But we may add to what Dr. Haeckel says on this point, that if we trace the development of the ovarian ovum, we actually can and do follow it back to the cytod condition. Dr. Haeckel would suggest that the disappearance of the nucleus which certainly occurs in some ova, at the time of impregnation (though in others it as certainly persists), is a reversion to the ancestral cytod form and is to be explained in this way. These views give very great importance to the cell-nucleus, and it is well to dwell on this, since there is a tendency to overlook it, even to consider it an artificial product of the reagents used in microscopical investigation. Dr. Haeckel is very firm on this question; he points to a division of labour between nucleus and surrounding plasm, and adduces the observation of the nuclei in the cells of living transparent pelagic organisms to confront those who doubt their living existence. On the other hand, he distinguishes two kinds of cytods. It is not every Plastid devoid of nucleus which is a cytod, for by "degradation" or "retrogressive metamorphosis" (Rückbildung), a cell may lose its nucleus and is not then to be confounded with an ancestral, nucleusless cytod, though like it in simplicity. It is a "sham-cytod" or "dyscytod." Such are the red blood-cells and the horny epidermic scales of mammals. Plastids and cytods have been elsewhere further classified by Haeckel according to such characters as the presence of a wall (cell-wall), &c. It is this modification, then, of the cell-theory, viz., the Plastid-theory, which gives the Monera so much interest in connection with the doctrines of evolution and the question of Abiogenesis.

Following his remarks on the Plastid theory Haeckel gives a detailed account of Bathybius, fully abstracting Huxley's memoir, in which its existence was first made known, published in this Journal in October, 1868, and adding an account of his own researches. The protoplasmic network of Bathybius is considered by Haeckel apart from the coccoliths with which it is often densely studded, but of which it is sometimes destitute. He points out that the separate "cytods" of Bathybius average about $\cdot 08$ of a millimetre in diameter, reaching $\cdot 1$ of a millimetre, and their protoplasm is spread out in ramifying branches as in many myxomycetes (Pl. V, fig. 5).

He differs from Huxley, who found the "protoplasm" to consist of a jelly-like matrix, unstainable by iodine, and not affected by dilute acetic acid, enclosing granules which are stained yellow by iodine, and dissolve in acetic acid. Haeckel has, indeed, found this jelly-like matrix in some cases, but these were shrivelled-up masses, not like the ramified *Bathybius* cytods, and he thinks their form and the jelly-like matrix are due to *post-mortem* change, the matrix having, in fact, been compared by Huxley to a similar substance formed by the death of the protoplasm of the Radiolarian *Sphærozoum*. This substance Haeckel does not consider to be protoplasm at all, though the granules it encloses are. The true protoplasmic cytods were more abundant in the Atlantic ooze (preserved in strong alcohol), which Haeckel examined; they stained yellow with iodine, orange-yellow with nitric acid, and red with carmine solution in ammonia, which the jelly-matrix does not, though its enclosed granules do. Haeckel considers the carmine staining a reaction of the highest importance in micro-chemical investigations. With very high powers and great care a granular structure was detected in some of the protoplasmic cytods. This was probably the first indication of that *post-mortem* change which gave to Huxley the jelly-like matrix enclosing fine granules.

Some additions are made in this memoir to Huxley's description of the coccoliths and coccospheres. Haeckel remarks upon the great difficulty of satisfactorily investigating these very minute bodies, since it is necessary to get a flat and a side view of the same specimen. Their enormous abundance, however, lessens the difficulty. We have found glycerine jelly or serum a better medium for their examination than Canada balsam. A power of 1200 diameters is necessary. Haeckel distinguishes in all, five zones—a central *nucleus*, sometimes double, lying in a *medullary substance*, which is surrounded by a *medullary ring*; external to this follows the *granular zone*, and then the outermost *marginal ring*. Huxley describes discoliths or simple monodiscous coccoliths, and cyatholiths or amphidiscous coccoliths. Haeckel points out that there are circular discoliths as well as oval ones, which alone were described by Huxley. He also remarks that the cyatholiths are simply two discoliths united by an axial piece, generally a smaller circular discolith with a larger oval discolith. The convexity of the oval discolith varies very much, as also does the length of the uniting axial piece. The exact nature of the connection between the two parts of the cyatholith Haeckel cannot decide, though he thinks that protoplasmic matter present in the *granular zone* of the two

takes part in it. He does not determine how their connection came about, whether when very minute or after growth, or whether they were ever separate at all. The coccospheres Haeckel found to be excessively rare. He, however, found the granular zone present in their component coccoliths, which Huxley did not. He found them made up either of oval or round discoliths, or of cyatholiths, the coccoliths in one coccosphere being nearly always of the same kind. He agrees with Huxley that it is improbable that the coccoliths result from the breaking up of the coccospheres. At the same time his detection of the granular zone proves the absolute identity of the two in structure.

The most important part of Haeckel's researches in this matter is now to be mentioned; we have briefly called attention to it in our last volume. In February, 1867, Haeckel found floating on the surface of the sea numbers of a new Radiolarian—allied to the *Thalassicollæ*—which he proposes to call *Myxobrachia*, and which contains concretions embedded in its extra-capsular sarcode, which are identical with the coccoliths and coccospheres.

Myxobrachia is very large, seeing that it is one of those Radiolarians having but one central capsule, namely, about half an inch long. Two species are distinguished, one *M. rhopalum* (Pl. V, fig. 1), pear-shaped, floating with the larger part just on the surface of the sea, and the stalk-end hanging down; the upper part contains the central capsule: the depending process has an axis of the yellow cells characteristic of Radiolaria, and a mass of calcareous concretions at the end. The second species, *M. pluteus*, looks like an Echinoderm larva; it has exactly the same structure as *M. rhopalum*, but in place of one process depending there are sixteen arranged in three rows (Pl. V, fig. 2). The calcareous concretions in this present the closest resemblance to the coccoliths and coccospheres, but Haeckel will not assert absolutely their identity. Both species are capable of elongating and contracting themselves, and are beset with short pseudopodia. The central capsule (figs. 1, 2 *cc*) is about one millimetre in diameter, perforated by fine pore-canals. It contains a *vesicula intima* (fig. 3), which is constricted into a number of oblong bladders radially, as in *Thalassicolla pelagica*. Between it and the wall of the central capsule are numerous small cells (the truly cellular nature of these probably reproductive bodies, as seen in their nuclei, is important), and protoplasmic fluid. There are also floating in this space numerous blood-red oil-globules. The mass of the body is composed in both *Myxobrachiæ* of *sarcodæ jelly*, which is relatively more abund-

ant in this form than in any other of the Monocytaria, and the whole surface of which is covered with numerous fine and short pseudopodia (fig. 4). Around the central capsule is a mass of clear hyaline corpuscles (figs. 1 and 2 *ac*), which Haeckel has elsewhere called extra-capsular alveoli. They contain each a nucleus and a watery fluid, and are probably true *cells*, as above defined in discussing the nature of plastids. These hyaline cells are probably to be considered as a large-celled form of connective tissue, and are similar to the tissue so common in the lower animals (worms, molluses, crustacea), known as "Blasengewebe." Besides these extra-capsular cells there are extra-capsular oil-globules and yellow cells which contain starch, the latter being aggregated to form the axis of the finger-like process or processes, each of which has calcareous concretions at its end. Radiating streams of softer protoplasm pass from the central capsule to the surface through the denser, structureless, sarcode jelly.

The coccoliths are to be regarded as spicula of Myxobrachia in all probability. Similar spicula were figured by Haeckel in *Thalassicolla morum*, but *calcareous* spicula were not certainly known before in Radiolaria, though all Radiolaria do not necessarily possess siliceous skeletons. A new *Thalassicolla*, of smaller size than the large Myxobrachia, was found by Haeckel off the Canaries, which he calls *Th. sanguinolenta*. It presents strong resemblance to Myxobrachia in its alveolar cells and central capsule, and it is suggested that this form may ultimately develop into Myxobrachia. The great peculiarity of the latter is in its finger-like processes with their concretions. It is possible but not likely that the coccolith-like concretions are taken in with food, but the other accompanying Radiolaria do not exhibit them. In any case, if we admit the coccoliths to be the spicula of Myxobrachia their history is not solved, for, says Haeckel, it is very unlikely that the innumerable masses of myriads of coccoliths and coccospheres forming the Atlantic ooze have been derived from Myxobrachia, which have sunk to the bottom after their death. He waits for further observation.

The discovery of starch in the yellow cells of Myxobrachia and several other Radiolaria—which cells, by the way, are true cells—is recounted in detail. Both Müller and Haeckel had previously failed in recognising the starch on former occasions with the iodine test (iodine dissolved in potassium iodide), with which he has now succeeded. He attributes this to the use of higher powers (1200 diameters), which enables him clearly to see the *blue* coloration of the *nucleus* of the yellow cells when the test is applied, the blue

being again discharged by caustic alkali. The amount of starch thus indicated is something enormous, more than the half of the whole animal's bulk. The physiological significance of this is very great. Haeckel has a laugh by the way at Alexander Stuart, of St. Petersburg, whose remarks on Radiolaria, based on the study of his *Coscinosphaera ciliosa*, are futile, since that form is no Radiolarian at all, but only *Globigerina echinoides*.

Some highly important remarks are made by Haeckel as to the cellular, or rather plastidian, structure of the Rhizopoda. He, as is well known to the reader, separates from the class Rhizopoda the Monera, the Protoplasta or Amœboidea (Amœbæ, Arcellæ, Gregarinæ, &c.), and the Myxomycetes, leaving as true Rhizopods the Acyttaria (Monothalamian and Polythalamian foraminifers), and the Radiolaria (Monocytaria and Polycyttaria), as well as the small group of the Heliozoa (*Actinosphærium Eichhornii*, *Cystophrys* of Archer, and other forms which that writer has made known). Max Schultze has said that the contractile substance of all Rhizopods consists of the naked, free, contractile protoplasm of *one cell*, or of *several cells fused together* so as to form a larger mass of protoplasm. This is true, Hæckel says, for those Rhizopods in which true cells are to be traced. Such cells are found in Heliozoa, for instance, in *Actinosphærium*, and occur in all true Radiolaria, *e. g.* the yellow cells, the intra-capsular pigment cells, the alveolar cells surrounding the central capsule, and (as he now shows from examination in several cases with reagents) the numerous clear intra-capsular corpuscles, which he feels convinced are true reproductive elements. The objective proof of this subjective conviction he has not, in spite of efforts made in the Canaries, been able to obtain. The probability is that the cells in the central capsule are spores, which either within the capsule or after bursting from it develop each into a multicellular body. Of the cells of such a body some become pigment-cells, some yellow starch-holding cells, some other spores, whilst others, by fusion, form the sarcode mass and the free protoplasm of the Radiolarian. He has convinced himself that *no central capsule exists*, but simply a central mass of cells in the young stages of the *Acanthodesmiadæ* and *Sponguridæ*. The young Radiolaria, devoid of central capsule, are the morphological equivalents of the Heliozoa (*Actinosphærium*, *Cystophrys*, &c.).

In the Acyttaria, on the other hand, there is absolutely no trace of cell structure. *Gromia*, *Globigerina*, and others, give no trace of a nucleus. They are simply cytods, not

cells. They reproduce by spore-formation, amounting merely to the separation of a piece of their body-substance.

The Acyttaria are simple cytods or aggregates of cytods, and stand genealogically at the base of the Rhizopoda; the Heliozoa in which the component plastids first develop a nucleus, connect them to the more complex Radiolaria with their central capsule. Hence, it cannot be said with Schultze that the protoplasm of all the Rhizopoda arises from the fusion of *cells*. An artificial classification would lead us to relegate the Acyttaria thus to the Monera as cytods, and to class the Heliozoa and Radiolaria as truly cellular organisms, with the undoubtedly cellular Myxomycetes. A difficulty would arise from the fact that the free plasmodium of the Myxomycetes is devoid of nuclei, and resembles an aggregate of cytods, though the spores are true, nucleated cells. As we have sham cytods, dyscytods (red blood-corpuscles, &c.), so we have sham cytod-aggregates, resulting from the degradation of true cells, and such is the plasmodium of Myxomycetes. The natural or genealogical classification of the Rhizopods is to place the Acyttaria, Heliozoa, and Radiolaria as three steps in the development of the same group.

Magosphæra is the name of a new organism which Haeckel places in a new class, the Catallacta, intermediate between the Flagellata and Protoplasta (Amœboidea). He found it in September last year, in some conferva in salt-water ditches in the Island of Gisoë, off the coast of Norway. He observed its complete life-history, which he figures in a plate in this book. As we noticed on a former occasion, the conversion of definite cilia into protoplasmic pseudopodia was observed in the development of this form by Haeckel, as well as the converse in the ova of certain Siphonophora, and the consequent *identity of ciliary and amœboid-protoplasmic movement* inferred. The successive stages presented by Magosphæra may be thus grouped: A. *Quiescent* (vegetative period). 1. Unicellular quiescent stage (egg). 2. Multicellular quiescent stage (cleavage). B. *Active* (animal period). 3. Multicellular swarm stage (Volvox-like form). 4. Unicellular ciliate stage (Peritricha-like form). 5. Unicellular amœboid stage (Amœba-like form).

A new species of the genus *Vampyrella* of Cienkowski, which forms one of Haeckel's Monera, is also described here as living on a Gomphonema found on the Norway coast; also a new Protomonas (another genus of Monera, described by Cienkowski, for which see the Monograph of Monera in

this Journal, 1869) to be called *Protomonas Huxleyi*, and some new Protamœbæ, all of which are figured.

A telling chapter is headed the Plastid theory and the Carbon theory; it contains views which have been already put forward by the author in his general 'Morphology,' and which have been before this expounded to the people of England. Either, says Haeckel, there is one nature manifest in the laws which rule supremely and on every side, or there are two natures—an organic nature, in which necessarily working causes (*causæ efficientes*) are active, and an organic nature in which specially contrived causes (*causæ finales*) are at work. The adherents of evolution accept the first, its opponents the latter view. The former hold to a *monistic* and mechanical view of nature, the latter to a teleological and dualistic one. The plastid and the carbon theory—that is, the conception of life as the property of the simplest bits of jelly—of protoplasm as its "materielle Grundlage"—this protoplasm or *urschleim* being nothing more than a carbon-compound, owing all its wonderful properties to the unique power of complex chemical binding possessed by carbon, enables us to dispense with the second nature. By it and Darwin's law of survival of the fittest, we can hope to account to ourselves for all phenomena by one universal code of laws, and establish the philosophy of Monism.

It is Professor Haeckel's great merit to have discovered life without structure, which was first clearly made known by his 'Researches on Monera.' He claims to have advanced a step towards the goal of biological science, pointed out by Carl Ernst Baer in his classical 'History of Animal Development,' "That fortunate one will win the palm for whom it is reserved to trace back the constructive forces of the animal body to the universal forces or laws of being of the entire world."

Professor Haeckel's remarks on the spontaneous generation question are especially interesting at this time. Approached in the light of his researches and the evolution theory, we must recognise, he says, that the oft-repeated, much be-wondered experiments which are made to prove or to disprove spontaneous generation, are useless. We must go another way to work. We could never hope to see the development of life from inorganic matter as long as cellular organisms were the simplest known to us, nor can we attach value to experiments professing to show this; our chance is, however, bettered by the discovery of the Monera. These we may possibly see developing from matter devoid of life. Of these *Bathybius* is the most likely to present such a phenomenon. If Monera

are not produced at the present time by Abiogenesis, they must have gone on reproducing under their present simple form, unchanged in all essential respects for countless ages. For the consideration of those who would hold living matter to be something mysterious, endowed with a force unlike that which we see in other things, Haeckel submits the following grouping:

a. Natural world: simple combinations of the elements, salts, alcohol, acetic acid, which have been formed synthetically by chemists.

b. Supernatural world: Felspar, Fluorspar, Augite, most other minerals, albumens, chitin, &c.: all bodies which have not been artificially made yet, and which, therefore, are said to have arisen by "creation," that is, by supernatural ways through some external, mysterious, creative power.

An enumeration of the Monera as they now stand finishes this most interesting collection of "studies," with which we will conclude our review.

a. Gymnomonera. *Protamæba* (3 freshwater, 2 marine species). *Protogenes* (1 species, marine). *Bathybius* (1 species, marine).

Lepomonera. *Protomonas* (1 freshwater, 1 marine species).

Protomyza (1 spec. marine), *Vampyrella* (3 freshwater, 1 marine species), *Myxastrum* (1 spec. marine).

It is probable, the author observes, that the common *Actinophrys sol* belongs here. Of the 15 known species Haeckel described 11, Cienkowski 3, and Huxley 1. They are widely distributed, occurring in ponds at Jena, in the Atlantic, and off Norway. It is probable that they will prove to be very numerous.

Principles and Practice of Medical Jurisprudence, by
ALFRED SWAINE TAYLOR, M.D., F.R.S. London: J. and
A. Churchill.

If any one will take the trouble to compare this work with those that have preceded it, he will at once perceive to how large an extent the study of medical jurisprudence is indebted to inquiries conducted by the aid of the microscope. It was an early hope of those who had investigated the tissues of the animal body with the microscope, that one day its results would influence decisions in our courts of law, and that its power to detect the nature of blood-produced stains might take from the murderer his too frequent excuse, that the spots of blood on his garments were those of

some of the lower animals. These hopes have been more than realised by the application of the microscope to almost every department of medico-legal inquiry. In the great work which has been produced by Dr. Taylor, and which may be justly regarded as the most important and reliable in the British language, he has everywhere indicated where the inquiries of the medical jurist may be aided by the use of the microscope. It would be impossible for us here to go through the details of this great work on medical jurisprudence, to show where the microscope is needed; but we will endeavour to pass in review some of the points where medico-legal inquiries may be justly regarded as imperfect without the aid of this instrument.

There is a large class of agents derived from both the mineral and vegetable worlds which act as poisons on the human system, and which only a few years since were regarded as impossible of detection but by the agency of chemical analysis. It is in these cases that recently the

FIG. 1.

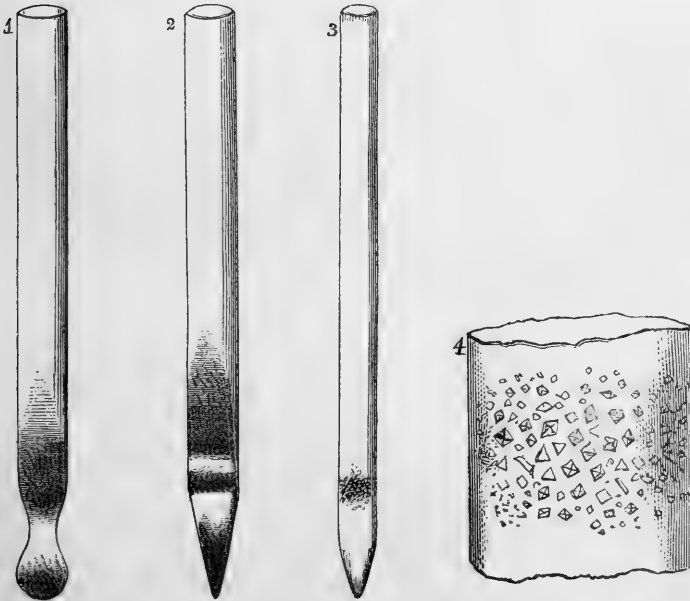

microscope has not only come to the aid of the chemist, but has supplied the means of discovering these agents where chemistry has entirely failed. Of the many substances from the mineral kingdom to which we might allude, we refer

only to arsenic. This substance, so well known of old to the criminal poisoner as an agent that might be introduced into the system without fear of detection on account of the small quantities required to produce a deadly effect, is now not only detected by chemists in quantities that could not produce a poisonous effect, but by the microscope in such small proportions, that even a quantity accidentally introduced by medicine or other sources can be easily recognised. When chemical reagents fail clearly to indicate the presence of arsenic, the process of reduction may be employed, and the sublimate on the sides of an ordinary glass tube will by the aid of the microscope yield conclusive evidence under the powers of the microscope of the presence of arsenic. We give here from Dr. Taylor's book the appearance of sublimated arsenious acid under a glass magnifying 30 diameters (fig. 1).

A solution of the same substance will throw down crystals by evaporation, which present the same unmistakable forms as presented by the engraving, showing the same under a power of 20 diameters.

FIG. 2.

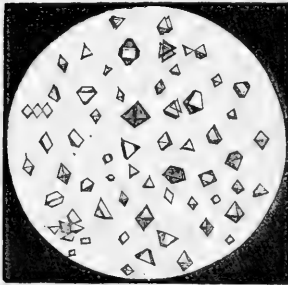

Crystals of arsenious acid by sublimation, magnified 20 diameters.

Fig. 3.

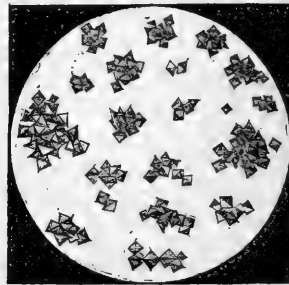

Crystals of arsenious acid, magnified 124 diameters, p. 203.

It is calculated that $\frac{1}{30000}$ th of a grain of arsenic may be detected in solution by chemical tests, but the microscopical test is said to be applicable equally to $\frac{1}{30000}$ th of a grain.

What is true of arsenic is also true of other poisonous agents belonging to the mineral kingdom. Thus corrosive sublimate, the bichloride of mercury, and tartarised antimony, the potassio-tartrate of antimony, have both been too peculiarly brought before the public as agents by which the secret poisoner seeks to produce a destructive effect on the lives of

others. These agents are undoubtedly not difficult to detect by chemical agency, but here again the skilful microscopist by the aid of his instrument renders almost certain the presence of these agents where chemical evidence hesitates with regard to its results. We give the appearance of crystals of corrosive sublimate and tartar-emetic under a power of only 30 diameters.

FIG. 4.

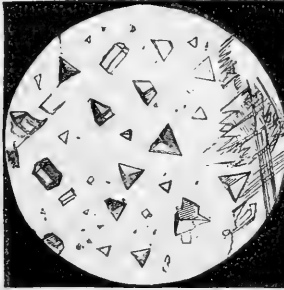

Crystals of tartar emetic magnified 30 diameters, p. 251.

The substances we have mentioned are those derived from the mineral kingdom, which are most commonly used for the purposes of self-destruction or the murder of others. At the same time it ought not to be forgotten that a large number of mineral substances requiring to be exhibited in larger quantity are constantly employed in the destruction of human life. Of these, the most common are acetate of lead and oxalic acid. These substances, though easily detected

FIG. 5.



Crystals of corrosive sublimate, 30 diameters, p. 227.

FIG. 6.

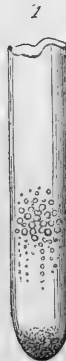
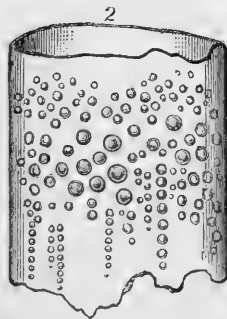

FIG. 7.



Mercury sublimed from corrosive sublimate, p. 227.

by chemical agents, are also recognisable by the aid of the microscope, and it is in cases where only small quantities of the fluids suspected to contain the poison can be procured for inspection that the microscope lends its invaluable aid. We give from Dr. Taylor's book illustrations of the crystals of acetate of lead and oxalic acid as seen under low powers of the microscope.

FIG. 8.

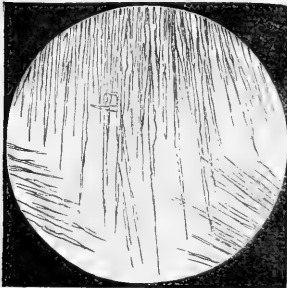

Acetate of lead magnified 30 diameters.

FIG. 9.

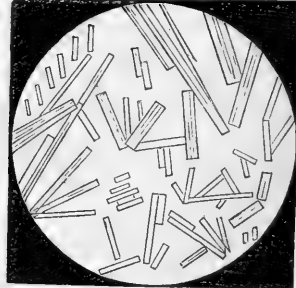

Oxalic acid magnified 30 diameters.

Were it our object here to give an exhaustive account of where the microscope can be used with advantage in medical jurisprudence, we could from the pages of Dr. Taylor's work show how large a number of other mineral poisons may be detected most successfully by its aid. The salts of potassium, sodium, barium, and strontium have all occasionally acted as poisons, and the definite forms which these salts assume even when crystallised from the weakest solutions are far more secure guides than any mere chemical analysis.

We follow, however, Dr. Taylor in his illustrations, and arrive at the group of poisons, which in their separated forms are known as vegetable alkalies and alkaloids. Here we have a series of substances which from the earliest times have been known to exert the power of destroying life. Although we have to thank chemistry for revealing to us a knowledge of the existence of these substances in plants where poisonous powers have been known in all countries and in all times, it is to the microscope that we are indebted for a knowledge of the fact that these alkalies and alkaloids have definite forms by which their presence may be detected in much more minute quantities than by the aid of chemical analysis. We know that this position may be controverted by the chemist, but we know that it could be only controverted by the chemist who is destitute of that ability to use the microscope

which is possessed by few chemists at the present day. The preparation of liquids and substances containing small quantities of the poisonous agents to which we have alluded is not to be attained by a rude handling of the microscope, but can only be acquired by long training in the art of observation by its aid. It is, in fact, one of the things to be deplored at the present day, that almost any person who possesses a microscope thinks that by putting their eyes at the one end of a microscope they are capable of making accurate observations on anything they put at the other end. The fact is, to detect vegetable alkalies and alkaloids under a microscope requires a special training. When this training has been accomplished, such alkaloids as morphine—the active principle of opium, strychnia—the alkali of nux vomica, and atropine, and daturia, the active principles of deadly nightshade and stramonium, may be easily detected. The following illustrations from Dr. Taylor's work show the forms of these alkaloids under low power.

FIG. 10.

Crystals of morphia, 124 diameters,
p. 293.

FIG. 11.

Crystals of strychnia, 124 dia-
meters, p. 328.

FIG. 12.

Crystals of strychnia obtained by adding ammonia to the sulphate,
magnified 124 diameters, p. 338.

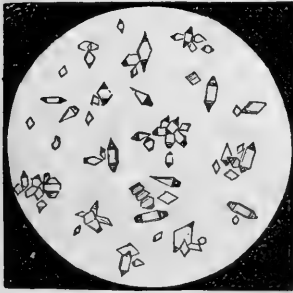
Not only is the microscope of value in detecting the minute crystals of these poisonous agents, but portions of vegetable

FIG. 13.

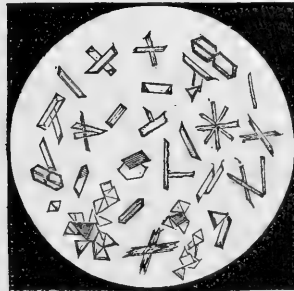
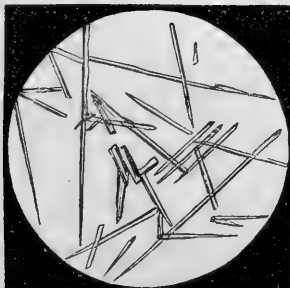
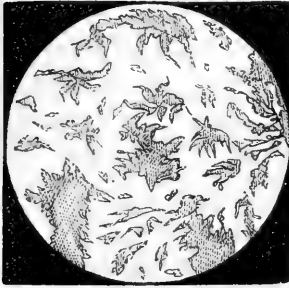

Crystals of sulphate of atropia,
30 diameters.

FIG. 14.

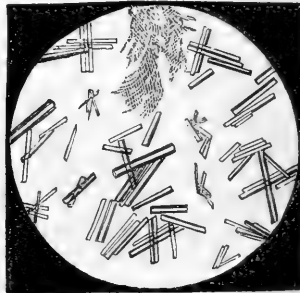

Crystals of daturia, 30 diameters,
p. 370.

substances which are taken or administered and act as poisons on the system, are detected by its aid. Various poisons are used as medicinal agents in the form of powder. Thus savine, foxglove, henbane, hemlock, nightshade, tobacco, and other plants are used in the form of powder. These may all cause death by being taken or given in large quantities. Chemistry in these cases is entirely unavailable and useless, but the microscope detects in the intimate structure of the various parts of the plants peculiarities by which their presence can be positively indicated. In a large number of cases coming before our criminal courts, not only is a knowledge of the crystalline structure of vegetable compounds under the microscope of importance, but also the structure of vegetable tissues. Poisons are frequently administered in the form of powder, and portions of the vomit or contents of the stomach being placed under the microscope, will by careful inspection be found to reveal the nature of the poison employed. We make no doubt that a much larger number of cases of poisoning occur amongst children from eating poisonous berries and leaves from gardens and waysides than are at present apprehended. In all cases where anomalous symptoms set in suddenly with vomiting, the vomited matter should be submitted to investigation by the microscope. The number of our native wild plants and in our gardens that are poisonous are not numerous, and every medical practitioner should be made acquainted with the structure of their tissues under the microscope.

Another curious set of cases in which the microscope is of

the utmost importance in our criminal courts is the investigation of the clothes and persons of murderers, and the suspected instruments of murder with the microscope. Here a knowledge not only of vegetable but of animal histology is of the greatest importance. The presence of a cotton hair or linen fibre, or a human hair upon a knife or other instrument, may by identity with the clothes or hair of a murdered person become a link in the chain of evidence. The presence of a human hair under a nail in the sole of a boot has connected the owner of the boot with the crime of trampling on the face of the dead person he has murdered. The examination of mud and dirt on clothes has connected suspected persons with the mud and dirt of the ground where persons have been found murdered. In a case near Hull the skilful microscopists of that town showed in the presence of peculiar forms of diatomaceæ on the sole of a boot that the possessor had been at the spot where a dead man lay murdered. Of all the applications of the microscope to criminal cases, the detection of the stains of human blood have gained the most interest in the public mind. Ever since the discovery of the persistent character of blood-globules the investigation of the nature of blood-stains has occupied the attention of microscopical observers. Unfortunately, however, for medical jurisprudence, the human blood-globule cannot always be distinguished from the blood stains of the lower animals. From a vast number of investigations, more especially those

FIG. 15.

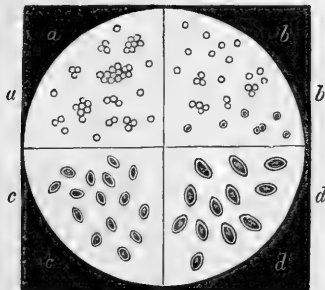

Blood-globules, 319 diameters.

a. Of the horse. *b.* Of the sheep. *c.* Of the common fowl. *d.* Of the salamander.

of Mr. Gulliver, the size of the blood-globules of a large number of the lower animals has been ascertained. Where the size or the form of the blood-globules of the lower animals differ much from the human globule they may be dis-

tinguished, but it requires a very practised eye to say to what animal a particular globule belongs. In the accompanying figures the size and form of globules of some of the lower animals are given approximatively.

The oblong forms of the globules of birds, reptiles, and fishes are the great distinction of the blood-globules of the classes below the mammalia. Size is the great distinction between the various groups of mammalia, but in some instances, as in the dog, their size approaches so near that of man, that it is difficult to recognise the difference. It is very evident that in the present state of our knowledge of this subject, great caution is required in giving opinions on facts where the lives of individuals are concerned. It is, however, a matter for especial regret that these subjects are not brought more systematically before the mind of the medical

FIG. 16.

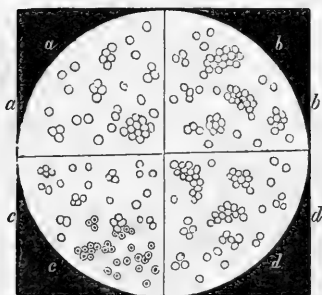
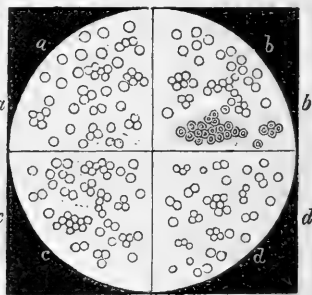

FIG. 17.



Blood-corpuscles, 319 diameters.

- | | | | |
|-----------------------|-----------------------|--------------------------|-------------------------|
| <i>a.</i> Of the cow. | <i>b.</i> Of the pig. | <i>a.</i> Of the dog. | <i>b.</i> Of the mouse. |
| <i>c.</i> Of the ox. | <i>d.</i> Of the cat. | <i>c.</i> Of the rabbit. | <i>d.</i> Of the ass. |

student in his ordinary course of study. It is on the medical man in ordinary practice that the law, through the Medical Witnesses' Act, throws the whole burden of making these investigations, and yet the law gives the right to men who have undergone *no examination on these subjects* to assume the position of witnesses on these important subjects in all our courts of law.

There are many other subjects connected with our law courts in which the microscope is an instrument of the greatest importance. Thus, in the present volume Dr. Taylor devotes a chapter to the subject of rape. Some of the most important points connected with this subject can only be made out by the aid of the microscope. The detection of spermatozoa in linen and on the person can only be done

by the aid of the microscope, and its use in the hands of those accustomed to its employment has supplied the most important evidence in these cases.

Even in the common-place cases which are occurring before us from day to day, where women are accused of destroying the lives of children by starving or improper feeding, the microscope may be used in discovering the nature of food found in the stomach, and thus to confirm or contradict the statements of the witnesses.

In past times the causes of sudden death have often been inscrutable to the medical witnesses in our coroners' courts, but now that the microscope has revealed pathological conditions inconsistent with life, the mystery of sudden death is frequently cleared up. This is more especially the case with that condition of the tissues of the heart known as fatty degeneration. A person dies suddenly, and to the naked eye no token is to be found that will account for death, but no sooner is a portion of the tissue of the heart no bigger than a mustard-seed placed under the microscope, than the deficiency of striped tissue and the presence of fatty matter at once reveals the cause of death. It is very obvious that any mere general inquiry into the causes of sudden death, or of persons found dead at the present day, without a thorough examination of the body after death by a skilled person, must be unsatisfactory, but it will also be seen that in a large proportion of cases, unless the medical witness who is called upon to make the inspection is thoroughly acquainted with the use of the microscope, his conclusions may be altogether erroneous. Just in proportion as the facts collected by microscopic observers are found to bear more or less on the causes of death or other incidents connected with our legal courts, is it important that the medical evidence should be given by men thoroughly instructed and competent to observe with the microscope. Dr. Taylor even raises the question in this work, as to whether it is possible to instruct the ordinary medical practitioner in such a way as to make him a reliable witness on microscopic points in a court of law. At any rate, it appears that the time is coming when encouragement should be given to the special education of a class of men who should be independent of all the calls of practice, and who, by their great knowledge of subjects involving microscopic examination, should be called in, in all cases where such acquirements may be required in cases before our coroners and criminal courts.

NOTES AND MEMORANDA.

Erratum.—Our esteemed contributor, Mr. W. S. Kent, desires us to make the following correction in his paper published in our last number. On page 397 of Vol. X, line 10 from the bottom, for “parasites of spicula” read “fascicles of spicula.”

Charts for recording Absorption Spectra.—Mr. John Browning of the Minories has, after much trouble, succeeded in getting a sheet printed in colours, giving seven coloured spectra of the size and appearance obtained by his micro-spectroscope. The position of the chief solar lines is marked, and the position and intensity of absorption bands may be put in with pencil or paint-brush. The sheets are sold at a very small price, Mr. Browning's object being to encourage the *recording* of observations. This he has further facilitated by his illuminated moveable scale, which he now fits to the micro-spectroscope.

Cheap High-power Objectives.—Mr. Baker of Holborn has become agent for the supply of the objectives made by Gundlach, of Berlin, and we have been favoured by Mr. Curties with several for examination. The glasses are remarkably cheap and well worth the money which they cost. The $\frac{1}{3}$ rd costing one guinea is a useful glass for general work; the $\frac{1}{8}$ th, at a little less than two pounds, is excellent, and fully equal to all requirements in histological work. At three pounds thirteen, a dry $\frac{1}{12}$ th, or an immersion $\frac{1}{16}$ th with corrections, is sold. These glasses require picking over before purchase, since some, especially among the $\frac{1}{16}$ th immersions, are not so good as others. The $\frac{1}{12}$ th with corrections, or at sixteen shillings less if without corrections, is the most to be recommended in the series. It is, for histological work, and for all purposes, but the resolution of the very finest tests, as useful as any $\frac{1}{12}$ th by our best makers. It is necessary now for the medical student and the naturalist to have higher powers at hand than the one quarter with which most are supplied. The difficulty of expense is removed by the low price of Gundlach's glasses, and now that Mr. Hartnack has been obliged to

leave his workshop in Paris, we know of none we can recommend so highly. We may mention that Dr. Carpenter has spoken to us very favorably of the $\frac{1}{12}$ th. The price of Gundlach's immersion powers is less than half what Hartnack charges for the same number; but we can not say that the specimens of Gundlach's immersions which we have seen at all equal Hartnack's. Probably some of Gundlach's higher lenses are very much better than others. A $\frac{1}{4}$ th, at five pounds eight, which we have examined, gave good working distance and light but was wanting in sharpness. We feel it is only fair to give all publicity to so laudable an attempt as that of Mr. Baker in introducing cheap glasses of high power to the English market; it must have a beneficial effect on the work of our own makers, and if insular prejudice can be removed, microscopists will find that their pockets are saved and their powers greatly extended by these admirable objectives.

New Work on the British Diatomaceæ.—Dr. Donkin, a valued contributor to this Journal, has undertaken to bring out with Mr. Van Voorst a 'Natural History of the British Diatomaceæ.' As yet only the first part has appeared, so that we cannot speak of the merits of the work. We hope in succeeding numbers to see more natural history in its wide sense.

Dr. Gumbel on Bathybius.—Reports have appeared in one or two English journals as to researches on Cocoliths and on Bathybius, by Dr. Gumbel of Munich. His results must be very much modified by the observations of Haeckel, of which we give a notice. Dr. Gumbel has asserted the occurrence of cocoliths in older sedimentary rocks than the chalk, and also has said that Bathybius occurs in shallow seas everywhere. No evidence of these facts has, however, been given of a detailed kind.

The Government Investigation of Cholera-fungus.—Dr. Timothy Richard Lewis, one of the commissioners recently appointed by the Government to study cholera in India, and who first of all proceeded to Halle and Jena to make himself acquainted with the views of De Bary and Hallier, has produced a very beautiful set of drawings (published by the Indian Government) of appearances, fungi, epithelium, and various other structures, seen in cholera-stools and in fungus-cultivation experiments. He gives no very positive conclusions, but lays his evidence fully before the public in a most creditable manner. The summary of these experiments given by Dr. Lewis is, however, not favorable to the views of Hallier.

Rhizopods in London.—

“Animalia muta

Quis generosa putet nisi fortior...?” *Juven.*, Sat. viii, 56.

Many who could easily afford means and leisure for a microscope, perhaps have never heard of, or seem entirely to ignore the very existence of those singular creatures which go under the name of root-footed animals, or Rhizopods—a rather puzzling, though very interesting class of Protozoa, that seems to point to the very dawn of life. Borrowing for themselves the silly sentence of the Roman satirist, quoted above, “What are they to us?” they would say, “these paltry creatures! these helplessly weak animalcules, in which we do not see a spark of life, no vitality, no animation at all? Go, we shall have nothing to do with them!” Such is their peremptory answer. Yet a fresh current of better feelings in favour of these admirable creatures seems to be setting in, since the indefatigable Mr. Archer of Dublin has called the attention of his brother microscopists to that special group of freshwater Rhizopods which, whatever may be the object of our researches, rarely fail to come under the field of the microscope.

A great difficulty, however, which still remains to be surmounted in order to render their study more attractive, is,—“How to get at them?” It is all very well for the sanguine correspondent of the ‘Quarterly Microscopical Journal’ to ask,—“How it is that we do not hear of any of Mr. Archer’s beautiful forms from English localities?” Unless we can show our tryo-microscopists some easier and more alluring way to procure them, without travelling far off from home, and being obliged—what is perhaps worse and more discouraging still—to tread upon treacherous bogs, and dabble in slimy pools, they will hardly be enticed to set their hands at work, and carry it on in earnest.

When Dr. Wallich, some six or seven years ago, had noticed first the occurrence, in the immediate vicinity of this metropolis, of a certain undescribed sort of *Amæba*, which soon turned out to be the “great shaggy changeling,” (*A. villosa*), a good deal of interest was awakened amongst the brotherhood of the microscope. That such an interest will not fail to be felt now that another not less amusing sort of *Amæba* has just been, and is yet easy to be found, not only in the vicinity, but within the boundaries of this same metropolis, yea, I dare say, in any private garden, in any domestic pailful of water, is my hopeful idea.

The new *Amæba* I am alluding to is that much wondered at, and really suprising sort of animalcule which like a

mole-cricket or a particular garden-mollusc (*Testacella*) seems mostly to enjoy its life when it is buried underground; from which odd manner of living the German doctor, Richard Greef, who claims to have first brought it to light from its earthly grave, thought himself entitled to name it *A. terricola*. Were we allowed, not indeed to coin a new word, but simply to make use of a rather old one, we should call it in English, the land or ground OAF.

The ground it chooses in preference to live in, and where one is pretty sure to find it at home, is that covered with deep green *prothallium*—a confervoid expansion, consisting of newly-formed cellular structure of either mosses or lichens, commonly found along damp banks. Garden walks, too, where they are left alone for a short time, have such green patches, ordinarily made up of *Microcoleus repens*, Harvey, or of that blackish phormidium, which is only a first stage of the beautiful *Oscillatoria autumnalis*, Ag.

Now, having chosen one of these dark spots in Victoria Park, for sake of experiment, I found, besides several other curiosities, what Dr. Greef would probably have styled a new *Land Amœba*; but I must confess that it was no novelty to me; nay, a rather old acquaintance, which I had met some years since in Leicestershire; easily obtained by simply straining a few branches of *Anacharis alsinastrum*, that were there floating on the surface of a pond.—The rather rare *Ochlochæte hystrix*, was abundantly growing epiphytically on its leaves.—It was on this occasion that I got acquainted with the problematic *Corycia* of Dujardin, a genus which from that time I study *con amore*, believing that it will soon be admitted to a special rank distinct from other amœboid rhizopods, and form, as Claparède has foretold, “un genre à part,” to which Greef’s *A. terricola*, with Auerbach’s *A. bilimbosa*, and others, that may still be discovered of this kind, will probably be referred.

For those who have not yet acquired the practical knack of managing, *comme il faut*, such uncouth matter as is that which is surrounded, I have said, with *Prothallium*, or *Oscillaria*, I would suggest to try, as I did, at first a single green tuft of tree-moss or wall-moss. Whilst musing some time ago in Highbury Park, the fancy came to pluck out of a wall there a pinchfull of mixed-up silver and screw-moss (*Bryum argenteum*, et *Barbula muralis*). This I steeped in water, when I came home; and I had soon the satisfaction to see, out of that stuff, a cloudy amœboid form, much like Greef’s *A. terricola* (fig. 1), *in ruhenden und contrahirten Zustande*. Nor was it there alone; but concealed within the

same stuff, and probably feeding on the succulent rootlets of the mosses, were several, at first contracted and sluggish, but soon merrily wheeling rotifers, with some anguilluloid *Nematoidea*, and many other undescribed inhabitants of the microscopical ocean. A uberous field, a very rich mine indeed, this new underground searching, worth working by all means!

It is not for me to give here a strict account of all I have discovered this way. This I may be able perhaps to do another time. Suffice now to call your earnest attention to that "startling novelty" (as Dr. Fripp, who has so thoughtfully and wisely commented upon this subject, likes to call it, which the Privatdocent of Bonn has more than sufficiently described and wonderfully sketched.

What I wish now particularly to tell you is, that the same, or, after all, a very similar form of the would-be *A. terricola* has been, and is yet easily to be found in the very water we use to drink. The 15th of this month (Nov.) I tried, for the first time, a somewhat troubled *residuum* of water, that was at the bottom of a jug-ewer, which had previously been filled with that common water-supply that issues from the water-works at Stoke Newington. Nothing was there appearing at first except a few straggling infusoria, and heaps of all sort of dust; all around it looked still dead and motionless; but, after a while, some flaky lumps of sarcode (they generally stick upon shreds of dust, or decayed fragments of vegetable or animal organisms, and are thus overlooked) began to move on, slowly, and to change shape and place by degrees; then, rousing their inmost energy, the lazy creatures commenced to unfold fan-like, snowy white sheets, and glide along, skimming the thin film of water which, to their tiny rafts, is what the expanse of a lake, or of a sea, would be to a sailing vessel.

With a good $\frac{1}{4}$ -objective, accurately focussed, you might easily have seen the endosarc carrying in its flowing currents several many-coloured granules (where the garnet-reddish and yellowish ones come from I am puzzled to tell, though I suspect some may perhaps come from decomposed chitinous substance, such as may easily be the case with the elytrae of dead coleoptera). Carried by the same stream, you might have seen here and there an oval roundish body of a slightly bluish colour (encompassed, as some believe it to be, by a transparent capsule; it appears sometimes as if surrounded by a brilliant red-looking ring, which I suspect is only a mischievous, however pleasing, play of light). This is the *nucleus*, that all-important germinal portion which goes to

propagate the species. It is often, however, buried under the flowing matter, and thus turned away from observation—nay, sometimes it is utterly wanting, viz., when it has burst already within the uterus of the mother amœba, as Dr. Greef has observed, and scattered therein its sarcoblasts, or rife germinal vesicles.

One might also easily have seen the pinkish “contractile vesicles,” spaces, or chambers, or, as some prefer to call them, “pulsating vacuoles.” The most conspicuous and apparently most energetic ones were there in the rear, guiding, as it were, and propelling with their normal and rhythmical diastolic and systolic action the sailing mysterious vessels. To watch them properly one must get accustomed to their movements. (See Lankester’s figures, ‘Q. J. M.,’ vol. x, pl. ix, fig. 6.)

After all this, I had no doubt indeed that my water creatures were truly representative, if not precisely the same, of Greef’s, *A. terricola*. The only apparent difference was a comparatively smaller size, and a less prominent feature, of what he calls “Zottenanhang,” or villous appendage, which, even according to Wallich’s observations, seems to occur but occasionally. Both differences, however, may easily be attributed to the want of power in the microscope.

Besides, I should observe that, notwithstanding Greef’s assurance of his having found “die Thierchen im trochenen Sande,” or, as his commentator has translated, in the *driest* earth or sand, this very earth and sand was, to use again his expressions, “unter Mossen und fletchen,” that is, under never-dying cryptogams, which, “largely sharing of the dew of heaven,” do always maintain a considerable degree of moisture, wherein the amœbæ can easily live safely, if not fully develope.

Again, the skilful German doctor could hardly have brought his cumbrous earthy stuff within the range of the microscope, in its dry state, without having it previously bathed in water, or otherwise disposed of in *wet* chambers. Thus much he seems freely to avow, where he says that he had his “Thierchen unter wasser aussetzt,” and covered “vermittelst einer Deckergläschen.” Now, this refreshing and *re-creative* bathing is just what the benumbed creatures require to be roused from the dormant condition, which they are probably living in, whilst kept under ground. After which arguments in favour of the *amphibious* nature of these creatures, I would invite some better and more competent judge—and they are so many amongst the learned members of both the Royal and the Quekett Microscopical Societies—

to take in hand and re-examine this subject, since this can be done so easily. The water and earth which is wanted for the experiment is readily found everywhere and at any time within the ever-extending boundaries of this metropolis. If, then, the new experimentalists come to the same conclusion, I would leave them to decide whether Greef's *Amœba* be or not entitled to its assumed name of *terricola*.

About the other two forms of *A. granifera* and *gracilis* I am quite disposed to agree with Dr. Greef, as far as the amœboid nature of the creatures is concerned. Their *flowing*, for a practical eye, readily distinguishes them from the *sailing* habit of the *Corycia*. Forms, however, like these will easily be discovered, as I am convinced by experience, in the same London water, especially the *A. gracilis*, which is an extremely minute form, the opposite pole, I would say, of the comparatively gigantic *A. villosa* of Dr. Wallich, which, however, has the same nature.

A very singular discovery, owed entirely to the ingenuity of our German doctor, is that quaint double form of *Amphizonella violacea, digitata*. As to his *A. flava*, I am rather inclined to consider it as another form of *Corycia*, scarcely differing from *C. Dujardini*.

Thus I would consider Greef's Fig. 13 (*Amœba brevipes* 'in der Theilung begriffe') as a mere incomplete stage of *Amphizonella digitata*.

I should not wonder so much at his having found a dead and empty test of *Arcella arenaria* (?) as I really do at his having found it living, not only, but protruding such a mass of sarcode, as is rarely the case with the fresh-water Arcellæ.

JOSEPH GAGLIARDI.

P.S.—For those who are not well acquainted with Dujardin's genus *Corycia*, we beg to subjoin his diagnosis:

"An amœboid being covered by a very expansible, elastic, flexible membrane or sac, which becomes folded in different directions by the movements and contractions or expansions of the animalcule. The whole organism sometimes, after it has several times turned on itself, looking like a folded piece of linen.....The contents consist, besides sarcode, of granules, vacuoles and forming particles; the first named move in currents from one part to another. The expansions are not pushed forward, nor do they glide along the surface of reptation like those of *Arcellina* or of *naked Amœbæ*; they proceed from various points of the general mass or body, and seem to serve rather to change the centre of gravity than to furnish a *point d'appui*.

“The name (a diminution of *χόρυχος*, sacculus, marsupium) is suggested by the membranous envelope, which preserves the animalcules from being dried up during the alternations of dryness with moisture, which they are exposed to by their *habitat in mosses*. (Hence there is a very small step to Greef’s *habitat under mosses*.) They are procured by lightly pressing the *Jungermannia*, moistened by the rains of November or December, or after they have been preserved a little time in water.”

The objects must be watched in their living state to be thoroughly appreciated. We can give here only a brief account, as an aid to other microscopists to look after them.

Researches on Rhizopods.—Dr. Fripp, of Bristol, gives in a late number of the proceedings of the Natural History Society of that city, a most excellent account of Greef’s researches on terricolous *Amœbæ*.

An extensive memoir on *Amphizonella* and other new rhizopodous forms, from the pen of Mr. Archer, of Dublin, is ready for our April number. We are compelled to postpone its publication owing to an unfortunate delay in executing the coloured plates accompanying it.

QUARTERLY CHRONICLE OF MICROSCOPICAL SCIENCE.

Histology. NERVE.—*Endings in Smooth Muscle.*—W. Krause (Reichert und Reymond's 'Archiv,' April, 1870) describes the nerve-endings in the rectococcygeus muscle of the rabbit. Hénochque ('Archives de Physiologie,' May, 1870) describes the same in the muscular wall of the bladder. Both authors describe the end-organ as a swelling. Krause says with three or four nuclei, easily distinguished from the proper muscle nuclei; Hénochque says the swelling is frequently placed near the nucleus of a smooth muscular fibre. Krause remarks that whereas in striped muscular tissue each fibre has its own end-plate, in the smooth hundreds of muscle-spindles are dependent on one end-plate. This is as we should expect from the comparative structure of the striped fibre and the smooth cell.

Endings in Glands.—Krause (Reichert und Reymond's 'Archiv,' April, 1870) cannot confirm Pflüger as to the nerve-endings in the cells of salivary glands. He is of opinion that the use of weak acid in preparing gland-tissue may, owing to the properties of the albuminoid constituents of the tissue, produce altogether erroneous results.

Tactile Hairs of Mammalia.—Odenius, who recently investigated this point of histology, has stated that the nerves of the tactile hairs ended, after becoming non-medullated, with terminal enlargements in the homogeneous layer of the papilla. In the annular swelling around their bases he was unable to find any nerves, and considered that it fulfilled only a mechanical function. In a paper in the 'Centralblatt für die medicinischen Wissenschaften,' Dr. R. Burkart states that the annular swelling consists, in the hairs of the muzzle of the mouse, guinea-pig, rabbit, and cat, of finely-fibrillated connective tissue, containing cells in its fine meshes. By the aid of a method which he intends shortly to publish, he has been able to stain nervous tissue of a bluish or coal-black tint, without modifying the connective tissue, gland substances, &c. The agent employed is perosmic acid; and he has ascertained not only that the annular swelling is sup-

plied with nerves, but that the source from which it receives its nerves is the innermost part of the compact layer of the papilla.—*The Academy*.

A paper, most beautifully illustrated, on the hairs of the bat's wing appears in the first part of Schultze's 'Archiv' for 1871.

CONNECTIVE TISSUE.—*Cornea*.—A writer in the 'Academy' gives the following account of Schweigger-Seidel's views on the lymph-spaces of the cornea, which was briefly mentioned in our last chronicle.

By the action of certain reagents on the cornea there are brought into view, under the microscope, a series of irregularly stellate, multiramified, and nucleated bodies, which have been hitherto regarded as essential constituents of the corneal tissue, and are known as "connective-tissue-corpuscles." These corpuscles appear under the microscope dark on a light ground, and have received the further appellation of "positive images," to distinguish them from a series of negative images, appearing light on a dark ground, which are observed when the cornea is treated with nitrate of silver, and which were discovered by Recklinghausen. The negative images exactly resemble the positive in form, and are considered by Recklinghausen to be spaces from which the lymphatic canals take their origin. He calls them "Saftkanälchen," and has described other similar ones in the central tendon of the diaphragm. He further considers that the connective-tissue-corpuscles lie within the "Saftkanälchen," each process of the former being contained within a corresponding process of the latter. Schweigger-Seidel, who has already combated the reality of the "Saftkanälchen" of the diaphragm, brings forward evidence to prove that the negative images are not spaces, but masses of albuminous substance, and that they are identical in nature with, and not external to, the positive images. Further, both these images are not due to any structure pre-existing in the cornea, but are artificial products caused by the action of the reagents employed. Since the cornea corpuscles have been made use of by Stricker and others as a means of investigating the changes produced by inflammation, these observations will have a special interest for pathologists.

Schweigger-Seidel believes in the existence of interstitial spaces from which the lymphatics originate, and has succeeded in injecting a series of wide anastomosing canals into the cornea, confirming Bowman's and C. F. Müller's results in this matter. He finds that the deeper side only of these canals is lined with an epithelium. The cells composing

this are flat, join one another by broad edges, and closely resemble those lately described by Ranvier as existing in the tendons ('Quarterly Journal of Microscopical Science,' Oct., 1870). A more intimate connection is thus shown to exist between the structure of the cornea and that of ordinary connective tissue.

Under the flat epithelial cells lies a gluey albuminous substance which also extends into the interspaces between the felted fibres of which the mass of the cornea is composed. It is the aggregation of this substance in irregular masses round the nucleus of the superincumbent cell under the influence of reagents, to which the positive and negative images are due. Schweigger-Seidel has further discovered a remarkable geometrical structure in Descemet's membrane, or the posterior elastic layer of the cornea, which is brought into view by the use of a solution of common salt as a reagent.

Connective Tissue of the Brain.—Signor Golgi (in 'Rendiconti del R. Istituto Lombardo di Scienze e Lettere,' ser. ii, vol. iii, fas. vii, p. 3) has been making some interesting investigations on the structure of the brain after maceration for twenty-four or forty-eight hours in osmic acid. Thin sections thus treated exhibit numerous stellate cells, the protoplasm of which gives off a variety of branches, some of which anastomose with those of other cells, whilst others are lost in the grey and finely-granular neuroglia; and others again, and these are the most numerous, pass to the walls of the capillary blood-vessels and larger lymphatics. He makes the observation that in such sections the brain substance is seen to be in immediate contact with the vascular walls, no intervening space being visible, as in preparations that have been treated with bichromate of potash. This has an important bearing on the histology of the brain, since Eberth, His, and others have regarded these spaces as the lymphatics of the brain. The anastomosing connective tissue cells above described are most abundant near the surface of the brain, and they gradually diminish in the deeper parts, so that in the region of the ganglion-cells, and still more of the white substance, they are very sparingly present.

Development.—*Parthenogenesis in the Pupa state of Insects.*—In vol. xv, No. 8, of the 'Memoirs of the Academy of St. Petersburg,' M. O. von Grimm describes a curious instance of Parthenogenesis in a species of the dipterous genus *Chironomus*. Like the well-known case of *Miastor*, discovered by Professor Wagner, this is an example of reproduction by an insect in one of its preparatory, and therefore sexless

stages, called *Pædogenesis* by Von Baer. The formation of the egg-like reproductive bodies commences in the larvæ; but the eggs are not extruded until the insect has passed into the pupa state. It appears that in the spring the larvæ, produced in the ordinary way from eggs, grow rapidly, and after the third change of skin attain their full size, and show distinct traces of the pupa within them. The eggs are produced direct from the pupa in this condition. In the autumn the course of development during the preparatory changes is precisely the same; the pupa, however, changes into the imago, which deposits the eggs, probably after copulation, in the ordinary manner. The mode of development of the eggs and ovaries, and that of the embryo in the egg, are described by the author at considerable length, and illustrated by good figures. The eggs are developed in the same way, both in the spring and in the autumn, although in the one case they will be deposited by the pupa, and in the other by the imago; and as they present no difference in their structure, the author regards them all as eggs, and rejects the distinction into *ova* and *pseudova*. He seems inclined to adopt the notion that the supposed cases of parthenogenesis may be due to self-fecundation.—*The Academy*.

Young Stages of the King Crab.—It is hardly to the credit of our American brother naturalists that the development of the interesting and peculiar form *Limulus* has hitherto not been worked out by them, seeing that they are favoured by its presence in abundance on their coasts. Mr. Lockwood and Dr. Packard have made a step in the right direction by observing the later changes which the embryo undergoes. They find that in accordance with Haeckel's law of individual development epitomising palæontological development, the young *Limulus* agrees in its form with those palæozoic allies of the genus which have been worked out by Mr. Henry Woodward. These writers, whose observations appear in the 'American Naturalist,' do not, however, appear to have worked at the earlier developmental changes, at the various coats of the embryo in its successive periods of intraovular development, which have a surpassing interest at this time in connection with Dr. Anthon Dohrn's and Dr. Edouard Van Beneden's researches and speculations on the phylogeny of Arthropoda. The eggs are said to possess great vitality—would it be possible to obtain some in this country? We shall be very glad to enter into correspondence with any one who will suggest a means of obtaining, or undertake to procure a supply of these ova.

Microzoology. The Siliceous Sponges.—Dr. Oscar Schmidt

has brought out a large memoir on the Sponges of the Atlantic bottom, in which some new forms of siliceous sponges are described, and the characters of others given. Mr. W. Savile Kent, of the British Museum, dredging in the Norna with Mr. Marshall Hall, and using his eyes in the museum of Lisbon and elsewhere, has this year added greatly to our knowledge of these forms. It will be remembered that much interest was excited by the discovery by Dr. Thomson of *Holtenia*, an ally of *Hyalonema*. Mr. Kent has added a new species to each of these genera, showing also that *Holtenia* is probably the *Pheronema* of Leidy. He has also discovered two new genera, *Askonema* and *Dorvillia*, belonging to the same group, of which he has read an account to the Microscopical Society. Two other genera, not so closely allied to *Hyalonema*, have also been discovered by Mr. Kent. We subjoin his list of this interesting and beautiful group of sponges, characterised by their hexradiate spicula.

Order HEXACTINELLIDÆ. Oscar Schmidt.

Sponges with a siliceo-fibrous or siliceo-spicular skeleton. Spicula of the hexradiate-stellate type invariably present.

Sub-Ord. I. CORALLIOSPONGIÆ. J. E. Gray.

Sponge body supported by an anastomosing or continuous reticulate skeleton. Reproductive gemmules entirely membranous, aspiculous (?).

Gen. <i>Euplectella</i> , Owen.		Gen. <i>Aulodictyon</i> , W. S. Kent.
<i>Habrodactylon</i> , Wyv. Thomson.		<i>Macandrewia</i> , J. E. Gray.
<i>Aphrocallistes</i> , J. E. Gray		<i>Dactylocalyx</i> , Stutchbury.
<i>Farrea</i> , Bowerbank.		<i>Fieldingia</i> , W. S. Kent.

Sub-Ord. II. CALLICISPONGIÆ. W. S. Kent.

Sponge body supported by an interlacing or isolated spicular skeleton; never by a reticulate and continuous one. Reproductive gemmules membranous, furnished with protective spicula (?).

Gen. <i>Pheronema</i> , Leidy.		Gen. <i>Lanuginella</i> , Oscar Schmidt.
<i>Hyalonema</i> (et <i>Carteria</i>), Gray.		<i>Vazella</i> , Gray. (<i>Holtenia</i> pars, Oscar Schmidt).
<i>Askonema</i> , W. S. Kent.		
<i>Sympagella</i> , Oscar Schmidt.		<i>Dorvillia</i> , W. S. Kent.

Microbotany. *Diatomaceæ*.—Count Castracane has lately been engaged sifting and classifying the new forms of diatoms he discovered in the muddy deposits of the Atlantic dredging.

He is soon to read a paper on this subject, at the first meeting of the Academia dei Linnei at Rome. Whether, however, he will do so, owing to the recent changes there, we cannot say. This year he passed a good part of his vacations at Falaise with the famous French naturalist Brébisson, comparing notes with him, to ascertain the genuineness of the species he intended to photograph. At the annual meeting of the Linnean Society of Normandy at Valogne, he went with his friend, and was glad to meet there, amidst other celebrities, his brother academician Le Foly, who proposed him in turn, and had him named a correspondent member of the Société des Sciences Naturelles. Leaving Falaise, after another week, he was determined to visit Belgium, Holland, and Germany before returning home. At Paris he joined his friend l'Abbé Carnoy, a distinguished microscopist, and they went together to Nieuwport, where they gathered important materials, amongst which was the beautiful *Aulacodiscus margaritaceus*, a new species of *Halionyx*, and several other curious diatoms. At Anvers he joined another friend of his, J. Gautier—a prodigy, he says, of memory. Hence he went to Haya in Holland, visiting Professor Ardemans in Amsterdam, Artig in Utrecht, Swingar in Leyden, and other scientific friends on his way back to Paris, where, having been dissuaded by his friends from going to Berlin whilst the war was on foot, he lastly resolved to go home through Marseilles, Toulon, and Nice, where he filled up his gatherings for the winter work.

PROCEEDINGS OF SOCIETIES.

DUBLIN MICROSCOPICAL CLUB.

29th April, 1870.

REV. EUGENE O'MEARA exhibited specimens of *Gomphonema balticum* (Cleve), kindly supplied to him by Herr Cleve himself, there being, therefore, no possible doubt about the identity of the form. The point to which Mr. O'Meara wished, however, to draw attention was that there existed well-marked transverse striæ, as well as a central nodule, characteristics which are not described nor figured by Cleve, so that his account of this species requires this important correction.

Mr. Archer exhibited several Desmidiæ rarely met with, and one at least new, taken on a recent visit to Kylemore, County Galway, in company with Professor E. Perceval Wright. Amongst these was to be noticed *Sphærozozma secedens* (de Bary), a form not yet recorded, so far as Mr. Archer was aware, by any other observer, nor hitherto detected by himself. Though referred to the genus *Sphærozozma* by de Bary, this form belongs properly to de Brébisson's genus *Spondylosium*. On this latter genus de Bary makes no further comment in his work ('*Untersuchungen über die Conjugaten*') beyond simply quoting de Brébisson's original description in Latin ('*Liste des Desmidiées observées en Basse-Normandie*'), and adding the remark, "unknown to me." The minute connecting processes between the joints characteristic in *Sphærozozma* are wanting in *Spondylosium*, and, simple as this distinction may be, it yet seems to be of value, and even Dr. Wallich seems to have seen the necessity for such a genus when he instituted the genus *Leuronema* ('*Ann. of Nat. Hist.*, 3rd ser., vol. v, pp. 186 and 193), which corresponds nearly completely with *Spondylosium*, to which name Dr. Wallich's must, therefore, seemingly give way. It is true, indeed, that some of the described forms referred to *Leuronema* (Wallich) are three-angled in transverse view, whilst others, like the known European and British forms, are plane. Still, even the three-angled forms could not be correctly kept out of the genus *Spondylosium* on that ground merely, just as we have compressed as well as angular species in the genus *Desmidium*, and even in *Staurastrum*. There could be no doubt of the identity of the form now shown with that of de Bary; if there was any difference traceable it would be the slight concavity shown in his figure at the top or end of the segments was less expressed in the present specimens.

Another desmid new to Britain, shown by Mr. Archer, from the same locality, was the form designated by Prof. Wittrock *Staurastrum*

læve, var. *Clevei*. Side by side with the examples Mr. Archer showed that author's figure ("Anteckningar om Skandinaviens Desmidiaceer," Upsala, 1869, p. 18, fig. 9, *a* and *b*, in 'Nova Acta Societ. Upsal.,' vol. vii), which is excellent, and leaving not the smallest doubt of the identity of the two forms. Whether, indeed, the very elegant form in question might or might not really more correctly be regarded as quite distinct from *St. læve* (Ralfs), Mr. Archer felt unable to do otherwise than leave the point in abeyance, as it would be premature in him to venture to speak decidedly, as he had not yet had an opportunity to see veritable examples of the typical *St. læve* (Ralfs); still, he suspected they would prove distinct. The present form is an exceedingly elegant one—indeed, far prettier than one might think from the figure merely.

Mr. Archer also showed examples of Dr. Barker's new *Staurastrum*, first detected by him at Glengariff, and called *St. elongatum* ('Minutes Dubl. Micros. Club,' in 'Quart. Journ. Micros. Sci.,' vol. ix, n. s., p. 424). The specimens now exhibited from Kylemore, Connemara, though comparatively few, were more numerous than they had occurred in any gathering made at Glengariff. It must, however, be accounted a rare and scanty form, and, so far as experience goes, seeming confined to our western districts.

Mr. Archer likewise showed a new species of *Euastrum*, from Kylemore, County Galway; this he had taken on a former occasion at Glengariff, but he had not had an opportunity to exhibit a specimen, nor did he record it pending seeing the figure of Professor Cleve's *Euastrum intermedium*. Thanks to that gentleman, he possessed a copy of his paper, and there could hardly be a doubt but that the present form was quite distinct therefrom. The forms which most resemble the present are, however, undoubtedly *E. intermedium* (Cleve) and *E. ansatum* (Ehr.); this latter common species Mr. Archer exhibited side by side for sake of contrast and comparison. It would be of little value to give here a description of this form, unaccompanied by a figure. This he would postpone for a little, till time permitted to put together this and a few other new forms he had in view. It would suffice here to mention that the thickened prominences on all the protuberant parts, and the thickened rounded elevation on each front surface of the segments, which are dotted, coupled with the small size of this form and its broadened depressed segments, all combined, would render it not readily to be mistaken for any other described *Euastrum*.

Professor E. Perceval Wright desired to mention that on microscopical examination of a section of the so-called *Myreosteon Higginsii* (Gray) the organism appeared to be some part of the bony skeleton of a fish.

Dr. Pearsall exhibited slides containing material taken from the stomach of a trout from the Annamoe River, Co. Wicklow. Some spicules were noticeable, also various diatoms. Amongst the latter Mr. O'Meara identified *Himantidium undulatum*, *Navicula rhomboides*, and *Tetracyclus emarginatus*, which last, he said, was of very rare occurrence in Ireland, never himself having taken specimens.

Mr. Archer desired to record the occurrence near Kylemore, County Galway, of the remarkable and curious organism of "Labyrinthulean" affinity, first detected in, as yet, but a single pool only in the County Westmeath (and briefly referred to in the minutes of the Club in this Journal, vol. x, n. s., p. 303); this station at a distance of close on 150 miles from the first at which it was found, thus widely extending the limits in Ireland of this form. It is possible, indeed, now that we know this production so far as to recognise it when seen, that it may be more common and widely-spread than we might suppose from its having been encountered in as yet but the two localities; these are, as is seen, however, widely remote. It would be of little value to expatiate here, further than has already been done, without figures, upon this singular form, beyond a mere record of a new locality, as to do so would require more space than could be available in Minutes like these, as well as reference to Cienkowski's account of the marine forms, to which the present offers so much resemblance, of an opportunity to do which, however, Mr. Archer hoped to avail himself on some future occasion.

19th May, 1870.

Dr. John Barker exhibited a piece of apparatus contrived by him for the purpose of catching atmospheric dust for microscopic examination, consisting of fanners enclosed in a tube, worked by a handle at the side, these destined to carry removable slips of glass, moistened with glycerine, in order to retain the deposit.

Dr. Barker also exhibited examples of an *Ædogonium*, doubtless *Ædogonium punctato-striatum* (de Bary), distinguished by the cell-wall being marked by spiral striæ of a dotted character, these finely and closely set; these seen in an empty cell, through and through, the upper and lower striæ being nearly in focus simultaneously, presented a somewhat decussate appearance. The examples now shown were not in fruit, rendering it impossible to say whether this characteristic of the filament itself accompanied any speciality of the fertile condition.

Mr. Crowe presented examples of *Stephanosphaera pluvialis*, accompanied by *Uvella*, from the Bray-Head Station—always pretty objects—the former interesting, as no further station had as yet been found in Ireland. Surely it cannot be restricted to that single locality, however?

Dr. Moore exhibited examples of a confervoid growth of a reddish colour, growing in tufts on the apices of the leaves of *Hypnum stramineum*, and having much of the appearance of a distinct alga, the moss with these appendages presenting a remarkable appearance. Notwithstanding, however, their seeming want of affinity with the moss upon which these tufts of filaments were attached, and the striking constancy with which they were confined to the extremities of the leaves, it is most likely they were truly protonematous growths, probably derived from the *Hypnum* itself by germination of spores, or—from the chances against the spores always alighting at the ends of the leaves—could they, on the other hand, be terminal

cells themselves, giving off these filaments, just as some mosses can give off buds, a supposition favoured by their constancy of situation? The septa between the joints were oblique, the cell-wall reddish, thus agreeing in character with certain "protonemata," and antagonistic to the assumption that this was an independent algal growth; but still it so may be, and in this latter view Dr. Moore was inclined to acquiesce.

Mr. Woodworth exhibited some fine micro-photographs which had been sent him from America by Colonel Woodward, executed by that gentleman, including (on various scales) the whole of Möller's type-slide of 100 diatoms, and all very sharp and beautiful.

Rev. E. O'Meara showed a slide of diatoms from African guano, supplied to Mr. Early, of the Chemical Laboratory, Trinity College. The material was cleaned by incineration, a process which in this case was most effective. Amongst the forms presented was a fine specimen of *Coscinodiscus Mossianus*.

Mr. Archer showed examples of *Staurastrum maamense* (ejus), and of *Micrasterias fimbriata* (Ralfs), both rare, and found in the recent gatherings from Connemara. The former is, as yet, altogether western. The latter occurs very scantily, and only seldom encountered, in County Wicklow and in County Westmeath.

23rd June, 1870.

Dr. Moore showed a preparation of the "collecting hairs" clothing the filaments of the stamens of a species of *Bulbenia*, forming a pretty and interesting object. These hairs presented a dense mass radiating from the "filament" all round, of considerable length, unicellular, and terminating in a somewhat clavate extremity, their walls marked by finely set, closely wound, spiral striæ. These latter, when viewed on a hair much collapsed, and then seen simultaneously on both upper and lower surfaces, presenting a decussate appearance. It could not be well made out whether these spiral striæ were due to a spiral marking or structure in the cell-wall, or to secondary fibres. Whether viewed under a low power as a whole, or more magnified to see the striæ, this formed an exceedingly pretty object.

Mr. Archer presented several examples of the conjugated state, showing the zygospores, of *Staurastrum furcigerum* (Auct.) = *Didymocladon furcigerum* (Ralfs). This had never before been recorded, although this fine species, whilst never abundant, is seemingly not amongst the rarities. The zygospore is rather large compared to the dimensions of the pair of conjugating cells in this species, orbicular, beset (but not very closely) by rather long and slender spines, these broadest at the base, whence they quickly taper into a linear shaft, and they are twice or thrice branched at the apex. Thus they are not exactly like those of any already known species, and they form a singularly elegant object.

Dr. Traquair showed preparations of the scales of *Calamoicthys*, being various sections well calculated to show the histological details,

and were those illustrative of his recent paper on this subject in the 'Annals of Natural History.'

Dr. Purser exhibited two microscopes—one by Nacet, the other by Hartnack—his principal object being to show the immersion lenses of those makers, which have gained so great a celebrity on the Continent. Dr. Purser claimed that they admit more light, have a greater working distance, and require much less pains in the illumination, than non-immersion lenses of the same power.—Dr. Purser likewise exhibited a stage upon which objects could be kept at an elevated temperature whilst under examination. He further showed some preparations illustrative of the use of chloride of gold and nitrate of silver in histological research.

Mr. Archer drew attention to the most abundant gathering of the unicellular alga, *Polyedrium lobulatum* (Näg.), he had met with, noteworthy, perhaps, as this not uncommon form generally occurs seemingly rather isolated. From another gathering he showed uncommonly large examples of a *Polyedrium*, more approaching the more rare *Polyedrium tetraedricum* (Näg.), but the angles more rounded, and without spines. It may remain a question if this be really a distinct thing. Only for its (comparatively) large size (about $\frac{1}{300}$ " in diam.) one might be inclined to regard this as *Polyedrium muticum* (Al. Braun), which, however, is recorded as only $\frac{1}{75}$ mm. in diam. (Al. Braun, in 'Algarum unicell. Genera nova,' &c., p. 94, in note).

Dr. Moore showed the beautiful and curious aquatic moss *Conomitrium Julianum* in various stages of development, which made very interesting microscopical objects in a young state. When the calyptra almost envelopes the whole capsule the bright purple teeth of the peristome are seen through it to good effect, and when more advanced and the calyptra removed the pyriform capsule with pointed lid is also a pretty object. Dr. Moore mentioned that he was indebted to W. Wilson, Esq., of Warrington, the veteran muscologist, for the possession of this rare moss, which he was cultivating successfully in one of the small conservatories in the Botanic Garden, in a jar filled with water. From his experience he believed it would be most valuable for cultivating in small fresh-water aquaria, in a similar manner as *Fontinalis antipyretica* or *Cinclidotus fontinaloides* are now grown, but much prettier than either.

21st July, 1870.

Mr. Crowe showed a *Cosmarium* from near Multyfarnham, which seems most likely to be new; it may be said to be medium-sized, its segments elliptic, longer than broad, rough with minute pearly granules; end-view circular; constriction shallow, acute. This is rather a difficult form to decide upon; it resembles somewhat *C. amœnum*.

Mr. Archer mentioned he had taken this *Cosmarium* both at Multyfarnham and at Glengariff the previous spring, but had kept it in abeyance until he might become acquainted with *C. amœnum*, and compare both with *C. cylindricum*.

Rev. E. O'Meara showed a slide of diatoms collected lat. 3 south, and long. 15 west, upon which he would more enlarge hereafter; he likewise showed an unidentified *Synedra* from a well at Ballinasloe, which he thought likely to turn out new, of which, however, more on a future occasion.

Mr. Archer drew attention to some examples of a production not in itself very attractive as a microscopic object, but on account of its incapability of being identified as to what it was or to what belonged, might possess some interest until those points should be decided, when, perchance, indeed it might turn out to be something sufficiently commonplace. He had noticed it first at Kylemore, Connemara, but had seen it since in several other places. Occasionally, at first glance under a moderate power, it might be taken for some elongate form of diatom, but that it certainly was not. The closest examination that could be bestowed upon it seemed to show that this was composed of a hyaline, somewhat tough, smooth and colourless membranous substance, which is folded longitudinally in a scroll-like manner. If formed of a membrane really so folded, it would appear as if it must be of a more or less circular outline, or of some such shape, and possessing a gradually diminishing width, the edge, which ultimately sticks out when folded, being curved or rounded. And that this is most likely so would appear from the fact that at each end of the object could be seen a zigzag line as if formed by the edge of the supposed longitudinally folded membrane, whilst, moreover, along the edges of the scroll several series of lines could be seen, each terminating where begins a zigzag line, these longitudinal lateral lines seemingly indicating the bounds of the folds. Further, mostly there appears a lateral wing-like projection, presumably the last uncoiled outer rounded edge of the membrane, these wing-like projections gradually diminishing in width till terminating at the beginning of the first or innermost zigzag lines. All the specimens presented these characteristics; in some might be seen this wing-like portion broader than in others, indicating a partial unfolding or less completed folding, or two wing-like projections, as if the sheet of membrane were doubled up the middle, then coiled, and both flaps left outwards. No contents or living portion could be noticed. If we take an elliptical piece of semi-transparent paper and fold it longitudinally, causing each fold as it is made to be very slightly wider than the preceding, finally leaving the last rounded portion of the paper projecting, and then hold the scroll thus made between the eyes and the light, the seeming structure and appearance of this (under a low power) somewhat *Nitzschia*-like object will to a great extent be realised. To this attempt to convey an idea of the thing or portion of thing now in question must be superadded that the examples are sometimes, though rarely, met with cohering or united in twos by the ends, and Mr. Archer mentioned that he had seen some instances in which four examples were so united in a parallelogram, enclosing a quadrangular space between them; or two or three scrolls are sometimes somewhat irregularly appended together, thus, indeed, losing their quasi-diatomaceous

aspect. So far only did observation as regards this not very striking but puzzling production reach. If a *folded membrane actually*, whence does it originate? If the exuvium of any creature, what power folds it into these seemingly methodically made-up scrolls? If it be such a "skin" or "cell-wall" of any organism, where are the living parts or the "contents"? The very inexplicability of this production would be Mr. Archer's excuse for drawing attention to an object so very unattractive to look at; indeed, he had to apologise for adding one more to the crude nondescripts he had before now drawn attention to, but perchance a record of such might educe from others some elucidation of a thing, it may be, very simple, though just now here to us, possibly from oversight or misapprehension, extremely enigmatical.

Dr. John Barker exhibited a large and handsome form of *Euglena* (which latter, indeed, all the forms are), which he was disposed to identify as *Euglena geniculata* (Duj.). It seemed, however, to agree with the forms referred to *Euglena spirogyra* (Ehr.) by Carter (in 'Ann. Nat. Hist.,' n.s., vol. xviii, pl. vii, fig. 87) in several details. The present form was large, of very slow motions, flexible, but not metabolic, prismatic in section and twisted; nuclear body central; "glair-cells" (Carter) two, one before and one behind the nucleus, these elongate, straight-sided with rounded ends, eye-speck large, body spirally striate, striæ uninterrupted (that is, not dotted), tail long, straight, obliquely set. Thus this agreed with Carter's figure, save that that does not depict the spiral striæ. But the description of *Euglena geniculata* and *E. spirogyra* attribute cylindrical or depressed bodies to those forms, whereas here it was prismatic. In this latter character, then, it agreed with the *Phacus tripteris* (Duj.) so called, but that form is described as without striæ. In this confused condition appears to be the identification of these handsome forms.

Dr. John Barker showed specimens from County Westmeath of a very pretty alga-form, found in Ireland but once only before by Mr. Archer, and, doubtless, the *Hormospora transversalis* (Bréb.). Dr. Barker was disposed, however, to think it distinct therefrom, and it certainly differs from de Brébisson's figure by the cells being stouter and more broadly elliptic, and not having the tendency to become grouped in fours within the characteristic investing mucous tube; but it coincides with the woodcut figure given in Rabenhorst's 'Flora Europæa Algarum Aquæ dulcis et submarinæ.' These very pretty examples were, at all events, quite identical with those previously taken by Mr. Archer at Kilbride, County Wicklow; it is seemingly rare.

Mr. Vickers showed examples of growing grapes attacked by the vine-fungus, and exhibited the strings of spores under higher powers.

18th August, 1870.

Rev. E. O'Meara exhibited and made some remarks on various specimens of the diatoms furnished in Herr Eulenstein's 'First

Century' just published, referring to the great interest of many which had already been very useful to himself, as well as to the great elegance of the preparations, one and all.

Mr. Archer showed fine examples of that handsome rotatorian *Noteus quadricornis*, which, at least in our walks, appears to be a rare form. He also showed *Anurea heptodon*, seemingly not common, and some other forms.

Mr. Archer showed various species of *Euglena* and *Phacus* in contradistinction, which presented themselves in a rather fortunate collection for these forms; some of these it was not an easy matter to identify; Dujardin's figures do not appear sufficiently graphic in certain cases. Amongst those shown attention was drawn to a much twisted form of *Phacus longicauda*; this often occurs with one twist, but the present examples were three or more times twisted, and, moreover, presented the characteristic of possessing a keel- or wing-like projection upon one face, giving the form still more of a screw-like aspect, and forming a pretty object as it progressed along, turning on its axis as it went, and presenting a varied outline as it revolved. This could not be regarded as else than a form of *Phacus longicauda*, and might seemingly go to indicate that *Phacus triquetra* (*Euglena triquetra*, Ehr.) and *Phacus pleuronectes* (Nitzsch) were but one and the same. These were both shown in the water, as well as that most tiny and, perhaps, most elegant of all, *Phacus pyrum* (*Euglena pyrum*, Ehr.). It would seem, perhaps, even to further indicate that the form brought forward at last meeting by Dr. Barker, considered by him to be *Euglena geniculata*, and now again shown for comparison, may be the representative of but one truly distinct form only, called by the various names of *E. geniculata*, *E. spirogyra*, and even *Phacus tripteris*, supposing the striæ on examples of the latter to have been overlooked. There is, however, a considerably smaller form than these, darker in colour, the skin brownish and thicker, and, above all, distinguished by the spirals being due to rows of thickened dot-like prominences, not uninterrupted minute ridges; this form Mr. Archer showed side by side in the present gathering, so fortunate for forms appertaining here. If this latter be the true *E. spirogyra*, then Dujardin's figure is erroneous in presenting the striæ as linear ridges, not as rows of conspicuous dots. This latter form occurs in several places. There was also shown a very elegant form, probably the *Euglena acus* (Ehr.). This is long, slender, fusiform, not flexible, swimming along by no means slowly; eye-speck rather large and bright red, anterior extremity truncate, "tail acute; this, in outline of the anterior extremity, might somewhat call to mind the aspect of a "pipe-fish," without its flexibility. All these are, however, hard to discriminate, but, nevertheless, appear to be pretty constant to themselves. And besides certain specialities of the externals, those of the contents appear to be often characteristic too. Still, how far these are actually "specific" in their importance, though seemingly constant in their recurrence, would require a great deal more experience and research to determine.

29th September, 1870.

Read letter from Dr. J. M. Currier, Newport, Orleans County, Vermont, U.S., proposing to exchange 'The Archives of Science and Transactions of the Orleans County Society of Natural Sciences' for the 'Proceedings' of this Club, and offering to furnish objects in exchange.

Resolved, that the foregoing proposal be, with thanks, accepted.

Mr. Vickers exhibited a "mechanical finger" which he had just designed and himself constructed for the purpose of assisting in the removal of individual diatoms under the microscope in order to mount them separately, by means of holding the "cover" intended to receive the specimen in such a sloped position in focus of a low power of the microscope as would be suited to conveniently receive the example to be mounted, first on the edge of the cover so held, and then pushed up to its centre and final position by the hand.

Mr. Vickers also exhibited stereoscopic transparencies taken with different parts of the same lens; these, when transposed, had a pseudoscopic effect, proving that there is a real difference in pictures so produced. He therefore inferred that the images presented in the binocular microscope, being obtained in the same way, have a real difference, though produced by the one lens; hence the conclusions arrived at by appearance in the binocular microscope should be considered reliable.

Mr. Crowe again showed *Stephanosphæra pluvialis* from the original site, thus probably later in the year than it had hitherto been seen.

Rev. E. O'Meara exhibited a new and very handsome Pinnularia, of which he would soon furnish due description under the name of *Pinnularia Vickersii*. The same gathering (from stomachs of Ascidians, Roundstone Bay) afforded other fine forms; amongst the species presented was *Donkinia compacta*.

Mr. Archer mentioned having met with for the first time the seemingly cosmopolitan, but certainly not abundant, little alga, best known, perhaps, under the name *Botrydium argillaceum* (Wallr.), but, doubtless, more properly called *Hydrogastrum granulatum* (Desv.), the latter name having the priority. He had often looked for this little denizen of the muddy bottoms of partially or nearly dried-up pools, but, strange to say, never before encountered it, though, no doubt, it will be found, under suitable circumstances, in various parts of the country. These specimens were taken from the bottom of the large pool to right of "Rocky Valley," near Bray, a pool so large and deep that he had often wished for a boat to explore its middle weedy parts; but this unprecedentedly dry summer had dried it up so nearly completely that you could traverse the whole site through and through, finding only here and there a few damp, not wet, spots.

Mr. Archer brought for exhibition two new species of Staurastrum, one of *Cosmarium* (descriptions deferred), as well as the rare forms *Olosterium prælongum* (Bréb.), *Desmidium aptogonum* (Bréb.)

(the plane variety—this he had only once obtained before, and it appears rare), also *Sphærozosma filiforme* (Ehr.). As time was limited, however, he would not now dilate on these, but pass on to two rhizopodous forms which would not keep.

Mr. Archer then exhibited a form of rhizopod new to Britain, and which he had encountered for the first time about a year ago, at first thinking, until he had had an opportunity to see Bailey's paper in full, that it must be a new form; it is, at all events, one very distinct; there, however, could be extremely little or no doubt but that this was truly none else than Bailey's *Pamphagus mutabilis* ('American Journal of Science and Arts,' vol. xv, 2nd series, May, 1853). It would seem, at all events, sufficiently interesting to detect on this side of the Atlantic so singular a form, the present being only the second instance, so far as Mr. Archer was aware, of its record, thus, after being lost to observation for eighteen years, possibly ignored by some as an apocryphal species. Bailey's numerous figures, it is true (*loc. cit.*), are but poor, being only rough woodcuts, yet there could hardly be a doubt, from his general description, but that the form now shown was that *hungry* species, though the varied shapes assumed by Bailey's specimens were not here presented, possibly owing to the food occurring in the pools whence these examples came being more compact morsels than the elongate confervoid filaments taken in by Bailey's specimens, thus producing less outward distortion. It was curious, however, to note the extraordinary variety and quantity of the most diverse prey which these insatiable examples of rhizopodous life had captured—diatoms, desmids, infusoria, algæ (detached confervoid joints and protococoids), in fact, everything manageable, ultimately densely and closely packed when fully digested. A new point worth recording is the possession by this form of a large elliptic so-called "nucleus," like that of *Amœba*, but this is surely not at all an *Amœba*. Its very long and linear branching and fitful pseudopodia (issuing from the broad end of a normally rather large pyriform body) cause it more nearly to approach the genus *Plagiophrys* (Clap. et Lachmann); but though it may be said to have a kind of skin, it does not appear to possess the distinct hyaline test-like coat of the form which Mr. Archer would refer to *Plagiophrys spherica* (Clap. et Lachm.). The examples are very rare, and found as yet only in one or two pools in County Westmeath, but Mr. Archer hoped not to lose sight of it, this record being enough for fugitive Minutes; still, if future gatherings should present suitable specimens it would, no doubt, be worth while to try and make a sketch of this most insatiable of gluttons, the highest goal of whose existence, at which some even seem to arrive, would actually appear to be to live its gormandizing life and then to die of sheer repletion.

Mr. Archer further showed some examples of another sufficiently remarkable rhizopod, which at first glance would be accounted an *Amœba*, but which, on closer examination, showed a speciality which would seem to place it apart. Under ordinary circumstances, still less than *Amœba* proper, did it show any projections or prolonga-

tions that could be called pseudopodia. It occurs of very varied dimensions, from a minute size even up to a diameter, spread upon a slide, of as much as one fourth of an inch. Some of those even now under view covered a space of $\frac{1}{10}$ th or $\frac{1}{8}$ th of an inch across, as they lay spread for observation on the slide. The more minute examples maintained more or less of an oval figure, and progressed along (in a manner similar to an *Amœba limax* or an *Amœba villosa*) with no inconsiderable amount of locomotive power. The larger examples, forming a little whitish patch on a slide, presented an indefinitely lobed figure, with only slow and very gradual changes of outline. Such specimens showed a considerable tendency to open up into *holes* of varying sizes, several of which could be sometimes seen in a single individual. All the examples were characterised by a thick and hyaline, and seemingly comparatively unyielding and, so to say, somewhat tough "ectosarc," this very smoothly bounded, never falling into folds or inequalities, but occasionally spreading in shallow *waves*, the "endosarc" keeping equidistant, thus maintaining a sharply bounded, very hyaline, narrow rim-like border to the body-mass, as well all round the exterior as around the boundaries of the holes or apertures formed through and through the body. The endosarc was of a nature seemingly different from that of a typical *Amœba*, in that it presented an alveolar or quasi-cellular appearance quite comparable to that of *Actinosphærium Eichhornii*, but *no trace* of "cortical" or "central" strata or regions. In all this, however, there may not be much to distinguish this from an *Amœba*-form; however, Mr. Archer, on more than one previous occasion on which he had seen it, had looked in vain for the so-called "nucleus," which should appertain to a typical *Amœba*. The present examples proved, he regretted to say, that he had previously given this form a far too hasty examination, for here were multitudes of nuclei. As is well known, in an ordinary *Amœba* proper there is but a single "nucleus," and the examples now shown were sufficient to arouse attention. The nuclei here were far more minute and different in appearance from that of an *Amœba*. In a word, they formed little round bodies lodged in the angles between the areolæ quite like those of *Actinosphærium Eichhornii*, and like them they comparatively quickly take a deep red colour under treatment of Beale's Carmine Solution; but, as was mentioned, the body showed no cortical margin. Numerous and varied objects were here and there imbedded in the body-mass incepted as food. Now, if this form should turn out a really distinct type, that may be said to bear (to a certain extent) a relationship to *Amœba* similar to that of *Actinosphærium Eichhornii* to *Actinophrys sol.* It is well known, however, that *Actinosphærium Eichhornii* possesses the faculty or tendency to become fused several into one, and such examples are sometimes met with; indeed, Mr. Archer had just seen five of different sizes partially fused into a common mass, each, however, maintaining to a certain extent an individuality, and the external borders of the so-united examples keeping their rounded outline. Mr. Archer had brought down specimens showing this phenomenon, but time did not allow him to

produce them. Such examples present a very conspicuous appearance, and rival the dimensions attained by the form now exhibited. But the latter is without pseudopodia, the whole endosarc being alike through and through, and is bounded by the conspicuous thickened hyaline "ectosarc," but no "cortical" border. It is true that across the holes which originate in the larger specimens when spread upon a slide there are sometimes temporarily stretched slender thread-like sarcode emanations from one side to the other, proceeding from the border-like "ectosarc," for so it is, though not in the normal external position. But these thread-like extensions soon snap across and become obliterated, and do not appear to possess the seeming axis penetrating into the body-mass characteristic in *Actinosphærium*. Further, at one portion of the border in some of the examples could be seen what seemed to be a localised still further thickening of the "ectosarc," showing in its substance vertical lines, as it were indications or roots (so to speak) of villi, thus with a certain amount of the appearance, though without all the characters, of a "villous patch." Thus, though it cannot be averred that this may not be a whole congeries of individuals of *Actinosphærium* combined into one and considerable amount of modification of the, so to say, structural or histological characters undergone, yet it would seem that the considerations drawn attention to would rather point to the present form representing a distinct type, and, as has been mentioned, one bearing such a relationship to *Amœba* as is that to a certain extent (only) of *Actinosphærium Eichhornii* to *Actinophrys sol.* The question arises, has this form been recorded before, and what can be supposed to be its position? Whether it may ultimately prove a distinct type or not, Mr. Archer had previously thought it must be the same thing as that alluded to by Greeff in a paper published in 'Schultze's Archiv für mikroskopische Anatomie' for 1867, Bd. iii, p. 400, in a paper entitled "Ueber *Actinophrys Eichhornii* und einen neuen Süßwasser-rhizopoden, besonders in Rücksicht auf Theilbarkeit derselben resp. Vermehrung durch künstliche Theilung." The present, Mr. Archer ventured to think, was most likely the "new freshwater rhizopod" referred to in the paper alluded to, but not named or figured by Greeff, who attributes to it only a size reaching that of a "pin's head" (but, perhaps, there are *pins* and *pins*, little and big), the actual measure stated as being attained being 1.5 mm., which, however, shows his examples really fell short of some of the present in dimensions. Greeff's account would seem to apply here very closely. In brief and sketchy minutes like the present it would be unadvisable to go into detail and narrate the particulars given by him; suffice it to mention that only in one circumstance did the present examples seem to fall short of Greeff's, and that was that the present had never shown the evolution of the problematic basillar or wand-like bodies ("stabförmige Körperchen") referred to by Greeff as having been evolved from the "nuclei," and conjectured to represent spermatocytic elements. This form, large as many examples are, seems rare, and hence the opportunity to make observations upon it are not often presented.

No doubt it is well worthy future research, and to that it must be left. Greeff, in a note (p. 402), remarks that, "Regard being had to its peculiar structure, the rhizopod in question cannot be relegated to Amœbæ proper, nor, on account of its Amœba-like movements and want of radiating pseudopodia, to the Actinophryans, but rather represents a special form." And so it is, provided only it be *not* a congeries of individuals of *Actinosphærium Eichhornii* (called *Actinophrys Eichhornii* by Prof. Greeff—Mr. Archer would venture to think wrongly, for that form is something a good deal *more than* an Actinophrys); but under such a supposition it must be admitted the specimens of *Actinosphærium* would have suffered much modification, losing the most characteristic features and gaining others to an extent that would be sufficiently surprising. Doubtless Greeff will ere long be in a position to shed a light upon this as yet enigmatic form, and so must it for the present be left in abeyance.

ROYAL MICROSCOPICAL SOCIETY.

October 12th, 1870.

Read papers on the "*Coralliospongia*, or Anastomosing Sponges," by Mr. W. S. Kent.

"On Aplanatic Illumination and Aplanatic Definition," by Dr. G. W. Royston-Pigott.

At the reading of this paper Professor Huxley was present. He said that being practically interested in researches such as those which Dr. Pigott was conducting with so much ability, and having seen his paper in the 'Proceedings' of the Royal Society, he had been much struck by it, and being very much in want of means of looking through tolerably thick glass under a high magnifying power, he made it his business to ask Professor Stokes about Dr. Pigott. The reply was so favorable that he wrote to Dr. Pigott for assistance, by whom he was told to apply to Messrs. Powell and Lealand, who made an aplanatic searcher for him; and he (Professor Huxley) having used it frequently, must bear witness that there was no sort of doubt as to the wonderful illuminating power it possessed, combined also with the great magnifying power which could be got out of a comparatively low object-glass by the use of this instrument. But when the attempt was made to go farther, that is to say, when the instrument was applied to deeper object-glasses (it might be from want of proper knowledge in the use of it), it did not seem to be of much use. It was an exceedingly important practical question

at the present time, and he was inclined to think that in histology, for the purpose of analysing organic structures, the existing microscopes were, as the Yankees would say, "played out." We have got as far as they will take us. He believed that a $\frac{1}{50}$ th did not enable anybody to see anything which could not be seen with a good $\frac{1}{12}$ th of Ross. He considered these deep objectives to be eminently delusive, and they were so doubtless for the reasons which had been stated by Dr. Pigott. He could not doubt that Dr. Pigott had got on the right track of showing what was to be done in the present state of affairs. Practically the nature of the question just now is whether, in an organic tissue, one could truly define a point not more than $\frac{1}{30000}$ th of an inch in diameter. There was always that unhappy luminosity about the margins of such objects, which he did not doubt arose from the causes which Dr. Pigott had pointed out. Histologists, he feared, were at the end of their work unless, by the aid of some such appliance as Dr. Pigott had endeavoured to furnish, they could obtain microscopes which would enable them to separate two points the 100,000th of an inch apart. Only then could they say whether the object was homogeneous or not. At present when they talked about homogeneous solids or fluids, or attempted to define an object like *Bacterium*, they were absolutely in cloudland. He had come to the meeting in the hope that he might hear that some light had been thrown upon this subject; and he did indeed trust that Dr. Pigott had proceeded some way on the road towards the solution of the difficulty; at any rate, he had *macadamized* the road, and that was a great matter.

Dr. Pigott said he could well understand that so ardent a worker as Professor Huxley should feel the urgency of those wants to which he had referred. He thought, however, he might be allowed to say that in correcting the aberration of objectives, if there was nothing else to point to than a power of varying chromatic effects by means of the aplanatic searcher, a great improvement would have been made. The object-glasses of the present year were greatly in advance of those of previous years as regards the correction of visible error which must therefore have existed, however unsuspected and denied, for the very fact of their present superiority is a conclusive answer to the question as to whether any improvement had been made.

Professor Huxley has published the following statement since the meeting:

"I have had the great advantage of applying the 'searcher' to deep objectives under Dr. Royston-Pigott's guidance, and I am disposed to form a very much more favorable opinion of its utility."

November 9th, 1870.

Read papers "On Notes on the Minute Structure of Insect Scales," by Mr. S. McIntyre.

"On a new Species of Sponge," by Mr. W. S. Kent.

"Note on Fluorescence *versus* Pseudo-dichroism," by the Rev. J. B. Reade, President of the Society.

It is with great regret that we have to announce the death of the Rev. J. B. Reade, the President of this Society. He was thoroughly devoted to scientific pursuits, and remarkable for his urbane and courteous manner. He joined the Microscopical Society in its infancy, and no one could more appropriately have filled the Presidential chair.

QUEKETT MICROSCOPICAL CLUB.

September 23rd, 1870.

Dr. LIONEL BEALE, F.R.S., in the Chair.

A paper was read "On the So-called Spontaneous Generation," by Mr. Benjamin P. Lowne. This paper was followed by a discussion of some length, in which the President took part. Dr. Beale avowed himself as entirely opposed to the doctrine of spontaneous generation.

MEMOIRS.

On some FRESHWATER RHIZOPODA, NEW or LITTLE-KNOWN.
FASCICULUS II. ON AMPHIZONELLA VESTITA (sp. nov.),
ACANTHOCYSTIS SPINIFERA (Greeff) and PLAGIOPHRYS
SPHÆRICA (Clap. et Lachm.)¹ By WILLIAM ARCHER.
(With Plates VI and VII.)

ON a former occasion,² I brought before the notice of those interested in types of existence so lowly, a series of forms in certain groups of Rhizopoda, at once novel to our freshwaters, as well as some of them possessing in themselves a considerable interest as connecting links, leading on to their more complex and structurally more differentiated marine relatives. Having, since then, continued to bestow some attention to the subject, I venture to propose to bring forward from time to time, as opportunity may offer, such casual jottings, or accounts of any few additional new forms, as good fortune may enable me.

In bringing forward those I was able to present in my former communication, owing to their heterogeneous nature, and their positive and negative characters, *inter se*, I experienced a difficulty in endeavouring to put them before the reader in anything like a "natural" sequence. In this, and any further communications I may be able to make, my difficulty alluded to is removed, while the disadvantage remains; for I must just submit to take them in such order as accident and opportunity may present them, irrespective of any mutual affinities; and indeed, this is the less to be regretted, for as yet the freshwater forms, or rather the types they represent, are too few, and their characters too negative, to be able satisfactorily to relegate them to established Classes and Orders. Nor indeed, possibly, do the freshwaters really possess forms calculated to fill up the intervals, or lacunæ, between certain therein existent and already recorded representatives. At least, I think matters must remain as they are in that regard for some considerable time longer.

¹ Read before the Royal Irish Academy, 12th December, 1870.

² 'Quarterly Journal of Microscopical Science,' Vol. IX, N. S., pp. 250 and 386, and vol. X, N. S., pp. 17 and 101

The difficulties I advert to, as they appear to me, I have already tried as succinctly as possible to set forth,¹ so that I need not here recapitulate them. I would only just mention, as connected with the question, that, as it would seem to me, the more the "Heliozoan" group are studied, the more closely do certain representatives of them, at least, appear to annex themselves to the marine "Radiolaria," but yet, from such, however, the transition is not abrupt to others whose negative characters would seem, rightly enough, to forbid their admission into that Order. Nor is this in itself to be wondered at. In all forms of organization the transitions are more or less gradual, and, as bearing on the relations of the Heliozoa and the Radiolaria, it is interesting to note Haeckel's statement in a recent memoir (one as noble and interesting as we yet owe to his busy pen), that the *young* condition of a typical or true "Radiolarian" is morphologically that of a "Heliozoan."² It is scarcely necessary, of course, to remark, still less to urge, that this is by no means a statement that any of the recognised forms which can rank only as Heliozoa are but young or progressive states of forms, which, in course of individual development, are fated to rise to the dignity of Radiolaria. It seems, I think, as if it might rather be interpreted as a statement, that a young Radiolarian indeed may be, from a morphological point of view, but equivalent to a Heliozoan, but whilst the former by-and-by puts on additional characteristics, a *true* member of the latter group can rise no higher, but must remain, with its fellows, to present us with a continuous supply, as we find them, of examples of its kind.

Before directly passing on to endeavour to give some account of the forms which I have tried to portray in the accompanying drawings—one at least new, the others, if not new, at all events seemingly comparatively rarely encountered, and "little-known,"—I cannot but make use of the opportunity to reiterate my own view as to the seeming constancy with which the freshwater representatives, at least, of the Rhizopoda,³ maintain their characteristics and special identities, and recur, again and again, more or less commonly or rarely. I cannot coincide with those who hold that their differences are but accidental and casual, being simply due to surrounding circumstances; that, because the *living* part in all throughout is essentially but a little mass or

¹ Loc. cit., Vol. X, p. 21.

² Haeckel, "Beiträge zur Plastiden-theorie," in 'Jenaische Zeitschrift für Medicin und Naturwissenschaft.,' Bd. V, page 530.

³ I here use the term in a comprehensive significance.

patch of "sarcodæ," and so all have a pervading uniformity of nature, they are, therefore, all as it were, but one Rhizopod, this protean creature presenting itself to view under various aspects, whose seeming specialities are but accidental and unessential. If, indeed, I have misapprehended the views of Dr. Wallich and others in thinking they hold the extreme opinion I have just indicated, they at least urge that, not only are the individual "species" in certain types or genera, to a great extent, invalid, but would even combine together certain recognised distinct "genera" as hardly correctly or actually distinguishable individual forms. As regards *Diffugiæ*, the view propounded by Dr. Wallich seems to be endorsed by Mr. H. B. Brady,¹ that is, that the differences these present are due but to the influence of external circumstances.

But I venture to think that such a view is untenable, when, time after time, and season after season, in pools many miles asunder, or in a single pool, with exactly the same crude materials around, exactly the same substances in suspension or solution in the water, exactly the same kinds of food accessible, and (so far as we can observe) exactly the same influences in action, such as regard light, &c., current or stillness of the water, or such-like mechanical or physical circumstances,—when I say, under all these precisely similar conditions we constantly find associated and maintaining their specialities—it may be in one and the same drop of water—a more or less considerable number of forms, with more or less mutual affinity, representing, it may be, several recognised distinct genera, or even families.

There is a little mass of "sarcodæ," side by side with several other little masses of "sarcodæ," all very like one another, each of which somehow contrives to build an edifice in which to dwell. An abundant quantity of different and various materials abounds around. Some choose long diatoms, others short; some choose sandy particles, or other materials. One form constantly contrives to attach its materials in the roughest and most "slovenly" manner. Is it with a view to the grotesque or the picturesque, or what? Another form as constantly impacts its building materials with a mosaic evenness and regularity. Is it with a view to turn itself out elegant and spruce? Another form constantly sticks on its materials externally, so loosely as hardly to deserve to gain credit for any architectural capacity. Is it due to inherent laziness of disposition? Another form wants

¹ H. B. Brady, "Analysis and Descriptions of the Foraminifera," in the 'Ann. Nat. Hist.,' October, 1870, p. 273.

no such extraneous assistance; its inherent nature admits of a test sufficiently strong being secreted in its own structural development. There are, then, various "sarcode" bodies, capable each of making such choice from a common stock of materials; each capable of applying those materials in its own way; whilst to me these and such like specialities seem to be bound up with a considerable amount of constancy in outward figure, and a certain amount of constancy, also, in dimensions, which are more than accidental. Again, there is "sarcode" capable of secreting solid "skeletons" of various types and forms, and side by side with it other "sarcode" not capable of this, the external circumstances being alike. There is "sarcode" which makes its "skeleton" a hollow globular fenestrate structure, finally external to its own living mass, and, side by side with it, other "sarcode" which makes its skeleton separate portions (variously figured "spicules"), deposited in the external region of its living mass; and yet other "sarcode" hard by, which produces its solid parts more deeply immersed in its living mass, and in all the external circumstances being alike. There is "sarcode" always colourless, or nearly so—"sarcode" imbued with diverse variations of hue—"sarcode" bearing certain pigment granules—each speciality bound up with individuality of form, and in all the external circumstances being alike. There is "sarcode" slow in projecting and retracting the characteristic "pseudopodia," and "sarcode" which can send forth and withdraw its "pseudopodia" with comparative rapidity and energy; there is "sarcode" which can send out comparatively very slender and long, even delicately filiform pseudopodia, and other "sarcode" which cannot project such prolongations, except as little more than, as it were, narrow lobes of its own body-mass, and produced only to a comparatively limited extent—such specialities, in various degrees, seemingly bound up with certain outward figures, and at the same time the external circumstances being alike. There is "sarcode" seemingly quite, or nearly all but, rigidly abstinent, with *lots* of food around, and side by side "sarcode" gluttonous to satiety; "sarcode" in whose substance not yet any crude food has been seen, and "sarcode" so *hungry* that at least one form of rhizopod exists, whose seemingly highest aspiration and even ultimate aim in existence would appear to be to die of sheer repletion—these specialities, in various degrees, likewise seemingly bound up with certain outward figures, and at same time the external circumstances being alike.

In thus cursorily drawing attention to some of the idiosyn-

crasies of one "sarcodé" as compared with another "sarcodé," or, very probably better, definite patches of "bioplasm" (Beale), I need hardly say I refer now to such as is presented by Rhizopoda only, and in referring to Rhizopoda, I refer to freshwater Rhizopoda only. "Sarcodé" plays a part in higher beings subserving to more exalted ends, but I refer to that which meets our attention in the *pools* to which my own experience is confined. If, indeed, I were acquainted with marine rhizopodous forms, I might possibly be of a different view in respect to them, from that I feel as yet constrained to hold as regards their freshwater relatives. Of course, I do not pretend to aver that some of the more minute forms we now and then encounter may not be young or transitory or undeveloped states of certain others, but this would not, I imagine, greatly militate against the *general* correctness of the view for which I here contend; neither do I aver that the various forms we from time to time meet with are immutable or not subject to a certain amount of modification. I would only venture to urge that such does not appear to be by any means so great as some would hold. I do not now dwell on the fact of "zygosis" taking place uniformly like form with like form; whatever may be the significance of that phenomenon, it is at least one which I have noticed myself in nearly every form of all the genera, each individual species always *conjugating* only with its *own* fellow.

Nor does a certain amount of difficulty in identifying even some common forms with some of the older authors' descriptions or figures argue materially, if at all, against my view; for, as I would as yet rather venture to think, such difficulty may be attributable, not so much to the deviation of any particular form in question from the *author's* "species," which he may have had before him, as to the original want of completeness in seizing the details and want of conformity of the author's "description," or figure to nature's "species," if I may rightly here use the term—due, perhaps, in great part to the fact that Nature is so chary in giving us more than glimpses of her doings, and all that the author saw was but a single aspect or only a few of the features of a form of existence, the rest of which, it might be, on that occasion, were screened and hidden from his ken.

Hence I imagine that descriptions of these forms cannot be too minute or too much in detail. If such be as carefully and as closely as possible carried out, and figures made as painstakingly as possible, and examples afterwards found cannot be identified therewith, then that form must present various aspects or phases, and on the next occasion the varia-

tions should be noticed, or such examples *may* represent a form essentially distinct. But if, on the other hand, at hundreds or thousands of miles distance, one and the same form turns up, presenting when fully developed the same details, there cannot, I imagine, be a reasonable doubt but that such may legitimately be regarded as a permanent form or "species," if the term be allowed.

With an apology for obtruding these preliminary remarks, somewhat at variance with the views of observers, for whose opinions I have the most lively respect, I proceed to offer an account of my new form.

AMPHIZONELLA VESTITA (sp. nov.) (Pl. VI, figs. 1—6).

In endeavouring to bring before other more distant students of the Rhizopoda the somewhat variable aspects presented by the *fout ensemble* of the new form I name as above, I shall follow the precedent of my previous communication, giving first a running commentary on the details presented by an examination of a number of examples, the characteristics of which I have made an effort to seize on in the accompanying figures, and defer short diagnostic characters to the conclusion.

As on former occasions, it may, perhaps, be most convenient to begin the description of this form, as it were, from within outward.

We have, then, a minute sarcode body of what may be said to be normally of a globular figure, not exceeding say $\frac{1}{400}$ of an inch in diameter, but sometimes examples presenting themselves not reaching more than two-thirds of that measurement. The basic substance of the body-mass might indeed be called by some colourless; but, to my observation, it does not quite so appear, but sub-pellucid, and not quite uniform in tint, nor altogether homogeneous in consistence. The hue presented to my eyes is what I may call somewhat clouded, and varying from a very pale yellowish-brownish, in some places, to a very pale bluish in others, especially at the circumference, and but very slightly granular, while the pseudopodia, and the part whence they emanate, appear colourless, or pale bluish.

In all the specimens I have seen (from three localities), just beneath the outer boundary of this sarcode-body there occurs a stratum of irregularly scattered, generally elliptic, or rounded, but sometimes irregularly figured, very minute, greyish, or somewhat purple coloured, sharply and darkly

bounded, and clear and shiny bodies; these are sometimes comparatively evenly distributed, though without any definite order; at other times more or less crowded in clusters, but do not ever seem to extend quite through and through the body-mass (Figs. 1, 2, 3). In nearly all the examples I have seen, taken from two out of the three situations in which I have met with this form, immediately beneath the stratum of bodies just mentioned, there occurred a more or less dense stratum of large and conspicuous chlorophyll-granules of a deep green tint, the green colouring portion forming a horse-shoe-shaped or crescentic body at one side, leaving an uncoloured portion at the other, as if enclosed in a wall, these mostly imparting to the specimens, at first sight, an appearance almost like some chlorophyllaceous alga (Figs. 1, 2); commingled, however, with such examples occurred others comparatively poor in chlorophyll-granules, and presenting under a low power a yellowish grey colour, the elliptic bodies being predominant, whilst examples from the third locality showed no chlorophyll-granules at all, but abundance of the pale elliptic bodies (Fig. 3). Below the stratum of chlorophyll-granules, when present, not however central, but rather to one side, yet not touching the periphery of the body-mass, there presents itself an elliptic bluish-grey-coloured granular-looking "nucleus" (Fig. 1). Although the sometimes very densely crowded elliptic bodies and chlorophyll-granules render it difficult to discern the nucleus, yet, by a little patience and manipulation, the intervening granules becoming in the meantime altered in distribution, I have nearly always succeeded in gaining a view of this body, without the aid of re-agents, whilst their use, as will presently be mentioned, never fails to disclose its presence. It does not *appear* to be covered by a special membrane or wall.

Having arrived so far in the descriptive building up, as it were, of our form, we have what, if it indeed presented no additional character, would be simply an Amœba—a variably-figured sarcocoe body, bearing a "nucleus,"—for quite similar little elliptic, or rounded little bodies, as well as chlorophyll-granules, also occur in Amœbæ, though I am not aware of the latter fact being recorded, nor would elongate pseudopodia be requisite to exist, as the lobe-like expansion of many Amœbæ are not more than alterations of outline.

But to continue the examination of the form before us, we find that it can do more than alter its outline from orbicular to sub-triangular, or a cornered figure, or present one or more lobe-like projections: it can send forth short, more or

less elongate, blunt and conical, or slender and tapering, colourless or pale bluish, processes or pseudopodia (Figs. 1, 2). These, for a reason to be immediately explained, mostly emanate from a restricted region of the body-mass, and are very fitful, never kept extended long at a time, nor that often; but further, a few still more fitful and less elongate pseudopodia can sometimes be projected from other parts (Fig. 2). The locomotive power of this form appears very restricted. If then our form presented no additional character, it would still be but an *Amœba*-form, or one, owing to the pseudopodia being of a one-sided tendency, perhaps, approaching Bailey's genus, *Pamphagus*.¹

But our form is *more* than this; and, to continue our progressive examination from the *Amœba*-like form we have reached, we find this so described body-mass is enclosed in a kind of mantle or coat, closely investing it; and this is of a highly curious and remarkable character, which I shall now endeavour to describe.

When a living example of this Rhizopod is first placed under examination, even though its normally orbicular figure be more or less distorted, this outer coat appears not only to surround the body closely at every part, but to form a rim-like exterior in complete union with it; that is, as it were, but a more dense and differentiated, but sharply-marked off, outer boundary to the body-mass, whose changes of figure it necessarily follows. On further examination, it is seen to possess a number of vertically-posed and parallel lines in its substance, and reaching through its thickness, giving a striate appearance to this rim-like investment. This appearance is often very striking; but specimens occur in which it is, more or less, difficult to be made out; yet a little trouble, and it can be seen in all. Further, on the outer surface of this coat, there mostly occurs a dense clothing of more or less elongate

¹ In referring to the form *Pamphagus mutabilis* (Bailey, in 'American Journal of Science and Arts,' 1853, vol. xv, second series, p. 1) I do not do so merely on a book-acquaintance with it, for, as will be seen by the minutes of the Dublin Microscopical Club, published in the last number of this journal (page 101), I have met with it in this country, being its first re-discovery, so far as I am aware, since Bailey published it at the other side of the Atlantic close on eighteen years ago. I venture to think there can be no doubt at all of its being a perfectly distinct and singular Rhizopod. Since the Club-minutes were sent to the printers I have seen six specimens from Co. Tipperary, all my previous acquaintance with it being made from specimens taken last and this year very sparingly in Co. Westmeath; it is always scanty. Should, however, good characteristic examples hereafter present themselves it might be worth a future effort to try and make a more accurate portrait of the form, than any of Bailey's numerous but very rough, yet valuable, woodcuts.

colourless, very slender, hair-like processes, of very variable degree of development. Sometimes these attain a length at least equal to one-third (Fig. 1), perhaps even sometimes approaching one-half the diameter of the body of the Rhizopod, whilst, in other specimens, these hair-like processes appear much shorter, giving a merely pilose appearance to the surface (Fig. 2), or, so short are they, as even to impart a merely roughened or granular aspect to the surface or periphery of the coat (Figs. 4, 5); and again, they appear in certain other examples as all but obsolete (Fig. 3). An empty coat presents a dotted appearance all over (Fig. 4). These hair-like processes, especially when well developed, appear, on first examination, not unlike pseudopodia, and we might be inclined to suppose we had before us a Heliozoan or Radiolarian form (possibly referable to Greeff's genus, *Astrodisculus*),¹ rather than one of Amœban affinity; but that, as is seen, would be a wholly incorrect interpretation of the characteristics of our form.

I have said this outer coat appears to form not only a complete investment at all points to the body-mass, but, *at first sight*, to be even in complete union therewith. But this latter is not the case, for more exact examination of a number of examples shows not only that it can become locally, though but slightly, removed from contact with the body-mass, but also that, in the majority of cases, a region of the body exists, from which this outer coat appears to be *absent*. That this outer coat is in reality not only a completely differentiated portion of the creature's structure, but even, so to say, an independent part of its organization, is shown not only by meeting occasionally the empty, as it were discarded, coats in the water (Fig. 4), but by the action of re-agents on ordinary examples, as I shall presently allude to.

I have mentioned that very often a portion or region of the surface of the living sarcode body of this Rhizopod appears to be destitute of this coat, around which the latter often appears to thin off, retaining, however, its ordinary superficial characteristics. And it is from just this region that the greater part of the conical or slender tapering pseudopodia above described emanate. Sometimes the outer coat appears to push up here all round, and a somewhat broad projection of the sarcode body comes forth, this giving off a considerable number of the pseudopodia, projecting outwards like a crown, or, may I say, like an "*aurora*?" (See Figs. 1 and 2.) For,

¹ Greeff, "Ueber die Radiolarien und Radiolarien-artige Rhizopoden des Süssen Wassers," in Schultze's 'Archiv für Mikroskopische Anatomie,' Bd. v, p. 496.

like an *aurora*, in a few minutes, the tuft of pseudopodia seems to change, and perhaps then disappears.

But what is more remarkable, not only do pseudopodia emanate from this seeming vacant part of the investing coat, but the body-mass occasionally can project a short blunt conical pseudopodium, sometimes, even simultaneously, two or three, from indifferent portions of its surface. Now the singular circumstance here is, that such a pseudopodium does not, as one might at first suppose, push up the outer coat before it, thus creating an interval or space between it and the body-mass, but what is more curious, urges or bores its way right through the outer coat and projects beyond it. (Fig. 2.) Such a pseudopodium appears to be more transitory or evanescent than those emanating from the ordinary region, and is usually pretty soon retracted. But, what is still more extraordinary than its boring its way out, is that, on being again withdrawn, there is not a trace apparent of the place through which it passed, just as if the aperture in the coat, which must have existed, became, as it were, completely healed up.

Of course the possibility suggests itself that the outer coat may, in reality, be pushed up before the advancing pseudopodium, and in the act become so thinned and attenuated as to present the appearance of a naked pseudopodium. But, admitting the possibility that the outer coat, which would thus clothe the pseudopodium, from its acquired tenuity, would escape detection, still I think the superficial hair-like processes would hardly be obliterated all along the stretched outer coat, and must present themselves to view, even if seemingly more sparsely present. But no such appearance is evident; and I have endeavoured as faithfully as I can to repeat in Fig. 2 the appearance presented during the period of the extension of no less than two such temporary pseudopodia in the example under view. Another interpretation might present itself, which is, that the fine vertical lines seen in the rim-like margin presented by the edge view of the outer coat, may represent so many really existent minute apertures or fine canals in its substance, which may be of a highly elastic nature, and that when the point of an advancing pseudopodium pushes against one of these, the aperture becomes so stretched as to give passage to the comparatively thick conical pseudopodium; and further, that upon its withdrawal, the elastic force comes again into action, and closes up the little fine passage to its normal dimensions. But I would myself be inclined to imagine the extraordinary characteristic of this outer coat, forming so remarkable a part

of the organization or structure of the rhizopod, goes even further, and is even more strongly evinced. I have mentioned that from a definite region, from which the outer coat appears to be wanting, emanate the ordinary pseudopodia, and that these can be withdrawn. Now examples are, however, by no means rare, which watched for a long time and made to roll over, show no tendency to project pseudopodia nor any difference in the outer coat, which, viewed from various points, seems like an everywhere present sharply-defined rim, and, as the case may be, more or less pilose or hairy in appearance. I am, then, half inclined to suppose that even the parts of the outer coat which permitted the exit of the tuft of pseudopodia, or perhaps too allowed a prominent portion of the body-mass to project, can again become closed up, and the creature become completely invested at all points by this remarkable outer coat. Nor is such a hermetically closed in example torpid or "encysted;" it is perhaps quietly all the time assuming various contours, from a nearly globular to various bluntly angular forms; and even perhaps, as I have seen more than once, such an example may send forth unexpectedly, mostly at one or even two of the corners produced, a blunt pseudopodium through the wall. On the other hand, that a certain amount of what may point to the reality of a kind of differentiation into "anterior" and "posterior" ends, may be said to be evinced not only by the frequency with which examples present themselves with the pseudopodia confined to one space only, but also by the fact, so far as it goes, that the "nucleus" appears usually to occupy a position at the side remote from that of the pseudopodial region, thus *perhaps* offering a certain amount of analogy to several other forms of Rhizopoda, where anterior and posterior extremities are distinctly pronounced, and in which the "nucleus" always occurs behind.

In the progress of our ideal building up of the form now under consideration, and in our gradual advance from within outwards, I purposely left in abeyance a characteristic evinced by the sarcode body-mass, one however which appertains to it in common with a great many other Rhizopoda, and to that body-mass itself I must for a moment revert. I refer to the formation of vacuoles therein. I left the allusion to this in abeyance, because the appearances accompanying its display are curious in relation to the presence of the remarkable outer coat, which I proceeded therefore to describe first.

Although, however, the formation of pulsating and non-pulsating vacuoles is a phenomenon so frequent in various

genera of Rhizopoda, their existence in the present form seems to be rather exceptional than otherwise.

Such a specimen as that repeated in my fig. 2, offers however an example of this condition in a pronounced degree. Here the whole body-mass is more or less areolated by the presence of vacuoles, and the green and colourless granules are pushed aside, and these run more or less into a reticulately disposed arrangement between the vacuoles, the elliptic bodies naturally falling into a position more or less end to end. But not only do those internal vacuoles exist, but no less than three marginal ones appear in the example figured, showing a distinct pulsation in action, very much like that of the marginal pulsating vacuoles in *Actinophrys*, *Actinosphærium*, *Heterophrys* (*H. Fockii*, mihi) and others.

But, perhaps, the most interesting circumstance connected with these pulsating vacuoles is the way they stretch and seem to attenuate the outer coat, as seen in two of those present in the example figured (Fig. 2). I have not been able to see that they caused an opening in the coat; at all events, on collapsing, the latter had quite its ordinary appearance. From the appearance here presented we see something like what I imagine ought to reveal itself before an advancing pseudopodium, did not it actually penetrate through and project beyond the outer coat, as I have already conveyed. The third marginal vacuole in the rather energetic example figured occurs on the broad projection giving off the pseudopodia, and seemingly here without the covering of the outer coat. Unlike the marginal vacuoles of the *Actinophryans*, these were slow in action, pulsating only a few times and disappearing, nor recurring after a long time of waiting, until finally the dip dried up.

But our form occasionally, indeed rarely, presents yet another characteristic: this I tried to repeat in Fig. 3. This consists in the somewhat sudden appearance of a fitfully more or less deep *halo* of very pellucid sarcode matter, outside the whole body-mass and outer coat—sometimes involving the example completely round, at other times seemingly developed over only a portion of the superficies. So far as my observation reaches of the occurrence of this curious-looking envelope, it has presented itself only in the examples from the third locality (county Tipperary), and in those without chlorophyll-granules, and in which, too, the hair-like appendages were least developed, or, as in the example figured, all but obsolete. Whether, however, there is more than meets the eye in the circumstances just mentioned, I must leave in abeyance. But to describe the appearance

presented more closely: one is watching an example in the hopes that pseudopodia may be extended, or to have a view previous to treating the example with a re-agent, and, perhaps, nothing particular as yet discloses itself, when, I might say, all of a sudden, there appears to grow off from the periphery, an at first homogeneous, pellucid, rather sharply bounded, nearly colourless, or very faintly bluish, sarcode border, either nearly simultaneously all round or at one part only first; or, it may be, that this never, during protracted observation at least, presents itself universally. The first time I noticed this seeming sudden growth of this very subtle, or, as I might almost say, of this ethereal-looking covering, it was certainly with some surprise. One watches, and this delicate *halo* grows here and there broader, again narrowing here and there, keeping up this play for a length of time; and so the border, hardly ever at one time of equal depth for any long stretch, thus presents more or less of a broadly-lobed outline. The broader and more pronounced this envelope gets as one watches, the more readily is seen in its very attenuated looking substance, when focussed equatorially, a number of radial lines, beginning at the surface of the outer coat, and reaching to its own outer contour. These lines are not always like continuous striæ, but of a dotted or, so to say, somewhat *shaky* appearance. A moment more, and probably they cannot be discerned; and yet, in a brief interval, they seem at once, perhaps all round, to reappear. When these dotted lines are about most pronounced, so also, though always sharply marked off, is the edge or outline of the hyaline investment most pronounced, and the lines seem to broaden there and form a bluish margin to the whole, this again soon becoming paler and disappearing. I have tried to realize the most pronounced appearance of this pretty condition in my Fig. 3. After a short while again, perhaps, this beautiful play ceases, and this hyaline investment disappears, nor longer leaves any appreciable evidence of its having been.

I have said there is *sarcode abstinent* and *sarcode voracious*—these idiosyncrasies, as if bound up with certain forms, and maintained, so far as I can see, seemingly irrespective of the *supplies* around. Our rhizopod does not belong to the former category, but neither still is it a hungry form. Crude food within its substance is not abundant, nor, as a matter of course, are the objects incepted large in dimensions, consisting seemingly only of minute protococoids, and such like. In the first gathering in which I met this rhizopod, there occurred numerous examples of a curious little chröococcaeous alga (one endowed with a locomotive power, and one

which, I may parenthetically observe, well deserves in itself a closer investigation, to which I may hope for an opportunity, should I re-find it, to return on a future occasion,) and this organism seemed therein to form its principal food. Fig 2 represents a vigorous specimen, which has more than once afforded us instructive details in connexion with its behaviour, and which contains a specimen of the alga referred to, which it had incepted. Fig. 3 shows a small proto-coccoid which has been incepted.

Having, then, thus tried in idea to build up the structure step by step, or to give such a descriptive picture, as it were touch upon touch, of our form, as well as having made an endeavour in the figures by the aid of the brush, to realize its likeness, I trust I shall have succeeded in conveying to observers a fair and available representation of this rhizopod, in some of the somewhat varied aspects of its living condition. I must, however, devote a few words to a record of how far the behaviour of this rhizopod, under the action of certain reagents, bears out or explains the preceding account of its structure, and then speak of its seeming affinities, and assign it to its genus.

On the application of Beale's Carmine fluid, a collapse of the whole Rhizopod, coat and all, takes place; the green granules become more glassy in appearance; soon the whole, coat and all, begins to swell out again as globular as before; no retraction of the sarcode body-mass from the coat seems to ensue, nor any dissolution of the hair-like external processes. The body-mass by-and-by becomes granular in appearance, and far less hyaline. But the most important effect produced by this valuable reagent, is the unfailing certainty with which it brings to view the "nucleus," by reason of the extent to which this body absorbs the carmine colour, until by-and-by it assumes an intense red colour, far in excess of the pale rose tint presented by the remainder of the sarcode mass. The nucleus appears, as before, mostly slightly longer than broad, and sharply bounded. Sometimes a second rather sharp outline is apparent a little within the outer one; the former of which, when present, bounds a space more highly coloured than the border beyond it. This, however, appears to be exceptional, and although in the living condition the nucleus appears evenly granular, its substance now appears smooth and homogeneous. This experiment then is very satisfactory, as disclosing the presumably constant "nucleus," but it does not seem to demonstrate the body-mass and its outer investing coat as independent structures; for, altered in appearance as may be the former, and though

some of the granular contents and even some basic sarcode may become extruded, the body-mass and the coat still seem to remain closely applied to each other.

The application of acetic acid does not seem to produce any very noteworthy effect, save rendering the outline of the nucleus more sharp and marked. No very evident contraction of the body-mass from the coat took place. But this experiment I have not tried sufficiently often to rely very much upon its general results; and I imagine I did not succeed in bringing this re-agent to bear with sufficient energy.

The use of a re-agent I happened to have by me for another purpose, a weak solution of iodine and iodide of potassium, was attended with very pretty results. This re-agent, vigorously applied, caused an immediate contraction, or rather coagulation, of the sarcode body-mass into one or several balls, the whole coming clean away from the outer mantle or coat (Fig. 5); when allowed to act more slowly, the result of the gradual retraction of the body-mass as above can be seen. If, indeed, the finding of empty coats (see Fig. 4) in the material did not already prove the independent character of this investment, I mean its want of organic union with, that is, its being no mere condensed exterior, or thickened or consolidated and altered ectosarc to the body-mass, I think this experiment would demonstrate the point. If the rhizopod and its investment were like "endosarc" and "ectosarc," I should suppose that this experiment must also have given, in this regard, a similar result to the preceding. But this experiment, the effect of which in a single specimen I depict in Fig. 5, gave other curious results. As I have already described, the body-mass, in the majority of the examples, presented a stratum of the pale, shiny, elliptic bodies, just under its periphery, and immediately beneath this, it presented the more or less dense stratum of bright chlorophyll-granules; and within all, generally at the side most remote from the pseudopodium-bearing region, it admitted of being seen (with patience) the elliptic "nucleus." Now the immediate effect of the present re-agent was, as it seems to me, highly curious and interesting. I have said the sarcode mass coagulated into one or several balls, leaving the mantle bare, but not only did it do so, but these balls, in contracting, carried with them and *huddled* together the elliptic shiny bodies, which in the normal state formed the outer stratum, or that the more distant from the centre—whilst, at the same time, the chlorophyll-granules were left outside the contracted sarcode balls, though they, in the normal state, formed the inner stratum, or that nearer the centre—thus,

a complete transposition taking place in a moment, those granules which had been the outer being carried in, and those which had been the inner left out. Further, in the majority of the instances in which this experiment was tried, the nucleus was likewise not included by any of the sarcode balls, but left outside as a somewhat shrivelled or lobed pale greyish-bluish coloured, rather shiny, body; in other instances, however, I could not again find the nucleus, and it must have either been imbedded in some of the balls of sarcode or ejected, and got lost. The action of the present reagent on the mantle or coat itself, seems to be that of causing its expansion or inflation, as it assumed a nearly circular and somewhat enlarged outline; the specimens which happened to be experimented upon were some in which the external hair-like processes were very short, yet quite distinctly marked, nor did the action of the reagent cause any very great alteration in their aspect, and the general surface retained the colourless character and the dotted appearance due to the linear markings in the substance of the coat, or to the hair-like processes themselves; whilst at the periphery, just as in the normally empty coat, where a thicker mass of the substance is seen rim-like, and where, of course, we thus look through a greater density, the coat appears of a bluish colour. Upon adding a very little of the ordinary tincture of iodine, the coat took a straw colour, the other portions remaining as before. This experiment, therefore, was not without instructive results.

The action of sulphuric acid was also interesting. Brought to bear very slowly at first, this time upon examples showing no chlorophyll-granules, this reagent caused a slight inflation or expansion of the total rhizopod, coat and all, simultaneously. One specimen, presenting two lobes, from which pseudopodial projections were pushed out, presently assumed a more orbicular outline, and the pseudopodia disappeared. There were examples which possessed rather long, hair-like external processes. At first these were not seemingly affected by the action of the acid, neither was the mantle or coat, and I had begun for a moment to query were these hair-like processes of a rigid and siliceous nature, but the results soon gave a negative reply. By degrees there took place a *slight* widening of the hair-like process, from being of a fine linear appearance as in the normal condition, so that I could attribute to them a certain amount of width and, as I might say, two sides; these seemingly somewhat wider below or during their length than at the acute apices, that is slightly tapering. They could not, then, be siliceous.

Presently a few of these processes seemed to *drop off*, and showed a *slightly* capitate lower extremity, and several showed a more or less curved figure. I tried in Fig. 6 to convey an idea of the appearance such detached processes now presented to me. But, perhaps, the most interesting result followed the application of a stronger dose of sulphuric acid, when at once the outer coat, hair-like processes and all, became quickly dissolved, leaving the sarcode body a naked somewhat sharply-bounded globular mass, the contained granules broken up, the pale elliptic bodies dissolved or disappeared. The result of this experiment was, therefore, not less satisfactory than the preceding, though in a reverse kind of way, in demonstrating the complete difference and independent character of the outer coat and the inner sarcode body-mass.

I have to add, that any reagent applied to an individual showing the faint and pellucid outer investment already described and attempted to be portrayed in Fig. 3, causes its immediate disappearance, even though its action be too weak to call forth any of the previously mentioned results.

All these experiments, then, seem to me to corroborate and shed a light upon the interpretation previously advanced of our examination of the structure of the living rhizopod. Perhaps, indeed, some may think the word "structure" misapplied to a being so lowly, and, after all, so little differentiated; but, at least, like other Rhizopoda, it cannot be denied its special characteristics, even by those to whom one *sarcode-patch* is the same as another *sarcode-patch*, each of which is only moulded into this or that by *accident*. Here is a "form," at all events, which may or may not be independent, but such a form in its "specific" details, so far as I am aware, as has not yet met observation. Until then it proves to be but a transitory form, it possesses quite as distinguishable features as very many others constantly recurring; it has presented itself in three distinct localities—one a hundred miles and more distant from the two others—and, on the whole, deserves a record as well as more familiar types.

But having now gained as much acquaintance with the characteristics of this rhizopod as present research has disclosed, we may just for a moment speculate as to the analogies, so to say, of its composition. The central body of all, the so-called "nucleus," is, of course, quite homologous with the similar so-called body in Amœba, in Diffugia, in Diaphoropodon, in Pleurophrys, in Euglypha, in Cyphoderia, in Plagiophrys, in Pamphagus, &c. &c. The tapering hyaline

non-coalescing pseudopodia have the essential characters of an "Amœban" rhizopod, whilst the contractile vacuoles, if not exactly alike, much resembles them, but still more those of an "Actinophryan." The pale shiny, mostly elliptic, granules are again found in Amœba and related Rhizopoda, and are probably equivalent to the "sarcoblasts" (Wallich) of Amœba; whilst the chlorophyll-granules of the present are again seen in some Diffugiæ as well as *various* other Rhizopoda, temporarily in some, or possibly constantly in others. The special and very remarkable and very puzzling character of the investing mantle or coat would place such a form as ours out of all the older "Amœban" genera. This coat is at once yielding and plastic, elastic and tough, seemingly capable of being bored through and effacing the aperture—*possibly*, however, minutely perforate—and clothed with processes of variable length, these separable under certain reagents as if in a measure articulated, resisting some reagents, at once disappearing under the action of others. This is, therefore, not a test comparable to that of Diffugia, or Euglypha, or Plagiophrys, &c. What, too, may be assumed to be the nature or *homology* of the outer hyaline investment depicted in Fig. 3, and described above? Does its existence at all point to the presence of actual canals in the coat indicated by the vertical or radial striæ, and is this an emanation poured out through such canals, comparable to the ectosarc of an Amœba, or is it rather to be regarded as "chitonosarc" (Wallich)¹? If, indeed, the mantle or coat described be not, as I have throughout regarded it, a truly external investment, but a wall placed between the inner body-mass and an always existent, though, on account of its very pellucid and subtle nature, seldom visible outer region of the total rhizopod, then the existence of little actual canals need not be necessarily assumed; and, perhaps, such an assumption may not, after all, be quite unfounded, for though this *halo* is rarely evident, yet a kind of bright outline often presents itself immediately external to the striate, often hairy, coat, which, however, I have rather been inclined to ascribe to an optical effect than to the visible expression of the existence of an actual outer investing sarcodic stratum, however delicate, or of however slight depth. Might the fine vertical lines seen in the substance of this subtle covering actually indicate the very moment of formation or deposition of the hair-like processes? The weak action of the sulphuric

¹ Wallich, "On the Polycystina," in 'Quart. Journ. Micr. Science,' Vol. V, N. S., p. 71.

acid seems to have the effect of dislocating (some, at least, of) these as if they were, in a measure, articulated to the coat.

While, then, much that is puzzling and enigmatical remains unsolved, enough is evidenced to show the immediate Amœban affinity of this form. But while it cannot appertain to any of the genera *Amœba*, *Diffugia*, *Arcella*, or to any other distantly related types, as *Pleurophrys*, *Plagiophrys*, &c., it is, perhaps, sufficiently fitly referable to an Amœban genus lately established by Greeff—I mean *Amphizonella*—to find a place legitimately there, at least temporarily, and until further research may possibly show its specialities to demand its removal, or show its nature and affinities to be distinct therefrom.

Having, then, from what has preceded, gained a conception of our rhizopod and its characteristics, as I have said, the next step is to assign it to its generic position—one which, as we have seen, is peculiar. However, the “genus” which it might typify, as I have mentioned, I think I find already instituted by Greeff in his *Amphizonella*,¹ and it will therefore be necessary that I should here endeavour to convey a conception of that genus, and of the three forms referred to it by Greeff, which, I may here mention, have all occurred not in water, but damp earth. This, indeed, may be the more advantageous, as no account of it exists in English works, nor have hitherto, so far as I am aware, any of the forms referable to it been recorded in this country, though I now myself have little doubt but that I have seen on one occasion his typical form, *Amphizonella violacea*, though, at the time, I paid far too little attention to it to note its specialities, or even as yet to venture definitely to announce its occurrence; but I have little doubt but that proper search must again disclose it.

Greeff does not give, unfortunately, any diagnostic characters of his genus, so that one has to construct *in idea*, gleaned from his general description, such a type as would include his forms (and mine), and exclude other “Amœbina.” And this type, briefly expressed, seems to be an Amœban body, *plus* a hyaline coat, penetrable by the pseudopodia, its previous condition recoverable, and strangely resistant to the action of some re-agents and at once succumbing to others, yet quite soft and yielding in its natural condition.

But now to recapitulate Greeff’s account of his principal

¹ Greeff: “Ueber einige in der Erde lebende und andere Rhizopoden,” in Schultze’s ‘Archiv für Mikroskopische Anatomie.’ Bd. ii, p. 323, T. xviii, figs. 12, 13, 14, 15, 18, 19.

or typical form, *A. violacea*, following his words as closely as may be without altogether a full or precisely literal word-for-word translation:—

AMPHIZONELLA VIOLACEA (Greeff).¹

“The fully-grown individuals of this form have”(says Greeff) “a diameter about 0·15 mm., and are of a more or less globular figure, which undergoes little change, even during the movements of the rhizopod; this rotund body shows a hyaline outer margin, and an inner mass mostly coloured a beautiful violet. At first glance”(says the author) “we might suppose we had before us the ordinary structural condition of an *Amœba*, that is a particularly dark and coloured granular endosarc, with a hyaline ectosarc universally surrounding the former. But upon closer examination it is seen that this external layer represents a completely independent margin or border (‘Saum’), with an outline of its own both outwardly and inwardly, and which surrounds the body proper of the rhizopod. All round the circumference can be seen the limits of this border (‘Saum’) in apposition to the surface of the inner body-mass. Still more clearly can this be seen when the outer investment is burst by compression, and some of the sarcode mass ejected.

“Upon the application of re-agents, the distinction of this outer coat (‘Hülle’), as an independent part of the structure from the inner body, becomes even more decidedly expressed. Under acetic acid whilst the body-mass collapses, ejects the granules and shows every indication of coagulation, the outer hyaline ‘capsule’ (‘Kapsel’) remains intact, and this even though the acid be allowed to act in a more concentrated condition, or for a longer time. The same thing takes place under dilute sulphuric acid, whilst in a more concentrated form, the capsule wholly, and the contents partially, become dissolved. However, during the dissolution of the capsule no other alteration takes place, that is, no sign of coagulation or like. Under the action of alkalis this capsule shows at first a tolerably persistent resistance, afterwards, however, becoming dissolved, without, however, having become previously altered in appearance. The action of iodine is remarkable: so soon as this, in a dilute form, is applied, the violet colour becomes destroyed, and its place is taken by an at first clear yellow colouring of the whole of the contents, which gradually, under prolonged action, passes over into a deep blackish-brown, all which time the outer border maintains perfectly its colourless hyaline appearance, and only when

¹ Loc. cit., T. xviii, figs. 12—15.

penetrated at all sides by the iodine does it acquire a slightly yellow appearance, which, however, upon being removed by blotting paper, and water added, again disappears. Only under persistent action (of the iodine) does the capsule become tinged a light yellow, retaining, however, its pellucid glassy appearance.

“From all this” (urges the author) “it follows that as regards the problematic hyaline outer border in *Amphizonella* it is not a protoplasma-layer appertaining to the rhizopod-body, but we have really to do with a comparatively thick ‘capsule,’ bounded off and essentially distinct therefrom.

“As regards the body-mass included by this capsule,” (the author goes on to say,) “this is permeated by a mostly dark violet pigment, frequently, however, it assumes a trace of yellow or brown, and this again depends upon a second pigment diffusely distributed in the body, which, under circumstances hereafter to be mentioned, sometimes presents itself exteriorly. Under natural conditions, and without pressure on the covering-glass, little can mostly be made out as to the contents owing to the darkness of the colour, with exception of the vacuoles, always existent in considerable numbers, but minute, as well as a large round body (nucleus), which structures make themselves evident from within, by their somewhat clearer appearance. The violet colouring substance is, however, very sensitive, and readily destroyed by the gentle action of acids, alkalies, alcohol, iodine, &c., and then the contents, having become considerably clearer, can be examined. Sometimes compression succeeds in extruding and isolating, uninjured, the contents and the most important parts. Amongst the varied kinds of food expelled (*Diatoms*, *Arcellæ*, *Euglyphæ*, &c.), a large round body, the ‘nucleus,’ at once strikes the eye. This measures about 0.04mm. in diameter, and has a rather soft consistence. It resembles in structure that of *Amœba*.” [The author here adduces that of his *A. terricola*, previously described by him; a perfectly hyaline investment surrounds a space, which is completely filled with round solid granules, and the author has every reason to suppose that the progress of development of these granules is essentially the same as in *Amœba terricola*, although he has not yet been successful in observing the transitional forms. The author here alludes to a breaking up of the nucleus and scattering around of the granules, each one the germ of a young *Amœba*, by successive stages, putting on the character of the mature form—see the preceding portion of this memoir on *Amœba terricola*]. “The young of *Amphizonella violacea*” (continues Greeff) “or

what appeared allowable to be regarded as such, were still destitute of the above described hyaline outer coat, were still naked, as if it appeared those were developed only at a certain stage; these conditions demand a closer investigation.

“The movements of this creature,” (says the author), “are peculiar,—the contractions and modifications of form of the whole body take place exceedingly sluggishly, and the form must be observed carefully and persistently in order to make one’s self certain about them. These consist ordinarily of only slight undulate projections from the circumference of the body, the roundish form of which only exceptionally passes over into an oval. In all these general movements of the body the outer capsule takes a constant, if, indeed, only a secondary part, in that it readily yields to every impulse outwards of the inner body.

“The movements of the sword- or finger-like pseudopodia, projected from the interior, evince themselves differently. These project forth with a perfectly hyaline blunt apex, pushing on in advance only a simple contour, never (according to the author’s observation) the double contour of the outer coat, thus proving that the latter becomes perforated with readiness by the inserting of the cuneate process.” [The author adds that] “This fact is confirmed by the circumstance that the pseudopodium can be frequently followed through the outer capsule down to its basis, that is to say, to its origin in the interior of the body-mass. Ordinarily, the pseudopodia do not extend outwards beyond a certain limit, remaining hyaline throughout the whole length; however, if they become more elongated, which rarely happens, then a dark and coarsely granular substance streams forth from the interior into them, not, however, pressing on further than about half-length. Their motions are much more vigorous than those of the body in general; they usually come forth rapidly, but only when the creature has been permitted to remain for some time at rest and undisturbed, disappearing again just as quickly upon any jar.

“If we revert to the outer capsule, we find it showing wonderful peculiarities—on the one hand an extraordinary resistance to outer influences (as before detailed) and on the other hand, as it appears, a soft and gelatinous consistence, readily permitting the penetration of the pseudopodia, and, without doubt, after their retraction, filling up the openings produced in the substance by fusion at those places.” [Touching the latter point, that is the ready fusibility of the substance of the capsule, the author next communicates a peculiar observation, one at the same time of further interest.]

“This was an extremely curious fusion, or firm hanging-together (seen, however, only on one occasion) of two individuals. The capsules only were here fused together by their margins, whilst the two body-masses remained free, and without any connexion. This latter was, however, brought about by a peculiar indirect way, by a commissure of clear yellow hyaline substance proceeding from one individual to the other, of which substance mention was made above as a pigment sometimes occurring in the contents. This commissure originated on both sides, with a broad basis, taking up almost the one-half of the circumference of the inner body, giving the appearance as if it flowed out therefrom, and it formed at the place of union an isthmus (or bridge), passing through the hyaline capsule-substance. The question becomes (says the author) what significance is to be attributed to this remarkable object—whether it represents an individual just about to undergo self-fission, or an act of impregnation, described for other Rhizopoda under the name of Conjugation or Zygosis.” [Although meantime the author was not in a position to prove either the one or the other for want of further observation on the object, he gives his adhesion rather to the interpretation of the case he describes as one of zygosis, from his having observed the young forms of the animal, as previously mentioned, which are distinguished by the want of the outer hyaline capsule. From these and other reasons (the above described nature of the nucleus) the author thinks he is justified in attributing to this form “a sexual reproduction, or rather a development of a young brood in the interior of the mother-body, and not a propagation by fission.”]

The foregoing recapitulation (expressed in the third person) presents the account given by Greeff of his type-form nearly in full. To make the data more complete, by which readers of the present communication can the better realize the generic idea of *Amphizonella*, in which my own new form seems to fit, I add in the same manner, but slightly contracted, all he has to say of the next form, called

AMPHIZONELLA DIGITATA (Greeff.)¹

As a second representative of the same genus as the foregoing (*i.e.* *A. violacea*) the author points to the form named *A. digitata*, presenting, as he describes, the same characters of structure and movements—“that is, an universally closed

¹ Loc. cit., T. xviii, fig. 18.

hyaline outer coat or capsule, with extremely pale digitate processes projecting through the latter. In *A. digitata* the separation of the hyaline protoplasm of the rhizopod from the outer capsule is still more distinctly evident, since the first surrounds the granular interior substance as a more or less broad stratum. The motions are more vigorous, and are indicated by the fact that mostly at first broad hillock-like processes, still encompassed by the outer border, become pushed forth, from whose ends then the digitate pseudopodia project. The granular inner parenchyme (endosarc) shows for the most part a coarsely granular substance, which, however, appears enclosed in an extremely finely granular one. In the interior there is to be seen constantly a large round nucleus, with a likewise comparatively large and sharply-bounded nucleolus, and besides mostly a large and a couple of smaller contractile vesicles. Likewise, the above mentioned lime-crystalloids are never absent. The animal reaches a diameter of about 0.1mm."

This, then, is all Greeff has to say on this form, and he gives no more close description. All his forms, however, are illustrated by figures.

Yet a third form, named *Amphizonella flava*, is (provisionally) referred by Greeff to the genus typified by the two preceding forms, and I would complete the data to enable the conception to be gained thereof by giving his words:

AMPHIZONELLA FLAVA (Greeff).¹

"Although," says the author, "I at first hesitated to refer this form to the same genus as the preceding, still I may do so, be it, perhaps, but provisionally. This is likewise surrounded by a coat, but a much firmer one, as it would appear a peculiar 'cuticular shell' ('häutige Schale'). This 'shell' ('Schale') is of a light yellow colour, and, unlike that of the two previously described species, is not directly applied to the body proper of the rhizopod, but lies loosely round about it as a wide sac, and it thus follows the contractions and modifications of the inner body, so far as these touch its walls, but always with a certain tenacity, whereby continually alternating folds and lines travel over the surface. Nevertheless, the 'skin' ('Haut') possesses an extraordinary extensibility, so that sometimes it becomes stretched, by the pressing forwards of the processes of the inner body, to an extremely thin and delicate layer, which may be carried on to

¹ Ibid., T. xviii, fig. 19a, b.

such a degree that the skin at this place appears quite white, whilst in its ordinary condition, as above mentioned, it is of a yellow tint. Sometimes (says the author) I saw pale, long, hyaline processes from the interior press against the outer capsule, but I was unable to establish with certainty whether the latter became broken through in the previously described manner thereby. It appears, however, undoubted and even essential, that this problematic 'skin' must, in fact, possess such an extensibility and elasticity, that it becomes ultimately broken through by bodies pressing against it, be it from without inwards by inception of food, or be it by projected pseudopodia. But just as undoubted and essential is it also, that subsequently, as well following the incepted food-particles, as after the pseudopodia are again retracted, the breaches which had taken place should become at once again restored, through the elasticity and easy fusibility of the skin.

"I was not able to find a nucleus in the interior of the granular parenchyme, but, however, some minute contractile vesicles; its dimensions reach a diameter of 0.04 mm."

This, then, is all Greeff gives us in connexion with these interesting forms. It is a pity his account of the two latter forms is so short, but should they turn up in other quarters, his figures would most likely render the identification not difficult. It is perhaps also, to a certain extent, a pity, that he calls the outer coat by such varied names as "Saum—Schale—Haut—Kapsel, &c.," when, perhaps, the more general term "Hülle," might, at least, be preferable, that part of the structure being, at all events, one and the same thing throughout. Combining, however, what we have learned respecting my own new form, brought forward on the present occasion, with what Greeff has communicated, of the three he has named, we gain a conception of a seemingly distinct generic type of rhizopod, previously to his memoir, not defined, and one of considerable interest.

It may look somewhat like temerity, on my part, to essay to do what Greeff has unfortunately left in abeyance; that is to try to comprehend in a diagnostic form what appear to be the characteristics or essentials of this genus, so far as observation reaches.

Genus, *Amphizonella* (Greeff).

Generic characters.—*Rhizopod, with a "nucleated" body-mass, enclosed in a distinct (and separable), more or less pellucid, elastic and yielding investment, through which it*

temporarily protrudes a greater or less number of digitate or tapering, short, hyaline pseudopodia, upon the retraction of which the extemporized openings in the investment become effaced by virtue of its inherent fusibility.

Affinities and Differences.—The “nucleus” and the digitate, or short tapering pseudopodia presented by the forms appertaining to such a genus as the foregoing diagnosis may, perhaps (so far as present information goes) successfully define, seem at once to stamp its “Amœban” affinity. There might be thought to be some resemblance—nay, close affinity, to Greeff’s *Astrodisculus*,¹ but the want of the so-called “nucleus,” the presence of the “central capsule,” and of the numerous exceedingly slender filiform, (not short digitate or conical), pseudopodia, as far as I can see, completely place the forms referable to that genus apart from the present, and amongst *Radiolaria*. I have no doubt that I have now myself met with more than one *Astrodisculus* form, but so sparingly, that I have yet had no opportunity to submit them to anything like a sufficient examination. But though the *Amphizonella*-forms are then “Amœban,” in their affinity they seem generically quite distinct from all such recorded previous to Greeff’s memoir, by the special and peculiar character of the “outer coat.” Possibly, further research may disclose transitory stages in development of the forms referable here, which may present conditions falling short of those assumed as typical in the present state of knowledge about them, but as yet, I venture to think, the genus must be taken as a “good” one.

It seems exceedingly probable that the form named by Auerbach, *Amœba bilimbosa*,² ought to be referred here; this has not, however, so far as I am aware, been ever rediscovered. Many of the characteristics described for it seem to point to a community of structure with such as the present, and, therefore, in fact, to its necessary exclusion from *Amœba* proper, notwithstanding that Auerbach has endeavoured to demonstrate that “all Amœbæ are encompassed by a universally-closed membrane, which is structureless, very extensible, and perfectly elastic.” To combat this view, however, is no part of the object of this communication, nor to give a *résumé* of Auerbach’s now well-known memoir, to which I would refer, however, as interesting in connexion

¹ Greeff, “Ueber Radiolarien und Radiolarien-artige Rhizopoden des süßen Wassers,” in Schultze’s ‘Archiv für Mikrosk. Anatomie,’ Bd. v, p. 496, T. xxvii.

² Auerbach, “Ueber die Einzelligkeit der Amœben,” in Siebold and Kolliker’s ‘Zeitschrift für wissenschaft. Zoologie,’ Bd. vii, p. 374 (1856).

with the present forms. Still, however, Auerbach's experiments, with reagents or otherwise, do not seem to have produced a separation of the body proper from the closely investing covering, that is, they do not seem to demonstrate their, so to say, independent character.

Descanting, however, upon this outer, doubly-contoured investment, which he was inclined to regard as nothing else than the presupposed cell-membrane, which he would ascribe to all *Amœbæ*, and, alluding to the mode of projection of the pseudopodia and the thinning off and interruption of the investment where they occurred, Auerbach goes on to say:—“Allein indem ich länger beobachtete, wurde ich über diese Ansicht bedenklich. Namentlich war mir das Verhalten der Contouren an der Basis der Fortsätze ein Stein des Anstosses. Ich hielt es für unwahrscheinlich, dass eine dicke Zellenmembran an einer so scharf begränzten Stelle so sehr sollte verdünnt werden können. Deshalb warf ich mir die Frage auf, ob ich nicht vielleicht Rhizopoden mit einer membranösen Schale vor mir hätte, welche an gewissen Stellen für auszustreckende Fortsätze durchlöchert wäre.” And with the light thrown by the knowledge of the form described in the present paper and of those made known by Greeff, does it not appear that Auerbach's conjecture in the foregoing extract is right: in other words, that if it should turn up once more it is highly probable that *Amœba bilimbosa* will reveal itself as appertaining to *Amphizonella* (Greeff)?

A form of rhizopod, described as involved by a very flexible “membranous tegument,” met with by Dujardin, to which he has given the generic name of *Corycia*,¹ seems possibly to come close to this genus. The account given by him, unaccompanied by any illustration, is, however, too meagre to be certain as to what this actually is; it does not seem, however, to be the same thing as *Amœba bilimbosa* (Auerbach); it probably most resembles one of the forms referred to *Amphizonella* by Greeff—*A. flavva*—but is most likely not specifically identical therewith; a decision in respect to it must, I fear, remain in abeyance.

I have sometimes thought that the unnamed rhizopod referred to by Focke² in a recent paper, simply under the designation of “No. iii” (loc. cit.), might be closely related to my form, here named *Amphizonella vestita*. But the account given by that author of the form he had in view is

¹ Dujardin, in ‘Annales des Sciences Naturelles,’ 1852, p. 241.

² Dr. G. W. Focke, “Ueber schalenlose Radiolarien des süßsen Wassers,” in Siebold and Kölliker's ‘Zeitschrift für Wissensch. Zoologie,’ Bd. xvii, p. 355, t. xxv, iii, a, b, c.

far too brief and meagre to be able to arrive at an opinion. Could his figure possibly represent such a form as mine, no pseudopodia present, and with very long and comparatively coarse, hair-like external processes? or could his form possibly rather represent an *Acanthocystis*? So uncertain does it, however, appear to me, as regards its true character, that I would here simply content myself with referring to his communication, and leave the determination of his rhizopod and its possible relationship here, though such as that I now bring forward, to the future.

Possibly, should any of the (now four, perhaps I might write five, or even six) forms referable here be encountered by observers in this country, an attempt likewise to embody their seeming individual specialities, as well as those of the present new form, in short characters, may not be quite without use (leaving, however, *Amæba bilimbosa* (Auerb.) and *Corycia* (Duj.) in abeyance). I may begin with Greeff's type-form:

Amphizonella violacea (Greeff).¹

Large, mostly rotund in figure; nucleus large, enclosed in a hyaline wall, filled with round solid granules; the granular body-mass permeated for the most part by a dark violet pigment, imparting that prevailing colour, which, however, towards the exterior, is varied somewhat by another diffuse yellowish, or somewhat brownish pigment; the pseudopodia colourless, conical, blunt; the investing coat colourless, of varying depth or thickness, outwardly smooth.

Amphizonella digitata (Greeff).²

*Medium sized, variable, and mostly lobed in figure; nucleus large, containing a comparatively large and sharply-bounded nucleolus; body-mass colourless, coarsely granular at the central region, inclosing, however, a further finely granular substance containing lime crystalloids, outer marginal region hyaline; pseudopodia colourless, very short, conical and blunt; the investing coat of less depth than in *A. violacea*, uniform in thickness, smooth.*

Amphizonella flava (Greeff).³

Minute, variable in figure; nucleus not detected; body-mass colourless (?), granular; pseudopodia pale hyaline; outer

¹ Loc. cit., p. 323, T. xviii, figs. 12, 13, 14, 15.

² Ibid., p. 328, T. xviii, fig. 18.

³ Ibid., p. 329, T. xviii, fig. 19 a, b.

coat standing apart from the inner body, pale yellowish, very thin, smooth, often falling into folds.

Amphizonella vestita (Arch.)¹

Minute, but variable in size, normally rotund, but capable of varying its figure; nucleus comparatively large, elliptic, granular, smoothly bounded, but not seemingly enclosed in a special investment; body-mass nearly colourless or bluish, varied by a palish-brownish hue, enclosing a number of minute clear shiny purplish-grey, generally elliptic, sharply-bounded corpuscles, these forming a stratum just under the periphery of the body, below which often occurs a more or less dense stratum of large bright chlorophyll-granules; pseudopodia hyaline, generally emanating in a cluster from a comparatively restricted region, but occasionally singly, from other different points, short and conical, or more elongate and tapering, bluntly pointed; investing coat thin and of uniform depth, often seemingly deficient at the region giving off the corona of pseudopodia, at other times seemingly completely covering the body, showing a number of sharply-marked, closely and vertically posed equidistant lines, seen, when viewed equatorially, in its substance, reaching through its depth, and clothed superficially with a dense covering of more or less elongate extremely fine filiform hair-like processes, giving a hirsute or pilose or narrow fringe-like appearance, and when empty, a dotted aspect, or these obsolete.

Measurements.—Diameter varying from about $\frac{1}{400}$ "', down to perhaps two-thirds of that size.

Localities.—Pools in counties Westmeath and Tipperary. In the latter locality no specimens were seen showing chlorophyll-granules—a temporary character however in many Rhizopoda.

Affinities and Differences.—Considerations which would fall under this head, so far as they have a bearing in a generic point of view, and so far as the genus *Amphizonella* is typified by Greeff's forms, have been already adverted to. In respect, however, to our new form, it might suggest itself just possibly that certain considerations might operate in a measure to exclude it from one and the same genus with Greeff's. I allude to the mostly one-sided emanations of the pseudopodia; to the seeming absence of the coat at a given area; to the presence of the superficial hair-like processes, and to the subtle hyaline sarcode envelope sometimes seen. The first circumstance might be thought to bear a parallelism to

¹ Pl. VI, figs. 1—6, accompanying this paper.

conditions constant in Pamphagus, Lieberkühnia, &c., separating them from their allies—the second to represent a definite anterior opening (thus unlike Greeff's forms)—the third to present a distinct portion of the organisation of the total rhizopod not evinced by Greeff's forms—and the last a greater amount of differentiation, or of superaddition of parts, indicating a certain advancement. But we have seen that all these are variable characteristics evinced in various degrees: these variations in reality, taken all together, constituting so much of the sum total of the characteristics of our rhizopod, whose nature is to show now some of them, now others, more prominently or in a more pronounced manner—in other words, these characteristics, though attaching themselves to the *species*, not of *generic* significance. Greeff's figures of *A. violacea* convey the idea of the pseudopodia being confined to a separate region, but he does not speak of this in the text. The peculiar elastic and yielding outer coat, penetrable by the pseudopodia, would *seem* to be the great character of the genus, coupled with the Amœban body; and in that our form agrees. I need hardly say, its distinctions *in itself* from Greeff's three forms are sufficiently striking. The vertical parallel closely-posed lines in the outer coat do not exist in them, nor do they show the hair-like processes, nor, of less importance, have they ever shown chlorophyll-granules. Indeed, it is unnecessary to contrast them, *inter se*, very rigidly or closely. Its possible relationship to Focke's "No. iii" (loc. cit.) has been above alluded to. "Affinities and Differences" can, however, be regarded from at least two points of view—a morphological and a developmental. From the former point of view, enough has been demonstrated, indeed, to determine as to our form; from the latter, nothing very reliable has shown itself to me. I have no doubt, however, but that earlier or later phases occur without a coat, and that it seems to be formed subsequently, as in Greeff's forms and others appertaining elsewhere. My data in that regard are, I regret to say, only obscure and conjectural. Should good fortune ever yield an opportunity to gain any insight into these points in connexion with our form, I may at some future time revert to our rhizopod herein described, which, at least, morphologically viewed, stands as a good species, and may, for the present at least—with a double allusion on the one hand, to the often well-developed covering of hair-like processes, and on the other to the less often seen hyaline and subtle outer envelope—pass as *Amphizonella vestita*.

Acanthocystis spinifera (Greeff).

In my preceding fasciculus I gave a description of a new form appertaining to the genus *Acanthocystis* (Carter), named by me *Acanthocystis Pertyana*,¹ and on discussing its relations and resemblances, under the head of "Affinities and Differences," I had naturally occasion to contrast that form with the one it most approaches, the above-named *Acanthocystis spinifera* (Greeff),² and I drew attention to the distinctions between the two forms, which, indeed, still appear to me to hold good.

That occasion afforded me also the requisite opportunity to give a *résumé* of Greeff's views and ideas as to the supposed or conjectured further developmental stages, or at least assumed modified conditions of his form. He conceived, namely, that the yellow globules occurring in the body-mass of *A. spinifera*, becoming extruded therefrom, involved in a hyaline covering, then give off opposite pencils or tufts of very slender and delicate pseudopodia, and at last acquire characteristics of which he gives figures.³ Further, he conceived that these afterwards may become combined into considerably larger groups, the slender and delicate pseudopodia being now confined to the outer or circumferential parts of the cluster or aggregation of such bodies, of which he also gives a figure.⁴ The first of these forms, as I then adverted to, is identical with that previously named *Diplophrys Archeri* (Barker),⁵ and the second with *Cystophrys oculea* (mihi),⁶ and I followed up a review of that portion of Greeff's memoir by some considerations which appeared to me to render his views thereupon, as yet at least, improbable, and therefore to indicate that those names should stand.

Amongst those considerations opposed to Greeff's conjecture touching *A. spinifera* and the other forms alluded to, was adduced the negative, and far the least important one indeed—that is, that whilst the latter occur with us not very uncommonly, the former had not yet been found in this country.

¹ 'Quarterly Journal of Microscopical Science,' Vol. X, N. S., pp. 101-3.

² Greeff: "Ueber Radiolarien und Radiolarien-artige Rhizopoden des süsßen Wassers," in Schultze's 'Archiv für mikrosk. Anat.,' Bd. v, p. 493, t. xxvii, figs. 20-3.

³ Loc. cit., figs. 26-28.

⁴ Ibid., fig. 29.

⁵ 'Quarterly Journal of Microscopical Science,' Vol. VIII, p. 123.

⁶ Ibid., Vol. IX, N. S., p. 265.

Now, the object of the present additional brief note is threefold—first, to correct what turns out to be a misstatement on my part as to the non-occurrence of *Acanthocystis spinifera* in this country; in the next place, to point out certain features in the accompanying drawings (Pl. VI, figs. 7, 8), which seem to be of possible interest in connection with this elegant form; and lastly, to draw attention to two drawings (fig. 9, and Pl. VII, fig. 10), which I take the opportunity to insert in the plates, of the little organism, already alluded to by me,¹ possessing so great a resemblance to a *Diplophrys*, pseudopodia retracted and surrounded by an aggregation of foreign bodies, although there is, so far as I can see as yet, no evidence that, though to a certain extent so very like, it actually has anything to say to that form, and still less to *Acanthocystis spinifera*; nor have I, indeed, anything to add to the crude record I have already given of it.

I must now own that I ought to have put forward the statement that *Acanthocystis spinifera* (Greeff) did not occur with us, in at least a more qualified manner, for I was then, and have long been, acquainted with what I now feel very well satisfied is no other, the yellow globules, however, not present, and varying comparatively a good deal in dimensions. But it was not until subsequent to my previous communication having been published that I met with fully characteristic examples confirming Greeff's description, so far as relates to the form itself, in all particulars. The well-marked outline of the presumed "central capsule"—the numerous yellow globules immersed in the body-mass, but exterior to the "capsule"—their occasional extrusion through openings made by the temporary displacement of the long and fine and slender, equal-sized, pointed radial "spines"—in fact, all the described characteristics presented themselves to observation. The examples previously met with by me I now regard as simply smaller and probably young states of one and the same form, the "capsule" not yet formed nor yellow globules present, or indeed these, perhaps, but few or faint in colour; in fact, Greeff himself states these do not always occur. Such examples I had, indeed, before me, in my "mind's eye," when I wrote, but kept a mention of them in abeyance, imagining they might probably be younger states of *Acanthocystis turfacea* (Carter), and required further observation. It is true the spines here are different from what is characteristic of that species; but it struck me they might, by fresh accretion, eventually assume their ultimate

¹ *Ibid.*, Vol. IX, N. S., pp. 323-4, and Vol. X, N. S., pp. 102-3.

varied lengths and bifid apices. I admit such an assumption was gratuitous, the more especially after a perusal of Greeff's memoir, and due consideration of the characteristics of his *A. spinifera*.

I have now, however, no hesitation in recording this form (*A. spinifera*, Greeff) as occurring in this country, for, besides the more minute forms alluded to, I have lately taken a number of perfectly typical examples from both County Westmeath and County Tipperary. Of the smaller forms I have tried to reproduce an example in fig. 8, to which I shall presently advert, first drawing attention to the features illustrated by fig. 7, representing a preparation after treatment in Beale's carmine fluid.

Amongst the points illustrated by the example before us (fig. 7), the first that may probably attract notice is the fact that we have here two individuals in a state of "zygosis." This phenomenon is occasionally seen in all Rhizopoda, but is, perhaps, more noteworthy in those "Radiolarian" forms, like the species of *Acanthocystis*, which, unlike those of "Amœban" affinity, are altogether surrounded by a kind of wall of solid parts (spicula) which might be supposed to interfere with, or act as a bar or hindrance to, the mutual fusion of the sarcode bodies. However, not only the present form, but likewise *Acanthocystis turfacea* (Carter) and *A. Pertyana* (mihi) sometimes present themselves in this condition, and the present pair of examples of this form, so "conjugated," have not been chosen by me for illustration merely on that account. Whilst as yet regarding such an example as that seen in fig. 8 as a younger specimen of *A. spinifera*, yet it may be worthy of mention that even such minute forms occasionally present themselves "conjugated" — just a possible argument, indeed, that they may be actually distinct, supposing "zygosis" to indicate "maturity." It might, however, be held by some that such a condition does not really represent a case of "conjugation" of two distinct individuals, but rather of incomplete self-fission of a single individual; but although the true import of the phenomenon remains very problematic, still I think a consideration, to be mentioned below, seems to indicate that this does not represent an act of mere division, but really represents two "individuals" in a state of fusion or "zygosis." Accepting it as true that so it is in the case before us, perhaps the only circumstance directly connected with this particular condition really worthy of being drawn attention to, is, that the radial or vertical spines are distributed seemingly as evenly over the broad connecting isthmus, or commissure, as at any

other portion of the circumference of the conjoined pair of individuals, showing that during the original act of fusion, by mutual putting forth of a projection from each inner sarcode-body, the spines must have become raised up thereby, and, as it were, *shunted* aside, so as still, however, to come to stand vertically on the exterior of the broad connecting *isthmus*. There is no apparent line of demarcation evident between the two conjoined individuals; nor could it be decided, as regards certain of the spicula, standing, as it were, half-way, to which of the conjugated individuals they may have originally belonged; nay, it is just conceivable that, after separation, there may even take place an actual mutual interchange of a few of these.

But the point which most of all deserves consideration in the specimen before us, and probably that which would next attract attention on looking at the figure, is indicated by the small, bright, red, round body at the middle of each of the "conjugated" pair of individuals, the high colour presented being due to the extent to which the carmine dye has been absorbed. I would here refer to Greeff's figures of living specimens of *Acanthocystis spinifera*¹ to show the appearance presented by the presumed "central capsule," which I was able very well to see in many of the examples I have had under examination. In relation to this form and its central body, Greeff nowhere, however, goes so far as to call it a "central capsule" (he refers to it as a "centrales kernartiges Gebilde;" in another place as "Kern;" again, as "centrale Blase"). But to the very similar, nay, seemingly quite identical-looking body in species of *Astrodisculus*, he does not seem to hesitate to apply the term "central capsule." To my eyes this has here a somewhat solid-looking aspect and appears colourless, and of course prevents the intrusion of any of the granular contents of the "extra-capsular" region of the inner sarcode-body. We have, then, in the conjoined specimen, shown by my fig. 7, the outline of this "central capsule" still faintly indicated, but which has not acquired any higher colour from the carmine solution than that of the extra-capsular region; but the minute round body in the centre of each, as before alluded to, has imbibed the colour very strongly. Now, the question at once presents itself, what does this little rounded central (here highly dyed) body represent? If, indeed, observers will go so far as to conceive that the structure first described by Greeff in this form be truly homologous with the central capsule of the marine *Radiolaria*, then I would venture to suggest that the

¹ Loc. cit., t. xxvii, figs. 20, 32.

more minute (highly dyed) body occupying the centre of each of the conjugated individuals in the figure, may represent the *vesicula intima*, or inner vesicle ("Binnenblase," Haeckel). If, indeed, I may be correct in that assumption, then this will be the first instance (so far as I am aware) in which that element of the organization of a typical "Radiolarian" has been perceived in any *fresh-water* representative. Still, it is a portion of the structure that I believe would be quite impossible to detect or see in this form in the ordinary condition of the fully-grown rhizopod, owing, I may presume, to the solid or opaque appearance of the "central capsule" above alluded to. At least, I fear, I should never myself have suspected its existence or have seen it in such examples without the application of the reagent.

But the experiment illustrated by the figure having shown the actual existence of such an inner body, leaving its precise homology in abeyance, I naturally was anxious to refind some of the more minute, and, therefore, less opaque and less granular forms, which, as I have said, I would be much inclined to regard as younger examples of *A. spinifera*, in order to submit such to a more critical examination. Fortunately a gathering, just made in County Tipperary, revealed a few such, and of one of these I endeavour to give a portrait in fig. 8, which, indeed, though so minute, seems to give a certain indication of the yellow globules, though faint in colour. I had now, however, no difficulty in perceiving in the centre of such a minute example a delicate pale and colourless globular little body, whose nature can admit of but two interpretations, one only of which, of course, can be the true one. It is either a structure quite homologous with that represented in Greeff's figure, and indicated also in mine (fig. 7), in fact, the presumable "central capsule," or else it represents the inner minute body so deeply dyed in the example figured. Probably, had the very small specimens in this particular gathering been sufficiently numerous, the experiment of the application of the carmine solution would have assisted to decide the point; I could not succeed, however, as yet in bringing it to bear on any of those minute specimens. But although I must leave the question an open one as yet, I may draw attention to the consideration that if the little central body in fig. 8 really represents the same body as figured by Greeff, and readily seen in examples taken by myself—the presumed "central capsule"—it ought to be larger in proportion, as this generally occupies in this form a comparatively considerable extent of the body, and that therefore, so far as I can yet form an opinion, it should rather be

regarded as equivalent to the body dyed red in the example in fig. 7, that is, *presumably* homologous with the *vesicula intima* ("Binnenblase," Haeckel). If, indeed, this be really so, then it may be asked where is the structure surrounding it or the "central capsule" itself? Perhaps, then, the answer to this query may be that the latter is *not yet* formed, and that the "*vesicula intima*" is the *first* produced. On this point I may call to mind that Haeckel himself informs us that there is a time in the young condition of a veritable and altogether typical marine Radiolarian, in which no "central capsule" exists.¹

Having thus, in the case of *A. spinifera*, been able to demonstrate, at least in undoubted typical examples, two differentiated structures, one within the other, which may seemingly as yet legitimately be interpreted as "central capsule" and "inner vesicle" ("Central-kapsel" and "Binnenblase"), I was naturally desirous to experiment upon the form described by myself in my preceding fasciculus, *Acanthocystis Pertyana*, and, fortunately, some specimens lately turned up, though I regret I have been unable to prepare a figure in time for insertion in the present plate. In my previous description of *A. Pertyana* I stated that no "central capsule" nor "nucleus" could be made out, nor, indeed, can such be perceived by mere examination of an ordinary living example; it is to be regretted that I had not at command at that time Beale's useful carmine fluid, for its application has disclosed at least an equivalent structure to that in *A. spinifera*. In *A. Pertyana*, however, the result of the application of this reagent was not quite the same as in the case of *A. spinifera*; for though a smaller round central body took quite as high a colour as that in that species, yet, unlike it, the presumable "central capsule" likewise became comparatively highly coloured, but by no means so intensely as the more minute inner body, both one and the other becoming individually very clearly marked off, each with a sharp outline.

Of course the appearances presented in even both forms, resulting from the experiment described, might be capable of a different interpretation—that is, that these structures, in place of "central capsule" and "inner vesicle," may represent rather "nucleus" and "nucleolus;" but I should myself as yet be more disposed to accept the former view, supported as it is by the analogy of the structure of the marine forms—a view in which I imagine most other observers will rather be inclined to acquiesce. Bearing on this

¹ Loc. cit., p. 530.

point, I may, perhaps, have an opportunity to offer some notes on a future occasion relating to certain other rhizopods.

Regarded, however, in *either* light, the presence of these central structures in *each* of the conjoined examples in fig. 7 would seem to go to indicate that they are really two distinct *individuals* mutually "conjugated," rather than truly only one individual becoming two by a self-division.

The specimen before us (fig. 7) happens to present a further characteristic, which, perhaps, may be worthy of just a passing note, for no light can be thrown on its possible significance. I allude to the presence of the rather large, opaque, colourless, shiny, somewhat pearly-looking, broadly-elliptic body immersed in the sarcode body-mass, and between the two conjoined bodies of the "conjugated" pair of individuals; this seems homogeneous, and does not seem to show any nucleus or wall. It appears, I think, to be a precisely similar body to that recorded and figured by Stein, as present in examples of his so-called *Actinophrys oculata*, themselves conjoined or conjugated.¹ Upon this problematic body Stein himself seems to be able to throw not any light, thinking it, however, an introduced foreign body, and referring to Cohn's remarks on a similar body in *A. Eichhornii* (which see). I should myself hardly be disposed to attribute its existence here to a result of the "zygosis" or "conjugation," for quite identical bodies occurred in the extra-capsular region of unconjugated specimens in the same material; still, it might possibly be supposed in their case, too, that such may be produced in some way as a result of conjugation, and that, after separation, one of the individuals may have borne away with it this peculiar-looking body. I have also sometimes seen similar-looking bodies in the substance of certain other Rhizopoda. Although, then, the significance of this structure is so obscure, it seems to be too conspicuous and prominent a constituent of the *tout ensemble* of the present examples to be altogether unimportant, but a decision as to its nature must be left for further observation.

Another point presented by the examples shown in my figures (figs. 7, 8) relates to the *yellow* globules appertaining to *Acanthocystis spinifera*. Greeff seems to suggest the probable identity or homology of these with the green chlorophyll-granules of *A. turfacea*, and of those again with "yellow cells." I believe, however, they are here nothing but oil-globules. Greeff depicts them as all of one light yellow

¹ Stein: 'Die Infusionsthierc auf ihre Entwicklungsgeschichte untersucht,' p. 163, t. v, fig. 27, x and x; also Pritchard's 'Infusoria,' pl. xxiii, fig. 25.

colour; they appear rather of various hues, ranging from a pale yellow to a deep orange, and even a bright coppery colour, in one and the same individual; they are of very shiny appearance and of varied sizes—in fact, altogether like admitted oil-globules in other organisms; they have no “special wall,” no “nucleus.” Their varied and bright appearance, when present, renders this form one of singular beauty. Greeff very correctly describes the fact that they sometimes come forth from the rhizopod, not, indeed, simply, as I regard them, as isolated oil-drops, but these are surrounded, as he mentions, by a *halo* of pale sarcodic-looking substance. They *then*, no doubt, very closely resemble what would be a very minute form of *Diplophrys* (Barker), wanting, however, the tufts of pseudopodia. But I must still observe that to my eyes they do not seem identical either with that form or with the individual globules of the form I named *Cystophrys oculea*. I would here beg to refer to my previous remarks thereon.¹ I have occasionally since then taken examples of both one and the other, still maintaining the characteristics and appearances they originally presented. It will, perhaps, not be unconnected with the subject to mention here that, since my preceding communication appeared, in which I stated I had not then seen anything like Greeff’s figure 25 (*loc. cit.*), I have now had more than one opportunity to do so. The specimens I have seen, however, were like, but in one respect not identical with, Greeff’s. His figure shows the pencils of pseudopodia as proceeding from the exterior margin of the four juxtaposed bodies, whereas the pseudopodia in mine emanated from the clefts or intervals between the four bodies. Now, these bodies were considerably *larger* than the yellow bodies, with their surrounding *halo*, emanating from certain specimens of *Acanthocystis spinifera*, and go far to indicate that *Diplophrys* can repeat itself by a complete subdivision into several. Bearing in mind that this form is characterised by the possession of two tufts of pseudopodia given off from opposite ends, and that one of these tufts sometimes is projected and not the other (not unfrequently, indeed, neither), the difference between the position of the place of origin of the pseudopodia, shown in Greeff’s figure 25, and in my examples referred to, may be probably explained by supposing that, in the former, one set of pseudopodia were predominant, and in the latter the other set were those rendering themselves conspicuous. I must admit, however, that the whole question of the relations of the forms just now adverted to is as yet problematic;

¹ ‘Quart. Journ. Micr. Science,’ Vol. X, N. S., pp. 101-3.

and it may take a long time, and the result of many fortunate observations, but seldom, indeed, obtained, to dispel all obscurity that may exist.

I have taken the opportunity, as possibly not unconnected with the question, to insert on the accompanying plates a couple of sketches of an organism, previously adverted to by me,¹ very enigmatical in itself, but curious as presenting so close a *resemblance* to a specimen of *Diplophrys* without pseudopodia, or these retracted, and irregularly surrounded by a cluster of minute diatoms and fragments of larger diatoms, as well as various fibrous elements and indescribable "bits of things," forming a kind of "nest," in which it occupies the centre. Sometimes this "nest" is almost wholly made up of diatoms (fig. 9), and at others heterogeneous in materials, and sometimes not any diatomaceous frustules are to be seen (fig. 10). This aggregation of foreign bodies seems to be held together by a very delicate and very pellucid colourless connecting medium, but what relation this latter may have to the body itself is problematic; the whole usually possesses a decided more or less oval general shape, although, as in undoubted *Diplophrys*, the body within is nearly quite orbicular, not rarely, however, more or less, though but slightly, longer than broad, that is, broadly-elliptic. The body suspended within has the faintly granular aspect and somewhat palish-blue hue of that of *Diplophrys* itself, and the same larger or smaller orange or amber coloured shiny oil-globule—this oil-globule not always uniform in shade, sometimes a reddish-orange at one side passing off into a greenish-yellow at the other. This form occurs of various sizes. It has never yet shown any pseudopodia or other external portion of structure, nor any movement. It is widely distributed in this country, though not abundantly present in any gathering made; nor, indeed, is it often encountered, which, however, may be due rather to its very minute size causing it to be overlooked; it is, however, more frequently seen than *Diplophrys*, though the latter sometimes occurs more numerous in a gathering than the former seems ever to do. A curious question arises as to when or how this puzzling organism, so inert as it appears, can collect and pose the heterogeneous foreign bodies forming the "nest" in which it becomes embosomed.

In thus once more drawing attention to the forms immediately in question in this additional note thereupon, I do not suppose the subject is by any means disposed of or exhausted; it is quite possible that, by good fortune, some

¹ Loc. cit., Vol. IX, N. S., pp. 323-4; also Vol. X, N. S., pp. 102-3.

new or unexpected features in connection with them may become revealed. Should such occur to myself, I trust I might be once more borne with in reviving allusion to *Acanthocystis spinifera* or its allies. Should such occur to others, I should hail with a lively interest a record of their observations.

Plagiophrys sphaerica (Clap. et Lachm.).

In the course of this and my preceding communication I have sometimes made allusion to the form which I am inclined to believe must be identical with *Plagiophrys sphaerica* (Clap. et Lachmann);¹ it is, at all events, one which now and again sparingly presents itself from various localities. If, however, I am quite correct in this identification of the rhizopod I have had in view, it has struck me that the figure (loc. cit.) is not sufficiently graphic; still, had I not lately met with some examples not altogether coinciding with that which I had previously known, and which, for the present at least, I must continue to regard as Claparède and Lachmann's species, I would not (as yet at least) have thought it desirable to attempt a drawing of the form. But though certain specimens lately taken present some distinctions from the former, and on that account it has appeared to me to be perhaps worth while to endeavour to convey a likeness of both, I am, however, not as yet sufficiently satisfied that these are truly two distinct rhizopods, and I content myself with simply submitting the drawings to the notice of other observers whose experience may assist in throwing a light on the question.

But although I am disposed, at all events provisionally, to regard the first rhizopod I have in view, and attempt to repeat [in Pl. VII, fig. 11, as *Plagiophrys sphaerica* (Clap. et Lachm.), still, on comparing our form, after a prolonged examination and experiments with reagents, with Claparède and Lachmann's diagnosis, I am at the first step met with a character which might seem possibly to exclude it from the genus *Plagiophrys*. I allude to the fact that those rhizopods, meant to be included here, are said by the authors to be comparable to "Actinophryens non cuirassés," and whose numerous pseudopodia originate in a tuft from a single portion of the surface of the body. But if those authors deny a *test* (they ordinarily use the word "coque") to the (two) forms included in *Plagiophrys*, they attribute to *Plagiophrys cylin-*

¹ Claparède and Lachmann: 'Études sur les Infusoires et les Rhizopodes,' p. 451, pl. xxii, fig. 2.

drica (a form I have never encountered) a *skin* ("peau"), whilst in respect to *P. sphaerica* they are silent in this regard; but it is, I imagine, exceedingly probable that, so far as concerns this, the account given of each should coincide, and were most probably meant by the authors to be so understood. But beyond the fact that the figures represent the forms as possessing a quite smooth surface and sharp outline, there is no evidence afforded of the so-called "skin." The question, then, becomes what they meant exactly to convey by that term; but presumably it must have been not a separable integument enclosing the sarcode-body (certainly not a test or "coque"), but only a more dense and hardened, or rather toughened, exterior to the body, forming therewith a single inseparable whole, both being in complete organic union, and thus, only that it is less yielding, hardly, if at all, more than what has been attributed even to *Amœba* itself by some observers, as Auerbach and others. And, in fact, I had myself several times met with the rhizopod I am still disposed provisionally to regard as Claparède and Lachmann's form alluded to, and that without perceiving any further differentiation into body and integument than that I should suppose those authors were inclined to attribute to it.

Hence the experience, presently to be adverted to, gained from the preparations of both my forms under Beale's carmine fluid (fig. 16), and under acetic acid (fig. 12), does not appear to militate against the correctness of the identification of the first form here figured with *Plag. sphaerica*, for in the living example this outer *case*, or *covering*, is always so closely applied to the body as to appear, indeed, no more than a smoothly bounded exterior, which might seem possibly, to a certain extent, to be comparable to a "skin."

But although I cannot but suppose the identity of the form I sketch in fig. 11 to be probable, as I have mentioned, I regard this determination as yet as but provisional for certain other reasons.

The first is that my form shows a distinct "nucleus," or body so called. Now, in this regard Claparède and Lachmann are silent concerning their *Plag. sphaerica*, but they distinctly state they were unable to detect this in their *Plag. cylindrica*. Still, as this is only evidence of a negative character, it does not disprove the identity, for, owing to the density of the contents, the nucleus may have been present in both their species, but have been overlooked by them. When our form (fig. 11), alluded to, is treated with the carmine fluid the nucleus takes a deep dye (fig. 13), and when treated with acetic acid (fig. 12) it is mostly ejected, and can

be seen as a sharply marked-off elliptic body, or sometimes somewhat kidney shaped in figure, and of a granular appearance and bluish colour, like that of many other kindred Rhizopoda, but does not appear to show any wall or surrounding investment, though sharply bounded.

Probably, then, a stronger reason—one, indeed, that to some, however, may appear really but a very weak one—for doubting the strict identity of either of my forms with Claparède and Lachmann's, resides in the seemingly different character of the pseudopodia, as seen in their figure, and as may be gathered from the text. In referring to the figure given by those authors I need hardly here guard against a possible misconception in supposing it is meant to be indicated that the pseudopodia originate equatorially from the periphery of the orbicular body, which would be contrary to the description. The specimen is drawn as viewed from above, the posterior part being towards the observer, and, though the pseudopodia really originate in a single tuft from the side turned away, they appear, of course, seen from that point of view, to radiate around. In fact, all Rhizopoda of this character, that is, giving off the pseudopodia exclusively from an "anterior" end (such as Euglypha, Arcella, Diffugia, and many others), have a decided tendency to turn up (so to say) vertically, and creep, by action of the pseudopodia, along the surface on which they find themselves. In fact, it is hard to get a "Plagiophrys" to remain very long presenting to the observer a side or profile view. The distinction, however, to which I allude is the coarse, granuliferous, and unbranched character of the pseudopodia, as shown in Claparède and Lachmann's figure as compared with the slender and hyaline and tufted tree-like bundle of very fitful pseudopodia presented by our form. In fact, the authors attribute to their genus Plagiophrys "Actinophryan" pseudopodia. Now, the form I have in view does not possess pseudopodia comparable to those of an Actinophrys, nor to those of any heliozoan species. It is quite true "Actinophryan" pseudopodia sometimes inosculate, or even occasionally can temporarily divaricate; but I do not think they ever form a shrub-like or tree-like perpetually altering tuft, somewhat quickly appearing, branching, waving, extending, contracting, and, perhaps, as quickly disappearing, or at other times somewhat rigidly maintaining themselves as a little *tree*. To some these may appear as too fine-drawn distinctions, but I cannot yet but think that these idiosyncrasies are, on the whole, characteristic in these forms.

On the other hand, apart from these distinctions, we have

in our rhizopod a minute globular body, with at least *slender* pseudopodia, emanating in one bundle from a single little depression (or "boule," Clap. and Lachm.) at one side, and with an integument, which might, perhaps, when seen only in the living example, appear only as a "skin" (fig. 11), and thus, at all events, to a considerable extent falling in with the authors' description of their form.

But when our form is treated with acetic acid the body completely retracts from the integument, and it is shown as an independent, colourless, and smooth coat or case, or—may we call it—"test"? (see fig. 12), thus proving a characteristic not claimed for their forms, at least to this extent, by Claparède and Lachmann, something more, in fact, than what would, I think, be called a mere "skin." Might not our forms, indeed, be designated as "cuirassés"?

But to advert, then, to the mutual differences presented by the examples lately met with by me (fig. 14), as compared with the form here designated *Plagiophrys spherica* (fig. 11). I found it impossible to attain a good profile view of one of the former, so, like Claparède and Lachmann themselves, in this instance, I have been obliged to be content with a figure drawn from the posterior aspect. Comparing, then, the form we are the more familiar with (fig. 11) with that more recently met with (fig. 14), we see the colour of the body, or rather contents, is much darker in the latter (fig. 14); this, indeed, is probably of but little moment; the wall or exterior appears even thinner, smoother, sharper, more glossy. We see, too, the pseudopodia far more conspicuous, longer, here and there more broadened out, granular, more fitful and changeable, and, so to say, of a more solid character, less hyaline; but all this, it may be, requiring far more observation to decide as to its being specially characteristic of truly distinct forms. The differences under the action of Beale's fluid are more tangible. Specimens of the rhizopod represented by fig. 14, upon being treated with this reagent, *immediately* collapsed, and assumed the *crumpled* appearance indicated by the outline shown by fig. 15. In a few minutes this crumpled form began to expand, and speedily the folds all became obliterated, and the whole inflated, until a balloon shape was assumed (fig. 16). After a time some of the sarcode-mass became expelled through a rather wide truncate neck-like anterior extremity, and the body-mass became distinctly retracted from the outer case (test?); the nucleus took a bright red colour. Sometimes, but by no means in every instance, there was to be seen a brighter, smaller, "nucleolus-like" (?) dot within. In the instance figured a couple of

yellow oil-like globules presented themselves, very like the yellow globules of *Acanthocystis spinifera* (Greeff), and, in my opinion, seemingly largely going to prove that in that form these cannot be at all properly regarded as homologous with "yellow cells." The other specimens (fig. 11), those of the presumed *Plag. sphaerica*, also treated with the carmine fluid, behaved somewhat differently. No collapse or crumpling up of the total rhizopod took place; on the contrary, rather by degrees a slight expansion. Nor was it for a very considerable time, comparatively, that the nucleus took its dye completely, nor was there any apparent retraction of the body-mass from the outer envelope, nor did the latter become balloon shaped, but its anterior border assumed a very broadly conical figure, no very evident apical opening offering itself to view. But that there is, and, indeed, as a matter of course, must be, such an opening, is shown by the specimen treated with acetic acid (fig. 12); for here the contents, becoming retracted, are partially extruded, and even the nucleus expelled through the rather minute aperture at the apex, this frontal region assuming an appearance showing two transverse annular folds, giving a zigzag lateral outline. It is the portion which, in both examples, in the living state, is pushed inwards, giving the depressed and folded appearance then seen—the "boule" of Claparède and Lachmann. The anterior opening therein, indicated in fig. 12, though seemingly so very small, must, however, be of considerable power of expansion to allow the entrance of so comparatively large an object as that shown within the specimen represented by fig. 11, which presents an example of *Cosmarium cucurbita* incepted as food.

All this, then, seems to evidence that there must be attributed to these beings more than a *skin*—a distinct and separable *test*—and this would bring the forms very close to *Euglypha* and *Trinema* in a generic point of view; and, in fact, the widest distinction is the faceted test of the forms appertaining to those genera, and the absolutely smooth one here; moreover, the behaviour of the pseudopodia is not alike in those. In a specific point of view, be these two, here drawn attention to, really mutually distinct or not, which I leave an open question, I need not urge that neither could for one moment, either in form or habit, be mistaken for any described *Euglypha* or for *Trinema*. But besides the smooth exterior, our forms are distinguished from those genera by the flexible infolded frontal region of the "*test*," so unlike the rigid neck-like aperture of theirs, as the case may be, either prolonged externally or introverted.

In thus bringing forward these two forms to notice I own they require a great deal more research; perhaps, then, I may hereafter revive attention to them, should I obtain for any future observations the fitting opportunity.

On CERTAIN METHODS which may be EMPLOYED in the INVESTIGATION of the DEVELOPMENT of the FROG'S EGG.
By H. N. MOSELEY, B.A. Oxon., Radcliffe Travelling Fellow.

At the present period, at which frogs' spawn is to be procured in abundance, I propose to give a short account of some methods which may be conveniently employed in the investigation of its development, hoping that they may be of some use to those interested in the subject. The first point is to obtain fresh spawn. This is best effected by catching a pair of frogs or toads, and keeping them in a largish vessel of water. The spawn should be taken away from the parents, and placed in plenty of fresh water as soon as extruded, and this water should be changed every day, so long as it is desired to preserve the ova or embryos alive.

The freshly laid ova have a large white spot, due to the absence over this opaque white area of the pigment, which invests the remainder of the ovum beneath the vitelline membrane. The ovum is so attached to its albuminous envelope that when it is floating this spot is always on the under side.

About three hours after fecundation appears the first fissure in which the segmentation commences.¹ The process of segmentation is best observed by placing one or two ova in a small watch-glass with water, and examining them with an inch objective as opaque objects by reflected light. The periods at which the segmentation commences and at which it reaches its successive stages, differ considerably, according to temperature. The first fissure appears on the dark surface of the ovum, or that which naturally floats uppermost, and passes through the central point of this upper hemisphere. About one hour later appears a second fissure at right angles to the first, then comes an equatorial one, and so on. If the ovum be turned on its side, and a portion of the periphery be brought into focus, and carefully watched, a curious undulation of the mass may be

¹ My observations made at Vienna were confined to the ova of *Rana esculenta* and *Bufo cinereus*. I have taken the times of these stages of development of *R. temporaria* from Owen's 'Vertebrates,' vol. i.

observed just at that point where a fissure is about to commence. A shallow depression is seen to form slowly, the dark substance of the ovum being apparently drawn inwards at one spot. The bottom of the depression is then slowly pushed forwards again, and the depression thus obliterated. These undulations continue for some time, the depression becoming deeper on each occasion, its sides becoming more and more vertical, till at length the return of the wave ceases, and the shallow cleft becomes permanent. The cleft rapidly deepens, and if it be now viewed directly from above a series of beautiful plications will be observed to form themselves at right angles to it on its sloping sides. The process of segmentation goes on until the ovum, from being first coarsely and then finely tuberculated, becomes smooth again. If, when this latter stage is reached, an ovum be broken with needles, and a portion of the contents placed on a slide covered with thin glass, surrounded with oil to prevent evaporation, and viewed with a quarter objective, it will be seen to consist of large rounded pigmented cells, having a transparent nucleus. These cells exhibit a curious movement. They throw out from their periphery one or more hyaline bladder-like processes. These processes are never drawn out into long threads, but remain nearly circular in outline. They are soon withdrawn, and fresh processes are thrown out. So far for the appearances which may be observed in the ovum in the fresh state. Now, as to the more difficult question of the investigation of the relation to one another of the cells composing its internal structure.

At each period of successive development, *e. g.* immediately on extrusion, then, when the first cleft is perfect, and then soon after the completion of the second, samples of ova should be taken and placed in a half per cent. solution of chromic acid to harden them for further examination. It is not necessary to remove the investing albumen. It disappears in the chromic acid. It is better to have a series of two ounce bottles with wide necks, and to keep the successive batches of ova apart. The ova will have a great part of their colouring matter discharged by the chromic acid solution, which will become much darker in consequence. As soon as this process is complete, and the ova look whitish, in about three or four days the chromic acid solution should be poured off, and alcohol (strength about 35 per cent.) substituted. After they have remained in alcohol about twenty-four hours, they are ready for imbedding and cutting. For imbedding, a small tray of blotting-paper should be made, about $1\frac{1}{2}$ inches long, 1 inch broad, and $\frac{1}{4}$ an inch deep. A mixture of half part wax

and half sweet oil should be melted in a porcelain dish. A small portion of the wax should always remain unmelted in the dish to provide against overheating. The tray should be half filled with the melted mixture, and its contents blown upon so as to cool them as rapidly as possible. One of the prepared ova which has been just before placed on blotting-paper to remove the superabundant moisture, should then be placed on the surface of the cooled wax, near one end of the tray, in such a position that it has the plane through which it is desired to cut sections of it parallel to that end. As the wax in the tray was rapidly cooled by being blown upon, that in the dish will still remain fluid. With this the tray should now be filled up to the brim, and the whole allowed to cool.

There is considerable difficulty in imbedding an embryo or egg so as to cut it exactly in the desired direction. I think that this tray plan will be found most conducive to success in this particular. The ova should be lifted from place to place by means of a thin substance inserted under them. The best thing for the purpose is what the Germans call a *löffel* or spoon; it consists of a handle of tolerably stout wire, about five inches long, with the end beaten out flat and turned up, till it is nearly at right angles with the handle. This instrument is most useful for moving all kinds of fine microscopic sections from one reagent to another, &c. It is impossible to lift a prepared ovum with forceps or needles, as it is very brittle and easily crushed. The wax in the tray being set, the paper should be removed, and the end of the block at which the ovum rests should be sliced away with a razor till the ovum comes into view. A section as thin as possible should then be made of the ovum, as little wax being taken with it as possible. The razor must be thoroughly wetted with alcohol, and it will be found that in all cases much finer sections can be cut when absolute alcohol is used; absolute alcohol adheres so much more closely to the razor than weaker spirit, and thus allows the section to slide over its surface without wrinkling, which in the case of the frog's egg means breaking to pieces. The section must be washed carefully down to the extremity of the razor, which must be inclined downwards, by means of absolute alcohol applied behind it with a brush. It must then be washed off on to the centre of a clean side.¹ Decently thin sections of the frog's egg during the

¹ I have not found it necessary to use carmine staining for sections of frog's ova or early embryos, as the cell structure is sufficiently defined by the natural pigment which the cells contain. If in later embryos this be found necessary, the staining should be done at this stage.

early stages, *i.e.* from the time of fecundation till the primitive cavity (furchungs höhle) is complete, are extremely difficult to make, and when made, still more difficult to float off on to the slide without breakage occurring.

As soon as the primitive groove begins to make its appearance, the egg becomes tougher and comparatively easy to cut. I have found it better to place the ova, after they have been twenty-four hours in alcohol, in strong glycerine till they are thoroughly imbibed with it, and to imbed directly from this in the ordinary way. If care be taken to dry the outsides of the ova well on blotting-paper before putting them in the wax, they will be found to adhere very firmly to the imbedding substance. By the action of the glycerine after the spirit, the eggs become remarkably tough, and much easier to cut than when treated with spirit alone. A stock of prepared ova and embryos, and full grown tadpoles, may be kept in a bottle of strong glycerine, and cut at leisure. I have such a stock, which I have kept since last breeding season, and the ova now yield quite as good preparations as when just freshly hardened. I have not yet been able to try this method with the common fowl's egg in very early stages, but expect it would yield excellent results. The section is treated in the same manner with absolute alcohol, whether glycerine be employed or not. I find the best razors for the purpose, and indeed for all microscopic purposes, to be the flexible edged razors made by John Heifor, Sheffield, and stamped "Made for the Army." In order to render the edge flexible, these razors have their surfaces ground hollow. This hollow holds a great deal of spirit, and thus renders it easier to float sections off. Moreover, the edge is extremely thin, and thus does not act as a wedge on a brittle substance like a frog's egg, and break the section in half. Again, these razors are extremely easy to sharpen, and every microscopist ought to be able to put a fine edge on his own razor. In cutting sections of ova in early stages, it will be found better to push the razor almost directly through, drawing it along very little, as in this stage the brittle substance resists compression much more firmly than extension. Of course, in later stages, and in cutting sections of ordinary tissue, it is better to use as much of the edge as possible, the razor here acting as a very fine saw.

The sections should be allowed to remain about two minutes upon the slide in a drop of absolute alcohol. The slide should then be tilted so as to let as much as possible of the alcohol run off, and the remainder should be wiped away from round the section with a handkerchief, or soaked up with blotting-paper. A drop of oil of cloves should now be applied to the

section, which will speedily render it transparent. As soon as this is the case, the oil of cloves should be removed as far as possible, in the same way as the alcohol. A small quantity will of course remain behind. A drop of Dammar varnish should now be let fall on the section, and a covering glass applied, when the preparation will be finished. It is better to put a piece of tissue paper, with a hole punched in the centre, under the covering-glass. It becomes soaked through with varnish, and adheres to the slide and cover. If this paper be not used in preparations of early stages, the weight of the covering glass is very apt to crush the section, and spoil it before the varnish has had time to set.

By cutting sections of sufficiently advanced embryos at right angles to the long axis of the body, very interesting preparations illustrative of the development of the sense organs may be obtained.

I have ventured to describe these methods at such length here, because they are applicable not only to the frog's egg, but also with slight modifications to all the finer histological problems, such as the retina, the organ of taste, the Schneiderian membrane, and Corti's organ.

A paper in Max Schultze's 'Archiv,' 1869, erstes heft, by Dr. A. Goethe, on the development of *Bombinator igneus*, will be found very useful by those working up the subject. The plates are very clear, and there is no difference of any moment between this animal's development and that of the frog. Consult also Rathke's 'Entwickelungs-geschichte der Natter,' Königsberg, 1839; Reichert 'Das Entwicklungsleben im Wirbelthierreich,' Berlin, 1840; Remak 'Untersuchungen über d. Entwicklung der Wirbelthiere,' Berlin, 1855; 'Vogt. Unters. ü. d. Entwicklung der Geburtshelferkröte,' Solothurn., 1842.

On some INTERESTING POINTS concerning the MODE of REPRODUCTION of the BRYOZOA. By Dr. HINRICH NITSCHKE, of Leipzig.

A great many papers on Bryozoa have been published, but since the majority of them give mere descriptions of the various external forms of the colonies and single cells, our knowledge of the anatomy, histology, and mode of reproduction of these interesting animals is still very limited. A great advance as regards the latter point, the reproduc-

tion, is due to the researches made by Smitt a few years since. In his interesting paper "Om Hafbryozoernas utveckling koch fettkropper,"¹ Smitt registers many new facts of such a nature as to throw quite unexpected light on the evolution of the Bryozoa. Every reader must be astonished by the immense store of precious observations accumulated on a few pages of Smitt's memoir; but the conclusions and theories based upon these observations seem to be not always quite as correct as would be expected from so skilful and learned a naturalist.

My own interpretation of some facts observed by Smitt, and afterwards by myself, differing in some respects from his, I shall try to give a preliminary sketch of my views upon this subject, hoping to be able to give very soon a more elaborate account of a series of inquiries made by myself about the anatomy of some marine Chilostomata.

Smitt distinguishes four modes of reproduction in the Bryozoa, three of them taking place in an asexual way.

1. The growth of the whole colony by external buds. 2. The reproduction by eggs formed by internal buds of the endocyst. 3. The production of new polypides and eggs in empty zoëcia or cells, by "groddkapslar," *i. e.* by brown bodies produced by a retrogressive metamorphosis of the former polypide. 4. Sexual reproduction by eggs and spermatozoa.

Smitt believes that the growth of the colonies by external buds is effected in a very peculiar manner, differing from this process in all other compound animals. He observed that very often young buds, seeming at first to be equivalent to a single zoëcium, become afterwards divided by longitudinal and transversal septa, each partition transforming itself into a perfect zoëcium or an homologue of such (an avicularium, vibraculum, &c.).

Such buds he designates as "samknoppar," *i. e.* "common buds," produced not by a single cell, by a single individual, but by the whole colony. To this view he has been, I think, principally led by his observation on the budding process of *Flustra membranacea*. Certainly every one is able to satisfy himself very easily that often one, at first simple bud, is afterwards divided into different zoëcia; or into a zoëcium, avicularium, and vibraculum; such buds are very properly designated as "common buds," but they always are the offspring of *one* mother-cell.

Such "common buds" are always produced when a crust-like colony expands. The radiating arrangement of the cells in most of the crust-like colonies, together with the fact that

¹ 'Oefversigt af Kongl. Vet. Akad. Förh.,' 1865, No. 1.

the breadth of the single cells is limited, though variable, makes it a necessity that at different times new series of zoœcia become interpolated, the colony otherwise acquiring a lobed outline. This interpolation of a new series of cells or zoœcia is effected in this way, viz., that a zoœcium instead of producing one zoœcium at its anterior edge produces two, both of them originating from an at first simple bud—a *common bud*, by secondary division. The same process often takes place when in an arborescent colony a twig dichotomizes.

That a "common bud" is produced by two or more mother cells, or by the margin of the whole colony, I never was able to observe, and it is also difficult to agree with this doctrine from a theoretical point of view, since it is quite incompatible with the scientific conception of the individual in so highly organised a class, that many of them should unite to the production of one bud in common.

A careful examination of many colonies of *Flustra membranacea*¹ gave me the conviction that also in this species a "common bud," in the meaning given to this designation by Smitt, does not exist.

The increase of the colonies of *Flustra membranacea* during the summer is a very rapid one, and the growing margin shows a very peculiar appearance. A marginal zone, of sometimes an inch in breadth, contains not fully developed zoœcia, but only more or less immature ones. The immature cells, which are nearest to the centre of the colony, are principally distinguished by the more imperfect calcification of the ectocyst, and the smaller size of the polypides. The still younger and more eccentrically situated cells do not show any calcification at all, the two posterior spines of the cell are represented only by small rounded knobs, and the opercular opening in the ectocyst not yet opened, and consequently the very small polypides are not yet able to become protruded. In the last zone of distinct cells every zoœcium consist of a quadrangular depressed bag surrounded by a tough chitinous membrane lined with a layer of cells, and showing at its posterior wall a small knoblike polypide bud.

¹ Smitt gives in his admirable paper, "Kritisk förteckning öfver Skandnaviens Hafs-Bryozoa," 'Oefversigt af Kongl. Vet. Akad. Förh.,' 1867, No. 5, p. 357, the following diagnosis of this species:

Fl. membranacea (Lin. Sol.).

Char.—Colonia in crustæ formam expansa zoœcia ad angulos distales (*i.e.*, juniores exteriores) setâ brevi mucronata præbet. Avicularia et œccia desunt.

But I have satisfied myself that the two spines Smitt attributes to the distal part of the cell belong really to the proximal, *i.e.*, the older part of the cell.

But even these latter zoëcia are not the outermost components of the colony; from the anterior wall of each of them originates a long slender flattened tube of the same breadth, but two or three times as long as a normal cell. These tubes are surrounded by a very delicate chitinous membrane, and lined with a layer of prismatic cells. Smith having in some cases overlooked the longitudinal septa between the different tubes, believes this zone to form at first an undivided flattened expansion surrounded by a membrane, and filled with "adipose corpuscula" (so he calls, in this case, the prismatic cells which secrete the endocyst); but this is, I think, a mistake, and the appearance of an undivided margin is caused only by the fact that the chitinous membrane is very transparent, and the single tubes are in very close juxtaposition.

The examination of specimens preserved in spirit and especially transverse sections made from this part of the colony, show very clearly that the longitudinal septa are always present from the beginning. The marginal zone of *Flustra membranacea* is, therefore, not to be regarded as a "common bud" of the whole colony, but as an aggregation of many "common buds" produced by single zoëcia, every tube being really a "common bud" in the way I should like this name to be understood. Indeed, every tube is equivalent to two or three zoëcia, into which it is afterwards divided by secondary transversal septa.

The most curious and interesting mode of evolution Smitt attributes to the Bryozoa, is the so-called reproduction by "groddkapslar," *i. e.* "germ capsules." Every one who has studied the anatomy of marine Bryozoa is well acquainted with the fact that only a very small part of the little cells of which every colony consists contains completely developed polypides; whilst the younger cells at the edges of the colonies enclose immature buds, the eldest cells are either quite destitute of polypides and contain nothing only circular or oval, sometimes also irregularly-shaped brown bodies or these said bodies together with a new budding polypide. Only the intermediate cells between the youngest and the eldest show completely developed polypides. These brown bodies, lying in the interior of the cells of this part of the colony, which was formerly believed to be in a state of decay from want of polypides, have been mistaken very often for true ova. Smitt having witnessed many times the true ova of different species, rejects wholly this opinion, and states quite correctly that these brown bodies are products of the decomposition of the polypide formerly lodged in the cell; but the fact that they are often found associated together with a new bud of a

polypide, forces upon him the conviction that this new bud is the descendent of the brown body; therefore he designates this body as "groddkapsel," "a germ capsule," produced in an asexual way, and showing much affinity in function with the statoblasts of the Phylactolamata.

Professor Claparède, in his late paper,¹ devotes a separate chapter to the discussion of this mode of reproduction. This very conscientious zoologist does not agree with the views of Smitt; he believes that the brown bodies are not the result of a retrogressive metamorphosis of the polypide formerly contained in the lodge, but a secretion of the endocyst, and that the real products of this retrogressive metamorphosis are the things which Smitt looks upon as young buds produced by the groddkapslar,—the retrogressive metamorphosis taking place in such a way that the polypide, having attained its maturity, passes anew but in inverse order through all the stages through which it has passed during its development. The process he supposes to take place is, therefore, the same a flower would undergo if, after having fully expanded, it should close again and retransform itself into a bud, vanishing by and by by gradual diminution.

Professor Claparède was kind enough to express in his paper a regret that I had not put forward my opinion about the point in question, and being now able to do so, I will not delay to comply with his wishes.

One of the species which furnished to Smitt the evidence that the "groddkapslar" are the result of a decomposition of the polypides, is *Flustra membranacea*. This author gives also a drawing of some zoëcia of this species whose polypides are decaying, but it is so minute, and the description of the process itself so very laconic, that it is not very persuasive, and a more accurate drawing seems to be required. The cells in the interior of a colony of *Flustra membranacea* are, in most cases, provided with polypides, but a closer inspection shows that scattered over the whole colony there are groups of a few cells containing decaying polypides; such a group is represented by the adjoined woodcut.

A still stronger evidence of the correctness of the views of Smitt about the origin of the brown bodies is offered by the circumstance that it is very often possible to distinguish in the interior of them distinct remains of the food swallowed by the polypides when living, especially the siliceous tests of diatomaceous algae and radiolarian animals, a fact utterly incompatible with the suggestion of Claparède that the brown

¹ 'Zeitschrift für wissenschaftl. Zoologie,' xxi, p. 147.

bodies are secretions of the endocyst. But these facts speak just as strongly against the supposition that they are in any

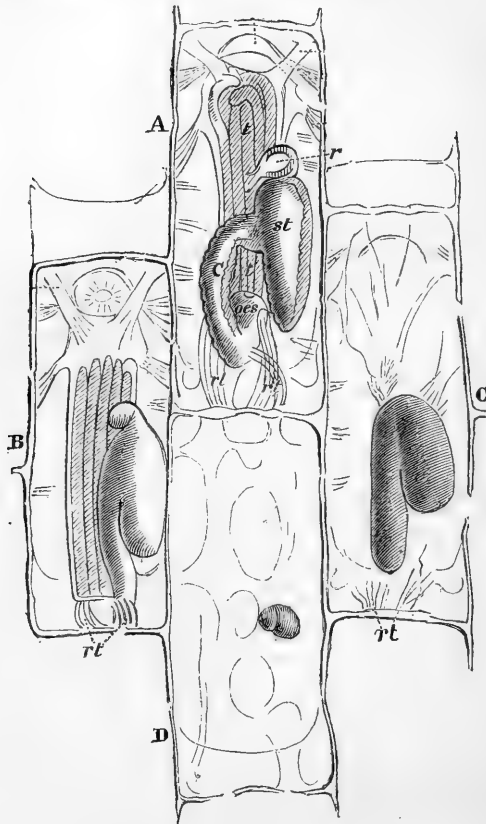

In the cell A, the polypide is still intact in its ordinary state of retraction. In the lodge B, the polypide is so strongly retracted that the base of the tentacular crown almost touches the posterior wall of the cell; the tentacula exhibit some signs of commencing decomposition. In the third cell C the tentacular crown, together with the tentacular sheath and the oesophagus, have disappeared. The great retractors are still preserved, but their anterior point of attachment having vanished, they project freely into the cavity of the cell. The remains of the polypide form a bilobed bag, whose narrower portion consists of the cardiac portion of the decaying intestine, the bigger one corresponding with the cœcum. In the last lodge D the retractors too have disappeared, and the remains of the polypide are transformed into a brown body filled with granular substance, and surrounded by a tough membrane, the only trace of its former shape being the faint bilobation it shows.

way concerned in the reproduction of a new polypide in the deserted cell, or of an egg. I have satisfied myself that the new buds found associated in a cell with a brown body take their origin from the endocyst, just in the same way in which the first polypide was produced by the budding of the endocyst at the time when the cell did not yet occupy its actual position, but was a still immature bud without calcareous skeleton in the margin of the colony. The fact that both buds and brown bodies are often found in close contact does not furnish any proof of a correlation between them, that is, of the existence of a generative link; it is merely caused by the circumstance that whilst the first polypide-bud in every cell originates in the angle formed by the posterior and upper wall of the cell, the second bud originates in the centre of the upper wall, and the brown body occupies the centre of the lodge. The occasional occurrence of two "groddkapslar" in one lodge, which Smith has witnessed in some species, is very easily explained by the supposition that the secondary polypide too has undergone the retrogressive metamorphosis.

A further proof that the appearance of a new polypide in a lodge is in no way connected with the presence of a "groddkapsel," is afforded by *Alcyonidium hispidum*. "Groddkapslar" are also found in the older cells of this species, but the formation of a new bud is not delayed till the retrogressive metamorphosis of the polypide occupying the cell has become complete; it takes place by the budding of the endocyst in the centre of the upper wall of the cell at a much earlier period, when the polypide, though already altered, in general still retains its former shape.

I have satisfied myself (1) that the "brown bodies," being in no way endowed with any reproductive function, are mere remains of decaying polypides. (2) That the vitality of the zoëcia does not all depend upon the presence of a polypide, and that a zoëcium having lost its polypide can produce a new one by an internal budding of its endocyst.

The facts just recorded speak very much in favour of the views many years ago stated by Allman,¹ and newly again advanced by Reichert,² who seems to ignore completely that they are not at all a novelty, though he is acquainted with the monograph of Allman, viz., that the polypide is not to be considered as a mere organ of the Bryozoon, but as a distinct zoöid produced in an asexual way by another zoöid,

¹ 'A Monograph of the Fresh-water Polyzoa,' p. 41.

² "Vergleichende Anatomische Untersuchungen über Zoobotryon pellucidus," 'Aus den Abhandlungen der Königl. Akademie der Wissenschaften zu Berlin,' 1869. Berlin, 1870, n. 238.

the zoecium, or cell. To this view of Allman I must completely assent, though I cannot go so far as to regard likewise the ovarium and the testis as distinct zooïds.

Indeed I look upon every colony of "Bryozoa entoprocta"¹ as being a compound animal ("Thierstock"), composed of two different classes of zooïds, the "cystoid zooïds" and the "polypoid zooïds." The cystoid zooïds assume very different shapes, their various forms causing the great diversity of the external form of the Bryozoa. In this group are to be reckoned—

1. The coenœcium of the Phylactolæmata, showing not yet separated lodges (Lophopus), and the cells or zoœcia of the Phylactolæmata with distinct lodges, Chilostomata, Ctenostomata, and Cyclostomata.

2. The avicularia of the Chilostomata.

3. The ovicells or oœcia of the Chilostomata.

4. The vibracularia of the Chilostomata.

5. The stem-joints of the Vesiculariadae.

6. A part of the spines and root filaments of the Chilostomata and Ctenostomata (?).

The primary zooïd of every colony is a cystoid zooïd produced by a direct metamorphosis of a ciliated larva.

The polypoid zooïds are always produced by a process of budding from the inner side of the endocyst of a cystoid zooïd; but since only the two first-mentioned modifications of cystoid zooïds are endowed with the faculty of producing polypoid buds, there are only two forms of polypoid zooïds:

1. The common polypide, generally considered as the intestinal apparatus, and the tentacular crown of the polyzoon.

2. The round bodies, bearing a brush of sensible setæ, in the avicularia of some species.²

The cystoid zooïds are intrusted with the whole amount of reproductive functions, both sexual and asexual, the polypoid zooïds providing for the nutrition, the respiration, and the sensitive functions, the functions of the polypides of the avicularia being limited to the latter function.

Lastly, I must state that I cannot find any adequate reason to regard the so-called "nervous system of the colony" as a true nervous organ.

A more elaborate account of the facts leading me to this conviction I shall give in a subsequent paper.

LEIPZIG, 1st February, 1871.

¹ H. Nitsche, 'Beiträge zur Kenntniss d. Bryozoen. Zeitschrift für Wissenschaftliche Zoologie,' v. xx, p. 34.

² Busk, "On Avicularia," 'Quarterly Journal of Microscopical Science,' New Series, Vol. II, 1854, p. 26, Pl. II.

On some SPECIES of PARASITES hitherto undescribed. By
ALEXANDER MACALISTER, Professor of Zoology and
Director of the Museum, University of Dublin.

IN the course of the dissection of some birds and mammals in the anatomy department of Trinity College, Dublin, I met with the following species of parasites, which I think are as yet undescribed. The animals from which these specimens were obtained were mostly purchased by the Rev. Dr. Haughton, from the Dublin Zoological Gardens, and I have looked in vain for the description of these species in the works of Denny, Walckenaer, Nitzsch, Burmeister, Giebel, or Rudow; so I suppose them to be as yet unnamed. The new species are as follows:

1. *Lipeurus Phænicopteri.*

This was obtained from the body of a fine female flamingo



Antenna.



Claw.

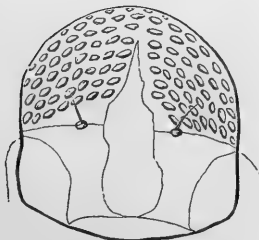

Labrum.

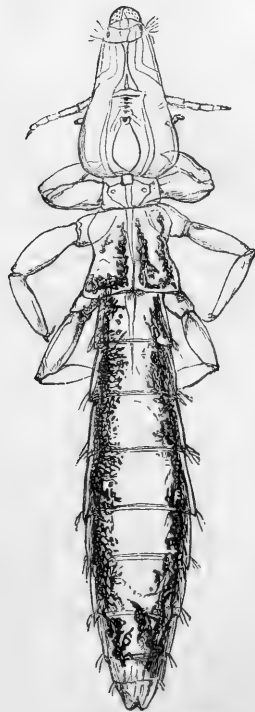

Lipeurus Phænicopteri.

(*Phænicopterus ruber*, Temminck), which had been but a short time living in the gardens. I could only find a single individual of the parasite, a female, although I examined the surface carefully. By its elongate body, its absence of trabeculæ, long legs, obtusely setaceous antennæ, and posterior notch, it is plainly a *Lipeurus*, and belongs to the section of the genus characterised by the possession of an elongated head. Its specific characters may be summarised thus:—Glistening white; depressed head; elongated triangular labrum, covered with rows of depressed, rounded, or lenticular depressions, arranged quincuncially in seven or eight series; posterior clypeus with two lateral depressed lines, concave internally; antennæ with the second joint longest; prothorax quadrilateral; first pair of legs short, with a wart-like black dot at the posterior part of the extremity of the femur; abdomen margined with irregular pigment masses, in the form of a slightly sinuated and occasionally interrupted line, the last segment being immaculate and notched. The specimen being a female, has simple antennary joints, the fifth being very short and obtuse. The length of the entire insect is a line and a half, and its greatest breadth is about the one eighth of this.

The only other flamingo parasite that I am acquainted with is the *Lipeurus subsignatus* of Nitzsch, from the *Phænicopterus antiquorum*, Temm., referred to by Giebel, in his 'Zeitschrift für die Gesammten Naturwissenschaften,' vol. xxviii, p. 384; but this has not got the dotted labrum, nor the sinuated abdominal marginal pigment-line. It differs from the *L. squalidus* of the duck in these respects also, and in not having the regular quadrilateral markings on the side of the abdomen.

2. *Colpocephalum marginatum*.

This specimen was obtained from the feathers of the *Ardea comata* of the South of Europe, and it seems to me to come close to *C. importunum*, Nitzsch, of the *Ardea cinerea*; to *C. nyctarde*, Denny, of the *Nycticorax ardeola*; and to *C. vittatum*, Rudow, of the *Ardea ralloides* ('Zeitsch. für Gesammt. Nat.,' vol. xxvii, p. 469).

My specimens are 1-11th of an inch long, of a deep chestnut-brown colour, smooth on the surface, and much darker along the margin than in the middle. Head large, flat; anterior margin of labrum plane, posterior border of occiput concave, temporal lobes large rounded, lateral margin of clypeus deeply sinuated, orbital sinus deep and acute, antennæ small, obscure, clypeus with two dark sepia-brown

patches in front of the eye, and with three rounded umber spots at the sides and centre of the anterior border; two

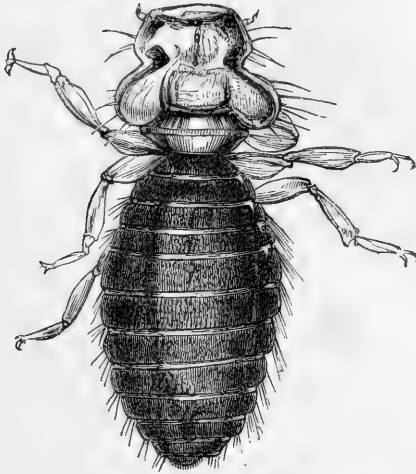

Colpocephalum marginatum,

light brown lines extend, one on each side, from the lateral notch to the base of the occiput; prothorax subrhomboidal, with a transverse line from angle to angle; mesothorax very short, metathorax not so wide as head; abdomen elliptical, longer in proportion than that in *C. Nyctarde*, and not at all claviform, as in *C. importunum*, much paler in the centre than at the side, last segment of the abdomen fringed densely with short close hairs, in a continuous series along the posterior margin, lateral border of the abdomen exhibiting indentations between the somites; femora oval, tibiæ clavate, second joint of the tarsus much longer than the first; the last joint of the hindmost leg a little longer than that of the middle, and that a little longer than the corresponding segment of the anterior pair. It differs from *C. vittatum* in its more elliptic abdomen and its darker margins.

3. *Ixodes Phascolomyis*.

This specimen was obtained from the wombat (*Phascolomys wombata*). It measures $\cdot 65$ of an inch in length; its greatest breadth is $\cdot 45$ of an inch. In shape it is pyriform-oval, with an elongated depression on its posterior surface, with a central rugous elevation; ventral surface with a triangular depression; limbs attached to a short oblique ridge, $\cdot 15$ of

an inch long; they are $\frac{1}{2}$ of an inch in length, and terminate each in a double claw, with an expanded pulvillus, clypeus,

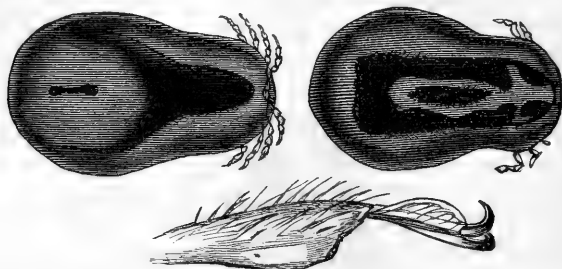

Ixodes Phascolymis, Tick of the Wombat (*Phascolomys Wombata*).
Twice natural size.

somewhat heart-shaped, lighter in colour than the rest of the body, which is deep chestnut-brown; stigmata ventral at the apex of the triangular ventral depression, and in a small sulcus posterior; rostrum small, conical. This specimen is thus of very large size and firm and tenacious in the consistence of its integument. Several species of the genus are described from Australia, but they are all, as far as I am aware, reptilian parasites with this exception.

DR. ROYSTON-PIGOTT'S RESEARCHES.¹

THE great interest which attaches to all researches directed to the improvement of the microscope, and especially to the invention by which Dr. Royston-Pigott claims to increase magnifying power, without, in the same degree, diminishing focal distance, make us desirous of laying before our readers as complete an account of them as possible. We have, therefore, gladly availed ourselves of the kind permission of the Council of the Royal Society, and of Dr. Pigott himself, to reproduce the substance of a paper communicated by him to the 'Philosophical Transactions,' and the illustrative plates, without which, in fact, much of what he has written would be unintelligible.

¹ 'On a Searcher for Aplanatic Images applied to Microscopes, and its Effects in Increasing Power and Improving Definition.' By G. W. Royston-Pigott, M.A., M.D. Cantab., M.R.C.P., F.C.P.S., F.R.A.S., formerly Fellow of St. Peter's College, Cambridge.

In this paper are described—

I. Some experiments which suggested an inquiry into a method of raising microscopic power consistent with a corresponding improvement in the precision of definition, so generally destroyed by excessive amplification.

II. The inquiries by which the construction of an aplanatic-image searcher was gradually arrived at; the object of which was to search for aplanatic foci, to compensate residuary errors by new spherical and chromatic corrections whilst amplifying power, and to increase the small interval existing between a deep objective and its object, whilst the focal perspective or depth was also increased.

The research was originally suggested by the accidental resolution of the Podura scale. This exquisite object, so justly prized by the optician for the trial of microscopes, affords peculiar markings resembling notes of admiration, of sufficient delicacy to put even the defining-power of objectives of one fiftieth of an inch to a severe ordeal. Dr. Pigott had observed these markings to disappear and be resolved into black beads. The objective employed had nearly one seventh of an inch focal length, and an aperture of 50° . The object was illuminated by solar rays reflected obliquely by a plane mirror. Having related this effect to eminent opticians, he was informed that no objectives (at that time, 1862) could resolve this test. Messrs. Powell and Lealand were, however, prevailed upon to construct a "very fine" one eighth expressly for this resolution; as this totally failed, a one sixteenth was carefully constructed with no better success, and finally a one fourth of very large aperture; all these failed to exhibit the Podura beading. Some unsuspected cause of this failure evidently remained to be investigated. The evidently delusive character of the standard test, so much relied upon for the construction of microscopic object-glasses, suggested the necessity of a search for other less uncertain methods of testing. The principle of proceeding from the known to the unknown appeared to offer the only sound basis of inquiry.

Simple objects were now examined. The finest glass threads presented linear images of any conceivable degree of proximity, whilst their fused extremities, when selected as forming refracting spherules one thousandth of an inch in diameter, presented miniature landscapes and points of light of remarkable precision, the spherical aberration of which could be easily calculated to be of insignificant amount for limited apertures. Even a plano-convex lens of one thirtieth of an inch focal length and three hundredths aperture dis-

played, though uncorrected, miniature pictures of marvellous beauty, bearing considerable amplification; whilst a combination of achromatic lenses corrected with all the resources of modern art, seemed capable of forming an exquisitely small image of any given object placed at a distance from it, the appearance of which, when examined by the microscope to be tested, could at once be verified by the object producing the miniature test. When suitable precautions are taken—such as (1) axial coincidence of the objectives; (2) proper corrections for an “uncovered” or aerial, or for an aqueous image when immersion lenses are employed, and for the distance of the object from the image-forming objective,—these miniature test-images bear an extraordinary amount of amplification by the microscope, displaying at once the erroneous corrections. It was found convenient in general to use the image or *miniature*-forming objective of a deeper focus than the observing, generally one half.

The following experiments were undertaken to elucidate the operation of this system of testing. The mechanical arrangements are shown by diagrams, figs. 1, 1a, Plate IX.

Experiment 1.—Miniature of a small thermometer, the ivory scale being graduated 24° to the inch. A power of 300 diameters, gained by a low eyepiece “A” and the objective of one eighth focal length (made expressly for Podura beading-test), was applied to view the miniature formed by a one sixteenth objective of excellent quality; and the following appearances were carefully noted at the time of observation.

Result.—The sparkle of light on the bulb of the instrument, the graduation, and the metallic thread within the glass tube are invisible, obscured by a nebulous yellow fog which no objective adjustments are able to dissipate. Fig. 3, Plate IX (fig. 5 shows improving definition).

In consequence of this unexpected discovery, regarding the quality of a “very fine” one eighth, it was returned to the opticians to their surprise for better compensation. It was then, after more accurate compensation by them, again submitted to precisely the same testing conditions.

New results.—Appearance of a slight nebulous yellow cloud through which could be distinctly seen the ivory scale finely graduated, the bulb sparkle, and even minute separated mercurial particles scattered within the glass stem (fig. 7).

The definition had been therefore decidedly reformed. Previously, however, to the alteration, experiments had been tried for the purpose of ascertaining whether a defective glass

would still form a fine miniature. It might be reasonably expected that such slight errors as had escaped the notice of eminent opticians would not materially injure a miniature image in which the aberration would probably be reduced in the miniature itself. The image of the thermometer now formed with the imperfect eighth was viewed with a fine sixteenth (at about 800 diameters), when it was gratifying to observe a very beautiful display of the picture well defined in all respects (fig. 4).

These and other experiments appeared to warrant an important conclusion—that an image-test miniature formed by an objective of fair quality enjoyed sufficient accuracy of definition in miniature (even when the object was placed at varying distances from the stage or focal point of vision) to form a trustworthy test of microscopical definition, provided the aperture of the miniature-forming objective was equal to that of the objective to be tested.

To estimate the size of a miniature (a) of a given object (θ) placed at a considerable distance (d) from the miniature (fig. 1 a), it is necessary to consider that the conventional focal length F of an objective may be defined to be 10 inches divided by the micrometric ratio of amplification (m) when the image is thrown on a screen 10 inches from the object, so that

$$F = \frac{10}{m}, \text{ when } d = 10,$$

or

$$m = \frac{10}{F},$$

$$\propto \frac{1}{F}, \text{ when } d \text{ is constant} \quad (1)$$

When very deep objectives are used (fig. 1) the position of the plane of focal vision varies very slightly for a considerable increase of the length of the microscope, so that if the draw tube be graduated, the increase of power is nearly proportionate to the increased length or reading, because, the focal plane being nearly fixed, the image will appear upon a screen enlarged proportionally as its distance (d) increases. On reversing the rays, the miniature diminishes in proportion as a given object is removed further from it: from which it follows that approximately, and sufficiently near for the purpose in hand,

$$m \propto d \text{ when } F \text{ is constant.} \quad (2)$$

Compounding these expressions (1) and (2),

$$m \propto \frac{d}{F} = p \cdot \frac{d}{F}.$$

The constant $p=1$; for if m be made equal 160, the conventional focus $F=\frac{1}{16}$, when $d=10$, and hence (d being large and F small) approximately,

$$m = \frac{d}{F} \dots \dots \dots (3)$$

If (f) be the focal length of a small lens whose thickness is neglected, a very similar approximate result can readily be obtained from the optical formula

$$\frac{1}{u} + \frac{1}{v} = \frac{1}{f}$$

For by construction

$$u + v = d,$$

and by similar triangles

$$mv = u.$$

Eliminating the unmeasured distances u and v of the object and image from the "centre" of the lens, it will be found that

$$f = \frac{d}{m+2+\frac{1}{m}}$$

and m being very large in these experiments,

$$f = \frac{d}{m+2} \text{ nearly}^1, \dots \dots \dots (4)$$

or

$$m = \frac{d}{f} - 2. \dots \dots \dots (5)$$

But in the case of the miniature images employed, m is so large that (-2) may be neglected, so that $m = \frac{d}{f}$ is sufficiently near for their measurement.

The thermometer was now placed 100 inches' distance from the microscopical focus ; the one sixteenth being employed to form the image, $f=\frac{1}{16}$, $d=100$; hence

$$m = 100 \div \frac{1}{16} = 1600 \text{ very nearly.}$$

The divisions on the thermometer would be therefore reduced in the image to a miniature 1600 times less than the original, or about 40,000 to the inch, whilst the breadth of a single line would be only the 400,000th.

The means being thus obtained of readily estimating the

¹ This method also gives the focal length of a minute lens, to determine which accurately is attended with no little difficulty.

size of images of known objects at known distances, the examination of immersion objectives was next undertaken. Double stars were artificially produced in thin brass ($\frac{3}{1000}$ of an inch thick) by placing minute apertures ($\frac{1.2}{1000}$ in diameter) in front of a brilliant flame, at the distance of 100 inches from the focal point of observation (fig. 9, Plate IX). The apertures were so arranged as to gradually exhibit closer double disks (as shown roughly in fig. 9), which were carefully drawn on brass under the microscope and then accurately pierced. The miniature effect of the star-doublets is represented in the following Table, the immersion one sixteenth objective being converted into one twentieth,¹ so that f here = $\frac{1}{20}$, $m=2000$ at 100 inches distance (nearly).

Doublet.	Size of disks.	Calculated size of images nearly.	Distance between their centres.
No. 2.	$\frac{1.2}{1000}$	$\frac{1}{166000}$	$\frac{1}{40000}$
No. 3.	$\frac{1.2}{1000}$	$\frac{1}{166000}$	$\frac{1}{20000}$

It will be readily seen from the diagram (fig. 8) that, in No. 2 the disks being $\frac{1.2}{1000}$ and the separating interval between centres being $\frac{1}{20}$, the actual dividing interval is $\frac{3.8}{1000}$, or above three times the real diameter of each disk.

Experiment 2.—A drop of distilled water being suspended between the objectives, both of which were fitted with single front “immersion lenses,” it was found that the separating interval (accurately measuring $\frac{3.8}{1000}$ of an inch) between the centres of the disks had totally disappeared in the miniature image. The disks now resembled a finely divided double star just separated by a black line, yet this minute interval should have appeared above three times the diameter of a disk, as at B in fig. 6 & BC fig. 8. Apparently, therefore, in the eyepiece, spurious disks had been formed four times and one sixth larger than a true aplanatic representation by the microscope.²

It follows from this experiment that if the disks be sup-

¹ By the adaptation of a “water-lens” one-thirtieth inch focus.

² It will be observed in this experiment that the standard distance of 9 inches at which the object should be placed from the objective was increased to 100. It was found that only a very slight adjustment of the screw collar of the image-objective was necessary to compensate for this great increase of defining distance. It is hardly necessary to remark further that in a minute miniature image the aberration is insignificant compared with that taking place in a greatly magnified image of an object placed in the focus. This distinction is inseparable from this experiment, as already explained.

The minute apertures, made accurately with Swiss watchmaking tools, were carefully blackened, to prevent internal reflexion, with a solution of perchloride of platinum.

posed to gradually diminish to points, the limiting value of the residuary spurious disks would give nearly $\frac{1}{52000}$ of an inch for the diameter of the least circle of confusion, representing the actual amount of residuary lateral aberration.

This appears from a diagram, where in the limit (fig. 8) $EF = 4AE$, when AB, CD both vanish in the case of the disks being reduced to points.

The phenomena presented by these artificial doublet-image tests, gave fine evidence of the skill employed in the construction of the glasses, and of the accuracy with which the axes of the optical parts had been made to coincide in this delicate experiment.

All the disks appeared sharply cut and planetary (fig. 10), surrounded with a black ring supplemented by accurately formed diffraction rings, which enlarged and glowed with prismatic colours, both within and without the sharpest focal point or image, forming concentric intersections, displaying coloured pencils passing either to or from their finest point of focal combination where colour should be destroyed (fig. 6).

Experiment 3.—The disks (λ) shown by the apertures $\frac{1}{1000}$ of an inch in diameter, and separated between centres $\frac{1}{20}$, were now brought nearer to the objective O' . It was then observed that the image-disks (of above four times their proper size) began to separate; and since the spurious disk retains its false *annular* expansion independent of the true magnitude, it became evident that the exact distance at which the test doublet was first divided, gave for other objectives a comparative measure of their aberration; the very slight aberration in the image (of the sixteenth) being scarcely appreciable, especially when favoured by the advantage of the water-film to enhance the precision of definition on the immersion system.

By such experiments, with the finest glasses obtainable, the existence of an aberration of material and measurable amount being thus established, the next question to be settled assumed the following character, viz.

What was the nature of the aberration produced by displacement of the final focal image viewed by the eye-lens; and whether better effects could be produced by a different distribution of the magnifying powers.

It was now found that increasing the distance between the eye-lenses and the objective, gained power indeed, but caused the aberration to increase faster than the power gained.

Intermediate Huyghenian eyepieces, inverted, were found

to increase power but sacrifice definition ; the apparent aberrations seemed incorrigible, so that this plan was finally abandoned in 1864. Although by this means the *Pleurosigma rhomboides* was fairly shown to Messrs. Powell and Lealand, with their one sixteenth objective (dated 1862), they stated this method had been tried long before and relinquished as useless to improve definition.

Sliding-tubes (made by them for the purpose) were now furnished with a "universal screw," in order to admit a great variety of single and compound cemented lenses (more or less chromatically and spherically corrected) being inserted within the draw tube midway between the eyepiece and the objective. So, also, whole or parts of objectives were similarly applied, thus forming a microscope within a microscope admitting endless combinations of compensations.

It now seemed perfectly clear that any attempt to improve high-power definition must be preceded by the attainment of a ready and decisive method of ascertaining whether the balance of compensations was equal, or, on the other hand, over- or undercorrected. The *Image-test* already described appeared to effect this object in the following manner. The finest glasses, it is well known, are constructed upon the principle of balancing compensations, the effect of the posterior combinations when overcorrected compensating that of the anterior glasses which are undercorrected. To ascertain therefore the indications of the character of a given correction (still employing the exquisite images formed by "the sixteenth") wire gauze, forty meshes to the inch, was placed in front of a brilliant light ; the image of the gauze was distinctly visible under the one quarter objective ($\times 250$ diameters) finely corrected for an uncovered object.

To ascertain the appearances due to *overcorrection*, the front glasses were removed ; whilst to examine those of *undercorrection* the front set alone was employed, the inner glasses being removed.

First result.—The image no longer appeared like gauze, but displayed (unless the aperture was reduced) extraordinary patterns, prismatic, translucent, and, as it were, chequered or plaid-like ; all of which were situated entirely *above* the best focal point, and nothing but a confused nebulous field *below it*.

Second effect.—The employment of the front lenses alone now reversed the position of these appearances.

Readjusting all the glasses, it was then discovered that the false images were developed principally below the best focal

image (ascertained by reducing the aperture of the microscope¹) when the objective was undercorrected, and above it when overcorrected. Brilliant images of glittering particles of mercury scattered on black cloth *nearly vertically* illuminated, fine gauze 80 meshes to the inch perforated metal, gold-leaf displaying against a brilliant light immeasurably small perforations exposed on a rich malachite green ground,² were submitted to be examined in miniature as test-objects. From a variety of experiments of this kind the following data were arrived at, to guide preliminary observations:—

That when any well-defined structure is viewed by the best microscopes, there exist *eidola*³ or false images on each side of the best focal point.

That they are placed principally above or principally below the focal point of central pencils, according as the glasses are over or undercorrected; and that for a *single* stratum sufficiently thin, these *eidola* are nearly symmetrically exhibited on both sides of the best focal point only when the compensations are perfectly balanced.

It follows from these results that when a structure consists of two superimposed strata, in such close contiguity as to come within the optical limits of the *eidola*, the false images of the lower stratum are liable to be confused and commingled with the true image of the upper stratum when the objective is overcorrected, and when it is undercorrected the false images of the upper are confused with the true of the lower stratum. These coincidences of *eidola* with true focal images may in both cases equally delude the observer.

The next question was the most favorable distribution of the elements of magnifying-power. According to a well-known optical principle, it seemed desirable to bend the rays by less sudden refractions. It is a peculiar result that when the incident and emergent pencils are equally bent so as to be equally inclined to the axis of an equi-convex lens, that then only is the aberration a minimum.

The effects of different distribution of power are well shown by the following experiments, in both of which the same amplification was employed of 400 diameters.

¹ The true image is at once seen by reducing the aperture; for this purpose a system of circular stops was applied to the microscope at the part where the objective is attached, admitting an instantaneous change in the aperture, and showing remarkable effects produced by change in the excentric aberration. Its mode of attachment is shown at β , fig. 1, Plate IX, where it is marked *aberrameter*.

² The gold-leaf is mounted on a slide in the ordinary way, and exhibits interesting and instructive phenomena.

³ *Εἰδωλον*.

Experiment 4.—A miniature landscape formed by a convexo-plane lens $\frac{1}{30}$ focal length and $\frac{3}{1000}$ aperture was examined with the one eighth and an "A" eyepiece: axis horizontal and window open.

Result.—Landscape dark and hazy, as seen in the microscope.

The deficiency of light was most remarkable.

The same power (400) was now obtained with the half inch objective and a D eyepiece.

Experiment 5.—The miniature being formed as before by the small lens, the microscope was now again brought into operation on the minute image horizontally.

Result.—Exquisite picture brilliantly lit up; even the foliage glittering in the sunlight was sharp, clear, and decisive, so that the details of the garden picture were marvellously displayed.

The difference appeared truly surprising as regards the two methods of obtaining the same magnifying power, especially the increased light *with diminished aperture*.

In both these cases the greatest pains were taken to properly adjust the index collars of the objectives for the finest possible definition of an uncovered object.

A new fact had appeared highly suggestive of further inquiry. Accordingly, distribution of power was now varied by employing differently constructed eye lenses, especially "crossed lenses,"¹ and *inserting, midway between the objective and eyepiece, convex lenses* of great variety. It was now seen that these lenses, intermediately placed, developed an entirely new aberration of a negative kind.² It became important to

¹ Crossed lenses, well known to give a minimum aberration having the radii of their curved surfaces as 6:1.

² It is convenient to define the aberration to be positive or negative, or the lens to be *over-* or *undercorrected*, by the simple fact that a convex lens causes the excentric rays to cross the axis at a point nearer the centre of the lens than the central rays, in which case, and in all analogous cases, it may be said that the lens is undercorrected and afflicted with a negative aberration. English objectives are now constructed on the principle of having the posterior sets overcorrected and the anterior undercorrected so skilfully as to destroy, by opposite errors nearly, the residuary aberration; but the opinion may be hazarded that future combinations will yet be found which will completely throw into the shade the present powers of the microscope, when perhaps we shall be in a better condition to attempt to determine the microscopical features of molecular life, at present probably beyond its grasp, as no single particle so small as the *sixty-thousandth* of an inch in diameter can be clearly defined if isolated, until residuary error is very much reduced.

It is to be regretted that the precise nature of the marvellous combinations invented by Professor Amici for objectives remain unknown. As one of the Jurors in the Paris Exposition, his microscope necessarily remained both uncelebrated and unelucidated in the Reports.

decide whether compensations of aberration could be effected by attending to some definite principle or law.

The previously ascertained properties of *eidola* enabled many experiments to be made with rapidity and certainty. The following principles were, in short, patiently arrived at by experiments extending over several years:—

I. Displacement of the final focal image towards the eyelenses, provided the front lens or facet of the object-glass is kept at the same distance from the object under observation, is caused by approximating even slightly the component adjusting lenses of the objective, and this movement causes a negative aberration, and *vice versâ*.

II. With test-images, both observing and miniature or image-forming objective follow the same law of compensation. If one be overcorrected the other must be similarly adjusted, and *vice versâ*.

III. Using additional compensating lenses to gain increase of power, intermediately placed between eyepiece and objective, the finest definition is obtained when each of the three sets, viz. lenses, observing and image-objective, are similarly though slightly overcorrected, as compared with a standard defining distance of 9 inches.

Although a fine definition seemed now attainable by means of supplementary compensating lenses, if judiciously introducing balancing compensations, yet their practical adjustments were innumerable and tediously accomplished.¹

In the distribution of the power lenses, and in the application of a traversing searcher, it was indispensable that the object should be kept distinctly visible in the field of view, by a proper selection of lenses, whilst the optical compensations were being adjusted. The form finally adopted is simply this:—

A pair of slightly overcorrected achromatic lenses, admitting of further correction by a separating adjustment, are mounted midway between a low eyepiece and the objective, so as to admit of a traverse of two or three inches by means

¹ During 1865—1869 many experiments were tried with complete objectives and various parts of them, either over- or undercorrected by means of a sliding-tube carrying them and fitting into the "draw tube."

Professor Listing of Göttingen has confirmed the value of this method of amplification quite independently in two papers published in 1869. 'Nachr. d. kgl. Gesell. der Wissensch,' 1869, No. 1, and 'Poggend. Annalen,' 1869, vol. xvi, p. 467 ('Nature,' Jan. 27, 1870).

In the first he recommends an inverted Huyghenian eyepiece, and in the second intermediate achromatic lenses.

As regards intermediate lenses, the writer has ascertained (Nov., 1870) that Dr. Goring ('Micrographia,' ed. 1837) has anticipated both these methods.—Note added Nov., 1870.

of a graduated milled head. These lenses are conveniently traversed within the draw tube; and can be brought to bear within four inches of the objective, or at a distance of ten inches.

The focal length of the combination forming the aplanatic image-searcher may vary from $1\frac{1}{2}$ inch to $\frac{3}{4}$ of an inch. The latter applies more effectively to low objectives when it is desirable to obtain extraordinary depth of focal penetration, and vision through very thick glass¹—as with a half inch giving 700 diameters with a C eyepiece. A Wray half-inch objective² was found to bear an E eyepiece and searcher. It should now be stated that the searcher may be employed with very different intentions. Thus—

When it is desirable to view an object through a very thick refracting medium, the searcher is brought as close as possible to the objective, which action lengthens the focus of the objective; and the same thing is necessary when the observer wishes to throw the *eidola* of an upper structure above and away from the true image of the lower but contiguous stratum—as when the lower beads of the Podura are required, or when it is required to give additional negative aberration to an objective too positively corrected in which the front glasses are already forced into a dangerous proximity.

On the contrary, when the searcher is traversed the opposite way, the *objective lenses* require to be brought nearer together; the instrument is then more adapted for viewing objects or particles lying in the upper plane of a complex structure, throwing the *eidola* of the lower layer below that layer itself, and so leaving the upper stratum less disguised by the false images of the lower.

In intermediate cases, where greater penetration or focal perspective is required, with a thin glass cover, the objective lenses must be proportionately separated by an increased interval, the searcher being traversed towards the objective; and in general confused images of both upper and lower strata can be obtained by opposite arrangements.³

A very interesting refinement upon the corrections for chromatic effects may be accomplished by gradually traversing either way both searching and objective lenses and closely watching the effect.

¹ Nearly one fourth of an inch thick.

² With a "Kelner" two thirds of an inch focal length, a very clear, very large, and flat field is presented to the eye, notwithstanding the increased power with the searcher. A one and a half inch objective by Ross was used generally for a condensing illuminating apparatus more or less stopped off.

³ Such as separating the objective lenses and traversing the searcher further from them.

The most brilliant definition is generally obtained when the searcher (a little more overcorrected) is used as close to the objective as possible.

The overcorrection of the searcher is increased by separating its component lenses according to the divisions upon the sliding tubes of the searcher.

It will be seen that an exceedingly small pencil engages the surface of the searcher diverging from a point in the image $p' q'$, which is inverted again at $p'' q''$. As the searcher is traversed nearer the eye the pencils become less divergent, and the effect of the searcher is diminished. On the contrary, as it approaches the objective, $p' q'$ being formed nearer to the latter after refocusing, a more divergent pencil engages a greater aperture of the searcher, and this now automatically causes a stronger overcorrection than before. The essential action of the searcher is to apply a rapid variable correction by a traversing movement (fig. 2, Plate IX).

The use of this instrument will be facilitated by first setting the microscope for ordinary use without the searcher, adjusting an eyepiece, the focus, and screw-collar to the most distinct vision, and then applying the draw-tube containing the searcher placed at a point nearest to the eyepiece E. As the searcher is traversed towards the objective, the lenses of the objective may require separation.

The change in the general aberration is shown by the divided index of the milled head actuating the movement of the searcher (M, fig. 1).

The power obtained is in general from two and a half to four times greater than that given with the third eyepiece C of 1 inch focal length. With a very fine eighth of Messrs. Powell and Lealand's new construction, a clear and satisfactory definition of the beading of the *Pleurosigma formosum* was exhibited to them, by means of the aplanatic searcher, at a power estimated at 4000 diameters.¹ Several inferior objectives have acquired a fine definition by the application of the searcher.

The instrument will be most effectively employed by considering it as a conjugate portion or integral part of the objective itself, in which the minute traversing adjustment of the objective lenses finds its counterpart in the more extended, and, therefore, more delicate adjusting traverse of the searcher itself; so that, in short, during the minute microscopical research each adjustment should be intelligently

¹ The usual power of the one eighth with a C eyepiece is 800; a power of 4000 is given by an eye piece of one fifth of an inch focal length.

applied, according to the nature of the research in hand. The indications of the one adjustment should be employed to verify those of the other. Correlative movements by the aid of the searcher may introduce aplanatic images, whilst a violation of their correlation will exhibit deformity.

In every case either an extra thickness of glass cover or a deeper immersion of a given object in the film of Canada balsam (or other fluid used for mounting it) was found to require for a precise definition additional adjustment; the searcher should be made in this case to traverse towards the object to attain the new correction requisite. The same remark is applicable to immersion lenses. Further slight improvement can be effected in the precision of definition by separating more or less the component glasses of the Huyghenian eyepiece (the power of which is preferred as low as 3-inch focal length for the $\frac{1}{20}$ "immersion") or by substituting for it a single achromatic combination slightly overcorrected for spherical aberration of two inches focal length, or less according to the power required.¹

An additional cap containing a supplementary achromatic lens is sometimes advantageously fixed upon the lenses of the searcher, when (for instance) a power of 700 diameters is desired to be developed by a half-inch objective (for test *Podura* beading).

In conclusion, the experiments detailed in this paper, selected from a great number made within the last few years, it is hoped will induce more able observers to repeat them in a more general form; but, so far as they are detailed, they appear satisfactorily to demonstrate the detection of residuary aberration of considerable amount in the very finest microscopes, and enable one to measure it, and to suggest means of diminishing the errors of the glasses whilst greatly increasing the power. Whether a similar method can be applied also to telescopes has been some time under the author's consideration, with results which he hopes on a future occasion to have the honour of communicating to the Society.

¹ Dr. Pigott adds in a note that a Wray one fifth, made expressly, admitted of as great amplification as an ordinary one twelfth. In fact, these researches appear to point decisively to greater advantages to be expected from raising the quality of the lower objectives rather than deepening focal length. Observers are more numerous every year who prefer the one eighth to the one twenty-fifth and one fiftieth.

On the STRUCTURE and ORIGIN of the SPERMATOPHORS, or SPERM-ROPES, of two SPECIES of TUBIFEX. By E. RAY LANKESTER.

IN the April number of this Journal last year I called attention to the fact that the so-called opalinoid parasite *Pachydermon* of M. Claparède, found in the copulatory pouches of certain Oligochæteous Annelids, is in reality a felted mass of spermatozoa, *i.e.* a spermatophor.

Such bodies have been described as occurring in Mollusca and Insects, sometimes presenting remarkable complexity of structure. Their occurrence in the Leeches was noticed, many years since, by Professor Max Schultze (also by Fr. Muller), who does not, however, ascribe to them, in this case, anything beyond a simple rope-like structure. The same authority makes the statement that spermatophors occur in the "Regenwürmer," but does not specify species nor form. Professor Leuckart, in his "Bericht," for the years 1848 to 1853, points out that the filamentous bodies found in *Stylaria* by d'Udekem, are spermatophors; a view which d'Udekem subsequently adopted. In Troschel's 'Archiv' for 1850, in a paper by Professor Budge, where the generative organs of a species of *Limnodrilus* and of a species of *Tubifex* are described as belonging to *T. rivulorum*, the spermatophors are figured, but their nature is not determined.¹ The very curious structure of these built-up masses of spermatophors, the fact that they are an example of a *kind of organisation* elsewhere without parallel—a secondary aggregation, not due to growth, as ordinarily presented by organized beings, but to accumulation of free independently-developed elements, gives them a claim on our attention, as well as the facts that they have been misunderstood by the ablest and latest writer (M. Claparède) on the animals which present them; and that they exhibit marked variations in form in the various genera and species of Oligochæte worms.²

In my former paper I figured, but roughly, the sperm-rope of a *Limnodrilus* and of *Nais serpentina*. In the plate accompanying this paper, more careful figures are given of

¹ I am indebted to Prof. Leuckart for reference to the papers in which spermatophors have been assigned to the Oligochæta. Prof. Gegenbauer in his 'Grundzüge der Vergleich Anat.,' second edition, p. 294, gives a brief but accurate notice of those of *Tubifex*—apparently from original observations—which has come under my eye whilst writing this.

² They do not occur in the earth-worm; perhaps this is correlated with its not inhabiting the water.

the sperm-ropes of two species of *Tubifex*—*T. rivulorum*, a worm abundant in nearly every muddy stream or river, and *T. umbellifer*, a remarkable form, living with the latter and *Limnodrilus Udekemianus*, in the Thames below London (see ‘Annals and Magazine of Natural History,’ February, 1871).

The sperm-ropes of *Tubifex rivulorum* I have found in the copulatory pouches both in summer and winter, but especially abundant and well-formed in the winter. They have a worm-like figure, with a curious conical head, and average from $\frac{1}{20}$ th to $\frac{1}{15}$ th of an inch in length, and from $\frac{1}{500}$ th to $\frac{1}{200}$ th of an inch in breadth, the narrowest part being that immediately succeeding the conical head, which has a breadth of about $\frac{3}{1000}$ ths of an inch (Pl. X, fig. 1).

The general form of the sperm-rope is due to its being moulded in the long neck of the copulatory pouch. This is plainly seen from the manner in which the conical head corresponds with the shape of the orifice of the pouch (fig. 18). The sperm-rope may sometimes be seen lying in this position, in course of being moulded. The sperm-rope of *T. umbellifer* does not present the conical head which we find in *T. rivulorum*, and in accordance with this is the absence of the reduplication of the wall of the copulatory pouch at its orifice; the mouth is simple, and accordingly gives rise to a simple tapering extremity in the sperm-rope.

Not all the sperm-ropes, however, which are to be met with in the reservoirs of *T. rivulorum* have the conical head; some have been moulded lower down in the neck, and, consequently, exhibit a single blunt extremity, as fig. 9; others, again, from an insufficiency of the plastic material, are quite short, and consist of nothing but the conical head (fig. 8). All gradations are to be met with, parts of the conical heads short and long, according to the amount of plastic material introduced into the moulding reservoir-neck, and according to the part of the neck in which the moulding has taken effect.

It appears that the material of which the sperm-ropes are formed, namely, spermatozoa and a cementing matrix, must be introduced in a viscid form from the male efferent duct, through the penis of one worm into the copulatory reservoir of another, and in the neck of that reservoir a “setting” occurs; for the sperm-ropes, when fully formed, are very firm and compact bodies, of high light-breaking power. The wall of the copulatory pouch is glandular, and undoubtedly furnishes a secretion which occupies part of its cavity, and in all probability also assists as a cementing material in the formation of the sperm-ropes. But the fact that the

sperm-ropes are moulded in the mouth of the pouch makes it probable that the bulk of the cementing matrix is introduced into them with the spermatozoa from the male organs of another worm. A very large gland, adapted in every respect to this function, is situated on the male efferent duct in both *Tubifex* and *Limnodrilus*, and its function has hitherto been in doubt. Claparède regarded it as a seminal vesicle, though he admitted that he had never seen any spermatozoa in it, nor had he grounds for considering it vesicular. The gland may be called a "cement-gland," and its large size in *Tubifex* and *Limnodrilus* is in correlation with the abundant and complete character of their spermatophors. In *Clitellio*, which presents sperm-ropes, but has not this gland, the glandular portion of the male efferent duct itself is largely developed, and probably supplies its place. In *Nais*, where the sperm-ropes are very simple and small as compared with the Sænuridæ (see this Journal, April, 1870), there is no glandular development at all in connection with the male efferent duct, which is of a perfectly simple membranous character, and very short. In *Nais*, therefore, it is probable that the secretion of the copulatory pouch alone forms the cementing matrix of the spermatozoa.

It is not unusual to find (especially in the summer) very loose aggregations of spermatozoa in the copulatory pouches—such as that drawn in fig. 13—which are apparently ill-formed spermatophors. They are wanting in the compact, sharply-outlined character which the well-formed spermatophor presents, and this may be attributed to a deficiency in the secretion of the cement-gland, or to their not having been properly "set" in the neck of the copulatory pouch. They, and others less incomplete, are sometimes observed to adhere more or less to the wall of the copulatory pouch, which seems to show that a secretion from that wall enters into their formation. This adherence to the wall of the pouch is especially noticeable in *Nais*, where the spermatophors seem sometimes to be actually continuous with the lining membrane of the pouch. Those of the sperm-ropes of the Sænuridæ, which are well formed, do not exhibit this adherence.

A difference is noticeable among the sperm-ropes of *Tubifex rivulorum* in their refractive power, and their colour (some being of a brownish tint), which is in all probability due to the amount and quality of the secretion from the cement-gland, and perhaps, too, to their age.

In most of the sperm-ropes it is easy to observe a striated structure, which is clearer in some specimens than others. Further observation shows that this striated structure is due

to the spermatozoa, which together with the cementing substance make up these bodies.

An optical longitudinal section of a well-formed spermatophor of *Tubifex rivulorum* exhibits the following structure (fig. 1, fig. 4):

Centrally an axial canal, or least refractive portion (*a* in figs. 4 and 7), probably more or less liquid, which is stained by carmine, the rest of the spermatophor being unstained, and contains granular matter and shrivelled epithelial cells; this canal runs from end to end, and varies much in width, enlarging in the broader posterior part of a large sperm-rope, and becoming finer towards the conical head, through which, however, it extends, expanding there in conformity with the outline. External to this, a dense, highly refringent layer, in which a dark line (*b*) is seen to run; following this, a less refringent striated layer (*c*), the striæ in which are directed, when thus seen in optical section, from without obliquely backwards (that is, away from the conical head), and towards the axial canal. External to the striated layer, we come again upon a bright, highly refringent layer (*d*), which in some cases, unless a very good glass is used, appears to bound the spermatophor, but there is externally to this a fringe (*e*) of excessively delicate filaments, the projecting vibratile portions of the spermatozoa. The extent to which these project varies, so that in some sperm-ropes it is difficult to make them out at all; in others, they are very obvious. In the sperm-rope of *T. umbellifer* they are longer (fig. 14) than in *T. rivulorum*, and in *Limnodrilus* and *Clitellio* they are even longer still. But the extent to which they are left free must depend very much on the completeness with which the spermatophor is developed, on the amount of cementing substance, and on its more or less complete condensation. This will vary much from time to time, and in different specimens.

The two bright borders *d* and *b* are due to a peripheral hardening of the cementing substance, a more complete condensation at the inner surface where the axial canal is excavated, and at the outer free surface. The dark line *b*, which is sometimes seen very clearly traversing the inner bright layer, is interesting as an optical phenomenon, in connection with the dark line traversing the intermediate substance placed between the doubly refracting discs in striped muscular tissue, and like it, as explained by Heppner, is due to total internal reflexion.

Whilst a longitudinal section may be easily obtained through the focussing of the microscope, to obtain a satisfac-

tory transverse section the spermatophor must be imbedded in wax and oil, and cut with the razor. A section so obtained is drawn in fig. 7. The same layers are seen as in fig. 4, but it is observed that the filaments (spermatozoa) visible in the striated layer have an imbricated, curved arrangement. This is important, as it helps to explain the way in which the spermatozoa have been felted together. The section represents the proximal portion, that is, the portion nearer the conical head, and it indicates that the sperm-rope has been twisted from right to left (on its own axis), by which means the curved, imbricated radiation has been produced.

If we now examine the structure of the sperm-rope from the surface downwards, we find the following structure. In a living specimen from *T. rivulorum* the surface is often, but not always, seen to be in a state of active vibration. With a high power (No. 10 à immersion, Hartnack) the vibratory surface presents the appearance drawn in fig. 2, when in active movement. The moving bodies are the vibratile filaments of the spermatozoa, three of which, isolated and greatly enlarged, are seen in fig. 6. The reflected portion forming a loop is the filament of the spermatozoa. In *T. rivulorum*, as before observed, the projecting portion of the filament is short, but in *T. umbellifer*, and other Sænuridæ, it is of considerable length, and gives rise to most active locomotion of a very graceful kind, and strongly resembling that of the ciliated Infusoria. This is a very remarkable phenomenon, and calculated to throw some light on the nature of ciliary movement, when we remember that each of the vibrating elements here cemented together, has had an independent development, and is in no kind of organic connection with its neighbour, and yet the vibration of the whole surface proceeds with as much regularity and results in as definite a locomotion as in the case of Infusoria whose cilia are presumably in organic connection, and, therefore, possibly under some central control. We might have expected in these spermatophors irregular spasmodic vibrations of the component spermatozoa, the one acting so as to neutralise the other, but instead of this we obtain a perfect and regular "wave" of vibration, which resembles that seen on any ciliated membrane. This fact proves, firstly, an actual identity between cilia and the filaments of spermatozoa, and secondly, that the co-ordination of ciliary movement is independent of any common organic connection of the cilia.

Leaving, for the present, the physiological questions here raised, we pass below the vibrating surface of the sperm-rope, and find a striated structure indicating the spiral arrange-

ment of the heads or motionless portions of the spermatozoa embedded in the cement. The striation of the most superficial layer invariably presents an oblique direction passing from left to right posteriorly, as seen in fig. 3. Focussing more deeply, we come upon the optical long-section already described (fig. 4); and then, more deeply still, we obtain the converse of fig. 3, the striation running from right to left obliquely and posteriorly. These appearances may be explained if we imagine a cylinder of a soft viscid material, to be stuck full of small bristles, each a little longer than the radius of the cylinder's cross section, each placed at right angles to the cylinder's surface, and passing nearly to its centre, in fact, arranged somewhat like the bristles of a rotatory hair-brush, but more deeply set. Then we must imagine the viscid cylinder, with its embedded bristles, to be pushed into a closely fitting sheath, and slowly rotated on its own axis from right to left, whilst it is, at the same time, undergoing the longitudinal movement. In this way all the bristles would become directed along the lines of a series of spirals, running from above downwards, from left to right of the observer, and the transverse and longitudinal sections would give the same appearance which we observe in the spermatophor of *Tubifex*. Hence we may suppose that some such process has taken place in the building-up of these bodies.

I have already mentioned that considerable difference is exhibited in the intensity with which the spermatozoa make themselves apparent as a spiral fibrous structure. Some spermatophors are quite brown and strongly marked in this respect, others are much paler, and some present actually no trace at all of spermatozoa; so that I am inclined to regard them as blank "cement-forms," which have assumed their appropriate shape without enclosing any spermatozoa (fig. 12).

The spermatophors of *T. rivulorum* will bear considerable pressure without breaking, and are of a tough leathery consistency. When they do break, they tear, along spiral lines, and become teased out into fibres, as seen in fig. 11. Strong acetic acid facilitates this tearing, but does not otherwise alter them. I have not made a thorough micro-chemical examination of the spermatophors. They may be preserved excellently, apparently without any change, in glycerine jelly.

As already mentioned, the free vibracula of the component spermatozoa are sometimes to be seen moving with great regularity, whilst the sperm-ropes are lying within the copulatory pouches. A solution of from one to two per cent. of

common salt served to bring them into action when they were previously quiescent.

Sperm-ropes of Tubifex umbellifer.—The sperm-ropes of this species, the characteristic setæ of which are drawn in figs. 16 and 17, are somewhat smaller and of a more elegant and tapering form than those of *T. rivulorum*. In this interesting worm—recorded as yet only from the neighbourhood of Lake Onega and the Thames—the penis is not preceded by a short pyriform glandular enlargement of the vas deferens, on to which the cement-gland is grafted, as in *T. rivulorum*, but a long tortuous canal, resembling the preceding portion of the vas, comes between the penis and the enlargement on to which the cement-gland is grafted. This may possibly have some connection with the difference in the form of spermatophor. The chief difference is in the absence of the conical head, which is due to the fact that the neck of the copulatory sac in *T. umbellifer* is of a different shape to that of *T. rivulorum*, and consequently moulds the mixture of cement and spermatozoa to another form. This form is seen in fig. 14. Both extremities are acute and tapering, but that which corresponds to the “head” of *T. rivulorum*’s sperm-ropes is broadened out for some length. This general form—but more blunt and rounded than here seen—occurs in *Limnodrilus* and *Clitellio* (see Claparède’s figures of Pachydermon from *Clitellio*, ‘Recherches sur les Oligochètes’). The same constituent parts are noticeable, as in *T. rivulorum*, but I have not seen sperm-ropes of so compact and dense an appearance in *T. umbellifer* as in the former species. The fringe of vibratile filaments is always deeper and more obvious than in *T. rivulorum*. The axial canal widens out to a correspondingly large cavity in the broad anterior extremity of this spermatophor, and there are granular or sometimes broken-down cellular contents in it.

Three of these sperm-ropes extruded from their containing copulatory pouch into a two per cent. solution of salt, exhibited very graceful movements of a definite character. The whole body, assuming a double curve of a sigmoid character, moved with great rapidity, in such a way as to describe a figure of eight passing and repassing on the same track, or very nearly the same. Fig. 15 is intended to represent one of these bodies in motion; all three presented the same graceful sigmoid movement. It was impossible in watching this regular, rapid and graceful gliding movement, in which the whole body seems to take part like that of a coiling snake, to persuade oneself that one was not looking at an organized being, but at an agglutination of seminal filaments. The beat of the cilia

was so regular and exact—the longer and more delicate extremity so gracefully arched as it flowed after the broader head and again straightened out and again bent round to form the second loop of the figure of eight, and this motion was so continuously kept up—that it was difficult to look upon it as due to a mere mechanical fusion of uneducated (*i. e.* not originally developed in connection with this condition) independent vibratile elements.

The spermatozoa do not appear to fuse in the way in which the amœboid “Schwärmer” of *Didymium* fuse to form a plasmodium, which is the nearest approach to be found to such a building up of an organism as the spermatophors present. It is probably more correct to suppose that each spermatozoon remains perfectly distinct from its fellows, and that the unity of their action is due to their uniform condition and properties and to the uniformly diffused character of the stimulus (a chemical one) in response to which they act. If this view be correct we may assume similar independence for the cilia of all ciliated membranes—a fact already inferred from experiment. Did we know of a number of free unicellular organisms after complete development becoming fixed together by a cement to form a secondary organism capable of locomotion and possibly of nutrition, we should have a parallel to the spermatophors; as it is, they are, I believe, the only examples¹ of the building up of an organ or quasi-organism by agglomeration instead of histogenesis.

¹ Such social organisms as *Conochilus* may be regarded as in a measure parallel. But the union in that case is less intimate, and moreover is a union of secondary aggregates.

REVIEW.

Microscopic Objects, figured and described.—By JOHN H. MARTIN, Honorary Secretary to the Middlesex and Mid-Kent Natural History Society. London, John Van Voorst, 1870.

THIS work contains 194 tolerably executed figures of what are sometimes called “natural history objects,” among which we find, for instance, the “pollen of the evening primrose,” “a skin parasite from the human nose,” and “marble from the Temple of Diana, at Ephesus;” represented under various degrees of magnifying power, and some without any enlargement at all. The figures are accompanied by short descriptions and a few hints as to preparation. When we say that the specimens selected are almost unclassified, and that the author does not claim to establish, by his delineations, any facts unknown before, or to contribute anything to the settlement of disputed points, the character of his book will, we think, be evident. It does not fall specially under the head of any one of the sciences which the microscope is used to illustrate, but rather appeals to those who are on the look-out for objects to use their microscope upon. It is obviously the work of a zealous and experienced field naturalist, who has brought together his materials from very various sources, and takes genuine delight in the beauty and strangeness of the forms which display themselves before him.

Mr. Martin has evidently bestowed considerable pains upon the preparation of some of the objects which he figures, such as the rock sections, which, though not so successfully represented as some of the others, are samples of a field of activity, to which it is highly desirable that the attention of those who have microscopes, time, and the requisite patience should be drawn. There is hardly any branch of microscopical science in which so much is to be made out, with regard to the commonest objects, as in this. An immense number of well-known rocks have never been examined by these processes; and yet, when such researches have been made, they have never failed to produce most interesting and valuable results. If every one of our country microscopists will set himself to find out what is actually known respecting the structure of those rocks or fossils of his own

neighbourhood which are susceptible of microscopical investigation, he will, unless he is either very well read, or else quite incapable of surprise, be astonished to find how blank a page of geology, more especially in English books, this is; and if he will then set himself to fill up some of the gaps thus discovered, he will, we think, arrive at results not only more valuable to science, but more satisfactory to himself than he is likely to attain by following the beaten track of mounting diatoms and putting small flies in Canada balsam. In the one case he will be able to put on record facts, which may be of the highest importance in solving great geological problems; in the other, he will be fortunate if, after collecting innumerable specimens, he hit upon a species differing ever so little from those already described. It is true that the methods are laborious, and the number of completed specimens may be comparatively small, but we may be permitted to point out that the value of a specimen to the preparer (supposing it to be successful in showing what it is meant to show) is simply proportionate to the amount of labour and time he has spent upon it. There is a genuine satisfaction about the production of an object which is really a work of art; which it has taken labour and skill to develop out of some shapeless mass, far greater than that derived from a dozen "easy" objects, which when put up are after all not so good as when they were fresh, and whose only superiority to natural specimens is in their permanence.

The value of a miscellaneous series of specimens, then, depends so entirely upon the "technik," as the Germans say;—upon the art which has been employed to produce them, that we could wish Mr. Martin had given more prominence to those objects, such as rocks, which require serious preparation, than to simple figures of insects, &c., which would seem more fitly to belong to systematic works of natural history. Some good directions for preparing rock specimens (for instance) would have been both more novel and more valuable than the few hints about mounting which he has thrown together.

We do not, however, wish to judge the book by any other standard than that to which it appeals. It is intended for amateurs, and to amateurs we can fairly recommend the attempt to reproduce these specimens as a useful preliminary training for more systematic studies. If they succeed in putting up as well as Mr. Martin has done the objects he has represented, they will have acquired a technical skill which may be put to good service in scientific research. Research in some form or other is, we must repeat, the goal at which all microscopical observers should aim.

NOTES AND MEMORANDA.

DR. WILHELM KÜHNE, Professor of Physiology at Amsterdam, well known for his researches in histology as well as in physiological chemistry, has been appointed Professor of Physiology in the University of Heidelberg, as the successor of Professor Helmholtz, who has been called to a similar post at Berlin.

Improvements in the Lenses of Microscopes.—For some time people in England have been content to let the improvement of the optical powers of the microscope remain entirely in the hands of the makers, believing, apparently, that Mr. Lister had effected all in his suggestions and improvements that could be desired. Dr. Royston Pigott, an able mathematician, formerly Fellow of St. Peter's College, Cambridge, and a Doctor of Medicine of that University, was not, however, inclined to look at the matter in this way, and for many years has been working and experimenting with a view, first, to test the accuracy of our best object-glasses, and, secondly, to suggest means for their improvement. It should be remembered that Oberhäuser, Nacet, and especially Hartnack, on the Continent, not satisfied with the old system of combinations for object-glasses, and not having the benefit of Lister's researches, have made excellent objectives on a totally different system, and during the last few years the last-named maker has carried his system of "immersion lenses" to such a point of excellence as really to surpass the best glasses on Lister's system, in definition, penetration, working distance, and illumination. Those who do not admit the excellence of these objectives, which are now used by nearly all German histologists, have probably seen older glasses, made at a time when Hartnack had not reached his best. It is worth stating, now that the Parisian opticians are inaccessible, that Gundlach, of Berlin, has succeeded in making excellent glasses of high power at astonishingly small prices, some of his 1-12ths and 1-16ths immersion 1-16ths (so-called) being admirable in their performance. They are not, however, equal to Hartnack's glasses, which, though costing far less than what similar English

glasses cost, yet are more expensive than Gundlach's. It is only fair to all parties concerned to state that the terms 1-8th, 1-12th, 1-16th, &c., as now applied to an object-glass, appear to have no definite meaning, but depend on the caprice of the maker, since the magnifying power of glasses, with the same fraction assigned to them, differs enormously.

To return to Dr. Royston Pigott. He found the usual means of testing an object-glass by trying if it gave some particular appearance with a "test object," such as the Podura-scale, very unsatisfactory, since we have no certainty to begin with as to what is the true appearance of such an object. He therefore examined minute images of objects of which he knew the true form, such as a watch-face or thermometer-scale, forming these images by aid of mercurial globules and the condenser properly adjusted below the microscope-field. By this means he has found that object-glasses corrected so as to show dark, sharply marked spines (like !!!) on the Podura-scale—a favourite test-object with our microscope-makers—give false, blurred, and distorted appearances with his known images, and on making such corrections of the objective as to show the known images in their true form, he finds that the Podura-scale, examined with the corrected objective, is not really marked at all as supposed, but is beset with a series of bead-markings, which by intersection, when improperly defined, give the curious appearance like notes of exclamation.* This important discovery of the falsity of our high powers (1-8th to 1-16th), has led Dr. Royston Pigott to pay more attention to the lower powers, and he finds that, though you may not get so much actual amplification, you yet get a truer effect, and greater clearness of detail, by employing very carefully made low powers (1-2nd to 1-5th), and increasing the magnifying power at the other end of the microscope, *i. e.* the eye-piece. We have in this way seen the beaded structure of the scales of Podura more satisfactorily than with very high objectives, even when corrected so far as they would admit, and we may say the same of some Diatom-valves, *e. g.*, *Pl. formosum*. It would be most important to know how far such a change of combination would be useful in histological work.

The general upshot of Dr. Royston Pigott's investigations appears to be that it is desirable to shift the burthen hitherto cast almost wholly upon the objective to the other parts of the instrument. We should be content with an objective as high as a fifth, or even less. A very deep eye-piece is to be

* See Plate VIII of this number.

used; and to correct residuary aberrations of the objective, and at the same time amplify, Dr. Pigott has introduced an important adjustable combination *between the eye-piece and the object-glass*. There seems to be considerable reason for the step proposed by Dr. Royston Pigott. Just as great results were obtained in passing from the single lens or combination to the compound microscope of eye-piece and objective, so by adding distinct integral factors to these two, such as Dr. Pigott's "aplanatic searcher," we may obtain excellences quite impossible by any amount of attention bestowed on the objective alone, or only with difficulty reached by long labour, leading to very high price for high powers.

Dr. Pigott has, during the past year, published some account of his researches in the 'Quarterly Journal of Microscopical Science,' and has communicated papers to the Royal Society, one of which is about to appear in the 'Philosophical Transactions.'

Naturally at first the makers in London and the Microscopical Society were sorely tried by Dr. Pigott's exposure of the Podura-scale, but we hear, as one good result already obtained, that Messrs. Powell and Lealand have constructed a new 1-8th, both dry and immersion, with great care, which is declared to be the best glass yet made. It has been proposed to form a committee for the purpose of examining carefully as to penetration, definition, and angular aperture, the best glasses of our English makers, the best American glasses, and the best of Hartnack's, Gundlach's, and others, the glasses being mounted similarly, with private marks only for recognition, so as to prevent all possibility of prejudice on the part of the committee. Were this done, the result, whichever way it tended, would be eminently satisfactory. Of this the writer is sure, that many persons—even eminent microscopists—have made up their minds about the qualities of foreign objectives, without having seen any, or only very poor examples, and then when a really fair specimen of such a glass is placed before them, they exclaim with astonishment, "Why, this is the finest glass I have ever seen." We shall be glad to receive suggestions or assistance in carrying out the proposed comparison of objectives. Dr. Royston Pigott has expressed his willingness to aid in such an undertaking.

E. R. L. [*Nature*.]

The Microscope in the Study of Rocks.—Professor Archibald Geikie contributes to 'Nature' (February 9th and 16th) two elaborate reviews of "Recent Petrographical

¹ See p. 166 of the present number of this Journal.

Literature," from which we extract the following passages bearing on the use of the microscope:

"English petrography does not exist; what we have in its stead is an indefinite obsolete grouping of rocks patched up with occasional borrowings from the Continent. And yet, strange to say, it is in England that the most important steps in modern petrography has originated. Sorby's application of the microscope to the study of rocks has opened a new era in the science, and our good friend Sorby himself is regarded as a kind of demi-god in the eyes of our German brethren of the hammer.

"The great paper of Mr. Sorby published here thirteen years ago has done much to quicken research by showing that the older methods were in many respects untrustworthy. These methods were based primarily upon chemical analysis. But such analysis, while it reveals the ultimate chemical constitution of the rock, may not explain its mineralogical composition. The various stages of the metamorphism of the component minerals are thereby often lost sight of. Hence two rocks, having by analysis approximately the same chemical composition, may differ materially from each other in mineralogical composition. It is here that, as Sorby showed, the microscope comes in to our aid, and shows what the different mineral ingredients of the rock are, how far they have respectively undergone alteration, how they are built into each other so as to form the rock-mass, and under what conditions they may originally have been formed. This important addition to the methods of research has so powerfully affected petrography, that this branch of science must be regarded as at present in a transition state.

"Among the Continental petrographers who have led the way in the recent reform and extension of this branch of science, none can claim a more prominent place than Dr. Zirkel. Although still a young man, he has held professorships successively at Lemberg and at Kiel, and we rejoice to hear from him that he has been selected to succeed the venerable Dr. Naumann at Leipzig. He is the author of many excellent mineralogical and petrographical papers, and of the best text-book of petrography which has yet been published. Especially has he distinguished himself by the zeal with which he has followed out the ideas first broadly sketched by Mr. Sorby, and has shown how absolutely indispensable is the application of the microscope to the study of the composition and history of rocks. His researches, while extending over the length and breadth of Germany, have not been confined

to the Continent, but have been carried with characteristic enthusiasm even as far as the peaks of Arran, and the cliffs and glens of our north-western isles.

“A few years ago he resolved to devote himself to a comprehensive study of the rocks to which the general name of basalt had been given. Though abundant chemical analyses had been made the ultimate chemical constitution of these rocks well known, the mineralogical composition of them still remained rather vaguely defined. Men were still speculating about the mineralogical nature of that part of basalt which is soluble in acid, when Dr. Zirkel set to work to collect specimens of basalt from every available locality, and to prepare thin transparent sections of them for examination with transmitted light under the microscope. The result of these investigations appears in the little volume now before us, which is appropriately dedicated to Mr. Sorby. In a brief introduction the author recounts the state of the question when he took it up. Having collected and prepared upwards of 300 sections of basalt from the most varied localities, he believes that he has obtained samples of at least the chief types of composition and structure among the basalts, and he now gives us this first instalment of his labour.

“That Professor Zirkel is still busy with his researches is shown by the paper (second in the list at the end of this article) which appeared in a recent part of the ‘*Neues Jahrbuch*,’ and in which he investigates the peculiarities in the minute structure of rock-forming minerals, and also of artificially-fused basalt and syenite.

“Herr Vogelsang is another ardent student of the microscopic structure of rocks. A few years ago he published a little work containing the most beautiful coloured illustrations of that structure which have yet appeared. In the present paper he describes under the name of *crystallites* the non-crystallised, but yet more or less regularly grouped inorganic bodies which are found in crystals and rocks.

“Professor Fischer’s little pamphlet is a modest production, but one which could not have been prepared without a great deal of hard work. Finding that minerals which to all outward appearance are simple and homogeneous, can yet be resolved by microscopic examination into as many as sometimes four distinct minerals, he has analysed by this method some sixty minerals, and publishes his results in the present paper, which should be in the hands of every petrographer.

“Professor Tschermak’s essay shows how by microscopical examination with polarised light it is possible to distinguish

augite and hornblende, even when minutely diffused through a rock.

The following are the titles of the works referred to :

Untersuchungen über die Mikroskopische Zusammensetzung und Structur der Basalt-Gesteine. Von Dr. F. Zirkel. (Bonn, 1870.)

Mikromineralogische Mittheilungen. Von Dr. F. Zirkel. Pp. 801. ('Neues Jahrbuch für Mineralogie,' 1870.)

Sur les Crystallites, études crystallogéniques. Par H. Vogel-sang. ('Archives Néerlandaises,' 1870.)

Kritische Mikroskopisch-mineralogische Studien. Von H. Fischer. (Freiburg.)

Mikroskopische Unterscheidung der Mineralien aus der Augit, Amphibole und Biotit-gruppe. Von G. Tschermak. (Proceedings of the Vienna Academy of Sciences, 1869.)

Spontaneous Generation.—The controversies on this subject have not ceased. Professor Frankland has repeated for himself the experiments which he formerly carried on for Dr. Bastian, on the supposed development of organisms in saline solutions within closed tubes, but "taking additional and much more stringent precautions against the subsequent admission of atmospheric germs into the tubes."

For this purpose four tubes of hard Bohemian glass were about half filled with a solution of carbonate of ammonia and phosphate of soda in distilled water. No care was taken to exclude living germs from these ingredients. These tubes were carefully exhausted by the Sprengel air-pump and hermetically sealed, and then exposed for four hours to a temperature varying from 155° to 160° C. in a Papin's digester. When cool the tubes were removed from the digester and immediately plunged, two of them into colourless concentrated oil of vitriol; and the remaining two into a nearly colourless saturated solution of carbolic acid in water. These precautions were taken in order to avoid the possible admission of atmospheric germs through invisible cracks in the glass; such cracks, entirely invisible to the naked eye, being sometimes known to exist. On examining the tubes when they came out of the digester, it was evident that their interior walls had become corroded by the enclosed liquid.

The cylinders containing the immersed tubes were now maintained at a temperature from 60° to 75° F., and were exposed to bright diffused daylight, and sometimes to sunlight, for more than five months. The liquid in all the tubes became more or less turbid, and in some cases a small quantity of a light flocculent precipitate subsided to the bottom.

Two of the tubes which exhibited the greatest turbidity were selected for examination, and were opened in the presence of Professor Huxley and Mr. Busk, who, with Dr. Frankland, submitted their contents to a searching microscopical examination. So far as the optical appearances of the sediment went they might be appropriately described in the terms applied by Dr. Bastian to the matter found by him in a solution of like composition and similarly treated (see 'Nature,' July 7th, 1870, p. 200). "A number of little figure-of-eight particles, $\frac{1}{100000}$ th in diameter, were seen in active movement. The portions of the pellicle were made up of large irregular and highly refractive particles, imbedded in a transparent jelly-like material," &c.

But the movement of the particles which was observed was obviously mere Brownian motion, and many of the particles were evidently minute splinters of glass; there was not the slightest evidence of life in any of the particles. When they were treated with hot concentrated sulphuric acid there was no blackening, and the rounded and dendritic bodies were as unaltered as the glass splinters. Indeed, some of the larger spheroidal bodies were evidently rounded particles of glass which had become detached from the tube by the corrosive action of the enclosed liquid at the high temperature to which it had been exposed in the digester.

Dr. Bastian, in his reply, contends that the experiments described by Dr. Frankland are in reality different from those of his own, to which they were supposed to be similar. The walls of the tubes in his experiments were not in the least corroded, and that there was no flocculent sediment, except in one instance, in which a tube of English glass was used instead of one of Bohemian; that his observations were made not on a sediment but on a *pellicle*, in which alone were found the *spherical* or *ovoid spores* on which he relied as indicative of the presence of living things. He also suggests that Dr. Frankland's tubes should have been subsequently exposed to a somewhat higher temperature, and that the fluids in which the tubes were immersed may possibly have been impervious to the chemical rays of light. — *Nature*, Jan. 19th and 26th.)

The 'Journal of the Quekett Microscopical Club' for January, 1871, also contains an article on so-called spontaneous generation, by Benjamin T. Lowne, M.R.C.S. Mr. Lowne has repeated and varied some of Dr. Bastian's experiments. He placed spores of *Pericillium glaucum* in a solution of acetate of ammonia, and, after boiling the fluid, enclosed some in capillary glass tubes, when, after remaining

twenty-four hours in a warm place, numerous mycelial filaments were seen to protrude from the spores. Other experiments confirmed the conclusion that the vitality of these spores is not destroyed by simple boiling. Some of Dr. Bastian's results are explained by Mr. Lowne as due to the accidental presence of foreign substances; for instance, certain "spiral organisms" described by Dr. Bastian are believed by Mr. Lowne to be filaments of spider's silk, which are, by the action of alkaline solutions, caused to twist into a spiral form.

Striated Muscular Fibre in Gasteropods.—W. H. Dall ('American Journal of Science and Arts,' February, 1871, p. 123) has observed striated muscular fibre in a species of *Acmæa*; and believes "that this is the first instance in which it has been shown to exist in the class Gasteropoda."

Fungus as a cause of Whooping-cough.—The germ theory of disease, which some pathologists seek to extend so widely, has been applied by Dr. Letzerich ('Virchow's Archiv,' vol. xlix, p. 530, 1870) to explain the extremely infectious disease whooping-cough. He thinks he has discovered a form of fungoid growth which vegetates in the epithelium of the air-passages, and by its irritation causes the convulsive attacks of coughing. The expectorated mucus in patients suffering from this disease is said to contain masses of brownish-red spores with occasional threads of mycelium, which in later stages of the disease becomes very abundant. The spores are coloured blue by iodine and sulphuric acid. These observations were controlled first by cultivation of the spores on pieces of bread soaked in milk, and further by introducing masses of the fungus growth thus obtained into the trachea of young rabbits. This was effected by tracheotomy, but the animals rapidly recovered from the effects of the operation, and in a short time became affected with a cough of a very violent and noisy character; in fact, a genuine whooping-cough. The rabbits thus affected were killed, and their air-passages and lungs found to contain an enormous quantity of the same fungus as that met with in the sputa from human whooping-cough; and, in fact, the mucus expectorated by the rabbits showed precisely the same appearance. Dr. Letzerich had already published very similar observations on a supposed fungus causing diphtheria; but neither set of observations seems, as yet, to have been confirmed by any other investigator.

QUARTERLY CHRONICLE OF MICROSCOPICAL SCIENCE.

Histology.¹

Textbooks.—The recently-issued fourth part of Stricker's 'Handbook of Histology' contains the following articles—the Mammary Gland, by C. Langer; the Genital Organs, by E. Klein; the Spinal Chord, by J. Gerlach; the Brain, by Th. Meynert; the Sympathetic Nervous System, by S. Mayer; the Organs of Taste, by T. W. Engelmann; and the Ear, by J. Kessel.

Rindfleisch's 'Manual of Pathological Histology' has appeared in a second edition.

Migration of Cells.—Dr. Caton, of Liverpool, has published in the 'Journal of Anatomy and Physiology,' for November, 1870, some further "contributions to the cell migration theory," made with the help of the apparatus described by him in this Journal (July, 1870). He has arrived at the conclusion that migration is a very common phenomenon in Tadpoles, and may occur quite independently of inflammation. In fish no migration could be observed. The paper is illustrated by an interesting plate, giving representations of different stages in the passage of leucocytes out of the vessels.

Bone. *Formation of Lacunæ and Canaliculi.*—A paper with this title, by Dr. Lionel Beale, appears in his 'Archives of Medicine' (No. 17, vol. v, p. 38), directed against the views of several German histologists, notably Kölliker and Virchow. In opposition to the latter, Dr. Beale denies that the bone-cells become stellate, or that the canaliculi are filled with the extension of protoplasmatic processes from them. The bone-cells are always simple and usually oval; while the canaliculi are simply gaps in the fundamental substance. These views appear to be substantially the same as those promulgated by the author in his lectures on the tissues, published in 1861.

Cartilage and Ossification.—Professor Neumann ('Archiv der Heilkunde,' xi, 5, p. 414, 1870) has examined the structure of normal cartilage and its ossification. He denies altogether the existence of cavities commonly supposed to surround normal

¹ By Joseph Frank Payne, M.B.

cartilage cells, and thinks the appearance of spaces is produced by the fact that the cartilage substance in the neighbourhood of the cells has a refractive index equal to that of watery fluids, and thus contrasts with the surrounding more highly refractive substance, and especially with the capsular layer. Between the cell and the wall of the cavity there is accordingly not a space filled with fluid, but a solid substance continuous with the rest of the solid cartilage, but differing from it in its optical properties. To this he gives the name of *pericellular* substance. The shrinking of cartilage cells (in various reagents) depends on the swelling up of this substance, which thus compresses the cell. Neumann points out that cartilage cells, in their sections, do not shift their position or shape with slight movements of the object-glass or cover, as must be the case if they were free in a cavity; and that when the cells fall out, the space left behind is seen to be lined with a pale hyaline zone, which becomes especially prominent after the application of carmine or iodine.

The true fundamental substance of the cartilage, which is, if these views be correct, everywhere in close contact with the cartilage cell, is then differentiated into three modifications—the *pericellular* substance; the *capsular* substance (or so-called wall of the cartilaginous space); and the true *intercellular* substance; of which the first may become transformed into the second and the second into the third. Whether the *pericellular* substance is a secretion of the cell, or (according to the views of Schultze and Beale) a transformation of part of the cell substance, Neumann cannot decide. He further draws attention to the action of iodine on cartilage cells, in producing a brownish-red or black-brown colour like its reaction with “amyloid” substance, but which is not further charged by sulphuric acid.

In his remarks on the ossification of hyaline cartilage, Neumann omits the consideration of the actual deposit of lime, so often and minutely described, but devotes himself to the question of the formation of the original “medullary spaces,” or cavities of the medullary tissue. According to the views of H. Müller, these were formed by the opening into one another of a number of cartilage spaces arranged in a row or column; an explanation which, if the cartilage spaces do not exist, of course becomes untenable. According to Neumann, the cartilage cells become arranged, as has often been described, in rows or columns, and the remaining true intercellular substance, with part of the capsular layer between these rows, forms the longitudinal trabeculæ of bone; while the transverse septa connecting these are formed entirely of

the *capsular* layer (or walls of the cartilage cavities). Each column or row of cartilage cells thus formed corresponds and is found to be placed opposite to one of the growing processes of the medullary tissue, and the liquefaction of all the cartilage substance, except the cells, precedes and gives room for the growth of this offshoot of medullary substance. The cartilage cells are not, however (as has been generally supposed), simply displaced by the growing cells of the medulla, but they themselves undergo proliferation, and become converted into masses of nucleated protoplasm, which ultimately become medullary cells. A certain number of the latter are accordingly lineal descendants of the original cartilage cells. This parentage involves the transformation (or retransformation) of the substance of the cartilage cell into the protoplasmatic substance of the medullary or lymphoid cells, which, if expressed in Beale's terminology, is a metamorphosis of "formed matter" back again into unformed or "germinal matter." No ground was seen for supposing an endogenous or independent formation of blood-cells in the medulla.

Glands of the Stomach.—Two important memoirs have appeared on this subject; one by Heidenhain on the peptic glands; another by Ebstein on the so-called mucous glands of the stomach (Schultze's 'Archiv,' vi, p. 368, and *ibid.*, p. 515, 1870). In both sets of researches the stomachs of dogs were used, and specimens were taken at different times from animals both fasting and during digestion. The stomach was hardened in alcohol, and the sections tinted with carmine or aniline blue, the latter reagent being very useful in tinting different structures unequally. The peptic glands are either single or—frequently in the dog, more rarely in man—compound; but in most respects these varieties agree. According to Heidenhain, three parts may be distinguished in each—the orifice which is lined with cylindrical epithelium like that of the mucous surface; the contracted neck of the follicle; and the dilated body of the gland or follicle itself. In the compound glands the arrangement may be compared to the hand and fingers of a glove. In the follicles themselves, which are usually spoken of as containing the peptic cells, two forms of cells may be traced—the prominent, large, external-cells, which H. calls "*investing*" cells (Belegzellen), apparently the "peptic cells" of authors; and certain smaller, pale, and less conspicuous cells, situated internally, apparently unnoticed before, which he believes to be the true agents in secreting pepsin, and therefore calls the "*capital*" cells (Hauptzellen). These two varieties differ in their behaviour with reagents, but especially so when examined during

digestion. In this condition the *capital* cells were found to be swollen and more granular than in preparations taken from a fasting animal, and to be coloured in a very striking manner by aniline blue. The investing cells are comparatively little altered, but the cavity of the gland becomes fitted with yellowish or brown granular matter. Nothing was seen which proved that the cells divide or multiply during digestion.

The memoir of Ebstein is an interesting supplement to that of Heidenhain. He has studied the glands found especially at the pyloric end of the stomach, discovered by Wasmann, and called "gastric mucous glands," which have been thought to secrete only acid or mucus, and to have nothing to do with the production of pepsin. They occur in groups at the bottom of the "mucous crypts" of this part of the stomach, and in their general form resemble the peptic glands. The follicles themselves are lined by a cylindrical epithelium; the cells of which are, however, smaller, more granular, and in other respects different from the epithelium of the mucous surface. These cells have, moreover, a striking resemblance to the "*capital*" cells of Heidenhain, from the peptic-glands, both in form and in chemical properties. Furthermore, they are affected in the same manner in digestion; they become granular, and are coloured by aniline blue; points which are thought to show that they become more albuminous. They do not, however, enlarge, but become smaller, apparently because they give exit to a quantity of albuminous matter which fills the excretory part of the gland, and is remarkably tinted by the aniline blue. The conclusion indicated by these results, that these glands might equally with the "peptic" glands be concerned in the production of pepsin, was confirmed by actual experiment. Fluid obtained from these glands was found, when acidified, to have the same solvent action on fibrin and albumen as the secretion of the "peptic" glands. The inference would be that the power of producing pepsin resides in the structures common to both classes of glands, namely, in those cells which are called "*capital*" cells in the peptic glands, and form the normal epithelial lining in the mucous glands. The function of the "investing" cells or peptic cells of authors become obscure.

Liver.—Dr. Lionel Beale, in his 'Archives of Medicine' (No. 17, vol. v, p. 71), takes up again the question of the "minute anatomy of the liver," especially as to the relation of the liver-cells to the minute bile ducts. The result of numerous researches and experiments made since the publication of his former paper in 1856 has not led him in any degree

to modify his views, but have rather confirmed and extended them. Dr. Beale remarks upon the improbability of the structure of the mammalian liver being so entirely different from that of invertebrata or reptiles, as the views of Hering would imply.

The figures given represent sections from a human liver somewhat altered by disease (*i.e.* in a state of venous congestion from obstructive disease of the heart). The bile ducts were injected with Prussian blue solution, and the result was, in Beale's opinion, to inject fully and normally the "cell-containing network" of bile capillaries. A tubular network is seen containing the blue injection, and also liver cells, scattered and displaced, lying within the tubes. Some figures show this injected network to be continuous with the interlobular bile ducts. The appearances are, on the whole, the same as those shown in former figures published by the author (as in the 'Philosophical Transactions,' for 1856), but are clearer and more complete.

Dr. Beale admits that no compromise as regards the question is possible; that if the view now generally entertained in Germany be true, his conclusions are false; but he contends that while his opponents cannot account for the facts demonstrated by him, he can explain their (*i.e.* Hering's) results by the inadequacy of their injection, which, by being introduced under very slight pressure, had only made its way into the narrow spaces between the cells and in the intervals between these and the walls of the tube; having, in fact, taken the course pursued by the bile during life. The appearances thus produced are seen here and there in all injected livers, but more uniformly in the liver of the rabbit than in most vertebrated animals. What Hering calls gall-capillaries are then simply spaces between the cells.

We may remark that as several histologists in England have now had the opportunity of examining Hering's preparations, there ought to be no difficulty in seeing precisely where the point in dispute lies; but Dr. Beale's figures are not minute or precise enough to give any information as to the special points on which Hering relies, namely, the position of individual cells in relation to one another.

Nervous System. *Brain.*—The most important and original article in the last part of Stricker's 'Manual of Histology,' and perhaps in the whole work, is Meynert's essay on the brain. It is illustrated with thirty-two figures (mostly original, a few from Lockhart Clarke), which are marvels of beauty and clearness in wood engraving. A considerable part of the paper is occupied with a topographical account of the dis-

tribution of nerve-fibres and ganglionic masses in the brain, which is very necessary, if not strictly histological. With respect to the structure of the grey or cortical substance of the brain, we note that Meynert recognises as the general type of cortical structure of the cerebral hemispheres, five layers—1, the external stratum of small scattered cortical corpuscles or nerve-cells (with predominating basis substance or connective-tissue); 2, stratum of closely-set small pyramidal cortical corpuscles; 3, stratum of large pyramidal cortical corpuscles; 4, stratum of closely-set, small, irregular cortical corpuscles (granular layer); 5, stratum of spindle-shaped cortical corpuscles. Besides this predominant type, there are other plans of structure which prevail in particular parts of the brain. Thus, he describes as the second type of structure that which is met with in the occipital convolutions, and especially in the sulcus of the hippocampus minor; in which the fourth or granular layer predominates and becomes very complex, so that there are in all eight strata. (This part of the brain was taken by Lockhart Clarke as the starting point of his researches, but by a difference of arrangement he makes six instead of eight strata). A third type is represented by the structure of the convolutions of the sylvian fissure, where the spindle-shaped corpuscles are more especially developed, or the fifth stratum predominates. A fourth type is seen in the temporal portion of the *gyrus fornicatus* and in the *subiculum cornu ammonis*; and is characterised by the great predominance of the pyramidal cortical corpuscles or third stratum of the typical cortical structure and deficiency of the other strata. Finally, a fifth type of structure is displayed in the olfactory bulb, which, when compared (as it must be morphologically) to the cerebrum itself, shows, beside an external layer of structures connected with the olfactory nerves, a layer of pyramidal nerve-cells corresponding to the second and third strata of the cerebral cortex (the stratum gelatinosum of Lockhart Clarke), and within this a stratum of irregular cells corresponding to the fourth or granular layer of the cerebrum, or to the granular layers of the retina. The interesting and complicated details of the arrangement of nerve-fibres in the brain must be read in the original, which will, we hope, soon appear in English. A very full list of literary references is appended.

Terminations of Nerves in the Tongue.—In the last part of ‘Stricker’s Histology’ an excellent account is given by Engelmann of the structures discovered by Lovén and Schwalbe in the tongue of mammalia, which appear to be the true organ of taste. The account of these organs in the rabbit, given by H. v. Wyss, formerly referred to in this Journal, agrees

precisely with the observations of Engelmann, for which the latter claims an independent position. There is also an account of the better known structures in the tongue of the frog, which have been traced into direct continuity with nerve-fibres, as is not yet the case with those of mammalia.

Terminations of Nerves in Glands.—We have more than once noticed the investigations of observers who have endeavoured to repeat, for themselves, the observation of Pflüger on the terminations of nerve-fibres in the cells of salivary glands and other glandular organs, and who have, in most cases, failed entirely to confirm his results. These negative results have, of course, been announced and received with that amount of hesitation which is unavoidable in rejecting the conclusions of so trustworthy and experienced an observer as Pflüger; and the more because it has not been certain that other observers have used precisely the same process as he did. Great interest, therefore, attaches to a paper recently published by Pflüger himself, in his own 'Archiv,' 1871, 1tes Heft, p. 50, in which he gives a summary reply to his critics, and at length, what is more important, describes the methods by which his results were obtained. Against his assertion that medullated nerve-fibres can be traced to end directly in the salivary glandular epithelium, the following objections have been made; which, with his replies, we give as literally as possible.

First objection.—The fibres figured by Pflüger are said to be capillary vessels; but (*a*) the fibres are stained bluish-black or coal-black by the application of osmic acid, while capillary vessels are quite uncoloured; (*b*) the threads figured, sometimes have a degree of fineness never seen in capillary vessels; (*c*) these fibres are directly continuous with the glandular epithelium, and not merely applied to its surface, as must be the case with capillary vessels; (*d*) these fibres often lie packed together in bundles, and surrounded by a sheath (neurilemma), which is not the case with capillary vessels; (*e*) the minute structure of these fibres differs from that of capillary vessels, precisely as a medullated nerve-fibre differs from a capillary vessel.

Second objection.—The fibres in question are said to be mucous threads; but (*a*) threads of mucus do not blacken with osmic acid as nerve-fibres do; (*b*) threads of mucus cannot occur where there is no mucous substance; and these fibres have been seen in the submaxillary gland of the rabbit, which Heidenhain has shown not to be a mucous gland; (*c*) were these fibres mucous threads, they could have no detached sheath enclosing them; (*d*) if they were mucous threads, they

could not be arranged, side by side, in bundles within a common sheath (or neurilemma), but must fuse together.

Third objection.—The fibres in question are said to be disintegrated fat; but to this, similar replies may be made; (*a*) the fibres are seen running in the nerve stems, enclosed in a common neurilemma, and giving off twigs to the glandular epithelial cells one after another; (*b*) single fibres are observed with a detached sheath, which could not be the case with disintegrated fatty masses; (*c*) these fibres are, by means of their axis cylinder, directly continuous with the substance of the epithelial cells.

If, then, there are fine fibres, stained with black by osmic acid, which are enclosed in bundles in one common sheath, then ramify and become continuous with the substance of epithelial cells, the only doubt which can remain is as to the reality of this asserted continuity; a point which Pflüger admits to demand the most minute scrutiny of the preparations in question.

The methods of investigation were as follows:—

Salivary glands.—It must be remembered that osmic acid makes its way into the deeper parts of a tissue with difficulty, and that it renders the nerve-fibres especially brittle, so that these should be isolated before, not after the application of the osmic acid. A fresh submaxillary gland from the ox must be taken, and very fine sections made from it with a razor. These must be teased out in a solution of osmic acid of sp. gr. 1.003, and covered with a thin glass supported on a small drop of wax to avoid pressure on the specimen. A great many such preparations should be made and preserved in a moist chamber. The water as it evaporates may be replaced by glycerine. They may be examined after twenty-four hours, when the fibres will be dyed black while the cells are pale. For the *liver* that of a dog or pig is best, and should be quite fresh. A large number of very fine sections should be made and placed, ten or twelve together, in watch glasses, filled with Beale's carmine solution, and carefully protected from dust, evaporation, or mechanical injury.

After fourteen days the sections are ready for examination, and remain so for some weeks. They are removed on the point of a preparing needle, and washed on a slide in a drop of osmic acid solution to remove the carmine; then placed in a fresh drop of osmic acid on a clean slide, when they may be very carefully teased out with needles. The sections are then to be examined with a low power of 150 to 200 diameters, till a point is seen where the nerve-fibres appear to be continuous with epithelium, and this spot more closely

inspected with a higher power. By giving a slight motion to the cover-glass, or producing currents in the fluid, the reality of the connection may be demonstrated.—(Communicated by Mr. Moseley.)

The Wing of Bats.—In Max Schultze's 'Archiv,' Band 7, 1tes Heft, is a most exhaustive and interesting paper on the structure of the bat's wing, by Dr. Jos. Schöbl, of Prague. Long ago Spallanzani discovered that bats which had had their eyes put out were able, nevertheless, when allowed to fly about in a room, to avoid threads stretched across it. This faculty he attributed to some highly developed sense of touch possessed by the wing. Dr. Schöbl has repeated these experiments; but for the putting out of the eyes he has substituted the less painful method of covering them with sticking plaster. He has kept bats thus treated for a year alive in his room, and has entirely confirmed Spallanzani's results. To account for these phenomena, the wings of bats have been examined for peculiar nerve-endings by Cuvier, Leydig, and Krause, but without any success. The author's discoveries are therefore quite new to science. The following is a short abstract of his results. The bat's wing membrane consists of two sheets of skin, the upper derived from that of the back, the lower from that of the belly. The epidermic and Malpighian layers in each sheet remain separate, whilst the true skins are inseparably fused. In this fused median layer are imbedded the muscles, nerves, vessels, &c., of the wing. A complicated arrangement of delicate muscles is described, which have their tendons formed of elastic tissue instead of the usual white fibrous tissue. There are also present numerous long elastic bundles stretched in different directions in different regions of the wing. The arteries are each accompanied by a single vein and a nerve, the three keeping company as far as the commencement of the capillary system. With regard to the pulsation in the wing, Dr. Schöbl has nothing new to add to the observations of Wharton Jones and Leydig. The whole wing is covered, both on the upper and under surface, with extremely fine, sparsely scattered hairs. These hairs are most numerous on the inner third of the hinder part of the wing, and they gradually decrease in number towards the tip. The two wings taken together contain from 8000 to 10,000 of them. They have a general resemblance to those on the body, but are simpler in form. Their length is about 0·2500 mm. in *Vesperugo serotinus*, the species principally made use of in these investigations. Each hair sac has from two to seven sebaceous glands, according to the species; and one sweat

gland opening into its sac. The two outer fibrous layers of the hair sac have no sharp line of demarcation to separate them from the surrounding connective tissue, but the inner or hyaline coat is highly developed, and, after being constructed beneath the hair bulb, widens out and encloses the Tastkörperchen (touch-corpuscles), one of which organs is connected with each hair.

The nerves of the wing may be considered to consist of five layers, *i.e.* there is one occupying the centre of a transverse section of the wing, which gives off on each side of it four others, and these are successively finer and finer as they approach the opposite surfaces. The inner layer and the one immediately on each side of it consist of nerve fibres with dark borders, the other layers of pale fibres only. The Tastkörperchen are connected with the second layer. The fifth layer of finest fibres ends as a network between the innermost layer of cells of the Malpighian layer of the epidermis. The Tastkörperchen are shaped like a fir-cone, with a rounded apex turned inwards. They lie immediately below the root of the hair; and their core or central substance is formed of a prolongation of the cells forming the two root-sheaths of the hair. Their length is 0.0259, their breadth 0.0175 mm. A nerve containing about six dark-edged fibres is distributed to each Körperchen. Just before the nerve reaches this organ, it splits into two, and three fibres pass to one side of it, three to the other. The fibres are then wound round the body so as to sheath its cellular core. Dr. Schöbl thinks it probable that the fibres on one side are continuous with those on the opposite side, and that there is thus a bipolar arrangement here. He attributes to the fine network of pale nerve-fibres belonging to the fifth layer the appreciation of temperature, pain, &c.; to the Tastkörperchen the highly exalted sense of touch. It is curious that both kinds of nerve endings are connected with the Malpighian layer of the skin. In conclusion, the author states that he believes he has found similar bodies in peculiarly sensitive places in other mammals, and promises an early account of them.—*Academy.*

PROCEEDINGS OF SOCIETIES.

DUBLIN MICROSCOPICAL CLUB.

20th October, 1870.

REV. EUGENE O'MEARA exhibited *Trinacria regina* from Arran, a form hitherto found only in Jutland. This interesting addition to the Diatomaceous Flora of Ireland is in itself an extremely pretty object.

Dr. Moore exhibited sections, made by Mr. Keit, of *Loranthus Europæus*.

Mr. Archer presented living examples and drawings of the new rhizopod, a description of which appears in the present number of this Journal, and named *Amphizonella vestita* (Pl. VI, figs. 1—6). He showed Prof. Greeff's figures of the type-form, *A. violacea*, contrasted and compared the present in its generic relations, and endeavoured to explain the points illustrated in the sketches, into which it is, of course, here unnecessary to enter.

Mr. Archer likewise exhibited drawings of two rhizopods referred by him to the genus *Plagiophrys* (Clap. et Lachm.), and showed some preparations under re-agents in illustration of certain specialities evinced by each; these are, however, detailed in a paper in the present number of this Journal (see Pl. VII), and do not, therefore, require to be expatiated on here.

Mr. Archer showed for the first time to the Club undoubted living examples of the rhizopod *Acanthocystis spinifera* (Greeff), presenting the presumable "central capsule," the yellow globules, &c., in fact all the characteristics depicted by Greeff, and forming extremely pretty objects. In a paper published in this Journal ('Quart. Journ. Micr. Sci.,' vol. ix, n. s., pp. 250, 386, and vol. x, n. s., pp. 17 and 101), Mr. Archer had mentioned that previous research had not hitherto disclosed the existence of this form in this country, and to a certain extent he had based some arguments on that fact, which, of course, so far as that bears, now fell away. The present examples showed not only the ordinary characteristics, but several cases of "zygosis," with a large opaque pearly-looking body in both "conjugated," and single specimens. These various points, with others, are likewise alluded to in a paper in the present number of this Journal, thus precluding the requirement of any more enlarged reference thereto in this place.

Mr. Archer desired to record having seen the direct evolution and swimming away of the "monads" from the summits of the branches of the rather common organism which he had for some time known and thought of as the *Aporea ambigua*, Bailey. For some idea of this somewhat tree-like structure (believed to be

the original Aporea of Bailey, "Micros. Obs. in S. Carolina, &c." in 'Smithsonian Contrib.,' 1st Dec., 1850), see 'Quart. Journ. of Micr. Science,' vol. vi, n. s., p. 183, Dec., 1865. The monads are globose, whitish, their substance granular in appearance, without eye-speck, seemingly unciliated. The long, flagellate, exceedingly delicate cilia, to be seen sometimes at the ends of the branches of this organism, had some time ago been detected by Dr. Barker and pointed out by him. Occasionally since then, opportunities to notice these cilia had presented themselves, but Mr. Archer could never before perceive the monads individually; in the present examples they crowned the summit of every branch of this compressed, brownish, striped, granular-looking tree-like production, just like great clusters of some whitish *fruit*, thus presenting a remarkable and rather conspicuous appearance. There could be but little doubt that this production must be most probably very closely related to, if not congeneric with, certain organisms recorded on a previous occasion by Mr. Archer ('Quart. Journ. Micr. Sci.,' vol. viii, n. s., p. 119), one of which, at least, he thought must be equivalent to *Monas consociata* (Fresenius, "Beiträge zur Kenntniss mikroskopischer Organismen," in 'Abhandlungen der Senckenbergischen Gesellschaft,' Bd. 2, p. 237). If he were not wrong, this would prove another of the same type, yet still more distinct from the three previously adverted to by Mr. Archer than they from each other, *inter se*. This form in question is common; in fact, gatherings from all parts of the country had shown it; yet the presence of the "monads" seems to be rare, or, at least, rarely seen, though, doubtless, every branch of the structure, at some epoch or other, must produce its "monads." The form named *Monas consociata* by Fresenius (loc. cit.), which is most likely equivalent to one, or perhaps to both, of the two first referred to by Mr. Archer (loc. cit.), if, indeed, the whole three be not states of one another, had been lately referred to a new genus by Professor Cienkowski, and named *Phalansterium* (Cienkowski, "Ueber Palmellaceen und einige Flagellaten," in Schultze's 'Archiv für mikroskopische Anatomie,' Bd. vi, p. 428), of which genus *Monas consociata* (Fresenius) makes one species (*Phalansterium consociatum*, Cnk.), and a new form occurring as comparatively long, brownish, slender, filamentary aggregations makes a second (*Ph. intestinum*, Cnk.). Professor Cienkowski's figure of the former (t. xxiv, f. 29, loc. cit.) appears rather formal and rigid; it is possibly the same as the second form referred to by Mr. Archer (loc. cit.), but there is not any reference to the irregularly divaricating and more or less radiate branching of the granular gelatinous matrix (Gallerthaufe, Cienk.) forming the "monads" habitations (Wohnstätte, Cienk.), characteristic of the first form previously referred to by Mr. Archer. There is, however, much probability that the latter may be only a more fully grown condition of the second. Cienkowski, however, speaks of a brown colour and an irregular contour often eventually assumed by his form, thus approaching the third form referred to by Mr. Archer

(loc. cit.). *Ph. intestinum* (Cienk.) had not yet been detected in this country. If the organism here referred to as *Aporea ambigua* should really turn out to represent another species in the same genus as Cienkowsky's, it would almost appear in that case as if that genus should be designated *Aporea* in place of *Phalansterium*, the former having the priority, notwithstanding Bailey's name being contrived, owing to his absolute want of knowledge of its nature, with a view to imply utter vagueness.

Dr. E. Perceval Wright exhibited some preparations of several new sponges from the Seychelles, drawings of which had been made for him by Mr. Lens Aldous. One of these, referable to a new genus, perhaps near *Stelletta*, was remarkable in having developed from it a number of flat spoon-shaped appendages, some of which ended in oscula, while others seemed to act as protective shields to these. Nearly all the sponges indicated had been examined in a living state, and had been collected from the sides of the coral reef surrounding Mahè.

Mr. W. H. Furlonge, from London, exhibited a series, new to the Club, of the objectives made by Gundlach of Berlin. Several of these were of high power and all of excellent performance, and are sold at comparatively very moderate prices. These new powers were brought to bear upon several of the diatoms in Möller's "type slide" of 400 specimens, also kindly exhibited by Mr. Furlonge.

17th November, 1870.

Dr. John Barker exhibited a very pretty rotatorian referable to the genus *Philodina*, and he thought truly *Philodina aculeata*. This differed, however, in the spine-like processes not forming two marginal rows, but rather a dorsal group, and these curved or hooked; the eye was cervical and placed rather far down, and the trochal discs double, forming a striking appearance when in action; the lateral proboscis furnished with three pencils of minute rigid cilia.

Dr. Moore showed a fungus which had made its appearance on a plant of a species of *Catasetum*, imported from South America. It began with a slight discoloration of spots on the leaves, which gradually grew darker and softer until the spot became covered with watery fluid. At this state the mycelium could be seen penetrating the soft mass and issuing through the stomates on the leaf. The watery fluid dried up, but the diseased spot rapidly extended until it destroyed the leaf altogether. The stem of the plant afterwards became affected, and was partially destroyed in a similar way as the leaves had been. It was considered that this destructive fungus had been imported with the plant it affected. It has not yet been identified with certainty, but Dr. Moore thought it might be a form of a parasitical fungus described and figured by the Rev. Mr. Berkley in first number of London 'Horticultural Society's Journal.'

Rev. E. O'Meara exhibited a new *Mastogloia* from the Seychelles material, of which, under the name of *Mastogloia binornata*, he would presently prepare a description.

Mr. Archer had to offer to examination of the Club one more of such nondescript objects as he had occasionally brought forward—almost, he was sorry to say, meaningless in their obscurity—yet, perhaps, interesting to a certain extent from their very uncertainty. There was the more excuse for exhibiting the present production as it formed rather a pretty little object. From the colour and general appearance of the contents it might be conjectured that the present was a “resting” state of some *Peridinium*; but if so, and of which, was a puzzle. This formed an angular body, of a cubical, pentagonal, or hexagonal figure (or shaped like a “concertina case”), each outer angle produced into a thickened, more or less numerous knobbed, pellucid projection; a similar projection occurred some half-way down each corner, and a single long, smooth, hooked, bluntly pointed, hyaline, *nose-like* projection from the middle of *one only* of the plane surfaces; the entire wall very thick and colourless, the contents coarsely granular, of a kind of olivaceous green, and carrying immersed in the centre a large brilliant red globule or clusters of bright, very red granules; these always conspicuous through the dense remainder of the contents. The general appearance of the contents and the thick wall thus much resembled the undoubted resting-stages of some forms of *Peridinium*, but the singular external figure rendered the present a much more remarkable object; this curious outline could be best seen in an empty cell-wall, examples of which were now and again found in the gatherings. With such a crude and bald account of this odd-looking object, Mr. Archer would be obliged to content himself; may it turn up again some time hereafter and reveal more tangible *data*.

Mr. Archer had brought down for exhibition, but time did not admit of their being presented, examples of the desmid *Pleurotænium cosmarioides* (de Bary, ‘*Untersuchungen über die Familie der Conjugaten*,’ t. v, f. 32, 33) = *Cosmarium De Baryi*, Pritchard’s ‘*Infusoria*.’ This species Mr. Archer had only once before met with, and on that occasion he had omitted to exhibit or record it. The present example showed a beautifully dotted appearance of the cell-wall, readily seen on the rim-like outline (adding to the pretty appearance of the form), which is not shown in de Bary’s figure; but as he refers in the text to the occasional occurrence of this character, there could hardly be any further doubt as to the identity of the present with de Bary’s form. Touching the value of the characters derivable from the arrangement of the endochrome in a generic or a specific point of view, as Mr. Archer had ere now expatiated thereon, there would be no further occasion to enlarge upon the question here (‘*Quart. Journ. Micr. Science*,’ vol. ix, n. s., pp. 194, 5); of one thing, however, there was no doubt—there could be no more constant character in these forms than the mode of arrangement of the endochrome, that is

to say, whether in parietal bands or radiating central masses, and the only question, indeed, was whether such could be rightly regarded as characteristic of groups or as more special to individual forms, that is (more broadly) of generic value, or (more restrictedly) of simply specific importance.

Mr. Archer showed a new form referable to the genus *Oocystis* (Al. Braun.). This was minute, elliptic, and presented the peculiarity of being clothed with a number of elongate, very slender and delicate hair-like processes, quite as long as the longest diameter of the cells. It would require a figure, however, to convey a due conception of objects of such minute size, and further to dilate upon the present form here might not prove of much use.

8th December, 1870.

Dr. John Barker showed a Saprolegnian obtained from *Amblyopsis spelæus*, showing sporangia and zoospores; no oogonia were evinced, hence the species not determinable; the plant was most likely *Achlya prolifera*, obtained, however, from probably a new host.

Mr. Archer exhibited some fine active living examples of *Vasicola ciliata* (Tatem) and *Anthophysa Mülleri* (Cohn), perhaps to some extent of interest, taken in thus almost midwinter.

The following communication was made to the Club:—

On an Achromatic Combination for use with Blue Light.

By G. JOHNSTONE STONEY, M.A., F.R.S., &c.

In achromatic combinations of flint and crown glass only two points of the spectrum can be accurately brought to focus together. With lenses as usually achromatised the green rays are those brought to focus nearest to the lens, then the red and blue a little farther out, and, lastly, at a considerable interval, the violet. Such a lens will give for the image of a white point a small patch of light consisting of red, yellow, green, and blue, surrounded by a haze of indigo and violet, which, from being faint, does little harm when the lens is used in the ordinary way.

But if we wish to see the most minute objects with the microscope, there would appear to be an advantage, as was pointed out to the Club in a communication made on the 21st of March, 1867,¹ in using only the blue and violet rays; and in this case an achromatic lens of the ordinary construction will plainly not produce the best effect. Better definition would be obtained by using a lens which is what the opticians call under-corrected, so adjusted that the indigo rays shall be those first brought to focus. Such a lens will unite the indigo, blue, and violet rays emitted by a point of the object, into a very small patch. With white light this would be surrounded by a haze of the red, yellow, and yellowish-green rays; and these, being the brightest rays of the spectrum, would blur the image and destroy all accurate definition.

¹ See 'Microscopical Journal,' vol. vii, n. s., p. 234.

But the case would be very different if these rays were excluded; as, for example, by employing direct sunshine or other intense source of light, and interposing a sufficient screen of the ammonio-sulphate of copper. Under these circumstances, a lens of the proposed kind may be expected to perform in a very marked degree better than one of the usual construction. But to exhibit its advantage, it is essential that all rays of lower refrangibility be stopped. This can be easily effected by ammonio-sulphate of copper, but is not effected by the cobalt-blue glasses which are commonly used. These shades, when dark, have the double disadvantage both of weakening the blue light in a considerable degree and of allowing the extreme red to pass abundantly.

With object-lenses which have a flint-glass lens between the convex of crown glass and the image, the requisite adjustment might be attained by separating these lenses; and in all cases it would appear to be possible to effect it very simply by interposing a shallow plano-convex of crown glass between the object-glass and the image, taking care to turn the convex side towards the object-glass, so as not to increase the spherical aberration. By shifting this lens backwards and forwards it would be easy to determine the position in which it will give the best definition with blue light.

Rev. E. O'Meara exhibited a slide containing several diatomaceous forms from mud furnished by Professor Sullivan. The locality in which the material was gathered was not described more particularly than that it was on the coast of the Co. Clare. The forms contained, however, indicated that it was near the shore in the vicinity of a stream or river which proceeded from neighbouring hills.

The following is a list of the forms:—

Actinoptychus senarius.	Pinnularia distans.
" triradiatus.	" major.
Achnanthes brevipes.	" mesolepta.
Cocconeis scutellum.	" peregrina.
" " var. β .	" divaricata.
Coscinodiscus cervinus.	Pleurosigma balticum.
" excentricus.	" fasciola.
Diatoma grande.	" formosum.
Grammatophora marina.	" quadratum.
" serpentina.	" Wansbeckii.
" macilenta.	Podosira Montagnei.
Melosira Westii.	" maculata.
Navicula clathensis.	" hormoides.
" punctulata.	Raphoneis rhombus, <i>Ehren.</i>
" pygmæa.	" amphiceros, <i>Ehren.</i>
" solaris.	Stauroneis salina.
" elegans.	Schizonema cruciger.
Nitzschia sigma.	Synedra affinis.
" panduriformis.	" pulchella.
Orthosira marina.	Scoliopleura convexa.
" angulata.	" Jenneri.
" physoplæa =	" Smithii.
Discoplæa physoplæa? <i>Ehren.</i>	Tryblionella punctata.
	" acuminata.

Dr. Moore showed *Lichmophora flabellata* gathered at Malahide, a new locality for this form.

Mr. Archer exhibited a new and minute algal form, referable to the genus *Merismopædia*. This was a singularly neat little object in the exquisite elegance of its even files of rather elongate reddish cells, with a bluish margin, held together into little parallelograms (like little *windows* with bluish *sashes* and very minute reddish coloured *panes*), and requiring a rather high power to view them. The peculiar colour of the component cells, and the comparatively sharply angular tablets formed by them rendered this little alga a very distinct looking thing from ordinary forms of *Merismopædia*; Mr. Archer hoped for a possible future occasion to refer to this little production more at large.

Mr. Archer brought down a preparation under Beale's carmine fluid, of specimens of *Acanthocystis Pertyana* (ejus), and at the same time he exhibited a drawing of *Acanthocystis spinifera* (Greeff), treated in the same way, both showing the central highly dyed body, the presumed "*vesicula intima*," and the presumed "central capsule." The appearances presented, and the deductions therefrom which seemed to him legitimate to draw, are adverted to in a paper in current number of this Journal, and hence any further reference here would be but superfluous.

MEMOIRS.

On the COLOUR of LEAVES at DIFFERENT SEASONS of the YEAR. By H. C. SORBY, F.R.S., &c.

THE number of distinct vegetable colouring matters is so great, and there are so many plants which merit careful examination, that any general conclusions I might now form would probably be considerably modified by further inquiry. This makes me hesitate in giving a decided opinion on many questions connected with my subject; but, at the same time, I feel that it is better to run the risk of making some errors than to describe the facts without uniting them by such an amount of theory as may serve to lead to intelligible general principles. I shall, therefore, endeavour to draw such conclusions as the present state of the subject admits, and beg my readers to place no more value on them than I do myself, and to look upon them as provisional, to be modified as our knowledge increases.

It would make this communication far too long if I were to explain in detail how all the various different coloured substances may be identified or distinguished by their spectra, previous to, or after, the addition of suitable reagents, and must therefore refer to my papers already published,¹ confining myself now chiefly to what is new or requisite in connexion with the subject before me; but, at the same time, must mention numerous well-known facts, which may not have been looked upon from my particular point of view.

As I have explained in some of my published papers, it is

¹ 1. "On a Definite Method of Qualitative Analysis of Animal and Vegetable Colouring Matters by means of the Spectrum Microscope." ('Royal Soc. Proceed.,' xv, 1867, pp. 433—455; 'Phil. Mag.' (4th ser.), xxxiv, 1867, pp. 144—166.)

2. "On the Colouring Matters of Blue Decayed Wood." ('Quart. Journ. of Micros. Science,' IX, 1869, pp. 43, 44.)

3. "On some Technical Applications of the Spectrum Microscope." (Ib., pp. 358—383.)

4. "On the Colouring Matters derived from the Decomposition of Minute Organisms." ('Monthly Micros. Journ.,' iii, 1870, pp. 229—231.)

5. "On the Various Tints of Autumnal Foliage." ('Quart. Journ. of Science,' XXIX, 1871, pp. 64—77.)

very convenient to divide animal and vegetable colouring matters into three groups, distinguished by the manner in which they behave when their solutions in water are treated with sulphite of soda. Thus—

Group A.—Absorption removed when the solution is alkaline with ammonia. For example, changed from deep blue to pale yellow.

Group B.—Absorption not removed when the solution is alkaline with ammonia, but removed when it is acid with citric acid. Thus, for instance, altered from deep pink to nearly colourless.

Group C.—Absorption not removed even when the solution is acid with citric acid. No alteration in the colour.

It is also sometimes most useful to arrange different colours into other groups, distinguished by optical and physical peculiarities. This is particularly the case in the present inquiry, since it enables us to group together a considerable number in such a manner as to make the subject far more simple and intelligible. The individual species of these groups, distinguished by the number or position of the absorption-bands in their spectra, are changed in an analogous manner, when acted on by reagents, so that the general relation between the rays of light absorbed by the various modifications or new products is the same as that between those absorbed by the separate substances in their unaltered state. This sort of connection between the chemical and optical changes is of very great use in such inquiries as the present, since, when we know the character of the optical change, we may often form a tolerably satisfactory opinion on the nature of the chemical. This may perhaps appear hazardous, but is really only an extension of a principle constantly employed by chemists. Most vegetable blue colours belong to groups in which the broad absorption is raised by acids from the red towards the blue end of the spectrum, and lowered by alkalis. On adding any solution to a blue vegetable colour, we therefore conclude that, if it be turned red, an acid, but, if green, an alkali, is present. Now, I find that in the case of very many kinds of colouring matters a slight amount of oxidization lowers the absorption towards the red end of the spectrum, quite as uniformly as it is raised towards the blue end by acids, and lowered by alkalis, in the case of those just named; and, therefore, when we find that such a change has occurred, it seems reasonable to infer that it has probably been due to this action of oxygen, if the circumstances of the case agree with such an explanation.

One of the chief difficulties in studying the colours met with in plants is that they are often mixtures of quite distinct colouring matters. Sometimes these may be easily separated, for one may be soluble, and the other insoluble, in such reagents, as water, alcohol, ether, or bisulphide of carbon. The fact of being soluble or insoluble is not, however, an invariable proof that the colours are essentially different, since the presence of some other colourless, insoluble substance, which has a strong affinity for the colour, may prevent solution. In many cases, however, there is a mixture of colouring matters so closely related that anything like a complete separation is perhaps impossible; but, even in such instances, we may be able, at all events, to effect a partial separation by agitating the alcoholic solution with bisulphide of carbon or the aqueous with ether. In this latter case, for example, both colours may be soluble in water and in ether, but the relative amount of one may be far greater in the solution of water in ether, which rises to the surface, than in the solution of ether in water, which sinks to the bottom. On evaporating these two different solutions, and examining the residue, it is often easy to recognise the presence of two different substances, mixed in various proportions; and, with proper care, their general properties may be sufficiently well ascertained. Nature also herself often assists us in this inquiry, for different plants, or the same in different states, may furnish particular colouring matters, comparatively pure, or so variably mixed that the character of the mixture may be recognised. So much, however, depends on the particular circumstances, that it would be difficult to give any rules applicable in all cases, and I will, therefore, describe what appears requisite when treating of special examples.

As already named, the number of different coloured substances met with in plants is very great—probably there are hundreds. I shall not attempt to describe individually even those found in leaves, but classify them into such groups as not only have intimate optical relations, but also are to a great extent connected in a similar manner with the development of the leaves.

1. The *chlorophyll* group is distinguished by being insoluble in water, but soluble in alcohol and in bisulphide of carbon. There are three or four species, giving well-marked spectra, with several narrow, dark absorption-bands, one or more of which occur at the red end. The mixed chlorophyll of ordinary green leaves may be obtained in a tolerably satisfactory state by heating in alcohol dark-green holly leaves, previously well crushed, so as to insure rapid solution, and

then, when cold, agitating in a test-tube with bisulphide of carbon. This sinks to the bottom, holding nearly the whole of the chlorophyll in solution, whilst nearly all the xanthophyll remains dissolved in the alcohol, along with all the various substances soluble in water. Leaves having an acid juice must not be used, for that would change the normal chlorophyll into another modification, which gives an entirely different spectrum; nor, in any case, should the solution be left long in contact with them, for then the separation of the chlorophyll and xanthophyll is comparatively very imperfect.

My reason for thinking that there is a mixture of two substances in the normal chlorophyll of leaves is, that when the spectrum of the light transmitted through them is compared with that of the light transmitted by certain species of *Oscillatoria*, it is seen to differ in having a very narrow absorption-band in the red, which is absent in the case of the *Oscillatoria*. The chief absorption-band is the same in both; and their relations may easily be explained by supposing that the chlorophyll of the *Oscillatoria* is a single substance, and that in most green leaves it is mixed with another, which gives a somewhat different spectrum, but has such very similar properties that they have not yet been separated. When dissolved in bisulphide of carbon there is an analogous difference in the spectra, but the above-named narrow absorption-band is not nearly so distinct as in the spectrum of the light transmitted by the well-illuminated leaves.

2. The *xanthophyll* group also contains several distinct species, but only two are common in leaves, one being more, and the other less, orange. These respectively may be obtained separate by heating in alcohol the orange exterior and the yellow interior of some carrots, and agitating with bisulphide of carbon, which removes much of them from the alcohol. They are insoluble in water, but soluble in alcohol or bisulphide of carbon; and, when dissolved in this latter, their spectra show two rather indistinct absorption-bands at the blue end, but the red, yellow, and yellow-green rays are freely transmitted. In preparing xanthophyll from yellow leaves, it is well to digest them for some time in considerably less alcohol than would dissolve the whole of it. This removes the greater part of the unchanged chlorophyll, and on digesting them in fresh alcohol, and agitating with bisulphide of carbon, or on evaporating to dryness and dissolving in it, a tolerably pure preparation may be obtained. By examining the colouring matter thus extracted from various leaves, I have been led to conclude that the most common

kind is similar to that found in the yellow interior of carrots, but sometimes mixed with more or less of the orange species, as may be proved, not only by the character of the spectrum, but also by the fact of our being able to partially separate them by the careful use of bisulphide of carbon and alcohol. I am much inclined to believe that the more orange kind may be formed naturally by the partial oxidization of the other, for it is sometimes only developed after the leaves have turned yellow, and then undergo further change; and the lowering of the absorption-bands towards the red end of the spectrum entirely agrees with this explanation, in accordance with the principles already described.

3. The *erythrophyll* group comprises a number of different colours soluble in water, in alcohol, and in ether, but not in bisulphide of carbon. Those met with in leaves are usually more or less purple, made bluer by alkalis and redder by acids, and thus very similar colours might make a plant with a very acid juice bright red, and another with a more neutral juice, dark purple; whilst, on the contrary, two quite different substances might give rise to exactly the same general tint. The erythrophyll may be obtained free from chlorophyll and xanthophyll by heating the reddest leaves in alcohol, evaporating to dryness, redissolving in water, filtering, and evaporating to dryness at a gentle heat; but it then contains more or less of the colours of the following group. It is, however, much better to digest the leaves for a few hours in so much cold ether as will dissolve all their contained water. If the plant be very succulent, and too little ether used, the water is displaced and sinks to the bottom, with nearly all the colour in solution, and the ether is left almost free from erythrophyll. On agitating the ethereal solution in a test-tube with water, it sinks to the bottom, with nearly all the erythrophyll, whilst the chlorophyll and xanthophyll are left in the ether, along with a considerable part of the colours of the chrysotannin group. This ethereal solution should then be removed, as far as possible, by means of a suction pipette with an elastic top, and the rest by blotting paper, the aqueous solution evaporated to dryness at a gentle heat, redissolved in water, filtered, if turbid, and again evaporated to dryness. For this purpose the small saucers used by artists are very convenient, and the dry colour may be kept, sometimes for years, without any material change. It is, however, difficult, if not impossible, to effect a complete separation of the chrysotannin colours, and we must always be prepared to find the reactions of the various reagents modified by the presence of yellow colours belonging to

Group C. On this account the same kind of erythrophyll may, for example, be changed by ammonia in one case to blue and in another to green, and the only certain method to distinguish the different species is to observe the position of any well-marked, narrow, absorption-bands, or, in case none are developed by reagents, to observe the limit of the general broad absorption towards the red end of the spectrum, which is almost, or entirely, free from the effects of any such yellow colour. In all cases, when it is desirable to identify or distinguish colours in this manner, their spectra should be compared together *side by side*, and care used to have the solutions of *equal depth of colour*, and so far diluted that the absorption is dark, but not black, or else it is impossible to know that they are equally dark. For this purpose the most useful spectra are those of the alcoholic solution treated with ammonia, of the aqueous solution treated with hydrochloric acid, or of the solution in sulphuric acid diluted with two or three times its volume of water, so as to avoid any charring effect. Sometimes this solution is so turbid that it must be filtered, but it gives an excellent spectrum, and also enables us readily to ascertain a very important fact connected with these colours. In my paper on some technical applications of the spectrum-microscope, I pointed out that, when the colouring matter of fresh grapes is slightly oxidized, the absorption is lowered towards the red end of the spectrum, and that it then corresponds with the colouring matter of new red wines. By following out this inquiry I have been led to conclude that certain substances exist naturally in such a state that they are merely decolorized by further oxidation, whereas others are first changed into another colour of the former kind. On adding by degrees a little hypochlorite of soda to a solution of the colouring matter in the diluted sulphuric acid, until it begins to turn paler, and then comparing side by side the spectrum of this with that of the unaltered, both carefully diluted with the sulphuric acid and water to such a degree that it is easy to see that the intensity of absorption is exactly the same in both, it will be found that, in the case of some kinds of erythrophyll, the general colour has been changed from orange-red to pink, and the absorption, instead of extending over the green, also extends over the yellow; whereas, in the case of other kinds of erythrophyll, it will be found that no such alteration has been produced. The extent to which the absorption is thus lowered is tolerably definite, and about equal to the distances between the solar lines b and E . It is important to note this, since, if we had an artificial mixture of the two different

modifications, the absorption would be lowered to a less extent, and such a fact, along with others, might be good evidence of the existence of such a mixture, produced by a partial natural change of one into the other. Since it is only within the last few weeks that I have learned the full value of this method, I have not yet been able to apply it in all cases, but some of the more important facts so far observed will be described below. In studying the different kinds of erythrophyll it is also very important to ascertain whether they belong to Group A, B, or C; since that alone may completely distinguish such as are otherwise very similar.

By these various means I have been able to establish the existence of a number of quite distinct species of erythrophyll, some of which have so far been found only in particular groups of plants. Thus, for example, the young fronds of several species of tropical ferns, cultivated in hothouses, contain a red colour, not yet found in any other plants, which belongs to Group A, and, when dissolved in water or in alcohol, and treated with ammonia, gives a well-marked absorption-band between the yellow and green. A red moss, which in early spring produces a fine effect on the scenery of some parts of the Yorkshire and Derbyshire moors, contains a very similar colour, belonging to Group A, but completely distinguished by the position of the absorption-band both of an alkaline and an acid solution. I have not met with this colour in any other plant. The leaves of some of the *Pelargonium* of our gardens contain the same red colour as that found in the flowers of some species, and in the purple leaves of turnips occurs the same substance as that in the petals of the purple stock and some other flowers. The purple stalks of *Heracleum sphondylium*, and probably of several other common *Umbelliferae*, contain a colour which is very similar to, but does not exactly correspond with, that of the leaves of *Tamus communis*, when they have turned very dark in autumn. These belong to Group B, and so does the colour of red cabbage, which also I have not yet found in any other plant. The red colour of the leaves of the beet belongs to Group C, and is the same as that found in the root. The bracts about the flowers of several plants contain the same colouring matters as those found in the petals, and they often give very well-marked spectra. Such cases, however, produce but a very limited effect on the general character of foliage, and by far the most abundant red colouring is due to two substances of Group B, not giving any narrow bands, but perfectly well distinguished from one another by the position of the broad absorption in the green

of their solutions in water treated with hydrochloric or sulphuric acid. The relation of these two colours to each other, and to the development of the leaves, will be described in the sequel.

4. The *chrysotannin* group. When I wrote my paper on the various tints of autumnal foliage, published in the 'Quarterly Journal of Science,' I hesitated to decide whether certain changes were due to the alteration of coloured substances, or to the development of new colouring matters from compounds previously almost colourless. I had observed facts indicating that probably the tannic acid contained in some leaves might have considerable influence in giving rise to the autumnal tints, but had not had time and opportunity for clearing up that question in a satisfactory manner. Since then I have paid much attention to this point, in order to ascertain what connexion there is between tannic acid and the substances described by me as the *chrysophyll* group. If we compared some of the yellow colours found in leaves with the tannic acid used by photographers, prepared from Chinese galls, we might be led to conclude that they could not be looked upon as members of one group of substances; but further inquiry has shown that there are at least six entirely different kinds of tannic acid, some almost colourless, and others so yellow that I had included them in the *chrysophyll* group. Not only is there this gradual passage from one to the other, but the character of the different changes produced by the action of various reagents shows that they are so intimately connected, that for the purposes of the present subject they must be classed together as one great group, the various members of which have more or less claim to be called tannic acid or *chrysophyll*. On the whole, then, it seems to me that it would be better to call it the *chrysotannin* group, and to confine the name *chrysophyll* to those members which do not strike a dark colour with persalts of iron. Those having this latter character may be considered to be more or less connected with the typical kinds of *tannic acid*. Some of these are very nearly, if not quite, colourless, whereas others are very decidedly yellow, even when their solution is acid, and still more so when it is alkaline. They are soluble in water, in alcohol, and in ether, but not in bisulphide of carbon. The spectra show a variable amount of absorption at the blue end, but usually no well-marked absorption-bands in their natural state. When oxidized and otherwise changed they, however, sometimes give bands in different situations, or they are distinguished by other characters. The intensity of their colour is usually much increased, and the absorption lowered

towards the red end by partial oxidization, and they are then changed into colours of the group described below.

The best way of preparing these chrysotannin colours is to digest leaves as free as possible from red colour, for a few days in enough cold ether to dissolve all the contained water, and proceed as described when treating of erythrophyll ; but it is also very desirable to evaporate to dryness the solution in ether, separated from the water after agitation, and dissolve what may be soluble in water, filter, and evaporate to dryness. We thus obtain two different preparations, both soluble in water, and on examining and comparing them, they may be found to differ very considerably, and we may thus be able to establish the existence of two or more colouring matters, which were dissolved to a variable extent in the water and in the ether. In each case the aqueous solution should be evaporated to dryness at as low a temperature as is convenient, and attention must be paid to any change in colour that may occur then, or subsequently when kept dry.

I have found the following methods extremely useful in studying mixtures of different colours of this group, more especially in ascertaining the relation between the chrysophyll and the tannic acid sub-groups. Taking two of the experiment cells, I add to each so much of the aqueous solution of the two different preparations under examination, as will, for example, give exactly the same depth of colour with a little bicarbonate of ammonia, which is employed in order that one may not be more acid than the other, and that there may thus be a perfect equality as far as the *colour* is concerned. I then add a small quantity of iron alum along with some double tartrate of potash and soda, to prevent the precipitation of ferric oxide, and observe the relative depth of the dark colour due to the presence of any tannic acid. Perhaps it may then be found that one is made four or five times as deep as the other, as proved by dilution with water, from which we may at once conclude that some yellow colour is present, independent of the tannic acid, for, if not, equal amounts would have been made equally dark. Two other equal tubes may then be taken, and carbonate of soda added to each. At first they may be almost equally changed by the stronger alkali, but when left exposed to the air for a day or more, under a bell-glass lined with wet paper to avoid evaporation, both may gradually change, from the top downwards, to a fine red ; but that preparation which had been found to contain four or five times as much tannic acid may become four or five times as deep a red. In such a case we may conclude that this red colour is due to the action of the air on the

alkaline solution of the *tannic acid*, and not to a change in the original *yellow* colour, since the intensity of the red varied as the amount of the tannic acid, and not as that of the yellow colour. On the contrary, when prepared in very different ways, or from leaves in very different states, if we find that all the reactions are equal when the original depth of the yellow is made equal, it is probable, if not certain, that the substance which gives the dark compound with the ferric salt, is itself of yellow colour. When any well-marked absorption-band occurs in the spectrum, such methods are much simplified, and I have found that by carefully carrying them out they yield such uniform and intelligible results as to inspire great confidence in the conclusions. Some cases no doubt present great difficulties, but by care and perseverance they may be generally tolerably well overcome.

By adopting such processes I have been able to prove that there are several different yellow colours not belonging to the tannic acid sub-group, some of which give spectra with tolerably well-defined absorption-bands when dissolved in alcohol, and oxidized by means of nitrite of potash and hydrochloric acid. They also differ in the extent to which they are changed by the addition of ammonia; but, in applying that test, they must always be dissolved in alcohol, since the presence of tannic acid might at once give rise to an abnormal depth of colour by oxidization, rapidly increasing by exposure to the air, if the colour were dissolved in water—a change which takes place far more slowly when alcohol is used. One of the most common kinds of chrysophyll is that which may be obtained from the yellow leaves of the elm, poplar, and many other trees, and one which gives the most characteristic spectrum, when oxidized, is that found in the yellow leaves of some plane trees. Much, however, remains to be learned, and the reactions are interfered with by the presence of tannic acids. The different kinds of this latter sub-group may often be distinguished by exposing to the air their aqueous solutions treated with carbonate of soda, or, in other cases, with a small piece of magnesium wire. Some also give very well-marked differences when their solutions in alcohol are treated with nitrite of potash and citric acid, and kept for a few hours. We thus get fine, well-marked, red, yellow, green, blue, or brown, according to the particular kind under examination; but, though some of them are of much interest in other respects, yet only three or four are of much importance in connexion with my present subject, and these will be described in the sequel.

5. The *phaiophyll* group comprises a number of more or

less brown colours, insoluble in bisulphide of carbon, and of very variable solubility in water or alcohol. The spectra show strong absorption at the blue end, extending over the green; often the red is very dull, and sometimes they show definite absorption-bands in the central part of the spectrum, when the solution is acid, neutral, or alkaline. On the whole, they are in that state of oxidization which has a maximum intensity of colour, and are simply decolourised by further oxidization. This, however, they resist strongly; and since, moreover, they are often very insoluble in water, leaves containing them retain their colour unchanged for a long time, even when lying on the damp ground.

It may be convenient to separate the dark colours produced by more complete decay from the group just described, and to designate them by the term *humus*; but, at the same time, it is difficult to point out any very decided physical distinction. We might, indeed, say that humus is a phaiophyll colour, but could not say that all phaiophyll colours are humus.

Having thus given a general account of the leading groups of coloured substances occurring in leaves, I will proceed to describe the manner in which they are related to one another, since the very numerous tints of foliage depend almost entirely on their relative and absolute amount. At the same time I must say that much more must be learned before we shall be able to explain all their relationships, and to understand why they are produced in some cases and not in others.

The colour of green leaves is mainly due to a mixture of chlorophyll and xanthophyll, and the variation in the relative and absolute amount of these completely accounts for the darker or brighter greens. The tints are also much modified by the presence of colours of the erythrophyll group, which, according to circumstances, may give rise to reds, or lighter or darker browns, approximating in tint to some of the colour of the phaiophyll group, but really due to a very different cause—to mixtures, and not to simple colours. Healthy unchanged leaves also contain various substances belonging to the chrysotannin group; but in many cases, when these belong to the more typical kinds of tannic acid, their colour is so faint that they have little or no influence on the general appearance of the leaves. The peculiar blue tinge seen on some mosses appears to be due to interference of light, and not to the presence of any blue colouring matter.

The relation of these groups to one another is still somewhat obscure. There are facts which seem to indicate that

chlorophyll may, in some cases, pass into xanthophyll by oxidization, and xanthophyll into chlorophyll by deoxidization; but neither point can be considered to be established. Chlorophyll, when dissolved, is oxidized with considerable difficulty. On adding a little bromine to its alcoholic solution, it is first changed into an orange-yellow colour, which gives a spectrum with a dark absorption-band in the green, and perhaps this compound is changed by more bromine into a yellow colour, cutting off the blue end of the spectrum, with no well-marked bands, and is made colourless by further change. These products have strong analogy with xanthophyll, but do not actually correspond with it. Perhaps this is scarcely likely, for it is at once decomposed and rendered colourless by such powerful oxidizing processes as can change chlorophyll. Still, as far as they go, they show that chlorophyll can be converted by oxidization into yellow colours, corresponding, in many particulars, with xanthophyll. Judging from what occurs in the leaves themselves, high vitality, and a strong light, are more essential for the production of chlorophyll than for that of xanthophyll, and hence not only do leaves become deeper green by continued exposure to light, but some tender variegated plants lose that character when kept at a temperature more favorable to their growth. The production of an abnormally large amount of xanthophyll seems, therefore, to indicate low vitality. When certain leaves rapidly change from green to red, it appears very much as though erythrophyll could be derived from the chlorophyll by some direct and simple alteration. There is no doubt that this change of colour is often accompanied with the disappearance of the greater part of the chlorophyll, as may be seen by examining the spectrum of the light transmitted by the leaves themselves; but by digesting them in water containing sulphite of soda and citric acid, so as to remove the red colour, it is easy to see that they are of the same yellow colour as if they had faded without having turned red. Moreover, in many cases much erythrophyll is developed when the amount of chlorophyll is but slightly diminished, and thus it could scarcely have been due to any simple change of the latter. This conclusion is also supported by the fact that no substance analogous to erythrophyll is produced by the artificial oxidization of chlorophyll. There is, however, certainly a connection of some kind; for when erythrophyll is developed in patches in young leaves, there is usually a decided deficiency in the amount of chlorophyll in those parts, as shown by the spectrum of transmitted light. In the present state of our knowledge it appears as though

the best explanation were, that chlorophyll is formed when the vital functions of the leaves are very active, and erythrophyll, like an excess of xanthophyll, when they are less active, but not destroyed.

After I had found that a number of colours belonging to the erythrophyll group could be prepared artificially by the oxidization of the different kinds of tannic acid, I felt much inclined to believe that those found in red leaves might originate in this manner; but by using equal quantities of the green and red parts of the same leaves, I was able to prove that the change of colour was not accompanied with any corresponding diminution in the amount of tannic acid. On the whole, then, it seems difficult to account for the production of erythrophyll by any mere chemical change, and this agrees well with the general facts of the case. It is often very specially developed in partially broken twigs, in those parts of leaves which have been damaged by insects, and in detached leaves lying on damp ground with their under surfaces upwards; also when they die, and turn brown in patches, or at the edges, a band of erythrophyll is often found along the border of the part still green, which is, perhaps, not yet actually dead, but certainly would be very soon. Exposure to light is also necessary, and we often see rough natural photographs of superjacent leaves produced in this manner. This result seems to depend more on general intensity than on any particular rays. All these facts indicate an impaired vital action; but, at the same time, it is quite clear that in certain plants analogous conditions are met with, even when they are growing vigorously. Thus, in early spring many young leaves are red or brown, but as their chlorophyll-producing powers increase, the erythrophyll disappears, or is confined to the stalks and other parts, where the true functions of leaves are not actively carried on. Sometimes, indeed, as in the case of the red beech, it increases in amount, and remains during the whole summer, but more frequently it is lost, and again makes its appearance in autumn, either before the chlorophyll disappears, so as to give a dark brown, or, when it disappears, so as at once to give a fine red. Its production, therefore, does not depend on the weakening of that kind of vitality which manifests itself in mere growth, no more than the formation of an abnormal amount of xanthophyll in plants grown in the dark, or in those varieties with very yellow leaves; and yet we know that in this latter case they cannot permanently live unless some of the leaves contain chlorophyll. What is seen in green leaves variegated with yellow and red, also

shows that all these different conditions may occur in different parts of the same healthy leaf.

As I have already said, the red colour of by far the greater number of leaves is due to two substances belonging to Group B, which are related to one another in a very simple manner. One of these may be obtained from the red skin of the leaf-stalks of the common rhubarb, from the very young leaves of the red beech, or from the flowers of *Calceolaria* and some species of *Dianthus*. It is in an unoxidized state, but when dissolved in sulphuric acid diluted with an equal bulk of water, and carefully oxidized by means of a little solution of hypochlorite of soda, the absorption seen in the spectrum is lowered from about the red end of the green to the red end of the yellow, whilst the colour is changed from orange to pink. This alteration is permanent, and is not reversed by the addition of deoxidizing reagents.

The other kind of erythrophyll is met with in so very many leaves that it may be looked upon as the characteristic substance of the red tints of autumn. This is naturally in an oxidized state, and its spectrum exactly corresponds with that of the other kind which has been oxidized artificially. Both are completely decolorized by the addition of an excess of the hypochlorite, unless, indeed, some member of the chrysoannin group be present, which may give rise to a more or less deep yellow or orange.

Now, I find that when the unoxidized modification is kept in a dry state, exposed to the air, it slowly, but gradually, passes into the oxidized, and a similar change takes place naturally in leaves. Thus, for example, in early spring, the very young shoots of the common bramble contain the unoxidized colour, but later in the year it is replaced by the oxidized. This change occurs at a very early period in some plants, so that, as in the case of the bilberry, the very young leaves, and also the flowers, appear to contain a mixture of the two modifications, and the very youngest red leaves of the hawthorn and of the sycamore are coloured by the oxidized kind alone. It is, therefore, apparent that a certain amount of oxidizing action may occur in young leaves; but still it is quite limited in its amount. Probably, in some cases, it extends so far as to destroy the erythrophyll altogether, but does not produce any important effect on the colours of any other group so long as the leaves are healthy. Though much evidently depends on the species or variety of the plant, yet, on the whole, it seems to me that we might easily explain the partial or entire disappearance of the erythrophyll from the red leaves of early spring, and its reappear-

ance in autumn, by supposing that it is destroyed by the ozonized oxygen given off by the growing chlorophyll, and can be again formed when that action becomes impaired or altogether ceases. We could also thus explain why it is so much more prevalent in the stalks, which contain far less chlorophyll, than it is in the leaves themselves.

On the approach of autumn, before the leaves have withered, we have thus in the foliage of different plants an exceedingly variable mixture of chlorophyll, xanthophyll, and erythrophyll, with the different members of the chryso-tannin group, and it is to the changes which afterwards occur in some or all of these substances that the very variable tints of autumn are mainly due. The most striking of these depend on the alteration of the chlorophyll. So long as it remains green, the production of bright reds and yellows is impossible, but, when it disappears, the yellow colour of the xanthophyll is made apparent; and, if much erythrophyll is also present, its colour combined with this yellow gives rise to scarlet or red. In many cases, however, the chlorophyll does not disappear, but it changes into the dark olive modification, easily prepared artificially by the action of acids. This gives a spectrum with an absorption-band in the green, which does not occur in normal chlorophyll, and may even be seen in the light transmitted by such changed leaves, when illuminated by condensed direct sunlight. We may thus easily understand why the special tints of early autumn are yellows and reds, or dull and dark green. In these changes the various pale yellow substances of the chryso-tannin group remain comparatively unaltered, and in some cases actually increase in quantity. They, however, soon pass into the much darker red-browns of the phaiophyll group, whilst the erythrophyll fades, and thus later in the autumn the most striking tints are the bright or duller browns characteristic of different kinds of plants or trees.

As already named, there are many different species of colouring matter belonging to the chryso-tannin group, both of those which are, and of those which are not, closely related to the more typical kinds of tannic acid. The study of these has occupied more time than that of all other groups, and it seems likely to throw much light on certain branches of vegetable chemistry. It would require more space than can be devoted to this paper to describe in detail the separate substances, and I must, therefore, confine myself to such general particulars as are essential to the proper understanding of the subject before me. One of the most striking peculiarities of these compounds is, that they are readily

converted by oxidization into a number of coloured products, which, though differing from one another in detail, have all certain optical characters in common. The properties of the resulting oxide depend very much on the conditions under which oxidization takes place, and no doubt many of them are mixed colours. Thus, for example, when oxidized by means of nitrite of potash and some acid, they often differ entirely according as the colour is dissolved in water or in alcohol, and in both cases they may also differ according as a weak acid like citric, or a strong one like hydrochloric, is used. They also sometimes vary further when oxidized by means of hyponitric ether, and still more so when the solution in water or alcohol is exposed to the air for a few days, after having been made alkaline or acid in various degrees. Much remains to be learned before we can understand the cause of these differences and relationships, but they appear to me to be of much interest in connection with the formation of the different colours of the petals in varieties of the same plant, for they show that variations in the intensity of the oxidizing process may give rise to a considerable number of very different colours; and, since the chemical changes taking place in leaves are manifestly related to their vital state, it seems by no means improbable that the production by cultivation of very different colours in flowers naturally of nearly uniform character may be due to some kind of abnormal change in their vital powers, thus modifying chemical affinities. In connection with this I might refer to the difference in the colours of certain flowers, according to the time of the year at which they happen to bloom, but must leave the consideration of such questions, and return to the more immediate subject of this communication. Though there is a material difference in different cases, yet, on the whole, the various substances of the chryso-tannin group changed by oxidization from more or less pale yellow to orange or red compounds, and some of these readily pass into blue or green, or into brown modifications of greater stability, apparently by undergoing some molecular change independent of further oxidization. These facts may be expressed by saying that, by combining with a certain amount of oxygen, the absorption of light is much lowered from the blue towards the red end of the spectrum, and that there is often a tendency to pass into a further modification, characterised by absorption at the red end. Such results of experiments made with the different colours in a separate state are completely in accordance with what occurs in natural foliage, not only agreeing in general character with fading leaves as

a whole, but also with those of different kinds of plants or trees. So far I have not been able to ascertain whether there is any one particular artificial oxidizing process which will in each case give rise to the exact products naturally found in the leaves themselves, but there is sufficient similarity to show what is the true character of the change, and that it is independent of vitality or the action of light, and is a mere chemical change in dead matter. It therefore appears almost certain that the rich brown tints of autumn are mainly due to the oxidization of previously existing more or less pale yellow colours of the chrysotannin group, and this agrees with the fact that the leaves then contain no tannic acid, or very little compared with what is found in them when they are green or yellow. The erythrophyll appears to have very little, if any, influence on these final tints, for it is decolorised by further oxidization; but the continued presence of the dull olive-coloured modification of chlorophyll completely prevents the production of any fine, clear, bright brown. As a general rule, therefore, such tints are seen to the greatest advantage in the case of leaves which first turn yellow or scarlet; and a good clean background having been thus formed, the subsequent oxidization of substances belonging to the chrysotannin group gives rise to the redder or yellower browns seen in the foliage of different trees. This will be better understood by means of a few special examples. The leaves of the common beech first change into a bright yellow. They then contain, besides xanthophyll, a pale yellow colour, soluble in water, which is closely allied to, if not absolutely the same as, the quinotannic acid found in the dry bark of commerce, but more pure in the fresh green leaves of the *cinchona* plant. This kind of tannic acid when oxidized gives rise to several different coloured products, but, on the whole, they correspond very closely with the red- or brown-orange colour characteristic of the leaves at a later period. This colouring matter of the natural leaves is insoluble in water or neutral alcohol, but is easily dissolved in the latter, when made acid with hydrochloric acid; and then it agrees very closely with the product of the artificial oxidization of the pale yellow substance by means of nitrite of potash and hydrochloric acid, added to its solution in alcohol. The yellow leaves of the elm contain apparently the same tannic acid, along with a colour of the chrysophyll sub-group, which does not strike a dark colour with ferric salts. This when oxidized gives rise to a dark, dull brown substance. These two are mixed in varying proportions in the leaves of different elm trees, and thus some turn to a moderately bright

and others to a very dull brown. From these alcohol extracts a brown colour, soluble in water, similar to that produced artificially. The leaves of the oak and the Spanish chestnut contain the same chrysophyll as the elm mixed with the gallotannic acid found in various galls occurring on oaks. This kind of tannic acid differs from all others in giving rise to several well-marked products. When dissolved in alcohol and oxidized by means of nitrite of potash and hydrochloric acid, a substance is formed, which, when the solution is only slightly acid, is of splendid red colour. This belongs to Group C, and is not at all changed by adding sulphite of soda. When made slightly alkaline, this red substance rapidly passes into a colour belonging to Group A, which is of a splendid deep blue colour in a solution containing considerable excess of citric acid, and is then immediately altered by sulphite of soda to a pale yellow, the well-marked absorption-band in the orange being completely removed. No such substance is formed in the case of the tannic acid used by photographers, prepared from Chinese galls, which is undoubtedly quite a different modification. When oxidized under other conditions, gallotannic acid gives rise to a deep brown colour, similar to that found in the changed leaves, and this difference between it and quinotannic acid readily explains why the leaves of the oak and Spanish chestnut change from yellow to brown, and not to the brighter tints seen in those of the beech and a few other trees. The leaves of the *Acuba japonica* of our gardens contain a rather singular kind of yellow colour belonging to the chrysotannin group. When kept dry at the ordinary temperature it gradually changes into a very insoluble dark brown colour, precisely like that seen in the faded leaves; and it differs from the more typical kinds of tannic acid in being oxidized by the oxygen of the atmosphere when in an acid solution, but agrees with them in giving a dark colour with ferric salts. The chrysophyll colours which do not turn dark with persalts of iron seems usually to pass by oxidation into brown substances, and it is very probable that similar dull brown tints result from the oxidization of a great variety of compounds met with in plants. On the whole, so far as my present experience enables me to decide, the brighter and redder browns of autumn are mainly due to the previous existence of quinotannic acid, modified by the presence of other substances, but there seems reason to believe that in different plants and in varying conditions it gives rise to several distinct colouring matters, differing in solubility, but being all more or less red, orange, or brown.

The affinity for oxygen of the various kinds of chrysohyll and tannic acid, and the rate at which they are changed by exposure to the air, vary in most cases with the intensity of the alkaline reaction of their solutions. They remain unchanged for a long time when acid, are very slowly altered when neutral, but rapidly when very alkaline; and, therefore, it is possible that the amount of free acid of the natural solution in leaves may sometimes have an important influence in causing the chrysohyll colours to remain for a long time unaltered, whilst, if this acid became neutralized or were destroyed, these oxidizing processes would commence and progress rapidly. Though these principles must certainly be taken into account, yet alone they do not appear sufficient to explain why the chrysohyll substances are so permanent in living and so soon oxidized in dead leaves.

On the whole, we may, I think, express the connection between the various tints of leaves at different seasons of the year, and the vital and chemical changes, in a very simple manner. Chlorophyll is formed when the condition of the leaves is such that, under the influence of light, the affinity of oxygen is not only resisted, but actually overcome—carbonic acid decomposed, and oxygen evolved. Xanthophyll, erythrohyll, and the chrysohyll substances are formed when the vital and chemical forces are more nearly equal, so that certain chemical changes occur which may be imitated artificially, along with others depending on the presence of vitality and light. At a later period, when the leaves have died, the affinity of oxygen meets with no resistance, and the changes are entirely of that kind which we can imitate artificially by acting on dead compounds without the instrumentality of light.

As I have already explained, the finer autumnal tints mainly depend on the complete disappearance of chlorophyll, so as to allow the bright colours of the xanthophyll and erythrohyll to be seen unimpaired. If little or no erythrohyll be present, we then have clear yellow foliage, but, if it had been developed in considerable quantity, we have brilliant scarlet and red. The production of these striking and beautiful tints therefore depends on special conditions, subject to considerable variation in different countries and in different years. Apparently, the vital powers of the leaves must be more or less paralysed, but no active oxidizing processes set up, or else the red colour would be destroyed, and the yellow completely hid by the darker and duller phaeophyll. Early frosts, occurring whilst the daylight is still strong, and before wet weather has set in, appear to me to be just what would

be likely to meet the requirements of the case; and from what I can learn respecting the splendid tints of the Indian summer in America, and from what I have seen in the Highlands of Scotland, as compared with my own neighbourhood, I am very much inclined to believe that no conditions are more favorable. At the same time, of course very much depends on the particular species of tree or plant growing abundantly in each locality. English woodland scenery suffers much from the want of those large trees which, like some species of *Aria*, develop erythrophyll even in our own climate, the only extensive, well-marked, red colouring being due to such a small plant as the bilberry of our moors. At a later period of the year the more striking tints depend not only on the disappearance of chlorophyll, but also on the presence of substances like quinotannic acid, changed by oxidization to a bright orange-brown, as seen in our own beech trees, which are so great an ornament to the scenery late in autumn.

In bringing this paper to a close, I would say that I have now carefully studied the different colouring matters met with in plants for a number of years, and am more and more convinced that such methods as I have described enable us to identify or distinguish them, even though, as is often the case, more than half a dozen exist mixed together. The field of research is extremely wide, and years of study would be required to work out the detail, and to ascertain the connection between the different coloured compounds and the botanical character of the various plants in which they occur, but would, I believe, yield many interesting results. For my own part, I must say that I have derived very great pleasure from the inquiry; for, spending as I do several hours almost every day in the open country, I have found that at every season of the year, and in nearly all kinds of localities, facts may be observed which confirm previous conclusions, or correct errors; and I hope that this account of what I have been able to learn may be the means of inducing others to pay attention to this subject, and that the study may conduce as much to their pleasure as it has to mine.

NOTE on Dr. HINRICH NITSCHÉ'S PAPER on "SOME INTERESTING POINTS concerning the MODE of REPRODUCTION of the BRYOZOA." By the Rev. THOMAS HINCKS, B.A.

IN the following brief communication I propose to offer one or two remarks on the important paper by Nitsche published in the last number of this Journal, in which he criticises some of the views of the eminent Swedish naturalist Smitt respecting the reproduction of the *Polyzoa*. I shall confine myself at present to a single point, the theory of the "germ-capsule" ("*groddkapsel*") of Smitt. This term has been employed to designate the dark-coloured, more or less circular bodies, which are commonly present in the older cells of the Polyzoan colony, and were long regarded as ova. Smitt claims to have established the very interesting fact that they are in reality produced by the decomposition of the polypides previously in possession of the cells, and that they originate fresh zooids to fill the places of those which have thus disappeared. He describes the "germ-capsule," as it occurs in several species, and also the evolution from it by budding of a new polypide.

Nitsche, while admitting the correctness of Smitt's views respecting the *origin* of the "*groddkapsel*," denies that it is "in any way concerned in the reproduction of a new polypide in the deserted cells." The *buds* which the Swedish naturalist describes and figures as proceeding from the germ-capsule, he has satisfied himself, take their origin from the endocyst. From their position they are often in close contact with the "brown bodies," and this circumstance has led to an error of observation and, consequently, of interpretation.

Upon this I remark that the mere *ipse dixit* even of so able and accomplished an investigator as Dr. Nitsche cannot be accepted as against the careful and patient observations of Smitt, accompanied as they are by illustrative drawings, which tell their own tale. The supposition that in so simple a matter and in such numerous cases there has been a blunder of observation is almost incredible on the face of it, and is hardly just to a most competent microscopist. It must be remembered that it is not a difficult problem in histology, demanding for its solution great resource and very delicate manipulation, that is at issue; but that the question simply is, whether certain buds originate from the inner wall of a cell, or from a body lying in the centre of the cell, a point which it certainly requires no special gifts to determine.

Smitt states that he has seen a polypide sprouting from the "germ-capsule," and he has figured the nascent bud;¹ and the weight of this positive evidence will hardly be affected by the bare statement that Dr. Nitsche "has satisfied himself" that it is otherwise.

Our author would seem not to have appreciated the kind of evidence on which Smitt grounds his opinion, for he writes, "the fact that they (the 'groddkapslar') are often found associated together with a new bud of a polypide forces upon him the conviction that this new bud is the descendant of the brown body." As I understand him, this is by no means the case; he does not rely on an inference, but on direct observation. The conviction has resulted from his having seen the bud forming on the germ-capsule.

Dr. Nitsche supplies us with little evidence in support of his own view, but he finds a proof that the appearance of a new polypide in a lodge is in no way connected with the presence of a "groddkapsel," in the fact that he has observed (in the case of *Alcyonidium hispidum*), a new polypide budding from the endocyst "in the centre of the upper wall of the cell," while the original occupant still retained its position and shape, and therefore before the formation of a "groddkapsel." I do not for a moment question the accuracy of this observation; I have a great deal too much respect for Dr. Nitsche's powers as a microscopist to do so. But I submit that it is no proof whatever that new polypides do not *also* originate from the "germ-capsule," as Smitt reports. The base is much too narrow for the superstructure that is reared upon it. It would be too much to require us to believe that, because Nitsche has seen a new bud originating from the endocyst, Smitt must be in error when he tells that he has seen one originating elsewhere.

We have, perhaps, hardly a right to expect any detailed evidence in a mere "preliminary sketch of his views," which is all that Nitsche's paper professes to be, though some slight account of the process by which he has reached his conclusions would have been satisfactory. But in the absence of it we may reasonably regret that the explicit testimony and laborious research of Smitt should have been summarily disposed of by the dictum, "I have satisfied myself that the 'brown bodies' ('groddkapslar'), being in no way endowed with any reproductive function, are mere remains of decaying polypides."

The Swedish naturalist, however, will no doubt speak for himself and make good his position. It is my principal

¹ *Vide* Smitt's paper, plate v, fig. 5, 3.

object in writing to put on record the results of my own independent observations, which, so far as they go, are entirely in agreement with those obtained by Smitt.

I have studied the history of the "germ-capsule" more or less in many species, but more especially and most thoroughly in *Bicellaria ciliata* (Linn.). In general structure it is a granular mass, of somewhat variable form, enveloped in a membrane, which is thickly covered with pigment spots. It is found attached to the cord that connected the polypide with the base of its cell, occupying, indeed, much the same position as it did when an integral portion of the digestive sac. The first sign of its having entered upon a course of development is the appearance of a clear space, and then of a small swelling or protuberance on its upper surface. This bud is of a light greyish colour, and shows distinctly in contrast with the dark reddish-brown of the capsule itself. It increases in size, and is gradually moulded into a tentacular crown and rudimentary intestinal canal, and at last a perfect polypide replaces the original tenant of the cell. The budding tentacles are of a light colour, while the lower portion of the "groddkapsel" retains its dark-reddish tint, so that the course of development is easily followed. It seems to correspond very closely with that which has been described by Nitsche in his account of the development of the primary cell from the larva in *Bugula flabellata*.¹ I have sketches of various stages of growth, made at the moment of observation, which would have accompanied this paper had there been time for the preparation of the engravings.

I may remark, further, that Nitsche's opinion, that the so-called "germ-capsules," or "brown bodies," in the cells of the Polyzoa, are "mere remains of decaying polypides," is quite inconsistent with *the history of their formation*, which has not received sufficient attention. The "groddkapsel" is in no true sense "the remains of a decaying polypide." It is a special body, elaborated out of the substance of the polypide, passing through a fixed and constant course of development, which commences at a comparatively early period in the life of the polypide, and exhibiting at last a definite form and structure.

I have repeatedly studied its origin and formation in various species, and always with the same result. At a certain point in the life of the polypide a very marked change is seen to be taking place towards the base of the body. It consists in the gradual separation of the lowest portion of

¹ *Vide* his admirable paper, "Zur Kenntniss der Bryozoen," 1869.

the stomach from the rest of that organ.¹ A constriction of the walls of the stomach takes place at a definite point, and this increases until the lowest section, which assumes a somewhat globular form, is connected with it by a narrow channel only, and hangs suspended beneath it like a distinct organ. This semi-detached portion continues to share in the contractile movements of the stomach, and the food is driven down into it through the channel that I have just mentioned. In this state it was noticed by J. V. Thompson in the following passage, which is quoted by Smitt:—"From the stomach the viscus appears to descend considerably lower, and from its acquiring a spherical shape, opaque yellowish colour, and its persisting after the death of the animals in many of these zoophytes, is most probably an ovum or ovarium." The stomach now appears to consist of two connected chambers, of which the lower and smaller is globular in form. I have never witnessed the actual separation of this portion from the rest; but at length, whether before or after the death of the polypide I cannot say, it is cast off, and lies within the cells as a separate structure, the "germ-capsule" of Smitt, "the dark body" of earlier observers. This course of development seems to be constant, and the history, as I have now given it, would certainly lead us to suppose that the "groddkapsel" has some further and probably important function to discharge for the Polyzoan colony. Thus definitely formed, and holding so constant a place in the life history, it certainly cannot be correctly viewed "as the mere remains of a decaying polypide."

It may be remarked in passing, that these observations completely exclude Claparède's conjecture, that the "dark bodies" are a product of the endocyst. Relying on the evidence now adduced, I hold that Smitt's view of the "groddkapsel" is substantially correct, and that it is rightly regarded as one of the reproductive bodies of the Polyzoan colony.

¹ *Vide* a paper by the author in the 'Popular Science Review' for January, 1870, entitled "On some Interesting Points in the History of the Polyzoa."

On a SUBMERSION MICROSCOPE. By R. E. DUDGEON, M.D.

FOR the examination of minute aquatic vegetable and animal organisms in a considerable quantity of their native element, it is desirable to have a microscope which can be plunged into water without affecting its optical qualities. The ordinary microscopes are only intended for use in an aerial medium, and were we to insert the end of the object-piece into water we should at once destroy the magnifying power of the object-glass to a considerable extent, and run the risk of injuring the brass work and screws constituting the mechanism of the object-piece.

For some time past I have endeavoured to devise a microscope which should enable me to study objects in a considerable depth of water without injuring the instrument or destroying its magnifying power. I need not detail the various plans that successively occurred to me for effecting this object, but will only describe the means by which we can convert an ordinary microscope for viewing objects in an aerial medium into a microscope for observing objects beneath the water, without in any way injuring it for its original purpose.

Over the object-piece I screw a brass or other metal tube, closed at the further end by a disc of plain glass, cemented into its place so as to be perfectly water-tight. The length this tube projects beyond the inferior surface of the object-glass must, of course, be less than the focus of the latter. Thus, if the object-glass have a focus of one inch, I find it best not to have the enveloping tube projecting more than half an inch beyond the object-glass. If the focus of the object-glass be $\frac{1}{4}$ inch, the tube should not project more than $\frac{1}{8}$ inch beyond it.

A microscope so protected may be plunged into water as deep as the protecting tube will admit, with scarcely appreciable loss of magnifying power, and with no loss of distinctness of definition or illumination of the object. This arrangement possesses great advantages over the ordinary "tank microscope," in which the microscope is suspended above the water, and not intended or fitted for submersion. For while with this latter instrument the least movement of the table or tank causes a tremulous motion of the surface of the water, which distorts all objects seen below it, by my arrangement the distinctness of the image is not marred by any agitation of the surface of the water. The glass disc of

the submerged tube keeps the water through which the rays of light penetrate to the lenses of the microscope as smooth and unruffled as itself. Again, the proposed arrangement allows us to use object-glasses of much greater power than can be employed in the "tank microscope." Thus, I find that I can work beneath the water perfectly with a power of $\frac{1}{4}$ inch, and a higher power might be used, only I do not think there is much occasion for a higher or even so high a power in the investigations likely to be undertaken with this instrument.

I said that I had applied these submersion tubes to the object-pieces of an ordinary microscope. The microscope is one of Bryson's, in which the vertical motion is communicated to the microscope-tube by means of a rack and pinion on the tube itself, and not on the supporting pillar, as is the case in many microscopes. I place my tank on the movable stage of the microscope, which must, of course, be maintained in a horizontal position, if by a clamp so much the better. The tank is formed by pieces of glass cemented together by marine glue. The back and outward-sloping sides are made of opaque white glass, the front and bottom of clear plate glass. By this arrangement a great amount of light is thrown in upon the water, which receives light also from the mirror beneath the stage. If it is desired to have the object illuminated from above only, a piece of black cloth may be placed beneath the tank, or a piece of tinfoil may be used for certain cases.

I have here described the adaptation of submersion tubes to an ordinary microscope, but were it thought desirable to construct a microscope solely for subaqueous investigations the arrangement would, of course, be different to that of ordinary microscopes. The tank I would make rather larger than that at present used by me, the size of which was limited by the dimensions of the microscope and its parts,¹ or, rather, I would have several tanks of various sizes, suited for different purposes. The tank should stand on a fixed stage, fitted to the upright of the microscope. The microscope should be made capable of movement in every direction, not merely vertically, but horizontally and obliquely, and the water in the tank should be capable of being illuminated from the top, the front, or the bottom, as desired. I would also extend the length of the object-piece covered by its submersion tube, so as to admit of submersion to a depth of three or four inches. I had, in fact, designed a

¹ The actual size of my tank is:—depth $2\frac{1}{2}$ inches, sides $3\frac{1}{2}$ inches wide, front 4 inches, back 3 inches wide.

microscope of this description before I found that the principle could be applied to microscopes of the ordinary construction.

It may be interesting to know what is the exact loss of power in the object-glasses by submersion in water when enclosed in the protecting tube. I give the results in the case of three object-glasses belonging to my microscope :

- No. 1.—Focus in air, $\cdot 82$ inch.
 " water (with submersion tube on), $\cdot 95$ inch.
 Difference, $\cdot 13$ inch.
- No. 2.—Focus in air, $\cdot 27$ inch.
 " water (with submersion tube on), $\cdot 31$ inch.
 Difference, $\cdot 04$ inch.
- No. 3.—Focus in air, $\cdot 11$ inch.
 " water (with submersion tube on), $\cdot 14$ inch.
 Difference, $\cdot 03$ inch.

The differences in these cases are of little practical consequence,¹ and are very much less than when either surface of the object-glass comes directly in contact with the water. In the case of a plano-convex lens, if the plane surface only touches the water, one third of the magnifying power is lost; and if the convex surface touches the water, the magnifying power is diminished to less than one fourth of what it is in air.

I should add that it makes no difference in respect to the magnifying power of the object-glass in air whether the submersion tube be on or off, nor, in fact, does it make the slightest perceptible difference in any way, whether as regards definition or illumination; so that for viewing objects in air there is no need to remove the submersion tube at all, which may, indeed, be regarded as a protecting cover for the object-piece under all circumstances.

¹ The slight loss resulting from submersion may be avoided by closing the end of the tube with a plano-convex lens of low power (the plane surface downwards) in place of a disc of plain glass.

RESEARCHES on the DEVELOPMENT of the GREGARINÆ. By
EDOUARD VAN BENEDEN, D. Sc., Professor of Zoology
and Comparative Anatomy in the University of Liege.

THE development of the Gregarinæ has been the object of a great number of investigations, and has exercised the sagacity of a number of distinguished observers. Nevertheless, at the present time it is not fully elucidated. The relation existing between the Gregarinæ and the psorospermic vesicles was first perceived by von Siebold,¹ Henle,² and von Frantzius,³ and definitely demonstrated by the beautiful researches of Stein,⁴ Kölliker,⁵ and Lieberkühn.⁶ It appears well established that, although sometimes two Gregarinæ conjugate, fusing subsequently into a common mass in one and the same cyst (Stein), yet the conjugation does not necessarily precede the encystment, and often a single Gregarine transforms itself into a vesicle (Bruch, Frantzius, Leuckart, and myself), to give birth, quite as in the first case, to a great number of psorosperms. There are certain Gregarinæ in which the conjugation is never observed; others which one finds always apposed (Zygocystis, Didymophyes), either by their analogous extremities, or by their opposite extremities (Gregarinæ).

The granular contents of the cysts may divide, and the capsule common to the two globes thus produced may disintegrate and become transformed into a viscid and granular substance, after a new membrane has developed round each of the new globes of the second generation. These again may divide in their turn, and there will be thus presented series of cysts, enclosing some a single granular mass, others two similar masses enclosed in a single capsule. All these cysts, which may be compared as far as their mode of multiplication is concerned, to the corpuscles of cartilage, are held in suspension in a common fundamental material resulting from the disintegration of the original capsules (Edouard Van Beneden).⁷ In this manner we can explain the presence of those linear series of cysts which are met with in the thick-

¹ Von Siebold, 'Beiträge zur Geschichte wirbelloser Thiere,' 1839, p. 69.

² Henle, 'Müller's Archiv,' 1845, p. 574.

³ Von Frantzius, "Observationes quædam de Gregarinis," Berol, 1848.

⁴ Stein, 'Müller's Archiv,' 1848, p. 204.

⁵ Kölliker, 'Zeitschrift für wiss. Zool.,' t. i, p. 1.

⁶ N. Lieberkühn, "Evolution des Gregarines," 'Mem. Acad. Roy. de Belg.,' c. xxvi.

⁷ Edouard Van Beneden, 'Quarterly Journal of Microsc. Science,' New Series, No. XXXVII, 1870.

ness of the walls of the intestine of the lobster or, indeed, the existence of strings of vesicles bound together by a homogeneous substance, like those which MacIntosh¹ found in *Borlasia octoculata*. In this way, also, is explained the fact that the cysts are often much smaller than the Gregarinæ to which they have to be referred. We know also through the researches of Stein,² of Bruch,³ and, above all, of Lieberkuhn,⁴ what is the mode of formation of the psorosperms at the expense of the granular masses; but the question as to the manner in which the psorosperms are developed later into Gregarinæ, remained an enigma until the day when Lieberkuhn⁵ established in a decisive manner that a body exhibiting amœboid movements comes out of the psorosperms, and moves itself in the same way as the corpuscles which occur in suspension in the blood of the earth-worms, and which were observed and described for the first time by Morren.⁶ According to Lieberkuhn the globules of the perivisceral liquid of the earth-worm are true Amœbæ, which must be connected with the development of the Gregarinæ. We find in this cavity structures which present characters intermediate between those of Amœbæ and those of Gregarinæ; and Lieberkuhn admits the direct transformation of the Amœbæ into Gregarinæ. But it is very necessary to remark that the exactitude of the observation has been contested by Schmidt,⁷ and at the end of his work Lieberkuhn says himself: "I am far from maintaining that all the Amœbæ are born from psorosperms, or that all the Gregarinæ develop from Amœbæ."⁸ The observations which I have had the opportunity of making on the successive phases of the development of the Gregarinæ of the lobster serve to fill up the gaps which the history of the development of these mono-cellular beings hitherto presented, and to elucidate some points which have remained obscure in this evolution. I have been able to follow step by step in the *Gregarina gigantea* all the successive transformations of the little protoplasmic mass which

¹ "On the Gregariniform Parasite of *Borlasia*," 'Quart. Journ. of Mic. Sci.,' 1867.

² Stein, 'Müller's Archiv,' 1848.

³ Bruch, 'Zeitschr. fur Wiss. Zool.,' Bd. ii, p. 110.

⁴ Lieberkuhn, loc. cit.

⁵ Ibid., p. 16, "Ueber die Psorospermien," 'Müller's Archiv,' 1854; "Notice sur les Psorospermies," 'Bull. de l'Acad. Roy. de Belg.,' c. xxi, No. 7.

⁶ Morren, "De Structurâ Lumbrici terrestris," 'Acta Akad. Gandar,' 1825, p. 170.

⁷ Schmidt, "Beiträge zur Kenntniss der Gregarinen," 'Abhandl. der Senkenberg Gesellschaft,' 1854.

⁸ Lieberkuhn, "Evolution des Gregarines," p. 27.

comes out of the psorosperms, up to the complete Gregarina, which may attain a length of sixteen millimeters.

In the month of May of the past year I found in the small intestine of the lobster little protoplasmic masses entirely naked, devoid of nucleus as well as of membrane, and which, in respect of their finely granular aspect, their continual changes of form, and their entire constitution, may be compared with the *Protamaeba agilis* or the *Protamaeba primitiva* of Haeckel. They differ from these solely in the fact that fine molecular granulations are met with even at the periphery of the body, and in the fact that the forms scarcely depart from those of a globular body more or less irregular at its surface (Pl. XII, figs. 1, 2, and 3). I have never seen pseudopodia projected to a distance.

As we shall see, these little protoplasmic globes are the point of departure of the development of the Gregarinæ; they are distinguished from true *Amæbæ*, which always possess a nucleus, and often also a contractile vacuole by the absence of both one and the other. From a morphological point of view these little protoplasmic globes, devoid of any nuclear structure, are true Gymnocyotods.

By the side of these little living masses devoid of all organization, we find here and there other little protoplasmic globes, which only differ from the first in the fact that they have lost the faculty of moving themselves and of changing their form (fig. 4). On the surface is observed a somewhat thick layer of a brilliant protoplasm, highly refringent, perfectly homogeneous, and absolutely devoid of all granulation, whilst the central protoplasmic mass holds numerous molecular granulations in suspension of which some appear as points of the extremest tenuity, whilst others have dimensions appreciable by the microscope. These last granules are probably only nutritive elements. I have been able to establish, as will be seen further on, the greater fluidity of the central granular matter; but the line of demarcation between the peripheral perfectly homogeneous zone and the central granular mass is not sharp and defined; the small protoplasmic mass is not delineated by a membrane properly so called, but rather by a layer of condensed protoplasm, if one may thus term that which acts as a membrane in such a way as to preserve the spheroidal form of the cytod.

In consequence of this tendency to the separation of the protoplasmic mass into two distinct layers, a cortical substance and a medullary substance, these globes rise to a position above the Monera. The latter never exhibit this separation, although it is general in the other lower Protista.

By the side of these sharply circumscribed and entirely motionless globular forms are to be observed certain cytods quite similar to those just described, excepting that they carry either one or more often two prolongations in the form of arms, which I should call pseudopodia, if they did not exhibit entirely peculiar characteristics which separate them very obviously from the pseudopodia of the Monera, the Foraminifera, and the Radiolaria. I should be more inclined to compare them to the mobile appendage of the Noctiluca, chiefly on account of the constancy of their form and of the nature of their movements. These cytods with prolongations I shall call *generating cytods*.

Firstly, as to the characters which were presented by the prolongations of the cytod which I have represented in figs. 6, 6'', 6'''. The prolongations to the number of two are inserted at a little distance one from another on the same hemisphere. They are not only of unequal length, but they differ notably from one another in all their characters. That which is the shorter is at the same time the thinner, more delicate, with paler outline, and almost completely devoid of mobility. If in a displacement which the corpuscle undergoes either in virtue of its own vitality, or in consequence of a current which carries it along—this arm comes in contact with a resisting body, it becomes reflected, bent back, and I have seen this bend, produced accidentally, persist during more than three quarters of an hour. The protoplasm which constitutes this arm is pale but slightly refringent, very finely granular, and almost devoid of granules of appreciable dimension. I consider these last granules as being nutritive, combustible elements; and the almost complete absence of mobility in this arm may be explained by this fact that the combustion—that is to say, the liberation of the force necessary for mechanical movement—does not operate except with extreme slowness in this inert arm.

The other arm is notably longer, and also a little broader; its contours are darker, and the protoplasm which compose them is more refringent. Besides the almost imperceptible molecules which distinguish the protoplasmic matter, in this arm opaque granules are remarked. These granules are chiefly abundant at the slightly enlarged and very mobile extremity of this arm. It is thus very granular, and this character is sufficient to enable one to distinguish, at first sight, the second arm from its neighbour. It differs further from the first-mentioned prolongation by its extreme mobility. Two modes of manifestation of this mobility are distinguishable. Firstly, the arm can vibrate, very much as does the

“lash” of the Noctiluçæ. In the second place, a peculiar mode of movement is observed, which has probably, as end and result, the progressive elongation of the arm. The extremity of the prolongation is spontaneously reflected, and then one observes the reflected part gradually elongating; whilst at the same time the point of flexion gradually approaches the body of the cytod (fig. 6', 6''). The straight part of the arm appears to contract at the same time, and a very slight transverse striation is seen to appear in this part of the prolongation (6'' and 6'''). Then suddenly and briskly the entire arm recovers its position, as though it were made of some eminently elastic substance; and at the same time the granular and fluid protoplasm of the centre of the cytod rush, forming a sort of current, into the interior of the arm. It is clear that these movements, which succeed at short intervals, ought to result in the progressive elongation of this arm. I have been able to establish the fact of this gradual elongation by observing the same cytod during several hours. The only other modifications which appear in the character of the prolongation are the pinching in of its basilar portion, and the accumulation of nutritive granules in its terminal portion, which I shall designate “*cephalic*.”

When the mobile arm has attained a certain length, it detaches itself from the body of the cytod, and, becoming free, executes undulatory movements in the manner of a Nematoid worm. I have not seen this arm actually detach itself from the cytod, but quantities of these filaments are found moving freely in the intestine by the side of the cytods, on to which they are also found fixed by one of their extremities.

To elucidate completely this part of the evolution of the Gregarinæ, we ought yet to inquire whether all the body of the cytod is not employed in the elaboration of one of the free mobile filaments.

It follows from the facts which I am about to enumerate that one and the same cytod gives rise to two filaments, destined each to become a Gregarine, that is to say, that two Gregarinæ always are produced from a single cytod, which, on this account, I have called the “*generating cytod*.” The first to attain maturity is the mobile arm, it detaches itself from the cytod before the second—the right arm—attains the phase of mobility. On the other hand, all that remains of the body of the cytod is employed in the maturation of this second arm.

Among the cytods with two arms, one inert, and the other extremely mobile, some cytods are found which have only a single prolongation. Of these, some possess an inert arm,

presenting all the characters of that which we have described above (fig. 9); others have, on the contrary, a mobile arm, and are devoid of the inert arm (figs. 10, 11, and 12). It is to be observed that in this latter case the body of the cytod has smaller dimensions than belong to those cytods with two prolongations. Among the cytods with only one prolongation, some are found with the arm presenting characters intermediate between those of the mobile and those of the inert arm. It results clearly enough, from the comparative examination of these various forms, that the inert arm of the two-armed cytods is destined to become in turn a mobile arm; after the original mobile arm has become detached from the cytod. The inert arm is then merely a still younger pseudopod than the mobile arm, destined to take on at a certain epoch the characters of the latter.

The fact which is regularly observed in the two-armed cytods, that the mobile prolongation thins away progressively at its basilar portion (figs. 7 and 8) when it has attained a certain length, proves that the prolongation tends to detach itself from the cytod; and this conclusion is confirmed by the existence of cytods, having only an inert prolongation.

But this now requires for its development all the rest of the body of the cytod. That is at least the conclusion which appears to be deducible from the occurrence of free filaments, having a vesicular enlargement at their posterior extremity; although no narrowing is observed between the body of the filament and the terminal enlargement.

These facts lead to the following conclusions:

1st. Each cytod gives rise to two filaments, destined to develop each into a Gregarine; but the development of the two processes takes place *successively*.

2nd. The filament which develops first attains its maturity, and detaches itself from the body of the cytod, before the other proceeds with its development, and before it attains the phase of "the mobile arm."

3rd. This latter does not detach itself from the cytod; it develops by gradually absorbing the body of the cytod, as the embryo of a vertebrate absorbs little by little the contents of the vitelline vesicle. It passes successively through the same phases of development as the mobile filament.

The protoplasmic filaments thus developed from the cytod move in the intestine with extreme activity (figs. 13 and 16). The only movements which they execute are undulatory movements, in every respect comparable to those of the Nematoid worms. In consequence of their resemblance to the Nematoid worms, I have termed these protoplasmic filaments

pseudo-filaria. If these vermicular filaments had not been seen developing under one's eyes at the expense of a cytod, it would be difficult to believe that they were not young Nematoids. We know, in fact, that it is always extremely difficult to distinguish cellular elements in these little worms, and often it is not possible to detect, except with great trouble and in a very obscure manner, any trace of a digestive tube. It is the "pseudo-filaria" of the Gregarinæ of the earthworm in all probability which have been taken for young Nematoids, and we have here clearly enough the explanation of the very erroneous opinion which has prevailed, according to which the Gregarinæ are only a phase in the development of the Nematoid worms. This opinion has been defended by naturalists of the first rank, such as Henle,¹ Bruch,² Leuckart,³ and Leydig.⁴

In 1845 Henle expressed himself thus as to these relations between the Gregarinæ and the Anguilluloid parasites of the earth-worm:⁵—"It has become my conviction that the Gregarinæ of the earthworm stand in the same relation to the Anguillula-like Entozoa of the same animal, as, according to Miescher, do the rigid chrysalids in the intestines of many fish to the *Filaria piscium*. I have detected a series of transition forms between Anguillula and the Gregarina, of which some have been already described by Dujardin⁶ as *Proteus tenax*, and by Sarissay⁷ as *Sablier proteiforme*. The Anguillula becomes stiff, and its intestine breaks up within the outer skin into a granular mass, whilst the form of the body is changed from an elongated into an oval or spheroidal form."

Whilst Bruch and Henle admitted the possibility of the transformation of worms similar to young Filariae into Gregarinæ, Leydig, according to observations made on the parasites of a *Terebella*, was more inclined to believe in a metamorphosis in the other direction—that is, from Gregarinæ into Nematoids.

It is not to be doubted that it is the analogy between the forms and the movements of these protoplasmic filaments, which I have just described under the name of "*pseudo-filaria*," with young Nematoids, which has caused these

¹ Henle, 'Müller's Archiv,' 1845.

² Bruch, 'Zeitschrift für Wiss. Zool.,' t. ii.

³ Leuckart, 'Archiv für Phys. Heilkunde,' xi, 1852, p. 429.

⁴ Leydig, 'Müller's Archiv,' 1851.

⁵ In his 'Jahresbericht für Histologie,' 1845.

⁶ 'Annales des Sciences Naturelles,' 2nd series, t. iv.

⁷ *Ibidem*, 2nd series, t. vi.

errors; and it clearly results from their mode of formation that they are no more Nematoids than are the whales—fishes.

We have now to set forth the modifications which the pseudo-filaria undergo during their transformation into Gregarinæ.

The pseudo-filaria, simple threads of protoplasm, attenuated at one extremity, slightly swollen at the other or cephalic extremity, which is always richly charged with refringent granules, move about freely in the intestine during a certain time. Then the movements languish, and the length of the body diminishes little by little at the same time as the breadth, especially in the anterior portion (figs. 13 to 18). Soon all undulatory movement ceases, and the pseudo-filarium becomes quiescent. This is at least the conclusion derivable from the comparative examination of individuals, which are found in great numbers in the intestine. Some are seen which are very long, very thin, and extremely agile, side by side with others which are rigid, shorter, and obviously broader, especially in the anterior part of the body. At the same time there is seen to appear, near the middle of the long axis of the body, a dark circular spot, which is formed of a more refringent matter than the protoplasm (figs. 15 to 17). The dimensions of this spot vary very slightly, but its limits become more distinct. This is the *nucleolus* which appears directly in the protoplasm, probably as the result of a deposit, around an ideal point, of certain peculiar chemical elements, previously diffused in the protoplasmic mass.

I can only explain this formation to myself by comparing it, as Schwann has done, in describing the free formation of cells in a blastema to a crystallisation. In the same way as given chemical elements in solution in a liquid can dispose themselves around a fictive point, so as to form a crystal, so here the elements of the nucleolus, diffused at first in the protoplasm, aggregate to form a *globular* body, a veritable nucleolus.

The cell taken in its entirety appears to be an organic combination, comparable to those mineral combinations formed by crystals imbedded one in another.

The nucleolar layer is of a different chemical nature from that of the nuclear layer, just as this also itself differs from the cell-substance. This nucleolus is formed of a substance which differs from the primitive protoplasm by its physical and chemical properties, and these elements of the nucleolus have evidently a special function (as yet unknown) to perform in the life of the cell.

These elements, primitively scattered in the protoplasm,

unite into a small distinct corpuscle, in virtue of the law of localisation, all the while continuing to perform in the economy of the organism the same functions as when they were scattered in the nucleo-cellular layer. It is this same law which is apparent in the progressive complication of any cell whatever, of a muscular cell, for example, when the myosin, at first scattered in the protoplasm, accumulates at a special point of the cell, in which one can then distinguish a protoplasmic body, and a part formed of contractile substance.

It is the same law, again, which presides over the formation of organs by division of labour; the biliary cells, scattered in the lower animals among the epithelial cells of the digestive-tube, continue to fulfil the same function when they have become united in such a way as to form a particular organ—the liver—which presides over the secretion of the bile.

All around the nucleolus can soon be distinguished a perfectly transparent zone, free from molecular granulations; but it is not possible to determine the limits of this zone (figs. 18 and 21).

The pseudo-filarium continues to shorten itself, and the protoplasmic filament soon becomes a body of more or less oval form (figs. 20 to 22), presenting often towards its middle a slight attenuation (sometimes the pseudo-filaria take on the biscuit-form, fig. 19). This body is limited by a dark contour, except at its anterior extremity, where this contour is much more pale. In some individuals the protoplasm bulges out at this point in such a way as to form either a discoid flattened eminence (figs. 19 and 20), or a hemispherical protuberance (figs. 21 and following). Sometimes this is situated in the main axis of the body, at other times it is placed a little on one side (fig. 25). It is in this anterior, somewhat prominent part, that the refringement-granules are always found in greatest number. They are to be distinguished also, but less numerous, in all that portion of the body situated in front of the nucleus. But it appears that all these granules have a tendency to pass to the anterior extremity of the body, and accumulate in the terminal enlargement.

Beneath the dark outline which demarcates the body of the young Gregarina is found a homogeneous and transparent layer of protoplasm, in which not a trace of granulation is discernible. The medullary substance alone is finely granular (figs. 20 and following).

The nucleolus is always very distinct; it is a refringent corpuscle, always rather large, but with dimensions varying

in different individuals. In some there is to be observed in the nucleolus a small vacuole (figs. 25 and 26).

The layer of the nucleus tends to acquire more and more sharply defined limits; in all the nucleolus is surrounded by completely transparent zones, of a very variable thickness, and more or less sharply delineated (figs. 20, 22, and following). In small *Gregarinæ*, of the same size, very notable differences are to be observed in this respect. By the side of small *Gregarinæ*, whose nucleolus is surrounded by a transparent thin layer sharply circumscribed, others of the same size are found, where the nuclear layer is, on the contrary, thick, but with very vague outline. The position of the nucleus is not more constant than its dimensions. Sometimes it is situated in the middle of the body, and in its narrowest part (fig. 19); at other times it is situated in front, in the broadest part of the cell; more rarely it is situated in its posterior half.

We have henceforward under our eyes a young, well-characterised *Gregarina*, which has only to grow in size to become that fine cell of sixteen millimètres in length, which well justifies the name of *Gregarina gigantea*, which I have given to it.

The body elongates progressively, assuming more and more clearly the shape and the characters of a cylindroid sac, a little enlarged only in its anterior fourth. But the posterior part of the body elongates more rapidly than that which is situated in front of the nucleus, and from this it follows that the latter, which in all the young *Gregarinæ* occupied generally the middle of the body, exhibits itself now constantly at the line of junction of the anterior third of the body, with the two posterior thirds, as in the adult (fig. 26 and following).

The little enlargement of the anterior extremity of the body, which is often hemispherical, has also developed itself; only it is no longer circumscribed by a so clearly marked form. It is continuous almost insensibly with the rest of the body, from which it is no longer separated, except by a slight constriction (26 and 27).

The refringent granules which have accumulated in this terminal enlargement have agglutinated themselves into a mass separated from the granular protoplasm of the axis of the sac by a perfectly transparent layer of protoplasm. This layer forms, in the interior of the sac, a transverse partition, which divides the cavity of the sac into two chambers—the one, anterior, very small, is filled with refringent granules, which were at first scattered in the anterior portion of the

body, at the period when the two chambers were not separated; the other, posterior, embraces the larger part of the body of the cell (fig. 26 and following). It is remarkable that from the very commencement of the development of the protoplasmic filament on the surface of the "generating cytod," its free end was more charged than the rest of the body with opaque granulations. The cephalic extremity or "anterior compartment" of the body of the adult Gregarina was already indicated.

The partition between the two chambers which is in continuity with the hyaline protoplasm of the periphery of the body differentiates itself little by little as it gets rid more and more completely of molecular granulations.

Another modification which manifests itself in the constitution of the body of the Gregarina is the more and more complete delimitation of the most external portion of the protoplasm, which soon appears under the form of a membrane with double contour. This membrane, which becomes more and more distinct, can be compared to the cuticle of the Infusoria, and, consequently, may be distinguished as the cuticular membrane.

At the same time as the body elongates, it broadens notably, and the quantity of semi-fluid granular protoplasm which fills the greater part of the sac augments rapidly whilst the external protoplasmic layer, always hyaline and resistant, augments but slightly in thickness.

The nucleus takes on a perfectly regular oval form; it enlarges at the same time as the cell, and it surrounds itself with a membrane, the presence of which, indicated by a double contour, can be demonstrated by making the nucleus submit to a transverse pressure. When the pressure has attained a certain degree of intensity, the nuclear membrane becomes rent (figs. 28 and 29).

I have not recognised in the young Gregarinæ the successive disappearance of the nucleoli, so easy to observe in the adults. In the young Gregarinæ the nucleus never encloses but a single large nucleolus, in which very generally is observed a small vacuole.¹

To complete this work it is necessary to compare the observation which I have above recorded with the most recent researches, of which the lower organisms have been the

¹ Since the publication of my first work on the Gregarina of the lobster (this Journal, January, 1870), where I announced for the first time this fact of the successive disappearance and reappearance of the nucleoli in the nucleus of a cell, M. Svierczweski, Assistant in the Physiological Laboratory at Kiew, has made known analogous facts observed by him in the ganglionic cells of the frog.—*Centralblatt für die M. W.*, 1869, No. 41.

object, and consider them from the point of view of the cell theory and of the protoplasm theory.

Professor Ernst Haeckel¹ has made, in these last few years, a discovery of great importance, in demonstrating the existence of a whole series of lower organisms, devoid of all organisation, of all appreciable structure, of all determinate form. In all phases of existence they consist of simple little masses of protoplasm, without any membrane, and without any nucleus. He has formed them into a special group, which he has called the Monera. These beings are not only the simplest organisms known, but they are the most simple beings which one can imagine. Their existence demonstrates that there are beings to be met with simpler than the monocellular organisms. In fact, the Monera are not cells; life manifests itself in small masses of albuminoid material, without form and without organisation. One cannot distinguish in them any differentiation of parts, any organ, any trace of nucleus. Cienkowski² had observed and described, nearly at the same time as Haeckel, organisms of this group—the Protomonas and Vampyrella; but it is Haeckel who first demonstrated that it is necessary to separate these organisms from all the groups hitherto known; it is he who has demonstrated their extreme importance from the point of view of general morphology; it is he who has proposed to constitute the group of Monera, and who has made known the greater part of the creatures belonging to this group.

The Monera, not being cells, Haeckel proposes to distinguish them, histologically, under the name of Cytods, and he distinguishes the Gymnocytods and the Leptocytods according as these little living masses are devoid of or provided with an enveloping membrane.

The substance which constitutes these organisms is identical, as far as its physical characters are concerned, with the sarcode of the Rhizopods; this is itself nothing more than that protoplasm which one finds in every living organic element, cell, or cytod, whether belonging to a protiston, a plant, or an animal.

From the chemical point of view there ought to be a difference between the protoplasm of the Monera and Cytods generally and the protoplasm of cells. The sarcode of the

¹ E. Haeckel, "Der Sarcode Körper der Rhizopoden," 'Zeitschrift für wiss. Zool,' 1865, Bd. xv. 'Generelle Morphologie der Organismen,' 1866.

² Cienkowski, 'Beiträge zur Kenntniss der Monaden,' Max Schultze's 'Archiv für Mikr. Anat,' 1865, t. i.

Rhizopods, which appears to be identical with the protoplasm of cells, differs from the protoplasm of the Monera and Cytods generally, in that the chemical elements of the nucleolus and of the nucleus diffused uniformly throughout the entire substance of the body of these latter, occurs in the cellular beings separated into distinct organs, the nucleolus and nucleus.

The protoplasm of the Monera, from the chemical and physiological point of view, represents the protoplasm of cells plus the nuclei and the nucleoli. The two substances being different in spite of the identity of their physical characters, and the apparent similitude of their physiological properties, there is ground for distinguishing them, and to distinguish them efficiently it is desirable to designate them under different names. Haeckel has remarked, with reason,¹ that the word "protoplasm" signifies not *formative* substance, but much more *formed* substance (το πλασμα). The word *plasson* (το πλασσον) would serve better to designate the material which is *par excellence* formative, that which constitutes those living beings devoid of organization—the monera and the cytods. I propose the introduction of this word *plasson* into the scientific vocabulary, to designate the substance of cytods, which is capable of becoming, either in ontogenetic course or in phylogenetic course, mono-cellular elements after that the chemical elements of the *plasson* have been separated to constitute a nucleolus, a nucleus, and a protoplasmic body, and to preserve the word protoplasm to designate the substance of the body of a *cell*.

Protoplasm is really relatively to *plasson* a formed material, which has undergone a first differentiation by the formation of the nucleus and nucleolus. The *plasson*, on the contrary, is the formative substance *par excellence*, at the expense of which have been formed in due phylogenetic order all living beings.

Plasson differs from the "germinal matter" of Beale, in that Beale gives this name to the living elements of the cell, whether the nucleus be differentiated or not. *Plasson* cannot exist in a cell; it ceases to exist from the moment when the cellular element has become characterised as such; it is then broken up into protoplasm, nucleus, and nucleolus. *Plasson* and protoplasm present the same physical characters; they can both manifest the phenomena called "vital."

The existence of the Monera and of cytods demonstrates that life is connected with the existence of a determinate chemical composition, much more than to a form; and the

¹ *Generelle Morphologie*,² vol. i, p. 276.

question of spontaneous generation, which has for so long a time been bound up with the question as to whether a cell can take origin independently of a pre-existing cell, becomes now an inquiry as to whether it is possible artificially to engender plasson, and to cause vital phenomena to appear therein. It is quite certain that the Monera—simple fragments of plassic matter—manifest their vitality quite as do the most elevated organisms by the phenomena of nutrition, of multiplication of movement, and of irritability.

Every small living mass of plasson is a cytod, and the cell differs from the cytod in that a nucleus is differentiated in its interior from the surrounding matter. It clearly results from the theory of evolution, that plasson must have existed before monocellular beings, and the latter take their origin in cytods.

The ontogenetic evolution of the Gregarinæ represents the history of the genealogical or phylogenetic development of the cell. The psorosperms give rise to the globules of plasson, devoid of all nucleus, vacuole, or membrane; they may be compared to the simplest Monera. The Gregarinæ are originally then simple naked cytods (Gymnocytods). But soon a clearer and denser peripheral layer appears around the cytod, whilst the central part of the globule remains formed of a more fluid and more granular plasson. The Gymnocytod tends to elevate itself above the Monera, which are always devoid of a cortical layer; whilst we find regularly such a layer in the Protoplasta, viz. the Rhizopods, the Myxomycetæ, and above all, in the Infusoria. In speaking of *Protomyxa aurantiaca* (see this Journal, 1869), Haeckel says clearly, "Nothing is to be observed of a separation into a thicker cortical layer and a thinner fluid medullary layer, as is found in many Rhizopods and Myxomycetæ."

But the Gregarina in course of development remains still in the cytod condition, and on the surface of the cytod the two pseudofilaria develop as buds formed at the expense of the material of the cytod, as described above. In the gradual formation of nucleolus, nucleus, and cortical substance, we see a gradual differentiation and localisation of chemical elements, primitively united in the plasson of the cytod.

There is not a general agreement as to what must be understood by the endogenous multiplication of cells. It has been long admitted that endogenous generation consists essentially in the division of the cellular contents without the cell-membrane taking part in this division; but since we have learnt the true nature of the cell-membrane, we know that it never takes part in the process of cell-division. The

only rational distinction which can be made between endogenous cell-formation and cell-division consists in this, that in the multiplication by division the nuclei of the daughter cells form at the expense of the nuclei of the pre-existing cell; whilst in the multiplication by the endogenous method (which the botanists call "free cell-formation"), the nucleus of the daughter cell develops in the body of the mother cell without the participation of a pre-existing nucleus.

Each of these two modes of multiplication can present itself in connection with a sort of budding. The multiplication by budding is only a particular case of the two fundamental modes of cell-multiplication. What distinguishes this particular mode of division is, that in the case of budding, a generating and an engendered element can be distinguished, a mother cell and a daughter cell; whilst in division, pure and simple, the two cells are derived from one mother cell; they are, both one and the other, daughters, and therefore sister cells.

It is undeniable that the formation of the nucleus in the body of the pseudo-filaria presents us with a true endogenous generation, following on a multiplication by budding of the generating cytod.

The only examples of endogenous generation which I have found mentioned are the endogenous formation of the blastodermic cells in the eggs of a great number of insects, especially of the Diptera;¹ the development of an entire layer of cells in the interior of the vitelline membrane of the ovarian egg of the *Ascidia canina*, without the germinal vesicle participating in the least degree in the formation of these cells;² and finally, the generally admitted fact of the formation of a nucleus in the egg of animals after fecundation, to replace the germinal vesicle.

The observations of Weissman on the formation of the blastodermic cells do not appear to me conclusive; they do not demonstrate that the nuclei which appear in the protoplasmic layer (Keimhautblastem) are not derived from the germinal vesicle. It is notorious that the opacity of the vitellus of the egg of insects generally, renders these delicate observations impossible. And Weissmann's interpretation is rendered doubtful by the fact that in the Cecidomyiæ and the Aphides, where the vitellus is nearly transparent, the nuclei of the blastodermic cells are derived from the germi-

¹ Weissmann, 'Entwicklung der Dipteren.'

² Kupffer, "Die Stammverwandschaft zwischen Ascidiën und Wirbelthieren," 'Archiv für Mikr. Anat.,' Bd. vi, 1870.

nal vesicle, as Metschnikow has demonstrated.¹ The much more recent observations of Kupffer on the development of the Ascidians have brought to light a most remarkable fact; it is the development in an endogenous manner of an entire layer of cells under the membrane of the ovarian egg, and that, too, before fecundation. These cells are formed at the expense of a continuous layer of finely granular protoplasm, and the nuclei are said to appear in the cells after their individualisation.²

I have elsewhere expressed my views as to the development of the nucleus in the fecundated egg in the place of the germinal vesicle.³

In the vegetable kingdom also, certain examples of this mode of cell-multiplication are known, to which botanists give the name of "freie Zellenbildung."⁴ Such are the formation of the embryonic vesicle, and of the first cells of the endosperm.

Seeing that the cases are few in which endogenous cell-formation is demonstrated, my observations on the development of the Gregarinæ have interest from this point of view, since here certainly the nucleolus and nucleus are developed in the cytod by endogenous formation. When I observed, for the first time, the disappearance and reappearance of the nucleolus in the nucleus of the Gregarina, it seemed to me that these facts tended to diminish the importance which one is accustomed to attribute to the nucleolus as a constituent part of the cell. It is, therefore, with astonishment that I saw the nucleolus appear before the nucleus in the progressive development of the cell; and as a result, one must admit a stage intermediate between the cytod and the nucleus-bearing cell; this stage being that of the cytod provided with a nucleolus.

This fact of the appearance of the nucleolus before the nuclear layer confirms the view of the illustrious founder of animal histology, who held that the nucleolus appears first, then the nuclear layer, and finally the body of the cell.

The existence of the Monera, which have been the origin of all living beings, and whose extreme simplicity is found again in the youngest Gregarinæ, proves the existence of

¹ Metschnikow, "Embryologische Studien an Insecten," 'Zeitschrift für Wiss. Zool.,' Bd. xvi.

² Kupffer, *loc. cit.* This cellular layer persists during the entire embryonic development of the Ascidian, and is destined to become the test or external layer of the mantle.—Kupffer.

³ Edouard Van Beneden, 'Recherches sur la Composition et la Signification de l'œuf,' 'Mem. de l'Acad. Royale des Sci. de Belg,' t. xxxiv.

⁴ Sachs, 'Lehrbuch der Botanik,' p. 11.

the plasson as the primitive condition. But in the plasson the nucleolus appears before the nuclear layer. If we identify plasson with the blastema, such as Schwann understood it, we shall return to the views of the celebrated histologist who assigned to the cell a centrifugal evolution. The parts then develop from within outwards, and the nucleolus assumes as great an importance as, or one comparable to that of, the nucleus. It is not easy to reconcile this with the fact of the possible disappearance of this element of the cell, as observed by me in the Gregarina.

Haeckel has, with much reason, arranged the Gregarinæ by the side of the Amœbæ in his group of the Protoplasta; he considers the Gregarinæ as parasitic Amœbæ. "I regard the Gregarinæ as Amœbæ, which have become degenerate (*ruckgebildet*) by parasitism." Every parasitic animal is evidently derived from a form originally living in the state of liberty. It is clear that the Gregarinæ are at least as intimately related to the Amœbæ as are the Lernæans to the free Copepods. But whilst one observes generally in parasitic animals a retrogressive development, the Gregarinæ, instead of retrograding, appear to me to be raised in the scale by their parasitic life. Evidently the Gregarinæ are very high "Lepocellulæ," as the study of their entire organization proves.

By elaborate researches on the chemical composition of protoplasm (analysis of the protoplasm of the Myxomycetæ), Kühne has demonstrated the complex nature of this material. Protoplasm is formed of a mixture of different albuminoid matters, among which are especially found myosin, lecithin, &c. Protoplasm contains, moreover, a substance very similar to vegetable cellulose.¹ In accordance with this, it is very evident that the progressive differentiation of cells and their characterisation from the physiological point of view, depends on the preponderating accumulation of one or other of these principles, and on the separation of this or that from the other elements of the protoplasm (law of localisation).

The muscular cell contains a larger quantity of myosin, able to separate itself progressively from the other elements of the protoplasm in proportion as it is formed. We know that in a monocellular being, somewhat elevated in organisation, this myosin tends to separate itself also, and to become deposited, in one form or other, under the cuticular layer, and to bring into existence in this way, in the cell, a locomotive system, comparable, in a physiological sense, to that of the nematoid worms. The cuticle in the Nematoids is a sort of

¹ Verbal communication from Professor Kuhne.

framework, able to act in virtue of its elasticity; under the cuticle is found a layer of contractile substance, formed of muscular cells.

We find also, in the Gregarinæ, this muscular layer. Leidy¹ was the first to recognise it, and he endeavoured to demonstrate that there exists under the cuticle a muscular membrane, which, when it contracts, becomes plicated longitudinally, in such a way as to produce a well-marked striation. Leuckart² and Ray Lankester³ have arrived at the same conclusion. In studying, by means of reagents, the immense Gregarinæ of the lobster, I have quite satisfied myself of the existence of a veritable system of muscular fibrillæ, comparable to the muscular fibrillæ of the Infusoria. I hope to be able to demonstrate the existence of this system of fibrillæ in a further work on the intimate structure of the *Gregarina gigantea*.⁴

If we take into consideration only this single fact of the existence of a muscular layer, recognised since Leidy by all naturalists who have occupied themselves seriously with the Gregarinæ, we must recognise that these cells rise far above the Amœbæ. In my opinion it is impossible to consider the Gregarinæ as *Amœbæ which have undergone a retrogressive development*.

However that may be, the Gregarinæ of the lobster passes successively, in the course of its embryonic development, through the following stages.

1. Moner stage. 2. Generating cytod stage. 3. Pseudo-filarium stage. 4. Protoplast stage. 5. Encysted Gregarine stage. 6. Psorosperm stage.

It is certain that few of the higher organisms even have so complex an evolution.

Before finishing I have yet to examine the question as to whether one must admit a true alternation of generations in these beings. The solution of this question is entirely dependent on the question as to whether it is necessary to admit the existence of a true conjugation⁵ in these organisms.

That certain species are always found attached end to end is incontestable. But we must not, therefore, conclude from

¹ Leidy, 'Transact. Amer. Phil. Soc. Philadelphia,' 1852, vol. x.

² Leuckart, 'Jahresbericht Archiv fur Naturgesch.,' vol. xxi, p. 108.

³ Ray Lankester, 'Quart. Journ. of Micros. Science,' 1863.

⁴ In a more recent work, Ray Lankester expresses the opinion that the longitudinal striation depends on the cortical protoplasmic layer.—Notes on Gregarinæ, Ibidem, 1865.

⁵ By true conjugation, I understand a fusion having for its object fecundation.

them that there is necessarily conjugation. Certain Gregarinæ can become encysted without a foregoing conjugation ; but when this conjugation does occur, is its object the fecundation of the two individuals, the one by the other, the Gregarinæ being sexual forms ? or is it not rather an accidental phenomenon ? What makes me rather inclined to admit this last interpretation is, first, that the conjugation is not necessary ; secondly, that this apposition of Gregarinæ is observed in certain species in quite young Gregarinæ ; thirdly, that this apposition does not always present itself in the same way. Sometimes the individuals are attached by their homologous extremities, sometimes by their opposite extremities ; fourthly, that one sometimes finds several Gregarinæ attached, one behind the other (Von Siebold, &c.) ; fifthly, that often two Gregarinæ enclosed in one cyst do not fuse together into a single granular mass, but they give rise, each on its own account, to a brood of psorosperms.

I think it is more just to compare the supposed conjugation of the Gregarinæ to the fusion of Amœboid particles forming a *plasmodium*, as De Bary first observed in the Myxomycetæ, and Haeckel in the Monera (*Protomyxa aurantica*). For in these beings this fusion of elements has simply for its object the enlargement of the protoplasmic mass, in order to arrive more rapidly at the reproduction by Sporogonia.¹ In that case, then, the multiplication by division would be the only mode of multiplication in the Gregarinæ, and there would be no digenesis. The multiplication by division would be the only one possible ; but this manifests itself at two distinct stages of their evolution :—1st, it follows upon the encystment, and results in the production of the psorosperms (sporogonia) ; 2nd, it takes place in the generating Cytod, to produce the pseudofilaria (budding).

Haeckel has characterised his kingdom of Protista by the absence of all sexual reproduction. The Gregarinæ find their place in this kingdom, side by side with the true Amœbæ.

¹ Haeckel, "Monograph of Monera," 'Quart. Journ. of Microscopical Science,' 1869.

SOME REMARKS *on the NERVES of the CORNEA of the RABBIT and FROG.* By H. N. MOSELEY, B.A., Radcliffe Travelling Fellow. (With Plate XIII.)

GOLD preparations of the cornea after they have been in the cabinet for five or six months in a glycerine mount, generally turn dark and very often lose their transparency so thoroughly as to become apparently spoiled. It will be found, however, that from such specimens really beautiful preparations can often be obtained. After this long maceration in glycerine, the cornea can readily be torn into a series of extremely fine layers, so fine, indeed, as in the case of the frog, to be only one cornea-corpuscle thick. As the nerves continually get darker and darker by the further reduction of the gold chloride, these thin layers are extremely instructive with regard to these nerves generally, and especially with regard to their relation to the corpuscles, which it is extremely difficult if not impossible to determine when several layers of corpuscles with the surrounding nerves are in the field at once. Although so much has been written on the subject of the nerves of the cornea, it is hoped that the following remarks and accompanying drawings may not be without interest.

Schweigger Seidel in his exhaustive essay on the structure of the cornea in 'Ludwig's Arbeiten,' has figured the points of junction of the larger nerves of the frog's cornea, and has described them as resembling in some degree those of Auerbach's plexus. Those from the cornea of the rabbit have, I believe, not yet been figured, though they are far more complex in internal structure than those of the frog. This structure is only to be seen to advantage in very fully stained preparations which have been macerated in glycerin for some time and then separated into fine layers. The separate fibres of each plexus thus come into view. Two of these are figured in the plate (Plate XIII, figs. 1 and 2), having been drawn with a camera lucida. It will be observed that every branch of each plexus has connecting fibres which connect it with each of the other branches. As the branches are given off in an irregular manner, the plexus thus assumes also an irregular form. The two figured are selected as good typical examples. There are commonly in each plexus two or three fine fibres which do not pass through the general mass, but take as it were a short cut from one branch to another. There are nuclei in each plexus, but they are no longer visible in preparations such as those which

are intended only to show the peculiar arrangement of the fibres.

It is still a question among histologists whether the nerves in the body of the cornea are in connection with the corpuscles. Kühne first described this connection. Kölliker is opposed to him, and Engelmann has observed such a connection in very few instances. On examining a preparation of the cornea in which the nerves are well stained as there figured (fig. 4), it appears at the first glance as if anastomoses between nerves and corpuscles occurred in all directions, it is only after carefully tracing the fibres one by one that such is found not to be the case. The fibres nearly always pass either under or over the processes of the corpuscles. Still there can be no doubt that in gold preparations a direct continuity is to be observed between the substance of the corpuscles and that of the nerves. Such, however, occurs, as far as I have been able to observe, very seldom. No certainty can be arrived at, unless a very thin layer not more than one corpuscle thick be examined, so that no deception may occur from superposition. Two corpuscles from such a preparation are figured (fig. 3); they are from the cornea of *Rana esculenta*. There can be no doubt here about continuity of substance, and the appearance is the same when the preparation is examined with very high powers. If Schweigger Seidel's view as to the post-mortem nature of the corpuscles be correct, it naturally follows that such connection as this is also an artificial production due to the reagents employed. It is merely here contended that an actual connection between corpuscles and nerves is to be seen in gold preparations of the cornea, a fact doubted by many observers. The nerve in connection with a corpuscle is not by any means one of the finest twigs. In the same preparation is another case in point in which the nerve is much finer. The present example is merely chosen because it is so very distinct.

Figured also in the plate (fig. 5) is one of the finest nerve-fibres from the front of the cornea of *Rana esculenta* just below the epithelium. Kölliker mentions the varicose appearance of these fibrils as seen in gold preparations. As their appearance is very remarkable, a drawing of them is given as seen under $\frac{1}{32}$ immersion of Gundlach. The varicosities are so regular that there must be some structural peculiarity which causes them to assume this form under the action of the reagents. I have not noticed anything very similar in other fine nerve-fibres when treated with gold.

On the EMBRYOLOGY of LIMULUS POLYPHEMUS. By A. S. PACKARD, JR., M.D.

(*Read before the American Association for the Advancement of Science, August, 1870.*¹)

THE eggs on which the following observations were made were kindly sent me from New Jersey, by Rev. Samuel Lockwood, who has given an account of the mode of spawning, and other habits, in the 'American Naturalist.' They were laid on the 16th of May, but it was not until June 3rd that I was able to study them. The eggs measure $\cdot 07$ of an inch in diameter, and are green. In the ovary they are of various hues of pink and green just previous to being laid, the smaller ones being, as usual, white. The yolk is dense, homogeneous, and the yolk granules, or cells, are very small, and only in certain specimens, owing to the thickness and opacity of the egg-shell, could they be detected.

Not only in the eggs already laid, but in unfertilised ones taken from the ovary the yolk had shrunk slightly, leaving a clear space between it and the shell. Only one or two eggs were observed in process of segmentation. In one the yolk was subdivided into three masses of unequal size. In another the process of subdivision had become nearly completed.

In the next stage observed, the first indications of the embryo consisted of three minute, flattened, rounded tubercles, the two anterior placed side by side, with the third immediately behind them. The pair of tubercles probably represent the first pair of limbs, and the third, single tubercle the abdomen. Seen in outline the whole embryo is raised above the surface of the yolk, being quite distinct from it, and of a paler hue. In more advanced eggs three pairs of rudimentary limbs were observed, the most anterior pair representing the first pair of limbs (false mandibles of Savigny), being much smaller than the others. The mouth opening is situated just behind them. In a succeeding stage the embryo forms an oval area, surrounded by a paler coloured areola, which is raised into a slight ridge. This areola is destined to be the edge of the body, or line between the ventral and dorsal sides of the animal. There are six pairs of appendages, forming elongated tubercles, increasing in size from the head back-

¹ Dr. Packard complains that he has been misrepresented in our paper on the subject of his present paper, and we gladly avail ourselves of his permission to publish the paper at length.—EDS.

wards; the mouth is situated between the anterior pair. The whole embryo covers but about a third of that portion of the yolk in sight. At this time the inner egg membrane (blastoderm-skin?) was first detected.

The outer membrane, or chorion, is structureless; when ruptured the torn edges show that it is composed of five or six layers of a structureless membrane, varying in thickness. The inner egg membrane is free from the chorion, though it is in contact with it. Seen in profile it consists of minute cells which project out, so that the surface appears to be finely granulated. But on a vertical view it is composed of irregularly hexagonal cells, sometimes 5-sided, and rarely 4-sided, hardly two cells being alike. The walls of the cells appear double, and are either strongly waved, or have from three to five long slender projections, with the ends sometimes knobbed, directed inwards. These cells are either packed closely together, or separated by quite a wide interspace.

In a subsequent stage the oval body of the embryo has increased in size. The segments of the cephalothorax are indicated, and the legs have grown in length, and are doubled on themselves. But the most important change is in the small size of the rudiments of the mandibles, compared with the remaining five pairs of limbs; and the origin of two pairs of gills, forming pale oblique bands between the sixth pair of legs and the end of the abdomen, which forms a narrow semicircular area.

A later stage is signalised by the more highly developed dorsal portion of the embryo, and the increase in size of the abdomen and the appearance of nine distinct abdominal segments. The segments of the cephalothorax are now very clearly defined, as also the division between the cephalothorax and abdomen, the latter being now nearly as broad as the cephalothorax, the sides of which are not spread out as in a later stage. At this stage the egg-shell has burst, and the "amnion" increased in size several times exceeding its original bulk, and has admitted a corresponding amount of sea water, in which the embryo revolves. At a little later period the embryo throws off an embryonal skin, the thin pellicle floating about in the egg.

Still later in the life of the embryo the claws are developed, an additional rudimentary gill appears, and the abdomen grows broader and larger, with the segments more distinct; the heart also appears, being a pale streak along the middle of the back extending from the front edge of the cephalothorax to the base of the abdomen.

Just before hatching the cephalothorax spreads out, the

whole animal becomes broad and flat, the abdomen being a little more than half as wide as the cephalothorax. The two eyes and the pair of ocelli on the front edge of the cephalothorax are distinct; the appendages to the gills appear on the two anterior pairs; the legs have increased in length, though only a rudimentary spine has appeared on the coxal joint, corresponding to the numerous teeth in after life. The trilobitic appearance of the embryo is most remarkable. It also now closely resembles the Xiphosurian genus *Bellinurus*. The cardiac or median region is convex and prominent. The lateral regions are more distinctly marked on the abdomen than on the cephalothorax. The six segments of the cephalothorax can, with care, be distinguished, but the nine abdominal segments are most clearly demarked, and in fact the whole embryo bears a very near resemblance to certain genera of Trilobites, as *Trinucleus*, *Asaphus* and others.

In about six weeks from the time the eggs are laid the embryo hatches. It differs chiefly from the previous stage in the abdomen being much larger, scarcely less in size than the cephalothorax; in the obliteration of the segments, except where they are faintly indicated on the cardiac region of the abdomen; and the gills are much larger than before. The abdominal spine is very rudimentary, forming a lobe varying in length, but scarcely projecting beyond the edge of the abdomen. It forms the ninth segment. The young swim briskly up and down the jar, skimming about on their backs, by flapping their gills, not bending their bodies. In a succeeding moult, which occurs between three and four weeks after hatching, the abdomen becomes smaller in proportion to the cephalothorax, and the abdominal spine is prominent, being ensiform, and about three times as long as broad. At this and also in the second or succeeding moult, which occurs about four weeks after the first moult, the young *Limulus* doubles in size.

Conclusions.—The eggs are laid in great numbers loose in the sand, the male fertilising them after they are dropped. This is an exception to the usual mode of oviposition in Crustacea; *Squilla* and a species of *Gecarcinus* being the only exception known to me to the law that the Crustacea bear their eggs about with them. Besides the structureless, dense, irregularly laminated chorion, there is an inner egg membrane composed of rudely hexagonal cells; this membrane increases in size with the growth of the embryo, the chorion splitting and being thrown off during the latter part of embryonic life. Unlike the Crustacea generally the primitive band is confined to a minute area, and rests on top of the

yolk, as in the spiders and scorpions, and certain Crustacea, *i.e.*, *Eriphia spinifrons*, *Astacus fluviatilis*, *Palæmon adspersus*, and *Crangon maculosus*, in which there is no metamorphosis.

The embryo is a Nauplius; it sheds a Nauplius skin about the middle of embryonic life.

This Nauplius skin corresponds in some respects to the "larval skin" of German embryologists.

The recently hatched young of *Limulus* can scarcely be considered a Nauplius, like the larvæ of the Phyllopora, *Apus* and *Branchipus*, but is to be compared with those of the trilobites, as described and figured by Barrande, which are in *Trinucleus* and *Agnostus* born with only the head and pygidium, the thoracic segments being added during after life. The circular larva of *Sao hirsuta*, which has no thorax, or at least a very rudimentary thoracic region, and no pygidium, approaches nearer to the Nauplius form of the Phyllopora, though we would contend that it is not a Nauplius.

The larva passes through a slightly marked metamorphosis. It differs from the adult simply in possessing a less number of abdominal feet (gills), and in having only a very rudimentary spine. Previous to hatching it strikingly resembles *Trinucleus* and other trilobites, suggesting that the two groups should, on embryonic and structural grounds, be included in the same order, especially now that Mr. E. Billings¹ has demonstrated that *Asaphus* possessed eight pairs of five-jointed legs of uniform size. The trilobate character of the body, as shown in the prominent cardiac and lateral regions of the body, and the well-marked abdominal segments of the embryo, the broad sternal groove, and the position and character of the eyes and ocelli, confirm this view. The organization and the habits of *Limulus* throw much light on the probable anatomy and habits of the trilobites. The correspondence in the cardiac region of the two groups shows that their heart and circulation was similar. The position of the eyes shows that the trilobites probably had long and slender optic nerves, and indicates a general similarity in the nervous system. The genital organs of the trilobites were probably very similar to those of *Limulus*, as they could not have united sexually, and the eggs were probably laid in the sand or mud, and impregnated by the sperm cells of the male, floating free in the water.

¹ "Proceedings of the Geological Society of London," reported in 'Nature,' June 2nd, 1870. In this communication Mr. E. Billings announces the important discovery of a specimen of *Asaphus platycephalus*, showing that the animal possessed eight pairs of five-jointed feet, widely separated at their insertions by a broad sternal groove.

The muscular system of the trilobites must have been highly organized as in *Limulus*, as like the latter they probably lived by burrowing in the mud and sand, using the shovel-like expanse of the cephalic shield in digging in the shallow palæozoic waters after worms and stationary soft-bodied invertebrates, so that we may be warranted in supposing that the alimentary canal was constructed on the type of that of *Limulus*, with its large, powerful gizzard and immense liver.

NOTES on APPENDICULARIA and the LARVAL CONDITION of an ACANTHOCEPHALOID SCOLECID from the COAST of PORTUGAL. By W. SAVILLE KENT, F.Z.S., F.R.M.S., &c., of the Geological Department, British Museum.

THE figures accompanying this communication illustrate two floating forms encountered last summer during my dredging trip with Mr. Marshall Hall and Mr. Edw. Fielding to the coast of Spain and Portugal, in the former gentleman's commodious yacht the "Norna."

The two were observed on one occasion only, early one calm morning in June, when the surface of the sea was like a millpond. Both occurred in large patches, at the surface of the water, and as they floated past the vessel received from our crew the very comprehensive term of "spawn."

The microscope, however, or the unassisted eye even at close quarters, speedily revealed to us that they were bodies of a far higher type, in the literal sense of the term, than had been accredited to them, and at the same time, that the two were essentially distinct from one another, in both histological structure and general form.

A perfect individual of the first of these (Pl. XIV, figs. 1 and 2) might be described as a minute hyaline body, roughly resembling, in configuration, a transparent tadpole, having an inflated anterior portion divided into two separate chambers, with a dependent tail-like appendage attached to it, whose rapid vibrations served to propel the organism through the water. The two chambers of the body proper differed considerably in size, as also in the nature of their respective contents and colorisation, the anterior and larger one being completely filled with pale amber-coloured spherical bodies, varying in number from 80 to upwards of 100, which must undoubtedly be identified as ova, while the posterior, and by

far the smaller one of the two, contained a bright orange-coloured substance, which, on examination with the higher powers of the microscope, was found to consist of incalculable numbers of spermatozoons, either clustered together, or independent of each other, as shown at fig. 4. The anterior chamber, at this stage, exhibited no trace of an opening of any kind; but from the posterior portion of the smaller one a tubular passage proceeded downwards and backwards, terminating in an orifice at *b*.

After floating about for a greater or less time in the condition just described, a sudden change took place, and the wall of the anterior chamber giving way, the enclosed ova were discharged with some amount of force into the surrounding medium, the appearance then presented by the organism resembling that shown at fig. 3, the letter *a* indicating the irregularly outlined aperture through which the ova had burst their way. In this last condition I find it impossible to disassociate it from the form first described under the name of *Appendicularia flagellum*, by Chamisso, since productive of material for elaborate memoirs by Professor Huxley, Leuckart, Gegenbaur, and other eminent authorities, and if not identical with it, it is certainly a very closely allied species. Assuming this, it would appear evident that these singular organisms have been hitherto observed and described only under one phase of their existence, and that subsequent to the discharge of the most important function they are destined to fulfil. Professor Huxley's remarks on the "crumpled and wrinkled" condition of the body, the ill-defined edges of the anterior portion, and his inability to detect any other than spermatoc reproductive elements, recorded in the 'Philosophical Transactions' for 1851, and further confirmed in the volume of this Journal for 1856, of themselves indicate the collapse succeeding the discharge of the ova had already taken place when he examined them.

I may add that the ova on their release were perfectly transparent, and presented no trace of cleavage or differentiation of any kind, and hence we may justly infer impregnation is effected in the water after their expulsion, and not necessarily from the spermatoc elements contained in the same capsule. The discharge of the spermatozoons from the smaller chamber is by no means so sudden or complete, a large portion of them remaining within, and imparting to it the orange tint already noticed, long after the ova have been released.

At this stage the ciliary action observed by other writers

was very conspicuous at the base of the passage (*b*), and by whose means it appears more than probable the evacuation of the spermatozoons is principally effected.

After watching them to this condition of their existence the bodies grew gradually more languid in their movements, the caudal appendage ceased its vibrations, and sinking to the bottom of the receptacle containing them, the disintegration of the whole rapidly set in.

Unfortunately, the specimens set aside in a phial for future study have been mislaid, and the sketches made on the spot and a few brief notes constitute all the material left at my present disposal for drawing up this communication. The day of their capture was an exceedingly busy one, and my non-apprehension at the moment of the many important points still at issue in connection with their structure and economy influenced me to bestow upon them a more cursory and superficial examination than I should otherwise have instituted. Hence the complex respiratory, circulatory, and neural systems, if present, escaped my notice; yet the evidence independently adduced is sufficient, I think, to justify the assumption that *Appendicularia* is neither an adult organism, as premised by Professor Huxley, Gegenbaur, and other writers, nor yet a true larval condition of some higher form, as supposed by Leuckart. The whole organism, in its matured state, as shown at fig. 2, being, indeed, a mere locomotive reproductive sac, would lead me rather to suggest that we have here a true locomotive reproductive zooid, bearing, in all probability, a similar relationship to some stationary tunicate¹ as the locomotive reproductive medusiform zooid does to the fixed Hydroid colony which gives it birth.

Since my return to England I have carefully dissected numerous specimens of the large *Ascidia mamillata*, dredged in the same locality, in the hopes of finding some clue to the development of these puzzling organisms; but hitherto these investigations have been unattended with success, though they have rewarded me in another direction by revealing an interesting example of "commensalism," the ample spaces between the folds of the tunic, in almost every instance, containing numerous specimens of an amphipodous crustacean closely allied to *Leucothæ*, who had evidently made themselves quite at home at those snug quarters.

Before dismissing the subject, I must not forget to refer to the article on various species of *Appendicularia* and the

¹ Assuming from their likeness to the tailed larva of numerous *Ascidia* that they do belong to the same group.

anatomy of the genus, by Mr. Moss, in the second part of the 'Linnæan Transactions' for 1870. The mode of development of Merten's "Haus" is there satisfactorily explained, a phenomenon I have not yet witnessed; but in none of the examples examined does the author report the occurrence of the conditions encountered by myself.

In conclusion, it is not without the greatest diffidence I venture to record the result of my own observations, after the diversely expressed opinions of naturalists of such high standing; yet I the more willingly do so, in the hope that it may lead to further investigation, and still more important discoveries on the part of those to whom these ocean waifs are already to a large extent familiar.

Larva of ECHINORHYNCHUS? (Pl. XIV, figs. 5—7.)

Remarks on this form will be published in a future number of this Journal. The examples from which the accompanying drawings were made were taken floating at the surface of the sea, on the same day and under similar circumstances to those associated with the capture of the Appendiculariæ.

An IMPROVED APPARATUS for DRAWING with the MICROSCOPE. By E. T. NEWTON, H.M. Geological Survey.

THE camera lucida, which is very generally used for drawing with the microscope, has, in common with most of the instruments used for this purpose, the disadvantage of requiring the microscope body to be placed in a horizontal position.

The inconvenience of having to move the microscope after the object has been adjusted, makes it very desirable that some means should be devised by which this could be obviated. The instruments described by M. Nacet, jun. ('Quart. Micros. Journ.,' Vol. VIII, p. 158) all require the microscope to be placed in a definite position, and are somewhat complicated. As these are constructed upon a principle altogether different from that of the apparatus under consideration, it will not be necessary here to do more than call attention to them. A form of prism described by Dr. John Antony, as Nacet's,¹ when mounted in the same way as a camera lucida, can be used for drawing when the microscope

¹ 'The English Mechanic,' Dec. 2, 1870, p. 251.

is set at a certain angle. It is not, however, always convenient to use the microscope at one definite inclination, and for this reason I think that the instrument about to be described will commend itself, since it can be used with the greatest ease whatever may be the angle at which the microscope is inclined. It has also the advantage of being simple in construction, and consequently inexpensive.

This apparatus is, as will be seen, a modification of the steel disc of Soemmering,¹ and the neutral tint reflector described by Dr. Lionel S. Beale.² It consists essentially of a reflector, which can be inclined at any angle; and when set for drawing, is used in exactly the same way as the camera lucida. The arrangement will be best understood by reference to the accompanying figures:—(a) is a silver or steel reflector, the upper edge of which is made thin like a knife blade, as indicated in fig. 3, so that the view of

FIG. 1.

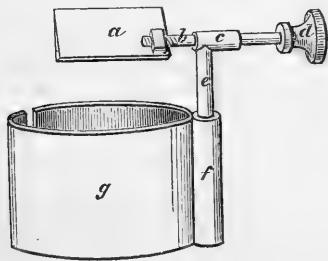

FIG. 2.

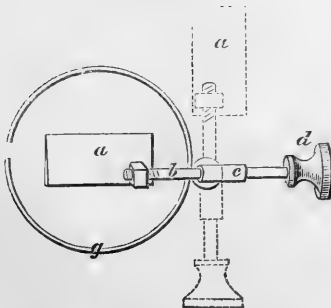
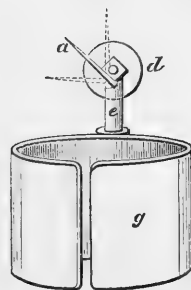

FIG. 3.



the pencil used in drawing may not be interfered with.

¹ *Vide* Dr. Carpenter, 'The Microscope and its Revelations,' 4th edition, p. 100.

² 'How to Work with the Microscope,' 4th edition, 1868, p. 27.

This is most necessary when the microscope is being used at a high angle. The reflector is supported upon the rod (*b*), which turns, not too easily, in the socket (*c*), by means of the milled head (*d*), so that the reflector (*a*) may be placed at any angle desired, as shown by the dotted lines in fig. 3. The socket (*c*) is firmly fixed to a second rod (*e*), which turns somewhat tightly in the tube (*f*). The ring (*g*) to which the tube (*f*) is immovably attached serves to connect the apparatus with the eye-piece of the microscope, which may be done either before or after the object is arranged and focussed. If placed in position before the object is arranged, it can be turned on one side, so as to be out of the way, as indicated by the dotted lines in fig. 2. When it is desired to draw any object that is under the microscope, the reflector is turned into the position shown in fig. 11, until it receives, close to its thin upper edge, the pencil of light from the eye-piece. The ring (*g*) is now turned upon the eye-piece, until the upper edge of the reflector is exactly horizontal. By means of the milled head (*d*) the reflector should now be set at an angle with the drawing paper, this angle being just half the magnitude of that formed by the axis of the microscope and the paper. When thus arranged, which is accomplished more rapidly than can be described, the instrument is used in exactly the same manner as the camera lucida; and any one familiar with the camera would find no difficulty in its use.

For those persons who prefer drawing with the Beale neutral tint reflector, an ordinary thin cover glass¹ may be substituted for the metallic mirror, and the apparatus arranged as before, except that the pencil of light from the eye-piece need *not* fall upon the reflector close to its upper edge, as the drawing pencil can be seen through the glass; whilst in using the metallic reflector, the eye must look over the thin edge in order to see the image of the object and the pencil at the same time.

This apparatus may be used when the microscope is horizontal, or when nearly perpendicular, or at any angle between these two positions. It has also this advantage over the camera lucida, that the object which the microscope has reversed, is again brought into its natural position.

¹ There is no necessity for this to be tinted, as the light may be otherwise moderated.

EXAMINATION of TWO SOUNDINGS obtained in 62 and 68 FATHOMS respectively, LATITUDE $41^{\circ} 52'$, LONGITUDE $9^{\circ} 8'$; and the DISCOVERY of BUCCAL TEETH in the GENUS FIROLA. By JOHN DENIS MACDONALD, M.D., F.R.S., Staff-Surgeon H.M.S. "Lord Warden." Communicated by the Director-General of the Medical Department of the Navy.

THE soundings obtained as above were first closely inspected with a pocket lens, after which they were washed in a saucer of sea water, the delicate objects being cautiously removed with a camel hair pencil, and noted as follows:

1. A minute triangular crab (Maiadæ), invested with sponge, and still living, though the carapace has been so injured as to expose the internal organs.

2. A small Madiola, with yellowish-brown epidermis, ornamented with filiform appendages, was detached with its byssus entangling numerous Foraminifera and one little spiral univalve.

3. A minute Crania (Brachiopoda) upon the dead valve of a Balanus. In this specimen, which was smaller than the head of an ordinary pin, no cilia were observable on the tentacula (the cirri of the authors), though invested with a distinct epithelium.

The puncta of the orange-coloured shell were frequently branched, and in some instances appeared to intercommunicate. It was probably the young of *Crania anomala*.

4. The shell fragments of a recent Lima-shaped Terebratula.

5. The jointed cirrus of an encrinite, evidently detached from the living animal by the contact of the lead.

6. Numerous living Foraminifera.

Considering that the whole area of the arming of the lead could scarcely have exceeded an inch and a half in diameter in the present case, if a swab had been attached to the line the result would have been proportionately more satisfactory. In the year 1852, when H.M.S. "Herald," Captain (now Rear Admiral Sir) H. M. Denham, F.R.S., was at anchor on the Victoria Bank, off Cape Frio, many objects of interest were obtained by sweeping the bottom, as it were, with ordinary swabs. This principle has been most successfully applied by Staff Captain Calver, of H.M.S. "Porcupine," by attaching "hempen tangles" to the dredging apparatus.

A subsequent sounding in Lat. $42^{\circ} 13'$, and Long. $9^{\circ} 1'$ (67 fathoms), proved to be a dark, slate-coloured ooze, loaded

with Foraminifera of various types, but mainly consisting of finely divided matter and mineral particles. There can be little doubt, from the frequently variable success experienced in sounding and dredging over contiguous parts of the same area or district, that at the sea bottom regions of life and death may be conterminous, and are very often irregularly distributed.

Discovery of Buccal Teeth in the Genus Firola.

When favorable opportunities arise in the "Lord Warden," the towing net affords abundant material for study and intellectual enjoyment; and it is quite pleasing to see the interest evinced by officers of all classes in the discovery of new forms, or, at least, such as they have not seen before. This is, however, more especially the case when the difficulty of displaying them under the microscope is removed, and observation is so far rendered easy.

Having frequently taken *Firolæ* of large size in the towing net, even when other marine creatures, with the exception of *Salpæ*, were few and far between, I found, as a new fact, that the mouth was furnished with a longitudinal row of fine conical teeth on either side. These were also in general slightly curved, with the convexity forwards, and exhibited

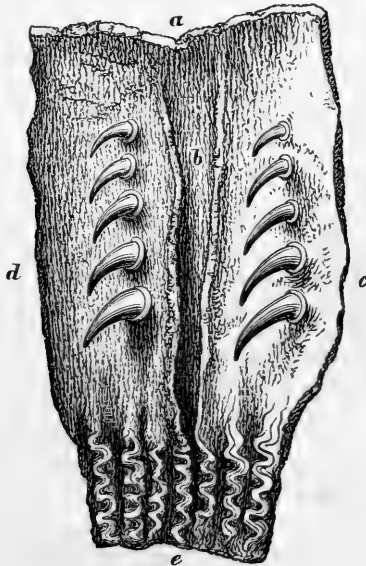

an increase in size from before backwards; the first being

quite rudimentary, and the last highly developed, as shown in the accompanying figure.

Although I had previously communicated researches on the anatomy of the Heteropoda to the Royal Society of Edinburgh, I had altogether overlooked the buccal teeth of *Firola*; and now I am quite sure that further investigation will reveal similar organs in the other genera of the order.

References to the figure which represents the upper and lateral parts of the mouth, with the inner surface turned upwards after the removal of the tongue and buccal mass, improperly so called.

a. The upper lip. *b.* The roof of the mouth. *c.* The left row of buccal teeth. *d.* The right row of ditto. *e.* Œsophageal rugæ.

The NATURE of CONNECTIVE TISSUE. By DR. W. KRAUSE, Professor in Göttingen.¹

IT is usual to distinguish as the fundamental types of connective tissue two modifications, the ordinary fibrous or homogeneous and the reticulated. The former is usually regarded as consisting of a distinctly or indistinctly fibrillated intercellular substance, and variously formed cells, the connective-tissue corpuscles, imbedded therein; and these are described sometimes as stellate, sometimes as spindle-shaped or roundish, sometimes angular and flat. Reticular or areolar connective tissue is composed of anastomosing stellate cells (connective-tissue corpuscles), in the interstices of which is contained fluid with suspended lymph corpuscles.

There would thus be two varieties of connective tissue, the essential difference between which would be that in the former the intercellular substance is solid or fibrous, in the latter fluid. This distinction does not, however, exhaust the molecular arrangements which are ascribed to the connective tissue. A third state of molecular aggregation, certainly not known in the other sciences, is recognised under the name of semi-solid (*festweich*), and a fundamental substance of this kind is ascribed to the homogeneous or gelatinous connective tissue, which is supposed to be connected by transitional forms with the solid or fibrous.

It is obvious, then, that there is only one morphological attribute common to all modifications of the so-called con-

¹ Translated from 'Deutsche Klinik,' May 20th, 1871, by J. F. Payne.

nective tissue; they must all consist of cells and intercellular substance, the first with any kind of form, the latter of any kind of consistency. The indefiniteness of the conceptions which must attach themselves to views so vague is too generally known to need dwelling upon. They are no longer tenable;—not more so than the whole cell theory itself. To begin with the reticular connective tissue, this does actually consist of stellate cells. Their nuclei are oval, their numerous and many times subdivided prolongations are connected with one another, while lymph circulates in the interstices. The structure here described recurs in all organs which can be regarded as belonging to the lymphatic system in a wide sense of the word. To this system belong especially the lymphatic follicles which I first described in 1860 as characteristic structures of the human conjunctiva, Bruch having already observed them in animals.

Now, fibrillated connective tissue, as, for instance, that of a tendon, consists of the very same nucleated cells [which in this situation should now be called inoblasts], only the prolongations of the cells are longer, finer, and do not anastomose with one another. By extending themselves exclusively in two opposite directions, they produce, in virtue of their parallel and undulating course, the appearance of connective-tissue fibrils arranged in bundles.

If a tendon be macerated in Müller's solution, or, according to the method proposed by myself,¹ in molybdate of ammonia, we obtain, beside fibres, a larger or smaller number of spindle-shaped elements. These are the connective-tissue nuclei of the earlier writers, the nuclei of the connective-tissue corpuscles according to later authorities, so called because they have a power of resistance to the action of dilute acids. Sometimes, as is well known, there is observed at the pointed ends of these spindle-shaped elements a fine thread-like prolongation. Closer investigation, however, shows that they pass into very long, delicate, undulating fibres, which are nothing else than the connective-tissue fibres of authors. We can accordingly distinguish in every inoblast its nucleated central portion (formerly called connective-tissue nucleus) and its prolongations (connective-tissue fibres). The somewhat thickened origin of the latter, at the termination of the spindle-shaped central mass, often still contains some protoplasmic granules.

Sometimes only a single fibre is observed at each end. In other cases this fibre splits up into several, or the spindle-shaped corpuscle is itself already divided in its mass. Flat

¹ 'Archiv für Anat. u. Physiol.,' 1871, s. 11.

corpuscles also occur, as was formerly brought into prominence by Billroth, and more lately by Ranvier (without alluding to Billroth). From the ends of these flat and generally multipolar corpuses there often proceed many delicate fibres; at all events, the inoblasts are sufficiently numerous in the tendon to give rise by means of their prolongations to all the connective-tissue fibres.

All the fibres here described of course agree with what are called connective-tissue fibres in their chemical relations. More especially do they become invisible when treated with acids or alkalies, and hence cannot be confounded with the scanty elastic fibres of the tendon. Their length, which has never been seriously taken into account, is considerable, perhaps to be reckoned by centimètres, but in no case so great as that of the tendon itself.

When I proved in 1863 that even the longest muscles of the human body consist exclusively of spindle-shaped, transversely striated fibres, whose length does not exceed three or four centimètres, it was natural to ask the question how long the connective-tissue fibres of the corresponding tendons might be. The length of tendons may even, as is known, exceed a foot, but it can easily be shown that the connective-tissue fibres must be very much shorter.

Since, as was shown above, one or several fibres may proceed from each end of each inoblast, these must be closely applied to the adjacent fibrils. Starting from the attachment of a tendon to a bone, it is obvious that each inoblast sends out fibres in the direction of the muscle. The direction and abundance of the inoblasts may, however, be easily determined after the addition of acids, since each of them possesses a central portion (the connective-tissue nucleus), which resists these reagents. As is well known, these nuclei lie in longitudinal rows. Accordingly, if the prolongations of the inoblasts, which are near the bony attachment of the tendon, reached the muscle—that is to say, if they were as long as the tendon itself—the latter must be tapering or conical. The apex of the cone would be at the bone, the base at the insertion of the tendon into the muscle. Tendons are, however, in contradistinction to the conical form, everywhere of equal thickness, forming flattened cylinders. The prolongations of the inoblasts must accordingly come to an end within the tendon, and cannot attain any considerable length, since if they did there must be some indication of a conical shape, at least near the insertion into bone. If this reasoning be not admitted, it must be concluded that the fibres or prolongations of opposite ends of the inoblasts, must at least near the bony

or muscular insertion, be very different in length, a supposition which is not supported by observation. The tendon is accordingly, when looked at as a whole, constructed precisely like the muscle, if thin inoblasts arranged close one to the other be mentally substituted for the transversely striated, spindle-shaped muscular fibres. The facts of embryology teach, as is well known, that tendons, like muscles, originally consist of series of spindle-shaped cells; and from what has been said above, it results that these relations remain unaltered in the main through the whole of life.

The connective-tissue fibres are, as has been said, nothing more than long, narrow radiations of the embryonal spindle-shaped cells; but while the latter contain albuminous protoplasma, the radiations consist (apart from the scattered granules at their origin above mentioned) of homogeneous gelatinous substance.

The differences between reticular and fibrillated connective tissue reduce themselves accordingly to the different amount of interstitial fluid, without reckoning the anastomoses, which may perhaps be quite wanting in the fibrillated form. The tendon is composed of spindle-shaped or stellate, or again of flattened inoblasts, the prolongations of which all run in the same direction, namely, in the long axis of the tendon. In the reticular connective tissue the prolongations cross one another. In all connective tissue which is composed of bundles the arrangement seen in the tendons is repeated, only that the prolongations of the inoblasts stretch a little inwards towards the central axis of the original fibrillar bundle, since the corpuscles or nucleus-like central portions of the inoblasts are situated, as is well known, only on the outer envelope of the primitive fasciculi.

The most important point is that the connective-tissue fibres of authors are not intercellular substance, but processes of cells, and there is accordingly no intercellular substance in fibrillated connective tissue except the tissue-fluid which permeates the interstices. Since this fluid usually contains some leucocytes (lymph corpuscles, migratory cells, amœboid cells, unattached connective-tissue corpuscles of different authors), as is certainly not the case in the tendon, it may be designated as lymph. In this way a perfect analogy with the reticular connective tissue is established.

According, then, to what has been said, the inoblasts of any portion of connective tissue are collectively identical with the connective-tissue nuclei and connective-tissue fibres of earlier authors, or with the nuclei of connective-tissue corpuscles, *plus* intercellular substance of later authors (Virchow). For

the stellate connective-tissue corpuscles seen in the cross sections of tendons are, as is now generally recognised, nothing more than gaps between the connective-tissue bundles. The nuclei of the inoblasts are equivalent to the nuclei of the spindle-shaped corpuscles of Langhans, or the nucleoli of the connective-tissue nuclei of some writers.

The considerations here urged have also a certain pathological interest. For the cellular pathology, founded upon the connective tissue, rests on the article of faith that the cells are active in disease, but the intercellular substance inactive. It requires, also, the admission of the identity of bone, cartilage, and connective tissue, derived from the supposed demonstration of cells and intercellular substance in all these tissues. But connective tissue has no intercellular substance, except a little fluid. The fundamental substance of bone is, moreover, not an intercellular substance, but originates in the cell bodies of the "osteoblasts," fused together and incrustated. With respect to cartilage, we know, it is true, nothing more than that it consists of cells and intercellular substance; but its share in the production of bone must at least appear doubtful, since the importance of the interstitial [not intercellular] growth has been recognised even in the hollow bones. Finally, as to the part played by connective tissue in the so-called proliferations of cells, no one will now doubt that the inoblasts are as innocent in this respect as what were formerly called stellate connective-tissue corpuscles.

It remains to speak of certain subordinate varieties of connective tissue which may be included under the two main varieties.

What is called homogeneous connective tissue is said to consist of round or stellate cells and homogeneous intercellular substance. With improved optical aids to observation this tissue may be resolved into its constituents.

In the apparently gelatinous tissue of the tadpole's tail stellate anastomosing cells and a homogeneous fundamental substance have been distinguished; but the latter substance is in reality fluid enclosed in a fine network of threads, which are in connection with the inoblasts or stellate cells. These threads are the ultimate prolongations of the processes of the cells, but migratory cells may make their way in the midst of the fluid.

A modification of the reticular connective tissue, which is usually called adenoid or cytogenous tissue, deserves special mention. As long ago as 1860, that is, long before this was regarded as a special variety of tissue, I described the

diffusion of lymph corpuscles in connective-tissue membranes as "lymphatic infiltration" (of the conjunctiva, the intestinal villi, &c.). A similar construction of connective tissue is seen in the neighbourhood of lymphatic follicles wherever these exist, and in part is due to larger lymphatic channels filled with leucocytes.

In the lymphatic follicles, and especially in their central portions, the above-mentioned reticular connective tissue occurs. The small absolute size of the inoblasts themselves, the shortness and manifold ramifications of their processes, are combined with a denser accumulation of the inoblasts, which are placed closer together, and from all these causes that peculiar appearance results which so readily distinguishes the tissue of the lymph follicles from all other connective tissue. Henle was, therefore, not correct in regarding the tissue of the lymphatic follicles as ordinary connective tissue, or in denying the existence of its numerous nuclei.

When the interstices of the reticular connective tissue are filled with round cells and albuminous fluid, a soft, spongy consistency of the tissue results. This is the case not only in the interior of lymphatic follicles, but also in other tissues which belong to the lymphatic apparatus—for instance, in the intestinal villi. The fundamental tissue consists of the fine prolongations of scanty inoblasts, which are stretched between the blood capillaries of the villus. In the meshes lie numerous lymph corpuscles, separated from one another by spaces filled with fluid (lymph). The comparatively small number of inoblasts in an equal volume, and the apparently larger quantity of fluid in proportion to the suspended corpuscles, distinguish this tissue from the reticular tissue of the spherical lymph follicles.

Instead of homogeneous, semi-solid fundamental substance, there is, then, in reality a network of very fine threads filled with fluid. Although invisible when fresh, owing to their having almost the same refractive index as the surrounding fluid (lymph), these threads readily become visible by the action of reagents (chromic acid, dilute soda, even water). As in other cases, a so-called semi-solid substance shows itself, on more accurate investigation, to be made up of solid parts and fluid.

The investigations here communicated date from the summer of 1870; their publication was delayed by the war. The important result is that the connective-tissue fibres are prolongations of cells, not intercellular substance, and that there is in this respect a uniformity in all kinds of connective tissue.

REVIEW.

On the so-called Chorda of the Ascidian larvæ, and the alleged affinity of the invertebrate and vertebrate animals.
By W. DONITZ ('Reichert und du Bois Reymond's Archiv für Anatomie et Physiologie').

DR. DONITZ has availed himself of a stay in Naples to study the development from the egg of *Clavellina lepadiformis*. The Berlin zoologist, as a result, comes to the conclusion that Kowalewsky and Kupffer have unfortunately made a very great mistake in pronouncing the development of Ascidi-ans as broadly and generally identical with the develop-ment of the vertebrates. He, on the contrary, has been taught by his researches that the development of the Ascidi-ans speaks in a very distinct manner precisely *against* the affinity of the invertebrates and the vertebrates. One would think that men like Kowalewsky and Kupffer under-stand something of the developmental history of animals, and especially of the vertebrates. Dr. Donitz, nevertheless, ad-monishes the former especially, that he makes use of such expressions as keimblätter, chorda, nervous system, &c., in such a way as though a signification, long since firmly estab-lished in science, had not been attached thereto. Now, since others are included in this crushing condemnation of Kowa-lewsky and his work, who have given their adhesion to his researches; and since to these last, such men as Gegenbauer and Haeckel belong, not to mention so many others, we are naturally in a state of anxiety to know what kind of argumentation it is which Dr. Donitz brings into the field.

Fortunately we find at once a capital point discussed, namely, the definition of the chorda—that is, of course, the signification of this structure, “so long since firmly estab-lished in science.” It is, according to Dr. Donitz, “an un-paired connecting-piece between the two symmetrical halves of the vertebral system and is itself a part of the same. The existence of the chorda is accordingly conditioned not by its histological structure but by its embryological development.”

That is to say, not the histological structure, but the manner of its development makes the chorda to be the chorda. Have we then any knowledge of development at all, which is not that of one histological structure in the midst of other histological structures? But then the chorda is nothing more than "a connecting-piece" between the two symmetrical halves of the vertebral system. We are really compelled to ask what is it that is actually, and in what way, connected? The vertebral system grows long after the origin of the chorda, from both sides over the chorda, encloses it, and finally produces the result that the chorda entirely disappears. What becomes then of the function of the "connecting-piece?" And further, the chorda is asserted to be primarily merely "the connecting-piece of the two symmetrical halves of the vertebral system, although at the same time it is itself a part of the vertebral system." According to the first part of this definition, the chorda cannot be an integral part of the vertebral system; for then it could not connect the two halves of this system. According to the second part, however, it is an integral part of the same, and, at the same time, its proper connecting-piece. Which half of this definition are we to believe? Does the truth, perhaps, lie there also in the middle, and connect the two symmetrical halves of the definition in the same way as the chorda connects those of the vertebral system? In reality the definition of Dr. Donitz is nothing more than a vague dogma, which has not the least connective force in it. In direct opposition to this dogma, the chorda appears really to have nothing at all to do with the vertebral system, but is originally, in all probability, only a connective-tissue rod to which a portion of the body-musculature has become attached. Through this its gradual change into hyaline cartilaginoid substance is brought about, as we remark everywhere in the embryos of vertebrata, as to the change of connective-tissue into cartilage. Finally, as quite recently has been especially proved by Wilhelm Müller, the connective tissue in the neighbourhood of the chorda grows out into a skeleton-forming sheath, and becomes ossified. And accordingly, since the musculature was previously segmentally arranged, the skeleton-forming sheath becomes also segmentally arranged in connection with it, and receives the vertebrate character. And so, as a result, the chorda has nothing to do with the vertebræ, but is, on the contrary, gradually squeezed out of existence by them.

As to Dr. Donitz's opinion, therefore, that the development of the Ascidians speaks in a most emphatic manner against

the affinity of the invertebrates with the vertebrates, it may be desirable to inquire what Dr. Donitz exactly means by affinity (*Verwandtschaft*); whether, perhaps, he was thinking of something like chemical affinity? But if he uses this expression in the ordinary sense in which it is daily used, it is difficult to understand how he supposes the vertebrate animals to have taken their origin. One certainly would not be indisposed to conceive of the vertebræ as something gradually brought about in the forefathers of the vertebrate animals, somewhat in the way in which we have above briefly endeavoured to explain. But then the forefathers of the vertebrate animals before they developed for themselves vertebræ, necessarily must have been invertebrate; and yet we should account these invertebrate forefathers of the vertebrate as having "affinity" to them. It is, however, possible that Dr. Donitz figures to himself the process of the origin of the vertebrata in some other way, more in the nature of a crystallisation; so that suddenly, from an appropriately large mass of blastema, the entire definitive organs came into existence as a kind of precipitate, or by successive segregations around a centrum, which is perhaps to be discovered in the chorda. Then, in truth, we should have to understand by his expression "affinity" (*Verwandtschaft*) a chemical affinity.

There is only one more remark to make. *Amphioxus* develops notoriously in almost identically the same way as do the *Ascidia*. Should then *Amphioxus* also be excluded from the "*Verwandtschaft*" with vertebrata and the *Petrony-zontes*? Yet they, too, have no proper vertebræ. Perhaps Dr. Donitz may succeed in a new essay in throwing some light on this matter. The gratitude of science will certainly not be withheld from him.—N. N.

NOTES AND MEMORANDA.

Sections of Coal. BY J. SLADE.—The origin of coal has ever been a subject of great interest to the naturalist; but so far as the microscope has been concerned in the investigation, no satisfactory progress has been made until quite recently.

The examination of sections of coal under low powers, either as transparent or opaque objects, is almost useless; but sections, averaging between the two and three hundredths of an inch in thickness, under a quarter, or an eighth objective, show a structure as unmistakably as do sections of recent vegetable organisms. The teachings resulting from examination of such sections have been truly and clearly brought before the public by Professor Huxley in a lecture at Bradford in January last, and again at Leicester in November last, and reported in the 'Contemporary Review.' The means of confirming these observations is in the hands of any one accustomed to prepare objects for the microscope, while the material is close to our hands at any moment. The method of proceeding is as follows:—

A piece of coal being selected, a surface is at first obtained roughly by a file, or piece of sandstone; then a finer, by means of a hone, or piece of fine glass paper; then a still finer, by means of pumicestone, and after rubbing upon Arkansas stone, finally brought to the highest polish possible by friction upon plate glass.

If the coal be very friable (which it sometimes is), it will be necessary to macerate the specimen in thin shell lac varnish and dry it, before the whole process can be accomplished.

In order to secure success, it is impossible to bestow too much pains in this preliminary operation.

Having made a good surface, next cement it to a glass slip by marine glue; the marine glue used, requires careful selection; that usually sold frequently contains particles of the undissolved materials, which are visible enough under the microscope.

However, having obtained the right sort, cut thin slices;

lay them upon the glass slip, and melt over a flame; when thoroughly melted, drop the specimen (the polished surface being downwards) into it, and press out the air bubbles. When air bubbles appear between the glass and the surface of the coal—which they often do, and sometimes prove very annoying—they must be got rid of; otherwise it is useless to proceed, for long before the specimen is thin enough to show structure, the coal over the air-bubble comes away, leaving a hole. If they be not present, the preparation may be proceeded with, first reduced on sandstone, and then finished by pumicestone; and after scraping away the superfluous marine glue, mounting in Canada balsam, and covering in the usual way.

As the preparing goes on, the specimen will be occasionally viewed under the microscope. The first to appear will be the spore cases, and a careful continuance of the grinding will finally render the spores visible.

Spores and spore cases are to be found in every successful preparation of coal; but their relative proportions and degree of preservation vary considerably; thus Wigan Canal almost entirely consists of spores, very few spore cases. Bradford coal, spores and spore cases in nearly equal proportions. Silkstone coal, spore cases few, and much compressed spores in abundance. Moira coal, Leicestershire, spore cases beautifully preserved, and in some, spores *in situ*. Dalkeith coal, the same, the spore cases, on the whole, being slightly more compressed. Wallsend, spore cases much compressed and altered, and mixed up with a quantity of grit and amorphous bituminous matter. White coal, of Australia, consists almost entirely of spore cases.—*Proceedings of Quekett Club, No. 13.*

New Botanical Periodical.—Mr. Currie, in 'Nature' (Jan. 26th), notices a new botanical periodical, 'Beiträge zur Biologie der Pflanzen, Herausgegeben von Dr. Ferdinand Cohn.' Breslau, 1870. (Contributions to the Biology of Plants.) It is established primarily for the publication of the results of the observations made at the Botanico-Physiological Institute of Breslau. The first part contains five papers on different microscopic algæ and fungi and their pathological effects. Three refer to parasites affecting plants, one to a fungoid disease affecting caterpillars; and the last to a plant discovered by Dr. Cohn in the water of certain wells which had the reputation of being unhealthy; but whether the plant in question had any injurious effect on health, Dr. Cohn could not say.

Solution of Acetate of Potash as a Substitute for Glycerin in Preserving Animal Tissues.—Professor Max Schultze in a

late number of his 'Archiv' (vii, p. 180) points out that glycerine, in spite of its undoubted merits as a fluid medium for preparations of animal tissues, has the great drawbacks of causing too great transparency, dissolving fatty molecules, and so on, while it is particularly unsuitable for objects which have been hardened or preserved in osmic acid. None of these disadvantages belong to a nearly concentrated aqueous solution of acetate of potash; which may, like glycerine, be allowed to run in without removing the cover-glass, and will then replace the water or other fluid in which the object is immersed. After twenty-four hours, when the water is evaporated and the saline solution has completely replaced it, the cover may be cemented down. As the fluid neither dries up nor crystallises, the preparations may, if desired, be left some time without any cement. This medium is said to possess all the advantages with none of the drawbacks of glycerine. The latter has the great disadvantage of turning specimens treated with osmic acid dark brown or black, and so destroying the preparation if every trace of the acid be not washed out before mounting, and this is not possible. Since the very extensive use of osmic acid, of which Professor Max Schultze recently spoke to us as neither more nor less than 'himmlisch,' and of such fascinating power as to make one desire to give up everything else and work all day with the microscope, it becomes very desirable to have some other preservative fluid than glycerine.

Parasitic Ear Fungi.—'The Bulletin de la Société Imperiale des Naturalistes de Moscou,' No. 1 for 1870 (just published), contains a paper by Dr. Karsten on the parasitic fungi found in the human ear, with copious illustrations. The writer confirms the statements made by Hallier and other previous observers, that when the spores of these fungi are sown elsewhere, they assume very different forms, according as the matrix on which they are sown is rich or poor in material for nutrition; and that fungi described by earlier writers as distinct species, or even as belonging to different genera, are frequently merely different forms in the genetic cycle of the same plant.

Chemical Society. Fungi in Potable Water.—Professor Frankland, F.R.S., read a paper "On the Development of Fungi in Potable Water." He began by alluding to the experiments Dr. Heisch had made some months back with water contaminated with sewage matter. When to such waters some sugar was added, very soon a kind of fermentation ensued, and a rich fungoid growth made its appearance. Professor Frankland has now repeated and

extended these experiments and arrived, with one or two exceptions, at the same results. But in the course of his researches he encountered some reactions which revealed to him that the presence of sewage matter in saccharic water is in itself not sufficient to produce fungoid growth, but that the presence of phosphates in some form is indispensable to such production. Professor Frankland further found that the germs which give rise to the development of fungi need not necessarily come from sewage contamination, but that they may be derived from the atmosphere. Finally, he found that animal charcoal does not remove those germs. Dr. Frankland thinks that the sugar test of Dr. Heisch for the detection of traces of sewage contamination may be turned into a very delicate reagent for the detection of minute quantities of phosphates; for when these defy the power of the usual laboratory tests, they yet are capable of feeding those germs, and thus giving rise to the fungoid growth. From all his observations Professor Frankland draws the following conclusions:—1. Potable water mixed with sewage, urine, albumen, and certain other matters, or brought into contact with animal charcoal, subsequently develops fungoid growth, and other organisms, when small quantities of sugar are dissolved in them, and they are exposed to a summer temperature. 2. The germs of these organisms are present in the atmosphere, and every water contains them after momentary contact with air. 3. The development of these germs cannot take place without the presence of phosphoric acid, or a phosphate or phosphorus in some form of combination. Water, however much contaminated, if free from phosphorus, does not produce them. A German philosopher has said “ohne Phosphor kein Gedanke.” The above experiments warrant the alteration of this dictum to “ohne Phosphor gar kein Leben.”—*Nature*, February 9th.

Use of Gold Chloride in examining the Tissues.—I may add some remarks to those of my friend Mr. Moseley, for the service of those who wish to make use of that most valuable reagent gold chloride. In all cases where it is wished to follow out fine nerve fibres, gold chloride is very valuable, though dilute acids have also advantages. It is also to be preferred in many respects to carmine in staining gland cells and connective tissue corpuscles. Combined with *freezing* for the purpose of cutting the sections to be acted on by it, its value is greatly enhanced. During the past winter, I have thus made use of the gold chloride, and can recommend the method strongly. A freezing mixture of salt and snow, a pair of wooden forceps (or an American clothes-peg)

and pith to hold the frozen tissue, a small metal box about an inch by half an inch in area to hold the piece of tissue while freezing, are the necessary implements. The razor used for cutting the section must also be cooled in a bason full of snow, and the sections are most conveniently cut in a room which is at or below the freezing temperature. It is convenient to have three razors in use, in order that the one used for cutting may be continually changed, since it rapidly gets warm, and begins to thaw the piece of frozen tissue. Very thin sections may be cut from frozen tissues, and immediately removed from the razor into the gold chloride solution, $\frac{1}{2}$ per cent. (or if so desired into silver nitrate). After remaining there from five to seven minutes, they should be removed to a vessel containing distilled water and there allowed to soak for a few hours. They are then to be placed in water acidulated *not* with acetic but with *lactic acid*. Lactic acid, as pointed out to me by Dr. Kutschin at Leipzig, has a more rapid and certain action in reducing the gold chloride than has acetic acid. After the red-violet colour is fully developed, the sections may be teased out or mounted whole in glycerine.—E. RAY LANKESTER, *Radcliffe Fellow*.

Dammar Varnish.—The following formula, for which we are indebted to Dr. Klein, will be useful to those who wish to try this medium:—Dissolve 1 oz. of gum Dammar in one fluid ounce of turpentine. Dissolve 1 oz. of Mastic in two fluid ounces of chloroform. Filter both liquids and mix.

Mobility of Spines on Certain Insects' Eggs. By H. DAVIS, F.R.M.S. (Communicated by Mr. Curties, August 26th, 1870.) The following communication from Mr. Davis, addressed to Mr. Curties, was read by that gentleman:—

Encouraged by your opinion that my observation of the mobility of spines on certain insects' eggs would be a suitable offering to the Quekett Club, I venture to send some brief notes thereon, a few objects and illustrative drawings for exhibition at the meeting, and a parcel of photographs for distribution among the members. The discovery, such as it is, is a simple matter, and lies in a nutshell, or rather in an eggshell. You know that the eggs of some bird parasites have lately attracted much attention from their novelty and peculiar beauty; foremost among them, the eggs found on the black-quilled Peacock, and on the Mallee bird: now the elegantly curved petaloid spines on the former quickly uncurl, straighten, and contract on the lid *when the egg is placed under water*. They remain thus close until the water is removed, when, as the egg becomes dry by evaporation, the spines loosen; they

gradually and gracefully recurve until the egg again assumes its flower-like form. A group of these eggs in drying make a pretty sight in the microscope,—it is a bouquet of flower-buds actually blooming under the eye of the observer.

The action of the spines seems independent of vitality, and is renewed apparently as often as moisture is applied or removed; thus, on one of my slides, some of the lids are gone and the shells empty, while the contents of other unhatched eggs are shrivelled and dead; still all the spines continue to contract and expand on provocation after a score of immersions.

The parasite eggs found on the Mallee bird possess appendages actuated precisely as are those of the species described; these are the only two I have examined, but it is likely that a few experiments with water on some of the many insects' eggs which bear spines and wing-like processes, would lead to interesting results: desirable also is careful examination with a view to detecting the *cause* of the spines uncurling when wet. An unequally greasy appearance in the eggs when partly dry, leads me to think that one side of each spine is much more absorptive than the other, a quality which would readily account for its activity in water; but this is a mere suspicion, and of no scientific value.

Without pretending to any exclusive knowledge of Nature's object and intentions in this case, and indeed, making only a modest guess at them, I may suggest the probability that the contracted state of the spines over the lid in wet weather only, strengthens and bars that outlet for the time, perfectly restraining the hatching of even mature eggs until the advent of dry favorable weather.—*Proceedings of Quekett Club, No. 13.*

The Mouse's Ear as an Organ of Sensation.—Dr. Schöbl, of Prague, who lately published a remarkable paper on the wing of the bat, has made similar researches on the ear of the white mouse, with very interesting and surprising results (in 'Schultze's Archiv,' vol. vii, p. 260). The first thing which struck Dr. Schöbl was the immense and "fabulous" richness of the ear in nerves. Even the bat's wing is but poorly supplied in comparison. The outer ear was carefully divided horizontally through the middle of the cartilage into two laminae, each of which was found to be equally supplied with nerves, and was then examined by removing the epidermis and the Malpighian layer of the skin. In each of these laminae were discovered three distinct strata of nerves, which are thus described:—The first or lowest stratum lies immediately upon the cartilage; it consists of the largest trunks

which enter the ear, 5 to 7 in number, and their next branches, varying from .074 mm. to .018 mm. in diameter. The mode of division of these trunks is mainly dichotomous, but they are connected by several different kinds of anastomoses; as, for instance, by decussation of two adjacent trunks, by transverse or oblique connecting branches, by plexuses, by loops, &c.; while branches also perforate the cartilage, and bring the nerves of the two halves of the ear into connection. The general distribution agrees with that of the larger blood-vessels. The second stratum lies immediately over the first, and is connected with it by a multitude of small branches, and by a fine marginal plexus at the outer border of the ear, which may be regarded as common to both. The diameter of its nerves is from .0185 mm. to .0098 mm; it lies immediately under the capillary vascular network of the skin, and has a generally reticulated arrangement, forming plexuses of very various shapes. The third stratum of nerves, developed out of the very finest twigs of the second, lies at the level of the capillary network; it is composed of branches .0098 mm. to .0037 mm. in thickness, which (like those of the other strata) contain medullated nerve-fibres. It forms an extremely delicate network, like the second layer, but its finest branches may terminate in two ways. Some of them, each containing two to four medullated fibres, run directly to the hair follicles, and form a nervous ring round the shaft of the hair, terminating below the follicle in a nervous knot. Others, again, consisting of not more than two medullated fibres, bend towards the surface where the fibres lose their double outline, and form, immediately under the Malpighian layer of the skin, a fine terminal network of pale fibres, which is the fourth and ultimate stratum of nervous structures. The terminal "knots" or corpuscles, and the nervous rings, are inseparably connected with hairs, and their sebaceous glands, so that through the whole of the external ear no hair can be found without this nervous apparatus, and *vice versâ*. The connection of the hair follicle with the nerve termination is as follows:— Under the bulb of the hair in each follicle is a more or less conical prolongation, composed of distinct nucleated cells, which runs vertically downwards, and is enclosed within the limiting membrane of the follicle. The nervous twig which, as has been said, runs to each hair follicle from the third stratum of nerves, makes several turns round the shaft of the hair, and from the ring thus formed two to four nerve-fibres run vertically downwards to the prolongation of the follicle, immediately beneath which they form a knot. These knots

are almost always spherical, sometimes oval, and about .015 mm. in diameter.

In each square millimètre of the marginal part of the ear there are about 90 such bodies, and near the base perhaps 20, so that the average number may be 30. Calculating from the average size of the ear of a common mouse, it is then found that there are on the average 3000 nerve terminations on each of its surfaces, making 6000 on each ear, or 12,000 altogether. The function of this elaborate arrangement would seem to be, like that in the wing of the bat, to supply by means of a very refined sense of touch, the want of vision to these subterranean animals.

QUARTERLY CHRONICLE OF MICROSCOPICAL SCIENCE.

HISTOLOGY.

Blood.—Professor Neumann, of Königsberg (*Archiv der Heilkunde*,¹ bd. xii, p. 187, 1871), continuing his researches on the formation of blood-corpuscles, noticed in our last number, has observed coloured nucleated cells, which he regards as transitional forms between the white and red corpuscles of the blood, in several instances in the blood of new-born children (born at the full time), and concludes that the embryonal formation of blood must go on till a later period of development than has been generally supposed—certainly beyond the fifth month indicated by Paget. Further researches must show how long these embryonic forms survive after birth; they were found wanting in the case of a child who died at sixteen days (of disease). Kölliker had previously found them in the spleen and liver of new-born infants. Neumann has found the same embryonic type of blood-cell in the blood of two persons suffering from the disease known as “Leukæmia” (or in England, “Leucocythæmia”);¹ a fact well worthy the attention of physicians.

Medulla of Bones.—In the account which we lately gave of the researches of Neumann on the structure of the osseous medulla and its relation to the formation of blood, no mention was made of the parallel and independent researches of Bizzozero,² of Pavia. In *Virchow's Archiv* (vol. lii, p. 156, heft. 1) a summary of Bizzozero's researches is given, to which we are indebted for the following abstract.³ He dis-

¹ The occurrence of coloured nucleated cells in the blood of mammalia has been observed in many isolated instances. Professor Rolleston has observed them in the blood of the two-toed sloth, and has given several references to similar observations (see *Quarterly Journal*, new series, vol. vii, p. 127, 1867), one of which, by Mr. Busk, in this *Journal*, 1852, refers to man. Eberth found the same in a case of leukæmia (*Virch. Arch.*, xliii, 8.

² *Sul Midollo delle Ossa*, studi del Dr. G. Bizzozero. Napoli, 1869.

³ Professor Virchow remarks, in a footnote, that he himself long ago

tinguishes three kinds of osseous medulla, the *red*, the *yellow*, and the *gelatinous*. The red occupies the most important position with respect to the formation of blood. It consists of three varieties of cells.

1. Cells analogous to the white corpuscles of the blood. These are from $\cdot005$ mm. to $\cdot010$ mm. in diameter, are sometimes without a nucleus, sometimes contain a divided nucleus, or even two. Their contractility is very remarkable, and was observed by Bizzozero so long ago as 1865. He has also directly observed in four frogs multiplication of these cells by division; the actively moving cell drew itself out, became constricted in the middle, and finally separated into two parts. The obvious objection that such cells might be migrated blood cells, was met by the experiment of carefully washing out the vessels of rabbits recently killed by bleeding with solution of common salt before examination of the medulla. The number of bodies resembling leucocytes was not in any degree diminished. It was also observed that the number of such cells contained in the medulla was very far out of proportion to any that could be contained within the vessels.

2. Red nucleated cells, discovered by Neumann. These vary from $\cdot008$ mm. to $\cdot012$ mm., or more, in diameter. They show every transitional form, from the colourless nucleated cells to the red blood discs; some showing a large nucleus and colourless protoplasm, others one or more small nuclei, and a protoplasmic mass of the same colour as the red blood discs. The vanishing of the nucleus takes place by a kind of atrophy, the nucleus breaking up into granules. Elongated cells with two nuclei, one at each end, were also observed; they are either spindle-shaped or narrow in the middle, and show the process of division of red cells.

3. "Gigantic" (or myeloid) cells, with proliferating central nucleus, were observed; their size is from $\cdot025$ mm. to $\cdot045$ mm. They have an irregular round, oval, or kidney shape. They differ from the *myélopaxes* of Robin in shape, size, and consistence, as well as in their locality.

4. White cells containing red globules were first discovered by Bizzozero himself in 1868, and are commonly, though not constantly, present. The shape of these is extremely various, in animals most round or oval; in man more often angular or spindle shaped. Their size is from

distinguished three kinds of medulla—the red, the yellow, and the gelatinous; and also pointed out the analogy of the cells of the red medulla with granulation cells, as well as the occurrence of pigmented cells in that structure.

·01 mm. to ·05 mm. The protoplasm is colourless or slightly yellowish, but contains red blood-globules and pigment-granules. The number of red blood-globules is from one to eight; or in pathological conditions even as many as thirty or fifty. Pigment-granules occur with or without the blood-discs, and are sometimes three or four times as large.

These cells Bizzozero declares without hesitation to be concerned in the destruction of blood-discs, and compares them to the similar forms described by Kölliker in the spleen.

The blood-vessels are described by Bizzozero (agreeing with Neumann) as being extremely abundant in the red medulla, and composing more than the half of its substance. He has observed *capillaries* also, which the German observer failed to find, and has both isolated them and demonstrated, by silver injections, their longitudinal spindle-cells.

The arteries and veins form a kind of framework, in the interstices of which are contained the proper elements of the medulla. While Neumann finds the red blood-cells always within the vessels, Bizzozero observed his cells containing red blood-globules always outside the vessels. The medullary cells are scattered in a quite disorderly manner in the meshes of the vascular network; the "gigantic" cells occur at intervals, and separated by more or less considerable masses of medullary cells. The connective tissue-cells, with their prolongations, form a sort of network, which is demonstrated very clearly on teasing out sections of the medulla hardened in potassium bichromate, or, better, in osmic acid.

The gelatinous medulla differs from the red by its abundant intercellular substance. While in the red medulla the spaces between the vessels are almost filled with cellular elements, there is in the gelatinous a large quantity of amorphous, translucent, colourless, or faint yellowish substance, which coagulates with dilute acetic acid, and dissolves in an excess of that reagent. Moreover, the nucleated blood-cells, and especially the cells containing blood-globules or pigment, are rare.

The yellow medulla is distinguished by its richness in fat-cells from both the others. Various transitional forms between these three varieties of medulla may be met with.

These facts of structure, as well as the variations met with in pathological conditions, illustrate the great analogy of the medulla with the spleen.

Some experiments were made to determine the effect of starvation on the medulla. In a healthy, well-fed rabbit the

leg was amputated, and the medulla of the tibia found to be of a grey colour below, and greyish-red in the upper part, while the microscope detected a large number of fat-cells. In starved rabbits the corresponding structure was found of a dark red colour, and highly vascular. The microscope showed enormous dilatation of the vessels; the veins in some parts touching one another, and leaving hardly any space for the proper medullary tissue. Where there was any interval, it was found occupied by amorphous matter, or else by nothing but medullary cells.

Development of Fatty Tissue. — Flemming, in ‘Max Schultze’s Archiv,’ vol. vii, p. 32, in a paper entitled “Ueber Bildung und Rückbildung der Fettzelle im Bindegewebe,” discusses the formation of adipose tissue, its relation to connective tissue, and its retrogression into the condition of the latter. His observations were made on embryos and newly born animals, and also on animals artificially fattened, in order to make sure that the fatty tissue should be in the condition of increase; also on animals in a state of progressive emaciation. He is in agreement with most of the physiological and pathological observers on the point that fatty tissue is nothing but a modified connective tissue. The only observer who had previously investigated the subject by artificial fattening was Czajewicz, with whom Flemming does not always agree. Flemming finds that the development of fat is always dependent on vessels. The first deposit of fat takes place in the *tunica adventitia* of the blood-vessels, so that adipose tissue might in fact be called a loosely spread adventitious coat of the vessels. Moreover, the fat does not accumulate round newly-formed outgrowths of vessels, but rather round those which are completely formed and comparatively thick. The mesentery, which has been studied by previous observers, was found to be an unsuitable object. The subcutaneous tissue of mammalia was preferred. The advantages of observing mammalia are, that by artificial fattening an unquestionable production of fat can be secured. Rabbits, on account of their numerous parasitic diseases, are unsuitable. Guinea pigs and puppies are better. Young mammalia, still sucking, or shortly before birth, show the same fat-generating process as artificially fattened animals. The production of fat takes place only in isolated foci, round certain vessels of the fatty lobule, while other quite similar vessels show nothing of the kind. The fat does not appear at first, as observed by Czajewicz, in the periphery of the lobules, nor is it contained, as has been asserted by other observers, in special, smaller cells. A certain quantity is

accumulated in the wall of the larger, completed fat-cells, and a small number of fatty molecules are seen free, perhaps in consequence of the mode of preparation; but most is seen in what are believed to be fixed connective-tissue-cells. Migratory cells are seen in great abundance, but are not different from the white corpuscles of the blood, and do not contain fat. The genuine young fat-cells have no membrane, and look at first sight like a heap of fatty molecules varying in size; they are angular or spindle-shaped or polygonal, and only occasionally, when they contain several larger drops of fat, are they round. The smallest of them hardly exceed in size the normal fixed connective-tissue-corpuscles. Although it might seem natural to suppose that the migratory cells should be the early stages of fat-cells, no evidence of this could be found. The fat-containing cells never show spontaneous movements; pigments introduced into the blood pass into the migratory cells, but never into the fat-containing cells.

Observations were also made on fishes, which in the spring, when their nutrition is active, give excellent objects. A small portion of the parietal peritoneum is carefully stripped off and laid on a glass in iodized serum; if surrounded by a ring of oil and covered with thin glass it preserves its appearance, and even the mobility of its cells for as long as half a day. Migratory cells are seen in great abundance, and also young fat-cells, but these structures seem to be perfectly distinct from one another; the migratory cells never containing fat, and the fat-containing cells having the closest resemblance to the fixed connective-tissue-cells. Besides these forms, however, there are others, which have previously been noticed by Leydig as "mulberry-shaped fat-cells," which appear to be nothing else than ready-formed fat-cells, which increase in size by the accumulation of fatty granules in their periphery. These forms are met with rather on the outside of a fatty lobule. Neither in the mesentery nor in the medullary tissue of bone could Flemming find any evidence that the production of fat begins, as has been supposed, in any special round cells, but always in ready-formed connective-tissue-cells. In embryos (of the rat, &c.), the fat production seemed to take place in cells of all kinds, among which were round embryonic cells.

In his observations on the wasting or absorption of fat, Flemming comes to the conclusion that the fat-cells become ultimately converted, not into a "serous fat-cell," as has been said, but simply into the ordinary flattened connective-tissue-cell; in fact, that the process is precisely the converse

of that seen in the production of fat. The cells left after the fat has vanished have no membrane; and Flemming even asserts that the perfectly formed fat-cell has, in some cases, for instance in *amphibia*, no true membrane, the drop of fat being encircled by a ring of homogeneous protoplasm.

The general results are summed up as showing that fat-cells are formed out of the ordinary fixed elements of connective tissue, and can, by the loss of their fat, return to the condition of such connective-tissue-cells again. That there is no special preliminary tissue, and that the name adipose or fatty tissue is accordingly superfluous. The "mucous tissue" of Virchow has no special relation to fat; it has merely the characters of all embryonic connective tissue.

The passage of fat into the fixed connective-tissue-cells is not to be explained by its transmission through plasmatic channels communicating with connective-tissue-corpules; the existence of these channels Flemming does not admit; but he proposes the hypothesis that fat circulates in, and passes out from, the vessels in a liquid form, and then, being absorbed by the connective-tissue-cells, is precipitated in their substance.

The remarkable localisation of the production of fat, he thinks, depends upon the dilatation of the vessels at particular points, and sees another evidence of this dilatation in the large number of migratory (extravasated) cells at these points.

In an introduction, Flemming discusses the general structure of the connective tissue, especially in relation to the views of Ranvier, with which he expresses a general concurrence, rejecting altogether the notion of *hollow* corpuscles communicating by a system of plasmatic channels. His methods were principally the same as those of Ranvier; producing an artificial œdema of the connective tissue, with injections of size, mixed with silver solution, which coloured the tissues, and on cooling produced a mass sufficiently firm to cut fine sections. For tinting, he especially recommends the picrocarminate of ammonia solution of Ranvier, made by *precisely* neutralising an ammoniacal solution of carmine with a pure, concentrated, and filtered solution of picric acid.

Lymphatics in connection with Cerebral Arteries.—'Virchow's Archiv der Pathologischen Anatomie' (Vol. li, p. 568, Dec. 1870) contains an abstract of a paper, not yet published in full, by Dr. Golgi, of Pavia, on the "perivascular spaces" of His. The author holds (with Kölliker and others in opposition to His) that these

spaces are true canals limited on the outside by the *adventitia*, on the inner side by the vascular wall. He has arrived at this opinion by investigations conducted on the vessels of fresh brain substance, as well as on specimens hardened in osmic acid, and in bichromate of potassium. His results were also confirmed by injected preparations, made by injecting a solution of Prussian blue under very gentle pressure into the subarachnoid spaces; which not only filled very beautifully the meningeal perivascular spaces, but penetrated into the cortical part of the brain along the vessels, and along the inner, not the outer, wall of the lymphatic sheaths.

The size of these channels was found to vary with the age of the individual, the particular part of the brain, and the diameter of the adjacent vessel. They are, on the average, wider in children than in adults; and larger in the cerebral hemispheres than in any other part of the brain. From more than a thousand measurements the author finds the average diameter to be—in adults 62μ ;¹ in children 70μ . The following table shows the average diameters in different parts of the brain:

	ADULTS.	CHILDREN.
Cerebral hemispheres . . .	99 μ . . .	81
Corpora striata . . .	77 . . .	75
Thalami optici . . .	76 . . .	54
Cerebellum . . .	56	
Pons varolii . . .	38	

Very careful comparative measurements also established the fact that the lymphatics are not filled from the adjacent vessels, but that their distension holds a converse relation to the fullness of the blood vessels. Hence in rapid hyperæmia of the brain the lymphatics are compressed; when the blood-pressure diminishes they dilate, and so on. These relations were well illustrated by measurements taken from brains in several morbid states; all those in which there was hyperæmia showing the lymphatics small, while in anæmia they were larger.

Many interesting details are given respecting pathological conditions of the lymphatics, which we cannot further enter into.

Researches on the Normal and Pathological Anatomy of the Frog's Skin—By Carl Jos. Eberth, Professor of Pathological Anatomy in Zurich; with three plates (Untersuchungen, &c. Engelmann, Leipzig).

Professor Eberth's researches were made on *Rana escu-*

¹ μ = one thousandth of a millimetre.

lenta, *R. temporaria*, and *Hyla arborea*. His work forms the most complete account of the frog's skin which has been published, which is thus carefully worked out with a view to further studying it under pathological conditions. Amongst the more remarkable facts recorded are—1st. The round openings or pores between the cells of the epidermis, also found passing *through* the actual substance of epidermic-cells, sometimes three through one cell, already observed by F. E. Schulze, most of which are the openings of underlying unicellular goblet-shaped glands. Eberth regards some as mere pores, and suspects the presence of very much finer pores in immense numbers. 2nd. The similarly placed openings of the proper cutaneous glands, which have a curious shape, formed by three converging lines like the bite of a leech. 3rd. The structure of the cutaneous glands, the smooth muscle-fibres of which, the areolar tunica propria, and the nerve-supply, are described and figured. Of this we have given some account below. 4th. The well-known swellings which appear on the thumbs of male frogs are carefully examined. Eberth cannot find touch-corpuscles nor multipolar ganglion-cells in these organs, as some have described. He finds peculiar cells, like white blood-corpuscles, with large round nuclei, but does not consider these as nervous organs. The cells taken by Ciaccio for multipolar ganglion-cells he regards as connective tissue-corpuscles. 5th. The pigment-cells of the cutis are specially examined. Eberth confirms Wittich, as against Brücke, in the conclusion that the green colour in the green skin of the back of frogs is caused by the covering over of the black pigment-cells by *yellow* pigment-cells, and is not an "interference-colour," and hence there is not the difference between *Hyla* and *Chameleon* which Brücke had maintained, for in the former, as in the latter, the granules in the pigment-cells which appear bluish and yellowish-green by incident light, are few and subordinate in effect to the super- and juxta-position of the yellow and black pigment-cells. 6th. The fibres in the small papillæ of the cutis, described by Ciaccio as nerves, are shown by Eberth to be smooth muscle-fibres, which run perpendicularly and spirally into the papilla. The connection of nerve-endings with these muscle-cells is described. Instead of ending in connection with the nucleus or in its neighbourhood, as recently described by Krause for other smooth muscles, in these the muscle-cell tapers away to a very long and fine process below, and the nerve-fibre joins this long process of the muscle-cell. When the medulla oblongata of a frog is cut through there often comes

on, after a few seconds or a few minutes, a very obvious wrinkling of the skin, a true *cutis anserina*. 7th. The nerves of the skin are not very favorably studied in the frog, especially their endings.

Eberth, after several attempts, was obliged to give up the attempt to follow the nerves into the epidermis, and confine himself to those of the cutis, which he studied in *Hyla*. We may refer to Eberth's previous papers on the ending of nerves in the tadpole's tail, and also to some observations made by Dr. Klein, of Vienna, in which gold chloride was used, showing a remarkably fine network of nerves in the epidermis. Eberth describes fine networks of nerves in the cutis of *Hyla*, but insists that these cannot be regarded as terminal. Stellate connective tissue corpuscles, remarkably like those in the frog's cornea, and having the same apparent relation to the nerves, are described and figured; but Eberth does not find himself able to confirm his previous views as to the termination of the nerves in such corpuscles, which he advanced in his paper on the tadpole's tail ('Archiv für Mikros. Anat.,' Bd. ii). At the same time, though the cutis of *Hyla* does not confirm the existence of such a relation, Eberth cannot, in the face of repeated observation, deny the connection in the case of the tadpole's tail.

Researches on the Olfactory Mucous Membrane of the Frog.
By Dr. Sigmund Exner, Assistant in the Physiological Institute, Vienna ('Sitz. der R. Akad. der Wissensch.,' vol. lxxiii, part 1. Read December 15th, 1870).

The author divides the nasal mucous membrane of the frog into three layers—1st. The epithelial layer. 2nd. The subepithelial network. 3rd. The connective tissue layer, with its nerves and vessels. In the fresh condition the cells of the first layer are very soft and elastic, and like blood-corpuscles. They present, on their outer surface, hairs, the longer of which are immovable, whilst the smaller give from forty-nine to sixty strokes in the second. The movement was not affected by the electric induction current, but the cells appear to stretch and return again to their original form. The fresh cells were examined in humor aqueus.

Chromic acid, of 0.5 per cent., and, in other cases, osmic acid in saturated solution, were used for the observing the form of these cells. In concordance with Max Schultze's observations, made on the same subject, Exner finds two kinds of cells, the one (epithelial-cells) having the front portion of the elongated cell-body of about the same width as the nucleus, and the hinder portion passing off into a narrower, but still tolerably thick prolongation; whilst the

other sort (smelling-cells) have an anterior portion much narrower than the nucleus, and an excessively fine long thread-like prolongation from the deeper surface, which passes towards the connective tissue layer Exner, however, cannot confirm Max Schultze as to the essential differences between these two forms, and is, accordingly, not prepared to assign them distinct functions, as that histologist has done. He denies that the nuclei differ in the two forms, but finds that the nucleus exhibits some variation in form and optical character in both. He also states that the difference in the thickness of the portion of the cell in front of the nucleus is of no importance, since he has most carefully and amply observed forms of intermediate thickness. Pigment-drops also occur in the thin anterior piece of the smelling-cells, as well as in the broad epithelial-cells. Schultze pointed out a difference between the two kinds of cells in the presence of hair-like projections on the "smelling-cells." But Exner finds these on the epithelial-cells too. He attributes the absence of them, which is commonly remarked, to their getting detached; such portions of epithelial-cells, *e. g.* in the case of the striated piece on the cells of the intestinal villi, not unfrequently becoming broken away under the influence of reagents.

Exner says he has been very careful not to confuse the proper epithelial-cells of the olfactory region with the ciliated epithelium of the surrounding parts, and gives drawings of two or three undeniable cases in support of his statement, the best of which were obtained by the osmic acid method. That there should be two forms of cells which equally have claims to be regarded as "smelling-cells" is of interest, in conjunction with the fact that two forms of nerve-endings, the rods and the cones, occur in the eye. It would be worth inquiring whether any transition forms between rods and cones occur in the retina as here, between "epithelial-" and "smelling"-cells, and whether, in either case, the transitional forms indicate an actual metamorphosis of the one form into the other—points of which Dr. Exner does not profess to treat. The parallel is striking between the very delicate "centrale Forssatz" of the "smelling-cells" and the similarly delicate thread coming from the "rods," on the one hand, and the thicker corresponding parts of both so-called epithelial cells and the cones.

The *subepithelial network* is a nervous structure, which has been more or less clearly seen by previous observers, and which is very exactly represented in the tongue of the frog, as described both by Axel Key, and more recently by Engel-

mann (in Stricker's 'Handbuch,' Heft iv), in direct connection with which the forked taste-cells are placed. Exner describes a perfectly clear and simple connection of the "epithelial"-cells with this nervous network, and figures their continuity. Max Schultze had described these cells as passing to the deeper lying connective tissue layer, to which they appeared connected by a three-cornered enlargement. This network, now pointed out by Exner, appears to consist of a protoplasmic mass, with numerous meshes in it containing nuclei, which nuclei are like those of the "smelling-cells." With very thin sections, prepared in osmic acid, and teased out, it was possible to observe the direct connection of the cells with this network. Max Schultze describes a network in the olfactory mucous membrane of the Plagiostomi, which agrees very closely with this, and he also appears to have seen, though not fully to have described and figured, Exner's network in the frog.

The olfactory nerve forms a plexus in the connective tissue beneath Exner's network, and the branches from this plexus pass straight up directly into the overlying network, such a branch occupying the space between two of the nucleus-containing meshes. Here the branches gradually lose their characteristic fibrillar aspect, and pass by degrees into the protoplasmic matter of Exner's meshwork, thus completing the connection of the nerve with the cells. This connection is fully illustrated in nature-true drawings in the paper, and rests on observation, not on hypothesis.

Exner doubts whether the fine fibrillar structure often to be seen in branches of the olfactory nerve, when they have been torn so as to present a jagged end, is a living or a post-mortem structure. Max Schultze has regarded these very fine fibrillæ, with their intermittent swellings, as continuous with the identical fine fibrillæ, one of which comes from each "smelling-cell" (so also with the rods of the retina). The course of the fine fibril coming from each "smelling-cell" appears to be quite impossible to follow; it may, and probably does, end in the protoplasmic substance of Exner's meshwork, but is so fine that it would be apparently impossible to trace it further. Two folding plates illustrate Dr. Exner's paper.

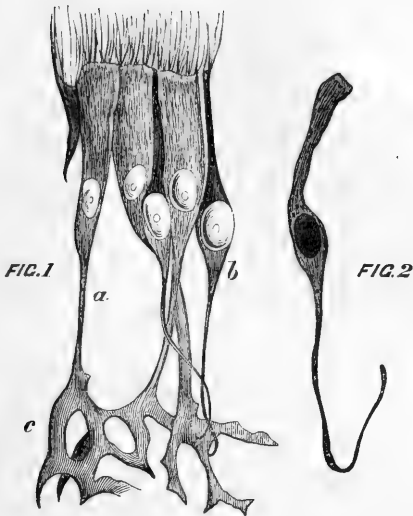

FIG. 1.—*a*, Epithelial, and *b*, Smelling-cells in continuity with Exner's network, *c*.

FIG. 2.—A transition form of the olfactory cells:—the hair-like fringe is broken away.

The Nature of the Influence of Nerves on Gland-cells, as illustrated by the Cutaneous Glands of the Frog.—Two papers have recently appeared of considerable physiological interest in relation to the 'gland and nerve' question, one is by Engelmann, of Utrecht, in Pflüger's 'Archiv.' The other a separate work on the 'Skin of the Frog,' is by Professor Eberth, of Zurich (see above). It has long been known that some of the cutaneous glands of the frog are contractile, and their structure has been very carefully studied with not quite concordant results by Stieda, Ciaccio, Szczesny, Leydig, and Hensche. Engelmann finds that if the foot of *Rana esculenta* be spread out so that the small glands in the swimming membrane are observable, and the sciatic nerve in the thigh be then irritated by the induction-current, a contraction of the glands is at once observed, the lumen almost disappearing and the cells of the gland altering their form.

Engelmann found that the administration of curare does not affect this phenomenon, so that the experiment may be very easily made on curarized frogs.¹ He seems to have

¹ I have repeated Engelmann's observations, obtaining a very sudden contraction of the gland so that the secretion is sharply spurted out.—E. R. L.

been inclined to ascribe the contraction of the gland to a direct action of the nerve on the proper gland-cells. In the larger cutaneous glands of the frog, smooth muscle-fibres have been described by Szczesny and Ciaccio, also in the smaller ones surrounding the gland-cells and enclosed by the tunica propria of the gland, which tunica appears to be of an areolar character. Eberth in the paper above noticed figures the smooth muscle-cells as seen in sections of the glands, but remarks curiously enough that he has failed to detect them in the glands occurring in the swimming membrane of the foot. There can, however, be little doubt that they are represented there, and it is through the contraction of these proper contractile elements that the change in the dimensions of the glands is effected. Engelmann has, it is said, more recently observed elongated cells in the cutaneous glands of the foot, to which he attributes the contractile property, and which, doubtless, correspond to the previously described smooth muscular fibres. Szczesny says that some of these muscular fibres exhibit cross-stripping, but Eberth cannot confirm him in this; such markings are due to plications and not to differentiation of the cell-substance.

The nerves of the cutaneous glands first mentioned by Ciaccio are described and figured in Eberth's paper. A very fine network of nerves is described by him lying close round the gland-cells, the points of intersection of the fibres having often spindle-shaped nuclei. From this fine net-work, which is not due to any deceptive appearance of the intermediate substance of the gland-cell, since it is brought to view by dilute acetic acid, which shrinks up the gland-cells, proceed still finer fibres which appear to pass to the gland-cells, whether entering into direct connection with them or not Eberth does not say. Here, again, the histologist is baffled in attempting to determine the connection of nerve- and gland-elements. It is, however, clear that Eberth's thoroughly trustworthy observations do not tend to confirm the view of an abrupt junction of nerve- and gland-element as maintained by Pflüger for the liver and salivary glands.

Retina.—Landolt (M. Schultze's 'Archiv,' Bd. vii, 81) has studied the retina of the frog on preparations made with the help of osmic acid, especially of the stützgewebe.

He confirms generally the observations of M. Schultze (in his 'Archiv,' Bd. ii, s. 267).

Another research on the retina of the frog appears in Reichert and Dubois-Reymond's 'Archiv,' 1870, p. 642, by Dr. Merkel, who worked independently of Landolt, but finds

himself in the most important points in agreement with that observer.

EMBRYOLOGY.—Oellacher ('Die organischen Veränderungen des unbefruchteten Hühner-Eies, Zeitschrift des natur. med. Vereins in Innsbruck,' 1870; Centralblatt, May 27th, 1871) has observed the remarkable fact that even in warm-blooded vertebrata, the first act of embryonic development, namely, segmentation, may take place independently of impregnation by male semen. The author found in unimpregnated fowls' eggs, the yellow spot composed to external observation of three zones, namely, of an outer homogeneous ring, an inner spotted one, and a central homogeneous spot. The two first are only condensed portions of the white outer layer of the yolk which here, going under the central spot, passes into the central process of the yolk. The central spot alone is the true germ, and this has the form of a biconvex body. Microscopical examination now shows the germ to be composed of small roundish angular elements arranged in several layers, and each with a yellow nuclear spot, as after impregnation. When seen as a flat object, the appearance is also very much like what Coste has described as that of segmentation in impregnated fowls' eggs, namely, a mosaic of cells in the centre and radiating grooves passing to the circumference. On incubating eggs of this kind, the author first saw the elements of the uppermost layer multiply, and those of the under layer become larger and finely granular; but then solution of the cells gradually took place. Such eggs are accordingly incapable of further development. Nevertheless the process described constitutes the first step, though an abortive one, to parthenogenetic development. Attempts at parthenogenesis and partial embryonic cell-formation in unimpregnated eggs have, however, been already observed. The author draws attention to the observations of Hensen on the eggs of rabbits, which unimpregnated, and within closed cysts, developed themselves into poly-nucleated protoplasmatic masses and fibres; and further to the memoir of Kupffer on *Ascidia canina*, in which creature there arises in the egg, before impregnation, a peripheral layer of epithelium, which later on, after impregnation, becomes the external covering of the animal.

MICROZOOLOGY.—'On the production of Swarm-spores in *Noctiluca miliaris*,' by Prof. C. L. Cienkowski. With two plates. (Max Schultze's 'Archiv,' 2nd part, 1871).

The developmental history of the *Noctiluca* is very imperfectly known up to the present time; the multiplication by division and production of internal buds is nearly all

the knowledge we possess upon this matter. Baddeley in this Journal ('Q. J. Mic. Sci.,' 1857, p. 189), fully described the process of division. On the other hand, the supposition of Busch that the youngest stage of *Noctiluca* proceed, from internal germ-bodies is not proved. Gosse ('Rambles on the Devonshire Coast, 1853') endeavours to establish a reproduction by internal budding. Busch observed round, transparent discs, of the same size, consistence, and optical properties as the *Noctiluca*, often occurring among these. Their contents were nearly homogeneous, except at one spot where several yellow processes were remarked. Busch could not determine what relation these bodies bore to the *Noctiluca*. It is such bodies as these which Prof. Cienkowski has studied during April and May, 1870, at the Island of Prinkipo, off Constantinople. He has succeeded in tracing the formation of spores (drawn in the woodcut), similar in appearance to those of some fungi, and swimming round about like algæ-zoospores.

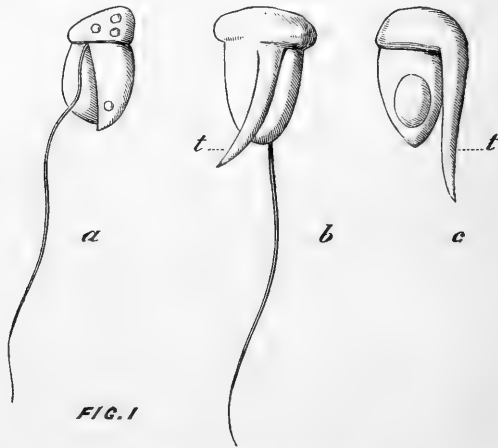

Swarm-spores of *Noctiluca*.

The process of formation was inferred first from the observation of different specimens, and then traced by direct observation step by step in the same individual through some important stages, though it was not possible to do so throughout. It is exceedingly difficult to keep the same *Noctiluca* during a length of time for observation. Prof. Cienkowski found that placing them in a drop of water on a thin glass cover which was placed over a *moist chamber* so as to exclude all access of

dry air to the water in which the animals are living, succeeded best. In this way he kept specimens twelve hours. The stages observed are—1st. Noctiluca-like bodies, but without mouth or lash, and having a doubly spherical or so-called biscuit form, each partial sphere having a granular protoplasmic mass with fine branching rays, the two masses being connected more or less. 2nd. The protoplasm collects so as to form a disc on one pole of the irregular double spheroid, which gradually becomes spherical, exhibiting three or four depressions at one pole. 3rd. The protoplasmic disc sends out stumpy processes which project from the surface of the spheroid and exhibit peculiar wriggling movements. 4th. The mass commences to divide into smaller pieces, the vesicle being now quite spherical. The commencement of this division was not directly observed, but later stages, in which clumps of protoplasmic matter were seen arranged at first in groups of eight; these, then, were followed carefully through their division into groups of sixteen irregular, oblong particles. These products of division appear like denser, sharply-defined masses or nuclei, lying in a less dense surrounding granular plasma. 5th. The next stage was one of the first and most commonly observed, in which the protoplasmic disc, formed as above described, has become entirely split up into small oval bodies, each $\cdot 016$ millimètre long. The aggregated mass of these oval spores sometimes appears as a disc at one pole of a Noctiluca-like vesicle, or as a girdle passing round it. 6th. By high powers each oval particle is seen to have a terminal cilium, and whilst under observation many were seen to separate from the disc and swim about as free swarm-spores: such as that drawn in woodcut fig. 1 *a*; fig. 1 *b*, and *c*, are later stages of the free development of the swarm-spores. The large development of the process *t* is very interesting. Professor Cienkowski thinks it not improbable that this becomes the “tooth” of the adult *Noctiluca*. The further development of these spores was unfortunately not traceable, and there are some difficulties in attempting to harmonise their appearance with young *Noctiluca*, as described by previous authors.

A further point, however, of much importance, is established by Cienkowski. He has succeeded in observing, step for step on the stage of the microscope, the copulation of the two *Noctiluca*. The two animals place themselves with the two so-called “oral apertures” close to one another, and through these a protoplasmic bridge is formed, which unites the nuclei of the two individuals. Later, at the points of contact,

the outlines of the two Noctiluca-vesicles fuse, and thus the double spheroid or biscuit-shaped bladders are formed. By further fusion the pinching in of the vesicle disappears from one side, so that the vesicle becomes more nearly spherical. Meanwhile the two nuclei become completely fused into one, retaining, however, their radiating threads and network, as in normal individuals. The cross-striped "lashes" and the "teeth" of the two fused Noctiluca also disappear. All trace of the double origin of these "copulated Noctiluca" may pass away by the disappearance of the fold on the surface, near to which the nucleus lies, and thus a Noctiluca vesicle is formed, which is always larger than the normal Noctiluca, and seems identical with the bodies noticed by Busch, and also very probably identical with the biscuit-shaped and spherical Noctiluca vesicles in which Cienkowski has traced the formation of the swarm-spores. A direct observation of the formation of swarm-spores in the copulated forms Cienkowski was not able obtain.

Ciliary Movement.—In the 'Biologische Studien,' his latest contribution to scientific literature, Professor Haeckel gives the result of some highly important observations on the nature of ciliary movement. The most recent investigations on this subject, viz. those of Dr. W. Engelmann ('Jenaische Zeitschrift,' 1868, vol. iv, p. 321), as also the earlier ones of Dr. M. Roth ('Virchow's Archiv,' Bd. 37, p. 184), have shown that physiologically the ciliary is much more nearly related to the amœboid movement than to the muscular. Professor Haeckel's observations show that the ciliary movement is merely a modification of the amœboid movement of protoplasm. Ciliated cells are of two kinds. In the one kind (epithelium flagellatum) each cell is provided with a single long flagellum or lash—sponges possess only this kind; in the other (epithelium ciliatum), numerous hair-like appendages take the place of the flagellum. This is the kind found in most of the higher animals. The old notion, that in ciliated cells the cilia are attached to the outside of the cell membrane, must now be considered as entirely set aside. Many, probably most, ciliated cells are destitute of a membrane, and the appendages, whether flagella or cilia, are direct processes of the protoplasm of the cell. Professor Haeckel's observations on lower organisms during the last year have led him to the conclusion that ciliated cells arise directly by the transmutation of amœboid cells. This transmutation he has observed in the case of the motus flagellaris, in Monera, such as *Protomyxa anurantiaca* and *Protomonas*

Huxleyi. The swarm spores of these species, when they leave the parent cyst, are pear-shaped, with a single long hair-like flagellum, by the lashing movement of which they swim about. After a time they settle, whereupon the flagellum becomes an amœboid process. These are merely cytods, but the same phenomenon has been observed in the case of swarm spores with a nucleus, *i.e.* real cells, and described by De Bary, in his monograph of the Myxomycetæ. The same thing was seen in the epithelial cells of sponges of the order Leucoscleria by Professor Haeckel, whilst at Bergen, in Norway, in August and September, 1869. But by far the most interesting observations of the Professor on this subject are those made in the Canary Island Sanzerote. Here he has been able to observe the direct origin of the motus ciliaris from amœboid protoplasmic movement, first, in the spherical masses arising from the division of the egg in the Siphonophora; secondly, in a new and very remarkable form which he has discovered, and which he calls *Magosphæra Planula*, and considers to represent a new and separate group of the kingdom Protistæ. This creature has a ball-like body, consisting of pear-shaped cells, bedecked with many cilia. These ciliated cells not only can be seen to develop out of amœboid cells, but also subsequently to resume that condition. For after the ciliated ball has swum about for some time, its component ciliated cells separate from one another, and gradually pass into an amœba form. These observations of Professor Haeckel are not only of importance as confirming physiological results, but also of classificatory value, as showing that their possession of cilia, as opposed to the exhibition of an amœboid movement, must not any longer be considered as a ground for placing the Infusoria in a separate group.—*Academy*.

Histological Classification.—Rollet has published [‘*Untersuchungen aus dem Institute für Physiologie in Graz*,’ 1871, 2tes Heft, p. 111; ‘*Centralblatt*,’ No. 20, 1871, p. 308] a valuable paper on the discrimination of elementary parts and tissues. In the first part Rollet opposes the rigid distinction lately introduced by E. Hæckel between cells and cytods, as well as the theory of the same writer relative to the homogeneousness of protoplasma. In the second part he develops the principles which should be made the basis of a scientific classification of tissues, and criticises the systems of Henle, Frey, Beale, Kölliker, Leydig, and Hæckel. Rollet’s own system claims to be founded upon physiological experience. He adopts the views of His relative to the distinc-

tion of epithelia and endothelia, and shows the fallacy of certain objections which have been made to this distinction, viz. the supposed occurrence of ciliated epithelium upon serous surfaces. Waldeyer had already shown that the presence of cilia on the peritoneum is dependent upon the peculiar connection of the female sexual apparatus with this cavity; but several observers had thought they had detected cilia on the pericardium of the frog. Rollet shows that this is an error, part of the peritoneum having been removed with the pericardium.

PROCEEDINGS OF SOCIETIES.

DUBLIN MICROSCOPICAL CLUB.

26th January, 1871.

DR. JOHN BARKER explained the principle, by the aid of diagrams, of the "Aplanatic searcher" proposed by Dr. Royston-Pigott, and expressed his view that the researches of that gentleman would hereafter be found to open up the way to very extended and improved means of investigation being placed at the command of microscopists.

Dr. Frazer exhibited specimens of Topaz showing crystalline cavities containing a fluid of a different nature, also gaseous matters.

Dr. Macalister exhibited prepared examples of the new louse parasitic on the flamingo, and named by him *Lipeurus Phoenicopteri*, description and figure of which are given in the 'Quart. Journal of Micr. Science,' vol. xi, n.s., p. 163.

Dr. Moore showed a preparation by Mr. Keit of the statoblasts of a Plumatella from the tank in the Botanic Garden, forming a pretty moderate-power object.

Rev. M. H. Close showed Gundlach's new so-called "1-24th" objective, bringing it to bear upon some difficult diatoms, which performed very satisfactorily.

Rev. E. O'Meara exhibited some forms of Polycystina obtained from soundings made by Capt. Chimmo, R.N., H.M.S. "Nassau," 16th July, 1870, in the Indian Ocean, lat. 3° 23' N., long. 84° 44' E; also slides containing some forms of *Synedra* new to Ireland, perhaps to Great Britain; *Synedra debilis*, Kütz., from a gathering, River Dour, Co. Cork, in the herbarium of Trin. Coll., Dublin; *Synedra gracilis*, Kütz., very different from that of Wm. Smith so-named, occurring on sea-weeds collected at Salt Hill, and mixed with the variety *S. barbatula*, Kütz. and Grunow; *Synedra parva*, Kütz., occurring with tolerable frequency in the same gathering; *Synedra Nitzschioides*, Grunow, 'Verhand. der k. k. Zool. bot. Gesells.,' xii Band, 1862, p. 403; found by that author in the Pacific Ocean, and occurring occasionally among other forms in the stomachs of Ascidiæ, collected in Roundstone Bay by A. G. More, Esq.

Mr. Archer had been lately considerably struck by certain cases of the phenomenon of locomotion without visible motory organs, as evinced by some minute organisms, one of which, at

least, was of a type, so far as he was aware, in which such had not been noticed by other observers. This is, of course, in itself—putting the molecular or “Brownian” motion altogether aside—no new phenomenon, inasmuch as we have it presented by Oscillatoriaceous forms, diatoms, Bacteria, &c. But of the two organisms he would, on the present occasion, present for exhibition to the Club (side by side upon the same slide, so as to detain the meeting as briefly as possible), one, at least, as mentioned, had not, he thought, attracted the notice of observers, if at all, certainly not in this regard—that is, as evincing active spontaneous motion without the least appearance of cilia or flagella, or, indeed, any other motory organs. Morphologically viewed, the first to which he would draw attention was a species of the algal genus *Cœlosphærium* (Näg.). As is characteristic of that genus, the cells here are combined into a peripheral stratum around a globular or more or less irregularly lobed mucous mass; in this form the cells, which are closely apposed, are minute, reddish, each with a bluish envelope or margin. They are considerably more minute than in *Cœlosphærium Ehrenbergianum* (Näg.), being about $\frac{1}{10000}$ of an inch in diameter, that of the families, of course, very variable. But the remarkable speciality, however, in the present form is the active movements executed by the colony or family as a whole. Probably the smaller ones evinced this phenomenon more vividly than the larger, but this might be to a great extent due to the fact that such were less pressed upon by the covering-glass, &c., and thus more free to move. Their action consists in a vigorous revolution, now this way, now that, combined with a more or less rapid onward motion of the whole—each rotating, spinning on its axis, rolling onwards, returning, a while quiescent, then again revolving and moving onwards, backwards, and forwards, in a most indeterminate manner; in the examples occasionally presenting themselves of a lobed or indefinite figure the motion is more or less jerky and eccentric. Thus, the movements executed are in the main comparable to those of *Volvox globator*, but very greatly more rapid, though fitful. The largest family ever seen was not a quarter the diameter of a *Volvox*, whilst some families were not more than $\frac{1}{20000}$ of an inch across. Nevertheless, not any cilia or evidence of cilia could be as yet detected. Can this alga be known to other observers elsewhere? Mr. Archer could not by any means think it a “*Volvo-cine*,” perhaps opportunity might occur to give this curious form more due study, and to that it must be left.

The other organism seemingly moving without locomotive organs Mr. Archer was inclined to suspect to be a motile stage of a very common production, whose identity was unknown to him, consisting of an elliptic seed-like body, of smooth exterior, ordinarily very densely filled with shiny, opaque, greyish or somewhat brownish “starchy” looking granules; the outer “wall” is very smooth, delicate, pellucid, of a bluish tinge. This organism, be it what it may, as yet baffled attempts, so far as he could dis-

cover, to decide as to its nature, and yet it is widely distributed in the deeper pools in suitable situations. *A priori*, it cannot be a "spore" or "ovum," as it constantly repeats itself by transverse self-division; the elliptic figure becomes cut transversely into a "figure-of-8" by a constriction, at first shallow, then going deeper and deeper, until presently the two new "cells" (so to call them) are held together by a mere narrow thread, eventually separating; it does not seem to disclose a nucleus. It occurs of various sizes: breadth of large specimen, say about $\frac{1}{750}$ of an inch; length, one and a half to three times the breadth; and, indeed, it would appear, when a good gathering is kept some time in the house, as if the individuals diminished in size, seemingly due to a dwindling down in the growth of the new "cells." The larger ordinary examples appear sometimes to have a very slight, from side-to-side, automatic vibratory kind of motion, but generally this is very faint or absent; when a quantity of them is placed on a slide, their tendency is to roll down by gravitation, and become accumulated at the lower margin of the slide, thus *seeming to move up* the field. For want of any special appellation, Mr. Archer, in order to put hands readily upon it amongst other bottles, had frequently temporarily labelled gatherings containing this production simply "80," the first figure symbolising the *dividing* state, the other the *ordinary elliptic* form. Would such a crude description suffice to convey an idea so as to gain an opinion as to the identity or nature of this *thing*, or would a drawing be requisite to elicit such from some more experienced observer? It may be, indeed, some commonplace enough affair, and a marvel here with us only just so long as we are ignorant. But in relation to the phenomenon of motion and no visible motory organs existent, what Mr. Archer desired now to draw the Club's attention to was, as mentioned, what appeared to be a condition or stage of the organism just referred to. This moving thing, of greatly smaller size (say, about $\frac{1}{3000}$ of an inch in diameter, and three or four times longer), has a more elongate and tapering figure, but contains granules quite alike in colour and nature, of the same shiny aspect and opaque greyish starchy appearance. They are, however, fewer; the larger ones at the middle, two notably larger than the rest, and smaller ones at each end beyond these, and a few smaller still sometimes filling up the interstices, the whole surrounded by a similar smooth, pellucid, bluish-tinted envelope. Now, these bodies move along with great vigour, in a more or less straight direction, now one end foremost, now the other, at "random," pretty rapidly revolving on their longitudinal axis as they progress, but no evidence of any cilia or flagella, or other motory organ. If this organism represent the *Bacterium triloculare* (Duj.), then Dujardin's figure cannot be accounted good; his form is represented like a short, somewhat tapering *confervoid* filament, with very short joints and septa exactly transverse. Moreover, one figure gives a short *flagellum*, but this latter organ attributed thereto is but conjectural. In the present the

intervals between the granules do not appear like septa, nor has the organism a jointed appearance. The intervals between the variously sized and somewhat variously figured granules are, indeed, but the irregular interspaces between these, enclosed within a common cavity, not septa shutting off distinct "joints;" it is unilocular. Be it, however, as it may, the production now shown is not at all uncommon, but not till hitherto had the idea presented itself that it is most likely a stage of the nondescript elliptic body above referred to; and this Mr. Archer concluded not only from the great resemblance of both envelope and contents in each, but from frequently finding, in the same gatherings, specimens intermediate in appearance between the two; of course the decisive proof would be the evolution from the larger elliptic quiescent form of the smaller elongate motile ones, but of this Mr. Archer had as yet no direct evidence. But though it has been mentioned that the shiny, greyish granules appertaining to the narrow motile form are pretty nearly in single file and few, this applies to what may, for the occasion, be called the typical form thereof. Sometimes narrow cylindrical or subelliptic examples occur with granules, quite identical, densely scattered therein; in fact, the whole quite like the ordinary larger elliptic, presumed quiescent condition of the same thing, except in being narrower, more cylindrical, and smaller, and these latter evince a very decided locomotive power, accompanied by a revolution on the longitudinal axis. And here, as little as in the narrow tapering form with the granules, on the whole, in single file, the larger in the middle, can any cilia or flagella be detected, and these *look* exceedingly like as if they were produced by an increase in number of the shiny, greyish granules, accompanied by an expansion or enlargement of the hyaline delicate outer envelope, just as if they were growing on to acquire the size and appearance of the quiet state—as if reverting to our original *puzzle*, in fact, some of which, indeed, sometimes, as mentioned, show a faint inherent movement.

This "80" affair, however, presents two states different from what has just been described for it; one is a far paler condition, the granules very much smaller than usual, the remainder of the watery looking contents colourless, while the outer wall retains its usual appearance, giving the whole a far more hyaline general aspect; the other is what may be said to be, on the whole, just the reverse of this, that is, an increase in quantity of the shiny, opaque granules and a disappearance of the common bluish envelope, possibly burst by the enlargement due to the greater abundance of the granules, these now forming an irregularly spreading, interrupted cluster; still, each granule, or sometimes a small aggregation of these granules of such a group, appears to have acquired a faint bluish pellucid envelope, somewhat, indeed, like the original common one. As to the first of the just-mentioned conditions, Mr. Archer would venture to conjecture nothing; it *looks* "abnormal," or indicating decay. As to the second, it has

a good deal of the aspect as if little groups of the larger clusters of granules, seemingly arising from the breaking-down of the original quiescent elliptic form, might afterwards assume the condition of the minute motile organism here drawn attention to, and acquire the active locomotive power; but he had not seen this, though indications seemed thus in favour of the assumption. And so remains this matter, so far as can be made out.

Both these organisms, if not remarkably striking as *show* microscopic objects, formed a pretty and curious sight, withal not a little puzzling; if they *have* motory organs, they, as yet, elude observation. If they are well known, indeed, to other observers elsewhere, Mr. Archer trusted that those who might hereafter peruse this record would pardon our oversight, and throw a light upon the obscurity. These Minutes are but of what may be called a merely "gossipy" nature; if a "mare's-nest" be now and again part of our "discoveries," those whose experience may have disclosed to them more of Nature's *arcana*, if they be not quite in a position to contribute in removing the veil, will, it is to be hoped, at least regard such records as the present with a kindly forbearance.

16th February, 1871.

Dr. Macalister exhibited the new louse he had obtained from *Ardea comata*, and had named *Colpocephalum marginatum* in the last number of this Journal ('Quart. Journ. Micr. Science,' vol. xi, n.s., p. 163).

Dr. John Barker showed his new form of parabolic condenser, for use with high powers, from which he had got very satisfactory results. He was trying some further experiments in this direction, and hoped soon to be able to exhibit to the Club some good effects he had obtained in its applicability to lined objects.

Mr. Tichborne showed, under the microscope, a sample polarized of so-called *terra alba*, frequently used for adulterative purposes, which is ground selenite.

Rev. Eugene O'Meara showed a slide of diatoms from America, containing many interesting and rare forms sent to him by S. A. Briggs, Esq., of Chicago, which, after he had had time to correspond with that gentleman, would form the subject of a future communication.

Dr. Moore exhibited the pollen of an unknown plant sent to him without comment for identification, but the specimen was so fragmentary and incomplete it was impossible to decide upon it; he hoped shortly to become possessed of a more available specimen. The pollen, however, formed a very pretty microscopic object, triangular, the angles enlarged, like that of *Onagraceæ*, but it was certain that the plant in question did not belong to that order.

Professor Thiselton Dyer showed a section of the stem of a fossil fern from the Lower Eocene of the Thames valley and named by

Mr. Carruthers *Osmundites Dowkeri*. The specimen was extremely interesting, as showing copiously contained in the cells the silicified casts of starch-granules, as well as being traversed here and there by well-preserved jointed filaments, most probably those of the mycelium of a fungal growth. For detailed description and figures, see 'Proceedings Geol. Soc.,' 1870, p. 349.

As further examples of a locomotive power, to say the least, without *visible* motory organs, Mr. Archer exhibited numerous pretty specimens of that elegant, though common, little organism *Spirillum volutans*. The little moniliform chains of which it is composed keep rapidly urging themselves along, with their well-known undulatory and fitful serpentine motion. An additional example of the same apparent phenomenon was prettily presented by another minute organism, not as yet identifiable, which occurred in a gathering made in the County Westmeath in great numbers. These formed short, cylindrical, minute bodies, with rotundate-truncate ends, of a light brownish colour and a granulated or roughened surface, which very rapidly swam about in the water, in variously curved courses, each revolving quickly on its longitudinal axis as it progressed, but no flagellum or any such motory organ could be discerned. Sometimes one of these *poked* its way into a vacated carapace of *Dinobryon sertularia*, where, its onward progress being barred, it maintained a rapid spinning on its longitudinal axis. Of course, it cannot be denied but that flagella *may* be present, though baffling detection.

Mr. Archer drew the attention of the Club to a rough sketch of what there could be but little if any doubt was a peculiar condition of *Syncrypta volvox* (Ehr.). When he first encountered, some time since, this puzzling looking object in a gathering in which it occurred in rather considerable quantity, for a short time he had thought that he must have had before him some form of undescribed Rhizopod, not a little calling to mind Haeckel's *Myæodictyum* at first glance. Here were a number of sarcode-looking little masses of irregular figure grouped together in clusters, each of these giving off several irregular, rather slender and sometimes long, slightly tapering, colourless processes; these, indeed, to all intents and purposes, might be denominated pseudopodia, still any change of outline or extension was but slow. Under a low power it looked as if the whole represented a group of minute rhizopodous organisms, these more or less united by inosculation of the slender pseudopodia; however, on examination by a higher power, it did not appear that these processes were really mutually inosculated, or only slightly so, still they had all the aspect of a common group or colony of the same rhizopodous form. But a further examination under the higher power soon showed apparently beyond doubt that these seeming Rhizopoda were nothing less than so many of the disassociated constituent monads of a *Syncrypta*-colony, thus remarkably modified. But though *every* conceivable intermediate phase between both did not become revealed, yet enough was evidenced, he

thought, to render the conclusion decisive. Not only in the *most rhizopodous* form could the yellowish pair of longitudinal bodies running along both sides and enclosing a central space, as seen in the normal form of each monad in the typical state, as well as a characteristic sharply marked dark granule, be readily seen, though often more or less disturbed in position or distorted, but further, examples were not wanting in which the detached monad, so to say, was there still intact, and at the same time (by no means faint) indications of a sarcodic envelope were present and pseudopodial processes evident. With the hope of being able to confirm this curious observation, should he have an opportunity during the coming summer, Mr. Archer had intended to have kept it merely in his "mind's eye." Meantime, however, Professor Haeckel's beautiful account of his remarkable marine organism *Magosphæra planula*, referred by him to a new order—Catalacta—had made its appearance ('Biologische Studien,' p. 139, t. 5). An inspection of his plate (which Mr. Archer thought was a pity had not been printed in the natural *actual* colour of the organism, or else *black*) would suggest the affinity of *Magosphæra* rather with *Synura*, *Syncrypta*, and *Uvella* (as he thought he should identify those types with what he had regarded as their representatives, as occurring at least with us), than with what may be, perhaps, designated the *Volvocinaceæ proper* (*Volvox*, *Pandorina*, *Stephanosphæra*), and naturally the foregoing observations at once recurred to his mind, not to speak of those of Dr. Hicks and of others on *Volvox globator*, and what he had witnessed himself in that form as well as *Pandorina* and *Stephanosphæra*. He was much interested, therefore, to find that Haeckel himself in the text strongly points to the relationship of his new genus *Magosphæra* and *Synura* (Ehr.), going so far as to say that if the two genera coincided in development they would be identical; he had, however, himself but once met with the latter form. In at least the form occurring with us, which, notwithstanding the contrary view of so able an authority as Mr. Carter, seemed as yet to Mr. Archer to be truly the *Synura uvella* (Ehr.), and *not* a developmental state of *Volvox globator*, Mr. Archer has not, indeed, seen any state showing *rhizopodous* characteristics, but the condition described of *Syncrypta* is strongly suggestive of at least its occasional occurrence here also. However, if only in the latter of the two forms which Mr. Archer thought thus identifiable the *rhizopodous* or *amœboid* condition had presented itself, *both* undergo (at least occasionally) an encysted condition. In the organism occurring in this country which as yet seems justifiably to be identified with *Synura uvella* (Ehr.), only a few, not each and all, of the monads of each colony become encysted; these encysted individuals retain their position at the apex of the ultimate branch of the dichotomously ramified dendroid structure sustaining the whole colony (with the *appearance*, indeed, as if they were joined by the "tails"), and such form comparatively large globular cases attached to the end of the branch by a minute

handle-like process. In the other form which seems identifiable with *Syncrypta volvox* (Ehr.) every one of the constituent monads going to make up a colony seems to become encysted, and, unattached to any stipes, they form a considerable sized rounded aggregation of rather large yellowish thick-walled globular bodies involved in a hyaline matrix, probably the softened down and enlarged so-called "lacerna." In *Syncrypta*, then, we would appear to have the rhizopodous and the globular encysted state parallel to and comparable with those conditions of *Magosphæra*; in *Synura* only the latter has as yet evinced itself. Now, a question had suggested itself to Mr. Archer as to whether the rhizopodous or amœboid state in these, even in *Magosphæra*, was to be regarded as an essential or constant phase in their life-history, but rather as exceptional, or, at least, not recurring during each and every cycle of development—that is, may the "infusorial" or the "volvocine" state pass normally into the *encysted* ("Ei-Stadium"), without assuming the *rhizopodous* phase? May it be, indeed, only as it were exceptional circumstances which induce the exceptional (?) rhizopodous state even in *Magosphæra*? At least, in the fresh-water forms, especially leaving the typical *Volvocinaceæ* out of view, it must be considered rare. Certainly, at least, in the fresh-water forms, and taking into view not only such as *Synura* and *Syncrypta*, but also *Volvox*, *Pandorina*, and *Stephanosphæra*, it would seem to Mr. Archer as if the rhizopodous state was more prone to evince itself when the subjects are *cultivated* in restricted quantities of water, but he would not build very much on that, which may not be fully borne out. At least, however, it has occurred to himself to see the polymorphous condition of the "primordial cells" of *Volvox* and of *Stephanosphæra* in examples in *captivity* on a growing slide; and of *Pandorina* when kept in a bottle for some time in the house. Hæckel's examples of *Magosphæra* were, it would also seem, confined in a watch-glass. On the other hand, the specimens in which the condition referred to in *Syncrypta* was observed were tolerably freshly taken. This fugitive record of the curious state of *Syncrypta* which Mr. Archer had noticed he thought might be worth a small place in these Minutes; taken in connection with the presumptive relationship of it and *Synura* with *Magosphæra*, should it be borne out by subsequent observation, it may, indeed, become a question whether the two fresh-water forms mentioned will turn out to belong to "Catallacta," or whether that Order fall away and *Magosphæra* form a marine representative of *Volvocinaceæ*, connected with the typical fresh-water genera, through *Synura* and *Syncrypta*, if not also *Uvella* and others. Should good fortune place in Mr. Archer's way an opportunity to confirm or enlarge the observations here attempted briefly to be chronicled, it might be worth while to endeavour to convey a more exact idea by aid of a drawing, as well as to try to draw attention to the distinctions and characteristics, which appear here to exist, more at large.

23rd March, 1871.

Dr. John Barker showed, in use, his new paraboloid, with lateral stop, on immersion principle, by which he succeeds in very effectively bringing out the extremely delicate striæ of *Amphipleura pellucida*, and of other equally difficult tests.

Dr. Richardson exhibited a varied series of stops he had contrived for use with the condenser for producing obliquity of light, which he had found very advantageous in bringing out the delicate markings on diatomaceous frustules.

Mr. Arthur Andrews drew attention to a peculiarity in a marine species of Cythere, which had struck him as being noteworthy, consisting in the fringe of long hairs somewhat unevenly surrounding the margin of the shell. Mr. Andrews would investigate this form more closely, and again refer to it.

Mr. Archer exhibited some examples of the seeming encysted state of Syncrypta, referred to in his remarks at last meeting.

Dr. E. Perceval Wright exhibited mounted calcareous spicules from the barkly layer of a very pretty Gorgonoid Coral, which he had lately received from the Bermudas. It had been sent by the Honble. R. Rawson, entangled in the long arms of *Asterophyton muricatum*. On examination it proved to belong to a new genus, *Callicella* of Dr. J. E. Gray, who had described it from a specimen brought by Consul Swinhoe from Formosa. The Bermuda specimens did not appear to differ from those from Formosa, and Dr. Wright, therefore, referred the former to the *Callicella elegans* of Gray. The branches of the coral could scarcely be said to be dichotomous. The bark in fresh specimens was moderately thick, and the spicules were of that rough irregular outline more or less characteristic of the *Primnoadæ*. The wide distribution of this apparently little-known form, and the fact that the spicules connect it closer to the *Primnoadæ* than to the *Callogorgonidæ*, where it had been placed by Dr. Gray, would be sufficient excuse for bringing it before the Club.

Professor Thiselton Dyer exhibited a section of the fossil vegetable form called *Prototaxites Loganii*, and simultaneously a section of *Taxus*, with a view to draw attention to the structural distinctions which seemed to indicate that the so-called *Prototaxites* was most probably rather allied to some algal form; he would suggest possibly to some belonging to *Codiææ*, such as *Rhipozonium*, than to a *Gymnosperm*. There was no appearance of "discs;" both longitudinal and vertical sections seemed to indicate that the mass was composed of a number of tubes, running in a nearly parallel direction, rarely bifurcating, and seemingly not septate or tapering, and with an intercellular medium, apparently formed of minor tubes. The principal longitudinal tubes appeared, on transverse section, to have a wall concentrically stratified. Principal Dawson, in describing the Devonian rocks of

Canada, speaks of the occurrence, in the lower beds of the system, of "trunks of drifted trees in the sandstones, at first sight resembling those of *Dadoxylon* They present," he says, "a regular tissue of long cylindrical fibres, marked on their sides with irregular spiral lines, and very distinct from those of modern conifers, though their markings suggest the spiral lines on the cells of the genus, whence I have taken the name *Prototaxites* for these remarkable trunks. They have medullary rays and regular lines of growth, and attained sometimes a diameter of three feet. Unfortunately we know nothing of their foliage or fruit, and can but suppose that they constitute a prototype of the coniferous trees, probably very different from any known in the modern world" ('*Proc. Royal Inst.*,' vol. vi, pp. 169, 170). Mr. Carruthers, however, remarked, in a paper read to the British Association at Liverpool, that "the supposed Taxineous wood from the North American Devonians, to which Principal Dawson gave the name of *Prototaxites*, was a remarkable alga of enormous size" ('*Nature*,' Oct. 6th, 1870). Portions of the supposed wood, transmitted by Principal Dawson to Mr. Carruthers, showed that they belonged to two very distinct plant-structures. One consisted exclusively of a regular parenchyma; the other, of which specimens were exhibited to the Club, was totally different, and it was to this that the description above quoted applied, at least as far as the microscopic characters. The appearance of medullary rays was probably produced by accidental cracks or fissures, no structure corresponding to them being shown under the microscope. The "lines of growth" would have their parallel in the pseudo-exogenous stems of the existing *Lessonia*. In connection with this alga it is a curious coincidence that Dr. Hooker remarks that in the Falkland Isles the ignorant observer at once takes the trunks of *Lessonia* washed up on the shore for pieces of driftwood, and on one occasion no persuasion could prevent the captain of a brig from employing his boat and boat's crew, during two biting cold days, in collecting this incombustible wood for fuel (quoted by Berkeley, '*Introd. to Crypt. Bot.*,' p. 222).

Rev. E. O'Meara brought under the notice of the Club a specimen of earth obtained through the kindness of Rev. Dr. McIlwaine, and discovered by W. Gray, Esq., of Belfast, under peat at Drumlough, near Lough Ahery, parish of Dromore, Co. Down. The material was very rich in diatomaceous forms, of which those of most common occurrence are comprised in the following list:

Amphora ovalis.	Navicula bacillum.
Cocconeis pediculus.	" cocconeiformis.
Cocconema lanceolatum.	" gibberula.
Cyclotella antiqua.	" firma.
Cymbella cuspidata.	" Kotzchii.
" Ehrenbergii.	" minutissima.
" helvetica.	" semen.
" maculata.	" seminulum.
Cymatopleura solea.	Odontidium parasiticum.
" elliptica.	Pinnularia acuta.
Epithemia argus.	" borealis.
" gibba.	" divergens.
" granulata.	" major.
" Hyndmanni.	" mesolepta.
" sorex.	" viridis.
" turgida.	Pleurosigma attenuatum.
" zebra.	Stauroneis acuta.
Himantidium arcus.	" phœnicenteron.
" bidens.	" punctata.
Gomphonema acuminatum.	Surirella nobilis.
" constrictum.	" elegans.
" geminatum.	

Particular attention was directed to a species of *Orthosira* which occurred not unfrequently. It was like *Orthosira arenaria* (Moore), with this difference, that the striation in the side view is marginal, whereas in the case of *Orthosira arenaria* it runs from the circumference to the centre. The form indicated bears a strong resemblance to that figured by Ehrenberg ('Mic. '), as *Gallionella varians*, t. xiii, fig. 29; also to another form, *Gallionella punctigera*, t. xv, B, fig. 5; t. xii, fig. 9, *h, i*. In the latter the striation on the side view is not continued to the centre, but is much broader than in any specimen as yet found in the Dromore earth. Mr. O'Meara was disposed to regard the form as probably a variety of *Orthosira arenaria*.

Mr. Archer exhibited two examples of the conjugated state of the common diatom *Stauroneis phœnicenteron*, one showing the two new frustules in the fully-formed condition, once before exhibited to the Club ('Quart. Journ. of Micr. Science,' vol. viii, n.s., p. 189), the other in the very earliest stage, or rather just immediately after conjugation having been effected. On the former occasion on which he had seen this form conjugated only *one* new young frustule presented itself, and he had thought that so far this might be peculiar; in the present instance, however, there were *two*, so that in the former instance one must have been accidentally removed in the treatment or otherwise. As before, however, the two young fully-formed frustules of the new cycle were similar to the parent form, except in being twice their linear dimensions, bearing, however, at their apices the "caps" formed by the remains of the primary envelope borne aloft. The other example now exhibited presented the two globular "zygospores," each with a thin coat or wall and greenish-yellow contents. These coats were evidently destined to be stretched and rent by the

growth and development within of the future frustules, and ultimately to produce the "caps" seen in the other examples. In fact, the whole process seems to be quite like that described by Carter in *Navicula serians* ('Ann. and Mag. of Nat. Hist.,' vol. xv, 3 ser., p. 161); probably, indeed, in general details all the navicular forms coincide.

Mr. Archer drew attention to the incipient state of the conjugation in a *Pinnularia*. Immersed in a common hyaline envelope, the conjugating frustules had commenced a mutual fusion of their contents extruded therefrom; no further or more advanced stage had, he regretted to say, fallen under notice.

Mr. Archer thought it might be worth while to draw attention to some examples of *Clathrulina elegans* (Cienk.), remarkable for their seemingly exceptionally large dimensions, being fully $\frac{1}{170}$ of an inch in diameter—more than twice, nearly three times, as great as any he had before noticed; the stipes appeared to be equivalently long and thick, but while the fenestrate "skeleton" was of a dark brown colour, the stipes were perfectly clear and colourless, and without any apparent structure, except that it appeared tubular. In some instances the fenestrate globes were closely filled with numerous encysted sarcode masses, not seemingly individually larger than the few or one only found in the similar condition of ordinary sized examples.

MEMOIRS.

*The ORIGIN and DISTRIBUTION of MICROZYMES (BACTERIA)
in WATER, and the CIRCUMSTANCES which determine their
EXISTENCE in the TISSUES and LIQUIDS of the LIVING
BODY. By Dr. BURDON-SANDERSON, F.R.S.*

(Reprinted, by permission, from the author's second "Report of Researches concerning the Intimate Pathology of Contagion," in the Appendix to the '13th Report of the Medical Officer of the Privy Council.')

IN my previous report on the intimate pathology of contagion, microzymes were defined as living particles which in their earliest state are spheroids, and do not exceed $\frac{1}{20,000}$ of an inch in diameter, but subsequently elongate into rods. As regards the conditions of their development, their existence was said to be associated with the commencement of putrefactive decomposition of nitrogenous compounds. The question of their origin and destiny was left unanswered. It was left undecided whether on the one hand "they constitute a race of more or less similar individuals, each of which springs from and reproduces its like," or, on the other, are "germs in which a specific form is wrapped up," capable of developing to the higher organisms from which they spring.

It is to this question principally that the experiments we have now to bring before the reader relate. Our purpose is to examine into the origin, growth, and development of microzymes, to investigate the conditions which are fatal or favourable to their existence in the liquid and gaseous fluids by which we are surrounded, in the hope that by doing so we may be enabled to approach one degree nearer to an understanding of their influence on the processes which go on in the living body.

In dealing with the question of origin, we again encounter the more general question of what is called "spontaneous generation." I have no intention, however, of entering upon it. I shall be able to prove in the most decisive manner that as regards the animal liquids and tissues, and the liquids which will be used as tests for the presence of microzyme germs, no spontaneous evolution of any organic form ever takes place; but it will be quite unnecessary either to deny or to assert its possibility under other and different conditions.

Before proceeding to state the results of our experiments, a more complete account must be given of microzymes, and something must be said as to the views entertained by naturalists of their nature, origin, and relation to other organic forms. The methods of investigation which have been employed must also be explained.

Bacteria or microzymes are placed by most naturalists in the animal kingdom, and have a position assigned to them next to the monads. Hallier, on the other hand, believing that they originate by the cleavage and multiplication of nuclei in the cells of fungi, and that they develop to the same forms from which they spring, regards them as plants. Their claim to be considered animals is founded partly on their motions, partly on the fact that their chemical reaction on air, when alive, resembles rather the respiration of animals than that which is associated with vegetation. The question is of importance only in so far as it involves that of origin and development. If it can be shown that they neither spring from higher forms nor grow to them, the discussion of their animal or plant nature may be left to those interested in verbal definitions.

Microzymes grow either in liquids or moist air. In liquids they present different appearances, as they are observed in the depth or on the surface. In the former case they show no tendency to assume any special arrangement to each other if they are motionless; nor if they are active are their motions governed by any mutual relation. At the surface of the liquid, on the other hand, although the individual bacteria show no definite arrangement when they first appear, they soon place themselves in such a manner as to form a membrane, the beginning of the bacterium scum, to which we shall have frequent occasion to refer. In this membrane, when it first appears, each rod stands vertically, one end forming part of the free surface, the other part of the deep surface of the membrane. The rods adhere together by their sides after the manner of the elements of columnar epithelium, but there is, I think, strong reason to believe that this adhesion is not direct, *i. e.* that they are not in actual contact, but glued together by a viscous intermediary substance. Consequently on this arrangement the "scum," when first formed, presents under the microscope the aspect of an evenly dotted surface, the distance between each dot and its neighbour corresponding approximately to the diameter of a rod. This appearance, indeed, is so deceptive, that for a long time I supposed, as others have done, that the constituent particles were round; nor was it until it was discovered that the mem-

brane could be resolved by mechanical means into rods that I understood the real nature of the membrane. As the structure (if one may call it so) becomes thick enough to form a visible scum, the arrangement of the particles can no longer be made out, for it is not possible to subject it to examination without dislocating it to such a degree as to render their relative positions indistinguishable.

When common microzymes grow on moist surfaces, they with their intervening jelly sometimes form viscous masses of sufficient size to be cognoscible by the unaided senses, these consisting of a material similar to that of the "scum" which forms on the surface of liquids in which microzymes are growing. This fact is expressed by the term *Zooglæa* applied to such masses or colonies of microzymes by Cohn.

It is on observations made as to the growth of microzymes in colonies that the little which can be stated as to the *form* in which they originate is based. In the spheroidal masses above referred to, and indeed whenever microzymes occur in a gelatinous matrix which can be distinguished, we observe foci of growth at which the particles are indefinitely minute and spheroidal; around these foci there are zones of matrix, already obsolete and disintegrating, which are inhabited by staff-shaped microzymes of larger size, which eventually become free and display their proper movements. Here therefore it seems probable that bacteria come into distinguishable existence not as rods but as spheroids. Subsequently they multiply, as is well known, by division.

As to the *conditions of their origin* there is even less knowledge and more difference of opinion. There being an immense preponderance of evidence that they do not spring into existence of themselves in the media in which they grow, most observers have looked for germs in the atmosphere, but with no success. Nor has anyone excepting Professor Hallier even suggested a plausible theory on the subject. Liquids which contain no particle distinguishable under the highest powers of the microscope can often (as will be hereafter shown) be proved to possess the property of evolving microzymes without contact with external media, and must therefore contain the germinal substance from which these organisms spring. In interpreting this fact it may be supposed either that the germinal substance is universally and equally distributed, *i. e.* dissolved in such liquids, or that it is unequally distributed or particulate. That any living substance is soluble in water is not at present admissible; we must therefore accept the other alternative, and believe that we have to do with particles so minute that they do not

interfere with the homogeneity of the liquid. In so far as relates to the ultra-microscopical origin of the bacteria, this inference harmonises entirely with what has been stated above as to their development in gelatinous masses from foci. Here, as in the other case, it would surely be an error to suppose that in these proliferous foci the apparently hyaline material is really homogeneous. It appears to be so, merely because the particles are so extremely minute. Hence when we apply the term matrix to this subject, we must guard against the word being understood to imply that in the present instance bacteria arise out of an amorphous jelly. What is meant is, that the jelly is itself so organised throughout, that the smallest conceivable bit of it, if separated from the rest, would still possess structure, and consequently the power of reproduction.

Chemical composition of Microzymes, and their relation to the media in which they grow.—Of the chemical composition of microzymes we know very little. It is assumed that the particles are albuminous, because they are readily stained with carmine and browned by iodine; but of the matrix little can be said, excepting that it is probably also albuminous. Chemistry can as yet give no account of the difference between them. As regards their action on the liquids in which they live the most important facts are: (1) That their growth is attended with absorption of oxygen and discharge of carbonic acid. (2) That they are remarkably independent of the chemical constitution of the medium, provided that they are supplied with oxygen; and (3) That they take nitrogen from almost any source which contains it, and use it for the building up their own protoplasm.

It is this last power which specially indicates what may be called their place in nature as the universal destroyers of nitrogenous substances, acting as the pioneers if not the producers of putrefaction. They exercise this function not by virtue of any special relation of their own nutritive processes to putrefaction as such, but simply by their extraordinary power of seizing on the elements which they require for the construction of their own bodies.

The necessity of oxygen to bacteria is so great that they cannot grow even for a short time without it. Thus if liquid containing living bacteria be placed under a cover glass for microscopical examination, it is seen that towards the centre of the cover glass their movements become sluggish and eventually cease, although towards the edges they are still lively. If bacteria are confined in a tube without air they soon die. If the supply of air is limited they continue to

live only so long as the air to which the liquid is exposed still contains sufficient oxygen. If microzymes exist in great numbers in a liquid, air which has remained for a length of time in contact with it has a large excess of carbonic acid, and occupies less volume than it did originally under the same conditions of pressure and temperature. We have found that in such air a taper is immediately extinguished, whence it would seem that microzymes are able to use up nearly the whole of the oxygen which is supplied to them.

When microzymes grow at the expense of disintegrating organic substance, it cannot be supposed that they avail themselves of the albuminates already existing in it to build up the material of their own bodies. If this were the case it would be impossible to understand the fact that they grow quite as luxuriantly when the nitrogen they require is supplied to them in the form of salts of ammonia, as when it is in the form of ready-made albumen; for clearly it must require a much greater expenditure of plastic energy to build up protoplasm of elements derived from such sources, than merely to convert one albuminous compound into another. It therefore seems probable that bacteria do not use the material on which they feed until it has already been converted by oxidation or by splitting into lower chemical combinations.

The question how far microzymes are the cause of putrefaction will, I think, be elucidated by the results of the following experiments. It will be shown that so long as the germinal matter of microzymes is excluded, animal fluids or tissues withstand decomposition for very long periods, while the slightest contact with media containing this material at once determines septic changes. Consequently it can be asserted positively that under certain circumstances the presence of microzymes excites putrefaction; but the facts do not afford grounds for stating that they are the cause of putrefaction, or that if it were not for them the process would be postponed indefinitely. It is indeed asserted by chemists, and we do not propose to deny, that organic matter may, under the influence of heat and moisture alone, undergo decompositions which present all the chemical characters of putrefaction, even though no microzymes be present.

Method.—As regards the questions which form the principal subject of this report, we at present possess no exact information. As has been already stated, there is a general belief that microzymes exist potentially in the air, and it is also admitted that they may be met with in the blood in certain septic diseases. Hallier, on the other hand, finds

them not only in septic, but in all contagious fluids, while Béchamp imagines that they form part of healthy structures. To determine these questions it was necessary (1) to subject the media to the action of some qualitative test by which the presence of the germinal matter of microzymes could be detected; and (2) to make experiments in which their action on the animal liquids and tissues would be observed under conditions similar to those which exist in the living body. As a test for the presence of microzyme germs we have used first, Pasteur's solution, and secondly animal fluids, either diluted with pure water or undiluted. These liquids were selected on the ground first that they contain nitrogen, in the one case in the form of an ammonia salt, in the other in that of an albuminous compound, and secondly that although transparent and free from visible particles when fresh, they become in a short time peopled with microzymes when kept under ordinary circumstances and at ordinary temperatures. Before using them, however, for the purpose intended, it was necessary to determine that they do not in themselves contain the conditions of evolution; in other words, that they can be prepared and kept in a state of absolute barrenness without prejudice to those qualities by which they are fitted to be employed as tests. These requirements could only be satisfied by a preliminary series of experiments having for their purpose to determine the question of so-called "spontaneous generation," not in general, but with respect to the particular liquids to be used. In approaching a question of such difficulty, even with the limitation above stated, there are two methods of inquiry which suggest themselves; one consists in the comparison of results obtained when the cause to be investigated is present, with those which are produced when it is absent, all other conditions remaining unaltered (method of crucial experiment); the other in the comparison of variations in the results with variations in the circumstances that lead to them (method of concomitant variations). We shall find that the first of these methods, which is clearly the most conclusive, is as applicable as the other to the particular question before us, that of the spontaneous evolution of organic forms in any given medium. But even if it had not been so, the other method would still have been open to us, for if it could be shown that the appearance of microzymes in a given liquid is either delayed or diminished, in a degree proportionate to the degree of exposure to external influences, it might be safely inferred that exposure to the air is the efficient cause of their development. In the present instance it is possible to exclude all conceivable sources of

contamination, and so to obtain a positive answer to the question; but this does not render it the less advantageous to compare the varying effects of contamination with the conditions to which they correspond, for by so doing we acquire a better knowledge of the nature of these causes, and of the means of obviating them.

The experimental results are stated under three headings, according as they relate to the conditions which limit the evolution of organic forms, and particularly microzymes, in test liquids; to their distribution in ordinary water and in most substances; and lastly to their occurrence in the tissues and liquids of the animal body.

While considering myself exclusively answerable for the accuracy of every statement contained in the report, I am anxious that in so far as the investigation has been a successful one, my assistant, Dr. Ferrier, by whom many of the experiments were both planned and carried out, should participate in whatever credit may be accorded to me.

SECTION I.—*Experimental Determination of the Conditions which govern the Development of Microzymes in certain Organic Liquids to be used as Tests.*

I.—July 22nd, 1870.—A large number of capillary tubes prepared for the purpose were filled with serum of blood obtained from a guinea pig a few hours before. According to the mode of filling, and the conditions under which they were subsequently placed, the tubes were divided into five batches, designated respectively *a*, *b*, *c*, *d*, and *e*. The tubes *a* were exposed, unsealed, to the air of the laboratory; *b* were hermetically sealed; *c* were sealed, and thereafter placed in the incubator, in which a temperature of about 40° C. was maintained during the whole period of the investigation, with the aid of a Geissler's regulator; *d* were sealed and heated in the oven to 180° C., and thereafter exposed to the air of the laboratory by breaking off one end; *e* were sealed and heated in the same manner as *d*, and then placed in the incubator. The tubes were examined at various periods within a month after they were prepared. Bacteria were found in numbers in *a*, *b*, and *c*, but no organic forms could be detected in *d* and *e*. The remainder of these two batches were therefore preserved for further examination, until the beginning of March, 1871. They then exhibited the appearances always observed under the microscope in superheated serous liquids,¹

¹ The most remarkable peculiarity of such liquids is that they contain

but on the most scrupulous examination no organic forms could be discovered either in the tubes which had been kept at the ordinary temperature, or in those which had remained in the incubator.

On August 11 the experiments were repeated under similar conditions, with the exception that the serum employed to fill the tubes was first rendered alkaline by the addition of 0·5 per cent. of soda. In this case no organic forms had appeared in any of the tubes at the end of a month, nor could any be discovered afterwards. The superheated tubes were examined with the rest in March, 1871, with the same result. Two quantities of the same serum were kept in glasses side by side in the laboratory, to one of which only, soda had been added in the proportion already mentioned. In the one containing no soda a luxuriant growth of bacteria and leptothrix appeared in a few days, but nothing whatever could be found in the other. Soda, therefore, in the proportion of half per cent., appears to prevent the development of microzymes.

II.—August 24, 1870.—The albumen of a fresh egg was collected in a clean dry test glass, and several tubes of tolerably large size were filled in the ordinary way and hermetically sealed. Some of them which were not heated were kept at the ordinary temperature, others were subjected in the hot-air oven to a temperature of 200° C. All of these tubes were kept until March, 1871, when it was found that the unheated tubes were still perfectly clear, with the exception that on the side which was undermost as the tube lay on the shelf, its internal surface was lined with whitish granular deposit. The liquid showed no other change, and on a microscopical examination no organic forms could be found. The superheated tubes were in this respect in the same condition. From the negative results in the tubes which had not been heated, it might be inferred that white of egg is incapable of maintaining the life of microzymes, but we shall see hereafter that the fact admits of a totally different interpretation.

III.—August 30.—A large number of capillary and other tubes were filled with a solution of sugar, tartrate of ammonia, and yeast ash, according to M. Pasteur's formula, and divided into two batches, designated respectively *a* and *b*. Some of the tubes *a* after having been sealed, were kept either at the ordinary temperature or in the incubator. The rest were left

masses of apparently semi-fluid material resembling oil drops. These masses are of a distinctly yellow colour, and vary indefinitely in size. They are found in superheated liquids immediately after they are prepared.

open and kept in the laboratory. *b* were sealed and raised to a temperature of 200° C. Some of them were afterwards placed in the incubator, others remained at the ordinary temperature. Specimens of *a* and *b* were examined at various periods up to March, 1871. All of the tubes *a* became turbid sooner or later, and were then found to be crowded in different degrees with bacteria and fungi (torula cells and mycelium). When the remaining tubes were finally opened it was found that in many of them gas had been disengaged in such quantity, that when the end of the tube was broken off the liquid was expelled with violence. In others this evidence of increased tension was wanting. On comparative microscopical examination it was found that the liquid in these last, contained no torula cells. *b* were kept till March, 1871, at which time they were found to exhibit no trace of organic life, whether they had been kept in the incubator or at the ordinary temperature.

IV.—August 18.—It has been imagined that the so-called spontaneous evolution of organic forms is materially increased when the air to which the liquid is exposed has a tension much inferior to that of the atmosphere, and conversely that in liquids subjected to pressures greater than that of the atmosphere the development of such forms is arrested. The following experiments were made to test this supposition. Several capillary tubes were filled with fresh serum of blood of a rabbit kept in an ordinary clean glass. These were sealed and placed in a larger glass tube closed at one end, which after having been drawn out at a short distance from its open end was attached thereby to one branch of a T tube by means of a vulcanite junction. The stem of the T tube was then connected with an air pump, and the other branch with a long barometer tube standing vertically in a cup of mercury. The air was then exhausted, and as soon as the mercury had risen in the barometer tube 15 inches, the flame of a blow-pipe was directed against the narrow drawn-out part of the experimental tube, which was thus sealed while the air which it contained had a tension not more than half that of atmospheric air. The tube was then shaken so as to break all the capillary tubes, so that the whole of the liquid which they contained was exposed to the pressure above indicated. It was then kept at the ordinary temperature. Another tube was filled with capillary tubes containing serum, exhausted to 15 inches, and closed hermetically in the same way. It was then placed in the oven and raised to a temperature of 200° C., after which the capillary tubes inside were broken as before, so as to expose the liquid to

superheated air at 15 inches pressure. Both of the tubes were kept until March, 1871. On opening the one which had not been heated, air rushed into it with great force. Its contents had a putrid smell, and the liquid on microscopical examination was found to contain numerous bacteria. When the superheated tube was opened, the ingress of air was equally forcible, but on microscopical examination no trace of organic forms could be discovered.

From this experiment it would appear that diminished tension has no very considerable effect on the process we are studying. It is further evident that the non-appearance of organic forms in superheated liquids cannot be accounted for by supposing that it is attributable either to the relatively large proportion of the liquid, as compared with the volume of the air which is enclosed with it, or to any other circumstance arising from its being contained in so small a receptacle. A third experiment of the same kind was made on August 30th. A number of capillary tubes were filled with Pasteur's solution, and then sealed and introduced into a large tube, closed in the same manner as in the previous experiment. The whole was then subjected to a temperature of 170° C., after which the contained tubes were broken by shaking. On examining the liquid contained in the broken capillary tubes after several months no organic form could be detected.

The above observations (I to IV) show conclusively that no evolution of organisms took place in the superheated liquids, provided that the air with which they were in contact had also been superheated, whether they were kept at an ordinary temperature or at that of the body; and that the effect was not modified, either by the tension of the air or by its quantity as compared with that of the liquid; and it is further shown that in all the experiments, organisms appeared in the same liquids kept under precisely similar conditions, which had not been superheated. Before, however, drawing any further conclusions from these facts it may be inquired, in how far the cause of the non-appearance of organic forms is dependent on the liquids having undergone chemical changes of such a nature as to render them incapable of supporting life, in which case the negative results obtained could not be attributed exclusively to the non-exposure of the liquids to external media. It will be shown in the sequel that this is true as regards microzymes, that is to say, that superheated organic liquids are incapable of supporting the life of these organisms. It is therefore clear that such liquids do not furnish a suitable soil for studying the question we have in view. With respect to fungi, however, the case appears to

be different; for numerous experiments show that superheated liquids, and particularly Pasteur's solution, when freely exposed to the air in a watch glass or an open tube, become eventually covered with tufts of penicillium.

In the further progress of the inquiry it was found entirely unnecessary to employ so high a temperature as 170° to 200° C. in order to prevent the evolution of organic forms, provided that the liquids were protected from contamination by external media. The experiments which led to this result were as follows:—

V.—August 10.—A number of tubes were filled with serum of rabbits' or sheep's blood. They were then sealed and boiled for an hour or two in a water bath, in consequence of which the liquid contained in several of the tubes became gelatinous, still, however, remaining perfectly transparent. From time to time during the next few months a tube was broken for microscopical examination of its contents, the result being always negative. In March, 1871, the remaining tubes were finally examined. No organic forms could be traced either in those which were gelatinous or in those which remained liquid.

VI.—October 5.—Pasteur's solution was prepared according to formula (the distilled water employed for the purpose being obtained from Messrs. Hopkin and Williams), and placed in a clean capsule. A number of tubes of various sizes were then filled, in the manner already described, with the solution (which had not been heated), and sealed. The solution was then boiled in the capsule for a few minutes, and another batch of tubes were filled in the same manner by breaking their points underneath the surface of the liquid while it was still in a state of ebullition. Each tube was sealed the moment it was withdrawn from the boiling liquid. The two sets of tubes were placed side by side in the laboratory under precisely similar conditions. Some of them were examined microscopically on the 17th. In those of the first batch microzymes in immense numbers, and torula cells, were found along with several filaments of *sporotrichum*. No

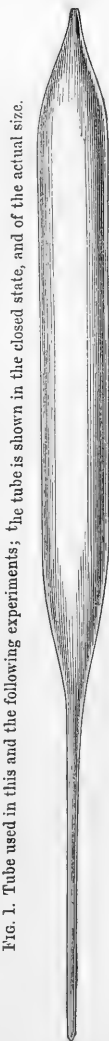

FIG. 1. Tube used in this and the following experiments; the tube is shown in the closed state, and of the actual size.

organisms whatever existed in any of the tubes containing the boiled liquid. Single tubes of both batches were examined from time to time until March, 1871, the results being always the same. Hence it was concluded that thoroughly boiled liquids, preserved in tubes first prepared and sealed, remain perfectly free from organic forms.

VII.—October 5.—Four tubes, each a quarter of an inch in diameter, were prepared in the usual manner and filled with Pasteur's solution which had not been boiled. Tube *a* was placed vertically in a cork support, its end being truncated so as to expose the upper surface of the liquid to the air. Tube *b* was also placed upright, its upper end having been previously drawn out to a long capillary beak, the tip of which was broken off, so that the interior of the tube communicated with the atmosphere by a small aperture. Tube *c*, of the same form as *b*, was also placed vertically, but its open point was bent downwards at a very acute angle. Tube *d* was sealed at both ends.

Four similar tubes marked respectively *a'*, *b'*, *c'*, *d'*, were then filled with boiling solution and placed side by side with the others, three of them having openings of the characters already described, the other being closed. On October 12 the only change which could be distinguished without the microscope was a very remarkable one. A tuft of penicillium had appeared on the surface of the liquid in tube *b'*, the interior of which communicated with the air only by a capillary aperture. Nothing was visible in the others; but a few days later it was observed that all the open tubes (*a*, *b*, *a'*, *b'*), excepting those of which the ends had been bent down, had similar tufts. In the course of the following six weeks the tufts increased considerably in size. On the 24th of November the liquid in tubes *c* and *d*, in which no penicillium existed, was observed to be hazy and had a slight scum on the surface. Tubes *c'* and *d'* remained perfectly unaltered. The liquid in the open tubes was examined microscopically from time to time during the period of observation, the drop required for this purpose being on each occasion transferred to the object glass of the microscope either by means of a glass rod, the end of which had been first passed through the flame of a Bunsen's burner, or the capillary tube which had been drawn out immediately before, so as to avoid all risk of contaminating the liquid.

In all of the open tubes containing unboiled solution torula cells and microzymes began to appear after the first week. On November 24 they existed in great numbers, in addition to mycelium and filaments and spores of sporotrichum. In the closed tube *d* there were bacteria but no torula or peni-

cillium. At the same date the open tubes *a'* and *b'*, containing boiled solution, were free from microzymes, but contained numerous torula cells and mycelium. *c'* and *d'* were not examined until the 4th of January, at which time both liquids were perfectly clear and contained no organic forms of any description.

VIII.—October 5.—Two test glasses were placed side by side on a shelf under a glass shade, one of which, marked *a*, contained unboiled Pasteur's solution, the other, marked *b*, boiled solution. On October 10 glass *a* was turbid, and was found on microscopical examination to be teeming with bacteria; a thick whitish scum had formed on its surface. Glass *b* was perfectly clear; there were, however, great numbers of torula cells on its surface, but no bacteria. On October 12 *b* exhibited numerous tufts of penicillium, but the liquid still remained limpid and free from bacteria; five days later similar tufts appeared on the surface of *a*.

In the last two experiments it is seen that fungi (torula and penicillium) appeared in unboiled solutions whether they were exposed or not, but much more abundantly when they were exposed than when they were protected; and that in boiled solutions the growth of penicillium was somewhat more luxuriant than in unboiled under similar circumstances of exposure. Microzymes did not appear in the boiled liquids under any circumstances, but were quite as numerous in the tube *d* (Obs. VII), which remained closed for many months, as in any other of the same series. From these facts it seemed clear, not merely that the conditions of origin and growth of microzymes and fungi are considerably different, but that as regards the former the germinal matter from which they spring *does not exist in ordinary air*. The experiments to be next related, however, showed that it would have been wrong to have inferred from these facts that the boiling of a liquid is of itself sufficient to prevent the development in it of these organisms, or that their complete absence in the tubes of the second series of Observation VII (*a'*, *b'*, *c'*, *d'*) was exclusively attributable to this condition.

IX.—October 25.—A solution (A) according to Pasteur's formula, was prepared in the same manner as before, with the exception that water distilled on the same day in the laboratory was used instead of the ordinary distilled water, great care being taken to prevent its contamination. At the same time another solution (B) was made with the same water, of materials which had been previously heated in the hot-air bath to 110° C. Eight glasses were at the same time prepared, of which four, marked severally with the odd num-

bers 1, 3, 1', and 3', were washed and dried with a towel. The remainder, numbered 2, 4, 2', and 4', were immersed for some time in a vessel of boiling water and then dried as before. The two solutions were then distributed in these glasses as follows:—In 1 and 2 solution A unboiled; in 3 and 4 the same solution after previous boiling; in 1' and 2' solution B unboiled; in 3' and 4' the same after boiling. Glasses 1, 2, 1', and 2' were placed under one shade, and the other four glasses under another. On November 1, tufts of penicillium were obvious on 1, 2, 1', and 2', and were beginning to appear on the rest. The liquids were examined microscopically at this date and again on November 8, when the tufts had increased in size. All contained torula cells and mycelium, but microzymes were found only in 1, 3, 1', and 2'. Thus it appeared that neither the boiling of the liquids, nor of the glasses, nor the superheating of the materials, had exercised any appreciable influence in preventing the development of microzymes. It was still more remarkable that in glass 2, which contained unboiled solution, none of these organisms could be discovered.

These facts, apparently so contradictory, were explained by subsequent experiments.

X.—November 11.—Pasteur's solution was prepared with ordinary distilled water obtained from Messrs. Hopkin and Williams, and distributed in five glasses designated by numbers, the conditions being as follows:—1, a clean test glass, taken from the shelf, was filled without further cleansing with solution which had not been subjected to heat; 2, a similar glass, previously rinsed with distilled water, was filled with the same liquid; 3, a glass just before heated to 200° C. was also filled in like manner. The other two glasses (4 and 5) were charged with boiled liquid, the method used being to boil the solution in a test tube for a few minutes, then to cool it rapidly by dipping it in a stream of cold water, and transfer it at once to the experimental glass. Glass 4 was merely rinsed with distilled water; 5 was previously heated to 200° C. The results were as follows:—On November 20, torula cells were found on the surface of all the liquids. On the 26th, bacteria had appeared in immense numbers in 1, 2, and 4, so that the liquid was milky. In 3 it was apparently clear, but was found on microscopical examination to contain bacteria. Subsequently it also became opalescent. At the same date all the glasses showed tufts of penicillium; those on 3 and 5 were more advanced than the rest, and had become greenish from the development of heads of spores. At this time, and on all subsequent occasions, the liquid in 5 was found to be

perfectly limpid and free from microzymes. The conditions under which the liquid in glass 5 was placed differed from those to which that in glass 4 was subjected in one particular only, viz., in the fact that the former, instead of being rinsed with distilled water and dried, had been superheated. The teaching, therefore, of the experiment was, that the germinal particles from which the microzymes sprung must have been contained either in matter adherent to the surface of the glass, or in the distilled water used to cleanse it, or in both. That the former was not without its influence is rendered probable by the circumstance that in glass 3, which differed from 2 only in having been superheated, bacteria appeared latest. To determine this question was the purpose of the next experiments.

XI.—December 1.—Pasteur's solution was prepared with water obtained from a well at Stevington, in Bedfordshire, which was sent to the laboratory for microscopical examination. The water in question was perfectly limpid; but after it was allowed to stand, a few microzymes could be discovered in the surface layer. None could be detected in the rest of the liquid. It contained a scanty deposit in which one or two *monera* occurred. The solution was distributed in five test glasses, the conditions being as follows:—(1) The solution was boiled in a tube, cooled rapidly, and then poured into a test glass which had just been heated to 200° C.; (2) solution boiled in the same manner was transferred to a glass which had been rinsed and dried; (3) the boiled solution was received in a superheated glass, but just before pouring it in, *the glass was rinsed with ordinary distilled water*; (4) the conditions were exactly the same, excepting that the distilled water used for rinsing *had first been boiled*; (5) the solution was not boiled, but the glass in which it was placed had been previously superheated. The five glasses were numbered in the order in which they have been referred to, and placed under one shade. On December 7, 5 was already milky, the turbidity being due to torula cells and bacteria; 2 and 3 also contained bacteria. On December 8, the turbidity of 5 had increased, and 3 was opalescent. There were no microzymes either in 1 or 4. On the 13th, there were tufts of penicillium on all the liquids; the tufts were more advanced in fructification in 1 and 4 than the rest, but these liquids were still entirely free from microzymes. The last examinations were made on the 21st of December, when 1 and 4 were still in the same condition.

Here the two liquids in which no development of microzymes took place differed from each other in the circumstance

that the glass in which one of them was contained (4) was rinsed with boiled distilled water just before it was charged, both glasses having been superheated. On the other hand, 3, in which microzymes appeared, differed from 4 only in the omission of the boiling of the water used for cleansing. By the comparison of these two results we were enabled to conclude that ordinary distilled water may contain the germinal particles of microzymes in such profusion that even so small a quantity as is introduced into a glass in rinsing is sufficient to render a relatively enormous volume of liquid fruitful. The following is one of a series of experiments which were made to confirm this result:—

XII.—December 3.—Pasteur's solution prepared with the same (Stevington) water was distributed in six glasses, all of which were superheated. Of these three, marked *c*, were filled with solution which had not been boiled, the remainder, *b*, with boiled solution. They were placed in pair's, one of each series in each pair, in different rooms. On December 8, the glasses *c* were all hazy, and found to contain innumerable bacteria, *b* were perfectly transparent; as time went on the contrast became more and more striking in consequence of the increased turbidity of *c*. Subsequently tufts of penicillium appeared on the surfaces of all the glasses, which in this as in the previous experiments progressed more rapidly in the clear solutions than in the others.

This experiment was repeated several times with corresponding results.

In many preceding experiments it has been shown that although torula cells and penicillium appear invariably and without exception on all nutritive liquids of which the surfaces are exposed to the air, without reference to their mode of preparation, no amount of exposure has any effect in determining the evolution of microzymes. This conclusion although it is in complete accordance with what we have already learnt as to their relations both in the visible and invisible state to moisture, is of such importance that it seemed necessary to establish it by special experiments.

XIII.—January 7.—The bent glass tube for the absorption of carbonic acid by potash, known as Liebig's bulbs, was heated to 200° C. and filled with boiling test solution. It was then attached by a vulcanite connector which had been previously boiled, to an aspirator. During the following week air was drawn through it for a few hours daily. On the 23rd there were numerous torula cells with submerged tufts of mycelium in the liquid, especially in those bulbs to which the air had access first, but no trace of microzymes.

On March 18 the surface of the liquid in the first bulb was crowded with a dense crust of penicillium; in the last bulb there were no tufts, and the liquid was still entirely free from microzymes. The result shows in a most striking manner not only that ordinary air is entirely free from living microzymes, but that the activity of the development of penicillium is in proportion to the degree of exposure.

XIV.—March 2.—A test tube, containing Pasteur's solution, in which there were immense numbers of microzymes and torula cells (penicillium), was plugged with cotton wool, boiled for a few minutes, and placed, still plugged, in a rack, where it remained for some time. The liquid which, at the time of boiling, was quite opalescent, gradually became clear, from the subsidence of the organisms it had contained. It remained perfectly clear and free from organic forms until the 18th of March. The plug of cotton wool was then removed, soon after which tufts of penicillium appeared on its surface; but up to the present time (March 31) the liquid is entirely free from microzymes.

SECTION II.—*Distribution of the Germinal Matter of Microzymes in ordinary Water.*

Having thus found in a number of cases that either contact with surfaces which had not been superheated, or the admixture of water which had not been boiled, was the exclusive cause of the growth of microzymes in the experimental liquid, it was not necessary to go far in order to arrive at the inference that water is the primary source from which the germinal particles of bacteria are derived, whenever they seem to originate spontaneously in organic solutions. To prove this a number of experiments were made with different varieties of water in ordinary use, in order in the first place to confirm the observations already made, and to ascertain whether all waters possess the properties in question in a like degree.

XV.—January 2, 1871.—A number of eprouvettes of the form shown in the margin were placed in the hot-air oven and heated to 200° C. They were then filled with Pasteur's solution made with ordinary distilled water, under the following conditions:—*a.* Solution not subject to heat. *b.* Solution introduced boiling, which was then allowed to cool; immediately after, a single drop of cold distilled water was added to it. *c.* The same as *b*, with the exception that water from the tap was used instead of distilled water. *d.* The eprouvette was filled with boiled solution, as in *b* and *c*, b

nothing was added to it. The glasses were then carefully

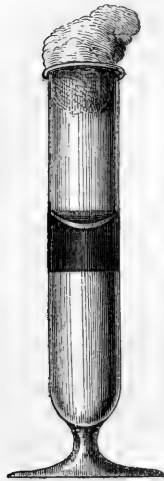

FIG. 2. Eprouvette used in this and the following experiments. It is plugged with cotton wool and charged with test liquid, to which distilled water has been added in the prescribed proportion, so as to avoid mixing. After standing a week the upper layer, with which distilled water is mixed, has become turbid.

plugged with cotton wool. On Jan. 12, glass *a* was quite milky in appearance, and had a gelatinous scum on the surface. It contained myriads of bacteria and a few torula cells. Glasses *b* and *c* were also turbid, the former more than the latter. The microscopical appearances were the same in all. In *d* no change could be detected either by the naked eye or with the microscope. Some of the liquid which remained in a glass exposed to the air was covered with tufts of penicillium.

In this experiment, which was confirmatory of the preceding, it is worthy of note that the two waters used to impregnate the test solution

the most decided effects were produced by the distilled water.

XVI.—January 17.—Pasteur's solution was made with ordinary distilled water. A sufficient quantity was then boiled, and immediately distributed in four eprouvettes, all of which had been heated immediately before to a temperature of 200° C., the quantity of liquid in each being about equal. The conditions of experiment were as follows:—1. The liquid was allowed to cool, and then three drops of freshly distilled water were added to it with the aid of a small pipette which had just been heated in the flame of a Bunsen's burner. This water was collected in a superheated glass from the glass distilling apparatus, which had been previously thoroughly steamed out. 2. The same, excepting that three drops of ordinary distilled water were used. 3. Three drops of water from the tap were added. To a fourth eprouvette no addition was made.

On January 24 the liquids in 1 and 4 were perfectly limpid, and showed no trace of organic forms; 2 and 3 were milky, especially the former. Both contained bacteria. Up to the present time the eprouvettes 1 and 4 remain perfectly barren.

This experiment shows that if due precautions are taken, distilled water may be obtained in such complete purity that it is free from germinal particles, whether of microzymes or fungi; and that the zymotic power (if I may be permitted to use this term to express the faculty to determine the development of organic forms in a test solution to which it is added)

of ordinary distilled water is acquired after distillation, either by mixture with extremely small quantities of other waters, or by contact with the surface of the vessels in which it is contained. It was also evident that between waters of different kinds and of different sources there are corresponding differences in the degree of zymotic effect they produce, whence it seemed probable that a practical method of judging of the amount of zymotic impurity contained in any two waters might be founded on the comparison of the degree of opalescence produced by each in the same time and at the same temperature. In how far this surmise was justified may be judged of by the results of experiments to be hereafter referred to, relating to the zymotic powers of the waters supplied to the metropolis.

If the apparently inevitable contamination of originally pure water, when kept, is due not merely to admixture with other water, but also to contact with surfaces impregnated with living matter, it becomes of interest to inquire by what conditions the action of such surfaces is limited or determined. In the course of one of the observations already related it was observed that a boiled liquid contained in a superheated test glass, which had long remained perfectly limpid, and entirely free from organic forms, became turbid after a pipette employed in order to procure a specimen for microscopical examination had been dipped in it; and that the time which intervened corresponded with that which usually elapses after impregnation before the effect manifests itself. This occurrence suggested the following experiments, which were undertaken in order to ascertain how far it is necessary that a surface should be moist in order to its acting zymotically.

XVII.—January 30.—A glass rod was charged with bacteria by dipping it into a solution on the surface of which there was a viscous scum, consisting entirely of these bodies imbedded in gelatinous matrix. The rod was allowed to dry in the air for a few days; it was then introduced into boiled test solution contained in a superheated glass. On February 6 the liquid was already milky and teemed with microzymes. On the same day a portion of the same scum was introduced into a test glass and dried with a gentle heat. The glass was then filled with test solution which had just before been boiled and cooled in the usual way. The result was the same as in the previous experiment.

In these instances it may be readily understood that the drying was very imperfect. To determine the effect of more complete desiccation, an eprouvette containing one cubic centimetre of cold water previously ascertained to be zymotic,

was evaporated to dryness in the incubator and kept for some days at a temperature of 40° C. On February 20 the dried glass was charged with boiled and cooled solution, and plugged with cotton wool in the usual way. The liquid was examined microscopically on March 2, when it contained numerous torula cells, but no trace of microzymes. It therefore appeared that the germinal particles of microzymes are rendered inactive by thorough drying without the application of heat. As, however, it could not be concluded therefrom that drying acted in a similar manner on the microzymes themselves, an experiment was made on this point also.

XVIII.—March 4.—As it appeared probable that in the previous experiments with bacteria scum, desiccation might be prevented by the gelatinous matrix, a portion of the same scum was thoroughly washed with water, collected in an eprouvette, and dried for some days in the incubator. The eprouvette was then (March 4) charged with boiled and cooled Pasteur's solution, and plugged with cotton wool. On March 11, the liquid was slightly hazy, but on microscopical examination was found to contain no trace of microzymes. The haziness was due to the presence of torula cells in great numbers. On the 18th the appearances were similar, but mycelium now existed in addition to torula. It thus appeared that fully formed bacteria are deprived of their power of further development by thorough desiccation; so that we may conclude that the *contamination of water by apparently dry surfaces happens only in those cases in which desiccation is incomplete*. It will be seen that this conclusion is quite consistent with the previous observations.

Method of testing the zymotic property of water.—As a test of the faculty possessed by all water which is not absolutely pure, of determining the growth of microzymes, Pasteur's solution gives results so constant and satisfactory that it appears scarcely necessary to seek for better, although there is no doubt that many other liquids would answer the same purpose, and that some would react with greater delicacy. The method consists, as already indicated, in the addition of a small quantity of the suspected water to a relatively large volume of the solution. As it is very desirable that the conditions of experiment should be subject to as little variation as possible, in our test experiments we add one drop of water to a centimetre of solution, always using the same dropping pipette. As the eprouvettes commonly employed contain five centimetres when half full, this quantity is preferred, so that in the following paragraphs the term "charged eprouvette" is understood to mean an eprouvette which has

been first superheated and then filled to five cubic centimetres with boiling solution. After each testing the pipette is immersed for several minutes in boiling distilled water. In six days after impregnation with any zymotic water such an eprouvette becomes hazy. It need scarcely be added that in each experiment a second charged eprouvette must be placed beside the impregnated one for comparison. Both must be protected from the air by plugs of cotton wool.

From the most careful and repeated examinations of waters known to be zymotic, we have learnt that such waters often contain no elements or particles whatever which can be detected by the microscope; so that it may be concluded that the elements of which the germinal substance of microzymes consists are of extreme minuteness. It therefore appeared to be of great importance to extend our inquiries to water which is optically pure, not merely in the sense that it contains nothing which can be detected by the microscope, but in the much higher sense that when viewed in the electric beam by the method employed by Professor Tyndall it shows no haze. Unfortunately it is not as yet possible to procure such water. Professor Tyndall has, however, been good enough to give us the opportunity of testing specimens obtained by the fusion of ice which approach the standard of optical purity so nearly that the electric beam in passing through them displays a blue colour. Of the results of our examination of these specimens it is sufficient to state that they are as zymotic as many other varieties of water which in the beam are seen to be full of light-scattering particles.

To determine in how far the zymotic properties of water are affected by chemical compounds which are believed to have the power of arresting the evolution of living forms in organic liquids, a series of experiments were made in which the zymotic power of water was tested before and after the addition of such compounds, the supposed anti-zymotic being contained sometimes in the water to be tested, sometimes in the test solution.

XIX.—March 2-10.—1. A quantity of water previously ascertained to be zymotic was ozonised by subjecting it to the action of air which has passed over fresh and moist phosphorus, the apparatus for this purpose consisting of (*a*) two Woulff's bottles containing sticks of phosphorus; (*b*) a washing bottle containing solution of caustic potash; (*c*) a flask containing the water to be ozonised. Air was made to pass slowly through *a*, *b*, *c* in succession, by means of an aspirator, for several hour, after which the liquid in *c*, and the air in contact with it, reacted strongly on iodide of potassium and

starch paper. Charged eprouvettes were then (March 2) prepared in the usual way, to each of which a few drops of the ozonised water was added. On March 21 no organic forms whatever could be discovered in the liquid. The plugs were then removed. On the 27th the first tufts of penicillium appeared, which have increased up to the present time. There are no microzymes in the liquid.

2. Water known to be zymotic was treated with Condy's liquid in quantity sufficient to colour it slightly, A few drops were then (March 2) added to a charged eprouvette. Up to the present time the liquid remains free from microzymes, but contains torula cells. On the same day a second charged eprouvette was treated with two drops of undiluted Condy's liquid and plugged. It remained absolutely barren till March 21, when the plug was removed. In a few days torula cells appeared, and on the 27th there were tufts of penicillium.

3. A charged eprouvette was impregnated (March 2) with ordinary distilled water containing 0.1 per cent. of carbolic acid. At the end of a week the liquid was hazy and teemed with bacteria and torula cells. Ultimately penicillium tufts appeared on the surface. On March 8 the experiment was repeated with water containing 0.5 per cent. of carbolic acid. It remains up to the present moment free from microzymes, but contains torula cells and mycelium.

4. A charged eprouvette was impregnated with ordinary distilled water (March 2) containing 0.1 per cent. of sulphate of quinia, and plugged. At the end of a week it was opalescent and full of bacteria; it also contained torula cells and mycelium. On March 8 the experiment was repeated with water containing 0.5 per cent. of the salt. At the end of a week it was hazy, but on microscopical examination this was found to be due exclusively to torula cells.

5. March 11.—A charged eprouvette was impregnated with distilled water containing 10 per cent. of the solution of peroxide of hydrogen. The liquid remained free from microzymes until March 21, when the plug was removed. Tufts of penicillium had already appeared on the 27th.

6. March 11.—A charged eprouvette was impregnated with distilled water containing five per cent. of liquor chlori. The liquid remained barren until March 21, when the plug was removed. It is now crusted with penicillium.

7. February 13.—A superheated eprouvette was charged with some of the superheated Pasteur's solution which had been prepared five months before. The liquid was then impregnated with distilled water known to be zymotic. On March 4 the liquid was examined and found to be entirely

barren. It was then treated with boiled solution of pure sugar. As on March 21 the liquid was still entirely free from organic forms it was sown with some fresh spores of penicillium. Up to the present time there has been no change.

XX.—February 23.—For the purpose of investigating the zymotic property of any water, it may be conveniently collected in a tube of the form and size shown in Fig. 1. It is essential that it should be used in a state of absolute purity. As it is seldom possible to draw the tube at the time that it is to be filled, it must, as a rule, be prepared beforehand, in which case it is necessary to close it hermetically at both ends before it is removed from the flame. Such a tube obviously contains calcined air, of which the tension is very much less than that of the atmosphere; consequently it is very easily filled by breaking off its end under the surface of the water of which a specimen is to be collected. If the water is flowing from a tap or in a stream it must be received in a boiled capsule, in the contents of which the tube may be dipped.

Fifteen specimens of water supplied by the London companies were collected in this way during February last, and tested with reference to their zymotic power on the 23rd of the same month. The results of the experiment are exhibited in the following table, in which the number printed below the designation of each specimen indicates the order in which it would have stood if the tubes had been arranged in a linear series according to the degree of turbidity which each manifested on the ninth day after impregnation.

Letter designating Water Company.	Water before filtration (from subsidence reservoir).	Water after filtration (from pump well).	Water as distributed (from main).
A	15	3	13
B	14	10	7
C	5	2	6
D	1	12	8
E	4	9	11

The specimens to which the numbers 15, 14, 13, 8, 7, 5, correspond, became hazy as early as the fifth day. On the ninth day it is noted that the eprouvettes to which the six highest numbers correspond were milky, while those in which the turbidity was least marked were merely hazy; the rest

are described as being opalescent. All, therefore, acted zymotically in different degrees.

All of the eprouvettes were plugged with cotton wool. As in previous experiments, the quantity of water introduced was in each case measured with the same pipette, which was immersed in boiling distilled water for a few minutes between each impregnation. A check eprouvette was then impregnated in the same way as the rest with the water in which the pipette was washed. It remains to the present moment perfectly transparent and barren.

Excepting in so far as this experiment shows that filtration exercises no perceptible influence on the zymotic power of water, no conclusion can be drawn from the comparison of the results. It happens that the water designated C stands considerably higher than the rest, and that designated A considerably lower. It would be premature, however, to attach importance to this fact.

SECTION III.—*Circumstances which Determine the Existence of Microzymes in Organic Liquids and Tissues.*

The experiments to be related in the following paragraphs were undertaken for the purpose of ascertaining whether the tissues and liquids of the living body participate in the zymotic property which has been shown to exist in ordinary water and moist substances: in other words, whether the living matter with which the body is in constant contact by its external surface penetrates into its interior.¹

XXI.—March 24.—A glass canula of suitable size, which had just been drawn, was introduced into the carotid artery of a rabbit, and secured with a ligature. The arterial blood as it flowed from the canula was received into four ordinary test glasses (marked *a, a*, and *b, b*), and into an eprouvette (marked *c*). The quantities of blood collected in *a, a* were mixed with boiled and cooled distilled water, and left freely exposed under a bell jar. In two or three days bacteria appeared and the liquid became offensive. The quantity in *b, b* was left undiluted, and each glass was covered with a layer of cotton wool. On the 30th they remained unaltered,

¹ As to the existence of *visible* microzymes in the liquids of persons affected with contagious diseases, I had already satisfied myself that I could not accept Hallier's observations; for on examining the blood of patients affected with scarlatina (in which, according to Hallier's statement, micrococcus is constantly observed and very abundant) at all stages of the disease, I had found that no such bodies existed in it. It does not, however, follow from this that organisms are not present potentially, *i.e.* in the form of germinal particles not distinguishable by the microscope.

and contained no organic forms excepting those proper to the liquids. They were then carefully mixed with boiled distilled water by the aid of a freshly prepared pipette, and again covered with cotton wool. [On April 3 the liquid was entirely free from microzymes, and exhibited no sign of decomposition.]¹ The blood contained in the eprouvette was allowed to coagulate, and yielded a clot and very limpid serum. Up to March 30 it remained quite unaltered, and on microscopical examination it was found to be quite free from microzymes. On that day the serum was transferred by means of a superheated pipette into another superheated eprouvette, and diluted with boiled and cooled distilled water: it was then placed in the incubator. To the clot distilled water was added in quantity corresponding to that of the serum which had been abstracted: it was placed in the incubator. [When these preparations were examined on April 3, the serum was still limpid and perfectly free from organic forms, and the clot-preparation showed no change.]

Other experiments were made, consisting in impregnating charged eprouvettes with drops of blood taken directly from the finger, great care being taken in each case to cleanse the surface of the skin where the puncture was made. In each case the blood-corpuscles subsided to the bottom of the eprouvette, leaving a clear liquid in which no development of microzymes took place, although they were kept under observation for several weeks.

We have no hesitation in attributing the development of bacteria in the liquid in the test glasses marked *a*, *a*, to an accidental contamination (*e.g.* to the falling into the glass of a hair of the rabbit, or possibly a drop of saliva), and in concluding that normal blood contains no microzymes potentially or actually.

XXII.—February 24.—A guinea pig was killed, and, immediately after, the integument was stripped off the back. Portions of the muscles and cellular tissue of the rump were then rapidly cut out with scissors which had just been heated in the flame of a Bunsen's lamp. The pieces were then seized with the aid of glass hooks which had just been made for the purpose, and transferred into charged eprouvettes (marked *a*). Others were placed in superheated test glasses, and covered with boiled and cooled distilled water, but by accident one of them fell from the hook on to the table (marked *b*). The skin was then stripped off the thighs, which were immediately separated from the body with the

¹ The Report bears date March 31st, 1871. The passages in brackets were added during the first week of April.

same precautions as before, and hung up under a bell jar by wires which had been heated and cooled. The liquid in the eprouvette *a* was subjected to repeated examination until March 3, when it was still perfectly limpid and entirely free from organic forms. A single drop of common distilled water was then added to it. In a few days it became milky and acquired a putrid smell. In the glass *b*, there were already signs of bacteria on March 2, and the liquid soon became offensive. The thighs which were hung up, shortly became covered with a crust of penicillium. One of them was examined on March 9. On removing the crust and cutting into the muscle it was found to be less moist, but otherwise of natural appearance. There was a musty but no putrefactive smell. The cut surface was neutral to test paper. The other thigh was examined March 27, and was in a similar condition, excepting that the muscular substance was drier and of darker colour.

XXIII.—February 1.—Five centimetres of urine were introduced into an eprouvette, which was then plugged with cotton wool and placed under a glass shade. It retained its acid reaction and limpidity till February 9, when a drop or two of ordinary cold distilled water was introduced from a fine capillary pipette prepared just before. On the 16th the liquid was hazy and crowded with bacteria. In the course of a few days more, a sediment subsided to the bottom of the eprouvette, and the liquid became alkaline and ammoniacal. This experiment was subsequently repeated with similar results.

It has been long known that the tendency of urine to undergo decomposition may be obviated by protecting it against contamination from without. The preceding experiments show that here, as elsewhere, water is the contaminating agent.

XXIV.—January 2.—An abundant flow of saliva having been determined by introducing a few drops of ether into the mouth, one or two drops were allowed to fall into a charged eprouvette. The liquid was repeatedly examined during the next three weeks, but no microzymes could be detected. The salivary secretion, as it is discharged from the salivary ducts, is no doubt inactive; but inasmuch as the mixed liquid with which the mucous membrane is moistened is exposed to several sources of contamination, and moreover can be often shown to contain leptothrix filaments, it would not have been surprising if the result of the experiment had been otherwise.

XXV.—It is scarcely possible to obtain milk in a state of

purity, for the liquid as it issues is exposed to contamination both from the hands of the milker and from the surface of the test itself. It is not therefore surprising that the results of our experiments with this secretion were not uniform. Their variations, however, exhibit so complete a correspondence with the varying conditions of the experiments, that they are scarcely less confirmatory of the general conclusions we have arrived at than if they had been positive.

February 28.—Milk was received directly from the cow into two flasks (marked *a* and *b*) which had been previously superheated. The flasks were immediately plugged with cotton wool. Another specimen of milk “as delivered to customers,” was brought from the dairy at the same time in a clean bottle which had not been superheated. All the specimens were alkaline. On March 4 it was found that the milk in the bottle was slightly acid and crowded with bacteria. On the 9th it was curdled and smelt offensively. The flask *a* was also acid on March 4, and contained a few groups of bacteria. In the flask *b* the acid reaction was scarcely appreciable, and no bacteria could be discovered in it. On the 9th the contrast between *a* and *b* was still very striking, the liquid in *a* having separated into whey and curd, while *b* remained apparently homogeneous. Charged eprouvettes were then impregnated with drops of the liquid in *b* in which no bacteria could be detected. After a few days bacteria appeared in the test liquid, and in the liquid which still remained in the flask.

The difference between *a* and *b* was of course accidental, for both were exposed to equal chances of impregnation.

XXVI.—February 21.—It has been already stated that superheated tubes containing egg albumen which had been kept from August, 1870 to March, 1871, were found absolutely free from organisms, and to all appearance unaltered. The liquid contained in one of these tubes which was perfectly limpid was emptied into a superheated eprouvette and impregnated with two drops of cold distilled water. On March 2 the liquid had acquired a yellowish green tint, a scum had formed on its surface, and the liquid was full of separate bacteria.

XXVII.—March 20.—Pus was collected from a deep-seated abscess in the thigh of a child by introducing the capillary end of a collecting tube into the path of the bistoury which had been used for opening it, the bistoury having been itself immersed in boiling water. It was then transferred to a small eprouvette and exposed to the air. On March 30 there were no bacteria. It was then diluted with

boiled and cooled distilled water. [It was again examined on April 3, when it contained no organic forms whatever.]

February 7.—A pyæmic abscess of the elbow joint was opened; a full stream of pus issued from the incision. Several large but still capillary tubes were then filled by inserting their open ends into the track of the bistoury. The tubes were immediately sealed, and the contents used the same day to impregnate a charged eprouvette. After a few days the test liquid was teeming with bacteria.¹ In this case the knife was not previously immersed in boiling water, but the discharge of pus from the wound was so copious that I do not think there is the slightest doubt that the quantity used was collected without any contamination, whether arising from this source or from the surface of the skin.

XXVIII.—The collection of blister fluid is attended with much greater difficulties than that of pus, for it is almost impossible to abstract it from the vesicles without risk of contact with the surface of the skin. It can be best obtained by opening both ends of a collecting tube, and then introducing the capillary end into a vesicle after first snipping the epidermis. This done, the liquid must be drawn into the tube by suction. Liquid thus collected was used as follows:—

January 10.—Blister fluid was added in the usual proportion (one drop to one cubic centimetre) to a charged eprouvette. For a long time the liquid remained clear, but eventually bacteria appeared in small numbers.

February 13.—Blister fluid from another source was used in a similar manner and with a similar result.

March 27.—The same experiment was repeated with different fluid, but in this case the eprouvette was kept in the incubator. The development of bacteria was much more rapid. On the same day another quantity of the same liquid was diluted with boiled and cooled distilled water in a superheated eprouvette and also placed in the incubator. [In a few days it became turbid and swarmed with bacteria.]

The equivocal results of these experiments are to be attributed entirely to the difficulty of obtaining blister fluid pure, that is, to accidental contamination in the process of collection.

¹ This important experiment could not be repeated, for an attendant who entered the laboratory in my absence carelessly destroyed all the tubes excepting the one which had been already used. The single result was so satisfactory that I myself entertained no doubt of its significance.

From the consideration of a number of facts which presented themselves in the course of the experiments related in the previous pages, it has appeared certain that there is no developmental connection between microzymes and torula cells, and that their apparent association is one of mere juxtaposition. The grounds of this conclusion may be shortly stated thus:—

1. The prompt appearance of torula cells in Pasteur's solution whenever it is exposed to the air, and the rapid development and luxuriant fructification of the higher form (penicillium), show that so far as the chemical composition of the liquid is concerned, there exist in it all the conditions favourable to the process.

2. Our experiments prove that when precautions are taken to prevent contamination by impure surfaces or liquids, the development which ends in penicillium goes on from first to last without the appearance of microzymes.

3. Whenever it is possible to impregnate the test liquid with microzymes without at the same time introducing torula cells or germs, the development of the former begins and continues by itself without any transformation into the latter.

Thus fungi are not developed, *notwithstanding the presence of microzymes* in the same liquid in which, *microzymes being absent*, but air having access, they appear with the greatest readiness.

This being the case we are enabled to eliminate the question of the quasi spontaneous evolution of fungi altogether in the present discussion, as lying beyond the limits of our inquiry. It can hardly, however, be considered out of place to state to the reader some of the results to which our observations have led us with reference to this question, especially considering that however improbable it may seem to ourselves that fungi have any important relation with the processes of disease, there are others who are of a different opinion.

To determine the forms in which germs of fungi exist in the air, the best method is that long ago used by Pouchet—that of projecting a jet of air on a glass plate moistened with glycerine or syrup. A few experiments were made, but the results were mostly negative, for in London the particles of soot and refuse fragments which are collected by this method are so numerous that organised particles, even if present, could scarcely be distinguished. We find it a much more successful plan simply to expose a glass surface covered with glycerine to the air. In examining such a surface it was always possible to discover a certain number of cells

which resembled torula cells, and occasionally penicillium acrospores.

From this result we do not, however, conclude that it is by these forms that the cosmopolitan fungus (as Hallier calls it) is usually propagated; it frequently happens that liquids which have been once exposed, although they contain no visible cells whatever, rapidly germinate without further exposure. We are also certain that although air is the main source of what we may venture to call fungus impregnation, as distinguished from impregnation with microzymes, yet the two acts may take place at the same moment—germs of torula being often contained in the same liquid media as the germ particles of microzymes. That this is so is proved by instances already referred to, in which liquids protected from air filled with torula cells. Here we relinquish this question, although in a biological point of view it is of the greatest interest and importance.

On the COLOURING MATTER of some APHIDES.

By H. C. SORBY, F.R.S., &c.

THOSE who have orchards are no doubt often only too familiar with the red Aphides found in downy patches on the bark of the apple tree. These are coloured by a substance possessing somewhat remarkable properties, connecting it on the one hand with cochineal, and on the other with the hæmoglobin of the blood of vertebrate animals. It rapidly changes into a series of new products, which have remarkable optical characters, and are in some respects analogous to the colouring matters of oils and fats.

In order to obtain this red colouring matter in a state suitable for examination, the insects, fresh taken from the tree, should be crushed up in a small quantity of boiling water, and the solution filtered. It is then of a fine crimson colour, giving a spectrum with a broad general absorption, extending from the yellow over the whole of the green to the centre of the blue, without any well-marked narrow band, as shown in No. 1 of the accompanying fig. 1.

Fig. 1.—Spectra of the light transmitted by aqueous solutions.

Red end.

Blue end.

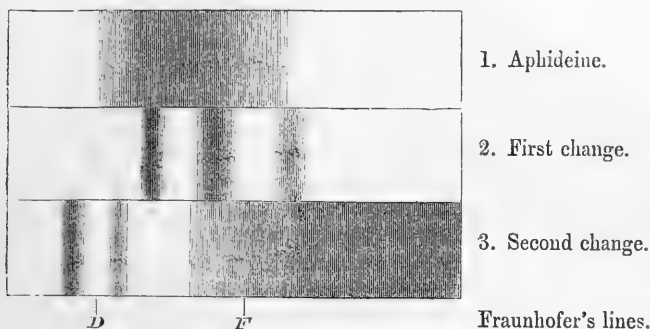

The addition of a small quantity of citric acid immediately alters the colour to yellow, and then the spectrum merely shows an absorption of the blue end, extending to about the centre of the green, without any definite absorption-bands. A little ammonia restores the colour to its original state, and therefore the crimson colour is characteristic of a neutral or slightly alkaline solution. When a small quantity of the double sulphate of protoxide of iron and ammonia is added to the solution in its natural state (as in all similar cases, using along with it some of the double tartrate of potash and soda, to prevent the precipitation of oxide of iron), it is changed at once to a pale flesh-colour; and, if a little ammonia had been previously added, the solution becomes quite colourless. On exposure to the air, it changes back again to the original tint, from the surface downwards. No such alteration is produced by adding the ferrous salt to an acid solution. This red substance, therefore, like hæmoglobin and hæmatin, exists in an oxidised and in a deoxidised condition, and, like them, can be deoxidised by the above-named process only when the solution is somewhat alkaline. It thus seems reasonable to suppose that it may perform the same functions in the economy of those insects which contain it that hæmoglobin does in the case of the vertebrata. For convenience, it may be well to call this red colouring matter of *Aphides Aphideine*. It is entirely different from any substance on which they feed, and is the same in several species living on entirely different plants.

One of the remarkable peculiarities of hæmoglobin is that it can be changed into a number of substances, each giving a

well-marked spectrum, and in this respect Aphideine is little, if at all, less remarkable. On very gradually adding a small quantity of hypochlorite of soda to a recently prepared solution, the original spectrum No. 1 is changed to that shown in No. 3; but the compound then formed changes quickly into another, the spectrum of which shows two similar narrow absorption-bands, somewhat nearer the red end, not removed by the addition of ammonia or citric acid, disappearing at once when the ferrous salt is added to an alkaline solution, and partially restored by reoxidation, if not kept long in a deoxidised state. The same results may be obtained by using the Aphideine extracted cold by crushing the insects in a small quantity of water, but this solution, which is often turbid, changes so rapidly on exposure to the air, that it is difficult to examine it before it has been considerably altered. On crushing the living insects in a watch-glass with a little water, the solution is at first pink, but rapidly becomes orange. On pouring this off into another watch-glass, leaving it for a short time, and then pouring the comparatively clear solution into an experiment cell, it will be found that the original Aphideine has been completely altered. On adding a little ammonia, instead of the spectrum showing a broad, continuous band like No. 1, three well-marked narrow bands are seen, as shown by No. 2. For the actual position of these and those in other spectra, I refer to the table given at the end of this paper.

The relative intensity of these three bands varies considerably, and this led me to conclude that two different substances were present, as was subsequently proved in the manner described in the sequel. A weak acid entirely removes the narrower band nearest the red end, raises the others somewhat, and develops a new band still nearer the extreme blue, which can only be seen with excellent sunlight. On adding the ferrous salt to the alkaline solution, the absorption-bands gradually vanish, and, if kept deoxidised for some time, a new compound is formed with an absorption-band between the orange and yellow, and another in the green, disappearing when reoxidised. On the contrary, if the solution which gives the spectrum No. 2 be kept for a while exposed to the air, it is gradually changed into another compound, giving the two absorption-bands shown in No. 3. On keeping still longer these disappear, and the spectrum shows only a general absorption extending over the blue and green without any narrow bands. I am therefore inclined to believe that the compounds which give spectrum No. 2 are gradually altered into two other substances, which when mixed give

spectrum No. 3, the narrow bands being due to one and the greater part of the broad absorption of the blue end to the other. These two narrow bands are at once removed by citric acid. The addition of the ferrous salt to an alkaline solution also removes the bands, and they are restored if reoxidised in a short time. When the solution is kept for a day or two deoxidised, and then rapidly reoxidised, no bands make their appearance; but if, after having been thus kept deoxidised, the cell be exposed uncovered to the air, so as to reoxidise slowly, another compound is formed, which gives a spectrum with an absorption-band nearer the red end than that shown in No. 3, made much more faint by citric acid, removed at once by deoxidising the alkaline solution, and reappearing when reoxidised. Since some of these solutions are often turbid, it is requisite to use strong concentrated sunlight to penetrate through them.

It will thus be seen that by exposing the solution to the air Aphideine passes successively into four different coloured products, and by deoxidisation and by subsequent exposure two others are formed. These complicated changes do not thus rapidly occur in the comparatively pure solution obtained by boiling the insects in water. It seems requisite that it should contain some of the (perhaps albuminous) substances present when the insects are crushed up in cold water, which by their rapid decomposition seem to induce the above-named changes in the Aphideine itself.

In my paper on some compounds derived from the colouring matter of blood,¹ I briefly described some of the products of the oxidisation of hæmoglobin. Of these there are at least four, three of which are characterised by the presence of absorption-bands at the red end of their spectra when the solutions are deoxidised. The products of the change of Aphideine are in some respects analogous to these, only that except in one the bands are characteristic of the oxidised state. The physical and optical properties of Aphideine and its products differ completely from those of the colouring matter of the cochineal insects of commerce. Whether this is a normal constituent of the living insects or a product can only be decided by examining them when alive, which hitherto I have not been able to do. I have met with Aphideine only in several dark-coloured species of Aphides, but at the same time I must confess that my acquaintance with the colouring matters of insects is very limited.

When carefully selected living Aphides of the apple tree are quickly crushed up in ether, and the clear solution agi-

¹ 'Quart. Journ. of Micros. Science,' x, 1870, pp. 400—402.

tated with about an equal quantity of water, it sinks to the bottom coloured pink-red by the Aphideine, whilst the supernatant ether is of pale yellow colour. On evaporating this to dryness, and dissolving in bisulphide of carbon, the yellow solution gives a spectrum without any decided absorption-bands, and seems to be coloured by a substance like that occurring in the fat or wax of other insects. If, however, similar living Aphides are crushed up in a test tube, kept in that state for a few minutes, and then treated with ether, on agitating with water it subsides almost colourless, whilst the ether is coloured deep yellow, and its spectrum shows two well-marked absorption-bands in the blue. When this solution is agitated with water, no colour is dissolved from it, but on adding a little ammonia the greater part of the colouring matter passes to the water in the alkaline modification, of orange colour, giving two well-marked absorption-bands between the blue and the green part of the spectrum, corresponding exactly to the two bands in No. 2, fig. 1, which are nearest to the blue end. On adding a little citric acid that on the green side is removed, and another developed still nearer to the blue end than the one which remains nearly in the original position. If the crushed Aphides are kept longer and treated in the same manner, we obtain a spectrum with three bands, analogous to No. 2, fig. 1; and after they have been kept crushed and damp for half a day, the spectrum shows only two bands, which lie so much farther from the blue end than in the former that the band nearest to it in this case almost coincides with that farthest from it in the other. On agitating this solution with water and a little ammonia, the colouring matter is deposited as a pink layer between the ether and the water, the alkaline modification of this substance thus differing from that of the former in being insoluble in water as well as in ether. Separating it and mixing in alcohol it gives a spectrum with two well-marked absorption-bands in the green and green-blue, corresponding exactly with the two bands in No. 2, fig. 1, which lie towards the red end; and on adding a little citric acid the band in the green disappears, and another is developed in the blue. There is thus good evidence to show that the variation in the relative intensity of the bands in spectrum No. 2 of fig. 1 is really due to a variable mixture of these two substances. Both are of yellow colour when the solution is neutral, and when dry are of waxy consistence. They are manifestly formed by an alteration of the original Aphideine, and therefore it may perhaps be well to call the former *Aphidiluteine*, and the latter *Aphi-*

diluteoleine. On still further exposure to the air a red colouring matter is formed, which may be distinguished by the name of *Aphidirhodeine*; but this may be more conveniently obtained pure in the manner described in the sequel.

As in the case of all such substances, their spectra are best seen when they are dissolved in bisulphide of carbon, for then the absorption-bands lie farther from the blue end, and there is no chance of there being any variation in their position, owing to any difference in the amount of water that may be present in alcohol or ether. When carefully picked out living Aphides are crushed up in a test tube with the bisulphide, the colour is at first red, but almost immediately changes to yellow; and on stirring them up so as to expose to the air and to the bisulphide, the original Aphideine is rapidly altered into Aphidiluteine, which dissolves in the liquid, giving a bright yellow solution. This should be filtered and examined at once. The spectrum of transmitted light shows two well-marked absorption-bands in the blue, situated much nearer to the extreme blue than those of any other analogous substance which has come under my notice. It is also very fluorescent, of a fine green colour, and this light of fluorescence gives the spectrum shown in No. 4 of the following woodcut, fig. 2:

Fig. 2.—Spectra of the Light of Fluorescence.

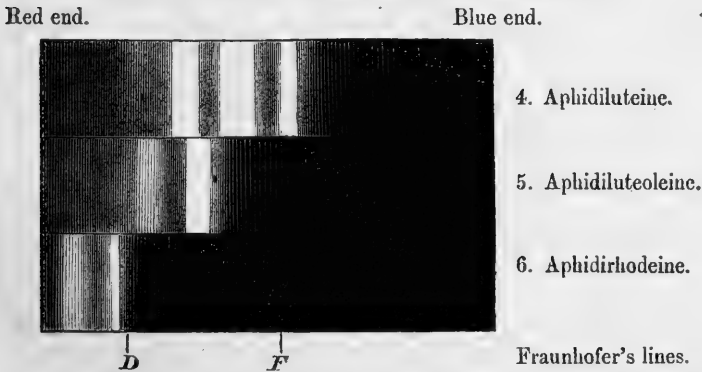

The whole of the green part of the spectrum is seen, with the exception of two somewhat faint bands, which I believe are due to the Aphidiluteine itself, but am not quite certain, since it rapidly changes into other compounds which have absorption-bands nearly in the same situation. On keeping the above-named solution for some hours it is completely

changed. The spectrum of transmitted light shows two absorption-bands situated very considerably further from the blue end than before, and the light of fluorescence is yellow-green, giving the spectrum No. 5 with a bright band nearly in the centre of the green and a fainter between the green and yellow. This change takes place much more slowly in the case of the solution in ether, but much more rapidly when crushed insects are exposed to the air, and a third compound is formed, which may be obtained in a very satisfactory manner by digesting dead insects, kept dry for some weeks, in a solution of bisulphide of carbon in alcohol, and after it has remained for a few days agitating the clear solution with excess of the bisulphide. This sinks to the bottom with the greater part of the required substance, and leaves various impurities dissolved in the alcohol. After washing with more alcohol, the solution in bisulphide when evaporated leaves an oily or waxy substance coloured brown orange. When dissolved in bisulphide of carbon this gives most remarkable spectra. The transmitted light is of an orange-red colour, giving five well-marked absorption-bands, one in the orange, dark, narrow, and well defined; one at the yellow end of the green, very dark and well defined, with some general shading on the green side; a third and a fourth, less dark than the above two, one nearly in the centre of the green and the other at the green end of the blue, whilst the fifth is nearly in its centre. This spectrum is not only remarkable for the number of bands thus spread over so large a space, but also for the manner in which they are related to one another. This is much like what might be due to a mixture of two substances, and yet there is no further evidence of its being so.¹ The solution is strongly fluorescent, the light of fluorescence is orange-coloured, and its spectrum is as shown by No. 6. The yellow, green, and blue are entirely absent; there is a red band, but it is comparatively so faint that the light may be said to be nearly monochromatic, being almost entirely due to the well-defined orange band shown by the figure, which is so narrow that it is only about $\frac{1}{50}$ th part of the whole visible spectrum of daylight. As will be seen, it is quite on the red side of the sodium line D, but when the substance is dissolved in ether instead of bisulphide of carbon, the centre of the bright band almost exactly coincides with D, and all the various bands in the other spectra already described are raised to about the same

¹ See my late paper, "On the Examination of Mixed Colouring Matters," 'Monthly Micros. Journal,' vol. vi, pp. 124—134.

extent towards the blue end, when ether is employed as the solvent.

On agitating the solution of this Aphidirhodeine in ether with water containing a little ammonia, the greater part of the colour is deposited as a green layer between the water and the ether, as though the alkaline modification were insoluble in both water and ether. Separating this and mixing it up in dilute alcohol it gives the spectrum No. 3 of fig. 1, and this fact led me to think it probable that the substance which gives these bands, formed on exposing a solution of aphidieine to the air, is really Aphidirhodeine remaining in a state of very unstable solution. I therefore added to such a preparation two or three times its bulk of alcohol, and on agitating with excess of bisulphide of carbon obtained a red solution of Aphidirhodeine with some Aphidiluteoleine. It therefore appears that though the products derived from Aphideine are not dissolved by water, they may in some cases remain in solution for a time, so as to give a more or less clear liquid. I specially mention this because as an almost universal rule colouring matters soluble in water are insoluble in bisulphide of carbon, or in fats and oils; and misled by the apparent solubility in water, it was some time before I discovered that this brown, dirty-looking solution was in great measure coloured by the clear red and highly fluorescent substance obtained as already described by the use of bisulphide of carbon, for on superficial examination they seem to have so very little in common.

As already named, when the living insects are crushed up in ether, a small quantity of a yellow colour is obtained analogous to that in the fat or wax of other insects, but no Aphidiluteine, which, therefore, appears not to be a normal constituent. If the insects be killed by exposure for a short time to the vapour of bisulphide of carbon, and the colouring matter dissolved out by ether in the course of a few minutes, the amount of Aphidiluteine obtained is very small; but, if the insects have been kept dead for a quarter of an hour, there is no difficulty whatever in proving that a considerable part of the Aphideine has changed into Aphidiluteine even in so short a period of time. After having been kept dead for about a day very little unaltered Aphideine remains. On keeping them much longer they turn darker and transmit red light, showing the absorption bands of Aphidirhodeine. These facts clearly prove that in such inquiries it is most important to decide whether the colouring matters are or are not present in the living insects. The change from Aphideine to Aphidiluteine is so rapid that I was for a consider-

able time led to conclude inaccurately that Aphides contained a waxy substance coloured yellow by that compound. Such an instance of rapid and remarkable changes may be rare, but at the same time it serves to show the importance of our taking into consideration the possibility of its occurrence, even when circumstances are not so favorable for deciding the question. When exposed to the vapour of ether, though apparently killed, the insects sometimes revive, and, even if they do not, the Aphideine changes far more slowly, which may explain why bisulphide of carbon has a so much more poisonous action.

Since it may, perhaps, be convenient for reference, I here subjoin a table of the character and position of the more important absorption-bands seen in some of the spectra roughly described in this paper, making use of the notation explained in a previous communication.¹

TABLE OF SPECTRA.

Fraunhofer's lines, D is at $3\frac{1}{2}$ and F. at $7\frac{1}{2}$.

1. As dissolved in water :

Aphideine, alkaline	$3\frac{1}{2}$	$8\frac{1}{2}$
„ acid	6	7 - - 8—

The first mixed product :

When alkaline varying as thus shown	}	$5\frac{1}{8}$ 7 $8\frac{1}{2}$
		$5\frac{1}{8}$ $6\frac{7}{8}$ $8\frac{1}{2}$

When acid	$7\frac{3}{8}$ $8\frac{7}{8}$ $10\frac{1}{2}$
---------------------	---

The second product	$2\frac{3}{4}$ $4\frac{1}{8}$
------------------------------	-------------------------------

2. As dissolved in ether, &c. :

Aphidiluteine in ether	9	$10\frac{5}{8}$
----------------------------------	---	-----------------

„ in ammoniacal solution of ether in water	$6\frac{3}{4}$	$8\frac{3}{8}$
--	----------------	----------------

„ in acid solution of ether in water .	$8\frac{3}{4}$	$10\frac{1}{2}$
--	----------------	-----------------

Aphidiluteoleine in ether	$7\frac{1}{2}$	$9\frac{1}{8}$
-------------------------------------	----------------	----------------

„ suspended in dilute alcohol with ammonia	5	$6\frac{1}{2}$
--	---	----------------

„ „ „ „ citric acid	$7\frac{3}{8}$	9
---------------------	----------------	---

¹ "On Some Technical Applications of the Spectrum-microscope," 'Quarterly Journ. of Micros. Science' (N.S.), Vol. IX, pp. 358 and 359.

Aphidirhodeine in ether	$3\frac{1}{2}$	$4\frac{3}{8}$...	5	6	$7\frac{5}{8}$	$9\frac{1}{4}$
„
„	$2\frac{3}{4}$	$4\frac{1}{8}$
*						
3. As dissolved in bisulphide of carbon :						
Aphidiluteine					$8\frac{1}{2}$	$10\frac{1}{4}$
Aphidiluteoleine					$7\frac{1}{8}$	$8\frac{3}{4}$
Aphidirhodeine	$3\frac{1}{4}$	$4\frac{1}{8}$...	$4\frac{3}{4}$	$5\frac{3}{4}$	$7\frac{3}{8}$	9

OBSERVATIONS *and* EXPERIMENTS *on the* RED BLOOD-CORPUSCLE, CHIEFLY *with* REGARD *to the* ACTION *of* GASES *and* VAPOURS. By E. RAY LANKESTER, Radcliff Travelling Fellow, University of Oxford.

Preliminary.—1. The uses of gases and vapours as a means of micro-chemical research.—2. Opinions and doubts concerning the red blood-corpucle (bibliography).—3. The normal appearance of the frog's red blood-corpucle.—4. The normal appearance of the human red blood-corpucle.—5. Means of studying the changes of the blood-corpucles in disease.—6. Effect of pressure on the red blood-corpucle.—7. Effect of isolation: *a*, by adhesion; *b*, by oil.—8. Effect of water in minute quantities gradually added.—9. Effect of CO₂ gas.—10. Effect of osmic acid (vapour).—11. Effect of acetic acid (vapour and liquid).—12. Effect of alcohol.—13. Effect of ammonia gas.—14. Effect of chloroform (vapour and liquid).—15. Effect of bisulphide of carbon.—16. Effect of benzine.—17. Effect of turpentine oil.—18. Effect of solution of acetate of rosanilin and of tannin (Robert's experiments).—19. Effect of carbonic oxide.—20. Effect of cyanogen gas.—21. Effect of sulphuretted hydrogen.—General conclusions and summary.

THE object of the disconnected observations which are here recorded was threefold: firstly, to ascertain whether certain vapours and gases having marked physiological influence on animals exert any direct action on the red blood-corpucles, and to determine whether those known, by investigation with the spectroscope, to affect the hæmoglobin produce visible changes in the corpucle; secondly, to examine into the chemical and formal structure of the red corpucle; thirdly, to obtain, by a detailed examination of the influence of reagents, and especially gaseous reagents, on a typical histological element, a starting-point for further micro-chemical studies. I cannot consider, as far as relates to the chemical

side of the inquiry, that I have by any means carried out my object, for the subject has yet to be approached by the methods of analysis, with the view of recognising in this or that separable portion of the corpuscle this or that proximate chemical substance, in place of the tentative method of introducing reagents in order to observe how they may possibly act. At the same time, whilst we are waiting for chemists to give us some precise tests or series of reactions by which such highly complex bodies as those forming the blood-corpuscles can be recognised under such restricted conditions as microscopic inquiry involves, my results may not be uninteresting as bearing on the physical structure of the corpuscles, and as indicating a method of applying reagents in micro-chemical research, which has hitherto been but little used.

1. *The use of gases and vapours as a means of micro-chemical research.*—By means of the gas-chamber, Kühne, von Recklinghausen, Boettscher, Stricker, and Schweigger-Seidel have studied the action of oxygen, and more especially carbonic acid, on cilia, leucocytes, and the red blood-corpuscles. I have found a modification of one used by Schweigger-Seidel the most cleanly and convenient for the employment of a variety of gases. A is a watch-glass-shaped

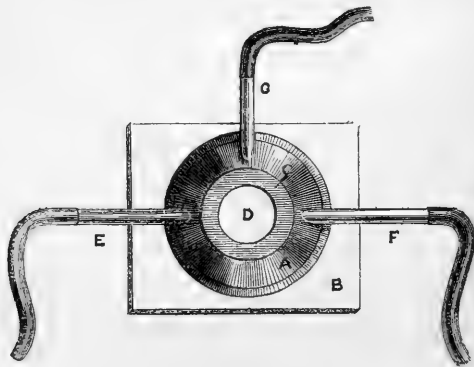

piece of glass, with its edges ground flat and cemented (by paraffin, Canada balsam, putty, or whatever may best suit the case) to a flat piece of glass (B). D is an aperture in the dome or convex portion of the glass, with its edges also ground flat, and of considerable breadth (C). On to this an ordinary thin cover glass is placed, with the blood or other object to be examined on its lower surface, the rim C having been first smeared with oil, so as to render the closing of the aperture

air-tight. Three glass tubes (E, F, G) form part of the glass dome A, being blown in one piece with it. To these caoutchouc tubes are attached, and the desired gases drawn into the chamber by their means. When the third tube is not in use it is simply closed by a pinch-cock. The tube coming from E is placed in the mouth or attached to an aspirator, whilst that from F is connected with the reservoir of gas or vapour to be used. In the case of vapours the tube from F is attached to the shorter tube of a Wolff's bottle containing the evaporating liquid, and by suction at the tube E a stream of air charged with the vapour can be obtained, varying in its intensity at the pleasure of the observer. Heat applied to the generating flask will of course furnish an increased strength of vapour. In some cases it is desirable to pass the stream of vapour through water to prevent a too rapid desiccation of the drop of blood under observation. This is readily effected by means of a second Wolff's bottle containing water a little warm. Gases which are passed from a gas-holder of course do not require the use of the suction tube at E. The chief use of the third tube (G), which in experimenting with a single gas or vapour is closed, is to introduce a second gaseous reagent immediately after, or simultaneously with, the introduction of another. It also may be used for the insertion of a stout copper wire, which is bent round after its introduction into the chamber, the other end remaining projecting from the apparatus. The projecting portion of the wire being heated as in Stricker's hot plate, a considerable temperature may be obtained within the chamber, and vapour may by this means be generated from a few drops of water placed in the chamber in contact with the copper wire. In the same way other vapours, for the production of which a high temperature is required, may be evolved from liquids introduced into the chamber. Further, in place of the copper wire, a platinum wire in connection with the poles of a galvanic battery may be used, and a very much higher temperature obtained, if desired. Since the cement which fastens the glass plate and dome together is easily removed and replaced, the pieces can continually be separated for thorough cleaning, and thus any contamination of the reagents used prevented.

As to the reagents which may be used in this way they are sufficiently numerous, and though used in combination with liquid reagents, still have great advantages. The advantage which I claim for gaseous reagents—apart from the fact that some bodies are necessarily only to be used in the gaseous state—are, firstly, that in this manner the re-

agents are applied to the microscopic particle under observation without a deluging stream being produced so as to carry the particle right out of the field of the microscope. Such a stream is produced when a liquid is allowed to pass under the thin glass cover as ordinarily used, but with the gas chamber the reagent acts quietly, and without the least inconvenience to the observer, so that he is able to retain one individual particle under observation throughout the process. A second advantage in the gaseous method over that of solutions is, that the action of the diluents, water, or spirit is avoided. A third, and perhaps the most striking, is, that exceedingly minute traces of a reagent can thus be brought to bear and very gradually increased in strength whilst the observer is watching the object submitted to the reagent; at any moment the action may be stopped, and with the greatest facility and rapidity a second counter-acting or other reagent introduced by the use of the second tube of the chamber.

Among the reagents which may thus be used and of which I have made some trial are water, hydrochloric acid gas (by current of air drawn through its solution), carbonic acid gas, acetic acid, osmic acid, nitrogen tetroxide, hydrogen sulphide, chlorine, iodine, bromine, ammonia, alcohol, ether, chloroform, carbon bisulphide, carbolic acid, and other gases and vapours of volatile liquids. Without now entering into further detail, I will merely express my belief that it will be found of great importance to apply all reagents used in chemical histology in the gaseous form where possible, though, of course, it is necessary also to have recourse to liquid bodies.

2. Opinions and doubts concerning the red blood-corpuscle.—The literature on such a subject as the red blood-corpuscle is so extensive that it would be quite out of the question to attempt to give here a summary of it. The excellent though somewhat partial article of Rollett in ‘Stricker’s Handbuch’ contains a general statement of what has been done and thought in the matter. I was led to make the observations described below from repeating with Stricker, in the spring of last year, his experiments on the action of alternating carbonic acid and atmospheric air on the red blood-corpuscle. I thought it would be desirable to ascertain whether if the carbonic acid were alternated with any other inactive gas a similar result could be obtained, and accordingly examined the action of a variety of gases and vapours, a consideration of which necessarily throws some light on the still unsettled points concerning the structure of the corpuscle. The problems (belonging

to the second category alluded to in the first paragraph of this paper, viz. the chemical and formal structure of the red blood-corpuscle) which present themselves are,—Can any of the chemical constituents of the stroma of the red blood-corpuscle be distinguished and identified by means of reagents under the microscope, and what is their condition in the living corpuscle? Does the red corpuscle of either mammal or other vertebrate possess a differentiated envelope or wall? Is the nucleus of the frog's red corpuscle merely a post-mortem product? Is there any trace of a nucleus in the mammalian red corpuscle? These questions are suggested by well-known researches. Another important question, viz. What is the nature of the Robertsonian macula? is suggested by certainly the most remarkable contribution to the histology of the blood published of late years, that of Dr. Roberts of Manchester. I must confess that I am at a loss to understand how it is that his most important observation, demonstrating a well-marked point (either normal or cadaveric) capable of taking strongly the aniline dye—in the walls of the red corpuscle of all vertebrata, both mammals and ovipara—have been so largely ignored. Rindfleisch has, I believe, made a similar observation, but in the writings of Stricker, Schweigger-Seidel, and others, specially dealing with similar phenomena, and in the article of Rollett, I find no reference to Roberts' paper. Boettscher, it is true, discusses Roberts' views and observations at length. In the following list I have given references to the more recent papers relating to the structure of the red blood-corpuscle, and have briefly indicated the contents of the paper in each case. This list and the works cited in Rollett's article, as well as the standard hand-books will furnish the reader with a nearly complete catalogue of the literature of this subject.

Gulliver, in Hewson's works, *ibique citata*, Sydenham Society, 1846-47. (References to the older writers and to Mr. Gulliver's other papers are here to be found, as well as observations on the properties of the corpuscles and the most extensive series of measurements of the vertebrate red blood-corpuscle.)

Rollett, in Stricker's 'Handbuch der Histologie,' or the Sydenham Society's translation, *ibique citata*. (References to numerous papers by Rollett himself and the Vienna school are given, and a discussion of most of the important points relating to the red corpuscle.)

Brücke, "Ueber den Bau der rothen Blut-körper," lvi Bd.

of the 'Sitzungs. der Wiener Akad.,' ii Abthl., 1867. (Describes the action of boracic acid, distinguishes the "œcoid" or sac of the corpuscle and the "zoid" or coloured contents.)

Hensen, "Untersuchungen zur Physiologie der Blut-körperchen sowie über die Zellennatur derselben," 'Zeitschrift für wissensch. Zoologie,' vol. xi, 1862, p. 253. (Describes peculiar appearances in corpuscles of a frog in which the blood was nearly devoid of these bodies, also a method of producing this condition of Acythæmia. Distinguishes a layer of fluid protoplasm surrounding the colouring matter by cadaveric alteration of which he believes the supposed membrane of the corpuscle to be formed.)

Boettscher, "Untersuchungen über die rothen Blut-körperchen der Wirbelthiere," 'Virchow's Archiv,' vol. 36, p. 342, 1866. (Discusses at great length the various views and observations on the red blood-corpuscle, gives some account of the effect of chloroform vapour and oxygen, advances the opinion that the mammalian red corpuscle is nucleated, also replies to objections in a later volume, vol. 39, and describes decolouration and formation of a Robertsian pullulation by placing red corpuscles in humor aqueus or serum of another species of animal.)

Schmidt and Schweigger-Seidel, 'Ludwig's Arbeiten,' 1867. (Describe action of aqueous vapour Co_2 and Chloroform, oppose Böttcher's notion of a nucleus.)

Klebs ('Virchow's Archiv,' Bd. 38) opposes Böttcher's view as to a nucleus in normal mammalian blood, and describes the nucleus present in the red corpuscles of leukæmic subjects.

Busk ('Quarterly Journ. Micros. Science,' 1852) describes the nucleation of the red corpuscle in pregnant women, first observed by Nasse ('Wagner's Handwörterbuch,' i, 90).

Rolleston (ibidem, 1867, p. 127) describes an appearance of nucleation in dried blood-corpuscles of the sloth, also in somewhat stale but liquid blood of the elephant, cites various authors.

Beale ('Quart. Journ. Micros. Science,' 1864, two papers) describes effect of heat on red corpuscles, also spontaneous changes in frog's red corpuscle, effects of pressure, &c., molecular matter of the blood, small red corpuscles, &c., opposes the notion of a wall to the corpuscles.

Preyer ('Virchow's Archiv,' vol. 30, 1864) describes amœboid movements and processes exhibited by red corpuscles of the frog extravasated into the lymph sacs, also spontaneous and regular fission of the same.

Max Schultze ('Archiv f. Mikrosk. Anatomie,' vol. 1) de-

scribes effect of heat, and denies contractility to the red blood-corpuscle, describes small-sized corpuscles from human blood.

Stricker ('Pfluger's Archiv,' vol. i, 1868) describes the effect of alternate Co_2 and atmospheric air on red corpuscles first acted on by aqueous vapour; distinguishes the "body" and the "nucleus" of the corpuscle, without prejudging the question of the existence of an œcid, discusses the structure and varieties of form which the corpuscle exhibits.

Addison ('Quart. Journ. Micros. Science,' 1861) describes changes in form produced by acidity and alkalinity.

Roberts ('Proceedings of Royal Society,' vol. xii; and 'Quart. Journ. Micros. Science,' 1863) describes a "macula" produced by nitrate of aniline dye in mammalian and other red blood-corpuscles; also a corresponding pullulation caused by tannin.

Savory ('Proc. Roy. Soc.,' xvii, 1868-69) denies the existence of a nucleus in living corpuscles of oviparous vertebrata.

Richardson ('Trans. American Medic. Assoc.,' Philadelphia, 1870) argues from the red contents separating from the contour-line as crystals within the corpuscles of *Menobranthus*, that the latter have a distinct wall. The observation is not new, *Owsjannikow* ('Bull. de l'Acad. St. Petersburg,' vol. viii, p. 561) having figured such, as well as other writers.

Norris, on the laws and principles concerned in the aggregation of blood-corpuscles, both within and without the vessels ('Proceedings of the Royal Society,' vol. xvii, p. 429, 1868-69).

Brunton, "On the Chemical Constitution of the Nuclei of Red Blood-corpuscles" ('Journal of Anatomy and Physiology,' November, 1869), gives reasons for supposing mucin to be present; this is one of the first attempts at methodical microchemical investigation of the red corpuscle.

The separately published works or essays of *Kneuttinger* and of *Rindfleisch* on the histology of the blood I have not seen, and cannot therefore speak of their contents.

3. *The normal appearance of the Frog's red corpuscle.* In fig. 1, plate XV, I have represented the blood discs of the frog. It is certainly quite impossible to detect anything like a membrane to these corpuscles in their fresh untouched condition; what *might* be taken for such proving, when the highest powers are used, to be a refraction illusion. It has also been denied that in the perfectly fresh corpuscle a nucleus can be detected (*Savory*, loc. cit.). This, I think, is an error. It sometimes happens that no nucleus can be at first

made out in freshly drawn corpuscles, that is to say, no outline marking off the central portion of the corpuscle, fig. 1*a*; but this appears to be a matter of degree. In perfectly fresh red corpuscles of the frog, and even in such corpuscles whilst still within the vessels of the mesentery, I have been able to distinguish the faint outline of the nucleus; and it seems to me that its greater or less distinctness depends on the condition of the blood in the frog, that is to say, on the frog's physiological condition. There is no doubt that, after the corpuscles are drawn and placed on a glass slide, the nucleus becomes more and more distinct in outline until it reaches a state of sharp definition. This *delimitation* of the nucleus must, however, be carefully distinguished from the *granulation* of it caused by acids. Whilst both may, no doubt, be considered as depending on the coagulation of albuminoid substances, the first may be compared to that form of muscle-coagulation or rigidity which is resolvable, and does not indicate death; whilst the granular condition is like the second or final form of cadaveric rigidity, and indicates an irremediable change. The mere delimitation, then, of the nucleus is not to be considered as always of *post-mortem* origin, but may occur more or less during life.

Although, as remarked above, no trace of a wall to the blood-disc can be made out with the highest powers on normal specimens, yet the elasticity and preciseness with which they recover their form and their sharp outline decidedly suggest something like a limiting outer coat or pellicle.

Amongst the normal blood-corpuscles in some perfectly fresh drawn, I observed the two copied in fig. 2*a*, *a*, in which the red-coloured portion of the cell or "zooid," as it is termed by Brücke, was shrunk and separated somewhat from the oval outline (œcoid) of the corpuscle, thus resembling, in some degree, corpuscles which have been acted on by certain reagents (boracic acid, Brücke; sugar, Hensen). I am not aware that such exceptional forms have previously been observed in normal unmanipulated blood. They are of importance as tending to show that the separation into zooid and œcoid is not an entirely artificial phenomenon, since it is thus seen to occur in otherwise healthy corpuscles whilst circulating in the blood. The two corpuscles figured had in every other respect the usual form of the frog's blood-disc.

It is necessary to observe that they were obtained in the early spring from one of a number of "winter frogs," that is, frogs preserved in a cage through the winter. From another frog were obtained the remaining corpuscles figured in fig. 2,

the blood being perfectly fresh, and placed directly from the animal's finger on to the microscope-slide. It seems highly probable that the red blood-corpuscles of the frog present, at different seasons of the year, somewhat different properties, as I shall have again to remark in speaking of the action of ammonia upon them; and it is likely that these curious forms are extreme examples of this variability. The corpuscles drawn in fig. 2 are remarkable for their irregular shapes; they were quite exceptional in the blood from which they came, by far the majority being of the usual oval contour; but in this same blood nearly all the corpuscles presented that curious frilled appearance of the margin which can be brought about by the action of many reagents in ordinary corpuscles. That this appearance was not due to any change after separation from the body I am tolerably certain, and I have observed such a condition of the corpuscles in quite fresh blood from other frogs. It is comparable to the so-called "thorn-apple form" of the human blood-corpuscle (fig. 18 e). The frilled appearance seen in these corpuscles is due to the commencing radial cleavage of its substance, successive stages of which phenomenon are seen in fig. 7 a, b, c.

4. *The normal appearance of the human red blood-corpuscle.*—The human red blood-corpuscle is a circular biconcave plate. It is, however, erroneous to regard this as the only normal form. In the blood of perfectly healthy persons I have frequently noticed the "thorn-apple form" (fig. 18 e), so immediately after the shedding of the blood, that I do not doubt that these forms existed in the circulating fluid. My own blood almost invariably presents these thorn-apple forms in large number, and I have not yet been able to connect their presence, or greater or less quantity, with any particular condition of health or nutrition. In addition to the thorn-apple form, my own blood frequently presents what I will term the "single" and "double watch-glass forms." In these corpuscles, in place of a concavity on each face of the disc, we have a very large convexity, of delicate appearance, and paler than the rim or margin of the corpuscle. Sometimes only on one face of the corpuscle is there this swelling out, and then the appearance is that of an old-fashioned watch seen from its side, the darker coloured rim of the corpuscle representing the metal watch, and the swelling representing the convex glass. Often these convexities appear on both sides of the corpuscle (fig. 18 c). I do not see any reason for attributing these forms to changes occurring in the corpuscle after it has been shed. I have observed them (with Hartnack's No. 10 à immersion), with the greatest

rapidity possible, after being shed from the finger, and do not doubt that they exist in their peculiar form whilst within the body.

5. *Means of studying the changes of the blood-corpuscles in disease.*—The study of pathological changes in the form-elements of the blood, as to their numbers, absolute and relative, size, shape, and properties, has hardly been yet attempted. Yet it can hardly be doubted that the physician should receive as important information from the careful examination of the blood in many cases of disease, as he does at present from the study of the urine. The reason why the blood is almost or totally neglected is, firstly, that the microscopes in the hands of most hospital students and practitioners are quite inadequate (a power of 200 diameters being their highest, whereas 450 is required); and, secondly, that hitherto the examination of the blood has been really a very difficult matter, requiring great haste and the exercise of some skill in drawing. A drop of blood taken from a patient must be immediately examined, drawings made, and notes written, and then it rapidly begins to change, dries up, and is lost. The observer too is never sure that what he may have seen is not due to the progressive changes accompanying the death of the drop of blood before him, and as he can never re-examine anything remarkable which he may have observed, can have but little confidence in his impressions concerning it. Drying has been used as a means of preserving blood, but is of very little or no use, since it necessarily causes distortion and changes in the corpuscles. All the reagents commonly used in microscopy affect, more or less, the form of the corpuscles. If the medical man possessed a reagent which would enable him instantaneously, on removing a drop of blood from his patient, to preserve all its form-elements *absolutely* unchanged, and in such a condition that he could place the specimen aside, and compare it with other cases and with specimens from the same individual from day to day, it is likely that our knowledge of pathological changes in the blood would advance, and that the condition of the blood would be made the subject of study in the wards of hospitals. Such a reagent exists in the so-called hyperosmic or osmic acid¹ introduced as a preservative agent by Professor Max Schultze. It is sufficient to expose a thin film of blood on a glass cover to the vapour arising from a bottle containing the two per cent. solution of osmic acid, during three minutes, to ensure its complete preservation.²

¹ To be bought of Messrs. Hopkin and Williams.

² This method is due to Professor Schweigger Seidel, of Leipzig.

Every corpuscle thus becomes "set," as it were, in its living form; there is no coagulation, no shrinking, no dissolution; but, as the corpuscle was at the moment of exposure to the vapour, so it remains. The white corpuscles even exhibit their pseudopodial processes arrested in the act of movement. It is as though the osmic acid bottle contained a Gorgon's head, which freezes the corpuscles, as they face it, into stone. Having been thus acted on by the osmic acid, the cover glass, with the blood on it, is placed on an ordinary glass slide, on which is a drop of a nearly saturated solution of acetate of potash, as recently recommended by Max Schultz (see the last number of this Journal), and there it may remain unchanged for as long as the physician wishes. The whole process is so simple that, in less time than it takes to examine the chest, a drop of blood may be taken, thus prepared, and placed on one side, for examination at a later moment. One may have perfect confidence, from careful comparative observations (see below), that the osmic acid does not change the form of the corpuscles *at all*, and thus all the advantages are obtained for a leisurely and deliberate study, which otherwise are only to be obtained by most inconvenient haste and precipitation. At the same time the indispensable opportunity is provided of retaining the corpuscles in their living form for *comparison* from day to day and from case to case.

6. *The effect of pressure on the red blood-corpuscle of the frog and of man.*—In fig. 3 *a, a*, corpuscles of the frog are drawn which were subjected to an oblique pressure, caused by squeezing the covering-glass under which they lay. A wrinkling of the surface has been produced, indicating the existence of a differentiated pellicle forming the outer wall. Such a wrinkling could not be produced were the corpuscle of homogeneous consistency.

The same result, due to pressure, is observable in the human corpuscles drawn in fig. 18 *f*.

In connection with the effect of pressure, I may refer to the observations which have been made by various microscopists on the tearing or cutting of the red corpuscle of the frog. It has been found that, by drawing a needle sharply across the slide on which a drop of blood is placed, the red corpuscles may be cut or torn in halves, and that, under these circumstances, no escape of the viscid matter from the corpuscle takes place, as would be expected were they membranous sacs containing a semi-fluid substance, but that the cut edges collapse, and each piece retains a rounded form. This, though negating the view that the corpuscles possess a membrane sharply limited on both sides, is not in antagonism

with the existence of a pellicle having no definite *inner* boundary, and similar to such a scum or pellicle as forms on the surface of a cooling mass of jelly.

7. *Effect of isolation from the plasma (a) by adhesion to a foreign body (b) by mixture with salad oil.*—A very strange phenomenon (not hitherto described) is seen when some of the corpuscles of the frog's blood become separated from the plasma through adhesion to the glass cover on which they are placed, and the drainage away from them of the liquid in which they usually float.

Such corpuscles may often be observed in using the gas-chamber, since the drop of blood is in contact with only one surface, not between two, as in the case of an ordinary slide, and they may be seen thus before any appreciable desiccation has taken place. They entirely lose their oval form, and have a tendency to run together, forming polygonal mosaic works.

By pressing a drop of blood into a small drop of salad oil, numbers of the corpuscles may also be obtained isolated from the plasma, and floating freely in the oil. The ready way in which the corpuscles float into the oil, whilst the plasma, of course, does not mix with it, seems to indicate a condition of the outer wall of the blood-corpuscle, which is *not* that of a membrane simply moistened with water. Both human and frog's blood-corpuscles, when thus passed into oil, lose their normal shape. Those of the frog run together, and become very closely adpressed in small groups, and some lose their hæmoglobin, which seems to be taken up by the oil (see fig. 4). The human corpuscles lose their biconcave character, and become more nearly spherical or polygonal when adhering together in masses (see fig. 21 *a*). By tapping the covering-glass I have seen the frog's corpuscles pass readily from the oil back into plasma, and *vice versa*; but I am not sure whether, after they have once lost their oval form in the oil, they can resume it on re-entering the plasma.

The effect of isolation from the plasma by means of oil is interesting in connection with the views of Dr. Norris¹ on the cause of the formation of the rouleaux of red blood-corpuscles, and deserves further investigation.

8. *Effect of water in minute quantities gradually added (by vapour).*—By means of his hot plate, consisting of a small glass-bottomed well, surrounded by a copper ring connected with a copper wire, which can be heated, Stricker was able to study the effect of minute quantities of water on the cor-

¹ 'Proceedings Royal Society,' vol. xvii.

puscles. A drop of water being placed in the well, and the blood on the under surface of the covering-glass closing it in above, the temperature is gradually raised by means of a spirit-lamp applied to the copper wire, and the aqueous vapour thus produced condenses on the glass. Thus the observer can watch the gradual addition of water to the sides of the drop of blood. The effect on the frog's blood-corpuscle is very remarkable, and has been described by Stricker, who does not, however, give figures of the corpuscles. As the plasma gradually becomes diluted, some of the corpuscles are seen to float about, and at first become oat-shaped, assuming sharper extremities than the normal form (fig. 5 *a*); then they gradually become spherical (fig. 5 *b, c*). If the addition of water is continued the corpuscles discharge their hæmoglobin, and, finally, with excess, appear to break up more or less, becoming irregular stromata, in which a large clear nucleus can generally be seen.

Human red corpuscles, treated in the same manner, become globular, *not swelling*, as has been asserted, of the action of water, by some writers, but simply changing their proportions. They finally with excess discharge their colour, and become irregular stromata, retaining a definite spherical outline if the action has not been rapid.

9. *Effect of carbonic acid gas.*—Stricker, who states that the object of his experiments was to ascertain the effect of the alternate action of carbonic acid and atmospheric oxygen on the red blood-corpuscles, found that on fresh normal corpuscles a stream of CO_2 introduced into the gas-chamber has no effect. But when the corpuscles have been previously acted on by aqueous vapour, as described above, to the extent that they have assumed the spherical form, a remarkable action is obtained.

In the case of the frog the nucleus immediately becomes sharply granulated (see fig. 6 *a*). Stricker then proceeds to pass atmospheric air into the gas-chamber in place of the CO_2 , and the granulation of the nucleus at once disappeared (fig. 6 *b*), and the corpuscle assumed once again an elongated shape. This change of shape is very strange, and not readily accounted for; the granulation of the nucleus is due, as pointed out by Schweigger-Seydel and Schmidt, to precipitation of paraglobulin, which is redissolved on removal of the carbonic acid. The nucleus can thus be made to come and go by alternate steams of CO_2 and atmospheric air several times; but after the first change of form from the spherical condition they retain the elongated shape. After a time the "starred" condition of the body of the corpuscle is

brought about (fig. 6 *d*), and this will sometimes disappear by the action of the CO_2 , and reappear with the atmospheric air.

If aqueous vapour be again allowed to act, the corpuscles again assume a rounded form, and, after the experiment has been carried on some time, lose their colouring matter. They do not so readily resume the elongate form after the second action of water, and the final stage of the experiment is obtained when they have become colourless, spherical, and the "body"¹ granulated as well as the nucleus. The granulation of the body, which is not obtained until water has acted two or three times and the carbonic acid for a considerable period, disappears and reappears at first with alternation of the CO_2 and atmospheric air. The nucleus finally becomes permanent (fig. 6 *e, f*). A small pullulation is sometimes obtained in the wall of the corpuscle at a late stage of the experiment, as drawn in fig. 6 *e, f*).

Having witnessed and repeated these experiments in Stricker's laboratory, I was anxious to ascertain whether the alternation of any neutral gas with CO_2 would produce the same results as the alternation of atmospheric air. I found that by passing a mixed current of CO_2 and hydrogen the granulation was obtained, and that on stopping the CO_2 , and allowing the hydrogen to continue, it disappeared just as when atmospheric air was used, the change in the forms of the corpuscles also occurring. The same result was obtained when using CO in alternation with CO_2 ; and further, by simply creating a minus pressure in the gas chamber by means of suction, exactly the same effects were obtained as when the stream of atmospheric air or inactive gas was used. Thus it was sufficiently demonstrated (what, indeed, was tolerably certain *à priori*) that the disappearance of the granulation of the nucleus, on passing the stream of atmospheric air, is due simply to the diffusion of the carbonic acid gas, and not to any specific action of the atmospheric oxygen.

¹ Brucke distinguishes the envelope of the frog's red corpuscle as "œcid" —its contents as "zoid." Stricker divides Brücke's zoid into a "body" and a nucleus. Rollett distinguishes colouring matter and stroma. We thus get the tabular statement :

	{ Stroma. Colouring matter.
Red blood-corpuscle of ovipara, divisible into	
	{ Œcid = or outer part of stroma. Zoid = rest of stroma plus hæmoglobin.
	{ Membrane = œcid. Body = zoid minus nucleus. Nucleus = zoid minus body.

Though a small point, this was left uncertain from Stricker's experiments.

When human corpuscles are used in place of those of the frog, the spherical condition having been first obtained by the action of aqueous vapour, Stricker showed that the normal biconcave form is obtained by the action of CO_2 , whilst the substitution of atmospheric air causes a more spheroidal condition again, and in many cases the "thorn-apple form," which again yields to the normal biconcave form on renewal of the CO_2 (see figs. 19 *a, b, c, d*). The alternation can be obtained several times.

10. *Effect of osmic acid vapour.*—I have above spoken of the use of the vapour of osmic acid. To observe its gradual working a drop of the concentrated solution may be placed in the gas-chamber, or air drawn into the chamber which has been allowed to bubble through a solution. On the human corpuscles it has absolutely no visible action, excepting that it changes their tint, by acting on the hæmoglobin. Although the blood becomes set by its action into a jelly-like film, no alteration of the form or inner aspect of the corpuscles is produced. This was determined by comparison of fresh blood and blood acted on by the OsO_4 . In the frog's blood-corpuscles the nucleus becomes rather sharply defined under the influence of the osmic acid vapour, but it is not coarsely granulated as by most acids.

11. *Effect of acetic acid, vapour, and in solution.*—If air be drawn into the gas-chamber, which has bubbled through acetic acid and the corpuscles of the frog exposed to it, the following effects are observed. If the solution of the acid be weak, so that but very little acts on the corpuscles, the first result noted is a "starring" of the body of the corpuscle and the sharp definition of the nucleus (fig. 8 *a*). The strength being increased, the nucleus becomes coarsely granulated (fig. 8 *b*). The strength being still further increased, so as to reach its maximum, the body of the corpuscles becomes granulated here and there, and its outline finely irregular and thickened; the plasma at this stage also exhibits a very fine molecular precipitate (fig. 8 *c*). When a solution of acetic acid is added directly to the blood, the extreme action is obtained at once, unless the solution is very dilute (2 per cent. of the glacial acid in water) when the earlier conditions are obtained.

12. *Effect of alcohol.*—Although the effect of alcohol is to produce a precipitation in the corpuscle, yet this is different from that produced by acetic acid. Weak vapours of alcohol have little effect; stronger cause an irregularity in the out-

line of the corpuscle of the frog, and a precipitation in the body, whilst the nucleus remains clear. If corpuscles of the frog be submitted suddenly to the action of absolute alcohol, many become distorted in shape; the outline of all assumes some irregularity, and the wall seems thickened (fig. 8 *d*). A coarse flocculent precipitate is visible in the body of the corpuscle, whilst the nucleus is not affected, except in so far as it is rendered less distinct by the turbidity of the body. Mammalian corpuscles become granulated by the action of alcohol.

We thus see in the action of weak acetic acid, or Co_2 , on the one hand, and of alcohol on the other, an important distinction between the chemical nature of the body and the nucleus of the oviparous corpuscle, and an agreement of the *entire* mammalian corpuscle with the body only of the oviparous corpuscle.

13. *Effect of ammonia gas.*—The action of ammonia on the red blood-corpuscles has not hitherto been studied. It is very curious, and I have examined it carefully. First, as to its effect on the frog's corpuscle. The first experiments I made on this point were in the summer of 1870.¹ I then found that on drawing strong ammonia gas into the chamber I instantly obtained the forms drawn in figs. 14 *a* and 5 *d*, and the corpuscles became very soon entirely broken up. But on diluting the source from which the ammoniacal fumes were given off, so as to admit but the merest trace of ammonia, just perceptible by the nose, I obtained curious changes in the form of the corpuscles, as seen in fig. 14 *a*, these being restored to the normal form (or to an oval form very nearly identical with their original one) by the substitution of a current of Co_2 for the ammonia. If the ammonia had been allowed to act a certain time, and Co_2 were then substituted, the nuclei became granulated as after the action of water. Atmospheric air then drawn in caused the radiate condition of the body. When the ammonia was slowly increased in strength, the corpuscles were caused gradually to assume a spherical form, then the sphere became smaller and smaller, and suddenly all the colouring matter, and probably other constituents, passed out of it, and left a pale, irregular stroma, with a large clear nucleus swollen up beyond its normal size. Further increase in the strength of the ammonia completely dissolved this. When liquid ammonia of considerable strength (I cannot give the exact strength at which such phenomena will occur) is allowed to run under the covering-glass where frog's blood already is,

¹ I have to thank Dr. Burdon Sanderson for allowing me to make some of these observations in his laboratory.

the corpuscles almost instantly assume the form of small spheres. Then it may be seen that the nucleus breaks up into bits which float about in the sphere (fig. 14 *a*), swimming round and round as the action goes on, then suddenly the sphere collapses, the colouring matter is diffused all round, and no trace of the corpuscle, except a few scattered specks, remain. The complete disappearance of the corpuscle, or the survival of a ghost-like stroma, depends on whether a strong or a moderately intense solution of the ammonia be used. As I set to work to repeat the observations on the effect of weak ammoniacal gas, in the early spring, I was surprised at not at once getting the change in the shape of the corpuscle which I have seen in the summer. The results which follow are explicable on the supposition that the outer portion or wall of the corpuscle is denser and more resisting in the early spring than later. It has often been remarked that one cannot at will reproduce changes in form caused by reagents acting on blood-corpuscles, and this, it is most probable, is due to some slight variation in their constitution from season to season, and from individual to individual. The elongated, pointed, and triangular shapes drawn in fig. 9 *a*. I did again get this summer with very weak vapour. In the spring, however (as also in some cases this summer), the action of very weak ammoniacal gas on the frog's blood gave three different types of action, which did not occur simultaneously in the same drop, nor lead one into the other, but seemed to depend on very slight differences in the rate at which the ammonia was allowed to act, its strength, and the condition of the corpuscles themselves.

The first condition which was obtained most frequently, and which I have again obtained during the summer, is drawn in fig. 9 *b*. As soon as a very small amount of ammonia is drawn into the gas chamber, a very weak solution of the gas being used as the source, and air being allowed to bubble through it and thence into the gas chamber, the corpuscles become irregular in shape, and assume lobular forms. The lobules tend to constrict themselves in various ways, and send out long irregular processes as represented in the figure (fig. 12), whilst the nucleus-remaining pellucid enlarges somewhat. Acetic acid vapour of maximum strength now substituted for the ammonia produces a remarkable result. The processes are withdrawn, and the corpuscles remain of an irregular form, but instead of the nucleus becoming granulated it remains perfectly clear and pellucid and much swollen, whilst the body of the corpuscle is granulated (fig. 12 *A'*). The matter which is precipitable by acetic acid passes under the

influence of the ammonia from the nucleus into the body. In some corpuscles I have found that the action had not proceeded to this extent, and the nucleus though much swollen granulated very sharply (fig. 13 *b*). In many cases the nucleus assumed the colouring matter or hæmoglobin, and remained pellucid whilst the body became colourless and granulated under the influence of the acetic acid (fig. 14 *c*). Similar results without much change of shape in the corpuscle were obtained when a weak solution of ammonia was allowed to act directly on the corpuscles (fig. 14 *c*). When strong ammonia gas or solution was allowed to act on the corpuscles so as to produce the small spherical form, the addition of acetic acid caused these small spherical corpuscles to burst, and then granulated spherical masses were obtained in various parts of the field, due to the fragments of the burst corpuscles. In one case (fig. 12 *A*) a corpuscle had thrown out two pseudopodial-like processes under the influence of the ammonia gas. I watched then the gradual working of acetic acid vapour, causing the processes to be slowly retracted just as in protoplasmic movement, and after a nearly circular outline had been assumed (fig. 12 *A'*), the granulation of the body came on, the nucleus remaining clear. The behaviour of these corpuscles under alternate weak ammoniacal and acid vapours furnished a very curious parallel to the movements of amœboid protoplasm, and a careful consideration of the phenomena may throw some light on the nature of protoplasmic contractility.

The second type of form assumed by the frog's red blood-corpuscles under the influence of weak ammoniacal vapour is seen in fig. 10 *a*. The red content of the corpuscles, the zoid of Brücke, contracts vigorously, and separates itself from the œcoid or dense superficial membrane, giving the various appearances depicted. This resembles the action of boracic acid described by Brücke, except in this, that the red matter, the zoid, is in no way granulated, but remains perfectly clear and homogeneous. Acetic acid vapour caused to act on the corpuscles in this state gives a general granulation of the whole of the red mass (fig. 10 *b, b*), but no delimitation or granulation of a nucleus, which seems to be lost or dissolved. In one case, from my notes, I find that weak ammoniacal vapour having been allowed to act, some of the corpuscles had assumed the form represented in fig. 10 *a*, with the "zoid" contracted away from the "œcoid," others had not reached this condition, and contributed but little change of form. Acetic acid vapour was now drawn in, the corpuscles with the contracted zoid became granulated in that part,

whilst no nucleus could be detected in them, the others exhibited then a granulated body and a *clear pellucid nucleus which was coloured red by hæmoglobin* as in fig. 14 c.

The third type of ammonia-action was seen in some corpuscles which at first exhibited a tendency towards the second type, the zooid partially contracting; instead, however, of remaining in this state, the edges of the corpuscles and of their contracted zooids began to break up, as seen in fig. 11 a, and particles separated from them and floated about exhibiting Brunonian movements. Larger particles separated in many cases, and in these it was quite easy to recognise the well-known double rhomboid form of hæmoglobin crystals. This observation is exceedingly curious, since it demonstrates a readiness of the material of the blood-corpuscle to assume the crystalline form which was only known previously in some mammalia. Beale has figured (loc. cit.) from the guinea-pig corpuscles disintegrating into small crystals, just as I have here seen them in the frog; but in that case the phenomenon was independent of ammonia or other reagents; also the crystals so formed were the so-called tetrahedral or sphenoidal forms characteristic of the guinea-pig's blood.¹ I have not been able to reproduce this crystalline disintegration of the corpuscles at pleasure, though I obtained it in several successive experiments from the blood of a frog in the spring of this year, at Leipzig.

Whilst the corpuscles were undergoing this disintegration, in one case I passed acetic acid vapour into the chamber, with the result depicted in fig. 11 b. The body of the corpuscle appeared to retain its hæmoglobin, and was coloured red; the nucleus became round and was pellucid; round it, however, was a very intensely marked ring, due to coagulation by the acid, and in its middle one two or three sharply cut coagula were seen.

These various effects of the action of ammonia in small quantities require explanation, in view of the chemical constitution of the various parts of the oviparous red blood-corpuscle. They appear to demonstrate that the wall of the corpuscle is readily soluble in ammonia, and more so in some physiological conditions than others, the amœboid figures produced under the action of ammonia being due to the

¹ I may take this opportunity of mentioning that in a specimen of the annelid *Tubifex rivulorum*, mounted in glycerine jelly, I obtained crystals of Hæmoglobin in the drops of the red vascular fluid of the worm expressed in the preparation. The crystals in one and the same preparation exhibited three of the forms seen in different mammalia, viz. rhomboid prisms (dog, man), sphenoids (guinea-pig) and hexahedral plates.

removal of the containing wall of the semifluid zooid. Secondly, they seem to demonstrate that there are at least two constituents of the nucleus, the one precipitable by acids, probably paraglobulin, which passes out into the body of the corpuscle under the influence of the alkaline gas, whilst the second (possibly the mucin which Dr. Brunton has shown reason to believe is a constituent of the nuclei) remains, and is not precipitable by acetic acid. I am conscious that the action of ammonia, which I have described, deserves to be investigated in a more methodical manner, and I draw attention to it on that account.

On the human blood-corpuscle ammonia has the same action as on that of the frog, excepting such phenomena as concern the nucleus. A fluidity (due as it seems to me to a solution of the wall or pellicle of the corpuscle) is produced by very weak ammoniacal vapour, resulting in the production of long threads or processes from the corpuscles, and the separation of minute particles from them, as in the case of the frog (fig. 20).

Acetic acid vapour admitted to human corpuscles after the action of weak ammoniacal vapour gave no granulation of the corpuscles, but the fine thread-like processes were rendered more distinct, and some corpuscles exhibited pullulations like those produced by tannin in Dr. Roberts' experiments (fig. 21 *b, c*).

In speaking of the action of magenta dye below I shall refer to its action after the corpuscles have been acted upon by ammonia.

14. *Effect of chloroform.*—Chloroform or ether being so generally used for separating the hæmoglobin of the red corpuscles from their stroma, it seemed to me to be interesting to examine carefully the steps of its action. Böttcher, Schweigger-Seidel, and Schmidt have noticed in their papers the fact of the removal of the colouring matter and the survival of a colourless stroma having the form of the original corpuscle. By the use of the gas chamber and the method of suction I have watched the process more closely.

When frog's red-corpuscles are submitted in the gas chamber to an increasing quantity of chloroform vapour, I have observed the following series of phenomena.

The first change noticeable is a very fine plication or wrinkling of the whole surface of the corpuscle (fig. 15 *a*), as though a delicate membrane were being caused to contract. Then an angular form is assumed by the corpuscle (figs. 16 *a*, 15 *b*), generally hexagonal, but sometimes diamond-shaped. I cannot refrain from pointing out the resemblance of these

angular forms to the crystalline form of hæmoglobin, and suggest that they are possibly due to modified crystallisation. Then, thirdly, the corpuscle resumes an oval shape (fig. 16 *b, b*), but not the original oval shape. It is now shorter and broader, and very distinct from the normal ellipsoid. Soon after this oval form has been assumed, numbers of the corpuscles are observed to become colourless (fig. 16 *c*). There is no collapse, no movement on their part, but simply their colouring matter passes from them, and they remain as oval "ghosts" or stromata of very definite shape with pellucid nucleus and well-marked outline. All this is under the influence of chloroform vapour drawn into the gas chamber, as described. Acetic acid vapour now drawn in granulates the nucleus very sharply (fig. 16 *d*). If instead of acetic acid vapour more chloroform vapour is drawn, no further result is obtained, the "ghosts" remain unchanged. But if, instead of the vapour, the observer now proceeds to make use of the liquid chloroform, vigorous action is obtained. A drop of chloroform placed on the already decolorised corpuscles causes an intense action, which looks like effervescence, around each ghostly stroma (fig. 17 *b, b*). Hundreds of minute globules, the character of which is not gaseous, form along the sides of the stromata and along the edge of the nuclei, and then float off and disappear in the plasma. This action goes on with repeated additions of the chloroform until the outer portions of the stromata are dissolved, so that only the nuclei remain. These seem to be more resistant, but finally are broken up also with formation of the evanescent globules (fig. 17 *e, e, f*).

When chloroform liquid is added to fresh red blood-corpuscles of the frog, they almost instantly give up their hæmoglobin, becoming nearly spherical, and the stromata have a collapsed and less regular outline than when chloroform vapour is gradually allowed to act.

Human corpuscles, subjected to the gradual action of chloroform vapour or to the action of chloroform liquid, exhibit identical appearances.

15. *Effect of bisulphide of carbon.*—With carbon bisulphide vapour I have obtained in the frog's corpuscles nearly identical results with those given by chloroform—the assumption of an angular form (fig. 15 *b*), followed by a short oval or spherical form, the diffusion of the colouring matter, and the production of colourless stromata. It appears to take longer to discharge the colouring matter than chloroform, though the change of form is rapidly produced. The direct addition of the liquid to the corpuscles caused the solution of the stro-

mata, with the formation of numbers of minute evanescent globules, just as with chloroform.

16. *Effect of benzine*.—Essentially the same as that of chloroform and carbon disulphide.

17. *Effect of turpentine-oil*.—Essentially the same as, but less vigorous than, chloroform on carbon disulphide. When the turpentine oil was added in the liquid form to the corpuscles the formation of the numerous fine globules was not obtained, and the stromata were not dissolved. Turpentine spirit may have a more vigorous action.

18. *Effect of solution of acetate of rosanilin and of tannin (Roberts' experiments)*.—As discovered by Dr. Roberts, of Manchester (loc. cit.), magenta dye, when allowed to act on either human or frog's red blood-corpuscles (also those of other vertebrates), causes a discharge of the hæmoglobin, and (colouring the nucleus deep red in the latter case) produces a well-marked red "macula," more or less oblong on the wall of the corpuscle. Tannin, on the other hand, causes a sharp little pullulation in the wall of the corpuscle, at the same time granulating the nucleus. In the human corpuscle Roberts found that there was rarely more than one such macula or pullulation; in the frog often two, three, or more. I have repeated Roberts' experiments, using a nearly saturated solution of the reagent in each case. In figs. 22, 23, 24, the results are depicted. The macula and the pullulation are due to something entirely distinct from what we have had evidence of in the action of the reagents hitherto considered. When the red corpuscles of the frog are mixed on a glass slide with a little of the magenta solution, and examined, they are found to have become small and spherical, as under the action of ammonia. The nucleus is rounded and sometimes granulated, sometimes not so, whilst the body is faintly stained or colourless. The outline or wall of the corpuscle looks thicker than under other circumstances, and one, or as many as four, points are seen in the circumference of the corpuscle deeply stained, like the nucleus (fig. 23). Besides this, very generally round each corpuscle, and more especially near the stained points or "maculæ," deeply stained granular matter is seen in the plasma. By allowing the magenta slowly to come in contact with the blood, whilst the slide was on the microscope stage, I was able, after many trials, to watch one corpuscle through its changes. The corpuscle first shortened and became nearly spherical (fig. 23 *a*, *b*), and then discharged its colouring matter. It then took a very slight pink tint from the magenta fluid (fig. 23 *c*), and next, suddenly the nucleus, which had previously been indistinct, assumed

a deep red colour, and burst into view. Almost at the same moment a point in the wall of the corpuscle gave way, and a very finely granular matter issued, which was stained red by the magenta, whilst, at the same time, a red "macula" formed internally at the point whence this had escaped. A second macula, accompanied with the escape of matter which took up the red colour, formed very shortly afterwards at another point of the corpuscle (fig. 23 *d*). I thus saw that the molecular matter, stained red in the plasma, was due to the escape of something from the corpuscles themselves, identical with the maculæ. The action of tannin (fig. 24) appeared to me to be very closely similar to that of magenta, excepting that the matter which escapes and forms a coloured molecular mass in the plasma when magenta is used, in the case of tannin is arrested and "set" as it escapes, thus forming the pullulation. That it is not always set, and that much of it escapes, may be seen from Roberts' figures, as also I observed in both human and frog's corpuscles.

I merely point to the sketches of human corpuscles treated with magenta and with tannin in order to confirm Roberts' description of them (fig. 22 *a, b*). The phenomenon is much better studied on account of size in the corpuscles of the frog. The magenta 'macula' in the human corpuscle almost invariably appeared to stand out a little from the surface, to be a very little raised, as it were, which is not the case in the frog. The reason I believe to be the greater delicacy of the pellicle or membrane of the corpuscle in Mammalia than in Ovipara.

There can, I think, be little doubt as to the identity of the magenta macula and the tannin pullulation. The questions which occur are: Is the Robertsian macula a physiological or a cadaveric differentiation? and what is the nature of this substance which thus takes up the magenta dye and is coagulated by tannin? As to the first question, there appears to be no ground for supposing that this differentiated 'macula' exists during the life of the corpuscles, since, as is obvious by their form, and the steps of the process as described above, the whole corpuscle is very much altered before the macula or pullulation makes its appearance. Moreover, they occur with great irregularity in the frog's corpuscle as to number and position, and, as observed by Dr. Roberts in the oval corpuscle of the camel, the usually single macula appears to have no definite position. It seems to me, then, likely that this macula is due to the separation or segregation of a constituent of the blood-corpuscles, which occurs as a cadaveric change under the influence of some reagents. The material, whatever it is, collects at the most yielding point or points

beneath the œcid or pellicle of the corpuscle, and there, forced by increased contraction of the more solid parts of the corpuscle, bursts out through the pellicle, escaping to a large extent in the case of magenta, and becoming diffused, but becoming fixed as a pullulation when tannin is used. It seems probable that the separation and escape of this constituent of the corpuscle goes on under the influence of other reagents, but that being neither stained nor precipitated by them we do not see it. Thus, after weak ammonia has been allowed to act, I found that neither human nor frog's corpuscles exhibit the macula with magenta. In the frog's red corpuscle so treated, the nucleus remained unstained in many cases, whilst the body took up the colour (fig. 23 *f*)—a similar result to that described above as to acetic acid and as to ammonia. Frogs' red corpuscles acted on with chloroform to the third stage did not give the magenta macula, though the nuclei stained well. Frogs' red corpuscles treated with aqueous vapour till they assumed the rounded form did not give the macula with magenta. Frogs' red corpuscles dried, as also human ones dried, did not, on treatment with magenta, give the macula, though the nuclei of the former stain most readily and brilliantly (fig. 23 *g*).

The reason that the ammoniacal solution of carmine does not bring out the macula as does magenta is probably due to the ammonia causing solution of the substance, whatever it may be, which is thus segregated or squeezed out from the rest of the corpuscle. The absence of the macula in dried corpuscles is easily understood as due to a prevention of the contraction which causes the separation of it under certain reagents from the other constituents of the corpuscle.

By further microchemical research, no doubt, the nature of the substance which forms the macula and pullulation may be more definitely ascertained. I am inclined to believe it to be a more fluid constituent of the body of the corpuscle.

It is especially necessary to remark that neither magenta nor tannin act on one part only of the red blood-corpuscle. They both affect it through and through. The connection of the molecular matter, supposed to belong to the plasma by Roberts with the maculæ, as seen by me, is of especial significance as to the mode of origin of the latter, and its connection with the tannin pullulation.

Experiments with certain gases remarkable for their combinations with the hæmoglobin of the corpuscles.

19. *Effect of carbonic oxide.*—CO, as is well known, forms a compound with hæmoglobin, having a characteristic ab-

sorption spectrum. I submitted frog's red corpuscles to the action of CO in the gas-chamber, but obtained no change of form whatever, though the carbonic oxide had acted on the hæmoglobin within the corpuscles, as demonstrated by the microspectroscope. On passing carbonic oxide into the chamber where frog's corpuscles were subjected to it, which had already begun to assume the stellate or radiate arrangement of the "body," I found that the radiate condition disappeared, this being apparently due to the action of the carbonic oxide.

20. *Effect of cyanogen gas.*—Cyanogen gas, as I have elsewhere pointed out ('Journal of Anatomy,' November, 1869, and Pflüger's 'Archiv,' 1869), acts upon hæmoglobin, first, by combining with it, without destroying its complex character, probably forming, first, hydrocyanic acid, which Hoppe Seyler showed could thus combine with Hæmoglobin.¹ Then, after a time, it breaks up the hæmoglobin forming the cyan-hæmatin of Hoppe Seyler, having its own very definite broad absorption-band. When the red blood-corpuscles of the frog are submitted to the action of a stream of cyanogen gas in the gas-chamber, the nuclei at first become distinct; there is then a visible contraction and plication of the surface of the corpuscle and the colouring matter, in the form of cyan-hæmatin, as proved by the microspectroscope, is suddenly discharged. A clear stroma, similar to that produced by chloroform, remains.¹ With human blood-corpuscles, clear, somewhat irregular stromata are left.

21. *Effect of sulphuretted hydrogen.*—Hydrogen sulphide produces a definitely characteristic absorption-band in hæmoglobin, as also do alkaline sulphides. This was first pointed out by Navroski. I have proposed to call the substance thus indicated sulphhæmoglobin, a name which has been accepted by Professor Preyer in his work 'Die Blutkrystalle,' wherein a detailed study of the action of sulphides on hæmoglobin is given.

When the red blood-corpuscles of the frog are submitted to a stream of H₂S the radiate form of the body was rapidly assumed, similar to that drawn in fig. 7*b*, whilst at the same time the corpuscles changed colour, though they did not discharge it at all. An examination with the microspectroscope proved that the hæmoglobin had been completely acted

¹ I was led to believe that the absorption spectrum of blood treated with cyanogen gas was at first identical with that of CO hæmoglobin. Preyer however, whilst confirming me on other points, and working with a large spectroscope, states (Die Blutkrystalle) that the spectrum is that of OHb.

upon, the corpuscles now containing sulphæmoglobin, as indicated by the persistence of two lines of oxyhæmoglobin, together with a new line in the red having a definite position, which was duly compared and recognised. It is interesting to find that sulphæmoglobin, like hæmoglobin, does not diffuse from the corpuscles under normal conditions.

If we compare now the reagents which affect the hæmoglobin of the blood-corpuscles, we find them acting very differently.

Causing its discharge :

Unchanged.—Chloroform, CS_2 , benzine, &c. Ammonia (in very small quantity). Water (requires time).

Changed.—Cyanogen (Cyanhæmatin), Ammonia (alkaline hæmatin).

Not causing its discharge :

Not changing.—Alcohol (or only to methæmoglobin) but precipitating.

Changing.—Carbonic oxide (CO hæmoglobin). Sulphuretted hydrogen (sulphæmoglobin). Acetic acid (acid hæmatin).

General conclusions and summary.—The red blood-corpuscle of the vertebrata is a viscid and at the same time elastic disc, oval, or round in outline, its surface being differentiated somewhat from the underlying material, and forming a pellicle or membrane of great tenuity, not distinguishable with the highest powers (whilst the corpuscle is normal and living), and having no pronounced inner limitation. The viscid mass consists of (or rather *yields*, since the state of combination of the components is not known) a variety of albuminoid and other bodies, the most easily separable of which is hæmoglobin; secondly, the matter which segregates to form Roberts's macula; and thirdly, a residuary stroma, apparently homogeneous in the mammalia (excepting so far as the outer surface or pellicle may be of a different chemical nature), but containing in the other vertebrata a sharply definable nucleus, this nucleus being already differentiated, but not sharply delineated during life, and consisting of (or separable into) at least two components, one (paraglobulin) precipitable by Co_2 , and removable by the action of weak NH_3 ; the other pellucid and not granulated by acids.

The chemical differentiation of the outer pellicle is rendered probable by the behaviour of the corpuscles under weak NH_3 , which appears to dissolve this pellicle, and so loose the viscid matter from that which restrained it to its oval shape; also from the inability of CO_2 to act on the corpuscle until it has

been subjected to the influence of aqueous vapour, which may be supposed to remove or render permeable this pellicle; also from the action of chloroform, oil, and cyanogen, which cause the discharge or diffusion of the hæmoglobin from the corpuscle, perhaps by first removing or rendering permeable—at any rate modifying—this outer pellicle.

Steam, chloroform, benzine, bisulphide of carbon, ammonia and cyanogen, act on the red blood-corpuscle so as to cause the escape of the hæmoglobin.

The further action of these reagents causes the elimination of what may be called Roberts's constituent, that which is stained by magenta and set by tannin.

A still further action of chloroform, of water, or of ammonia, dissolves first the stroma, lastly the nucleus.

The details of these actions are given in the paper.

Carbonic oxide and sulphuretted hydrogen produce their respective changes on the hæmoglobin, as demonstrated spectroscopically, without altering the form of the corpuscle, merely effecting the radiation of its body.

On UNDULINA, the type of a NEW GROUP of INFUSORIA.
By E. RAY LANKESTER.

IN making the numerous examinations of the blood of frogs above recorded, I have now and then met with the interesting little parasite drawn in the woodcut. When I first saw it, in some blood from a frog last summer, I took it for a very active white blood-corpuscle, since it is a very little smaller than one of the red corpuscles of the frog's blood. On using, however, a higher power (No. 10 à immersion of Hartnack) I made out its infusorial nature, though, on account of the great activity of its movements, I was long uncertain as to the nature of its locomotive organs. Numerous specimens occurred in the blood of a frog (*Rana esculenta*) examined at Leipzig, in March last, and by the use of a small quantity of acetic acid vapour, I was able to kill the little creature without injuring it, and then to make out its structure. It was seen to be a minute pyriform sac, with the narrower end bent round on itself somewhat spirally, and the broader end spread out into a thin membrane, which exhibited four or five folds, and was produced on one side into a very long flagellum. The wall of the sac was striated coarsely, as in *Opalina*; and the direction of the striæ on the

two sides of the sac, as seen one through the other, showed that the small end of the sac was twisted as well as bent over on itself. A pale, clear nucleus and a very few granules were also seen. In life the broad membrane undulates vigorously in a series of waves, the flagellum taking part, and presents then a deeply toothed appearance (fig. 1). The movements produced by the activity of this membrane tend to urge the animal in a wide circle. The opposite extremity of the sac twists and untwists itself to a small extent also during life. The series of waves of the undulating membrane are not incessantly in one direction; after a certain time they change to the opposite direction, and then resume their original direction, an alternation of from right to left and from left to right being kept up. When minute traces of acetic acid vapour are passed into the gas chamber, where this infusorian is, it soon becomes affected. The undulations

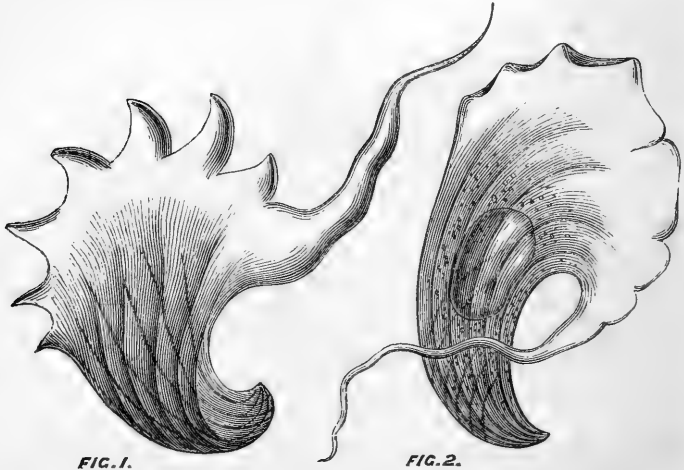

become deranged, starting from both ends simultaneously and meeting in the middle, and at length ceasing (fig. 2).

In the blood of one frog, where these parasites are not unfrequent, about five or six in a drop of blood as big as a large pin's head, I noticed very numerous minute oblong bodies, which reminded me strongly of the pseudo-naviculæ which I have found in the cysts of the Gregarina parasitic in *Tubifex rivulorum*. These little oblong bodies (fig. 4) were in many cases attached to the end of the red blood-corpuscles (fig. 3), just as I have seen the similarly sharply terminated pseudonaviculæ of *Tubifex* attached to pieces of tissue-

fibre, &c., by the penetration of their points into such foreign substances. It seems not improbable from their association

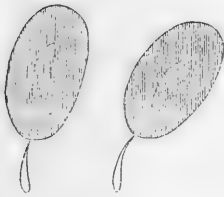

FIG. 3.



FIG. 4.

that these oblong bodies may be connected genetically with the little infusorian parasite. For the infusorian I propose the name *Undulina ranarum*. I have not been able to find any record of its occurrence hitherto, though I cannot but think it extremely likely that it has been seen and described. *Undulina* is a mouthless infusorian, closely allied to the *Opalinidæ*, from which, however, it differs essentially, as well as from the *Infusoria ciliata* generally, in possessing no cilia. In *Undulina* a wide flattened portion of the infusorial sac produced into a ribbon-like flagellum takes the place of cilia. We have indeed here an exemplary case of an "undulating membrane." On this account *Undulina* must be separated from the other Infusoria, logically indicating a new group of these animals characterised as devoid of mouth (as is *Opalina*) and devoid of cilia, but provided with a broad crest-like undulating membrane.

On the CIRCULATION in the WINGS of BLATTA ORIENTALIS and OTHER INSECTS, and on a NEW METHOD of INJECTING the VESSELS of INSECTS. By H. N. MOSELEY, Radcliffe Travelling Fellow, Oxford Univ. (With Plate XVII.)

WHILST working in the laboratory of Prof. Ludwig, at Leipzig, this spring, I obtained a number of specimens of *B. orientalis*, to look for nerve-endings in their salivary glands. I happened to examine their wings under the microscope, and finding a remarkably perfect circulation in them, was led to examine the wings of other insects, and study the subject somewhat closely. Several observers who have written on the circulation of insects have given lists of the insects in which they have observed the phenomenon.

Amongst these I have not found *B. orientalis*; and yet, as far as my observations go, owing to the large size and number of the corpuscles and the absence of dark pigment from the vessels of the wing, the circulation is here to be observed to more advantage than in any other insect. Insects are rather troublesome to tie down, and *B. orientalis* is particularly wild and difficult to keep quiet.¹ The small apparatus (fig. 1) will be found very convenient for fastening this insect for examination. To make it, a shallow rectangular box of the size of the figure should be taken, and filled with wet plaster of Paris, and into the upper surface of this, and near the edge, as seen in the figure, a dead blatta should be pressed down. When the plaster is set the insect should be pulled out, and a rectangular hole cut through the plaster slab opposite the impression. *a, a* are strips of paper glued on to the plaster, covering up the immediate front and hind portions of the impression, and also serving to hold in position a thin glass which covers the rectangular hole.

The Blatta to be examined is placed in the impression in the plaster, with his head under the front paper band and his tail under the hind one. *b* is a loop formed of a bent pin, with its two ends driven horizontally into the plaster. To it are attached two pieces of cotton, which are passed over the body of the insect, involving the wings not under examination, but leaving the others free, which are brought between the edge of the thin glass and the animal, and beneath the slab, to be fastened firmly to *c, c*, similar pins to *b*. This binding will generally suffice to hold the Blatta quiet; but it may be necessary to pass another cotton from *e* round the thorax under the slab and back. The front wing is now to be drawn forward, and may be fastened by means of a stout pin; or a piece of cotton may be tied round its lip, and may be strained to the pin *e*. The very tip of the hind wing should now be caught up in a loop of cotton and firmly fixed, and by straining this cotton more or less to the pin *d*, the whole hind wing will be fully expanded over the thin glass and rendered ready for examination.

The corpuscles in Blatta are so large that the circulation may readily be seen with a high power of a simple dissecting microscope. This is the most convenient method for making out the general direction of the currents in the wing. But with the wing fastened in this way it is quite easy to bring a Hartnack's No. 7 to bear on it. If an insect be carefully tied, the circulation may be observed in action for as long as

¹ N.B.—I have tried curare, but found that it had no effect on Blatta, even when used in a very concentrated form.

twelve hours. A freshly caught vigorous specimen should be chosen for examination (of course a male, the females have no wings), or one which, whilst in confinement, has had plenty of moist food. If specimens of *Blatta* be kept in a glass vessel for several days without food or water, the circulation will be found very feeble or almost absent. The animals' blood is almost dried up by evaporation, and if a few drops of water be given them they will drink it greedily.

Fig. 2 is a drawing of the hind wing of *B. orientalis*. N.B.—The circulation is also to be seen in the fore wing; but as there is more pigment present here, and the wing is thicker, the hind wing is more favorable for examination. The broad shaded vessels are the main vascular trunks, which are deeply pigmented, the transverse smaller vessels which connect them being nearly colourless. The dark filaments which follow the middle line of the main trunks are fine tracheæ. The direction of the blood-current is marked by the small arrows.

C. G. Carus¹ showed that in the antennæ and legs the blood-stream always flowed up on the anterior margin and back towards the body on the posterior margin. This is easily seen to be the case in the long antennæ of the male *Blatta*.

In the wings, as will be seen from the diagram, this rule is followed only in a general manner in *Blatta*. *a*, *a'* are the main arteries of the wing; but in *b* and *e*, *e*, *e* the blood also flows in a peripheral direction. The main veins are *e*, *e*, *e*, *e*, but there are also *a*, *a*, *a*, and the two vessels which lie one on each side of *b*, which convey blood in a centripetal direction.

It must not be supposed that the blood is always to be seen flowing in these directions. From comparing a number of healthy fresh specimens, I believe this to be its ordinary course. When a specimen is exhausted, or stasis from some cause occurs in one of the principal vessels, or the heart is rendered irregular in action from too tight ligatures, the course may be considerably changed for awhile. Thus, the current in *b*, *e*, *e* and *c*, *c* may be reversed. In *a* and *a'* I have never observed any but an arterial current. The veins *e*, *e*, *e*, *e* communicate with a venous trunk, which may be seen to pour blood into the body at the hind margin of the wing; but all the blood coming from these veins does not thus at once return to the venous sinus; but the vessels *e*, *e*, *e* also open into the venous trunk, and a large part of the corpuscles may be seen to turn off from the main stream in this

¹ Fernere Untersuchungen über Blutlauf in Kerfern. Verhandlungen der Kaiserlichen Leopoldinisch Carolinischen Akademie der Naturforscher 7a, Bd. 2te Abtheil, Breslau, Bonn, 1830.

latter vessel and pass up these three channels, thus taking a second course through the vessels of the wing. The same occurs with part of the blood returning by the veins *a, a, a*. This passes by a small branch into the artery *a*, and so on back into the wing, whilst the remainder flows on into the body.

We can hardly look upon this system of blood-vessels in the wing of *Blatta* as ensheathing the tracheæ.¹ These latter are very small in comparison with the former, and, moreover, do not send any branches into the transverse connecting vessels at all. The principal blood-vessels rather have small tracheæ running inside them. In many coleoptera the tracheæ are absent from these blood-vessels. In *Melolontha vulgaris* there are fine tracheal branches at the commencement of the principal vessels only. In most Lepidoptera they are very large, the expansion of the wing after emergence from the pupa being probably effected by a combined increase of pressure of air in these large tracheæ, and of blood in the vessels in which they lie. Of course the extensive circulation in a thin and generally moist membrane, such as is the wing of *Blatta*, must cause this latter organ to exercise to a great extent the functions of a lung; hence, perhaps, the smallness of the tracheæ. It is possible also that the absence of these aerating organs is compensated in the female *Blatta* by the very much larger size of the salivary glands.

In a paper published in the last number of the 'Cambridge Journal of Anatomy and Physiology,' Mr. Ainslie Hollis has come to the conclusion that the so-called salivary glands of *Blatta* perhaps act directly as aerating organs; but this author seems not to have met with the monograph of J. Basch² on the digestive and renal systems of this insect, where it is shown that these glands are capable, not only of converting starch into sugar, but also of digesting albumen. Moreover, on opening living specimens of *Blatta* I have more than once found the salivary receptacle, which Mr. Hollis has found always full of air, filled with a transparent fluid. It is possible that he may always have killed his specimens first, and that they may have ejected the contents of the receptacle in dying. If, therefore, the larger glands of the female compensate the wings of the male, I consider that they do so as excretory organs rather than as direct aerators.

Fig. 3 represents one of the transverse colourless vessels which connect the main trunks. It is drawn from a wing hardened in perosmic acid under a Hartnack's 7. On either

¹ Carpenter's 'Comparative Physiology,' 238.

² 'S. Basch Sitzungsberichte, Kaiser Akad. Wiss. Wien,' vol. 33, 1858, p. 234, Matt. Nat. Classe.

side are seen the large trunks, containing each a trachea, that on the left side branched, and also a nerve-fibre which accompanies the trachea in all the larger vessels in all insects which I have examined, and is present in the *Melolontha* where the trachea is absent. The transverse vessel is seen to have a thick lining of elongated, nucleated, closely packed cells. This layer of cells is present also in the main trunks, but is there, of course, not so easy to investigate, owing to the pigmentation and thickness of the outer chitinous investment. I have injected the vessels of the wing with silver solution, but have been able to find no other endothelial lining to the vessel than this thick stratum of cells.

Fig. 5 gives a group of the various forms of corpuscles, and fig. 4 shows one of the main trunks during active circulation. The direction of the current is shown by the arrows. The corpuscles behave in much the same manner as in the capillaries of a frog. Thus they change their form readily, the spindle-shaped ones doubling up in order to pass cross-ways through a narrow aperture, as seen in the one coming to the main trunk from the small transverse vessels on the left hand side of the figure. Moreover the corpuscles attach themselves to the inner wall of the vessel, and even seem to bury themselves a short way in it; though, of course, the chitinous investment renders diapedesis impossible. In the irregularly formed corpuscles, which seem to represent leucocytes, amœboid movements may be observed. Corpuscles pass freely above and under the tracheæ, showing that these latter lie free in the vessels.

Thinking that the cells lining the blood-vessels might be contractile, and that the nerves accompanying the trachea might be to some extent vaso-motor, I introduced fine wires into the hinder legs of a *Blatta*, and applied stimulus by means of an induction coil, but could not produce any effect. However, on repeating this experiment with *Melolontha vulgaris*, I found that there was an elongated sac projecting free into the main artery of the hind wing, which contracted readily on very slight stimulus being applied to the legs. If the stimulus were prolonged this sac remained in a state of tetanic contraction, but expanded again immediately the current was broken. This sac is one of the contractile organs which have been described as occurring in the limbs and wings of insects, and which assists the heart in maintaining the circulation. In the hind wing of some small hymenoptera occur three rhythmically contractile sacs, or rather dilatations of the vessels. They are represented in fig. 6, the contractile spots being marked with a cross. If electrical

stimulus applied to the body these sacs immediately contracted, and were thrown into tetanus by prolonged stimulus, as in *Melolontha*. These vessels seem therefore to behave somewhat like the small arteries in vertebrata, as seen in the rabbit's ear or skin. The contractile vessels continue to contract feebly for a short time after the wing has been severed from the body, as is evidenced by a backward and forward motion of the blood-corpuscles when a wing possessing them is placed immediately after separation under the microscope.

The blood-vessels of the wings of most insects which I examined (*Blatta*, *Dytiscus*, *Hydrophilus*, *Melolontha*) are infested with parasites, which attach themselves to the tracheæ, and always occur in greatest abundance in the main arterial trunks. These parasites seem to differ considerably in each species. Fig. 2 is taken from a wing hardened in perosmic acid, which stains the parasites which are filled with oil-globules black. They therefore appear in the figure as dark elongated spots attached to the central trachea in the main artery (*a*). I hope shortly to make a communication to the Journal on the subject of these parasites.

Blatta Orientalis casts its skin at certain periods, the chitinous investment splitting up the back, and the animal coming out, after several hours' labour, quite soft and milk-white. I have as yet only been lucky enough to obtain one specimen, a female, in this state. The insects, when thus fresh from the old skin, are very transparent. Light may be thrown right through their bodies, and the action of the heart and valves observed to great advantage. A venous sinus surrounding the heart can be clearly seen, and also that the corpuscles within it move towards the posterior extremity of the body. Moreover, the blood may be seen entering the heart by side apertures from the sinus, and apparently leaving it by others.

Although a good many fine tracheæ could be seen in the body quite distinctly, and though the power used was quite high enough to show corpuscles distinctly, no circulation taking place around these tracheæ was to be observed in the manner supposed by M. Blanchard. On account of the large size of the corpuscles, *B. Orientalis* is remarkably favorable for investigations of insect circulation. Unfortunately, these white insects rapidly—*i. e.* in a couple of hours—become so brown as to be no longer transparent, and rapidly become black.¹

¹ Thinking it just within the limits of possibility that this brown coloration might be due to the presence of silver, I analysed one pound weight of *Blatta*; I found no silver, but plenty of iron, and a remarkable quantity of manganese.

A ready method for injecting the circulatory system of insects has long been a desideratum. The injection from the heart is beset with many difficulties, owing to its brittleness, and has led, as yet, to no certain conclusions, the connection of the large afferent and efferent blood-vessels in the wings with the heart being still uncertain. It may be well here to add a short account of a method which, I believe, may be of much assistance in clearing up such points as these, and which may also yield some interesting physiological results.

When the fore wing of a large living Coleopterous insect (*Dytiscus marginalis*, *Hydrophilus piceus*, and *Melolontha vulgaris*, e. g.) is cut transversely in two with scissors, a row of blood drops may be seen along the edge of the cut, which proceed from the large vessels divided by the operation. At the front border or costa of the wing this bleeding is most profuse, since the largest artery occupies this position. At this spot a very fine-drawn-out glass tube can easily be introduced either into the half of the wing still attached to the body, or the corresponding half which has been cut away. I have found it most convenient to use as a pressure apparatus a simple short india-rubber tube filled with injecting fluid, having the canula at one end and stopped at the other. By pressure with the finger on the tube the fluid may readily be forced into the vessels. If the wing of *Dytiscus marginalis* be thus injected with indigo-carmin (which I have found to run best) or Berlin blue solution, a very beautiful preparation is obtained.

By injecting the other half of the wing in the direction of the body the heart may readily be filled. When an insect (Cockchafer or *Dytiscus*) has thus its blood-system filled with indigo-carmin, this pigment is rapidly excreted by means of the kidney tubes, just as is the case when the same experiment is made on mammals, as in Czerny's experiments. Basch has shown that the kidneys in *Blatta Orientalis* contain uric acid. This observation tends to show a further identity of function between these organs and the mammalian kidneys. The excretion takes place very rapidly, the tubes in *Blatta Orientalis* being filled with blue pigment a few hours after its injection into the heart. In *Hydrophilus piceus* a series of simple circular glands, with which the intestinal wall is crowded, also excrete this pigment; nearly the whole intestine, shortly after the injection of the indigo-carmin, becomes blue, and on microscopic examination the pigment is found collected in the lumen of these glands.

On the PRODUCTION of SPORES in the RADIOLARIA. By
Professor L. CIENKOWSKI. (With Plate XVIII).

(Translated from the fourth part of vol. vii (1871) of the 'Archiv für Mikroskop. Anatomie.')

ALMOST all that we know of the developmental history of the Radiolarians renders it extremely probable that the Capsule takes an important part in the reproduction of these organisms. Besides the oft observed multiplication of the Capsule by division, science possesses some other evidence which seems to be of great importance. Joh. Müller¹ saw in the interior of an *Acanthometra* a swarming of small monad-like vesicles, which moved about for a time, and then changed themselves into *Actinophrys*-like structures. Since the subsequent history of these monad-like bodies was not made out, the suspicion of the intrusion of some parasitic organism could not in this case be set aside.

Still more in favour of the existence of motile Radiolarian germs are the facts brought forward by Haeckel, in his celebrated work.² He saw, firstly, in *Sphærozoids*, the contents of the Capsules break up into many vesicles. and, secondly, in *Sphærozoum*, he observed masses of vesicles which exhibited a vibratory movement. What was especially convincing that these structures belonged really to the Radiolaria, was the circumstance that these vesicles contained the same wetstone-like crystalline bodies which are seen abundantly mixed up in the Capsule contents of the compound Radiolaria. Lastly, the groups of amœboid vesicles with movable flagellum-like processes observed by Schneider in *Thalassicola* Capsules must be mentioned.

The above observations make it, then, exceedingly probable that the Radiolaria reproduce by motile germs which are developed from the Capsule contents.

To the investigation of these phenomena, as also to the development of the still questionable yellow cells, were my energies chiefly directed, when I had the opportunity, in the past winter (January to the middle of March), in Naples and Messina, of examining living Radiolaria. It soon became apparent that the *Acanthometræ* and the simple Radiolaria, *e. g.*, the *Aulacantha*, so common in Naples, are little suited to the investigation. I therefore devoted myself mainly to the colony-building forms. I investigated especially *Collo-sphæra* and *Collozoum*.

The structural relations of the compound Radiolaria are in

¹ 'Abhandlungen der Berlin Akademie,' 1858.

² 'Die Radiolarien,' pp. 141, 147, Taf. 33, fig. 9; Taf. 35, figs. 11, 12.

all that is essential nearly exhaustively treated in Müller's papers and Haeckel's classical work, so that I may be very brief about this point. The Sphærozoids and Collosphærids present us with aggregates of Capsules, which are held together by a common mass of Protoplasm.

The Capsules are separated by a certain interval from one another; the Protoplasm binding them together consists of Alveoli (vesicles), of various sizes, between and on to which sarcodic threads and networks are disposed. I always found the capsules supported on the surface of the Alveoli, often lenticular, compressed, and enclosed by a radiating layer of Protoplasm, which also spreads itself over the Alveoli, and passed over continuously into the sarcodic envelope of neighbouring Capsules. Besides those Alveoli which carry capsules there are many smaller, which are free from Capsules. Lastly must be mentioned the Yellow Cells, which are scarcely ever wanting, and are found scattered in various positions, so that the chief soft elements of the compound Radiolaria are characterised by them.

The *Collosphæra* which I investigated in regard to their developmental history belong to the two species already described—*C. Huxleyi* of Müller, and *C. spinosa* of Haeckel.

As has been long known from Müller's and Haeckel's works, Collosphæra possesses a fenestrated shell, which encloses a Capsule with protoplasmic investment. In the first named species the shell is smooth and furthest removed from the Capsule (figs. 2—4); in *C. spinosa*, it is beset with short spines (figs. 7, 8). The contents of the Capsule is, in both species, homogeneous—here and there of a faint violet colour, and contains a central oil-bubble. The Yellow Cells I have generally found united in a mass within the shell, although some also adhered to the surface of the fenestrated shell outside (figs. 7, 8). The young capsules are naked, embedded, without any shell, in a radiated protoplasmic sheath, not emarginated by any sharply marked envelope (fig. 1). In this stage they often divide themselves by fission into two halves. Not until maturer age does the Capsule obtain a resisting membrane, and become enclosed in a fenestrated shell (fig. 2).

The changes which now further take place in the Capsule consist herein, that their entire content breaks up into a quantity of little spheroids (fig. 6 *c*). I was able to see this complete itself on the stage of the microscope in a single day in the case of *C. Huxleyi*. After a few hours many delicate vesicles appeared in the contents, which later broke up into smaller bodies (figs. 5, 6). Unfortunately it is not possible to

carry the "cultivation" in this species further whilst on the object-slide. However, in *C. spinosa*, luckily it was possible to get a step further. In some vigorous specimens which I caught at Naples in February, nearly all the Capsules were filled by an immense number of small spheroids (fig. 7). These Collosphæra colonies were laid in large flat vessels filled with sea-water, and in order to prevent the water becoming bad, bits of ulva and other green Algæ were placed in with them. After one day I found, instead of the common sausage-shaped or spherical colonies which I placed in the vessel, masses of yellow granules which when taken out with a glass tube and examined under the microscope proved to be Capsules of *C. spinosa*. The alveoli to which they had been adherent were entirely gone, only a trace remained here and there of the radial protoplasm, sticking on to the Capsules. The Capsules were thickly squeezed together. At the first glance the specimens seemed in the act of dying, and I was just going to throw them away, when I observed in several Capsules a tremulous movement of the enclosed corpuscles, which in a short time manifested itself in nearly all the Capsules of the mass, and ended with a copious outpouring or "swarming."

I could now quite comfortably observe a part of the material with the higher powers under a covering glass (care being taken to prevent its pressing too heavily) as well as in hanging drops.¹

In nearly every Capsule monad-like organisms vibrated, the liberated ones swam meanwhile actively in all directions round about. By the side of capsules, whose contents still remained homogeneous, not differentiated, lay those which were full of as yet quiescent, others full of moving, corpuscles. From one capsule I saw the latter issue forth in mass at one point (fig. 8). In some cases I believe I have quite clearly observed how they passed through the fenestræ of the shell.

Let us now pay somewhat closer attention to the little bodies swimming here and there around, which I shall henceforth speak of as zoospores. The Collosphæra zoospores are .008 mm. long, oval, somewhat obliquely trimmed away at the smaller end, which carries two long cilia (figs. 9, 10). In all the zoospores I found a crystalline little rod, .004 mm. in length, rounded at either end, or brought to a point, which often projected out somewhat from the body. Add a few oil drops, and you have almost all that one can make out of form-elements in the naked protoplasmic bodies of the zoospores.

¹ Prof. Cienkowski alludes to the use of a chamber such as that described in my paper in this number of the Journal.—E. R. L.

Among the swarms of swimming zoospores lay many motionless ones dispersed. They were round or angular, with drawn-out points; their contents had the same composition as those of the motile zoospores; in addition one or more constrictions could be seen in them. Apparently they were developmental stages of the zoospores, obtained as they were in formation from the contents of the Capsule (figs. 13—15). The same appearances I obtained again in the other specimens of *Collosphæra*, which I allowed to remain in the vessel for further "cultivation." The movement of the zoospores lasted over twenty-four hours, then they dissolved away, leaving the little rod and the oil bubbles behind. My efforts to cultivate the zoospores in various ways, in order to bring them to a further stage of development, ended always in negative results. In spite of this, and although the further fate of the swarming cells remained undetermined, I believe I may consider them as zoospores. In favour of this view speaks their formation from the Capsule contents, which I, at any rate in the first stages, was able directly to observe on the object-slide in *C. Huxleyi*; further, the bits of protoplasm caught in the act of constriction (ending in fission), which already contained the little rod which one so often finds in great quantity in the undivided Capsule-contents. These facts, as well as the normal appearance of the Capsule-content, make the supposition that we had here to do with parasitic monads, not admissible. When we have once obtained the conviction that swarm cells belong to the developmental cycle of the Radiolaria, some of the earlier statements, especially those of Haeckel as to *Sphærozoum*, acquire a high significance. The vibrating vesicles with wet-stone shaped bodies, which this naturalist found in *Sphærozoum*, were very probably identical structures with the zoospores of *Collosphæra*.

The second form of the colony-building Radiolaria investigated by me was the common *Collozoum inerme*. The results here obtained agree completely in the chief points with the earlier results obtained by Haeckel. In some points they extend these, and on account of the facility with which one can observe what goes on in the Capsule-contents, they are well fitted to support not unimportantly the view here put forward.

The Capsule is also in this case in the young stage devoid of an envelope, and imbedded in a radiant protoplasmic layer. They multiply by division, taking on the biscuit form or elongating in a worm-like form, and bending and then dividing by several constrictions into separate parts (figs. 20, 23).

Just as the Colloosphæra-capsules secrete a hard membrane before the formation of zoospores, so do also the Collozoa. Their Capsules acquire a sharp contour, and grow considerably larger. Their content contains besides the oil-bubbles not unfrequently a number of small crystalline rods, which are quite like those which we found in the Colloosphæra-zoospores. These little rods seem, however, to be of no importance in the further development of the contents, since Capsules which behave themselves similarly not unfrequently occur in the same colonies with or without the little rods. The beginning of the differentiation of the contents is inaugurated by its breaking up into cuneiform aræ arranged radially around the oil-globules (figs. 16, 17). To be sure, this arrangement is by no means without exception, since the divisions of the Capsule-contents as often form irregular or spherical masses. The differentiation now steps further in advance; the large protoplasmic aræ break up into a number of small bodies, which are again able to divide themselves by constriction (fig. 18).

When one squashes a Capsule in this stage, naked content-balls are seen to escape of various sizes, which are already entirely made up of small corpuscles. The indifferent behaviour of the oil-globules in the breaking up of the Capsule-content becomes here apparent. They lie partly enclosed in the balls, partly free between the masses round about. Where only one oil-globule was present, I have always found it outside the aggregate of small spheroids. As in Colloosphæra so also here, the complete differentiation of the contents is indicated by the commencing contraction of the Capsule. The colonies obtain in consequence a coarsely punctate aspect, occasioned by the sharp contours of the Capsules and the yellow cells which bedeck them. One after another the Alveoli disappear, and the radiant Protoplasm almost entirely; the Capsules become thereby generally so closely pressed against one another that they appear flattened out like a parenchyma-tissue whose intercellular spaces are filled up by Yellow Cells (fig. 19). In these masses of Capsules, as already the experience of Colloosphæra showed us, the differentiation of the Capsule-contents, *par excellence*, takes place, although this may begin even in the normal habitus of the colony.

So far the analogy of what takes place in the Colloosphæra is so close that it would be exceedingly strange if the last stage—the out-swarming of the corpuscles formed from the Capsule-contents—were to be wanting here. Unhappily, I was obliged by illness to break off my researches at this

point, and so to leave also undecided the question as to how, from the differentiated Capsule-contents, the whole colony takes its rise. Here I will only notice two observations which make the direct development of the Capsule from the radiant Protoplasm very probable. The first fact was found by Stuart.¹ In *Collozoum inerme* Stuart saw that a simple lump of thickened protoplasm became the seat of the development of new individuals. In this case small fat-drops are secreted from the clear protoplasm, which later unite themselves in a central drop; further, there follows a division of the protoplasm into a clearer outer layer and an inner darker, which develops itself into the Capsule. The youngest stages of the latter were recognised as such by the presence of small polyhedral crystals, which are characteristic of the species investigated. I had no opportunity of proving these statements.

The second fact, which appears to show that the capsules develop out of the radiant Protoplasm, I have myself often enough observed in *Collozoum inerme*. In place of the common layer of protoplasm which surrounds the capsules I often saw many vesicles, thickly pressed together, which possessed all the appearance of young capsules (fig. 24a). They were of various forms, often drawn out into sharply pointed processes, contained one or more oil-globules, and were caught in active division (fig. 24, b, c). Around the entire mass of these little vesicles, bedecking the old Capsule, was spread a thin viscid coat, the remnant of the enclosing protoplasm of the Capsule. After some days I found the little vesicles in question in a cultivated *Collozoum*, scattered about on the surface of the colony, and rounded off. Further their development did not allow me to follow it.

I conclude this notice with some remarks relating to the Yellow Cells. The writers who have busied themselves with *Radiolaria* regard the Yellow Cells as integral parts of these organisms, making not the slightest doubt about it. If we ask, however, what ground this conviction rests upon, all we get as an answer is, that the Yellow Cells always are present in most *Radiolaria*. The fact alone that in a given species the number of these said cells is subject to the greatest variations, and not seldom sinks to a very few, as well as that we possess no knowledge of the way in which they form themselves, is in itself sufficient to raise our suspicions as to whether the yellow cells really belong to the *Radiolaria*. And if we take into consideration with what a remarkable constancy some parasitic organisms insinuate

¹ 'Göttinger Nachrichten,' 1870, No. 6.

themselves into the developmental cycle of other organisms, it will not, perhaps, appear to be over rash if we raise the question whether, indeed, these Yellow Cells are to be considered at all as integral parts of the Radiolarian body? As a matter of course, developmental studies alone can bring light here.

In the first attempt to follow the origination of the Yellow Cells in the protoplasm, the observation did not appear to be encumbered by any serious difficulty. As is known, the Yellow Cells multiply by division, and one finds them of various sizes. Easy also is it to find in the body of the Radiolarian examined, naked, yellow-coloured, protoplasmic specks, which one would feel inclined to regard as the first steps in the development of a Yellow Cell. It has turned out, however, from more careful observations, that the particular Radiolarian observed had taken in as food yellow Tintinnoids, and that the yellow colour of the protoplasmic specks arose from the undigested food. I failed to discover any single fact which proved the direct origin of the Yellow Cells from the protoplasm of the Radiolaria. In order to get nearer to the question in another way, I availed myself of the interesting fact discovered by Schneider, that the Capsule of *Thalassicolla*, when extruded from its shell, had the power of building up anew the Radiolarian body. I thought in this way to be able to follow the formation of the Yellow Cell step by step, and the more so since Schneider succeeded in nursing the regenerated *Thalassicolla* up to the point of development of Yellow Cells. In my researches, which I also carried on with *Thalassicolla nucleata* (the blue coloured variety), the extruded capsules certainly did go so far as to produce new pseudopodia coloured with blue particles, only I had not the luck fully to follow out the process of regeneration. The only new fact which I have found relating to the Yellow Cells is this, that in Collozoum which for some time lay in sea water (over a week), the Yellow Cells proceeded gaily to grow even when the protoplasm and capsules of the whole colony were already completely decomposed. In this condition there appeared around the Yellow Cell a somewhat tough viscid membrane, which completely enclosed it (figs. 25, 26*h*). From this sheath the growing cells escaped very slowly, forming a new envelope which in turn became discarded also. This formation of a sheath occurred in the same cell several times; the escape from the sheath took place so slowly that it was not possible to observe it directly. The liberated cell grew, acquired a ragged outline, and multiplied itself finally by division. This pro-

perty of the Yellow Cells to grow and reproduce themselves after the death of the organism to which they are supposed to belong, and then the remarkable quantity of starch which they produce according to the important discovery of Haeckel, which I can confirm, are phenomena which, though certainly not decisive as the signification of the Yellow Cells yet appear very surprising if belonging to the life-history of the Radiolaria.

Odessa, 27th April, 1871.

NOTE.—Iodine stains, as Haeckel rightly states ('*Jenaische Zeitschrift*,' 1870, p. 534; '*Quart. Journ. of Micros. Science*,' January, 1871), most of the corpuscles enclosed in the yellow cells, blue. In order to obtain the reaction clearly, I have first extracted the yellow pigment with alcohol and then acted upon the Radiolarian several times with strong iodine tincture. With the chloride-of-zinc-iodine solution the coloration comes out more quickly and intensely.

NOTES on the GENUS *DOLIOLUM*. By EDWARD L. MOSS, M.D., F.R.C.S.I., Assistant-Surgeon R.N.

(Read before the Dublin Microscopical Club.)

THERE can be but little doubt that the distribution of ocean surface life is considerably influenced by the great systems of oceanic circulation which recent researches have disclosed. Such circulation probably tends to assimilate the inhabitants of adjacent ocean basins, and helps to explain the remarkable similarity in the faunas of even widely separated seas. But unless surface animals can live with equal facility at considerable depths, a sort of retentive selection will be exerted on those that drift in through narrow straits into seas like the Mediterranean, where the surface waters have an average inward flow, and where the denser outward current is in depths removed from the direct influence of light and air.

Like other Pelagic Tunicates, the genus *Doliolum* possesses a wide geographical range; but nevertheless, if I can judge by the results of my own "fishing" during voyages over more than a hundred thousand miles of Atlantic and neighbouring seas, it is far from being as widely spread as many of its relatives. *Salpa*, *Appendicularia*, and *Pyrosoma*, are not uncommon in the Mexican Gulf and Caribbean Sea, but *Doliolum* has never been captured in either. I have met with isolated specimens off Cape Clear, Cape St. Vincent,

Madeira, and the Canaries; but it is only in the Mediterranean, especially in its Levantine portions and near land, that this strange genus becomes the commonest of countless forms that crowd the surface water.

The general morphology of *Doliolum* has been described by Krohn, Gegenbaur, and Huxley; but its division into species must as yet be merely provisional, for its life history is far from complete. One large division of the genus has been traced only to the point where it commences its independent existence, on ceasing to be adherent, as one of the lateral series of buds from the gemmarium of its parent. The great majority of the specimens captured by me have differed in one or other particular from the forms described by the observers mentioned above; one of the commonest types, for example, closely resembled *D. denticulatum*, but the fin-like frill round its proximal opening was either altogether unrepresented or replaced by two anteo-posterior or four antro-posterior and lateral tentacles, measuring about one sixth the length of the body, and presenting bulb-like points and bases. Sometimes, when the tentacles were only anterior and posterior, a pair, without enlarged points, sprang from the same dilated base. This variety of *Doliolum*, as well as many others, is not unfrequently marked along its sides with the magenta-coloured spots on the surface of the inner tunic enumerated amongst the characteristics of *D. Mülleri*.

Two specimens recently captured near Malta differed from all the described forms in the structure of the gill-diaphragm dividing the internal cavity of the "little barrel." The ciliated perforations in this membrane, instead of being arranged in the usual bilateral series, were placed in pairs on the four sides of a lozenge-shaped space (see Plate XVIII, right division, fig. 2), through the hæmal angle of which the digestive canal passed. The posterior or proximal orifice of the body was guarded by four tentacles, such as are described above; but in its general anatomy the little animal presented few other peculiarities, its eight muscular hoops, the twelve-toothed collar round its distal opening, the position and structure of its ganglion, ciliated auditory (?) sac, endostyle, heart, and alimentary canal, being all in accordance with the usual type. Both the specimens captured measured about the one sixteenth of an inch, and both were furnished with germ-stems projecting—as in some of the varieties mentioned by Krohn—not from the hæmal surface, but from a corresponding part on the ventral side (fig. 1 *a*).

I have never been fortunate enough to find a *Doliolum* with a gemmarium sufficiently developed to exhibit the re-

markable difference between the median and lateral buds figured by Gegenbaur in Siebold and Kölliker's 'Zeitschrift' for 1856; but knowing by experience the inaccuracy of his delineations, I would suggest that a link between Appendicularia and Doliolum seems to be indicated in the general resemblance of structure between the side buds of the latter, and the form of Appendicularia (fig. 5) described by me in the 17th volume of 'Linnean Transactions.'

On the PERIPHERAL DISTRIBUTION of NON-MEDULLATED NERVE-FIBRES. By E. KLEIN. (With Plates XIX, XX.)

AFTER the terminations of non-medullated nerve-fibres had been discovered in the tactile corpuscles of the skin and in the Pacinian bodies; after Max Schultze had come forward with his surprising and stirring doctrine as to the special terminations of some of the nerves of the higher senses, and Krause had described what were named by him the "club-shaped extremities" in many nerves of common sensibility, as well as in those of the conjunctiva, oral mucous membrane, and genital organs; and after special terminal-apparatus had been found out in the striated muscles,—the doctrine of a terminal network of nerves in general seemed to be finally set aside, especially in the case of the nerves of common sensibility, which, according to it, break up into a network in the most superficial layers of the skin and mucous membranes, consisting sometimes of thin fibres partly medullated, partly non-medullated, or bending round to form a loop. Indeed, within the last ten years a great number of treatises have appeared on the modes of termination of the peripheral non-medullated nerves, showing in general that special terminal apparatus are to be found in the most various organs and in the most various nerves. Here I can call to mind only the termination of the nerves of common sensibility in the branching corpuscles lying between the epithelial cells of the *rete Malpighii* of the skin (1); the so-called *terminal corpuscles* of the genital nerves (2); the termination of nerves in the nucleolus of the smooth muscular fibre (3); the knob-shaped termination of the corneal nerves in the precorneal fluid (4); the ending of nerves in the corneal corpuscles (5); the nerve-termination in the nucleoli of the epithelium of the tail of the tadpole (6); and in the branched cells (7) of the same organ; the terminations of nerves in the pear-shaped structures of the

tissue of the epiglottis (8) ; in the nuclei of capillary blood-vessels (9) ; in special bodies in the mucous membrane of the urinary bladder (10) ; and in structures which lie between the epithelial cells of the mucous membrane of the stomach of the frog (11) ; the freely outrunning nerve-fibres in the tissue of certain serous membranes (12) ; the termination of nerve-fibres in the cells of the alveoli and of the ducts of the salivary glands (13) ; in the cells of the liver (14) ; and so on.

In regard to a number of these nerve-endings, on the one hand the very opposite has been demonstrated within the last few years ; it has been shown, that is to say, that the finest nerves may be followed over and beyond these so-called special terminal structures ; while, on the other hand, the existence of the same in some of the tissues has been called in question. Thus in the nerves of the conjunctiva, in the two last works (15) which have appeared on the subject, no mention is made of terminal corpuscles ; on the contrary, it is shown that fine nerves enter into the epithelium, and ramify farther between its cells. In the same way it was shown that the nerves of common sensibility of the skin (16) may be followed farther towards the surface than the above-mentioned branched corpuscles are to be met with. In the case of the nerves of the tail of the tadpole, their connexion has been disproved both with the branched connective-tissue cells (17), and with the nucleoli of the epithelium (18).

Similarly the connection of the nerves of the cornea with its corpuscles has been denied (19), but again maintained (20). In regard to the finest nerves of smooth muscular fibres, it was further demonstrated (21) that they do not end in the nucleolus, but that these nucleoli are intercalated in the intramuscular network. Finally, it was quite recently shown that the nerves of the mucous membrane of the vagina (22) and palate (23) are not furnished with terminal apparatus, but enter the epithelium to ramify farther within it, and to form networks.

The following treatise will be occupied, first, with the ramifications of the fine nerves of the cornea with relation to the anterior epithelium, the corpuscles, and the endothelium of the *Membrana Descemeti* ; secondly, with the nerves of the nictitating membrane of the frog with relation to the epithelium, the glands, and the blood-vessels which it contains ; thirdly, with the ramifications of the fine nerves in the canal to be found lined with ciliated epithelium in the tail of the rabbit ; and finally, with the nerves of the mesentery in relation to the *propria* and blood-vessels of the same (see ' Cen-

tralblatt,' September, 1871). From the description of these we shall be able to deduce how far we are right in assuming the existence of free nerve-endings in the organs just mentioned. To obtain an easier view, we shall divide our subject into two parts. The first of these—the following paper—will treat of the nerves of the cornea, while in the second there will be discussed the nerves of the nictitating membrane of the frog, of the canal in the tail of the rabbit, and of the mesentery.

PART I.—*Nerves of the Cornea.*

After the well known and able description of the corneal nerves by Cohnheim (24), who has much enriched the knowledge acquired by his predecessors, His (25), Arnold (26), and Hoyer (27), it seems superfluous, if not ungrateful, to make these the subject of a treatise; for the description that has been given by Cohnheim of the nerves of the cornea of mammals, including every detail, was in fact, by the adoption of the chloride of gold method introduced by him, confirmed in most points by G. Kölliker (28) very soon after its appearance as a preliminary contribution. Nothing is indeed more easy than to convince oneself of the truth of the individual assertions of Cohnheim. In undertaking, therefore, to produce something upon the subject of the nerves of the cornea, I do so for two reasons: first, I believe, as my preparations obtained by a somewhat modified method teach me, that I shall be able to examine the finest nerves of the cornea in their ramifications more perfectly and richly, and thus to make some not altogether unreal additions to our knowledge of them; and secondly, I have also obtained more complete specimens than have yet been described of the nerves which run in the substance and posterior portions of the cornea, and am therefore in a position to be able to contribute, if not much, yet something, about these nerves as an amplification of our present knowledge.

First of all I might make some remarks upon the method which I have adopted. To every one who has occupied himself much with colouring with gold, and especially with the investigation of the nerves of the cornea by means of the chloride, this has been a source of trouble, viz., that one obtains at times the greatest variety of preparations under otherwise similar modes of treatment, one has to wait frequently for an exceedingly tiresome length of time until the necessary colouring has been effected, one is so much dependent upon the influencing light, and is at times entirely destitute of success; occasionally, also, the results are perfectly disproportionate to the time and pains bestowed upon the preparation. After

having sought for a long time in vain after means of guessing at these misfortunes and hindrances, the contribution of Henoicque came to my sight, according to which by placing the tissue treated with chloride of gold in a vessel filled with a concentrated solution of tartaric acid, and by putting the whole into hot water, a rapid separation of the gold-salt is brought about. Accordingly, I tried this method, and my endeavours were crowned with the best result, so that I obtained *always* and in every cornea without difference of light, and under all conditions the same preparations equally complete and equally pretty. I proceed in the following manner:—From a rabbit yet alive or just killed, I cut out the cornea with a border zone of the sclera of a few millimeters, and place it, after having removed with care the iris or ciliary body which was, in some cases, extracted with it, in a watch-glass with a pure half per cent. solution of chloride of gold, in such a manner that the convex surface of the cornea looks upwards, and the structure rests upon its scleral border. After three quarters of an hour or an hour, I remove it from the gold solution and transfer it, in the same position to a vessel containing distilled water. Here I allow it to remain from six to ten hours in the light. After this time the colour of the cornea, which was at first yellow from the action of the chloride of gold, is replaced by a light grey or steel grey. I then place the cornea so coloured in a small glass flask with a wide neck, in which is a small quantity (five to ten cub. cent.) of nearly concentrated filtered solution of tartaric acid. As soon as the cornea has imbibed this fluid and sunk to the bottom of the vessel accordingly, we remark that its colour has become much deeper, it has become more or less of a greyish violet. I now immerse the flask in a capsule into which has been poured as much water at 40° to 50° C., as, at least, corresponds to the surface of the tartaric acid solution. After a very short time, often in a few minutes, the preparation assumes an intense violet-red colour, which continually increases until at last the cornea, when the water has quite cooled, appears of a dirty dark brown-red colour, and with a shining velvety surface. I now lift it out and wash it for two hours or more either in common or in distilled water. From eight to twelve hours have now been required since the colouring with gold. I have prepared a great number of cornea of the rabbit in this manner. I cut out the cornea usually between eight and nine o'clock in the morning, subject it to the various processes enumerated, and between four and five p.m. the same is as darkly coloured as possible, and on being washed

is perfectly fit for preparation. If the cornea is cut out fresh, coloured in good gold solution, and carefully treated afterwards, success is certain. The flake-preparation which I employ for the study of the fine nerves lying superficially, I make by pulling off the epithelium along with quite a thin layer of the corneal substance by means of a pointed forceps beginning at the scleral border—a proceeding which after some practice is accomplished without difficulty. Vertical as well as longitudinal sections are employed with good results. On such a flake preparation just mounted there appear not only the plexus of the more deeply lying nerves, but also those lying in the most superficial layers of the *propria* of the cornea. Besides these we see many of the fibres which form the subepithelial network, and several of those which run in the epithelium. What, however, comes into view with greater clearness is, that the epithelium is quite homogeneous over large tracts, and with moderate powers we can distinguish none of its elements. We recognise only the upper and under surfaces, respectively the anterior and posterior bordering surfaces of the same. The former is recognisable by means of the precipitate lying irregularly dispersed upon it, the latter by an extraordinarily pale mosaic, in some places more, in other places less indistinct. With stronger powers (450 diam.) we may even recognise just a slight indication of nuclei in the flat cells lying superficially. Further on we shall see of how great advantage this condition of the epithelium is in tracing the nerves within it. It is a matter of no consequence whether we preserve such preparations in the light or in the dark. After one or two days they become decidedly darker and the nerve-fibres are perfectly visible to their finest ramifications. Since the preparations thus become darker, it is very important that their thickness should not exceed a certain degree. If we have taken care that they contain only the epithelium and the most superficially lying layers of the corneal tissue, so, indeed, that the preparations may be penetrated through its whole depth by No. 8 Hartnack, we may be sure that they will be quite useful for a long time to come. I have in my possession some preparations which were made more than six months ago; and yet if the examination of these be only undertaken with good light, the relations of the finest nerves are to be seen with all the perfection to be desired.

It is by no means part of the plan of this treatise to describe minutely the distribution of the more deeply placed plexus of broader nerves, nor the subepithelial network of the fine nerve-fibres. This is all the more unnecessary, since I could

not produce much which could amplify or modify the complete statement of Cohnheim on this subject. I shall only allow myself to make some remarks upon the structural conditions. These remarks apply both to the plexus of the broad nerve-fibres, and to the subepithelial networks of the fine ones.

If the nerves are followed from their entry into the cornea uncut where they form a plexus in the tissue by the successive division and anastomosis of their branches, it is found on the one hand that the neurolemma, with its oblong nuclei, is prolonged from the trunk on to the branches, and on the other that the individual nerve fibrils of the trunk at the same time lose the medullary sheaths, but do not do so at corresponding points in their course. The branches, moreover, of the same trunk do not lose their sheaths at corresponding points in their course. In the non-medullated parts it may be recognised that the colourless or pale reddish neurolemma contains only bundles of delicate filaments, with varicosities at more or less regular intervals, which filaments may run more or less parallel to each other, or twine round one another in spirals. At the points at which a bundle of this kind divides into smaller bundles, or at which fibres branch off laterally, there exist enlargements of triangular form, the neurolemma being prolonged from the trunk on to all the branches.

The filaments of the branches of this plexus, which are to be met with in all parts of the *cornea propria*, are consequently to be regarded as bundles of fine fibrils, which were separated so long as they formed a series of single axis-cylinders.

In addition to the points already mentioned as to the arrangement of the non-medullated fibrils, another peculiarity is to be noticed. The fibrils form within the neurolemma, particularly at the points of enlargement, a mesh-work of extraordinary closeness, which is produced by the bifurcation and coalescence of neighbouring fibrils. The interspaces are rhomboid or oblong.

In the anterior superficial layers of the corneal tissue, minute bundles of fibrils spring from the plexus, which lose themselves in the subepithelial network. Cohnheim has explained in the most complete manner the differences which this network presents in the central, peripheral, and middle parts of the cornea. Cohnheim's research is so well known, that it is scarcely necessary to give quotations. I will content myself with adding to his description, that as well on the central as on the intermediate zone, between centre

and periphery, finer bundles of fibrils spring from the plexus of thicker fibrils, which either immediately after their origin spread out into individual fibrils anastomosing with each other, or give off fibrils in succession in a manner resembling the mode of branching of a weeping willow; these, like others, reticulating with each other.¹ It is at all events certain that the subepithelial network, whether its arrangement is that of a trellice-work or a network, consists of extremely fine fibrils, which are marked by the possession of varicose swellings. It is maintained by Cohnheim that fibrils of extreme tenacity spring from the subepithelial network in a direction almost vertical to the surface, finding their way between the deepest cells of the epithelium; and that after giving off connecting fibres in the middle layers, they can be traced to the surface where, although some of them terminate among the superficial layer of cells, they mostly end in filaments with terminal knobshaped swellings (*Endknöpfchen*), which float free in the præcorneal fluid. As regards this distribution in the epithelium my preparations show the following:

The fibrils which rise among the pallsade-shaped epithelium, give off very numerous fibrils, often only distinguishable as linear series of granules, which take a horizontal course on the ends of the columnar cells next the surface. These horizontal filaments wind among the epithelial elements in zigzag lines, and are connected together both directly and by lateral branchlets, and thus form a network which is not much inferior to the subepithelial network in density. After giving off the horizontal branches, the vertical fibrils wind in a convoluted manner towards the surface. In this part of their course filaments spring from them which bifurcate, and either anastomose together, or accompany them towards the surface. The nerve fibrils which are to be found in the superficial layers, exhibit here and there in their course, in addition to the minute varicosities above described, swellings of relatively much larger dimensions. Separated from the surface by one, or at most two, layers of elements, they form a very dense network of fibres, the meshes of which are smaller than those of the deeper network, and the fibres (which have

¹ While this is going through the press, I have made out in preparations from which only the anterior epithelium had been removed, that the network which is so well drawn by Cohnheim, and which is seen in my figure 1, Pl. XIX, by no means contains the finest and most numerous fibrils. With an immersion 10, I have discovered an immense number of the very finest fibrils given off from each of those seen in fig. 1; all of these run nearly parallel with one another, join with one another with similar fine fibrils, and are, without exception, marked by regularly placed bead-like enlargements. A drawing of these fibres will be given in the next part of this essay.

a more or less winding course among the epithelial elements) somewhat thicker.

Finally, fibrils spring from this superficial intra-epithelial network which, after attaining the free surface, divide into two branches. These at first run horizontally in opposite directions, and soon take a course towards the depth of the cornea, and lose themselves in the superficial intra-epithelial network above described.

No one will be disposed to dispute that it is a matter of great difficulty to determine in a preparation in which the epithelium-elements are not distinctly seen, whether a nerve filament attains the under or the upper surface of the most superficial layer. I cannot, however, regard this difficulty as insurmountable, on the following grounds:—It is in the first place to be borne in mind that by comparison of surface-preparations with vertical sections of the same part of the cornea, it is always possible in any given preparation to determine whether or not the whole of the epithelium is present. Further, we have a certain guide for the recognition of the true surface in the precipitate which adheres to it. Secondly, I have observed, when I have exercised the greatest caution in cutting the cornea and in preparing it, that the more perfect the preparation was, *i. e.* the more completely the intra-epithelial network could be distinguished, the more rarely did it happen that filaments could be seen either on the surface or between the superficial cells which could not be shown to be connected on either side with others. It follows, then, from this that the terminal knobs of Cohnheim are only intercalated swellings occurring in the course of fibres, and that the appearances he has described depend on imperfections in the preparations.

To sum up what has been stated as to the intra-epithelial network of the cornea of the rabbit, we have to distinguish two nervous networks, the one at a level corresponding to the ends of the pallasade-epithelium, the other separated from the surface only by one or two layers of cells. The former we propose to designate, the *deep intra-epithelial network*; the latter *the superficial intra-epithelial network*. The latter is distinguished from the former in the greater density of the network, in the greater thickness of the fibres, and in the existence (in addition to the smaller varicosities which also exist in the deep network) of yet larger swellings above described, which are merely found at the junctions of two filaments. From this network filaments spring similar in character to those of which it is formed,

which reach the surface; they do not end there, but return towards the depth of the cornea.

We come now to the second division of this part of our undertaking, that is, the nerves of the substance of the frog's cornea. The results to which I am led by the investigation of the same were obtained by the following methods. I must, however, first state that although very fine nerves of the frog's cornea have been minutely described in fresh preparations, though chiefly in such as had been treated with gold chloride, they are not always and not so completely to be made out by the ordinary method of gold preparation as in that now to be described. I pass a silk thread through the centre of the cornea of a healthy middle-sized or large specimen of *Rana esculenta*, and bringing it out again at the sclerotic ring, tie in it a loose knot to hold it fast; in short, I proceed in the same way as one does in inflammation studies. After the thread has remained from five to eight hours in the cornea, I cut out the latter with the greatest care, allow it to remain from a quarter to half an hour in pure half per cent. solution of gold chloride, and place it then in distilled water so long as the action of the light lasts, that is, until it has obtained the well-known dark violet-red or red-brown colour, a space of time which varies according to the season from one to three days. Then I tear off from this the epithelium, together with a very thin layer of the corneal tissue, and enclose the remaining portion in glycerine. We must assume that the reader is too well acquainted with the characteristics of the corneal corpuscles, both the still normal, beautifully branched ones, as well as those exhibiting already some slight change, and the wander-cells present in some places sparingly, in other places abundantly, than that we need go into greater detail here concerning them.¹

¹ The controversy concerning the cells and plasmatic channels (Saftkanälchen) of the cornea substance, which has been going on during the last few years, will, as well as the physiological and pathological characters of the lymph system and the cellular elements of connective tissue, be treated at length on another occasion. Only one remark will here be made. Those who maintain that the sharply-marked, clear, branched figures, embedded in a yellowish-brown ground substance, which come out in a corneal tissue after treatment with silver, and which correspond to the well known beautiful branched flat cells with oblong flattened nucleus, produced by gold treatment, do not represent the cellular elements of the cornea, but are occasioned by coagulation, fissures, or the like, in an inter-fibrillar albuminoid substance, and who take their stand upon this—that no one has yet succeeded, nor ever will succeed, in demonstrating in the silver figures the branched cellular elements,—these persons, I say, I would advise of the following facts. When the cornea of a living rabbit is rubbed with lunar caustic so long that a great portion of the interior epithelium is

We have to deal here only with the nerves. The nerve-trunks form, as is well known, in the corneal substance by division and anastomosis a rich plexus. What we have said with regard to the plexus of the rabbit's cornea holds true equally of this in the frog. Here also we find the nucleus-bearing sheath of the same to be a prolongation of the neurilemma of the trunk, and so also the fibrillæ possessing granular enlargements and embedded in the sheath, exhibit the same relations to one another as those of the rabbit's cornea. We find them here also running side by side, stretched or undulated, or spirally entwined, or, finally, in many places by dichotomous division, forming a network within the sheath.

We may distinguish these branches of the plexus as *nerves* or *bundles of the first order*. From them branch forth smaller bundles, which for a short distance have a serpentine or rectilinear course. They possess no sheath of Schwann, and hang together by a few anastomoses to form a not very dense plexus. These we will call *nerves* or *bundles of the second order*. They give off after a longer or shorter course numerous lateral fine fibres, or terminate in several such fine fibres arising at one point. These we will call *nerve-fibres of the third order*. They are distinguished by the following characters:—(a) Apart from their size, varying only within small limits, they possess more or less regularly placed varicosities stained dark by the gold. The clearer portions

removed in the form of a cauterized membrane, and then after an interval of a quarter to half an hour, a few drops of a twenty per cent. solution of gold chloride are allowed to fall on the ash-coloured cornea, and then, after fifteen to twenty minutes the cornea is sliced off with a razor, and for four and twenty hours is placed in the light in very slightly acidified water, and is examined by means of horizontal sections, or by thin layers torn off, we find remarkable appearances. More or less darkly grey-coloured areæ are separated from circumscribed violet-red-coloured areæ by darkly red-coloured intermediate areæ. In the first of these the branched spaces are seen embedded in a yellow-brown ground substance, in the second the same spaces are embedded in a violet-red ground substance, and in the third we find only sharply-outlined, uniformly-granulated, branched, dark-violet-red corneal corpuscles. The nearer one approaches the central region, the more clearly do the characteristic nuclei of the corneal corpuscles make their appearance in the spaces; and, secondly, a substance at first of a pale blue, then violet, then dark violet, is more and more to be seen filling up the spaces. It is possible, without much trouble, to find places where branched clear spaces and branched dark and violet coloured cells, sharply defined in all their parts, are so situated that the processes of the coloured cells on the one side project into the channels of the clear spaces, and on the other side are in connection with the processes of other red stained cells. I cannot conceive of appearances more significant than those which the method just described afford. Should, however, any one still maintain in the face of these facts, that after all these very figures stained by the gold are not in reality pre-existing formations, then I cannot help him further.

of such fibres lying between the varicosities appear, with a high magnifying power (immersion 10), striated, as if made up of fibrillæ. (b) They possess a nearly completely direct rectilinear course, and bend after a longer or shorter course into a direction which is at right angles to the former one. (c) They remain for long distances unbranched. It is not rare to find a field of view with the microscope, where, out of the enormous number of fine fibres crossing one another in all directions, relatively few give off a lateral branch at right angles, which connects itself at a similar angle with another distant fibre. This is found to be true of all the fibres of this order when they are followed out—*i. e.* that they are connected one with another by cross fibres running at right angles to them, and in this way a rectangular trellice-work is formed. In a successful gold cornea from which only the outer layer of epithelium has been removed, it is quite impossible to say precisely, on account of the great richness of the network of the finest nerves, and of the network of the processes of the corneal corpuscles, whether the fibres of the one come into anatomical connection with the processes of the other. It is otherwise, however, when one splits up the cornea into as fine lamellæ as possible, and makes use of these for the investigation. In such a preparation where the corneal corpuscles are present only in one layer in some places, in others in two layers, we see finer fibres passing off at right angles from the fibres of the nerve trellice-work, which finer fibres are also beset with globular enlargements. Two or more of these finer fibres pass directly on to a corneal corpuscle, on the surface of which they divide themselves into short branches, and join together by these branches reticularly.

I could not convince myself of a penetration of these fibres (which may be called *fibres of the fourth order*) within the substance of the corpuscles, nor of a connection with the nucleoli of the nuclei of the corpuscles. Where I find these connected fibres in my preparations forming a terminal network—and as such I will venture to designate them—I observe them always to lie on that surface of the corneal corpuscle which is directed to the outer surface of the cornea.

In preparations, which consisted of the hindermost layers of the cornea, indifferently whether they were mounted with the endothelium (28) of Descemeti directed upwards or downwards, I found fibres of the fourth order, which I was able exactly to follow into the layer of the endothelium. This is the easier, since one has no trouble from the interference of

the lines of the cement substance of the endothelial cells in this preparation. We find the *Membrana Descemeti* in this case covered with a more or less granulated violet coloured substance, in which clear nuclei, some ovoid, some constricted, are inlaid at nearly regular intervals. Only here and there can we see between the nuclei pale contours, by means of which areæ of more or less polyhedral shape are delimited. Corresponding to these contours run our dark, varicose, finest nerve-fibres. In some of them dichotomous division can be seen. They withdraw themselves, however, completely after a short course from our view. I may once again mention that we have here to do with fibres which can be traced to the fibres of the third order lying beneath (that is, deeper in the substance of the cornea than) the *Membrana Descemeti*.

NOTES AND MEMORANDA.

Foreign Microscopes.—Hartnack is back at work in Paris, just as he was before the war. He is about to establish works at Potsdam.

Death of Professor Schweigger-Seidel.—It is with profound regret that we record the death of this skilful histologist, who has been for some months despaired of. He was histological assistant to Professor Ludwig in the Physiological Institute at Leipzig, and was there much regarded for his personal qualities, as well as valued for his efficient services in the laboratory. Phthisis was the cause of his death. He was reporter on histology in Virchow's *Jahresbericht*, and proved himself therein an able critic. His chief works are on the structure of the kidney and on the plasmatic channels and the corpuscles of the cornea.

The Muscular Fibre of the Pharynx of Gasteropods.—We recorded in July Mr. Dall's paper on this subject, without mentioning that he is in error in supposing that his observation is in any way new. Besides many older papers, there are those of Schwalbe and of Boll in *Schultze's Archiv*, in which a long account of such striated fibres is given.

At the meeting of the British Association (see also '*Pflüger's Archiv*' for 1871), Mr. Ray Lankester announced the existence of Hæmoglobin in the muscular fibres of the pharynx of Gasteropods, though it is entirely wanting in their blood. The physiological importance of this observation (as to the function of Hæmoglobin) is obvious.

A New Book on Hæmoglobin.—Professor Preyer, of Jena, has just published a very elaborate and assuredly most useful book on the '*Blood-crystals*.' It contains all that can be said about them, both crystallographically, zoologically, physiologically, physically, chemically, and historically. Two most beautiful plates of a vast number of absorption spectra are given, besides one of various blood-crystals. The book is indispensable to those who are working at the absorption spectra of blood and blood-derivatives. This part of the

subject is most amply and ably treated. We shall return to this book hereafter.

Structure of *Cordylophora lacustris*.—This lovely polyp, which is so common in the Victoria Docks, has been made the subject of a monograph by Professor Franz Eilhard Schulze, of Rostock. He uses osmic acid and colouration with Ranvier's picrocarminate of ammonia (prepared by neutralising ammoniacal solution of carmine with picric acid), and has made important histological observations. Professor Allman's splendid work (Ray Society) on the Hydroid Polyps is also just out, and the first part contains *Cordylophora* amongst other forms; so that those who wish for a turn at Cœlenterate morphology have material and guides ready to hand.

Proceedings of Societies.—Owing to pressure of matter (this being the concluding volume for the year), we are compelled to defer the publication of the Dublin Club Minutes until our next.

QUARTERLY CHRONICLE OF MICROSCOPICAL SCIENCE,

Cell Pathology.—Kundrat ('*Med. Jahrbücher,*' 1871, Heft 2, p. 226) has investigated the pathological changes of the serous epithelium (endothelium), especially that of the peritoneum in inflammation, tubercular growth, &c., and finds in both these cases enlargement of the endothelial cells and multiplication of their nuclei, pointing to the production of new cells from them. He also thinks that new connective tissue is produced by fibrous prolongations of the endothelia and fibrillar lamination of the cell substance. The latter observation leads us back from the views of Virchow to the older conception of Schwann and others, lately revised by Krause (see the last number of this Journal).

Inflammation.—Hansen has investigated in Stricker's pathological laboratory the alterations produced by inflammation in the corneal corpuscles of mammalia; the investigation of Stricker and Norris having been confined to the cornea of the frog. The method of investigation consisted in producing traumatic inflammation of the cornea in cats and rabbits, and examining sections either unprepared or tinted with gold. Hansen's observations confirm those of Stricker and Norris as to the changes produced in the corneal corpuscles, and the production from them of new elements, which he cannot admit, with Cohnheim, to be migratory cells derived from the vessels. In another set of experiments the living cornea was irritated with nitrate of silver (as previously done by Genserich), so as to produce inflammation, and stain the structure at the same time. From these also the conclusion was drawn that the corneal corpuscles divide and multiply, so as to be replaced by a number of small cells, which are nothing but pus-corpuscles ('*Medizinische Jahrbücher,*' 1871, Heft 2, p. 210).

Circulation.—Stricker has published ('*Medizinische Jahrbücher,*' 1871, Heft 2, p. 123) a further account of the method of observing the circulation in mammalia, which he

first described in conjunction with Dr. Burdon-Sanderson (see this Journal, October, 1870). He has now, with the help of Geltowsky, introduced some improvements. One of these consists in drawing out from the guinea pig's abdomen the omentum alone without the stomach. Other details are given respecting the method of keeping the apparatus at a constant temperature, which could not be rendered intelligible without figures.

Formation of Blood-vessels.—Arnold (Virchow's 'Archiv für Pathologische Anatomie,' vol. liii, p. 70) has observed the development of capillary blood-vessels in the restoration of the tail of the tadpole when purposely cut off. Some new growth was seen a single day after the operation, and in two or three days they became suitable objects for examination. On the capillary vessels of the growing part were seen protoplasmic *buds* of triangular form usually unprovided with nuclei, which tapered away into a row of fine granules, and were constantly lengthening. They sometimes formed the extremity of a vessel, and were sometimes situated laterally. Beside the buds were seen also a number of protoplasmic threads, starting either from the wall or the termination of a vessel, and becoming gradually prolonged. They varied much in thickness, and were sometimes hollowed out for a little distance, the cavity containing blood-corpuscles, and communicating with adjacent vessels. These threads always tended to form curves returning towards the body.

Another form of protoplasmic structures were arches, stretched from one vessel to another; some were thread-like in appearance, some solid cords of protoplasm, others already partly tunnelled; they sometimes contained nuclei, sometimes none. These three forms of structure were all seen by actual observation to originate in buds from the walls of capillary vessels, either complete or in process of formation; and by observation from hour to hour the formation of the rudimentary vessels as protoplasmic cords and their subsequent hollowing out were traced. A number of figures illustrate successive stages in the formation of the same vessel as seen at intervals. The complete formation of an average capillary occupied ten or twelve hours. These observations agree in the main with those of Billroth on the same object; and with those of Stricker and Golubew on the normal development of the tadpole's tail. Further observations on the same process in other organs are promised.

Schultze's 'Archiv,' vol. vii, Heft 3, contains the following papers:

1. EIMER describes the terminations of nerves in the

epidermis covering the nose of the common mole. The organ is seen by the naked eye to be covered with minute dots, which are in reality papillæ, and each of these contains the peculiar nervous structure described as an organ of touch. The papilla consists of a dome-shaped elevation, involving the mucous layer as well as the external layer of epidermis, and projecting a little into the true skin. In its centre is a nearly cylindrical or hour-shaped cavity forming an epidermic tube, in which is contained a structureless mass of connective tissue, imbedding nerve-fibres. This is the organ of touch. To the lower end of each of these passes a bundle of about twenty medullated nerve-fibres, proceeding from the extremely rich nerve-supply of the true skin. On entering the touch organ the fibres lose their sheath, and pass onwards as simple "axis cylinders." Most of them are symmetrically arranged in a ring, while two or three are centrally situated. The outer part of the epidermic tube containing this structure is composed of very regular layers of epidermic cells, and each of the finest nerve-fibres as it passes these is attached to the cell by a nodule about four lines its own diameter. The nodules thus form a series of very symmetrical rings. This arrangement is continued till about the fourth or fifth epidermic ring from the surface, beyond which the tube appears to be empty. Some quite isolated "axis cylinders" were also seen traversing the epidermis quite outside these structures, and were connected in the same manner with the epidermic cells. These arrangements unquestionably constitute a direct connection of nervous and epithelial structures. In most cases, but not in all, the nodule of attachment of the nerve-fibre coincided with the nucleolus of the cell. The mole's nose is thus an exceedingly delicate organ of touch. It is calculated that there are on its surface 5000 papillæ, so that more than 100,000 nerve-fibres must terminate on it.

2. SCHENCK (Schultze's 'Archiv,' vol. vii, p. 192) discusses the formation of the amnion, seeking to fill up certain gaps in its history, especially as to its closure. He suggests that in addition to the division and multiplication of elements in the embryo rudimentary organs may also be formed and increased by elements which pass out of the vascular spaces, like emigrant leucocytes in the adult organism; but was not able to observe any actual passage of elements through the vascular walls.

3. LEYDIG has investigated the organ of hearing in Gasteropoda; and confirms the discovery of Lacaze-Duthiers that the nerve to the auditory apparatus proceeds from the supra-

œsophageal ganglion; not the sub-œsophageal, though situated near the latter.

4. HEIDENHAIN defends his observations on the gastric glands against Rollet.

5. VALENTIN, continuing his "Contributions to Microscopy," treats of the ocular spectrum apparatus as applied to the microscope.

6. MAX SCHULTZE contributes a valuable paper on the retina, containing new observations.

7. SCHÖBL's account of the nervous structures in the mouse's ear we have already noticed (see this Journal for July).

8. LANDOIS and THELIN contribute permanent reproductions of photographs of microscopic objects printed by the gelatine process. The specimens are somewhat rough, but for some purposes the process might be valuable,

INDEX TO JOURNAL.

VOL. XI, NEW SERIES.

- ACANTHOCEPHALOID SCOLECID, notes on appendicularia and the larval condition of an, by W. Saville Kent, 267
- Acanthocystis spinifera* (Greeff), by W. Archer, 137
- Acetate of potash, solution of, as a substitute for glycerin in preserving animal tissues, by Max Schultze, 285
- Achromatic combination for use with blue light, by G. Johnstone Stoney, 212
- Allman, Prof., on a mode of reproduction by spontaneous fission in the hydroids, 18
- Amnion, Schenck, on development of the, 421
- Amphidotus cordatus*, notes on, by D. Robertson, 25
- Amphiprora, on some new species of the genus, by Rev. E. O'Meara, 21
- Amphizonella digitata* (Greeff), 129, 134
- " *flava* (Greeff), 130, 134
- " *vestita* (Greeff), 112, 135
- " *violacea* (Greeff), by W. Archer, 126, 134
- Archer, W., on some freshwater Rhizopoda, new or little-known, 107
- Ascidian larvæ, on the so-called chorda of the, and the alleged affinity of the invertebrate and vertebrate animals, by W. Donitz, 281
- BACTERIA, origin of, by Burdon-Sanderson, 323
- Barker, Dr. J., on an open compressorium, 23
- Bathybius, by Dr. Gumbel, 79
- Beneden, E. van, researches on the development of the Gregarinæ, 242
- Biologische Studien, Haeckel, Dr., 60
- Bizzozero, Dr., medulla of bone, 292
- Blatta orientalis*, the circulation in the wings of, by H. N. Moseley, 389
- Blood, by Prof. Neumann, 292
- Blood-corpuscle, on the red, by E. Ray Lankester, 361
- Blood-corpuscles, theory of the development of, by Neumann, 43
- Blood-vessels, formation of, 420
- Bone, by Dr. L. Beale, 198
- Brain, connective tissue of the, by Dr. Golgi, 88
- Bryozoa, note on Dr. H. Nitsche's paper on "Some interesting points concerning the mode of reproduction of the," by Rev. Th. Hincks, 235
- " on some interesting points concerning the mode of reproduction of the, by Dr. H. Nitsche, 155
- Buccal teeth in the genus *Firola*, discovery of, by Dr. Macdonald, 272
- Burdon-Sanderson, on the origin and distribution of microzymes (bacteria) in water and in the living body, 323
- CAMPANULARIÆ, family of, 18
- Cartilage and ossification, by Prof. Neumann, 198
- Charts for recording absorption spectra, 78
- Chloride gold, in examining the tissues, by H. Moseley, 287
- Cidaris, on the minute structure of certain hard parts of the genus, by Ch. Stewart, 51

- Cienkowsky, Prof. C. L., on the production of swarm-spores in *Noctiluca miliaris*, 305
- " " " on the production of spores in the Radiolaria, 396
- Ciliary movements, by Prof. Haeckel, 308
- Cholera-fungus, the government investigation of, 79
- Classification, histological, by Rollet, 309
- Coal, sections of, by J. Slade, 284
- Cohn's, Dr. F., new botanical periodical, 285
- Colouring matter of some aphides, by H. C. Sorby, 352
- Compressorium, on an open, by Dr. J. Barker, 93
- Connective tissue of the brain, by Golgi, 88
- Cordylophora lacustris*, structure of, 418
- Cornea, some remarks on the nerves of the, of the rabbit and frog, by H. N. Moseley, 261
- DAVIS, H., mobility of spines on certain insects' eggs, 288
- Death of Professor Sweigger-Seidel, 417
- Diatomaceæ, new work on the British, 79
- Doliolum, notes on the genus, by Dr. Moss, 403
- Donitz, W., on the so-called chorda of the ascidian larvæ, and the alleged affinity of the invertebrate and vertebrate animals, 281
- Dudgeon, Dr. R. E., on a submersion microscope, 239
- EBERTH, Prof., researches of the normal and pathological anatomy of the frog's skin, 298
- Egg, mobility of spines on certain insects, by H. Davis, 288
- Egg of frog, on certain methods which maybe employed in the investigation of the development of the, by H. N. Moseley, 151
- Embryology, 305
- Exner, Dr. S., researches on the olfactory mucous membrane of the frog, 300
- FLEMMING, development of fatty tissue, 295
- Foreign microscopes, 417
- Fungi in potable water, by Prof. Frankland, 286
- " parasitic ear, by D. Karsten, 286
- Fungus as a cause of whooping-cough, 197
- GASTEROPODS, striated muscular fibre in, 197
- " muscular fibre of the pharynx of, 417
- Gland-cells, the nature of the influence of nerves on, 303
- Glands of the stomach, by Heidenhain and Ebstein, 200
- Golgi, Dr., lymphatics in connection with cerebral arteries, 297
- Gregarinæ, researches on the development of the, by E. van Beneden, 242
- Grimm, O. von, parthenogenesis in the pupa state of insects, 88
- Gümbel, Dr., on bathybius, 79
- HAECKEL, Dr. E., biologische studien, 60
- " ciliary movement, 308
- Hæmoglobin, new book on, 417
- Handbook of Histology, by Stricker, 198
- Hincks, Rev. Th., note on Dr. H. Nitsche's paper on "Some interesting points concerning the mode of reproduction of bryozoa," 235
- Hydroïda, on a mode of reproduction by spontaneous fission in the, by Prof. Allman, 18
- IMPROVEMENTS in the lenses of microscopes, 190
- Insects, parthenogenesis in the pupa state of, by O. von Grimm, 88
- KARSTEN, Dr., parasitic ear fungi, 286
- Kent, W. Saville, notes on Appendicularia, and the larval condition of an *Acanthocephaloid scolecid* from the coast of Portugal, 267
- King crab, young stages of the, 89
- " cornea, 87
- Klein, Dr., dammar varnish, 288
- " on the peripheral distribution of some non-medullated nerve-fibres, 405
- Krause, Dr. W., nerve, 86

- Krause, Dr. W., the nature of connective tissues, 275
- Kühne, Dr. W., appointment of, 190
- Kundrat, on cell pathology, 419
- LANKESTER, E. Ray, on the red blood-corpuscle, 361
- " on the structure and origin of the spermatophores, or sperm-ropes, of two species of *Tubifex*, 180
- " on *Undulina*, 387
- Leaves, on the colour of, at different seasons of the year, by H. C. Sorby, 215
- Lewis, Dr. T. R., the government investigation of cholera-fungus, 79
- Limulus polyphemus*, on the embryology of, by A. S. Packard, 263
- Lindsay, W. Lauder, observations on lichenicolous micro-parasites, 28
- Liver, 201
- Lymphatics in connection with cerebral arteries, by Dr. Golgi, 297
- MACALISTER, Prof., on some species of parasites hitherto undescribed, 163
- Macdonald, Dr. J. D., examination of two soundings, 273
- " discovery of buccal teeth in the genus *Firola*, 274
- Manual of pathological histology, by Rindfleisch, 198
- Martin, J. H., microscopic objects figured and described, 188
- Medical jurisprudence, principles and practice of, by A. Swaine Taylor, M.D., 68
- Medulla of bones, by Dr. G. Bizzozero, 292
- Microscope, an improved apparatus for drawing with the, by E. T. Newton, 270
- Microscope in the study of rocks, 192
- Microscope, on a submersion, by R. E. Dudgeon, 239
- Microscopes, foreign, 417
- Microscopic investigation, notes on the method of application of nitrate of silver and chloride of gold in the preparation of certain tissues for, by H. N. Moseley, 55
- " objects, figured and described, by J. H. Martin, 188
- Microscopical Club proceedings, Dublin, 92, 208, 311
- Microscopical Club, Queckett, 106
- " Society, Royal, 104
- Microscopical vision, researches on the errors of, and on new methods of correcting them, by Dr. Royston-Pigott, 1
- Migration of cells, by Dr. Carton, 198
- Mole, nose of, as an organ of touch, 420
- Moseley, H. N., on certain methods which may be employed in the investigation of the development of the frog's egg, 151
- " some remarks on the nerves of the cornea of the rabbit and frog, 261
- " on the circulation in the wings of *Blatta orientalis*, 389
- Mouse's ear as an organ of sensation, by Dr. Schöbel, 289
- Moss, Dr., notes on the genus *Dolium*, 403
- Muscular fibre of pharynx of *Gastropods*, 417
- NERVE fibres, on the peripheral distribution of some non-medullated, by E. Klein, 405
- Nerve, W. Krause, 86
- Nervous system, by Meynert, 202
- Newton, E. T., an improved apparatus for drawing with the microscope, 270
- Nitsche, Dr. H., on some interesting points concerning the mode of reproduction of the bryozoa, 155
- Neumann, Prof., cartilage and ossification, 198
- " theory of the development of blood-corpuscles, 43
- OBJECTIVES, cheap, of high power, 78
- Oellacher, embryology, 305
- Olfactory mucous membrane of the frog, researches on, by Dr. Exner, 300
- O'Meara, Rev. E., on some new species of the genus *Amphiprora*, 21
- Origin and distribution of microzymes (bacteria) in water, and the circumstances which determine their existence in the tissues and liquids of the living body, by Dr. Burdon-Sanderson, 323

- PACKARD, junr., Dr., on the embryology of *Limulus Polyphemus*, 263
 Parasites, observations on lichenicolous micro-parasites, by Dr. Lauder Lindsay, 28
 Parasites, on some species of, hitherto undescribed, by A. Macalister, 463
 Periodical, new botanical, 285
Plagiophrys spherical (Clap. et Lachm.), by W. Archer, 146
- RADIOLARIA, production of spores in the, by Cienkowski, 396
 Retina of the frog, 304
 Rhizopods in London, 80
 Rhizopoda, freshwater, new or little-known, by W. Archer, 107
 Rhizopods, researches on, 85
 Robertson, D., notes on *Amphidotus cordatus*, 25
 Rollet, histological classification, 309
 Royston-Pigott, Dr., researches on the errors of microscopical vision, and on new methods of correcting them, 1, 166
- SCHMIDT, Dr. O., the siliceous sponges, 89
 Schöbel, Dr. J., the mouse's ear as an organ of sensation, 289
 " the wing of bats, 206
 Schultze, Prof. Max, solution of acetate of potash as a substitute for glycerin in preserving animal tissues, 285
 Schweigger-Seidel, death of Professor, 417
- Skin of frog, on the normal and pathological anatomy of the, by Prof. Eberth, 298
 Slade, J., sections of coal, 284
 Sorby, H. C., on the colour of leaves at different seasons of the year, 215
 " on the colouring matter of some aphides, 352
 Soundings, two, examination of, by Dr. Macdonald, 273
 Spermatophores, or sperm-ropes of two species of tubifex, on the structure and origin of the, by E. Ray Lankester, 180
 Sponges, siliceous, 89
 Spontaneous generation, 195
 Stewart, Ch., on the minute structure of certain hard parts of the genus *Cidaris*, 51
 Stricker, Dr., 'Handbook of Histology,' 198
 Structure of *Cordylophora lacustris*, 418
 Swarm-spores, on the production of in *Noctiluca miliaris*, by Prof. Cienkowsky, 305
- TAYLOR, Dr. A. Swaine, principles and practice of medical jurisprudence, 68
 Tissue, connective, the nature of, by Dr. Krause, 275
 Tissue, fatty development of, by Fleming, 295
- UNDULINA, by E. Ray Lankester, 387
 VARNISH, dammar, by Dr. Klein, 288

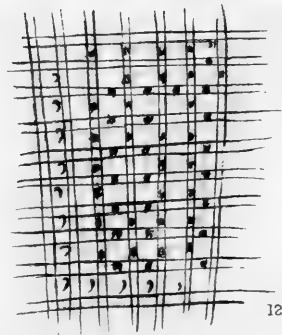
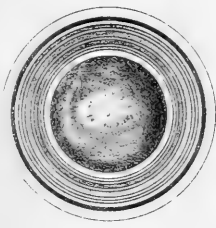
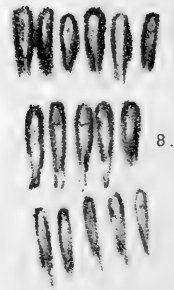
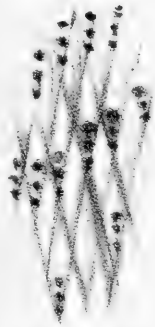
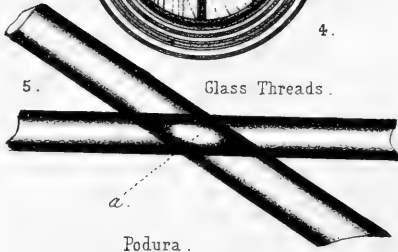
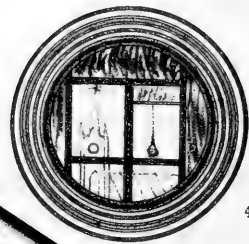

JOURNAL OF MICROSCOPICAL SCIENCE.

EXPLANATION OF PLATE I,

Illustrating Dr. Royston-Pigott's paper on Microscopical Vision.

Fig.

- 1.—*a, b, c, d, e.* Transparent refracting spherules, showing a gradually increasing dark *annulus* as the aperture of the objective is gradually diminished.
- f.* The fused extremity of a thread of glass, forming a lens $\frac{1}{10000}$ th of an inch in diameter, and exhibiting the cross bars of a window frame. The *annulus* large and broad from reduced aperture.
- 2, 3.—Threads of spun glass: black bands and lenticular annuli dependent on aperture.
- 4.—Appearance of the window and details, when seen in the focus of an aplanatic condenser.
- 5.—Jet black bands of minute glass cylindrical threads and central spectrum of intersection (*a*).
- 6, 7, 8.—Remarkable appearances of Podura markings. In fig. 7, a double development of black lines as seen with the $\frac{1}{5}$ th immersion and oblique light from a concave mirror. Fig 8. THE STANDARD TEST MARKING OF PODURA CURVICOLLIS, being *eidola*, or false images caused by confusion of the true images of double structure.
- 9.—Black borders of the finest hairs of the *Antennæ* of the male gnat, showing spectral bright spaces at *a, a, a*, analogous to those of fig. 5 in refracting cylinders intersecting.
- 10.—The display of RESIDUARY ABERRATION by using a fine objective as condenser and viewing it with an imperfect microscope, supposed to be of fine quality.
- 11.—The same thing exhibited by a very highly corrected instrument. (See 'Phil. Transactions of the Royal Society,' vol. ii, 1870.)
- 12.—One example of false images. Wire gauze appeared translucent; like threads of opaline glass; interspersed with chequered black dots, sharply defined. In an unknown structure such false appearances might readily be mistaken for true.

JOURNAL OF MICROSCOPICAL SCIENCE.

DESCRIPTION OF PLATE II,

Illustrating Professor Allman's paper on the Mode of Reproduction by Spontaneous Fission in the Hydroida.

Fig.

1. *Schizocladium ramosum*, nat. size.
2. A portion of a colony magnified. *a*, A fissiparous ramulus previous to the commencement of fission; *b*, the cœnosarcal contents of the ramulus have extended themselves beyond its extremity, having in their elongation ruptured the chitinous perisarc which lay over this part of the ramulus, while the commencement of fission shows itself in a constriction of the cœnosarc at a little distance behind its free extremity; *c*, the constriction has advanced so as to have now cut off a piece from the extremity of the cœnosarc and the detached frustule has begun to slip out of the chitinous sheath; *d*, the frustule has become a free zooid entirely disengaged from the sheath of the ramulus.
3. The free fission-frustule more magnified.
4. The frustule has become attached to the sides of the vessel and has excreted a membranous tube from which it has partially withdrawn itself.
5. The frustule has begun to emit a bud from its side.
6. The bud has become elongated into a stem.
7. The free extremity of the stem is becoming developed into a hydranth with its hydrotheca.
8. The hydranth and hydrotheca are now fully developed, and the young trophosome has begun to complicate itself by the emission of a branch.

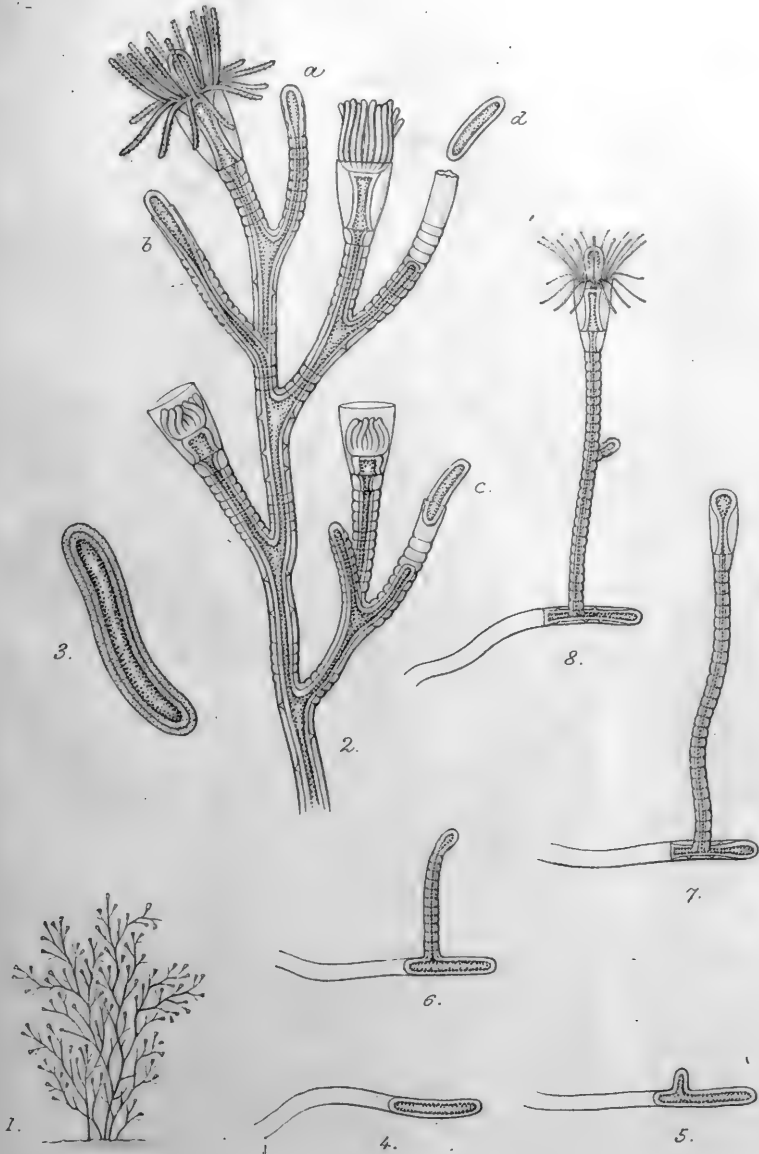

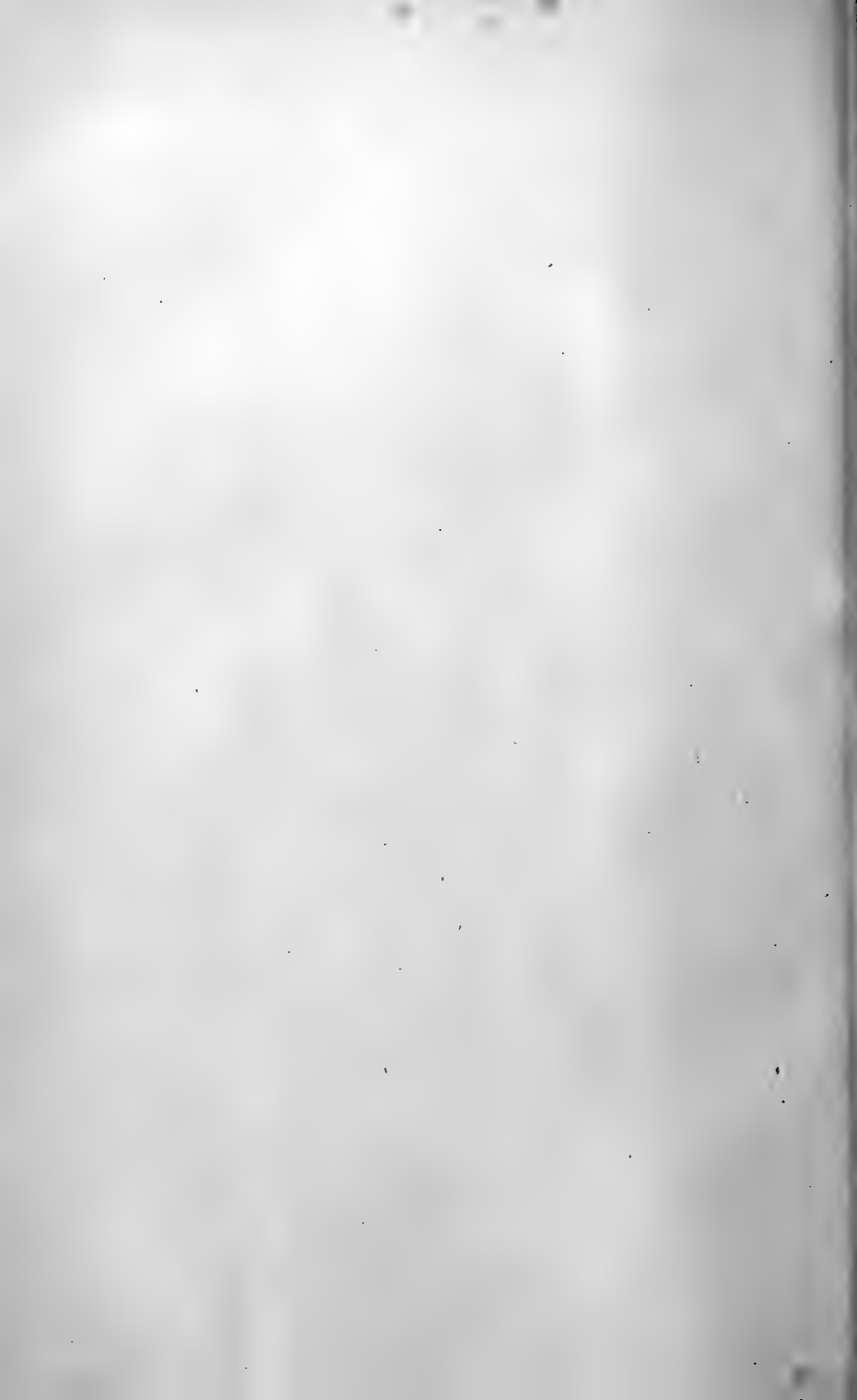

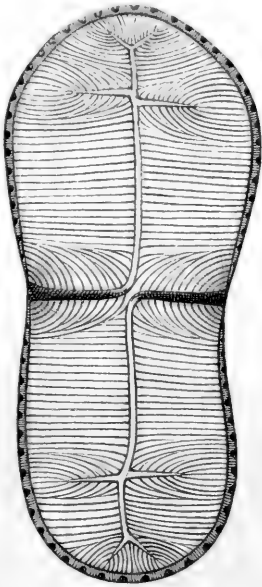

Fig. 1.

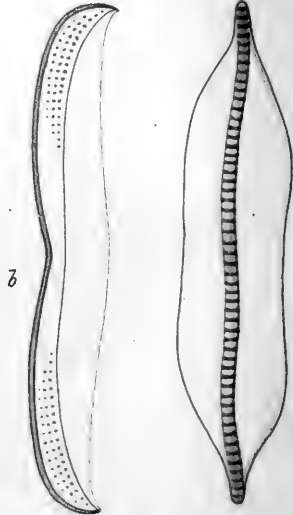

Fig. 2.

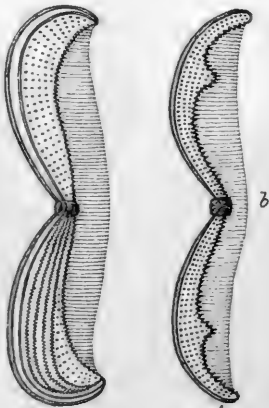

Fig. 3.



Fig. 5.

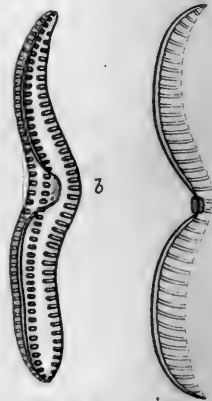

Fig. 4.

JOURNAL OF MICROSCOPICAL SCIENCE.

DESCRIPTION OF PLATE III,

Illustrating the Rev. Eugene O'Meara's paper on Some New
Species of the Genus *Amphiprora*.

Fig.

1. *Amphiprora rimosa*, $\times 400$.
2. *A. Nitzschia*, $\times 400$.
 - b. Same ; front view.
3. *A. sulcata*, $\times 400$.
 - b. Partial front view of same.
4. *A. biseriata*, $\times 800$.
 - b. Side view of same.
5. *A. diadema*, $\times 400$.

JOURNAL OF MICROSCOPICAL SCIENCE.

EXPLANATION OF PLATE IV,

Illustrating Mr. Stewart's paper on the Minute Structure of certain Hard Parts of the Genus *Cidaris*.

Fig.

- 1.—Sector of a transverse section of the primary spine of *Cidaris annulata*.
- 2.—Upper part of a pedicellaria of the same, including the head and portion of the stem; the faint shaded bands seen through the transparent lower part of the head indicate the closing muscles of the jaws.
- 3 and 4.—Varieties presented by the jaws of this species.
- 5.—Transverse section of the lower part of the head of a pedicellaria, showing the chambers of the jaws and the three bands of muscles which close them.
- 6.—Spicula of the ambulacral tubes.
- 7.—Spicula of the ovary.

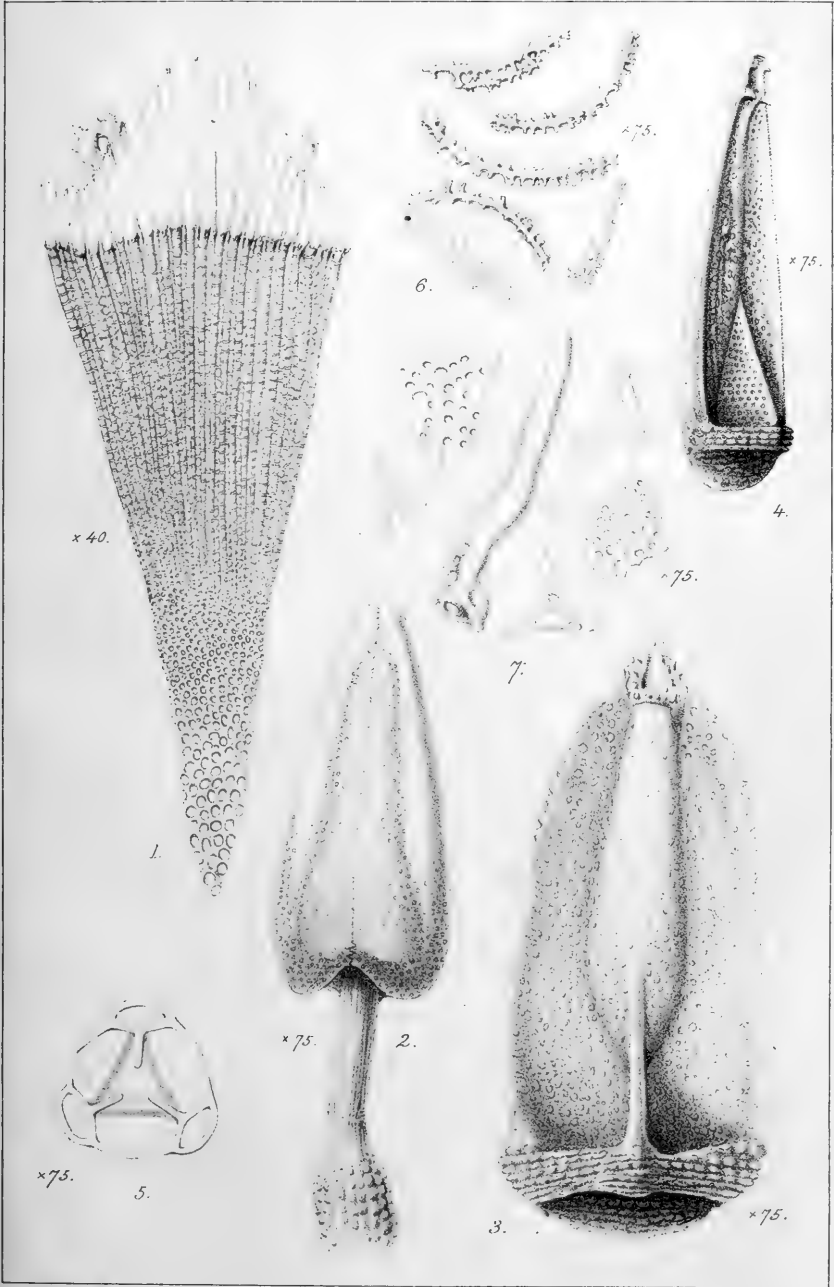

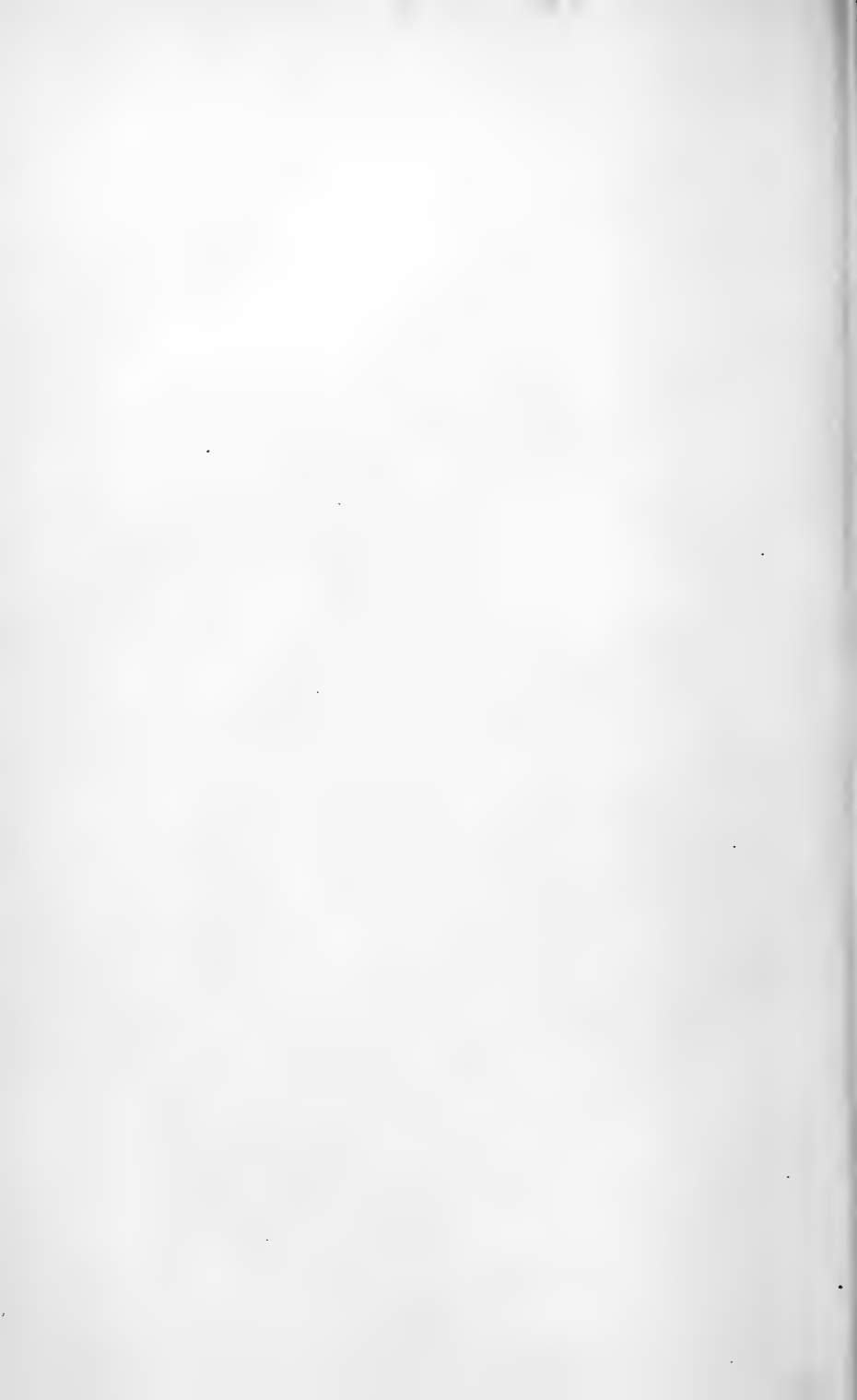

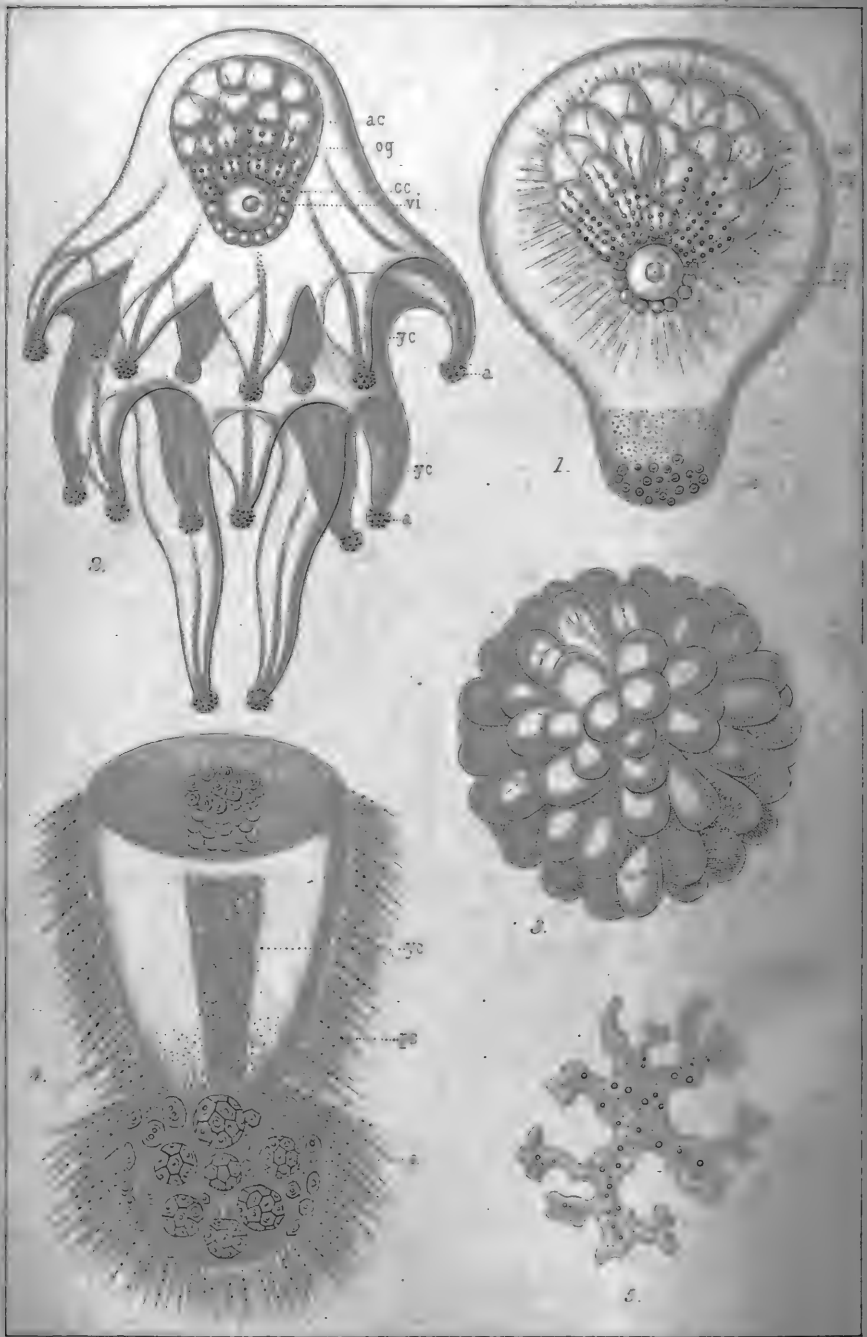

JOURNAL OF MICROSCOPICAL SCIENCE.

EXPLANATION OF PLATE V,

Illustrating Professor Haeckel's views on Bathybius and Cocoliths.

Fig.

- 1.—*Myxobrachia rhopalum*, from the Atlantic Ocean, off Lanzarote, Canary Islands. *cc*, Central capsule; *vi*, *vesicula intima*, enclosed with numerous small reproductive cells and red oil-globules, not seen in the drawing, within the central capsule; *ac*, alveolar cells or extra-capsular vesicular tissue (Blasengewebe); *og*, extra-capsular oil-globules; *a*, calcareous concretions. $\times 10$.
- 2.—*Myxobrachia pluteus*, from the same locality; letters as in Fig. 1. *yc*, Rows of the 'yellow cells,' forming the axes of the finger-like processes. $\times 10$.
- 3.—Vesicula intima or Binnenblase of *Myxobrachia*, showing radially disposed bladder-like constrictions. $\times 180$.
- 4.—End of a process of *M. pluteus*, showing—*a*, coccospheres and cocoliths; *yc*, yellow cells; *ps*, pseudopodia. $\times 100$.
- 5.—A small cytod of *Bathybius*. $\times 700$.

THE UNIVERSITY OF CHICAGO

PH.D. THESIS

THE UNIVERSITY OF CHICAGO

THE UNIVERSITY OF CHICAGO



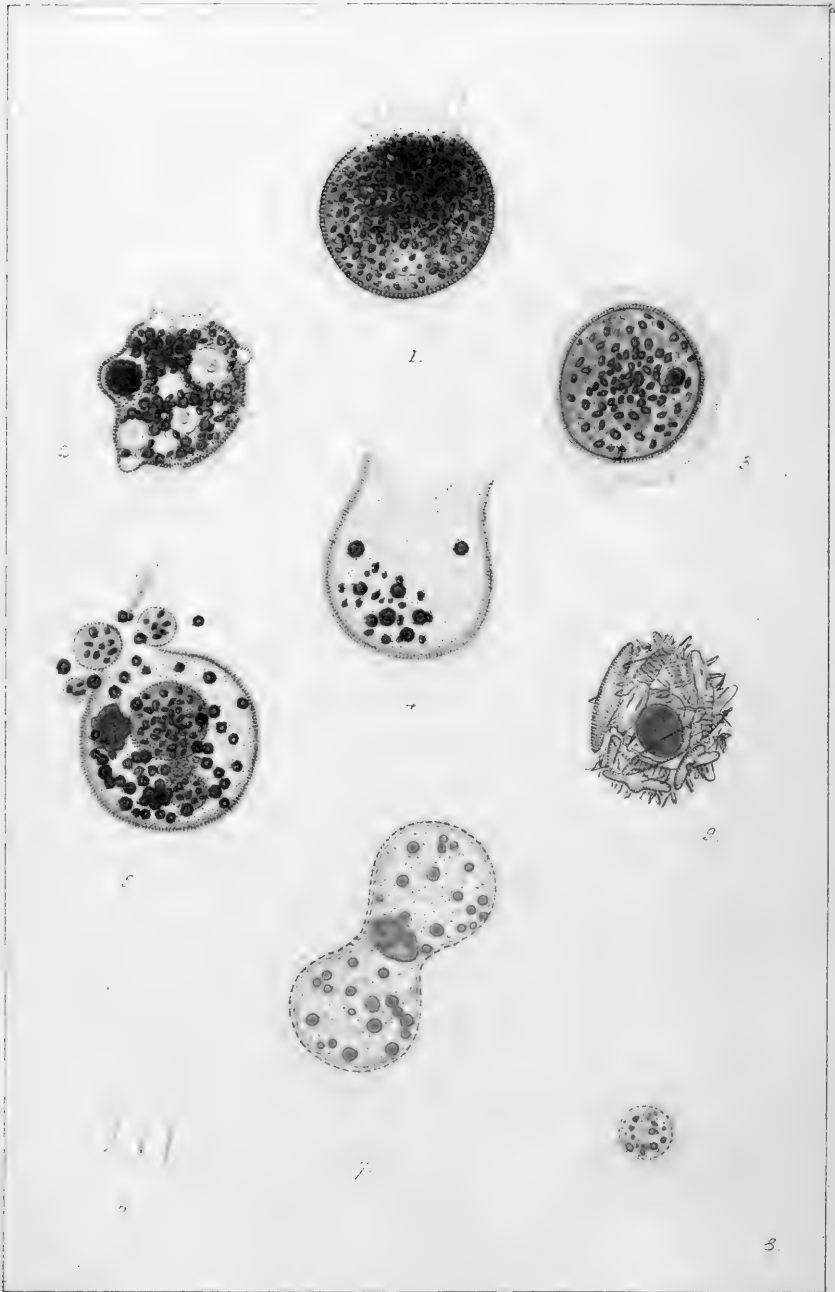

JOURNAL OF MICROSCOPICAL SCIENCE.

DESCRIPTION OF PLATES VI & VII,

Illustrating Mr. William Archer's Paper on Fresh-water
Rhizopoda.

PLATE VI.

Fig.

- 1.—*Amphizonella vestita* (sp. nov.), showing the "corona" of pseudopodia, the outer coat, with its vertical, radial, and parallel markings, its clothing of very fine hair-like processes, the subjacent elliptic colourless bodies, a dense stratum of chlorophyll-granules beneath same, and the internal elliptic "nucleus;" the latter, in this specimen, posed at the side most remote from the pseudopodial region. In this example the chlorophyll-granules are very abundant, no crude "food" making itself apparent.
- 2.—Another specimen of the same, chlorophyll-granules not so abundant as in the foregoing, nor the superficial hair-like processes so long, showing several vacuoles, three at the periphery—two of which, at the point of greatest distension, press up the outer coat—the third, on the bare pseudopodial region; showing, also, two conical pseudopodia projecting through the outer coat; a minute reddish coloured alga has been incepted as food. This specimen did not disclose the "nucleus;" but there could be no doubt that further examination would have revealed it, but it was desirable to sketch the example with its natural appearance as regards the other details.
- 3.—Another specimen of the same, showing the stratum of elliptic bodies, but neither chlorophyll-granules, nor pseudopodia, nor vacuoles; the "nucleus" is, however, apparent; this example, though fitfully changeable in contour, presents no apparent opening or vacant region of the coat, the hair-like processes not evident, and is surrounded by a somewhat deep, changeable, very subtle, hyaline, bluish sarcode-envelope, showing faint vertical lines in its substance. A "protococcoid" is seen immersed in the body-mass, previously encepted.
- 4.—Separate coat of another specimen of the same, found in the gathering, evacuated by the sarcode body-mass, but a few chlorophyll-granules and elliptic granules (accidentally) left behind. The outer hair-like processes are but short; the general surface presents a coarsely dotted appearance.
- 5.—Another specimen of the same after application of a weak solution of iodine and iodide of potassium; the sarcode body-mass has become retracted from the outer, slightly hirsute, now globularly expanded coat (thus proving its distinct and independent structure), and has become coagulated into several balls, these having retained in their substance the pale elliptic granules, but left outside the chlorophyll-granules as well as the "nucleus," which latter is seen to the left, having assumed a contracted and lobed, internally homogeneous, externally smooth, appearance.
- 6.—Three of the hair-like processes which had become somewhat expanded and then detached from an example of the same, after the at first slow action of sulphuric acid, and then showing a slightly capitate basal extremity and pointed apex.
- 7.—A preparation by treatment with Beale's carmine fluid of an example of "zygosis" in *Acanthocystis spinifera* (Greeff), showing in each of the "conjugated" individuals the central presumed "*vesicula*

PLATE VI.—Continued.

intima," the outline of the presumed "central capsule," the problematic opaque, colourless, shiny, elliptic body, the ordinary yellow oil-globules, and the outer linear and pointed spines; these latter as equally distributed over the connecting isthmus as over the periphery of each of the conjugated individuals; the specimens being "killed," pseudopodia, as a matter of course, have completely disappeared.

- 8.—A very small, presumably a young, example of the same in the living condition, showing the minute inner central body within the granular general body-mass, the peripheral hyaline and glassy spines, and the very pellucid, extremely slender, filiform, straight, and long pseudopodia.
- 9.—A large example of the "Diplophrys-like" organism, having enclosed itself in the middle of an aggregation of frustules of heterogeneous minute diatoms and fragments, along with small fibrous and nondescript shreds, and showing its nearly orbicular, faintly granular body with a large oil-like globule therein.

All the figures $\times 400$.

PLATE VII.

- 10.—A small example of the "Diplophrys-like" organism (considerably more minute than fig. 9), the surrounding aggregation of foreign bodies containing no diatomaceous elements, but made up of rather short, somewhat hyaline, arenaceous and nondescript granules.
- 11.—*Plagiophrys sphaerica* (Clap. et Lachm.) (?), living, seen in profile, and showing its little tree-like cluster of slender-branched pseudopodia, emanating from a hollow or depression at one side, which latter presents a number of more or less evident alternate creases and rounded prominences, seemingly due to the mode of infolding at this place of the closely-investing outer integument or "test." The specimen has incepted an example of *Cosmarium cucurbita*.
- 12.—Another example of the same treated with acetic acid, showing the "nucleus" ejected, the body-mass retracted from the outer integument, which at the frontal or anterior, formerly infolded, portion, presents a generally broadly conical shape, but characterised by annular ridges, giving a zigzag lateral outline.
- 13.—An example of the same after treatment in the carmine fluid, showing the elliptic "nucleus" highly dyed, the body-mass not retracted, and the frontal or anterior portion of the integument (or "test"), formerly infolded, now pushed outwards in a broadly conical shape, with a straight outline.
- 14.—An example of another form, probably provisionally referable to the same species, viewed "dorsally" and presenting a dark, very shiny exterior, and very long, branched, and sometimes inosculating granu-
liferous pseudopodia.
- 15.—Outline of the contracted and crumpled appearance at once assumed by an example of the foregoing on being treated with the carmine fluid.
- 16.—Balloon-shaped figure, quickly assumed by an example of the same under the action of the carmine fluid, the creases and wrinkles (indicated by previous figures) being obliterated; the elliptic "nucleus" highly dyed, and the sarcode-body retracted from the integument and partially ejected through the anterior opening in the formerly infolded, now prolonged, truncate, neck-like portion caused by its evagination.

All the figures $\times 400$.



10.

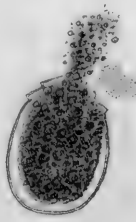

12.

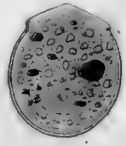

13.

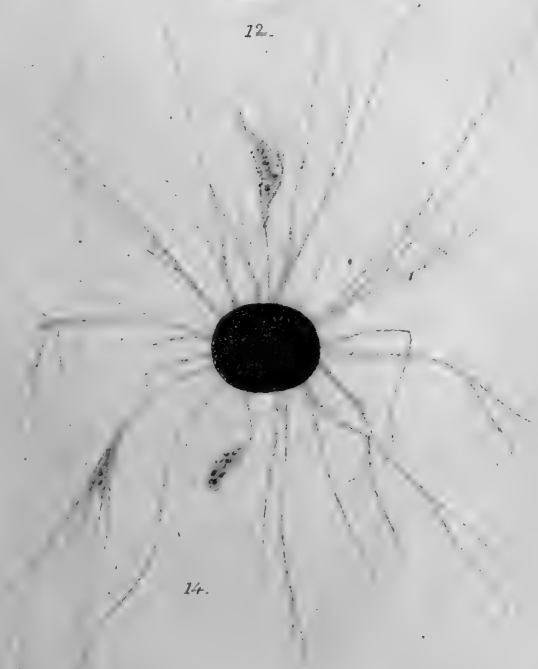

14.



11.

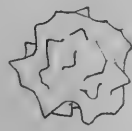

15.

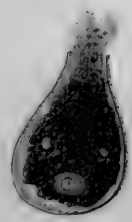

16.

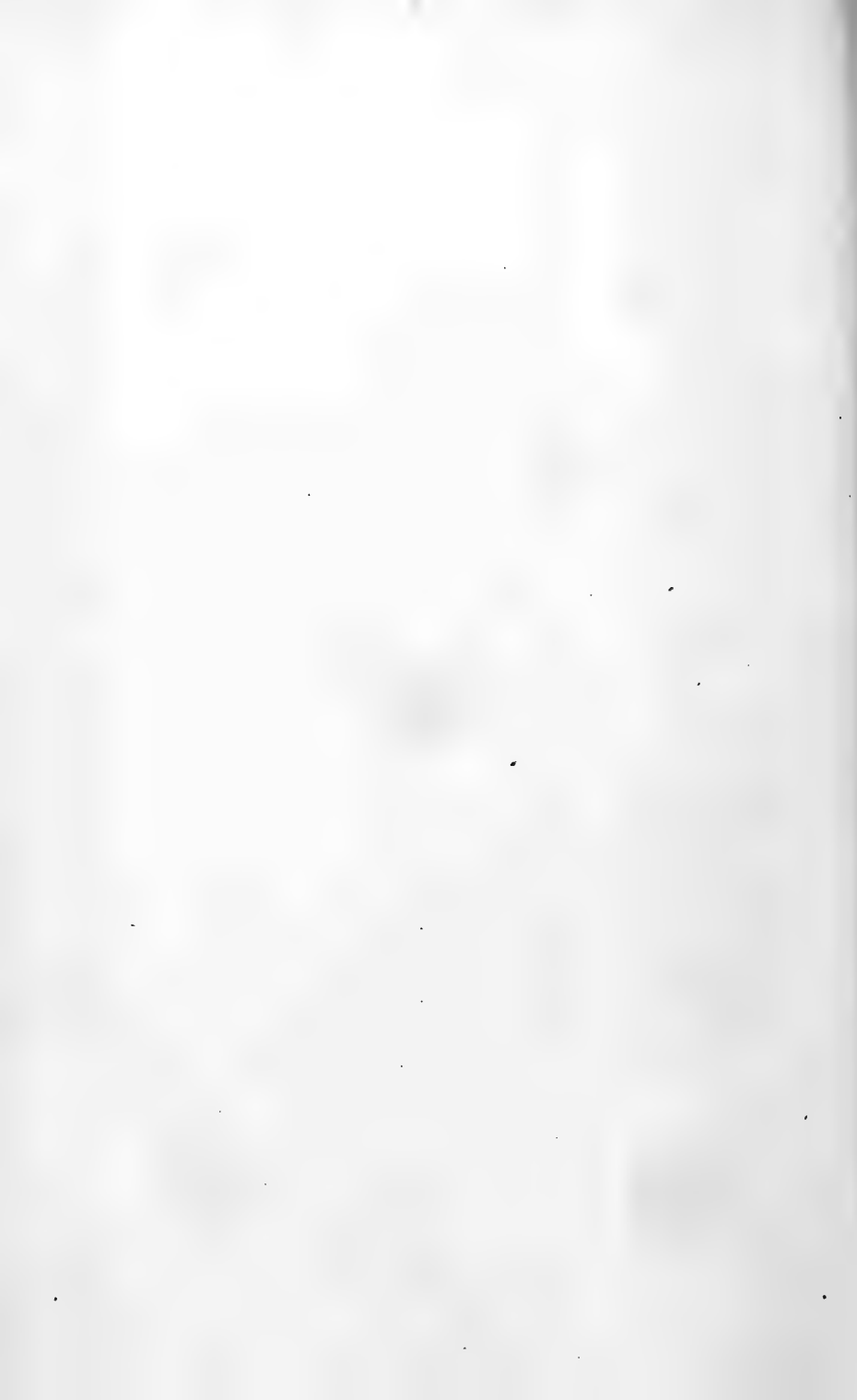



COMPENSATED ABERRATION.

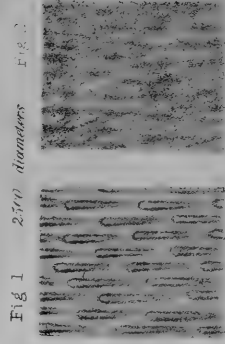

Fig. 7
Lepisma

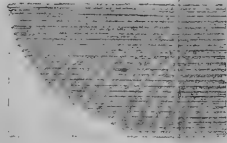
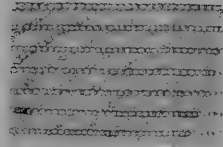
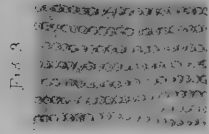

Fig. 8
Lepisma



$\frac{1}{8}$ inch
objective



$\frac{1}{8}$ inch

1660

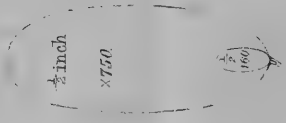

1660

Fig. 10

$\times 800$

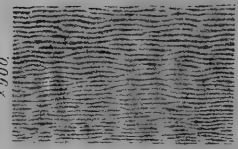

$\times 1500$

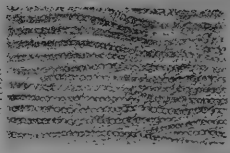
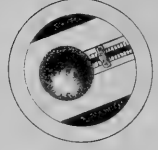
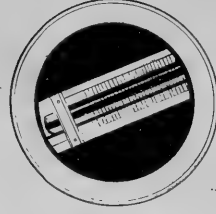
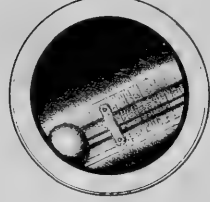
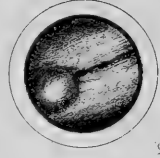
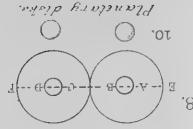
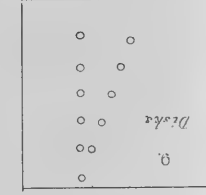
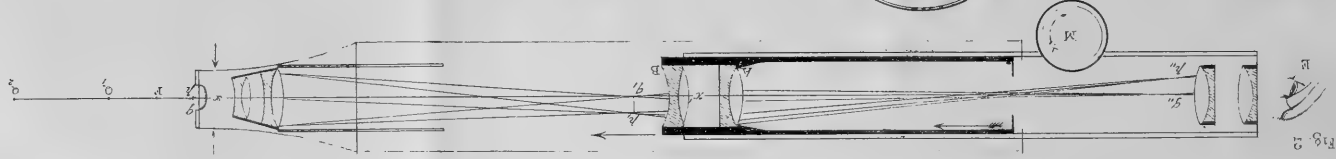
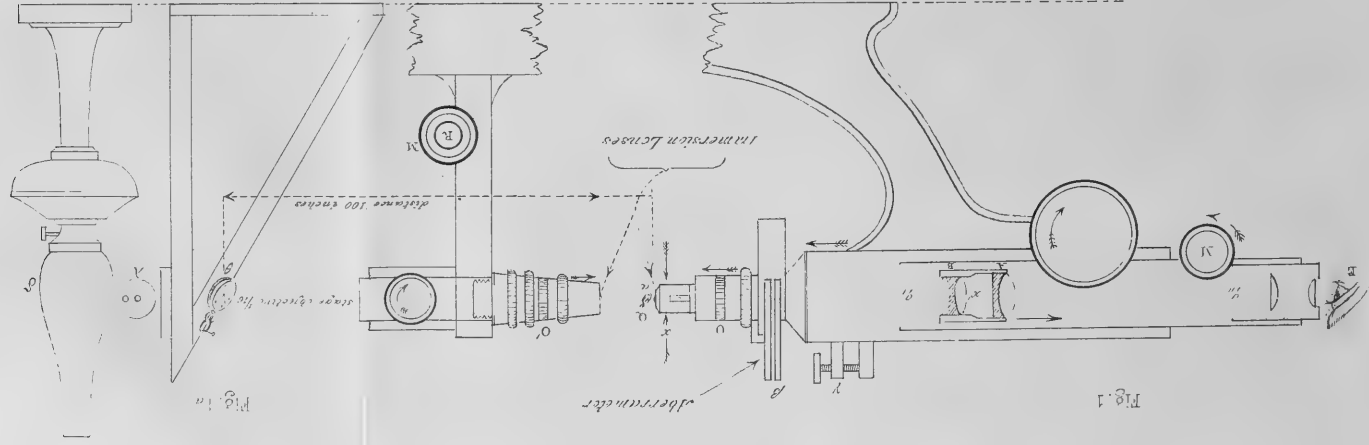

Fig. 5

Structure of the Polara Scale



JOURNAL OF MICROSCOPICAL SCIENCE.

EXPLANATION OF PLATES VIII AND IX,

Illustrating Dr. Royston-Pigott's Researches.

PLATE VIII.

Plate VIII is intended to represent the working powers gained by the use of the Aplanatic Searcher by means of comparative outline drawings of a given "scale" taken by Mr. Aldous with the camera under the magnifying powers and objectives indicated.

Fig.

- 1.—The standard appearance of the Podura under the $\frac{1}{50}$, $\frac{1}{25}$, and $\frac{1}{8}$ Powell and Lealand objectives.
- 2.—Resolution of the lower beads of Podura.
- 3.—The beads of the upper stratum.
- 4.—Comparative magnifying power of the $\frac{1}{8}$ objective with the searcher, and also in the ordinary way with a "third" eye-piece, C, of 1 inch focal length.
- 5.—General appearance of the wavy markings of the Podura, consisting of beaded ribbing faintly visible here with a pocket-lens.
- 6.—Both sets of beading exhibited at once.
- 7, 8.—Ordinary and extraordinary appearance of Lepisma.

PLATE IX.

This Plate shows the image-test arrangements of the objectives and object of which a miniature is desired, and also the construction of the searcher.

M. The divided milled head of the traversing aplanatic searcher, consisting of separable lenses, A, B, having a variable interval, x' , between them. The searcher traverses the draw tube, into which is fixed the eye-piece E. R, M are adjusting milled heads of the stage supporting the image objective O' (fig. 1 *a*).

O, O' , fig. 1, fig. 1 *a*, are the objective to be tested and the miniature-forming $\frac{1}{16}$ immersion objective, giving an image a of the object θ , or double disks λ , illuminated by a lamp, δ .

γ represents the focal adjustment, and

β the aberrameter inserted into the nose of the microscope containing two revolving disks forming central and peripheral stops.

Fig. 2 represents the course of the rays from the object Q to the last focal image $q''p''$ erected.

JOURNAL OF MICROSCOPICAL SCIENCE.

DESCRIPTION OF PLATE X,

Illustrating Mr. E. Ray Lankester's paper on the Structure and Origin of the Spermatophors, or Sperm-ropes of two Species of *Tubifex*.

Fig.

- 1.—Sperm-rope of *Tubifex rivulorum*.
- 2.—Surface of the same, with the filaments in a state of vibration.
- 3.—The same a little more deeply focussed.
- 4.—Optical longitudinal section of the same.
a. Axial canal. *b.* Dark line lying in inner bright layer. *c.* Striated or fibrous layer. *d.* Outer bright layer. *e.* Free ends of the spermatozoa, *i.e.*, vibrating filaments.
- 5.—The same more deeply focussed.
- 6.—Spermatozoa of *Tubifex rivulorum*.
- 7.—Transverse section of sperm-rope of *T. rivulorum*, proximal end; letters as in fig. 4.
- 8.—Short spermatophor of *T. rivulorum*.
- 9.—Headless ditto.
- 10.—Diagram to show the form of the head.
- 11.—Portion of a sperm-rope of *T. rivulorum* torn and teased, showing spiral structure.
- 12.—A portion of a cement-form, *i.e.*, a spermatophor devoid of spermatozoa.
- 13.—Incompletely cemented spermatophor.
- 14.—Sperm-rope of *Tubifex umbellifer*.
- 15.—A specimen of the same, in movement.
- 16.—Form of seta in the first ten dorsal pairs of fascicles of *T. umbellifer* (camera sketch).
- 17.—Form of the posterior dorsal and central setæ (camera sketch).
- 18.—Diagram of orifice of the copulatory pouch of *Tubifex rivulorum*; showing the reduplication or ridge causing the conical head of the spermatophor.

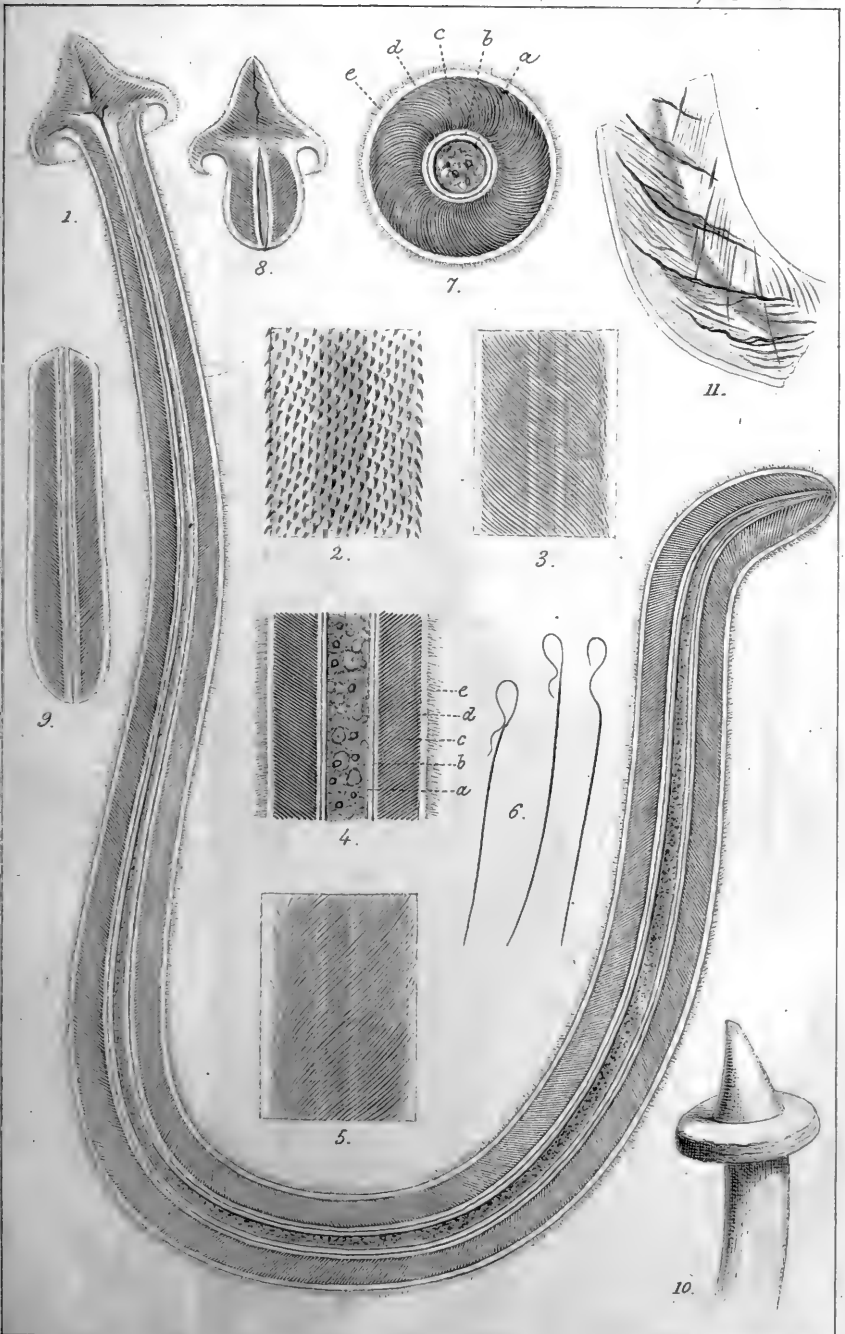



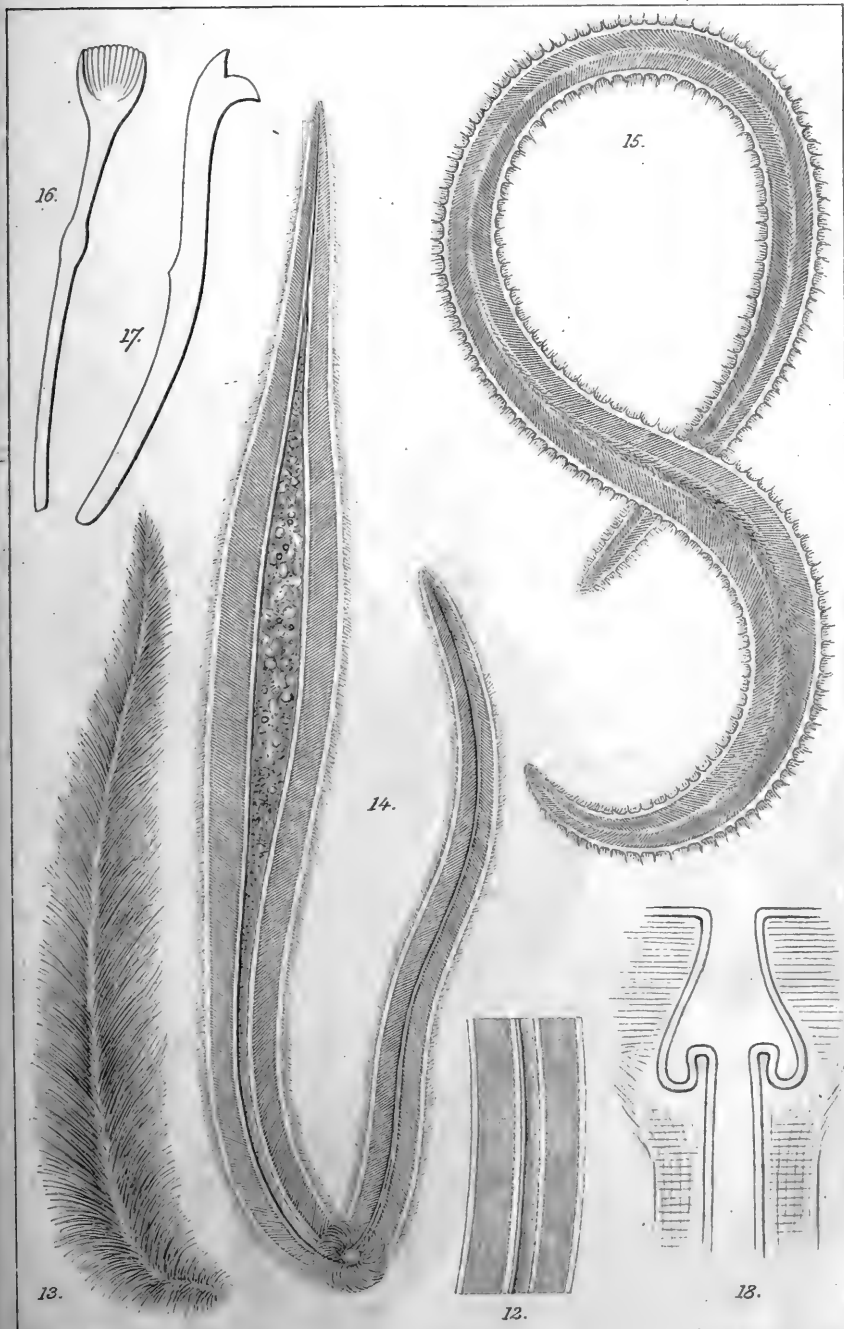

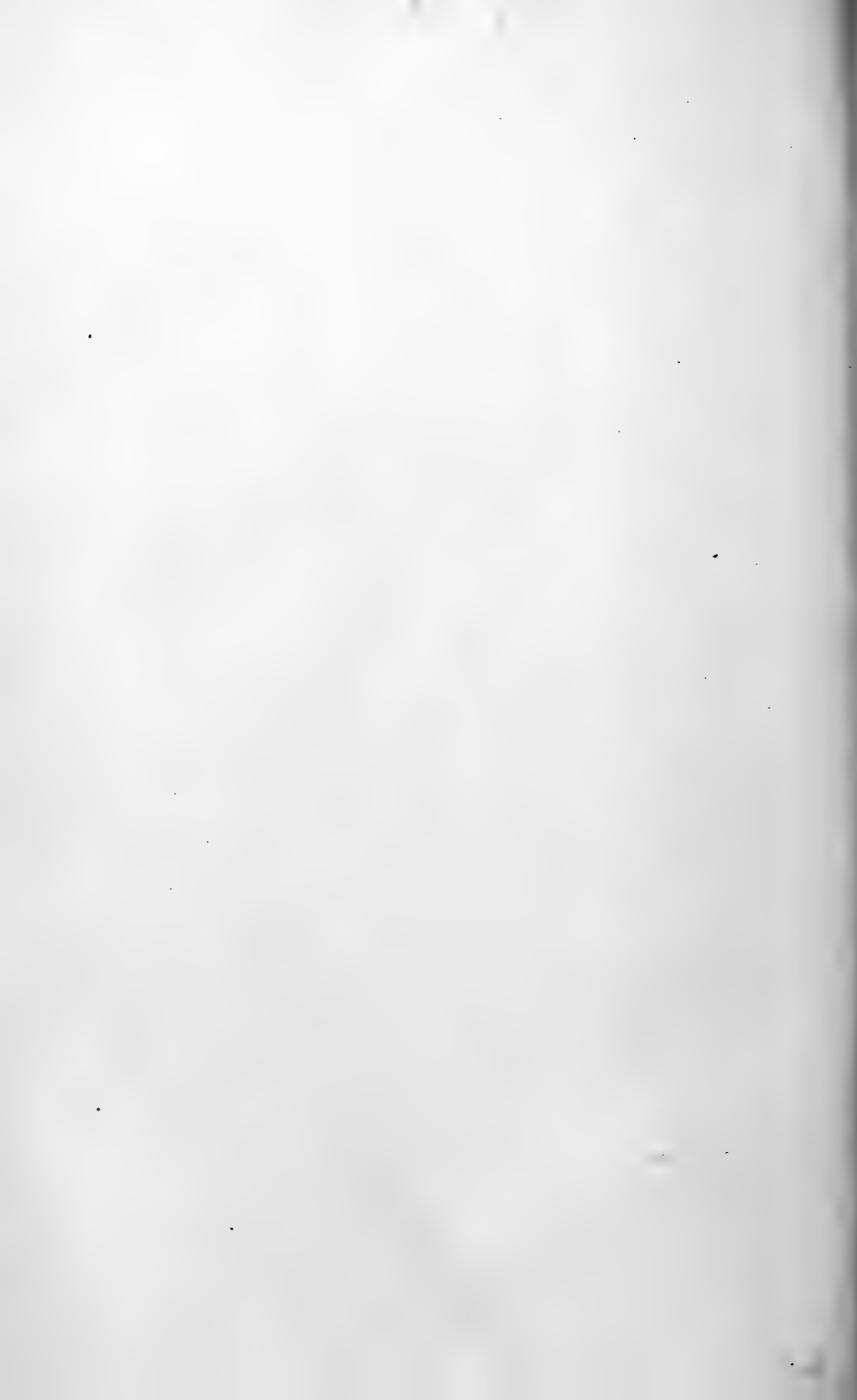



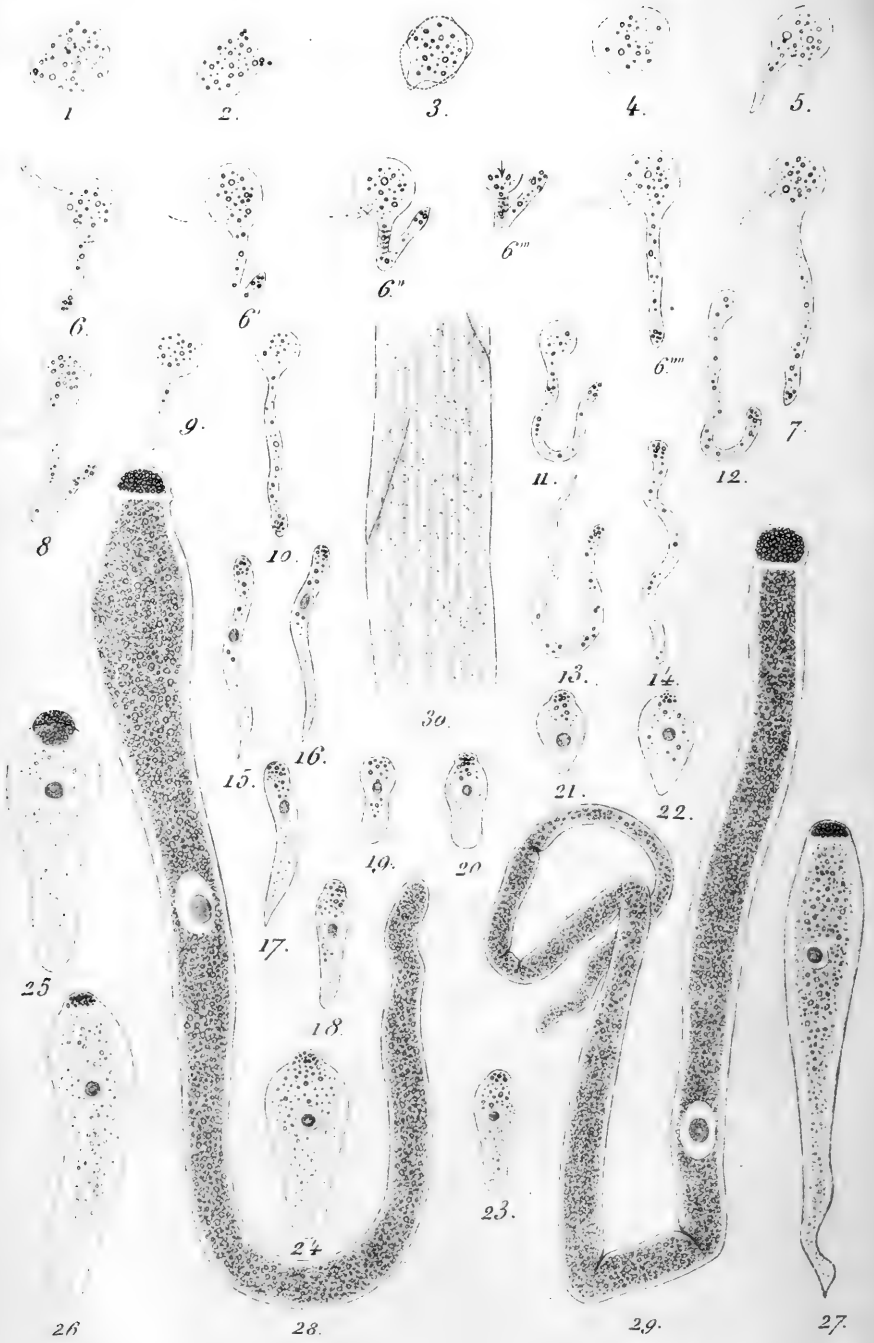

Ed. Van Beneden ad. nat. del.

Lith. G. Saeveryns Bruxelles.

Gregarina Gigantea.

JOURNAL OF MICROSCOPICAL SCIENCE.

DESCRIPTION OF PLATE XII,

Illustrating Edouard Van Beneden's Researches on the
Development of Gregarinæ.

Figs. 1—27 \times 950. Figs. 28 and 29 \times 250. Fig. 30 \times 450.

- 1, 2, and 3.—Naked cytod liberated from the psorosperms (Moner-stage).
- 4.—An external layer devoid of granules surrounds the cytod, and gives a certain degree of fixity to its form.
- 5.—Generating cytod, with two prolongations in course of development.
- 6 to 6'.—Generating cytod, showing different positions assumed by the mobile arm, and the distinguishing characters of the rigid arm. This same cytod has been observed during two hours. Figs. 6'' and 6''' show the transverse striations of the basilar portions of the arm.
- 7 and 8.—Cytod with two prolongations. The mobile arm is on the point of detaching itself.
- 9 to 12.—Different phases of the evolution of the second arm. The body of the cytod is absorbed little by little by its elaboration.
- 13 and 14.—Free pseudofilaria. They exhibit great activity.
- 15 to 18.—Pseudofilaria become rigid. They shorten gradually, taking on more and more the characters of young Gregarinæ. A nucleolus is differentiated. Figs. 17 and 18 show the first traces of nuclear layer.
- 19 to 27.—Successive stages of the development of the young Gregarina.
- 28 and 29.—Gregarinæ more advanced in development.
- 30.—Portion of the body of an adult Gregarina preserved in glycerin to show the muscular subcuticular fibrillæ. The portion of the body here represented is situated immediately behind the nucleus.

JOURNAL OF MICROSCOPICAL SCIENCE.

EXPLANATION OF PLATE XIII,

Illustrating Mr. Moseley's paper on the Nerves of the
Cornea of the Rabbit and Frog.

Fig.

- 1.—Points of junction of nerve-fibres in the cornea of the rabbit, forming a plexus.
- 2.—A similar plexus. Both from preparations stained with gold chloride.
- 3 and 4 represent the relation of nerve-fibres to the corneal corpuscles, as seen in thin layers from the cornea of *Rana esculenta*.
- 4.—A general view of the nerves and corpuscles, showing many apparent anastomoses between the two.
- 3.—Actual connection of nerve-fibres with two corneal corpuscles.
- 5.—One of the finest nerve-fibres from the cornea of *Rana esculenta*; showing the varicose appearance produced by the action of gold solutions. Drawn under a $\frac{1}{3\frac{1}{2}}$ immersion lens of Gundlach.

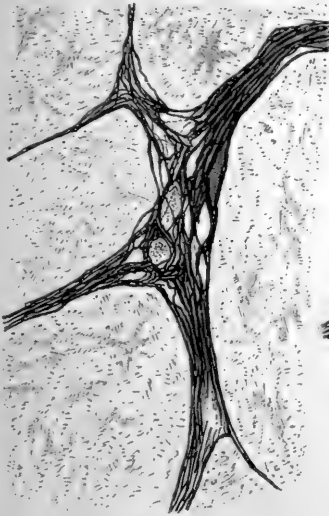

1. 100th of a Millimetre.

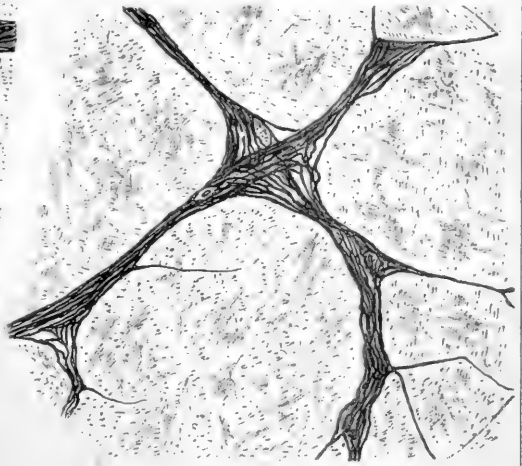

2. 100th of a Millimetre.



3. 100th of a Millimetre.



4. 10th of a Millimetre.

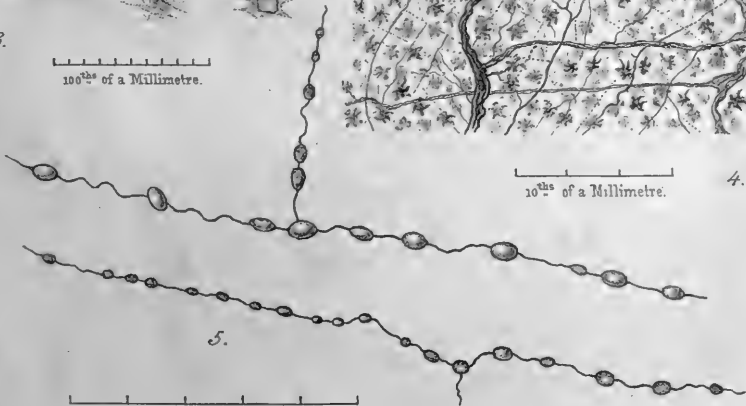

5. 100th of a Millimetre.



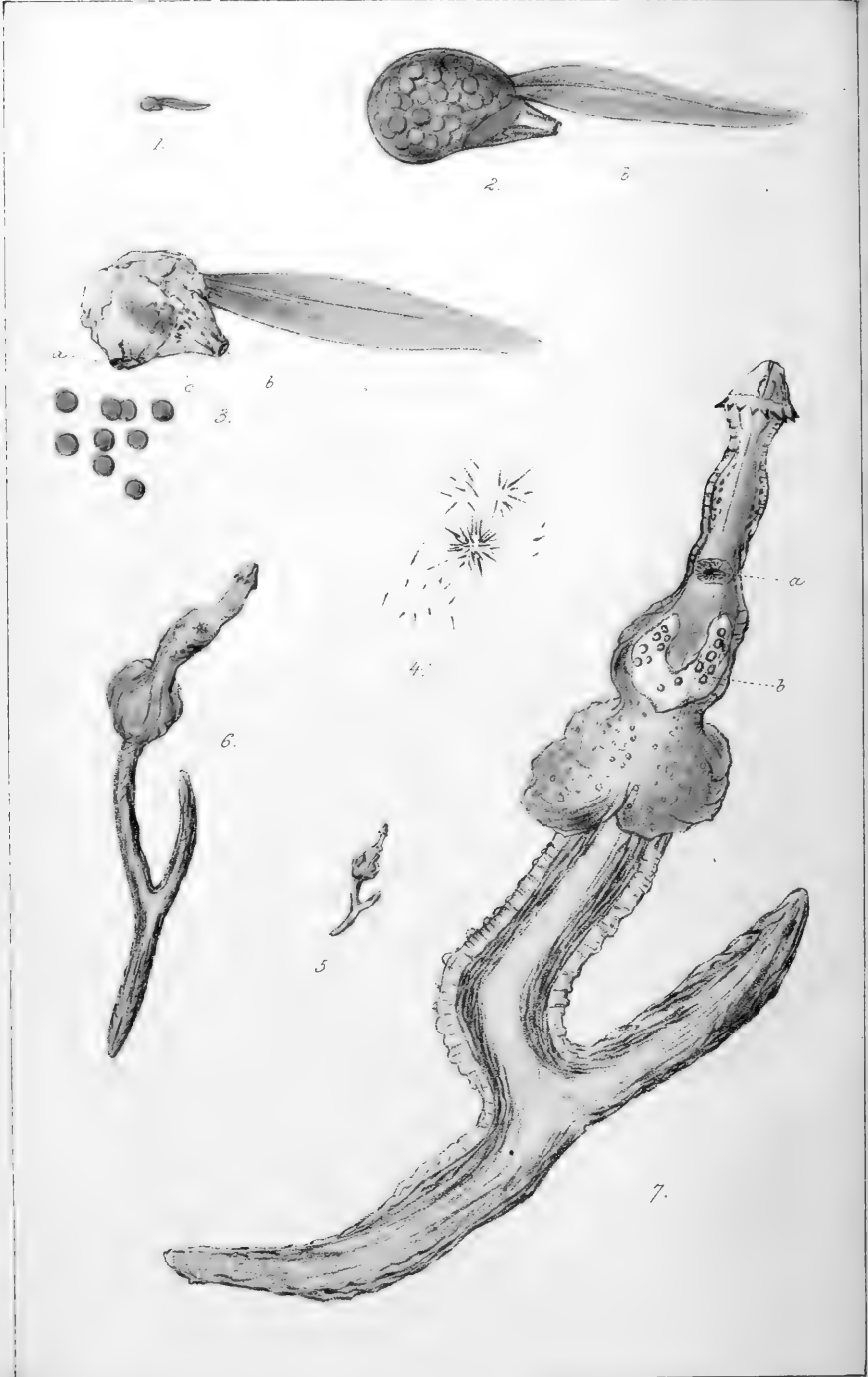

JOURNAL OF MICROSCOPICAL SCIENCE.

EXPLANATION OF PLATE XIV,

Illustrating Mr. Saville Kent's paper on Appendicularia, and the Larval condition of an Acanthocephaloid Scolecod from the Coast of Portugal.

Fig.

- 1.—*Appendicularia sp.*, nat. size.
- 2.—The same enlarged, showing an anterior chamber filled with spherica ova, and a posterior one, coloured orange, containing spermatic elements. *b.* Indicates the aperture of this last chamber.
- 3.—Another individual in which the walls of the anterior chamber have given way and collapsed, releasing the ova through the irregularly outlined fissure *a.* *c.* Indicates the ciliary band now visible, subservient to effecting the evacuation of the spermatozoons. *b.* The aperture of the spermatic chambers, as in the last figure.
- 4.—Spermatozoons, clustered and separate, highly magnified.
- 5.—Larva of *Echinorhynchus*? Nat. size.
- 6, 7.—Two individuals greatly enlarged. Descriptions of these last are postponed for future publication.



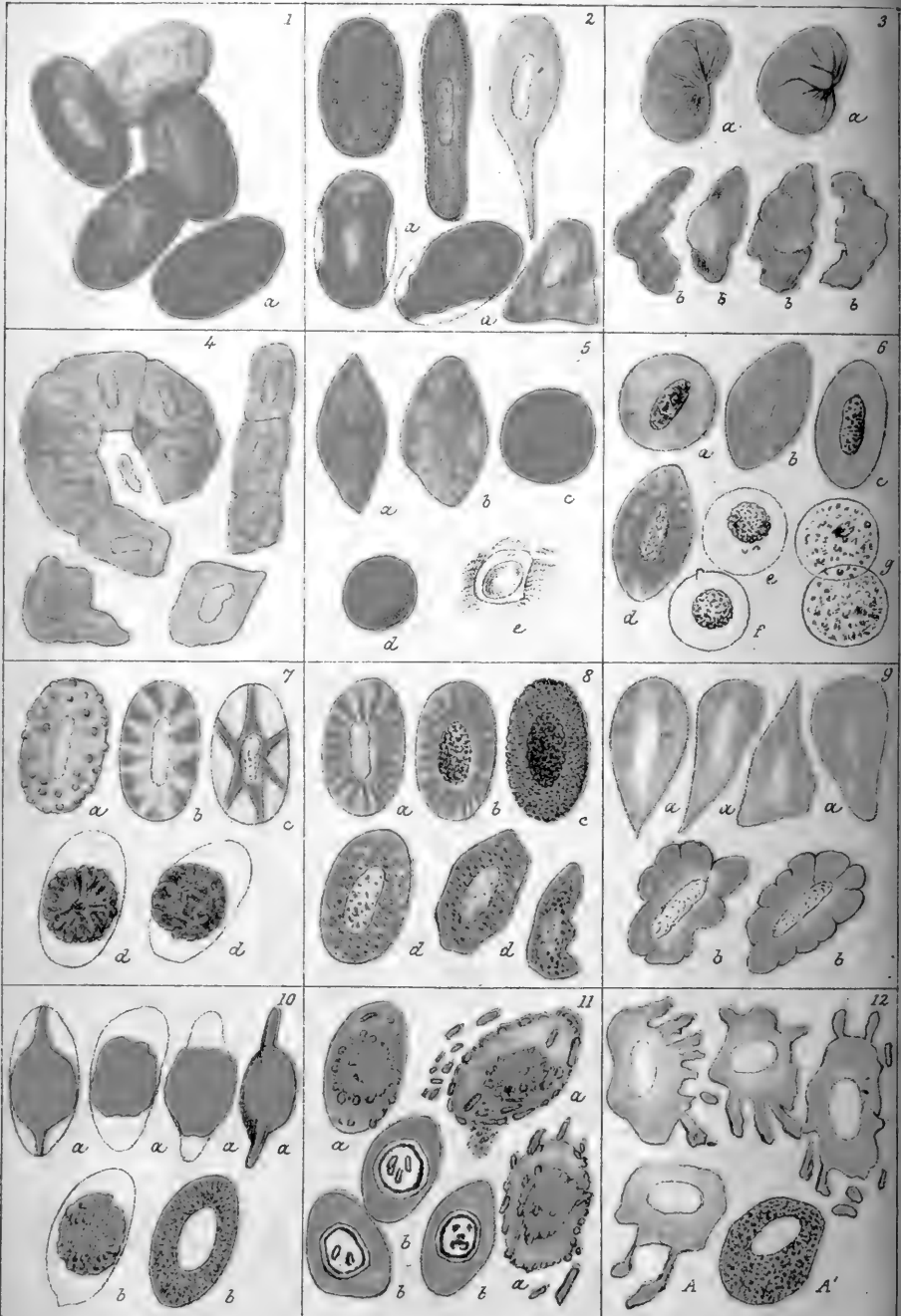



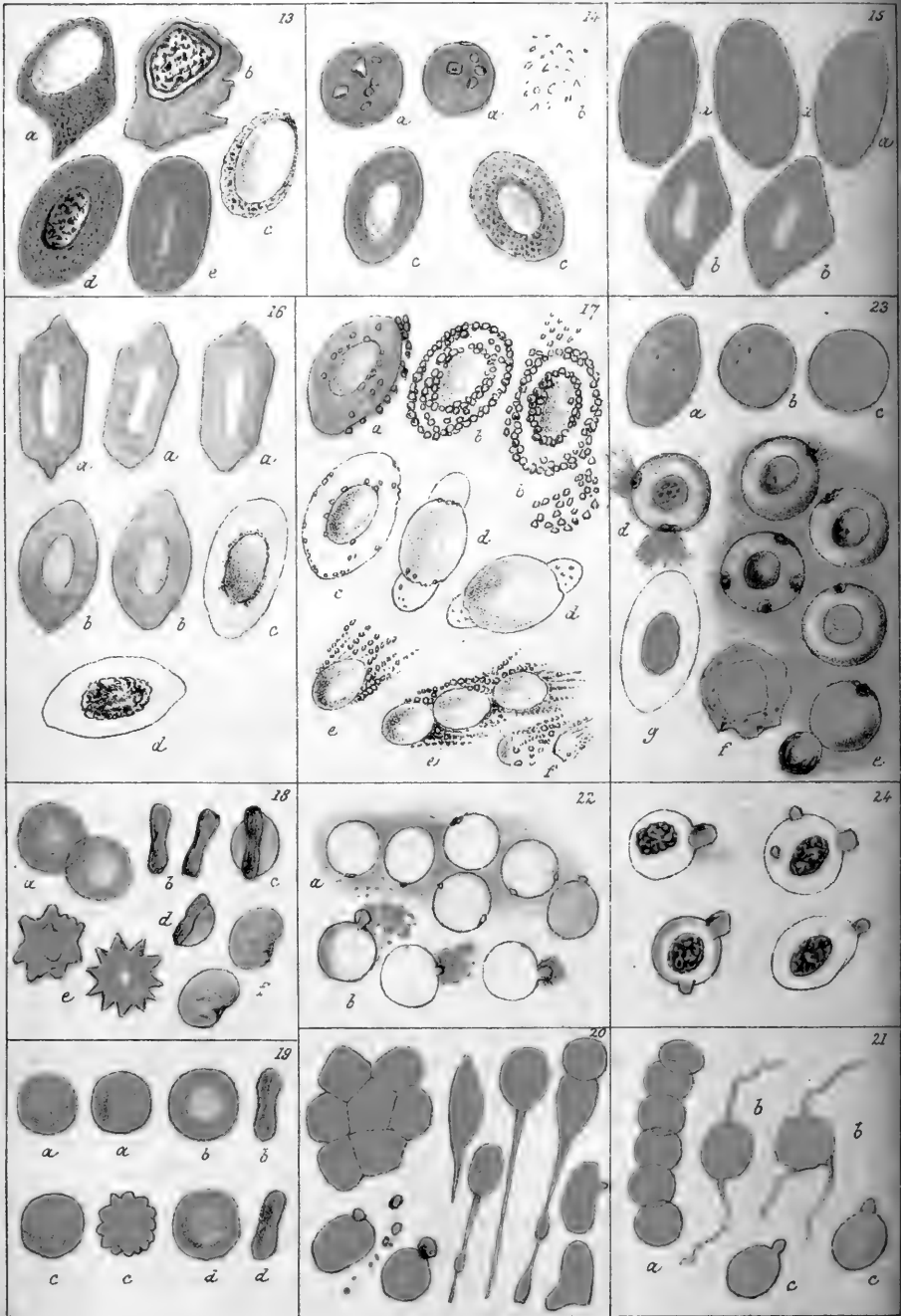

JOURNAL OF MICROSCOPICAL SCIENCE.

EXPLANATION OF PLATES XV & XVI,

Illustrating Mr. Ray Lankester's Observations and Experiments on the Red Blood-corpuscle.

Fig.

- 1.—Normal freshly-shed red corpuscles of the frog; *a*, with no nucleus to be seen.
2. Various exceptional forms from absolutely fresh and healthy frog's blood, not subjected to any reagents; *a, a*, are remarkable as showing a separation of the content (zoid) from the wall (œcoïd).
- 3, *a, a*.—Frog's red corpuscle subjected to oblique pressure; *b*, shrunk in 10 per cent. common salt solution, in which they subsequently dissolve.
- 4.—Aggregations of frog's red blood-corpuses, due to separation from the plasma by means of oil.
- 5, *a, b, c, d*.—Gradual action on the frog's red corpuscle of increasing condensation of aqueous vapour; *e*, stroma left after copious action of aqueous vapour.
- 6.—Action of CO₂; *a*, nucleus granulated by CO₂ in a "steamed corpuscle," such as fig. 5, *c*; *b*, the same corpuscle when atmospheric air or neutral gas is passed into the gas chamber so as to replace the CO₂; *c*, the same, when CO₂ is again introduced; *d*, the same, after several alternations of CO₂ and atmospheric air; *e, f*, similar corpuscles after repeated "steaming" and action of CO₂, with permanent nucleus; *g*, granulations in the body occurring under the prolonged action of CO₂, and repeated steaming.
- 7, *a, b, c*.—Various forms of the radial cleavage of the body of the frog's red corpuscle; *a*, tubercular form identical with the 'thorn-apple-form' of the human blood-corpuse.
d, d, Contraction of the zoid, caused by boracic acid.
- 8, *a, b, c*.—Gradual action of increasing strength of acetic acid vapour.
d, d, Granulation of the body with clear nucleus, caused by alcohol (frog).
- 9.—Action of ammonia: *a, a*, first changes due to small traces of NH₃ gas; *b, b*, further change of form (frog).
10. Action of ammonia: *a*, a remarkable result frequently obtained with slight quantities of ammonia-gas; *b*, acetic acid vapour added to *a* (frog).
- 11, *a, a, a*.—Separation and crystallisation of hæmoglobin, due to action of dilute ammonia gas; *b, b*, acetic acid vapour added to *a, a* (frog).
- 12.—Diffluent amœboid figures resulting from action of dilute ammonia gas on frog's red corpuscles; *A*, such a corpuscle throwing out its processes; *A'*, the same rounded, and its body granulated by the subsequent action of acetic acid vapour.

PLATES XV & XVI (*continued*).

- 13, *a*.—Frog's red corpuscle acted on first by dilute ammonia gas, then by acetic acid vapour; the nucleus is swollen and clear, the body granulated; *b*, a similarly treated corpuscle, the nucleus is granulated; *c*, nucleus of corpuscle greatly swollen by action of dilute ammonia gas; *d*, corpuscle acted on first by acetic acid vapour, then, *e*, by ammonia gas (frog).
- 14, *a*, *a*.—Frog's red corpuscle in course of destruction in a solution of ammonia: the nucleus is broken up; *b*, the stroma left after the process is complete; *c*, corpuscle acted on first by very dilute solution of ammonia, then by acetic acid; the body is granulated, the nucleus clear and colourless. In the right hand corpuscle, however, the nucleus is coloured and the body colourless, as sometimes occurs under the influence of this agent.
- 15.—Action of chloroform: *a*, first stage, wrinkling of the surface or membrane; *b*, *b*, angular forms, due to second stage of chloroform or of carbon bisulphide (frog).
- 16, *a*.—Second stage of the action of chloroform; *b*, *b*, third stage; *c*, fourth stage (this figure is too dark, it should be very pale and ghost-like); *d*, the nucleus of *c* granulated by acetic acid vapour (frog).
- 17.—Further action of chloroform (liquid): *a*, liquid chloroform added to a fresh corpuscle; *b*, action of liquid chloroform on the ghost-like stromata, fig. 16 *c*; *c*, *d*, *e*, *f*, further action of repeated additions of liquid chloroform, ending in the solution of the nucleus (frog).
- 18, *a*.—Ordinary form, flat view; *b*, ordinary form, edge view; *c*, double watch-glass shaped; *d*, single watch-glass shaped; *e*, thorn-apple shaped, human red blood-corpuscle; *f*, oblique pressure.
- 19.—Action of aqueous vapour, followed by CO₂; *a*, normal disc; *a'*, aqueous vapour allowed to act; *b*, CO₂ allowed to act; *c*, CO₂ removed by influx of atmospheric air; *d*, CO₂ again introduced (human).
- 20.—Action of very dilute ammonia gas on human red blood-corpuscles.
- 21, *a*.—A rouleaux of human red corpuscles passed from the plasma into oil; *b*, *c*, human red corpuscles, acted on first by very dilute ammonia gas and then by acetic acid vapour.
- 22.—Human red corpuscles acted on, *a*, by solution of acetate of rosanilin; *b*, by solution of tannin.
- 23.—Frog's red corpuscle; *a*, *b*, *c*, *d*, gradual action of solution of acetate of rosanilin on the same corpuscle; *e*, various corpuscles, one with four Robertsian maculae, another with escaped nucleus, but retaining its maculae; *f*, having first been acted on by dilute NH₃ gas; *g*, having been first allowed to dry.
- 24.—Frog's red corpuscle; action of tannin.

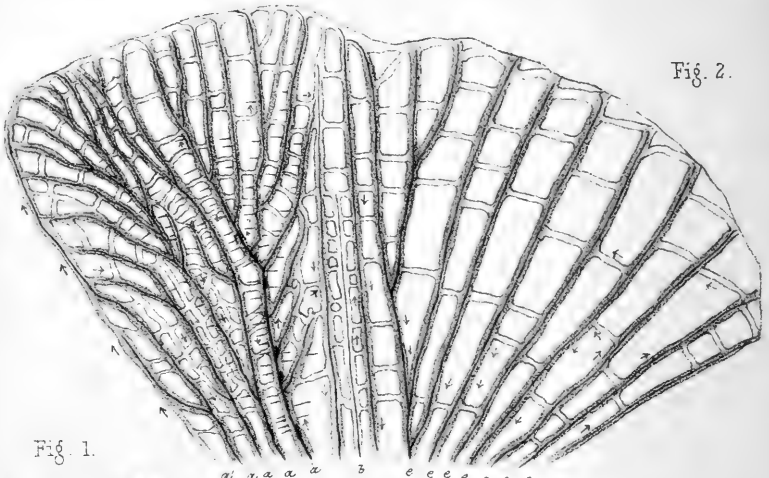
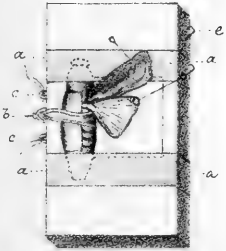

Fig. 2.

Fig. 1.



a a a a b e e e e c c c
1/4 inch

Fig. 3.

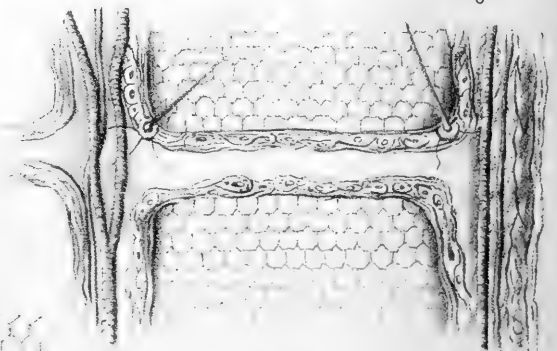

1/10 inch

Fig. 4.

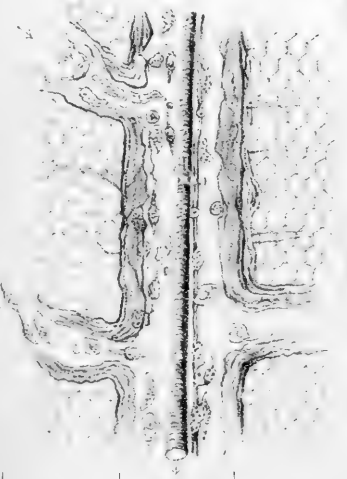

1/10 inch

Fig. 5.

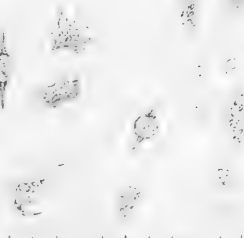

1/100 inch

Fig. 6.



1/10 inch

JOURNAL OF MICROSCOPICAL SCIENCE.

EXPLANATION OF PLATE XVII,

Illustrating Mr. Moseley's paper on the Circulation in the
Wings of *Blatta orientalis* and other Insects, and on a
New Method of Injecting the Vessels of Insects.

Fig.

- 1.—Sketch of apparatus for holding *Blatta* for observation.
- 2.—Hind wing of *Blatta orientalis*. The arrows indicate the usual direction of the blood-current.
- 3.—Portion of same greatly enlarged, showing the structure of vessels.
- 4.—Same, showing active circulation.
- 5.—Various blood-corpuses of *B. orientalis*.
- 6.—Vessels from base of hind wing of a small hymenopterous insect. The three crosses indicate the rhythmically contractile parts.

JOURNAL OF MICROSCOPICAL SCIENCE.

EXPLANATION OF PLATE XVIII.

Illustrating Prof. Cienkowski's Memoir on the production of Spores in the Radiolaria.

All the figures, with the exception of 9—12, are drawn by aid of the prism. The enlargement is given in brackets. In all the figures, K denotes the capsule; P, the radiant protoplasm; O, the oil globule; G, the fenestrated shell.

1—6.—*Collosphaera Huxleyi*, Müller.

FIG.

- 1.—A young naked capsule, without a fenestrated shell enclosed in the radiant protoplasm (180).
- 2.—An adult capsule shut in its fenestrated shell (180).
- 3, 4.—Shell-enclosed capsules, with protoplasm passing outwards (180).
- 5.—Many vesicles arise in the capsule-contents (480).
- 6.—Further differentiation of the contents into the corpuscles, *c*. In this, as in the last figure, the shell is not drawn.

7—15.—*Collosphaera spinosa*, Hæckel.

7. The capsule-content breaks up into a number of corpuscles (180).
- 8.—The out-swarming of the zoospores (180).
- 9, 10.—The zoospores (180).
- 11, 12.—Zoospores killed with iodine (600).
- 13—15.—Capsule-contents observed in the act of division (480)

16—30.—*Collozoum inerme*, Hæckel.

- 16.—The capsule-content breaks up into large masses (180).
- 17.—Radially-arranged content-balls (180).
- 18.—The corpuscles, observed in the act of division, of which the large balls are made up (480).
- 19.—The capsules squeezed together, forming parenchyma-like aggregates.
- 20—23.—The young capsules multiplying by constriction and division: 20, the common biscuit-form; 21, bent-up capsule with two constrictions; 22, a capsule broken up into four parts; 23, a very long capsule about to divide.
- 24.—A capsule surrounded by many vesicles (the young capsules?) which apparently have arisen *directly* from the protoplasm; *b*, *c*, the same observed in division.
- 25—30.—Various forms of the yellow cells, and their sheath growing after the death of the colony; *h*, the sheath (760).

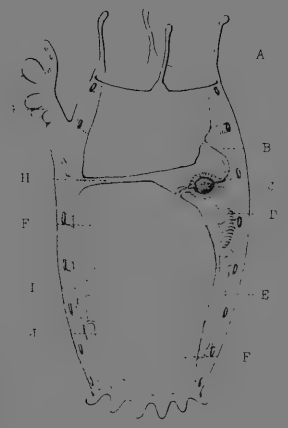
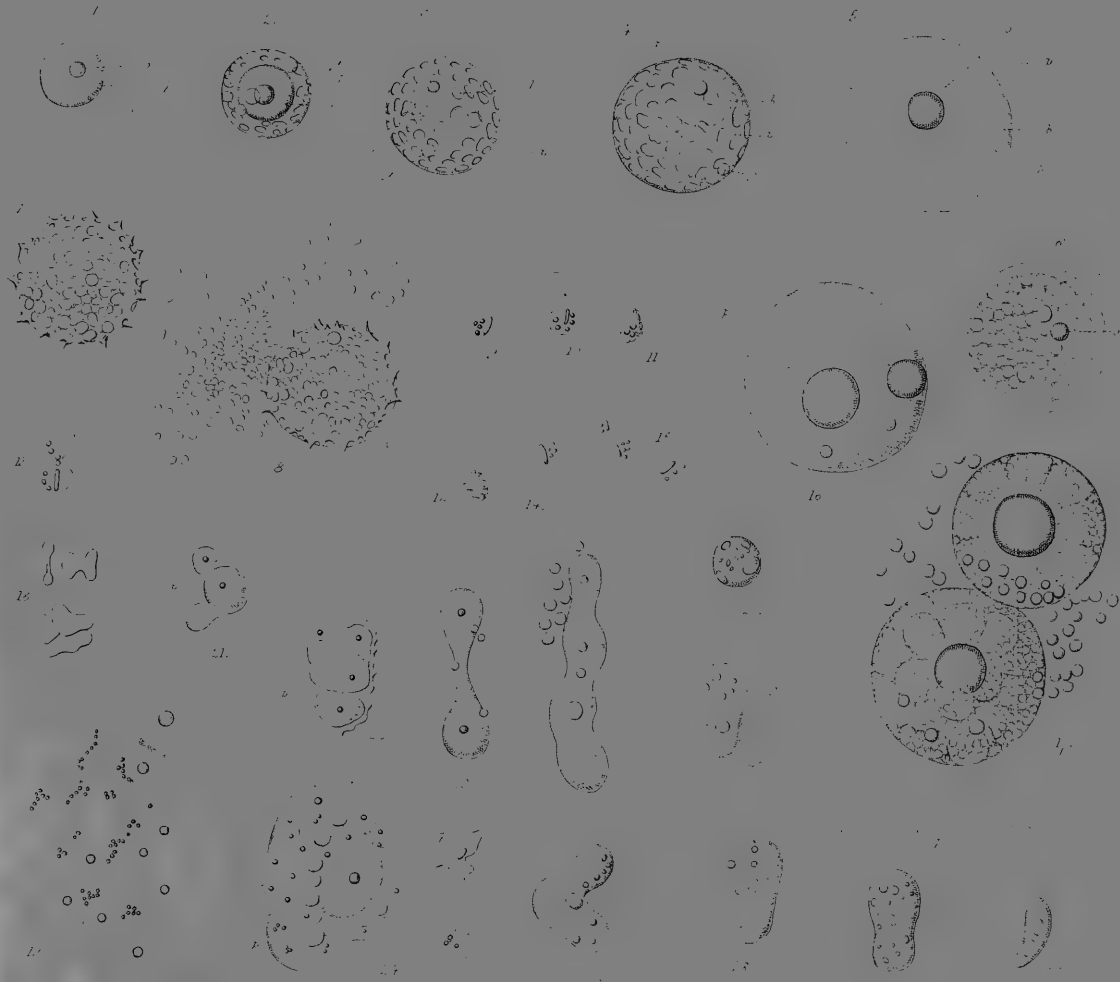

FIG. 1.

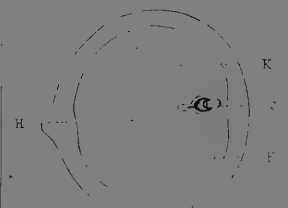

FIG. 2.



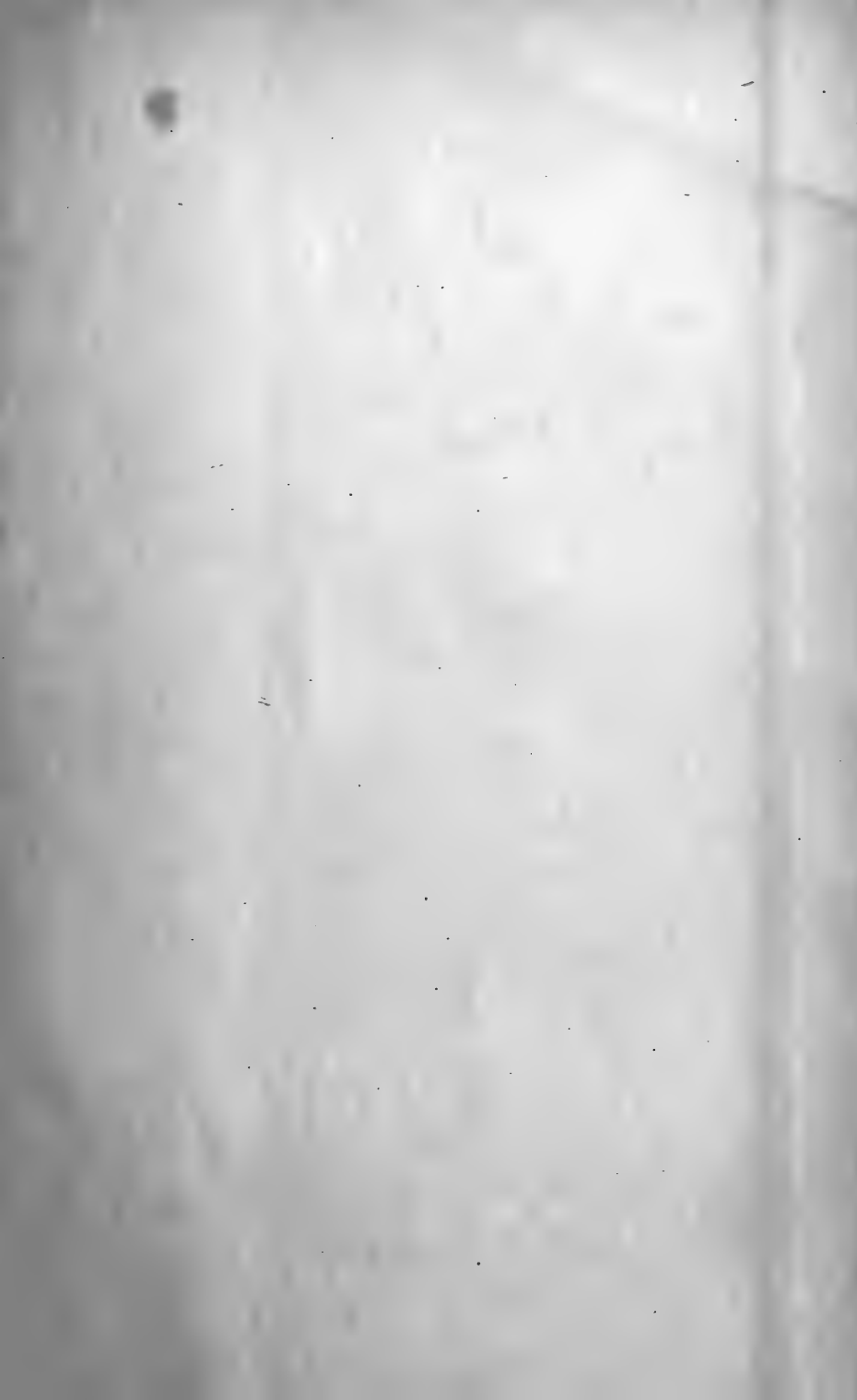



Fig. 1. A.



Fig. 1. B.

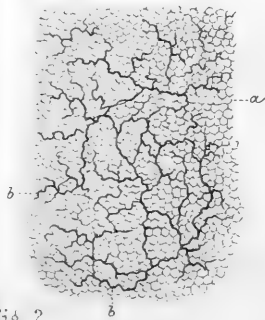

Fig. 2.

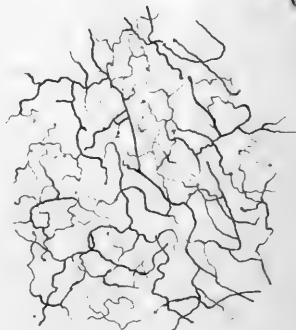

Fig. 3

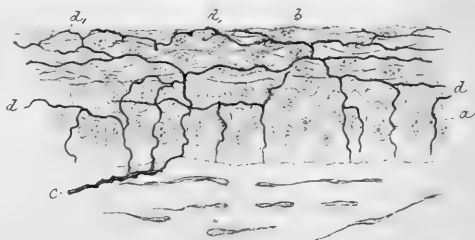

Fig. 4.



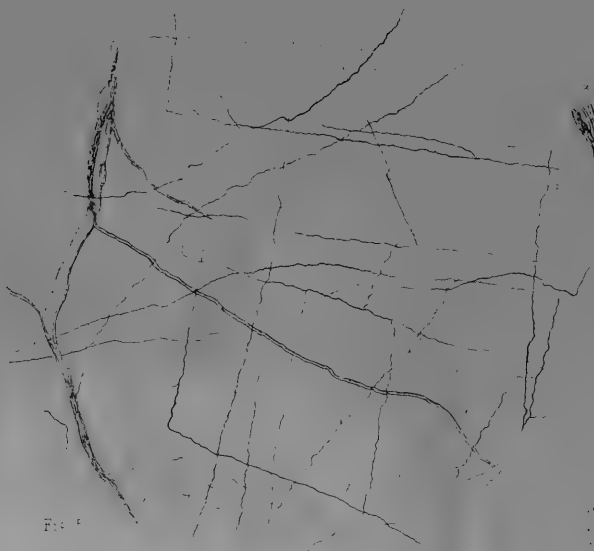

Fig. 6

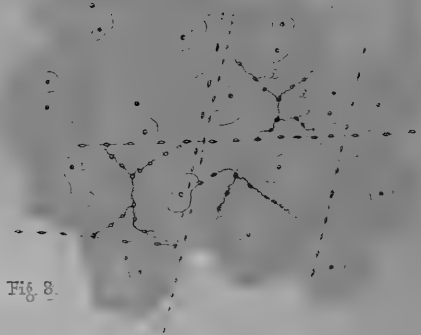
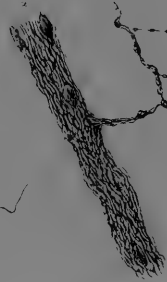

Fig. 8

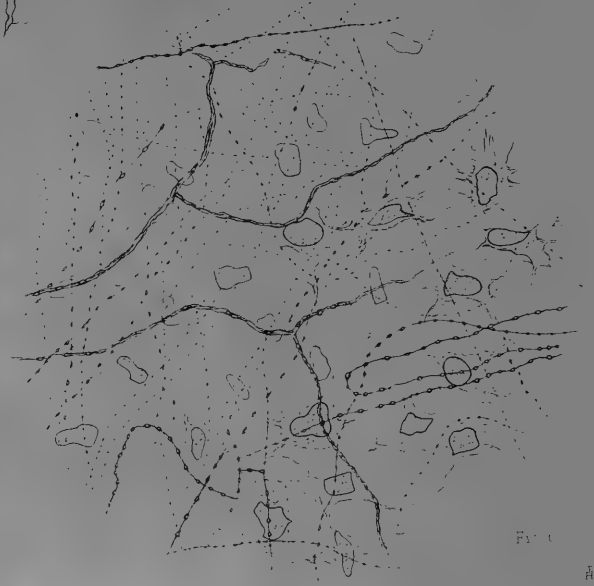

Fig. 7

JOURNAL OF MICROSCOPICAL SCIENCE.

DESCRIPTION OF PLATES XIX, XX,

Illustrating Part I of Dr. Klein's memoir on the Peripheral Distribution of some Non-medullated Nerve-Fibres.

Fig.

- 1.—A. Preparation of the rabbit's cornea. Magnifying power, Hartnack's ocular No. 3, objective No. 7.
a. Nerves of the plexus, which is placed in the outermost layer of the cornea propria. *b.* Small bundle of nerve-fibrillæ, from which *c.*, the fibrillæ of the subepithelial nerve-network proceed.
- B. Rabbit's cornea. A nerve branch from the middle layer of the cornea. Magnifying power, ocular No. 3, objective No. 8. Tube not drawn out.
- 2.—Rabbit's cornea. Magnifying power, ocular No. 3, objective No. 7.
a. Contours of the deepest cells of the outer epithelium. *b.* Nerve-fibrillæ of the deep intra-epithelial network.
- 3.—Rabbit's cornea. Magnifying power, ocular No. 3, objective No. 7. Superficial intra-epithelial network of nerve-fibrillæ.
Figs. 1 to 3 are flake-preparations.
- 4.—Vertical section through the rabbit's cornea. Magnifying power, ocular No. 3, objective No. 7.
a. Deepest epithelial cells. *b.* Superficial epithelial cells. *c.* Sub-epithelial nerve-fibrillæ. *d, d'.* Intra-epithelial nerve-fibrillæ.
- 5.—Preparation of the frog's cornea. Magnifying power, ocular No. 3, objective No. 7. Tube not drawn out.
a. Nerves of the first order. *b.* Of the second order. *c.* Of the third order.
- 6.—Frog's cornea. Magnifying power, ocular No. 3, objective No. 8. Tube not drawn out.
a, b, c. As in fig. 5. *k.* cornea-corpuscles.
- 7.—Frog's cornea. Magnifying power, ocular No. 3, objective No. 10, immersion.
a, b, c. As in figs. 5 and 6. *d.* Nerve-fibrillæ of the fourth order. *e.* Cornea-corpuscles.
- 8.—Frog's cornea. Magnifying power, ocular No. 3, objective No. 10 immersion.
a. Endothelial cells of the membrana Descemeti. *b.* Nuclei of the same. *c.* Nerve-fibrillæ of the third order disposed in the tissue of the cornea propria. *d.* Nerve-fibrillæ of the fourth order.

Fig. 1. The outermost layer of the embryo.

Fig. 2. The middle layer of the embryo.

Fig. 3. The innermost layer of the embryo.

Fig. 4. The outermost layer of the embryo.

Fig. 5. The middle layer of the embryo.

Fig. 6. The innermost layer of the embryo.

Fig. 7. The outermost layer of the embryo.

Fig. 8. The middle layer of the embryo.

Fig. 9. The innermost layer of the embryo.

Fig. 10. The outermost layer of the embryo.

Fig. 11. The middle layer of the embryo.

Fig. 12. The innermost layer of the embryo.

Fig. 13. The outermost layer of the embryo.

Fig. 14. The middle layer of the embryo.

Fig. 15. The innermost layer of the embryo.



ERNST MAYR LIBRARY



3 2044 110 319 985

Date Due

JUL 9 1968
JUL 9 1968

