

6204

HARVARD UNIVERSITY.



LIBRARY

OF THE

MUSEUM OF COMPARATIVE ZOOLOGY

7527

Bought.

January 10, 1917 - January 23, 1918.

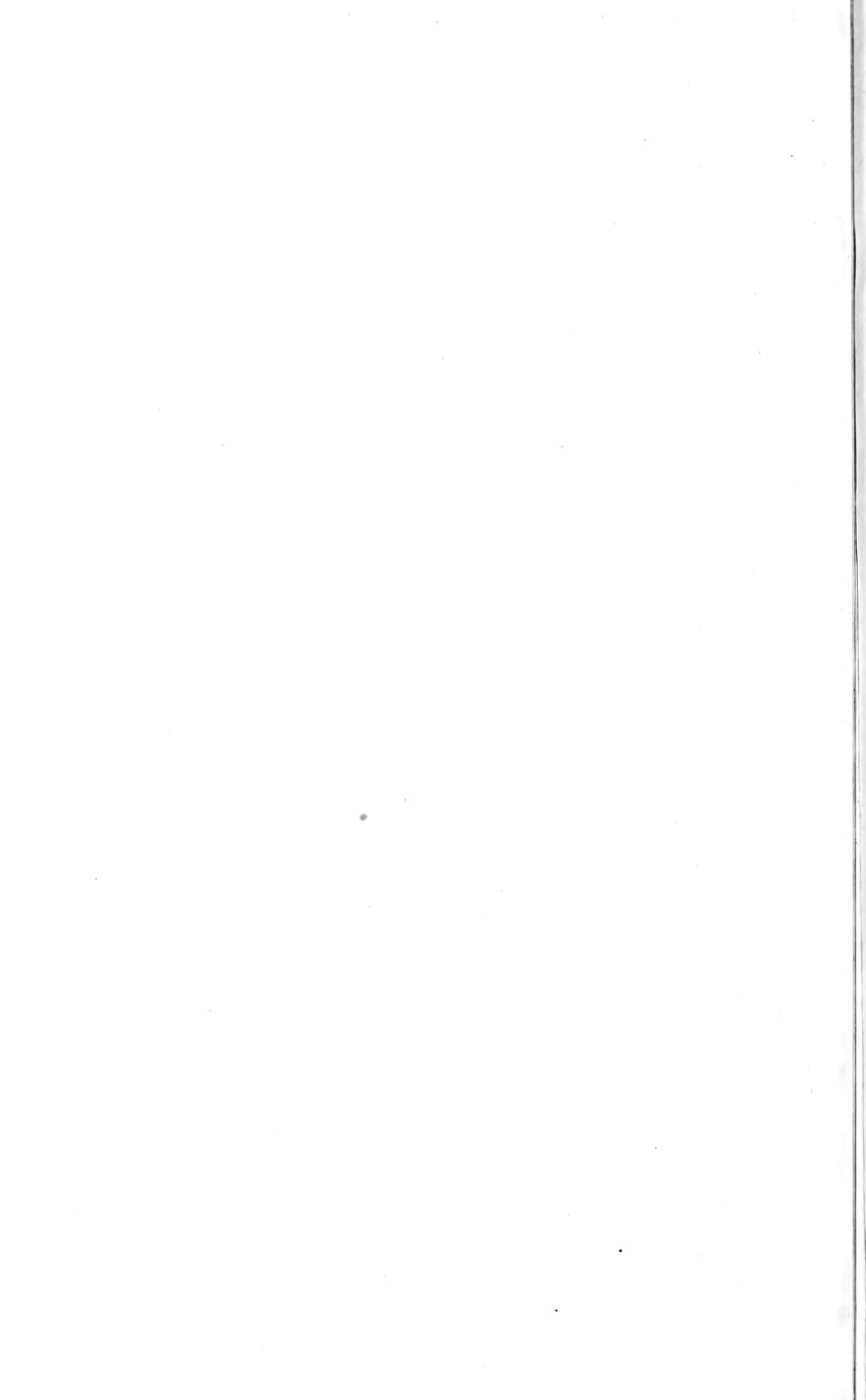

QUARTERLY JOURNAL

OF

MICROSCOPICAL SCIENCE.

EDITED BY

SIR RAY LANKESTER, K.C.B., M.A., D.Sc., LL.D., F.R.S.,
VOLUME 62.—NEW SERIES.

HONORARY FELLOW OF EXETER COLLEGE AND HONORARY STUDENT OF CHRIST CHURCH, OXFORD;
MEMBER OF THE INSTITUTE OF FRANCE (ASSOCIÉ ÉTRANGER DE L'ACADÉMIE DES SCIENCES);
CORRESPONDENT OF THE IMPERIAL ACADEMY OF SCIENCES OF ST. PETERSBURG, AND OF THE
ACADEMY OF SCIENCES OF PHILADELPHIA, AND OF THE ROYAL ACADEMY OF SCIENCES
OF TURIN; FOREIGN MEMBER OF THE ROYAL SOCIETY OF SCIENCES OF
GÖTTINGEN, AND OF THE ROYAL BOHEMIAN SOCIETY OF SCIENCES, AND
OF THE ACADEMY OF THE LINCEI OF ROME, AND OF THE AMERICAN
ACADEMY OF ARTS AND SCIENCES OF BOSTON; ASSOCIATE OF THE
ROYAL ACADEMY OF BELGIUM; HONORARY MEMBER OF THE
NEW YORK ACADEMY OF SCIENCES, AND OF THE
CAMBRIDGE PHILOSOPHICAL SOCIETY, AND OF
THE ROYAL PHYSICAL SOCIETY OF EDIN-
BURGH, AND OF THE

BIOLOGICAL AND ZOOLOGICAL SOCIETIES OF PARIS, AND OF THE CALIFORNIA ACADEMY OF SCIENCES OF
SAN FRANCISCO, AND OF THE ROYAL ZOOLOGICAL AND MALACOLOGICAL SOCIETY OF BELGIUM;
CORRESPONDING MEMBER OF THE SENKENBERG ACADEMY OF FRANKFURT-AM-
FOREIGN ASSOCIATE OF THE NATIONAL ACADEMY OF SCIENCES, U.S., AND MEMBER OF THE
AMERICAN PHILOSOPHICAL SOCIETY;

HONORARY FELLOW OF THE ROYAL SOCIETY OF EDINBURGH;
LATE DIRECTOR OF THE NATURAL HISTORY DEPARTMENTS OF THE BRITISH MUSEUM; LATE PRESIDENT OF THE
BRITISH ASSOCIATION FOR THE ADVANCEMENT OF SCIENCE; LATE FULLERIAN PROFESSOR OF
PHYSIOLOGY IN THE ROYAL INSTITUTION OF GREAT BRITAIN.
LATE LINACRE PROFESSOR OF COMPARATIVE ANATOMY AND FELLOW OF MERTON COLLEGE, OXFORD;
EMERITUS PROFESSOR OF ZOOLOGY AND COMPARATIVE ANATOMY IN UNIVERSITY COLLEGE, UNIVERSITY OF LONDON

WITH THE CO-OPERATION OF

SYDNEY J. HICKSON, M.A., F.R.S.,

BEYER PROFESSOR OF ZOOLOGY IN THE UNIVERSITY OF MANCHESTER;

GILBERT C. BOURNE, M.A., D.Sc., F.R.S.,

LINACRE PROFESSOR OF COMPARATIVE ANATOMY, AND FELLOW OF MERTON COLLEGE, OXFORD

J. GRAHAM KERR, M.A., F.R.S.,

REGIUS PROFESSOR OF ZOOLOGY IN THE UNIVERSITY OF GLASGOW;

AND

E. W. MACBRIDE, M.A., D.Sc., LL.D., F.R.S.,

PROFESSOR OF ZOOLOGY AT THE IMPERIAL COLLEGE OF SCIENCE AND TECHNOLOGY.

With Lithographic Plates and Text-Figures.



LONDON:

J. & A. CHURCHILL 7, GREAT MARLBOROUGH STREET.

1917.

~~A/E~~

CONTENTS.

CONTENTS OF No. 245, N.S., NOVEMBER, 1916.

MEMOIRS:	PAGE
On an Ichthyobdellid parasitic on the Australian Sand Whiting (<i>Sillago ciliata</i>). By CHARLES BADHAM, B.Sc., Junior Demonstrator in Zoology, University of Sydney. (With Plates 1 and 2, and 6 Text-figures)	1
The Development of <i>Alcyonium digitatum</i> , with some notes on the Early Colony Formation. By ANNIE MATTHEWS, M.Sc. (With Plates 3-5 and 53 Text-figures)	43
The So-called Labial Cartilages of <i>Raia clavata</i> . By EDWARD PHELPS ALLIS, JUNR., Menton, France. (With Plate 6)	95
INDEX TO VOLS. 29 TO 61 INCLUSIVE (July, 1888 to July, 1916).	

CONTENTS OF No. 246, N.S., FEBRUARY, 1917.

MEMOIRS:	PAGE
On <i>Phoronis ovalis</i> , Strethill Wright. By SIDNEY F. HARMER, Sc.D., F.R.S., Keeper of Zoology in the British Museum (Natural History). (Published by permission of the Trustees of the British Museum. (With Plates 7-9)	115
The Embryonic Development of <i>Trichogramma evanescens</i> , Westw., a Monembryonic Egg Parasite of <i>Donacia simplex</i> , Fab. By J. BRONTÉ GATENBY, Exhibitioner of Jesus College, Oxford. (With Plates 10-12)	149
On the Development of the Cape Cephalodiscus (<i>C. gilchristi</i> , Ridewood). By J. D. F. GILCHRIST, M.A., D.Sc., Ph.D. (With Plates 13 and 14).	189
Note on the Sex of a Tadpole raised by Artificial Parthenogenesis. By J. BRONTÉ GATENBY, B.A., Exhibitioner of Jesus College, Oxford. (With 5 Text-figures)	213
An Easy Way of Demonstrating the Nuclei of Nerve Fibres. By HENRY E. REBURN, Student of Medicine. (From the Physiological Laboratory, King's College, London)	217
On a Larval Actinian Parasitic in a Rhizostome. By C. BADHAM, B.Sc., Demonstrator in Zoology, University of Sydney. (With 3 Text-figures)	221
The Early Development of the Spleen of <i>Lepidosiren</i> and <i>Protopterus</i> . By G. L. PURSER, B.A. (Sometime Coutts-Trotter Student, Trinity College, Cambridge. (With Plates 15-17)	231
A Note concerning the Collar Cavities of the Larval <i>Amphioxus</i> . By K. M. SMITH, A.R.C.S., D.I.C., and H. G. NEWTH, Demonstrator in Zoology, Imperial College of Science and Technology. (With Plate 18)	243

CONTENTS OF No. 247, N.S., AUGUST, 1917.

MEMOIRS :

On the So-called Pharyngeal Gland-cells of Earthworms. By J. STEPHENSON, D.Sc., M.B., Lieutenant-Colonel Indian Medical Service ; Professor of Zoology, Government College, Lahore. (With Plate 19)	253
The Chromosome Complex of <i>Culex pipiens</i> . Part II.—Fertilisation. By MONICA TAYLOR, S.N.D., D.Sc. (With Plate 20 and 1 Text-figure)	287
The Homologies of the Muscles related to the Visceral Arches of the Gnathostome Fishes. By EDWARD PHELPS ALLIS, jr., Menton, France (With Plates 21 and 22 and 1 Text-figure)	303
The Cytoplasmic Inclusions of the Germ-cells. Part I.—Lepidoptera. By J. BRONTÉ GATENBY, B.A., Exhibitioner of Jesus College, Oxford. (With Plates 23-25, and 5 Text-figures)	407
The Degenerate (Apyrene) Sperm-formation of Moths as an Index to the Inter-relationship of the Various Bodies of the Spermatozoon. By J. BRONTÉ GATENBY, B.A., Exhibitioner of Jesus College, Oxford. (With Plate 26)	465

CONTENTS OF No. 248, N.S., DECEMBER, 1917.

MEMOIRS :

Notes on the Morphology of <i>Bathynella</i> and some Allied Crustacea. By W. T. CALMAN, D.Sc. (Published by permission of the Trustees of the British Museum.) (With 14 Text-figures)	489
On <i>Oxnerella maritima</i> , nov. gen., nov. spec., a new Heliozoon, and Its Method of Division ; with Some Remarks on the Centroplast of the Heliozoa. By CLIFFORD DOBELL, Imperial College of Science, London, S.W. (With Plate 27)	515
"Proboscis pores" in Craniate Vertebrates, a Suggestion concerning the Premandibular Somites and Hypophysis. By EDWIN S. GOODRICH, F.R.S., Fellow of Merton College, Oxford. (With Plate 28, and 3 Text-figures)	539
The Cytoplasmic Inclusions of the Germ-Cells. Part II.— <i>Helix aspersa</i> . By J. BRONTÉ GATENBY, B.A., Exhibitioner of Jesus College, Oxford (Dept. of Physiology). (With Plates 29-34 and 5 Text-figures)	555
Note on the Development of <i>Trichogramma evanescens</i> . By J. BRONTÉ GATENBY, Exhibitioner of Jesus College, Oxford	613

7527

New Series, No. 245 (Vol. 62, Part 1).

Price 10s. 6d. net.

Subscription per volume (of 4 parts) 42s. net.

NOVEMBER, 1916.

THE
QUARTERLY JOURNAL
 OF
MICROSCOPICAL SCIENCE.

EDITED BY

SIR RAY LANKESTER, K.C.B., M.A., D.Sc., LL.D., F.R.S.,

HONORARY FELLOW OF EXETER COLLEGE AND HONORARY STUDENT OF CHRIST CHURCH, OXFORD;
 MEMBER OF THE INSTITUTE OF FRANCE (ASSOCIÉ ÉTRANGER DE L'ACADÉMIE DES SCIENCES);
 CORRESPONDENT OF THE IMPERIAL ACADEMY OF SCIENCES OF ST. PETERSBURG, AND OF THE
 ACADEMY OF SCIENCES OF PHILADELPHIA, AND OF THE ROYAL ACADEMY OF SCIENCES
 OF TURIN; FOREIGN MEMBER OF THE ROYAL SOCIETY OF SCIENCES OF
 GÖTTINGEN, AND OF THE ROYAL BOHEMIAN SOCIETY OF SCIENCES, AND
 OF THE ACADEMY OF THE LINGEI OF ROME, AND OF THE AMERICAN
 ACADEMY OF ARTS AND SCIENCES OF BOSTON; ASSOCIATE OF THE
 ROYAL ACADEMY OF BELGIUM; HONORARY MEMBER OF THE
 NEW YORK ACADEMY OF SCIENCES, AND OF THE
 CAMBRIDGE PHILOSOPHICAL SOCIETY, AND OF
 THE ROYAL PHYSICAL SOCIETY OF EDIN-

BURGH, AND OF THE
 BIOLOGICAL AND ZOOLOGICAL SOCIETIES OF PARIS, AND OF THE CALIFORNIA ACADEMY OF SCIENCES OF
 SAN FRANCISCO, AND OF THE ROYAL ZOOLOGICAL AND MALACOLOGICAL SOCIETY OF BELGIUM;
 CORRESPONDING MEMBER OF THE SENKENBERG ACADEMY OF FRANKFURT-AM;
 FOREIGN ASSOCIATE OF THE NATIONAL ACADEMY OF SCIENCES, U.S., AND MEMBER OF THE
 AMERICAN PHILOSOPHICAL SOCIETY;

HONORARY FELLOW OF THE ROYAL SOCIETY OF EDINBURGH;
 LATE DIRECTOR OF THE NATURAL HISTORY DEPARTMENTS OF THE BRITISH MUSEUM; LATE PRESIDENT OF THE
 BRITISH ASSOCIATION FOR THE ADVANCEMENT OF SCIENCE; LATE FULLERIAN PROFESSOR OF
 PHYSIOLOGY IN THE ROYAL INSTITUTION OF GREAT BRITAIN.
 LATE LINACRE PROFESSOR OF COMPARATIVE ANATOMY AND FELLOW OF MERTON COLLEGE, OXFORD;
 EMERITUS PROFESSOR OF ZOOLOGY AND COMPARATIVE ANATOMY IN UNIVERSITY COLLEGE, UNIVERSITY OF LONDON

WITH THE CO-OPERATION OF

SYDNEY J. HICKSON, M.A., F.R.S.,

BEYER PROFESSOR OF ZOOLOGY IN THE UNIVERSITY OF MANCHESTER;

GILBERT C. BOURNE, M.A., D.Sc., F.R.S.,

LINACRE PROFESSOR OF COMPARATIVE ANATOMY, AND FELLOW OF MERTON COLLEGE, OXFORD

J. GRAHAM KERR, M.A., F.R.S.,

REGIUS PROFESSOR OF ZOOLOGY IN THE UNIVERSITY OF GLASGOW;

AND

E. W. MACBRIDE, M.A., D.Sc., LL.D., F.R.S.,

PROFESSOR OF ZOOLOGY AT THE IMPERIAL COLLEGE OF SCIENCE AND TECHNOLOGY.

WITH LITHOGRAPHIC PLATES AND TEXT-FIGURES.



LONDON.

J. & A. CHURCHILL, 7 GREAT MARLBOROUGH STREET.

1916.

CONTENTS OF No. 245.—New Series.

MEMOIRS:

	PAGE
On an Ichthyobdellid parasitic on the Australian Sand Whiting (<i>Sillago ciliata</i>). By CHARLES BADHAM, B.Sc., Junior Demonstrator in Zoology, University of Sydney. (With Plates 1 and 2, and 6 Text-figures)	1
The Development of <i>Alcyonium digitatum</i> , with some notes on the Early Colony Formation. By ANNIE MATTHEWS, M.Sc. (With Plates 3-5 and 53 Text-figures)	43
The So-called Labial Cartilages of <i>Raia clavata</i> . By EDWARD PHELPS ALLIS, JUNR., Menton, France. (With Plate 6)	95
INDEX TO VOLS. 29 TO 61 INCLUSIVE (July, 1888 to July, 1916).	

JAN 10 1917

AN ICHTHYOBELLID PARASITIC ON SAND WHITING.

**On an Ichthyobdellid parasitic on the Australian
Sand Whiting (*Sillago ciliata*).**

By

Charles Badham, B.Sc.,

Junior Demonstrator in Zoology, University of Sydney.

With Plates 1 and 2, and 6 Text-figures.

INTRODUCTION.

IN August, 1912, during a visit to the Fish Hatcheries Institution, Port Hacking, an inlet south of Port Jackson, New South Wales, my attention was called to a parasite which, I was informed, had for some time past caused the death of sand whiting kept in a large spawning pond. An examination of this parasite showed it to be a marine leech.

The history of the infestation, so far as I have been able to ascertain, is as follows.

It has been the custom for some years past to stock a large sea-water pond of the Institution with two or three dozen sand whiting taken from the shoals in the vicinity. This appears to have been done several times, and on each occasion the fish were killed by the attacks of these leeches.

The fish, shortly after being placed in the pond, sickened, developed large ulcerated patches on their integument and died. Within ten weeks of being introduced into the pond most of the fish would be in a moribund condition.

It was easy to know when the fish were seriously affected, for then they would swim very close to the surface, and on their sides. An examination of a badly infested fish usually

CHARLES BADHAM.

showed about a hundred leeches in various stages of development, ranging in length from 1 to 13 mm.

The parasites were found on the fins—pectoral, pelvic, dorsal, and caudal; their presence was also noticed around ulcerated patches on the sides of the fish, and a few were found in the proximity of, but not on, the gills.

Owing to their transparent nature, and the mucous secretions of the fish, they were not so readily visible as their highly pigmented form seen when magnified would suggest.

On the occasion of the first visit in August I secured several hundred specimens, and in March of the following year, having determined to work out the anatomy and systematic position of this leech, I again visited the Fish Hatcheries, but found that all the sand whiting had died. Dredging giving no results, arrangements were made to again place a number of the fish in the pond in order to obtain living specimens of the leech.

Owing to an oversight, I was not informed of the state of these fish until all save one had died. This remaining fish was caught on June 8th, 1913, and was found but slightly infested. Most of the leeches obtained died in the first few days, but two hardy specimens were kept alive for three weeks, and these served for an extended *intra vitam* examination, for taking photographs, and for making a coloured drawing.

Owing to the transparent nature and small size of the leeches, the details of the Blood-vascular, Nephridial, and Cœlomic systems could be followed, and this with only the slight compression of the leech produced by the pressure of a thin cover slip.

A number of photographs of the living form were secured showing these systems in detail, and have been of value in this work. The pond in which these fish were kept under conditions which so favoured the increase of the leeches was a large one, being about 50 × 100 ft. The water in it varied in depth from 2 to 6 ft., and was changed by means of valves, the water being run off at low and replaced at high tide.

About a dozen species of fish were kept in it; as well as the sand whiting (*Sillago ciliata*), there were present *Pagrosomus auratus*, *Chrysophrys australis*, and *Caranx georgianus*.

In no case were these leeches found on any fish other than the sand whiting. That this pond formed a favourable place for the development and increase of parasites was also shown by the fact that most of the fish, except the sand whiting, were infested by ectoparasitic Trematodes; these will in due course be described by Dr. S. J. Johnston, of the Sydney University.

At the beginning of February, 1914, I had the opportunity of examining many hundreds of sand whiting netted by fishermen or caught by line in the estuarine and ocean waters of Wreck Bay, about 100 miles south of Port Jackson. Among these fish it was rare to find an individual which did not have from two or three to half a dozen specimens of this leech. I examined a large number of other species of fish netted along with the sand whiting, but never found them infested with this or any other leech.

It was found necessary to create a new genus to contain this leech, which will be described under the name of *Austrobdella translucens*.

Austrobdella gen. nov.

Definition.—Small marine leeches with well-defined neck and body regions. The body cylindrical in the young, but much flattened in the adult. The lateral parts of the body below the clitellum bulging out and forming a shoulder-like appearance. Somite of six annuli. No pulsating vesicles present, their place being taken by a continuous contractile lacuna placed on either side outside the body musculature. Dorsal and ventral median lacunæ present, communicating by segmental lacunæ. Three pairs of pouches present in the thick-walled intestine, a fourth pair being represented by a flexure of the gut. Testes five pairs. Eyes one pair.

Type species *A. translucens*, mihi. Type specimen in the Australian Museum, Sydney, No. W. 403.

EXTERNAL FORM.

The material on which this work is based consists of a large number of specimens ranging from the young sexually immature to the adult form. From a number of specimens it has been possible to arrange a complete series of individuals to show the change of form during growth. I would lay stress on this very marked change in form, and my observations have convinced me of the likelihood of the younger forms of similar marine leeches being described as new genera or species in the absence of a series of individuals linking up the young to the adult.

In Text-fig. 1 are shown the outlines of specimens which measure 1.5, 3, 4, 5.5, and 7.5 mm. long, to illustrate the change in form which takes place during the growth of this leech. Young forms possess a cylindrical body, and the chief change in shape during growth is due to the great lateral development of the body posterior to the clitellum. The appearance of a specimen 1.5 mm. long is shown in Pl. 1, fig. 3. When this leech is 4 mm. long the testes become mature. At this stage the body is cylindrical (Pl. 1, fig. 4), there is but a faint indication of the clitellum, and the ovaries are quite undeveloped. In 6 mm. specimens maturation divisions are seen in the ova. At this stage the clitellum has become enlarged and is now well marked.

The young of *Austrobdella* have the anterior sucker of the same diameter as the cylindrical body and the posterior sucker nearly twice that size (Pl. 1, fig. 3). When a length of 4 mm. is reached the anterior and posterior suckers approach one another more closely as regards size and have a diameter a little less than the greatest diameter of the body (Pl. 1, fig. 4). When the leech has a length of 5.5 mm. (Text-fig. 1) the typical form of the adult is foreshadowed. At this stage the clitellum becomes evident, and owing to the increased lateral development that part of the body posterior

and lateral to it presents a shouldered appearance; but the body is only slightly flattened. When a length of 7.5 mm. (Text-fig. 1) is reached the lateral development is quite pronounced, causing a more flattened form, and the suckers have assumed the ratio shown in the figure of an adult specimen, 9 mm. (Pl. 1, fig. 5).

TEXT-FIG. 1.

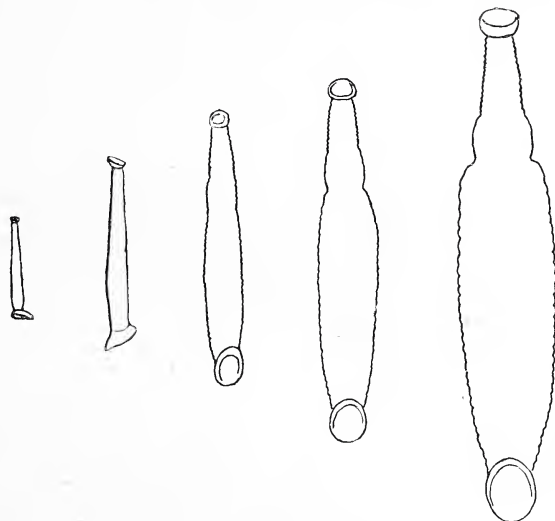

Outlines of specimens of *Austrobdella translucens* which measure 1.5, 3, 4, 5.5 and 7.5 mm. long. The figure shows the change in shape during the growth of this marine leech.

I give below a table to show the measurements at different stages of development :

Length.	Breadth below Clitellum.	Height.	Diameter Oral Sucker.	Diameter Posterior Sucker.
1.5 mm.	.13 mm.	.13 mm.	.13 mm.	.20 mm.
4.0 mm.	.52 mm.	.5 mm.	.30 mm.	.41 mm.
7.5 mm.	1.35 mm.	.7 mm.	.55 mm.	.91 mm.
9.0 mm.	3.25 mm.	1.0 mm.	.8 × .5 mm. =	1.75 × 1.1 =
			.65 mm.	1.42 mm.

The measurements given for the 9 mm. stage are from the specimen which is shown in Pl. 1, fig. 5. The following additional measurements are also from this specimen :

Distance from oral sucker to male opening 1.26 mm.

Diameter of neck at base of oral sucker 6 mm.

Breadth of clitellum 95 mm.

All these measurements are taken from leeches killed by means of boiling corrosive acetic solution while in a quiescent condition.

In describing *Platybdella michaelsoni*, Johansson (1911) states that the larger of two specimens secured was 6.9 mm. long. He found in this specimen that the testes were ripe but the ovaries slightly developed, despite the presence of spermatozoa. He therefore considers that this species would not attain a much greater size. However, if my observations on the growth of *Austrobdella* are found to be generally applicable to marine leeches, the species he describes might grow to nearly twice the length given.

COLORATION.

The transparent nature of the body of *Austrobdella* allows the beautiful pigmentation to be clearly seen. The drawing (Pl. I, fig. 1) is a careful representation in black and white of a living specimen, viewed from the ventral surface, as seen by transmitted light.

The specimen depicted is a young extended form in which neither the clitellar region nor the lateral parts of the main body region are as well developed as usual. This individual was made use of owing to its having retained its colour in captivity better than its fellows.

On the ventral surface most of the pigment cells are seen to be wrapped round what appears to be a tube. These cells, which are reddish-brown in colour, are in the walls of the ventral lacuna; their stellate nature is well represented. Similar pigment cells are seen in relation to the ejaculatory canals; these are here, as in most specimens, rendered conspicuous by their dark colour.

As well as the reddish-brown pigment cells mentioned, a smaller number of cells of varying shades of purple are

present; some of these show through from the dorsal surface. Large and more diffuse yellow cells are scattered about the surface, and at the posterior region of the body certain of the cocoon glands have a light brown colour.

Viewed from the dorsal surface the lighter coloured pigment cells of the neck region are seen to be placed in a single lateral and a medial double row.

The darker cells are found in a well-marked single row along the mediad wall of the contractile lacuna and are plentiful, but without any apparent regular arrangement in the dorsal body wall.

The lighter cells appear as five irregular rows in each side of the body.

In a living specimen the two eye-spots are very conspicuous. They are of a rich dark reddish-brown colour, larger than any of the pigment cells and characterised by their regular outline in place of the fringed appearance of the pigment cells. In the drawing they are shown as seen from the ventral surface through the body tissues.

A microscopic examination of the caudal fin of a living sand whiting to which a leech was attached showed a remarkable similarity in colour and arrangement of the pigment cells of the two animals.

So far as my observations go the pigment cells lose their fringed character in strong light and become more regular in outline.

MOVEMENTS.

During my observations of living specimens I never saw an individual swimming, neither could I, by dropping the leeches into salt water, cause any swimming motion. They would fall straight to the bottom of the beaker and then move slowly along the surface of the glass by leech-like movements. These observations were made on leeches ranging in size from 2 to 12 mm. They have a bearing on the question of the deposition of the cocoon and the manner of infestation of sand whiting by young leeches. Johannson (1898), writing

about *Abranchus* (a genus allied to *Austrobdella*), correlates the fact that the members of this genus are unable to swim, with the fact that they infest fish which live in shallow water among algal growths and so afford an opportunity for leeches to creep on to them. He also supposes that when the time comes for depositing the cocoon *Abranchus* drops to the bottom and fixes its cocoon in seaweed. I have not ascertained the method of depositing the cocoon in *Austrobdella*, but would point out that the fish on which it lives gets a great deal of its food by burrowing in the sand.

ANNULATION.

A typical somite consists of three annuli, and in the adult these three annuli are divided so that the somite is of six annuli. In young forms the somite consists of the three primitive annuli; this is followed by a stage in which there are five annuli to the somite, due to the division of the annuli anterior and posterior to the annulus in which the nerve ganglion is situated. This stage of five annuli to the somite may persist in specimens which are quite large, but in the largest specimens all the somites in the testicular region have six annuli. Thus it happens that specimens 6 mm. in length are seen, in which the primitive annulus containing the nerve ganglion is still undivided. It is owing also to this subsequent division of primitive annuli that a difficulty arises in regard to the number of annuli to be seen in the neck region, for these increase in number with the length of the specimen. In a leech of 4 mm. the male pore is between the 15th and 16th primitive annuli and the female pore between the 17th and 18th annuli. At this stage the somite in the testicular region is still trimerous. In a leech of about 9 mm. there are found twenty-three or twenty-four annuli in front of the male pore. The primitive annuli which divide to form the new annuli are the 4th, 5th, 7th, 10th, 11th, 13th, 14th, and 15th (Text-fig. 2). In regard to the total number of annuli, my determinations have been varied owing to the fact that

the annulation of the posterior part of the leech is very indistinct, so that in specimens in which the annulation of the neck

TEXT-FIG. 2.

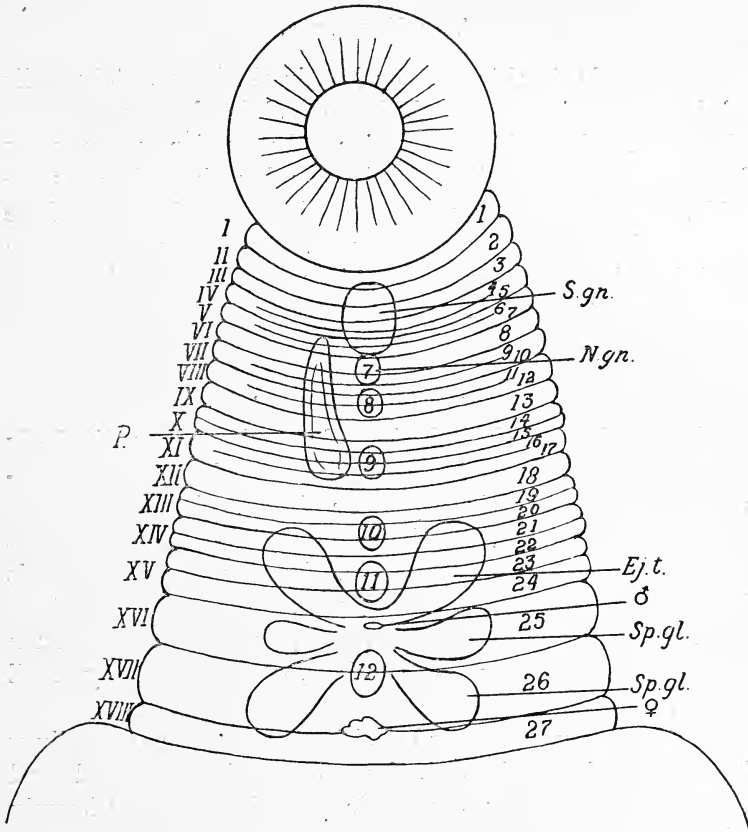

Diagram showing the character of the annulation of the preclitellar and clitellar regions of *Austrobdella translucens* and the relations of the nerve ganglia, proboscis, and sexual organs. *S.gn.* Subesophageal ganglia, *N.gn.* Nerve ganglion. *P.* Proboscis. *Ej.t.* Terminal part of ejaculatory canal. *Sp.gl.* Spermatophore glands. ♂ Male opening. ♀ Female opening. Roman numerals indicate primitive annuli, ordinary numerals the subdivision of the primitive annuli.

and mid-body can be seen, that of the posterior part of the body is not evident.

The relations of the nerve ganglia, male and female openings, and the male glands to the neck annuli are shown in Text-fig. 2.

THE EPIDERMIS.

The cuticle is thin, $2\ \mu$ or less in thickness. The cells of the epidermis are irregularly cubical in shape, measuring about $8\ \mu$. Towards the anterior and posterior suckers they become more cylindrical and have a length of $14\ \mu$ by $5\ \mu$ wide. On the ventral surface towards the median plane these epidermal cells are not so numerous. But a few of them are slightly enlarged and converted into gland cells with ducts opening on the surface.

HYPODERMAL GLANDS.

There is developed on the lateral margin of the main body region, partly surrounding the contractile lacuna, a remarkable layer of cells, three or four deep and of great size (Pl. 2, fig. 9, *L. gl.*). Each is a unicellular gland and its duct opens on the ventral surface. The largest of these cells has a diameter of $63\ \mu$ and the size ranges from this to about $15\ \mu$. The shape varies considerably, but in all the secretion space passes gradually into the duct, which has a very small lumen.

The nucleus varies a good deal in appearance; generally it is more or less spherical, but frequently elongated and twisted; it has many chromatin particles staining heavily with hæmatoxylin.

These glands appear to correspond to certain cells, not so well developed, called the lateral glands in Branchellion by Sukatschhoff (1912).

As is general in Ichthyobdellids, both mucous and albuminous unicellular glands are present in the two suckers.

In the oral sucker the albuminous glands are arranged around the dorso-lateral three-fourths of the sucker. They are placed inside the circular and longitudinal musculature of

the sucker wall, and, measuring about $20\ \mu$ in diameter, are about half the size of the same glands in the posterior sucker. Among them are placed the smaller mucous glands, and both types of glands open by ducts on the concave surface of the sucker. In the posterior sucker these glands are distributed over the whole sucker. The mucous glands are found also forming a pharyngeal group with ducts opening into the pharynx, and they extend posteriorly and lie among the salivary glands but nearer the body wall; they are not present below the glandular œsophageal pouches.

CLITELLAR GLANDS.

As has been remarked by various authors, the development of the unicellular glands in the Ichthyobdellids is most remarkable. To quote Bourne (1884): "They attain relatively, and in Pontobdella and Branchellion actually, huge dimensions."

In this leech the largest among these cells have a diameter of $170\ \mu$, and, if they are situated far back in the body, a duct 7 or 8 mm. long. The clitellar glands extend in the body region from the posterior sucker to the beginning of the clitellum.

They are placed inside the body wall musculature and occupy practically all the space between it and the alimentary, reproductive, and lacuna systems. Text-fig. 3, drawn from a transverse section through the region of the thick-walled middle gut, shows the degree of development of these glands (*Cl. gl.* 1, *Cl. gl.* 2).

Their ducts open all round the clitellum, that is from the level of the 10th nerve ganglion to midway between the 12th-13th nerve ganglia. Sukatschoff's (1912) excellent work on these glands showed that in Branchellion there were three types producing different secretions, and he gives a description of extraordinary development of the branched nucleus, which may come to measure $336\ \mu$ and which he compares (p. 488) with other examples of nuclei of this type in the animal kingdom.

In *Austrobdella* I shall content myself for the present with the appearances presented upon staining with Ehrlich's hæmatoxylin and eosin. By this means there are clearly differentiated two types of clitellar glands. The larger of these cells (Text-fig. 3, *Cl. gl.* 1), which are bowl-shaped or more elongated, are characterised by their large secretion space filled with a homogeneous substance showing a finely granular nature when highly magnified, and staining a light pink with eosin. These cells, which have an average diameter

TEXT-FIG. 3.

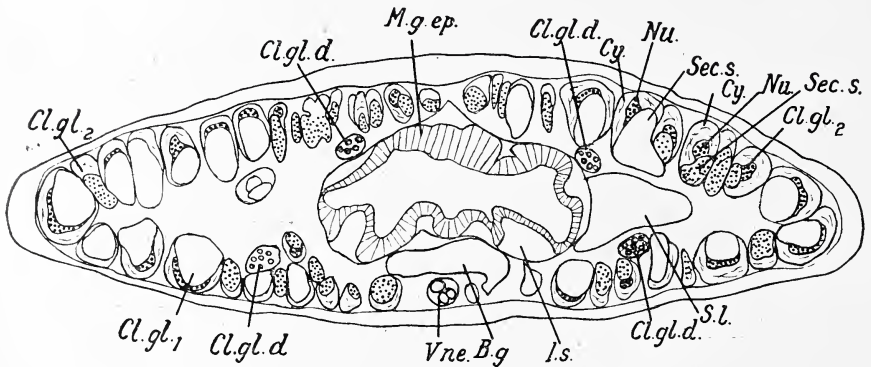

A transverse section through the thick-walled, middle-gut region of *Austrobdella translucens* ($\times 40$), showing the arrangement, development and character of the clitellar glands. The relation of the intestinal sinus to the epithelium of the thick-walled middle gut is shown. A portion of a segmental lacuna of one side is present. The blind gut has been cut at its narrowest part. *Cl. gl.* 1. Clitellar gland of the first type. *Cy.* Cytoplasm. *Nu.* Nucleus. *Sec. s.* Secretion space. *Cl. gl.* 2. Clitellar gland of the second type. *Cl. gl. d.* Groups of ducts of clitellar glands. *V. ne. B. g.* Ventral nerve cord. *B. g.* Blind gut. *S. l.* Segmental lacuna. *I. s.* Intestinal sinus. *M. g. ep.* Epithelium of thick-walled part of middle gut.

of 110μ , have the bulk of their cytoplasm at the peripheral end in a layer, which is 30 or 40μ thick, and which lines, as it were, the secretion space, becoming finer towards the ducts. This cytoplasm is of very coarse structure, and the nucleus, which is rich in large chromatin particles, has an irregular shape, as described by Sukatschoff in *Branchellion*, and is

placed next to the secretion space (Text-fig. 3, *Cy., nu., sec. s.*).

The other type of clitellar gland cell (Text-fig. 3, *Cl. gl.*; 2) is distinguished by the intense staining of the secretion by

TEXT-FIG. 4.

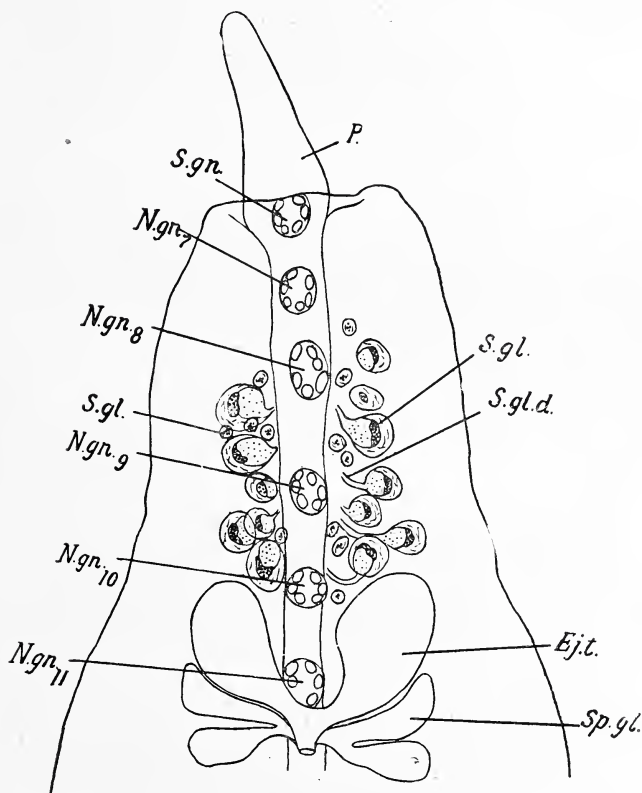

Drawn from a whole mount of a specimen of *Austrobdella translucens* 6 mm. long ($\times 100$) which was killed when the proboscis was protruding. The figure shows the character of the salivary glands and their relations to the nerve ganglia. *P.* Proboscis. *S.gn.* Subesophageal nerve ganglion. *N.gn. 7.* Seventh nerve ganglion. *S.gl.* Unicellular salivary gland. *S.gl.d.* Unicellular salivary gland duct. *Ej.t.* Terminal part of the ejaculatory canal. *Sp.gl.* Unicellular spermatophore glands.

eosin. This secretion is coarse and consists of particles of 2μ in diameter. These cells, which are a good deal smaller than those of the first type, have a diameter of about 60μ , and are placed in between the larger cells beneath the body wall musculature, as well as internal to the larger cells, and a few are found outside the salivary glands with their ducts passing

TEXT-FIG. 5.

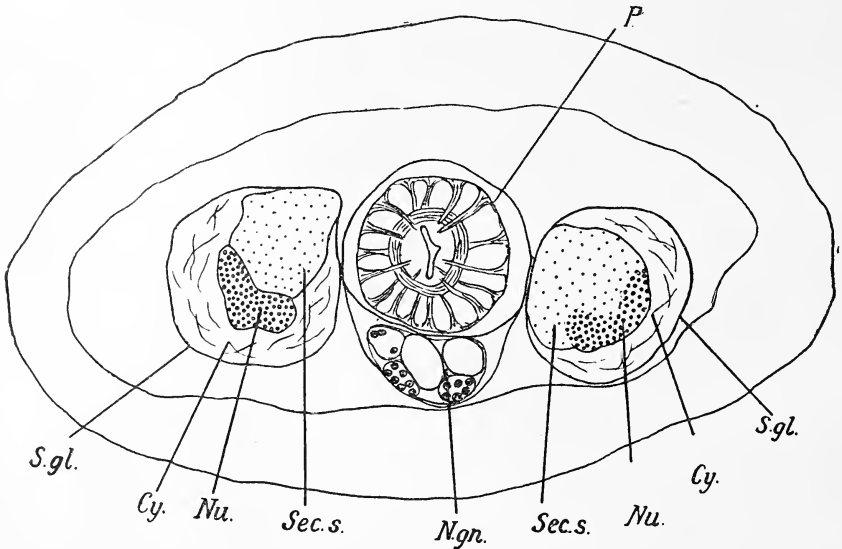

Transverse section through the preclitellar region of a specimen of *Austrobdella translucens* 7 mm. long ($\times 186$). The drawing shows the character of two of the unicellular salivary glands and their relatively large size. The position and character of the nucleus which is next to the secretion space is also shown. *S. gl.* Unicellular salivary gland. *Cy.* Cytoplasm. *Nu.* Nucleus. *Sec. s.* Secretion space. *N. gn.* A ganglion of ventral nerve cord. *P.* Proboscis.

back to open on the clitellum. The nucleus, which is irregular in shape, is either next to the secretion space or in it, and separated from the cytoplasm. The ducts of these two types of cells, filled with their characteristic secretion, are gathered into four bundles, which, just before the clitellum, are placed two in the dorsal and two in the ventral region.

The ducts of the larger glands have a diameter of $8\ \mu$, the smaller $6\ \mu$.

SALIVARY GLANDS.

The salivary glands, as shown in Text-fig. 4 (*S. gl.*) are placed between the upper level of the eighth, and the lower level of the tenth nerve ganglion. On either side of the proboscis there are about five or six giant-cells and a number of smaller ones. The large cells have a diameter of about $120\ \mu$, and other cells range in size from that down to $20\ \mu$. Their ducts curve at right angles to the body of the cell and enter the base of the proboscis. The character of these cells and their relatively huge size is shown in Text-fig. 5. The position of the nucleus, which is next to the secretion space, is also shown.

THE CÆLOMIC SYSTEM.

We owe to Johansson (1898) and to Selensky (1906) our main knowledge of the cœlomic system of the Ichthyobdellids other than Pontobdella, Branchellion, and Ozobranchus. The former in 1896 pointed out the great value of the knowledge of this system in systematic work, giving a number of examples of the chief features in different Ichthyobdellids. This leech, while possessing the main features of the cœlomic system as described for Piscicola and Callobdella, diverges widely in certain respects. This divergence is most marked in that part which corresponds to the contractile vesicles of Piscicola and Callobdella.

In Austrobdella, in place of a lateral row of such vesicles, there is a continuous contractile lacuna. This lacuna occupies the position of the contractile vesicles, as described for allied genera, lying laterally just beneath the skin outside the muscle layer. On either side it extends from the level of the proboscis to the level of the anus, but is contractile only in the region of the testes and the thick-walled intestine. This genus differs also in wanting altogether the lateral

lacuna found in a number of Ichthyobdellid leeches; a fact of considerable importance when considered in relation to the direction of the flow of lymph in the body-cavity. Proceeding to a detailed examination there are found the following lacunæ: Dorsal, Ventral, Contractile, and the Segmental Lacunæ.

I shall follow Oka and Selensky in the use of the term "lacuna" in place of "sinus" in dealing with the various portions of the cœlome, reserving the term "sinus" for the blood-space found round the intestine called by Johansson the "intestinal lacuna."

The Dorsal Lacuna may be considered in two parts, the testicular and the intestinal portions. It extends from the beginning of the testes to the anal region. In the testicular region it contains the dorsal blood-vessel (Pl. 2, fig. 8, *Dl.*); in the intestinal region it surrounds the thick-walled intestine and the blood-stream in relation with it.

Posteriorly the intestinal portion communicates with the ventral lacuna in the anal region. In each segment the dorsal lacuna communicates by a pair of segmental lacunæ with similar extensions of the ventral lacuna (Pl. 2, fig. 8, *S. l.*). The wall of the testicular portion of the dorsal lacuna has a thin well-defined membrane with small elongated nuclei, which are scarce. Beneath this membrane are a few muscle-fibres.

The musculature is increased where the dorsal blood-vessel is fused with the wall of the dorsal lacuna.

Frequently the dorsal lacuna is divided into two parts by the formation of septa placed dorsally and ventrally to the dorsal blood-vessel (Pl. 2, fig. 10, *Sep. d. Sep. v.*). Such septa generally begin with the origin of the valves of the dorsal vessel, but do not extend to the preceding or succeeding valve-origin; so that at certain places the dorsal blood-vessel lies free in the dorsal lacuna.

The Ventral Lacuna (Pl. 2, fig. 8, *v. l.*) occurs as a tube, which varies in size and runs from the anal region to the proboscis, ventral to the alimentary canal. Throughout

its extension it contains the ventral nerve cord and the ventral blood-vessels.

Anteriorly it is considerably expanded and entirely surrounds the proboscis and related organs.

A considerable expansion of the lacuna also contains the ovaries, and again it is dilated in the region of the posterior ganglionic mass. A pair of segmental communications is given off at the level of each nerve ganglion, joining with those given off more posteriorly in each segment by the dorsal lacuna.

Everywhere the ventral lacuna is lined by a membrane of the same character as that of the dorsal lacuna, but the muscle-fibres are few.

The Segmental Lacunæ, as already mentioned, extend from the dorsal and ventral lacunæ. They unite towards the lateral region of the body, just past the testes of each segment, and are also found in the thick-walled intestinal region. Reference to the figure of the Cœlomic System (Pl. 2, fig. 8) will aid the explanation of the course and branching of the segmental lacunæ.

Immediately after the junction of the dorsal and ventral extension, the lacuna divides and more laterally each division again divides in two; of the four ultimate branches, the two inside ones unite and open into the contractile lacuna (Pl. 2, figs. 8, 9, *S. l.*).

The two outside branches unite with the outside branches of the preceding and succeeding segmental lacunæ respectively. Thus it follows that in each segment there are two openings of the segmental lacunæ into the contractile lacuna. These openings into the contractile lacuna are furnished with muscle-fibres of annular arrangement and sphincter action.

The lining of the segmental lacunæ is a continuation of that of the dorsal and ventral lacunæ; no muscle fibres are found in their walls.

Contractile Lacunæ.—These extend on either side from the level of the base of the proboscis to the level of the anus, but are only contractile from the beginning of the testicular region. As already stated, their chief feature is their

extension as tubes in place of the row of vesicles found in allied genera. They possess, as shown in Pl. 2, fig. 9 (*C. l.*), the character of a series of pouches; their walls are furnished with delicate muscle fibres. Anteriorly the contractile lacunæ cease to be contractile at the level of the neck but are continued forward as non-contractile parts to the anterior sucker. I have not determined their course past this point, but they certainly do not appear to break up into capillaries.

Posteriorly their relations are more important. At the level of the posterior sucker they curve sharply, and, passing ventral to the two branches of the dorsal vessel, open into the lacuna in the anal region. They receive on either side of each segment the two openings of the segmental lacunæ (Pl. 2, fig. 8, *C. l.*). Dorsally in each segment they give off three or four pairs of capillaries (Pl. 2, fig. 8, *Cap. l.*); these run parallel to one another, just outside the muscle layer. In one living specimen I observed these opening into the dorsal lacuna, but was unable to demonstrate this in other specimens.

In *Callobdella* Johansson has seen three or four pairs of capillaries in each segment going from the dorsal lacuna and stretching into the surrounding tissue.

The Circulation of the Lymph.

In the description of the circulation of blood in the vessels mention will be made of the contraction of the pouches of the thick-walled intestinal region. By these contractions a space is produced between the wall of the intestinal sinus and the wall of the intestinal lacuna, which is immediately filled by the lymph flowing in from the lacuna formed in the anal region by the fusion of the dorsal and ventral lacunæ. When the intestinal sinus is again in the condition of diastole, the lymph is seen to be forced out of the dorsal lacuna and to flow into the segmental lacunæ. At the spot where the dorsal and ventral extensions of the segmental lacunæ join a great deal of regurgitation takes place. The lymph corpuscles

are seen to be violently hurried in various directions. Some are driven into the extensions of the segmental lacunæ on either side, some towards the ventral lacuna, but the majority pass through the openings leading to the contractile lacuna. These are immediately closed by the annular muscle fibres (Pl. 2, fig. 9, *S. m. f.*), which function as a sphincter when the contractile lacuna begins to contract. This contraction is from before backward and the lymph is carried to the lacuna, lying in the anal region, formed by the fusion of the dorsal and ventral lacunæ, whence it flows again into the dorsal lacuna. The contraction of the contractile lacuna immediately follows the diastole of the intestinal sinus, and the dorsal blood-vessel in the testicular region; so that it is seen, in a leech freshly taken from an ocean whiting, to take place about thirty times per minute.

In this description of the cycle of the circulation of the lymph, it will be observed that the events taking place in the ventral lacuna are not mentioned. This is due to the relative stagnation of the lymph in this lacuna. Despite repeated attempts to find a definite direction of flow in the ventral lacuna, I have been unable to observe anything more than a great deal of regurgitation both in this and the ventral parts of the segmental lacunæ. Frequently strong currents carry lymph corpuscles from the dorsal segmental lacunæ far into these lacunæ, and these, and other corpuscles therein, are kept in constant movement by eddies. But there appears to be no such definite direction of flow as is present in the dorsal and contractile lacunæ.

Comparison with the Lymph Circulation of other Leeches.

Salensky's (1906) description of the valve arrangement in the side vesicles of *Piscicola* makes evident the course of the circulating lymph in this leech and affords an interesting comparison with the circulation above described.

In *Austrobdella* I consider the contractile lacunæ, on account of their subcuticular position and pouched character,

to be homologous with the paired vesicles of other Ichthyobdellid leeches. They perform the functions of the side vesicles and lateral lacunæ of Piscicola-like forms. In place of the valve described by Salensky, there are found openings guarded by sphincter-muscle fibres.

The contraction of the dorsal vessel in the testicular region is not caused by the lymph flowing back from the lateral regions, as described by Johansson (1896 *b*) for *Callobdella*, for here in the segmental lacunæ the flow is always to the contractile lacunæ. It is mainly caused by the flow of lymph from behind and partly by the contractility possessed by the blood-vessel itself.

ALIMENTARY SYSTEM.

Here I shall employ the terms used by Sukatschoff (1912) in his excellent description of this system in *Branchellion*. The mouth opening is placed slightly towards the dorsal side of the anterior sucker and leads into the short pharynx (Text-fig. 6, *M.*). Following the pharynx is the œsophagus, which contains the proboscis characteristic of the Rhychobdellid leeches and capable of being protruded by the eversion of the pharynx and œsophagus. There follows then the entodermal anterior gut.

The proboscis, when retracted, occupies somites 7, 8, and 9 (Text-figs. 2 and 6, *P.*). The proboscis sheath consists of a thin ectodermal epithelium covering a number of longitudinal muscle fibres. It corresponds very closely to the same structure described in *Branchellion* by Sukatschoff—the

TEXT-FIG. 6.—Diagram of the Nervous, Alimentary and Reproductive Systems of *Austrobdella translucens*. ($\times 20$). *A. g.* Cæca of anterior entodermal gut. *A. m. g.* Cæca of anterior thin-walled part of middle gut. *A. s.* Anterior sucker. *B. g.* Blind gut. *Ej. t.* Terminal part of ejaculatory canal. *M.* Mouth opening. *M. g.* Cæca of thick-walled part of middle gut. *M. g. f.* Flexure of thick-walled part of middle gut, representing a rudimentary pair of cæca. *N. gn. 7.* Nerve ganglion 7, etc. *Œs.* Œsophagus. *Œs. gl.* Œsophageal glands. *Ov.* Ovary. *P.* Proboscis. *P. gn.* Posterior ganglion of ventral nerve cord. *P. s.* Posterior sucker. *R.* Rectum. *S. gl.* Salivary glands. *Sp. gl.* Spermatophore glands. *S. gn.* Subœsophageal ganglionic mass. *T.* Testis.

TEXT-FIG. 6.

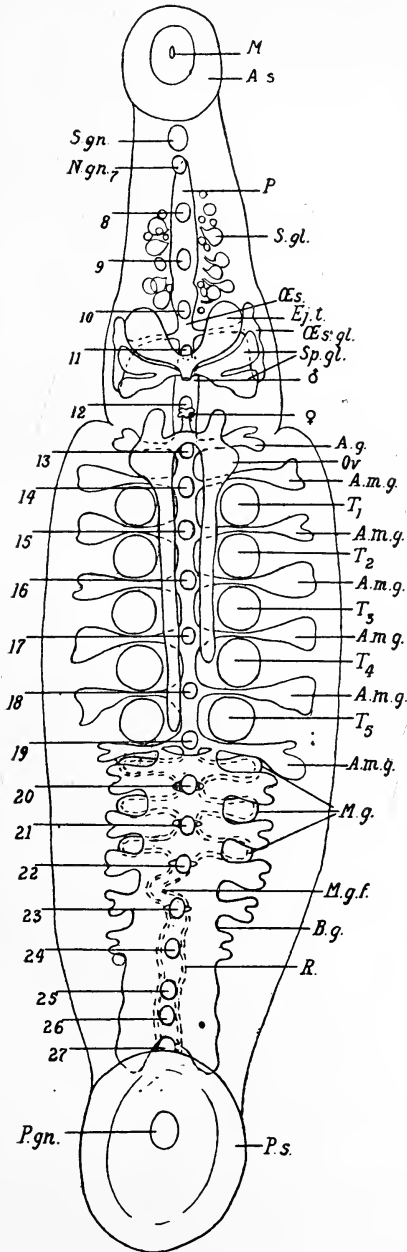

only difference being that the nuclei of the ectodermal epithelium cells are more numerous, there being always one and sometimes two between each bundle of muscle fibrils (compare Sukatschoff, fig. 73).

The proboscis is covered by a thin epithelium, beneath which are the longitudinal muscle fibres arranged in similar fashion to those of other Ichthyobdellid leeches. A number of radial muscle fibres more or less fan-shaped and 15 to 20 in one plane (Text-fig. 5, *P.*) stretch from the periphery of the proboscis to the epithelium lining the lumen. They frequently surround the longitudinal muscle fibres at their expanded ends. Midway between the periphery and the lumen of the proboscis are a series of annular muscle fibres. The epithelium lining the lumen of the proboscis is well developed. There is little difference in the muscular structure of the proboscis from that figured by Sukatschoff for *Branchellion* and by Johansson (1896) for *Callobdella lophii* and *Abranchus brunneus*. In the spaces between the radial muscles are placed the ducts of the salivary glands and the blood-vessels of the proboscis.

When the proboscis is retracted it lies surrounded by its sheath in the anterior lacuna, its apex lying close to the sub-oesophageal ganglion.

The lumen of the proboscis opens posteriorly into a slight expansion of the entodermal anterior gut, which has been called the bulb in *Branchellion*.

The gut narrows immediately and gives off in somite 11 a pair of oesophageal glands (Text-fig. 6, *Æs. gl.*). These lie in somites 10, 11, and 12, and communicate with the oesophagus by a very narrow lumen (5 to 10 μ in diameter) in the eleventh somite just above the nerve ganglion. These glands are placed dorso-lateral to the accessory male glands and are somewhat convoluted. They measure .3 mm. in a longitudinal direction, and may, when distended, measure .1 mm. transversely. Glands of this nature were first described by Johansson (1896) for the Ichthyobdellid leeches *Piscicola*, *Callobdella*, and *Abranchus*.

In 1913 Sukatschoff described similar glands in *Branchellion*, and compares them to the œsophageal glands of *Hæmenteria costata* described by Kowalevsky (1900), and to similar glands of *Clepsine plana* figured by Whitman (1891); Hemmingway (1912) found them also in the Glosiphonid leeches *Placobdella pediculata* and *P. parasitica*.

Both Johansson and Sukatschoff state that they are glandular organs and that fish blood-corpuscles are not found in them, and I agree with them.

The nuclei of the epithelial cells which line these glands are of the same character as those of the following pouches of the thin-walled parts of the middle gut, but they are larger, some being twice the size.

At the level of the opening of the female pore that is just below the 12th nerve ganglion the second pair of pockets of the anterior entodermal gut is given off (Text-fig. 6, *A. g.*). They have wide openings into the gut and are somewhat convoluted at their blind ends. These pouches appear to correspond to those figured in *Branchellion* by Sukatschoff (fig. 85, *V. d. t.* 2), and are homologous with the following six pairs of the anterior thin-walled division of the middle gut. Their difference in form is caused by their being pressed forward by the cocoon gland ducts, which prevent lateral distention. Behind this pair of pouches there is a sphincter of annular muscle fibres.

Following the anterior entodermal gut is the middle gut, which is divided into—

- (1) An anterior thin-walled part (Text-fig. 6, *A. m. g.*).
- (2) The blind gut (Text-fig. 6, *B. g.*).
- (3) A dorsal thick-walled part (Text-fig. 6, *M. g.*).

The anterior thin-walled division of the middle gut lies in the testicular region, and consists of a small median tube from which are given off six pairs of cæca opposite to nerve ganglia 14 to 19 inclusive. The position and form of these six pairs of cæca are shown in Text-fig. 6, *A. m. g.*

These pouches are lobed at their blind ends by the presence

of dorso-ventral muscle fibres, which produce two or more lobes in a distended pouch. A sphincter of annular muscle fibres surrounds the tube just before and immediately behind the first pair of pouches, and dorso-ventral muscle fibres are also present about the neck of the following pouches and may act as sphincters. A similar arrangement has been described by Sukatschoff in *Branchellion*, but Johansson (1896) states that all the pouches of this part of the gut of *Callobdella nodulifera* have sphincters of annular muscle fibres.

The anterior thin-walled part of the middle gut is followed ventrally by the blind gut (Text-fig. 6, *B. g.*), which in *Austrobdella* consists of a pair of elongated pouches which open into the last pair of cæca of the thin-walled part of the middle gut. They extend back to the anal region and are fused with one another in five places. In fact the fusion is so complete that the parts which are not fused form merely four small apertures. When this blind gut region is filled with fish corpuscles there is seen on either side a series of cæca extending laterally, which decrease in size from before backwards. The extent of the development of this blind gut has an important bearing on an interesting hypothesis put forth by Johansson (1898). All the thin-walled parts of the middle gut are lined by a single layer of flat epithelial cells, which become considerably stretched when a pouch is distended, but are well developed in the median parts. Weak muscle fibres are occasionally present, and the pouches are generally filled with undigested fish blood-corpuscles.

A comparison of the blind gut region of *Austrobdella translucens* with Johansson's (1898) figures shows that here the development of the blind gut is intermediate to that found in *Callobdella nodulifera* and *C. lophii*. In this paper Johansson compares the structure of this blind gut region in the different Ichthyobdellids and divides them into three types. The first, and in his opinion the most primitive, type is represented exclusively by the genus *Abranchus*, which has two completely, or almost completely, separated blind pouches. The second type, represented exclusively by the

genus *Pontobdella*, has a single large undivided blind pouch. The third type, to which all remaining genera belong, shows transition forms between these two types. They have blind pouches fused for a greater or less extent in five places. In this group he placed the genera *Platybdella*, *Piscicola*, *Cystobranchus*, and *Callobdella*, and by the researches of Sukatschoff (1912) *Branchellion* must be included along now with *Austrobdella*. The development of the structure of the blind gut seen in the second and third types Johansson correlated with the fact that the leeches possessing it are enabled to exist for some time away from a host by reason of the greater storage capacity produced by this partial or complete fusion: and with the fact that it is found along with well-developed musculature indicating good swimming power in such genera as are likely to experience difficulty in finding a fresh host. To this likely hypothesis as to the cause of the development of this fusion of the blind pouches *Austrobdella* affords little support. In fact, the case presented here is almost as hard to fit in with Johansson's hypothesis as that of *Callobdella lophii*, to explain which Johansson (1898) has to say that "it is hardly too bold to think that this leech never leaves its host." He offers no explanation as to how the cocoons are deposited, though elsewhere he states that all *Ichthyobdellids*, so far as is known, deposit their cocoons away from their hosts. Here I may mention a note by Leigh-Sharpe (1913) about the capture of a large angler (*Lophius piscatorius*), only a few hundred yards from shore, with five specimens of *C. lophii*. Now in *Austrobdella* the blind gut is better developed than in *C. lophii*; the musculature is weak (about the same as *C. lophii*), and the ability to swim absent. The sand whiting, on which *Austrobdella* is exclusively parasitic, so far as I can ascertain, is common, and lives in very shallow water and feeds along shoals and beaches, frequently burrowing in the sand. According to this mode of life, following the reason used by Johansson for *Abranchus*, there should be little need for extra storage of food, yet in *Austrobdella* I find a development of the blind gut about

half that of *Callobdella nodulifera*, a species parasitic on a deep-water fish; however, the latter has better muscular development. It seems that the explanation of these apparent exceptions to what appears to be a well-reasoned hypothesis can only be gained when the life history of these leeches is discovered. The only record of *Austrobdella translucens* being found away from its host is a curious one, a specimen being found by Prof. J. P. Hill some years ago in the gastric pouch of a jelly fish (*Cambessa mosaica*).

The dorsal thick-walled part of the middle gut.—In *Austrobdella* only three pairs of pouches are developed in this division (Pl. 1, fig. 1, *M. g.*). The fourth pair of thick-walled pouches is present only in a rudimentary state. The first pair of pouches lies between the 19th and 20th nerve ganglia (Text-fig. 6, *M. g.*); the fourth, which in other Ichthyobdellid leeches is placed between the 22nd and 23rd nerve ganglia, is represented here by a flexure of the intestine (Text-fig. 6, *M. g. f.*) The cells of the epithelium lining this part of the gut have their free surfaces covered with a film of densely-placed cilia, so that they present a fringed appearance in section, similar to that described by Sukatschhoff as occurring in *Branchellion* (1912, Fig. 78). There does not appear to be present a section of the gut bearing a ciliated epithelium of the usual type, such as occurs in *Branchellion* and in other Ichthyobdellids (Johansson, 1896 *a*). Following the thick-walled part of the middle-gut there is the posterior gut, formed chiefly by the rectum (Text-fig. 6, *R.*), which opens by the anus on the dorsal surface of the 27th somite. The walls of this portion of the gut are muscular and the epithelium is similar to that lining the thick-walled part of the middle gut, but is not ciliated.

THE BLOOD-VASCULAR SYSTEM.

Following the well-known work by Oka in 1894, dealing with the blood-vascular system in *Clepsine*, there appeared the investigations of Johansson (1896 *b*) and Selensky (1906).

relating to this system in *Piscicola*. In 1902 Oka published a paper, in which he summarised his investigations concerning the blood-vascular system in the various families of the Hirudinea. In a lucid manner he showed that only in the Glossiphonidæ and Ichthyobdellidæ was a true blood-vascular system present and that it had no communication with the lacuna system. Again, in 1904, Oka described in some detail the vascular system in *Ozobranchus*. My investigations of *Austrobdella* have shown that a closed blood-vascular system is also present here.

In general this system in *Austrobdella* resembles that described in *Ozobranchus* and differs from the *Piscicola* and *Callobdella* type.

There are, however, several important differences from *Ozobranchus*. The lateral paired branches in the anterior part of the body are three as compared with the four pairs found in *Clepsine* and the Ichthyobdellid leeches so far described. It is the second pair which are wanting. There is also a ring vessel in the posterior sucker with which the loops from the dorsal and ventral vessels connect; this is a very different arrangement from any so far described.

Lastly, the division of the dorsal vessel into two parts takes place in the 24th somite, which is much higher up than in *Clepsine* and *Piscicola*.

I have been favoured in these observations on the blood-vascular system by the transparent nature of the leech. The diagram of the blood-vascular system (Pl. 1, fig. 2), is a careful representation of the course and relations of the blood-vessels in the neck and anterior sucker.

The course of the blood-vessels is as follows :

The dorsal blood-vessel gives off, in the anterior part of the body, three pairs of lateral branches, and an unpaired proboscis branch. The first of these (Pl. 1, fig. 2, *L. v. 1.*), is formed by the forking of the dorsal vessel in the oral sucker. The two branches given off run round the eye-spots and unite in the region of the subœsophageal ganglion to form the ventral blood-vessel. The course of this first pair of lateral

vessels is very similar to that found in *Ozobranchus* (Oka, 1904, Fig. 1). The second pair of lateral vessels (*L. v. 2*), is given off in somite 9; these branches run ventrally and anteriorly, and unite with the ventral vessel just behind the spot where the first pair join. The third pair of lateral vessels (*L. v. 3*) are given off in somite 10; the two branches run at first posteriorly to the end of somite 11; then they curve sharply and, running forward, enter the ventral vessel, just behind the point of entry of the second pair of lateral vessels.

Immediately in front of the first valve the dorsal vessel gives off the proboscis branch (*P. v. 1.*) which runs to the apex of the proboscis and there bifurcates. The two vessels thus formed unite almost at once to form the efferent proboscis branch (*P. v. 2.*), which runs to join the ventral vessel, just behind the point where the second pair of lateral vessels enter into it. After emerging from its intimate relations with the cæca of the thick-walled intestine posteriorly (*I. s.*), the dorsal vessel divides in two at the beginning of the 24th somite. These branches extend in such a way as to form a vessel running round the periphery of the posterior sucker. This part of the dorsal vessel gives off on each side four or five short-looped vessels, which communicate with a ring vessel (*R. v.*) running right round the periphery of the posterior sucker. This ring vessel receives on each side seven branches of the ventral vessel. A certain degree of anastomosis is seen in these branches before they unite to form the ventral vessel. I have followed the course of this ring vessel in living leeches obtained from different places.

As stated in the account of the cœlomic system, the dorsal blood-vessel lies in the dorsal lacuna, or its extension the intestinal lacuna, for almost the whole extent of these lacunæ. Anteriorly the dorsal vessel passes out of the lacuna at somite 13. Pl. 2, fig. 12, shows the vessels in the 11th somite shortly after the dorsal blood-vessel has left the lacuna. The ventral vessel is lying free in the dilated lacuna which surrounds the accessory male glands.

Posteriorly the two branches of the dorsal blood-vessel in the 26th somite leave the lacuna, formed by the union of the intestinal and ventral lacunæ, and enter the connective tissue to course round the periphery of the posterior sucker.

The ventral vessel lies in the ventral lacuna from the 7th to the 26th somite. It is formed by the union of the first pair of lateral vessels, just above the 7th somite. These lateral vessels enter the lacuna opposite the spot where they fuse. The ventral vessel lies quite free in the ventral lacuna above or at the side of the nerve-cord and always above the nerve ganglia. It leaves the ventral lacuna near the same spot as the dorsal vessel in the 26th somite.

The histological features of the blood-vessel walls agree closely with those described for *Callobdella* by Johansson (1896 *b*) and for *Piscicola* by Salensky (1906).

The dorsal vessel, immediately on passing out of the dorsal lacuna, develops in the 13th somite a strong muscle layer of annular nature internal to a layer of finer muscular fibres. This structure continues until the diameter of the dorsal vessel becomes smaller after the proboscis branch has been given off. The anterior part of the dorsal vessel takes its origin in a peculiar way from that part of the dorsal vessel which has a much greater diameter. On the side of the dorsal vessel, opposite to the point of origin of the proboscis vessel, this anterior part lies laterally to the dorsal vessel and opens into it at two places, both of which are guarded by valves. The lateral vessels, possessing this well-developed muscle layer for but a little distance after they spring from the dorsal vessel, gradually come to resemble the ventral vessel in the nature of their walls. The wall of the dorsal blood-vessel in the dorsal lacuna possesses only a thin epithelium, with scattered nuclei (Pl. 2, fig. 10, *Nu. epi.*), save only at those places where the valves are placed. Here there are one or two annular muscle-fibres, such as are found in the preclitellar region, and which, in contraction, form a sphincter, against which the valve is pressed by the backward pressure of the fluid during the contraction of the dorsal vessel (Pl. 2,

fig. 11, *S. m. f.*) In somite 19 the dorsal vessel enters into intimate connection with the cæca of the thick-walled intestine. This remarkable arrangement was first described by Johansson for the Ichthyobdellids in *Callobdella*, and in many respects the relations of the blood-vessel with the gut-walls, as described by him, hold good also for *Austrobdella*.

Text-fig. 3 shows the relations of this vessel with the epithelium and muscular walls of the gut. At the beginning of the thick-walled intestine, the dorsal vessel is seen connected with the muscular layer of the gut, and almost immediately it opens on either side into the intestinal sinus, and ceases to be distinguishable from the walls of the sinus.

The intestinal sinus is formed by the separation of the epithelial and muscular walls of the gut. This separation is not complete in *Austrobdella*, for here and there the normal relations of the epithelial layer and the muscle layer are seen (Text-fig. 3, *M. g. ep.*), but save at these places of attachment, which are usually small, the blood-stream surrounds the epithelial layer of the thick-walled intestine. These relations are such as described for *Callobdella*. In the intermediate portions of the thick-walled intestine, which connect the paired pouches, the dorsal blood-vessel separates from the intestinal sinus and lies in the dorsal side of these regions. Also, in the region of the fourth rudimentary pair of cæca, the sinus developed from the dorsal vessel is very small, and only for a short distance does the dorsal vessel cease to be defined: following this part the dorsal vessel is clearly defined and remains single until above the ganglion of the 24th somite; here it divides in two. The two branches then run laterally to the gut closely connected with its muscular wall. In the 27th somite these two vessels diverge and run round the periphery of the posterior sucker on either side and finally unite (Pl. 1, fig. 2). The valves in the dorsal vessel are found from just before the giving off of the second pair of lateral vessels to the beginning of the intestinal sinus (Pl. 1, fig. 2, *Vl.*). They are placed somewhat irregularly, one or two in each somite. They are generally shaped

like a fir cone, measuring 80μ long, and are made up of about eight cells. In some cases these cells become separated and present the appearance in section shown in Pl. 2, fig. 11. The valve placed just before the intestinal sinus is twice the length of the others.

Circulation of the Blood.

I have investigated the circulation of the blood and the lymph in living specimens found on whiting which I caught on the ocean beach. The chief mechanism for propelling the blood is the peristaltic contraction of the muscular wall of the intestinal sinus, first described by Johansson (1896). This peristalsis occurs in the three pairs of pouches of the thick-walled intestine and also in the rudimentary pouch. In the living animal the whole of the thick-walled intestine is in a state of active contractile movements. These begin where the thick-walled intestine passes into the rectum. The general movement is from behind forwards. The whole of the contractile muscular wall appears to contract simultaneously when the animal is very active, but in specimens in which the rate of contraction is lowered it is seen that the peristalsis is from behind forward. There is seen, however, a certain amount of individual contraction of separate paired caeca. The most active specimens I examined showed a rate of contraction of over thirty times per minute. The blood forced forward by the contractions is prevented from flowing back by the valves of the dorsal vessel.

In the dorsal vessel the backward pressure of the blood causes the valve to press against the sphincter fibres of the dorsal vessel just behind it. Very rapidly the blood passes onward, and the next valve acting in the same manner, the first valve is again forced forward by the incoming blood. The constriction of the dorsal vessel is much greater at the sphincter muscle fibres than elsewhere. So great indeed is the contraction here that the dorsal vessel resembles a string of sausages. The constrictions being at the points occupied

by the sphincters (Pl. 1, fig. 2, *Vl.*), the dorsal vessel in the testicular region is caused to contract by the pressure of lymph in the lacuna, so that its walls come into contact. In this manner the blood is forced forward and ultimately enters the paired branches; these are not provided with valves. The blood then passes along the non-contractile lateral vessels into the non-contractile ventral vessel and so through the complicated branches in the posterior sucker, until it again reaches the intestinal sinus. The important relation of the contractions of the muscular walls of the intestinal sinus to the flow of the lymph and the contractions of the contractile lacuna has been dealt with in the section describing the circulation of the lymph.

NEPHRIDIAL SYSTEM.

There are eleven pairs of nephridia arranged segmentally in the 13th to the 23rd somite. These form what is practically a continuous network in this area. However, this is so arranged that the segmental character of the nephridia is obvious. An inspection of Pl. 2, fig. 7, will make this clear. The best developed parts of the nephridia are two tubes (*L. n. c.*), which are placed ventral to that part of the lacuna formed by the fusion of the dorsal and ventral segmental lacunæ. These tubes have a diameter of about $40\ \mu$, while the diameter of their lumen is $5\ \mu$. They pursue a tortuous course and frequently branch, and the branches anastomose. They give off in each somite branches which run to open at the nephridiopore (*Np.*), and they receive the branches which run from the dorsal and ventral networks.

The paired branches, which are given off in each somite to open at the nephridiopore, are of the same size as the chief branches of the lateral canals. They are given off from the lateral canals near the level of the first annulus of the segment, and run medially and posteriorly, curving sharply as they approach the ventral lacuna at an angle of 45° (*Np. b.*). They run laterally for about half the distance of their first course

and open on the second annulus of each segment. The diameter of the aperture of the nephridiopore is about 5μ . In each segment the lateral canals receive three or four main branches, which are the outcome of the anastomotic canals. These latter are best developed around the ventral lacuna, but they also surround the dorsal lacuna. The arrangement and relative size of these canals is shown in Pl. 2, fig. 7.

As is general in Hirudinea, the canals of this nephridial system are intracellular. The cells, which are burrowed through by these canals, have oval nuclei.

The nephridiopores open directly on the body surface and not into pits, like those of *Cystobranchus*.

Neither in the living animal nor in serial sections have I been able to find internal openings, so that the ciliated funnels, possessed by *Branchellion* and *Pontobdella*, are here absent. In this respect then *Austrobdella* resembles *Piscicola*, *Callobdella*, *Cystobranchus*, *Abranchus*, and possibly *Platybdella*.

This nephridial system is most like that described by Johansson for *Callobdella*. It differs in the much greater development of the branch going to the nephridiopore, and the greater degree of anastomosis of the smaller channels.

In *Austrobdella* there exists on either side a fine canal, which may represent the dorso-lateral canal described for *Callobdella*. The lateral tubes are well developed in *Austrobdella*, being 40μ as compared with *Abranchus* and *Callobdella* 20μ , *Piscicola* 30μ , but again are smaller than *Cystobranchus* 50μ (Johansson, 1896).

REPRODUCTIVE SYSTEM.

Thanks to the excellent work of Brumpt (1900), 'Reproduction des Hirudinées,' it is possible to compare the reproductive organs of *Austrobdella* with those of allied leeches. This species in its male organs resembles most *Callobdella* (*Trachelobdella*) *lophii* as regards the structure of the ejaculatory canal, but it lacks the muscular organ of Johansson

and the conducting tissue of the bursa described by Brumpt. Of the spermatophore glands, those described by Brumpt as A and B glands are present, while I am doubtful as to the presence of C glands. The glands A are well developed, and are enclosed in the muscular tunic of the terminal parts of the ejaculatory canals. The glands B, and perhaps C, surround the terminal parts of the ejaculatory canals and open into the common part. Here the resemblance, owing to the development of the A glands, is more to the *Glossiphonid* type than to *C. lophii*.

In the female organs, owing to the isolated ovaries and the absence of both copulatory area and conducting tissue, *Austrobdella* resembles *Callobdella lubrica*, *Platybdella solea*, and *Glossiphonia complanata*.

Concerning the interesting fertilisation by means of hypodermic injection of spermatophores, which Brumpt has shown to be true in most marine leeches, I have not yet ascertained if a similar phenomenon occurs in *Austrobdella*. I hope later again to keep these leeches in captivity and to endeavour to bring about copulation with a view to determining this point.

There are five pairs of testes (Pl. 1, fig. 1, *T.*, Text-fig. 6, *T.*) placed in somites 14–18 inclusive. The vasa deferentia (Pl. 2, fig. 12A, *V. def.*) on leaving the connective-tissue, become more than doubled in their diameter and constitute the ejaculatory canals, which lie in the expanded anterior end of the ventral lacuna. These ejaculatory canals become considerably coiled at the level of the 12th nerve ganglion (Pl. 2, fig. 12A, *Ej. c.*), and the lumen of each increases slightly and forms a seminal vesicle. They then come into close relation with the dorsal blood-vessel (Pl. 2, fig. 12, *Ej. c.*) and shortly open dorso-laterally into the terminal parts of either side (Pl. 2, fig. 12A, *Ej. t.*). The terminal parts of the ejaculatory canals are provided with a muscular tunic (Pl. 2, fig. 12, *Ej. t.*) which encloses the unicellular glands, called the A glands by Brumpt (1900). The two terminal parts open into a common part, the spermatophore sac of

Kovalevsky (1900) (Pl. 2, fig. 12A, *Sp. s.*), into which open the ducts of the unicellular spermatophore glands called the B glands by Brumpt (Pl. 2, fig. 12, *Sp. gl.*). The spermatophore sac leads into the bursa—an ectodermal invagination, whose external opening is the male orifice (Pl. 2, fig. 6). The muscular tunic of the terminal parts consists of a single layer of fibres imbricated at their ends. About four to six fibres complete the circuit. At the anterior end the wall becomes two or even three fibres thick. This circular musculature is continued on around the spermatophore sac, but here the fibres, placed two deep, are separated from those on either side by the ducts of the spermatophore glands. At the bursa the fibres decrease to a single layer, and placed external to them are several longitudinal fibres, apparently the diverted fibres of the body-wall muscles round the male genital opening, which may aid in the protrusion of the bursa (Pl. 2, fig. 6). The terminal parts of the ejaculatory canals are lined throughout with gland cells, the ducts of which run radially and are directed towards the spermatophore sac (Pl. 2, fig. 12, *Ej. t.*). These ducts almost obliterate the lumen into which they pour their secretion. There are found among these ducts the small cells of the supporting tissue.

The cytoplasm of these glands stains more deeply with hæmatoxylin than those of the accessory male glands outside the muscular tunic.

These latter cells make up a well-developed glandular mass, which lies in somites 11 and 12 (Text-fig. 6, *Sp. gl.*). Each is a unicellular gland (Pl. 2, fig. 12, *Sp. gl.*) and opens into the spermatophore sac. On either side this mass presents two lobes caused by dorso-ventrally placed muscle fibres.

The development of these glands is such that they wrap round the terminal parts of the ejaculatory canals (Pl. 2, fig. 12, *Sp. gl.*).

The secretion space of each cell is generally filled with numerous granular eosin-staining particles, as are also the ducts opening into the spermatophore sac.

I have not determined, by the staining methods of Brumpt, if there are two kinds of gland cells present; but in sections stained by hæmatoxylin and eosin they appear to be all of one kind.

The bursa, which is shown in Pl. 2, fig. 6 (a medial sagittal section) is lined by a continuation of the epidermis of the body.

The ovaries, which are two simple sacs lying free in the ventral lacuna, show considerable movement in the living animal—a fact which Moquin-Tandon (1846) says caused Rondeau to take them for hearts in certain leeches. They become united just above the 13th nerve ganglion, and from their junction the oviduct (Pl. 2, figs. 6, 12A, *Ovd.*) runs dorsally and curves to enter the glandular part of the bursa (Pl. 2, figs. 6, 12A, *B. gl.*). After their junction, the ovaries are continued forward to form each an anterior horn. The oviduct, which has a small lumen (Pl. 2, figs. 6, 12A, *Ovd.*), has a wall of circular muscle fibres, and external to these a well-developed connective tissue layer with large nuclei, such as Brumpt has described as general in Ichthyobdellids, and through which, he says, spermatozoa are frequently seen working their way.

The epithelium lining the vagina is a continuation of the epidermis of the body, which is thrown into folds in the glandular part of the bursa.

The ovaries in adult specimens are filled with ova in various stages of development. The development of the ovum (Pl. 2, fig. 6, *Ov.*) and the breaking-down of the yolk cells appear to be similar to what occurs in *Callobdella lophii*, as described by Brumpt. Near the oviduct the ova are seen undergoing the first maturation division.

This work was begun while holding the John Coutts' Scholarship. I wish to thank Prof. W. A. Haswell, in whose laboratories I worked, for his advice and kindness. Mr. F. W. Atkins, of the Sydney Technical College, re-drew the figures, and Mr. W. Graham, of the Department of Zoology

here, gave me great assistance with photographs of the living specimens.

LITERATURE.

1. Moquin-Tandon, A. (1846).—'Monographie de la famille des Hirudinées.' Paris.
2. Bourne, A. G. (1884).—'Contribution to the Anatomy of the Hirudinea,' 'Quart. Journ. Micr. Sci.,' vol. 24.
3. Whitman, C. O. (1891).—'Description of Clepsine plana,' 'Journal of Morph.,' vol. iv.
4. Oka, Asajiro (1894).—'Beiträge zur Anatomie der Clepsine.' 'Zeit. Wiss. Zool.' Bd. lviii.
5. Johansson, L. (1896*a*).—'Bidrag till Kännedomen om Sveriges Ichthyobdellider.' Upsala.
6. ——— (1896*b*).—'Über den Blutumlauf bei Piscicola und Callobdella,' 'Festschrift Lilleborg,' Upsala.
7. ——— (1898).—'Einige systematisch wichtige Theile der inneren Organisation der Ichthyobdelliden,' 'Zool. Anzeiger,' Bd. xxi.
8. Kovalevsky, A. (1900).—'Étude biologique de l'*Hæmenteria costata* Müller,' 'Mém. Acad. St. Petersburg (8) Cl.,' phys. math.,' vol. xi.
9. ——— (1900).—'Phénomènes de la Fécondation chez l'*Helobdella algira* (Moquin-Tandon),' 'Mémoires de la Société Zoologique de France,' Tome xiii.
10. Brumpt, E. (1900).—'Reproductions des Hirudinées,' *ibid.*, Tome xiii.
11. Oka, Asajiro (1902).—'Über das Blutgefäßsystem der Hirudineen,' 'Annot. Zool. Japon,' vol. iv, part 2.
12. ——— (1904).—'Ueber den Bau von *Ozobranchus*,' 'Annot. Zool. Japon,' vol. v.
13. Salensky, Von. W. (1906).—'Zur Kenntnis des Gefäßsystems der *Piscicola*,' 'Zool. Anzeiger,' Bd. xxxi.
14. Johansson, L. (1911).—'Hirudinea, Die Fauna Südwest-Australiens, Hamburger Südwest-Australischen Forschungsreise. 1905.' Michaelson und Hartmeyer, Bd. iii.
15. Sukatschoff, B. W. (1912).—'Beiträge zur Anatomie der Hirudineen. 1. Über den Bau von *Branchellion torpedinis* Sav.,' 'Mittheil. Zool. Station, Neapel,' Bd. xx.
16. Hemingway, E. E. (1912).—'Anatomy of *Placobdella parasitica*,' 'Geol. and Nat. History Survey, Minnesota,' Zool., series v.

17. Leigh-Sharpe, W. H. (1913).—“*Calliobdella lophii*, Van Beneden & Hesse,” ‘*Journal Marine Biological Assoc.*,’ vol. x.

EXPLANATION OF PLATES 1 AND 2,

Illustrating Mr. C. Badham’s paper “On an Ichthyobdellid parasitic on the Australian Sand Whiting” (*Sillago ciliata*).

[All figures refer to *Austrobdella translucens*.]

PLATE 1.

Fig. 1.—Drawing from life. Seen from the ventral aspect by transmitted light. The specimen is somewhat extended so that the shouldered appearance seen in large individuals (vide fig. 5) is absent. The pigment cells (*P. c.*) are represented and the ejaculatory canals (*Ej. c.*) show up on account of their pigmentation. The five pairs of testes (*T.*) are a marked feature. Certain parts of the Blood-vascular System appear, and the thick-walled part of the middle gut stands out clearly (*M. g.*). *A. m. g.* Cæca of anterior thin-walled part of middle gut. *C. l.* Contractile lacuna. *Cl. gl.* Clitellar glands. *E.* Eye spots. *Ej. c.* Ejaculatory canal. *M. g.* Cæca of thick-walled part of middle gut. *Ov.* Ovary. *P.* Proboscis. *P. c.* Pigment cell. *T.* Testis. *V. v.* Ventral vessel.

Fig. 2.—Drawing of the Blood-vascular System from life. The dorsal vessel is shaded, the ventral vessel is outlined. The origin of the dorsal vessel is seen in the posterior sucker; just above the union of the two branches from the posterior sucker this vessel enters into intimate relation with the cæca of the thick-walled intestine to form the intestinal sinus (*I. s.*). After leaving the sinus the dorsal vessel (*D. v.*) has a series of valves (*Vl.*), one being placed where a constriction is seen on contraction. Anteriorly, the dorsal vessel gives off two pairs of lateral vessels (*L. v. 3*, *L. v. 2*) and an impaired proboscis branch (*P. v. 1*), and bifurcates just above the level of the eye spots to form the first pair of lateral vessels. The paired lateral branches are gathered together to form the ventral vessel (*V. v.*). This runs posteriorly and gives off in the posterior sucker a series of anastomotic branches which go to form the ring vessel (*R. v.*). *D. v.* Dorsal vessel. *E.* Eye spots. *L. v.* Lateral vessel. *P. v. 1.* Afferent proboscis vessel. *P. v. 2.* Efferent proboscis vessel. *R. v.* Ring vessel. *Vl.* Valve.

Figs. 3, 4, 5.—Drawings of alcoholic specimens (fixed in boiling corrosive acetic), 1.5 mm., 4 mm. and 9 mm. long respectively. Fig. 3

is a side view, the other two figures are ventral views. This series shows the change from the cylindrical form of the young specimen (fig. 3) to the slightly flattened sexually mature specimen 4 mm. long (fig. 4). The shouldered appearance of the body of the specimen 9 mm. long (fig. 5) and its greatly flattened form are in striking contrast with the form of the younger specimens.

PLATE 2.

Fig. 6.—A medial sagittal section of a specimen 8 mm. long, showing the genital openings, bursæ, oviduct, ovaries, spermatophore sac, and the relations of the ventral nerve cord and the ventral and dorsal blood-vessels in this region. Compare with fig. 12A. The male genital opening is seen at ♂ and the bursa leading into the spermatophore sac (*Sp. s.*). The female genital opening is seen at ♀ leading into the bursa, which has the walls of its dorsal part plicated (*B. gl.*) to form the glandular part of the female bursa. The oviduct (*Ovd.*) has been cut at two places, where it leaves the junction of the ovaries and more dorsally where it is about to enter into the glandular part of the bursa. The sections of the ovaries (*Ov.*) show ova in various stages of formation by the breaking down of yolk cells; the two spindles represent maturation divisions. The relations of the ventral nerve cord and ganglia 11, 12, 13 to the sexual organs are shown, and may be compared with the model depicted in fig. 12A. The ventral vessel (*V. v.*) is seen lying free in the expansion of the ventral lacuna which contains the sexual organs in this region. The dorsal vessel (*D. v.*) is seen as it is entering the dorsal lacuna. The degree of development of the circular and longitudinal body-wall musculature is displayed. *B. gl.* Glandular part of female bursa. *C. m.* Circular body-wall musculature. *D. v.* Dorsal vessel. *L. m.* Longitudinal body-wall musculature. *N. gn.* Nerve ganglion. *Ovd.* Oviduct. *Ov.* Ovary. *Sp. s.* Spermatophore sac. *V. v.* Ventral vessel.

Fig. 7.—Diagram in relief of the Nephridial System in the testicular region of the body viewed from the ventral surface. The posterior end of the leech would be towards the observer. For the sake of clearness the somite is shown as consisting of the three primitive annuli. In order to show the segmental nature of the nephridial system one whole somite and its portion of the nephridial system is drawn, and parts of the preceding and succeeding somities with their portions of this system. The ventral and dorsal lacuna are shown, but neither the segmental nor the contractile lucunæ. On either side the lateral nephridial canal is seen receiving branches of the fine capillary network of nephridial tubules which extend in the dorsal and ventral sides of the body. The lateral nephridial canals are shown giving off in each

somite the pair of branches (*Np. b.*) leading to the nephridiopores (*Np.*). *D.l.* Dorsal lacuna. *D.v.* Dorsal vessel. *L.n.c.* Lateral nephridial canal. *N.p.* Nephridiopore. *Np. b.* Duct leading to nephridiopore. *T.* Testis. *V.l.* Ventral lacuna. *V.ne.* Ventral nerve cord. *V.v.* Ventral vessel.

Fig. 8.—Diagram in relief of the Lacuna System, viewed from the dorsal surface, in a somite of the testicular region of the body. The dorsal lacuna (*D.l.*) is shown containing the dorsal vessel (*D.v.*). In the ventral lacuna (*V.l.*) are the ventral nerve cord (*V.ne.*) and ventral vessel (*V.v.*). The dorsal and ventral parts of the segmental lacuna of either side of the somite are seen to junction laterally, and after bifurcating to join up with branches from the preceding and succeeding segmental lacunæ of the same side. The segmental lacuna opens into the contractile lacuna in two places in each somite. The contractile lacuna receives in each somite three capillaries dorsally on either side. *Cap.l.* Capillaries opening into contractile lacuna. *C.l.* Contractile lacuna. *D.l.* Dorsal lacuna. *D.v.* Dorsal blood-vessel. *S.l.* Segmental lacuna. *V.l.* Ventral lacuna. *V.ne.* Ventral nerve cord. *V.v.* Ventral vessel.

Fig. 9.—Drawing of horizontal section through the testicular region of the body showing the character of the contractile lacuna (*C.l.*) and the branches of the segmental lacuna (*S.l.*) leading to it. In one place a branch opens into the contractile lacuna and the opening is guarded by sphincter muscle fibres (*S.m.f.*). The large unicellular lateral glands (*L.gl.*) are shown, and the clitellar glands medial to the contractile lacuna. *C.l.* Contractile lacuna. *Cl.gl.* Clitellar glands. *L.gl.* Unicellular lateral glands. (*S.m.f.*) Sphincter muscle fibres. *S.l.* Segmental lacuna.

Fig. 10.—Drawing of a transverse section through the dorsal blood-vessel and dorsal lacuna in the testicular region of the body, showing the dorsal and ventral septa (*Sep. d.*, *Sep. v.*). The nuclei of the epithelial cells of the dorsal vessel bulge into the dorsal lacuna. *D.v.* Dorsal vessel. *D.l.* Dorsal lacuna. *Epi. nu.* Nucleus of epithelial cell. *Sep. d.* Dorsal septum. *Sep. v.* Ventral septum.

Fig. 11.—Drawing of a section through a valve of the dorsal blood-vessel in the testicular region of the body. Usually the valve (*Vl.*) is fir-cone shaped and when forced back rests against the sphincter muscle fibre (*S.m.f.*), but sometimes, as shown here, the valve becomes broken up into separate cells attached to a common stalk. On contraction of the dorsal vessel several cells of the valve may be forced past the spincter, as is shown here. *D.v.* Dorsal vessel. *Vl.* Valve. *S.m.f.* Sphincter muscle fibre.

Fig. 12.—Drawing of a transverse section through the neck region

of a specimen 7 mm. long. The section passed through the eleventh nerve ganglion and is cut obliquely so that the terminal part of the ejaculatory canal (*Ej. t.*) is shown on the right side and the main mass of the spermatophore glands on the left (*Sp. gl.*). The terminal parts of the ejaculatory canals are seen just before they have united to form the spermatophore sac (compare with fig. 12A). The ventral vessel is seen lying free in the ventral lacuna, here expanded to contain the sexual organs. The relations of the ejaculatory canals, œsophagus and dorsal vessel in this region are also shown. *D. v.* Dorsal vessel. *Ej. t.* Terminal part of ejaculatory canal. *Ej. c.* Ejaculatory canal. *N. gn. 11.* Nerve ganglion 11. *Es.* Œsophagus. *Sp. gl.* Spermatophore glands. *V. v.* Ventral vessel.

Fig. 12A.—Diagram in relief of the Reproductive System. The terminal part of the right ejaculatory canal (*Ej. t.*) is shown as cut away for the sake of clearness. The relations of the ventral nerve cord and ganglia to the male and female organs are made evident. *B. gl.* Glandular part of the female bursa. *Ej. c.* Ejaculatory canal. *Ej. t.* Terminal part of the ejaculatory canal. *Ovd.* Oviduct. *Ov.* Ovaries. *Sp. s.* Spermatophore sac. *V. def.* Vasa deferens. *V. ne.* Ventral nerve cord. 11, 12, 13. Nerve ganglia. ♂ Male opening. ♀ Female opening.

**The Development of *Alcyonium digitatum*,
with some notes on the Early Colony
Formation.**

By

Annie Matthews, M.Sc.

With Plates 3-5 and 51 Text-figures.

TABLE OF CONTENTS.

	PAGE
1. Preface	43
2. Introduction	44
3. Methods	44
4. General Account	45
5. Colony Formation	55
6. Food	59
7. Segmentation	60
8. Pre-planula and Planula Stages, followed by Settling of Larva	65
9. Mesoglaea	70
10. Mesenteries	72
11. Tentacles, Mouth and Stomodæum	78
12. Spicules	80
13. Mesenteric Filaments	81
14. Summary	86
15. Literature.	87

1. PREFACE.

I TAKE this opportunity of thanking the Council of the Marine Biological Association for the use of a table while working out these results. Also I gladly acknowledge the kindly and continued help given me by Dr. Allen and the various members of his staff. This generous aid rendered

the work very much easier, and enabled me to get all the necessary stages with a minimum amount of labour. My warmest thanks are also due to Prof. Hickson, of the Manchester University, for many useful hints and for reading through and criticising the completed paper.

2. INTRODUCTION TO THE DEVELOPMENT OF *ALCYONIUM* *DIGITATUM*.

The broad outlines of the development of *Alcyonium digitatum* were worked out by A. Kowalevsky in 1873 (8), and amplified later by Hickson (2, 3, 4, and 4a), and it has been the object of this paper to add further details to the information given by these authors. On the whole the results agree, except in some details concerning the sequence of development of certain organs.

There is an interesting general resemblance between the accompanying sketches of the segmenting egg, the planula and the early fixed polyp, and those previously given by :

- (1) de Lacaze-Duthiers, for *Astroides calycularis* (10).
- (2) Wilson, for *Renilla* and *Leptogorgia* (16).
- (3) Kowalevsky and Marion, for *Sympodium* and *Clavelina* (9).

A comparison of the plates given by these authors with those at the end of the present paper will demonstrate this. In particular, Pl. xiii, fig. 6, of de Lacaze-Duthiers' memoir (10) would illustrate excellently the way in which *Alcyonium* larvæ settled in the finger-bowls in which they were reared, during the experiments now described. Therefore, *A. digitatum* bears out the collected evidence that the Anthozoa develop roughly according to one and the same plan.

3. METHODS USED TO PRESERVE AND STAIN THE *ALCYONIUM* MATERIAL.

- (1) Preserving fluids.
 - (a) Schaudinn's fluid (corrosive sublimate and absolute alcohol).

(b) Corrosive acetic.

(c) Bouin's picro-formol-acetic.

The above three reagents appeared equally good for preserving all stages, except when the structure of the spicules was required. Perhaps (c) was the best general preserving fluid.

(d) Osmic acid, for preparations showing spicules and nematocysts.

(2) Staining reagents.

(a) Delafield's hæmatoxylin. For morulæ, and well-stained segmentation spindles; also for gland cells in the œsophagus and ventral mesenteric filaments.

(b) Ehrlich's hæmatoxylin, as (a).

(c) Borax-carminé and picro-nigrosin. For planulæ and all subsequent stages; for structure of mesogloæa.

(d) Ranvier's picro-carminé, followed by Kernschwarz, after fixing with osmic acid. For spicule structure. The picro-carminé stains the nuclei, while the Kernschwarz stains the spicule and its surrounding protoplasm.

(e) Iron-brazilin. Good for all settled stages, gland cells, etc., in combination with some plasma stain, e. g. safranin.

4. GENERAL ACCOUNT.

Ripe male and female colonies¹ of *Alcyonium digitatum* are brought in by the trawlers in the Plymouth district from early December to early February, and fertilised eggs were obtained:

(1) Between January 27th and February 13th, 1912.

(2) Between December 10th and February 10th, 1912-1913.

(3) Between December 14th and February 10th, 1913-1914.

¹ Hermaphrodite colonies occasionally occur, male and female polyps being present. Hermaphrodite individuals are also sometimes found in these colonies, such exceptions finding a parallel in the case of *Corallium nobile* (11).

These eggs were successfully reared in the Plymouth laboratory. The above data shows that *A. digitatum* spawns during two of the coldest and stormiest months of the year, when the supply of material is necessarily uncertain, and therefore the work of collecting the various segmentation stages is, as a rule, unavoidably spread over the whole of the spawning season. The colonies used for this paper came from the trawling ground between the Dodman and the Eldystone, i. e. outside and some miles west of Plymouth Sound. They reached the laboratory in good condition in buckets of sea-water, and after being well washed the ripest colonies were selected, the choice being easily made, as ripe ova are deep reddish-yellow in colour, and ripe sperm sacs a very opaque white. The colonies were then placed by themselves in one of the laboratory tanks, through which a constant stream of sea-water circulated, care being taken to avoid overcrowding. As the colonies generally remain healthy for only a few days in the laboratory tanks, even under the most favourable conditions, rarely expanding fully and possibly never feeding, those chosen must be in the best condition and ready to spawn.

Some hours later the circulation was stopped and the female colonies soon spawned in the still water. It seems essential to have the water still, as this is favourable to the necessary expansion of the very sensitive polyps. Simultaneously the male polyps discharged from their mouths large quantities of spermatozoa which swam freely and fertilised the floating ova. On microscopic examination the latter were then seen to be completely covered by a delicate fringe of spermatozoa which gave them a pseudo-ciliate appearance, but the "cilia," i. e. the tails, of the spermatozoa were non-motile.

It was impossible to distinguish the particular sperm which fertilised the ovum, or to say when this occurred. Different colonies began to extrude their ova at varying times of the day or night (unlike *Renilla*, which spawns only between 6 and 7 a.m. (16)).

The eggs of any one colony were passed out con.

tinuously for several days, until the spawning was complete.

On January 3rd, 1913, a spawning colony was placed in a beaker of water and closely watched from 11 a.m. to 3 p.m. The majority of the polyps were expanded while their tentacles were half retracted; others were only partly expanded (c.f. Text-fig. 1). Five eggs were successively extruded at regular intervals from the mouth of one polyp during a period of fifteen minutes. They passed up the stomodæum one by one and after escaping from the mouth remained in contact with the tentacles and oral surface until some slight

TEXT-FIG. 1.

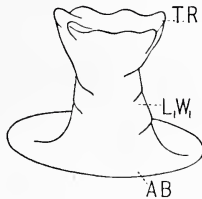

Solitary polyp, lateral view. Tentacles retracted, body slightly contracted. This also illustrates the appearance of the colonial polyp white spawning.

motion of the water finally dislodged them, when they floated upwards. In some cases several eggs were seen in the stomodæum simultaneously, one below the other, and in squeezing upwards through this narrow tube they became temporarily oval but regained their round shape after extrusion. The transparent membrane which surrounded them before spawning, and which always envelops eggs taken forcibly from the mesenteries, was thrown off during the process of spawning, and the empty membranes were ejected into the water after the ova.

Although artificially fertilised ova did in some cases segment satisfactorily, it was found more practicable for rearing on a large scale to collect the fertilised ova from the tank where they were naturally spawned and fertilised. To do this the water was siphoned over into white dishes, from which the eggs were removed with a pipette.

The eggs are opaque, very yolky, and reddish-yellow in colour. They are about 0.5 mm. in diameter, and float at

TEXT-FIGS. 1A-8.

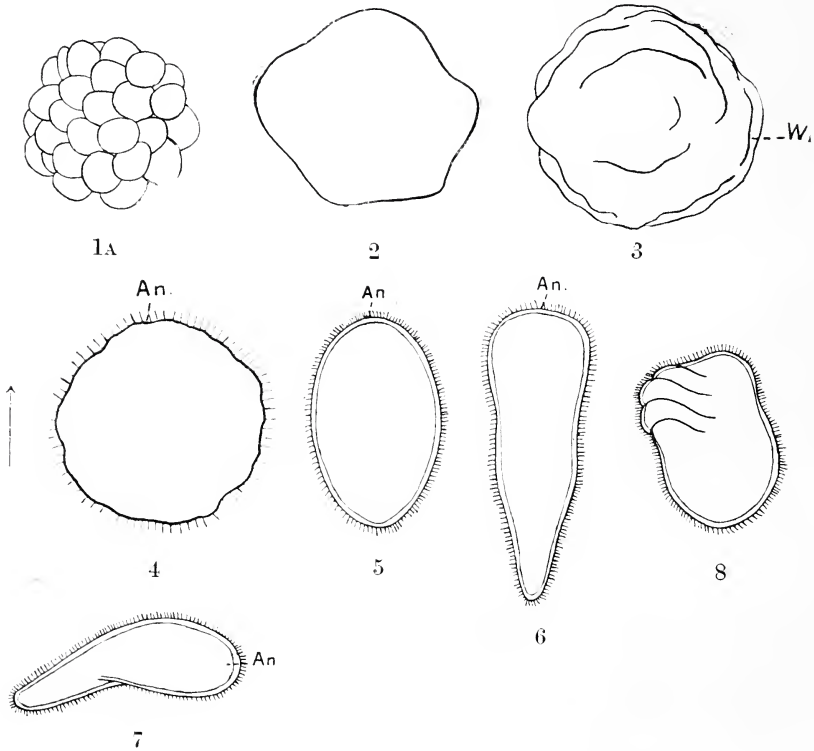

Fig. 1A. Sixty-four celled stage, $\times 46$. Fig. 2. Rather late pre-planula, with prominent lobes, $\times 56$. Fig. 3. Latest stage pre-planula; lobes softened into shallow wrinkles; succeeding Fig. 3. The arrow indicates the direction of progress, $\times 52$. Fig. 4. Round ciliate planula of sinuous outline, succeeding Fig. 3. The arrow indicates the direction of progress, $\times 52$. Fig. 5. Oval planula of smooth outline, twenty-four hours older than last figure, $\times 40$. Figs. 6 and 7 show planarian-like movements of long thin planula, $\times 40$. Fig. 8. Planula showing lateral ridges when contracted due to irritation, $\times 40$.

various depths in the tank as though their specific gravity is very near that of sea-water. After segmentation has begun

they increase slightly in size, and become somewhat paler in colour, and are thus distinct from newly-spawned eggs to the naked eye.

They were pipetted into finger-bowls of "outside" water (water brought into the laboratory from outside Plymouth Sound, and therefore in especially good condition), and development took place at the ordinary and by no means constant temperature of the laboratory. The developing eggs appeared to do equally well in outside, Berkefeld-filtered or ordinary tank water, and many larvæ went through all the stages of development, settled and produced tentacles in the laboratory tank where the eggs were spawned. Twenty-four hours after spawning the embryos were all morulæ, more or less advanced.

Fresh colonies were continually added to the tank, and spent and unhealthy ones removed during the whole of the spawning season. Judging by the proportion of ripe ones brought in, this season reaches its height towards the end of January, and soon declines after that date.

The segmenting egg (Text-fig. 1A) is in all stages typically spherical, though during segmentation some examples may become temporarily oval, regaining their globular shape later. At the close of the morula stage the embryo undergoes a curious change in shape. About the twenty to twenty-fourth hour the whole surface of the sphere is slowly drawn out into irregular blunt prominences with corresponding depressions (Text-fig. 2), the component cells meantime undergoing a modification of structure and the segmentation cavity gradually disappearing. This condition lasts for some time, but about the forty-fourth hour the knobs begin to withdraw again. Wilson (16) mentions a similar stage for *Renilla* and *Leptogorgia*, but apparently did not investigate it closely. As this definite stage is followed by the swimming planula, it was convenient to call it the "pre-planula" stage. By the end of the third day of development the pre-planula no longer shows definite protuberances and depressions, these having softened down into a gently wrinkled outline (Text-fig. 3).

On the fourth day the cells near the centre of the solid pre-planula begin to disintegrate, and so the larva again becomes hollow and passes on into a free-swimming planula stage with a definitely marked anterior pole. This planula develops cilia, is at first roughly spherical and of sinuous outline (Text-fig. 4), but lengthens somewhat in a few hours into a highly contractile oval planula still of wavy outline. By the fifth day it is a smooth oval planula swimming rather slowly at various levels in the water, usually in a horizontal plane (Text-fig. 5). Very soon the anterior end broadens and a pear-shaped planula results, which rotates continuously on its long axis while progressing in the water (Text-fig. 6). The reddish-yellow colour of the ovum is still present, but gradually becomes paler as the yolk is absorbed, and the planula increases in length. The larva continually changes its shape, so that measurements of the ever varying length and breadth are rendered difficult. While swimming it exhibits characteristic planarian-like contractile movements, which are represented in Text-figs. 6 and 7, and any irritation causes strong contraction and lateral wrinkling (Text-fig. 8).¹ By the seventh day the planula is very long and slender, measuring 1.3 mm. long and 0.3 mm. wide, but is not very often fully extended. The anterior and aboral pole is deeper in colour than the narrower posterior and oral pole where more yolk has been absorbed (Pl. 3, fig. 1). The surface at this time is abundantly supplied with nematocysts and mucous cells (Pl. 3, fig. 2), the latter being especially numerous at the anterior pole. At first the planulae swim at varying levels in the bowls, but towards the third free-swimming day they become more sluggish, and most of them keep in a vertical position with the thin aboral end hanging downwards (c. f. de Lacaze Duthiers (10), Pl. xiii, fig. 6). Many then sink to the bottom of the dishes in this position (possibly this is an

¹ All the young stages are very sensitive to heat, and the microscope lamp has to be used with caution while examining them or they quickly die.

attempt to settle), but usually they get caught up here in their own mucus and eventually degenerate.

Some larvæ develop more quickly than others, but usually on the fourth free-swimming day, i. e. the seventh day of development, many larvæ settle. After hovering motionless for some time with the broad anterior pole apparently touching the chosen place for settling, the planula becomes attached (Text-fig. 9). In this they agree with *Symphodium* and *Clavellina* (9). A thin disc of opaque white mucus (the mucous plug) fastens them to the substratum (Pl. 3, fig. 3, *M. P.*), this mucus being secreted by the mucous cells in the ectoderm of the anterior end. In bowls containing water only, the circulation set up by the constantly varying temperature of the laboratory carried many larvæ to the top of the water so that on becoming sluggish they were caught up in the surface film and settled there, either on the film itself or on the glass wall of the dish (c f. de Lacaze-Duthiers (10), Pl. xiii, fig. 6). In the former case the settled polyps also developed perfectly, hanging upside down from the film until this was disturbed, sending them down to the bottom.

In a certain number of bowls, wherein small *Pecten* shells were placed, the larvæ settled in great numbers on both surfaces of the shells and on the parts of the dish sheltered by them, i. e. the base and lower part. In these cases the circulation is modified by the presence of the shells, so the larvæ are less numerous in the surface film. In some dishes the planulæ did not settle until the fifth, sixth, to fourteenth day of free-swimming life, and although these are results obtained under laboratory conditions, a varying length of free-swimming life would obviously help dispersal in the sea, and give more larvæ a chance to find *Ascidians*, *Chætopterus* tubes, *Hydroids*, *Pecten* shells or other suitable objects to settle on. The planulæ often settled so close to one another as to render a group difficult to distinguish with the naked eye from a young colony. All the larvæ did not settle, and

TEXT-FIGS. 9-14.

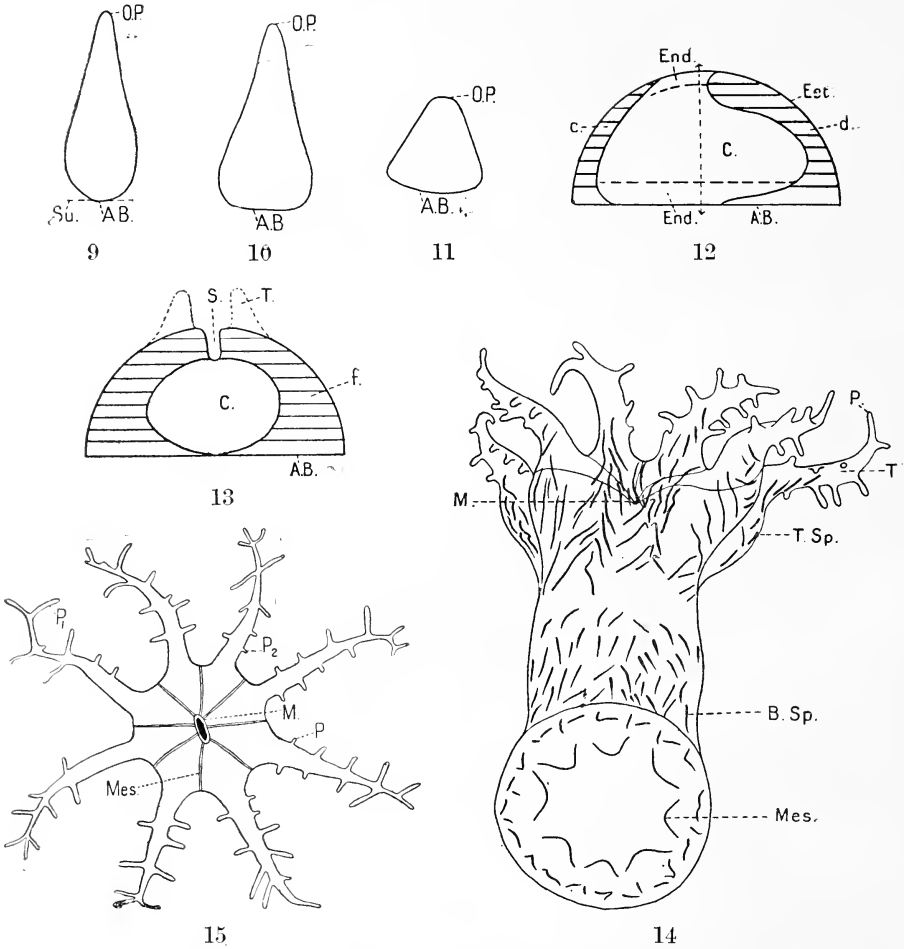

Fig. 9. Planula just settled (cilia not represented). Fig. 10. Same planula a little later, length shortening; still ciliate. Fig. 11. Same, length considerably shortened, cilia retracted. Fig. 12. Vertical section of young polyp arranged to illustrate two stages in the growth of the mesentery. The vertical dotted line divides the two. The mesentery (c) is intermediate in development between mesentery (b) of Text-fig. 40, and mesentery (d) in this figure. A broken line indicates the inner edge of the endoderm. Fig. 13. Similar section on the third day when the stomodæum is developing. The tentacles have arisen, but are shown by dotted lines as they are alternate with the mesenteries. Fig. 14. Lateral view of polyp about eighteen days fixed. Tentacles bearing five to six pinnules and spicules showing well. Fig. 15. Oral view of polyp with five to six pinnules. Tentacles well expanded, mouth almost closed (from bowl, $\times 25$).

those which passed beyond the fifteenth to sixteenth free-swimming day without fixing eventually degenerated.

The base of the newly fixed pear-shaped larva looks like a round pinkish disc from below, the planula for a time retaining its power of planarian-like contraction and expansion (Text-fig. 10). Soon the cilia¹ are retracted (Text-fig. 11), and the fixed polyp shortens first to a stumpy oval shape, and then to a flat mound shape by the end of the first twenty-four hours. At the beginning of the second day the mesenteries show by transmitted light as eight equidistant vertical ridges growing up from the base of the lateral walls (Pl. 3, fig. 4, *P. M.*). These shallow ingrowths almost meet on the aboral and oral surfaces by the end of the second day (Text-fig. 12, *d.*), while eight small blunt conical outgrowths alternating with them on the oral surface indicate the tentacles (Text-fig. 13, and Pl. 3, fig. 5). On the third day the polyp has increased in size, and the stomodæum is formed by an invagination of the oral surface, within the circle of the tentacles (Pl. 3, fig. 6, *M.*). This tube deepens rapidly, and by degeneration of its base the cœlenteron is put in communication with the exterior on the fourth day. Meanwhile the tentacles and body continue to lengthen (Pl. 3, figs. 6 and 7) and soon the former develop two rows of pinnules, seven being the maximum number developed in the laboratory on any one row (Text-figs. 14 and 15). The polyps had on an average produced in each row:

One pinnule by the sixth day.

Two pinnules by the seventh day.

Two to three pinnules by the eighth day.

Three to four pinnules by the tenth to twelfth day.

Five pinnules by the twelfth day.

Six pinnules by the eighteenth day.

Seven pinnules by the twenty-first day.

And while the older pinnules were carried along during development towards the tips of the tentacles, the new ones

¹ No cilia were seen on the ectoderm of the solitary polyp in any subsequent stage.

developed in succession below them, so that the youngest pinnule was always at the base (Text-fig. 15, P_1 and P_2). The numbers were variable in the two rows on any one tentacle, and on the eight tentacles of any one polyp. The tentacles were faint pink in colour at first, but this changed to pale cream during development. Some polyps seemed to develop rather quicker than others, as did the planulae. When fully grown the measurements of the solitary polyp are only about half the corresponding ones of the colonial polyp, i. e. about

TEXT-FIG. 16.

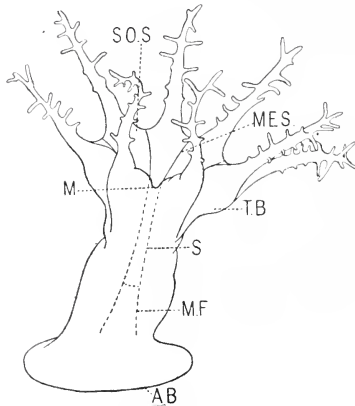

Solitary polyp, settled fourteen to twenty days; tentacles bearing six pinnules, diameter of base 1.2 mm. Lateral view, well expanded (from finger-bowl), $\times 10$.

6 mm. in height, tentacles 3 mm. long, and diameter of base 1.2 mm., while it is much more opaque, and consequently the stomodæum shows less plainly and the mesenteric filaments are obscured. As soon as the tentacles are long enough, they curl gracefully about in the water, seeking food (Text-fig. 16). Any vibration causes them to retract in part or wholly, the polyp in a complete state of retraction appearing as a small pink mound with an opaque centre. The spicules in the tentacles and body nearly meet in the solitary polyp (Text-fig. 14, *T. Sp.*, and *B. Sp.*), whereas they are widely separated in the individuals of older colonies. Some

polyps lived in finger-bowls in the laboratory for about three months, but eventually died without forming colonies. They seemed healthiest when the bowls were immersed in much larger cylinders of sea-water, with the growth of algæ and diatoms checked by limiting the amount of light, and with frequent changes of water. In finger-bowls through which air was constantly bubbled the polyps were nearly always expanded, but in others they were nearly always closed until dusk, although they usually opened if the bowls were removed from their containing cylinders for examination. Hence the polyps seem sensitive to light, currents in the water, and temperature. No regular alternation of the expanded and contracted stages was observed.

5. COLONY FORMATION.

Some of the polyps produced one bud in the laboratory, and one produced two daughter polyps. The finger-bowls were difficult to keep clean, as the algæ and diatoms in the fine townetting, which was added from time to time as food, settled down rapidly as a thick greenish coating. Therefore at this stage, as it seemed unlikely that the colonies would continue to develop in the laboratory, two bowls containing numerous solitary polyps and young colonies were taken out on March 17th, 1914, to Cawsand Bay, just outside Plymouth Sound, to continue their growth. They were fastened in wicker stands which were suspended inside a box-like raft into which the sea penetrated, and were brought in temporarily for examination on the following dates, after which they were always returned :

- (1) April 30th, after one and a half months on the raft.
- (2) July 15th, after four months on the raft.
- (3) September 16th, after six months on the raft.

This experiment was entirely successful, and the polyps gave rise to disc-shaped colonies in the early stages of which the new individuals arose according to a definite plan. As the polyps increased in number the parent individuals seemed

to grow larger themselves, and the number of tentacular pinnules increased gradually from seven to twelve or thirteen. When last examined (September 16th, 1914), although the best developed colony consisted of about thirty-two polyps, they still all grew out of a common flat encrusting base. The following account of the production of new polyps from the parent individual by stolonal gemmation is a summary of observations made on the young stages in the laboratory and the older ones from the raft. Young colonies trawled from the Rame-Eddystone grounds, and growing on *Chaetopterus* tubes, *Polycarpa*, etc., were found quite similar in their plan of growth.

Detailed Account of Colony Formation.

About three weeks after fixation the circular base of the polyp produced a blunt outgrowth opposite the two dorsal mesenteries (Text-fig. 17, *St.*). This stolon increased in size, became of circular outline and separated from the parent polyp by a slight constriction. Soon it produced a bud which rapidly grew into a second polyp (Text-figs. 18 and 19), with its dorsal mesenteries adjacent to the dorsal mesenteries of the parent.¹ Then a second bud formed quite similarly from

¹Hickson (2) describes an *Aleyonium* polyp which bore one bud. The figure he gives (Pl. iii, fig. 24), indicates budding from the lateral wall of the parent polyp, and not stolonal gemmation. It is difficult to reconcile this example with the present account, and no explanation can be offered.

Fig. 17. Aboral view of polyp, showing outgrowth of stolon previous to formation of first bud. Fig. 18. Similar view of well-expanded polyp with one bud. The two pairs of dorsal mesenteries are seen opposite one another, and the long axes of the mouths lie along one line. Fig. 19. Lateral view of colony of two. Size of polyps very similar (from finger-bowl). Fig. 20. Oral view of parent polyp and two buds (from *Chaetopterus* tubes). [In Figs. 20 and 22-25 the common stolon is ruled in with faint lines.] Fig. 21. Aboral view of polyp with three buds (raft). Figs. 22-24. Oral view of colonies showing four, six and eight buds respectively. Buds numbered in order of appearance. Fig. 25. Colony with three rows of buds—aboral view (raft).

TEXT-FIGS. 17-25.

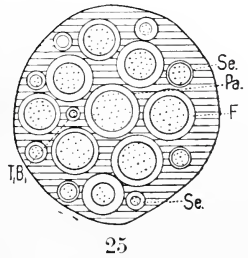
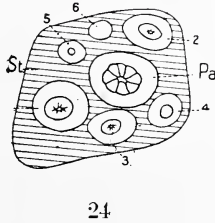
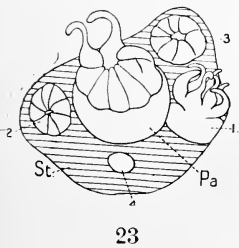
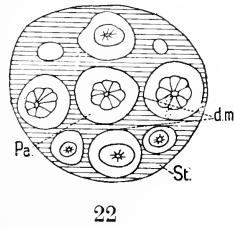
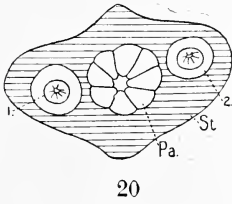
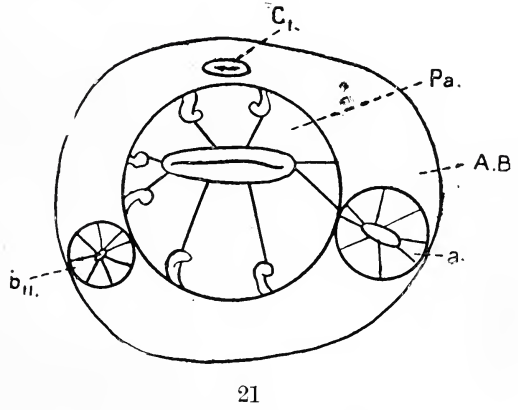
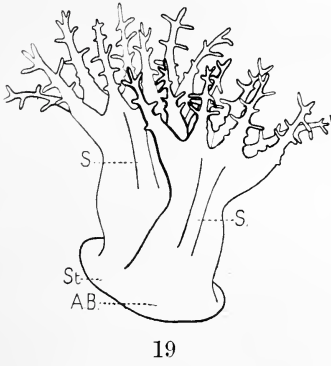
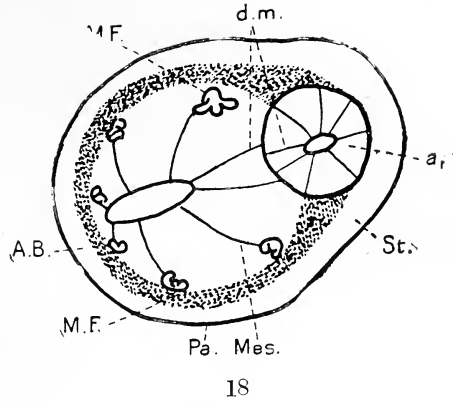
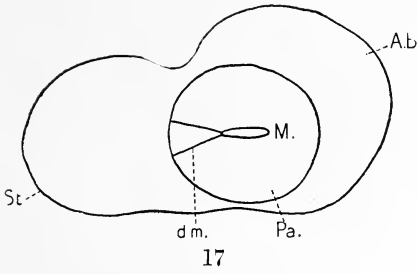

a stolon-like outgrowth on the opposite side of the parent's base and with its dorsal mesenteries likewise turned towards the original polyp (Text-fig. 20). By April 30th the parent polyp bore ten pinnules on the tentacles, many parents showing two buds, and one bearing three (Text-fig. 21). The second bud showed no definite relation to any mesentery, while the third one lay between the first and second (Text-fig. 21, a_1 , b_{11} , and c_1). By mid-July the colony, which consisted on April 30th of four individuals, had altogether produced eight buds by stolonial gemmation, and these lay in a circle around, and all with their dorsal mesenteries turned toward the original polyp (Text-fig. 22), and therefore with the long axis of the mouth lying always along a radius. Possibly this arrangement would facilitate a current of water and food upwards through the young buds from the parent polyp, as the dorsal filaments produce an upward current in *Alcyonium* (Hickson, 3a, and Wilson, 17). Other polyps in the bowl had also produced eight buds, and the rest from six buds downwards (Text-figs. 23 and 24). On September 16th it was found that several colonies had produced about thirty-two individuals, while others were not nearly so far advanced. The younger colonies still retained their circular outline, but the older ones had lost it. One had become quite oval because barnacles had prevented its lateral expansion.

After the production of the first circle of eight buds a second row forms outside these and alternate with them, giving two concentric rows (Text-fig. 25). The second row then increases greatly in number, and, later, young buds appear between the parent of the colony and the first row (Text-fig. 25). In still older colonies this regular system becomes obscured, young and old polyps being irregularly scattered throughout the colony. It was found that colonies dredged in the Sound at this date and on the Rame-Eddystone grounds contained a fair proportion of examples of similar size to those reared on the raft.

6. Food.

This appears to be almost wholly animal. In only one instance was evidence found of any vegetable matter being ingested—when a desmid was seen embedded in an endoderm cell in one of the ventral mesenteric filaments. The polyps reached quite an advanced stage of development while simply using up the embryonic yolk. Several pinnules had developed before this was exhausted, in bowls to which no food had been added. Cultures of *Nitzschia*, *Pleurococcus*, and other very small green algæ were tried as food with no success. Very fine plankton was added regularly to some bowls and to the water of the rearing tank, as adult colonies are known to thrive on Nauplii and small Copepods (12), and on this food the polyps developed six to seven pinnules, and small colonies were produced. The reddish remains of a fairly large copepod was one day found in a polyp, and on two other occasions *Temora longicornis* was swallowed, while *Balanus nauplii* were also accepted. However, those polyps kept in Cawsand Bay flourished best, and while in the laboratory for examination were frequently seen catching and swallowing the larvæ of *Leptoclinum*, which was also growing on the dishes. They were successfully fed with these larvæ and with similar larvæ of *Botrylloides*, from a pipette, and would also take adult individuals removed from these colonies when they were offered. The larvæ were swallowed head first, and the red *Botrylloides* larvæ could be traced excellently. Stages in the swallowing and disintegration of food exactly like those figured by Miss Pratt (12) were obtained. The young colonies showed no evidence of being preyed upon on the raft, nor did the settled polyps in the laboratory tanks, although shrimps ate the eggs and swimming larvæ readily. It was interesting to find a parasitic copepod in the cælonteron of the polyps of the female colonies feeding on the eggs.

7. SEGMENTATION.

The newly fertilised egg is of about 0.5 mm. diameter, opaque, and full of reddish-yellow yolk. It has accordingly to be rolled round in a suitable vessel of sea-water in order that the lobes and segments may be seen. Hence observations are less easy than in the case of the transparent eggs of *Echinus*. The eccentric oosperm nucleus is somewhat oval in shape, and resembles that figured by Hill (5). The problem of the maturation and fertilisation of the egg together with the first divisions of the oosperm nucleus was not attempted, as it is rather outside the scope of this work.

The outstanding feature of the early segmentation in *A. digitatum* is its great irregularity of procedure. It would seem as though the many ways of reaching the morula stage were highly variable and unimportant, the resulting embryos, however, being apparently of one kind. This bears out Wilson's remarks on *Renilla* (16), and is the first of a series of similarities shown during the development of these two *Acyonaria*. No polar bodies are extruded and no outward sign marks the time of actual fertilisation. Before any permanent alteration in appearance occurs the ovum seems to make violent but unsuccessful attempts at division, i. e. the spherical egg becomes temporarily polygonal, the surface being drawn out into irregular high ridges with corresponding depressions, possibly witnesses of internal activity (Text-fig. 26). These ridges disappear after some time and the egg returns to its spherical condition. The whole process may be repeated with no apparent result. In one case the ridges softened down into eight vaguely defined, lighter coloured areas which covered the whole surface of the egg, but these eventually disappeared, leaving a spherical egg as before. In other cases the ovum became temporarily long and oval, but regained its globular shape later. In artificial fertilisations the time elapsing between the adding of sperm to the bowl of ova and the above-described attempts at division varied from half an hour to two and a half hours in different cases. The

interval between the end of this stage and the subsequent formation of definite lobes, and again between the protrusion of lobes and the actual production of blastomeres was also very variable. Before segmentation begins the surface of the egg usually becomes pushed out into eight equal or unequal lobes (Text-fig. 27). However, sixteen lobes are sometimes protruded instead of eight (Text-fig. 28). In one such case the first lobe slowly formed about two hours after fertilisation, and soon afterwards the second, third, and fourth lobes followed, all at one pole (Text-fig. 29, *l.*). Next larger lobes slowly formed towards the opposite pole (Text-fig. 29, *L.*), and while these increased in number all the lobes became more prominent. Two and a half hours after fertilisation the lobes were still increasing in number, and half an hour later still sixteen were counted embracing the whole surface of the egg. Sections of this stage revealed one nucleus only, but in sections of other similar embryos the nucleus was rapidly dividing into daughter nuclei. When only eight lobes form they are necessarily larger in size than when sixteen are protruded (cf. Text-figs. 27 and 28). Great variability, however, exists in the protrusion of lobes; many eggs seem to throw them out in a very irregular manner, the lobes themselves varying in number: thirty-two, sixty-four, and other numbers have been counted.

In the majority of ova, while eight equal or unequal superficial lobes are protruded, the centre yolk remains at first undivided (Pl. 3, fig. 8, *C. M.*). Subsequently the grooves between the lobes deepen, extending towards the centre of the egg, and almost cutting it into eight segments. Finally the segments become rounded off from one another at the centre, leaving a little granular protoplasmic waste in the newly formed segmentation cavity (Text-fig. 30, and Pl. 3, fig. 9, *S. C.*). This cavity persists until the end of the morula stage. Usually the oosperm nucleus is found lying near the region where the first lobes form, and, though it may divide up into eight daughter nuclei while the lobes are being protruded, the fission of the oosperm nucleus is sometimes

delayed until the lobing is complete. Sections of ova during the continual subdivision of the parent nucleus show beautiful

TEXT-FIGS. 26-34.

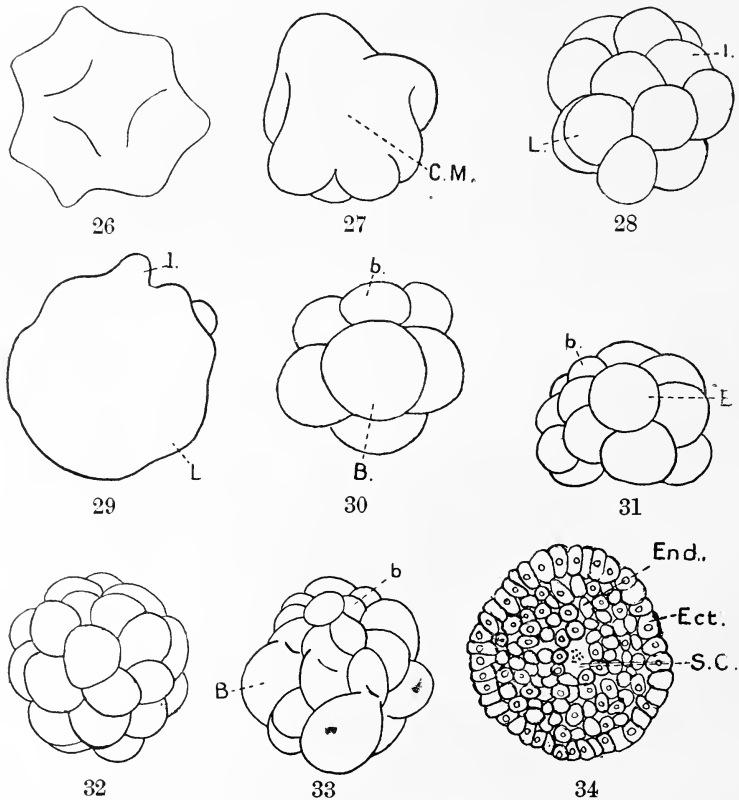

Fig. 26. Egg making abortive attempts to divide, $\times 32$. Fig. 27. Egg with eight unequal lobes, the primary nucleus and central protoplasmic mass being still undivided, $\times 48$. Fig. 28. Sixteen lobes protruded, eight large and eight small, $\times 50$. Fig. 29. Early lobed stage, two hours after fertilisation, $\times 54$. Fig. 30. Egg segmented into four large and four small cells, $\times 42$. Fig. 31. Sixteen cells—eight large and eight small, $\times 42$. Fig. 32. Thirty-two celled stage, $\times 42$. Fig. 33. Segmenting egg with many small cells at one pole, and fewer large ones at the other, $\times 45$. Fig. 34. Sagittal section of late morula, just passing into pre-planula stage, $\times 78$.

karyokinetic figures, one daughter nucleus passing to each of the eight lobes (Pl. 3, fig. 10). After the first segmentation the blastomeres may be uniform or may fall into groups of four large and four small cells (Text-fig. 30), or again may be quite irregular in size. The nucleus in each segment now halves, exhibiting meanwhile well-formed spindles, some with equatorial chromosomes and others with the halved chromosomes at each pole. Then the eight cells divide into sixteen, generally eight smaller at one pole and eight larger at the other. All the blastomeres do not divide simultaneously, and hence stages are found with ten, twelve, or fourteen cells only, but an examination of the nuclei shows that the undivided cells will also shortly segment, giving the typical sixteen cell stage. In some fourteen-celled embryos the nuclei of many of the segments had again halved ready for the thirty-two celled stage before the two slowest of the original eight cells had completed their first division. When sixteen lobes are protruded the egg divides immediately into sixteen cells instead of eight (Pl. 3, fig. 11, and Text-fig. 31). These segments again may be equal or unequal, and are, as in the case of the eight cell stage, separated by a segmentation cavity containing a little waste protoplasm. In all cases the sixteen cells halve, giving thirty-two blastomeres, and here again some segments divide very slowly, and so twenty, twenty-four, and twenty-eight celled embryos occur. The thirty-two blastomeres (Text-fig. 32) may or may not be uniform, and the irregularity in all the previously mentioned stages prepares one for and helps to explain other embryos where the segmentation seems quite irregular, or where numerous very small cells form a cap at one pole over a few large cells at the other (Text-fig. 33). Possibly the large amount of yolk in the ovum causes the unequal segmentation as well as the initial futile attempts at division and the retardation of fission in some blastomeres. The thirty-two celled embryo divides repeatedly, giving sixty-four, one hundred and twenty-eight, etc., cells. By this time the embryo has become two-layered, the segments at each division

becoming smaller and more numerous. Between the periods of division the segments are flattened, but just after segmentation they are very prominent, so that the contour alters considerably. The late morula is approximately spherical, and though during late segmentation it may become temporarily oval it soon regains its round shape. The first delamination cleavage occurs when the nuclei of the sixteen cell stage divide (Pl. 3, fig. 11, *D. N.*). Some of the spindles lie along a radius of the sphere, and hence the resulting daughter nuclei lie similarly, so that a cell is split off towards the centre of the embryo in all such cases, and thus an inner endodermic layer arises (Pl. 3, fig. 12, *End.*). Other spindles lie in a plane at right angles to the radius, and hence these daughter cells lie side by side with the parent cell in the outer ectodermic row (Pl. 3, fig. 12, *N.*). It is thus evident that all of the sixteen cells do not simultaneously contribute to the endoderm layer, and while both ectoderm and endoderm cells continue to divide, later radial spindles in the ectoderm afford evidence that the early endoderm cells are continually reinforced from the ectoderm (Pl. 3, fig. 12).¹ Hence from the thirty-two celled stage onwards the larva is two-layered (Text-fig. 34). The outer layer is somewhat irregular at first (Pl. 3, fig. 12), and, as Wilson says of *Renilla* (16), the ectoderm cells dovetail into those forming the inner mass. The endodermic yolk globules are much larger than those of the ectoderm at this stage (Pl. 3, fig. 21). As the number of cells increases the ectoderm becomes a more regular row of cuboid cells, staining much more deeply than the inner layer of larger polygonal endoderm cells (Pl. 3, fig. 21). Towards the end of the morula stage about thirty-two small cells can be counted round the circumference of the sphere, the ectoderm being now columnar (Text-fig. 34). The yolk in the endoderm has been partly used up, the vesicles having become smaller and similar to those in the ectoderm (Pl. 3, fig. 20).

¹ The writer hopes to discuss the question of the origin of the endoderm in greater detail in a subsequent paper.

Early Embryos in Section.

The granular protoplasm of the unsegmented egg is full of yolk globules. These are largest towards the periphery, while a shallow surface layer of the egg is finely granular and devoid of yolk. These areas are still visible in the eight and sixteen cell stages (Pl. 3, fig. 13), the finely granular surface layer being confined to the outer edge of the blastomeres. The yolk distribution in the later morula stages has been already described, the large round nuclei being surrounded by a deeply staining finely granular area (Pl. 3, fig. 20).

Other Types of Segmentation.

One embryo was sectioned in which an irregular outer layer of blastomeres had been cut off from an inner undivided mass.¹ This example agrees with Kowalevsky's description of the segmentation of the egg of *Alcyonium* (8). In this he relates how a complete covering layer of nucleate ectoderm cells of various sizes was cut off from an undivided central yolk mass, which itself split later into a few large cells, while further divisions of all the cells resulted in a morula similar to those now described. Hickson (4) records a four-celled embryo, and during the present investigations one embryo was followed to the late morula stage from two unequal blastomeres.

8. THE PRE-PLANULA.

After the twentieth hour the spherical morula becomes very gradually distorted, slowly protruding blunt lobes separated by corresponding depressions (Text-fig. 2). It is found that at this time the numerous yolk globules in the columnar ectoderm and the polygonal endoderm are still small and quite similar in the two layers. About the fiftieth hour, when the prominent lobes very slowly begin to soften down again,

¹ Very possibly this egg was unhealthy; it is quoted because Kowalevsky's account of the early development of the egg of *Alcyonium* differs so greatly from what is described above.

the yolk globules become fewer but larger in size, and continue this decrease in number and increase in bulk for some little time, apparently by fusion of the smaller globules (Pl. 3, fig. 18, and Pl. 3, fig. 14, *Y. V.*). Meanwhile the segmentation cavity, which has persisted until now (Text-fig. 34), disappears. The columnar ectoderm cells increase greatly in length and number, becoming very slender, while smaller rounded ones appear among them (Pl. 3, fig. 15, *Ect.* and *R. C.*). The outer halves of the columnar cells have become finely granular, the inner portions still containing yolk globules (Pl. 3, fig. 15, *Gr. E.* and *Y. E.*), while the round cells each contain about four large yolk globules.¹ The innermost endoderm cells, which are also the largest, now begin to degenerate (Pl. 3, fig. 16, c.), and by the continued absorption of these cells a series of cavities forms which presently fuse into one—the coelenteron—the wall of which consists of a layer of endoderm about three cells deep, with the columnar ectoderm outside. As development continues the endodermic layer becomes progressively thinner by the degeneration and ultimate absorption of the inner cells, until it consists of only one row of columnar cells about half as long and twice as broad as the columnar ectoderm cells. Round cells are at this time found lying between the tall ectoderm cells at both their inner and outer ends (Pl. 4, fig. 27, a drawing of the next subsequent stage, which would also serve as a figure of this stage). At times the columnar ectoderm cells proliferate very rapidly, and so the ectoderm becomes temporarily multilayered, soon, however, regaining its normal columnar character (Text-fig. 35). In the final stages (Text-fig. 3), the ectoderm cells of the pre-planula are very deep indeed, and become separated from the endoderm by a thin structureless membrane (Text-fig. 35, *S. M.*). There is no direct evidence to show which layer secretes this, but it seems identical with and indeed an early part of, the meso-

¹Hickson (4a) describes the endoderm in the planula of Alcyonarians as a plasmodium, but from the present account it is clear that in *Alcyonium digitatum* the endoderm is always a definite cellular layer.

glœa of the adult polyp. This being so, the endoderm must be regarded as its source of origin (see p. 72 seq.).

The Planula.

On the fourth day the pre-planula merges into a spherical swimming planula of wavy outline (Text-fig. 4). Cilia are developed by the ectoderm cells, and a definite anterior pole is marked by being held foremost while swimming. The cœlenteron is still partly filled by groups and strings of loose endoderm cells, empty cells, protoplasmic cell contents and yolk. The definite endoderm consists of a row of columnar cells full of yolk vesicles, and roughly pyriform, i. e. rather wider at the free nuclear end than at the base. To the inner edge of the permanent endoderm one or more rows of rounded cells still adhere as in Text-fig. 36. The yolk has all been absorbed in the columnar ectoderm, the cell contents being now granular, while the separating membrane is much more distinct. These ectoderm cells have slightly expanded and flattened bases where they rest on the membrane, and are about as tall as the permanent endoderm cells, and half as wide. Rapid proliferation will again temporarily obscure the columnar character of this layer so that it seems to consist of several rows of round cells, but, as in the previous and subsequent stages, they soon return to their columnar state. In a few hours the round planula has become oval, but at first its outline remains sinuous. The microscopic structure is little altered, save that the degenerating endoderm cells have been absorbed in increasing numbers, while the permanent row of endoderm cells stand out clearly (Pl. 3, fig. 17, c., *End.*). By the fifth day the outline of the planula is smooth, and soon the anterior pole broadens, so that the larva assumes its characteristic pear-shape (Text-fig. 6). It rapidly lengthens, while the permanent row of endoderm cells still shows several rows of rounded or polygonal cells clinging to it in places, and often forming club-shaped projections into the cœlenteron (Pl. 3, fig. 1, and Pl. 3, fig. 17, *C. P.*). Increase in the number of endoderm

TEXT-FIGS. 35-37.

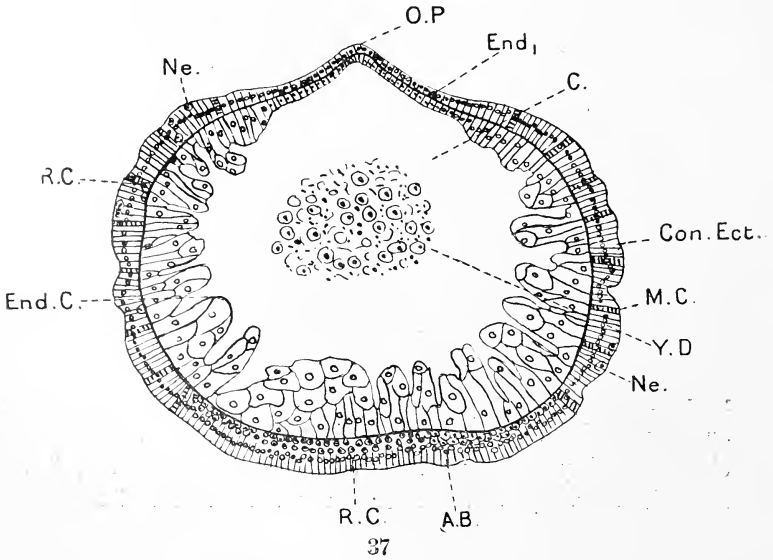
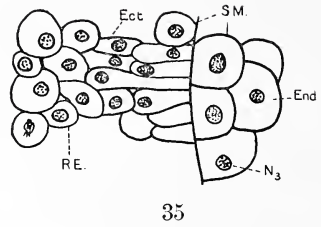
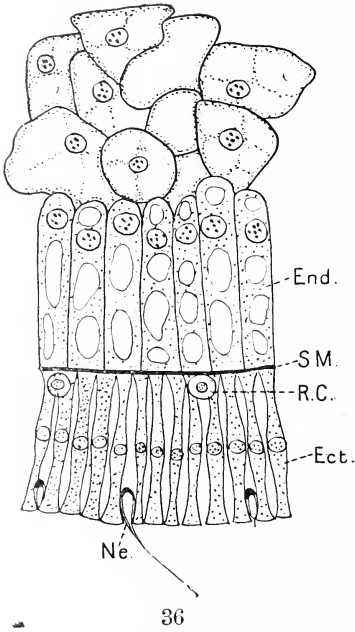

and ectoderm cells is brought about by the multiplication of very small interstitial cells found at their bases. When very young these are even smaller than the nuclei of the adult cells. Nematocysts are now formed by the rounded cells lying at the outer edge of the ectoderm (Text-fig. 36), these cells being also recruited from the interstitial cells (Pl. 3, fig. 19, *Ne.*). Previous to this many ectodermic interstitial cells give rise to broad columnar mucous cells, i. e. refringent cells with a protoplasmic network surrounding the mucus which stains deeply with hæmatoxylin (Pl. 3, fig. 2, *M. C.*). At the anterior pole the endodermic tissue forms a deeper layer than elsewhere (Pl. 3, fig. 1). The ectoderm cells of the anterior pole become specially long in the well-grown planula, and the mucous cells are particularly numerous. Now the larva settles by the broad anterior and aboral pole (see general account), and for some hours after fixation the still ciliate planula hangs freely in the water, retaining its characteristic contractile power. If forcibly detached from the mucus plug which fastens the broad anterior end to the substratum, it will swim freely again for some time and then resettle. The round flat disc formed by the anterior pole becomes the base of the new polyp, and hence the nucleus of attachment of a fresh colony. For some time after settling the cœlenteron still contains much yolky detritus, which is gradually used up. The endoderm is similar to that described for the late planula, i. e. many cells deep at the fixed aboral pole and one layer elsewhere, clumps of non-permanent cells clinging to it in places (Pl. 4, fig. 24, *End. M.*, and *End.*). Very many round cells arise next to the supporting membrane in the ectoderm of the fixed base of the polyp, soon giving it a multilayered character (Pl. 4, fig. 23, *R. C.*). Mucous cells are still abundant in the ectoderm, but gradually disappear,

Fig. 35. Ectoderm of stage shown in Pl. 3, fig. 16, at time of rapid proliferation of cells (temporarily multilayered). Fig. 36. Ectoderm and endoderm cells from late planula, showing nematocysts. Fig. 37. Sagittal section of newly settled polyp, now shrinking in length. The pointed posterior and oral pole of the planula is still visible ($\times 133$).

while nematocysts are very abundant over the whole surface. The long planula-shaped polyp now shrinks in length (Text-figs. 10, 11, and 37), the ectoderm and supporting lamella each becoming crumpled up on itself so that it is of wavy outline in section. The endoderm cells are indeed heaped up into a series of blunt processes separated by deep hollows, and projecting into the coelenteron (Text-fig. 37, *End. C.*). Soon the pointed aboral end flattens down, the larva in vertical section now appearing like Pl. 4, fig. 23. The endoderm is a single row, except at the base, where it forms a deep multilayered mass of cells each containing one huge vacuole (in stained preparations). Thus a mound-like stage is reached at the end of the first day of sedentary life. A little later the mesenteries arise, and simultaneously a great and rapid increase in the number of rounded cells at the base of the columnar ectoderm occurs all over the surface. Next these become surrounded by mesogloea, and from now onwards an intermediate layer separates the endoderm and ectoderm of the polyp. The rounded cells are young scleroblasts and nematocysts.

The next section of the paper deals with the secretion of mesogloea, as the further development of the polyp may then be more easily understood.

9. MESOGLEA.

In this paper the word mesogloea¹ will be applied to the structureless, deep-staining, jelly-like substance which lies between the ectoderm and endoderm of the polyp, and, aided by the spicules, gives rigidity to the body wall. The "endomesoglœal" cells are the cells which become embedded in it. The thin supporting lamella which first appears between the endoderm and the ectoderm of the late pre-planula, and can be traced in the planula (Pl. 4, fig. 27, *S. M.*) and earliest settled stages, stains quite similarly to the mesogloea of later

¹ This word was introduced with the significance given above by Prof. Gilbert Bourne, F.R.S., in 1887 (see 'Quart. Journ. Micr. Sci.,' vol. 27, p. 303).

stages, and seems to be simply an earlier secreted part of it. At the time of the early formation of the mesenteries the lamella of the body wall is first thickened by further secretion of mesogloea which is deposited on its outer side and separates it from the ectoderm. This process continues during later stages, and it is found that the most recently secreted part of the mesogloea, i. e. that part lying nearest the ectoderm (Pl. 5, fig. 39, *R. Mes.*), always stains more feebly than the rest (*E. Mes.*). The mesogloea, after thickening the supporting lamella of the attached base of the polyp (Pl. 5, fig. 40, *Mg.*), streams between the round cells of the multilayered ectoderm (*Ect.*) and unites with the original disc of adhesive mucus (*M. P.*), thereby strengthening the attachment of the polyp to the substratum. The mesogloea is thickest in the body wall, much thinner in the bases of the tentacles, and very little thicker than the original supporting lamella in the distal ends of the tentacles, the pinnules, the oral disc, and stomodæum. No cells have been found embedded in the mesogloea which could be shown responsible for its secretion. On the other hand, streams of newly secreted mesogloea (Pl. 5, fig. 35, *S. Mg.*), which would seem in this stage to be a very viscous fluid, are found running outwards, firstly from the very slightly thickened supporting lamella (Pl. 5, fig. 35, *Mg.*), and later from the gradually thickening mesogloea of the body wall (Pl. 5, fig. 36, *Mg.*) towards the ectoderm. They encroach on and finally surround the round cells at its base (Pl. 5, fig. 36, *Sc.* and *Ne.*), isolating them singly or in small groups in the mesogloea (*S. cell* and *Gr. cell*). These mesogloéal cells arise as interstitial cells (Pl. 5, fig. 37, *Sc.*), and give rise either to spicules or nematocysts. The formation of the latter has not as yet been followed, but it was supposed during these investigations that the small rounded cells which stain very blue with picro-nigrosin and are only about half the size of the young scleroblasts when engulfed are young nematocysts. Perfectly formed nematocysts may also be thus surrounded, and occasionally a scleroblast secretes a young spicule while still lying at the base of the ectoderm, i. e.

before it becomes surrounded by mesogläa. Evidence seems to indicate that the mesogläa flows out from the endoderm (Pl. 5, figs. 36 and 39). It is certainly not secreted by any of the ectoderm cells, and the direction of flow is always outward from the endoderm to the ectoderm, and then, as previously stated, in among and around the basal cells of this layer. During the later growth of the mesenteries they consist almost wholly of a thin sheet of structureless mesoglea, covered on both sides by endoderm (Pl. 5, fig. 38, *Mg*₁ and *End.*), so that this layer is probably capable of providing for all further secretion of mesogläa required by the growth of the mesenteries (see paragraph on mesenteries).

Nothing has been found to correspond with the irregular cells described by Bourne (1), full of minute highly refringent granules, which concealed the nucleus. He suggested that these might be the mesogläa-secreting cells, while Woodland (18) described some small rounded cells which he also noticed as full of refringent granules, without deciding whether these corresponded to Bourne's. As both these papers were founded on work done on *Alcyonium* colonies, cells may be present in the mesogläa which are not found in the solitary polyp. Still it seems very possible that Woodland's cells were merely young scleroblasts, judging from his figures. The "oval bodies" described by Hickson (3) and Woodland as occurring in the mesogläa are nematocysts which may be in process of migration. The coiled thread in the cell was clearly stained with picro-nigrosin after preservation with osmic acid (Pl. 3, fig. 22, *N. T.*)

10. MESENTERIES.

The eight characteristic mesenteries of *Alcyonium* are thin vertical sheets stretching radially into the cœlenteron from the body wall and dividing it into eight incomplete inter-mesenteric compartments, without meeting one another in the centre. They consist of thin sheets of mesogläal substance arising from the supporting lamella of the body wall (Pl. 3, fig. 19, *Mes.*), and covered on both sides by endoderm cells

(*End.*), which in the early stages are long and columnar, but become low and broad later when the mouth has opened. The mesenteries arise simultaneously early on the second day of fixation, and usually do not appear until the flattening of the larva is complete. They are visible before the original supporting lamella of the body wall is thickened by the addition of fresh layers of mesogloæal substance, and therefore before the development of the spicules, tentacles, and mouth, these organs following them in the order stated. Between the normal eight as many as eighteen rudimentary mesenteries are often developed (Text-fig. 38, *Sub. M.*), but these either remain very small or eventually disappear, and are possibly vestiges of a more primitive condition when the mesenteries were very numerous (cf. *Clavellina* (9)). In colonial forms the new polyps formed by budding never show these rudiments. In the early stages the mesenteries are indicated from outside by eight equidistant shallow vertical grooves, stretching up a little way from the base of the lateral wall (Pl. 3, fig. 3), while sections of rather older stages indicate that the mesenteries are already arranged in four pairs (Text-fig. 39). At this stage the mesenteries in vertical radial section resemble Text-fig. 12, *c*. During the earliest stage observed (Text-fig. 40, *a.*) the supporting lamella of each mesentery, consisting of a very thin sheet of mesogloæa, can be easily traced. Sections show it growing radially inwards from the supporting lamella of the body wall (Text-fig. 41, *Mes.*) between the endoderm cells lining the latter. At this time it is structureless, stains slightly with picro-nigrosin, and encloses no cells. Each mesentery grows rapidly upwards along the body wall and along the base of the polyp towards the centre (Text-figs. 40, *b*₁, and 12, *c*. and *d.*). Meanwhile it increases in radial depth (Text-fig. 40, *b*₁), and as the supporting lamella deepens, the endoderm cells surrounding it grow inwards with it, so that each mesentery soon projects into the cœlenteron as a shallow ridge formed by an infolding of the endoderm supported by a central ridge, the lamella (Text-fig. 42, *Mes.*). Figures of subsequent stages show that the

TEXT-FIGS. 38-45.

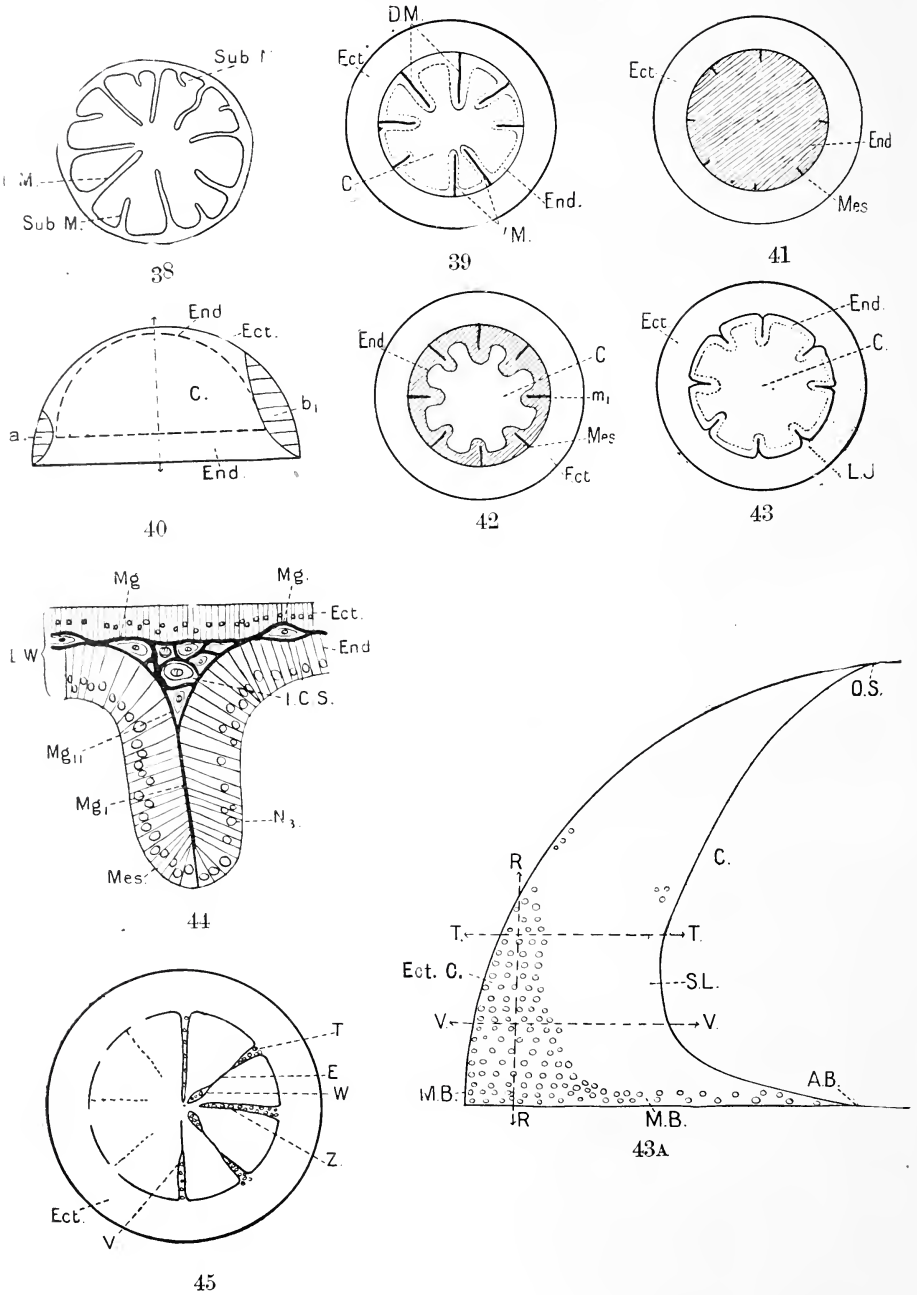

mesentery is free along its inner edge but attached elsewhere to the body wall and base of the polyp. By the end of the second day the mesenteries nearly meet in the centre of the oral and aboral surfaces of the polyp, but they are still fairly shallow (Pl. 3, fig. 5, and Text-fig. 12, *d.*). After the formation of the tentacles the stomodæum develops as an invagination of the oral surface, in the space encircled by the upper edges of the mesenteries, and as it grows inwards the upper edges of the mesenteries are carried down with it, so that all eight become attached along the entire length of the stomodæum (Text-fig. 13, *f.* and *S.*). There has been some discussion as to whether a mesentery is purely endodermic in origin (the view taken by Wilson and Kowalevsky), or whether both the endoderm and ectoderm contribute to its formation (the view held by de Lacaze-Duthiers), and the following account may

Fig. 38. Aboral view of polyp, some hours older than Pl. 3, fig. 4. The eight permanent mesenteries are distinguished from the subsidiary ones by their greater development. Spicules just appearing ($\times 27$). Fig. 39. Transverse section of polyp about stage drawn in Text-fig. 12, showing paired arrangement of mesenteries. Fig. 40. Vertical section of polyp with very young mesenteries, early on second day of fixation. The vertical dotted line divides the diagram into halves, the right showing a more advanced stage than the left. At *a.* a very young mesentery is drawn, which does not yet project beyond the endoderm. At *b.* a rather older mesentery is shown (at a stage similar to the mesenteries in Text-fig. 42). Fig. 41. Diagram of a transverse section of a young polyp near its base. The mesentery is similar to that shown in Text-fig. 40 (*a.*). Hence section cuts through a solid layer of endoderm (the multilayered endoderm at the base of the young settled polyp), and through the supporting lamella of eight young mesenteries (*Mes.*). Fig. 42. Transverse section of a rather older polyp, at stage drawn in Text-fig. 40 (*b.*), some distance higher up than the level of Text-fig. 41. The mesenteric ridges have deepened radially, and are covered by columnar endoderm cells. Fig. 43. Transverse section of polyp somewhat older than Text-fig. 42, showing how the lamella of the lateral wall becomes pulled in during the inward growth of the mesenteries. Fig. 43A. Lamella of young mesentery, reconstructed from sections. Fig. 44. Here the mesogloea is being rapidly thickened. It is seen penetrating between the ectodermic cells which have been drawn into the root of the mesentery, and isolating them (*Mg.* and *I. C. S.*). Fig. 45. Transverse section of polyp, showing mesenteries cut across near base, i. e. at level *M. B.* in Text-fig. 43A.

serve to show how support for both views could be obtained in the case of *Aleyonium* according to the part of the mesentery studied :

(1) Sections show that by the time the mesenteries reach up to the oral surface of the polyp, the supporting lamella contains a great many ectoderm cells which lie very near the body wall. Text-fig. 43A is reconstructed from a series of sections of a polyp with mesenteries at this stage. It is a diagram of the supporting lamella of one mesentery, while the covering endoderm is not represented. Many small round cells are seen embedded in it towards the outer edge and at the base (*Ect. C.*). These are nematocysts and young scleroblasts which have entered from the ectoderm in a manner to be discussed later. Therefore both ectoderm and endoderm elements occur in the mesentery at this stage. However, it is seen that the greater part of the lamella contains *no* ectoderm cells, while as the mesentery grows larger the proportion of the lamella which contains ectoderm elements grow necessarily less and less, so that in the adult the mesentery is almost wholly endodermic in structure. This seems to support the view that the function of the ectoderm cells in the mesentery may be unimportant, and that the endodermic covering can provide for all further increase in the size of the lamella.¹

(2) When the mesentery first develops, its supporting lamella grows radially inwards from the lamella of the body wall and is directly continuous with it (Text-figs. 41 and 42, *Mes.*). A little later, as the mesentery continues to grow inwards, the lamella of the lateral wall often appears slightly pulled in where the mesentery joins (Text-fig. 43, *L. J.*), and these two cases may appear in one section. Interstitial cells

¹ The fate of the nematocysts is uncertain: possibly they migrate to some definite place for future use. It is known that they occur in the six ventral mesenteric filaments, but probably all of these are derived from the ectoderm of the stomodæum, as described later. The spicules secreted by the scleroblasts found in the lamella would certainly help to stiffen it at the base and near the body wall.

are constantly arising in the ectoderm of the lateral wall, and some are often seen lying near the inner edge of the mesentery, and are therefore frequently found in the groove formed at this point. As the mesenteries grow these grooves deepen, and so more interstitial cells can enter. While the mesogloea of the body wall is being laid down outside the original supporting lamella (Text-fig. 44, *Mg.*), it appears to flow between these interstitial cells, cutting them off from the ectoderm either singly or in small groups, just as it envelops and isolates interstitial cells in other parts of the body wall (see chapter on Mesogloea). It is not impossible then that any ectoderm cells found in the mesentery are introduced by mechanical means, i. e. the ingrowing of the mesentery draws a few interstitial cells after it, which become enclosed in the supporting lamella, this process continuing in some regions until a large number are enclosed.

(3) Transverse sections of the mesentery in Text-fig. 43A at level *T.* (indicated by a dotted line) would show a few cells in the supporting lamella near the body wall. At level *V.* a similar condition would obtain. Lower still, the lamella in cross-section would show a very deep groove full of cells near the lateral wall, and a very short single sheet or none at all (Text-fig. 45, *V.* or *Z.*). Towards the base of the mesentery the lamella is double and full of ectoderm cells, or in some cases it contains a group of cells near its inner edge (Text-fig. 45, *W.*), cut off from the outer deep groove *T.* by a region *E.*, containing no cells. A vertical section of Text-fig. 43, *A.*, at line *R.* would obviously show a double lamella full of ectoderm cells and surrounded by endoderm, and this would appear to be the kind of section figured by de Lacaze-Duthiers (10).

Considered apart from the early history of the mesentery, Text-fig. 45 seems to indicate that the mesenteries are true invaginations of the body wall. A solid cord of ectoderm cells seems to grow in, surrounded by a tubular ingrowth of the supporting lamella, and a covering of endoderm cells, but whether the former cells are to be regarded as drawn in

mechanically during the ingrowth of the mesentery, or whether they have any embryological significance implying a true invagination of both layers is not altogether certain. If the first, then the mesentery is purely endodermic, as Wilson believes; if the second, then de Lacaze-Duthiers is correct. The total evidence afforded by these investigations seems, perhaps, to support the latter view. It may be added that the rudimentary mesenteries contain many ectoderm cells embedded in the supporting lamella.

11. TENTACLES, MOUTH AND STOMODÆUM.

Eight short broad tentacles develop on the third day (Pl. 3, fig. 5). They are simple hollow outgrowths of the upper surface of the young polyp, consisting, therefore, of ectoderm and endoderm separated by a supporting lamella (Text-figs. 46 and 47, *T.*), and arise between the mesenteries in a circle round the oral disc. A little later a shallow invagination of the latter forms the beginning of the stomodæum. This grows considerably in size and depth, the exterior and only opening being the mouth (Pl. 3, fig. 7, and Pl. 4, fig. 28). The lumen of the invagination soon widens considerably at the base, and the floor of the cavity is correspondingly enlarged (Text-fig. 46). During the fourth day the endoderm and ectoderm of this floor degenerate, either at the centre or near the side or in both regions simultaneously (Text-fig. 47). By this means communication is established between the cœlenteron and the exterior, and food may enter from outside. Until now all requisite nourishment has been provided by the embryonic yolk. By the fifth day the disintegration is complete, and the formation of the mouth and stomodæum is accomplished. The ectoderm covering the latter consists of taller columnar cells than elsewhere. Like the tentacles it is plentifully supplied with nematocysts, which, indeed, at this stage are abundant all over the surface of the polyp. Mucous cells and granular gland cells are soon formed in the stomodæum and pour their

TEXT-FIG. 46.

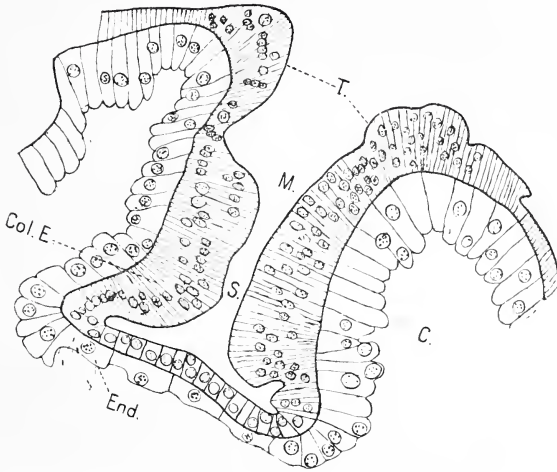

Longitudinal section of the stomodæal invagination, just before floor of canal begins to degenerate ($\times 380$).

TEXT-FIG. 47.

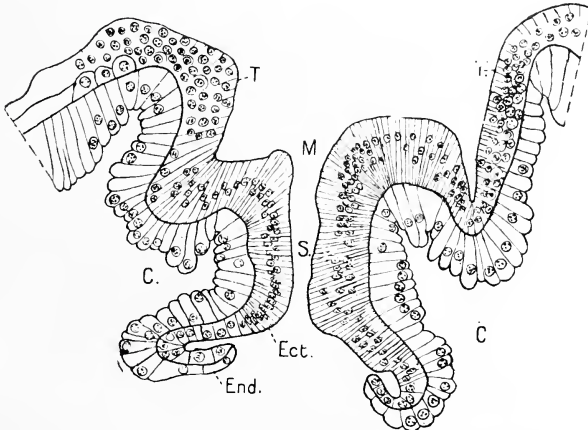

Same, when communication is established between the coelenteron and the exterior, by the degeneration of the endoderm and ectoderm at the centre of the base.

secretion upon the food while it is being passed down. The supporting lamella of the stomodæum always remains a thin sheet, while the endodermic lining is similar to that found throughout the cœlenteric cavity, as the endoderm covering the attached base of the polyp is by now reduced to one row of columnar cells (Pl. 3, fig. 19, *End.*). In section the top of the newly-opened stomodæum is round, but lower down it is keyhole shaped (Pl. 4, fig. 34), the narrow ventral end of the keyhole being the siphonoglyph. Hence in vertical sections which cut the stomodæum dorso-ventrally, the latter seems much wider than when cut in a plane at right angles to this.

12. SPICULES.

Investigation into the origin of the spicule in the young solitary polyp confirms Woodland's work on colonial forms (18), adding thereto one or two minor points of interest. Each spicule, as he states, is the product of a single cell, and during its elaboration the nucleus halves, each daughter nucleus apparently controlling one pole of the spicule (Pl. 4, fig. 31, Nos. 1 and 5). It was found, however, during the present investigations that some large spiculoblasts from *Alcyonium* colonies contained three or four nuclei. It was also seen that the young scleroblasts are of ectodermic origin (Pl. 4, fig. 32), and arise as round interstitial cells at the base of the ectoderm of the body wall and tentacles (Pl. 5, fig. 35, *Sc.*). These scleroblasts become stellate, spindle-shaped, oval or rounded, as they increase in size (Pl. 4, fig. 32), and, as explained previously, are encroached on and eventually surrounded by mesoglea, either singly or in small groups. In later stages the spicules become entirely isolated from one another by mesoglœa. As Woodland states, the cytoplasm of the scleroblasts eventually becomes reduced to a mere thin granular covering-layer over the greatly enlarged spicules (Pl. 4, fig. 31, Nos. 4 and 5). Pl. 4, fig. 30, shows that after dissolving away the spicules by an acid stain (picro-nigrosin), the mesoglœa is left full of corresponding

cavities lined with the cytoplasm of the scleroblast, each cavity shaped exactly like the spicule which occupied it. The earliest spicules arise on the second day of fixation, rather later than the mesenteries and before the tentacles, and may be examined with low powers of the microscope. They appear as small refringent nodules in the upper surface of the mound-shaped polyp, and show through by transmitted light. One row of small unbranched spicules is present in the body wall by the time the mouth opens (Pl. 5, figs. 36 and 37), and in older polyps they are found in the upper and lower regions of the body wall, the bases of the tentacles, and in the outer edge of the mesenteries very near the base (Text-fig. 14). According to Woodland, after the two daughter nuclei have formed in the scleroblast, the steadily growing round spicule lengthens and assumes a simple dumb-bell shape (Pl. 4, fig. 31, No. 3). The ends of this dumb-bell become gradually elaborated into processes, so that the spicule then resembles a caudal vertebra in shape (Nos. 4 and 5). The colonies he utilised in following out the development of the spicule were small—about half an inch across—and the drawings he made have all been verified on the solitary polyp, with the exception of his figures illustrating the cavities which the spicules occupied.

13. MESENTERIC FILAMENTS.

Each mesentery bears a filament on its free inner edge running down for some distance from the lower opening of the stomodæum (Text-fig. 48). While the two dorsal filaments create an upward current of water in the cœlenteron by the active lashing of the cilia borne on the cells which cover them (Text-fig. 49), the six ventral filaments are secretory and absorptive. The ferment poured upon the food by these filaments continues and probably completes the disintegration begun in the stomodæum. In the oldest solitary polyp examined (fixed from thirteen to fifteen days), the ventral filaments reached almost to the bottom of the free

edge of their respective mesenteries, and the dorsal not quite so far (Text-fig. 48). The first signs of each ventral filament

TEXT-FIGS. 48-51.

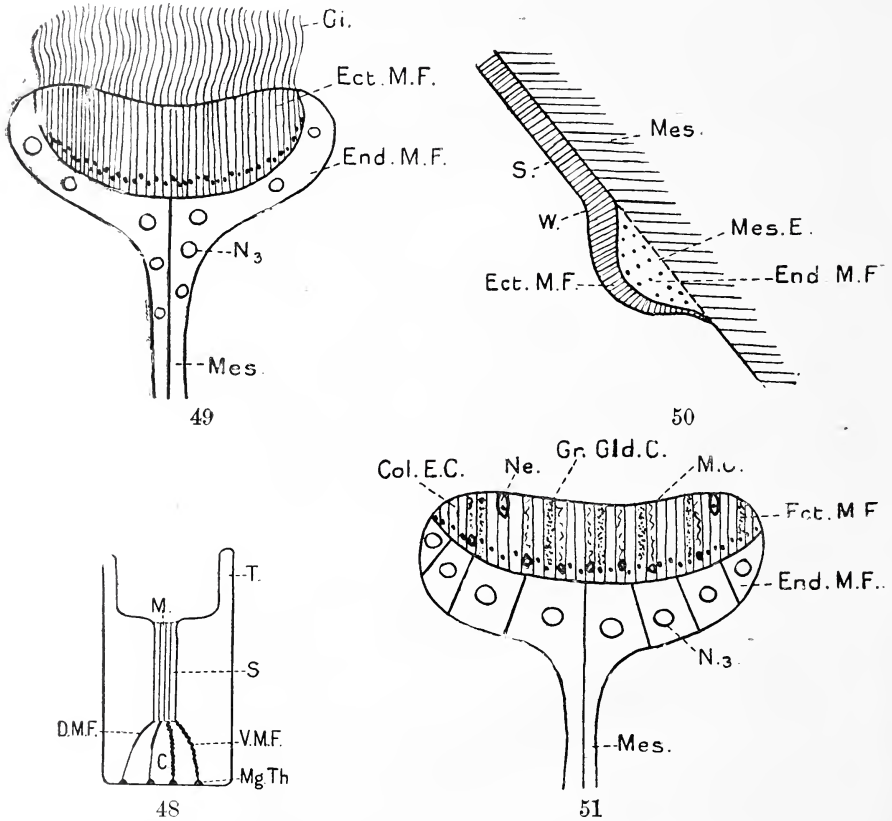

Fig. 48. Vertical section of polyp on thirteenth day of fixation, showing relative length of dorsal and ventral mesenteric filaments. Fig. 49. Transverse section of young dorsal mesenteric filament. Fig. 50. Longitudinal and radial section of very young ventral mesenteric filament, showing its relation to the thickened edge of the mesentery. Fig. 51. Transverse section of young ventral mesenteric filament.

are found on the fourth day of sedentary life, shortly before the mouth is open. Immediately below the base of the

stomodæal invagination the free edge of the mesentery becomes thickened by a proliferation of the endoderm cells in that region. These cells are longer than they are wide, whereas those on the rest of the mesentery are short and broad. After the mouth and stomodæum have completed their formation, on the fifth day, a narrow strap-like process of the ectoderm of the stomodæum grows out over the endodermic part of each filament (Text-fig. 50, *Ect. M. F.*, and Pl. 4, fig. 33, *E. S. O.*; c f. Wilson's fig. 21 (15)). In this ectodermic band, which is only $6\ \mu$ (or one section) broad at first, nematocysts, mucous and granular gland cells develop. The band, lying over the endodermic part of the filament, soon widens and forms an ectodermic layer covering the outer surface of the latter (Text-fig. 51). [In this figure the two layers in the filament are marked *Ect. M. F.* and *End. M. F.*, and are shown in transverse section, while Text-fig. 50 represents a much earlier stage in longitudinal section (about stage of Pl. 4, fig. 33), the dotted line marking the edge of the mesentery before the endodermic thickening began (*Mes. E.*). The letter *W.* marks the lower limit of the stomodæal wall (*S.*), before the ectodermic downgrowth developed.] By the sixth day these filaments extend half way down the free edge of the mesentery (Pl. 4, fig. 25, *S. O.*). During subsequent growth the filament becomes somewhat twisted laterally and gathered up into puckers on the edge of the mesentery as a result of growing faster than the latter. Consequently, sometimes the ectoderm and sometimes the endoderm cells lie uppermost, and this can be realised easily by imagining the filament shown in transverse section in Text-fig. 51 twisted from side to side. Longitudinal sections through the convoluted filaments are therefore somewhat difficult to understand at first sight, as groups of ectoderm and endoderm cells lie side by side.¹

While the ectodermic portion is secretive, the endodermic

¹ A model in red and white clay of the endodermic and ectodermic parts of the filament was similarly twisted from side to side and then sectioned to check this result.

part is absorptive. Food is engulfed by the amœboid processes of the latter cells in common with the endoderm cells lining the general body cavity (12). The above observations probably explain why in Miss Pratt's paper ((12) Pl. 21, fig. 4) the carmined food is absorbed, and has reddened the filament in certain definite areas and not in others. The colourless parts are the ectodermic and the reddened parts the endodermic areas twisted uppermost. It also explains the observation made early in the same paper, that histological study of the "stomodæum and ventral mesenterial filaments in several members of the family reveals many points of similarity, if not identity, in their elemental constitution. Both granular and mucous gland cells, as well as nematocysts, occur in all these structures." Briefly, this is because the secretory part of these filaments is ectodermic, the requisite gland cells and nematocysts being supplied by the downgrowth from the stomodæum. The dorsal filaments are very much narrower and straighter than the ventral in the solitary polyp. A transverse section of these dorsal filaments two days after they first appear is only two-thirds the size of a similar section of the ventral filaments on the same date. No indication of these dorsal filaments is found until the sixth day, i.e. they arise later than the others. Narrow processes of the stomodæal ectoderm are then seen growing down over the uppermost part of the free edge of the two dorsal mesenteries, thus giving rise to the filaments (Pl. 4, fig. 26, *D. O.*). No appreciable thickening of the endoderm forms, however, as a support for this ectoderm, whereas it was visible before the ectodermic part in the ventral filaments. A transverse section reveals that in rough outline the dorsal filament is quite comparable to the ventral, the difference being one of degree of development only (Text-figs. 49 and 51). In the former the ectodermic band, consisting of tall ciliate cells with deep staining nuclei, rests on a slender endodermic support, which is smaller than in the ventral filament. Therefore both kinds of filament consist of ectodermic and

endodermic portions, the endodermic being well developed in the ventral, and much less so in the dorsal. Growth seems slower in the dorsal than the ventral filaments, so that by the end of the seventh day they are still much shorter than the latter (Pl. 4, fig. 26).

Sections made of polyps for the examination of the filaments at this stage, also show that the retractor muscles of the mesenteries are now developing. By the thirteenth to fifteenth day of sedentary life the ventral filaments are twice as long as the dorsal, although they extend very little below them, because of their convoluted condition. By this date, also, the filaments approximate more nearly to the adult in transverse section, i. e. the ciliated surface of the dorsal filament has become more concave, while the glandular ectoderm of the ventral has become more convex, and extends further round (c f. Text-figs. 49 and 51 with Pl. 4, fig. 29, and (3) Pl. 38, figs. 18 and 19).

SUMMARY OF OTHER WRITERS' VIEWS ON THE DERIVATION OF THE MESENTERIC FILAMENTS, AND REMARKS ON THESE.

H. V. Wilson (15) considers that the ventral mesenteric filaments in the coral *Manicina* are wholly ectodermic in origin, and gives a very similar figure to the present Pl. 4, fig. 33, showing the downgrowth from the stomodæum of the ectodermic bands which give rise to the filaments. E. B. Wilson (17) states that the dorsal filaments in colonial polyps of *Alcyonium* are of ectodermic origin, but while he shows (16) that endoderm certainly enters into the ventral filaments of *Renilla*, he did not find any ectodermic outgrowth contributing to them. It is not impossible that he passed over this stage in development. J. Stanley-Gardiner (13) considers that the ventral mesenteric filaments of *Cœnopsammia* are purely ectodermic, basing this view on histological grounds. Also he mentions the same fact for *Flabellum* (14).

It is possible that investigations into the early development of other Anthozoa would confirm the fact that all the filaments throughout the group consist of ectodermic and endo-

dermic elements, both being well developed in the ventral, while the ectodermic part is alone elaborated in the dorsal.

14. SUMMARY.

(1) The fertilised eggs segment in various ways, but typical morulæ always result.

(2) When the sixteen cell stage again divides to produce the thirty-two celled embryo, delamination occurs, and from now onwards the larva is two-layered.

(3) The morula at the twentieth hour begins to undergo a series of contortions which last from the first to the third day. This solid contorted stage is here termed the pre-planula, as it passes on into the hollow planula stage.

(4) The pear-shaped planula, while swimming, exhibits characteristic "planarian-like" movements, and on the fourth free-swimming day (the seventh day of development) it settles down by the broad anterior and aboral pole.

(5) The settled larva soon flattens, assuming a mound-like shape, and on the second day of fixation eight mesenteries grow out simultaneously into the cœlenteron from the base of the lateral wall. The cœlenteron is identical with the hollow central space in the endoderm of the planula.

(6) The mesenteries, arranged in four distinct pairs, grow simultaneously and rapidly along the lateral walls and attached base, and soon nearly meet on the basal and oral surfaces of the polyp.

(7) Many round cells now appear at the base of the columnar ectoderm.

(8) Mesoglycæa is at this time secreted by the endoderm, and flows round the above-mentioned round ectoderm cells, cutting them off either singly or in groups. These isolated ectoderm cells produce either nematocysts or spicules, the spicules appearing soon after the mesenteries.

(9) Early on the third day eight simple hollow tentacles grow out, alternating with the mesenteries, and encircling the oral surface.

(10) Later on the third day the stomodæum and mouth arise by the appearance of a rapidly deepening invagination of the oral surface, in the centre of the circle of tentacles. Yolky detritus is still present in the cœlenteron.

(11) On the fourth day the base of this invagination degenerates, and so the cœlenteron communicates with the exterior.

(12) While the mouth invagination is still in process of formation, the endodermic portion of the mesenteric filaments arises on the six ventral mesenteries by a proliferation of cells on the upper part of the free edge.

(13) On the fifth day the ventral mesenteric filaments are completed by strap-like ectodermic downgrowths from the stomodæum over the endodermic thickening on each mesentery.

(14) On the sixth day the dorsal mesenteric filaments arise.

(15) The dorsal and ventral mesenteric filaments appear homogeneous in origin, though of diverse function.

(16) On the seventh day the eight filaments reach about half way down the free edges of their respective mesenteries.

(17) Further development consists of elaboration of the organs already present.

(18) At the end of the third week the first bud is formed, and the solitary polyp becomes a young colony by stolonal gemmation.

(19) The young colonies were successfully fed in the laboratory on larvæ and adult individuals from colonies of *Leptoclinum* and *Botryllus*.

15. LITERATURE.

1. Bourne, G. C.—“The Calcareous Skeleton of the Anthozoa,” ‘Quart. Journ. Micr. Sci.’ vol. 41, 1898–1899.
2. Hickson, S. J.—“*Aleyonium*,” ‘L.M.B.C. Memoirs,’ No. v, 1901.
3. ——— “The Anatomy of *Aleyonium digitatum*,” ‘Quart. Journ. Micr. Sci.’ vol. 37, new series, 1894–5.

- 3a. Hickson, S. J.—“On the Ciliated Groove (Siphonoglyphe) in the Stomodæum of the Alcyonarians,” ‘Phil. Trans. of the Royal Society,’ part iii, 1883.
4. ——— “Report on Mr. Wadsworth’s Collection of Material for the Study of the Embryology of Alcyonium,” Section D, ‘Report British Association, Bristol,’ 1898, p. 585.
- 4a. ——— “Cœlenterata and Ctenophora,” ‘Cambridge Natural History,’ vol. i.
5. Hill, M. D.—“Maturation of the Ovum of Alcyonium digitatum,” ‘Quart. Journ. Micr. Sci.,’ vol. 49, 1905-6.
6. Hoffman und Schwalbe.—‘Jahresbericht Anat. u. Physiol.,’ Bd. ii, 1875.
7. Korschelt and Heider.—‘Text-book of the Embryology of the Invertebrates,’ part i, 1895.
8. Kowalevsky, A.—“Untersuchungen über die Entwicklung der Cœlenteraten,” ‘Nachrichten der Kaiserl. Gesellschaft. der Freunde der Naturkenntniss der Anthropologie und Ethnographie,’ Moscow, 1873-4. [In Russian; the figs. can best be followed by using them together with paper (6).]
9. ——— et Marion, A. F.—“Documents pour l’histoire embryogénique des Alcyonaires,” *Memoire* iv, 1883; ‘Annales du Musée d’Histoire Naturelle de Marseille.—Zoologie,’ tome i, part ii.
10. de Lacaze-Duthiers, H.—“Developpement des Coralliaires,” Deuxième Mémoire, ‘Archives de Zool. Exp. et Gen.,’ tome ii, 1873.
11. ——— ‘Histoire Naturelle du Corail,’ Paris, 1864.
12. Pratt, Edith M.—“The Digestive Organs of the Alcyonaria, and their Relation to the Mesogleal Cell Plexus,” ‘Quart. Journ. Micr. Sci.,’ vol. 49, 1905-6.
13. Stanley-Gardiner, J.—“The Anatomy of a supposed New Species of Cœnopsammia from Lifu,” ‘Willey’s Zool. Results,’ part iv, Camb. Univ. Press, 1899.
14. ——— “Flabellum, Anatomy and Development,” ‘Marine Invest. S. Africa,’ Cape Town, 1902.
15. Wilson, H. V.—“On the Development of *Manicina areolata*,” ‘Journ. Morph.’ vol. ii, 1888-9.
16. Wilson, E. B.—“The Development of *Renilla*,” ‘Phil. Trans. of the Royal Society,’ part iii, 1883.
17. ——— “The Mesenterial Filaments of the Alcyonaria,” ‘Mitteilungen aus der Zoologischen Station zu Neapel,’ Leipzig, Bd. v, 1884.

18. Woodland, W.—“Studies in Spicule Formation, II,” ‘Quart. Journ. Micr. Sci.’ vol. 49, 1905-6.

EXPLANATION OF PLATES 3-5,

Illustrating Mrs. Annie Matthews's paper on “The Development of *Alcyonium digitatum*, with some notes on the Early Colony Formation.”

REFERENCE LETTERS OF PLATE FIGURES.

a. Radial vertical section of very young mesentery, before it projects into the cœlenteron. *a*₁. First developed bud of colony. *A. B.* Fixed base of polyp. *An.* Anterior aboral pole. *b.* Small blastomere. *b*₁. Radial vertical section of mesentery, rather older than stage (*a.*) of same text-fig., and stretching higher up lateral wall of polyp. *b*₁₁. Second bud. *B.* Large blastomere. *B. Sp.* Spicules of body wall. *c.* Mesentery: somewhat older than stage (*b*₁) of Text-fig. 40. *c*₁. Third bud. *C.* Cœlenteron. *C. End.* Columnar endoderm. *C. M.* Undivided central part of egg. *C. P.* Club-shaped processes of endoderm. *Col. E.* Columnar ectoderm. *Col. E. C.* Columnar ectoderm cell. *Con. Ect.* Contracted and wrinkled ectoderm. *Ci.* Cilia. *d.* Mesentery at a stage rather older than (*c.*) of the same figure. *d. Ect.* Deep columnar ectoderm in stomodæum. *d. m.* Dorsal mesenteries. *D. A.* Deeply staining, finely granular area round nucleus. *D. M.* Dorsal mesentery. *D. M. F.* Dorsal mesenteric filament. *D. N.* Delamination spindle. *D. O.* Dorsal filament just arising as downgrowth of ectoderm of stomodæum over free edge of mesentery. *E. Mes.* Earlier secreted mesoglea. *E. S. O.* Early stage of formation of ventral mesenteric filament, showing ectodermic band growing from stomodæum over edge of mesentery (*Mes.*). *Ect.* Ectoderm. *Ect. M. F.* Ectodermic part of mesenteric filament. *Ect. d.* Deep columnar ectoderm at base of lateral wall. *Ect. C.* Ectoderm cells. *End.* Endoderm. *End*₁. Endoderm cells, one row deep in this region. *End. C.* Contracted endoderm. *End. M.* Endoderm, several rows deep, lining attached base of polyp. *End. M. F.* Endodermic part of mesenteric filament. *End. S.* Endoderm cells in region where they are several rows deep. *f.* Radial vertical section of mesentery, at time when stomodæal invagination is forming. *F.* First row of buds. *G.* Glass. *G. P.* Granular protoplasm. *Gr.* Granular, yolk free area. *Gr. cell* Group of cells becoming embedded in mesoglea. *Gr. E.* Granular ectoderm. *Gr. Gld. C.* Granular gland cell. *I. C.* Interstitial cells. *I. C. S.*

Interstitial cells cut off singly from octoderm by mesogloea. *l*. Small lobe. *L*. Large lobe. *L. J.* Junction of supporting lamella of mesentery with that of body wall. *L₁W₁*. Somewhat contracted and therefore wrinkled lateral wall of polyp. *L. W.* Lateral wall of polyp. *m₁*. Supporting lamella of mesentery growing radially inward from lamella of body wall. *M*. Mouth. *M. B.* Base of mesentery. *M. C.* Mucous cell. *M. F.* Mesenteric filament. *M. P.* Adhesive plug of white mucus, attaching base of polyp to substratum. *Mes.* Mesentery. *Mes₃, Mes₅*. Two lateral mesenteries. *Mes. E.* Edge of mesentery before ventral filament developed. *Mg.* Mesogloea. *Mg₁*. Mesogloea of mesentery. *Mg₁₁*. Mesogloea flowing between interstitial ectoderm cells at root of mesentery. *Mg. Th.* Thickened ridge of mesogloea stiffening the line of attachment of mesentery to base of polyp. *N*. Nucleus halved by karyokinesis. *N₂*. One of daughter nuclei, formed before first segmentation. *N₃*. Nucleus. *N. T.* Nematocyst thread. *Ne*. Nematocyst. *Ne₁*. Nematocyst, in mesogloea of mesentery. *Ne₄*. Nematocyst, with thread stained. *O. P.* Oral pole. *O. S.* Oral surface, surrounded by tentacles. *P*. Pinnule. *P₁*. Earliest developed pinnule on the tentacle. *P₂*. Latest and youngest pinnule on the tentacle. *P. C.* Pre-oral cavity. *P. M.* One of eight permanent mesenteries. *Pa*. Parent polyp. *Pl*. Remains of degenerate base of stomodæal invagination. *R. C.* Rounded cells in ectoderm. *R. E.* Rapidly proliferating and therefore temporarily multilayered ectoderm. *R. Mes.* Recently secreted mesogloea. *R. Sc.* Remains of scleroblast. *S*. Stomodæum. *Sc.* Scleroblast. *Se.* Second row of buds. *Su.* Substratum. *St.* Stolon. *Sp.* Spicule. *Sp₁*. Spicule embedded in mesogloea. *Spb.* Spiculoblast with spicule dissolved out. *Spb₁*. Spicule left in scleroblast, embedded in mesogloea. *S. cell.* Cell embedded singly in mesogloea. *Sub. M.* Subsidiary mesentery. *S. B.* Termination of wall of stomodæum. *S. C.* Segmentation cavity. *S. L.* Supporting lamella. *S. M.* Separating membrane. *S₁ M₁*. Position occupied by supporting membrane in mesogloea of body wall. *S. Mg.* Mesogloea streaming out from endoderm among rounded cells at base of ectoderm. *S. O. S.* Sloping oral surface. *S. O.* Early stage in appearance of strap-like outgrowth of ectoderm of stomodæum, over endodermic part of ventral mesenteric filament. *T*. Tentacle. *T. B.* Swollen base of tentacle. *T₁ B₁*. Very young bud of the third row. *T. R.* Tentacles retracted. *T. Sp.* Tentacular spicules. *V. M.* Ventral mesentery. *V. M. F.* One of the six ventral mesenteric filaments. *V. M. F₁*. Lower limit of ventral mesenteric filament. *Wr.* Wrinkled outline of latest pre-planula stage. *Y*. Yolk globules. *Y₁*. Small yolk globules. *Y₂*. Large yolk globules. *Y. D.* Yolky detritus. *Y. E.* Inner half of columnar ectoderm cells, still containing yolk globules. *Y. V.* Large yolk-containing vacuoles.

PLATE 3.

Fig. 1.—Sagittal section of long highly contractile planula, towards end of free-swimming life. Yolky detritus still present in coelenteron. Ectoderm very full of mucous cells and nematocysts. $\times 78$.

Fig. 2.—Portion of ectoderm of full-grown planula, showing mucous cells and nematocysts among the ordinary cells. Granular reticulate protoplasm in mucous cells very deeply stained. $\times 507$.

Fig. 3.—Lateral view of polyp with older mesenteries than fig. 4. Second day of fixation. Adhesive plug shows well. $\times 16$.

Fig. 4.—Lateral view of polyp during early part of second day of attachment. Eight mesenteries appearing. $\times 16$.

Fig. 5.—Lateral view of polyp on the fifth day of attachment. Tentacles partly contracted, body expanded. $\times 37$.

Fig. 6.—Oral view of young polyp, with tentacles well expanded and mouth widely opened. The tentacles were still reddish-yellow and the body wall cream; spicules abundant (about five days fixed). $\times 35$.

Fig. 7.—Oral view of polyp about the sixth day. Tentacles partly contracted, but mouth still exposed. $\times 39$.

Fig. 8.—Section through the eight-lobed egg of Text-fig. 30. $\times 78$.

Fig. 9.—Sagittal section through eight cell stage. One of the several nuclei that have again divided ready for the next segmentation is shown at *N*. $\times 78$.

Fig. 10.—Section through an egg protruding sixteen lobes; two daughter nuclei are drawn. $\times 78$.

Fig. 11.—Sagittal section through sixteen cell stage, showing delamination spindle. $\times 78$.

Fig. 12.—Transverse section of a young morula showing delamination and ordinary spindles. $\times 78$.

Fig. 13.—Enlarged drawing of section of two blastomeres from the sixteen cell stage. The finely granular outer area, and large and small yolk globules are shown. $\times 133$.

Fig. 14.—Five endoderm cells from a late pre-planula, in which the lobes are almost withdrawn again. The yolk globules are few and very large and the segmentation cavity has disappeared. $\times 760$.

Fig. 15.—Ectoderm and endoderm cells from transverse section of a late pre-planula, when the ectoderm cells have become much longer and narrower, while large vacuoles are still present. $\times 78$.

Fig. 16. Transverse section of a very late pre-planula, with rapidly proliferating ectoderm (stage of Text-fig. 3), just before it passes into

the early round planula stage. A definite membrane is now present between the ectoderm and the endoderm. $\times 78$.

Fig. 17.—Sagittal section of smooth oval planula, with broadened anterior end. Endoderm cells in places only one row deep, but in others form club-like processes. (Second free-swimming day.) $\times 133$.

Fig. 18.—Ectoderm and endoderm cells from a somewhat younger pre-planula than Pl. 3, fig. 14, and at a later stage than Text-fig. 2. Yolk globules fewer than in early pre-planula and increasing in size. $\times 760$.

Fig. 19.—Part of a vertical section of a young polyp with mesenteries and spicules. One mesentery is cut through vertically near its attachment to the lateral wall. Many scleroblasts and nematocysts are thus cut across, which have been drawn into the mesogloea of the mesentery here. At the lower right-hand corner young scleroblasts and nematocyst cells are shown in situ at the base of the columnar ectoderm. $\times 380$.

Fig. 20.—Ectoderm and endoderm cells from a late morula stage. $\times 133$.

Fig. 21.—Transverse section of an earlier morula stage than fig. 20, showing large yolk globules in the endoderm and smaller ones in the cuboid ectoderm. $\times 167$.

Fig. 22.—Nematocysts (oval bodies of Hickson), from mesogloea of solitary and colonial polyps.

PLATE 4.

Fig. 23.—Sagittal section of a polyp about stage shown in fig. 3. This section does not cut through the mesenteries. $\times 133$.

Fig. 24.—Sagittal section of newly-fixed larva, still planula-shaped and ciliate. At the base the outer edge of the ectoderm has been diagrammatically thickened in the drawing, to indicate clearly the extent of the fixed area. $\times 133$.

Fig. 25.—Vertical section of polyp with only one pinnule on tentacles, i.e. about six days fixed. At Mes_2 and Mes_4 the basal attachments of the two lateral mesenteries Mes_3 and Mes_3 are seen. At $V. M. F_1$ is shown the termination of the ectodermic outgrowth forming the mesenteric filament of mesentery Mes_3 , i.e. about half way down the free edge of the mesentery. At $S. O.$ the continuity of the stomodæum and this outgrowth is shown. $\times 133$.

Fig. 26.—Vertical section of a polyp fixed from six to seven days, showing the strap-like ectodermic process on the right, which forms the ventral mesenteric filament, and on the left the shorter ectodermic

outgrowth over the free edge of the dorsal mesentery, which forms the dorsal mesenteric filament, *D. O.* The dorsal mesentery is only partly shown at *D. M.* $\times 133$.

Fig. 27.—Part of ectoderm and endoderm of swimming planula. Multilayered and adjacent one-layered endoderm both shown. Granular ectoderm cells expanded at base rest on the separating membrane. Round interstitial ectoderm cells seen. Endoderm still full of yolk globules. $\times 760$. (Ectoderm and endoderm of the pre-planula in the latest stage are very similar in detail.)

Fig. 28.—Vertical section of polyp showing stomodæal invagination. There is as yet no communication with the exterior. Yolky detritus is still present, and mesoglea is flowing between the ectoderm cells of the attached base, and round the inner ectoderm cells of the lateral walls. $\times 133$. (The stomodæal invagination is cut across laterally, and so is very narrow.)

Fig. 29.—Transverse section of polyp settled from thirteen to fifteen days, cut below stomodæum; the six ventral and two dorsal mesenteric filaments are shown. $\times 133$.

Fig. 30.—Section through the mesoglæa of a fairly old polyp after dissolving the calcareous part of the spicules by staining with picro-nigrosin. The nuclei and organic remains of the spicules are shown, and it can be seen that the cavities occupied in the mesoglea by the spicules are replicas of the latter. $\times 245$.

Fig. 31.—Young spicules in scleroblasts, from solitary polyp. $\times 760$.

Fig. 32.—Young scleroblasts before secretion of spicule. $\times 760$.

Fig. 33.—Vertical section through the stomodæum of a polyp five days fixed. The remains of the degenerate base of the stomodæum are still visible, and the ectoderm of the stomodæum is growing down over a mesentery as a strap-like process (*E. S. O.*); the section is beyond the actual mouth opening. The rest of the mesentery (*Mes.*) was seen in subsequent sections. $\times 450$.

Fig. 34.—Transverse section of a polyp settled from thirteen to fifteen days, cutting through the siphonoglyph. $\times 133$.

PLATE 5.

Figs. 35, 36, 37 and 39.—Vertical radial sections of part of wall of young settled polyp, showing ectoderm, endoderm and origin of mesoglæa:

Fig. 35.—Mesoglæa secreted by endoderm, beginning to stream between the interstitial cells at the base of the ectoderm, at the time of the early formation of the mesenteries. $\times 380$.

Fig. 36.—Streams of mesoglœa flowing between ectodermic interstitial cells, and cutting them off singly (*Spb.*), or in groups (*Gr. cell*). $\times 760$.

Fig. 37.—Scleroblasts surrounded by mesoglœa. (The spicules have been dissolved during preservation.) The mesoglœa is seen streaming round the interstitial cells at the left hand of the diagram. $\times 760$.

Fig. 38.—Part of a transverse section of a young polyp, cutting through stomodæum and mesenteries, and showing the thin sheets of mesoglœa, devoid of cells which together with the surrounding endoderm form the mesenteries. $\times 380$.

Fig. 39.—Faintly staining streams of mesoglœa, flowing in between the newly formed interstitial cells, from the endoderm. $\times 760$.

Fig. 40.—Vertical section of part of attached base of young polyp. The mesoglœa is shown streaming in between the ectoderm cells, and then strengthening the mucous plug. $\times 608$.

The So-called Labial Cartilages of *Raia clavata*.

By

Edward Phelps Allis, junr.,
Menton, France.

With Plate 6.

GEGENBAUR (1872), in his classical work on "Das Kopfskelet der Selachier," describes (l. c., p. 216), in *Raia* (species not given) and *Raia vomer*, two cartilages which he considers to be the homologues of the labial cartilages of Selachii. In *Raia* (species not given), which is the one first described, one of these two cartilages is shown lying definitely nearer the anterior end of the ventral surface of the snout than the other cartilage, and, doubtless because of this, the former cartilage is called the anterior upper labial and the other the posterior upper labial. The so-called anterior labial lies, however, farther from the symphysis of the upper jaw and farther from the upper edge of the mouth than the so-called posterior one, and if the mouth were terminal it would be the posterior instead of the anterior cartilage. Doubtless because of this, Gegenbaur says (l. c., p. 218) that it is evident that the so-called anterior upper labial of the Batoidei corresponds to the posterior upper labial of the Selachii, and the posterior upper labial of the Batoidei to the anterior upper labial of the Selachii. The posterior (oral) edge of the posterior labial is shown (l. c., Pl. 17, fig. 1) in contact, its full length, with the palatoquadrate; its anterior (aboral) edge is said to be bound to the posterior (oral) edge of the anterior

labial; and the lateral (absymphysial) end of the latter cartilage is said to be in contact with the palatoquadrate. There is accordingly no space either between the adjoining edges of the two cartilages, or between their posterior (oral) edges and the palatoquadrate, and the nasal groove (Nasenrinne) must accordingly lie either wholly lateral (absymphysial) to both labials or external to them.

In *Raia* vomer the posterior labial is said to be overlapped externally, in its middle portion, by the broad lateral (absymphysial) portion of the anterior labial, the latter labial thus not here having the markedly anterior and aboral relations to the other labial that it has in *Raia* (species not given). It however has the same absymphysial relations to that cartilage. The nasal groove (Nasenrinne) is apparently shown (l. c., Pl. 16, fig. 7) lying between the lateral (absymphysial) ends of the two labials, but it is said that both labials lie, in part, in the nasal flap, and hence necessarily external to the nasal groove, as will be later fully explained. The anterior labial is referred to, both in the figure and in the text, by the index letter *L*, while in *Raia* (species not given) that letter refers to the posterior labial.

In Rhinoptera, Gegenbaur says (l. c., p. 219) that there are, in addition to a cartilage that corresponds strictly to the so-called anterior upper labial of *Raia*, two small cartilages found near the angle of the gape of the mouth which together form a rudimentary labial arch similar to the arch formed by the posterior upper and the single lower labials of the *Selachii*. The presence of this posterior pair of labials in Rhinoptera is said by Gegenbaur to definitely confirm his already expressed conclusion that the other labial of Rhinoptera must be the anterior upper one. But it also evidently proves, if correct, that the so-called anterior upper labial of Rhinoptera, and hence also the corresponding labial of *Raia*, must be the homologue of the similarly named labial of the *Selachii* and not of the posterior one; which is in direct contradiction to the positive statement made on p. 218 of his work and already above referred to.

On a still later page of his work (l. c., p. 222) Gegenbaur says that the first (anterior) labial of selachians corresponds to the premaxillary bone of teleosts and the second (posterior) labial to the maxillary bone of those fishes, and as he includes both the Selachii and the Batoidei in the term selachians (Selachier), and as he makes no qualification whatever of the statement, it evidently implies that the so-called anterior and posterior labials of both these sub-orders of the Plagiostomi are homologous, which is again in direct contradiction to his positive statement made on p. 218.

T. J. Parker (1884) gives a figure of these labials in *Raia nasuta* which somewhat resembles Gegenbaur's figure of them in *Raia vomer*, but the so-called first labial of Parker's descriptions, which is Gegenbaur's anterior labial, is so long that it crosses the opening of the mouth and overlaps externally the mandible. This labial is said to support the corresponding flap of the fronto-nasal process, while the second labial, Gegenbaur's posterior one, is said to lie in a fold of skin external to the naso-buccal groove. But as there is no fold of skin external to the naso-buccal groove excepting only the flap of the fronto-nasal process, this labial is thus here said to also lie in that flap.

W. K. Parker (1878) also gives figures and descriptions of these labials in *Raia maculata* and *Raia clavata*, but they differ so radically from Gegenbaur's and T. J. Parker's figures and descriptions that there is no possibility of comparison.

These several descriptions of the labials of the Batoidei are accordingly not clear, and I have, in connection with my present work on the cranial anatomy of *Chlamydoselachus*, examined these cartilages in such specimens of these fishes as I happened to have at my disposal. These specimens consisted of a single head of *Raia clavata*, two small specimens of *Raia radiata*, two small specimens of *Myliobatis*, and two partly dissected specimens of *Torpedo ocellata*. The head of *Raia clavata* was a fresh one, while all the other specimens had been long preserved in alcohol, and were not in good condition for this particular dissection.

In *Raia clavata* (Pl. 6, figs. 1-3) the posterior (oral) edge of the nasal flap of either side occupies about two-fifths of the distance from the angle of the gape to the symphysis of the upper jaw, and it covers a depressed region that will be referred to, in its entirety, as the nasal-flap furrow. The term nasal groove is avoided, because that term (*Nasenrinne*), as employed by Gegenbaur, would seem to refer to a lateral and deeper portion, only, of the entire furrow, as will be later fully explained. Between the nasal flaps of opposite sides the edge of the upper lip of the fish is deeply re-entrant, exposing the teeth and a considerable portion of the upper jaw. A well-marked furrow separates this part of the upper lip from the underlying upper jaw, and may be called the upper labial sulcus. Laterally, on either side, this sulcus runs into the mesial (symphyseal) edge of the corresponding nasal-flap furrow, and the posterior (oral) edge of the nasal flap of either side accordingly appears as a direct continuation of the upper lip. It is, however, not a continuation of that lip, the lip and its related sulcus being prolonged a certain distance along the floor of the nasal-flap furrow, internal to the nasal flap, and there gradually vanishing, as shown in Pl. 6, fig. 2.

In the nasal flap, occupying approximately its entire posterior (oral) half and extending mesially (symphyseally) somewhat beyond the base of the flap into the subdermal tissues between the upper lip and the nasal capsule, lies the cartilage called by Gegenbaur the anterior upper labial. This so-called anterior upper labial of my specimen, like the corresponding one in Gegenbaur's figure of *Raia vomer*, lies external to the so-called posterior upper labial and farther from the symphysis of the upper jaw than that labial, but not definitely anterior to it. It is, however, not a labial cartilage, as will be later shown, but a cartilage developed strictly in supporting relations to the nasal flap. It can accordingly be called the nasal-flap cartilage, which will sufficiently distinguish it from the *Nasenflügelknorpel* of Gegenbaur's descriptions, which latter cartilage also in part supports the nasal flap and is the *ala nasalis* of certain.

English authors. J. Müller (1834) also did not consider this nasal-flap cartilage to be a labial cartilage, and he called it the inner Nasenflügelknorpel.

This nasal-flap cartilage of *Raia clavata* has the shape shown in the accompanying figures, and it is connected with what Gegenbaur calls the anterior process of the corresponding ala nasalis by the dermal and connective tissues of the nasal flap. At its anterior (aboral) corner there is, on one side of the head of my one specimen, a small and independent bit of cartilage. In about the middle of the postero-mesial edge of the cartilage there is a curved incisure, and slightly lateral to the bottom of this incisure, and parallel to the edge of the cartilage, there is a ridge on the internal surface of the cartilage. The mesial surface of this ridge is flat and slopes gradually to the edge of the cartilage, and, on either side of the incisure, it rests upon and is firmly bound to the posterior upper labial of Gegenbaur's descriptions, this contact with the latter labial being particularly large and strong anterior (aboral) to the incisure. The lateral (absymphysial) surface of the ridge is abrupt and curved, and forms the mesial (symphysial) boundary of the nasal-flap furrow, thus marking the base of the nasal flap. The nasal-flap cartilage thus extends mesially beyond the base of the nasal flap into the general tissues on the ventral surface of the head, but it in no place reaches or touches the palato-quadrato, being everywhere separated from it either by the so-called posterior labial cartilage or by the nasal-flap furrow. The incisure in the postero-mesial edge of the nasal-flap cartilage arches over the posterior (oral) end of a short section of the nasal latero-sensory canal (Garman, 1888) that is directed antero-posteriorly.

The posterior upper labial of Gegenbaur's descriptions above referred to, is the only labial found in either *Raia clavata* or *Raia radiata*, and it will accordingly be called, in the following descriptions, the upper labial, or simply the labial. It consists of two broad and approximately parallel portions connected by a narrow neck of cartilage which

extends from the middle of the mesial portion to the mesial end of the lateral portion. The mesial portion lies quite closely upon the palatoquadrate, but is separated from it by branches of the nervus trigeminus and other tissues. Its mesial end projects antero-mesially beyond the palatoquadrate. The antero-mesial end of the lateral portion of the labial lies against the posterior surface of the nasal capsule, the remaining portion lying external to the muscles of the region, but separated from them by tough connective tissues, the cartilage being bent in conformity with the shape of the underlying structures. The postero-lateral portion of this lateral portion of the labial lies immediately beneath the external dermis and parallel with it, and its posterior end lies at a considerable distance from the angle of the gape, separated from that angle by the bulging muscles of the region. The connective tissues in which it lies are attached to it, but it cannot be said that the cartilage runs gradually into ligamentous tissues that are continued into the mandible, as Gegenbaur says is the case in *Raia vomer*.

The narrow neck of cartilage that connects the mesial and lateral portions of the labial lies in the hollow between the aboral edge of the palatoquadrate and the posterior wall of the nasal capsule, and it is always somewhat bent or twisted. In my specimens of *Raia radiata* this twist is so pronounced that the primarily posterior (oral) edge of the cartilage is presented ventrally, the cartilage thus here lying, as Gegenbaur has said for *Raia vomer*, in a vertical position. The primarily external surface of the neck was thus, in these specimens, presented anteriorly instead of ventrally, and the nasal-flap furrow, having crossed the primarily posterior (oral) edge of the labial, had, anterior (aboral) to that edge, somewhat the appearance of lying on the internal rather than the external surface of the labial.

There were, in my specimen of *Raia clavata*, no special ligamentous attachments of the mesial (symphyseal) end of either the labial cartilage or the nasal-flap cartilage to the ventral surface of the rostrum, such as Gegenbaur describes

in *Raia vomer*; this end of the labial of *Raia clavata* simply lying in dense connective tissues of the region, and the corresponding end of the nasal-flap cartilage lying upon and being firmly bound to it. On each side of the head the ventral edge of the posterior wall of the nasal capsule was partly membranous, and in this membrane there was a narrow and independent strip of cartilage. In the mesial wall of the capsule, near its ventral edge, there was a hiatus closed by membrane. One or more branches of the *nervus trigeminus* perforated the cartilage between the hiatus and the edge of the capsule.

The nasal latero-sensory canal was so named by Garman (1888) in his descriptions of these fishes, and is the antorbital portion of the main infraorbital canal of my descriptions of *Mustelus* (Allis, 1901). Running mesially across the external surface of the *musculi adductor mandibulæ* and *levator labii superioris*, this canal reaches the lateral edge of the lateral portion of the labial cartilage immediately anterior to the point where that cartilage assumes a position parallel to the external surface of the head. The canal then crosses the external surface of this portion of the labial and reaches its mesial edge, where it continues onward and reaches and traverses the narrow neck of cartilage that connects this lateral portion of the labial with its mesial portion. Having reached the mesial portion of the labial the canal turns abruptly posteriorly (orally) and crosses the external surface of this part of the labial, lying close to its lateral edge. When the canal reaches the postero-mesial edge of the labial it traverses the incisure in the mesial edge of the nasal-flap cartilage and then turns abruptly antero-mesially along the postero-mesial edge of the labial; and continuing in that direction it joins its fellow of the opposite side in the median line to form the median canal of Garman's descriptions. The canal lies internal to the nasal-flap furrow, and internal also to the nasal-flap cartilage, and in no part of its course does it enter any part of the nasal flap. It lies everywhere external to the labial cartilage and is firmly attached to

that cartilage, but, excepting where it crosses the mesial portion of the labial, there is no noticeable groove to mark its course. In my specimens of *Raia radiata*, because of the marked twist in the neck of the labial, the canal there has markedly the appearance of lying on the internal rather than on the external surface of the labial. In *Raia clavata* some of those branches of the *nervus buccalis lateralis* that innervate the organs of the canal perforate the labial, but most of them pass over the anterior (aboral) edge of the labial and then turn posteriorly (orally) across its external surface. They always lie internal to the nasal-flap cartilage.

In *Raia batis* Ewart (1892) shows two loops in the nasal latero-sensory canal. No such loops were found in *Raia clavata*, and it is probable that they are exaggerated in Ewart's figure, the loops simply representing points where the canal follows bends or twists in the labial such as I find in *Raia radiata*.

In my specimens of *Myliobatis* the nasal-flap furrows are so wide (deep) that they nearly meet in the median line, a narrow "frenulum" (Gegenbaur) there alone separating them. In correlation with this extension of the nasal-flap furrows the nasal-flap cartilages have been carried toward the median line, and are there separated from each other by only a narrow space in which lies the small median bit of cartilage that Müller (1834) describes as the "Träger der Nasenflügelknorpel." The nasal-flap cartilage, called by Müller the inner *Nasenflügelknorpel*, has the triangular shape shown by that author in his figure of *Myliobatis aquila* (l. c. Pl. 9, fig. 13), but it is more deeply fimbriated in my specimens than shown by Müller. The *ala nasalis* is as shown in Müller's figure. The nasal-flap furrow lies internal to both these cartilages. The nasal latero-sensory canal runs internal to the nasal-flap furrow, and then outward and forward (aborally) in the frenulum to meet and fuse, in the median line, with its fellow of the opposite side. In one of my specimens the canal is enclosed in the ventral edge of a strip of cartilage that has

somewhat the position of the narrow strip found along the ventral edge of the posterior wall of the nasal capsule in *Raia clavata*, and already described. In the other specimen the canal is enclosed in an independent tubule of tissue that has a semicartilaginous appearance. In *Trygon tuberculata* Gegenbaur describes (l. c., p. 220) and figures what would seem to be a strictly similar tubule, but it is said by him to be a rod; and although he says that this so-called rod is of fibro-cartilage, he nevertheless considers it to be the homologue of the anterior upper labial of his own descriptions of *Raia* and *Myliobatis*, which latter labial is said to be of hyaline cartilage. The lateral portion of this tubular or rod-like cartilage of *Trygon* is shown, in Gegenbaur's figure, lying definitely internal to the *ala nasalis*, and it seems as if it must accordingly lie, as does the latero-sensory tubule in my specimen of *Myliobatis*, internal also to the nasal-flap furrow. If such be the case it cannot be a nasal-flap cartilage, or so-called anterior labial, of this fish. It probably contains, in both *Trygon* and *Myliobatis*, a remnant of the upper labial of the present descriptions. If not, then that upper labial is entirely wanting in my specimens of *Myliobatis*, as it was in those examined by Gegenbaur. The cartilage described by Gegenbaur, in *Myliobatis*, as the posterior upper labial I could not find in my specimens.

In *Torpedo ocellata* I find the nasal flap much less long; antero-posteriorly, than the flap of *Myliobatis*, this being due, as Gegenbaur has said, to the nasal capsules lying nearer the anterior edge of the mouth. The nasal flap is supported by a marked prolongation and development of the *ala nasalis*, similar to the prolongation of that cartilage in *Myliobatis*, but there is no indication of a separate nasal-flap cartilage. The frenulum is supported by a small median *Träger der Nasenflügelknorpel*, as in *Myliobatis*, and the posterior (oral) end of this little cartilage is strongly attached by connective tissues to the adjoining mesial (symphysial) ends of the palatoquadrates of opposite sides. No upper labial cartilage was found, and a cord of connective tissue lying internal

to the nasal-flap furrow alone represented the aborted nasal latero-sensory canal.

Certain of Gegenbaur's statements regarding the labials of the Raiidæ and their relations to the nasal flap may now be considered. In *Raia* (species not given), Gegenbaur says, as already stated, that the oral edge of the anterior labial is in contact with and bound to the aboral edge of the posterior labial, and that the lateral (absymphysial) end of the anterior labial is in contact with the palatoquadrate. Of *Raia vomer* he says (l.c., p. 216), that the posterior labial, where it bends posteriorly along the external surface of the muscoli adductor mandibulæ and levator labii superioris, "gelangt dadurch mit seiner Fläche an die hintere resp. obere Fläche des vorderen Knorpels, den er mit seinem Endabschnitte seitlich überragt." This statement certainly implies that the lateral ends of the two so-called labials of *Raia vomer* are in contact, as they had previously been said to be in *Raia* (species not given), but the figure given of *Raia vomer* apparently shows the nasal-flap furrow (Nasenrinne) lying between them; and it certainly shows the lateral end of the posterior labial lying internal to the nasal furrow. On p. 219 Gegenbaur says: "Wenn wir bei *Raja* erfahren, dass Labialknorpel in die mit der Bildung der Nasenfurche zusammenhängende Nasenklappe gelangen, in deren nicht bedeutende seitliche Zipfel sie einragen, so folgt daraus, dass bei einer medialen Verbreiterung des labialen Endes der Furche die Labialknorpel von ihrer Lagerung vor dem Oberkieferknorpel gelöst werdenmüssen. Indem die lateralen Zipfel der Klappe auf eine grössere Strecke hin von der Unterfläche des Kopfes sich trennen, kommen die Labialknorpel mehr oder minder vollständig in die Klappe zu liegen. . . . Je mehr die beiderseitigen Nasenklappen gegen die Medianlinie zu frei werden, um so mehr werden die Labialknorpel in sie eintreten." And on p. 226 he says: "Die beiden oberen Labialknorpel kommen ins Velum zu liegen. Der zweite obere Labialknorpel wird aber nicht immer vollständig vom Velum umschlossen. Ein Theil davon

tritt manchmal lateral über das Velum hinaus in den Boden der Nasenrinne, die er dann noch lateral mit begränzen hilft. Dem Nasenvelum gehört somit streng genommen nur der eine vordere, obere Lippenknorpel an."

These several statements of Gegenbaur's certainly definitely affirm that both the anterior and the posterior labials of either side of *Raia* enter into some part of the corresponding nasal flap, and they are apparently both said to extend into the tip of the flap. This is, however, evidently impossible, in so far as the so-called posterior labial is concerned, for in both *Raia clavata* and *Raia radiata*, which cannot differ markedly in this respect from *Raia* (species not given) and *Raia vomer*, the nasal-flap furrow lies definitely between the lateral portions of the two so-called labials, and it would necessarily continue so to lie however much the furrow might be reduced, or be extended mesially. The mesial edge, or bottom, of the furrow marks, or rather determines, the base of the corresponding nasal flap, and the so-called posterior labial could not possibly enter any part of that flap, as the flap is found in my specimens, nor could it enter into a velum formed by the fusion, in the median line, of two such flaps. Gegenbaur's several statements, above referred to, are accordingly certainly incorrect.

The nasal flap of *Raia* and the other non-electric rays is said by Gegenbaur to be derived from the much smaller and quite different nasal flap found in most of the Selachii, the Scylliidæ being said to present several intermediate stages in the process of development. A nasal velum is said to be formed in *Myliobatis*, in certain others of the non-electric rays, and also in certain of the Selachii, by the fusion, in the median line, of the nasal flaps of opposite sides. In the electric rays the method of development (Genese) of the velum is said (l. c., p. 221), to be totally different from that in the non-electric rays, the inference accordingly being that the vela in these two groups of fishes are equivalent but not homologous structures. This will be further discussed

after considering the intimately associated nasal-flap furrow and naso-buccal groove.

The nasal-flap furrow, as I have used that term, is the entire space that lies in the angle between the nasal flap and the underlying external surface of the dermis of the ventral surface of the head. The lateral (absymphysial) portion of this space is in *Raia clavata* deepened, and this depressed portion, beginning immediately mesial (symphysial) to the angle of the gape, runs at first anteriorly (aborally) and then turns antero-mesially to fall into the postero-mesial portion of the nasal pit. This deepened portion of the entire furrow thus forms a marked groove in the dorsal (internal) wall of the furrow, and it will be referred to hereafter as the naso-buccal groove, this term being taken from T. J. Parker's (1884) descriptions of this fish. Parker, however, used this term to designate, not the naso-buccal groove alone of my descriptions, but the entire nasal-flap furrow.

Gegenbaur says of the nasal groove of his descriptions (l. c., p. 224): "Durch den geschilderten Vorgang der Velumbildung werden nicht bloss die Nasenklappen dem Munde genähert, sondern die von der Klappe bedeckte Räumlichkeit dehnt sich dabei von der Nasengrube her gegen den Mundrand zu aus und bildet eine flache oder tiefere Rinne, die von der anderseitigen durch ein verschieden breites Frenulum getrennt ist, oder auch bei bedeutender Kürze jenes Frenulums mit derselben zusammenfliesst. Eine solche Einrichtung kann als eine Weiterbildung des bei den zuletzt aufgeführten Scyllien bestehenden Verhaltens gelten. Sie findet sich bei *Chiloscyllium*, ähnlich auch bei *Stegostoma*, bei denen die ziemlich tiefe Rinne zum Mundwinkel herabführt. Entfernter vom Mundwinkel führt sie bei *Crossorhinus* zum Munde, indem sie den Rand der Oberlippe durchbricht."

The "Räumlichkeit" or "Rinne" here described by Gegenbaur is evidently the entire nasal-flap furrow of my descriptions, but several others of Gegenbaur's statements seem quite definitely to make the term apply only to the naso-buccal groove. In a footnote on p. 218 he says:

“Scyllium besitzt keine Nasenfurche”; and this notwithstanding that there is a well-marked nasal-flap furrow in certain of the Scylliidæ, and that in his own figure of *Scyllium canicula* a so-called “Nasenrinne” is indicated by index letters. On p. 217 he says: “Denkt man sich an der Vorderfläche des Oberkiefers einen sich bedeutend verbreiternden Labialknorpel gelagert, so wird derselbe, da die Flächenvergrößerung nicht gegen den Mundrand zu stattfinden kann, nach vorn zu sich ausdehnen müssen und wird mit der Bildung einer von der Nasengrube zum Mundwinkel führenden Nasenfurche median von derselben zu liegen kommen.” On p. 218 he says: “Auf die Nasenfurche lege ich hiebei grösseres Gewicht als auf die Nasenklappe, denn durch den Verlauf der ersteren zum Mundwinkel ist die Zutheilung der bezüglichen Knorpel zu dem zwischen beiden Nasenfurchen gelegenen zur Nasenklappe sich differenzierenden Abschnitte des Integumentes zu erklären.” And on p. 224 he says: “Diese Nasenrinne oder Nasenfurche erscheint unter den Rochen allgemein verbreitet. Sehr ausgeprägt ist sie bei den Rajae, meist gerade zum Mundwinkel herabziehend. Durch eine mediale Verbreiterung erfährt die Rinne eine Abflachung, und beiderseitige Rinnen können vor der Mundöffnung zusammenfliessen, was bei einer geringeren Ausbildung des Velums, wie z. B. bei manchen Rhinobatiden, fast zu einem Verschwinden der ganzen Einrichtung führt. Aus demselben Grunde ist auch bei *Trygon* die Rinnenbildung schwer zu erkennen und eben so bei *Myliobatis*. Die ganze Erscheinung erlangt bei diesen den höchsten Grad ihrer Ausbildung und zwar in einem das Verhältniss bei den Rajae weit überschreitenden und es damit unkenntlich machenden Masse.”

In all these several quotations the so-called nasal groove (Nasenrinne) is evidently considered to be a groove that runs primarily from the nasal pit to the angle of the gape of the mouth, and the appearance of this groove is apparently conceived to precede the differentiation of the nasal flap. There is, however, no slightest indication in any of the many

fishes described by Gegenbaur of such a groove existing independently of the nasal flap and its related nasal-flap furrow, and it is quite certain that the groove is simply a secondary differentiation of the furrow. Such being the case the nasal-flap furrows of all the Plagiostomi are strictly homologous structures, and this is the conclusion that Luther (1909) arrives at from physiological considerations. A continuous nasal velum would then be formed if the furrows of opposite sides were to coalesce in the median line by the complete or partial breaking through of the intervening frenulum. There is, however, no indication whatever, in any of my specimens, that this frenulum is ever broken through, for even in *Myliobatis* the oral edge of the frenulum forms a part of the upper lip of the fish and not a part of the nasal flap of either side. The nasal-flap furrows of opposite sides are here certainly in communication with each other beneath the velum, but it is through the intermediation of the small persisting median section of the upper labial sulcus and not because of the coalescence of the furrows. I am accordingly convinced that a complete velum, extending across the median line, must, if ever found, be formed by the coalescence of the opposing mesial edges of the nasal flaps of opposite sides in fishes where those flaps have been prolonged beyond the oral edge of the upper lip; and this would seem to be confirmed by the conditions that I find in a small specimen of *Scyllium*.

In this small specimen of *Scyllium*, which I am quite certain is *Scyllium canicula*, I find the nasal flaps of opposite sides so much more developed than those shown in Gegenbaur's figure of this fish that it would seem as if the two fishes could not be of the same species. The flaps of opposite sides are separated by a small median incisure which extends to the oral edge of the frenulum, that edge certainly representing a small persisting median portion of the upper lip. There is accordingly no complete velum in my specimen of this fish. Such a velum would, however, be formed if the adjoining edges of the incisure were to fuse, and this is

apparently what does take place in older specimens, for Günther (1870) says of this fish: "The nasal valves confluent, without cirrus, forming together a simple broad flap in front of the mouth, the posterior edge of the flap being nearly free, not interrupted in the middle."

The nasal flaps of all of the Plagiostomi, whether Selachii or Batoidei, are accordingly simply folds of the dermal tissues of the internasal portion of the snout, this internasal portion of the snout being presented more or less ventrally according to the greater or less development of the rostrum and the correlated configuration of the head. If the mouth were terminal and the nasal apertures disposed as in *Amia* and most of the Teleostei, this internasal region would lie on the dorsal surface of the snout, and the relations, anterior and posterior, would be the reverse of what they are in *Raia*. In the Batoidei the nasal flap always lies external to the nasal section of the latero-sensory canals, and the nasal-flap cartilage, which lies in large part in the flap, also always lies external to that canal, and external also to the *nervus buccalis lateralis*. In most Selachii the nasal flap lies wholly aboral to the nasal latero-sensory canal, that is, on the opposite side of the canal to the labial cartilages; but in my specimen of *Scyllium* it lies external to the canal, as it does in the Batoidei. In *Chlamydoselachus* both labials lie oral to the suborbital latero-sensory canal but internal both to the third group of ampullæ of Merritt Hawkes' (1906) descriptions and to those branches of the *buccalis* that supply those ampullæ; the labials thus lying morphologically internal to the suborbital canal. In *Mustelus* (Allis, 1901) the labials have similar relations to the latero-sensory canals, ampullæ, and related nerves. In my specimen of *Scyllium* the anterior end of the single upper labial (Gegenbaur, 1872) lies directly internal to the latero-sensory canals at the point where the nasal canal joins the suborbital canal; and, in *Stegostoma tigrinum*, Luther (1909) says that the rostral (external) surface of the anterior labial is grooved to lodge the nasal canal.

The so-called anterior upper labial of Gegenbaur's descrip-

tions of the Batoidei, the nasal-flap cartilage of the present descriptions, can not accordingly be the homologue of either of the labial cartilages of that author's descriptions of the Selachii, and it is apparently a fibro-cartilage developed wholly in supporting relation to the nasal flap. Sections of it show the interior of the cartilage a mass of fibrous strings running gradually, toward the exterior on either side, into hyaline cartilage.

The nasal-flap cartilage of *Raia* thus not being the homologue of either of the labials of the Selachii, the single upper labial of the former fish might represent either one of the labials of the latter fishes. I am, however, strongly inclined to believe that it represents both the labials of the latter fishes, here secondarily connected by a narrow neck of cartilage; the mesial and lateral portions of the labial of *Raia* representing, respectively, the anterior and posterior labials of the Selachii. The general shape and disposition of the cartilage favours this view, and this composition of the labial would offer a possible explanation of the peculiar course of the nasal latero-sensory canal. The labials, in the Selachii, lie either oral or internal to the nasal latero-sensory canal, as just above explained. In *Raia* the labial lies in large part aboral to the canal, and, in acquiring this position, the two parts of which I consider the labial to be composed have necessarily pushed against and carried with themselves those branches of the *nervus buccalis lateralis* that supply the organs of the related portion of the canal. This push on the nerves would naturally tend to displace the canal, but the mesial section of the canal was held in place by the attachment of the nasal-flap cartilage to the lateral end of the anterior labial. The lateral portion of the canal was not so held in place, and would in consequence be carried aborally by the pull of the nerves, and these nerves, becoming more or less enveloped in the pushing edge of the labial, would be found perforating the cartilage in the adult. The sharp bend actually found in the canal would thus be accounted for. The relations of the nerves to the mesial

portion of the labial, in *Raia*, and the relations of the canal itself to the lateral portion of the labial are both against the view that these cartilages are developed in direct relation to the canal, but the cartilage of *Raia* is nevertheless evidently of fibro-cartilaginous origin, for sections of it show certain fibrous strings in the interior of the cartilage. They are, however, much less numerous than in the nasal-flap cartilage.

Gegenbaur considered the anterior and posterior upper labials of his descriptions of the *Selachii*, and their assumed homologues in the *Batoidei*, to be cartilages that served as groundwork (*Grundwerk*) on which the premaxillary and maxillary bones, respectively, of the *Teleostei* were developed. My work has as yet offered nothing decisive either in favour of or against this view, in so far as it applies to the two labials of the *Selachii* and the one upper labial of the present descriptions of *Raia*, but the relations of the labial of *Raia* to the branches of the *nervi buccalis* and *trigeminus* favour the view that its two portions may represent the two bones of the *Teleostei*. There is, however, doubt as to which part of the labial represents the maxillary and which the premaxillary. The nasal-flap cartilage, Gegenbaur's anterior labial, can not, however, represent either of the two bones of the *Teleostei*. Its general position, in *Raia*, and its relations, in *Myliobatis*, to the so-called *Träger der Nasenflügelknorpel*, strongly suggest that it may represent the ascending process of the premaxillary bone of the *Teleostei*, and that the *Träger der Nasenflügelknorpel* may represent the rostral cartilage of certain of those fishes.

In two of my earlier works (1898, 1909) I came to the conclusion that the ascending process of the premaxillary bone of the *Teleostei* was primarily an independent bone, the so-called dermal ethmoid, which later fused with the premaxillary. This primarily independent bone was said to have been developed in protective relation to a line of laterosensory organs, and to be found as such a protective bone not only in certain ganoids (*Amia*, *Polypterus*), but also in

Elops and probably also in Belone. In certain other Teleostei the corresponding bone, the supra-ethmoid of current descriptions, was said to underlie a line of surface pit organs that corresponded to the canal line in *Amia*. This supra-ethmoid bone was accordingly considered to be a bone of membranous origin that represented a deeper component of the canal-bearing bone of *Amia*, just as, in certain others of the canal-bearing bones of *Amia* and other fishes, there is an underlying membrane component apparently developed somewhat independently of the canal-bearing component. The conditions now found in *Raia* suggest that this supra-ethmoid bone of the Teleostei is represented in the nasal-flap cartilage of *Raia*. If this be so, the supra-ethmoid bone can not represent an underlying component of a canal-bearing bone, for the cartilage of *Raia* lies definitely external to the related canal. This origin of the supra-ethmoid bone from the nasal-flap cartilage might then account for the absence, in those fishes in which that bone is found, of the canal line found in *Amia*; for this cartilage, or bone, in sinking from the position which it has in *Raia* to that which it has in the Teleostei, would necessarily smother the underlying canal and ultimately lead to its complete abortion. The line of pit organs that overlies the supra-ethmoid bone in certain Teleostei would then be a secondary outgrowth from the end of the infraorbital canal line, and hence not the homologue of the cross-commisural canal line of *Amia* and the other fishes in which it is found. In *Amia*, *Polypterus*, and *Elops*, it is to be especially noted that the presence of a canal-bearing ethmoid bone is associated with the relation of the maxillary bone to the premaxillary that Sagemehl (1884) described as lateral, and that is said by that author to be found in only a few of the Teleostei. These two conditions may accordingly be related, but the want of proper material does not at present permit me to farther investigate it.

PALAIS DE CARNOLES, MENTON;
January 20th, 1916.

LITERATURE.

- Allis, Edw. P., jr. (1898).—"On the Morphology of Certain of the Bones of the Cheek and Snout of *Amia calva*," 'Journ. Morphol.,' vol. xiv, No. 3, Boston.
- (1901).—"The Lateral Sensory Canals, the Eye-Muscles, and the Peripheral Distribution of the Cranial Nerves of *Mustelus lævis*," 'Quart. Journ. Micr. Sci.,' vol. 45, part 2.
- (1909).—"The Cranial Anatomy of the Mail-Cheeked Fishes." 'Zoologica,' Hft. 57, Bd. xxii, Lief. 3/5, Stuttgart.
- Ewart, J. C., and Mitchell, J. C. (1892).—"The Lateral Sense Organs of Elasmobranchs. II. The Sensory Canals of the Common Skate (*Raia batis*)," 'Trans. Roy. Soc. of Edinburgh,' vol. xxxvii, part 1 (Nos. 5 and 6), Edinburgh.
- Garman, S. (1888).—"On the Lateral Canal System of the Selachia and Holocephala," 'Bull. Mus. Comp. Zool. Harvard College,' vol. xviii, No. 2.
- Gegenbaur, Carl (1872).—"Untersuchungen zur vergleichenden Anatomie der Wirbelthiere," Hft. 3, 'Das Kopfskelet der Selachier, ein Beitrag zur Erkenntnis der Genese des Kopfskelets der Wirbelthiere,' Leipzig.
- Günther, Albert (1870).—"Catalogue of the Fishes in the British Museum," vol. viii, London.
- Hawkes, O. A. M. (1906).—"The Cranial and Spinal Nerves of *Chlamydoselachus anguineus*" (Gar.), 'Proc. Zoolog. Soc. London for 1906,' part 2.
- Luther, Alex. (1909).—"Beiträge zur Kenntnis von Muskulatur und Skelett des Kopfes des Haies *Stegostoma tigrinum* Gm. und der Holocephalen, mit einem Anhang über die Nasenrinne," 'Acta Soc. Sc. Fennicae,' Helsingfors.
- Müller, Johannes (1834).—"Vergleichende Anatomie der Myxinoiden der Cyclostomen mit durchbohrtem Gaumen, Th. 1, Osteologie und Myologie," 'Abh. d. Berliner Akad. d. Wiss. (Phys-math. Abt.), Jahrg. 1834,' Berlin, 1835.
- Parker, T. J. (1884).—"A Course of Instruction in Zootomy,' London.
- Parker, W. K. (1878).—"On the Structure and the Development of the Skull in Sharks and Skates," 'Trans. Zool. Soc. London,' vol. x, part 4, No. 1, London.
- Sagemehl, M. (1884).—"Beiträge zur vergleichenden Anatomie der Fische. II. Das Cranium der Characiniden, etc.," 'Morph. Jahrb.' Bd. x, Hft. 1, Leipzig.

EXPLANATION OF PLATE 6,

Illustrating Mr. Edward Phelps Allis's paper on "The So-called Labial Cartilages of *Raia clavata*."

INDEX LETTERS.

a. n. Ala nasalis. *a. n. a.* Anterior nasal aperture. *ant.* Antorbital cartilage (Parker), Schädelknochen-Knorpel (Gegenbaur). *f. n.* Fenestra nasalis. *m.* mouth. *md.* Mandibula. *n.* Nasal section of latero-sensory canal. *n. b. g.* Naso-buccal groove. *n. c.* Nasal capsule. *n. f.* Nasal flap. *n. f. c.* Nasal-flap cartilage. *n. f. f.* Nasal-flap furrow. *orb.* Orbital section of latero-sensory canal. *pn.* Pre-nasal section of latero-sensory canal. *p. n. a.* Posterior nasal aperture. *pg.* Palato-quadrate. *r. b.* Ramus buccalis lateralis. *r. mx. t.* Ramus maxillaris trigemini. *so.* Suborbital section of latero-sensory canal. *sr.* Subrostral section of latero-sensory canal. *u. l. c.* Upper labial cartilage.

Fig. 1.—Ventral view of the snout of *Raia clavata*. On the right-hand side of the figure the dermis has been removed from the nasal flap so as to expose the ala nasalis, the nasal-flap cartilage, and the related sections of the nasal and pre-nasal latero-sensory canals.

Fig. 2.—The same; a deeper dissection. The nasal flap has been almost completely removed on both sides of the figure. On the left-hand side that part of the flap that contains the anterior process of the ala nasalis has been left and turned back so as to expose the nasal apertures and the nasal-flap furrow.

Fig. 3.—The same; a still deeper dissection. The nasal flap and the related portions of the latero-sensory canals have been removed on the right-hand side of the figure, exposing the ala nasalis and the upper labial cartilage. On the left-hand side these last two cartilages have been removed so as to expose the nasal capsule.

With Ten Plates, Royal 4to, 5s. net.

CONTRIBUTIONS TO THE KNOWLEDGE OF RHABDOPLEURA AND AMPHIOXUS.

By SIR RAY LANKESTER, K.C.B., M.A., LL.D., F.R.S.
London: J. & A. CHURCHILL, 7 Great Marlborough Street.

Quarterly Journal of Microscopical Science.

The SUBSCRIPTION is 42s. for the Volume of Four Numbers ; for this sum (*prepaid*) the JOURNAL is sent Post Free to any part of the world.

BACK NUMBERS of the JOURNAL, which remain in print, are now sold at a uniform price of 10/6 net.

The issue of SUPPLEMENT NUMBERS being found inconvenient, and there being often in the Editor's hands an accumulation of valuable material, it has been decided to publish this Journal at such intervals as may seem desirable, rather than delay the appearance of Memoirs for a regular quarterly publication.

The title remains unaltered, though more than Four Numbers may be published in the course of a year.

Each Number is sold at 10/6 net, and Four Numbers make up a Volume.

London: J. & A. CHURCHILL, 7 Great Marlborough Street.

TO CORRESPONDENTS.

Authors of original papers published in the Quarterly Journal of Microscopical Science receive fifty copies of their communication *gratis*.

All expenses of publication and illustration are paid by the publishers.

Lithographic plates and text-figures are used in illustration. Shaded drawings intended for photographic reproduction as half-tone blocks should be executed in "Process Black" diluted with water as required. Half-tone reproduction is recommended for uncoloured drawings of sections and of Protozoa.

Drawings for text-figures should NOT be inserted in the MS., but sent in a separate envelope to the Editor.

Contributors to this Journal requiring *extra* copies of their communications at their own expense can have them by applying to the Printers,

Messrs. ADLARD & SON AND WEST NEWMAN, 23, Bartholomew Close, E.C., on the following terms:

For every four pages or less—

25 copies	5/-
50	„	6/-
75	„	6/6
100	„	7/-

Plates, 2/- per 25 if uncoloured; if coloured, at the same rate for every colour.

Prepayment by P.O. Order is requested.

ALL COMMUNICATIONS FOR THE EDITORS TO BE ADDRESSED TO THE CARE OF MESSRS. J. & A. CHURCHILL, 7 GREAT MARLBOROUGH STREET, LONDON, W.

THE MARINE BIOLOGICAL ASSOCIATION

OF THE
UNITED KINGDOM.

—:O:—
Patron—HIS MAJESTY THE KING.

President—Sir RAY LANKESTER, K.C.B., LL.D., F.R.S.
—:O:—

THE ASSOCIATION WAS FOUNDED "TO ESTABLISH AND MAINTAIN LABORATORIES ON THE COAST OF THE UNITED KINGDOM, WHERE ACCURATE RESEARCHES MAY BE CARRIED ON, LEADING TO THE IMPROVEMENT OF ZOOLOGICAL AND BOTANICAL SCIENCE, AND TO AN INCREASE OF OUR KNOWLEDGE AS REGARDS THE FOOD, LIFE CONDITIONS, AND HABITS OF BRITISH FOOD-FISHES AND MOLLUSCS."

The Laboratory at Plymouth

was opened in 1888. Since that time investigations, practical and scientific, have been constantly pursued by naturalists appointed by the Association, as well as by those from England and abroad who have carried on independent researches.

Naturalists desiring to work at the Laboratory

should communicate with the Director, who will supply all information as to terms, etc.

Works published by the Association

include the following:—'A Treatise on the Common Sole,' J. T. Cunningham, M.A., 4to, 25/-. 'The Natural History of the Marketable Marine Fishes of the British Islands,' J. T. Cunningham, M.A., 7/6 net (published for the Association by Messrs. Macmillan & Co.).

The Journal of the Marine Biological Association

is issued half-yearly, price 3/6 each number.

In addition to these publications, the results of work done in the Laboratory are recorded in the 'Quarterly Journal of Microscopical Science,' and in other scientific journals, British and foreign.

Specimens of Marine Animals and Plants,

both living and preserved, according to the best methods, are supplied to the principal British Laboratories and Museums. Detailed price lists will be forwarded on application.

TERMS OF MEMBERSHIP.

ANNUAL MEMBERS	£1 1 0	per annum.
LIFE MEMBERS	15 15 0	Composition Fee.
FOUNDERS	100 0 0	" "
GOVERNORS (Life Members of Council)	500 0 0	

Members have the following rights and privileges:—They elect annually the Officers and Council; they receive the Journal free by post; they are admitted to view the Laboratory at any time, and may introduce friends with them; they have the first claim to rent a table in the Laboratory for research, with use of tanks, boats, etc.; and have access to the Library at Plymouth. Special privileges are granted to Governors, Founders, and Life Members.

Persons desirous of becoming members, or of obtaining any information with regard to the Association, should communicate with—

The DIRECTOR,

The Laboratory,
Plymouth.

New Series, No. 246 (Vol. 62, Part 2).

Price 10s. 6d. net.

Subscription per volume (of 4 parts) 42s. net.

FEBRUARY, 1917.

THE
QUARTERLY JOURNAL
 OF
MICROSCOPICAL SCIENCE.

EDITED BY

SIR RAY LANKESTER, K.C.B., M.A., D.Sc., LL.D., F.R.S.,

HONORARY FELLOW OF EXETER COLLEGE AND HONORARY STUDENT OF CHRIST CHURCH, OXFORD;
 MEMBER OF THE INSTITUT OF FRANCE (ASSOCIÉ ÉTRANGER DE L'ACADEMIE DES SCIENCES);
 CORRESPONDENT OF THE IMPERIAL ACADEMY OF SCIENCES OF ST. PETERSBURG, AND OF THE
 ACADEMY OF SCIENCES OF PHILADELPHIA, AND OF THE ROYAL ACADEMY OF SCIENCES
 OF TURIN; FOREIGN MEMBER OF THE ROYAL SOCIETY OF SCIENCES OF
 GÖTTINGEN, AND OF THE ROYAL BOHEMIAN SOCIETY OF SCIENCES, AND
 OF THE ACADEMY OF THE LINCEI OF ROME, AND OF THE AMERICAN
 ACADEMY OF ARTS AND SCIENCES OF BOSTON; ASSOCIATE OF THE
 ROYAL ACADEMY OF BELGIUM; HONORARY MEMBER OF THE
 NEW YORK ACADEMY OF SCIENCES, AND OF THE
 CAMBRIDGE PHILOSOPHICAL SOCIETY, AND OF
 THE ROYAL PHYSICAL SOCIETY OF EDIN-
 BURG, AND OF THE

BIOLOGICAL AND ZOOLOGICAL SOCIETIES OF PARIS, AND OF THE CALIFORNIA ACADEMY OF SCIENCES OF
 SAN FRANCISCO, AND OF THE ROYAL ZOOLOGICAL AND MALACOLOGICAL SOCIETY OF BELGIUM;
 CORRESPONDING MEMBER OF THE SENKENBERG ACADEMY OF FRANKFURT-A-M;

FOREIGN ASSOCIATE OF THE NATIONAL ACADEMY OF SCIENCES, U.S., AND MEMBER OF THE
 AMERICAN PHILOSOPHICAL SOCIETY;

HONORARY FELLOW OF THE ROYAL SOCIETY OF EDINBURGH;

LATE DIRECTOR OF THE NATURAL HISTORY DEPARTMENTS OF THE BRITISH MUSEUM; LATE PRESIDENT OF THE
 BRITISH ASSOCIATION FOR THE ADVANCEMENT OF SCIENCE; LATE FULBRIAN PROFESSOR OF
 PHYSIOLOGY IN THE ROYAL INSTITUTION OF GREAT BRITAIN;

LATE LINACRE PROFESSOR OF COMPARATIVE ANATOMY AND FELLOW OF MERTON COLLEGE, OXFORD;

EMERITUS PROFESSOR OF ZOOLOGY AND COMPARATIVE ANATOMY IN UNIVERSITY COLLEGE, UNIVERSITY OF LONDON

WITH THE CO-OPERATION OF

SYDNEY J. HICKSON, M.A., F.R.S.,

BEYRER PROFESSOR OF ZOOLOGY IN THE UNIVERSITY OF MANCHESTER;

GILBERT C. BOURNE, M.A., D.Sc., F.R.S.,

LINACRE PROFESSOR OF COMPARATIVE ANATOMY, AND FELLOW OF MERTON COLLEGE, OXFORD

J. GRAHAM KERR, M.A., F.R.S.,

REGIUS PROFESSOR OF ZOOLOGY IN THE UNIVERSITY OF GLASGOW;

AND

E. W. MACBRIDE, M.A., D.Sc., LL.D., F.R.S.,

PROFESSOR OF ZOOLOGY AT THE IMPERIAL COLLEGE OF SCIENCE AND TECHNOLOGY.

WITH LITHOGRAPHIC PLATES AND TEXT-FIGURES.



LONDON.

J. & A. CHURCHILL, 7 GREAT MARLBOROUGH STREET.

1917.

CONTENTS OF No. 246.—New Series.

MEMOIRS:

	PAGE
On <i>Phoronis ovalis</i> , Strethill Wright. By SIDNEY F. HARMER, Sc.D., F.R.S., Keeper of Zoology in the British Museum (Natural History). (Published by permission of the Trustees of the British Museum. (With Plates 7-9)	115
The Embryonic Development of <i>Trichogramma evanescens</i> , Westw., a Monembryonic Egg Parasite of <i>Donacia simplex</i> , Fab. By J. BRONTÉ GATENBY, Exhibitioner of Jesus College, Oxford. (With Plates 10-12)	149
On the Development of the Cape Cephalodiscus (<i>C. gilchristi</i> , Ridewood). By J. D. F. GILCHRIST, M.A., D.Sc., Ph.D. (With Plates 13 and 14)	189
Note on the Sex of a Tadpole raised by Artificial Parthenogenesis. By J. BRONTÉ GATENBY, B.A., Exhibitioner of Jesus College, Oxford. (With 5 Text-figures)	213
An Easy Way of Demonstrating the Nuclei of Nerve Fibres. By HENRY E. REBURN, Student of Medicine. (From the Physiological Laboratory, King's College, London)	217
On a Larval Actinian Parasitic in a Rhizostome. By C. BADHAM, B.Sc., Demonstrator in Zoology, University of Sydney. (With 3 Text-figures)	221
The Early Development of the Spleen of <i>Lepidosiren</i> and <i>Protopterus</i> . By G. L. PURSER, B.A. (Sometime Coutts-Trotter Student, Trinity College, Cambridge. (With Plates 15-17)	231
A Note concerning the Collar Cavities of the Larval <i>Amphioxus</i> . By K. M. SMITH, A.R.C.S., D.I.C., and H. G. NEWTH, Demonstrator in Zoology, Imperial College of Science and Technology. (With Plate 18)	243

On *Phoronis ovalis*, Strethill Wright.

By

Sidney F. Harmer, Sc.D., F.R.S.,

Keeper of Zoology in the British Museum (Natural History).

(Published by permission of the Trustees of the British Museum.)

With Plates 7, 8, and 9.

INTRODUCTION.

IN 1913 Miss R. E. Roper, who was working with Professor A. Meek at the Polyzoa of the Northumberland coast, was kind enough to send to the British Museum an empty shell of *Neptunea antiqua* bearing specimens of *Alcyonidium mammillatum*, Alder. On examining the surface of the shell on which this Polyzoon was growing, a curiously eroded appearance was noticed. In order to ascertain the meaning of this appearance, a fragment of the shell was decalcified; and it was at once obvious that the substance of the shell was traversed by the burrows of numerous boring animals. A few of these belonged either to the Sponge, *Cliona*, or to a small Polychæte, probably *Polydora ciliata*. The great majority of them belonged, however, to a minute species of *Phoronis*, which has proved to correspond closely with the description of *P. ovalis* given by Strethill Wright (1856¹, 1856²) in the papers in which the genus *Phoronis* was established. The *Neptunea* which is here considered was obtained to the south-east of St. Mary's Island, off the Northumberland coast, in 16 fathoms; and it has

been registered in the British Museum collection as 13. 7. 10. 1-2.

Since the publication of the original description, *P. ovalis* appears never to have been rediscovered (cf. Selys-Longchamps, 1907, p. 188); and it has been supposed that the species had been founded on the immature condition of some other species. I am happy to be able to confirm the accuracy of Strethill Wright's account; and to show, by the occurrence of well-developed ovaries and testes, that it must be regarded as an adult form, in spite of its minute size and the small number of its tentacles. The examination of the Northumberland material has furnished some explanation of the fact that this interesting species has so long escaped notice. Although present in very large numbers in the material under consideration, it is so completely concealed in the substance of the shell that its presence would not have been suspected unless the shell had been decalcified. Although I have not obtained other specimens, there seems every reason to think that the species will be discovered in equal abundance when shells of *Neptunea* or other Molluscs from the north-east coast of England and the east coast of Scotland are examined by the method of decalcification.

A further result of the present investigation has been to demonstrate the occurrence of a remarkably active process of reproduction by fission, in confirmation of the results of certain other observers, for other species; though taking place with far greater frequency than is indicated by anything that has previously been published.

The genus *Phoronis* was established by T. Strethill Wright in a paper communicated to the Royal Physical Society of Edinburgh on April 23rd, 1856, and published in two Edinburgh journals (1856¹, 1856²). Two species were distinguished—*P. hippocrepia*, the tubes of which were embedded in a stone obtained at Ilfracombe; and *P. ovalis*, found in a decayed oyster-shell, inhabited also by *Cliona celata*, dredged near Inchkeith in the Firth of Forth. Of *P. hippocrepia* an excellent description is given, so far

as the structure could be made out in the part of the animal protruded from the membranous tube. This account includes an accurate description of the hippocrepian lophophore, the number of tentacles being given as about sixty; of the descending œsophagus and the ascending rectum, the position of the mouth, epistome, and anus being well described; of the blood, containing red corpuscles; and of the principal vessels, including the afferent and efferent trunks, the tentacular vessels, and some of the lophophoral vessels. The structure of *P. ovalis* is described in less detail, but stress is laid on the form of its lophophore, which is oval but slightly flattened on one side. The tentacles were eighteen in number, and the blood-corpuscles were noticed. The entire animal was about half an inch in length, and the gullet terminated in a globular gizzard, which communicated with a thick-walled stomach. Good figures are given of the oral ends of both species, the body of *P. ovalis* being figured as protruding from a delicate tube, embedded in the substance of the oyster-shell. The examination of Strethill Wright's figures and description leaves no doubt that the specimens described in the present paper belong to *P. ovalis*.

Although the eroded appearance of the outer surface of the *Neptunea*-shell furnished the clue which led to the discovery of the *Phoronis*, it does not appear to have been caused by the presence of this animal. The outer layers of the shell, both on the outer and on the inner side, are traversed by a number of branching hypha-like threads, which reach a diameter of as much as 24μ ; and it appears probable that these are the principal cause of the erosion noticed on the outer surface. This is in accordance with the statements of Bornet and Flahault (1889), who give an account of various Algæ and Fungi which bore in the shells of Molluscs. According to these authors the organisms in question commence their work by extending horizontally in the epidermic layer of the shell, subsequently sending branches vertically into the shell-substance and others parallel with the first set. These become so numerous and their branches

so close together that the interposed calcareous substance finishes by disappearing, and the plant thus comes into contact with the external water, and is able to discharge its reproductive cells. The surface of the shell is thus rendered rugose and uneven. This process is supposed to be the principal cause of the disappearance of empty shells in quiet bays.

I have not succeeded in determining the vegetable organisms found with the *Phoronis ovalis*, though they appear to have some resemblance to the Alga described by Bornet and Flahault as *Gomontia polyrhiza*. The hyphæ of this plant are said to have a maximum diameter of $12\ \mu$ —a size which is considerably exceeded in the largest filaments found in the Northumberland material.

The thickness of the *Neptunea*-shell varies between about 2 and 4.5 mm. In the neighbourhood of the columella it reaches its greatest thickness, while it is much thinner in the middle of the whorls. The diameter of the tubes of the majority of the *Phoronis* individuals is from .250 to .275 mm. Even in the thinnest part of the shell the diameter of the burrow of the *Phoronis* is thus not more than about one-eighth of the thickness of the shell, and there is accordingly plenty of room in the substance of the shell to accommodate a large number of these burrows.

The general arrangement of the cavities inhabited by the *Phoronis* may be indicated by comparing the shell with a mass of wood excavated by the burrows of *Teredo*. The *Phoronis* is present in very large numbers, its burrows passing in all directions through the shell, and opening to the exterior either on the outer side or on the inner side. The distal end of the burrow is commonly placed at right angles to the surface, but in some cases part of the tube lies in a superficial groove of the shell. In addition to the *Phoronis* and the Alga already mentioned, the substance of the shell is inhabited by other boring organisms, and particularly by the Sponge *Cliona* and a *Polychæte* which

is probably *Polydora*. The Sponge forms much larger cavities than those produced by the *Phoronis*, and these naturally have a form corresponding with the lobes of the Sponge, being quite different in shape from the cylindrical *Phoronis*-tubes, which remain of approximately the same diameter throughout their course. The *Polychæte* tubes are larger than those of the *Phoronis*; and, instead of having the hyaline character of the tubes of this organism, their transparency is affected by the presence in them of numerous granular particles.

The tubes of the *Phoronis* are represented in several of the figures (e. g. Pl. 8, fig. 15; Pl. 9, fig. 37). It will be seen that they are by no means uniform in shape, but that they are generally curved in various ways. The thin membranous tube is closely applied to the inner surface of the excavation in the shell, and the burrows are accordingly curved in correspondence with the form of the tubes seen in a decalcified preparation.

The most superficial examination of a number of the tubes set free by decalcifying the shell shows that there is an extraordinary amount of variation in the included organisms. It is hardly going too far to say that it is difficult to find two individuals alike on a slide containing a large number of individuals. The length of the animal varies within wide limits, while differences in the transverse diameter of the specimens are also marked. The most striking differences are seen, however, in the extent of the development of the lophophore. While some of the individuals are provided with a lophophore bearing well-developed tentacles (Pl. 7, figs. 1-3), the lophophore is completely absent in others (Pl. 9, figs. 29, 30). In others again a lophophore in an early stage of development can be made out at the distal end (Pl. 8, fig. 13); while all stages between this and the fully-developed lophophore can be found without difficulty among the other individuals on the slide (Pl. 7, figs. 5, 4, 8). It is impossible to interpret these appearances on any other supposition than the assumption that regeneration of the

lophophore takes place with great readiness in this species of *Phoronis*. Although it is probable that this regeneration may be no more than the replacement of the lophophore previously present, there is reason to suppose that in other cases it indicates the occurrence of a process of asexual reproduction, the regenerating lophophore being formed, in such cases, at the distal end of a proximal part of the body separated off from the remainder by a zone of transverse fission. Before considering the evidence in favour of this view it will be convenient to notice previous observations bearing on this subject.

The power of regeneration possessed by *Phoronis* early attracted the attention of observers of this animal. Dyster (1858, p. 251) states that "an abstracted head [of *P. hippocrepia*] is renewed within forty-eight hours, not completely developed, but with a serviceable mouth and its covering valve and stumpy tentacles which do their work of providing food." In the same year Van Beneden (1858¹, p. 460, Plate, figs. 4-6, and 1858², p. 18, Pl. v, figs. 4-6) describes and figures the spontaneous loss of the lophophore and its subsequent regeneration in *P. gracilis*. Cori (1890, p. 502), in describing *P. psammophila*, mentions the same phenomenon, which occurs spontaneously, although he refers to the belief of the fishermen of Messina that the "heads" are bitten off by small fishes. In the course of a paper dealing with Cœlenterates, Cerfontaine (1902, p. 262) records some interesting observations on *P. kowalevskyi*,¹ which occurs at Naples in a very restricted situation under a bridge in the "arrière-port de Naples." The animal forms large colonies in this locality, and these are found in a flourishing condition during a certain part of the year, namely from May to November. They are provided, at this period, with lophophores, among the tentacles of which occur numerous

¹ De Selys-Longchamps (1907, p. 173) points out that this form is indistinguishable on anatomical grounds from *P. hippocrepia*, but that its tubes are encrusting, while *P. hippocrepia* is a boring species.

eggs and developing embryos, a great number of larvæ being set free from time to time. At the end of this season the lophophores are lost and the colonies then consist of blackish "cakes" of matted tubes, from 1 to 2½ cm. in thickness. At the recommencement of the favourable season these cakes become covered by "une riche végétation de Phoronis." The tubes, examined during the "mauvaise saison," were found to contain remains of the body of the Phoronis, with lophophores in all stages of regeneration. Actinotrocha is said to occur rarely in the plankton at Naples at any time in the year, and Cerfontaine points out that it is difficult to suppose that the innumerable Phoronis which appear on the surface of the old cakes in a few days, at the commencement of the favourable season, can have been derived from larvæ. He concludes, therefore, that *P. kowalevskyi* possesses a mode of spontaneous annual regeneration.

A more detailed account of the process of regeneration is given by Schultz (1903¹), who describes the spontaneous loss of the lophophore in *P. mülleri* at Heligoland, and compares it with the loss of the calyces in the Polyzoa *Pedicellina* and *Urnatella*, or of certain parts in Compound Ascidians (*Diplosomidæ*) and Hydroids. He states that the process occurs, in Phoronis, whenever the conditions become unfavourable; and that it is followed by the regeneration of the lophophore as soon as better conditions return. The loss of parts of the body under unfavourable conditions is regarded as a physiological necessity which has become a normal process in various animals and plants (as in the loss of leaves by deciduous trees); this "reduction" being explained as the loss of parts which can be dispensed with temporarily during a period of hunger, thus leaving fewer structures to be nourished during times when nutriment is not abundant. Schultz points out that a reduction-process of this nature, in an animal which has a high capacity for regeneration, may lead to transverse fission, "and so indirectly to budding," although he does not prove that an asexual method of reproduction occurs in Phoronis.

On dividing a *Phoronis* transversely with a pair of scissors Schultz found that regeneration took place readily in both the pieces thus separated. Although he did not determine the minimal size of the fragments which were capable of regeneration, he states that this process occurred, in both the proximal and the distal portions, wherever the cut was made. The distal portion regenerates a proximal end, for instance, even if the part separated consists only of the lophophore and a part of the body containing the commencement of the œsophagus and the extreme end of the rectum. The proximal portion regenerates a new distal end whether the cut be made through the commencement of the œsophagus, or at practically any lower level, while the distal end regenerates a new proximal end with a similar disregard of the region where the section has been made. The details of the process of regeneration are described.

In a later paper (1903²) Schultz shows that regeneration takes place in the *Actinotrocha* larva of *Phoronis*, similarly divided by transverse cuts, although it proceeds at a much slower rate than in the adult animal.

None of the papers so far quoted contain any suggestion that the regeneration in *Phoronis* may be associated with a process of reproduction by fission.

In his monograph of the *Phoronidea* of the Gulf of Naples (1907, pp. 161-) de Selys-Longchamps gives further information with regard to the regeneration of species of this group. No evidence was obtained that the lophophoral end spontaneously thrown off was capable of regeneration. The lophophore may be thrown off several times in succession by the same individual, which regenerates this portion after each reduction. The proximal end of the body, or "ampulla," is incapable of regeneration, a process which appears to be confined to the muscular region. On cutting this part, in *P. psammophila*, into six pieces of approximately equal size, each of these pieces regenerated so as to become a complete individual, while the lophophore and the ampulla did not regenerate. Fragments hardly longer than wide in which the

lophophore was being regenerated were found in certain colonies.

On p. 164 of his monograph, de Selys-Longchamps makes the significant remark that it is difficult to believe that the numerous individuals which compose a colony of *P. kowalevskyi* can have been derived from as many Actinotrocha larvæ. It seems most unlikely that these larvæ, which lead a pelagic existence, can assemble at the time of their metamorphosis in sufficient numbers to build up a colony of the kind characteristic of this and other species. Allusion is made to the observations of Cerfontaine, who found numerous regenerating fragments in colonies of *Phoronis* which appeared to be dead and decomposing; and to others by Ikeda (1901, p. 580), who had found young animals which he supposed—probably wrongly—to have been derived from larvæ, in the débris of old colonies. De Selys-Longchamps believes that fragmentation of the individuals is a normal process, and, as this is followed by regeneration of the pieces, that it is a method of asexual reproduction. The correctness of this conclusion is borne out by my own observations on *P. ovalis*.

SPECIFIC CHARACTERS OF PHORONIS OVALIS.

It has already been pointed out that *P. ovalis* has not hitherto been recognised since its original description by Strethill Wright in 1856. As doubts have been cast on its claim to be regarded as an adult form (cf. de Selys-Longchamps, 1907, p. 188), it is important to notice that the Northumberland material includes specimens possessing fully developed ovaries (Pl. 7, fig. 2) or testes. The following diagnosis of the species may be given:

Size very small compared with that of other species of the genus. Total length reaching at least 6 mm., the diameter of the body being about 250 μ , and of the tube, in large specimens, about 250–350 μ . Tube delicate, hyaline, embedded in the substance of shells of molluscs. Lophophore oval, not much broader than long, one of the longer sides of

the oval indented, thus indicating the hippocrepian form of the lophophore in other species. Number of tentacles very small, about twenty-two. Metasome (body) sharply divided into two distinct regions, the distal portion with strong longitudinal bundles of muscles, the proximal portion with an extremely thin body-wall in which muscles are absent or at most very slightly developed. The proximal end of the muscular region is slightly invaginable, so that in contracted specimens this portion forms a shallow cup surrounding the more distal part of the muscular region. About fourteen bundles of longitudinal muscles occur on each side in the distal portion of the body. Regeneration of the lophophore occurs with great facility, and this regeneration is frequently the result of transverse fission.

Phoronis ovalis differs from other species in its relatively minute size, in the remarkably simple character of its lophophore, which is, however, hippocrepiform, in the very small number of its tentacles, and in the sharp differentiation of its body into two regions, the proximal end of the muscular region being slightly invaginable. As the occurrence of functional gonads in some of the specimens indicates that it is really an adult form, the claims of the species here described to be regarded as a distinct species seem to be incontrovertible.

P. ovalis has often been referred to in literature, but as no subsequent observer has hitherto succeeded in obtaining it, these references are all based on Strethill Wright's original account. De Selys-Longchamps (1903, p. 32) has stated that he considers the claims of *P. ovalis* to specific rank not improbable, and that *Actinotrocha pallida*, Schneider, may be its larva.

The only description which might refer to the same species is Van Beneden's account of *Crepina gracilis* (1858¹, 1858²). This was described as having from twenty-four to forty tentacles, and as reaching a length of 8-10 mm. The epidermis is provided with numerous stiff hairs, the points of which project to the exterior. The lophophore, as shown in

the original figures, has a simple structure, its ends not being in-rolled. In this respect it agrees with *P. ovalis*; but Van Beneden's figures represent animals with about forty tentacles, a number which is considerably in excess of that given by Strethill Wright for his species, and of that found by myself in the Northumberland material. De Selys-Longchamps (1903, p. 25) has found a form at Heligoland, which he refers to Van Beneden's species; and in support of this conclusion he emphasises the occurrence, in the Heligoland specimens, of very numerous epidermic structures (see his Plate ii, figs. 22-26), which he identifies with Van Beneden's "hairs." This resemblance is certainly a striking one, especially as the author points out that he has not found these structures in any other species. The number of tentacles found by de Selys-Longchamps was, however, greater than that given by Van Beneden, being commonly fifty to sixty, but sometimes as much as eighty. The length of the tube of the Heligoland species is said to be 10-20 mm.

It may be remarked that *P. hippocrepeia*, *P. gracilis*, and *P. ovalis* are all found in burrows in the shells of Molluscs, or in other calcareous substances. They appear to differ from one another in size and in the number of their tentacles; *P. hippocrepeia* having the largest dimensions and the greatest number of tentacles, *P. ovalis* occupying the other end of the series in both respects, and *P. gracilis* taking an intermediate position.

P. mülleri, also described by de Selys-Longchamps (1903, p. 6) from Heligoland, does not form colonies. It reaches a length of 40-80 mm. and has fifty to sixty tentacles, of which those on the oral side of the lophophore are specially short.

STRUCTURE OF *P. OVALIS*.

The general structure of the members of this genus is so well known¹ that it will not be necessary to describe that of

¹ See especially the elaborate monograph of de Selys-Longchamps (1907), who gives full references to the literature of the subject.

P. ovalis in great detail. I confine myself, therefore, to a description which is sufficient to show that the subject of this paper is rightly referred to *Phoronis*, and also brings out some of the more noteworthy features of *P. ovalis*.

Tube.

The characters of the tube can be readily examined after decalcification of a fragment of the shell containing the animals. The single shell which furnished the whole of the material must have contained hundreds of individuals, whose tubes penetrated the substance of the shell in all directions. Although accompanied by other boring animals (*Cliona*, *Polychæta*) there is not the slightest reason to suppose that the *Phoronis* inhabits burrows excavated by other organisms. The diameter of its tubes is distinctly smaller than those of its associates; and each *Phoronis*-tube closely lines the burrow in which it lies, along the whole of its course. De Selys-Longchamps (1907, p. 28) thinks that the tube is secreted by the proximal end of the ampulla, and that its growth takes place at this end. I have no observations to indicate how the boring is effected, but I am inclined to think that the main increase in length takes place as suggested by that author. The set of tubes shown in Pl. 8, fig. 15, seems to prove, however, that this explanation is not sufficient, and that the faculty of boring and secreting a tube is not restricted to the region of the ampulla. The figure shows that secondary deposits of tube-material may be formed inside the original tube. Some of these are more or less curved transverse septa (*E*, *B*, *H*), occurring on the proximal side of the ampullar region. Others may be formed in an irregularly longitudinal direction, as at *L*. In three places (*C*, *G*, *J*) a lateral opening has been formed on the proximal side of a transverse septum, and a new tube has grown out at an angle with the original tube. These lateral tubes, which will be considered below in the section dealing with regeneration, can hardly have been formed by the

proximal end of an individual; and it seems necessary to assume that the faculty of producing a tube and of boring in the shell is possessed by a considerable part of the body-wall.

Structure of the Animal.

Owing to its small size many of the principal points in the structure of this species can be made out in stained preparations of the entire animal mounted in Canada balsam. The frequent occurrence of regenerating lophophores gives rise to an extraordinary want of uniformity in the appearance of the individuals. The even more striking variation in size, as exemplified, for instance, by Pl. 7, figs. 2 and 5, appears to be due to the reduction in length produced by transverse fission.

A specimen with expanded lophophore is represented in Pl. 7, fig. 1. The small number of the tentacles is at once apparent, and it constitutes one of the most characteristic features of the species. How striking is the difference between *P. ovalis* and some other species of the genus may be illustrated by the comparison with *P. buskii*, the number of whose tentacles is estimated by de Selys-Longchamps (1907, p. 33) at about one thousand.

In the great majority of the specimens the tentacles lie in their retracted condition inside the tube. This condition of the tentacles is shown in Pl. 7, fig. 3, and other figures. In favourably prepared specimens (Pl. 9, fig. 40) the epistome (*ep.*) can be seen as a distinct lip overhanging the mouth and surrounded by the bundle of tentacles.

The distal part of the body-wall is thick (Pl. 7, fig. 3), a condition which is largely due to the presence of strong bundles of longitudinal muscles. These end abruptly at about the middle of the length of the body in this particular individual, although the proportion which the muscular part of the body-wall bears to the non-muscular part is highly variable. In Pl. 7, fig. 2, for instance, the muscular region

is not more than a quarter of the entire length, although absolutely of about the same length as in Pl. 7, fig. 3. In many of the specimens the proximal region of the muscular part of the body is slightly invaginated (Pl. 7, figs. 4, 8), thus forming a sort of shallow cup surrounding the base of the remainder of the muscular portion. The cavity of the cup faces distally, towards the lophophore.

The remainder of the body-wall is extremely thin and transparent. In some individuals (Pl. 7, fig. 8) the extreme proximal end has the ampulla-like form usually found in *Phoronis*. The absence of a typical ampulla in other specimens is doubtless due to the loss of this region when transverse fission takes place; but the ampulla is probably regenerated in due course by the distal individual formed by fission. Muscles have not been detected in the "non-muscular part"; and if they occur they must be excessively thin.

The alimentary canal has the form usual in the genus. The first part of the descending limb is formed by an oesophagus, sharply marked off from the succeeding part, and occupying from half to a quarter of the length of the muscular part of the body (Pl. 7, figs. 3, 8). The remainder of the descending limb, constituting the proventriculus (*pr.*), is relatively narrow throughout the muscular region, but it gradually dilates in the non-muscular part, reaching its maximum size in the ampullar region, but before the extreme proximal end is reached. From the dilated stomach (*st.*) thus formed (Pl. 7, fig. 8) a short section of the descending limb, of distinctly smaller size than the stomach, continues to the proximal end of the body, where it curves round into the ascending limb (*int.*). This portion is for the most part of small diameter, though its size depends partly on the amount of the remains of food (commonly Diatoms) or the faeces which it contains. The last part of the intestine is of small size, and opens by the anus (Pl. 9, fig. 40, *an.*) close to the lophophore, and on the side corresponding with the base of the epistome.

In a few individuals (Pl. 7, fig. 2) a number of large eggs may be seen lying in the body-cavity of the non-muscular region. These no doubt constitute the ovary, and the occurrence of this organ is of importance as evidence that animals in this condition are mature.

In most of the specimens a considerable amount of granular tissue is visible, lying in the body-cavity, principally of the non-muscular region, between the alimentary canal and the body-wall (Pl. 9, figs. 29, 33, *ad.*). This is the "adipose body" or "vaso-peritoneal tissue" of other authors; and, as in other species of *Phoronis*, a part of this tissue commonly has the histological characters of a testis. I have not convinced myself that ovary and testis may occur in the same individual, and it is possible that *P. ovalis* is diœcious. If this difference really occurs between *P. ovalis* and other species (which are usually hermaphrodite) it is perhaps the result of the small size of the animal.

Some of the anatomical features have been examined in sections; but the material, contained as it was in the burrows in the shell, is not sufficiently well preserved to show the finer details.

Pl. 8, fig. 14, an approximately sagittal section of the distal end of the animal, shows the muscular region of the body-wall and the cup-like invagination (*inv.*) at its base. The strong muscular bands (*l. m.*) are clearly seen, as well as the origin of the bundles from the body-wall in the region of the invaginated part. The epistome (*ep.*) is visible, surrounded by the tentacles, while the œsophagus (*œs.*) is cut along the whole of its length, and is separated from the proventriculus (*pr.*) by a circular valve. The terminal portion of the intestine (*int.*) is seen by the side of the œsophagus; and the position of the anus (*an.*), which opens into a depression of the body-wall close to the lophophore and the base of the epistome, is indicated.

A few sections from a series cut transversely to the long axis of the body have also been figured. In the first of these (Pl. 8, fig. 16) the tentacles are seen to be arranged in the

form of a horse-shoe, though the ends of the lophophore are not drawn out to the extent found in species with numerous tentacles. Twenty-two tentacles can be counted, and this was the full number present in this individual. The tube (*t.*) is seen to consist of several superposed cuticular layers.

In the next section shown (Pl. 8, fig. 17) the bases of the tentacles have become confluent on the anal side, and the lophophore is now clearly seen to be hippocrepiian in form. Some indication of the tentacle-vessel can be seen in several of the tentacles, in addition to the cavity of the tentacle. The tip of the epistome is cut at *ep.*

In Pl. 8, fig. 18, the union of the tentacle-bases is more complete, and a considerable part of the epistome (*ep.*) is visible. The next figure (Pl. 8, fig. 19) shows the epistome at its largest part. In Pl. 8, fig. 20, the tentacle-bases have all united, so that the mouth (*m.*) is completely outlined. The anus (*an.*) opens into a depression between a lobe of the metasome and the lophophore, and a part of the nerve-ring (*n. r.*) is visible between it and the mouth. The two nephridia are seen in one or two of the sections which come next in the series; but they have not been drawn, as the preparations are not very favourable for showing their details. In Pl. 8, fig. 21, the œsophagus (*œs.*) and the intestine (*int.*) are seen, as well as the oral part of the nerve-ring (*n. r.*). The afferent blood-vessel (*a. v.*) occurs between the œsophagus and the intestine, and some of the longitudinal muscles of the body-wall are visible.

Pl. 8, fig. 22, shows a complete median mesentery (*mes.*) supporting the two limbs of the alimentary canal; and both the afferent (*a. v.*) and the efferent (*e. v.*) blood-vessel. The longitudinal muscles of the body-wall are now well developed. In Pl. 8, fig. 23, the longitudinal muscles (*l. m.*) are still stronger, and about fourteen bundles can be seen on each side of the median mesentery. Both the longitudinal blood-vessels are still visible. Pl. 8, fig. 24, is through the proximal end of the muscular part of the body-wall, and shows part of the

shallow invagination (*inv.*) above described. Pl. 8, fig. 25, represents a section passing through the non-muscular part of the body, and shows the thin character of the body-wall in this region.

Pl. 8, fig. 26, is from another series of sections, and it represents a section through the distal end of the body, not far from the lophophore. A considerable part of the nerve-ring (*n. r.*) is visible, as well as both nephridia (*neph.*). The small lobes projecting into the body-cavity, near the tubes of the nephridia, are probably parts of the funnels of these organs.

REGENERATION AND FISSION.

In the material under consideration there is no need to make a careful search for evidence of regeneration. It is more difficult to find a lophophore provided with tentacles of the full length than to find one with immature tentacles. It is, moreover, a striking and most obvious fact that the dimensions of the individuals vary to such an extent as to be unintelligible on any hypothesis of orderly growth from the immature to the mature condition. It may further be noted that there is no relation between the condition of the lophophore and the size of the specimen. It will be convenient to analyse the facts under the following heads:

- (a) Regeneration of the lophophore.
- (b) Direct evidence of transverse fission.
- (c) Method by which the tube of the proximal segment is completed.
- (d) Size of regenerating individuals as indirect evidence of fission.
- (e) Position of the zones of fission.

(a) Regeneration of the Lophophore.

Assuming provisionally that transverse fission is a process of normal occurrence, it is obvious that the conditions under which a new lophophore is formed is not quite the same in

the two individuals formed by the fission. In the case of the proximal individual, the entire lophophore has to be formed *de novo* from a region which is far removed from the original lophophore. In the distal individual, regeneration, if it takes place, presupposes the loss of the original lophophore. This latter process is of the same nature as that which has been described in other species, where the lophophore is thrown off, the wound closes, and a new crown of tentacles is formed from the extreme distal end of the animal.

Many of the specimens figured illustrate the regeneration of the lophophore at the distal end; and where the relations of the tube give no indication of the previous occurrence of fission in this region (cf. section (c)) the regenerating lophophore appears to be a replacement of the original lophophore. But as none of the regenerating specimens figured are as long as the fully adult specimen shown in Pl. 7, fig. 2, it may be considered probable that they are all fractional portions of individuals produced by the metamorphosis of larvæ. Neglecting for the moment the differences in the length of the individuals, the regeneration of the distal end may be illustrated by the following cases:

In the distal individual shown in Pl. 9, fig. 32, the thick-walled muscular region of the body is clearly indicated, with the collar-like partial invagination (*inv.*) characteristic of the proximal end of this part. The new lophophore is represented merely by the thickened body-wall at the extreme distal end.

In Pl. 9, fig. 36, the distal thickening indicating the new lophophore is more distinct, and is separated by a slight annular constriction from the beginning of the muscular part of the body-wall.

In Pl. 8, fig. 13, the lophophore is still more distinct and shows distal lobulations which will become the new tentacles.

Further stages in the growth of the tentacles are shown in Pl. 8, fig. 11, and Pl. 7, figs. 5, 4, and 8; and in the last of these the formation of the new lophophore is practically complete.

For a more detailed description of the growth of the regenerating lophophore reference should be made to the memoir of Schultz (1903¹).

(b) Direct Evidence of Transverse Fission.

It has not been very easy to obtain unmistakable evidence of the occurrence of this process, but several specimens have been found which appear to be demonstrative in this respect.

Pl. 9, fig. 31, represents what may be regarded as the commencement of this process. At the extreme distal end of the non-muscular part of the body an annular layer of tube-substance has been formed, projecting into the cavity of the tube, and slightly constricting the body-wall, which does not as yet show any indication of transverse division.

In Pl. 9, fig. 29, a similar process of constriction is taking place in the non-muscular region, at some distance from its distal end. The tube lies in very close contact with the body of the animal, but a constricting lamina can be seen on the left side of the figure. The body-wall now shows evidence of being constricted, and it may be noticed in particular that the mass of adipose tissue (*ad.*) which fills up most of the proximal region of the body-cavity is being divided into two parts by the constriction. This specimen furnishes the most direct evidence which has been obtained of the occurrence of the process in question.

In Pl. 9, fig. 32, two individuals lie in the same tube, the cavity of which has been divided by a transverse septum. The proximal end of the distal individual has a bilobed character, differing from the evenly rounded surface which characterises the normal ampulla. This lobed appearance of the proximal end has been noticed in many of the individuals, and may be taken as evidence of the occurrence of fission, the rounded form of the ampulla not being yet reconstituted. The figure shows that the mesentery of the alimentary canal is attached to the emargination between the two lobes. The distal end of the individual on the proximal side of the

septum is also lobed, and this region shows indications of regeneration, particularly in the commencing differentiation of an œsophageal portion of the descending limb of the alimentary canal. It appears to be practically certain that this specimen represents a stage not long after the occurrence of transverse fission.

In Pl. 9, fig. 37, there are also two individuals in what may be considered one original tube. The individual on the proximal side of the septum already shows a recognisable lophophore and œsophagus, but it is constituting a new distal end to its tube by growing out laterally from the original tube.

(c) Method by which the Tube of the Proximal Segment is completed.

The specimen last described furnishes the evidence required, and the explanation it suggests is fully confirmed by a number of other cases which have been noticed. In most of the specimens referred to, a tube makes a sudden bend outwards, immediately on the proximal side of a transverse septum; and this outwardly bent portion contains the distal end of an individual. This is represented, for instance, in Pl. 8, fig. 9, and Pl. 9, fig. 34; and the natural interpretation of the conditions shown is that the portion of the tube containing the proximal end of the individual in question is part of an original tube, from the rest of which it is separated by the transverse septum; and that at the formation of this septum the proximal part of the tube, being cut off from the exterior by the septum, has grown out laterally so as to form a new opening for itself. It may be noted that the formation of these laterally growing tubes makes it almost impossible to accept the view of de Selys-Longchamps, alluded to on p. 12, that the tube is secreted only by the ampullar end of the animal.

The system of empty tubes represented in Pl. 8, fig. 15, may be taken as distinct evidence, in the light of the facts

already recorded, that the process of fission may be repeated several times in one original individual and its products. The tube *A-K* appears to be part of a tube originally inhabited by a single individual, and added to from time to time as the result of successive transverse fissions of its inhabitants. *A* is the proximal end, and *K* the distal end of the portion represented. The transverse septa at *B*, *F*, and *I*, may be taken as indications of as many transverse fissions. The segment of the tube between *B* and *F* has been occupied by an individual which has formed a new distal end to its tube at *G*, and has restricted the size of the rest of its tube by the formation of the irregular, longitudinal, secondary deposit of tube-substance seen at *L*. The septum *H* may indicate merely a part of this process of reducing the size of the tube, but fission may have occurred at this point, in which case it must be assumed that the segment of the animal which occupied the portion *B-H* had not succeeded in forming a new distal end to its tube. The portion of tube situated proximally to the septum *I* has grown out into the irregular tube *J*. On the proximal side of the septum *B* a considerable length of the distal part of a tube has been formed at *C*. This individual occupied only a short portion of the original tube, a septum having been formed at *M*; and it then appears to have grown out proximally, in the direction *D*, a further fission of the inhabitant of the tube being indicated by the septa *E*. It is not impossible that the fragment of the individual left in *D* may have turned completely round in its tube, so that *E* became the proximal end and *D* the distal end of its tube, but of this there is no evidence.

The appearances presented by this system of tubes, together with the evidence brought forward in the next section (*d*) suggest that fission occurs repeatedly in this species, and it seems not improbable that all the numerous individuals found in a given area of the shell may have been derived by fission from a single metamorphosed larva, or from a small number of individual larvæ which succeeded in

effecting their metamorphosis in the neighbourhood of the shell.

Further evidence of the correctness of the interpretation of Pl. 8, fig. 15, suggested above, is furnished by Pl. 8, figs. 9, 28, and Pl. 9, figs. 34, 37, which show individuals, in varying conditions of regeneration, in which the distal part of the tube arises laterally from another tube, and, usually, immediately on the proximal side of a tube-septum which appears to indicate the position of the zone of fission.

(d) Size of regenerating individuals as indirect evidence of fission.

The variation in length of the regenerating individuals is a very striking fact. The individual shown in Pl. 7, fig. 2, is about 6 mm. long, while that represented in Pl. 7, fig. 7, is only .3 mm. long. If what is here described as regeneration were really explainable as the various stages by which a metamorphosed larva reaches its adult condition, there would be some definite relation between the size of the specimen and the stage of development of the body and lophophore. Nothing of the kind can be made out. The earliest stages in the development of the lophophore may be found in very long individuals, as in Pl. 9, fig. 36; and, conversely, very small specimens (Pl. 7, fig. 5) may have a well-grown lophophore. The only legitimate explanation of the facts seems to be that regeneration of the lophophore may occur indifferently in large and in small specimens; and from the evidence which has already been brought forward it appears to be fair to conclude that this process is commonly the result of fission. In cases where no tube-septum can be discovered on the distal side of a regenerating specimen, the process appears to be the consequence of the spontaneous loss of the lophophore, as has been described in other species of *Phoronis*. But in cases like Pl. 9, figs. 32, 33, the new lophophore is clearly being developed as the direct result of the formation of a fission-zone. Pl. 9, fig. 35, represents what appears to

be an unusual condition. The position of the fission-zone which cut off the small individual shown is clearly indicated by the annular tube-septum. But in this case the regenerating distal end is growing into the part of the original tube situated distally to the septum, instead of growing out laterally to form a completely new opening. Perhaps the septum was not a complete one; but if not it must be assumed that the central part of the septum has been absorbed by the regenerating fragment. It is not more difficult to make this assumption than to assume that in other cases a lateral part of the tube can be absorbed, in order to allow the proximal fission-segment to form a new orifice to its tube.

The great capacity for transverse fission possessed by *P. ovalis* is indicated by the very small size of the regenerating fragments. The smallest specimen shown (Pl. 7, fig. 7) is only .3 mm. long, but it shows clear signs of regeneration in the differentiation of a new muscular region of the body-wall, indicated by a greater thickness of this part distally, and by the formation of a distinct line of separation between it and the future non-muscular portion. The appearances here shown give reason to suppose that a fragment no more than .3 mm. long can regenerate a complete individual. The complicated arrangement of the tube-septa in this case implies that the cavity of the original tube has been reduced in size several times, probably in correlation with the small size of the living fragment left in this section of the tube.

(e) Position of the zones of fission.

The direct evidence obtained on this subject points to the non-muscular part of the body as the region where fission may occur. This is illustrated by Pl. 9, figs. 29-31. It may be noted that this is not in agreement with the statement of de Selys-Longchamps (1907, p. 163), according to whom it is the muscular region that is specially capable of regeneration. The observation by this author that, having cut the muscular region of a *Phoronis psammophila* into six fragments,

each of these regenerated a complete individual, is too precise to be disputed. But in *P. ovalis* I have found no certain evidence that the muscular region shares the power of division which is undoubtedly possessed by the non-muscular region. It is possible that Pl. 8, fig. 10, indicates that fission may occur in the muscular region, since in this case the longitudinal muscles are well differentiated in a fragment which is only just beginning to develop a new lophophore. Pl. 9, fig. 35, may also imply that the fission-zone was formed just distally to the junction of the two regions of the body-wall. But in most of the specimens drawn, the muscular part is at first indicated merely by a thickening of the body-wall, and no distinct muscle-fibres can be recognised in the early stages. The regeneration of the distal end in fact commences, as has already been pointed out, with the regeneration of a muscular region, and the lophophore appears subsequently at the distal end of the muscular region.

The general result of these observations is that fission may occur in *P. ovalis* at practically any point of the non-muscular body-wall, and that very small fragments separated off in this way are capable of complete regeneration. No certain evidence has been obtained that the muscular part can form fission-zones, though this possibility is not excluded. A lobed condition of the proximal end of the body, as shown in Pl. 9, figs. 32, 36, 39, appears to indicate that the ampullar region has not been completely reconstituted since the last fission took place.

Many of the individuals, whether regenerating or not, show a great development of the adipose tissue which accompanies the two longitudinal blood-vessels. In many cases, as in Pl. 7, fig. 6, Pl. 9, fig. 29, the body-cavity of a regenerating fragment contains a large quantity of this tissue, which may probably be regarded as a reserve of nutrient material, at the expense of which the fragment can continue to survive until it has reconstituted its alimentary canal and has formed a new orifice to its tube. Larger specimens which have developed a considerable amount of this tissue are probably in a favourable condition for undertaking fission; and it may be noticed

that the specimen shown in process of dividing in Pl. 9, fig. 29, is well provided with adipose tissue. The regeneration of the lophophore without fission may also be facilitated by the previous deposition of a sufficient reserve which can be drawn on for the nourishment of the other tissues during the temporary closure of the alimentary canal. It may be noted that the intestine of a regenerating fragment without a functional lophophore frequently contains the remains of Diatoms, which must have been taken in during a period when well-developed tentacles occurred.

The presence of a large amount of adipose tissue is not, however, a necessary prelude to fission, even though it may favour this process. Some of the specimens of full length are remarkable for being of smaller diameter than usual, their tissues being more transparent than in other cases, and the adipose tissue being deficient in amount. These seem to be ill-nourished individuals, and their occurrence probably accounts for certain abnormally slender regenerating fragments, of the kind shown in Pl. 9, fig. 38, which are sometimes found. The muscular part of the body-wall has commenced to differentiate in Pl. 9, fig. 38, and although its small diameter points to a want of vigour, this individual, and others like it, may have been in a condition to complete the regeneration.

THE OCCASIONAL COMPLETE INVAGINATION OF THE MUSCULAR PART OF THE BODY-WALL.

In several cases individuals have been found in the peculiar condition shown in Pl. 9, figs. 41 and 39. In Pl. 9, fig. 41, the partial invagination which normally occurs at the proximal end of the muscular body-wall has become so complete as to result in the invagination of the whole of the lophophore and of the tentacles. The invaginated muscular wall is now turned entirely inside out, forming a sheath opening distally (*or.*), containing the tentacles (*tent.*), and having its epidermal portion lining the cavity of the introvert and its longitudinal muscles on the outer side of the

epidermis. The junction between the muscular and non-muscular parts of the body-wall now lies at the distal end of the introvert, and the outermost layer in this region is the part of the non-muscular wall into which the more distal part has been invaginated. The invagination has resulted in the formation of a loop of the alimentary canal which passes distally along one side of the invagination.

Pl. 9, fig. 39, is in a similar condition, except that the introvert contains no tentacles. In their place may be seen a projection which obviously consists of a regenerating muscular part of the body-wall, terminated by a commencing lophophore.

I am unable to give a satisfactory explanation of these appearances, although the fact that three or four specimens have been found in this condition shows that the complete invagination of the muscular body-wall happens not infrequently. It is perhaps one of the methods by which the lophophore may be regenerated, as it seems probable, from a comparison of the two specimens figured, that Pl. 9, fig. 41, is the earlier stage in the process, and that the invaginated tentacles would have been thrown off somewhat later, the wound closing, and the body-wall in that neighbourhood then growing out into the part seen inside the introvert in Pl. 9, fig. 39. It is not obvious what the later course of the regeneration would have been, though it is possible that the introvert would have been evaginated and the muscular wall reconstituted, partly from the old wall and partly from the portion which is being regenerated in Pl. 9, fig. 39. It does not seem probable that the loss of the original lophophore always takes place in this way. It is not easy to explain the mechanism by which the complete invagination of the muscular part of the body-wall takes place in these cases.

The condition shown in Pl. 9, fig. 41, resembles that found in *Ectoproct* Polyzoa during the retraction of the tentacles, though the *Phoronis* has no retractor muscles comparable with those of the Polyzoa. The resemblance does not appear to me, however, to lend any support to the view maintained

by some authors of a relationship between these two groups. The Phoronidea differ from the Polyzoa in their embryonic development, as well as by striking morphological characters, and in view of these differences the resemblance of the invaginated body-wall to the tentacle-sheath of the Polyzoa seems to be merely a fortuitous one. The formation of an introvert containing the retracted lophophore might perhaps be compared with more reason with the similar introvert in Sipunculoid Gephyrea, though the affinity of the Phoronidea to that group has not been established with any certainty. The introvert of these specimens of *P. ovalis* is not unlike that which occurs in certain Gasteropoda (e.g. *Buccinum*), but it would hardly be maintained that this resemblance is any indication of affinity.

THE LARVAL FORM OF PHORONIS OVALIS.

Although the observations here recorded do not throw any direct light on this question, one or two remarks on the subject may not be out of place. *P. ovalis* is known from Strethill Wright's original account to occur in the Firth of Forth, while the large number of individuals found by me in a single shell from the Northumberland coast suggests that the species is common along the eastern coast of the northern part of England, although it has hitherto been overlooked owing to its retiring habits. *Actinotrocha* has more commonly been found in these regions than the adult *Phoronis*; and it is, for instance, of frequent occurrence at St. Andrews.

The adult characters of *P. ovalis* seem to be so distinctive, particularly the small number of the tentacles and the restriction of the bundles of longitudinal muscles to a small part of the metasome, that a recently metamorphosed *Actinotrocha* belonging to this species might well be recognisable. It should, however, be pointed out that the characters of the individual produced by the metamorphosis of a larva may differ from those of any of the specimens examined from the

Northumberland material. Reproduction by fission appears to take place so frequently in these specimens that all the observed individuals may well have been produced in this way. It would thus be unsafe to assume that primary individuals metamorphosed from larvæ have so restricted a muscular region as that of their fission-products. This may, however, be the case; and it would be desirable to bear in mind the short muscular region and the tendency for its proximal end to be slightly invaginated, should the opportunity occur of examining recently metamorphosed specimens from this part of the British coast.

Observations which I have attempted to make on this subject have led to no definite result. By the kindness of Prof. W. C. M'Intosh, F.R.S., I have been able to examine specimens of *Actinotrocha branchiata* from St. Andrews; and amongst them I have found one or two specimens which have recently completed their metamorphosis. There appear to be no sufficient reasons for referring these specimens to *P. ovalis*. I have also examined three recently metamorphosed *Phoronis* kindly lent to me by Prof. J. Graham Kerr, F.R.S., who obtained them on the West Coast of Scotland, off the Island of Arran. The number of tentacles in these specimens seems to be not less than twenty-eight to thirty, and there is no obvious differentiation of muscular and non-muscular portions in the metasome. The evidence thus appears to indicate that the specimens in question do not belong to *P. ovalis*.

De Selys-Longchamps (1903, p. 43) has convinced himself that *Actinotrocha branchiata* is the larva of *P. mülleri*, a species described by him from Heligoland, but not, so far as I am aware, at present recognised as a member of the British fauna. In the same memoir (p. 47) he has advanced reasons for believing that *A. pallida*, Schneider, is not the larva of either *P. hippocrepia* or *P. gracilis*; and he suggests that it may belong to *P. ovalis*, if that form is really a distinct species. His statement (p. 47) that the worm produced by the metamorphosed larva of *A. pallida*

has eighteen bundles of longitudinal muscles appears to be significant in this connection, though it should be remarked that the number of muscle-bundles which I have found in *P. ovalis* (cf. Pl. 8, figs. 22, 23) appears to exceed eighteen.

Actinotrocha pallida was described by Schneider (1862, p. 64, Pl. ii, fig. 12) from Heligoland, where it is said to be as common as *A. branchiata*. It is stated to have not more than ten tentacles, which are broader and shorter than those of *A. branchiata*. It possesses only a single mass of larval blood-corpuscles, while *A. branchiata* has a pair of these masses, one in connection with each of the nephridia. De Selys-Longchamps (1907, p. 190) has found *A. pallida* at Wimereux (Pas-de-Calais) as well as at Heligoland, and he represents two young stages in Pl. xi, figs. 21, 22. He states that there are never more than six pairs of larval tentacles, and that the length of the larva does not exceed .6 mm., while that of *A. branchiata* (p. 189) is as much as 2 mm.

The evidence at present available thus seems to point to *A. pallida* as being the larva of *P. ovalis*, and the small dimensions of this larva are in accordance with the small size of the adult form to which it is supposed to belong.

SUMMARY.

Phoronis ovalis, which has usually been regarded as the immature form of some other species, is shown to be a well-characterised adult form. It inhabits burrows which it excavates in the shells of molluscs. It possesses in a high degree the faculty of regenerating the distal end, which is of common occurrence in the genus. Its gregarious habit is probably the result of its power of reproducing by transverse fission, a process which takes place repeatedly and profusely. There is reason to believe that a similar process occurs in certain other species which are found as colonies consisting of numerous individuals, though it is uncertain whether other species have the power of reproducing by fission.

LITERATURE.

- 1858¹. Beneden, P. J. Van.—“Notice sur un annélide céphalobranche sans soies, désigné sous le nom de *Crepina*,” ‘Bull. Acad. Roy. Belgique’ (2), v, p. 450.
- 1858². ——— “Notice sur un annélide céphalobranche sans soies, désigné sous le nom de *Crepina*,” ‘Ann. Sci. Nat.’ (4), Zool. x, p. 11.
1889. Bornet, E., and Flahault, C.—“Sur quelques Plantes vivant dans le Test Calcaire des Mollusques,” ‘Bull. Soc. Botan. France,’ xxxvi (Congrès de Botanique, Paris, 1889), pp. 1-31 (sep.).
1902. Cerfontaine, P.—“Recherches expérimentales sur la Régénération et l’Hétéromorphose chez *Astroïdes Calycularis* et *Penaria Cavolinii*,” ‘Arch. de Biol.’ xix, p. 245 (p. 262: Account of *Phoronis kowalevskyi*).
1890. Cori, C. J.—“Untersuchungen über die Anatomie und Histologie der Gattung *Phoronis*,” ‘Zeitschr. f. wiss. Zool.’ li, p. 480.
1858. Dyster, F. D.—“Notes on *Phoronis hippocrepia*,” ‘Trans. Linn. Soc.’ xxii, p. 251.
1901. Ikeda, I.—“Observations on the Development, Structure and Metamorphosis of *Actinotrocha*,” ‘J. Coll. Sci. Tokyo,’ xiii, p. 507.
1862. Schneider, A.—“Ueber die Metamorphose der *Actinotrocha branchiata*,” ‘Arch. f. Anat. u. Physiol.’ 1862, p. 47.
- 1903¹. Schultz, E.—“Aus d. Gebiete d. Regeneration,” iii, “Üb. Regenerations-erscheinungen b. *Phoronis Mülleri* Sel. Long.” ‘Zeitschr. f. wiss. Zool.’ lxxv, p. 391.
- 1903². ——— Ib., iv, “Üb. Regen. b. *Actinotrocha branchiata* Müller.” ‘Zeitschr. f. wiss. Zool.’ lxxv, p. 473.
1903. Selys-Longchamps, M. de.—“Beiträge zur Meeresfauna von Helgoland,” “Ueber *Phoronis* und *Actinotrocha* bei Helgoland,” ‘Wiss. Meeresunt. Kiel u. Helgoland,’ n.F., vi Bd., Abt. Helgoland, Heft 1.
1907. ——— “*Phoronis*,” ‘Fauna u. Flora G. v. Neapel,’ 30 Monogr.
- 1856¹. Wright, T. Stretchill.—“Description of two Tubicolar Animals,” ‘Proc. Roy. Phys. Soc. Edinburgh,’ i, 1858, p. 165.
- 1856². ——— “Description of two Tubicolar Animals,” ‘Edinb. New Phil. Journ.’ iii, n.s., p. 313.

EXPLANATION OF PLATES 7, 8, AND 9,

Illustrating Mr. Sidney F. Harmer's paper "On *Phoronis ovalis*, Strethill Wright."

REFERENCE LETTERS.

ad. Adipose tissue, or vaso-peritoneal tissue. *amp.* Ampulla. *an.* Anus. *a.v.* Afferent blood-vessel. *ep.* Epistome. *e.v.* Efferent blood-vessel. *f.* Fission-zone. *int.* Intestine, or ascending limb of the alimentary canal. *inv.* Invagination of the proximal end of the muscular part of the body-wall. *l.* Lophophore. *l.m.* Longitudinal muscles. *m.* Mouth. *mes.* Median mesentery. *musc.* Muscular part of the body-wall. *neph.* Nephridium. *n.r.* Nerve-ring. *æs.* Œsophagus. *or.* Orifice of invaginated body-wall. *ov.* Ovary. *pr.* Proventriculus, constituting the greater part of the descending limb of the alimentary canal. *s.s.*, Septum of tube. *st.* Stomach. *t.* Tube. *tent.* Tentacles.

[All the figures refer to *Phoronis ovalis*. The sections, Pl. 8, figs. 14 and 16-26, were drawn with a Zeiss C Obj.; the remaining figures with a Zeiss A Obj. All the figures have been reduced two-thirds.]

PLATE 7.

Fig. 1.—The expanded lophophore of an adult specimen. Eighteen tentacles can be counted. Slide L.

Fig. 2.—A fully adult specimen with expanded tentacles. The ovary (*ov.*) is developed. The lobed character of the proximal end of the body probably indicates, as in other similar cases, that the ampulla (*amp.*) has not been completely reconstituted after transverse fission. Slide O.

Fig. 3.—A smaller specimen with retracted tentacles. Slide M.

Fig. 4.—A small regenerating fragment. The marked angle between the axes of the proximal and distal parts of the body probably indicates, as in fig. 3 and other specimens drawn, the lateral outgrowth of the new distal part of the tube necessitated by the closure of the original tube by the septum formed during the process of transverse fission. Slide O.

Fig. 5.—A smaller regenerating fragment. Slide N.

Fig. 6.—A small regenerating fragment in which the lophophore is not yet developed. The muscular part of the body-wall (*musc.*) is already indicated. The adipose tissue (*ad.*) fills most of the body-cavity. Slide M.

Fig. 7.—An extremely small fragment in about the same stage of regeneration as the preceding figure. The cavity of the tube is restricted by a complicated system of septa (*s.*). Slide Q.

Fig. 8.—A regenerating specimen resembling those shown in figs. 4 and 5, but more completely developed. Slide M.

PLATE 8.

Fig. 9.—A completely regenerated individual. The original tube has been subdivided by septa (*s.*), and the new distal end of the tube has been developed as a lateral outgrowth starting immediately on the proximal side of the septa. Slide Q.

Fig. 10.—A small regenerating fragment in which the muscular part of the body-wall is unusually long; *l.*, the commencing lophophore; *l.m.*, longitudinal muscles. Slide M.

Fig. 11.—The appearances of this specimen suggest that a small fragment produced by fission on the distal side of the septum (*s.*) has formed a new distal end to its tube by lateral outgrowth instead of making use of the original distal end of the tube. Slide P.

Fig. 12.—Another small fragment. The muscular part of the body-wall (*musc.*) is already invaginated at its base (*inv.*); *l.*, the commencing lophophore. Slide N.

Fig. 13.—A specimen with strongly marked invagination (*inv.*) of the proximal end of the muscular region (*musc.*) and a commencing lophophore (*l.*). Slide M.

Fig. 14.—A sagittal section passing medianly through the distal end of the body. *inv.*, invaginated part of body-wall; *ep.*, epistome; *æs.*, œsophagus, separated by a circular valve from the proventriculus (*pr.*); *an.*, position of anus. (Zeiss C Obj.) Slide F.

Fig. 15.—A system of empty tubes from which the course of the transverse fissions of the animal can be inferred. For explanation see text, pp. 12, 20. Slide K

Figs. 16-25.—From a series of sections transverse to the principal axis of the body of an adult specimen. (Zeiss C Obj.)

Fig. 16.—Through the retracted tentacles, of which 22 are present, arranged in the form of a horse-shoe. Slide A¹.

Fig. 17.—The tentacles have united at their bases on the anal side (*l.*); *ep.*, the tip of the epistome. Slide A¹.

Fig. 18.—A more proximal section; *ep.*, epistome. Slide A¹.

Fig. 19.—The epistome (*ep.*) is cut at the level where it reaches its greatest size. Slide A¹.

Fig. 20.—The tentacles have completely united at their base, and the mouth (*m.*) is thus outlined. The anus (*an.*) lies between the lophophore (*l.*) and a lobe of the metasome; *n.r.*, part of the nerve-ring. Slide A¹.

Fig. 21.—Through the commencement of the metasome. The afferent blood-vessel (*a. v.*) is visible; *n. r.*, the part of the nerve-ring on the oral side. Slide A¹.

Fig. 22.—A more proximal section. Both limbs of the alimentary canal are supported by the median mesentery (*mes.*). Both longitudinal blood-vessels (*a. v.*, *e. v.*) are visible. Slide A¹.

Fig. 23.—A more proximal section. The longitudinal muscles (*l. m.*) form strong bundles. Slide A¹.

Fig. 24.—Showing part of the invagination (*inv.*) at the proximal end of the muscular part of the body. Slide A².

Fig. 25.—Through the distal part of the non-muscular region of the body. Slide A².

Fig. 26.—From another series of "transverse" sections, through the region close to the base of the lophophore; *n. r.*, part of the nerve-ring; *neph.*, nephridia. (Zeiss C Obj.) Slide B¹.

Fig. 27.—A small regenerating fragment which is not yet provided with an orifice to its tube. Slide M.

Fig. 28.—Regeneration practically complete, the distal end of the tube having been formed as a lateral outgrowth developed on the proximal side of the septum (*s.*). Slide Q.

PLATE 9.

Fig. 29.—A regenerating specimen which is commencing to divide. At the distal end, the muscular part (*musc.*) is developing, while the lophophore (*l.*) is recognisable owing to the presence of a septum dividing its body-cavity from that of the metasome; *f.*, zone of transverse fission, accompanied by the formation of a tube-septum. The adipose tissue (*ad.*) is present in large quantity. The proximal end is lobed, indicating a previous fission, further evidence of which is afforded by the tube-septum (*s.*). Slide L.

Fig. 30.—A larger specimen in the same condition. Slide O.

Fig. 31.—The first indication of fission is afforded by the formation of the annular tube-septum (*s*¹), which in this case occurs at the commencement of the non-muscular part of the body. Slide Q.

Fig. 32.—A later stage in the fission-process. The two products of fission are completely separated, the distal one showing a lobed proximal end, and the proximal one showing signs of regeneration distally. Slide N.

Fig. 33.—The proximal member of the result of the occurrence of fission, the evidence of which is the tube-septum (*s.*) and the lateral outgrowth of the tube (*t.*) on its proximal side. Slide Q.

Fig. 34.—A similar specimen of much smaller size. Slide N.

Fig. 35.—A very small regenerating fragment, the distal end of which is growing through the annular tube-septum (*s.*) which presumably indicates the previous occurrence of fission. Slide Q.

Fig. 36.—A large specimen, of a kind frequently observed, in which the alimentary canal is thin and occupies only a small part of the body-cavity: a condition which is probably due to deficient nutrition. Regeneration of the distal end is taking place. Slide O.

Fig. 37.—The two specimens here shown have probably been separated from one another by fission, as indicated by the septum (*s.*) and the lateral outgrowth of the tube on its proximal side. The lophophore (*l.*) of the proximal individual is in an early stage of development. Slide N.

Fig. 38.—A very slender and presumably ill-nourished regenerating specimen. Slide N.

Fig. 39.—The significance of the condition here shown has not been ascertained. The entire muscular region has been invaginated, forming an introvert opening to the exterior at *or.* The introvert contains a regenerating distal end, in which the new muscular region (*musc.*) and lophophore (*l.*) can be distinguished. By the formation of the introvert the alimentary canal has been thrown into a loop, the portion of which belonging to the descending limb (*pr.*) is seen to the right of the introvert. The ascending limb of the alimentary canal probably has a similar course, but it was not observed in this specimen. The outgrowth of the proximal end of the body in a direction at right angles to the axis of the original tube probably indicates a lateral extension of the proximal end of the tube in order to provide room for the elongation of the corresponding region of the body, the growth of which, in this direction, would otherwise be prevented by the septum *s.* Slide N.

Fig. 40.—Lateral view of the distal end of a mature specimen, showing the epistome (*ep.*) inside the group of retracted tentacles. Slide M.

Fig. 41.—Another stage of the condition shown in fig. 39. The introvert contains a bundle of fully developed tentacles. This may be either an earlier stage than fig. 39, in which case the original lophophore has been completely retracted into the introvert, and was destined to be thrown off later; or a later stage, in which the new lophophore has been completely regenerated. In this specimen there is evidence that the ascending limb of the alimentary canal, as well as its descending limb, forms a loop passing up one side (left in the figure) of the proximal end of the introvert. Slide M.

The Embryonic Development of *Trichogramma evanescens*, Westw., Monembryonic Egg Parasite of *Donacia simplex*, Fab.

By

J. Bronté Gatenby,

Exhibitioner of Jesus College, Oxford.

With Plates 10, 11, and 12.

INTRODUCTION.

SINCE the description of polyembryony in some parasitic Hymenoptera by Marchal (1) the attention of a few zoologists¹ has been turned to the interesting problems these forms offer.

¹ Sir Ray Lankester has kindly drawn my attention to the writings of the Polish Embryologist, Ganin, whose work on *Platygaster*, carried out forty years ago, is of great interest. *Platygaster* is a parasite on the larvæ of some Diptera (*Cecidomyia*), and its larval form is curiously modified in early stages. According to Ganin the larva has neither nervous, vascular; nor respiratory systems (Compare p. 20 of this paper), and its last abdominal segment terminates in a curious caudal organ of a tree-like nature, almost certainly concerned in nutrition. The larva undergoes a number of moults, loses its caudal organ, and gradually becomes vermiform. I have lately noticed that the larva of an *Apanteles* parasitic on *Porthesia* has a remarkably modified ultimate abdominal segment, which is very large, vesicular, and formed of hypertrophied cells. The gut of this larva is in all the early stages completely blind, and the animal depends on the swollen abdominal segment for its nutrition. Like Ganin's larvæ this form loses the vesicular segment just before pupation. It is a very remarkable fact that the ultimate abdominal segment should be modified for this purpose (*Zeit. f. Zool.*, Bd. xv.).

Silvestri (2) has contributed some important papers on the subject, but these have appeared in an Italian agricultural journal only taken by a small number of the scientific libraries of this country. Considering the vast number of parasitic Hymenoptera which exist, and their diversity and remarkable instincts, a rich field, only now being explored, is opened to zoologists. But it is a field full of difficulties, for the Trichogrammids, to mention one group alone, are, as Perkins (4), has said, among the smallest of known insects. In several other groups of parasitic Hymenoptera there are to be found numbers of forms whose life history and habits are of absorbing interest. The pure observer finds problems and instincts of wonderful diversity, and the embryologist is impressed with the remarkable adaptations for the *modus vivendi* which these forms follow.

The remarkable oogenesis of some of these parasites has been the subject of some interesting papers by R. Hegner (3).

The parasite, a part of whose embryology I have described in this paper, is a member of that important family the Chalcididæ, a numerous and highly interesting assemblage of minute Hymenoptera. These insects are of great importance to the economic entomologist, because among them one finds forms which aid the agriculturist, and which often injure. *Trichogramma* might be said to aid.

It is a pleasant duty to express my thanks to Mr. Goodrich for his kind interest in this work, and for advice and criticism, which has been of great value.

THE HOST¹ (*DONACIA SIMPLEX*, FAB.).

Donacia simplex is quite common around Oxford in the early summer. Commander Walker informs me that he has occasionally taken this species at Oxford in winter. In the early summer one can always find the beetles on the water-

¹ Kindly identified by Mr. H. Britten, Assistant of the Hope Department, Oxford Museum.

reads which grow from shallow ponds and the sides of streams; they may be observed copulating and laying their eggs. The latter are laid in masses in a regular manner, the whole group forming a rectangular mass containing a varying number of eggs. In one mass eggs of several shades of brown may occur in patches, as if a number of beetles had oviposited in the same place. Whether this is so I do not know. The egg groups do not adhere very closely to the surface of the reed, and they are easily removed by bending the surface upon which they are laid. From the number of parasitized eggs which one can find there is no doubt that this Trichogrammid must cause a great deal of destruction among the broods of beetles, and were the *Donacia* a pest on valuable plants it would be quite easy and worth while to rear batches of parasites. This has been done in the case of parasites of injurious insects, particularly in America, and such methods of attacking pests have so far met with a good deal of success. In the case of *Donacia* almost the entire number of eggs laid in a locality where the parasites are common will be found parasitised. In Pl. 10, fig. 3, is drawn an enlarged figure of *Donacia simplex*; in *A* the egg mass (*OV.*) viewed in profile upon the reed (*R.*) is shown, and resting on the lower eggs a *Trichogramma* (*P.P.*) is seen, drawn to about the same scale as the beetle.

THE PARASITE (*TRICHOGRAMMA EVANESCENS*, WESTW.)

I have to thank Commander Walker for drawing my attention to some literature on *Trichogramma*. The Rev. J. Waterston, B.D., of the Imperial Bureau of Entomology, in kindly identifying this insect, writes that *Trichogramma evanescens* is generally found as a parasite upon the eggs of insects whose habits and place of oviposition are similar to that of *Donacia*.

As is common with many of the parasitic Hymenoptera, *Trichogramma evanescens* has very gaudy colouring. The wings, which are a shiny blue, at once attract attention

to the insect as it walks over the *Donacia* egg mass. In collecting my material I found it most convenient to examine the rushes for *Donacia* egg-masses from a boat, and those upon which parasites were seen were removed from the water-plant and placed in a box. A most unfortunate circumstance, unknown to me then, was the fact that the time¹ taken to walk to the laboratory with the material was just long enough to allow the newly-laid eggs to form polar bodies, segment, and enter upon the blastoderm stage. Except in the case of a small number of eggs laid in the laboratory, all my sections begin from the blastoderm stage onwards, and some important stages are missing. If the insect is taken into the laboratory and placed with an egg mass of *Donacia*, it is possible to watch oviposition taking place. The little parasite may be observed to walk somewhat rapidly over the eggs, continually tapping them with its geniculate antennæ. When is satisfied with the egg it has chosen it stops, unsheaths its ovipositor, and moves its abdomen backwards and forwards with a sawing motion about eight times, until the chorion of the *Donacia* egg is pierced. When this happens the parasite may be seen to depress its abdomen, thrusting home the ovipositor. It pauses about five seconds while the egg passes down the ovipositor into the *Donacia* egg, withdraws its ovipositor, and generally begins on the next egg in the row. Though the parasite does not seem to work systematically along the rows, in many cases all the eggs in a mass are parasitised, though more often a few are left untouched.

In cases where all the eggs have been parasitised several parasites may have laid in one mass. It is quite common to observe two or three *Trichogrammids* on one *Donacia* egg-mass. In very rare cases there are two eggs laid in the same *Donacia* egg; one so seldom finds this that it is probable that a parasite is able to tell whether one of its fellows has previously given attention to an egg. What

¹ Added to the fact that the fixative I used does not penetrate the chorion of the beetles' eggs as quickly as desirable.

happens in development when two eggs are laid in the same *Donacia* egg I do not know, but one generally finds the two eggs in different stages of development. Probably the older embryo succeeds in the end in killing the other, for I have not yet found more than one insect emerging from one egg.

I am unable to say whether there is more than one brood of parasites during the summer, but it is possible to collect at the same time eggs containing parasites ready to emerge, and some containing newly laid eggs. This points to there being more than one brood. There are two or three species of *Donacia* fairly common at Oxford, and they appear one after the other, so that this strengthens the view that several broods occur in one season. During the winter months I have not found the empty egg-cases of *Donacia* on the stems of the reeds, and I have not been able to satisfy myself as to whether the parasite hibernate in the egg-cases or whether they emerge in summer and creep into crevices with a view to wintering there. Nearly every year the reeds upon which the egg-masses are laid are submerged in the floods, and become withered and torn, and thoroughly soaked. For this reason it is unlikely that the parasites would remain in the eggs which they have destroyed.

In remarking on the parasite and its host, I do not overlook the possibility of *T. evanescens* being found on the eggs of other insects.¹

TECHNIQUE.

The egg of *Donacia* is covered by a thick chorion which, added to the yolk, makes sectioning a very difficult business. The parasitised egg-masses were generally preserved in Petrunchekewitsch, with a little more nitric acid than usual. This often gave splendid results. A mixture of Petrunchekewitsch² and Bouin² was also tried with about equal results.

¹ Prof. Poulton informs me that this Chalcid parasitises the eggs of Dragon flies. I have since been able to observe this interesting fact myself.

² For these fixatives see Bolls Lee's *Microtomists' Vade-Mecum*.

In some cases the eggs were pricked and the whole thrown into picro-nitric.

After some trials Petrunchekewitsch was almost exclusively used, and in most cases it gave a fine fixation, but not always. In using this fixative it is not necessary to prick the eggs. Ordinary preservatives like Bouin, corrosive acetic, or Flemming will not penetrate the chorion. This at once causes difficulties, for alcoholic fixatives are not always reliable. The eggs were left over night in the Petrunchekewitsch and washed out in 70 per cent. alcohol.

When in xylol the eggs were pricked with a fine needle and placed in the paraffin bath. It was not always possible to successfully prick the eggs, but unless this was done it was necessary to leave the masses longer in the bath. This hardens the eggs and makes sectioning a dreadfully difficult task. The eggs were cut in their groups, $5\ \mu$ in thickness, on a Yung microtome, each section being painted with celloidin and ether. One could not be sure that the eggs were not parasitised until after staining, and three or four batches would often be cut without finding any stages. It was only by staining overnight in Iron Hæmatoxylin that a suitable differentiation could be got. Ehrlich and the carmines were useless. In some cases alternate slides were counterstained in orange G. or dilute acid fuchsin.

GENERAL FACTS CONCERNING THE APPEARANCE OF THE MATERIAL IN SECTIONS AND IN WHOLE MOUNTS.

In Pl. 11, fig. 8, there is drawn a part of the section of a parasitised egg-mass. The larval parasite (*D.P.*) lies in the yolk of the *Donacia* egg, and a little to the right and lower edge of the larva is the remains of the embryonic gut of the host (*G.*). At *N.S.* are the remains of the *Donacia* larva's nervous system, and below at *L* is a still recognisable degenerate leg. The parasite has reached the stage just before it begins to swallow the yolk in which it lies. Abutting against the chorion of the egg in the middle of the field are

the chorions of the neighbouring eggs, all of which were parasitised.

It will be seen that when these eggs were attacked the contained embryos had become far advanced and were almost ready to hatch. Though one can observe a *Donacia* ovipositing, and a parasite on the same mass piercing and depositing its eggs in the newly laid beetle's eggs, it is possible to find eggs parasitised at any stage. If one removes *Donacia* embryos from their chorion by means of fine needles and stains them in paracarmine, one can often find the developing parasites as in Pl. 10. fig. 2, at *D.P.* Now this embryo lies at the posterior pole of the embryo beetle, and is too far down to have been oviposited there. It may be that this egg was an outside one of the mass and that the parasite bored it from the side; but such cases occur too frequently in sections of eggs in the middle of the mass, and I am inclined to think that in those *Donacia* eggs laid in a horizontal position the developing *Trichogramma* embryo may sink downwards. I cannot otherwise explain how parasites' eggs are found in this position, because the beetle's eggs seem too closely applied to one another to allow the parasite to get its ovipositor between them, and reference to Pl. 10, fig. 1, will show how short the little insect's ovipositor is. (Both fig. 1 and 2 are drawn to the same scale: $\times 75$.)

THE EFFECT OF THE DEPOSITION OF THE EGG IN THE DEVELOPING EMBRYO'S BODY.

Primarily the effect is to arrest further development of the host, but all life is not killed immediately, for living nuclei are to be found much later on as the parasite develops. As is well known, the nuclei in the yolk of an insect's egg are very large, and such vitellophags become larger than the other cells almost from the time they are established. I believe that it is the vitellophags which manage to live longest after the parasite has oviposited in the beetle's egg, and in

some cases degenerate, but evidently still living yolk cells can be found in the gut of the young larval parasite.

In degeneration the nuclei become hyperchromatic, large stainable masses collecting in both nucleus and cytoplasm, the cell finally becoming a black shapeless mass. I am inclined to believe that the large cells forming the serosa also live longer than the ordinary embryonic cells, after the *Trichogramma* embryo has been developing some time.

THE OVARIAN EGG WHEN READY TO BE LAID.

In Pl. 11, fig. 9, a longitudinal section of the nearly mature ovarian egg is drawn. The egg is of an elongated oval shape, the anterior pole (*A.*) being somewhat broader than the posterior, and the cytoplasm appears homogeneous except for the occurrence at the posterior pole of a large dark mass (*G.C.D.*), the so-called germ-cell, or germ line, determinant. The probable nature, mode of appearance, and the fate of this protoplasmic inclusion will be dealt with under a separate heading. The follicle cells are much drawn out in Pl. 11, fig. 9, and it is very difficult to distinguish between the wall of the ovary and the follicular layer. The nucleus lies slightly towards the anterior yolk of the egg in the mid line. It consists of a large condensed mass of chromatin surrounded by a clear nucleoplasmic zone. In the latter minute stainable granules may be found. The manner in which this condensed form of nucleus is produced is, as far as I am able to judge from my material of adult insects, the same as that described by Hegner for *Copidosoma* (3).

THE NEWLY LAID EGG.

In the eggs at this period I have found a small body near the surface, which, I think, is the spermatozoon. In Pl. 11, fig. 10, this darkly staining body is seen to be surrounded by a number of small granules. I have been unable to find any signs of activity around this body as one would expect if it

were a spermatozoon, though in some insects no clearing of the cytoplasm around the male pronucleus, or other event, takes place at this period. In the stage later, during the formation of the polar bodies, the granules which were present in Pl. 11, fig. 10, around the male pronucleus (*M.P.N.*) cannot be seen, but the latter has penetrated further into the egg. In all the sections of newly laid eggs that I have found, the cytoplasm towards the central region of the egg has become partially vacuolated and thinner, while the germ cell determinant has become much more faintly staining. My collection of newly laid eggs is not complete enough to show whether this thinning out of the central region of the egg is the rule, and it should be observed that in Pl. 11, fig. 11, which shows the formation of the polar bodies, this vacuolisation was quite absent. In Pl. 11, fig. 7, I have drawn a transverse section of an egg which shows the nucleus lying in a central clear region, and quite close a denser part of the cytoplasm containing a cloud of granules (*G.G.*).

The egg, when laid, lies almost always towards the top of the *Donacia* ovum, and it never has a definite orientation, for in a section of a group of the host's eggs one cuts across eggs in all directions. In a brood of parasites which I caught emerging, some had their heads downwards in the *Donacia* egg, some their abdomens. At the stage when the larva begins to feed, it is forced to lie lengthwise in the host's egg, because it has by then become too long to lie in any other way. It is obvious that the orientation of the pupating *Trichogramma* larva in relation to the *Donacia* egg is not governed by any special circumstance. Nevertheless it is possible, though to my mind unlikely, that the larva may be able to turn around at will within the *Donacia* egg.

The newly laid egg is provided with a vitelline membrane and a thin chorion (*C.H.*).

FORMATION OF THE POLAR BODIES.

In the one egg I found at this stage there were two polar bodies (Pl. 11, fig. 11). One polar body (*P.B.*¹) has been

extruded and lies on the surface of the egg. The spindle of the second polar body is in the telophase and the chromosomes seem fused. No aster or centrosomes could be seen. Around the neighbourhood of the forming polar body is a clear zone, and a little above the dumb-bell shaped figure are two large granules. I do not know exactly how these granules arise, but I think that they are possibly extrusions of the polar figures, for expulsion of granules from the nuclei can be observed in later stages. The fate of the polar bodies is not known. In *Oophthora* and *Encyrtus* they eventually degenerate (Hegner, 3a).

THE STAGES BETWEEN FORMATION OF POLAR BODIES AND THE BLASTODERM.

These are not described in the present paper; through lack of material last spring I have been unable to get the stages. This spring I was able to procure a great deal more material, with which I hope to describe the early segregation of the germ-cells and the accompanying phenomena.

THE BLASTODERM STAGE.

The material from the blastoderm stage onwards to the formation of the young larva is very complete. The germ-cell determinant at the posterior pole of the egg has, by the time of formation of the polar bodies, become more faintly staining, and considerably broken up (Pl. 11, fig. 20, broken pieces *P.P.*). Such broken pieces come apart, and the whole determinant loses almost all affinity for stains of any kind. The exact time at which the determinant usually disappears is at present unknown, but very rarely one can find rather darkly staining patches in the germ-cells of the blastoderm stage, which may be the remains of the germ-cell determinant (Pl. 12, fig. 36 *G.*)

In Pl. 11, fig. 12, the earliest blastoderm stage is seen in longitudinal section. The number of germ-cells is very difficult to determine, for at about this stage the latter lose almost

all affinity for stains. I feel quite sure that there are at least six germ-cells in the blastoderm stage, but often one counts more during later stages, in some cases as many as nine. Mitotic division of the germ-cells between the blastoderm stage and the adult larva I have not yet found, and I feel the more certain of this at the period of germ layer formation, because one never finds the germ-cells assuming a greater affinity for chromatin dyes as they would do if they were in the prophases of mitosis. From the time of their segregation onwards to the formation of the larva the germ-cells are resting. At the time when the larva has swallowed almost all the yolk (see Pl. 12, fig. 38 and p. 25) the germ-cells seem to become active again, but though I believe they begin to divide by amitosis, I have not enough material of this stage to feel quite certain of this. The germ-cells have the appearance of fig. 36 of Pl. 12, and the granules (*G.*), which one can in rare cases discover, may be the remains of the germ-cell determinant. In Pl. 11, fig. 21, the structure of the germ-cells and the blastoderm nuclei is shown. The arrangement of the latter is very peculiar and characteristic. The nucleus consists of an oval nucleoplasmic zone, Pl. 11, fig. 21 *A.* (*N.P.*) in which is placed excentrically, and always towards the periphery of the blastoderm, a large chromatin nucleolus (*M.G.*). This large granule is rounded on the side touching the edge of the nucleus and generally more irregular on its inner surface. Placed on the periphery of the nucleus, and always pointing towards the central region of the egg, is a granule, or two, much smaller, and quite spherical (*G.R.C.*) (Pl. 11, fig. 21). This remarkable arrangement and the peculiar orientation of the nucleus and its granules is quite clear. Observe also the transverse section in Pl. 11, fig. 12, and in fig. 17.

This arrangement is quite constant and typical, but in one blastoderm alone did I find a difference, and this lay in the presence of other granules (*O. G.*) near the large main nucleolar granule (*M. G.*), Pl. 11, fig. 16. It may be possible that the blastoderm was younger than its fellow drawn in

Pl. 11, fig. 12, and that the exceptional nucleus is an intermediate form.

The nuclei at the anterior end of the egg are orientated in relation to the centre, as are those of the posterior. In the central region of the egg are found a number of black masses (Iron Hæmatoxylin staining) of approximately the same size and shape as the excentric nucleolar mass of the blastoderm nuclei. That these masses are extrusions from the latter is proved by the fact that all stages in their expulsion can be found. In Pl. 11, fig. 12, there were twenty-three in the egg. When the nucleolar mass is shot out towards the centre of the egg the nucleoplasm and the other granules break apart. The former disappears, the latter may be found in the egg (Pl. 11, fig. 12, *G. R. C.*). In Pl. 11, fig. 17, at *X.*, there is a space left in the row of nuclei; exactly on the same level, and quite near, are two nucleoli labelled *Y.* I believe that the empty space was occupied by the chromatic masses, both of which have lost their nucleoplasmic zone and their small granule. Additional proof that my conclusion concerning the character of these masses is correct will be mentioned below. In Pl. 11, figs. 12, 13, 16, and 17, the central part of the egg is seen to contain extruded nucleoli. I have been able to count the number extruded in various eggs.

In Pl. 11, fig. 12, there were twenty-three; in Pl. 11, fig. 13, there were fifty-three; in Pl. 11, fig. 16, there were twenty-four; in Pl. 11, fig. 17, there were thirty; and so on, the number usually varying from twenty to fifty. In Pl. 11, figs. 12, 16, and 17, are younger than Pl. 11, fig. 13, so fewer nucleoli have been expelled. It is generally true that the younger the blastoderm, the fewer the extruded nucleoli. Examination of the figures of blastoderm stages will fail to reveal any dividing nuclei, and none are ever found in the sections. It is quite obvious that if it is true that nuclei are extruded and no division takes place, one should find a decrease in the number of nuclei in the growing blastoderm. Up to a certain point this is so. In Pl. 11, figs. 12 and 14 are both longitudinal

sections through the egg, the former at a time when most nuclei are present, the latter when fewest are present and just before multiplication begins again. Pl. 11, fig. 12, has thirty-eight nuclei in the section; Pl. 11, fig. 14, has thirty. Counts of a large number of sections yield similar results, though the total number of nuclei in a number of blastoderm stages varies a good deal. From Pl. 11, fig. 12 to fig. 14, it will be noticed that the egg has broadened and contracted in length a good deal. Measured roughly from the camera lucida drawing, Pl. 11, fig. 12, is a centimetre longer than the much older stage Pl. 11, fig. 14. We then realise that two curious processes take place at this time; one, the expulsion of as many as fifty nuclei, the other, an obvious shortening and broadening of the egg. Explanations for both occurrences are difficult to formulate. In cases where no shortening can be shown to have occurred it is equally true that no lengthening has taken place, so that it remains correct that the developing egg departs from the proportions which it had when laid. A relative shortening always occurs, i. e., in comparison of lengths and breadths of the eggs at different stages, for Pl. 11, fig. 8, is one and three-quarter times as broad again as Pl. 11, fig. 12, and a little shorter. Pl. 11, fig. 13, is the later stage of the blastoderm. The egg has become relatively broader and shorter, and important changes have been taking place in the nuclei. It has already been remarked that in this egg fifty-three of these have been extruded. The germ-cells now stain quite faintly, but their arrangement is still unaltered. Most of the blastoderm nuclei in Pl. 11, fig. 13, are the same as those in Pl. 11, figs. 12 or 21, but others show differences. Many of them have lost their small spherical granule, which was directed centrally, and in these the large nucleolar mass has shifted from its position in the periphery of the nucleoplasmic wall (Pl. 11, fig. 21A) to the middle of the nucleoplasmic zone (Pl. 11, fig. 13A, 2 and 3). The latter figure is much enlarged and shows three stages in the alteration of the nuclear arrangement. At a later stage these changes become

widespread, and by the stage in Pl. 11, fig. 14, no granules are left and all nucleolar masses are found in the mid-region of the nucleoplasmic mass. I have not discovered the early blastoderm form of nucleus in any other stages.

Pl. 11, fig. 18, is a transverse section of an interesting stage. It shows that the blastoderm nuclei have grown and that changes have taken place in their disposition, while the mass of extruded nuclei which, in Pl. 11, figs. 12, 13, 16, and 17, was situated in the centre of the egg, appears to be shifting outwards. Now, an examination of all later stages after the blastoderm will reveal the fact that the extruded nuclei leave their central position in the egg, and pass to the periphery (see Pl. 11, figs. 14, 15, 18, 19, 24, 25, and 27, *E. X. N.*).

It is just after the stage drawn in Pl. 11, fig. 12, that this occurrence takes place, and Pl. 11, fig. 18, shows what happens. The central mass containing the nuclei, as is seen in Pl. 11, fig. 13, is somewhat vacuolated. Almost the whole of this central region streams out to the periphery, carrying the extruded nuclei with it, and breaking through and disarranging the layer of blastoderm nuclei on one side; in the process several healthy nuclei are carried out as well (Pl. 11, figs. 18 and 19, *L. E. N.*). The space left by the out-streaming mass is soon closed up, and the disarranged nuclei resume their places; the new membrane appears between the re-formed blastoderm and the extruded mass (*M. B.*, in Pl. 11, fig. 19).

Regarding the position in which this final expulsion of extruded nuclei takes place, though no absolute regularity exists, it is a fact that the outbreak appears generally towards the middle at any place, but more often than not on the future dorsal side of the embryo. In Pl. 11, figs. 14, 18, and 19, it was ventral; in Pl. 11, figs. 15 and 25, it was dorsal. In Pl. 11, fig. 14, it was near the posterior pole; in the others about median.

As will be seen in Pl. 11, figs. 15, 18, 19, and 27, at *E. X. N.* this extruded mass is quite large and consists of the

wider reticulate central part of the egg. After its expulsion the widely reticulate central part of the egg (Pl. 11, fig. 13) disappears (observe Pl. 11, figs. 14, 18, and 19). A partial vacuolisation may reappear secondarily, as in Pl. 11, fig. 15, but this is rare. Further description of the fate of this extruded mass will be postponed, but it remains for a good while lying between the chorion (Pl. 11, fig. 19, *V.M.*) and the re-formed blastoderm, often becoming much flattened.

THE APPEARANCE OF THE GERM LAYERS.

The expulsion of the inner waste mass is a preliminary to the incipient formation of the germ layers. On what is later the dorsal surface of the embryo a longitudinal groove appears, and beneath this groove the regularity of the arrangement of the blastoderm nuclei becomes disturbed. On a space occupied by about five or six nuclei broad and seven or eight nuclei long a gradual sinking-in begins. In Pl. 11, fig. 18 and 19, the groove is marked *I.N.V.* and the sinking nuclei *N.S.I.* In Pl. 11, fig. 14, the egg at this period is seen in longitudinal section.

This process is undoubtedly gastrulation, though in view of the fact that the representative of the blastula is solid the event is somewhat disguised. Pl. 11, fig. 19, has a striking resemblance to a gastrulating blastula, though there is no segmentation cavity or blastocœle. That the groove represents the early blastopore (*I.N.V.*) I have no doubt, and were the depression to become deeper it would form the mesenteron. As it happens, this never takes place, the cavity of the gut being formed in a different way.

It has already been shown that about the stage in Pl. 11, figs. 13, 14, the nuclei lose their granule, and the large nucleolus becomes placed in the centre of the nucleoplasmic zone. By the stage in Pl. 11, fig. 14, this has taken place in every nucleus. In this figure the blastopore (*I.N.V.*) appears on the dorsal surface of the anterior end of the egg, but its

position varies little. The row of nuclei which will form most of the gut, and which are now sinking in (*N.S.I.*) are, on the average, a little bigger than the other nuclei. At the anterior pole of the egg, near the letters *E.X.N.*, is seen an extruded nucleus. It is a fact that though the main expulsion of nuclei occurs between the stages in Pl. 11, fig. 12 and fig. 13, even after the throwing out of the central part of the egg which contains these large granules, sporadic extrusion may take place. That these later extrusions do really occur is shown by comparing the size of expelled granules. In Pl. 11, fig. 14, the granule in the anterior end of the egg is twice as large as those extruded earlier at the posterior region. (Compare also Pl. 12, fig. 32.)

The germ-cells in Pl. 11, fig. 14, have changed their position somewhat, becoming arranged towards the ventral edge of the posterior pole. In this figure the germ-cells are drawn a little darker than they should be. Pl. 11, fig. 19, is drawn from such a transverse section as that through *K.* in fig. 14. The insinking nuclei (*N.S.I.*) are shown.

Such an arrangement does not last long, for as the nuclei sink inwards they lose their order. This is caused by the fact that some lag behind while others penetrate more quickly towards the centre of the egg. This is shown in Pl. 11, fig. 15, at *N.S.I.* By this time these nuclei have become very large. The relationship of the various nuclear elements in the egg now becomes more complicated, because at intervals around the periphery other nuclei grow larger and sink inwards (Pl. 11, fig. 15, at *X.Y.*). All these nuclei are quite distinct from those which were the first to begin sinking inwards, and I feel sure that some of them at least contribute to the formation of the gut. Others form loose cells lying in the cavity between the gut and the ectoderm. Often just before and at this stage amitotic division of nuclei is found taking place. Moreover, the chromatic arrangement of some of the nuclei changes curiously. In these the large centrally placed nucleolus becomes ragged at the edges and pieces break off and become arranged around the periphery

of the nucleoplasmic zone. This process may go on till the nucleus becomes normal, that is, until a rough reticulum is produced, and sometimes the chromatin becomes very sparse. These changes are shown in Pl. 12, figs. 40-43. In Pl. 11, fig. 15 such nuclei are marked *N.*, and in Pl. 11, fig. 25, there is a large group of them towards the centre of the embryo. I do not know the reason for this reversion to the usual chromatic arrangement, but at a much later stage during pupation the early abnormal form of nucleus gives place to the normal one. The nervous system of the larva, for instance, is formed of nuclei having quite a different chromatic arrangement from that of the adult. I feel convinced that the curious form of nucleus found in the larva is connected with the unusual metabolic conditions to which the developing egg is exposed. Inspection of Pl. 11, fig. 15, will show that a large number of nuclei are sinking inwards, but among them the nuclei marked *N.S.T.*, which are the original endoderm, are remarkable for their size. In this figure the extruded nuclei and the inner mass of the egg have been thrown out on the mid-dorsal side, and lie in the space formed by the gastrulating periphery of the ovum (*INV.*). The germ cells lie towards the ventral edge of the posterior pole of the egg and have sunk inwards; at *Z.* the edge of the blastoderm tends to embrace the pocket in which the germ cells lie. The latter stain very faintly, and form a light area on the posterior pole of the egg. Fig. 23 of Pl. 11 is a transverse section through this part of the egg, near the letters *A-A* in Pl. 11, fig. 15. The latter figure is a little earlier than the former. In Pl. 11, fig. 22, drawn at twice the magnification of either Pl. 11, figs. 9 or 23, is an oblique longitudinal section of the posterior pole of the egg to show both the manner in which the germ cells sink into the egg in the form of a pocket (*GCP.*), the neighbouring blastoderm nuclei (*X.X.*) surrounding and protecting the pocket, and the relative staining power of the egg cytoplasm and the germ cell cytoplasm. Up to the stage drawn in Fig. 15 of Pl. 11, the somatic nuclei of the egg are scattered in a syncytium; in

Fig. 24 of Pl. 11 a transverse section of the embryo is drawn at a stage when the cell outlines begin to appear. At the places where the body cavity is formed, the syncytium becomes thin and vacuolated, and between the future cell elements, cell walls are deposited. In Pl. 11, fig. 24, the large endoderm cells have become arranged in a definite manner (*END.N.*), and the beginning of the lumen of the future gut is seen at *GL*. Beneath the ring of endoderm nuclei (*END.N.*) a large cavity (*CAV.*) has already appeared, but otherwise the separation into regions is still slight. On what is the ventral side of the embryo, at the letters *NCN*, will be noticed three rows of nuclei. The upper row (*MCN.*) just beneath the embryonic body cavity (*CAV.*) becomes detached by further vacuolisations in the region marked *X, X*, and in the larva becomes loose in the body cavity (Pl. 12, fig. 37, *MCN.*).

Of the two lower rows, the bottom one, and at least some of the upper row nuclei, form the nerve chain of the adult. Fig. 39 of Pl. 12 should be compared with this figure.

In Pl. 12, fig. 39, the body cavity is better formed (*CAV.*). It will be noticed in Pl. 11, fig. 18, that there are four large nuclei marked *Z* which do not seem to be included in the forming gut. The upper two may form such large glandular cells as those marked *Z* in Pl. 12, fig. 39, for in this figure it will be noticed that in places the wall of the gut (*GL.*) is formed of two rows of cells. One can often find very large unattached cells in the newly-formed body-cavity, and these may break up later on (Pl. 12, fig. 39, *XX.*). Immediately after the final sorting up of the cell elements, and after each nucleus has taken its place, there is an expulsion of superfluous cells, which degenerate either in the hæmocœl, or are cast from the surface of the ectoderm (Pl. 12, fig. 39, *X, X.*).

THE FORMATION OF STOMODÆUM, MESENTERON, AND PROCTODÆUM.

As far as one can tell in a case where such wide variation occurs, the large dorsal mass of nuclei which sinks inwards

takes part in the formation of no organ except the mid-gut, but, as I have already pointed out, some of the cells forming the mesenteron may conceivably be of another origin, namely from nuclei which sporadically wander in from the periphery on other parts of the surface of the embryo (Pl. 11, fig. 15, XY). From the first the nuclei destined to form the mid-gut are conspicuous by their large size and rapid growth. The lumen of the mesenteron appears just after the stage drawn in Pl. 11, figs. 27 and 28. It seems to be formed by an internal delamination of the solid endodermal cell mass in some cases, but in others it looks as if, during growth, the ring of cells, gradually enlarging, left a lumen in their centre, just as the lumen is known to appear in an ordinary duct. In any case there is always a residuum left in the developing lumen (Pl. 12, figs. 27 and 28). After the endodermal cells have grouped themselves as shown in Pl. 11, fig. 24, the proctodæum and stomodæum begin to be quite recognisable; and there is no doubt that the latter is formed by a regular invagination (Pl. 12, fig. 31, ST). The manner in which the proctodæum is formed is a little more doubtful. In the case of the stomodæum the invagination is normal (Pl. 11, fig. 27). The inpushing cells meet the roughly disposed endoderm cells, and when the final dissolving out and disintegration of that part of the embryo which forms the body-cavity takes place the connection between the stomodæal and mesenteron cells remains unbroken. The same thing applies to a region where the proctodæum is formed, but it is difficult to be sure of a true invagination such as occurs with the stomodæum. The latter is formed of much smaller cells than the proctodæum, and is longer, while the demarcation between mesenteron and proctodæum is quite indistinct. In Pl. 12, fig. 30, which is a horizontal section of the front region of a larva of the same age as that drawn in Pl. 12, fig. 38; the stomodæum, mouth, and mesenteron are shown. In Pl. 12, fig. 34, there is a longitudinal section of the proctodæum of a somewhat younger larva, but it serves to show how short the hind gut is. This

seems to be the rule in many Hymenopterous larvæ. In the oldest larvæ I have found there is no œsophageal valve formed, nor is there any differentiation in the proctodæal end of the gut.

As the larva grows it swallows all the host's yolk in the egg, and no defecation takes place until every yolk disclet has been swallowed; by this time the animal is enormously stretched, and the body-wall and gut-wall are so thin as to be overlooked unless care is taken. Pl. 12, fig. 38, is drawn when the swallowing is well advanced, Pl. 12, fig. 33, when the first food has reached the mesenteron. When the larva has finished swallowing the yolk, it occupies almost the whole extent of the egg.

THE HEAD REGION OF THE LARVA OF TRICHOGRAMMA.

In Pl. 12, fig. 30, I have drawn the horizontal section of the head region. The mouth (*MTH.*) is a simple opening; but pointing forwards and outwards are two extraordinary horn-like processes (*PRC.*). These are seen to protrude from a pair of lateral thickenings—one on each side of the head. These thickenings arise quite early, and are closely associated with the inner side of the epidermis. In Pl. 12, fig. 29, (*TH.*) I have drawn a transverse section of a younger head to show the thickenings before the horn is secreted from them. Beyond this curious organ I have been unable to discover any other mouth parts whatsoever.

THE LATE LARVA.

In the stage when the larva has swallowed all the yolk several facts may be noticed.

The first is absence of tracheæ; the second, absence of any external sign of segmentation; and the third, the absence of completely differentiated muscles or heart.

The larva is merely an ovoid sac, provided in front with two horn-like processes, and with an opening at either end, for taking in food and casting out waste matter; internally there is a gut divided as usual into three regions; and finally

there is the single median ventral germ-cell pocket, beneath the proctodæum.

In Pl. 12, fig. 30 (*CU.*), a distinct cuticle could be seen. It dipped into the pockets from which the horn-like jaw-processes protruded, and the latter are probably cuticular in nature. The thickening (*TH.*) is ectodermal. Cuticle (chitin) was found in the stomodæum, but I am not quite sure of its presence in the proctodæum. It is possible that the processes are used for scooping up the yolk of the host as the larva feeds, and they are probably much modified mandibles.

When the larva has swallowed all the yolk, very often not the smallest particle can be found outside its gut, and exactly how the yolk at the posterior end of the host's egg is worked to its mouth is impossible to say; but it is probably by means of movements of the body that the unswallowed parts are brought forward.

THE FATE OF THE EXTRUDED MATTER.

In Pl. 11, fig. 15, the extruded mass still lies within the vitelline membrane of the egg. As the larva grows the membrane becomes stretched and the waste mass flattened; but, though it remains intact for a good time, it eventually bursts. The extruded mass then floats free in the yolk of the *Donacia* egg. In Pl. 11, fig. 27, *EM.*, it is shown to the right of the ventral side of the posterior pole of the embryo. In Pl. 12, fig. 35, it is seen quite close to the embryo at *EM.*

Curiously enough these fragments seem to live a good while, and nuclear changes, such as those undergone in the blastoderm, take place in some cases.¹ The mass may become spherical, as in Pl. 12, fig. 32, and may resemble the egg itself. Eventually the mass either degenerates outside the

¹ One is tempted to entertain the view that this peculiarity may be in some way or other connected with a faculty that culminates in the establishment of polyembryony. Were the extruded mass to contain enough live nuclei it might partially follow the development of the embryo.

embryo or is swallowed by the latter. The live nuclei, to which the temporary persistence of the extruded mass is due, may develop the microsome granule (*GRC.*) drawn in Pl. 11, fig. 21 A. This is the case with the nuclei marked *LEN.* in Pl. 12, fig. 32. (See addendum, p. 30.)

THE NERVOUS SYSTEM.

The nervous system can be recognised very early; it arises from the multiplication of ectodermal cells in the usual manner found in insect larvæ, but it never becomes properly separated off from the ectoderm. Even in late larval life the nervous system seems "coarsely" made; that is to say, it is formed of comparatively few cell elements which are not differentiated in the characteristic manner, and there are no such things as nerves in the sense of offshoots or twigs to organs, such as exist in other larvæ, such as *Vespa*. The nerve-cells do not differ in any way from other cells in the body, always excepting germ-cells. In Pl. 11, fig. 18, the nerve-chord is seen in a rudimentary condition, and consists of the bottom row of nuclei marked *N. C. N.*, and an unknown number of the row above. In Pl. 11, fig. 21, the brain (*BR.*) and nerve-chord (*N. C.*) are cut longitudinally. In Pl. 11, fig. 22, Pl. 12, figs. 33 and 38, a better view of the chord in transverse section is seen, and in Pl. 11, fig. 29, the brain (*BR.*) is cut transversely, to illustrate its close connection with the epidermis (*EP.*) and œsophagus (*STD.*). No such things as ganglia exist, and the chain ends a little before the germ-pocket; it does not reach the proctodæum. In late stages (Pl. 12, fig. 38, *N. C.*) it becomes an increasingly difficult matter to recognise the chain, so stretched does it become, and by the time the larva has swallowed all the yolk in the *Donacia* egg, the nervous chain is for most of the hinder part of its length quite unrecognisable. The œsophageal connectives seem to consist of single cells applied to one another (Pl. 12, fig. 30, *ÆS. CON.*), and are extremely rough.

THE AMITOTIC DIVISION IN THE DEVELOPING EMBRYO.

It has been shown that the number of nuclei in the blastoderm stage becomes subsequently reduced, but that soon afterwards, at about the stage in Pl. 11, fig. 15, amitosis can be found. Mitosis never occurs in the stages I have examined, and I suspect that it never occurs at any stage of development; but between polar bodies and blastoderm, and larva and pupa, I have no stages. I cannot find mitosis in the ovary of the imago, but my series is not satisfactory, and subsequent work may cause me to alter my views. In the dividing nucleus the large median chromatic body may be seen to elongate (Pl. 10, figs. 6A and 6B), while the nucleoplasmic zone (*NP. Z.*) is unaltered in shape. The nucleoplasmic zone soon constricts and becomes elongate. The chromatin mass becomes roughly dumb bell-shaped, and the nucleus divides into two by a constriction (Pl. 10, figs. 15A and B).

From the scanty evidence afforded by Pl. 11, fig. 11, it seems probable there is no proper mitotic figure in the polar bodies. The figure drawn in Pl. 11, fig. 11A, closely resembles the stages of amitosis in the embryonic nuclei, except for the absence of the nucleoplasmic zone. It is probable that mitotic figures will be found during and after the formation of the pupa. The probable reason for the absence of mitosis during early development is evidently connected with the explanation of the form of the nucleus. (See the discussion, p. 26.)

MESODERM.

In the section of the young larva one always finds loose cells in the body cavity. These I believe to be mesoderm; such cells are shown in Pl. 11, fig. 27, *MC.*; Pl. 12, fig. 33, *MC.*; fig. 34, *X*. The formation of mesoderm is quite unaccompanied by the appearance of mesoblastic somites; these cells which form the mesoderm are derived from nuclei which sink inwards from the periphery in the stage of fig. 15, Pl. 11, but as the disposition of such nuclei varies I find it impossible to state exactly where they arise. It will be clear, after

an examination of Pl. 12, fig. 39, that the cells marked *MCN.*, which form the mesoderm, appear in a scattered manner, being set free by vacuolisations which rise around them as the body-cavity is formed. It has already been noticed that at this stage many such cells degenerate completely (*X, X.*, Pl. 12, fig. 39), and the number which persists in the young larva is never constant.

It is the body cavity cells which most usually exhibit that curious resumption of the reticulum of the nucleus shewn in Pl. 11, figs. 27 and 28, *X*, and in Pl. 12, fig. 34, *X*. The fate of these cells, and the part they play, if any, in histolysis, I do not know at present, but at the stage when the larva has swallowed up all the yolk in the *Donacia* egg, they seem few in number and much compressed, while their nuclei never show the reticulate structure. Some of the loose cells in the body-cavity also form muscles, becoming slightly flattened under the ectoderm.

THE GERM CELLS.

Trichogramma evanescens is one of those remarkable animals where a definite difference can be seen very early to exist between germ cells and soma cells; the difference between the two lies in the presence of a germ cell determinant in the former. At the time of segregation we know, from the cases of such insects as *Chironomus* or *Calligrapha*, the germ cell determinant becomes included in the pole cells which later form the gonads, and in some special examples pieces of the broken-up determinant can be found in fairly late stages of development. The germ cells at the blastoderm stage (Pl. 11, fig. 12, fig. 14, and fig. 15) have been described. They have already lost a great deal of affinity for any stains, and in bad preparations the nuclei can hardly be found. Not long after the extruded centrally-placed nuclei are finally thrown out to the periphery of the egg, the germ cells begin to sink inwards. Exactly what causes them to move in this manner I am quite at a loss to say, but it is easy to watch the event taking place. In the fully formed

larva the germ cells lie in a pocket beneath the proctodæum, that is, on the ventral edge of the body-cavity. In the earliest stages the germ cells may be seen moving in this direction (fig. 14 of Pl. 11, in the direction of the arrow). One germ cell (*M.*) has begun its migration. By the stage in Pl. 11, fig. 15, the germ cells have sunk right into the ventral edge of the posterior pole, pushing aside the blastoderm nuclei. In Pl. 11, fig. 22, which is a somewhat oblique longitudinal section, this inpushing is finished, and the germ pocket is formed by the nuclei (*X.*, *X.X.*). The latter are quite early set aside for this work, and continue in that position in late larval life. During the time the other organs are being differentiated the germ cells remain closely embraced by these cells; and just when the lumen of the gut is appearing (Pl. 11, figs. 27 and 28) the germ pocket has the appearance drawn in Pl. 12, fig. 37, in transverse section, and in Pl. 12, fig. 34, in longitudinal. The germ cell socket is enclosed by about four cells, and contains the germ nuclei in what appears to be a syncytium, though faint cell outlines and slight vacuolisations can sometimes be noticed. The germinal cytoplasm stains very faintly in plasma dyes. In Pl. 12, fig. 34a, I have drawn an enlarged view of the pocket in order to show the staining reactions. In the case of nearly every nucleus the nucleolus alone can be made to stain. Regarding the number of nuclei in the pocket I could count seven in one, and in another six, but there were always doubtful nuclei at or on the edge of the syncytium, which may or may not have been germ nuclei; it is probable that the number of germ cells is subject to variation, though I have never found less than six.

After the stage drawn in Pl. 12, fig. 34, my material is not very good, but at a stage a little after the time the larva has distended itself with the yolk of the host, the germ cells seem to become almost similar to the somatic cells, and amitotic division begins. The exact details and further confirmation of the facts cannot be given at present.

It will be noticed in Pl. 11, figs. 21, 22, and Pl. 12, figs. 34

and 35, that the germ nuclei gradually lose all staining power, except that of the chromatic nucleolus, the reticulum disappearing. In later stages, when the germ cells begin to stain more heavily, only the nucleolus can be made to take up chromatin dyes.

With regard to the migration of the germ-cells from outside the embryo inwards (Pl. 11, figs. 21 and 22, no pole canal could be recognised. The germ cells seem to sink in passively, and never become amœboid as in *Calligrapha* (3).

The Germ Cell Determinant.

The origin of the germ cell determinant, even in those insects where the eggs are larger and technique easier, is still in doubt. I have examined several Hymenopterous insects parasitic upon Aphids, and find that the determinants appear as a cloud of granules towards the posterior pole of the egg.

In *Trichogramma* the determinant is densest and most darkly staining during the period in which it still lies in the ovarian tubule, but is just about ready to lay (Pl. 11, fig. 9). By the time the egg has been laid and the polar bodies are in process of formation the determinant loses a great deal of its affinity for stains, and begins to break into pieces (Pl. 11, fig. 26, *P, P.*) At the blastoderm stage the determinant has completely disappeared, and with the exception of the rarest cases nothing of it remains (Pl. 12, fig. 36, *G.*). Indeed at at this stage the cytoplasm of the germ-cells, instead of staining more heavily than that of the somatic syncytium, as one would expect, has lost a great deal of staining power, both in nucleus and cytoplasm. This soon becomes very accentuated (Pl. 11, fig. 22). In the newly laid eggs in Pl. 11, figs. 10 and 20, the germ cell determinant has become rather shrunken and faintly staining, though in the case of Pl. 11, fig. 11, the determinant has a good deal more affinity for stains.

DISCUSSION.

The Significance of the Nuclear Changes during Blastoderm Stage.—Many nuclei (from twenty-five to fifty-five) are cast out altogether. Others, as far as I can tell all of them, extrude the microsome or small chromatin granule, marked *GRC.* in Pl. 11, figs. 16 and 21. In some cases there are two granules of the same size, both of which are expelled into the cytoplasm. No granule can be found to be extruded from the germ cells, and it might follow therefore that the latter, at this period at least, contain more chromatin than the ordinary blastoderm nucleus. In *Miastor*, Kahle (5) and Hegner (3) have described a definite chromatin diminution process whereby the somatic nuclei are deprived of a part of their chromatin during certain divisions. Though I do not overlook the possibility of a homologous occurrence taking place in *Trichogramma evanescens*, I am more inclined to believe that another explanation should be attached to the remarkable chromatin diminution in the parasite. In the first place the chromatin diminution in *Miastor* takes place quite early, before the blastoderm is formed completely, and, moreover, the process is brought about in a different manner, not by extrusion of a granule, but by the discarding of the larger part of the chromosomes during the mitotic division, only the extreme ends of the chromosomes going to the opposite spindles at the telophase. The residual mass in the middle of the spindle undergoes degeneration.

No satisfactory explanation of the occurrence in *Miastor* has been advanced, but in *Trichogramma evanescens* I would suggest that the process is connected with the curious metabolic influences which must affect the nuclei. It must be remembered that all nourishment which is necessary for the development of the egg, and which is ordinarily provided by the central mass of yolk of the insect-egg, is, in the case of this parasite, derived from the yolk of another insect's egg and without the aid of vitellophags. Such nourishment

must be received over the surface of the ovum, and it follows that the surface nuclei must be partly engaged in the taking up of the food matter. A glance at Pl. 11, fig. 7, and fig. 28, will show how enormously the egg has grown during development. Both figures are drawn to the same scale, and the embryo in Pl. 11, fig. 28, had not yet begun to swallow food. All the food necessary for this growth has been derived through the surface of the embryo and of the developing egg; and without the help of yolk cells, which are so characteristic in hexapod embryology. The form of nucleus in the blastoderm must be the one suited to the requirements of the developing embryo, and the occasional expulsion of whole nuclei, and the constant extrusion of the granule, is probably due to the fact that the nuclei become hyperchromatic. That this nuclear arrangement is artificial and temporary is shown, in the first place, because it is not found in the adult insect (follicle cells of ovary excepted); and secondly, because there is always a tendency for the nuclei to regain the normal reticulate arrangement. It is as if the forces which suppressed the usual chromatic arrangement were overcome now and again, but soon recovered their power. To illustrate this suggestion it may be mentioned that the changes shown in Pl. 12, figs. 40-43 take place sporadically. Nuclei like that figured in Pl. 12, fig. 43, occurred in the embryos in Pl. 11, figs. 27 and 28 (*X.*), were absent in Pl. 12, fig. 33, but were common in Pl. 11, fig. 15 (*N. N.*), and were found to occur in a scattered manner right up to the formation of the larva, when they became suppressed. It was particularly in the loose cells in the body cavity that such nuclei were found, and it seems fair to conclude that these are the cells which would be least affected by the metabolic influences surrounding the embryo.

The occurrence of the modified nucleus in the follicle cells of the adult insect's ovary is due to the fact that such cells are exposed to somewhat the same conditions as the nuclei in the embryo, and are engaged in passing on food to the ovum (Pl. 11, fig. 9, *FN.*).

Hyperchromatic nuclei are known to occur in nurse cells of insects, in various cells of vertebrate foetal membranes, and in many tissues concerned in nourishment, and where these nuclei do not become noticeably hyperchromatic, they generally hypertrophy.

The extruded granules are, therefore, to be regarded as superfluous chromatin, which has arisen through the peculiar conditions to which the blastoderm nuclei are exposed.

Formation of the Germ Layers.—In view of the fact that the egg of *Trichogramma* is not provided with yolk the formation of the germ layers is of great interest, for the yolk profoundly alters the organogeny in the usual hexapod development. That one would receive a faithful representation of the ancestral mode of development of the insect from the case of *Trichogramma* is too much to expect, because the method of development, though primitive in some respects, is overshadowed by the effects of the parasitic mode of life. The blastoderm stage is without doubt quite normal, and except for minor nuclear phenomena differs not at all from that of the host or of *Miastor* (3), but the events leading to the formation of the endoderm are interesting. That the progress figured in Pl. 11, figs. 14 and 19, is one of gastrulation one hardly doubts. In the case of *Polygnotus minutus* Marchal (7) describes how the embryo is formed by a complete invagination of one side of the hollow blastula, to form a two-layered gastrula. The method of gastrulation in the parasite treated in this paper is somewhat less distinct than in the case of *Polygnotus*, and before the process is far advanced a secondary insinking of other peripheral nuclei almost completely obscures it (compare Pl. 11, figs. 14 and 15.)

The manner in which the endoderm is formed in *Trichogramma* is of very considerable interest in view of the discussions which have been caused by the different opinions expressed by several authors (Dohrn, Kowalevsky, and Ganin (7)), but it is not intended here to review their widely different suggestions in the light shed by *Trichogramma*.

Germ Cell and Determinant.

In the ordinary Hymenopterous larva (e. g. *Vespa*) the germ cells lie about two-thirds way in the length of the body and above and resting upon the mid-gut.

In the *Trichogramma* larva the germ cells are situated at the posterior pole and ventral to the proctodæum. In the adult insect the ovaries occupy the same position as they do in the *Vespa* imago. Migration of germ cells is very small in the developing embryo. In most insect embryos the germ cells are carried into the tail fold, and may be said to either migrate or be passively carried a good distance, but except for the early insinking of the germ cells and the formation of the germ pocket in *Trichogramma* the position of these cells is hardly altered.

I have looked carefully at my sections of the adult ovary, and find that the germ cell determinant appears as a cloud of granules, which become more and more heavily staining, and denser and denser, until the determinant resembles a dark spherical ball at the posterior pole of the egg. The whole history of the germ cell determinant, in so far as the ovary is concerned, has been exhaustively treated by Hegner (3) in more suitable insects. I have examined a number of sections of the Hymenopterous parasites common on Aphids, and I am able to substantiate most of his remarks; but in the nurse cells, as well as in the developing oocyte, I have found curious large spherical granules which have not hitherto been mentioned. These seem to appear after synezeisis in the oocyte, and whether they have anything to do with the germ cell determinant I cannot at present say. If suitable material is procured I hope to examine this point.

ADDENDUM.

When this work had been finished I had not had the opportunity of acquainting myself with Prof. Silvestri's writings, only knowing of them through short reviews in

other papers more accessible to me. Since then I have been enabled, through Mr. Goodrich's kindness, to read Silvestri's valuable articles. I have been impressed by the similarity between all stages in the development of *Oophthora* and of *Trichogramma*. To my eye, untrained in the appreciation of small systematic differences in Chalcids, the adult insects in these species are closely similar, and the peculiar larvæ of both species are structurally identical.

Apart from differences due to different interpretation there is no doubt that the course of organogeny in these parasites is parallel.

Silvestri ('*Bolletino del Laboratorio de Zoologia Generale e Agraria*,' vol. i and iii) identifies the darkly staining masses of the inner region of the blastoderm stage (Pl. 11, figs. 12 and 13 in my drawings) as a "piccolo numero di nuclei, che in seguito degenereranno," but has overlooked the small granule (*GRC.*) (if really present in *Oophthora*) which is so characteristic of stages such as that of Pl. 11, figs. 12, 13, and 21. In *Oophthora* the germ cells have sunk into the egg before any marked differentiation of the primary germ layers has taken place (vide Silvestri, vol. iii, p. 78, fig. xxx, vii, 5), for it will be remembered that in the stage drawn in my fig. 15, Pl. 11, the germ layers are distinctly forming and the germ cells still situated at the pole of the egg.

Regarding Silvestri's statement that the extruded masses are nuclei, it might be well to mention that these darkly staining masses are but a part (i. e. the nucleolus) of the original nuclei (see p. 11, and the figs. 13A and 21 of Pl. 11).

In *Trichogramma* I have not described the formation of an embryonic membrane, nor do I believe that such exists. In *Encyrtus aphidivorus* and in *Oophthora* Silvestri describes the formation of a "pseudoserosa" from a delamination of the surface cells of the embryo. He states: "L'involucro embrionale dell' *Oophthora* è in parte omologo a quello dell' *Encyrtus*, perchè in questo sembra che derivi completamente per delaminazione delle cellule embrionali, mentre nell'

Oophthora la parte di esso, che prima si forma, deriva dalla parte spugnosa del protoplasma che occupava, a blastoderma completo, il centro dell'ovo. Intorno a tale differenza io però non voglio insistere troppo perchè potrebbe essermi sfuggito il primo vero periodo di formazione dell'involucro embrionale nell'Encyrtus, mentre ho potuto seguirlo con ogni precisione nell'Oophthora."

In Encyrtus Silvestri gives several figures (vol. iii, 1908, p. 67) of the "inizio della pseudoserosa," which I find not unconvincing, but I cannot see any delamination taking place in fig. xxvi, 2, except at *P.*, which I think has little in common with the "pseudoserosa" drawn in fig. xxv, 3. I will leave my comment at this point because Encyrtus is in some ways different from Trichogramma, and will consider Oophthora (vol. iii, pp. 71, 79). Whether Prof. Silvestri's or my views concerning these forms are correct, I am convinced that we have to deal with two species whose development is closely similar. I find stages such as those drawn by Silvestri in figs. xxxvii and xxxviii, and in almost all others of his figures. Not only this, but the modified larvæ of both Trichogramma and Oophthora are similar.

He believes that one part of the pseudoserosa is formed by the extruded inner mass (protoplasma superficiale spugnoso), while the other is formed like that of Encyrtus, and is homologous with this membrane in the latter.

In my figs. 15, 18, 19, 24, and 25 of Pl. 11, I have drawn at *EXN.* what Silvestri calls the "pseudoserosa." Since reading the Professor's papers I have very carefully re-examined my sections, and find nothing to alter in my interpretations; but I have drawn Pl. 10, fig. 4, with a view to the clearer explanation of my view of the "pseudoserosa" of Silvestri.

The egg when laid is surrounded by a vitelline membrane and a thin chorion, which, however, is quite distinct (Pl. 10, fig. 6, *CII.*) As development goes on the waste nucleoli collect in the centre of the egg, and are soon extruded (Pl. 11, figs. 18 and 19). They come to the surface of the egg, and at first form a slight cavity in the ovum. But as

the egg grows rapidly the chorion becomes slightly stretched, and the lump of "protoplasma spugnoso" becomes pressed flat, and mechanically spreads around the egg (Pl. 10, fig. 4, X, X, X.). Now should the chorion by any chance burst, as it sometimes does, the extruded mass is released and lies near the egg and embryo (Pl. 11, fig. 27; Pl. 12, fig. 35, *EXN.*).

In Pl. 10, fig. 4, the extruded mass (*EXN.*) lies inside the chorion, and has been flattened out between the points X, X, X., on the dorsal surface of the embryo, but on the ventral surface (*V.*) the chorion, though somewhat stretched and thinner, is still recognisable, and cannot be confused with any other structure. The "protoplasma spugnoso" of Silvestri is an extruded dead mass, and is in no way comparable or homologous with either the amnion or serosa of other insects, and since, as Silvestri shows, there is really a living embryonic membrane around the egg of *Encyrtus*, it is incorrect, in my humble opinion, to say that "L'involucro embrionale dell' *Oophthora* è in parte omologo a quello dell' *Encyrtus*." In his figure on p. 67 of vol. iii, he depicts a membrane (*P.*) which has nuclei evenly distributed, and the tout ensemble is far more convincing than his fig. xxxvii, 6, of *Oophthora*. In the latter figure there are no nuclei in the "pseudoserosa" except those on one side, which he had already declared were "in seguito degenereranno."

I feel convinced that in *Trichogramma* and *Oophthora* the "pseudoserosa" of Silvestri is merely an artefact produced by the mechanical flattening out of a waste mass of protoplasm and chromatin. If the chorion bursts early no "pseudoserosa" can be formed.

I agree with Silvestri's description of the larva except that his fig. *XL*, p. 81, which, he says, is a sagittal section, he marks what I consider to be the longitudinal nerve-chord, as "cellule muscolari *M.*" It is true that no properly differentiated muscles seem to exist in the larva of either species, and the movements of the animal are brought about by flattened mesoderm cells lying here and there under the

ectoderm. These cells only differ from the other somatic cells in that they are more elongate, their nuclei and cytoplasmic structure being normal.

It is a curious fact that Silvestri, though not paying much attention to the formation of the germ layers, has not figured the invagination of the endoderm (Pl. 11, figs. 14 and 19). I cannot but believe that this happens in *Oophthora*, where all our other stages are almost identical.

In *Oophthora* that remarkable nuclear arrangement of early stages (Pl. 11, figs. 16 and 21) has not been described, and it possibly is absent; however, Prof. Silvestri does not appear to have paid great attention to the nuclei of early stages, and it may have been overlooked. I mention this because the early changes in the nuclei of *Trichogramma* are so striking.

As Silvestri has pointed out, *Encyrtus aphidivorus* is not a parasite on aphids, but a hyperparasite on one or two other true aphid parasites. With regard to the fate of the embryonic membrane which he figures enveloping the larva (on p. 69, fig. xxix) he says: "E in tale stato di sviluppo che la larva allungandosi rompe nella parte anteriore e nella posteriore la serosa e libera comincia a nutrirsi dei tessuti dell'ospitatore."

It will be seen that, with the exception of those parts of organogeny which Silvestri has not treated at length, his admirable work agrees fairly well with the few remarks I have been able to pass on the embryology of *Trichogramma*, and I have no doubt that when the Professor examines his stages in greater detail, his results will fall into line with my own.

SUMMARY.

(1) *Trichogramma evanescens* lays its eggs on the egg mass of a beetle, *Donacia simplex*, a single parasite emerging from one host's egg.

(2) The ovum has a large germ cell determinant at its posterior pole, and in segmentation the determinant is

divided among the large cells at the posterior pole, which are the germ cells.

(3) In the single case found there were two polar bodies.

(4) The blastula is fairly normal except for the curious arrangement of the chromatin in the somatic nuclei.

(5) Many nucleoli are cast out into the centre of the egg, where they collect till from twenty-five to fifty are present; the mass is then extruded on the periphery of the egg.

(6) As the blastoderm grows it broadens without lengthening up to the stage where the germ layers begin to form.

(7) About thirty-five nuclei sink inwards from the dorsal surface of the embryo to form endoderm.

(8) From the blastoderm stage to that of the gastrula no nuclear division appears to take place.

(9) Shortly after the formation of the endoderm amitosis may be found, and from this onwards the number of nuclei increases.

(10) The mesoderm seems to be formed from peripheral nuclei, which sink in sporadically; no somites can be made out, nor does any segmental method of formation of the mesoderm occur.

(11) The nervous system, stomodæum, and probably proctodæum, are normally formed.

(12) The germ cells lie in a pocket formed by several somatic cells, which embrace them.

(13) Ordinary mouth parts, tracheæ, heart, and œsophageal valve are wanting; the head has two horn-like mandibular processes, which may assist in scooping forwards the food.

(14) The larva does not feed on the food little by little, defecating as it eats; instead, it begins by swallowing all the yolk at once, so that its body becomes enormously distended and stretched.

(15) Metameric external segmentation is absent, the body and head being continuous and sac-like.

BIBLIOGRAPHY.

1. Paul Marchal.—“Recherches sur la biologie et le développement des Hyménoptères parasites,” ‘Arch. de Zool. Exp.,’ 4^e Série, 2.
2. Silvestri, F., 1906–08.—“Contribuzioni alla conoscenza biologica degli Imenotteri parassitici,” i–iv, ‘Bollet. Scuola sup. Agric., Portici,’ T. 1 and 3.
3. Robert W. Hegner.*—“Studies on Germ Cells: IV, Protoplasmic differentiation in the oocytes of certain Hymenoptera,” ‘Journal of Morphology,’ vol. xxvi, No. 3.
- 3a. ——— ‘The Germ Cell Cycle in Animals,’ New York, 1914.
4. Perkins.—“Trichogramma evanescens and Pentarthron,” ‘Trans. Ent. Soc.,’ 1913.
5. Kahle, W.—“Die Pädogenese der Cæcidomyiden,” ‘Zoologica,’ 1908, Bd. xxi.
6. Henneguy.—‘Les Insectes,’ Paris, 1904.
7. ‘The Embryology of the Honey Bee,’ J. A. Nelson, Princeton Univ. Press, 1915, p. 72.

* After Hegner’s paper (3) a useful bibliography is found.

EXPLANATION OF PLATES 10, 11, AND 12,
 Illustrating Mr. J. Bronté Gatenby’s paper on “Trichogramma evanescens (W.): a Monembryonic Egg Parasite of Donacia Simplex.”

LETTERING.

ANT. Anterior pole. *B. C.* Body cavity. *BR.* Brain. *CAV.* Developing body cavity. *CH.* Chorion. *CU.* Cuticle. *D.* Dorsal surface. *D. P.* Developing parasite. *E.* Ectoderm. *ECD. N.* Ectodermal nuclei. *E. M.* Extended mass of cytoplasm and chromatin. *END. N.* Endodermal nuclei. *F.* Food. *F. N.* Follicle nuclei. *G.* Stainable granule. *G. C.* Germ cell. *G. C. D.* Germ cell determinant. *G. C. N.* Germ cell nucleus. *G. C. P.* Germ cell pocket. *G. L.* Gut lumen. *G. R. C.* Minor granule of nucleus. *GT.* Gut. *INV.* Invagination. *L.* Leg of host. *L. E. N.* Healthy nucleus extruded. *M.* Muscle cells. *M. C.* Cells of body cavity. *M. T. H.* Mouth. *N.* Nucleus. *N. C.* Nerve chord. *N. P. Z.* Nucleoplasmic zone of nucleus. *N. S. I.* Nuclei sinking inwards (endoderm). *ŒS.* Œsophagus. *ŒS. COM.* Œsophageal commissure. *OV.* Eggs of *Donacia*. *P.* Broken pieces of germ cell determinant. *P. P.* Parasite. *P. B.* 1st polar body.

PD. Proctodæum. *POST.* Posterior pole. *P. R. C.* Frontal process of larva. *R.* Reed. *S. L. N.* Mostly vitellophags of host. *ST.* Stomodæum. *TH.* Glandular thickening secreting frontal process. *V.* Ventral. *V. C.* Vacuoles in cells. *V. M.* Vitelline membrane. *Y.* Yolk.

[In reproduction all figures reduced by one-half.]

Figs. 7, 9, 10, 11, 12, 13, 14, 15, 17, 18, 19, 20, 23, 24, 25, 28, 29, 30, 32, 33, 34, 35, 37, drawn with a Zeiss $\frac{1}{2}$ oil immersion and compen. eye-piece 8. A camera lucida was used, with drawing-board slightly inclined towards the microscope, and at table level. Magnification about 1,760 diameters.

Figs. 27, 31, and 38 from Zeiss $\frac{1}{2}$ and comp. eye-piece 4.

Figs. 10A, 11A, 13A, 16, 21, 22, 26 enlarged about twice from camera drawings with O. $\frac{1}{2}$ E. 8.

Figs. 36, 40, 41, 42, and 43 enlarged in the same way about four times.

Fig. 8 drawn with O. $\frac{1}{6}$ E. 2, drawing-board at table level. (Camera lucida).

Fig. 39 was drawn with Zeiss O. F. E. 4.

Fig. 4.— $\times 2400$ (Koristka $\frac{1}{2}$ th \times Hug. oc. 5).

PLATE 10.

Fig. 1.—*Trichogramma evanescens* (Westwood), adult female (now $\times 75$.)

Fig. 2.—*Donacia* embryo $\times 75$ containing at its posterior pole a parasite (*D. P.*). Whole preparation. The parasite was at the stage drawn in Pl. 11, fig. 24.

Fig. 3.—*Donacia simplex* (*F.*) $\times 4$.

Fig. 3A.—Egg mass of *Donacia*, viewed from side with parasite (*P.*). All to same scale as beetle.

Fig. 4.—Transverse section in mid region of an embryo when the gut lumen has formed. Shows the flattening out of the extruded mass (*EX. N.*) under the chorion (*CH.*).

Fig. 5.—Stages in amitosis of somatic cells.

Fig. 6.—Part of early blastoderm stage to show chorion (*CH.*) and extruded nucleolus (*EX. N.*).

PLATE 11.

Fig. 7.—Part of *Donacia* egg showing the newly-laid egg of the parasite in transverse section.

Fig. 8.—Part of egg mass of *Donacia* in transverse section showing a parasite at the stage drawn in fig. 28.

Fig. 9.—Nearly mature ovarian egg of parasite to show nucleus (*N.*) and germ cell determinant (*G. C. D.*).

Fig. 10.—Newly-laid egg, with spermatozoon (*M. P. N.*).

Fig. 11.—Formation of second polar body.

Fig. 12.—Typical blastoderm stage showing extruded nuclei (*EX. N.*) and germ cells (*G. C.*).

Fig. 13.—Later blastoderm to show stages in nuclei and shortening of egg.

Fig. 14.—Late blastoderm stage showing beginning of formation of endoderm (*N. S. I.*).

Fig. 15.—Stage after fig. 14 to show beginning of insinking of peripheral nuclei ($\times Y$), and penetration and change of position of germ cells.

Fig. 16.—Part of transverse section of blastoderm stage to show structure of nuclei.

Fig. 17.—Transverse section of a blastoderm stage to show expulsion of nuclei (*Y*).

Fig. 18.—Transverse section showing final extrusion of nuclei (*EX. N.*) and beginning of gastrulation.

Fig. 19.—Gastrula stage in transverse section after expulsion of nuclei (*EX. N.*). Nuclei in this specimen a little larger than usual.

Fig. 20.—Transverse section of posterior pole of the same egg as that in fig. 7, to show germ cell determinant.

Fig. 21.—Posterior pole of blastoderm stage to show germ cells (*G. C.*) and structure of nuclei.

Fig. 22.—Posterior pole of egg just after sinking inwards of germ pocket (*G. C. P.*) and when the nuclei (*X. X.*) form a covering for the pocket.

Fig. 23.—Transverse section of same embryo as that in figs. 24, 25, and Pl. 12, fig. 31, to show germ cells. Such a section as this is through the points *A . . . A* in Pl. , fig. 15.

Fig. 24.—Transverse section of embryo during the formation of gut (*END. N.*) and nervous system (*N. C.*), etc.

Fig. 25.—Section through anterior region near stomodæum.

Fig. 26.—Enlarged view of posterior pole of the egg drawn in fig. 11, to show breaking up germ cell determinant (*P. P.*).

Fig. 27.—Obliquely sagittal section through embryo to show formation of gut (*G. T.*), stomodæum (*STD.*), proctodæum, brain, and nerve chord.

Fig. 28.—Section such as that through points \times γ \times in fig. 27. \times is a cell whose nucleus has temporarily resumed the usual reticulate arrangement. Compare Pl. 12, figs. 40–43.

PLATE 12.

Fig. 29.—Transverse section through brain and thickening (*TH.*) which secretes the horn-like process. Same age as embryo in Pl. 11, figs. 27 and 28.

Fig. 30.—Horizontal section through head region of a young larva to show horn-like processes (*P. R. C.*), mesenteron (*MES.*), and mouth (*M. T. H.*).

Fig. 31.—Transverse section through developing stomodæum. Same embryo as that in Pl. 11, figs. 23, 24, and 25.

Fig. 32.—Cast-out mass of cytoplasm with the extruded nuclei. Has become round, and the nuclei still live (*L. E. N.*).

Fig. 33.—Transverse section of larva near midgut when it begins to take in food (*F.*).

Fig. 34.—Longitudinal section through germ pocket (*G. C. P.*) of same embryo as that in Pl. 11, fig. 27.

Fig. 35.—Part of embryo and the extruded mass (*E. M.*) with some nuclei still living (*L. E. N.*).

Fig. 36.—A germ cell of blastoderm stage containing the faint remains (*G.*) of the germ cell determinant.

Fig. 37.—Transverse section through germ cell pocket (*G. C. P.*) in same embryo as that in Pl. 11, fig. 23.

Fig. 38.—Larva in transverse section after it has begun to swallow yolk (*F.*), and when the body becomes stretched thereby.

Fig. 39.—Transverse section through embryo after the stage drawn in Pl. 11, fig. 24, to show formation of body cavity (*C. A. V.*).

Fig. 40–43.—Stages in the resumption by mesoderm nuclei of the typical reticulate arrangement. Compare fig. 34 at X.

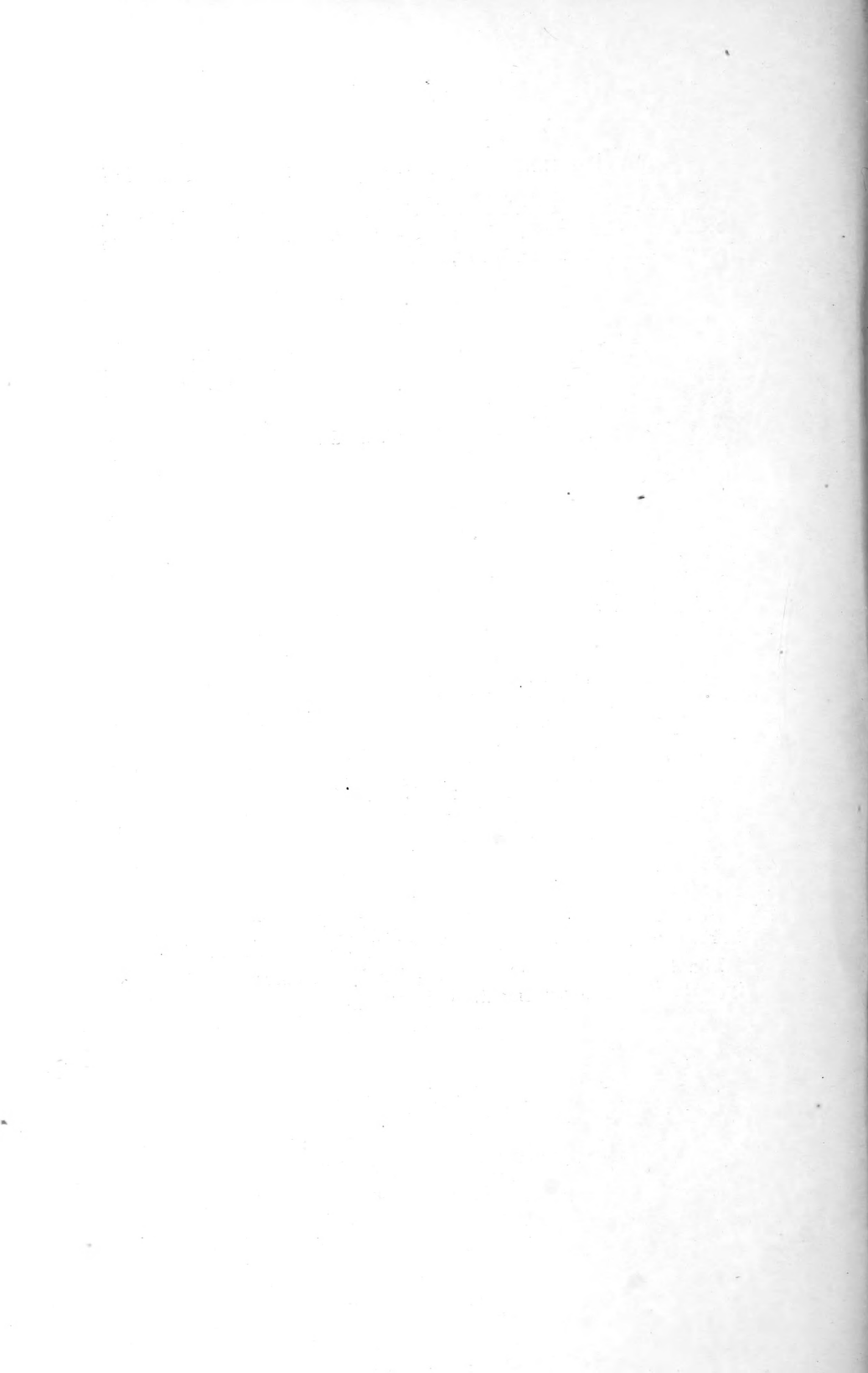

**On the Development of the Cape Cephalodiscus
(*C. gilchristi*, Ridewood).**

By

J. D. F. Gilchrist, M.A., D.Sc., Ph.D.

With Plates 13 and 14.

IN October, 1915, I recorded some observations on living specimens of the Cape Cephalodiscus, its eggs and larvæ (4). I had hoped in the following summer to be able to procure additional specimens, more especially of advanced larvæ, showing the process of metamorphosis. Contrary however, to all expectations, not a single living specimen was procured by the trawlers during the summer months. One colony, very much damaged, and with the zooid cavities filled with sand grains, was found on a sandy bottom, some six or eight miles from the usual habitat of the animal, of value only as indicating that the animal may be carried some distance by currents. The reason for this scarcity probably was, as suggested by the captains of the trawlers, that there had been no heavy seas, and no great "drawback" or strong currents to detach the colonies from the rocky ground which, there is reason to believe, is their natural habitat.

The material, procured during the previous summer, however, has proved on examination sufficient to indicate some new facts regarding the development of the animal, which it may be desirable to put on record, without waiting an indefinite time for the uncertain possibility of procuring and rearing the larvæ to later stages.

This material was preserved in a variety of ways. Subli-

mate, sublimate-acetic, Gilson's fluid, formalin-alcohol, alcohol, Fleming's fluid, and formalin in sea-water were employed. Sublimate preparations seemed to be unfavourably affected, more especially in the yolk-laden parts; osmic acid caused great contraction, though the fixing was good, at least in the larva; the best results were obtained from 10 per cent. formalin in sea-water, provided care was taken to pass the tissue slowly through gradations of absolute alcohol and xylol. The passage from absolute alcohol to xylol was best effected by using half a dozen gradations of these up to pure xylol, though good results were obtained by passing the material from absolute, through to one-third and two-thirds xylol to pure xylol. By the use of this method some very distinct preparations were procured, showing cellular structure, of the early stages within the egg capsule, though, for some reason, the method was not successful in larvæ hatched out from the egg.

The history of the investigation into the development of *Cephalodiscus* need not be here gone into, further than to indicate certain points on which further information is desirable, or which are not beyond dispute. Masterman (1900) observed some segmenting eggs in the material procured by the "Challenger" Expedition. Andersson (1903) noted the planula-like larva for the first time. Harmer (1905) described the eggs, heavily laden with yolk, their holo-blastic and nearly equal segmentation, and suggested that they may give rise to solid embryos, in which the endoderm arises by delamination. He showed that the five body cavities of the adult arise at an early stage in the embryo. Andersson (1907) described his material more fully, and recorded the occurrence of a gastrula-like stage, in which there is a centrally placed mass of yolk with a narrow lumen; he believes that this is the endoderm formed by a process of invagination. He also confirmed the early appearance of the body cavities. Schepotieff (1909), though adding nothing further towards the elucidation of the gastrula stage, confirms the existence of the planula-like larva, and adds a

further stage, which is free-swimming, and in which the five body cavities may be recognised. He regards the central mass of yolk in the embryo and larva as representing an endoderm formed by involution. Braem (1911) draws a comparison between this free-swimming larva and that of certain Polyzoa. Harmer (1915) draws attention to the different disposition of the body cavities, and gives a summary of the points in the development of *Cephalodiscus* on which there appears to be unanimity, drawing attention to the unexplained origin of the gastrula-like stage.

There are, as will be seen from this review, several important gaps in the development of *Cephalodiscus* which have not yet been filled up, and on which further information is very desirable. Thus, nothing is known of what occurs between the first segmentation stages and the gastrula—this alleged gastrula requires further investigation; the exact mode of origin of the body cavities has not been explained; and finally, the metamorphosis of the larva into the adult still remains to be elucidated.

The chief points on which the present work seems to throw further light with regard to these questions are: Segmentation stages leading to the formation of a blastula, which does not become invaginated to form a gastrula, but develops into a solid body, the outer parts of which become differentiated into an ectoderm and endoderm, the main inner yolk mass not representing the endoderm, nor its cavity the archenteron; the origin of the body cavities, the anterior as a part partitioned off from the archenteron, and the posterior as a lumen internal to the developing endoderm.

OVARY AND OVARIAN EGG.

The structure of the ovary of this species has been briefly described by Ridewood (7). It consists of a very narrow oviduct, leading into a mass of developing eggs in which no distinct lumen can be made out. The great majority of the eggs are comparatively small, one or two, at the point furthest

from the oviduct, being greatly developed, and constituting the main part of the whole ovary. Each of these eggs is lodged in a follicle of small cells. Schepotieff (8, p. 81, fig. 63) has described the large ova of certain species as lying between a central epithelial lumen and the wall of the oviduct, where they are surrounded by a relatively large quantity of blood. This has not been observed in the present species, in which the ovum in its follicle is always in close contact with the surrounding ova. The ova appear to arise in the walls of the oviduct.

Two questions have been raised with regard to the ovary—the function of the pigment of the oviduct, and the method of discharge of the very large ova. With regard to the first, there is nothing new to add, except that the pigmented oviduct does not seem to be a luminous organ as has been suggested. None of the living animals examined, with a special view to ascertaining this, showed any trace of luminosity. With regard to the second question, Masterman's suggestion, with which Andersson (2, p. 86) does not agree, that the ova are set free on the death of the animal, seems to have some partial confirmation, from the fact that, in the fresh material, detached ovaries were frequently found. These may, of course, have been forcibly detached in the trawl, but living zooids were also observed in which the ovary, loosely attached to the animal, was seen to be quite exposed, suggesting that the whole ovary, or part of it, may break away from the body, without, however, necessarily involving the death of the animal—a condition which may also, perhaps, have been brought about by pressure in the trawl-net.

Certain histological features of the ovarian egg, which do not seem to have been noted, may be worthy of mention, as they seem to indicate that the subject is worthy of further study. The nucleus (Pl. 13, fig. 1) is a prominent feature of the developing egg. It is of a clear, almost homogeneous appearance, with only indistinct indications of chromatin elements. It has a distinctly demarcated border, which may,

however, assume various irregular shapes, as if it were of an amœboid nature, though there were no prolongations into the surrounding yolk mass. It is never of the elongate or semilunar form figured by Schepotieff for his species. A conspicuous, deeply staining nucleolus is always present, and, in some preparations, was observed to have a series of rounded vacuole-like spots, arranged around its border; in other cases there appeared to be a single large vacuole, seemingly confirming the view that the vacuoles are of a changing nature. That the nucleolus takes a part in the functional activity of the egg at this stage is indicated by these different appearances, and also by the fact that in some cases it was observed drawn out in a tapering manner quite to the periphery of the germinal vesicle, and, in one case, a small detached part of it was observed lying in the germinal vesicle not far from it.

Stages in the formation of the yolk granules are well illustrated. These granules are very numerous, of an oval or rounded shape, with well-defined borders, and stain deeply with eosin. Scattered throughout them appeared a number of minute bodies (Pl. 13, fig. 1, *y. n.*), which readily stained with hæmatoxylin. The transformation of the homogeneous substance of the ovum into yolk granules does not appear to begin in the immediate neighbourhood of the nucleus, as in some other cases, for, in several instances, the nucleus with its nucleolus was observed in a homogeneous matrix in the form of a crescent at the periphery of a large mass of yolk granules. In others, the homogeneous part assumed the form of a portion slightly constricted off from the main mass of the egg. The boundary between the homogeneous and the granular part of the egg in these cases was well defined, and in it occurred a layer of the deeply staining bodies above mentioned, which may be termed yolk nuclei, though a variety of objects seem to be included under this term. So definite was the demarcation that it was at first supposed that there were here two cells, the semilunar homogeneous cell with its nucleus being a nourishing cell, assisting in building up the relatively enormous yolk mass. The fact that

both were enveloped in a common follicle was not sufficient in itself to disprove this, but, as no nucleus could be found in the larger mass, it must be concluded that we are dealing here with one ovum. More advanced ova, completely transformed into yolk granules and yolk nuclei, possessed a large nucleus and nucleolus, located now in the centre.

The origin and nature of the yolk nuclei in general is still an obscure question. It has been suggested that they arise independently in the cytoplasm, that they are derived from the nucleus, and that they are derived from the nucleolus. The evidence in this case seems to be in favour of the last suggestion, in view of the appearances in the nucleolus noted above. The nuclei did not appear to originate from a single large yolk nucleus as is the case in other instances of such structures. The further study of the change in the ovarian egg seems to be worthy of attention.

THE FERTILISED OVUM.

Two or three specimens only of the unsegmented ovum, enclosed in its clear capsule and presumably fertilised, were procured. Such eggs (Pl. 13, fig. 2) were quite spherical, in contrast to later stages. In sections, among the numerous eosin-stained yolk granules, were seen some small bodies, stained, though not conspicuously, with hæmatoxylin, presumably the yolk nuclei.

The eggs of *Cephalodiscus* have been described as oval and of a varying diameter. These are probably late stages of the ovum, in which the embryo is fairly advanced, and the egg proper may not vary much in diameter, though sufficient material at this stage was not available to give any certainty on this point.

Segmentation.

The first division of the ovum, from the beginning of the constriction to the complete separation of the blastomeres, was observed. More examples of this stage were found than

of the undivided egg, but still comparatively few (about ten out of several hundreds examined). This probably indicates that this stage is passed through at a comparatively rapid rate. Segmentation was in all cases total and usually about equal. A typical case is shown in Pl. 13, fig. 3, in which the blastomeres are about equal. Cases of decidedly unequal division, however, occurred as shown in Pl. 13, fig. 4, and in one case the smaller blastomere was $\cdot 21 \times \cdot 16$ mm., the larger $\cdot 29 \times \cdot 37$ mm. A large nucleus with nucleolus was conspicuous in some cases in each segment.

Stages of four blastomeres were about as numerous as those of two. In some the second division was of the typical form, equal and at right angles to the first (Pl. 13, fig. 5). In others there were decided departures from this type. Thus a stage was found (Pl. 13, fig. 6), in which the blastomeres did not lie in one plane, each of them being so placed that it was in contact with the other three, as if a relative change in position had taken place subsequently to the second division, or the division spindles of the second division had been at right angles to each other. A second aberrant type (Pl. 13, fig. 7) was found in two cases, in which two segments were widely separated, the other two being in close contact with each other. Both of these types may be connected with the fact, shown in another case, in which the division in one segment has been more rapid than in the other, resulting in the formation of three blastomeres, one large and two small (Pl. 13, fig. 8).

This segmentation may therefore be unequal, not only in quantity, but in point of time and method of division, probably connected with the great amount of yolk in the egg, a fact which also, as will be seen later, has a striking effect in further development. It apparently indicates a very indeterminate type of segmentation which is seen also in the next stage observed. This consisted of six cells (Pl. 13, fig. 9).

Blastula.

The earliest appearance of the segmentation cavity was at

a stage showing six segments in section (Pl. 13, fig. 10) ; here it was very small, and was occupied by a homogeneous substance stained faintly with hæmatoxylin. A well-marked blastula is soon developed after this stage, for a section showing nine cells has a relatively large blastocœle (Pl. 13, fig. 11). Here the cells at one side appear larger than at the other. Other sections, however, show that the grouping of large cells at one point does not appear to be constant.

In a blastula of fourteen cells in section (Pl. 13, fig. 12) one cell was observed entirely within the hitherto complete circle of cells. It seems from subsequent events that this arises by proliferation of an outer cell rather than by ingrowth of a cell. It marks, as will be seen in later stages, the posterior end of the developing embryo.

The beginning of a further change is seen in a blastula of about twenty-nine cells in section (Pl. 13, fig. 13), in which a more marked polar disposition of parts becomes evident. At one end, which, as subsequent development shows, becomes the anterior end of the animal, the cells are decidedly elongate, while more posteriorly they are still rounded. The nucleus in the elongate cells appears at the distal end, while, in the rounded posterior cells, it appears in the centre.

Formation of the Yolk Column.

The elongate outer cells begin to assume a columnar form, whose main body consists of an elongate mass of yolk cells with a peripherally placed nucleus (Pl. 13, figs. 14 and 15, *ev. y. c.*). This is probably due to their increase in number, and consequent mutual pressure. The elongate character is gradually assumed by the other cells in a more posterior position, and ultimately all the outer cells assume the form of columns with peripheral nuclei. The last of these outer cells to assume the columnar form is a group of rounded cells at the extreme posterior end, from which the internal cells are proliferating. The internal cells are still somewhat rounded, and ultimately completely fill the blastocœle, so as to form a solid mass of cells.

An interesting result of the rapid increase of these yolk columns is that an invagination is formed near the point (Pl. 13, fig. 15, *p. inv.*) where they are attached to the inner mass, apparently due merely to mechanical causes associated with the increase of the outer layer. This gives the appearance of a gastrula-like structure, which, however, can only be fully discussed when the changes in the inner yolk mass are considered.

Origin of Ectoderm.

After the formation of the external yolk columns, their cells divide rapidly, and the demarcation between them, so clearly marked before, disappears. In view of their origin, we must regard each of the yolk columns as representing a single cell, and the breaking down of the cellular structure as due probably to the great abundance of yolk, the cell having lost control of the elongate and attenuated column. What was observed to occur at this stage was that the multiplying nuclei, with a certain amount of protoplasm, became each closely applied to a yolk granule, the two forming an ovoid body, in which the yolk granule, deeply stained with eosin, could be clearly distinguished from the nucleus, which was as distinctly stained with hæmatoxylin. Presumably the yolk granules serve as nourishment for the rapidly multiplying cells, for, ultimately, the yolk granules disappear, first from the peripheral parts, and later from the deeper parts of the ectoderm, till finally only a network of protoplasm, or rather a vacuolated protoplasmic mass, with numerous nuclei embedded in its substance, is left.

Two other points may be noted in connection with the origin of the ectoderm, viz. the formation of a basement membrane and the occurrence of excretory matter. With regard to the first, the outer cells were always distinguishable from the inner, except posteriorly, and an intervening space is seen in preparations of the more advanced stages. This demarcation becomes more distinct by the appearance of a

fine basement membrane at the base of the ectoderm cells, apparently secreted by these cells (Pl. 13, fig. 17, *b. m.*). This basement membrane was not, however, usually so distinct as in the case figured, and it may be formed by the endoderm cells described later.

With reference to the second fact, there are to be seen in the developing ectoderm, after the cellular structure has been lost, a number of small bodies about the size of nuclei, but readily distinguished from them by their black colour. These become larger, and are frequently fused together to form elongate black masses. That they are ultimately passed out to the exterior was evident from some which were observed partly protruding beyond the surface of the developing embryo. This accounts for the presence in the living state of dark particles floating in the space between the embryo and the egg capsule, the rotation of the ciliated embryo causing them to move about rapidly, so that their presence is readily detected. It also accounts for the characteristic pigment spots of the embryo, which sometimes assumed an elongate shape, and formed a ring round the anteriorly situated sense organ.

Certain areas of the ectoderm seem to retain their distinctly cellular structure throughout the changes which take place in the ectoderm. The most prominent of these is the part which appears as a ventral thickening in the embryo (Pl. 13, fig. 18, *v. th.*), and which may, as Harmer suggests, represent the disc-like face of the proboscis. Its early appearance is noteworthy. The sense organ also consists of independent cells, as also the glandular cells of the ectoderm, but these are not seen at this early stage, and their cellular condition may be of much later origin.

Origin of Endoderm.

The origin and mode of formation of the endoderm is, as already indicated, one of the outstanding problems of the development of *Cephalodiscus*.

The cells of the ectoderm before fusion are arranged radially, and are at this stage clearly marked off from the inner cells; a little later they are further marked off from them by the basement membrane. Soon after the fusion of these ectodermal cells a few cells appear below the basement membrane. These are closely applied to yolk granules, and form with them a distinct layer round the anterior end of the yolk mass, but clearly marked off from it (Pl. 13, figs. 17, 18 and 19, *end.*). As the yolk granules in this layer are used up, each of the cells sends out a long protoplasmic process towards the other, so that, ultimately, they form a chain of attenuated cells devoid of yolk granules. These cells appear first at the anterior end and later more posteriorly, so that the chain of cells gradually extends backwards, over the internal yolk mass, as an uninterrupted series, to the posterior end, at the point where the internal cells remain in connection with the ectoderm.

Formation of the Yolk Cavity and Andersson's "Gastrula."

Meanwhile a change has taken place in the inner cells, associated perhaps with the appearance of the endoderm. Unlike the ectodermal cells, they do not assume a columnar form, but remain more or less rounded, each, however, with a nucleus and a distinct cell boundary, and as heavily laden with yolk granules as the ectodermal cells. On the appearance of the endodermal cells their cellular structure can no longer be distinguished. It appears as if the nuclei, with their associated protoplasm, no longer controlled these cells, and had wandered to the periphery, as in the case of the ectodermal cells, leaving a central non-cellular mass of yolk granules.

All the cells of the inner mass do not pass to the periphery, but some find their way to the centre, where they form a small but distinct group, embedded in a substance nearly devoid of yolk granules. A small cavity then appears in

this substance. The cavity as seen in sections is usually rounded or oval in shape, but that it is in reality of an elongate nature is evident from the fact that it can be followed through a series of consecutive sections. It ends abruptly when traced in one direction, but may be followed in the other direction to the periphery of the embryo, where it suddenly ends in a shallow pit in the ectoderm, apparently the involution or invagination of the ectoderm already noted. This was most clearly seen in sections which passed through the axis of this part of the embryo (Pl. 13, fig. 16). The whole assumed the form of a structure, which, without this explanation of its origin, might be taken to be a typical gastrula, in which the central yolk-laden mass represents an endoderm, formed by invagination, and a central cavity, the archenteron; the only suspicious feature being the very narrow lumen and the absence of cellular structure of the endoderm.

Andersson (2, p. 87) was the first to notice and figure this gastrula, and he has apparently no doubt as to how it has arisen. He notes Harmer's suggestion (5, pp. 109, 110) that the gastrula is probably formed by a process of delamination, and considers that for his species at least this is not the case, but that "die Gastrula durch eine typische Invagination sich bildet" (p. 89). He was unfortunately unable, he adds, to carry out any study of the cellular structure, as owing, he believes, to imperfect preservation, the ectoderm and endoderm appeared uniformly filled with yolk granules, which he notes, however, were absent in the immediate vicinity of the central lumen. His figure, however, indicates the existence of the external yolk columns. Schepotieff (8, p. 437) states that he found gastrula stages in *C. indicus*, but was unable to follow out their formation. That, however, he accepts the view that the central yolk mass represents an endoderm formed by invagination, is apparent from his description and figures of larval stages of the species. Harmer also (4, p. 245) accepts the view that the central yolk represents the wall of the archenteron.

It appears from what has been observed that, in this species, the central yolk-laden cells arise solely by unipolar proliferation of cells into the cavity of the blastula, that the cellular structure breaks down, and some of the nuclei, with their associated protoplasm, go to form the endoderm, while others pass towards the centre and become vitellophags. Owing to the activity of these latter the yolk granules become used up, leaving a homogeneous detritus in which a cavity subsequently appears. This cavity extends at first to an ectodermal involution, and it may be that the excretory matter passes out in this way to the exterior, just as the excretory products of the growing ectoderm are given off in another manner already indicated. The subsequent changes in this cavity and its relation to the posterior involution, as well as to the cavity immediately enclosed by the endoderm, will be described in later stages.

Formation of Internal Yolk Columns.

After the inner yolk-laden cells become a homogeneous mass of yolk with scattered cells, and soon after these reduced cells begin to migrate, some towards the periphery, some to the centre, a change takes place in the uniform distribution of the yolk granules, and they assume the form of a number of yolk columns, or rather pyramids, whose apices meet round the central cavity, and whose broader distal extremities are in the proximity of the cells which form the endoderm (Pl. 13, figs. 18 and 19, *i. y. c.*). The result bears some resemblance to what has occurred in the ectoderm, but it has apparently been attained in a different way, for the large yolk-laden cells do not individually become yolk columns; at least there was no appearance of this, and it can hardly be imagined how they could do so, unless perhaps the cells, migrating outwards to form the endoderm, retained for a time some control over their original yolk masses, and similarly the cells migrating inwards draw out their associated yolk into lenticular masses.

The functional significance of the whole process seems very evident. A very little of the yolk is necessarily used up in the formation of the thin endodermal layer, and the main mass is reserved to be transformed by vitellophags into a form which can be absorbed by the archenteron to feed the rapidly developing ectoderm, which has now used up its original supply of yolk.

The inner yolk pyramids persist as such for a considerable time, but later, when their yolk granules have been much reduced, they seem to disappear.

Origin of Body Cavities.

As development proceeds and the anterior part of the endoderm increases in size, a space (the archenteron) appears between it and the central yolk mass (Pl. 13, fig. 19, *-arch.*). Posteriorly the endoderm is still in close contact with the yolk mass, but later a few cells, evidently arising from the yolk mass, as the endodermal cells did, appear below it on the yolk. These increase in numbers and ultimately form a distinct layer, so that the endoderm here seems double. The cavity between these two layers is very evidently the beginning of the first pair of posterior body cavities (Pl. 13, fig. 19, and Pl. 14, fig. 20, *b. c.₂*). The second pair of body cavities is subsequently formed in a similar manner (Pl. 13, fig. 18, and Pl. 14, fig. 20, *b. c.₃*). The body cavities may therefore be regarded as of endodermal origin, which, though not typically enterocœlic, is a modified form of such a method of development. At later stages both pairs of body cavities may be seen with a complete epithelial lining (Pl. 14, fig. 21, *b. c.₂* and *b. c.₃*).

The definite origin of the single anterior body cavity was not observed until later, but it may be mentioned here that it is developed from the anterior part of the archenteron.

THE LARVA.

The structure of the larva soon after hatching is not very different from that of the late embryo, but certain points,

obscured by the compression of the embryo in a small space, become clearer or assume a different aspect in the early larva. Thus the ectoderm, very much folded in the embryo, now expands, and the body cavities can more readily be made out. Certain more definite changes, however, were observed in older larvæ.

The general structure of the larva has already been described by Harmer (5), Andersson (2), and Schepotieff (8). The chief new points to be added are in connection with (1) the fate of the internal yolk mass, (2) the arrangement of the body cavities and the mode of origin of the anterior body cavity, (3) the origin of the anus, (4) the involution of the sense organ and its nervous tissue, and (5) a postero-ventral thickening and involution.

(1) Fate of yolk mass.—Neither Harmer nor Andersson found any trace of cellular structure in the yolk. Schepotieff, however, indicates clearly (8, Pl. 8 fig. 16) that this part is divided up into large columnar cells, which, but for their distinct demarcation and single nuclei, might pass for the internal yolk columns, already described for the species under consideration. His fig. 7 also shows the walls of what he regards as the proboscis-cœlom, ending abruptly at the anterior part of the yolk, instead of passing round it to the posterior extremity, as here described. The cells of this body cavity are obviously very diagrammatically drawn, and it may be that those of the "Urdarm" in fig. 16 are of the same nature, in which case it would not be so difficult to interpret them as internal yolk columns. It is not, however, absolutely necessary to reconcile other accounts of the formation of the endoderm with that given here, as both may be correct; the mode of development, even in closely related forms of animals, having been proved in some cases to be very different.

The further changes observed in the central yolk mass were as follows: The anterior space (archenteron) between the endoderm and the yolk becomes very large, and at the same time the yolk lumen increases in size (Pl. 13, fig. 19, *y. l.*).

This lumen appears somewhat triangular in longitudinal section; in sagittal sections of some advanced embryos it is seen that the part of the yolk forming the upper portion or roof of the central cavity has disappeared, and it is now in connection dorsally with the archenteron. The consumption of these yolk granules in this particular region is apparently associated with the active growth in the tissues immediately adjacent to it. More posteriorly, a part of the roof of the lumen is still present, and a transverse section of this part would show a circular cavity in the yolk. This is very well illustrated in Andersson's figs. 73-78, and in transverse sections of younger larvæ of this species. He still regards this diminishing cavity as the archenteron, and its walls, including the homogeneous substance which is interpreted here as the detritus of yolk granules attacked by vitellophags, as the endoderm formed by invagination. The very large cavity in front of and above the yolk can in this case only be considered, as he does, to represent the cavity of the proboscis. Later embryos, however, show that the roof of the yolk lumen disappears even from the posterior part, just as it did in the anterior, so that no yolk cavity is left at all. This is seen in transverse sections (Pl. 14, figs. 23-30) of an advanced larva the exact age of which cannot be determined; it was found crawling over a cœnœcium and kept alive for about two days afterwards. Here the roof of the yolk lumen has entirely disappeared, though the floor, or ventral part, still persists as a fairly large mass, with the cavity of the archenteron above it. The ventral part of the yolk is probably used up in the next step in the metamorphosis of the larva, as yet unknown, but probably most marked on the postero-ventral aspect of the larva, where this yolk mass lies.

(2) The body cavities of the larva.—The four posterior body cavities can usually be seen distinctly in suitably prepared material, provided there is not too great contraction of the tissues. Their epithelial lining can also be sufficiently distinguished. As they are of importance in the

organisation of *Cephalodiscus*, and as their relative position and extent may have a bearing on the subsequent processes of metamorphosis, some details may be added to what is already known for other species.

Only a limited number of larvæ were available, and several of these were, for various reasons, unsuitable for detailed examination of the cavities, some being too contracted or distorted, others were somewhat broken up, owing to the difficulty of getting whole sections through the yolk mass. One or two series of transverse sections were, however, satisfactory, and showed the body cavities clearly. In one of these, cut into a series of 140 sections, the sixth from the posterior end (Pl. 14, fig. 22) showed that the two posterior body cavities extended backwards beyond the yolk and archenteron. At the 17th section (Pl. 14, fig. 23) the body cavities are very large, extending almost completely round the yolk, but are separated from each other dorsally by a mesentery- and ventrally by the posterior thickening already mentioned. That there is a here a ventral mesentery obscured by the pressure of the yolk is shown in other series, and it is evident in the next or 24th section (Pl. 14, fig. 24). Here the upper wall of the archenteron has become broadly attached to the ectoderm, and the body cavities are beginning to disappear from the dorsal side. A few sections further on, at the 25th, the beginning of the second body cavity appears on the right side at its dorso-lateral corner, and, at the 27th section (Pl. 14, fig. 25), it is of considerable size. At the 29th section (Pl. 14, fig. 26) it has extended to the right side of the archenteron, and in this section the second body cavity of the left side appears at the upper angle formed by the ectoderm and the wall of the archenteron. That the point at which the second body cavities begin on each side is therefore not similar is evident from this, and in other series of sections it also shows a variation, as, for instance, in one in which it begins quite at the lateral wall of the ectoderm. The 36th section (Pl. 14, fig. 27) shows further advance, and, at the 45th (Pl. 14, fig. 29), the third body cavity has disappeared

on the right side. In the 67th section (Pl. 14, fig. 30) both pairs of body cavities have disappeared. At the 95th section (Pl. 14, fig. 31) the yolk mass is much smaller, and the ectoderm has the clear spaces and the elongate cells characteristic of the dorsal and ventral parts of this region of the body respectively.

The formation of the definite body cavity of the proboscis was not seen in these transverse sections, but in some longitudinal sections a division appeared running obliquely across the cavity of the archenteron anteriorly, and cutting off a portion of this cavity, the portion cut off being about one-fourth of the whole archenteron. This division was observed in two longitudinal sections only, and in these the thin wall of the archenteron was incomplete in places (Pl. 14, fig. 37). How this division arose is not quite clear, and the question is perhaps better left open till further confirmation is possible.

(3) Appearance of the anus in the larva.—In a sagittal section (Pl. 14, fig. 38) of a larva the cavity of the archenteron extends to the posterior end, and comes in contact with the ectoderm. At the point of contact there is a slight involution and indication of a pore, though there is no well-marked opening. There seems little reason to doubt that this is the point of origin of the anus. In the section it is situated towards the dorsal aspect of the body. It doubtless, therefore, represents the point at which the yolk mass remains in contact with the ectoderm, but has no connection with what is described later as a postero-ventral thickening and involution of the ectoderm. The section, however, was not entirely convincing, and later stages are desirable to clear up and confirm this point. There is no indication of the anal opening in Pl. 14, fig. 22, a transverse section posterior to yolk and archenteron.

(4) Changes in the sense organ appear in the larva. In the earlier stages it consisted of a group of elongate ciliated cells, at the base of which appeared a small patch of nervous tissue, as described for other species. In the more

advanced larvæ the nervous tissue is seen to extend in a posterior direction under the general tissue of the ectoderm (Pl. 14, fig. 32), and the cells of the sense organ now assume the same character as this nervous tissue. They lose their cilia, and become sunk in an ectodermal pit (Pl. 14, fig. 33), which may be drawn out posteriorly into a tubular structure (Pl. 14, fig. 35, *inv. s. o.*).

(5) A postero-ventral thickening and involution of the ectoderm was observed in some sections under the hinder end of the yolk mass. This thickening is seen in Pl. 14, fig. 23, and, a few sections posterior to it, it is seen to lead to an involution. This involution is, however, more clearly seen in another series (Pl. 14, fig. 36). It may not prove to be of any particular significance, but may be noted, as it is in this region that the greatest change will probably take place in the metamorphosis of the larva.

SUMMARY OF RESULTS.

(1) Certain facts are noted with regard to the formation of yolk granules, presence of yolk nuclei, character of nucleus and nucleolus.

(2) The segmentation is holoblastic, equal, or markedly unequal, and apparently indeterminate.

(3) A blastula stage occurs.

(4) The blastula becomes solid by proliferation of cells at one end; there is no invagination at this stage.

(5) The point of proliferation marks the posterior end, and the anterior end is distinguished by the elongation of its cells.

(6) All the outer cells become elongate, and assume the character of columnar cells full of yolk. As these increase in number a small posterior invagination appears.

(7) The cellular character of the yolk columns disappears; the yolk granules are used up, and an ectoderm consisting of many nuclei in a protoplasmic network, with a basement membrane, is formed.

(8) Excretory matter in the form of dark specks and elongate rods is formed during this process and constitutes the characteristic pigment of the late embryos and larvæ.

(9) The ventral thickening of the ectoderm is found at an early stage.

(10) The endoderm appears under the ectoderm, first as a number of cells at the anterior end, and ultimately as a complete chain of cells extending over the inner yolk, except at the point of proliferation at the posterior end.

(11) The cells occupying the blastocœle break down like the outer cells, and become a mass of yolk granules, in which are scattered a number of nuclei with associated protoplasm.

(12) Some of these pass outward to form the endoderm, others pass inwards to form vitellophags.

(13) A lumen is formed in the yolk mass and it becomes connected to the posterior involution, giving rise to a gastrula-like structure.

(14) The internal mass of yolk assumes the form of a number of yolk columns or pyramids.

(15) The posterior body cavities arise by a number of cells from the yolk mass forming a second layer under the endodermal layer.

(16) The yolk lumen increases in size, the yolk granules becoming converted into a homogeneous substance. This takes place chiefly on the dorsal side, where the yolk lumen becomes connected with the archenteron.

(17) The position and extent of the five body cavities in the larva are shown.

(18) The yolk in the larva is in the form of an elongate mass of granules and homogeneous matter, lying on the floor of the archenteron.

(19) Changes are described in the larval nervous system, and the appearance of a posterior thickening and involution of the ectoderm below the yolk mass is noted.

REFERENCES.

1. Andersson, K. A.—“Eine Wiederentdeckung von *Cephalodiscus*,” ‘Zool. Anz.,’ xxvi, 1903, p. 368.
2. ——— “Die Pterobranchier der schwedischen Südpolar-expedition, 1901–1903.” ‘Wiss. Ergebn. schwed. Südpolar-Exped.’ v, 1907.
3. Braem, F.—“Pterobranchier und Bryozoen,” ‘Zool. Anz.’ xxxviii, 1911, p. 546.
4. Gilchrist, J. D. F.—“Observations on the Cape *Cephalodiscus* and some of its Early Stages,” with an Appendix by Sidney F. Harmer, ‘Ann. Mag. Nat. Hist.,’ ser. 8, vol. xvi, 1915, p. 233.
5. Harmer, S. F.—“The Pterobranchia of the ‘Siboga’ Expedition, with an Account of other Species,” ‘Résultats des Explorations à bord du “Siboga,” Monogr.’ xxvi bis, 1905.
6. Masterman, A. T.—“On the further Anatomy and the Budding Processes of *Cephalodiscus dodecalophus*,” ‘Trans. Roy. Soc. Edinb.,’ xxxiv, 1900, p. 507.
7. Ridewood, W. G.—“A new species of *Cephalodiscus* (*C. gilchristi*) from the Cape Seas,” ‘Mar. Inv. S. Africa.’ vol. iv, 1908.
8. Schepotieff, A.—“Die Pterobranchier des Indischen Ozeans,” ‘Zool. Jahrb. Abt. Syst.,’ xxviii, 1909, p. 429.

EXPLANATION OF PLATES 13 AND 14,

Illustrating Dr. J. D. F. Gilchrist’s paper “On the Development of the Cape *Cephalodiscus* (*C. gilchristi*, Ridewood).”

EXPLANATION OF FIGURES.

The following reference letters are used in the figures: *an.* Anus. *arch.* Archenteron. *b.m.* Basement membrane. *d.* Yolk detritus. *end.* Endoderm. *ex.y.c.* External yolk columns. *i.y.c.* Internal yolk columns. *inv.s.o.* Involution in nervous tissue of sense organ. *N.* Nucleus. *n.* Nucleolus. *p.inv.* Posterior invagination. *p.v.inv.* Postero-ventral involution. *p.v.th.* Postero-ventral thickening. *s.o.* Sense organ. *vit.* Vitellophag. *v.th.* Ventral thickening. *y.* Yolk. *y.gr.* Yolk granules. *y.l.* Yolk lumen. *y.n.* Yolk nucleus.

[All the figures have been drawn by camera lucida except figs. 5.

and 8; figs. 1, 17, and 20 with a Zeiss F objective; figs. 2-13 with a Zeiss A, and the remainder with a Zeiss C. The ectoderm is represented diagrammatically by a light shading, the yolk granules by a stippled shading, where details are unnecessary. The scale of magnification is shown by a line representing 50 μ .]

PLATE 13.

Fig. 1.—Section of ovarian egg. *N.* Nucleus. *n.* Nucleolus. *y. gr* Yolk granules. *y. n.* Yolk nucleus.

Fig. 2.—Fertilised ovum.

Fig. 3.—Two-celled stage with nearly equal division.

Fig. 4.—Two-celled stage with unequal division.

Figs. 5-7.—Four-celled stage showing various methods of division.

Fig. 8.—Three-celled stage.

Fig. 9.—Six-celled stage.

Fig. 10.—Section of egg showing 6 blastomeres and segmentation cavity.

Fig. 11.—Section of blastula showing blastocœle and contents.

Fig. 12.—Section of blastula showing beginning of internal proliferation at posterior end.

Fig. 13.—Section of blastula showing elongation of cells at anterior end of embryo.

Fig. 14.—Section showing a solid embryo, the blastocœle being filled with cells from the posterior proliferation. The external cells assume the form of external yolk columns (*ex. y. c.*).

Fig. 15.—Longitudinal section of an embryo showing the external yolk columns in increased numbers, and an invagination at the posterior end.

Fig. 16.—Section of gastrula-like structure showing vitellophags (*vit.*), homogeneous detritus (*d.*), yolk lumen (*y. l.*), posterior invagination (*p. inv.*), and traces of external yolk columns (*ex. y. c.*), now disappearing at the anterior end.

Fig. 17.—Section of part of anterior end of embryo showing the formation of the endoderm (*end.*), and the appearance of a basement membrane (*b. m.*).

Fig. 18.—Longitudinal section of an embryo showing the formation of inner yolk columns (*i. y. c.*), the further development of the endoderm (*end.*), and the early appearance of the ventral thickening (*v. th.*).

Fig. 19.—Longitudinal section showing further development of endoderm, and formation of posterior body cavities (*b. c.₂* and *b. c.₃*),

increase in yolk lumen (*y. l.*), and disappearance of inner yolk columns from dorsal region of yolk lumen.

PLATE 14.

Fig. 20.—Longitudinal section showing details of formation of posterior body cavities, a second layer of cells forming the inner wall of *b. c.*₂ but not yet in *b. c.*₃.

Fig. 21.—Horizontal section showing the completed epithelial lining of *b. c.*₂ and *b. c.*₃.

Figs. 22-34.—Transverse sections selected from a series of 140 of a larva to show the positions and relations of the posterior body cavities (*b. c.*₂ and *b. c.*₃), the archenteron (*arch.*), the yolk (*y.*), and the sense organ (*s. o.*).

Fig. 22 is the 6th from the posterior end.

.. 23	..	17th
.. 24	..	24th
.. 25	..	27th
.. 26	..	29th	..	∴
.. 27	..	36th	..	,
.. 28	..	40th
.. 29	..	45th
.. 30	..	67th
.. 31	..	95th
.. 32	..	123rd
.. 33	..	132nd
.. 34	..	138th

Fig. 35.—Transverse section from another series showing involution (*inv. s. o.*) in nervous tissue of sense organ below ectoderm.

Fig. 36.—Transverse section showing postero-ventral thickening (*p. v. th.*), and involution (*p. v. inv.*).

Fig. 37.—Longitudinal vertical section of larva showing the anterior body cavity (*b. c.*₁).

Fig. 38.—Longitudinal vertical section of posterior end of larva showing origin of anus (*an.*).

11. 1. 1918. 11. 1. 1918. 11. 1. 1918.

11. 1. 1918. 11. 1. 1918. 11. 1. 1918.

11. 1. 1918. 11. 1. 1918. 11. 1. 1918.

11. 1. 1918. 11. 1. 1918. 11. 1. 1918.

11. 1. 1918. 11. 1. 1918. 11. 1. 1918.

**Note on the Sex of a Tadpole raised by
Artificial Parthenogenesis.**

By

J. Bronté Gatenby, B.A.,
Exhibitioner of Jesus College, Oxford.

With 5 Text-figures.

WITH the object of ascertaining what is the sex of tadpoles of *R. temporaria* raised by artificial parthenogenesis I undertook some experiments last April. As my intention was to procure as many tadpoles as possible, I adhered to the method of smearing the eggs with a mixture of blood and lymph and then pricking each one with a very fine glass needle. The usual precautions were taken in this work, even the water in which the eggs were raised being drawn from a tank where it had remained for several days; the frogs were carefully washed in alcohol before opening, and the eggs were not allowed to touch the skin while being withdrawn from the swollen uterus.

Two sorts of glass needles were used; one was drawn from glass tubing and the other from solid glass rod; the former gave a higher percentage of burst and spoilt eggs, but while the latter sort of needle gave fewer irretrievably ruptured eggs, the percentage of successful segmentations was lower. There is little doubt that the minute lumen left in the glass-tube needle served to introduce more of the blood and lymph into the egg, and hence to promote segmentation. In some experiments carried out by the late Dr. Jenkinson different

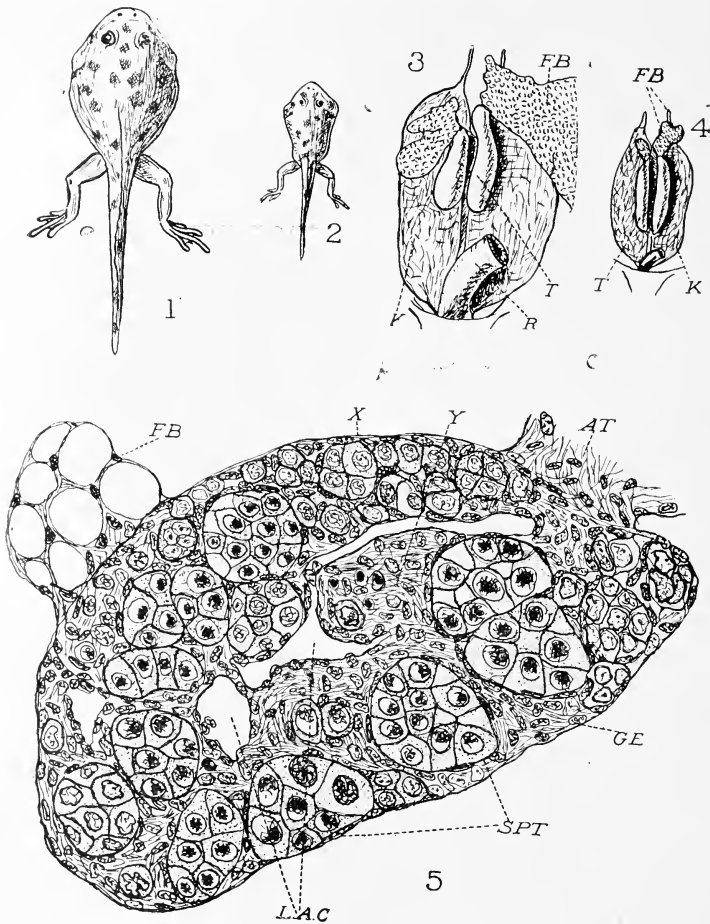

TEXT-FIG. 1.—Parthenogenetic tadpole three months old. $\times 1$.

TEXT-FIG. 2.—Control fertilized tadpole at same age raised under same conditions. $\times 1$.

TEXT-FIG. 3.—Gonad and surrounding organs of the parthenogenetic tadpole. *F. B.* Fat body. *K.* Kidney. *R.* Rectum. *T.* Testis. $\times 10$.

TEXT-FIG. 4.—Gonad and surrounding organs of control male. $\times 10$.

TEXT-FIG. 5.—Obliquely longitudinal section of part of the gonad and fat body (*F. B.*) of the parthenogenetic tadpole. *A. T.* Attachment of gonad to roof of peritoneal cavity. *G. E.* Germinal epithelium. *L. A. C.* Lacunæ in gonad. *S. P. T.* Spermatid tubules. $\times 270$.

fluids were injected into the egg, but though very large numbers were treated, only one abnormal tadpole was procured. The data got from these experiments and from those since carried out by myself seem to show that there are almost certainly other factors in the problem, as, for instance, in one batch of eggs pierced by a solid needle a very good percentage of tadpoles was got, while in another lot pierced by a hollow needle, not one even segmented. Nevertheless the whole series of experiments clearly showed in my case that the hollow needle was the better. Individual frogs differed markedly in the number of tadpoles raised from their eggs.

I pricked five thousand eggs of *R. temporaria* and raised about fifty tadpoles to the closure of the neural folds. There were, as is usual, many abnormal specimens, and the death-rate of those which hatched was high. Without going into details, it may be mentioned that fifteen tadpoles were raised to a stage when the external gills become covered by the epidermal overgrowth. Two of these were scarcely able to swim, and they soon died. Of the remainder all died except two, just before their hind limbs broke through. Those which died at this time did so, I believe, because the weather was most inclement, for the tadpoles born under natural conditions in the ponds were extremely backward for the season of the year. One of the survivors died at the critical period when the germ cells were beginning to become grouped in the manner which shows their sex. I believe this one would have been a male, but there was still undifferentiated material in the gonad. The sole survivor grew at a great pace and quickly outstripped the controls, so that it was nearly two and a half times normal size. In Text-fig. 1 and 2 are natural size drawings of this tadpole and a normal control raised in the same way; the parthenogenetic tadpole is normally proportioned, its hind limbs, tail, fæces, and its general outward morphology being proportionately large. The rectum, as was shown by the size of its fæces, and as subsequent dissection showed, was also very large.

At the age of three months the tadpole was placed in an

aquarium from which it was known normal tadpoles could not escape. To my regret I found that just as the front limbs had broken through, the tadpole jumped out on to the floor, where it died before I discovered its plight. In figs. 3 and 4 are drawn the gonads (*T*), kidneys (*K*), and rectum (*R*) of the parthenogenetic and normal tadpole respectively. When I sectioned the gonads of the former, I found that it was a well developed male, as the external appearance seemed to show, for the gonads were distinctly testiculiform.

In section the germ cells are clearly marked into numerous incipient spermatid tubules; though the section drawn in fig. 5 was across the least well-differentiated region, the spermatogonial nests are well marked. Undoubtedly the gonad had passed beyond the indifferent stage during which it is impossible to speak with certainty as to the sex. The part marked *X* in fig. 5 contains germ cells which have just begun to form spermatogonial groups, while that marked *Y* is apparently nothing more than a non-germinal core, the cells and their nuclei staining like the tissue forming the mesorchium (*A. T.*).

I feel quite sure that this tadpole was a male. Mr. Goodrich, whom I have to thank for his usual kind interest and suggestions, lately drew my attention to an abridged account of a paper by J. Loeb read before an American philosophical society on the same question as that dealt with in this note. Loeb found that the sex of an American species of parthenogenetic frog a year old was male. I have not yet seen Loeb's paper, but his results agree with mine as to the sex.

An Easy Way of Demonstrating the Nuclei of Nerve Fibres.

By

Henry E. Reburn,

Student of Medicine. (From the Physiological Laboratory, King's College, London.)

WHILE attending the histology class this summer, I, in common with my neighbours, found great difficulty in rendering visible the nuclei of teased, fresh nerve fibres. Using gentian violet as recommended in Sir Edward Schäfer's 'Essentials of Histology,' the nerve fibres were almost uniformly stained, and the nuclei did not stand out convincingly. I tried other stains with equally disappointing results, and at last, in desperation, I used a mixture of nearly all the stains on the table (Ehrlich's hæmatoxylin, methylene blue, and alcoholic solution of eosin) and thus obtained a preparation in which blue nuclei stood out prominently on a reddish background. The preparation was shown to Dr. de Souza and Prof. Halliburton, who suggested to me that I should proceed to investigate the matter and ascertain what was the cause of success in this "blunderbuss" experiment.

Without going into all the details of the numerous preparations I made subsequently, I may state at the outset that the principal factor is the alcohol, in which, in my first successful experiment, the eosin had been dissolved. Aqueous solutions of eosin are quite as ineffective as the other stains. Fresh nerve fibres (and especially their nuclei), teased on the slide in the usual way, stain with great difficulty. But the nuclei stain readily with practically any dye (methylene blue, hæma-

toxylin, picro-carmin, gentian violet) after preliminary treatment with alcohol. Or if the dye is added first and the nuclei remain unstained, the stain in the nuclei becomes evident on subsequent addition of alcohol to the preparation.

The difficulty of staining these nuclei in fresh preparations appears to have been noticed by others. Thus in Foster and Langley's 'Practical Physiology and Histology' (7th edition, p. 125) I find this statement: "The nuclei of the sheath may be stained by placing a piece of nerve after brief treatment with osmic acid in picro-carmin or hæmatoxylin for an hour." In Stirling's 'Practical Histology' (2nd edition, p. 206) the directions for staining the nuclei include the statement that after osmic acid picro-carmin may be used, but it is best to leave them for several days in the stain.

In consequence of these statements I made numerous preparations in order to see whether preliminary treatment with osmic acid will take the place of the alcohol, but with very indifferent results. Hæmatoxylin after osmic acid gave a brownish appearance to the whole nerve fibre, but the nuclei did not stand out; and in the case of gentian violet after osmic acid the nuclei were apparent because they were stained less darkly than the rest of the fibre. Picro-carmin after osmic acid did stain the nuclei red, but this took a considerable time, and the preparations were not nearly so good as after treatment with alcohol. In A. B. Lee's 'Microtomists' Vade-mecum' (7th edition, p. 136) I find the following, which seems germane to the present question: "Living tissue elements in general do not stain at all, but resist the action of colouring reagents till they are killed by them. . . . Objects which have been passed through alcohol generally stain better than those which have only been in watery fluids. But long preservation of tissues in alcohol is generally unfavourable to staining."

It is well known that the nuclei of nerve fibres are usually quite well stained in sections, and in this case alcohol is usually employed in the stages of preservation or embedding.

I can, however, confirm Lee's statement that long preservation in alcohol is not beneficial to the staining of nerve nuclei; after a nerve has been kept for some days in alcohol it is almost as difficult to stain its nuclei as when it is in the fresh condition.

The following is the method I would recommend for general routine work when a rapid result is wanted. The fresh nerve is teased on a dry slide in the usual way, the preparation being kept moist with the breath. A drop of absolute alcohol is added and then a drop of Ehrlich's hæmatoxylin, followed by a drop of methylene blue. Either dye may be used alone, but the nuclei are most deeply stained when both are employed. An alcoholic solution of eosin may be substituted for the absolute alcohol; the alcohol here is the essential reagent, but the eosin provides a red counter-stain. The preparation is then washed, cleared, and mounted in the usual way, and the whole operation is completed within a few minutes.



On a Larval Actinian Parasitic in a Rhizostome.

By

C. Badham, B.Sc.,

Demonstrator in Zoology, University of Sydney.

With 3 Text-figures.

OUR knowledge of the medusophilous larval Actinians has been summarised by Haddon (1) and by McMurrich (2). The last-named author says: "The available evidence seems accordingly to point strongly in favour of the various medusophilous forms being the young stages in the development of *Peachia* rather than *Halcampa*; but a direct linking-up of the immature examples of *Bicidium*¹ with their respective adults is necessary to settle the question."

In this paper I will show that I have found the larvæ of *Peachia hilli* parasitic in a Rhizostome up to the stage in which they have been found free-living—thus linking up this medusophilous form with the adult. There is described, for the first time, the function of certain structures (the conchula and pores of the physa) found in *Peachia* larvæ, and their importance in connection with the parasitism of the widespread genus *Peachia* is emphasised. So far as I am aware, this is the first time that a larval Actinian has been described as parasitic in a Rhizostome. The parasitic larvæ hitherto described differ from the larvæ of *P. hilli* in this

¹ A genus in which he places these medusophilous forms.

respect—that they live either on the exterior of their host, or in the gut which opens freely by a mouth. The larvæ of *P. hilli*, however, live for a considerable period in the radial canals of a Rhizostome, from which they can only escape by perforating the body-wall of their host. This host is a large form, *Crambessa mosaica*, which is found in the land-locked harbours along the coast of New South Wales. This medusa is frequently found in large numbers, possibly brought together by currents and tidal action. At other times it is widely scattered. At all times it forms a very characteristic faunal element of the various inlets. So far as I can ascertain, it passes through its life-history in these waters.

Peachia hilli, the adult form of these larvæ, is found in Broken Bay, and was described by Miss Wilsmore (3) in 1911. She also described a free-living larval form, the internal anatomy of which showed that it was the larva of *P. hilli*.

The larvæ which are found parasitic correspond in their older stages with the larva found free-living, and so link up the medusophilous forms with the adult.

Character and Occurrence of Larvæ.

The larvæ are found in various parts of the large radial canals adhering to the ex-umbrella wall of the gut, excepting when they are making their way out of their host. I found them at various stages of development from 5 mm. to 40 mm. long. They occur in about every tenth medusa examined during the months of September and October, but by January it is rare to find them.

In October they were noticed in the act of escaping from their host, going through a hole, regular in outline, made in the sub-umbrella wall of the gut, near its periphery. I have found larvæ lying free in the gut, but near a hole, others actually filling up such a hole, with their œsophageal end protruding, and yet others, having effected their escape, adhering to the tentacles of their host. This latter condition

recalls the discovery in a similar situation of another and possibly closely related Actinian found by the Astrolabe Expedition (4) off the east coast of Australia in 1833, and recently investigated by Pax (5). The escaping larvæ varied in length from 20 mm. to 40 mm.

Description of Larvæ.

Both the adult and the larval form of *P. hilli* found free-living have been described by Miss L. J. Wilsmore from specimens obtained from Broken Bay by Prof. J. P. Hill.

In regard to the colour of the larva, the body is light amber, the œsophageal folds somewhat flesh-coloured or tawny, and the twelve tentacles have purplish-brown markings. There is a spot at the apex of each tentacle, and next to this is a line encircling the tentacle. The five markings which follow are V-shaped, and are on the œsophageal surface of the tentacle only. The colour of the apex of the V is weak or absent. There are no processes on the body resembling the suckers described by Haddon and Dixon (6) in the adult *P. hastata*; and neither while the larva is in its host nor "in vitro," have I seen any attempt on the part of the larva to attach itself except by its œsophageal folds.

There are two points which call for a further description, and which are, moreover, of considerable interest in connection with the parasitic life of the larva: I refer to the conchula and the pores present in the physa. Both of these structures are best studied in the living animal.

The Conchula and Pores of the Physa.

In the genus *Peachia* there is a single deep siphonoglyph. When the lips of the siphonoglyph come together, there is formed a tube which runs from the enteron to the exterior. In some species the external opening is surrounded by a complicated series of lobes, forming a conchula. In others the conchula is of a simpler nature.

McMurrich (2) gives a useful account of the conchula in the various species of *Peachia*. In the larva of *P. hilli* the peripheral ends of the lips of the siphonoglyph project as a pair of small processes (Text-fig. 2, *S.l.*), while from the base of the external opening there projects a median lobe. In this manner the conchula presents a simple three-lobed

TEXT-FIG 1.



Drawing of a fully-extended, living larval specimen of *Peachia hilli* ($\times 1\frac{1}{2}$). The subject has been kept detached from its host for a few days and the conchula (C.) is somewhat contracted. The œsophageal folds and the character of the tentacles are seen. The grooves on the surface of the body are clearly shown and some of the pores of the physa. The trilobed character of the conchula is evident.

structure, such as appears to be the basis of the conchula of all species of the genus *Peachia*. Haddon (6), writing of *P. hastata*, says that the conchula varies greatly in complexity, but that "one basal, and two lateral lobes may

always be detected, which are larger and carry more secondary lobes than the remainder. The basal lobe forms a kind of lid or operculum to the siphonoglyph." An original observation which I have made is that, when the larva is attached by the œsophageal folds, it is through the conchula that a constant stream of fluid bearing food particles goes to the enteron. This fact I have made out by studying living larvæ which were still attached to the gut-wall of a Rhizostome. Correlated with the function of the conchula is the

TEXT-FIG. 2.

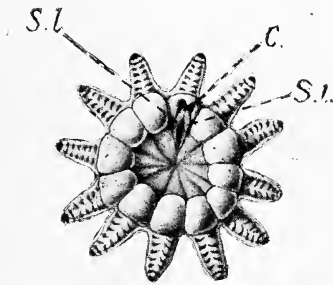

Drawing of the œsophageal surface of a living larval form of *Peachia hilli* ($\times 2$). The nature and markings of the tentacles are shown and the character of the œsophageal lobes. The conchula (C.) is seen to consist of a basal and two lateral lobes, the latter being borne by the lips of the siphonoglyph (S.L.), which are in contact near the periphery but slightly separated near the centre.

presence of a large number of pores in the physa. These pores were mentioned by Haddon (6) as occurring in *P. hastata* and included in his definition of the genus *Peachia* (7). They were noted by Miss Wilsmore (3) in sections and described by her so far as her material permitted. They are placed in the twelve external grooves of the physa, which, however, is not marked off from the scapus except in extreme contraction. There are generally twenty pores in each row arranged somewhat irregularly (Text-fig. 3). There is no central pore.

These pores are a conspicuous feature when the anemone is extended. The intake of fluid by the conchula is continuous, and as these pores, which lead from the interior of the animal, are widely opened at such times, I consider that they serve to carry away the fluid taken in by the conchula. So that, in the attached larva, there is a constant stream of water, bearing food particles, going into the interior of the anemone through the conchula, and a stream of water passing out through the pores of the physa. It would appear as if the conchula has been developed as a larval organ, correlated with

TEXT-FIG. 3.

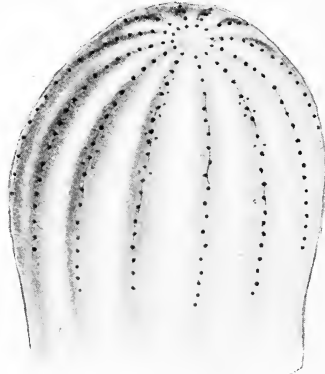

Drawing of the physa of a living larval *Peachia hilli*, showing the character and arrangement of the pores as seen when the anemone is extended and the pores open.

the parasitic existence of the larval forms of the genus *Peachia*; and, associated with it, is the development of the pores of the physa.

The manner in which the medusophilous larvæ of Actinians take in their food has not been elsewhere described. Haddon (1), however, suggests that the form he described as the larvæ of *Halcampella chrysanthellum* detaches itself and floats in the water. Other authors assign this form to the genus *Peachia*. The deep siphonoglyph present has an external

opening (Haddon (8)), and when the anemone is attached, would, I take it, function as does the conchula of *P. hilli*.

McIntosh (9), writing of the parasitic larva of *P. hastata*, says:

“They appear to adhere to the medusa by the sucker-like action of the mouth, which is widely open, though the tentacles are closely applied to the surface. The free-swimming larval forms are thus, at a subsequent stage, carried about, without effort, by the medusæ, and as there is abundance of nourishment of a suitable kind around, it is not necessary to limit the view only to the possibility of their feeding on *Thaumantias*, for by the use of their tentacles as organs of attachment the mouth may, at any time, bes et free.”

My observations show that the larva of *P. hilli* adheres by the sucker-like action of the closely-applied œsophageal folds—the closed lips of the siphonoglyph completing the sucker—and that the tentacles are not brought into use. The larva is always found adhering in this way, save when escaping from its host, and it is through the conchula that the food is taken in.

I am tempted to put forward the hypothesis that the larvæ of the widespread genus *Peachia* are all medusophilous, and that the single deep siphonoglyph, possessing as it does an opening below the œsophageal folds, is a larval organ, correlated with such parasitism. The development of a conchula, as a series of processes round the external opening, is seen in the older larvæ.

In support of this hypothesis I would draw attention to the distribution of the larval forms—of *Peachia hilli* parasitic in *Crambessa mosaica* on the EAST COAST OF AUSTRALIA; of *Peachia parasitica* on *Cyanea arctica* in the NORTH ATLANTIC; of *Peachia hastata* on various medusæ in the NORTH SEA; and of *Bicidium aequoreae*, the probable larval form of *P. quinquecapitata*, off the coast of BRITISH COLUMBIA.

In regard to the second and third forms, McMurrich (2)

prefers to place these larvæ in the genus *Bicidium*, until they are proved to develop into the adult *Peachia*. He regards the occurrence of *P. quinquecapitata* in the same locality as *Bicidium aequoreae* as suggestive, and considers it not improbable that their differences are due to age.

It is to be noted that there are so far described, according to McMurrich (2), seven species of *Peachia*, and these, together with an eighth species described by Miss Wilsmore (3), are as widely distributed as the medusophilous Actinian larvæ.

In conclusion, it would seem that the parasitism of these larvæ is only compatible with the presence of a deep siphonoglyph having an external opening or conchula, and such a structure is possessed only by the genus *Peachia*, if we except the little-known genus *Actinopsis*, which is said to possess a double conchula.

I wish to thank Prof. Haswell, in whose laboratory this work was done, for his kind help and advice.

The figures were re-drawn by Mr. F. W. Atkins, of the Sydney Technical High School.

LITERATURE.

1. Haddon, A. C.—“Note on the Arrangement of the Mesenteries in the Parasitic Larva of *Halcampa chrysanthellum* (Peach).” ‘Proc. Roy. Dublin Soc.’ vol. v, 1886-7.
2. McMurrich, J. Playfair.—“On Two New Actinians from the Coast of British Columbia.” ‘Proc. Zool. Soc. London,’ 1913, p. 963.
3. Wilsmore, Leonora J.—“On some Hexactiniae from New South Wales.” ‘Journ. Linnean Soc., Zoology,’ vol. xxxii, 1911.
4. Quoy et Gaimard.—“Zoologie du Voyage de la corvette ‘Astrolabe.’” Paris, 1833.
5. Pax, F.—“Revision des types des Actinies décrites par Quoy et Gaimard.” ‘Ann. Sci. Nat.’ sér. 9, xvi, 1912.
6. Haddon, A. C. and Dixon, G. Y.—“The Structure and Habits of *Peachia hastata* (Gosse).” ‘Sci. Proc. Roy. Dublin Soc.’ new series, vol. iv, 1885.

7. Haddon, A. C.—“Revision of the British Actiniæ.” ‘Trans. Roy. Dublin Soc.,’ vol. iv, ser. 2, 1888–92.
8. ——— “Researches at St. Andrew’s Marine Laboratory, on Larval Actiniæ parasitic on Hydromedusæ at St. Andrew’s,” ‘Ann. Mag. Nat. History,’ vol. ii, ser. 6, p. 256.
9. McIntosh, W. C.—“On the Commensalistic Habits of Larval Forms of Peachia.” ‘Ann. Mag. Nat. History, ser. 5, vol. xx.

The Early Development of the Spleen of Lepidosiren and Protopterus.

By

G. L. Purser, B.A.,

(Sometime Coutts-Trotter Student, Trinity College, Cambridge.)

With Plates 15, 16, and 17.

My first words must be those of thanks to Professor Graham Kerr for providing me with every facility for carrying out the research, the results of which are embodied in this short paper. He invited me to work in his laboratory, provided me with material already stained and mounted, and was especially helpful in suggestion and criticism.

Owing to the uncertainty as to the time available for this work, I have done no fresh section-cutting, nor have I retained any of the sections already made. This being so, I found that the earlier stages of Protopterus were more suitable for the present investigation than those of Lepidosiren, and so I will first describe its development in detail, and then contrast and compare that of Lepidosiren, adding further details where I can.

THE SPLEEN OF PROTOPTERUS.

In the earlier stages than N.T.XXXII.¹ the foregut is short, thick, and solid, its enveloping mesoderm being yolky, and with difficulty distinguishable from the subjacent endoderm.

¹ The stages are designated by the numbers used in Keibel's *Normentafeln*.

Just about this stage, however, the foregut elongates and narrows, and the mesoderm loses its granules, but remains fairly compact.

On the right-hand side of the foregut, where it overlies the intestine, there is a distinct thickening of its layer of mesoderm, which is particularly vascular. This is where the spleen will arise (fig. 1 and 1a). It is in front of the dorsal rudiment of the pancreas, the only one which has developed at all at this stage, and, except for the posterior lobe of the liver, is entirely posterior to that organ. This posterior lobe is ventro-lateral on the right side of the position of the spleen, but more or less in the mesial plane of the embryo itself, the foregut being to the left of the middle line.

The vascularisation is entirely venous, being part of the gut circulation.

There is nothing to suggest that the endoderm has anything to do with the formation of this thickening, but it is impossible to be dogmatic on the point, because at stages just prior to the one under discussion the two layers seem completely fused, and it is impossible to decide in many instances whether a nucleus belongs to a cell of the endoderm or of the mesoderm. Since, however, all the organs known certainly to be of endodermal origin, e.g. liver, pancreas, or thyroid, arise as heavily-yolked rudiments, therefore the development of the spleen from tissue entirely free from yolk granules and in all other respects resembling the mesenchyme of other parts of the embryo seem to lend support to the view upheld by Laguesse against that by Maurer and Kupffer.

At Stage XXXIII (fig. 2 and 2a), the spleen rudiment is distinctly visible as a flat structure on the right side of the foregut extending as far forward as the point where the latter begins to bend to the mesial plane of the embryo over the lung outgrowth. The anterior ventral portion of the intestine extends for a considerable distance in front of the developing pyloric valve, and so the spleen rudiment is entirely dorsal to it. With regard to the glands of the alimentary canal, it lies behind the origin of the liver and the ventral pancreatic

buds but anterior to the dorsal bud, a position it keeps throughout life.

As yet the cells of the organ are quite undifferentiated from those of the rest of the mesenchyme, but the rudiment is apparent owing to its vascularisation. The vein from the intestine here breaks up into a number of branches which run into the rudiment in a more or less forward and dorsal direction. This is the afferent system. The efferent is formed by a number of small tributaries which unite and enter the liver as the Hepatic Portal Vein. The organ itself contains large sinuses, chiefly peripheral, with which these two systems communicate. They have no visible endothelial lining.

About this time in the development of the embryo the foregut greatly increases in length, and since the spleen lies embedded in its sheath it is to be expected that it would grow in that direction too. Examination of embryos at Stage XXXIV proves this to be the case, its length increasing from about .2 mm. at Stage XXXIII to about .5 mm., while its greatest diameter remains at about .15 mm. Anteriorly it is slightly twisted towards the dorsal side of the foregut, where the latter begins to arch over the lung rudiment: which seems to point to this portion of the foregut being at this stage included in the twisting which occurs chiefly in the intestine. The position of the spleen with regard to the gut appendages is the same as earlier, i. e., the bile-duct opening and the ventral pancreatic buds lie roughly in the same transverse plane as its anterior end, and the dorsal pancreas lies at the posterior end. The venous circulation of this portion of the embryo has undergone no change, except, perhaps, that the peripheral sinuses are better marked, and I have been unable to trace any arterial supply.

There is active cell-division going on throughout the organ, but particularly in the venous spaces, where the erythroblasts are multiplying freely.

At this stage (fig. 3 and 3a) the differentiation between the cells of the spleen and those of the rest of the mesenchyme

commences. The nuclei at the periphery begin to take up a position with their long axes tangential to the organ; the cells containing these will form the capsule. External to these the cells form a rather compact connective tissue, and within them the splenic tissue is but little more differentiated, but its spaces are, of course, venous sinuses.

The alimentary canal between Stages XXXIV and XXXV undergoes a considerable amount of remodelling (I use the word in the same sense as Professor Graham Kerr, 'Quart. Journ. Micr. Sci.,' vol. liv, p. 484). Whereas the first turn of the intestine has up to now been very prominent and has caused the embryo to be rather tadpole-like in shape, at this time there is considerable shrinkage in this region so that there is but little bulging exteriorly (vide Keibel's 'Normentafeln,' vol. x). The result of this is that the relative positions of the organs in connection with the foregut and the anterior portion of the intestine are altered. The foregut itself is rotated so that the spleen lies laterally anteriorly and ventro-laterally posteriorly on its right side: the dorsally placed wall of that part of the intestine projecting in front of the pyloric valve shortens, so that the three pancreatic buds become fused together and the bile-duct opening comes to lie just behind the posterior end of the spleen, a very marked difference from its earlier position: the pancreas extends forwards under the posterior half of the spleen, but gradually retreats further back as development proceeds.

The histology also has advanced, although the tissue is still very condensed. The trabeculæ are developing, as will be seen by examining fig. 4, but the cells, except for their arrangement, are indistinguishable from the rest of the mesenchyme.

By Stage XXXVI, the last one examined, the organ has become very well-marked and obvious in sections, but it never becomes so in dissection, because it remains embedded in the sheath of the foregut. It is just over 1 mm. long, and its greatest diameter, towards its posterior end, is about a third of this.

The first turn of the intestine has shrunk still more, so

that the spleen projects for most of its length, but the posterior end, where it continues to overlap the pancreas, is contained within it.

The histology is as follows: The cells are arranged to form closely-packed trabeculæ, surrounded by blood spaces. These have no endothelial lining, and are the venous sinuses previously mentioned. The peripheral sinuses, which were so well marked in the earlier stages, are now completely broken up by trabeculæ to form the channels of the sponge-work.

The blood supply is rather doubtful. There appears to be a small branch of the cœliac artery acting as an afferent vessel in addition to the branches of the intestinal vein; but, I think, some of the blood from the intestinal goes direct to the liver. The factors of the Hepatic Portal Vein compose, as before, the efferent system.

THE SPLEEN OF LEPIDOSIREN.

Turning now to the development of the spleen in *Lepidosiren*, the differences observable are not of much morphological significance.

It appears at just about the same stage as in *Protopterus*, but develops rather more quickly, so that by Stage 34, (figs. 5 and 5a) it is already about 1 mm. long, and shows the beginnings of a trabecular arrangement among its cells.

Its position, too, differs from that in *Protopterus*; it is dorsal to the foregut anteriorly, turning over to the right side posteriorly, and lies almost entirely in front of the intestine. This last point of contrast is due to the difference of distribution of yolk in the two species.

I have been unable to discover a branch of the cœliac artery supplying it, but the intestinal vein, besides supplying the spleen, does continue directly to the liver.

Already, however, at Stage 35, a branch of the cœliac artery can be made out going to the spleen, which is as far developed as the latest stage of *Protopterus* that I have examined (figs. 6 and 6a).

At Stage 36 (figs. 7 and 7a) the organ is clearly defined from the rest of the mesenchyme dorsal to the endodermal wall of the gut. It has sharply-marked boundaries, and is compact, while the neighbouring mesenchyme has developed the alveolar structure typical of ordinary connective-tissue. The capsule-forming cells appear as a single layer of nuclei bounding the organ. These cells have formed a definite connective-tissue sheath over a large portion of the surface by Stage 37, the most advanced stage I have examined.

For the histogenesis of the spleen in *Lepidosiren* I cannot do better than refer to Dr. Bryce's paper on the "Histology of the Blood of the Larva of *Lepidosiren*." One point only will I mention. The cellular elements show a marked reduction in size between Stages 35 and 37. This change seems to affect the whole of the mesoderm cells of the foregut, as will be seen by examining figs. 6, 7 and 8. I thought at first that it was due to variation in the amount of contraction which the larvæ had undergone during the preparation of the sections, but that this is not the case is shown by two facts: (1) the blood corpuscles do not show this change, and (2) the effect is observable in all the series examined.

To return to the question of the blood circulation. It is quite clear that this is, to begin with, entirely venous, so that there is a sort of splenic portal system. This is in connection with the veins draining the intestine. The development of these had not been fully worked out in either form, nor have I had the time to do it properly myself, so the following remarks must be accepted with all reserve.

Apparently, in both species the main intestinal vein which drains the intestine breaks up in the spleen. (It will have been noticed that I have referred to the vein which supplies the spleen as the intestinal. There is, of course, no vein ordinarily called by that name: I use it simply as a matter of convenience, because I do not wish to make any definite statement on the point.) The blood from the spleen runs to the

liver viâ the hepatic portal vein. There is, at first, no direct communication between the intestine and the liver, and no arterial supply to the spleen. This latter point seems to be general throughout the phylum, for Dr. Bryce states, in Quain's 'Elements of Anatomy,' vol. i, p. 237, that in the human embryo the artery develops late.

What the chief factor of this intestinal vein is, is uncertain. In *Protopterus* it appears to be the intra-intestinal, while in *Lepidosiren* it is the subintestinal. This, however, is most likely only a question of which is most developed at the stage under consideration.

At about Stage XXV in *Protopterus*, and earlier in *Lepidosiren*, there is visible a small vein which communicates directly with the liver. This is the Hepatic Portal Vein proper, which, in the adult, becomes a well-marked vessel.

In *Lepidosiren* at the latest available stage I carefully examined the veins of this region (omitting the smaller tributaries from the intestine). The arrangement is as follows, from before backwards. There are three veins which communicate between the spleen and the hepatic portal vein, and behind the last of these the latter forks; the right branch is confined to the liver, and the left, passing straight through the tissue of the pancreas and turning over the left side of the gut, gradually fades away in the latter's ventral mesenchyme.

I interpret this in this way. The subintestinal vein¹ runs round the left side of the intestine to the dorsal surface, and then gives off a branch running backwards into the right lobe of the liver. It then continues forwards and gives off one branch to the splenic spongework, receives two from it, and then disappears. After reaching the side of the liver the portal vein seems to give off small branches into the liver tissue along the entire length.

¹ Dr. Jane Robertson ('Quart. Journ. Micr. Sci.,' vol. lix, p. 121) describes this vein as the posterior part of the original subintestinal and the proximal part of the left vitelline vein.

W. N. Parker, describing the adult condition in *Protopterus*, states that the main factor of the hepatic portal is a large mesenteric which runs close to the intra-intestinal artery in the axis of the spiral valve and comes to the surface at the pylorus (this is the intra-intestinal vein of Laguesse). He mentions a subintestinal vein, the connections of which he has not made out, and then says that just anterior to the pylorus the mesenteric can be traced into an anterior and posterior branch, the latter supplying the posterior lobe of the liver behind the gall-bladder. (This is the first branch I have mentioned above.) He continues: "The former receiving a large lieno-gastric vein (the factors of which form a dense meshwork in the spleen) and a pancreatic vein, and then dividing into branches which supply the anterior lobe of the liver." According to him, therefore, there is but one efferent vessel, and the afferent supply is wholly arterial. This is in marked contrast with what obtains in other fish.

(A) T. J. Parker on *Mustelus*, for instance, describes two large veins connected with the spleen, an anterior and posterior lieno-gastric. The former runs with the lieno-gastric artery, and is most likely efferent; the latter lies between the pyloric division of the stomach and the right lobe (morphological posterior portion) of the spleen and "receives feeders from both."

(B) Laguesse on *Acanthias* says the hepatic portal is composed of two trunks: the supra-intestinal, running the length of the intestine, and, after passing the hilum of the spleen, receives from that organ the splenic vein; and the subintestinal, which receives blood from the pancreas, at the edge of which it receives the accessory splenic. These two veins correspond to the anterior and posterior lieno-gastric veins of T. J. Parker respectively. He states that in the adult they are anastomosed, and in the embryo it is on this loop that the spleen appears. He also states that there is a double anastomosing arterial supply, one directly from the aorta and one from the cœliac, a condition which, he says, is found in the Trout as well.

Judging, therefore, from these three descriptions, taken with the facts of embryology already known, one comes to the conclusion that the original circulation of the spleen must have been entirely venous, being a portal system between the intestine and the liver. Later it was "shunted" off the main vessel so as to lie on a loop alongside. Later still, the delivery of arterial blood removed the necessity of an afferent venous supply, so that in all forms above the Pisces there are present a single splenic artery and a single splenic vein only. In the class mentioned, however, both the veins persist, and there may be a second artery as well. The direction of the blood-flow in the veins is of some importance, a point on which authors are not very clear. Judging from T. J. Parker's description of *Mustelus*, it seems as if both the veins are efferent in function. This entails a reversal of the current, in the one serving the right lobe, during development. This is not a serious difficulty (it would be by no means an isolated case), but it makes the efferent system extraordinarily large compared with the afferent, both the veins being so much larger than the artery.

It seems, therefore, as if detailed investigation of the blood-vessels of this part of the body in *Lepidosiren* and *Protopterus* would be of much morphological value, and would most likely help to bring into line the various descriptions which have been published for the different fish investigated.

SUMMARY.

(1) The spleen arises in a thickening of the mesenchyme of the foregut, just after that mesenchyme has become free from yolk granules.

(2) It is, at first, a mass of mesenchyme cells, round about which are comparatively large venous sinuses without any endothelial walls; later the cells become arranged to form trabeculæ across these sinuses, which thus get broken up into the channels of a spongework.

(3) The afferent and efferent veins are in very close con-

nection with the veins from the intestine and to the liver respectively. The arterial supply of blood develops from the cœliac artery rather later.

(4) The organ remains throughout ontogeny embedded in the sheath of the foregut, and is therefore inconspicuous.

BIBLIOGRAPHY.

- BRYCE, T. H.—“The Histology of the Blood of the Larva of *Lepidosiren paradoxa*,” ‘Trans. Roy. Soc. Edin.’ vol. xli, p. 454, 1904.
- KERR, J. GRAHAM.—“Notes on Certain Features in the Alimentary Canal of *Lepidosiren* and *Protopterus*,” ‘Quart. Journ. Micr. Sci.’, vol. liv, p. 484, 1909.
- LAGUESSE, E.—“Recherches sur le développement de la Rate chez les poissons,” ‘Journ. de l’Anat.’ vol. xxvi, pp. 345–406 and 425–495, 1890.
- PARKER, T. J.—“The Blood-vessels of *Mustelus*,” ‘Phil. Trans. Roy. Soc. Lond.’ vol. clxxvii, pt. 2, 1886.
- PARKER, W. N.—“The Anatomy and Physiology of *Protopterus annectens*,” ‘Trans. Roy. Irish Acad.’ vol. xxx, pt. 3, 1892.

EXPLANATION OF PLATES 15, 16, AND 17,

Illustrating Mr. G. L. Purser’s paper on “The Early Development of the Spleen of *Lepidosiren* and *Protopterus*.”

All these figures have been drawn with the aid of a Zeiss Abbé drawing apparatus. I have to thank my sister, Miss Dorothy Purser, for making the diagrammatic drawings forming Plate 15.

LIST OF ABBREVIATIONS.

ao. Dorsal aorta. *er.* Erythroblasts. *f.g.* Foregut. *g.b.* Gall-bladder. *g.b.d.* Bile-duct. *h.p.v.* Hepatic portal vein. *int.* Intestine. *int. v.* Intestinal vein. *i. v. c.* Inferior vena cava. *k.* Nephridial tubes. *li.* Liver. *lu.* Lung. *pa.* Pancreas. *sp.* Spleen. *sp. a.* Splenic artery. *tr.* Trabeculæ. *v. s.* Venous sinus.

PLATE 15.

Series of diagrammatic figures of transverse sections through the embryos of *Protopterus* and *Lepidosiren*, to show the position of the spleen with regard to the neighbouring organs. Their numbers correspond to those of the lithographic figures, which are drawings of the same sections at a higher magnification.

Figs. 1a-4a.—*Protopterus*. $\times 20$ (circa).

Figs. 5a-8a.—*Lepidosiren*. $\times 10$ (exc. 5a $\times 20$).

PLATE 16.

Transverse sections through the spleen of *Protopterus*.

Fig. 1.—N. T. xxxii. $\times 180$.

Fig. 2.—N. T. xxxiii. $\times 180$.

Fig. 3.—N. T. xxxiv. $\times 220$.

Fig. 4.—N. T. xxxv. $\times 220$.

PLATE 17.

Transverse sections through the spleen of *Lepidosiren*.

Fig. 5.—N.T. 34. $\times 180$.

Fig. 6.—N.T. 35. $\times 180$.

Fig. 7.—N.T. 36. $\times 180$.

Fig. 8.—N.T. 37. $\times 180$.

**A Note concerning the Collar Cavities of the
Larval Amphioxus.**

By

K. M. Smith, A.R.C.S., D.I.C.,

And

H. G. Newth,

Demonstrator in Zoology, Imperial College of Science and Technology.

With Plate 18.

INTRODUCTION.

Notwithstanding the great volume of literature dealing with the development of *Amphioxus*, there are many points still outstanding on which the light of further investigation must be thrown. The present short communication attempts to dispose of one of these.

It is well known that in *Amphioxus* the cavities of the typical somites give rise, on the one hand, to all the myocœls except the first pair, and, on the other hand—by the fusion of their ventral moieties on each side—to longitudinal spaces which are the splanchnocœls. But the fate of the so-called “collar cavities” has not hitherto been satisfactorily established. It was known that from the walls of their dorsal parts were formed the first pair of myotomes; but there has been difference of opinion about the behaviour of their ventral parts.

MacBride (1) at first maintained that “the metapleural ‘lymph canals’ found in the atrial folds are the persistent

ventro-lateral extensions of the collar pouches"—having observed this relation to hold in the case of the right collar cavity, and inferring that it was true of the left side also.

Lankester and Willey (4) have described a pseudocœlic origin of the metapleural spaces, and MacBride, in answer to criticism by Lankester and others, returned to this subject in his paper of 1900 (2). Some of the conclusions arrived at, as a result of this re-investigation, were as follows:

"The ectoderm on the external side of these ridges" (i. e. the atrial ridges) "becomes thickened, the cells composing the thickening become clear and glassy and eventually are hollowed out to form a 'lymph canal.' My former statement as to the cœlomic nature of this lymph canal is therefore incorrect.

"The extensions of the collar cavities into the atrial ridges become first separated off as the metapleural cœlom on each side; later this cœlomic space becomes converted into a solid mass of cells from which arise muscular fibres in the neighbourhood of the gill openings, and almost certainly, later, the sub-atrial muscle."

In the following year van Wijhe (5) affirms: "Nach den Verhältnissen beim ausgebildeten Thiere halte ich die Angabe von MacBride aus dem Jahre 1898, nach welcher die Seitensflossenhöhlen in Continuität mit den 'collar pouches' entstehen würden, für richtiger als die spätere Behauptung des selbständigen Auftretens der Seitencanäle."

Finally, MacBride, in his latest contribution to this subject, reiterates his former assertion—made in his second paper—that the collar cavities form spaces in the atrial ridges, longitudinally co-extensive with the pharynx, and distinct from the splanchnocœl (3).

The present investigation was begun at the suggestion of Prof. MacBride, and was carried out in his laboratory. We wish here to make grateful acknowledgment of our indebtedness to him for the assistance he has given throughout the progress of the work, and for the generous permission to make use of his preparations for purposes of comparison.

MATERIAL AND METHOD.

Four larval stages were examined. Larvæ which had been fixed in Hermann's fluid were obtained from the Naples Zoological Station. They were cut into series of transverse sections by the method of double embedding in celloidin and wax, and the sections, 4μ or 5μ thick, were stained variously with Delafield's hæmatoxylin, thionin, alcoholic hæmatein; or with an aqueous solution of picro-nigrosin for the special purpose of making plain the relations of the myosepta.

It is, as other workers have found, difficult to obtain perfectly preserved material; larvæ of the same batch apparently vary in their reaction to the fixative. To obtain reliable results it was found necessary to section a large number of animals, discarding those which showed distension or contraction, and basing conclusions on those alone in which the histological detail was convincing.

Our drawings are, to the best of our ability, faithful reproductions of the appearance of the sections, except that in some of them the irrelevant cytological detail is omitted. They were all made at the level of the microscope stage with the aid of a camera lucida, the magnification being, in each case, that obtained with a 2 mm. apochromatic oil-immersion objective and No. 6 compensating ocular of Leitz.

DESCRIPTION.

The earliest stage examined was one in which the larvæ show as yet no indication of the formation of a mouth. The left head cavity is a vesicle unconnected with the ectoderm—though in contact with it—the club-shaped gland opens widely into the floor of the enteron, and the endostyle appears as a slightly thickened area of the right side of the swollen pharyngeal region. The formation of somites from the archenteron is still occurring at the extreme posterior end of the animal, and the tail has not begun to grow.

In such a larva the cavities of the collar somites have no

ventral extension round the sides of the fore-gut, and, indeed, in sections in front of the club-shaped gland the mesoblast does not appear at all between the ectoderm and the gut-wall (Pl. 18, fig. 1), save for an occasional isolated cell. In sections a little further back, in the region where the mouth will be formed, the collar somite on either side sends a ventral horn downwards round the gut as a thin plate of cells; but since there are no cavities in these extensions and the myosepta have not yet assumed their characteristic appearance, it is impossible to make out the relations of the somites in this stage.

The right collar cavity is completely separated from the gut, but on the left side there is a virtual communication, marked by the peculiar orientation of the cells of the gut-wall.

Our second (and critical) stage is one in which the mouth has just become established, but is still a mere pore. Pl. 18, fig. 2, shows the appearance of a section about 5μ behind the blind anterior end of the gut. The collar somites have considerable cavities which extend ventrally on either side of the pharynx. We will first deal with that of the right side. Into its dorsal part projects the mass of the first myotome, the cells of which are already differentiated as muscle; its ventral horn can be traced, with diminishing lumen, to the mid-ventral line. The next section of the series (Pl. 18, fig. 3) shows the ventral horn as before; but in the muscle a crescentic septum has appeared, dividing its mass into an inner and an outer portion. This septum is the first myoseptum, and the inner muscle mass (in contact with the notochord) is the anterior end of the second myotome (i. e., first trunk somite). Succeeding sections show the gradual increase in size of the trunk somite at the expense of the collar somite, as evidenced by the outward and downward migration of the septum (Pl. 18, figs. 4 and 5). Two sections further on (Pl. 18, fig. 6) the cavity of the trunk somite is seen to be well established above the dorsal edge of the septum, and four sections beyond this the septum has just

lost its apical attachment to the gut, so that the cavities above and below now communicate (Pl. 18, fig. 7). The remains of the septum have disappeared in the next section.

It will be plain from this description that the collar cavity of the right side is continuous with the splanchnocœl. It has a more extensive (longitudinally) communication with that space than have the succeeding myocœls, but essentially its relations are the same. We have not found anything comparable to the septum described by MacBride as separating a postero-ventral extension of the collar cavity from the splanchnocœl.

Turning now to the left side of the larva, we see that the first myoseptum is well in advance of that of the right side. In Pl. 18, fig. 2, the ventral horn of the collar cavity is already pushed down to the level of the middle of the notochord, and in tracing sections back the first trunk myocœl is found to be well established dorsally when the section passing through the mouth is reached—the septum between it and the collar myocœl having passed obliquely downwards and backwards to meet the upper lip. The cavity of the upper lip (virtual at this stage) is that of the first trunk somite.

What happens in the lower lip is more difficult to make out. A thickened layer of ectoderm, applied to the left head cavity and to the antero-ventral wall of the gut, suppresses altogether the ventral extension of the somite (Pl. 18, fig. 2); just behind this thickening the somite passes down, its lumen often occluded, to become continuous with the mesoblast of the lower lip, which, in its turn, is continuous with the splanchnocœl (Pl. 18, figs. 3, 4, 5). Again, no septum is observable between collar cavity and splanchnocœl; but, the spaces being for the greater part merely virtual, it is impossible to state with certainty whether there is actual continuity.

The great dilatation of the collar cavities, which MacBride took to be the first appearance of the atrial folds, is, in our opinion, largely a fixation effect. It depends, no doubt, as he

suggests, upon the amount of fluid contained in the cavities, but the actual ectodermal profile we take to be an artifact. On the left side, where the ectoderm is anchored, so to speak—by its fusion with the gut, to form the mouth, and with the head cavity to form the præ-oral pit—the swelling occurs to a lesser degree than on the right side, where no such attachments exist; and in the trunk region, where the cavities of the myotomes are small or virtual, and the close apposition of the walls of the splanchnocoel would preclude osmotic disruption, it occurs not at all. The artificial nature of the distension in question is frequently made apparent by a separation of the extremely thin outer wall of the somite from the ectoderm. This is seen even in so young a larva as that shown in Pl. 18, fig. 1 (q. v.); in later larvæ the action of the fixative is often to rupture the ectoderm on the right side.

The communication between the left collar cavity and the gut, described by MacBride, is indicated in larvæ of this stage (Pl. 18, figs. 2 and 3). It still appears in the majority as a funnel-shaped depression in the dorso-lateral wall of the gut, with sometimes a plug-like fascicle of columnar cells filling it (Pl. 18, fig. 2). It is never, in our sections, a very definite structure, but it gives a characteristic shape to the lumen of the gut, which is generally found to persist through several sections. In the preparations we have examined of a slightly later stage (mouth and one gill established) we have failed to demonstrate its presence; but the swollen, vacuolated condition of the gut cells in this later stage makes it easily possible that the connection, though not recognisable, is present.

In later larvæ still (seven or eight primary gills present) the nephridium of Hatschek appears, as described by Goodrich (6), lying in a space which is apparently a backward prolongation of the left collar myocoel. But whether this space is the original portal of communication, drawn out into a tube by the growth of the larva, and, if so, how the nephridium (an organ presumably of ectodermal origin) comes to lie naked within it, are questions that our materials

do not enable us to answer. Nevertheless, attention should perhaps be called to a constant but inconspicuous feature of our second stage larvæ—the mass of cells marked with a point of interrogation in Pl. 18, fig. 4. They occur just behind the communication above mentioned, and it is tempting to regard them as a proliferation of ectoderm into the first myoseptum and as the rudiment of the nephridium. We cannot, however, assert that this is so.

In conclusion, our acquaintance, limited as it is, with the early stages of development of *Amphioxus* has convinced us of the need of careful experiment with the object of discovering better methods of fixation of the larvæ. This can only be done by rearing them in large numbers in the laboratory—an undertaking never yet achieved. Only so can material be obtained the study of which will give satisfactory answers to the many morphological questions which still remain doubtful.

NOTE BY PROF. E. W. MACBRIDE.

The investigation carried out by Messrs. Smith and Newth in my laboratory on the development of body cavities in the larva of *Amphioxus* has led them to results which in some respects are different from those which I have published on the same subject.

In particular they find that the space into which the right collar cavity opens as it sweeps downwards towards the mid-ventral line is the splanchnocœl, and not, as I supposed, a distinct cavity lying external to the splanchnocœl, which later became the cavity of the atrial fold, or, as van Wijhe terms it, the pterygocœl.

After a careful examination of the preparations made by Messrs. Smith and Newth, which were based on better preserved material than was available to me, I have come to the conclusion that these authors are right, and I am prepared to accept their view. A re-examination of my own preparations leads me to believe that the septum which I believed to

divide the splanchnocœl from another cavity external to it is the parietal wall of the cœlom, which in the process of preservation has become separated from the ectoderm.

The facts elucidated by Messrs. Smith and Newth enable us to compare the collar cavity of *Amphioxus* directly with the mandibular cavity of the embryos of *Petromyzon* and the Elasmobranch embryo. This cavity has been observed by Hatta to originate in *Petromyzon* from the wall of the gut independently of the outgrowth which gives rise to the myotomes behind, but in both *Petromyzon* and the Elasmobranch embryo the mandibular cavity becomes subsequently connected by a long tongue-like ventral extension with the splanchnocœl.

LIST OF WORKS REFERRED TO IN THIS PAPER.

1. MacBride, E. W.—“The Early Development of *Amphioxus*,” ‘*Quart. Journ. Micr. Sci.*,’ vol. xl, 1898.
2. ——— “Further Remarks on the Development of *Amphioxus*.” ‘*Quart. Journ. Micr. Sci.*,’ vol. xliii, 1900.
3. ——— “The Formation of the Layers in *Amphioxus* and its Bearing on the Interpretation of the Early Ontogenetic Processes in Other Vertebrates,” ‘*Quart. Journ. Micr. Sci.*,’ vol. liv, 1909.
4. Lankester, E. Ray, and Willey, A.—“The Development of the Atrial Chamber of *Amphioxus*,” ‘*Quart. Journ. Micr. Sci.*,’ vol. xxxi, 1890.
5. Wijhe, J. W. van.—“Beitr. z. Anat. des Kopffregion des *Amphioxus lanceolatus*,” ‘*Petrus Camper*,’ vol. i, 1901.
6. Goodrich, Edwin S.—“On the Structure of the Excretory Organs of *Amphioxus*,” ‘*Quart. Journ. Micr. Sci.*,’ vol. liv, 1909.

EXPLANATION OF PLATE 18,

Illustrating Messrs. K. M. Smith and H. G. Newth’s paper,
“A Note concerning the Collar Cavities of the Larval *Amphioxus*.”

ABBREVIATIONS.

The asterisk marks the communication between the left collar somite and the gut.

ch. Notochord. *c. g.* Club-shaped gland. *esty.* Endostyle. *l. c. s.* Left collar somite. *l. h. c.* Left head cavity. *l. m. 2.* Second myotome of the left side. *l. mc. 2.* Second myocœl of the left side. *m.* Mouth. *n. c.* Nerve cord. *r. c. s.* Right collar somite. *r. h. c.* Right head cavity. *r. m. 1.* First myotome of the right side. *r. m. 2.* Second myotome of the right side. *r. mc. 2.* Second myocœl of the right side. *s.* Septum. *spl.* Splanchnocœl. *t. mc.* Trunk myocœl.

Fig. 1.—Transverse section through the pharyngeal region of a very young larva, showing the relations of the collar somites to the gut. The section is $4\ \mu$ thick and was stained with thionin. Note the separation of the outer wall of the right collar somite from the ectoderm.

Figs. 2-7.—Transverse sections through the pharynx of a larva in which the mouth is just formed. Figs. 2-5 are of consecutive sections; between 5 and 6 one section is missed, between 6 and 7 three sections are missed. The preparation from which the drawings were made was overstained in picro-nigrosin to make plain the septa, and this has obscured the cytological detail. For further description see text.

Fig. 8.—Diagrammatical representation of the relations of the cœlomic spaces of the left side of a larva in which the mouth is just formed. The dotted lines show the condition on the right side where the wide opening of the collar somite to the splanchnocœl is not interfered with by mouth or head cavity.

With Ten Plates, Royal 4to, 5s. net.

CONTRIBUTIONS TO THE KNOWLEDGE OF RHADOPLEURA AND AMPHIOXUS.

By SIR RAY LANKESTER, K.C.B., M.A., LL.D., F.R.S.

London: J. & A. CHURCHILL, 7 Great Marlborough Street.

Quarterly Journal of Microscopical Science.

The SUBSCRIPTION is 42s. for the Volume of Four Numbers; for this sum (*prepaid*) the JOURNAL is sent Post Free to any part of the world.

BACK NUMBERS of the JOURNAL, which remain in print, are now sold at a uniform price of 10/6 net.

The issue of SUPPLEMENT NUMBERS being found inconvenient, and there being often in the Editor's hands an accumulation of valuable material, it has been decided to publish this Journal at such intervals as may seem desirable, rather than delay the appearance of Memoirs for a regular quarterly publication.

The title remains unaltered, though more than Four Numbers may be published in the course of a year.

Each Number is sold at 10/6 net, and Four Numbers make up a Volume.

London: J. & A. CHURCHILL, 7 Great Marlborough Street.

TO CORRESPONDENTS.

Authors of original papers published in the Quarterly Journal of Microscopical Science receive fifty copies of their communication *gratis*.

All expenses of publication and illustration are paid by the publishers.

Lithographic plates and text-figures are used in illustration. Shaded drawings intended for photographic reproduction as half-tone blocks should be executed in "Process Black" diluted with water as required. Half-tone reproduction is recommended for uncoloured drawings of sections and of Protozoa.

Drawings for text-figures should not be inserted in the MS., but sent in a separate envelope to the Editor.

Contributors to this Journal requiring *extra* copies of their communications at their own expense can have them by applying to the Printers,

MESSRS. ADLARD & SON & WEST NEWMAN, Ltd., 23, Bartholomew Close, E.C., on the following terms:

For every four pages or less—

25 copies	5/-
50 "	6/-
75 "	6/6
100 "	7/-

Plates, 2/- per 25 if uncoloured; if coloured, at the same rate for every colour.

Prepayment by P.O. Order is requested.

ALL COMMUNICATIONS FOR THE EDITORS TO BE ADDRESSED TO THE CARE OF MESSRS. J. & A. CHURCHILL, 7 GREAT MARLBOROUGH STREET, LONDON, W.

THE MARINE BIOLOGICAL ASSOCIATION

OF THE
UNITED KINGDOM.

—:O:—
Patron—HIS MAJESTY THE KING.

President—Sir RAY LANKESTER, K.C.B., LL.D., F.R.S.
—:O:—

THE ASSOCIATION WAS FOUNDED "TO ESTABLISH AND MAINTAIN LABORATORIES ON THE COAST OF THE UNITED KINGDOM, WHERE ACCURATE RESEARCHES MAY BE CARRIED ON, LEADING TO THE IMPROVEMENT OF ZOOLOGICAL AND BOTANICAL SCIENCE, AND TO AN INCREASE OF OUR KNOWLEDGE AS REGARDS THE FOOD, LIFE CONDITIONS, AND HABITS OF BRITISH FOOD-FISHES AND MOLLUSCS."

The Laboratory at Plymouth

was opened in 1888. Since that time investigations, practical and scientific, have been constantly pursued by naturalists appointed by the Association, as well as by those from England and abroad who have carried on independent researches.

Naturalists desiring to work at the Laboratory

should communicate with the Director, who will supply all information as to terms, etc.

Works published by the Association

include the following:—'A Treatise on the Common Sole,' J. T. Cunningham, M.A., 4to, 25/-. 'The Natural History of the Marketable Marine Fishes of the British Islands,' J. T. Cunningham, M.A., 7/6 net (published for the Association by Messrs. Macmillan & Co.).

The Journal of the Marine Biological Association

is issued half-yearly, price 3/6 each number.

In addition to these publications, the results of work done in the Laboratory are recorded in the 'Quarterly Journal of Microscopical Science,' and in other scientific journals, British and foreign.

Specimens of Marine Animals and Plants,

both living and preserved, according to the best methods, are supplied to the principal British Laboratories and Museums. Detailed price lists will be forwarded on application.

TERMS OF MEMBERSHIP.

ANNUAL MEMBERS	£1	1	0	per annum.
LIFE MEMBERS	15	15	0	Composition Fee.
FOUNDERS	100	0	0	" "
GOVERNORS (Life Members of Council)	500	0	0	

Members have the following rights and privileges:—They elect annually the Officers and Council; they receive the Journal free by post; they are admitted to view the Laboratory at any time, and may introduce friends with them; they have the first claim to rent a table in the Laboratory for research, with use of tanks, boats, etc.; and have access to the Library at Plymouth. Special privileges are granted to Governors, Founders, and Life Members.

Persons desirous of becoming members, or of obtaining any information with regard to the Association, should communicate with—

The DIRECTOR,

The Laboratory,

Plymouth.

7527

New Series, No. 247 (Vol. 62, Part 3).

Price 10s. 6d. net

Subscription per volume (of 4 parts) 42s. net.

AUGUST, 1917.

THE QUARTERLY JOURNAL OF MICROSCOPICAL SCIENCE.

EDITED BY

SIR RAY LANKESTER, K.C.B., M.A., D.Sc., LL.D., F.R.S.,

HONORARY FELLOW OF EXETER COLLEGE AND HONORARY STUDENT OF CHRIST CHURCH, OXFORD;
MEMBER OF THE INSTITUTE OF FRANCE (ASSOCIÉ ÉTRANGER DE L'ACADEMIE DES SCIENCES);
CORRESPONDENT OF THE IMPERIAL ACADEMY OF SCIENCES OF ST. PETERSBURG, AND OF THE
ACADEMY OF SCIENCES OF PHILADELPHIA, AND OF THE ROYAL ACADEMY OF SCIENCES
OF TURIN; FOREIGN MEMBER OF THE ROYAL SOCIETY OF SCIENCES OF
GÖTTINGEN, AND OF THE ROYAL BOHEMIAN SOCIETY OF SCIENCES, AND
OF THE ACADEMY OF THE LINCI OF ROME, AND OF THE AMERICAN
ACADEMY OF ARTS AND SCIENCES OF BOSTON; ASSOCIATE OF THE
ROYAL ACADEMY OF BELGIUM; HONORARY MEMBER OF THE
NEW YORK ACADEMY OF SCIENCES, AND OF THE
CAMBRIDGE PHILOSOPHICAL SOCIETY, AND OF
THE ROYAL PHYSICAL SOCIETY OF EDIN-

BURGH, AND OF THE
BIOLOGICAL AND ZOOLOGICAL SOCIETIES OF PARIS, AND OF THE CALIFORNIA ACADEMY OF SCIENCES OF
SAN FRANCISCO, AND OF THE ROYAL ZOOLOGICAL AND MALACOLOGICAL SOCIETY OF BELGIUM;
CORRESPONDING MEMBER OF THE SENKENBERG ACADEMY OF FRANKFURT-AM-
FOREIGN ASSOCIATE OF THE NATIONAL ACADEMY OF SCIENCES, U.S., AND MEMBER OF THE
AMERICAN PHILOSOPHICAL SOCIETY;

HONORARY FELLOW OF THE ROYAL SOCIETY OF EDINBURGH;
LATE DIRECTOR OF THE NATURAL HISTORY DEPARTMENTS OF THE BRITISH MUSEUM; LATE PRESIDENT OF THE
BRITISH ASSOCIATION FOR THE ADVANCEMENT OF SCIENCE; LATE FULLERIAN PROFESSOR OF
PHYSIOLOGY IN THE ROYAL INSTITUTION OF GREAT BRITAIN;

LATE LINACRE PROFESSOR OF COMPARATIVE ANATOMY AND FELLOW OF MERTON COLLEGE, OXFORD;
EMERITUS PROFESSOR OF ZOOLOGY AND COMPARATIVE ANATOMY IN UNIVERSITY COLLEGE, UNIVERSITY OF LONDON

WITH THE CO-OPERATION OF

SYDNEY J. HICKSON, M.A., F.R.S.,

BRYER PROFESSOR OF ZOOLOGY IN THE UNIVERSITY OF MANCHESTER;

GILBERT C. BOURNE, M.A., D.Sc., F.R.S.,

LINACRE PROFESSOR OF COMPARATIVE ANATOMY, AND FELLOW OF MERTON COLLEGE, OXFORD

J. GRAHAM KERR, M.A., F.R.S.,

REGIUS PROFESSOR OF ZOOLOGY IN THE UNIVERSITY OF GLASGOW;

AND

E. W. MACBRIDE, M.A., D.Sc., LL.D., F.R.S.,

PROFESSOR OF ZOOLOGY AT THE IMPERIAL COLLEGE OF SCIENCE AND TECHNOLOGY.

WITH LITHOGRAPHIC PLATES AND TEXT-FIGURES.



LONDON.

J. & A. CHURCHILL, 7 GREAT MARLBOROUGH STREET.

1917.

CONTENTS OF No. 247.—New Series.

MEMOIRS:

	PAGE
On the So-called Pharyngeal Gland-cells of Earthworms. By J. STEPHENSON, D.Sc., M.B., Lieutenant-Colonel Indian Medical Service; Professor of Zoology, Government College, Lahore. (With Plate 19)	253
The Chromosome Complex of <i>Culex pipiens</i> . Part II. Fertilisation. By MONICA TAYLOR, S.N.D., B.Sc. (With Plate 20 and 1 Text-figure)	287
The Homologies of the Muscles related to the Visceral Arches of the Gnathostome Fishes. By EDWARD PHELPS ALLIS, jr., Menton, France (With Plates 21 and 22 and 1 Text-figure)	303
The Cytoplasmic Inclusions of the Germ-cells. Part I.—Lepidoptera. By J. BRONTÉ GATENBY, B.A., Exhibitioner of Jesus College, Oxford. (With Plates 23, 24, and 25, and 5 Text-figures)	407
The Degenerate (Apyrene) Sperm-formation of Moths as an Index to the Inter-relationship of the Various Bodies of the Spermatozoon. By J. BRONTÉ GATENBY, B.A., Exhibitioner of Jesus College, Oxford. (With Plate 26)	463

On the So-called Pharyngeal Gland-cells
of Earthworms.

By

J. Stephenson, D.Sc., M.B.,

Lieutenant-Colonel, Indian Medical Service; Professor of Zoology,
Government College, Lahore.

With Plate 19.

CONTENTS.

	PAGE
1. HISTORICAL	253
2. MATERIAL AND METHODS	260
3. PHERETIMA POSTHUMA	261
4. PHERETIMA HETEROCHÆTA	265
5. PHERETIMA HAWAYANA	267
6. LUMBRICIDÆ	269
7. THE APPEARANCES IN YOUNG SPECIMENS	274
8. THE CELLS IN THE LUMBRICID EMBRYO	279
9. FUNCTION OF THE CELLS	281
10. SUMMARY	283
11. REFERENCES TO LITERATURE	284
12. EXPLANATION OF FIGURES	285

HISTORICAL.

SUCCEEDING the buccal cavity in all earthworms is a swollen portion of the alimentary tube, the pharynx. The usual description of this portion of the tube in *Lumbricus* may be given in the words of Parker and Haswell (7): the "buccal cavity . . . is followed by a much larger thick-walled, rounded chamber, the pharynx. From the wall

of the pharynx there run outwards to the body-wall a number of radially arranged bundles of muscular fibres which, when they contract, draw the pharynx backwards, and at the same time dilate it."

One of the constituents of this pharyngeal thickening, not mentioned in the ordinary descriptions of the earthworm, is nevertheless a prominent feature, easily visible under the lens in the ordinary dissection, and immediately obvious, owing to its staining properties, in sections through the region where it occurs. This constituent is a cellular mass which forms soft white projecting lobules on the dorsal and lateral aspects of the pharynx; the lobules surround the muscular strands which issue from the pharynx, and in addition, the cells of the mass penetrate inwards between the interlacing muscular bundles of the thick dorsal pharyngeal wall in the direction of the lumen of the canal.

Though these cells have received some attention from previous writers, an adequate account of their nature and origin has not yet, I believe, been given.

References to previous authors are given by Vejdovsky (9, 1884), from whose account of them I quote, since the older literature is inaccessible to me. The earlier investigators—Leo, Clarke, Lankester—who saw these masses of pharyngeal cells in *Lumbricus*, interpreted them as glandular. Perrier described pharyngeal glands in several genera; in *Pontodrilus* they are said to be variously coiled tubes whose walls are composed of large cells with granular contents; in *Moniligaster* they pour their secretion into the pharynx by a multitude of small canals visible with the lens; *Perichæta houlleti* has several layers of glands which open into the interior by three pairs of orifices. Claparède refers to those cells of the pharyngeal mass which penetrate inwards between the muscular bundles as ". . . numerous polygonal cells with large round nuclei 6 μ in diameter. The import of these cells is at present not clear to me. Their similarity to ganglion-cells is not to be denied, though a connection with nerves could not be recognised.

The matter is best left undecided at present." The projecting lobules on the dorsum of the pharynx Claparède called "ganglia of the previously described pharyngeal plexus."

Vejdovsky's own account of the pharyngeal cells is not very clear, and is interpolated here and there amongst descriptions of the muscular and vascular apparatus of the pharynx, and of the occurrence and mechanism of its extrusion. Unlike Claparède, who recognised the identity of the cells of the lobules with those which penetrate inwards between the muscular strands (interpreting both as nervous), Vejdovsky considers them as distinct. Those which penetrate inwards he looks on simply as cellular elements of the cœlomic fluid, which become attached to the pharyngeal muscles as to other organs; and he makes the rather surprising statement that "had Claparède compared these cells with those suspended in the cœlomic fluid, he would certainly have recognised them as the latter." The projecting lobules, on the other hand, are interpreted as mucous glands (Schleimdrüsen); in vertical sections the glandular masses, contracting anteriorly to form long ducts, wind between the muscular bundles of the pharynx, and most probably empty their secretion into the pharyngeal cavity; these glands extend backwards far into œsophageal segments, and correspond to the septal or mucous glands of other Oligochæta. Vejdovsky also describes the ducts of the "septal glands" of *Criodrilus* as winding through the layer of muscular and vascular tissue on the dorsum of the pharynx, and the exceptionally large and numerous mucous glands of *Dendrobæna rubida* are said to consist each of a pear-shaped mass of cells with large round nuclei and containing a substance which stains deeply in picrocarmine.

Vogt and Yung (10, 1888) describe irregularly dispersed cells between the muscular fibres on the dorsum of the pharynx (in *Lumbricus agricola*). These cells have ill-defined outlines, a granular protoplasm, and a clear spherical nucleus containing a nucleolus. The authors refer to Claparède's interpretation of them as nerve cells; they

resemble, however, the unicellular glands found in a corresponding position in other animals; and though the authors had not succeeded in discovering their ducts, they thought it not impossible that they secrete the viscid substance which the worm mixes with its food.

Hesse (6, 1894) considers the pharyngeal cells of Oligochæta in general as belonging to the epithelial layer; in the Naididæ and Tubificidæ the ventral end of each cell is prolonged into a duct, which debouches between the lining epithelial cells of the pharyngeal cavity; the ducts of these cells are more drawn out in Lumbricus.

Beddard (2, 1895) does not treat of the pharyngeal gland-cells of earthworms apart from the well-known "septal glands" of Enchytraidæ, etc. The septal glands in general, and so by implication the cells under consideration, appear to him to be simply epidermic glands which have been invaginated along with the stomodæum, though their position causes him some doubt.

The author who has examined these cellular aggregates in detail in the largest number of species, and who has given the most precise accounts of their supposed ductules and manner of discharge is Eisen (4, 5, 1895, 1896). In *Phœnicodrilus* taste the masses (called "salivary glands") discharge through ducts which follow the muscle strands into the pharyngeal cavity; and it is probable that all the suprapharyngeal glands in Lumbricids open similarly and without any great variation as to detail; narrow ducts penetrate the pharyngeal epithelium, forming near the free surface small ovoid pockets for temporarily storing a small amount of the salivary secretion. These (suprapharyngeal) glands are connected posteriorly with the septal glands,—four pairs, superposed on several main longitudinal muscular bands which connect the pharyngeal glands with the body-wall in segment IX; their ducts, both wide and narrow, follow these muscles, so that the secretion of the septal glands also is emptied into the pharynx. In *Pontodrilus michaelsoni* the pharyngeal or salivary glands have a similar position,

and are directly connected by means of ducts with the epithelium of the pharynx; arrived at the pharyngeal epithelium the ducts branch out, sending numerous discharge tubes between the epithelial cells; these ductules are frequently, though not generally, branched while in the epithelial layer, and each ductule is furnished at the distal end with a small storage chamber of oblong form and considerably smaller than the nucleus of the epithelial cells. There are also in this species five pairs of septal glands, ventral to the œsophagus, and principally attached to blood-vessels, in segments V-IX, of similar structure; a very thin duct runs backwards and upwards from the upper end of each towards the alimentary canal at its junction with the septum, "but I have some doubt about it emptying into the intestine, and it is much more probable that . . . these septal glands empty into the pharynx. None of my sections however show this to be the case." The distribution of the septal glands in this species may be compared with what is found in *Helodrilus* (*Bimastus*) *parvus* (v. p. 23 post.).

In *Benhamia nana* Eisen states that the glands are evidently unicellular, and the fine ducts penetrate between the epithelial cells of the pharynx, the discharge pockets being almost globular; here and there the duct of a single glandular cell may be followed clear to the discharge pocket. "But to draw the conclusion . . . that all the pharyngeal and septal glands are unicellular is, I think, premature. In *Pontodrilus*, at least, there may be seen plainly numerous nuclei on the gland ducts, which of course indicates that we have here a fusion of several cells. . . . In *Pontodrilus* the majority, and all the large glands, consisted of several cells, the respective ducts of which finally united into one. In *Benhamia* I could see no such union, and the single ducts could be followed with great facility to the outlets." In *Benhamia nana* the septal glands, in segments IX, X, and XI, are very narrow and only one cell thick in the row. In *B. palmicola* the small septal glands are in IX and X, but

the author could not find that they were in any way connected with the pharyngeal system of glands.

The pharyngeal and septal glands of *Aleodrillus keyesi* are also described. Here it will be sufficient to call attention to the author's statements regarding the discharge of the gland-cells. The pharyngeal glands have discharge pockets which are much thicker than those seen in any other species; the septal glands are of the same nature as the pharyngeal, "but I have good reasons to believe that the glands in this species discharge into the tubular intestine. I have been able to follow the discharge duct as far as the muscular layers of the intestine, which would hardly have been the case if the ducts had continued forwards into the pharynx, as do those of the forward septal glands in many genera." In some other small aggregations of similar cells the author was unable to follow the ducts.

In *Sparganophilus* (which, though aquatic, belongs to the *Glossoscolecidae*, and so may be considered along with the earthworms), it is noted that in one species the ducts of the septal glands with precipitated secretions can be followed along the septum down towards the intestine, but the connection with the latter, if any, was not ascertained; in another species the discharge tubes and chambers are very large, the chambers occupying more than half the width of the pharyngeal wall (the meaning is more than half the height of the pharyngeal epithelium).

De Ribaucourt (8, 1901), describes in a few words the deeply staining mass of cells in the *Lumbricidae*: "On staining with methyl blue and iodine green one can easily establish the fact that these cells are continued as far as the epithelial layer by a fine prolongation; thus the cells may quite possibly have a secretory function." Miss Raff (7a, 1910), recognises the cells in the Australian *Megascolecidae*, but finds no trace of a duct in connection with the "glandular mass."

I omit the literature which deals with the septal glands of the specially aquatic groups—the *Microdrili*—as I hope to

return to these at a later date. Nor need I refer to a number of observations on the occurrence, form, and position of the pharyngeal and septal glands of earthworms by systematic writers, since these do not deal with their intimate structure.

The cells in question, therefore, are usually considered as gland-cells belonging to the epithelial layer of the alimentary tube, and they are supposed to pour their secretion into the lumen of the tube by means of long, fine ductules prolonged from the cell-body. Claparède saw no ductules, and believed the cells on the pharynx to be nervous in nature; Vogt and Yung, who nevertheless believed the cells to be secretory, could not discover the ductules; Raff also saw no duct; Vejdovsky saw "long ducts," but not, apparently, their connection with the pharyngeal cavity; de Ribaucourt saw the continuation of the cells as far as the pharyngeal epithelium; Eisen has given detailed accounts of the ductules, of their branching in the pharyngeal epithelium, and of their discharge pockets; Perrier (according to Vejdovsky) saw the ducts with a lens, and observed their paired orifices.

According to my observations the cells in question are not of epithelial origin, and have no connection with the pharyngeal epithelium. They originate at the peripheral limit of the pharyngeal mass, and are congeneric with the peritoneum; in the adult they extend deeply into the pharyngeal mass, and there become largely transformed into connective tissue; but what their primary function is I am unable to say. It will save repetition to state here that in none of my sections, which were taken in all three planes, have I seen structures that could be interpreted as ductules.

Claparède's view of the nervous nature of the cells probably originated in their superficial resemblance to the spinal ganglion cells of higher Vertebrates; there is no resemblance to the ganglion cells of the Oligochæta. Vejdovsky's statement as to the similarity to the cœlomic corpuscles of those

of the cells which lie deep among the muscular bundles of the pharynx is frankly unintelligible to me. The authors who have seen ductules and their endings in the pharyngeal epithelium have, I believe, been misled by preconceived ideas on the nature of the cells, and by the appearances due to the transformation of the deeper cells into connective tissue.

MATERIAL AND METHODS.

I have investigated in detail the five common species of earthworms found in Lahore; three of these, *Pheretima posthuma* (L. Vaill.), *P. heterochæta* (Mehlsn.), and *P. hawayana* (Rosa), belong to a genus of *Megascolecidæ*; two, *Helodrilus* (*Allolobophora*) *caliginosus* subsp. *trapezoides* (Ant. Dug.), and *Helodrilus* (*Bimastus*) *parvus* (Eisen), to the *Lumbricidæ*. In addition to adult specimens, I have examined a number of younger worms of both families, and also several *Lumbricid* embryos in various stages, taken from the cocoons; but only one of these latter gave me additional information. I am also familiar in a general way with the cell masses as they occur in a large number of other worms, which I have sectioned from time to time in the course of systematic work on Indian *Oligochæta*; though as I cannot answer for the histological condition of this material (which mostly formed part of the Indian Museum collections) I have not made use of it in the present account.

The methods of fixation employed were Zenker's fluid and sublimate-acetic for the embryos and smaller worms, including the adults of *Helodrilus parvus*; some specimens of *Pheretima* were also treated by one or other of these methods. Narcotisation with chloretone and fixation by 10 per cent. formalin were employed for most of the adult specimens of *Pheretima* and *Helodrilus caliginosus*.

For staining, the most generally useful method is some degree of overstaining with Delafield's hæmatoxylin, differentiation with acid alcohol, and counterstaining with alcoholic

eosin. Dobell's modification of Heidenhain's iron-hæmatoxylin method (3) has also given me excellent results, and I should like to confirm what its author says regarding its value and convenience. One or other of the above methods was employed for all specimens used in descriptions of the cells. In addition, I have used Heidenhain's original chromhæmatoxylin method, which gives unsurpassed differentiation of epithelial cells (skin, pharynx, œsophagus), but in my hands has been useless for the cells of the pharyngeal mass. Van Gieson's stain, and borax-carminé followed by picroindigo-carminé, were useful in differentiating the connective tissue and in distinguishing it from the muscular fibres.

I have to thank my friend and former pupil, L. Bains Prashad, M.Sc., Alfred-Patiala Research Student of the Punjab University, for kindly giving me the embryos and some of the youngest specimens used in the investigation.

PHERETIMA POSTHUMA.

General description.—In this species, in front of septum 4/5, a soft mass extends forwards almost to the anterior end of the body, filling up the available space, and hence narrower in front where the cerebral ganglion lies across it. The posterior end, or base of the somewhat conical mass, can be separated only with difficulty from septum 4/5, against which it lies, on account of the numerous strands of muscle which issue from the mass and pass backwards through the septum. When the separation has been accomplished, the posterior part of the mass is seen to be composed of numerous micronephridial tubules; the pharynx with its associated aggregations of "gland-cells" lies in front of this.

Emerging from the dorsal and lateral surfaces of the pharyngeal mass are numerous strands and sheets of muscle which take in general an obliquely backward direction; the obliquity is less in front, where the strands are more nearly transverse in direction, and greater behind, where they are

more longitudinal. Around the bases of these strands are a number of soft whitish lobular masses; these are either one to each strand, or the lobules are fused at their bases to form a transversely extended mass enveloping the origin of several strands. The whitish lobular masses are arranged in about four transverse series, and the muscle strands emerge in a corresponding number of transverse rows. The most anterior portion of the mass is smooth, and represents the thick muscular and connective tissue wall of the pharynx itself. The condition is similar to that shown in Pl. 19, fig. 1, for *P. heterochaeta*, omitting the masses in segment V.

In segment V, concealing the œsophagus, there is on each side posteriorly a considerable tuft of micronephridia, and anteriorly a mass of follicles of the so-called bloodglands (cf. Beddard, 1); these latter rest against and are connected with the posterior face of septum 4-5; they interest us here because some are found more anteriorly, embedded in the cells of the posterior portion of the pharyngeal mass.

On examining longitudinal sections through the anterior end of the worm the lobules previously mentioned are found to consist of the "pharyngeal gland-cells" of earlier authors; these cells also penetrate in for some distance between the muscular fibres, which, crossing and interlacing, form the main portion of the pharyngeal mass. The pharyngeal lumen is lined by a columnar epithelium; the ventral wall of the pharynx is thin, in contrast to the massive dorsal wall; the muscular coat is here no thicker than the layer of epithelium, and the "gland-cells" are absent.

Since these cells are certainly not glandular in the sense intended by previous writers, and since their function is not fully known, it is advisable to drop the earlier name. I propose to call them chromophil cells, because of their peculiar staining properties; which, in sections stained by hæmatoxylin, for example, render the masses immediately obvious even on a naked-eye inspection.

The Chromophil cells (Pl. 19, fig. 2).—The individual

cells are of various shapes—more or less polygonal, triangular, crescent-shaped, or altogether irregular—according to the disposition of the adjacent cells. They do not however as a rule fit closely together, and are mostly well separated by clefts from their neighbours. They are usually longer in one direction than the other; the longer diameter may measure, on an average, 17μ ; the shorter, perhaps, 10μ . Their outlines are not definite, and they are frequently continuous at their periphery with an amorphous or fibrillar coagulum-like substance, which partly fills up the intercellular spaces, and by the intermediation of which the cells may be continuous with each other.

The nucleus is often obscured by the deeply-staining portion of the cell-body to be described. It is subspherical or shortly oval, $4.5-6\mu$ in its long diameter. The nucleolus is large and distinct, evenly staining, and often somewhat excentrically situated; granules of chromatin occupy the more peripheral region of the nucleus (obscured in the figure).

The cell-body may be distinguished into deeply and more lightly staining portions. The deeper staining portion is always considerable in amount, and may form almost the whole of the cell-body; no further structure can be made out in this portion; it is seldom well defined in its extent, and merges into the more lightly staining portion at its periphery. The outer portion of the cells stains more lightly, and has a granular, or sometimes apparently a reticular constitution; it has often no definite peripheral boundary, the cell having a ragged edge as if its outer portion were disintegrating; or it merges into the loose substance between and sometimes connecting the cells.

Transformation of the Cells.—These cells are typically seen, and in large numbers, dorsally and posteriorly on the pharyngeal mass; where, as a compact aggregate, they form the lobules previously described, which are penetrated by the emerging muscular bundles; near the posterior limit of the mass there is in addition an admixture of follicles of "blood-

glands." Further forwards in the pharyngeal mass, dorsal to the cavity of the pharynx, in what may be called the transition zone, the cells become sparser, and interlacing muscular fibres form the bulk of the mass. In this zone the cells are seen to change their characters as they are traced gradually forwards and inwards. They become rather smaller in size; the deeply staining matter becomes less in amount, and is aggregated in smaller masses; and the cell-body becomes continued into the now abundant fibrillar strands between the muscle fibres. Numbers of such cells can be seen, which, with still a considerable amount of deeply-staining matter, dissolve at their periphery into the fibrillar or reticular packing tissue ("Füllgewebe") between the muscle fibres (compare Pl. 19, fig. 5, from *P. hawayana*).

Still further inwards and nearer the pharyngeal epithelium the deeply staining matter disappears altogether, and the tissue passes into the abundant connective tissue of the deeper portion of the pharyngeal mass, which is absent from the more superficial region where the typical chromophil cells are aggregated. The nuclei, no longer obscured, become conspicuous; the nucleolus diminishes in size, and ultimately disappears; the chromatin grains are distributed more evenly through the otherwise clear nucleus. But even quite near the pharyngeal epithelium occasional cells are still met with which retain the characters of those in the more superficial parts of the mass.

In this deeper region the nuclei appear to undergo a final change by becoming smaller; maintaining the above characters, they can be traced down to a size measuring 4μ in greatest diameter. Along with these, in the connective tissue, another type of nucleus is abundantly represented; these, about 3μ by 2μ , are often irregular in shape; the smallest ones stain darkly, and are almost homogeneous; some appear clearer, with a few grains of chromatin. These I believe to represent the nuclei of the original connective tissue element of the muscular dorsal wall of the pharynx. They are similar to connective tissue nuclei elsewhere, and, as will

be seen, are found numerous in young specimens, where the chromophil cells have undergone little change.

I am doubtful if it is always possible to distinguish between these smaller nuclei and the last stage of transformation of the nuclei of the chromophil cells. But, in spite of the fact that discrimination of the separate elements may be impossible in the adult, it seems necessary to attribute a double origin to the connective tissue of this region.

The Capsule.—In view of what will be said later, the relation of the cells to the peritoneum is of interest. The lobular masses are surrounded by a thin capsule,—a membrane-like expansion, with fairly numerous ovoid or flattened nuclei, which show scattered chromatin granules but no nucleolus. The membrane bridges over the clefts between adjacent cells at the surface of the mass; it is in many places distinctly differentiated from the underlying cells, staining pink with eosin, and hence sharply marked off from the chromophil cells beneath. In places the membrane may contain numbers of brown chloragogen grains; in this condition it may be still a moderately thin (3-4 μ) membrane, or it may be swollen so as to be fairly described as being composed of somewhat flattened chloragogen cells; but there are no chloragogen cells of the usual elongated type. In places the capsule is absent, and the—sometimes indefinite—limits of the chromophil cells themselves form the boundary of the mass.

PHERETIMA HETEROCHÆTA.

General description (Pl. 19, fig. 1).—In this species the cells, as in *P. posthuma*, form lobular masses on the pharynx (c^1); but in addition lobules composed of chromophil cells extend backwards, dorsal to the œsophagus, into segment V (c^2 , c^3), where they are altogether behind the pharyngeal region of the alimentary tube. Crossing segment V in a more or less longitudinal direction are a number of muscular bands which pass backwards from the pharyngeal mass in front; the more superficial of these (m^2)

are partly, the deeper are wholly, surrounded by the soft white masses of the cells (c^2 , c^3). The "blood-glands" appear as masses of grape-like follicles in segment VI, clustering round the backward prolongations of the muscle bands; follicles also occur, as seen in sections, within the lobular aggregations of the chromophil cells, both in segment V and on the pharynx.

The Chromophil Cells (Pl. 19, figs. 3, 4). The cells resemble, on the whole, those described for *P. posthuma*; but those of the posterior portion of the mass are in general more definite in outline than in the previous species, and do not here dissolve into the intercellular and connecting substance to the same extent. The nucleus is again characteristic,—a spherical or shortly ovoid vesicle with large nucleolus and scattered chromatin.

Transformation of the Cells.—In the backwardly projecting lobular masses of pharyngeal cells are strands of connective tissue,—a lightly-staining substance, scarcely definitely fibrillar in structure, though with an obvious longitudinal differentiation which is manifested by the deeper staining of small streaks in the direction of the length of the strand. In these strands are contained numerous cells, of the general nature of those already described; many of these dissolve at their extremities into the substance of the strand without any demarcation; some however are distinctly outlined; the nuclei may still be perfectly distinct when most of the cytoplasm has dissolved away. Indefinite masses of deeper staining material, continuous with the substance of the strands, and without nuclei, are also seen (possibly nuclei are not present merely because of the plane in which the section happens to be taken). (Compare Pl. 19, fig. 5, from *P. hawayana*).

Similarly amongst the muscular fibres on the dorsum of the pharynx are strands of connective-tissue of the above type with small islets of cells. The cells are in part individually distinct, in part continuous with the connective-tissue. As the transformation of the cells proceeds, the

nuclei become smaller; the nucleoli also diminish in size; and when the deeply staining substance has altogether disappeared the nuclei (or some of them) seem to disappear also, becoming fainter and less easily distinguishable; so that ultimately tracts of connective-tissue of some little size—at least as large as several of the original cells—show no nuclei at all.

The Capsule.—The lobes are surrounded by a capsule, which consists of a thin membranous sheet with not infrequent oval nuclei. This constitutes a very definite peritoneal covering over the posteriorly projecting lobules; over the more anterior masses it is less evident. But even there it can be made out in places by means of the somewhat flattened nuclei contained within a lightly staining material, which fills up little inequalities in the surface or forms small projections. In other parts however no capsule is discoverable; the limit of the mass is the limit of the chromophil cells themselves; and, as owing to the disintegration of the periphery of the cells this is not always sharply defined, it would be easy in such places to distinguish a limiting membrane if one were present (Pl. 19, fig. 4). A definite peritoneal investment covers the muscular strands which issue from the pharyngeal mass.

PHERETIMA HAWAYANA.

General description.—The condition is not unlike that of the last species (Pl. 19, fig. 1). The pharynx is covered by a soft white mass, from which muscle bands emerge. Projecting behind the pharynx, and therefore in segment V, there are on each side two lobes, one above the other. The upper lobe has a smooth surface, and three muscular bands emerge from its posterior border; the lower is larger, triangular in shape with its apex backwards, smooth for the greater part, but the posterior tapering portion consists of follicles of the "blood-glands" clustering round a muscle strand. Other strands also emerge from this lobe; and on

sectioning, follicles of the "blood-glands" are found numerous within the cellular masses, even deep amongst the chromophil cells of the dorsum of the pharynx.

The Chromophil Cells and their Transformation.
—The cells which compose the main portion of the white masses on and behind the pharynx are polygonal or irregular in shape, 20–25 μ in longest measurement, sometimes separated from each other by linear spaces; such have therefore a definite outline. The nucleus, up to 6 μ in greatest diameter, is conspicuous, vesicular, with large nucleolus and numerous granules of chromatin. The cytoplasm as a whole stains deeply but not homogeneously, and the lighter staining or non-staining portions of the cells appear sometimes as relatively large areas which may resemble vacuoles. (A similar condition is shown in Pl. 19, fig. 5, which, however, is from *P. heterochæta*.)

Besides the cells with definite outline, a number are also visible in which the central deeply staining cytoplasm shades off into a peripheral region, less deeply staining and with a fibrillar structure; this peripheral region again in places is indistinguishable from an intercellular substance.

Passing inwards towards the pharyngeal epithelium the continuity of the cells with the connective tissue, now considerable in amount, is very evident. The connective tissue accompanies the muscular fibres in close association, its fibrillæ often running parallel with the fibres. The cells still retain some of the darkly staining substance (Pl. 19, fig. 5).

Still deeper in the pharyngeal mass there may be no stainable cytoplasm in association with the nuclei; these then lie in the connective-tissue. Such nuclei are smaller, more irregular in shape, sometimes appearing shrivelled; the nucleolus decreases in size, and may become indistinguishable from the chromatin grains. Appearances suggest that some at least of these nuclei break up and disintegrate, sometimes by dividing into two small vesicles each with a staining granule in its interior, sometimes by becoming as a whole progressively more indistinct.

The Capsule.—A peritoneal covering limits the lobes in some places. The nuclei of this membrane are rounded or slightly flattened; the membrane itself is in places a distinct pink-staining (in hæmatoxylin and eosin preparations) moderately thick expansion. In some regions, while it is still possible to speak of an investing membrane, the cells composing this latter are seen to be continuous with the chromophil cells and to have the same cytoplasmic constitution. In other places no investing membrane is present.

In the adult *Pheretima* therefore, the chromophil cells form lobular aggregations covering the muscular mass of the dorsum of the pharynx; and in some species they also extend backwards behind the pharynx as lobe-like masses. The cells also extend deeply inwards amongst the muscular fibres in the direction of the pharyngeal epithelium; but here they become modified, the cytoplasm being progressively converted into connective tissue. The connective tissue of this region has therefore probably a double origin. The descriptions of the peritoneal capsule suggest that it and the chromophil cells are modifications of the same tissue; where the capsule is absent, the cells lining the cœlomic cavity have become chromophil cells; where present, the cells in immediate relation to the cavity have become flattened, while those underneath have taken on the chromophil character.

LUMBRICIDÆ.

As an example of what is seen in the dissection of one of the Lumbricidæ, it will be sufficient to describe *Helodrilus caliginosus*, perhaps the commonest of all earthworms; the histological appearances in this species are similar in all main features to those of *Pheretima* (except that there are no "blood-glands" among the chromophil cells), and they therefore need not be detailed. Instead, an account of the microscopical structure of the chromophil tissue in *Helodrilus parvus* will be given; this species is too small to

allow of much being seen in dissection, but examined microscopically it presents a number of interesting features which go some distance towards elucidating the origin of the cells.

The Disposition of the Cell-masses in *H. caliginosus* (Pl. 19, fig. 6).—The combined mass of chromophil cells is situated dorsally on the pharynx, and extends backwards as far as septum 5/6. The cellular aggregate appears as a number of white lobes amongst the muscular strands; the general arrangement is one of four transverse bands. The posterior of these transverse elevations is divided into two by a cleft in the mid-dorsal line, and forms a single rounded pillow-like mass on each side (c^4). The next is not divided, and forms a single transverse elevation across the dorsum of the pharynx (c^3). The second is divided up into a number of separate lobules (c^2), and appears therefore as a transverse row of rounded projections. The first is similar to the second (c^1).

The cellular masses extend downwards on the sides of the pharynx about as far as the lateral line or a little further; the first transverse row may be shorter.

Each lobule of the two anterior rows is associated with a muscular strand (m), the base of which it surrounds. The third, undivided elevation, has a number of muscular bands emerging in a transverse series from its posterior face. The fourth is not associated with muscular strands.

The General Relations of the Cell-masses in *H. parvus* (Pl. 19, fig. 7).—As seen in sections, the much lobulated pharyngeal cell-mass (c^1 , c^2 , c^3), situated dorsal to the pharynx, extends also behind this region, and partially surrounds the first part of the œsophagus. It thus occupies segments IV, V, and VI; the portion in segment VI is to some extent separate, being divided from the rest by septum 5/6, through which it communicates with the anterior portion by a constricted neck. In segments IV and V the mass is penetrated by a number of muscular strands.

But in this species the characteristic cells have a considerably greater extent of distribution than in the forms

previously described. Thus in segments V and VI the main mass extends downwards on each side to within a short distance of the mid-ventral line (*cv*). An aggregate of cells is present in segment VII, ventrolateral to the œsophagus on each side, in close association with the lateral œsophageal ("intestino-tegumentary") blood-vessel. Similar small aggregates occur in segments VIII and IX. Small masses of cells are present dorsally in VIII, between the wall of the œsophagus and the dorsal vessel; and, at least in one specimen more minutely examined in this connection, also dorsally on the œsophageal wall in IX, in the angle between the alimentary tube and septum 8/9; on both anterior and posterior faces of septum 9/10 below the œsophagus; ventrally in segment X in association with a blood-vessel; and on the wall of the œsophagus below the dorsal vessel at the level of septum 10/11.

The Chromophil Cells.—(Pl. 19, fig. 8).—The cells are oval or irregular in shape, a small one measuring $9\ \mu$, a large one $18\ \mu$ in greatest length. They do not fit closely together; the interspaces are empty or contain an intercellular matter.

The nucleus is large and conspicuous, vesicular, spherical or ovoid, $4\ \mu - 6\ \mu$ in longest diameter, often peripherally situated, and clearer than the stained cytoplasm around it. Besides small grains of chromatin there is a large nucleolus, of different material from the chromatin grains, the central portion of a bluish tinge in alcoholic iron-hæmatoxylin preparations, the periphery darker and more opaque. This large nucleolus may be absent; and then the deeply staining chromatic granules are alone visible, of which one may be larger than the rest.

The cell-body contains masses of deeply-staining material, the remainder of the cytoplasm being more slightly coloured. The less deeply staining areas are more peripherally situated; the more densely coloured portion usually encloses the nucleus, and on the whole is more central in position; it may be prolonged in one or other direction as fibril-like strands.

The intercellular substance is not as a rule sharply

marked off from the cells; the periphery of the cell fades away into the intercellular substance, and in the measurements of the cells as given above, the reference is to the deeply staining portion only, on account of the impossibility of determining the limits of cell and intercellular matter. In amount this latter may be very considerable, and the staining portions of the cells are then comparatively widely isolated from each other. It has the character of a granular amorphous matrix, into which the bodies of the cells merge, and through which some of the fibrillar processes of the deeper staining matter are continued.

Transformation of the Cells.—The chromophil cells in this species are more completely aggregated together on and behind the pharynx than, for example, in *Pheretima posthuma*; the number of the cells which penetrate inwards amongst the interlacing muscular fibres on the dorsum of the pharynx is much smaller. The chromophil cells which occur between the muscular fibres are mostly isolated, or in twos and threes; in them the densely staining matter becomes less in amount, the periphery of the cell may show a reticular structure, and the cell processes are distinctly fibrillar. At a further stage the deeply staining matter disappears; the cell elongates to form a strand, the nucleus is at one side, the pale-staining fibrillæ form a reticulum. Longer strands appear, composed apparently of several cells, since they may contain one, two, or more nuclei. The nuclear changes are similar to those previously described; the nucleolus becomes smaller, and disappears or becomes indistinguishable from the chromatin grains; the nucleus itself decreases in size, and becomes faint and difficult to distinguish; appearances here again suggest that at this stage it sometimes divides; ultimately it seems to disappear.

The Capsule.—In the adult, a peritoneal capsule is present in parts over the main mass of the cells, especially posteriorly; in other species also the posterior surface appears to be the region where a recognisable capsule is best developed. But it is absent in other parts,—perhaps in

most parts ; and then the chromophil cells themselves form the limit of the mass.

The smaller masses of chromophil cells, which occur in some abundance in this species in several segments behind the main mass, show interesting relations and give considerable help in elucidating the origin of the tissue.

Relation of Chromophil Cells to Septa.—The small masses of cells on septum 9/10 are directly in contact with the muscular fibres of the septum, taking the place of the peritoneum at the spots where they occur. At one point a still smaller aggregation appears to be essentially a slight swelling of the peritoneal covering of the septum. Again at another point a single cell of the chromophil type takes its place in the series of peritoneal cells with flattened nuclei on the septum. One of the larger aggregates is continuous through the septum with a smaller mass on the other side. The aggregates, of all sizes, are continuous with the peritoneum.

Relation to the Alimentary Canal.—The cells which lie on the alimentary wall in segment IX are situated immediately outside the muscular layer. Others are in close contact with the blood-vessels which occur external to the muscular layer on the surface of the œsophagus, and not only on the outer side of the vessels, but also between the vessels and muscular fibres of the alimentary wall. In places where the muscular layer of the wall is not visible (probably because of gaps in the arrangement of the fibres), the cells are in actual contact with the epithelium of the œsophagus. Occasional cells are found singly here and there internal to the muscular layer, in the irregular space between the muscle fibres and the base of the epithelial layer.

Relations to Blood-vessels.—The cells which are situated on the lateral œsophageal trunks are in direct apposition with the muscular or connective tissue coat of the vessels, which they surround on all sides. There is no separate peritoneal coat surrounding the vessel apart from

the chromophil cells; nor any peritoneal membrane outside the cell mass.

The appearances in *Helodrilus* are therefore confirmatory, in general, of the results obtained from a study of *Pheretima*; but in addition, the facts relating to the small masses of chromophil cells on the septa, on the blood-vessels, and on the alimentary canal allow us, more decidedly than in *Pheretima*, to derive them from the peritoneum,—to consider them as modifications of the peritoneal layer, with which they are continuous, or the place of which they take. The occurrence of a few cells or cell aggregates in close relation to the alimentary canal is interesting in connection with former views on the nature of the cells. But here also they are to be regarded as modified peritoneal cells, which in places come in contact with the base of the epithelial layer through a hiatus in the muscular coat, or perhaps here and there make their way inwards between the muscle fibres.

THE APPEARANCES IN YOUNG SPECIMENS.

I turn now to the results obtained from the examination of young worms, of various ages, of both genera. In the case of the *Pheretimas* it is impossible to be certain of the species to which young examples belong, since the discrimination of the three species which are found in Lahore is made by means of the genital system (including especially the external sexual marks). The young *Lumbricids* examined belonged to the smaller species, *Helodrilus parvus*.

Non-sexual Pheretima.—In a *Pheretima* which is approaching its full size but is still without sexual marks, the condition is not markedly different from that previously described. The cells of the lobular mass are irregular in shape but definite in outline; they do not dissolve at their margins into an intercellular substance. In size, 20μ would be the greatest length of a moderately large one. The nucleus has the same general characters as in fully-grown

specimens; the large nucleolus, always present, may measure a third to two-fifths of the long, and even a half of the short diameter of the usually ovoid nucleus. Here too the cytoplasm is not uniform, but shows darker and lighter patches, the latter sometimes almost clear and vacuole-like; the darker patches are homogeneous, more or less central, and contiguous to the nucleus.

Deeper in the pharyngeal mass (Pl. 19, fig. 9) the admixture of cells is not great. The nucleus enlarges; the cell-body, smaller, dissolves at its periphery into a reticulum of fibrillar connective tissue; or the cell-body may be absent as such, having wholly broken up into fibrils, so that one side of the nucleus is bare. Still nearer the pharyngeal epithelium the nucleolus decreases in size.

The chief features of this stage are, therefore, the integrity of the cells in the lobular masses, where they have not begun to disintegrate; and, apparently, the larger size of the nucleolus. The connective tissue change is proceeding in the cells which have penetrated inwards amongst the muscle fibres.

Pheretima of diameter 1.5 mm.—The cells in the posterior and superficial portion of the mass measure 15–25 μ , are of various shapes, and well defined in outline. The cell-body consists as before of two portions, a more lightly and a more deeply staining; the latter occurring as amorphous masses, the former having a granular structure. The granules of the lighter portion appear to be the same in substance as the deeper staining masses, only not so closely aggregated; and the deeper staining portion merges into the other by becoming looser in texture.

The passage forwards towards the pharyngeal epithelium is interesting. The cells, which posteriorly are in a compact mass with only an admixture of muscle strands, become much more scattered; the muscle fibres, now arranged in a variously interwoven felt, contain within their meshwork isolated cells; the whole texture is loose. In a few cells here and there the beginning of a connective tissue change is to

be recognised ; but in general even the deepest cells retain their original characters.

The cells cease altogether some distance from the pharyngeal epithelium ; in other words, they have not yet distributed themselves throughout the whole pharyngeal mass. Near the pharyngeal epithelium and between the interlacing muscle fibres are scattered nuclei belonging to the sparse connective tissue of this region. These nuclei are of various and sometimes of irregular shape, and scarcely any structure is to be made out in them ; the connective tissue, reticular or amorphous, is non-staining ; and there is no transition between this tissue and the chromophil cells. It represents the ordinary connective tissue of the muscle, and is comparable to the connective substance between the muscle fibres in the body-wall, or in other regions of the alimentary tube. The adult connective tissue of this region has, therefore, as previously surmised, a double origin.

For the greater part of the surface of the mass there is nothing of the nature of a capsule ; the margin of the mass is the distinctive cytoplasm, coarsely granular in character, of the chromophil cells, and there is an entire absence of any superficial differentiation, or of any special covering. In places however a little pinkish-staining (in hæmatoxylin and eosin preparations) matter, of a membranous or connective tissue-like appearance, is seen on the surface ; sometimes the membrane is of linear tenuity, sometimes more bulky.

Where the muscle strands leave the mass a few chromophil cells appear sometimes to have travelled a little way along the strand, and hence are seen adhering to the strand just after it has emerged from the main aggregate of the cells. While some such cells appear to be underneath the peritoneal investment of the strand, others are absolutely continuous with it ; in other words, some of the peritoneal cells, instead of retaining the usual flattened form, are swollen, and contain the chromophil substance.

Pheretima of diameter 1 mm.—In a still younger stage the cells, which already have a very marked chromophil

character, are still more definitely confined to the posterior and dorsal portions of the mass. They are entirely absent from half of the thickness of the mass,—that half which is nearest to the pharyngeal epithelium.

The shape of the cells is, as before, various; the outlines are well-defined, and there is for the most part no shading off into an intercellular substance. An average measurement in the longest diameter would be 15μ ; 20μ would be exceptional. The nuclei are to a considerable degree obscured; they measure $3.5-4\mu$ in greatest diameter, are vesicular, shortly ovoid, with large equably staining nucleolus and scattered, sometimes mainly peripheral, chromatin grains. The nuclear characters are thus already remarkably like those of the adult. The cells are rather loosely arranged, with considerable intervals.

Here and there, in the most deeply placed cells,—those which have wandered off a little from the main mass and form the outposts of the aggregate,—there is a slight indefiniteness of boundary owing to the peripheral portion of the cell-body becoming disintegrated into granular matter. But there is no formation of connective tissue; the connective tissue of the pharyngeal mass at this stage has therefore an entirely different origin. This specimen agrees with the last described in the nature of this connective tissue of the deeper part of the mass, and of its nuclei; and also in the absence or very slight and partial development of a capsule.

Summary of Appearances in Young *Pheretimas*.—
In successively younger specimens of *Pheretima* therefore:

(1) The cells are more and more confined to the superficial portion of the pharyngeal mass. This is strongly suggestive of a derivation from the peritoneum; it is the opposite of what, presumably, would happen if the cells were derived from the pharyngeal epithelium.

(2) The disintegration and the transformation of the cells into connective tissue is progressively less marked.

(3) The capsule is less differentiated; the chromophil cells, which in places even in the adult border the cœlomic cavity

without the intervention of a peritoneal layer, do so in the younger stages almost over the whole surface of the mass. In other words, the chromophil cells are not derived from a previously differentiated flattened peritoneal layer; the chromophil cells, and the flattened peritoneal cells which cover neighbouring structures, are equally specializations of the lining cells of the cœlomic cavity. The inference, drawn from the appearances in the smaller masses of cells in *Helodrilus parvus*, that the chromophil cells are derived from the peritoneum, requires to be understood in the above sense; the often flattened cells of the peritoneal membrane, which in the adult covers the greater portion of the mass, are derived from the superficial cells of the chromophil tissue, with which (cf. the description of *P. hawayana*) they may still be connected, rather than vice-versâ.

Young *Helodrilus Parvus*.—Two small specimens, in diameter .7 mm. in the anterior part of the body, were examined; and several still smaller, .5 mm. in diameter; even in some of these small specimens sexual organs, both testes and ovaries, were beginning to form. Since the appearances are merely, for the most part, confirmatory of what has gone before, a short account will be sufficient.

The chromophil cells scarcely penetrate at all into the muscular felt on the dorsum of the pharynx, and form only the lobed masses round the muscular strands which emerge. In the larger of these specimens these lobes extend backwards through segments V and VI; smaller patches of the cells are present in VII, VIII, and IX on the walls of some of the blood-vessels, on the septa, and in the angle between the septum and the alimentary tube; a few cells form a flattish layer on the ventral vessel in segment X. In the smaller specimens the lobes extend backwards, segmentally arranged, as far as segment VIII; they are as usual suspended on muscular strands passing obliquely to the parietes, and are also connected in a longitudinal series through the septa by thick strands of connective tissue, which, piercing the septa as cords, spread out somewhat in the lobed masses. The

connective tissue thus forms to a certain extent a central axis for the whole, though it is not very distinct as such in the middle of the lobes. While the appearances point, as before, unmistakably to the derivation of this connective tissue from the chromophil cells, that which sparsely penetrates between the interlacing muscular fibres of the dorsum of the pharynx has equally unmistakably another origin.

Nothing that can be called a capsule is visible; the cells form the surface of the mass. Here and there in the larger specimens, in a prolonged search, are seen a few elongated, or even flattened, nuclei on or near the surface; once a little reddish (eosin) tinted material allowed a distinction to be made between a superficial layer of tissue and the chromophil cells beneath. But practically everywhere the surface of the masses is the surface—it may be the irregular or disintegrating surface—of the chromophil cells; and where the interstices between neighbouring cells come up to the surface they are not bridged over.

These young specimens confirm in all respects what was said previously regarding the relation of the smaller masses to the septa and blood-vessels in this species. The cells appear as developments of their peritoneal covering, the place of which they take, and with which they are continuous.

THE CELLS IN THE LUMBRICID EMBRYO.

An embryo Lumbricid, pretty certainly *Helodrilus caliginosus*, about 2 mm. long, taken from the cocoon, yielded interesting results. Younger embryos, of which several were investigated, showed no trace of the chromophil cells.

The embryo was examined by transverse sections. Behind the region of the as yet entirely separate and laterally situated cerebral ganglia there is situated on each side, lateral to the alimentary tube, a mass of cells which appear to be dissolving into a reticular connective tissue, and amongst which a few muscular fibres are becoming differentiated.

This tissue is in two lateral masses, there being none covering the dorsal vessel (here still double), which lies directly on the gut. The tissue does not, as a whole, come in contact with the inner surface of the parietes—i. e. it does not fill up all available space between gut and body-wall, though connections with the body-wall exist in the form of strands of reticular nucleated tissue. The masses I take to be the dorsal mass of the œsophagus in an early stage.

At one place on the left side, at the periphery of this mass, is an aggregate of a few cells which are distinguishable from the rest (Pl. 19, fig. 10). These cells, about a dozen in number in the section which shows them best, and extending only through a few sections, are mostly elongated in one direction and $12-20\ \mu$ in greatest length. The nuclei are in most of the cells somewhat obscured and difficult to see; they are spherical or ovoid, $3.5-4\ \mu$ in greatest measurement, with a spherical homogeneous nucleolus of relatively considerable size, surrounded, in the cases where it is best seen, by a clear circular space; nucleolus and clear space are rather excentrically situated. The peripheral chromatin is distributed as distinct and fairly large granules. Some nuclei have two nucleoli; in other cells two relatively small nuclei are in close apposition; but I could not discover any mitotic figures (compare the various appearances of the nuclei in Pl. 19, fig. 10). The cytoplasm stains moderately deeply, but not so deeply as the chromophil substance of the adult cells; and not quite evenly, having a granular texture which is closer and more homogeneous in some parts than others.

These cells do not help to form the slightly pinkish (eosin staining) reticulum into which the main portion of the dorso-lateral pharyngeal masses seem to be dissolving. The cells are in several cases connected together among themselves, perhaps because nuclear division goes on in advance of division of the cell-body (see the upper left-hand part of the figure). No peritoneal membrane surrounds the mass; while on the body-wall the cells lining the cœlomic cavity are cubical with

spherical nuclei, or in places already flattened with elongated nuclei.

The characters of the nucleus, and to some extent those of the cytoplasm of these cells, resemble those of the chromophil cells of the adult; and it seems probable that we have here the first appearance of the characteristic cells of the pharyngeal mass. If so, they are evidently of mesoblastic origin, and make their appearance at the periphery of the pharyngeal mass.

FUNCTION OF THE CELLS.

Though in the light of what has gone before we may reject the usual supposition, that the cells pour a secretion into the pharynx (or œsoplagus, in the case of the smaller, more posteriorly situated aggregates), it is not easy to propose another hypothesis to take its place.

That some of the chromophil cells on the dorsum of the pharynx wander deeply into the pharyngeal mass in certain species and there give rise to a fibrillar connective tissue, seems plain. But this is obviously not the main function of the cells; nor does this change occur in the smaller, more posterior aggregates.

That the main function of the cells is metabolic is, though only a vague statement, perhaps as far as we are justified in going. In this connection the following considerations may be brought forward:

(A) Independently of the connective tissue change, the cells are frequently, or usually in the adult, seen to have indefinite outlines, and their margins appear to be disintegrating. This is visible even at the surface of the mass, in the cells which border the cœlomic cavity.

(B) The linear interspaces between the cells, always a marked feature, evidently allow of the easy percolation of the body fluids throughout the whole. Add to this the fact that the peritoneal capsule is never complete, and often (and especially in young specimens) largely absent, and we have the

possibility, at least, of an extensive exchange between the cells and the body-cavity fluid.

(c) The blood supply to the pharyngeal mass is extremely rich; this is a striking feature in the dissection of any earth-worm in which the vessels of the anterior end of the body happen to be engorged. Not only so, but in all the species of *Pheretima* examined in the present paper, as well as in certain others, there are present, within and immediately behind the pharyngeal mass, large numbers of the structures known as "blood-glands". These are spherical bodies with an afferent and efferent vessel at opposite poles, containing blood, but largely choked by a mass of blood-cells. How widely these glands are distributed is not at present known; of the many score of species of *Pheretima*, for example, by far the larger number have as yet only been examined from a systematic point of view. Blood-glands have been found in other genera of Megascolecidae also—in *Acanthodrilus* (Beddard, 1), in *Pontodrilus* (first by Perrier, cf. Eisen, 5), in *Argilophilus* (= *Plutellus*, cf. Eisen, loc. cit.)—as well as in *Sparganophilus* among the Geoscolecidae (Eisen, 5); and they not improbably occur in other genera also, where they will be revealed by a fuller examination than has yet been made. The situation of many of the smaller aggregates of chromophil cells on the blood-vessels in *Helodrilus parvus* may also be recalled in this connection.

(d) That active metabolism takes place in the pharyngeal region is also indicated by the great development of the nephridial tubules, in micronephridial genera, in some of the most anterior segments. Here again we are dealing with a character which is not of systematic importance, and which has, therefore, seldom been recorded. Very noticeable bunches of nephridial tubes opening to the exterior occur at the sides of the pharynx in several species examined by Miss Raff (7a). Bushy tufts, sometimes of relatively very great size, and always in marked contrast to the minute scattered tubules of more posterior segments, occur at the sides of and immediately behind the pharyngeal mass in, for

example, *Megascolides*, *Notoscolex*, *Megascolex*, *Lampito*, *Pheretima*, *Erythræodrilus*, *Octochætus*, *Eutyphæus*, *Eudichogaster*—to mention only genera in which I have myself observed them. The nephridia of meganephric forms are not enlarged in the pharyngeal and immediately subsequent segments; why no modification of any kind occurs in them, when in other and sometimes closely related genera a great multiplication and massing together of the micronephridial tubules takes place in this region, I am unable to say.

The chromophil cells do not stain with Lugol's iodine solution; glycogen seems therefore to be absent.

SUMMARY.

(1) The "pharyngeal gland-cells" of earthworms are not gland-cells in the usual sense, and do not communicate with the pharynx; the term "chromophil cells" is proposed for them because of their intense coloration by hæmatoxylin and similar stains. The so-called "septal glands" of earthworms are aggregations of similar cells at a more posterior level.

(2) In the chromophil cells the deeply staining matter is not equably distributed through the cell-body; the peripheral regions of the cells in general stain more lightly, and appear to be disintegrating, or merge into an intercellular substance.

(3) While most of the cells form a more or less compact aggregate on the surface of the pharyngeal mass, a number penetrate inwards towards the pharyngeal epithelium, and become progressively metamorphosed into fibrillar connective tissue.

(4) A capsule of flattened cells covering the mass, though present in part, is incomplete. The smaller masses of cells in *Helodrilus parvus* are frequently continuous with the peritoneal membrane, of which they appear as modifications.

(5) In *Helodrilus parvus*, and especially in all young earthworms, the inwandering and the connective tissue change

of the chromophil cells is less marked ; in very young specimens neither has taken place. The capsule is also more and more incomplete the younger the specimen.

(6) The cells are to be looked on as of peritoneal origin ; that is to say, they are modifications of the original lining cells of the cœlomic cavity. Hence the absence of capsule in the early stages ; and hence the original limitation of the cells to the superficial portion of the pharyngeal mass.

(7) The main function of the cells is probably metabolic ; but it is at present impossible to particularise further.

REFERENCES TO LITERATURE.

1. Beddard, F. E.—“Contributions to the Anatomy of Earthworms, with Descriptions of Some New Species,” ‘Quart. Journ. Micr. Sci.,’ (N.S.), vol. 30, 1890.
2. ——— ‘A Monograph of the Order Oligochæta,’ Oxford, 1895.
3. Dobell, C. C.—“Cytological Studies on Three Species of *Amœba*,” ‘Arch. Protistenkunde,’ vol. xxxiv, 1914.
4. Eisen, G.—“Pacific Coast Oligochæta,” ‘Mem. Calif. Acad. Sci.,’ vol. ii, No. 4, 1895.
5. ——— *Ibid.*, No. 5, 1896.
6. Hesse, R.—“Zur vergleichenden Anatomie der Oligochæten,” ‘Zeit. f. wiss. Zool.,’ vol. lviii, 1894.
7. Parker and Haswell.—‘A Text-book of Zoology,’ London, 1910.
- 7a. Raff, Janet W.—“Contributions to our Knowledge of Australian Earthworms. The Alimentary Canal ; Pt. 1,” ‘Proc. Roy. Soc. Vict.,’ vol. xxii (N.S.), pt. 2, 1910.
8. de Ribaucourt, E.—“Etude sur l’anatomie comparée des Lombricides,” ‘Bull. Scient. France et Belg.,’ vol. xxxv, 1901.
9. Vejdovsky, F.—‘System und Morphologie der Oligochæten,’ Prag, 1884.
10. Vogt and Yung.—‘Traité d’anatomie comparée pratique,’ Paris, 1888.

EXPLANATION OF PLATE 19.

Illustrating Prof. J. Stephenson's paper, "On the So-called Pharyngeal Gland-cells of Earthworms."

Fig. 1.—*Pheretima heterochæta*; dissection of anterior end. *c*¹, Masses of chromophil cells on pharynx; *c*², upper, and *c*³, lower cellular masses in segment V, behind pharynx; *d. v.*, dorsal vessel; *m*¹, *m*², muscular strands emerging from masses of chromophil cells; *n*, masses of micronephridia; *ph.*, pharynx; 4/5, 5/6, the corresponding septa, the latter turned back. × 8.

Fig. 2.—Chromophil cells from the pharyngeal mass of *Pheretima posthuma*. × 1250.

Fig. 3.—Individual chromophil cells from *Pheretima heterochæta*. × 1650.

Fig. 4.—Portion of the surface of the pharyngeal mass in *Pheretima heterochæta*, showing the general characters of the cells, clefts between the cells, and, at this place, entire absence of capsule. The surface of the mass is below in the figure. × 1000.

Fig. 5.—Chromophil cells at some depth in the pharyngeal mass of *Pheretima hawayana*, undergoing transformation into connective tissue. *n*, Nuclei whose stainable cytoplasm has undergone conversion, and which are themselves becoming fainter; *m*, mass of staining material, apparently without nucleus. × ca. 1250.

Fig. 6.—*Helodrilus caliginosus*; dissection of anterior end *c*¹-*c*³, Lobular masses of chromophil cells on pharynx; *m*, muscular strands emerging from the masses; 5/6, 6/7, the corresponding septa (the first few septa are absent or unrecognisable). × 6.

Fig. 7.—*Helodrilus parvus*, an approximately median longitudinal section. *c*¹, Lobular masses of chromophil cells in segment IV, on dorsum of pharynx; *c*², the same in segment V; *c*³, the same in segment VI; *cv*, a portion of the latter appearing ventrally; *c. g.*, cerebral ganglion; *d*, dorsal mass of the pharynx, consisting of connective tissue and muscle strands; *æs.*, œsophagus; *ph. div.*, dorsal diverticulum of pharynx; *v. n. c.*, ventral nerve cord; 4/5, 5/6, 6/7, the corresponding septa. × 40.

Fig. 8.—Chromophil cells of *Helodrilus parvus*. × 1250.

Fig. 9.—Chromophil cells of non-sexual *Pheretima* at some depth

in the pharyngeal mass. The features are the large nucleus and the relatively small amount of cytoplasm which is undergoing fibrillar change. $\times 2000$.

Fig. 10.—Certain cells at the periphery of the loose mass dorso-lateral to the pharynx in a Lumbricid embryo. $\times 1650$.

The Chromosome Complex of Culex pipiens.

Part II.—Fertilisation.

By

Monica Taylor, S.N.D., D.Sc.

With Plate 20 and 1 Text-figure.

CONTENTS.

	PAGE
INTRODUCTION	287
MATERIAL AND METHODS	289
THE REPRODUCTIVE ORGANS	295
THE EGG	295
GENERAL	298
SUMMARY	299
NOTE	299

INTRODUCTION.

In the summary of a paper, entitled "The Chromosome Complex of *Culex pipiens*" (4), it was stated that:

(1) The somatic number of chromosomes is three, both in the male and female.

(2) The number of chromosomes in the spermatogonia, as well as in the primary and secondary spermatocytes and spermatids, is three.

Two alternative suggestions as to the cause of this apparent anomaly were offered:

(1) The non-participation of one of the gametic nuclei in the formation of the "zygote" in "fertilisation."

(2) The fusion of three pairs of homologous chromosomes at some early stage in the life-history, this fusion remaining permanent throughout later divisions. In the discussion preceding the summary it was stated that the question could not be settled until the fertilisation process had been examined.

This work on the cytology of *Culex*, as stated in the introduction of the above paper, had been undertaken because of the importance of the conclusions given by Miss Stevens in her paper, entitled "The Chromosomes in the Germ-cells of *Culex*" (3).

The second of the alternative suggestions offered above is a modification to meet the particular needs of the case of *Culex pipiens* of Miss Stevens' statement that: "Parasynapsis (parasynopsis) occurs in *Culex* in each cell generation of the germ-cells, the homologous maternal and paternal chromosomes being paired in telophase, and remaining so until the metaphase of the next mitosis."

Difficulties in obtaining the necessary material, and in the technique connected with the food supply of the imagines, delayed, for the time being, the examination of the fertilisation processes, and prevented the demonstration of the whole history of oogenesis.

Dr. Woodcock's paper "On 'Crithidia' fasciculata in hibernating mosquitoes (*Culex pipiens*) and on the question of the connection of this parasite with a Trypanosome" (5) has, however, incidentally filled up some of the gaps left in the history of oogenesis, and, in this paper, the technique of artificial rearing of *Culex pipiens* in all stages of its life-history has been described.

I should like to take this opportunity of thanking Dr. Woodcock not only for sending me a Reprint of this paper, but also for giving me full details in writing of his experiments, by which I have been enabled to repeat his work with similar success, and also, as will be shown later, to confirm his statement that "*Culex pipiens* is essentially the British mosquito which likes Avian blood."

In the 'Proceedings of the Royal Society,' 1915, a full description of the chromosome cycle of Coccidia and Gregarines appeared (Dobell and Jameson) (1), a work which elucidates a cytological condition of affairs superficially somewhat similar to that which obtains in *Culex pipiens*. The authors of that paper demonstrate the presence of the haploid number of Chromosomes at every nuclear division in the life-history of *Aggregata* and *Diplocystis* except in the zygote.

In 'Chromosome Studies of Diptera' (2), July, 1914, Charles W. Metz calls attention to the neglect of Diptera by students of cytology—a neglect all the more pronounced when contrasted with the great amount of energy expended upon other insect-groups—notably Hemiptera, Orthoptera, Coleoptera. He offers, as a probable explanation of this neglect, the unsuitability of Dipterous material for cytological study and the great difficulties connected with such study. The results embodied in Metz's paper, as will be shown later, have been helpful in interpreting the phenomena observed in *Culex* and in showing that there is no essential difference between it and other Diptera.

Dr. Woodcock discovered that, after the summer female of *Culex pipiens* has fed once on the blood of a living bird, the eggs attain their normal size and are ready for fertilisation. The raft is laid almost immediately after the second feed—fertilisation taking place in the interval between the two meals. This probably accounts for the fact that females reared in captivity and fed on a fruit diet appear never to be fertilised.

MATERIAL AND METHODS.

In the summer of 1915 cages similar to those described by Dr. Woodcock were set up in the College Laboratory of Notre Dame, Glasgow, young pigeons being employed as food. A pigeon was also caged in the near neighbourhood of a wooden tub stocked with larvæ, and placed in a small garden at Notre Dame. Control experiments, which will be described

later, were also started at Ladywood, Milngavie, the source of the material for all these experiments being mainly a rectangular iron trough near the farm-yard of Garscadden Mains, Bearsden. Two rafts were found during the course of the summer 1915 in the wooden tub, although all attempts in previous years to induce the imagines to lay there, or to lay in any of the aquaria on the premises, had failed. This experiment would seem to show that wild birds are not so easily bitten by the gnats as domestic birds, since many sparrows, thrushes, and blackbirds visit the small garden in which the tub is situated.

The season's experience of artificial rearing showed that the number of egg-rafts produced under artificial conditions was not likely to be sufficient for a thorough investigation of the fertilisation processes. Moreover, unfertile egg-rafts were frequently obtained by Dr. Woodcock from the artificially confined imagines, and I too obtained rafts which produced no larvæ; while, on the other hand, egg-rafts laid in the open invariably produced larvæ. For these reasons the confinement of the imagines in netted chambers was abandoned, and the stocking of a pond at a convenient place in the country was resolved upon.

In view of the above experiments, and of the fact that all the sources of material already used had been situated in the vicinity of farm-yards, it was decided to establish such a pond at Ladywood, near a stock of poultry—these latter birds being evidently easier of access than wild birds. Earlier in the summer of 1915 several small troughs, 12 in. in diameter, and about 6 in. in depth, had been stocked with larvæ to serve as control experiments to those being carried on at Notre Dame. The results were disappointing. No egg-rafts appeared on these small ponds (during the summer of 1915). The number of female gnats seeking for hibernating quarters in the autumn of that year around Ladywood showed that the imagines, developed from the contents of the small troughs mentioned above, must have found a pond more suitable to the needs of their offspring than those pre-

pared for them in the garden of Ladywood. Mr. MacDougall's permission having been obtained, a hunt over his nursery gardens revealed the secret of the non-appearance of rafts on the Ladywood ponds. A large disused iron bath, elliptical in form (36 in. \times 26 in. \times by 11½ in.), and containing stagnant water, was swarming with larvæ and pupæ of every age which were evidently supplying hibernating imagines. This discovery was made too late in the year to be utilised for the further production of rafts—but it showed that the situation was a good one—the former experiments having possibly failed because of the smallness of the troughs, and because they were more or less concealed by the surrounding grass.

Early in 1916, thanks to the kindness of Mr. MacDougall, four ponds, A, B, C, and D respectively, were prepared: One (A), a large circular iron trough, diameter 30 in., greatest depth 24 in.; another (B), a wooden tub, 25 in. in diameter, depth 16 in.; the third (C) was the bath already selected by the gnats in 1915; the fourth (D), a rectangular porcelain sink, 20 in. \times 14 in. \times 10 in.

The first two, A and B, were situated side by side, being protected on the north by shrubs, and on the east by a wall. The iron trough (A) was exposed to all the sunshine of morning, afternoon, and evening; the wooden one (B), being nearer the wall, was more shaded. Both, however, were quite unhidden by vegetation. The tinned iron bath (C) was surrounded on three sides by glass-houses, and exposed on the southern side; the fourth (D) was placed in the open grass of an open space.

On May 21st, 1916, fifteen egg-rafts were discovered in A—there was thus no necessity to stock the ponds. No rafts appeared on the water in the wooden pond until June 15th. The preference shown by the gnats for the iron trough, and for the tin bath, may be due to the higher temperature of the water of these, or to the fact that they were in a more exposed situation, and consequently more easily found. The porcelain trough has never been popular, comparatively few rafts being forthcoming.

The rafts found in May and June were evidently those laid by the hibernating imagines seen in the previous autumn, since, after that date, eggs were not abundantly produced until the middle of July, when a spell of exceptionally warm, moist, weather conduced to an abnormally abundant supply. This supply continued to be good until the middle of August, when the spell of hot weather ceased. Odd rafts were occasionally found until the end of August.

In one of his letters Dr. Woodcock expressed his opinion that the rafts were deposited at about 5 o'clock in the morning, and text-books also state that the early hours of summer mornings are chosen by the gnats for the purpose of egg-laying. On July 12th, 1915, an egg-raft, cream-white in colour, was found at the Bearsden pond at 5 a.m. Portions of this raft were fixed at intervals of a quarter of an hour, and sections showed that it was quite young. After a careful study of ponds A, B, C, and D it became clear that, at Milngavie, most rafts are laid between the hours 9.30 p.m. and 12 p.m., very few between 12 p.m. and 4 a.m., and some between 4 a.m. and 6 a.m. As the season advances fewer are laid in the morning hours. Damp heat conduces greatly to the deposition of rafts, many more being forthcoming after a day of calm, moist, close weather. Numerous imagines were always hovering over the ponds in the evenings at a height of about six feet. These disappeared during the day time.

No difficulty in rearing the larval and pupal stages of the gnat occurred until the summer of 1915—the critical period in the life-history of the *Culex* being apparently the imago period. Even in exceptionally favourable circumstances the number of egg-rafts deposited at any one period bears a very small proportion to the number of imagines that escape from the pupal cases, and this has been very marked in a long study of the naturally occurring ponds. However, in the summer of 1916 *Daphnia* were introduced into the gnat cultures at Notre Dame, and since these, like the *Culex* larvæ, also flourish well on a diet of *Chlamydomonas*, the tub quickly became swarming with *Daphnia*, while the gnat

larvæ disappeared almost entirely. Perhaps this accounts for the more frequent occurrence of *Culex* in the fairly clean water of rain-barrels and drinking-troughs, in spite of the fact that, as shown by long experience, the larvæ grow more quickly in a good culture of *Chlamydomonas*, and that, on this account, one would expect the gnats to prefer a more stagnant habitat.

The egg-rafts, for the cytological studies in question, after being laid, which process takes about ten to fifteen minutes, were isolated, along with sufficient water from the pond, in Petri dishes, in which they underwent their subsequent development. Thus it was possible to determine the age of the eggs. Rafts just laid, and of ages ranging from half hour after the deposition of the last egg to two and three-quarter hours, were preserved. Imagines just before, during, and after oviposition were also fixed. Many rafts of unknown age were necessarily found during the season, their colour indicating to a certain extent their age.

My best thanks are offered to Sr. Carmela, S.N.D., who, during my absence in August, went on with the work of tending the ponds and fixing the rafts at timed intervals. She gives twenty minutes as the period required for the laying of one raft.

Carnoy proved an excellent fixative for both rafts and imagines. Bouin and Gilson-Petrunkewitsch were used as controls. The rafts did not sink in the former fixative, hence the results were not so good, but the Bouin material was more easily sectioned. Portions of whole rafts were embedded in paraffin, and sagittal sections of from 5μ to 8μ made of the whole mass. Thus many eggs could be examined at once. The funnel (see Text-fig. 1, *f*) was removed before embedding.

Mr. P. Jamieson's long experience in microtoming was placed entirely at my disposal in the matter of sectioning the proverbially difficult dipterous egg, and I should like to express my gratitude to him for this help, and also for actually cutting many of the sections used in this investigation.

TEXT-FIG. 1.

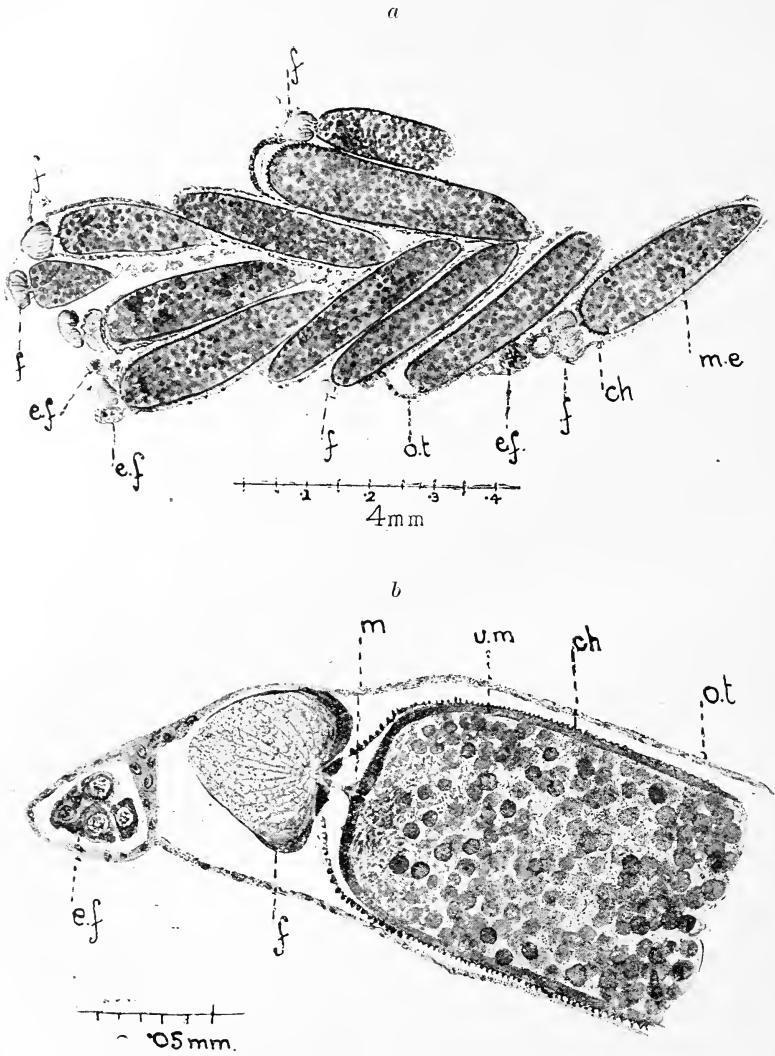

Sections through mature female gnat parallel to the sagittal plane (*b* under higher magnification). *ch.* Chorion. *e.f.* Young egg follicle. *f.* Funnel. *m.* Micropyle. *m.e.* Mature egg. *o.t.* Ovarian tube. *v.m.* Vitelline membrane.

The Reproductive Organs in the younger stages have already been described. In the mature ovary (Text-fig. 1) the egg is elongated, and is provided with a chorion, very beautifully sculptured, and a second membrane—the vitelline membrane—both of which are perforated before fertilisation by the micropyle. Separating one egg from its neighbour of the same size, or from a young egg follicle, is a chitinous structure (see fig. 30, 'Natural History of Aquatic Insects,' Miall.), like a funnel in shape, which remains attached to the laid egg at its broad anterior end. This funnel is perforated above the micropyle, and apparently serves to guide the spermatozoa to the micropyle. A somewhat similar structure is shown in Sedgwick's 'Student's Text-book of Zoology,' vol. 3 (fig. 400), for the egg of *Drosophila cellaris*. The future head end of the embryo lies in the anterior position in the ovarian tube, as is usual in insects—the hind end of the egg being the first to emerge from the imago.

Dr. Woodcock (5) expressed his opinion that an imago was probably capable of depositing more than one raft in the season. Sections of gnats, which were fixed immediately after depositing their rafts, showed that the contents of the spermathecae were by no means exhausted. Moreover, the gonad showed some large eggs, as well as very many small egg follicles, which evidence seems to support his opinion. The gnats, flying away after laying eggs, were perfectly vigorous, and showed no tendency to die.

The three spermathecae communicate with the hind end of the common oviduct by three minute tubes, so that the spermatozoa make their way into the funnel as the egg passes out.

In view of the foregoing description and the fact that eggs laid in captivity often produce no larvæ, the first hypothesis as to the origin of the haploid number of chromosomes in the somatic tissues of *Culex* can be rejected, and this is justified by actual observation of the two pronuclei in the egg.

The Egg.—I have not been able to observe the formation

of any polar bodies. The egg nucleus lies in the middle of the egg, and is a typical resting nucleus. It is surrounded by the large yolk globules which constitute the greater bulk of the egg. The cytoplasm, which is sparse, is densely staining and provided with numerous deeply-stained particles, as was the case in the tissues of the larva and pupa, and there are large numbers of small bodies surrounding the yolk globules which resemble chromatin in their staining reactions. These chromatin-like bodies, "yolk nuclei", seem to be intimately concerned with the digestion of the globular yolk-masses, and with their conversion into protoplasm, and sometimes resemble very minute chromosomes (Pl. 20, fig. 1). When surrounded by the digestion products, which have resulted from their activity, they do not stain so clearly, and eventually they appear in the fully-formed protoplasm as the particles already described. This quality of the protoplasm greatly detracts from the beauty of the histology.

The sperm nucleus (male pro-nucleus) assumes the resting condition very quickly. In one egg of a raft, fixed a few minutes after deposition, the two pro-nuclei are already in close contact. In one egg of a raft half an hour old, the spermatozoan has reached the egg nucleus, but is still sperm-like. In one-hour rafts there are several segmentation nuclei. (It must be remembered that there is a difference in age between the first laid egg of the raft and the last laid egg, of from ten to twenty minutes, hence these times are only approximate.)

The segmentation nuclei, which lie in little islands of protoplasm (Pl. 20, fig. 2) pass into a decided resting-stage after dividing, and several blocks have to be sectioned to make sure of obtaining mitotic nuclei.

The prophases (Pl. 20, figs. 4-9) of the dividing segmentation nuclei of *Culex* show six chromosomes. In early prophase a tendency to emerge in pairs from the resting nucleus is evident (Pl. 20, fig. 9). These six chromosomes (Pl. 20, fig. 10) arrange themselves on the equator of a perfectly typical spindle, split longitudinally, and in anaphase

and telophase six thin chromosomes can be seen going to each daughter nucleus (Pl. 20, figs. 11-13). In contrast to former experience of larval, pupal, and imaginal material the dividing nucleus is most frequently found in the metaphase and anaphase stage in the segmenting egg of *Culex*. What takes place in late telophase and in the passage of the chromosomes into the resting nucleus reticulum is difficult to follow.

There is thus no difficulty in demonstrating six chromosomes in the segmenting nuclei of *Culex pipiens*—fertilisation and the early stages of development are perfectly typical. No reduction in the "Zygote," as found by Dobell and Jameson in *Coccidia* and *Gregarines*, takes place. The second hypothesis set forth in the beginning, viz. "the fusion of three pairs of homologous chromosomes at some early stage in the life-history, this fusion remaining permanent throughout later divisions," most probably explains the case. Early prophases show decided tendency of the chromosomes to come out of the reticulum in pairs, full prophases show six chromosomes, among which pairing can sometimes be detected (Pl. 20, figs. 4, 7, 8, 9). As has been shown by Stevens and Metz a side-to-side pairing of homologous chromosomes is a characteristic of Dipterous cytology. Metz (2) states that Miss Stevens records it in nine species of *Muscidæ*, and four species of Mosquitoes, and that he has verified it in five of these species of *Muscidæ*, and extended it to eight others, in addition to species of *Drosophila*. An increasingly closer proximity of these homologous chromosomes one to the other, would produce, eventually, an actual fusion of the maternal and paternal constituents, with the result, in the case of *Culex pipiens*, that in full prophase three, and not six, would be the apparent chromosome number. The three chromosomes that appear so persistently in the somatic tissue of larvæ, pupæ, and imagines of *Culex pipiens* are, therefore bivalent in character; they are really three groups of chromosomes, with two in each group. I have not been able to trace out more fully the development of this tendency

of homologous chromosomes to fuse into an apparently single chromosome. This would entail a study of rafts ranging from a quarter hour to three and a half to four days old. (The development of the larva in Scotland occupies from three and a half to four days.) Moreover, the egg capsule becomes so hard and brittle as it changes from cream white to dark brown, that a special technique would have to be devised for sectioning these eggs without destroying the nuclear detail. All that can be stated with certainty up to the present is, that the homologous chromosomes have not fused in segmenting nuclei—while this fused condition has become a characteristic of *Culex pipiens* in the early larval stage.

It would seem, then, that parasyn-desis has reached its limit in the somatic tissues of *Culex pipiens*, resulting in the actual fusion of homologous chromosomes, and that extreme parasyn-desis is responsible for the apparent anomaly described in the 'Chromosomes Complex of *Culex pipiens*', I.

GENERAL.

There is general agreement that we are justified in assuming (1) that hereditary qualities are represented by material substance, and (2) that this substance is either chromatin or is inextricably involved in chromatin. Granting these two assumptions, we seem logically bound, by the generally occurring accurate longitudinal splitting of the chromosomes in mitosis, to admit that the patches of material representing definite hereditary qualities are arranged in linear fashion along the course of the chromosome or thread of chromatin. But this involves necessarily a tendency of the hereditary substance representing one particular quality, or group of qualities, to segregate together. In other words, there must be, in the case of hereditary substance, an attraction of like for like. If this be so, there will be a tendency for chromosomes composed of corresponding patches of hereditary material arranged in like order, to come

together side by side with homologous poles together, the opposite of what happens in the case of magnetic attraction.

Such a hypothesis will account for the frequent occurrence of parasyn-desis, and for the further accentuation of this into complete fusion as is supposed to take place in *Culex pipiens*.

SUMMARY.

(1) The egg-rafts of *Culex pipiens* are laid most copiously between hours 10.30 p.m. and 12 p.m. They are also laid between 4 a.m. and 6 a.m.

(2) Fertilisation in *Culex pipiens* is normal. Segmentation begins in less than an hour after the deposition of the last egg.

(3) The chromosome number in the segmenting nuclei is six.

(4) A tendency to parasyn-desis is exhibited by the segmenting nuclei.

(5) Parasyn-desis probably effects the condition of the chromosomes in the nuclei of larva, pupa, and imago, i.e. is responsible for the presence of the apparently "haploid" character of the nuclei in the somatic cells.

NOTE.—After the completion of the foregoing paper, Metz's "Chromosome Studies on the Diptera II. The Paired Association of Chromosomes in the Diptera, and its Significance", 'Journ. Exper. Zool.', xxi., came into my hands.

With regard to certain criticisms passed on my work, I should like to state :—

(1) The fixatives employed by me were precisely those employed by Metz (see p. 379, 'Quart. Journ. Micros. Sci.', vol. lx).

(2) Although I have not specified this, all the precautions recommended by Metz to secure good fixation and penetration were employed by me. I cannot, therefore, put my results down to bad fixation.

(3) I have failed absolutely in my former work on *Culex*, although I devoted much time and study to this point, to find any figures resembling Metz's figs. 166 and 167, or Stevens's figs. 8, 9, and 10. This failure may be attributed to differences in the material studied. It could not be due to bad fixation.

(4) Setting aside the Diptera, my figs. 68 and 69 (4), would be interpreted, by the vast majority of cytologists, as a split spireme, as chromosomes precociously split for metaphase.

(5) My conclusions in the present paper, made after a study of fertilisation, do not differ in principle from those of Miss Stevens. I state, for my variety of *Culex pipiens*, that parasyn-desis has resulted in actual fusion. Only the assumption that some such fusion has taken place can account for the striking recurrence of three chromosomes in the prophase of somatic tissues in larval, pupal, and imaginal material.

(6) In a preliminary investigation of *Chironomus* sp., an account of which I hope to publish later, I have found a confirmation of the results obtained in *Culex*.

LITERATURE LIST.

1. Dobell and Pringle Jameson (1915).—"The Chromosome Cycle in Coccidia and Gregarines," 'Proc. Roy. Soc.,' vol. lxxxix.
 2. Metz, C. W. (1914).—"Chromosome Studies in the Diptera. I. A preliminary survey of five different types of chromosome groups in the genus *Drosophila*," 'Journ. Exp. Zool.,' xvii.
 3. Stevens, N. M. (1910).—"The Chromosomes in the Germ Cells of *Culex*," 'Journ. Exp. Zool.,' viii.
 4. Taylor, Monica (1914).—"The Chromosome Complex of *Culex pipiens*," 'Quart. Journ. Micr. Sci.' (n.s.), vol. 60.
 5. Woodcock, H. M. (1914).—"On 'Crithidia' fasciculata in Hibernating Mosquitoes (*Culex pipiens*) and the Question of the Relation of this Parasite with a Trypanosome," 'Zool. Anz.' Bd. xviii, 8.
-

EXPLANATION OF PLATE 20,

Illustrating Miss Monica Taylor's paper on "The Chromosome Complex of *Culex pipiens*.—II: Fertilisation."

All figures were drawn with the Abbe camera to the given scales (Leitz $\frac{1}{3}$ oil imm., Zeiss compensating oculars).

Fig. 1.—Section through egg fixed Gil. Pet. Stained in thionin; differentiated to show "yolk nuclei." "Yolk nuclei" remain deeply stained; chromosomes lose stain when sections are left for some time in absolute alcohol.

Fig. 2.—Section through egg of a raft laid at 4.15 a.m. *ch.* Chorion. *c. m.* Closed micropyle. *f.* Funnel. *s. p. n.* Segmentation resting nucleus surrounded by mass of protoplasm. *v. m.* Vitelline membrane.

Fig. 3.—Resting nuclei; daughter nuclei of fertilisation nucleus; "yolk nuclei" around yolk globules.

Fig. 4.—Prophase of segmentation nucleus; egg one hour old.

Fig. 5.—Prophase.

Fig. 6.—Early prophase.

Fig. 7.—Prophase.

Fig. 8.—Prophase.

Fig. 9.—Early prophase.

Fig. 10.—Metaphase.

Figs. 11 and 12.—Anaphase.

Fig. 13.—Telophase.

The Homologies of the Muscles related to the Visceral Arches of the Gnathostome Fishes.

By

Edward Phelps Allis, jr.,

Menton, France.

With Plates 21 and 22 and 1 Text-figure.

IN 1874 Vetter published his well-known work on the muscles related to the visceral arches of the Selachii, and, clothed somewhat with Gegenbaur's authority, it immediately became the recognised standard of reference, and all later work relating to the subject has apparently been greatly influenced by it. Certain parts of Vetter's descriptions have, however, always been to me obscure, but I have attributed it to my not being personally familiar with the anatomy of the Selachii. Considering that this familiarity had been in a measure acquired by my present work on the cranial anatomy of *Chlamydoselachus*, I recently carefully re-read Vetter's descriptions, but I still found the particular parts referred to neither precise nor clear. Tiesing's (1895), Ruge's (1897), and Marion's (1905) later works not helping to a proper comprehension, I then had recourse to dissections of such few specimens of the Selachii, other than *Chlamydoselachus*, as I had at my disposal. The result has been to lead me to consider the particular parts referred to, in the several works above mentioned, incorrect, and it has also unexpectedly led me to seriously question every one of the several instances cited by Edgeworth (1911) in which one of these visceral-arch muscles of fishes is said to be innervated,

in the adult, by the nerve of a segment of the body other than that from which the muscle itself is developed.

The proof that Edgeworth offers that this change of innervation has taken place in these muscles is: that certain muscles that he finds in embryos are developed from certain segments of the body; that these muscles of embryos are the homologues of certain muscles described by other authors in the adults of the same fishes; and that these latter muscles of the adult are said to be innervated by nerves other than those of the segments from which he (Edgeworth) finds the muscles of embryos developed. If these several premises were all correct, the important conclusion that Edgeworth deduces from them would evidently also be, but it is equally certain that there is the possibility of error in some one of the premises. This seems not to have been given serious consideration, and yet Edgeworth's descriptions of the development of these muscles in the Selachii is markedly different from Dohrn's, to whose important work Edgeworth makes no reference, and it is well known that the innervation of these muscles in the adult has been frequently wrongly or incompletely given. Furthermore, I now find that even the descriptions of the muscles themselves in the adult Selachii are, in certain respects, incorrect.

Certain anatomists hold that a muscle fibre is, from the earliest embryonic stages, connected with the central nervous system by a protoplasmic strand, not yet demonstrable by known microscopic methods, which represents a future fibre of the motor nerve of the segment, or that a "something" (Braus, 1905) else establishes that connection. Other anatomists claim that there is no such connection, and that the motor nerve grows outward, independently, from the central nervous system, and in some unknown way finds its end organ.

According to the first of these two views a nerve should, in normal conditions, innervate a muscle derived from the myotome of its own segment and from that segment only. According to the second view the nerve might, in slightly changed, if not even in normal conditions, find its end organ

in a muscle derived from another segment; and if this change in innervation were then to be transmitted by inheritance, it is claimed that it is fatal to the first-mentioned view (Johnston, 1906, p. 63). There would, however, seem to still be question as to whether this inheritable mutation related to the directive impulse assumed to reside in a nerve fibre, or to a protoplasmic strand, or a something else, that pre-existed and determined the course of the nerve. The mutation might evidently have related to the one or the other. Furthermore, there is frequently question, in the cases cited of such a change of innervation, as to whether the definitive innervation was not in reality primary, being the only innervation that the particular fibres under consideration had ever had in ontogeny, instead of being secondary in the sense of replacing an earlier and normal innervation by the nerve of the segment to which the muscle belongs.

My work, it may here be stated, in no way attempts to solve this vexed and very complicated question. It does however raise serious question as to several of the examples that have heretofore been cited of the so-called secondary innervation of a muscle, and it also quite unexpectedly adds a series of instances in which there must be such an innervation if existing descriptions of the innervation are correct.

Before describing my own investigations, limited to a few Selachii, it will be well to point out some of the inconsistencies and contradictions in earlier descriptions of the development and anatomy of the visceral-arch muscles in these fishes.

BRANCHIAL ARCHES.

Dohrn (1884, pp. 109-115) says that the myotome of each of the branchial arches of selachians, meaning the Plagiostomi, becomes flattened "in the middle," and is finally there separated into two parts, and the descriptions and figures both show that this flattening and subsequent separation takes place antero-posteriorly along a dorso-ventral line passing through the middle of the externo-internal depth of the myotome. The myotome is thus here separated into

deeper and superficial portions, which Dohrn calls respectively the proximal and distal portions of the myotome, proximal meaning nearer the pharyngeal cavity and distal farther from that cavity. The separation of the myotome into these two parts did not apparently extend, in the embryos examined by Dohrn, the full dorso-ventral length of the myotome, for Dohrn definitely says that the dorsal ends of the two portions of the myotome remain attached by a thin intervening portion. The complete separation said to be found in the adult must accordingly take place in later embryonic, or possibly in postembryonic stages.

The cartilaginous bar of the arch, when it first begins to develop, is said by Dohrn to lie against the posterior surface of the proximal portion of the myotome at about the middle of its length, and the bar, as it develops, is more curved than the myotome. The proximal portion of the myotome thus stretches across the morphologically anterior but actually lateral surface of the curved bar, projecting, in the middle of its length, mesial to the bar, and there acquiring a position internal instead of external to it. This middle section of the proximal portion of the myotome is later cut out of the myotome along the line where the myotome crosses the bar, and from the portion so cut out the *musculus adductor arcus visceralis* is said to be developed. The remainder of the myotome is said to remain external to the branchial bar, and from those parts of its proximal portion that lie dorsal and ventral to the piece cut out to form the adductor, and hence also dorsal and ventral to the curved branchial bar, the *musculi interarcualis* and *coracobranchialis* are said (*loc. cit.*, p. 115) to be respectively developed; these two muscles and the adductor thus being primarily continuous and forming the entire length of the proximal portion of the myotome (*loc. cit.*, p. 117).

The dorsal and ventral ends of the myotome, including both its proximal and its distal portions, are each said to bend posteriorly across the dorsal or ventral edge, respectively, of the next posterior gill-pouch (*Kiemenspalte*), and from that

part of the distal portion of the myotome that lies between these dorsal and ventral bends the musculus interbranchialis is said to be developed. The musculus interbranchialis, as thus defined by Dohrn, is accordingly that part of the distal portion of the continuous myotome that lies in, and extends the full length of, the related branchial diaphragm, that diaphragm being limited dorsally and ventrally by the dorsal and ventral edges of two adjoining gill-pouches. The interbranchialis of the adult Selachii, as defined by Vetter, lies between the dorsal and ventral extrabranchials of the related arch, and the distal ends of these extrabranchials lie, respectively, ventral and dorsal to the dorsal and ventral edges of the next posterior gill-pouch, as will be later fully described, and as is imperfectly shown in Dohrn's figures 1-4, Pl. 7. The interbranchialis of embryos, as defined by Dohrn, is accordingly not the same thing as the one defined by Vetter in the adult. The difference is, in fact, morphologically quite important, although it seems not to have been noticed by Dohrn.

From the distal portion of that part of the myotome that lies dorsal to the dorsal bend in the myotome, Dohrn says (*loc. cit.* p. 113) that the musculus constrictor superficialis is developed. What is developed from the distal portion of that part of the myotome that lies ventral to the ventral bend is not clearly stated. Dohrn says (*loc. cit.* p. 114): "Wie an der dorsalen Seite schlägt sich auch an der ventralen die proximale Portion des Muskelschlauches um die Fortsetzung des Knorpelbogens herum und bildet die tiefen Portionen des Musculus constrictor superficialis (Vetter); diesen Namen verdienen sie freilich nur *cum grano salis*, denn der Constrictor superficialis sollte nur aus denjenigen Muskeln bestehen, welche von den distalen Portionen der ursprünglichen Muskelschläuche abstammen. In der That sind diese Muskeln auch vorhanden, aber in der Vetter'schen Monographie falsch gedeutet worden. Er beschreibt sie als einen Theil der M. Coraco-arcuales, unter dem Namen M. coraco-branchiales; sie haben aber ursprünglich nichts gemein mit M. coraco-

hyoideus, setzen sich vielmehr nur an sie an, durch eine Fascie von ihn getrennt. Der M. coraco-hyoideus ist ein echter Körpermuskel, aus den Urwirbeln herstammend, und hat genetisch nichts mit der Visceralbogen-muskulatur zu schaffen."

The deeper portion of the constrictor superficialis of Vetter's descriptions, above referred to by Dohrn, is simply a bundle of the proximal fibres of that muscle, and it is thus said by Dohrn to be developed from the proximal portion of the ventral end of the myotome of its arch. But Dohrn has elsewhere definitely said, as just above stated, that this part of the myotome of his embryos becomes the musculus coracobranchialis. These two muscles must then either have been considered by Dohrn to be identical, or he overlooked the fact that they were both said to be derived from the same part of the myotome. The muscle developed from the remaining, distal portion of the ventral end of the myotome is not specifically named by Dohrn, and although he says that it was wrongly called the coracobranchialis by Vetter, he nevertheless seems to refer to it in a later work (1885) by that name, as will be later shown. How he came to the conclusion that the coracobranchialis of Vetter's descriptions of the adult was developed from this part of the myotome, and that the muscle was wrongly named by Vetter, is not apparent; but it would seem as if it must have been because of Vetter's figure of *Acanthias*, which seems to show the ventral ends of the constrictores superficiales wholly wanting excepting as they are represented, in the first branchial arch, by a small bundle of muscle fibres. Probably misled by this figure, and Vetter's descriptions of it, which give, as will be later shown, an incorrect idea of the conditions, Dohrn seems to have concluded that the ventral ends of the constrictores must also be wanting in the adult *Scyllium*, and as he found, in his embryos of that fish, a distal portion of the ventral end of the myotome that had to be accounted for, he concluded that it must be the coracobranchialis of Vetter's descriptions of the adult.

But, whatever Dohrn may have considered to have been developed from the distal portion of the ventral end of the myotome of each branchial arch, it is certain that the *musculus interbranchialis* was considered by him to be intercalated, in the embryos described by him, between dorsal and ventral muscles, the dorsal one of which, alone, was the constrictor superficialis. This is, however, said by him (*loc. cit.*, p. 144) to be a secondary condition, the constrictor superficialis having certainly, in earlier phylogenetic stages, traversed the related branchial diaphragm along with the *interbranchialis*; and it is here further said, in direct contradiction to the statement made on p. 113 of his work and above referred to, that the constrictor superficialis is in reality simply the distal portion of the *interbranchialis*. How it was, or when, the *interbranchialis* became separated from the portions of the myotome dorsal and ventral to it, or that it ever became so separated, is not said; and as it is definitely said (*loc. cit.*, p. 119) that none of the muscles of the arch are directly inserted on any of the branchial rays, the extrabranchedials expressly included, it is certain that these three parts of the myotome were, in the embryos examined by Dohrn, simply arbitrarily established regions of a single continuous muscle.

In the identification, in embryos, of the several muscles above referred to, Dohrn makes frequent reference to Vetter's descriptions of the muscles in the adult *Selachii*, the evident inference being that, unless otherwise stated, the muscles described by himself, in embryos, were to be considered to be identified with the similarly named ones in Vetter's descriptions of the adult. To this Dohrn makes one exception, the *coracobranchedialis*, which has been above referred to and explained. No limitation or qualification of any kind is made by him in his use of the term *musculi interarcales*, and this term is used, where it applies to the muscles of a single arch, both in the plural (*loc. cit.*, p. 113) and in the singular (*loc. cit.*, p. 115). This muscle (or muscles) is said to extend from the pharyngobranchial of an arch to the corresponding element of the next posterior arch, and also ("resp.") to the epibranchial

of its own arch. Reference to Vetter's figures then certainly shows that Dohrn intended to include the *musculus interarcualis dorsalis I* of Vetter's descriptions in the muscles termed *interarcuales* by himself, for that muscle is the only one that extends from the pharyngobranchial of one arch to that of the next posterior arch. Fürbringer (1897), however, maintains that the *interarcuales dorsales I* were not intended by Dohrn to be so included. Fürbringer had previously found (1895) that these *musculi interarcuales dorsales I* were innervated by spinal or spino-occipital nerves, instead of, as Vetter maintained, by branches of the related branch of the *nervus vagus*, and he (Fürbringer) proposed for them the name *musculi interbasales*. In his later work Fürbringer says (1897, p. 406), in making reference to Dohrn's work: "Der *Mm. interbasales* thut er keine Erwähnung." This is strictly correct, but Dohrn also does not specifically mention either the *interarcuales II* or *III*, and it is certain that if so careful a worker as Dohrn had intended to exclude either of these three muscles from the term *interarcuales* as employed by him he would have definitely said so. This is all the more evident from the fact that, without making reference to these *musculi interarcuales I*, Dohrn himself says, in the work in question (*loc. cit.*, p. 117), that the *musculus subspinalis* of Vetter's descriptions, which is simply an anterior member of the *interarcuales dorsales I* series (Allis, 1915), is probably derived from trunk myotones.

Edgworth says (1911, p. 234) that, in 17 mm. embryos of *Scyllium*, the lower end of each of the branchial myotomes grows backward and becomes cut off from the remainder of the myotome to form the *coracobranchialis*. The ventral end of the remainder of the myotome is said to then grow ventrally, external to the *Anlagen* of the several *coracobranchiales*, to form the ventral end of the *constrictor superficialis*. It is then said that: "The upper ends of the myotomes, in embryos between the lengths of 17 and 20 mm., increase in antero-posterior extent, and, fusing together, extend backwards as the *trapezius* to the shoulder-girdle. Below the *Anlagen* of

the trapezius each myotome forms a transversely broad plate in the branchial septum. The part internal to the branchial bar forms the adductor; the part external to the bar forms dorsally the arcualis dorsalis, and below that the interbranchial, whilst the external edge forms the constrictor superficialis." The constrictor superficialis was accordingly developed from that part only of the myotome that lay primarily in the branchial diaphragm, and although a later, ventral downgrowth of this muscle is said to take place, as just above stated, no mention is made of any dorsal upgrowth from that part of the myotome that lies ventral to the trapezius. It is even definitely said (*loc. cit.*, 251) that no levator muscles are developed in the branchial arches of this fish. Here the embryological conditions, thus described, do not agree with the conditions found in a 42 cm. specimen of this fish that I have examined, and which will be later fully described, for in each branchial arch of this fish there is, as in *Heptanchus*, a dorsal portion of the constrictor superficialis which extends beyond the dorsal extrabranchial and overlaps externally the musculus trapezius. In the hyal arch of embryos of this fish Edgeworth himself describes this dorsal prolongation of the constrictor, and he there not only calls it the levator hyoidei, but says (*loc. cit.*, p. 228) that it is serially homologous with the levator muscles of the branchial arches of the Teleostei. The levator hyoidei is a part of the emuscl Csd₂ of Vetter's descriptions of the Selachii described by him, and as this muscle, in *Heptanchus*, and in my specimen of *Scyllium*, certainly has its serial homologues in the dorsal ends of the constrictores of the branchial arches, if the one is the homologue of the levators of the Teleostei the others must evidently also be.

The term "arcualis dorsalis" is said by Edgeworth (*loc. cit.*, p. 226) to be employed by him, as proposed by Fürbringer, to designate the interarcuales dorsalis II and III of Vetter's descriptions, one of which muscles is, however, (Vetter, Fürbringer) an interarcual and not an arcual muscle. The interarcualis dorsalis I of Vetter's description is called

by Edgeworth, as by Fürbringer, the interbasalis. This term I shall also employ in the following descriptions and discussions, the other two muscles being called the arcualis and the interarcualis. The term "interbranchialis" is said by Edgeworth (*loc. cit.*, p. 232) to be employed by him as Vetter employed it, and it is said to lie wholly proximal to the constrictor superficialis.

Dohrn does not specify to what particular fishes his several observations apply, classing them all under the general term "selachians"; but the figures that accompany his work are of *Scyllium*, *Pristiurus*, and *Torpedo*. Edgeworth limits his observations on the *Plagiostomi* definitely to *Scyllium*, but in his generalisations he considers them to apply to all the *Selachii*, and apparently also to the *Batoidei*. As both authors included *Scyllium* in their investigations it is instructive to note certain marked differences in their observations. According to Dohrn the dorsal end of each branchial myotome gives origin both to a dorsal portion of the constrictor superficialis and to the interarcuales dorsales of the related arch. According to Edgeworth a dorsal portion of the myotome of each arch is first cut off to form the *musculus trapezius*, and it is from that portion of the myotome that lies ventral to this dorsal portion that the *musculi constrictor superficialis* and *arcualis* (*interarcuales*, Dohrn) are developed. Dohrn accordingly entirely overlooked the separation of the *trapezius* from the dorsal ends of the several branchial myotomes, which would certainly be a serious oversight on the part of so careful a worker. According to Dohrn the *interarcuales dorsales I* are derived from the branchial myotomes, while, according to Edgeworth, they are of spinal origin. According to Dohrn the constrictor superficialis of each arch lies dorsal to the interbranchialis, or possibly both dorsal and ventral to that muscle, and it is definitely said that it does not traverse the branchial diaphragm. According to Edgeworth it is primarily limited to the branchial diaphragm, there lying distal to the interbranchialis; it has no dorsal, levator prolongation and never

acquires it, but it later acquires a ventral prolongation which extends beyond the branchial diaphragm. According to Dohrn the coracobranchialis is formed from the proximal portion only of the ventral end of the myotome of each arch, and the muscle so formed is not the coracobranchialis of Vetter's descriptions of the adults of other Selachii. According to Edgeworth the coracobranchialis is formed from the entire ventral end of the myotome, and it is identical with the muscle described by Vetter. Both authors maintain that the coracobranchialis of Vetter's descriptions is a muscle of branchial, and not of spinal origin.

This comparison of these two embryological works, which are the only ones I know of that pretend to give, in detail, the development of these several muscles, thus certainly shows that the published embryological investigations of these muscles must be accepted with some reserve.

The descriptions of the adult may now be considered.

In the adult *Heptanchus* the constrictor superficialis of each branchial arch is, as described by Vetter (1874), practically a continuous muscle-sheet with a large angular incisure in its proximal (actually anterior) edge. The dorsal attachment, or origin, of the sheet is said to be partly in a so-called dorsal superficial fascia, but mainly in thin tendinous bands (Platten), which lie external to the musculus trapezius, extend to the dorsal edge of that muscle, and represent the greatly and progressively reduced posterior portion of the superficial fascia above referred to (*loc. cit.*, p. 431). The ventral attachment, or insertion, of the sheet is mainly in a mid-ventral fascia which lies external and ventral to the ventral longitudinal or so-called hypobranchial spinal muscles. The large angular incisure in the proximal edge of the sheet is made by the articulating ends of the epibranchial and ceratobranchial of the arch, and the ends of the muscle fibres, on either side of this incisure, are inserted on those two cartilages. The triangular piece so cut out of the constrictor forms the musculus adductor of the arch, but this

adductor muscle is much smaller than the incisure in the edge of the constrictor.

The innermost (proximal) fibres of the dorsal portions of the constrictores are said by Vetter to have their origins on the inner ends of the "äusseren Kiemenbogen," that is, on the dorsal extrabranchials. It is not said to which arch the extrabranchial related to each muscle belongs, but the use of the expression "äusseren Kiemenbogen," without qualification, and the fact that there is no extrabranchial in the arch posterior to the posterior constrictor (Fürbringer, 1903, p. 432), leads me to conclude that this origin of these fibres of each constrictor is on the dorsal extrabranchial of the arch to which the constrictor belongs. In *Heptanchus*, the outer (distal) halves of the dorsal extrabranchials are said, in a footnote (*loc. cit.*, p. 409), to be almost completely imbedded in the fibres of the constrictores, and on a later page (*loc. cit.*, p. 429) it is said that: "Die sehr schwach ausgebildeten dorsalen wie ventralen äusseren Kiemenbogen liegen, z. Th. in die Muskeln selbst eingebettet, nahe deren obern und untern Enden auf denselben." This statement that the extrabranchials lie "on" the constrictores is markedly indefinite, but as they usually lie against the posterior surface of the constrictor of the arch to which they themselves belong, and as Vetter says that all of the branchial rays of this fish have that position, one at first concludes that that must also be the position of the extrabranchials. But in one of Vetter's figures (*loc. cit.*, fig 1, Pl. 14), six of these extrabranchials are shown lying one on the anterior surface of each of the six constrictores of the branchial arches, and apparently slightly imbedded in it.

This unusual position of these extrabranchials is one of the points in Vetter's description that I have never been able to comprehend, and as I have two considerably dissected heads of *Heptanchus* I have examined them with reference to this. In each of these heads the outer (distal) end of the dorsal extrabranchial of each branchial arch lies posterior (internal) to the constrictor of the related arch, as it

normally should. The outer ends of most of the branchial rays of each arch, however, pierce the constrictor of their arch, and from there onward lie against the anterior (external) surface of that constrictor, imbedded in that surface and covered by a thin sheet of connective tissue, which is strongly attached to the anterior (external) surface of the muscle on either side of the branchial ray. The muscle fibres pass unbroken beneath (posterior to) this end of the branchial ray, and none of them are inserted on it. There is no slightest indication that the fibres have been cut in two, and later grown together again. The conclusion is, therefore, inevitable that these branchial rays, in growing outward, have pierced the constrictor, and so passed from its posterior (internal) to its anterior (external) surface; and it seems probable that this is what happened with the extrabranchials in the specimen of this fish examined by Vetter. It is, however, singular that in my two specimens it should be the branchial rays that so pierce the muscle, and not the extrabranchials, while in Vetter's specimen it was the extrabranchials, and not the branchial rays. Vetter's figure is, in any event, misleading, if not actually incorrect, for no part of the constrictor of any of the branchial arches is shown lying anterior (external) to the related extrabranchial.

A deeper (proximal) bundle of the ventral portion of each constrictor superficialis of *Heptanchus* is said by Vetter to have its ventral attachment, called by Vetter its origin, on a tendinous band related to the dorsal surface of the hypobranchial muscles. Running dorsally from there, this bundle is said to either pass between two of the musculi coracobranchiales of his description, or to perforate one of those muscles, and to be inserted on the ceratobranchial of its arch. This bundle of fibres might accordingly be considered to be a coracobranchialis, and Dohrn did actually so consider it. No musculus interbranchialis is differentiated in this fish.

In *Acanthias*, as in *Heptanchus*, the proximal (anterior) fibres of the constrictor superficialis of each branchial arch

are said by Vetter to arise from the inner (proximal) end of the dorsal extrabranchial, but it is here said that it is the extrabranchial of the arch to which the constrictor belongs. The next distal fibres are said to arise from a small and thin tendon which perforates the musculus trapezius and the dorsal trunk muscles to have its insertion on the vertebral column, and the distal and larger part of the fibres to arise from a narrow tendinous aponeurosis which extends dorso-anteriorly from the top of the gill opening next posterior to the muscle. Such a linear aponeurosis is found related to both the dorsal and ventral ends of each of the first four gill openings, and each pair of aponeuroses is said to unquestionably represent the lines where the dorsal and ventral portions of the overlapping outer edge of a long and tall branchial diaphragm, such as is found in *Heptanchus*, has fused with the anterior (external) surface of the next posterior branchial diaphragm in order to form the small gill openings of *Acanthias*. It is said that, as a natural consequence of this method of formation of these aponeuroses, the extrabranchials (äusseren Kiemenbogen) lie immediately beneath them, firmly adherent to them. It is not definitely said to which arch the extrabranchial related to a given aponeurosis belongs, but it is said (*loc. cit.*, p. 430) that each aponeurosis marks the limit between the outer, visible, posterior portion of each constrictor (*Constr. super. s. str.*) and the musculus interbranchialis of the same arch, this latter muscle being covered by the next anterior branchial diaphragm. It is accordingly evident that Vetter considered the extrabranchial that underlies a given aponeurosis to belong to the posterior one of the two branchial diaphragms that have fused to form the aponeurosis.

Each of the linear aponeuroses of *Acanthias* is thus said to be a persisting cicatrice formed along the line where two adjoining branchial diaphragms have fused with each other, and, that being the case, the cicatrice in each individual fish must evidently have been formed during the life of that particular fish, for that a so-formed cicatrice could have been

acquired, by inheritance, from an earlier form would probably not have been maintained by Vetter. This cicatrice, important as it is, does not involve the dermal tissues, nor are those tissues even said to be adherent to it, as the extrabranhials are said to be. This, in itself, is singular, as is also the fact that whereas the distal fibres of each constrictor, in all the Selachii, *Acanthias* included, always have, throughout their entire course through the related branchial diaphragms, a course parallel to the free edge of that diaphragm, they are shown by Vetter running nearly at right angles into a line, whether cicatrice or aponeurosis, that is said to represent a part of the former free edge of that particular diaphragm. Vetter has himself called attention to this, and has attempted to explain it, but the explanation is not convincing. Furthermore, the conditions in specimens of *Scyllium* and *Mustelus* that I have examined, and that will be later described, are so decidedly opposed to this interpretation of the meaning of the aponeuroses that I consider it wholly impossible that they represent lines where adjoining branchial diaphragms have fused with each other, and, in my opinion, the small external gill openings of *Acanthias* are due simply to the retarded development of the outer edge of a gill cleft as compared with that of the inner edge of the same cleft.

From the several surfaces of origin above described by Vetter, the fibres of each constrictor superficialis of *Acanthias* run at first antero-ventrally, and the proximal (anterior) and larger part of them are said to be inserted either entirely (Vetter) on the next anterior aponeurosis, or partly also (Marion, 1905) on the extrabranhial that underlies that aponeurosis. This latter extrabranhial is, according to Vetter's descriptions (*loc. cit.*, p. 430), the one related to the arch to which the muscle belongs. But there is then confusion in the descriptions, for as Vetter has previously said, as just above stated, that certain of the proximal fibres of each constrictor have their origins on the extrabranhial of the arch to which the muscle belongs, these fibres could not have their insertions on that same extrabranhial. The

distal (posterior) fibres of the dorsal part of each constrictor, misleadingly called by Vetter the "untersten" and by Marion the "ventral" ones, are said by both those authors to traverse the branchial diaphragm and to be continuous with the corresponding fibres of the so-called ventral portion of the muscle.

The distal and larger part of the fibres of the ventral portion of the constrictor of each arch are said to have their origins on the linear aponeurosis that extends ventro-anteriorly from the ventral end of the next posterior gill opening. In the first branchial arch, the remaining, proximal fibres of the constrictor, here called by Vetter the "untersten," and by Marion the "median" fibres, are said to have their origins in the mid-ventral line from the tendinous ventral surface of the hypobranchial muscles, and the corresponding fibres in the second to the fourth arches to have their origins from a so-called aponeurosis related to a fascia that lies dorsal to the hypobranchial muscles and serves as surface of origin for them. Running antero-dorsally, the proximal (anterior) and larger portion of the fibres of each constrictor, including the little proximal bundles above referred to, are all inserted on the next anterior linear aponeurosis, while the remaining, distal (posterior) fibres turn dorsally and are continuous with the corresponding fibres of the dorsal portion of the muscle. Excepting only the little bundle of proximal fibres in the first branchial arch, the ventral ends of the constrictores superficiales of this fish thus only reach the dorsal or dorso-lateral edge of the hypobranchial muscles, and comparison with *Heptanchus* led Vetter to conclude that the ventral ends of the constrictores of *Acanthias* had undergone marked reduction. He calls especial attention to this, and says (*loc. cit.*, p. 441) that the disappearance of these ventral portions of the constrictores of *Acanthias* is related to the great development of the hypobranchial muscles, but he makes no mention of what would seem to be a strictly similar disappearance of the larger part of the corresponding dorsal fibres. This assumed disappearance in *Acanthias*, and also in *Scymnus*, of

the ventral portion of each constrictor superficialis, is probably, as already stated, what misled Dohrn in his interpretation of the muscles in embryos of *Scyllium*.

Musculi interbranchiales, not found in *Heptanchus*, have been differentiated in *Acanthias*. They are said to be found in each of the first four branchial arches of the fish, but not in the hyal arch. The muscle is said to form a thin muscle-sheet which extends, in each arch, between the extrabran- chials and the inner cartilaginous bar of the arch, completely filling the space between them. Marion says that "they are in no sense superficial, nor circular in the same sense that the other muscles are, and they lie in a different plane." Ruge (1897, p. 219) says that they extend from the branchial bar of the arch to the free edge of the related branchial diaphragm, and form the middle part of a "Muskel-Scheidewand," thus lying between dorsal and ventral portions of the muscles of the arch and wholly separating them from each other. Ruge's conception of these muscles is thus totally different from Vetter's and Marion's, but it agrees with Dohrn's description of the muscles in embryos. Vetter says that the interbran- chialis of each arch lies close against the anterior (external) surface of the branchial rays of the arch, and extends to the outer ends of those rays, there passing insensibly, without definite boundary, into that part of the constrictor superficialis of the arch that traverses the branchial diaphragm. The distal and larger part of the fibres of each interbranchialis are said to arise, both dorsally and ventrally, in part from the extrabran- chial of the related arch and in part from the linear aponeurosis that overlies that extrabran- chial, while the proximal (anterior) fibres arise, both dorsally and ventrally, in part from a feeble ligament that extends from the extra- branchial of the arch to the extrabran- chial of the next anterior arch, and in part from the latter extrabran- chial.

In *Mustelus*, the proximal fibres of the constrictor super- ficialis of each branchial arch are said by Tiesing (1895) to arise from a dorsal fascia similar to that described by Vetter in *Heptanchus*, while the distal (posterior) fibres arise, as in

Acanthias, from a linear aponeurosis, called by Tiesing a septum, said to be formed between it and the corresponding muscle of the next posterior arch. Running antero-ventrally, the proximal (anterior) fibres are said to be inserted on the next anterior so-called septum, while the distal (posterior) fibres traverse the branchial diaphragm and are continuous with the fibres of the ventral constrictor superficialis. The ventral constrictor superficialis of each arch is said to arise from a median ventral superficial fascia, as in *Heptanchus*, and, running antero-dorsally, to be continuous with the distal fibres of the dorsal constrictor superficialis. No mention is made of any fibres not continuous with those distal fibres of the dorsal portion of the muscle, that large proximal portion of the ventral constrictor that is found in the *Selachii* described by Vetter thus not being accounted for in these descriptions of *Mustelus*. It is said that no ventral septum is found in this fish, *Mustelus* differing in this from *Acanthias* and resembling *Heptanchus*. Ruge says that the fibres of the ventral portions of the several constrictores all have a parallel course, and, their edges being contiguous and intimately bound to each other, form a single continuous muscle-sheet.

The so-called septa of *Mustelus* are said by Tiesing (*loc. cit.*, p. 100) to be formed by the "Verwachsung der Kiemenlöcher" between two adjoining arches, this agreeing with Vetter's conclusion. Ruge (1897, p. 225) also says that these aponeuroses are found "an den Verwachsungsstellen der freien Ränder der Kiemen-Scheidewände." Tiesing says of each septum that, "nach innen und vorn zu befestigt es sich an dem betreffenden Kiemenbogen und schliesst den oberen äusseren Kiemenbogen ein." But it is evidently impossible that a septum, formed where the outer edge of a branchial diaphragm has fused with the next posterior one, could be attached to the inner branchial bar of either of those two arches. Tiesing does not say to which arch the extrabranchial related to a particular septum belongs, but Ruge says (*loc. cit.*, p. 227) that the constrictor superficialis of the

hyal arch of this fish is in part inserted on the extrabran- chial of the first branchial arch, which leads one to suppose that that extrabran- chial lies beneath the linear aponeurosis related to the first gill opening.

The musculi interbranchiales of *Mustelus* are said by Tiesing to be practically as described by Vetter in *Acanthias*.

These several descriptions of these visceral-arch muscles thus, as already stated, do not give a clear and concise idea of the conditions in these fishes, and I have accordingly, as already stated, had dissections made of such specimens of the Selachii as I have at my disposal, which specimens consist of a single already partly dissected head of *Triakis*, a 42 cm. specimen of *Scyllium canicula*, and a 43 cm. specimen of *Mustelus* (species unknown). The accompanying figures show the muscles as found in the two last-named specimens. The musculi constrictores superficiales, interbranchiales, and coracobran- chiales were alone particularly considered in the dissections, but other muscles are also shown in the figures. The constrictor superficialis of each arch will be considered as a single continuous muscle, instead of as two separate muscles, one dorsal and the other ventral. I retain the term constrictor superficialis, but, as there is no constrictor profundus, it seems a needless distinction.

In my specimen of *Scyllium* (figs. 1-7), those portions of the constrictores superficiales of the hyal and first four branchial arches that lie dorsal to the gill openings appear to form, in lateral view, a single continuous muscle-sheet. Immediately dorsal to the gill openings the lines of separation between adjoining constrictores are apparent, and, starting from there, each constrictor can be easily lifted off the next posterior one excepting at its dorso-posterior corner. At that corner each constrictor is inserted on the external surface of the next posterior one, but elsewhere its distal edge simply overlaps and is closely applied to that muscle. Ventral to the gill openings the constrictores are less closely applied to each other, the lines of separation between

adjoining muscles are there distinctly evident, and there is no insertion, at any point, of one muscle on the next posterior one. Both dorsal and ventral to the gill openings there are, in each branchial arch, two or three long muscle strands which start from the internal surface of each constrictor, near the dorsal and ventral ends of the next posterior gill opening, and running respectively dorsally and ventrally, join the muscle strands of the next posterior constrictor. They can, however, easily be lifted off that muscle, and are accordingly not shown, as separate strands, in the figures.

The fibres of the constrictores are everywhere grouped into bundles, which in most places form lamellar bands which occupy the entire thickness of the muscle. Where the muscles are thin these flat bands become simple rounded strands, and they can all be referred to, for convenience of description, as strands of the muscles.

The dorsal edge of the hyal constrictor is nearly straight, and reaches, or lies slightly ventral to, the latero-sensory canal of the body. Its anterior half, approximately, lies anterior to the musculus trapezius and external to the anterior portion of the dorsal muscles of the trunk. Its posterior half lies external to the musculus trapezius, and, at its hind end, overlaps the constrictor of the first branchial arch. The anterior portion of the muscle has its origin in part on the tissues that surround the latero-sensory canal, and in part, ventro-lateral to that canal, on a fascia that is evidently the dorsal superficial fascia of Vetter's descriptions of *Heptanchus*, *Acanthias*, and *Scymnus*. The posterior portion of the muscle has its origin mostly on the external surfaces of the trapezius and the constrictor of the first branchial arch, certain of the tendinous ends of the fibres penetrating those muscles, but it has its origin also in part on ventral prolongations of the tissues that surround the latero-sensory canal of the body. The tissues that surround the latter canal lie directly upon and are firmly attached to the dorsal superficial fascia, that fascia lying directly upon

and being firmly attached to the external surface of the dorsal trunk muscles, and as the line separating the dorsal and ventral trunk muscles here lies considerably ventral to the latero-sensory canal, and hence ventral to the dorsal edge of the trapezius, the fascia lies internal to the latter muscle as well as to the latero-sensory canal. Vetter says that this fascia lies upon the external surface of the musculus trapezius, and he so shows it in his figure of *Heptanchus*. It lies internal to that muscle in my specimens of *Scyllium*. There are however, in *Scyllium*, delicate tendinous lines which lie on the external surface of the trapezius and extend from the dorsal edge of the several constrictores to the tissues that surround the latero-sensory canal, and they apparently represent the tendinous bands (Platten) described and shown by Vetter.

The dorsal edges of the branchial constrictores are all irregular, the most dorsal point of each constrictor lying proximal (anterior) to the distal (posterior) edge of the muscle. From this most dorsal point the dorsal edge of each muscle descends anteriorly, crossing the external surface of the trapezius, and, in the anterior arches, extending ventro-anteriorly beyond the antero-ventral edge of that muscle. Where they cross the trapezius the dorsal edges of these constrictores are inserted on, or firmly attached to, that muscle, certain of the tendinous ends of the muscles penetrating the trapezius. The distal fibres of each constrictor are inserted, as already stated, on the external (anterior) surface of the next posterior constrictor. The distal (posterior) fibres of the fourth branchial constrictor cross the external surface of the shoulder-girdle, and are inserted on the anterior edge of that cartilage along with the fibres of the musculus trapezius.

The dorsal portion of the apparently continuous muscle-sheet that is exposed when the dermis is removed is thus not at all a continuous sheet, and the dorsal edge of the sheet, excepting in its hyal portion, is formed by the dorsal ends of those muscle-strands, only, that lie in the distal portion of

each constrictor. From this dorsal edge of the sheet delicate tendinous lines cross the external surface of the trapezius and extend to the dorsal edge of that muscle, apparently representing, as already stated, the tendinous bands there described by Vetter in *Heptanchus*.

There are no linear aponeuroses, either dorsal or ventral, related to the gill-openings, but the fibres of the proximal (anterior) half of the hyal constrictor are interrupted, as in many other *Selachii*, by an aponeurosis that lies approximately in the line of the middle line of the gill-openings. This aponeurosis is attached anteriorly to the mandibular cartilages, and covers the articulating ends of the hyal cartilages.

The muscle strands in the proximal (anterior) portion of the dorsal half of the hyal constrictor run antero-ventrally and are inserted on the ventral half or two-thirds of the hyomandibula, the deeper fibres being shorter than the superficial ones and having their origins on the dorso-lateral edge of the chondrocranium. The proximal fibres of this constrictor thus form a *musculus levator hyomandibularis* with two heads of origin. The next distal (posterior) strands of the constrictor are inserted in the aponeurosis, just above described, that extends posteriorly from the articulating ends of the mandibular cartilages. The distal (posterior) strands traverse the branchial diaphragm of their arch and are continuous from the dorsal to the ventral end of the muscle. In the dorsal and middle parts of their lengths these distal strands have a nearly dorso-ventral course. Ventrally they spread posteriorly and extend nearly to the ventral end of the shoulder-girdle, there lying external (ventral) to the ventral end of the constrictor of the first branchial arch and external also to the hypobranchial muscles. The strands, excepting a few distal (posterior) ones, all reach the mid-ventral line, and form, with the *musculus intermandibularis*, a continuous superficial muscle-sheet extending to the symphysis of the mandibulæ. In the posterior three-fifths of this continuous sheet the strands of opposite sides are separated

by a median aponeurotic line. In the anterior two-fifths of the sheet the strands of opposite sides are directly continuous with each other.

A large bundle of the superficial fibres of the ventral portion of the hyal constrictor, composed of a number of muscle strands, separates from the deeper fibres and has its origin on the articular end of the mandibula. Beneath this bundle, and also for a certain distance anterior to it, the deeper fibres of the constrictor have their origins on the ceratohyal, and the so-formed musculus interhyoideus is connected with the adductor mandibulæ by a tendinous fascia which passes internal to the large bundle of superficial fibres and is apparently the homologue of the tendinous fascia described by Vetter, in a similar but wholly superficial position, in *Acanthias*. Internal to the dorsal edge of this fascia the ligamentum mandibulo-hyoideum has its insertion near the dorsal end of the ceratohyal. Anterior to the large bundle of superficial fibres, the superficial fibres of the continuous muscle-sheet all have their origins on the ventral (morphologically posterior) edge of the mandibula, the line of attachment of the muscle beginning immediately anterior to the tendinous fascia just above described. The anterior portion of this musculus intermandibularis is innervated by a branch of the nervus mandibularis trigemini, and is hence of mandibular origin. The posterior portion is innervated by the nervus hyoideus facialis. The musculus interhyoideus extends to the mid-ventral line and is wholly separate from and independent of the superficial, intermandibularis layer of the sheet. It extends anteriorly slightly beyond the anterior end of the mid-ventral aponeurotic line that separates the constrictor fibres of opposite sides from each other, and is apparently not inserted in that aponeurosis.

The muscle strands of the constrictor of each of the branchial arches all have an approximately dorso-ventral course, and they lie, throughout much the larger part of their length, in the related branchial diaphragm and upon the anterior (external) surface of the next posterior gill-

pouch, separated from it by the branchial and extrabran- chial rays of their arch. The fibres that form the distal edge of the muscle, as they cross the dorsal and ventral edges of the next posterior gill-pouch, are strongly attached by connective tissues to those edges, and ventral to the gill opening a certain number of them unite to form a larger strand, which then forms the distal edge of the muscle. By far the larger part of the muscle strands of the dorsal half of the con- strictor traverse the branchial septum, only a few of them, one to three strands, being inserted on the epibranchial of the related arch. In the ventral half of the muscle, on the contrary, a considerable number of strands have their origins from the related ceratobranchial, and the additional strands having this origin apparently correspond to those fibres of the dorsal half of the muscle that have been utilised to form the musculi interarcales dorsales II and III of Dohrn's descriptions, these muscles being represented in *Scyllium* by a single muscle, the musculus arcualis dorsalis. A few strands of the constrictor have their origins, dorsally, on the dorsal extrabran- chial of their arch, near the dorsal bend in the extrabran- chial, and a somewhat larger number of strands are inserted, ventrally, on the ventral extrabran- chial of the arch, near its ventral bend. All of the fibres of the muscle that lie distal to those thus inserted on the extrabran- chials cross the external (anterior) surface of both the dorsal and the ventral extrabran- chials and, as shown in the figures, are attached ventrally, by connective tissue, to the external surface of the longitudinal hypobranchial muscles, none of them reaching the mid-ventral line.

Proximal (anterior) to the fibres that have their origins on the dorsal extrabran- chial a few strands of the muscle in each arch have their origins in loose connective tissues of the region, and proximal to the fibres that are inserted on the ventral extrabran- chial quite a number of strands unite to form a muscle bundle which, as just above stated, corresponds to the musculus arcualis at the dorsal end of the arch. These ventral strands have a different course and insertion in each

of the branchial arches. In the first branchial arch they pass internal (dorsal) to the musculus coracohyoideus, between it and the coracobranchialis I, and end, without reaching the median line, attached to the muscles between which they lie. They pass across the anterior edge of the ventral extrabran- chial of their arch at the point where that extrabran- chial bends posteriorly around the ventral edge of the next posterior gill-pouch, and they are twisted upon themselves so that their internal surface is presented externally. In the second branchial arch these fibres form a flat band which passes between the coracobranchiales I and II, and reaches the median line. There it is inserted, with its fellow of the opposite side, in a median aponeurosis which passes dorsally between the coracobranchiales II of opposite sides and is continuous with connective tissues that surround the truncus arteriosus and the pericardial chamber. In the third branchial arch the fibres separate into two bundles, one of which passes between the coracobranchiales I and II, and the other between the coracobranchiales II and III. The first bundle does not reach the median line, but the second and larger one reaches that line and is attached, with its fellow of the opposite side, to connective tissues that are attached to the tissues surround- ing the truncus arteriosus and pericardial chamber. Certain of those fibres of this muscle that are inserted on the ventral extrabran- chial of their arch pass, with that extrabran- chial, between the coracobranchiales III and IV ; the ventral end of this muscle thus being separated into three parts. In the fourth arch the fibres here under consideration form a flat band which passes dorsal to the coracobranchialis IV and is inserted on the lateral wall of the pericardial chamber, these fibres thus having the relation to the coracobranchiales that the extrabran- chial of the arch would have if it were present. The proximal fibres of a constrictor thus tend to acquire a position anterior to the coracobranchialis that is assigned, by nomenclature, to its arch, the extrabran- chial of the arch lying posterior to that coracobranchialis. This tendency is the more pronounced the more anterior the arch, and in the

hyal arch the entire ventral end of the constrictor lies anterior even to the coracomandibularis.

Most of the muscle strands of each constrictor lie everywhere anterior (external) to the extrabranchial and branchial rays of their arch, but a few of them are, as above described, inserted on the dorsal and ventral extrabranchials. An angular piece has been cut out of the proximal edge of the primitive constrictor by the articulating ends of the epi-branchial and ceratobranchial of the arch, and the cut ends of the muscle fibres are inserted on those cartilages; the angular piece so cut out forming the adductor of the arch, and the dorsal portions of the cut fibres becoming the *musculus arcualis dorsalis*.

The gill-pouches, with their enclosed branchial lamellæ, are thick, cushion-shaped structures. The external opening of the pouch lies, in a state of repose, at the outer edge of the posterior wall of the pouch, and it is smaller than the internal, pharyngeal opening of the pouch. The dorsal and ventral edges of the pouch are convex, the greatest height of the pouch being in the line of the outer ends of the branchial lamellæ and not at the pharyngeal opening of the pouch. The anterior wall of the pouch curves posteriorly over the distal ends of the branchial lamellæ, and the branchial rays, lying against the anterior (external) surface of that wall, are similarly curved at their outer (distal) ends. The constrictor that lies anterior to a gill-pouch lies on the anterior surface of these branchial rays, and, following the curve in the rays, curves posteriorly over them, the distal portion of the muscle lying in the plane of the external surface of the body, and the proximal portion lying in a plane directed antero-mesially at an angle of about 45° to that surface. The hyal constrictor is not so curved, there being no gill-pouch anterior to it and the cartilaginous bar of the arch lying nearer the external surface than do the bars of the branchial arches.

The posterior wall of each gill-pouch presses against the anterior surface of the constrictor next posterior to it, and forms a slight depression on that surface. The outer edge

of this depression corresponds to the outer edge of the pouch, and not, as might have been expected, to the outer edges of the branchial lamellæ; the lamellæ lying within the pouch and not extending to its outer edges. The constrictor is thinner in the depression than it is immediately beyond it. This, and the insertion of certain of the fibres on the dorsal and ventral extrabranchials of the arch, are the only indications of the differentiation of a musculus interbranchialis.

Dorsal extrabranchials are found in the hyal and first four branchial arches, but ventral extrabranchials only in the first three branchial arches. The dorsal extrabranchial of the hyal arch is a small rod of cartilage lying near the outer, distal ends of the branchial rays, and was not found by either White (1896) or Fürbringer (1903, p. 432) in the specimens examined by them. The dorsal and ventral extrabranchials of the branchial arches lie along the dorsal and ventral edges, respectively, of the depression, just above described, formed on the opposite side of the constrictor of their arch by the pressure of the next anterior gill-pouch. Each of the four dorsal extrabranchials, running dorso-anteriorly from its distal end, reaches the curved dorsal edge of the gill-pouch next posterior to it immediately proximal to the highest point of that edge, and there turns sharply ventrally and but slightly anteriorly over that edge, and then expands into a short spatula-shaped end (Fig. 7) which lies against the posterior surface of the gill-pouch. The dorsal end of each of these dorsal extrabranchials is thus crook-shaped, the crook lying close to the dorsal edge of the constrictor of the arch and embracing the dorsal edge of the next posterior gill-pouch, that pouch there being firmly attached to the extrabranchial by connective tissues. The dorsal half of the flat spatula-shaped end of the first extrabranchial lies against the external surface of the musculus trapezius, closely attached to it by connective tissues, and its ventral half against the external wall of the vena jugularis. The corresponding ends of the other three dorsal extrabranchials lie upon and are strongly attached to the musculus trapezius

alone, the vena jugularis here lying along the antero-ventral edge of the trapezius and partly internal to it.

Each ventral extrabranchial turns posteriorly, at its ventral end, around the ventral edge of the next posterior gill-pouch immediately proximal to the lowest point of that curved edge, and then spreads both anteriorly and posteriorly into long pointed processes. The posterior process hooks around the ventral edge of the next posterior gill-pouch and is prolonged, along the posterior surface of that pouch, by a line of fibrous tissue which lies in the line prolonged of the shank of the next posterior extrabranchial, and is inserted on that extrabranchial at the point where it bends posteriorly around the ventral edge of the gill-pouch next posterior to it. The anterior process of the extrabranchial of the first arch runs antero-mesially between the coracobranchiales I and II, and nearly meets its fellow of the opposite side in the median line, being separated from it by the connective tissues that surround the truncus arteriosus. The anterior process of the extrabranchial of the second arch is similarly related to the coracobranchiales II and III and to its fellow of the opposite side, while the anterior process of the extrabranchial of the third arch is similarly related to the coracobranchiales III and IV, but is separated from its fellow of the opposite side by a considerable interval because of the intervening ventral edge of the pericardial chamber. The antero-ventral ends of these anterior processes of the extrabranchialis approach somewhat the inner branchial bars of their respective arches, especially in the first arch, but they are not especially attached to them by connective or ligamentous tissues. They do not turn posteriorly toward the inner branchial bar of the next posterior arch, and they are not connected with that bar by special ligamentous or connective tissues.

The branchial constrictor that lies anterior to a given gill-pouch, and the related branchial and extrabranchial rays, are all quite strongly attached, by connective tissues, to the anterior wall of that pouch, but the constrictor of the arch

is not so attached, in my specimens, to the posterior wall of the next anterior pouch. The hyal constrictor and its related branchial rays are but loosely attached to the anterior wall of the first gill-pouch, this apparently being due to this muscle being a thicker and stronger muscle than the branchial ones.

On the external surface of each wall of each gill-pouch there are tall and narrow U-shaped lines which mark the lines of attachment of the branchial lamellæ on the internal surfaces of those walls. The loops on the posterior wall of the pouch lie against the anterior surface of the constrictor next posterior to the pouch, and, on that surface of that constrictor, and extending from the outer (distal) ends of the loops to the outer edge of the depression that lodges the gill-pouch, there are, dorsal and ventral to the gill-openings, several strands of a tissue that is largely fibrous, but that shows, under the microscope, certain transverse striæ. These strands are radially disposed, as are the branchial lamellæ; they cross the fibres of the constrictor at right angles, and they are closely attached to the anterior surface of that muscle. Their position suggests both the supporting rods of the branchial filaments in the Teleostomi and the radially arranged muscles related to those rods (Allis, 1903), but it seems improbable that they represent the beginnings of the formation of either of them. On the posterior wall of each gill-pouch, opposite the dorsal one of these two series of fibro-muscular strands, there are one or two flat muscle bands which lie approximately parallel to the fibrous strands, but closely attached to the wall of the pouch instead of to the anterior surface of the constrictor. Distally, these bands pass over the outer edge of the pouch, close to the dorsal end of its external opening, and, turning ventrally, join, near its distal edge, the constrictor that lies along the anterior wall of the pouch. Ventral to the gill-openings similar strands are found, but they here lie upon the internal (posterior) surface of the constrictor next anterior to the pouch, close against the outer edge of the pouch, instead of

on the posterior surface of that pouch (Fig. 3). The action of these fibres, although feeble, must be to retract and constrict the related gill-opening.

The dorsal and ventral edges of the gill-pouches are wholly free, excepting where they are each attached, as already described, to the dorsal extrabranchial of the next anterior arch and to the internal surface of the constrictor of that arch, and there are, as already stated, no linear aponeuroses in any of the constrictores. It is accordingly impossible that the dorsal edges of these pouches, in *Scyllium*, have been formed by the partial fusion of the edges of a taller gill-opening, as is maintained by Vetter, Tiesing, and Ruge for the *Selachii* examined by them.

The coracomandibularis, coracohyoideus, and coracobranchialis I all have their origins on the musculus coracarcualis communis, the other coracobranchiales having their origins on the ventral end of the shoulder-girdle. The coracomandibularis is inserted on the mandibula close to the symphysis, the coracohyoideus on the anterior edge of the ventral surface of the basihyal, the coracobranchialis I on the dorsal surface of the postero-lateral process of the basihyal, the coracobranchiales II-IV each on the hypobranchial of the related arch, and the coracobranchialis V on the ceratobranchial of its arch. There are arcualis, but no interarcualis muscles in this fish, each arcualis being a stout muscle, evidently primarily continuous with the constrictor superficialis of its arch, but lying ventral to the vena jugularis instead of lateral to that vein. The primitive constrictor, in growing dorsally, seems to have been split into two parts when it encountered the vein, one passing ventral and the other dorsal to it.

In the small specimen of *Mustelus* (Pl. 22, figs. 8-10) the constrictores superficiales of the hyal and branchial arches together present, in lateral view, the appearance, ventral as well as dorsal to the gill-openings, of a single continuous muscle-sheet, the sheet being perforated by the first four gill-

openings and bounded posteriorly by the fifth opening. Both dorsal and ventral to these gill-openings, the muscle strands of the continuous sheet incline posteriorly at a marked angle to the vertical line, this inclination being greater dorsal to the openings than ventral to them, and greater for the posterior strands of the sheet than for the anterior ones. A narrow aponeurotic line extends dorso anteriorly from the dorsal end of each of the four gill-openings that perforate the sheet, but there are no corresponding ventral aponeuroses. Most of the muscle strands on either side of the dorsal aponeurotic lines are juxtaposed, and faint tendinous lines cross the aponeuroses and connect them, this strongly suggesting that the muscle strands were here primarily continuous, and that the aponeuroses are simply tendinous formations, of secondary origin, that interrupt them. The muscle-sheet, *in situ*, accordingly presents the appearance of being formed by a series of contiguous constrictores, one hyal and four branchial, fused by their adjoining edges both dorsal and ventral to the gill-openings but separated from each other as they pass between those openings. The sheet is, however, not so formed, as will be immediately shown, but this superficial appearance, as it applies to the ventral part of the sheet, is doubtless what led Tiesing to say that, in this fish, the entire ventral constrictor of each arch traverses the related branchial diaphragm and is continuous with the dorsal constrictor.

The anterior edge of the dorsal portion of the sheet is considerably thickened, and this thickened portion is almost completely differentiated, as in *Scyllium*, as a levator hyomandibularis with two heads of origin, one arising along the line of the latero-sensory canal of the body, continuous with the fibres of the posterior portion of the sheet, and the other from the dorso-lateral edge of the chondrocranium, as Tiesing has already stated. Both portions are inserted, together, on the ventral end of the hyomandibula.

If that part of the muscle-sheet that lies posterior to this levator hyomandibularis be cut along its line of dorsal attach-

ment, or so-called origin, the entire sheet can be turned downward a certain distance, disclosing portions of the dorsal extrabranchials, the dorsal branchial rays of the hyal arch, and the dorsal portions of the five branchial pouches. It is then found that four thin sheets of muscle fibres still attach the large muscle-sheet to underlying structures, and if these thin sheets be cut the large muscle-sheet can be turned downward to the middle line of the gill-openings, as shown in Pl. 22, fig. 9. The entire distal portion of each dorsal extrabranchial is then exposed, and it is seen that they each lie against the anterior (external) surface of the gill-pouch next posterior to the arch to which the extrabranchial belongs, that this distal portion of each of the four branchial dorsal extrabranchials lies slightly posterior to and parallel to the dorsal edge of the gill-pouch next anterior to its arch, and that it extends ventro-posteriorly slightly beyond the level of the dorsal edge of the external opening of the latter pouch. The dorsal extrabranchial of the hyal arch is short, and extends but a short distance along the anterior (external) surface of the first gill-pouch.

The four linear aponeuroses of the large muscle-sheet are now seen to extend entirely through the sheet and to lie one external to each of the four branchial dorsal extrabranchials, attached to them only by loose connective tissues, and comparison with Dohrn's and Edgeworth's descriptions of the differentiation of the musculi adductores in embryos of these fishes definitely shows what the aponeuroses are. According to both those authors those primarily continuous muscle fibres (strands) of the constrictores that cross the inner branchial bars of their respective arches acquire insertion on those bars along the lines where they cross them, and, as a result of this, the musculi adductores are cut out of the primarily long and continuous fibres (strands) so concerned. But before that insertion of these fibres (strands) was acquired it is evident that the individual fibres concerned must first have become tendinous along the lines where they were later to be cut in two, this doubtless being due to the interruption of the

muscle substance of the fibres, because of pressure against the branchial bars, and the consequent formation of a tendinous membrane by the united sarcolemmæ of the fibres so interrupted. This same formation of a tendinous interval, with later insertion, might evidently take place along the lines where the muscle fibres of the primitive constrictores crossed any other skeletal element, and in my specimen of *Mustelus* it has quite certainly taken place where the fibres of the continuous muscle-sheet crossed the dorsal extrabran- chials, the process, with these particular fibres, not being carried to the point of section of the fibres with accompanying insertion on the extrabran- chials, while with other fibres this section and insertion has taken place.

The distal end of each extrabran- chial lies, as in *Scyllium*, on the anterior (external) surface of the gill-pouch next posterior to it, and when the dorsal edge of that gill-pouch passes its highest point and turns antero-ventrally toward the pharyngeal opening of the pouch, the extrabran- chial also curves antero-ventrally and lies along the edge of the pouch. In each of the branchial arches the proximal end of the extra- bran- chial then there expands into a flat and thin plate which projects ventrally along the posterior surface of the gill- pouch, there lying either between the pouch and the vena jugularis or between the pouch and the musculus trapezius, the exact relation of each extrabran- chial to the vena jugularis and musculus trapezius not being traced. In the hyal arch there is no plate-like expansion of the proximal end of the extra- bran- chial, this extra- bran- chial being, as in *Scyllium*, simply a slender rod of cartilage. In the second, third, and fourth branchial arches each extrabran- chial, at the point where it crosses the dorsal edge of the related gill-pouch and curves antero- ven- trally along that edge, is somewhat embedded in the musculus trapezius, and it there gives insertion to what appear to be superficial fibres of the trapezius, the number of these fibres increasing progressively from the second to the fourth arches. The fibres so inserted on each extrabran- chial lie not only parallel to the fibres of the musculus trapezius, but also in the

lines prolonged of the fibres of the related portion of the musculus interbranchialis of the arch to which the extrabran- chial belongs, the latter fibres being inserted on the opposite, ventral, edge of the extrabran- chial. In the fourth branchial arch a considerable number of the most proximal fibres of the interbranchialis cross the anterior (external) surface of the extrabran- chial of their arch and join the fibres, above described, that appear to form part of the musculus trapezius, lying contiguous with them, along their anterior edge, on the lateral surface of the trapezius. This definitely shows that the fibres that are inserted on the dorsal edge of the extrabran- chial are not parts of the trapezius, as they appear to be, but are the dorsal portions of certain muscle strands of the constrictor that have been cut in two by insertion on the extrabran- chial, the part ventral to the extra- branchial forming the musculus interbranchialis and the part dorsal to the extrabran- chial secondarily fusing with the trapezius.

The musculus interbranchialis of each branchial arch has its origin from that portion of the dorsal extrabran- chial of its arch that lies proximal to the point where it begins to curve antero-ventrally along the dorsal edge of the next posterior gill-pouch, and also from somewhat more than half of that part of the same extrabran- chial that lies postero- ventral to the curve, and its dorsal edge is seen in fig. 9 lying between the extrabran- chial and the dorsal edge of the next anterior gill-pouch. The fibres distal to those thus inserted on the extrabran- chial of the arch form the thin sheet of muscle fibres that had to be cut in order to turn the large muscle-sheet of the constrictores superficiales downward as shown in the figure. These distal fibres of each interbranchialis, thus here apparently inserted on the internal surface of the large muscle-sheet, must, in younger specimens, have formed the interbranchial portion of long and continuous muscle strands that passed over the anterior (external) surface of the extrabran- chial of their arch and were continued, beyond that extrabran- chial, to the dorsal

edge of the muscle. They formed the middle portion, approximately, of each branchial constrictor, and as the constrictores of this fish overlapped each other to a considerable extent, they must have lain internal to certain strands of the next anterior constrictor, and they and the overlying fibres both became tendinous where they crossed the extrabranhial. If, then, those portions of these deeper fibres, or strands, that primarily lay dorsal to the extrabranhial and the related secondarily formed aponeurosis did not abort, they must still persist as a deeper component of the large muscle-sheet.

Ventral to the gill-openings the conditions, aside from the absence of linear aponeuroses, differ in minor details only from those dorsal to the gill-openings. Here each *musculus interbranchialis*, excepting only a few proximal fibres, is inserted, its full length, on the ventral extrabranhial of its arch, and in each of the branchial arches of my preserved specimen there is a slight fold in the muscle just before it reaches the extrabranhial; the muscle passing, from above, posterior (internal) to the extrabranhial, then turning dorsally upon itself, and then again ventrally to its insertion on the dorso-anterior edge of the extrabranhial (Fig. 10). From the opposite, postero-ventral edge of the extrabranhial a corresponding portion of the fibres of the constrictor of each arch have their origins, and running ventro-posteriorly immediately join, on its internal surface, the continuous muscle-sheet formed by the constrictores superficiales of the several arches. These ventral fibres of the constrictor of each arch thus form a component part of the large muscle-sheet, and they here lie internal to certain fibres of the more anterior arches; but, after crossing the next posterior extrabranhial, they lie between those fibres and certain fibres of the next posterior arch, internal to the ones and external to the others. Here there can be no question as to the persistence of these ventral portions of the fibres of each arch, for they are not here interrupted by linear aponeuroses.

A few of the most proximal strands of the *interbranchialis*

of each arch unite ventrally to form a small bundle. This bundle contracts to a small and pointed head, which, passing anterior (external) to the ventral extrabranchial of its arch and anterior to the musculus coracobranchialis of its arch, between that muscle and the next anterior coracobranchialis, is inserted on the dorsal surface of the hypobranchial muscles. These bundles are always referred to, in all descriptions of these muscles, as parts of the muscoli interbranchiales, but it is to be noted that they are in reality the ventral ends of continuous dorso-ventral fibres of the constrictores, no interbranchiales having been cut out of these particular fibres by insertions on the extrabranchials. Convenience of description, however, requires that they be considered to form parts of the interbranchiales. The more distal strands of each musculus interbranchialis extend either from the dorsal to the ventral extrabranchial of their arch, or from the related dorsal linear aponeurosis to the ventral extrabranchial, lying along the anterior (external) surface of the branchial rays of the arch, between those rays and the posterior wall of the next anterior gill-pouch. Certain of the branchial rays, in certain of the arches, have cut through the muscle in places, and there give insertion to the cut ends of the fibres.

The coracohyoideus and coracobranchialis I are both inserted on the basihyal, the coracobranchiales II, III, and IV each mainly on the hypobranchial of the related arch, but also partly, in arches II and III, on a small cartilage interpolated between the hypobranchial and ceratobranchial, and corresponding, in position, to the most dorsal one of the three cartilages marked Hbr II in Fürbringer's figures of *Torpedo ocellata* (1903, Fig. 21, Pl. 17). In the fourth arch this independent cartilage has either fused with the ventral end of the ceratobranchial or has not separated from it, and the coracobranchialis is accordingly there partly inserted on the ceratobranchial. In the first branchial arch the cartilage is found lying between the ventral end of the ceratobranchial of that arch and the basihyal. The most anterior hypobranchial is related to the second branchial arch, as shown in Fürbringer's

several figures, and not to the first arch, as shown in Gegenbaur's (1872) figure of *Galeus*. The coracobranchiales I and II arise from the dorsal surface of the hypobranchial muscles, but the coracobranchiales III, IV, and V from the lateral surface of the pericardial chamber.

An angular piece has been cut out of the proximal edge of each constrictor, as in *Scyllium*, to form the *musculus adductor* of the arch, and the cut ends of the fibres are inserted on the related epibranchial and ceratobranchial.

In the large head of *Triakis*, the muscles were only superficially examined. The *constrictores superficiales* here, as in *Mustelus*, form a continuous muscle-sheet perforated by the first four gill-openings, and there are dorsal aponeuroses, but no ventral ones. The dorsal aponeuroses are not so well developed as in my specimen of *Mustelus*, certain of the superficial muscle strands of the *constrictores* crossing the aponeuroses, and others there being simply pinched, without being completely interrupted. The aponeuroses here seem to have been in part formed by the invasion of subdermal connective tissues, rather than by the interruption of the muscle substance of the fibres. Where the fibres of the hyal constrictor cross the extrabranchial of that arch the fibres are also partially interrupted, and the beginning of the formation of a linear aponeurosis is plainly evident; and here there is no invasion of connective tissues. That part of each constrictor that lies dorsal to the dorsal extrabranchial of its arch, excluding the first branchial arch, joins, as in *Mustelus*, and even more markedly so, the *musculus trapezius*.

Comparing the conditions in *Scyllium*, *Mustelus*, and *Triakis*, as above described, with those described by Vetter in *Heptanchus*, it is certain that the continuous muscle-sheet formed by the *constrictores superficiales* in *Mustelus* and *Triakis* has arisen by the fusion of the separate but overlapping *constrictores* of *Scyllium* and *Heptanchus*. To

what extent these overlapping and fused muscles have each been preserved, or have aborted, is problematical; but it is certain that the several sections of the continuous muscle-sheet that are included between each two of the series of dorsal aponeuroses each contains elements derived from at least two adjoining arches. In my specimen of *Mustelus* certain of the fibres of the constrictor of the hyal arch even cross, in their dorso-posterior course, all of the dorsal extrabranchials of the fish, including the somewhat rudimentary extrabranchial of the hyal arch. Those portions of the fibres of the constrictores of *Mustelus* and *Triakis* that lie ventral to the ventral extrabranchials are not interrupted by linear aponeuroses, and there is hence no reason to suppose that they there aborted, or even became tendinous. They must simply have joined the overlying fibres of the continuous muscle-sheet and persisted as part of it. There is, however, no noticeable evidence of any thickening of the sheet at these places. The muscle-sheet is, on the contrary, much thicker in its anterior portion, where there is no overlapping of these muscles, than in its posterior portion, where this overlapping takes place.

This interpretation of the constrictores in these several fishes, based wholly on anatomical investigation, finds unexpected confirmation in Dohrn's figures of sections of embryos said to be of *Scyllium canicula* (1884, Figs. 1-4, Pl. 7). In those figures Dohrn shows the constrictores superficiales overlapping each other to such an extent that three, or even four, of them may be superimposed the one above the others, and certain of them are even shown fused with each other to form a single muscle-sheet. How sections of a selachian, with the constrictor muscles arranged as described by Dohrn, Vetter, and others, could be sectioned so as to show these muscles in this relation to each other has heretofore been to me incomprehensible, but sections of a fish in which these muscles were as I have above described and interpreted them in *Mustelus* could easily be sectioned to show them as given in Dohrn's figures. It is, however, to be particularly

noted that in my specimen of a small but adult *Scyllium* it would be impossible to cut a section that could show the conditions given by Dohrn in embryos of that fish. The constrictores superficiales of this fish are so nearly dorso-ventral in position in their dorsal portions that no one of them overlaps more than the next posterior muscle, the gill-pouches elsewhere intervening and separating the muscles; and in their ventral portions the constrictores do not at any point fuse with each other, as Dohrn definitely shows them in his sections.

In the adult specimens of *Acanthias* and *Scymnus* that were examined by Vetter and Marion, conditions strictly similar to those above described in *Mustelus* and *Triakis* must certainly have existed, but they were misinterpreted by those authors. Minor differences, however, apparently exist, as in *Acanthias*, where it would seem, from Vetter's descriptions, as if the dorsal fibres of the constrictor of a given arch, had largely aborted after they had crossed the extrabranhial of the next posterior arch, had still more largely aborted after crossing the extrabranhial next posterior to that one, and had wholly aborted on reaching the third posterior extrabranhial.

The constrictores superficiales of *Mustelus*, *Triakis*, *Acanthias*, and *Scymnus*, and of all other *Selachii* where the conditions are similar, thus forming a continuous muscle-sheet which is subdivided, by the transverse aponeuroses, into what appear like several separate segments, the question of the innervation of these several segments becomes important. Vetter says that he could not satisfactorily determine the innervation of these muscles in the branchial arches either of *Acanthias* or *Scymnus*, but in the hyal arch of those fishes he limits the distribution of the branches of the *nervus facialis* strictly to the constrictor of that arch, as that constrictor is defined by him. Tiesing says that, in *Mustelus*, the branches of the *nervi glossopharyngeus* and *vagus* are distributed only to those segments of the dorsal portions of the constrictores of that fish that are included

between the corresponding linear aponeuroses, while in the ventral portions of the muscles, where there are no aponeuroses to interrupt the muscle fibres, those fibres are innervated, their entire lengths, by the nerve of the related arch. Ruge shows all those fibres of the hyal constrictor that are not interrupted by the most anterior linear aponeurosis continuing onward to the dorsal edge of the continuous muscle-sheet, and his descriptions lead one to conclude that these fibres are innervated, their full lengths, by the *nervus facialis*, while the fibres interrupted by the aponeurosis are only so innervated up to the aponeurosis.

If the innervations thus ascribed to these muscles by Vetter, Tiesing, and Ruge are correct, and if my conclusions regarding these muscles are also correct, the constrictores superficiales of all fishes in which they are interrupted by linear aponeuroses thus unexpectedly present typical examples of a muscle derived from one segment of the body being innervated by the nerve of another segment; and here, not only would the innervation be definitely a secondary one, replacing an earlier and normal innervation, but the change of innervation would have taken place in definitely postembryonic, if not in practically adult, stages. Furthermore, the secondarily acquired innervation of different parts of the dorsal strands, or fibres, of the constrictores of the hyal and first branchial arches of *Mustelus* would be by several different nerves, while the ventral portions of those same strands, or fibres, would be innervated by a single nerve. This certainly seems improbable, if not impossible, and until Vetter's, Tiesing's, and Ruge's statements have been properly controlled, it seems proper to conclude that the innervations given by them are incorrect, and that the muscle of each arch retains its primitive and normal innervation. That certain individual fibres of each constrictor are cut in two where they are crossed by the linear aponeuroses is practically certain, and in all such cases it is probable that that part of each muscle fibre that thus lost its connection with its motor nerve underwent paralysis and subsequent reduction,

or abortion; this then in part accounting for the absence of any undue or noticeable thickenings in the overlapping portions of the muscles.

In the Batoidei, as in *Acanthias* and *Scymnus*, the continuous muscle-sheet formed by the *constrictores superficiales* is said to be separated by septa into separate muscle segments, which are assigned one to each branchial arch and one to the hyal arch; but it is impossible to definitely determine, from the descriptions, whether or not these so-called septa of the Batoidei are similar to the linear aponeuroses of the Selachii. Dohrn's figures (1884, Pl. 7, figs. 5 and 6) of sections of embryos of *Torpedo* would lead one to conclude that dorsal to the gill-openings the conditions were as in *Mustelus*, while ventral to the opening the primitive constrictor of each arch turned posteriorly and fused with the external surface of the next posterior constrictor, not passing beyond the line of that contact and fusion. The ventral septa, at least, of this fish would then not be similar to those in the Selachii. There is, however, certainly some error in the descriptions of these fishes, for it is evident that the constrictor superficialis of a given branchial arch could not lie anterior to the gill-opening between that arch and the next anterior one, and yet that is the position that these muscles have in both Tiesing's (1895) and Marion's (1905) figures of these fishes.

The *musculi trapezius, coracobranchiales, and adductores arcuum branchialium* may now be more particularly considered.

Of the *trapezius* Edgeworth says (1911, p. 257): "*Levatores arcuum branchialium* are developed from the upper ends of the branchial myotomes in Teleostomi, *Ceratodus*, and Amphibia, but are not developed in *Scyllium*, Sauropsida, rabbit and pig. The method of development of the *trapezius*—apparently a homologous muscle throughout the vertebrate groups—is intimately related to these differences. It is developed in Teleostomi and Amphibia from the fourth, in *Ceratodus* from the fifth, levator, i. e. from the penultimate or ultimate levator; whereas in *Scyllium*, *Chrysemys*, *Gallus*

and rabbit, it is formed from the upper ends of the branchial myotomes—five in *Scyllium*, four in *Chrysemys*, two in *Gallus*, and three in the rabbit. In view of the facts that in *Scyllium* the sub-spinalis and interbasales, developed from trunk-myotomes, are attached to the pharyngobranchials, and that the trapezius is innervated only by the XIth—the most posterior of the vagus roots—even though a constituent from the glossopharyngeal (first branchial) segment takes part in its formation, it is probable that the absence of levatores and associated method of development of the trapezius in *Scyllium*, *Sauropsida*, and rabbit are secondary phenomena, and that the primitive condition is a series of levatores formed from the uppermost portions of the branchial myotomes.”

The trapezius is thus said by Edgeworth to be a muscle that is wholly of branchial origin but that varies greatly in the branchial myotome or myotomes from which it is derived, and in the adult *Scyllium*, at least, it is definitely stated that the muscle is innervated by the eleventh nerve alone. It is also elsewhere definitely stated (*loc. cit.*, p. 281) that muscles derived from the trapezius are innervated in *Lacerta* by spinal nerves alone, and in *Gallus* and the rabbit both by the eleventh nerve and by spinal nerves; and frequent references to the trapezius being innervated by the eleventh nerve, or by the eleventh spinal, leads one to conclude that Edgeworth considered the muscle to be innervated by that nerve, or by spinal nerves, in all vertebrates. The muscle is, accordingly, one of those to which I made reference in the opening paragraph of this paper as being said by Edgeworth to be innervated by the nerve of a segment of the body other than that from which the muscle is developed. The condition of this muscle, as found in the adults of fishes, does not, however, warrant this conclusion in so far as it applies to them.

In the adult *Heptanchus* certain fibres of the trapezius are said by Vetter to be inserted on the branchial bar of the most posterior, or seventh, branchial arch, the remaining fibres of the muscle being inserted on the shoulder-girdle. Between the seventh branchial bar and the shoulder-girdle

there is no gill-opening, and no *musculus constrictor superficialis* is described in relation to this seventh arch.

In the adult *Chlamydoselachus* I find conditions strictly similar to those in *Heptanchus*, excepting that in this fish there are but six branchial bars and six gill-openings, the sixth gill-opening lying anterior to the sixth branchial bar. The distal, ventro-lateral end of the so-called epipharyngobranchial of the sixth arch lies close to the shoulder-girdle, and that bundle of the trapezius that has its insertion on that element of this arch extends nearly to its hind end. The insertion of the trapezius on the shoulder-girdle begins opposite the hind end of the sixth epipharyngobranchial, and from there extends upward along the anterior edge of the shoulder-girdle. The trapezius is overlapped externally by the dorsal ends of all of the *constrictores superficiales*, including the constrictor of the fifth branchial arch, and each of the five branchial *constrictores* is similarly overlapped by the next anterior constrictor, the muscles thus being, in this respect, serially homologous.

In *Acanthias* and *Scymnus* the trapezius, as described by Vetter, resembles that in *Heptanchus* and *Chlamydoselachus* excepting in that its relations to the branchial bars are modified by there being but five branchial arches in these fishes, and in that the trapezius is here perforated by the slender tendons that are said to alone represent the dorsal portions of the four branchial *constrictores superficiales*. In the adult *Mustelus* the trapezius is said by Tiesing to closely resemble that in *Acanthias*, as described by Vetter, and Tiesing makes no mention of any fibres of the *constrictores superficiales* joining the trapezius, such as I find in my young specimen of this fish. In *Chimæra* (Vetter, 1878), there are minor, and for my purpose, unimportant variations in the muscle.

In *Heptanchus* and *Chimæra*, Vetter could not determine the innervation of the trapezius, but Fürbringer (1897) has since shown that in *Heptanchus* it is innervated by branches of the *nervus vagus*. In *Acanthias* and *Scymnus* the muscle

is said by Vetter to be innervated either by branches of the *nervus intestinalis vagi*, or, possibly, by that nerve together with delicate branches of other, more anterior portions of the *vagus*. In *Prionodon glaucus*, that anterior bundle of the *trapezius* that has its insertion on the branchial bar of the ultimate arch of the fish is said by Vetter (1878, p. 460) to be innervated by a branch of the *nervus vagus quartus*, the remainder of the muscle being innervated by the *nervus intestinalis vagi*. In *Chlamydoselachus* I find the muscle innervated by a branch of the *vagus* that lies next posterior to that branch of the nerve that is sent to the penultimate branchial arch.

The anatomical evidence regarding this muscle in these several fishes, taken by itself, would thus evidently lead to the conclusion that the *trapezius*, in each of the fishes considered, is simply a differentiation of the constrictor superficialis of the ultimate branchial arch of that particular fish—the seventh in *Heptanchus*, the sixth in *Chlamydoselachus*, and the fifth in *Acanthias*, *Scymnus*, and *Mustelus*—or, possibly, of that arch and other more posterior arches if such arches primarily existed and have successively disappeared by reduction or transformation. This conclusion would then differ from that arrived at by Vetter (1874, pp. 432–433) only in that the *trapezius* is considered to be derived mostly, or entirely, from the constrictor of the ultimate persisting branchial arch instead of from the constrictor of a modified and more posterior arch that is represented in the shoulder-girdle. This derivation of the muscle would also explain, and find confirmation in, Dohrn's otherwise inexplicable failure to find it developed from the dorsal ends of all of the branchial myotomes, as Edgeworth maintains that it is developed; and the partial fusion of the proximal fibres of the dorsal portions of the constrictores superficiales of the second to the fourth branchial arches with the *trapezius*, in my specimens of *Mustelus* and *Triakis*, would probably explain how Edgeworth came to consider the latter muscle to be developed from the dorsal ends of all of the branchial myotomes. It is, however,

to be noted that this partial fusion of these fibres with the trapezius is not found in my specimens of *Scyllium*, and it is to embryos of this particular fish that Edgeworth's descriptions relate. This view of the development of the trapezius from the constrictor of the ultimate branchial arch is also in fullest accord with Greil's very complete descriptions of its development in *Ceratodus*.

In this latter fish, *Ceratodus*, a muscle called by Greil the dorsoclavicularis is said by that author (1913, p. 1343) to represent the phylogenetic beginning of a *musculus trapezius*. This dorsoclavicularis is said by Greil (*loc. cit.*, p. 1139) to be derived from a ventral process of the posterior half of the second trunk myotome, which, forking over the fifth branchial cleft, sends one process down anterior to that cleft and the other posterior to it. The former process lies in the fourth branchial arch, and from it is developed the axial mesoderm of that arch. The posterior process is shown in Greil's fig. 1, plate 52, apparently lying posterior and partly internal to a branchial pouch which is called, in the index lettering, the "siebenten Schlundtasche," that is, the sixth branchial pouch. In figs. 3 and 4 of the same plate the process is shown lying directly external to this sixth branchial pouch, close against the posterior edge of the fifth branchial cleft. The sixth branchial pouch never breaks through to the exterior.

The posterior fork of the ventral process of the second trunk myotome of *Ceratodus* accordingly lies in the fifth branchial arch alone, or both in that arch and the region of a sixth branchial arch that never develops. The process is said to separate into superficial and deeper portions. The deeper portion grows inward, dorsal to the pericardium, and forms a muscle which, although lying ventral to the pharyngeal cavity, is called the *musculus dorsopharyngeus*. This large muscle is the exact serial homologue of a smaller muscle, called the *interbranchialis IV*, which is developed from the ventral end of the axial mesoderm of the fourth branchial arch; and both these muscles, lying dorsal to the pericardial cavity and the *truncus arteriosus*, are serial

homologues of the so-called musculi interbranchialis posterior, interbranchialis anterior, and ceratohyoideus, which are developed, respectively, from the ventral ends of the axial mesoderm of the third, second, and first branchial arches, but lie anterior to, and hence morphologically ventral to, the truncus arteriosus.

The superficial portion of the posterior fork of the ventral process of the second trunk myotome grows ventrally external and ventral to the pericardial cavity, and apparently separates into three muscles, but there is some confusion in the name given to them. One of them is certainly the musculus clavicularis, or dorsoclavicularis, which, as above stated, is said by Greil to represent the phylogenetic beginning of a musculus trapezius (den ersten phyletischen Anfang eines Trapeziums höher stehenden Formen). The second and third muscles are first called the dorso-branchialis and dorsohypobranchialis, but later the names dorsobranchialis, dorsoleidobranchialis, coracocleidobranchialis, cleidobranchialis, and coracobranchialis are apparently used either to designate those muscles themselves or muscles derived from them.

The musculi dorsopharyngeus and dorsoclavicularis are definitely said by Greil (*loc. cit.*, p. 1249) to be innervated by a branch of the nervus vagus given off close to the ramus intestinalis vagi. The other muscles derived from the ventral process of the second trunk myotome must then also, in embryos, be innervated by the vagus, but I do not find that this is so definitely stated. A muscle that Greil considered to be the homologue of the trapezius is, in any event, said by him to be derived from the axial mesoderm of the fifth (or fifth and sixth) branchial arch, and it is innervated by a branch of the nervus vagus that has the position, serially considered, of a nerve of that arch (or arches).

Froriep (Greil, 1907, Discussion) thinks that this origin of the axial mesoderm of the fourth and fifth branchial arches of *Ceratodus* from a trunk myotome needs confirma-

tion, and Edgeworth (*loc. cit.*, p. 176) also questions it, but as it is a question that relates primarily to the origin of the mesoderm of these two arches, and involves that in the other visceral arches also, the question of a secondary change in the innervation of a muscle, as I am at present considering it, is not involved.

Edgeworth (*loc. cit.*, p. 243), in his own investigations, finds the trapezius of *Ceratodus* "proliferated from the outer side of the fifth levator" *arcus branchialis*; these two muscles together thus strikingly recalling the trapezius of the adult selachian. This origin of the muscle is thus in accord with my contention that it is developed from the primitive constrictor of the ultimate branchial arch of the fish, and from that constrictor only, and that it accordingly retains, in the adult, its normal and primitive innervation.

In the Teleostomi the conditions are probably strictly comparable to those in *Ceratodus*, but this cannot be definitely established from the descriptions given. Edgeworth says that the trapezius is developed, in all these fishes, from the fourth levator *arcus branchialis*. In *Amia* it is said (*loc. cit.*, p. 239) to be represented by the fifth external levator of my descriptions of that fish, a muscle that I found innervated (Allis, 1897, p. 696) by a nerve that arose either from the base of the post-trematic branch of the third vagus nerve (nerve of the fourth branchial arch), or from the main trunk of the vagus near the base of that vagus nerve. In *Acipenser* the muscle is said by Edgeworth (*loc. cit.*, p. 236) to be found in $8\frac{1}{2}$ mm. embryos, given off from the fourth levator, but to be in process of disappearing in 11 mm. embryos. In the adult it is said, on Vetter's authority, to be absent. The fifth levator of Vetter's descriptions of this fish is said to be developed from the fifth branchial myotome, and although it persists in the adult, it is not considered by Edgeworth to represent the trapezius, as it does in *Amia*. This seems singular, for in *Polyodon* there is a well developed trapezius (Danforth, 1913, p. 141), innervated by a branch of the vagus, and but four *levatores arcuum branchialium*;

the trapezius thus apparently representing the fifth levator. In *Menidia*, Herrick (1899, p. 117) found a trapezius innervated by a branch of the vagus, and there are but four levatores in that fish. In *Scomber* I found (Allis, 1903, p. 207) five external levatores, the fifth one being inserted in a membrane attached to the clavicle, and there is no trapezius in this fish. In *Trigla* and *Scorpæna* I also found (Allis, 1909) five external levatores, and I now find that there is no trapezius in either of these fishes. In *Ameiurus* there is a trapezius innervated by a branch of the vagus (Herrick, 1901, p. 209), and the levatores of this fish are none of them inserted on the fifth branchial arch (McMurrich, 1884). In *Polypterus*, Edgeworth (*loc. cit.*, p. 241) finds a trapezius, and there are but four levatores in this fish.

These several facts regarding these fishes, when compared with Greil's descriptions of *Ceratodus*, seem certainly to warrant the conclusion that in the Teleostomi, as in *Ceratodus*, the trapezius is developed from the fifth branchial myotome, and that it always retains its normal and primitive innervation by the nerve of that segment of the body.

The musculi coracobranchiales are said by Dohrn to be developed, as already fully explained, from the deeper, proximal fibres of the ventral portions of the constrictores superficiales of the branchial arches and to be represented, in the adult, by those fibres as described by Vetter. They are accordingly said by Dohrn to be totally different muscles from the coracobranchiales of Vetter's descriptions of the adult, which are said by Dohrn to be simply the distal fibres of the ventral portions of the branchial constrictores superficiales, misnamed coracobranchiales by Vetter. Edgeworth says, as already explained, that the coracobranchiales are developed from the entire ventral ends of the branchial myotomes, and he considers the muscles so developed to be identical with the coracobranchiales of Vetter's descriptions of the adult.

The coracobranchialis of the first branchial arch of the

adult *Heptanchus* is said by Vetter to arise mainly from the tendinous dorsal surface of the *musculus coracohyoideus*; the *coracobranchiales* of the second to the fifth arches to arise mainly from the dorsal surface of the *musculus coracoarcualis communis*, but in part from a tendinous cord formed in the mid-ventral line of a fascia that covers, ventrally, the pericardial chamber; the sixth *coracobranchialis* to arise in part from the shoulder-girdle; and the seventh *coracobranchialis* to arise entirely from the shoulder-girdle. Running forward, these several muscles are all inserted mainly on the hypobranchial of the arch to which they are assigned, but certain of the fibres of the muscle of the first arch are inserted on the basihyal, and certain of the fibres of the muscles of the second to the sixth arches, and all of the fibres of the muscle to the seventh arch, on the *ceratobranchial* of the corresponding arch. Although not so stated by Vetter, the *coracobranchiales* must, because of these origins and insertions, in a measure embrace the pericardial chamber, running at first dorso-laterally and then dorso-mesially around it. Deeper (proximal) and distal fibres of the ventral portions of the *constrictores superficiales* both coexist with the several *coracobranchiales*.

In *Acanthias* and *Scymnus* the *coracobranchiales*, as described by Vetter, seem to differ from those in *Heptanchus* mainly in that they arise ventrally, in *Acanthias*, from the outer edge of the fascia that covers the pericardial chamber, and in *Scymnus* from the shoulder-girdle and a process of the fifth *ceratobranchial*. Marion (1905) says that, in *Acanthias*, the *coracobranchialis* is composed of five parts and forms the lateral wall of the pericardial chamber. In both *Scyllium* and *Mustelus*, as I have already fully described, *musculi coracobranchiales* coexist with both deeper (proximal) and distal fibres of the *constrictores superficiales*, and there is every reason to believe that similar conditions are found in both *Acanthias* and *Scymnus*.

In *Chlamydoselachus* I find the *coracobranchiales* of the third to the sixth branchial arches all arising, as a single

continuous muscle-sheet, from the lateral edges of a strong median fascia which is attached posteriorly, on either side, to the lateral edge of the ventral portion of the shoulder-girdle. This fascia extends anteriorly, beyond the united ventral ends of the shoulder-girdles, as a narrow median tendinous band, and, lying close against the ventral surface of the pericardial membrane, forms, with that membrane, the related ventral portion of the wall of the pericardial chamber. The fascia is apparently formed in large part by the tendons of origin of the fibres of the muscle-sheet, and from there the fibres run at first antero-dorso-laterally and then antero-dorso-mesially, thus encircling and enclosing the pericardial chamber and the truncus arteriosus. The musculi coracobranchiales of the third to the sixth branchial arches thus have every appearance of having been developed in intimate relations to the wall of the pericardial chamber, and of having retained their relations to that wall. The first and second coracobranchiales have become more or less independent of the pericardial wall and its related fascia. In this fish, as in *Heptanchus*, the deeper and distal portions of the ventral ends of the *constrictores superficiales* both coexist with the coracobranchiales.

The coracobranchiales of *Chlamydoselachus* are all innervated, as they are said by Vetter to be in the fishes examined by him, by a large nerve of spinal or spino-occipital origin, the exact origin and composition of which I have not as yet determined, this nerve also innervating the musculi coracareualis communis, coracohyoideus, and coracomandibularis. This common innervation of these several muscles, their practical continuity in the adult *Heptanchus*, and the fact that, in *Heptanchus*, *Chlamydoselachus*, *Scyllium*, and *Mustelus*, coracobranchiales, innervated by spinal or spino-occipital nerves, coexist with both the deeper (proximal) and the distal fibres of the ventral portions of the *constrictores superficiales*, all of which latter muscles are innervated by branchial nerves, give every reason to believe that both Dohrn and Edgeworth have in some way misinterpreted the

muscles in embryos, and that the coracobranchiales of Vetter's descriptions are not each derived from the ventral end of the corresponding branchial myotome, as they are said to be by both those authors.

The coracobranchiales of these fishes must then either be developed from trunk myotomes, as the coracohyoideus and coracomandibularis are said to be; be developed, as in *Ceratodus* (Greil), from the ventral end of the axial mesoderm of the ultimate branchial arch, as will be later explained; or, possibly, be developed from some part of the cœlomic wall. Their innervation, as at present given, is decidedly against the supposition that they are developed from the myotome of the ultimate branchial arch, and in favour of their being developed from trunk myotomes, as the other hypobranchial muscles are said to be. The conditions in *Chlamydoselachus*, if this fish is as primitive a one as it is generally considered to be, would favour their being developed from the cœlomic wall, and this derivation has been ascribed to them, in other *Selachii*, by van Wijhe.

Van Wijhe says (1882 b, p. 16): "Der *Musc. coracobranchialis* + *coraco-mandibularis* hat eine ganz andere Entstehungsweise als der *coraco-hyoideus*. Er entwickelt sich nämlich aus der unpaaren vorderen Verlängerung des Pericardiums, dessen Höhle, wie wir gesehen haben, im Stadium J mit den Höhlen der Visceralbogen communicirt. Nach dem Stadium K fängt diese vordere Verlängerung zu obliteriren an; die Zellen ihrer Wände werden Muskelfasern, und im Anfang des O ist die ganze Höhle geschwunden; ihre muskelösen Wände sind zusammengekommen, und bilden die Anlage des *Musc. coraco-mandibularis* + *coraco-branchialis*. In späten Stadien ist derselbe immer leicht von dem *Musc. coraco-hyoideus* zu unterscheiden. Die Nebenbranche, welche ersterer zu den Visceralbogen abgibt, sind aus den Unterenden der Wände der Visceralbogenhöhlen entstanden."

The "Nebenbranche" above referred to by van Wijhe are quite certainly simply the deeper, proximal fibres of the ventral portions of the *constrictores superficiales*, which

coexist, in *Heptanchus*, *Scyllium*, and *Mustelus*, with the coracobranchiales and are inserted on them, but form no part of them. The coracobranchiales would then not be derived in any part from branchial myotomes, and their primitive innervation would depend upon what nerve or nerves innervated the parts of the pericardial wall from which they were derived, and this might evidently be either by branchial or postbranchial nerves. But if these muscles and the coracomandibularis are both derived from cells of similar origin, as van Wijhe states, and if the coracomandibularis was primarily innervated by spinal or spino-occipital nerves, the coracobranchiales must certainly also have been so innervated, and even Edgeworth does not question that the coracomandibularis was primarily as well as actually innervated by those nerves. Edgeworth furthermore says (*loc. cit.*, p. 178) that no muscles are directly formed from the walls of the branchial portion of the cephalic cœlum, which, if correct, would indicate that the muscles described by van Wijhe were developed in the postbranchial, or spinal, region. The anatomical evidence is also all strongly in favour of the similarity of origin of these muscles ascribed to them by van Wijhe, and until the conflicting embryological evidence has been controlled it accordingly seems proper to conclude that all the so-called hypobranchial muscles are of similar origin, and that they were primarily, as they are actually, innervated by spinal or spino-occipital nerves.

In *Chimæra* coracobranchiales are said by Vetter (1878) to be found, and to there closely resemble the muscles found in the *Selachii*. These muscles are thus found in all the *Elasmobranchii*, and in all of these fishes they are said to be innervated by spinal or spino-occipital nerves.

In the *Teleostomi* and *Dipneusti*, coracobranchiales have been described as such in certain fishes, while, in other fishes, muscles described under other names are said to be the homologues of the coracobranchiales of the *Elasmobranchii*.

In *Acipenser* the coracobranchiales of the first three

branchial arches are said by Vetter (1878) to be represented by special tendons of the musculus coracoarcualis anterior which are inserted, one each, on the hypobranchial of the corresponding arch, the main tendon of the muscle being inserted on the hypohyal. The coracobranchialis of the fourth arch is said to be probably wanting. The coracobranchialis of the fifth arch is said to be represented by the single tendon of the coracoarcualis posterior, which tendon is inserted on a ligament which extends from the basibranchial of the fourth arch to the ventral end of the rudimentary branchial bar of the fifth arch. Fürbringer (1897, p. 460) found the tendon of the latter muscle separated into two parts, one of which was inserted on the branchial bar of the fourth arch and the other on that bar of the fifth arch. Vetter says that all these muscles are innervated by spinal nerves.

The coracobranchiales of the adult *Acipenser* are thus said to be so completely fused with the coracoarcuales anterior and posterior that they appear as simple tendons of those muscles, and Edgeworth says (*loc. cit.*, p. 235) that these tendons are developed from downgrowths of the lower ends of the first, second, third, and fifth branchial myotomes, while the coracohyoideus, which is Vetter's coracoarcualis anterior together with the tendon inserted on the hypohyal, is said (*loc. cit.*, p. 268) to be of spinal origin. No downgrowth, giving rise to a coracobranchialis, takes place in the fourth arch, this arch thus forming, for some inexplicable reason, a marked exception to the other arches.

This interpretation of these several muscles of *Acipenser*, based by Vetter on anatomical and by Edgeworth on embryological investigations and considerations, may perhaps be the correct one, but I strongly doubt it. Comparing the conditions in this fish with those in *Heptanchus*, *Scyllium*, and *Mustelus*, as I have described them, it seems much more probable that the so-called coracobranchiales of the first three branchial arches of *Acipenser* are simply the homologues of the proximal fibres of the ventral ends of the con-

strictores superficiales of *Heptanchus*, *Scyllium*, and *Mustelus*, and not the homologues of the hypobranchial coracobranchiales of those fishes. The musculus coracoarcualis posterior of *Acipenser*, if its innervation by spinal nerves is correct, might be the homologue of the coracobranchiales of the *Selachii*, but this innervation needs confirmation.

In *Ceratodus*, coracobranchiales are said by Edgeworth to be developed from the ventral ends of the second, third, and fifth branchial myotomes, but not from those ends of the first and fourth myotomes. In later stages, still another coracobranchialis is said to be differentiated from the already differentiated interarcualis ventralis of the first branchial arch. Greil gives quite a different account of the origin of these muscles. According to him (1913) there is but one coracobranchialis on either side of the head of this fish, and it is said, as already explained, to be developed from the external one of two processes of the ventral end of the axial mesoderm of the fifth branchial arch, that mesoderm being derived from a ventral process of the second trunk myotome. The muscle is said by Greil (*loc. cit.*, p. 1344) to grow forward and separate into three or four heads which acquire insertions on the ventral ends of the branchial bars. The ventral ends of the axial mesoderms of the first to the fourth branchial arches are said to develop, respectively, into the musculus ceratohyoideus, interbranchialis anterior, interbranchialis posterior, and interbranchialis IV, while from the deeper one of the two processes from the ventral end of the axial mesoderm of the fifth arch the dorsopharyngeus is said to be developed; all of these muscles being said to be serial homologues one of the other and all wholly independent of the coracobranchialis.

In *Amia*, Edgeworth says (*loc. cit.*, p. 237) that only one coracobranchialis is developed, the coracobranchialis V, and this muscle, in 14 mm. embryos, is said to divide into the pharyngoclaviculares externus and internus of the adult. In the *Teleostei* the development of these muscles is not particularly described, but references made by Edgeworth to

those fishes make it certain that the conditions were there considered by him to be similar to those in *Amia*. In *Polypterus senegalus* the musculi pharyngoclaviculares are said to be developed as in *Amia*, but from the ventral end of the fourth instead of the fifth myotome.

Regarding the innervation of the coracobranchiales, Edgeworth says (*loc. cit.*, p. 253): "A coraco-branchialis, or pharyngoclavicularis externus and internus, developed by backward growth from the last branchial myotome, i. e. fourth in *Polypterus senegalus*, fifth in *Amia*, *Salmo*, *Menidia*, may either retain its original branchial innervation from the tenth, e. g. *Amia* (Allis), *Esox* (Vetter), *Menidia* (Herrick), *Lepidosteus*, *Polypterus senegalus*, or be innervated by spino-occipital nerves, e. g. *Amiurus* (Wright), *Salmo* (Harrison). When coraco-branchiales are developed from all the branchial myotomes, they are innervated by the spino-occipital nerves, e. g. *Selachii* (Vetter, Fürbringer), *Acipenser* (Vetter), *Polypterus*? species (Fürbringer), *Ceratodus* (Fürbringer)."

Certain of the musculi coracobranchiales are thus, like the trapezius, muscles said by Edgeworth to be innervated by the nerve of a segment of the body other than that from which the muscle is derived. The muscles said by him to be innervated by the nervus vagus can be left out of account in this respect, and the muscles in the *Selachii*, and the tendons that are said to represent the muscles in *Acipenser*, have been already considered. In *Ceratodus*, the dorsocleidobranchialis of Greil's (1913) descriptions, from which the so-called coraco-branchialis is said to be developed, is said by that author to be innervated, in embryos, by the nervus vagus, and although Fürbringer (1897), who is quoted by Edgeworth, includes this muscle of this fish in the hypocranial spinal muscles, innervated by spino-occipital nerves, I cannot find that he himself traced their innervation by branches of those nerves. In *Ameiurus*, Herrick (1901, p. 209) says that the pharyngoclaviculares are innervated by the vagus, and not by spinal nerves as they were said to be by Wright, and I have con-

trolled and confirmed this innervation by the vagus in sections that I have of this fish. In sections of a 75 mm. specimen of *Polypterus senegalus* I also find these muscles innervated by a branch of the vagus and not by spino-occipital nerves. In *Polyodon*, which is not cited by Edgeworth, the pharyngoclaviculares are said by Danforth (1913) to be practically continuous, at their origin from the shoulder-girdle, with the coracoarcualis, and to be innervated, as the latter muscle is, by spinal nerves; and Danforth adds: "I could trace no branches of the vagus into their upper ends." I however find, in a series of transverse sections of a 141 mm. specimen of this fish, a branch of the vagus going into the upper ends of these muscles and apparently innervating them. The large spinal nerve that innervates the hypobranchial muscles passes close to the ventral ends of the pharyngoclaviculares, but no branch could be found entering them. An artery that accompanies the large spinal nerve leaves it and enters the pharyngoclaviculares.

The anatomical evidence regarding these muscles in the Teleostomi and Dipneusti is thus, as in the case of the Elasmobranchii, against the view that they have undergone a secondary change of innervation, but it is strongly in favour of the view that there are, in these several fishes, two totally different sets of muscles that have both been called coraco-branchiales, one being of spinal or spino-occipital and the other of branchial origin. The muscles of spinal or spino-occipital origin are found in the Elasmobranchii, while those of branchial origin are found in the Teleostomi and Dipneusti. In the Teleostomi, with the possible exception of *Polypterus* (Edgeworth), the muscles are derived from the ventral half of the primitive constrictor superficialis of the ultimate branchial arch, this portion of this constrictor thus being utilised, in these fishes, for the secondary purpose of forming this muscle just as the dorsal portion of this muscle has been utilised, in the Elasmobranchii, for the secondary purpose of forming the musculus trapezius. In the Elasmobranchii the muscles are quite probably derived either from trunk myotomes or from the

walls of the coelomic cavity, and hence not from branchial myotomes.

The development of these muscles in *Ceratodus*, as described by Greil, may perhaps offer an explanation of this difference of innervation and apparent derivation of these muscles in these two large groups of fishes. The coracobranchiales of *Ceratodus* are said by that author to be developed from a ventral process of the posterior half of the second trunk myotome. From a similar ventral process of the entire third trunk myotome a large muscle is said to be developed (1913, p. 1140) which acquires insertion on the hypohyal and ceratohyal and hence is evidently a musculus coracohyoideus, and from this muscle the coracomandibularis is differentiated. Similar ventral processes of the fourth and fifth trunk myotomes form the posterior portion of the hypobranchial muscles, these portions evidently representing the musculus coracoarcualis of the Selachii; and these muscles are all innervated by branches of a nerve formed by the fusion of the nerves of the fourth and fifth trunk segments (myotomes). Of these nerves Greil says (*loc. cit.*, p. 1139): "Es besteht jedoch keine engere Zugehörigkeit zu den betreffenden Segmenten, jeder Nerv versorgt auch den Myotomfortsatz des vorderen Segmentes, was sich schon daraus ergibt, dass der dritte Segmentnerv in der Regel keinen ventralen Nerven an die hypobranchiale Musculatur abgibt." Here it is said that the coracobranchiales and the coracomandibularis + coracohyoideus are derived from ventral processes of adjoining segments of the trunk which differ only in that one of them becomes affiliated with the branchial arches and acquires innervation by the vagus, while the other retains its affiliation with the trunk myotomes and acquires innervation by the nerve of the next posterior trunk segment. This change of innervation, based on embryological evidence alone, I am always inclined to doubt, but it is to be noted that if the process of the second trunk myotome had retained its primitive relations to the other trunk myotomes, instead of undergoing some sort of change because of its

affiliation with the branchial myotomes, the coracobranchiales would have been innervated by a spino-occipital instead of by a branchial nerve; and this is possibly what has occurred in the Selachii.

An adductor arcus branchialis is said by Vetter to be found, in all the Selachii examined by him, in each of the fully developed branchial arches, which would seem to exclude the ultimate arch in each of these fishes, that arch certainly not being fully developed. In *Chimaera*, Vetter says that similar muscles are found in the first three branchial arches, but that the corresponding muscles in the fourth and fifth arches resemble the arcuales dorsales of the Selachii rather than the adductores of those fishes. Tiesing (1895) says that in *Mustelus* and the Batoidei there is an adductor muscle in each arch, and I find an adductor in each of the six arches of the one specimen of *Chlamydoselachus* that I have examined for this purpose. Fürbringer (1903, p. 397) did not find an adductor in the first branchial arch of his specimen of *Chlamydoselachus*. Vetter says that the adductores in the Selachii, and also in *Chimaera*, are all innervated by branches of the nervus vagus of the related arch, but he does not give the course of those branches. Tiesing gives the same innervation in the Selachii and Batoidei examined by him, and he adds that the branch of the vagus that innervates the muscle perforates, in each case, the related epibranchial in order to reach the muscle. In *Chlamydo-elachus* I also find the nerve perforating the related epibranchial, near its anterior edge. The muscle, in all the Plagiostomi, and in the first three branchial arches of *Chimaera*, arises from the internal surface of the epibranchial of its arch and is inserted on the opposing, internal surface of the ceratobranchial of the arch.

In the Teleostei, Vetter (1878) found no adductores arcuum branchialium excepting in one large specimen of *Esox*, in which specimen they are said to be represented by a few scattered muscle fibres lying in connective tissue in the angle

between the epibranchial and ceratobranchial in each of the first three branchial arches. These fibres being found only in a particularly large specimen of this fish, does not favour the view that they are persisting fibres of a muscle that is in process of reduction; for one would naturally expect to find such a muscle relatively the more developed the younger the fish. In *Ameiurus*, Wright (1885) did not find any of these muscles, and they are said by Pollard (1892) not to be found in *Polypterus*. In the *Dipneusti*, also, they are apparently not found, for Fürbringer (1904) makes no mention of them in his descriptions of those fishes.

In *Amia*, I described (Allis, 1897) two *adductores arcuum branchialium*, one related to the fourth and the other to the fifth branchial arch. The fourth adductor arises from the internal surface of a posteriorly projecting process of the fourth epibranchial, and is inserted on a similar process of the fourth ceratobranchial, the muscle thus lying on the posterior surface of the branchial bar. The fifth adductor extends from the opposite side of the process of the fourth ceratobranchial just above mentioned to the fifth ceratobranchial, lies somewhat on the posterior surfaces of those two cartilages, and is in part continuous, ventrally, with the *transversus ventralis posterior*. The branch of the *vagus* that innervates these muscles passes, in each case, over the posterior edge of the related branchial bar.

In *Polyodon*, Danforth (1913) finds an *adductor arcus branchialis* in each of the first four branchial arches. Each muscle arises from the flat posterior surface of the related epibranchial, the surface of origin not approaching the margin of the cartilage at any point, and the muscle is covered by a tough aponeurotic sheet which binds it to the cartilage and also serves as a secondary basis of origin. Running ventrolaterally each muscle passes between the epibranchial and ceratobranchial of its arch and is inserted on the anterior surface of the latter cartilage. Branches of the *nervus vagus* of the related arch are sent to the muscle, passing, in each case, over the posterior edge of the related epibranchial.

Fibres of the ramus post-trematicus internus of the next posterior arch are said to also enter the muscle, but Danforth could not determine whether they were motor or sensory nerves.

In *Acipenser*, Vetter (1878) found a small adductor in each of the first three branchial arches.

Adductores arcuum branchialium are accordingly described only in the Elasmobranchii and Ganoidei, and in these two groups of fishes there is marked difference, not only in the position of these muscles, but also in their manner of innervation. The muscles in these two groups of fishes cannot, then, be homologous if the innervation of muscles, and the relations of nerves to skeletal structures, are as constant as I consider them to be. That the nerves that innervate the muscles in *Amia* and *Polyodon* have cut through the related epibranchials, from their anterior to their posterior surfaces, the perforation of the cartilage in the Plagiostomi representing an intermediate stage in this process, I, on principle, greatly doubt, and, furthermore, Dohrn's observations offer a different and more probable explanation of the conditions in the latter fishes. According to that author (1884, p. 111), a concentration of mesoderm cells takes place, at a certain stage in embryos of these fishes, posterior to the proximal edge of the related myotome, and soon afterwards a second concentration of similar cells takes place anterior to the myotome. These two groups of cells are said to represent the beginnings of the chondrification of the branchial bar of the arch, but it is not said how or when the two groups fuse. That part of the myotome of the arch that lies between the two groups of cells is said to later differentiate as the adductor of the arch, and it would seem as if the nerve that innervates the muscle so differentiated would of necessity lie between the two groups of cells, and hence later perforate the branchial bar, and this seems to find confirmation in conditions that I find in my 42 cm. specimen of *Scyllium*. In this fish each musculus adductor has its insertion, at either end, in a pit in the related epibranchial or ceratobranchial, and in each of the ceratobranchials this pit

in part perforates the cartilage, the muscle strands of the adductor there being directly continuous with those of the musculus interbranchialis of the arch. The adductor is thus here not yet fully cut off from the primitive constrictor of its arch, and if the epibranchial were similarly perforated in younger stages it is certain that these particular strands would be innervated by a nerve that traversed the perforation of that cartilage.

If this be the explanation of the conditions in the Plagiostomi, it is quite certain that the conditions in the Ganoidei were not derived from them. The conditions in these latter fishes are associated with, and quite undoubtedly correlated to, the presence of the straight form of branchial bar instead of the sigma form, and to the absence of cartilaginous branchial rays. Where these latter rays are found, the constrictor muscle of an arch could slip, or project, over the anterior edge of the related branchial bar, as described by Dohrn in plagiostoman embryos, and so give rise to an adductor muscle, but it could not so slip over the posterior edge of the bar. The ganoidean adductores could not, accordingly, have been developed in a fish already possessed of cartilaginous branchial rays, and it would even seem as if they could not have been developed in a fish already possessed of the cartilaginous or osseous rods that support the branchial filaments in all the Teleostomi. These osseous rods I have already described in *Scomber* (Allis, 1903), and I now find similar supporting rods, of cartilage instead of bone, in *Amia*, *Polyodon*, and *Polypterus*. In *Amia* they are not evident until the fish is over 12 mm. in length. These rods are found in two series, one along the anterior and the other along the posterior edge of the branchial bar, and it would seem as if a constrictor muscle, which must primarily have occupied a position between their lines of attachment to the branchial bar, could not, after their development, have slipped over either edge of the bar. The Ganoidean adductores must accordingly have been differentiated before these supporting rods were developed. In a specimen of *Ceratodus*

that has been long and not well preserved in alcohol, I do not find any of these supporting rods, and descriptions of this fish do not speak of them. There are also no adductores arcuum branchialium in this fish, but there are persisting remnants of the constrictores superficiales, as already explained. In such a fish as this, certain of the fibres of the constrictor of an arch might slip over onto the posterior surface of its arch and so give rise to the ganoidean adductor.

One other branchial muscle may here be mentioned, the retractor arcuum branchialium, found in *Amia*, *Lepidosteus*, and certain of the Teleostei, for this muscle is said by Edgeworth to be developed from trunk myotomes and to later acquire an innervation by a branch of the vagus. I have, however, recently shown (Allis, 1915) that this muscle of the Teleostei is quite certainly the homologue of a muscle, found in *Chlamydoselachus*, which is simply a differentiation of the anterior end of the constrictor œsophagi. If I am right in this conclusion, the innervation of the muscle of the Teleostei is normal and primary, and not secondary.

From the embryological and anatomical facts above presented regarding the several muscles related to the branchial arches, it seems quite certain that, in the gnathostome fishes, the primitive condition of these muscles was, as Vetter long ago concluded, a simple annular constrictor in each arch; and, to act as such a constrictor of the enclosed cavity, the muscle must have been attached both dorsally and ventrally either to some fixed structure or to its fellow of the opposite side. If attached primarily, at either end, to the related branchial bar, the muscle could not have acted as a constrictor.

The branchial bar, in this primitive condition, probably lay directly internal to the constrictor muscle, Dohrn's assertion that it lies posterior to the proximal edge of the myotome from which the muscle is developed probably applying only to early stages in the Elasmobranchii. The muscle and its related branchial bar probably lay primarily

in a plane perpendicular to the axis of the body, but this plane later became inclined to that axis, the acute angle lying posterior to the plane; and still later it acquired, in the Elasmobranchii, the well known sigma form. What impressed this sigma form on these arches is not known, but it would seem as if it must have been related to the relative lengths of the pharyngeal cavity and the occipital portion of the chondrocranium. But, whatever the cause, this sigma form of arch has definitely associated with it, in recent fishes, the presence of cartilaginous branchial rays, of muscoli constrictores superficiales, and of muscoli adductores arcuum branchialium of the plagiostoman type; while associated with the other, or straight, form of arch is the absence of the above cited features, the presence of supporting rods in the branchial filaments and of muscoli levatores arcuum branchialium, and the occasional presence of muscoli adductores arcuum branchialium that are innervated by nerves that pass over the posterior edge of the branchial bar of the related arch.

In *Ceratodus*, it is probable (Allis, 1915) that there are much reduced pharyngobranchials and that they are directed postero-mesially, as they are in the Elasmobranchii, while the hypobranchials are directed antero-mesially, as in the Teleostomi; and in this fish there are no adductores and apparently no supporting rods to the branchial filaments, but there are so-called muscoli interbranchiales which are probably persisting remnants of the plagiostoman constrictores superficiales.

This limitation of cartilaginous branchial rays or supporting rods in the branchial filaments, together with certain other associated and distinctive features, to the Elasmobranchii and Teleostomi respectively, and the probable absence of both branchial rays and supporting rods in *Ceratodus*, would seem to favour the view that the Teleostomi were descended from a fish in which the cartilaginous branchial rays had not yet been acquired. I have, however, quite recently (Allis, 1915) concluded that the basal portions, at least, of the cartilaginous extrabranchials are archaic structures, and that they are found, in modified form, either in the

branchial arches, in the hyal and mandibular arches, or fused with the neurocranium, not only in all living Teleostomi but also in most, if not all, higher vertebrates. If this conclusion is correct, and if these extrabranhials are simply modified branchial rays, as is generally accepted, then the early ancestors of the Teleostomi must have possessed those rays. But I have, since the publication of the paper above referred to, found that Braus (1906) concludes, from conditions found in embryos of *Heptanchus*, that the extrabranhials belong to an independent category of skeletal pieces. If this be so, it then seems probable that the early ancestors of the Teleostomi possessed these particular cartilages, but not the ordinary branchial rays with which they are usually associated.

The branchial muscles of the Selachii seem to be more primitive than those of any other of the gnathostome fishes. When, in the ancestor of the Selachii, the branchial arches acquired positions oblique to the axis of the body, and later, or at the same time, acquired the sigma form, the proximal edge of the simple dorso-ventral constrictor of each arch slipped, in the middle of its length, over the anterior (actually lateral) surface of the branchial bar of its arch, and the fibres of the muscle, where they crossed the branchial bar, there first became tendinous, by the interruption of their muscular substance, and were then later cut through by acquiring insertion on the bar. A triangular piece was thus cut out of the proximal edge of the muscle, and became the adductor of the arch. The gill-pouch anterior to the arch, pressing against the anterior surface of that part of the constrictor that remained external to the branchial bar, first caused a simple thinning of the muscle. The dorsal and ventral rays of the branchial series were then modified, as extrabranhials, in supporting relations to this thinned part of the muscle, or these extrabranhials were otherwise and independently developed for the same purpose, and at certain places in the lines where the muscle passed over these cartilages, it again became tendinous, or acquired insertion on the cartilages.

Two narrow and more or less extensive incisures were thus made in the muscle, and that part of the muscle that lay between these two incisures became the musculus interbranchialis. Where the muscle fibres were not thus cut through, or did not become tendinous, the musculus interbranchialis was simply a thinner portion of the primitive and continuous constrictor. That portion of the muscle that lay distal to the extrabranhials remained intact, and formed the continuous dorso-ventral fibres of the constrictor superficialis. The dorsal and ventral ends of the constrictores had, in the meantime, and in certain fishes, turned posteriorly, possibly influenced by the sigma form of the branchial bars. The arcual and interarcual muscles were then differentiated, and this, together with the overlappings and fusions of the dorsal and ventral portions of the constrictores superficiales with each other and with the musculus trapezius, and the formation of tendinous aponeuroses where the muscle fibres crossed the underlying extrabranhials, produced the many variations found in the adult. The constrictor of the ultimate branchial arch was utilised to form the musculus trapezius.

In the Teleostomi, the straight form of arch was retained, and correlated to this the constrictores superficiales did not slip over the anterior edges of the related arches, but, in certain fishes, certain of them slipped over the posterior edge of the related arch and gave rise to the ganoidean adductors. The constrictor of each branchial arch then apparently became rudimentary in the middle of its length, doubtless because of modifications in the branchial lamellæ and the development of supporting branchial rods, but it was in part utilised to form the delicate radial muscles related to the supporting branchial rods. The dorsal and ventral portions of the primitive constrictor then became the levatores, and the transversi and obliqui dorsales and ventrales, and the ventral portion of the constrictor of the ultimate arch became the coracobranhiales, or their homologues the pharyngoclaviculares. The levator of the ultimate branchial arch became, in certain of these fishes, a musculus trapezius.

Edgeworth comes to totally different conclusions regarding the primitive condition and the later differentiations of these muscles. He says (l. c. p. 259): "The probable primitive condition of each of the branchial myotomes was, from above downwards, a levator, a marginalis, an interarcualis ventralis, and (the lateral half of) a transversus ventralis," which would seem to imply that there was, in this primitive condition as conceived by him, no simple continuous constrictor extending the full length of the arch. The interarcuales ventrales are said by him to be muscles that extend between the ventral ends of the branchial bars. The marginales are said (l. c. p. 233) to be muscles found by Schultze in anuran larvæ and having their exact homologues in what Edgeworth calls the vertical muscles of *Ceratodus*. These vertical muscles of *Ceratodus* are called by both Fürbringer (1904) and Greil (1913) the interbranchiales, and they are said by Fürbringer to extend from the neurocranium to a process on the ventral end of the ceratobranchial of the arch next anterior to the one to which the interbranchialis belongs. It would accordingly seem as if these muscles must be remnants of the primitive constrictor of the arch and not interbranchiales; and yet Edgeworth intercalates them, in each branchial arch of the primitive vertebrate, between the muscoli levator and interarcualis ventralis of that arch. Edgeworth (l. c. p. 178) considers the branchial muscles in the Amphibia to represent the most primitive condition found in any vertebrate, and he (l. c. p. 176) furthermore thinks it probable that there were, in the primitive vertebrate, but two branchial arches, and that where other arches are now found they have been subsequently added posterior to those two.

HYAL ARCH.

Dohrn (1885) says that, in the hyal arch of selachians (*Plagiostomi*), that proximal portion of the myotome (*Musculatur*) out of which, in the branchial arches, the adductor is developed is wanting, its formation having been wholly pre-

vented by the one commissure formed, in this arch, in relation to the efferent arteries. The musculi interarcuales are also wanting in this arch, but it is said that in their place there is a complicated system of ligaments. It is not said that these ligaments are developed from any part of the myotome of the arch, but this would seem to be implied, the ligaments then representing the missing musculi interarcuales. In the ventral part of the arch the muscles are said to be found, undiminished in number, exactly as in the branchial arches.

The distal portion of the myotome (Musculatur) is said to form the constrictor superficialis of the arch, which is richly developed, especially in its ventral portion. Dorsally this constrictor is said to turn posteriorly and fuse with the corresponding portion of the muscle of the first branchial arch. Ventrally, the distal portion of the constrictor is said to fuse with a similarly named portion of a myotome (Muskelschlauchen) which comes from the mandibular arch, the two muscles, together, then running ventrally and fusing with the fibres of the coracohyoideus and coracomandibularis exactly as the "other coracobranchiales" do (in der Weise der übrigen M. coraco-branchiales). This expression evidently affirms that the distal portions of the ventral ends of the constrictores superficiales of the hyal and mandibular arches represent the coracobranchiales of those arches, and it would seem to imply that the coracobranchiales of the branchial arches were derived from the corresponding portions of the constrictores superficiales of their arches. But as, as has already been fully explained, the coracobranchiales of Dohrn's descriptions are said by him to be developed from the proximal portions of the myotomes of their respective arches, it must be that the coracobranchiales here referred to are the muscles so named by Vetter, but said by Dohrn to have been wrongly identified by him. What becomes of the remaining, proximal fibres of the ventral portion of the hyal myotome is not said, notwithstanding that they have been said to exist exactly as in the branchial arches. The descriptions are thus not clear, but it is important to note

that the ventral end of the constrictor of the hyal arch fuses with a muscle developed from a corresponding portion of the mandibular myotome.

Edgeworth says (1911, p. 206) that in 14 mm. embryos of *Scyllium*, the ventral end of the hyal myotome becomes continuous with the lateral edge (morphologically the dorsal end) of the future interhyoideus, this latter muscle being said to be developed, as will be later explained, from the walls of the cœlomic cavity and not from the hyal myotome. In 16 mm. embryos the myotome is said to be partly continuous with the interhyoideus and partly inserted on the lateral surface of the hyal bar to form a levator hyomandibularis (levator hyoidei, Edgeworth). In later stages the myotome becomes separated from the interhyoideus, and the lateral edge (dorsal end) of the latter muscle is inserted on the ceratohyal. A backward extension of the myotome and the interhyoideus then takes place, and a continuous dorso-ventral muscle-sheet is thus formed, which lies posterior to the hyal bar, and is said to be the muscle C_{2vd} of Ruge's (1897) descriptions of the adult. This dorso-ventral sheet is accordingly said to be formed, in its dorsal portion, by fibres derived from the hyal myotome, and in its ventral portion by fibres derived from the cœlomic wall. The constrictor superficialis of the hyal arch is accordingly not the strict serial homologue of the constrictores of the branchial arches, although this is not so stated by Edgeworth. It is said that the primary form of the interhyoideus, developed from the cœlomic wall, would appear to have been a transverse band connecting the two hyal bars.

In the adult *Selachii* the muscles of this arch have been described by Vetter, Tiesing, Ruge, and Marion, Ruge's descriptions being particularly complete. In this arch no muscoli interbranchialis, arcualis, or interarcualis are differentiated; but, according to Dohrn, the two latter muscles may be represented by ligaments. A musculus interbasalis (*Interarcualis dorsalis I*, Vetter) may be found extending from this arch to the first branchial arch (Allis, 1915), but

this muscle is derived from trunk myotomes and not from branchial ones.

In *Heptanchus* (Vetter), *Hexanchus* (Ruge), and *Chlamydoselachus* the fibres of the constrictor superficialis of the hyal arch have a nearly dorso-ventral course, but in most other Selachii that have been described the dorsal and ventral ends of this constrictor are directed more or less posteriorly, and it is probable that in all these latter fishes, as is certainly the case in my specimen of *Mustelus*, the distal (posterior) fibres cross, in their course, the extrabranchials of one or more of the branchial arches. In certain of these fishes the ventral fibres extend posteriorly nearly or quite to the ventral end of the shoulder-girdle. The fibres of the muscle may become tendinous where they cross the extrabranchials of the branchial arches, particularly the dorsal extrabranchials. They do not usually become tendinous where they cross the extrabranchials of their own arch, nor are they inserted on those extrabranchials, this doubtless being due to the absence of an overlapping branchial diaphragm and gill-pouch, and accounting for the absence of a *musculus interbranchialis* in this arch. In the middle of the length of the constrictor, opposite the hyomandibulo-ceratohyal articulation, the muscle fibres are, probably in all Selachii, interrupted by a more or less extensive aponeurosis. Dohrn describes this aponeurosis even in embryos, but it is evident that the fibres must here have been primarily continuous, and Ruge (1897, p. 224) says that the conditions in the adult *Hexanchus* warrant this conclusion.

In the proximal edge of the constrictor there is, as in the branchial arches, a large angular incisure, and this incisure is filled by the articulating ends of the epihyal and ceratohyal, the cut ends of the fibres being inserted on those cartilages. Comparison with the conditions in the branchial arches would then seem to make it practically certain that a piece has here been cut out of this hyal muscle, as it has been cut out of the branchial muscles, and that the pieces so cut out of these several muscles were all serial homologues. If this be so,

some indication of the piece so cut out of the hyal muscle should be found in some stage of development of these fishes. According to Dohrn, it is not found in embryos, and he further says that the conditions there are such as to preclude the possibility of its development. There is, however, in the adults of these fishes a large and important ligament, the inferior postspiracular ligament, found in the hyal arch but not in the branchial arches, and not accounted for in Dohrn's descriptions of embryos.

In a recent work I suggested (Allis, 1915) that this inferior postspiracular ligament of the Selachii was probably derived from the *musculus arcualis dorsalis* of the hyal arch. I at that time accepted the currently expressed opinion that an adductor muscle was not differentiated in this arch, or that if differentiated it had later completely aborted. My present work leads me to doubt both these assumptions, and it now seems to me much more probable that the ligament is derived from the adductor of the arch than from the *arcualis dorsalis*. The ligament is found in nearly all, if not in all, the Selachii, and it is not found either in the Batoidei or the Teleostomi. In the Teleostomi the plagiostoman adductores are not found even in the branchial arches, as has been already fully explained, this accounting for the absence of the ligament in the hyal arch of these fishes; and the reason for its absence in the Batoidei will be considered immediately below. In the Selachii, the adductor, probably developed exactly as in the branchial arches, ceased to be of functional value, doubtless because of the intimate attachment of the cartilages of the arch to those of the mandibular arch, and, travelling upward along the epihyal until it reached and acquired insertion on the chondrocranium, it became the inferior postspiracular ligament. The relations of the ligament to the nerves, arteries, and veins of the region, said by me to be in accord with the derivation of the ligament from the *arcualis dorsalis* of the arch, are equally in accord with its derivation from the adductor of the arch, and, while the ligament might apparently have been developed from either muscle, the derivation

from the adductor is much more in accord with the conditions in the Batoidei.

In the Batoidei there is no inferior postspiracular ligament. In these fishes the proximal portion of the myotome of the hyal arch apparently passed over onto the anterior surface of the cartilaginous bar of the arch exactly as in the branchial arches, but, because of the marked change in the angle between the epihyal and ceratohyal (see Parker, 1876, Pl. 61, fig. 4), and the separation of the epihyal from the pharyngo-hyal, which latter element was utilised to form the hyomandibula (Allis, 1915), the proximal portion of the myotome here separated from the distal portion throughout its entire length, and no small middle portion was cut out to form an adductor. The proximal portion then acquired attachment on the pharyngo-hyal (hyomandibula) and gave rise to the muscili levator and depressor hyomandibularis of Tiesing's (1895) descriptions, and possibly also to the depressor mandibularis, which is said by Tiesing to be innervated by the nervus facialis. The remaining, distal portion of the myotome formed the constrictor superficialis. No adductor muscle being differentiated in this arch in these fishes, an inferior postspiracular ligament was naturally never developed.

Ruge says that, in the Selachii, the dorsal and ventral portions of the hyal constrictor superficialis both tend to separate into superficial and deeper layers, the former acquiring an insertion on the mandibular cartilages while the latter retains its primary insertion on the hyal cartilages. The insertion of certain of the fibres on the mandibular cartilages he considers to be an ancient acquisition of these fishes, and whenever it is wanting, in recent fishes, he considers it to be due to retrogression. The nervus hyoideo-mandibularis facialis is said to always lie external (anterior) to that part of the hyal constrictor that is inserted on the hyal cartilages, and to usually, but not always, lie internal (posterior) to the fibres inserted on the mandibular cartilages. In the region of the hyomandibulo-ceratohyal articulation,

where the constrictor never separates into superficial and deeper layers, the nerve apparently always lies on the external (anterior) surface of the muscle.

In the several figures given by Ruge, the *nervus facialis* is seen to lie internal to the dorsal portion of the hyal constrictor superficialis only in *Heptanchus* and possibly, in part, in *Spinax*; the nerve in the latter fish first lying on the external surface of the muscle and then apparently piercing it before it, the nerve, reaches the level of the hyomandibuloceratohyal articulation. In all of the many excellent figures of these fishes given by Luther (1909), the nerve lies internal to this part of the constrictor only in *Heptanchus*, *Hexanchus*, and *Lamna*. In the remnant of a head of *Lamna* that I have, I find the anterior fibres of the proximal portion of this part of the constrictor inserted on the palatoquadrate, but the remaining proximal fibres inserted on the hyomandibula. The *nervus facialis* lies internal to those fibres that are inserted on the palatoquadrate, but, beyond those fibres, it lies between the palatoquadrate and the hyomandibula, and hence external to the fibres inserted on the latter cartilage. In all the other *Selachii* figured by both Ruge and Luther, the *nervus facialis* lies external to all the fibres of this portion of the hyal constrictor.

In *Heptanchus* and *Hexanchus* the hyomandibula is relatively slender and lies internal to the palatoquadrate (Gegenbaur, 1872). In *Lamna* I find the dorsal end of the hyomandibula lying internal to the palatoquadrate. In all the other *Selachii* figured by Ruge and Luther, the dorsal end of the hyomandibula, so far as I can determine from existing descriptions at my disposal, lies posterior to the palatoquadrate and separated from it by a considerable interval, as shown in Gegenbaur's figures of *Mustelus*, *Scymnus*, *Centrophorus*, and *Heterodontus*. This, then, probably gives an explanation of the differing relations of the *nervus facialis* to the dorsal portion of the hyal constrictor. Where the dorsal end of the hyomandibula lies internal and close to the palatoquadrate, the *nervus facialis* also lies internal and close to the

latter cartilage. The fibres of the hyal constrictor, all primarily inserted on the hyomandibula, were then overlapped externally by the palatoquadrate, and the dorso-posterior edge of the latter cartilage lay posterior (distal) to the nervus facialis. The superficial fibres of the hyal constrictor then acquired insertion on the palatoquadrate along the line where the dorso-posterior edge of that cartilage crossed them, and so acquired a position external to the nervus facialis. Other, deeper fibres of the muscle then followed and joined the superficial ones. Where the dorsal end of the hyomandibula lay at a considerable distance from the palatoquadrate, the fibres of the constrictor simply pushed bodily forward, carrying the nervus facialis with them, and so retained their primitive position internal (posterior) to that nerve.

In the Holostei and Teleostei the conditions are here quite different from those in the Selachii. In the former fishes, the epihyal does not acquire articulation with the neurocranium; the posterior articular head of the hyomandibula quite certainly being formed by the fusion of the suprpharyngobranchial of the arch, derived from the basal portion of the extrabranchial of the arch, with the epihyal (Allis, 1915). That part of the constrictor superficialis that lay dorsal to the suprpharyngobranchial (extrabranchial) must then have been cut off from the ventral portion of the constrictor, and, lying between the suprpharyngobranchial and the cranial wall, it became modified to form the muscoli adductor hyomandibularis and levator and adductor operculi. These three muscles of the Holostei and Teleostei are, accordingly, together, the serial homologue of the levatores arcuum branchialium in their own branchial arches, and the homologue of the dorsal portion of the hyal constrictor superficialis of the Selachii. The branch of the nervus facialis that innervated these hyal muscles, lying primarily on the anterior (external) surface of the constrictor of the arch, would naturally have followed the muscles, and so come to lie internal to the dorsal end of the hyomandibula. The

muscles would naturally retain their primitive relations to the vena jugularis, and when they acquired, by their dorsal ends, insertion on the neurocranium, that insertion would be dorsal to the vein; and such I find to be the relations of the muscles to the vein in *Amia*, *Lepidosteus*, *Polypterus*, *Polyodon*, and several *Teleostei* that I have examined for this special purpose, with the single exception of *Ameiurus*. In *Ameiurus* the vein passes over the posterior edge of the adductor hyomandibularis, and then lies dorsal (external) to that muscle, *Ameiurus* thus being exceptional in this as also in several other cranial features (Allis, 1915, p. 566).

Vetter (1878, pp. 532-534), also, considered that these muscles of the *Teleostei* were derived from what corresponds to the dorsal portion of the constrictor superficialis of the hyal arch of the *Selachii*, but he said it was difficult to conceive the intermediate stages in such an extraordinary change of position. The development of the hyomandibula in the manner that I have suggested wholly removes this difficulty. The levatores arcuum branchialium were considered by Vetter to represent remnants of the muscoli interbranchiales of the *Selachii*, this conclusion being evidently based on the assumption that the constrictores superficiales of the *Selachii* had entirely disappeared in the *Teleostei*, as he had previously concluded that they had disappeared in *Chimæra* and *Acipenser*.

In an earlier work I said (Allis, 1897, p. 751) that: "The adductor hyomandibularis is probably developed from a muscle comparable to one or more of the interarcual muscles of the branchial arches of selachians, and is thus homodynamous with the levators of the branchial arches of teleostomes, and not with the adductor mandibulæ. The adductor operculi and levator operculi, at least the latter, are derived from the interbranchial muscles of their arch, and are thus homodynamous with the levator arcus palatini, and not with the levator muscles of the branchial arches." These conclusions were based on my interpretation of Vetter's descriptions of the *Selachii*, and on the acceptance of his conclusion that the

constrictores superficiales had entirely disappeared in the Teleostei, but as, as I have fully explained in preceding pages, Vetter's descriptions of these muscles are not wholly correct, my deductions from them were also not wholly correct. In a recent work (Allis, 1915), still influenced by Vetter's descriptions, I suggested that the adductor hyomandibularis of the Teleostei might be the homologue of the inferior postspiracular ligament of the Selachii; but as the adductor hyomandibularis of the Teleostomi would then be the serial homologue of the adductores arcuum branchialium of the Selachii, this cannot be if my present conclusions are correct.

Edgeworth (l.c., p. 210) says that the retractor hyomandibularis of *Acipenser*, and the adductor hyomandibularis of *Lepidosteus*, *Amia*, and *Salmo*, are all derived from the anterior portion of the constrictor superficialis of the hyal arch of the Selachii, and that the musculus opercularis of *Acipenser* and *Lepidosteus*, and the adductor and levator operculi of *Amia* and *Salmo*, are derived from the posterior portion of that constrictor of the Selachii; which is in accord with my present conclusions. The levatores arcuum branchialium of the Teleostei are said by Edgeworth to be developed from the upper ends of the branchial myotomes, which is evidently correct, but he then further says that, because of this origin, these muscles of the Teleostei have no counterparts in the Selachii, unless it be in the musculus trapezius as described by him, which I consider incorrect.

The proximal (anterior) fibres of the ventral portion of the constrictor superficialis of the hyal arch must, primarily, have all been inserted on the ceratohyal, and, in the Selachii, they became connected with their fellows of the opposite side by a median ventral aponeurosis, and so formed a musculus interhyoideus which extended from one hyal arch to the other across the ventral surface of the head. But a more or less important portion of the fibres later here acquired, as in the dorsal portion of the constrictor, a secondary insertion on the mandibular cartilage of either side, and so became an

intermandibularis. Whether or not this intermandibularis, innervated by the *nervus facialis*, was overlapped externally by an intermandibularis derived from the corresponding portion of the mandibular myotome, and innervated by the *nervus trigeminus*, cannot be told from dissections of the adult, but it is certain that, in the adults of living fishes, these two muscles are indistinguishably continuous one with the other. There is, accordingly, question as to where one muscle ends and the other begins, and it is frequently asserted that that part of the muscle that is of mandibular origin has lost its primary innervation by the *nervus trigeminus* and secondarily acquired innervation by the *nervus facialis*. It is accordingly important to know the relations of the *nervus facialis* to these muscles.

The *ramus hyoideus facialis*, as shown in nearly all of Vetter's (1874), Ruge's (1897), and Luther's (1909) figures of the Selachii, leaves the external surface of the hyal constrictor to acquire a position between the *musculi interhyoideus* and *intermandibularis* and does not reappear on the external surface of the latter muscle. This is not, however, invariably the case, for in one of Luther's figures of *Heptanchus* (l. c. p. 75) so-called motor branches of the nerve are shown reappearing on the external surface of the *intermandibularis* near its anterior end, and in the same author's figures of *Chlamydoselachus*, *Heterodontus*, *Squalus*, and *Etmopterus*, small branches of the nerve are also shown reappearing on the external surface of the muscle, but it is not said that they are motor nerves, as in the case of *Heptanchus*. In *Chlamydoselachus* one of these small branches is shown re-entering the muscle. Ruge found no branch of the *nervus trigeminus* going to any part of the *musculus intermandibularis* in any of the fishes examined by him. Luther, on the contrary, found branches of that nerve going to, and apparently innervating, the anterior part of the *intermandibularis* in all of the *Plagiostomi* examined by him excepting only *Chlamydoselachus* and the *Notidanidæ*. In his earlier work (1909) he concluded, in accord with Fürbringer (1903) and

Ruge (1897), that when the intermandibularis is innervated wholly by the nervus facialis, a muscle of facialis origin has simply crowded out and replaced one of trigeminus origin, but in a later work (1913, p. 46) he concluded that the trigeminus muscle here persisted, but had secondarily acquired innervation by the nervus facialis. Because of the wide distribution of the innervation of certain fibres of the intermandibularis by the nervus trigeminus, he considers this to be an archaic feature in fishes.

In *Chlamydoselachus*, I find the muscoli interhyoideus and intermandibularis forming a single continuous muscle-sheet which extends transversely from one side of the head to the other, without the intervention of a median aponeurosis. The posterior quarter, approximately, of this muscle-sheet is inserted, on either side, on the corresponding ceratohyal, while the anterior half is inserted wholly on the mandibula. Between these two parts of the muscle-sheet, and lying immediately anterior to a tendinous band which extends from the musculus adductor mandibulae to the musculus interhyoideus (see Luther, 1909, fig. 1), I find, in all my specimens, the fibres of the remaining quarter of the sheet separated, for a short distance along each lateral edge, into deeper and superficial layers, the deeper (dorsal) fibres being inserted on the ceratohyal and the superficial (ventral) ones on the mandibula. The deeper layer lies external to the proximal (anterior) portion of the ventral end of the constrictor of the first branchial arch, but in large part separated from it by the hyal branchial rays and the hyobranchial gill pouch. The constrictor of the first branchial arch similarly overlaps and lies external to the constrictor of the second branchial arch. This overlapping of these muscles is well shown in Vetter's figure of *Heptanchus* (1874, Pl. 15, fig. 7), where the proximal fibres of the constrictores superficiales of the first and second branchial arches, are shown lying directly internal to the musculus interhyoideus.

There are accordingly here, in *Chlamydoselachus* and

Heptanchus, four muscle-sheets superimposed one above the other, the two internal muscles being wholly independent of each other and of the external ones, because of the intervening branchial pouches, but the two external muscles being fused to a greater or less extent with each other in the mid-ventral line. It might then be assumed that these two external muscles belonged the one to the hyal and the other to the mandibular arch, and that they had, because of the abortion of the intervening branchial cleft, partially fused with each other, as the overlapping constrictores of the hyal and branchial arches of *Mustelus* and certain other *Selachii* have, and as has already been described. The conditions in *Chlamydoselachus* and *Heptanchus* can, however, equally well represent two different stages in the change of insertion of a hyal muscle from the branchial bar (ceratohyal) of its own arch to that (mandibula) of the mandibular arch, similar to the change of insertion that takes place in the dorsal portion of the muscle and has just been described. The first assumption requires the further assumption that the overlapping muscle of mandibular origin has wholly, or in large part, lost its primary innervation by the *nervus trigeminus* and secondarily acquired innervation by the *nervus facialis*; and *Chlamydoselachus*, generally considered to be the most primitive of living *Selachii*, would present a more advanced stage, not only in the fusion of these two muscles but also in the secondary change of innervation, than any other selachian that I know of. The second of the two assumptions entails no secondary assumptions for its justification, excepting the readily acceptable one that part of a hyal muscle has secondarily acquired insertion on a mandibular cartilage, and *Chlamydoselachus*, if a primitive fish, would naturally show an early stage in the process. The innervation of the muscles in *Chlamydoselachus* favours the second assumption.

In this fish, *Chlamydoselachus*, in each of five specimens that I have examined, the *nervus hyoideus facialis* at first runs forward along the external surface of the posterior portion of the *interhyoideus*, and there gives off two or more

branches. These branches also at first lie on the external surface of the posterior portion of the interhyoideus, and send branches to that muscle and to the adjacent portions of the continuous, dorso-ventral fibres of the constrictor superficialis; these branches anastomosing more or less with each other. When the nerve and its branches reach the region where the primarily single muscle-sheet separates, along its lateral edges, into a superficial intermandibularis and a deeper interhyoideus portion, they, in four of the five specimens examined, all perforate the muscle-sheet, either at that line of separation or immediately anterior to it, and acquire a position between the two sheets. In this position the several branches either remain independent or unite to form one or two nerves, and, in one specimen which was examined simply for the muscles and not the nerves, they are shown, in my drawings, always lying between the two muscles, internal to the one and external to the other. In the other three of these four specimens, which were more carefully examined, the nerve or nerves ran forward for a certain variable distance between the two muscles, sending branches to them, and then perforated the intermandibularis, this time from within outward, and, reaching its external surface, there ran forward nearly to its anterior end. At this point, all the branches again penetrated the muscle-sheet, which was here represented by the intermandibularis alone, and did not again reappear on its external surface. In several instances the mesial branches of the nerves of opposite sides fused in the median line, anterior to the interhyoideus portion of the muscle, to form a single median nerve which then entered the musculus intermandibularis and was not farther traced.

On one side of the fifth one of the five specimens a large branch of the nerve remained on the external surface of the muscle-sheet, the main nerve perforating the sheet and running forward in the manner above described. The large branch crossed onto the external surface of the musculus adductor mandibulæ, sent a large branch to anastomose with the nervus mandibularis trigemini, and then itself turned

antero-mesially to reach and penetrate the anterior portion of the musculus intermandibularis. On the other side of the head of this same specimen, what was apparently the corresponding branch was given off while the main nerve was on the internal surface of the intermandibularis, and, having perforated that muscle from within outward, it joined and anastomosed with the latero-sensory nerve that innervates the sense organs of the hyomandibular line. No branch was noticed later leaving the latero-sensory nerve to go to the musculus intermandibularis, but as the dissection was made without any thought of there being such a branch it is probable that it existed but was overlooked. No branch of the nervus trigeminus was found going to any part of the muscle-sheet in any of my specimens. Luther (1909) shows a branch of this latter nerve going to the anterior end of the muscle, but he considered it to probably be a sensory and not a motor nerve.

The nervus hyoideus facialis must primarily have lain, in all the Selachii, along the anterior (external) surface of all the muscles it innervates that are derived from the myotome of its own arch, that being the position in which all the branchial nerves are found, and it does actually lie external to the interhyoideus in all of the five specimens of *Chlamydoselachus* above described. It, however, lies, in four of those five specimens, external to certain portions of the intermandibularis, but internal to certain other portions. If this intermandibularis muscle be developed from the myotome of the hyal arch, this difference in the relations of the nerve to the muscle can be naturally explained, as in the dorsal portion of the constrictor of this arch, by the assumption that certain of the fibres of the muscle, which were primarily inserted on the ceratohyal, had secondarily acquired insertion on the mandibula by passing external to the nerve as that nerve ran forward near the ventral (morphologically posterior) edge of the mandibula, while in other cases the muscle retained its primitive position internal (posterior) to the nerve. This explanation would, however, not apply if the intermandibu-

laris were of mandibular origin, for the muscle would then have lain primarily anterior and hence external to the nervus facialis, and it is difficult to conceive how certain portions of it, still retaining their primary insertion on the mandibula, could have shifted from this primarily anterior and external relation to the nerve to a posterior and hence internal relation to it. And as the muscle in no way lies in the path of, or interferes with the nervus facialis, it is difficult to conceive a reason for the perforation of the muscle by the nerve.

The interhyoideus and intermandibularis muscles of *Chlamydoselachus* could accordingly both be of facialis origin, so far as the relations of nerve and muscle are concerned, but in all probability only that portion of the intermandibularis that lies anterior to the point where the nervus facialis definitely disappears from its external surface could be of mandibular origin. And if this portion of the muscle be of mandibular origin, as several authors have maintained, I consider it certain that it is innervated by a branch of the nervus mandibularis trigemini, and that that branch has simply been missed in dissections, my own included. That it is possible that this nerve has been so missed is shown by the fact that in *Heptanchus*, where Fürbringer and Luther both found the intermandibularis innervated by the nervus facialis alone, my assistant, Mr. John Henry, finds, on both sides of the head of one of three specimens of this fish that were examined, a branch of the nervus mandibularis trigemini going to the intermandibularis in a position strictly comparable to that shown by Luther in several of the *Selachii* examined by him, while in the other two specimens it was not found.

Edgeworth says that the muscoli interhyoideus and intermandibularis, apparently wherever found in the vertebrate series, are not developed from the myotomes of their respective arches, but from related portions of the wall of the cœlomic cavity, and that they accordingly have no homologues in the branchial arches. According to him (*loc. cit.*, p. 178): "The cephalic cœlom disappears in the mandibular and hyoid

segments early in development, and its walls develop into the intermandibularis and interhyoideus, which are at first continuous with the mandibular and hyoid myotomes. The lower ends of the branchial myotomes separate from the wall of the branchial portion of the cephalic cœlom, and they develop into the branchial muscles. No muscles are directly formed from the wall of the branchial portion of the cephalic cœlom, which subsequently retreats from the head." This strikingly recalls van Wijhe's description of the development of the coracobranchialis + coracomandibularis muscles in these same fishes, but it seems certain that the observations of these two authors do not relate to the same muscles. Of the intermandibularis of *Scyllium* Edgeworth says (*loc. cit.*, p. 180): "The intermandibularis (Cs_2 of Vetter, C_{2mv} of Ruge) is formed from the ventral portion of the mandibular cavity, which, as mentioned above, does not meet its fellow in the mid-ventral line, but passes backwards ventro-median to the ventral end of the hyoid cavity to open into the fore end of the cephalic cœlom." Here, in *Scyllium*, the intermandibularis is thus definitely said to arise from the mandibular cavity and hence not from a part of the cephalic cœlom, which would seem to be in direct contradiction to the statement just previously made. Edgeworth then further says: "It results from this that there is no developmental stage in which the intermandibularis lies altogether in front of the interhyoideus. It gradually extends backwards, underlying the interhyoideus, so that in 23 mm. embryos its hinder end lies posterior to the ventral end of the ceratohyal."

Luther (1909, p. 97) has already made brief reference to this development of the intermandibularis and interhyoideus from parts of the cephalic cœlom, as set forth in an earlier work of Edgeworth's (1902) which I have not been able to consult, and he, Luther, expresses much doubt as to its being correct, an opinion which I strongly share. My reasons for considering it incorrect can be best explained by reference to Scammon's (1911) figures of the head somites in embryos of

Squalus acanthias. In fig. 20 of that work Scammon gives a reconstruction of the head somites in a 9 mm. embryo of *Squalus*, and I have reproduced it in the accompanying Text-fig. 1. In this figure it is seen that while the cœlomic cavity might properly be considered to be prolonged into the short united portion of the hyal and mandibular stalks, and even beyond the hyal stalk for a short distance into the ventral end of the mandibular stalk, it can no more be considered to be prolonged into the basal portion of the hyal stalk than also into the basal portions of the stalks of the branchial myotomes. The case is strictly similar to that of the truncus arteriosus and the afferent arteries that arise from it. The truncus arteriosus cannot be considered as in any way continued into any of these arteries excepting only into the afferent mandibular artery. With regard to this latter artery there is no line of demarcation to indicate where the truncus arteriosus ends and the mandibular artery begins, and in my discussion of these arteries in embryos (Allis, 1908) I assumed that the basal portion of the afferent mandibular artery represented an anterior prolongation of the truncus arteriosus. The cavity designated as the hyal cephalic cœlom in Edgeworth's Text-fig. 1, showing a transverse section of a 7 mm. embryo of *Scyllium*, is then certainly a part of the hyal stalk, and the fact that the interhyoideus muscle, developed from this part of the stalk, is said to be at first continuous with the hyal myotome would seem to be of greater significance than the further fact, to which Edgeworth gives the greater significance, that this part of the stalk does not separate from the wall of the cœlomic cavity before developing into muscle fibres, as the stalks of the myotomes in the branchial region are said to do. The so-called mandibular cephalic cœlom of this same Text-figure of Edgeworth's might, however, be considered to be a part of the cephalic cœlom, for, as in the case of the afferent mandibular artery, there is no line of demarcation to indicate where the cephalic cœlom ends and the mandibular stalk begins. But if the musculus interhyoideus is developed from the ventral portion of the hyal

myotome and not from a part of the cephalic cœlom, as above explained, then the musculus intermandibularis must be developed from a corresponding portion of the mandibular myotome, for Edgeworth says (*loc. cit.*, p. 226) that these two muscles are serially homologous. This conclusion is inevitable if the premises are correct, and the intermandibularis, although lying actually, in sections, ventral to the interhyoideus, would lie morphologically entirely in front of that muscle. This

TEXT-FIG. 1.

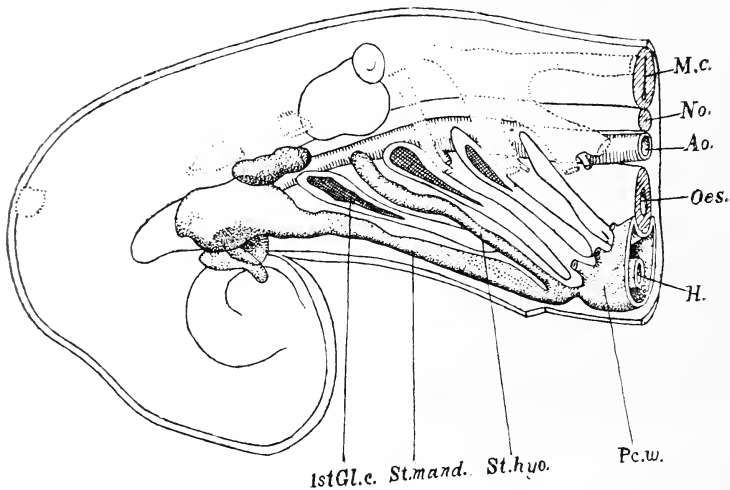

explanation of Edgeworth's observations would also establish that the intermandibularis and interhyoideus of his descriptions could not be the coracobranchialis + coracomandibularis of van Wijhe's (1882 b) earlier descriptions, notwithstanding the marked similarity in the descriptions of their derivation.

Of fishes other than the Selachii Edgeworth says (*loc. cit.*, p. 209) that, in 8 mm. embryos of *Acipenser*, the hyal muscles "consist of a hyoid myotome, the anterior part of which is inserted into the upper end of the hyoid bar, forming a levator hyoidei, and the posterior part of which forms a dorso-ventral sheet—homologous with C_{2vd} of selachians—

continuous with the posterior part of the interhyoideus, whilst the anterior part of the interhyoideus is inserted laterally into the hyoid bar." And also (*loc. cit.*, p. 210) that: "The fore part of the interhyoideus of *Acipenser* forms the hyochoideus inferior (Cs_5 of Vetter), the hinder part, i. e. the lower part of C_2vd , forms a constrictor operculi (Cs_3 and Cs_4 of Vetter). In *Polypterus* the condition is similar. In *Lepidosteus*, *Amia* and *Salmo*, the fore part forms the hyochoideus inferior; the hinder part becomes attached laterally to the hyoid bar (only partially so in *Lepidosteus*) and forms the hyochoideus superior."

In *Amia*, the superior or deeper, and the inferior or superficial portions of the geniohyoideus of my descriptions of that fish are respectively called by Edgeworth (*loc. cit.*, p. 210) the musculus hyomaxillaris and the musculus intermandibularis posterior. The musculus hyomaxillaris, as above defined by Edgeworth, is said by him to be differentiated from the "upper edge" of the hyochoideus inferior, but comparison with the adult shows that this so-called upper edge of that muscle must be the dorsal edge as seen in transverse sections of embryos, and hence morphologically the anterior edge of the muscle. In *Lepidosteus* and *Acipenser* these same fibres of the hyochoideus inferior are said to form a hyomaxillaris ligament, and this ligament is said (*loc. cit.*, p. 212) to be the ligamentum mandibulo-hyoideum of van Wijhe's (1882a) descriptions of the adults of these fishes. But there is evidently some error or oversight here, for a ligamentum mandibulo-hyoideum is described by van Wijhe in *Amia*, as well as in *Lepidosteus* and *Acipenser*, and hence coexists in the former fish along with the musculus hyomaxillaris of Edgeworth's descriptions. A further difficulty is that the musculus hyomaxillaris of *Amia* is said (*loc. cit.*, p. 223) to be a serial homologue of the interarcuales ventrales of the branchial arches of that fish, notwithstanding that the former muscle is said to be derived from the cephalic cœlom, as already explained, and the latter muscles to be developed from the ventral ends of the branchial myotomes. Edgeworth calls

attention to this, and explains it by saying that the corresponding muscle in *Alytes*, *Rana*, *Pelobates*, and *Lepus* is formed from the ventral end of the hyal myotome, and that this method of formation is probably the primitive one.

The intermandibularis of all teleostoman embryos is said by Edgeworth (*loc. cit.*, p. 187) to form at first, with its fellow of the opposite side, a transverse muscle attached laterally to Meckel's cartilage, and it is later said (*loc. cit.*, p. 202) that a comparison of the various forms of the muscle shows that this condition of a transverse sheet is the primitive one for the muscle. It is, however, immediately afterwards said that this condition of a transverse sheet persists ("exists") only in *Salmo*. Edgeworth further says (*loc. cit.*, p. 280): "(3) The intermandibularis anterior and posterior (the latter called 'inferior geniohyoid' by Allis) of *Amia* are innervated by both the fifth and seventh (Allis). (4) The hyo-maxillaris of Teleostomi, developed in the hyoid segment, is in some, e. g. *Menidia* (Herrick), wholly innervated by the seventh; whereas in others, e. g. *Esox* (Vetter), *Salmo*, its hinder part is innervated by the seventh and its fore part by the fifth; and in *Amia* (Allis) it is innervated by the fifth and seventh."

These latter two statements would seem to imply that certain of the individual fibres of the muscles referred to in *Amia* were innervated at the same time by two different nerves, and that they were in process of losing their normal innervation by the nerve of their segment of origin and secondarily acquiring an innervation by a nerve of another segment. If this be the meaning of the statements, the reference to *Amia* is unfortunate, and is apparently based on the literal acceptance of the heading of one of the sections of my work on that fish without any consideration of the accompanying text. That heading is (Allis, 1897, p. 559): "Muscles innervated by both the Trigemini and Facialis," which, literally accepted, might have the meaning that Edgeworth apparently gives to it. But in the text (*loc. cit.*, p. 613) it is carefully explained that the muscles in question are innervated by branches of a nerve formed by the anastomosis of trigemini and facialis branches

which run directly into each other and so form a complete circuit in which it is impossible to tell where the one nerve ends and the other begins. In the General Summary it is further said (*loc. cit.*, pp. 744-5) that the ramus maxillaris inferior trigemini probably innervates the musculus intermandibularis and all, or a part, of the inferior division of the geniohyoideus, and that the ramus hyoideus facialis probably innervates the superior division of the geniohyoideus, and a part, at least, of the inferior division of that muscle. The innervation, in each case, is only given as probable, and there is no slightest suggestion of any part of either of the muscles being innervated, at the same time, by both the nerves.

MANDIBULAR ARCH.

Dohrn says (1885, p. 13) that, in selachian embryos, a muscle is developed from a myotome that comes from the mandibular arch (eines Muskelschlauches welcher vom Kieferbogen kommt), and that this muscle corresponds to the ventral portion of the constrictor superficialis of the hyal arch. There is, as already explained, some question as to whether Dohrn considered a part of this muscle to be the homologue of the coracobranchialis of the branchial arches, but it is certain that the myotome, said to come from the mandibular arch, must be the ventral end of the mandibular myotome, and that the muscle said to be developed from it must be that part of the musculus intermandibularis of the adult that is primarily, if not actually, innervated by the nervus trigeminus. Edgeworth (1911) says, as has already been fully explained and discussed, that the myotome of the mandibular arch only extends to the ventral edge of the musculus adductor mandibulæ, and that the musculus intermandibularis is developed from the walls of the cephalic cœlom. There is thus here marked difference of opinion.

Accepting Dohrn's observations as correct, and assuming that there was primarily a premandibular arch separated from the mandibular arch by a visceral cleft, there must

have been primarily, in the mandibular arch as in the hyal and branchial arches, a single continuous constrictor muscle that had a dorso-ventral extent equal to that of the constrictor of the hyal arch. Branchial rays also probably primarily existed in this arch as in the more posterior arches, for remnants of them are said to be still found in certain recent fishes. Branchial lamellæ were then quite probably also developed in this arch as in the more posterior ones, and were probably found on the anterior as well as the posterior surface of the arch.

The conditions in this mandibular arch would then have been similar to those in the hyal and branchial arches, and, such being the case, there seems no good reason why, when the visceral arches all began to assume a position oblique to the axis of the body, a small adductor muscle should not have been cut out of the proximal edge of the constrictor of this arch, as it is said to have been cut out of the constrictores of the branchial arches, and as I assume that it was also cut out of the constrictor of the hyal arch.

When the hyomandibular cleft later became reduced to the small existing spiracular canal, the mandibular branchial diaphragm, which must primarily have existed as in the hyal and branchial arches, would necessarily have gradually ceased to be formed excepting as it may still be represented in some part of the anterior wall of the spiracular canal. Because of this gradual reduction and final almost complete disappearance of the branchial diaphragm of this arch, the middle portion of the long constrictor superficialis of the arch was necessarily forced over onto the anterior (lateral) surface of the cartilaginous bar of the arch, and it carried with it the nerve of the arch, and probably also the anterior efferent artery of the arch (Allis, 1916), this nerve and artery primarily lying anterior to the constrictor muscle, as they actually do in the branchial arches of living *Selachii*. The afferent mandibular artery and the branchial rays, both lying posterior to the constrictor muscle, were not so carried forward, and retained their primitive positions on

or near the morphologically external but actually posterior edge of the cartilaginous bar of the arch. The posterior efferent artery, also, was not affected by this change in position of the constrictor muscle, but it later underwent reduction or abortion in its ventral portion, while dorsally it persisted and retained its normal position posterior to the spiracular cartilage, that cartilage representing either the dorsal extrabranhial of the arch or one or more of the branchial rays. That any of the branchial rays of this arch could, in such a shifting of the constrictor, have acquired the positions of the labial cartilages seems quite impossible.

The long *musculus constrictor superficialis*, having acquired this position on the anterior (lateral) surface of the cartilaginous bar of its arch, was later more or less completely cut in two at the places where it crossed the palatoquadrate and the mandibula. The portion so cut out of the middle of the constrictor was then added to the small, pre-existing *musculus adductor* to form the large and powerful adductor of the adults of living fishes, while the ventral portion formed the *intermandibularis* and the dorsal portion the *levator* of the arch. Certain of the fibres of the original constrictor were, however, quite certainly not thus cut through at the places where they crossed the palatoquadrate and mandibula, for certain of them still extend, in the adults of living fishes, the full length of the arch. This is markedly the case in certain of the fibres of the *musculus spiracularis* of *Astrape*. This muscle is said by Luther (1909, p. 14) to be developed from the posterior fibres of the dorsal portion of the primitive constrictor of the arch and to have a ventral prolongation which lies along the internal surface of the mandibula (*kieferapparat*) and extends as far as the symphysis of the mandibulæ, there uniting with its fellow of the opposite side. This ventral prolongation is a feeble muscle, of no apparent functional importance, and certainly cannot be a secondary formation, as Luther considers it to be. It must, on the contrary, represent a persisting remnant of a distal part of the primitive constrictor which, when the

branchial rays aborted, slipped onto the posterior, instead of onto the anterior, surface of the cartilaginous bar of the arch, and so, not crossing that bar, was not cut in two as the other fibres of the constrictor were.

In certain other Batoidei, the *musculus spiracularis* is said by Luther to have a less extensive ventral prolongation than in *Astrape*, being said to extend either to the ventral end of the *hyomandibula*, to the abdentel edge of the *mandibula*, to the *ceratohyal*, or to the dorsal fascia of the *musculus coracomandibularis*. In *Astrape* and *Torpedo*, certain fibres of the muscle are said to be inserted on, and others to arise from, the spiracular cartilage, that cartilage thus lying between dorsal and ventral portions of the muscle; and as I have lately shown (Allis, 1915) that this cartilage of these fishes is quite certainly the dorsal extrabranchial of the mandibular arch, the muscle thus has the relations to this cartilage that the branchial *constrictores superficiales* of certain *Selachii* have to the dorsal extrabranchials of their respective arches.

Other portions of the primitive constrictor apparently lost only their ventral, *intermandibularis*, portion, retaining their full lengths dorsal to that muscle. Such portions are apparently found in the second and third divisions of the *levator maxillæ superioris* of my descriptions of *Amia*, and in the *levator labii superioris* of certain of the Batoidei, all of which muscles extend, with their tendinous ends, from the neurocranium to the abdentel edge of the *mandibula*. The *levator labii superioris* of the Batoidei, called by Luther the *musculus præorbitalis*, is said by that author to usually extend only to the angle of the gape of the mouth and to there be inserted in the aponeurotic septum of the *adductor mandibulæ*, but it may have a ventral ligamentous prolongation, or even a large muscle belly, which extends beyond the angle of the gape and is inserted, with the mandibular portion of the *adductor*, on the *mandibula*. In certain of the Batoidei it is even said that the tendinous ventral end of the muscle is practically continuous with the lateral edge, and hence

morphologically dorsal end, of the musculus intermandibularis, the constrictor fibres in these fishes thus apparently having retained their full primitive lengths.

Luther (1909, p. 49) considers the levator labii superioris (præorbitalis) to have been primarily simply a bundle of the adductor mandibulæ that had its origin at a high level on the neurocranium, anterior to the eyeball. The more ventral origin of this muscle, from the antorbital process, found in *Chlamydoselachus* and certain other Plagiostomi, he considers to be secondary and correlated either to an enlarged eyeball or to a large gape of the mouth with the angle of the gape far posterior, the muscle here secondarily becoming a "Spreizer" of the articulating ends of the upper and lower jaws. The eyeball is considered by him (*loc. cit.*, p. 36) to have been the chief one of these two causes of the splitting off of this bundle from the remainder of the adductor mandibulæ, and if this be so, the eyeball thus being assumed to have lain in the path of the muscle-fibres of the arch as they pushed dorsally to acquire insertion on the neurocranium, it would seem as if this split in the muscle must have begun at the dorsal end of the primitive constrictor and not at the dorsal end of that middle portion of that muscle that is usually considered to, alone, have given origin to the adductor mandibulæ. The dorsal portion of the præorbitalis would then contain the anterior fibres of the dorsal muscle, Csd_2 , of Vetter's descriptions, and where the præorbitalis extends beyond the angle of the gape the split that separates it from the adductor would extend from the dorsal end of the constrictor as far at least as the ventral end of the adductor. Such an extensive split in this myotome can certainly not be explained simply by the eyeball having caused the dorsal fibres of the constrictor to diverge anteriorly and posteriorly in order to acquire a dorsal attachment on the neurocranium, and if Luther is correct in his conclusion that this muscle had primarily its origin at a high level on the neurocranium, a much more rational explanation would seem to be that this muscle belongs to a pre-mandibular arch. The recorded innervation of the muscle,

and the embryological evidence are, however, both against this supposition.

Edgeworth (1911) derives both the levator labii superioris of the Plagiostomi and the four divisions of the levator maxillæ superioris of my descriptions of *Amia*, directly from the adductor mandibulæ, and from that portion only of the primitive mandibular constrictor. Luther also derives these four muscles of *Amia* directly from the adductor mandibulæ; and he proposes for the first and second divisions of the muscle the name *musculus adductor mandibulæ parabasalis*, because of their partial origin from the lateral wing of the parasphenoid (*parabasalis*, Gaupp), and for the third and fourth divisions of the muscle the names *musculus adductor mandibulæ præorbitalis* and *musculus nasalis*. Edgeworth considers the muscles of *Amia* to all be upgrowths of the internal and deeper portion, only, of the adductor of the adult, and suggests that they be named in terms of that internal adductor. The myotome of this arch is, according to him, definitely and entirely cut into dorsal and ventral portions where it crosses the dorsal edge of the palatoquadrate, these two parts remaining always distinct and separate, while the intermandibularis is, as already stated, developed wholly from the walls of the cephalic cœlom. Until the derivation of these muscles is definitely known it would seem best not to give them names based wholly or largely upon it.

There remains now only the aponeurotic septum of the adductor mandibulæ to be considered. Fürbringer (1903, p. 383), considered this aponeurosis to be of secondary origin and of no great morphological significance, it being developed, in fishes where the mouth opening had a pronounced posterior extension, simply in order to give space for suitable development of the belly of the adductor. Luther (1909, p. 61) thinks this an insufficient reason for the development of the aponeurosis, and considers it to have been secondarily developed, after the development of the levator labii superioris (*præorbitalis*), in order to furnish an attachment for that muscle on the quadrato-mandibular joint, and so facilitate its

action as a protractor of the palatoquadrate and also as a spreader (Spreizer) of the articular ends of the jaws. I consider the aponeurosis to have been developed wholly independently of either of these two functions. In my opinion, a small adductor muscle had already been differentiated in this arch before the remainder of the constrictor began to slip over onto the anterior surface of the cartilaginous bar of the arch. There was, at this period, quite certainly not sufficient space between the relatively close fitting integument of the arch and the cartilaginous bar to permit this large and long constrictor muscle to immediately assume the position that the adductor actually has in the adults of living fishes, and the small adductor already occupied the angle between the two elements of the cartilaginous bar. Certain of the fibres of the constrictor accordingly quite certainly acquired attachment on the internal surface of the dermis at the angle of the gape. These fibres would immediately act as an adductor when the mouth was widely open, but when the mouth was closed, or even nearly closed, they would act primarily as a protractor anguli oris, and secondarily as an abductor of the arch; for, being attached to the dermis at the angle of the gape, and the dermis being fixed, any contraction of the muscle would necessarily tend to open the mouth. This would evidently be of advantage to the fish, for, in the early stages of the development of the mouth, there was probably no other abductor mechanism, the ventral longitudinal muscles not yet having been developed. The fibres so inserted, increasing in number and importance, would, as the adductor muscle developed and a cheek was formed, pinch off the subdermal tissues to which they were attached and an aponeurosis such as is actually found in *Chlamydoselachus*, and will be fully described in my later work, would almost inevitably arise. If these fibres did not become attached to the dermis they would, in certain cases, become tendinous as they passed across the angle of the gape, as they do when passing over the extrabranhials and the middle rays of the branchial

series in the branchial arches of certain fishes (Vetter, 1874), and the condition found in the adults of many fishes would arise. If such fibres should then separate from the remaining fibres of the adductor, a musculus præorbitalis with dorsal and ventral muscle bellies, such as is described by Luther in certain of the Plagiostomi, would arise. And if the ventral, mandibular portion of the muscle became wholly tendinous, the condition found in the first and third divisions of the levator maxillæ superioris of my descriptions of *Amia* might arise. The aponeurosis would naturally tend to be developed only where the mouth had a marked posterior extension and the opening of the gape was long. According to Luther (*loc. cit.*, p. 62) the aponeurosis and the muscle Addy of Vetter's descriptions vary inversely, a marked development of the one being associated with a feeble development of the other, and he attributes this to the fact that a strongly developed Addy would act as a spreader of the jaws, and the musculus præorbitalis, being relieved of that function, there would be no call for an aponeurosis. As I attribute the development of the aponeurosis to a totally different cause it does not seem to me that this applies.

GENERAL SUMMARY.

The primitive condition of the muscles related to the visceral arches of the gnathostome fishes was, as Vetter long ago concluded, a simple constrictor muscle in each arch, and associated with this muscle there was a branchial bar which lay internal to the muscle.

From this simple primitive condition two distinctly different lines of descent are indicated by later differentiations of the muscles, and these differing differentiations are associated with, and caused by, two distinctly different forms of branchial bar in the branchial arches. One of these two lines of descent is represented by the Teleostomi and the other by the Plagiostomi, the Holocephali and Dipneusti apparently occupying somewhat intermediate positions.

In the Teleostomi, the four typical elements of each branchial bar of recent fishes lie, approximately, in a single plane, and this must have been their primitive relation to each other. Primarily this plane must have been transverse to the axis of the body, but it later became inclined to that axis. Associated with this form of arch the branchial filaments of the gill-bearing arches are supported by cartilaginous or osseous rods. In the hyal arch there are, in addition, osseous branchiostegal rays which lie anterior to the modified constrictor of the arch.

In the Plagiostomi, the dorsal and ventral elements of each branchial bar are directed postero-mesially at a marked angle to the middle elements of the bar, these latter elements lying, as in the Teleostomi, in a plane inclined to the axis of the body. A sigma form of bar is thus produced, and associated with it there are cartilaginous branchial rays in all the gill-bearing arches. These cartilaginous rays all lie, primarily, posterior to the constrictor muscle of the related arch, but the muscle fibres may later become in part inserted on them.

In the Holocephali and Dipneusti, the dorsal elements of the branchial bars are directed postero-mesially, as they are in the Plagiostomi, while the ventral elements are directed antero-mesially, as in the Teleostomi. In the Holocephali there are, according to Vetter, cartilaginous rays both in the hyal and the branchial arches, and the visceral muscles as described by him seem plagiostoman in character. In the Dipneusti there are cartilages in the hyal arch that are considered by Fürbringer to be branchial rays, but there are neither branchial rays nor supporting rods to the branchial filaments in the branchial arches; and the branchial muscles are teleostoman in character.

The constrictor muscle is found in a more primitive condition in the Selachii than in any others of the gnathostome fishes. Because of the sigma form of branchial bar in these fishes, the proximal (anterior) edge of the constrictor of each branchial arch has slipped forward over the anterior edge of the middle, posteriorly-directed angle of the sigma, and

backward over the posterior edges of the dorsal and ventral, anteriorly-directed angles of the sigma; and from the parts of the constrictor that cross or span these three angles are differentiated, respectively, the adductores arcuum branchialium, the arcuales and interarcuales dorsales, and the coracobranchiales of Dohrn's descriptions of embryos. These latter muscles are simply the proximal (anterior) portions of the ventral ends of the primitive constrictores of the branchial arches, they are of branchial origin, are innervated by branches of the nervus vagus of the arch to which they belong, and they coexist, in the adult, with the coracobranchiales of Vetter's descriptions. The latter muscles are said, by both Dohrn and Edgeworth, to be derived from the ventral ends of the branchial myotomes, but their innervation, in the adult, by spinal or spino-occipital nerves, their relations to the other hypobranchial muscles, and the marked want of accord in the descriptions of their development, all warrant the conclusion that they must be of spinal origin.

The distal (posterior) portion of the constrictor muscle of each branchial arch of the Selachii, the so-called constrictor superficialis, lay primarily not only on the anterior surface of the branchial rays of its arch, but also on that surface of the extrabranchials of its arch; and, in the adults of recent fishes, its dorsal and ventral ends turn posteriorly, to a greater or less extent, across the dorsal and ventral edges, respectively, of the next posterior gill-pouch. When the constrictor contracted, the muscle was accordingly stretched across the extrabranchials of its arch, and certain of the muscle fibres, in certain fishes, were there cut in two by acquiring insertion on the extrabranchials. Other fibres simply became tendinous where they passed over the extrabranchials, and so there gave rise to more or less pronounced linear aponeuroses, or so-called septa. That part of each constrictor that lay between the dorsal and ventral extrabranchials of its arch thus became more or less cut out of the primarily continuous constrictor, and formed the musculus interbranchialis. This muscle is never found definitely

differentiated in the hyal arch, but indications of the beginnings of its differentiation may there be found.

In the hyal arch of the Selachii, an adductor muscle was probably developed exactly as in the branchial arches, but it was later transformed into the inferior postspiracular ligament. Arcualis and interarcualis muscles are not found in this arch of the adult, but Dohrn says that they are represented, in embryos, by ligaments, which he does not, however, describe. The coracobranchialis of Dohrn's descriptions of the branchial arches is not differentiated in this arch. The dorsal and ventral portions of the constrictor tend to separate into deeper and superficial layers, as Ruge has stated, the deeper layer retaining its primitive insertion on the cartilaginous bar of its arch, while the superficial layer acquires a secondary insertion on the cartilaginous bar of the mandibular arch.

In the Batoidei, an adductor muscle was not differentiated in the hyal arch, and there is accordingly, in these fishes, no inferior postspiracular ligament. The proximal (anterior) portion of the primitive constrictor of this arch is differentiated into the levator and depressor hyomandibularis, and probably also the depressor mandibulæ, these muscles replacing the adductor, arcualis, interarcualis, and Dohrn's coracobranchialis of the Selachii. The so-called septa in these fishes are probably similar to those in the Selachii, but this cannot be definitely determined from existing descriptions.

In the mandibular arch of the Selachii, a small adductor muscle was probably developed exactly as in the more posterior arches. Later, because of the suppression of the branchial diaphragm related to this arch, excepting as it may be represented in the anterior wall of the spiracular canal, the entire constrictor muscle was forced, in its middle portion, onto the anterior surface of the cartilaginous bar of its arch, and, acquiring insertion on the palatoquadrate and mandibula, where it crossed their lateral edges, was added to the small, pre-existing adductor, and so gave rise to the

large adductor mandibulæ actually found in the adult. From those portions of the primarily continuous constrictor that lay dorsal and ventral, respectively, to the palatoquadrate and mandibula, the muscoli levator maxillæ superioris and intermandibularis were developed. The musculus levator anguli oris was probably derived from the anterior edge of the united levator and adductor muscles before they became separated from each other. The musculus intermandibularis underwent relative reduction, and, in the adults of recent fishes, is largely crowded out and replaced by those superficial fibres of the hyal constrictor that have secondarily acquired insertion on the mandibula. The relations of the nervus hyoideus facialis to the muscle fibres thus inserted on the mandibula is against the view that those fibres that are of mandibular origin have lost their primitive innervation by the nervus trigeminus and secondarily acquired innervation by the nervus facialis.

The posteriorly directed dorsal and ventral ends of the hyal and branchial constrictores of the Selachii always overlap, to a greater or less extent, the next posterior constrictor. Where the ends of the constrictores are strongly inclined posteriorly, they may overlap two or more posterior constrictores, the fibres of the muscles then crossing the extrabranhials of those arches and there tending to become tendinous exactly as they do where they cross the extrabranhials of their own arches; a series of tendinous aponeuroses thus being formed in each constrictor. The overlapping muscles then fuse more or less completely with each other, and, as the linear aponeuroses related to each extrabranhial are superimposed and transverse to the muscle fibres, the continuous muscle-sheet formed by the fusion of the several constrictores is cut up into what have heretofore been considered to be separate segments, one related to each branchial arch and developed entirely from the myotome of that arch. These segments are, however, each formed by muscle fibres derived from two or more consecutive constrictors, and hence from a similar number of consecutive myotomes.

The dorsal portion of the constrictor of the ultimate branchial arch undergoes excessive development and becomes the *musculus trapezius*.

In the Teleostomi, each branchial bar, although inclined to the axis of the body as in the Selachii, continues to lie, approximately, in a single plane, and the dorsal and ventral ends of the constrictores do not turn posteriorly as in the Selachii. The pull of the constrictor, when contracting, did not, accordingly, tend to make the muscle slip, in the middle of its length, over the anterior edge of the branchial bar of its arch, but in certain of the branchial arches of the Ganoidei the proximal edge of the muscle slipped over the posterior edge of the branchial bar, and there gave rise to an adductor that is the functional equivalent but not the homologue of the adductor of the Selachii. The remaining fibres of the middle portion of the constrictor either later aborted or, possibly, became modified to form the radially arranged muscles related to the supporting rods of the branchial filaments. The dorsal and ventral ends of the constrictores became the *levatores* and the *transversi* and *obliqui dorsales* and *ventrales*. The levator of the ultimate arch is a slender muscle, and may secondarily acquire insertion on the shoulder-girdle. It is the homologue of the large *musculus trapezius* of the Selachii.

In the hyal arch of the Teleostomi, the constrictor persists to a greater extent than in the branchial arches. Its dorsal portion becomes the *adductor hyomandibularis* and the *adductor* and *levator operculi*, these muscles, together, being the equivalent of the *levatores* of the branchial arches of the Teleostomi and of the dorsal ends of the constrictores of the Selachii.

The ventral portion of the constrictor of the ultimate, or fifth, branchial arch of the Teleostomi is modified to form the *musculi coracobranchiales* or *pharyngoclaviculares*, these muscles of these fishes thus being branchial muscles, and hence probably not the homologues of the *coracobranchiales* of the Selachii. They always retain, in all fishes that I have

been able to examine, their primitive innervation by branches of the *nervus vagus*. The dorsal portion of the constrictor of this arch forms, as already stated, the fifth levator muscle, which is the homologue of the *musculus trapezius* of the *Selachii*.

LITERATURE.

- Allis, E. P., jr. (1897).—"The Cranial Muscles and Cranial and First Spinal Nerves in *Amia calva*," 'Journ. Morphol.,' vol. xii.
- (1903).—"The Skull and the Cranial and First Spinal Muscles and Nerves in *Scomber scomber*," 'Journ. Morphol.,' vol. xviii.
- (1908).—"The Pseudobranchial and Carotid Arteries in the Gnathostome Fishes," 'Zool. Jahrb. Abteil. f. Anatom. u. Ontog.,' Bd. xxvii.
- (1909).—"The Cranial Anatomy of the Mail-cheeked Fishes," 'Zoologica,' Bd. xxii, Hft. 57.
- (1915).—"The Homologies of the Hyomandibula of the Gnathostome Fishes," 'Journ. Morphol.,' vol. xxvi.
- (1916).—"The so-called Mandibular Artery and the Persisting Remnant of the Mandibular Aortic Arch in the Adult Selachian," 'Journ. Morphol.,' vol. xxvii.
- Braus, H. (1905).—"Experimentelle Beiträge zur Frage nach der Entwicklung peripherer Nerven," 'Anat. Anz.,' Bd. xxvi.
- (1906).—"Ueber den embryonalen Kiemenapparat von *Heptanchus*," 'Anat. Anz.,' Bd. xxix.
- Danforth, C. H. (1913).—"The Myology of *Polyodon*," 'Journ. Morphol.,' vol. xxiv.
- Dohrn, A. (1884).—"Studien zur Urgeschichte des Wirbeltierkörpers IV," 'Mitteil. a.d. Stat. Neapel.,' Bd. v.
- (1885).—"Studien zur Urgeschichte des Wirbeltierkörpers VII," 'Mitteil. a.d. Stat. Neapel.,' Bd. vi.
- Edgeworth, F. H. (1902).—"The Development of the Head Muscles in *Scyllium canicula*," 'Journ. Anat. and Phys. London,' vol. xxxvii.
- (1911).—"On the Morphology of the Cranial Muscles in some Vertebrates," 'Quart. Journ. Microsc. Sci.,' vol. 56.
- Froriep, A (1907).—"Diskussion ueber die Bildung des Kopfmesoderms bei *Ceratodus Forsteri*," 'Anat. Anz. Erganz. zum.,' Bd. xxx.

- Fürbringer, K. (1903).—"Beiträge zur Kenntnis des Visceralskelets der Selachier," 'Morph. Jahrb.,' Bd. xxxi.
- (1904).—"Beiträge zur Morphologie des Skelets der Dipnoer nebst Bemerkungen über Pleuracanthiden, Holocephalen und Squaliden," 'Jenaische Denkschriften,' Bd. iv.
- Fürbringer, M. (1895).—"Über die mit dem Visceralskelet verbundenen spinalen Muskeln bei Selachiern," 'Jenaische Zeitschrift f. Naturw.,' Bd. xxx.
- (1897).—"Über die spino-occipitalen Nerven der Selachier und Holocephalen und ihre Vergleichende Morphologie," 'Festschrift f. Carl. Gegeubaur,' vol iii, Leipzig.
- Gegenbaur, C. (1872).—"Das Kopfskelet der Selachier," 'Untersuchungen zur Vergleichenden anatomie der Wirbeltiere,' Hft. 3, Leipzig.
- Greil, A. (1907).—"Über die Bildung des Kopfmesoderms bei *Ceratodus Fosteri*," 'Anat. Anz. Ergän.,' zum Bd. xxx.
- (1913).—"Entwicklungsgeschichte des Kopfes und des Blutgefäßsystemes von *Ceratodus forsteri*. Zweiter Teil: Die epigenetischen Erwerbungen während der Stadien," 39-48, 'Jenaische Denkschriften,' Bd. iv.
- Herrick, C. J. (1899).—"The Cranial and First Spinal Nerves of *Menidia*: A Contribution upon the Nerve Components of the Bony Fishes," 'Journ. Comp. Neurol.,' vol. ix.
- (1901).—"The Cranial Nerves and Cutaneous Sense Organs of the North American Siluroid Fishes," 'Journ. Comp. Neurol.,' vol. xi.
- Johnston, J. B. (1906).—"The Nervous System of Vertebrates," Philad.
- Luther, A. (1909).—"Beiträge zur Kenntnis von Muskulatur und Skelett des Kopfes des Haies *Stegostoma tigrinum* Gm. und der Holocephalen mit einem Anhang über die Nasenrinne," 'Acta Soc. Sc. Fenn.,' tome xxxvii, No. 6.
- (1913).—"Über die vom N. Trigeminus versorgte Muskulatur der Ganoiden und Dipneusten," 'Acta Soc. Sc. Fenn.,' tome xli, No. 9.
- McMurrich, J. P. (1884).—"The Myology of *Amiurus catus*," 'Proc. Canadian Institute,' vol. ii, fasc. iii.
- (1885).—"Cranial Muscles of *Amia calva*, with a Consideration of the Relations of the Post-occipital and Hypoglossal Nerves in the various Vertebrate Groups," 'Stud. Biol. Lab. John Hopkins University,' Baltimore.

- Marion, G. E. (1905).—"Mandibular and Pharyngeal Muscles of *Acanthias* and *Raia*," 'Tuft's College Studies,' vol. ii, No. 1.
- Parker, W. K. (1876).—"On the Structure and Development of the Skull in Sharks and Skates," 'Trans. Zool. Soc.,' vol. x.
- Pollard, H. B. (1892).—"On the Anatomy and Phylogenetic Position of *Polypterus*," 'Zool. Jahrb. Abtheil. f. Anat. u. Ontog.,' Bd. v. Jena.
- Ruge, G. (1897).—"Über das peripherische Gebeite des Nervus facialis bei Wirbelthieren," 'Festschrift Gegenhaur,' Bd. iii, Leipzig.
- Scammon, R. E. (1911).—"Normal Plates of the Development of *Squalus acanthias*," Jena.
- Tiesing, B. (1895).—"Ein Beiträge zur Kenntnis der Augen-, Kiefer- und Kiemen-muskulatur der Haie und Rochen." 'Jenaische Zeitschr. f. Naturwiss.,' vol. xxx.
- Vetter, B. (1874).—"Untersuchungen zur vergleichenden Anatomie der Kiemen- und Kiefer-muskulatur der Fische," 'Jenaische Zeitschr. f. Naturwiss.,' Bd. viii.
- (1878).—"Untersuchungen zur vergleichenden Anatomie der Kiemen- und Kiefer-muskulatur der Fische," 'Jenaische Zeitschr. f. Naturwiss.,' Bd. xii.
- White, P. J. (1896).—"Note on the Extra-branchial Cartilages of *Scyllium canicula*," 'Anat. Anz.,' Bd. xii.
- Wijhe, J. W. van (1882a).—"Über das Visceralskelet und die Nerven des Kopfes der Ganoiden und von *Ceratodus*," 'Niederl. Archiv. für Zoologie,' Bd. v. Hft. 3, Leiden.
- (1882b).—"Über die Mesodermsegmente und die Entwicklung der Nerven des Selachierkopfes," Amsterdam.
- Wright, R. R. (1884).—"On the Nervous System and Sense-organs of *Amiurus*," 'Proc. Canadian Institute,' vol. ii, fasc. 3, Toronto.

EXPLANATION OF PLATES 21 AND 22.

Illustrating Mr. Edward Phelps Allis's paper on "The Homologies of the Muscles Related to the Visceral Arches of the Gnathostome Fishes."

REFERENCE LETTERS.

Add. Musculus adductor mandibulæ. *Add. br. I-IV.* Musculi adductores arc. branch. of I-IV branchial arches. *ahy.* Afferent artery of hyal arch. *ap. I-IV.* Linear aponeuroses related to the first to fourth gill clefts. *Arc. I-IV.* Musculi arcuales of I-IV branchial arches. *bcl. I-V.* First to fifth branchial clefts. *BH.* Basihyal. *bp. I-V.* First to fifth branchial pouches. *BR.hy.* Branchial rays of hyal arch. *Carc.* Musculus coracoarcualis communis. *CB. I-II.* Ceratobranchials of first two branchial arches. *Cbr. I-V.* Musculi coracobranchiales of I-V branchial arches. *CH.* Ceratohyal. *Chy.* Musculus coracohyoideus. *Cmd.* Musculus coracomandibularis. *C₂₋₆.* Musculi constrictores superficiales of second to sixth visceral arches. *ex. I-IV.* Extrabranchials of I-IV branchial arches. *ex. h.* Extrabranchial of hyal arch. *HMD.* Hyomandibula. *hmf.* Nervus hyoideo-mandibularis facialis. *Ibr₃₋₆.* Musculi interbranchiales of third to sixth visceral arches. *Ihy.* Musculus interhyoideus. *Imd.* Musculus intermandibularis. *lc.* Lateral canal of body. *Lhmd.* Musculus levator hyomandibularis. *m.* Dorsal muscles of trunk. *MD.* Mandibula. *mt.* Nervus mandibularis trigemini. *pc.* Pericardial cavity. *S.* Shoulder-girdle. *sp.* Spiracle. *Tr.* Musculus trapezius. *vj.* Vena jugularis.

PLATE 21.

Fig. 1.—Lateral view of the head of a 42-cm. *Scyllium canicula*, with skin removed to show the branchial muscles. $\times 1\frac{1}{2}$.

Fig. 2.—The same. The constrictores superficiales cut along their dorsal edges and turned forward and downward so as to expose the underlying structures. $\times 1\frac{1}{2}$.

Fig. 3.—Ventral view of the same. The constrictor superficialis of the hyal arch cut through in the mid-ventral line and turned forward on the right-hand side of the figure. $\times 1\frac{1}{2}$.

Fig. 4.—The same; a deeper dissection. On the left-hand side of the figure the hyal constrictor has been cut through near its lateral edge and turned forward. On the right-hand side it has been wholly removed, and the ceratohyal turned slightly forward. On both sides

of the figure the ventral portions of the constrictores of the first three branchial arches have been cut away up to the line of the extrabranchial of the arch, and on the right-hand side of the figure the ventro-posterior portions of the gill pouches have been cut away so as to expose the underlying constrictor of the next posterior arch. In the fourth branchial arch a piece has been cut out of the constrictor of the arch (Cs_4) so as to expose the fifth gill pouch. The musculi coracomandibularis, coracohyoideus, coracobranchialis I, and coracoarcualis have been cut through and removed. $\times 1\frac{1}{2}$.

PLATE 22.

Fig. 5.—The same; a still deeper dissection. The ceratohyal and the extrabranchial of the first branchial arch both removed on the right-hand side of the figure. $\times 1\frac{1}{2}$.

Fig. 6.—The same; a still deeper dissection. The extrabranchial of the second branchial arch also removed on the right-hand side of the figure. $\times 1\frac{1}{2}$.

Fig. 7.—Lateral view of the branchial region of the same. The constrictores superficiales of the hyal and first three branchial arches, and the four related gill-pouches removed, but the cut dorsal ends of the extrabranchials of the first three branchial arches left in place. $\times 2$.

Fig. 8.—Lateral view of the head of a 43-cm. *Mustelus*. The skin removed so as to expose the constrictores superficiales of the hyal and branchial arches. $\times 2$.

Fig. 9.—The same. The continuous sheet formed by the constrictores superficiales has been cut along its dorsal edge, and those fibres of each musculus interbranchialis that are inserted in the related linear aponeurosis have also been cut close to their insertion on that aponeurosis, and the entire muscle sheet, excepting the distal portion of the constrictor of the fourth arch (Cs_4), then turned downward to the level of the middle line of the gill openings. $\times 2$.

Fig. 10.—Lateral view of the constrictor and interbranchialis muscles of the third branchial arch of *Mustelus*. Dorsally, the continuous muscle-sheet formed by the constrictores superficiales has been cut along the line of the linear aponeurosis related to the arch, and also slightly posterior to that aponeurosis. Ventrally, the muscle-sheet has been cut immediately anterior to the line where the ventral portion of the constrictor of the arch (Cs_3) joins it, and also slightly posterior to that line. $\times 2\frac{2}{3}$.

The Cytoplasmic Inclusions of the Germ-Cells.

PART I. LEPIDOPTERA.

By

J. Bronté Gatenby, B.A.,

Exhibitioner of Jesus College, Oxford.

With Plates 23, 24, and 25 and 5 Text-figures.

TABLE OF CONTENTS.

	PAGE
1. INTRODUCTION	408
2. PREVIOUS WORK	409
3. TECHNIQUE AND MATERIAL	412
4. NOMENCLATURE	414
5. Mitochondria (Male)	418
6. Comparison of Mitochondria of Several Species	421
7. Changes undergone by Mitochondria in Spermatocyte	423
8. Mitochondria in Spermatocyte Division	424
9. Formation of Macromitosome (Nebenkern)	425
10. Subsequent Fate of Macromitosome	429
11. The Micromitosome	430
12. Cell Processes of the Spermatocyte	434
13. The Spindle Bridge	435
14. The Probable Function of the Spindle Bridge	436
15. The Precociously Formed Flagella	436
16. Acroblasts and Acrosome	438
17. The Mitochondria of the Female	442
18. Other Cytoplasmic Bodies	446
19. Abnormalities	446
20. The Fixing Reactions of the Cell Inclusions	449
21. The Probable Nature of the Micromitosome	450
22. DISCUSSION	450
23. SUMMARY	457

INTRODUCTION.

SINCE the numerous important papers on the spermatogenesis of many animals have shown that the elaborate series of events leading to the metamorphosis of the spermatogonium into the spermatozoon entail not only great changes in the nucleus, but also the presence of a number of definite cytoplasmic bodies whose movements and staining powers are as regular as those of the nucleus and centrosomes themselves, it becomes increasingly evident that it is incorrect to look upon the sperm as simply the vehicle for the chromatin of the nucleus and for the centrosome. There are other bodies whose behaviour merits the belief that they are concerned in the transmission of some qualities to the egg, and therefore to the offspring. The Lepidoptera have several such bodies whose ultimate fate is obscure. Moreover, they are not properly understood, and their relationship to chromatin, if any, has not been determined. An examination of the fertilisation of the Lepidopteran has not hitherto been carried out with the intention of ascertaining what rôle these bodies play in this important stage of the germ cell cycle, and such a field would probably yield useful results. The spermatozoon becomes in later stages of formation such a difficult object to study that there is no doubt that the only manner in which one could feel sure as to whether any of the several bodies really reached the egg would be to examine fertilisation stages fixed in suitable media, which should be absolutely free from certain acids. This unfortunately introduces great difficulties of technique, for the chorion of insect eggs is extremely difficult of penetration by any fixatives except those containing the ingredients, which experience has shown are mostly harmful to most cytoplasmic inclusions. Nevertheless, there are ways in which such difficulties can be overcome, and subsequent research will be done on this work.

The subject of this research was suggested by Dr. E. S. Goodrich, whom I have to thank not only for his suggestions,

but also for his many kindnesses to me in the years during which, a student, I had the privilege of working under him.

This work was done in the Department of Physiology during a part of the time I relieved Dr. Scott, and I owe my warmest thanks¹ to Prof. Sherrington for the way in which he facilitated my task and encouraged my work.

A good deal of my material was derived from Prof. Poulton's Department, and his assistants, Mr. Hamm and Mr. Britten, aided me considerably in finding suitable species.

It had been intended in the first place to study the chromosomes as well as the cytoplasmic bodies, but as the work proceeded I found that the latter structures needed examination more than the former, and it was not possible to study both satisfactorily at the same time. This paper therefore deals exclusively with plasmatic inclusions.

PREVIOUS WORK.

It is not intended to give here an extended account of the great body of work done on the spermatogenesis of the Lepidoptera. The oogenesis has hardly been treated at all by those observers who have examined the spermatogenesis; the former provides problems somewhat more difficult to follow out, and perhaps also less attractive, for in the early stages it is difficult to find individual oogonia and oocytes sufficiently clear for study, so crowded are they. In this paper I have endeavoured, as far as I found possible, to find homologous processes going on in the germ-cells of both sexes. Of all the work done on the spermatogenesis of the Lepidoptera, that of Meves (1) stands out most prominently; Meves was not occupied so much with chromosomes as with the cell inclusions and the metamorphosis of spermatid into spermatozoon. In all his work on the spermatogenesis, Meves has overlooked important facts concerning the cytoplasmic bodies, some of which he has not found, and, moreover, his modified Flemming iron hæmatoxylin technique is not calculated to

¹ I have also to thank Prof. G. C. Bourne for some excellent suggestions with regard to the text.

give the best results if it is used exclusively. Examining Meves' beautiful plates one would be led to believe that the subject of the spermatogenesis of Lepidoptera, in so far as it touches upon the mitochondria and allied structures, has been exhausted. This is not the case. Meves has described for a number of species a remarkable dimorphism in the manner of formation of the sperms. Apart from the ordinary method, he describes how the chromosomes in the second maturation division fail to come together to form the spermatid nucleus but instead become at first vacuolated, and then finally reconstitute themselves each like a small spermatid nucleus. The behaviour of the large mitochondrial body is fairly normal. He calls the abnormal spermatozoa "apyrene Spermien" and the normal "eupyrene Spermien," and shows that the sperm-bundles of "apyrenes" are several times shorter than the normal "eupyrenes."

He finds such dimorphism in *Pygæra bucephala*, *Gastropacha rubi*, *Bombyx mori*, and in *Harpyia vinula*. According to Meves, who has some weighty conclusions to draw from the "apyrene Spermien," the latter are able solely to cause segmentation of the egg, only providing the centrosome, but not being able to carry paternal hereditary factors to the eggs which they fertilise, since they have no nucleus.

Among others, the work of Dr. M. H. Cook may be mentioned. In this paper (2) the chromosomes of the Lepidoptera have been examined successfully for the first time, and though no serious attempt was made to follow out the cytoplasmic inclusions, Dr. Cook's work adds many facts of interest to our knowledge of the spermatogenesis of the Lepidoptera. I am unable to agree with some of this observer's statements, especially concerning the spermatogonium, but otherwise we are generally in agreement. The remarkable bodies in *Acronycta*, sp., which Cook describes from a single pupa, would repay further observation; I have difficulty in bringing one large accessory body, described as "chromatin granule," into line with any structures that I have been able to find in the species that I have studied. (However, see p. 446.)

Henneguy, who, apart from his original work upon the germ-cells of Lepidoptera (3), has given a good review of the literature of the subject in that admirable text-book 'Les Insectes,' says, concerning the metamorphosis of spermatid into spermatozoon, "Le noyau de la spermatide subit, comme les elements cytoplasmiques, pendant la formation du spermatozoïde, des modifications importantes qui n'ont pas été encore suffisamment étudiées." That this remark is correct is confirmed by the difficulty one has in reconciling the statements of the various authors. The whole question of the correct homology of the bodies present in the spermatogonium and metamorphosing spermatid is in a confused state. Meves identifies in the spermatid, a mitochondrial mass, two centrosomes, an idiosome, and a "spindelrestkörper."

In Text-fig. 1 are drawn Meves' figures to illustrate his view. I incline to the opinion that the archoplasmic idiosome does not exist as such in the spermatogonium of moths, and that the "spindelrestkörper" is of transitory nature. I also consider that the "spindelrestkörper" is absent in the spermatid about to metamorphose, and that there is no connection between the bodies marked *I.* and *S.* in the spermatogonium and spermatid respectively. Moreover, Meves has failed to account for a characteristic body in the Lepidopterous spermatid, and he has also overlooked the second centrosome in all his diagrams of the spermatogenesis of the Lepidoptera. My statements, be it noted, are derived from the Lepidoptera alone, and I cannot reconcile Meves' sketch in Text-figs. 1, II with anything I have seen in my sections. This question is dealt with more fully in the discussion.

For reasons which will be clear later on, Meves' figures and description of the behaviour of the mitochondria during the later stages of spermatogenesis are not altogether correct. He leaves a great gap in the description of the behaviour of the centrosomes and quite overlooks the micromitosome. (He, however, figures it in one place, but does not mention it in the text.) Some of Platner's (4) figures, executed nearly thirty years ago, give a remarkably true picture of

these cytoplasmic bodies, but this cytologist unfortunately gave a confused account of idiosome, small mitosome, and centrosome. Nevertheless the figs. 8 and 10 are very good, and I have adopted some of Platner's nomenclature (Text-fig. 1, V). Quite recently Doncaster has studied the germ-cells of *Abraxas* and *Pieris* (5). With regard to Meves' two types, Doncaster mentions that Prof. E. B. Wilson suggests that the "apyrene" type may be abnormal. Doncaster says quite rightly, "The suggestion of Meves that "apyrene" spermatozoa are capable of fertilising an egg, but not of transmitting the paternal hereditary characters is not borne out by breeding experiments, nor do these confirm the suggestion that the two types of spermatozoa determine different sexes in the fertilised egg" (vol. i, p. 183).

Doncaster in this paper also figures abnormal mitosis of the "apyrene" spermatocyte divisions. On the whole Doncaster is more concerned with the chromosomes and sex than with cytoplasmic bodies.

TECHNIQUE AND MATERIAL.

Almost every modern observer of the germ-cells of *Lepidoptera* has used the strong Flemming-iron hæmatoxylin method. Some of my material was so treated, but I soon found this method gave only a caricature of the cells. Many acids, and especially acetic acid, either altogether destroy, or at least distort most plasma structures; though acetic acid helps to give a clearly differentiated preparation, it should be avoided altogether, as Champy has already pointed out. Most of my material was fixed either in strong Flemming without acetic acid, or in Champy's fluid. Flemming, with reduced acetic acid, according to Meves, was also used. All the other better known fixatives were tried, but were mostly found useless for my purpose. Sections were stained on the slide with either iron hæmatoxylin, Ehrlich's hæmatoxylin and Orange G, methyl blue eosin. Mayer's acid hæmalum,

pyronin and methyl green, Breinl's process or the carmine stains. Alizarin and crystal violet, and iron hæmatoxylin were used especially for mitochondria.

Among fixatives I also used Regaud's formol bichromate, but with little success in the bulk. With smears I found that this fixative gave an extremely useful result. Testes were smeared on a slide, fixed first in osmic vapour and then soaked for a short time in Regaud. Afterwards they were transferred to 90 per cent. alcohol where they remained several hours. They were then stained in iron hæmatoxylin by the long method. As a rule in such preparations the mitochondria alone were stained, astral rays of the spindle and chromosomes remaining colourless, but sometimes the nucleus in the growth stage took up the stain. As will be seen later this useful reaction helped me to clear up some doubtful points. Instead of further fixation in Regaud, smears were often transferred from the osmic vapour bath to water and alcohol and then stained. These also gave useful results. Bismark brown smears were not of much help. Under separate headings I have mentioned a few other special methods used by me.

Of the species of Lepidoptera used, *Smerinthus populi*, *Pieris brassicæ*, and *Orgyia antiqua* were most thoroughly studied in the order named. I carefully examined many preparations of *Porthesia similis*, *Pieris rapæ*, *Pygæra bucephala*, *Spilosoma lubricipeda* (*Arctia*), *Euchelia jacobæ*, *Cossus ligniperda*, *Bombyx lanestris* and *rubi*, and *Abraxas grossulariata*. In *Euchelia*, *Cossus*, and *Bombyx* no maturation divisions were found, because my material was not sufficiently advanced in development. In *Spilosoma* only the degenerate "apyrene sperms" were to be found because I took my larvæ too late. Smears of *Vanessa*, *Orgyia*, and *Porthesia* were also examined.

In later stages of this work Bensley's permanganate of potash, acid fuschin stain was used, but no one stain was found to approach iron hæmatoxylin for certainty and usefulness.

NOMENCLATURE.

In the spermatogonium of the secondary group four sets of bodies can be found in the cytoplasm:—

- (1) A centrosome.
- (2) A spindle body ("spindelrestkörper," "reste fusorial.")
- (3) A body somewhat larger than the centrosome and staining darkly (micromitosome).
- (4) A cloud of granules (mitochondria).

The first needs little notice, but I should mention that I have been unable to find an archoplasmic region surrounding the centrosome. Dr. Cook mentions an archoplasmic region after a spermatogonial division before the cells have completely constricted, but figures nothing resembling Meves' spermatogonial idiosome, nor can I find any similar body. The spermatogonial idiosome may be present in *Paludina*, but I feel sure that the centrosome in the "resting" spermatogonium is not imbedded in any such structure as Meves shows in his schematic plan. Even in the case of *Paludina* I do not think that Meves is justified in assuming that the acrosome body in the spermatid is identical with the idiosome body of the spermatogonium. His seemingly careful figures of this spermatogenesis provide not a tittle of evidence for this view, and I am at a loss to understand on what grounds he comes to his conclusions.

The second body mentioned is that left by the spindle when the two cells are constricting. This body is certainly present in both secondary oogonia and spermatogonia, but later becomes absorbed, at least in the case of the male germ-cell. Its probable use and significance will be discussed in a later stage of this work.

The third body is one quite overlooked by all previous observers. It later forms what Platner calls the small mitosome of the spermatid; Hennugy calls it "la petite mitosome." In this paper it will be called the micromitosome.

The fourth number refers to a cloud of granules which

are the mitochondria. They need no further mention at this juncture.

It will now be clear that my account of the bodies in the cytoplasm of the spermatogonium differs from that of Meves in my denial of the presence and significance of an idiosome (archoplasmic zone) and in my account of the micromitosome overlooked by the German cytologist. I would like to make it quite clear that if any small granules do possibly appear around the centrosome I am convinced that they have no connection with any other body in the spermatid, and that in this case Meves and I would differ in the significance we attach to such a zona. No other bodies can be seen with certainty in the cytoplasm of the spermatogonium.

Almost all the work on the cytoplasmic bodies of the germ-cells of insects consists in the description of these bodies from the spermatid onwards, and it is the identification and interpretation of these bodies in the spermatid which have led to a great confusion. Meves has, as already stated, overlooked some cytoplasmic bodies, both Munson (6) and Platner are confused in their treatment of these structures, and some other authors also seem to have failed to distinguish centrosome from acrosome. The correct usage of the term "nebenkern" is doubtful. According to Paulmier (12) "nebenkern" means a body formed from the spindle fibres and yolk granules. In the text-book on 'Cytology' Wilson (7) offers the following remarks: "The foregoing account shows that our positive knowledge of the formation of the spermatozoon still rests on a somewhat slender basis. . . . All agree, further, that the middle piece is of archoplasmic origin, being derived, according to some authors, from a true attraction sphere (or centrosome); according to others, from a 'nebenkern' formed from the spindle fibres. The former account of its origin is certainly true in some cases. The latter cannot be accepted without reinvestigation, since it stands in contradiction to what is known of the middle piece in fertilisation, and is possibly due to a confusion between attraction sphere and 'nebenkern.' Similar doubts exist

in regard to the origin of the apex, which is variously described as arising from the nuclear membrane, from the general cytoplasm, from the 'nebenkern,' and from the centrosome." No author, I believe, has given the correct version of what really happens in the formation of the Lepidopterous spermatozoon, and the bodies confused generally are micromitosome, acrosome, and centrosome. In the glossary of his book Wilson gives the following interesting definitions:

"Mitosome (*μίτος*, a thread; *σῶμα*, body), a body derived from spindle fibres of the secondary spermatocytes, giving rise, according to Platner, to the middle-piece and the tail-envelope of the spermatozoon. Equivalent to the Nebenkern of La Valette St. George. (Platner, 1889.)

"Nebenkern (Paranucleus), a name originally applied by Bütschli (1871) to an extranuclear body in the spermatid; afterwards shown by La Valette St. George and Platner to arise from the spindle fibres of the secondary spermatocyte. Since applied to many forms of cytoplasmic bodies (yolk-nucleus, etc.) of the most diverse nature."

I have been unable to find any body in the spermatid formed from "spindle fibres" or "yolk granules," and I do not intend to use the term "nebenkern," which has been, and still is, used without discrimination for almost any granule or body in a cell. For example, Hegner (8) lately draws attention to the "granules of Blochmann" in the wasp and two ants, which have also been called "nebenkerne," quite regardless of whether or no they are of the same nature as the original "nebenkern" of Bütschli.

In Text-fig. 1, I have drawn two figures (III and IV) to illustrate the nomenclature used in this paper. The bodies in the secondary spermatogonium have already been considered. In the spermatid we have the following bodies:

- (1) Two centrosomes without definite archoplasmic zone.
- (2) The micromitosome (identical with that body in the spermatogonium (*M.*)).
- (3) The macromitosome or middle part, formed from the

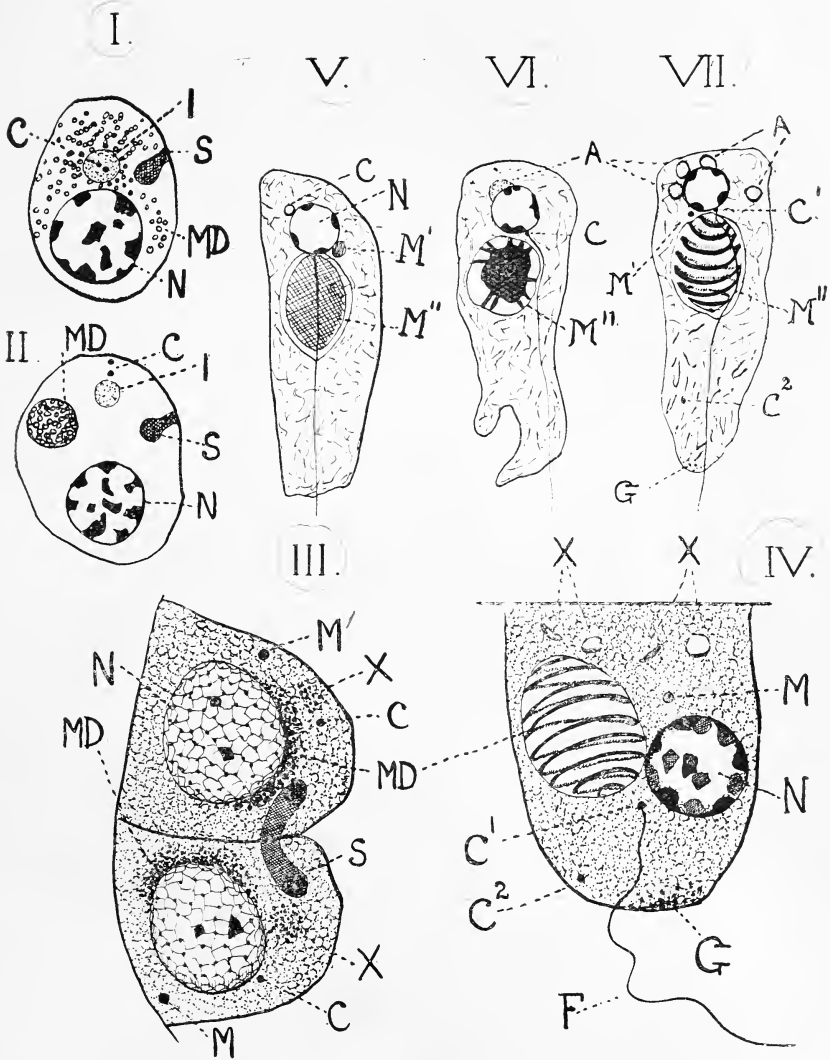

I and II (after Meves). Shows Meves' view of the relationship of the spermatogonial and spermatid bodies. *C*. Centrosome. *I*. Idiosome. *MD*. Mitochondrion. *N*. Nucleus. *S*. Spindle bridge (spindlerestkörper). III and IV. Shows the view adopted in the present paper. According to this the acrosome originates not from an archoplasmic zone, but from a definite number of bodies probably present in the spermatogonium (*X*). These form the acroblasts (*XX*) in the spermatid. *M'*. The micromitosome. V. The spermatid according to Platner and Munson; the acrosome has been mistaken for the centrosome. The micromitosome has been figured. VI. The spermatid according to Meves. The micromitosome has been overlooked, the second centrosome not figured (though placed in Meves' scheme in II), and the macromitosome (*M''*) has been distorted by the acetic acid fixation. The acrosome is partially dissolved away (*A*). VII. The spermatid according to the present paper. The macromitosome is a spireme (*M''*). The acroblasts are figured as well as the micromitosome and second centrosome. *G*. Excretory granules.

mitochondrial granules which have run together to form a spireme (*M.D.*).

(4) Several spherical acroblasts,¹ which soon unite to form the acrosome (*X.X.*).

(5) A number of excretory granules (*G.*).

The acroblasts can be found easily in late stages of spermatocytes and in all probability are present in the spermatogonium. I therefore add them to my scheme of the spermatogonium, only it should be understood that I could not find them until the spermatocyte was fairly large. The point which I particularly wish to emphasise is that the acroblasts are separate bodies in the young spermatocyte, and have nothing to do with the centrosome or archoplasm (if demonstrable).

If the idiosome (archoplasmic zone) of the spermatogonium is identical with that (acrosome) of the spermatid, we could only make certain of this in one way, that is, by following this body right up through the growth period; by explaining how the spermatogonial centrosome needs an archoplasmic zone and the spermatid centrosome not; by describing the time and manner of separation of the centrosome from the archoplasm (idiosome); and, finally, by showing why some spermatids have several idiosome-like bodies instead of the regulation one. This has not been done, and I venture to say never will be.

The Mitochondria.

In the primary spermatogonium and oogonium the nucleus is partially enveloped by a cloud-like body, which is formed by a closely-massed collection of minute granules. There is no doubt that at this stage these granules, which are the mitochondria, bear some definite relation to the nucleus. Almost always they lie in a crescentic cloud towards one side of the nucleus. Whether at this period they bear a relation-

¹ Acroblast: This useful term was suggested by Dr. H. D. King, 'Amer. Journ. Anat.', vii, 1907-8, and denotes a body which eventually gives rise to the acrosome.

ship to the centrosome it is impossible to say. It is certain that either the mitochondrial granules are not of the same size, or they have among them other larger granules of a different nature; but it is always possible to detect larger masses here and there among the smaller granules. It is these larger masses which make it so difficult to be certain of the identity of any given body in a primary germ-cell of either sex, and though the granule marked *M* in Pl. 23, fig. 1, is probably the micromitosome, it might quite possibly be of another nature. When the primary germ-cell is dividing, the mitochondria become disposed on one side of the spindle, as in Pl. 23, figs. 2 and 3, and in Pl. 24, fig. 21. At this stage, and for some time afterwards, especially in the female, the mitochondria resemble in shape rods rather than spheres or grains.

Viewed at the metaphase, the mitochondrial cloud is found to form a halo surrounding from one-third to two-thirds of the surface of the equator of the spindle; it never, or very rarely, forms a complete circle around the amphiastr, as the mitochondria often do, in the spermatocyte divisions (Pl. 23, fig. 11). It is impossible to say with certainty whether the amphiastral rays are concerned with the division of the mitochondria between the daughter cells, but I am inclined to think that they are not. In fact, mitochondria always seem to clear a path for the astral rays instead of being directly caught up in them, and my observations seem to favour the view that mitochondria are partly distributed by cytoplasmic currents.

Pl. 23, fig. 3, shows a later stage in division; the distribution of the mitochondrial matter seems to have been equally carried out, and I do not remember having seen any stage of division in which one cell appeared to be receiving more than its share. In all the spermatogonial divisions the cells act in the same way, and after these mitoses are finished the secondary spermatogonium about to become a spermatocyte possesses a cloud of mitochondrial granules at present distributed towards one side of the cell. This side is generally

the one in which lies the spindle bridge (Pl. 23, fig. 4), or "reste fusorial," which has been formed by a thickening of the spindle fibres at the telephase of division (see pp. 435 and 436).

In the female the mitochondrial fibres always seem to lie quite near, even enveloping the spindle bridge (Pl. 24, figs. 25, 26, and 28), but in the male the mitochondria, even if at first they always have this relation with the spindle bridge, soon become more granular, and tend to spread around the nucleus, as shown in Pl. 23, fig. 5. At about this period some changes come over the mitochondria; heretofore they resisted the action of acetic acid (Pl. 23, fig. 3, is drawn from a Flemming fixed cell), and in material fixed with acetic acid preservatives these bodies are either hard to see or altogether destroyed in later stages (compare figs. 8 and 18). It should be understood that up to the beginning of the growth stage of the spermatocyte and oocyte the mitochondria of both sexes are apparently identical, but after the synzesis stage and thence forwards the bodies in either sex behave quite differently. The case of the male will be described first. After synzesis the chromatin soon becomes arranged, as shown in Pl. 23, fig. 5, in the manner characteristic of the entry upon the growth stage. The mitochondrial cloud, which in some cases looks more fibrous than granular, gradually thins out, and moves around the nucleus till it eventually forms a complete outer sheath to the latter. In Pl. 23, fig. 6, it is in process of forming this sheath, and in fig. 7 the layer is complete.

As this has been taking place the individual mitochondrial granules have been changing. As far as one can ascertain from the powers of the microscope at one's disposal, the mitochondria in the stages drawn in Pl. 23, figs. 1, 2, 3, and 4 are solid, and from the point of view of staining, homogeneous, but from stage Pl. 23, fig. 5 and onwards in the male the character of these grains is altered. Each individual mitochondrial granule has formed within it, or absorbs in some way, a chromophobe substance. The mitochondrial matter

properly so called forms a cover for this central core, which shows no affinity for the stains mentioned on p. 412.— It will be seen at a later stage that this colourless inner matter forms the mechanism whereby the macro-mitosomal spireme is produced. In Pl. 23, fig. 7 the granules at *M.D.Y.* have the chromophobe core already clearly formed, while the grains at *M.D.X.* still are in the midst of forming this core. By stage Pl. 23, fig. 8, every mitochondrial granule consists of the inner and outer parts. The inner part is consequently of new origin, and has, I believe, no counterpart in the female. Up to the end of the growth period the mitochondria increase in size, but thenceforth I have not found that their size becomes greater.

A Comparison of the Mitochondrial Bodies in the Spermatocytes of *Smerinthus populi*, *Pieris brassicæ*, *Spilosoma lubricipeda*, *Orgyia antiqua*, and *Pygæra bucephala*.

An examination of Pl. 24, figs. 19 (*lubricipeda*), 22 (*brassicæ*), and 24 (*antiqua*)¹ show that these granules have a fairly characteristic shape in different families. *Smerinthus populi*, *Pieris brassicæ*, and *Spilosoma lubricipeda* have a mitochondrial body about the same size in proportion to the cell contents, but both *Smerinthus* and *Pieris* have a larger number than *Spilosoma*; the latter, again, has a larger number than *Orgyia antiqua*. *Pieris brassicæ* has mitochondrial bodies similar to those of the allied *Pieris rapæ*, and as numerous. *Cossus ligniperda* and *Pygæra bucephala* both have mitochondria very like those of *S. populi*. In some ways these structures in *Orgyia* are remarkable. Reference to Pl. 24, fig. 24 shows that the mitochondria of this species are very large, perfectly spherical, and of many sizes. In the material which I had

¹ The *Orgyia antiqua* material was fixed in Meves' fluid. From preparations subsequently made with my own modification of Flemming, I believe that the mitochondria in my figs. 24 and 27 are abnormal. This matter is now being examined.

preserved in Flemming with reduced acetic acid, and from which Pl. 24, figs. 24 and 27 were drawn, the inner substance of the mitochondria appeared to stain a very faint greyish tint after prolonged treatment in iron-alum hæmatoxylin, but this is the only case I found in all my material. Judged from seven species of Lepidoptera belonging to different families, it seems that, generally speaking, the mitochondrial bodies of the spermatocyte at the end of the growth stage are of the same general shape (spherical to ovoid) throughout, but differences exist more particularly not only in the proportionate size, but also in the number of these cytoplasmic structures in the cell. In not every species do the mitochondrial bodies resemble one another either in shape or staining affinities. Pl. 24, fig. 22 depicts the spermatocyte of *Pieris brassicæ*. The mitochondria are relatively small and spherical, being crowded towards one side of the cell. Some of these are seen to be somewhat compressed and irregular, and none is found in any cell process. The darker bodies, marked *A.B.*, are the acroblasts, and they are more conspicuous than the mitochondria.

Measurement showed that the size of the mitochondria of the several species dealt with was as follows, the average being taken in each case, for, as already pointed out, these bodies vary in size :

Orgyia antiqua, diameter of average full-grown mitochondrial body, 2 microns (Meves' fluid).

Smerinthus populi, 1 micron (Champy).

Pygæra bucephala, 1.5 microns (Champy).

Pieris brassicæ, 1 micron (Flemming without acetic).

Spilosoma lubricipeda, .5 micron (Flemming without acetic).

Vanessa urticæ, .5 micron (Regaud solution).

The above measurements give the average diameter, but it should be remembered that one could easily find a mitochondrial body in *Orgyia* as small as the average of *Spilosoma*. Some forms show a great tendency to variation in size (*Orgyia*), whilst others are more uniform (*Smerinthus*),

but I do not believe mitochondrial bodies of the spermatocyte will be found specifically different enough to distinguish satisfactorily genera, families, or even, sometimes, orders of Lepidoptera. Exceptions to this may be found; for instance, one could easily distinguish between *Orgyia* and *Pieris*, apart from other cell peculiarities in the two examples, by means of their mitochondria, but in all probability *Orgyia antiqua* and *Orgyia cænosa* would be just as much alike as the two Pierids mentioned in this paper. Then, too, it should be noticed that the Sphingidæ (represented by *Smerinthus*) have the same type of mitochondrial body as the Pieridæ—two families in no way related. Before comparison can be carried further, we must have at our disposal more work on the subject, and I leave the matter at this point.

Changes undergone by Mitochondria in the Spermatocyte.

The mitochondrial bodies never remain unchanged. They are able to move about in the cytoplasm, probably being carried by cytoplasmic currents. But there are other facts to be noticed. Near the end of the growth stage, and thenceforth, one often finds that several mitochondria have coalesced or run together and form a single, very large body as shown in Pl. 23, fig. 11, *V.V.*, and Pl. 25, figs. 32, 33, 34, and 43. In such cases I believe the running together may be caused by the close contact and subsequent fusion of the outer rim of the body, and the final flowing together of the chromophobe fluid core of adjacent mitochondria. It is often found that the mitochondria, where they are densest, run together to form cords or filaments, as shown in Pl. 25, fig. 31, and there is some probability that these large mitochondria and filaments are caused by the fixative. In my material of *Vanessa* fixed in the bulk in Regaud solution the mitochondria are bead-like, as is usually the case; in smears fixed previously in osmic vapour and then soaked in Regaud solution the mitochondria are filamentous, or apparently a solid mass. It

appears to me that such peculiarities are due to the effect of the fixative on the matter around which the true mitochondrial substance is applied; thus the filamentous condition, of which Pl. 25, fig. 31 is an example, is probably due to the rupture of the outer layer by the "brutality" of the fixative and the consequent running together of the rims of the mitochondria. This last process is one which the mitochondrial bodies always have a tendency to undergo. It may, then, be stated that the running together, though a natural process in later stages, is artificially hastened by the action of the fixative. In my sections of *Smerinthus populi*, the cells nearest to the periphery have a more vacuolated mitochondrial mass than the cells which are in the mid-region of the gonad, and to which the fixing fluid (Champy) must have taken longer to penetrate.

The Mitochondria in Division of Spermatocytes.

In Pl. 23, figs. 9, 10, and 11, Pl. 24, fig. 27, and in Pl. 25, figs. 32, 33, and 34 are drawn stages in division.

These stages seem to show that the amphiastral rays may be partly concerned in the division of the mitochondria between the two daughter cells. These bodies generally keep clear of and rarely become completely tangled in the spindle fibres. The mitochondria near the poles of the spindle in Pl. 23, fig. 9, are unusually near to the centrosomes, but there is a clear space left around the latter. This spermatocyte was drawn from material preserved in Champy, and the astral rays stain very slightly. The mitochondria generally become grouped to one side of the cell as in Pl. 23, fig. 9, but this is not the only state in which they are found. Very often they form a complete circle, as shown in an equatorial view in Pl. 23, fig. 11, and Pl. 25, fig. 33. It is during division that it becomes very obvious that the individual mitochondrial bodies are affected by what is taking place in the cell; some mitochondrial bodies become elongated in the longitudinal axis of the spindle, others run together

with their neighbours, and also become elongated in the same direction. In Pl. 23, fig. 10, this is clearly shown, and in extreme cases the mitochondria form threads, as in Pl. 25, fig. 31, elongated in the same direction as the spindle; this takes place especially in the anaphase and telophase.

In Pl. 25, figs. 32, 33, and 34, some stages are shown in which the mitochondria are blacked in for clearness. Pl. 25, fig. 32, was drawn after focussing on the cell till only the outer layer of mitochondrial bodies were in the field; by screwing the microscope tube further down one focussed upon the spindle and chromosomes, as in Pl. 23, fig. 10; only in the latter the bodies are grouped to one side of the daughter cells. Pl. 25, fig. 33, is drawn from such a section as that through X.—X. in Pl. 25, fig. 32. The clumped chromosomes are seen in the middle, and it will be clear from these two drawings that the mitochondria often form two funnel-like masses with their narrow ends applied to each other, representing the region where the cells constrict. In Pl. 25, fig. 32, the elongation of the mitochondrial bodies is evident; the figure suggests that such elongation might be due to mere mechanical reasons, pressing of the individual mitochondria one against the other.

In Pl. 25, fig. 34, a second maturation division is shown, and the tendency to a running together of the bodies is noticeable.

In both maturation divisions the behaviour of the mitochondria is similar, only in the second one the latter tend to run together more. In Pl. 25, fig. 27, I have drawn a first maturation metaphase of *Orgyia antiqua* to show the haphazard arrangement of the mitochondria and their independence of the spindle.

The newly-formed spermatid is a cell like that drawn in Pl. 23, figs. 13 and 14, the mitochondria rarely surrounding the nucleus, but being heaped to one side of the cell. In neither of these cases had the mitochondria run together at all. The mitochondrial bodies now proceed to form the macro-mitosomal spireme as follows :

Formation of Macromitosome ("Nebenkern" of some authors).

Immediately after the second maturation division and just as the nucleus becomes reorganised, the mitochondrial bodies show a tendency to form a horn-shaped figure (Pl. 25, fig. 35).

TEXT-FIG. 2.

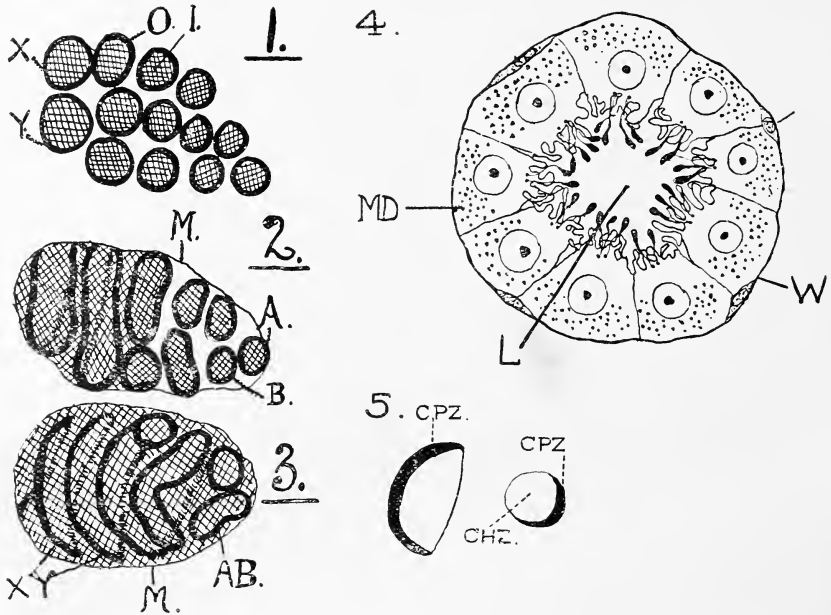

1. 2. 3. Supposed method in which spireme is formed from mitochondria. 1. Mitochondrial bodies agglomerated together, the running together will begin at X.Y. 2. The mitochondria (X and Y) and their neighbours have coalesced to form two loops confluent on the other side of the membrane (M.), with other loops likewise formed. 3. Spireme nearly formed, the bodies A and B in 2 have run together. O. Outer layer (mitochondrial matter). I. Inner vesicle of chromophobe substance represented by cross hatching. 4. Spermatocyte nest cut across the middle, showing the manner in which the flagellate organs (in black) project into the lumen (L). W. Wall of the follicle cells of the cyst. M.D. Mitochondria. 5. Much enlarged view of an acroblast in longitudinal and in transverse section. C.P.Z. Chromophile zone. C.H.Z. Chromophobe zone.

This process sometimes goes no further than in Pl. 23, fig. 13. When this preliminary formation of a horn-like figure has taken place, one end, almost always the broader, undergoes a change. The mitochondrial bodies at this region flow together, as shown in Pl. 25, fig. 35, forming at first elongated structures, then loops, and finally filaments, the latter joining up gradually to form a tangled anastomosing figure (Pl. 25, figs. 35, 36, 37, 38; and Pl. 23, figs. 14, 15, and 16). At X.X. in Pl. 23, figs. 14 and 15, the mitochondria are still beadlike, just as in Pl. 25, fig. 36 X. In Text-fig. 2 I have drawn a schematic plan of the manner in which I believe these occurrences take place. The sum total of a number of involved changes is the formation of a perfectly coiled spireme (Pl. 23, fig. 17; Pl. 24, fig. 23; and Pl. 25, figs. 39, 40, 41, and 42). In Text-fig. 2 this process is seen to fall under three stages: the first is the preparatory clumping together of the mitochondrial bodies; the second, the initiation of a flowing together to form loops; and the third, the joining up of these loops to form a spireme. The most important point to observe is that the spireme is formed from the chromophile rim (outer layer) of the mitochondrial body, while the substance, in which the spireme lies, is the coalesced inner substance (chromophobe part) of the mitochondrial layer. In Text-fig. 2, 1-3 this is shown taking place. The macromitosome so formed is drawn in Pl. 23, fig. 17; Pl. 24, fig. 23; and Pl. 25, figs. 39, 40, 41, and 42; it consists of two parts, the inner chromophobe cores now completely run together, and the contained spireme, or true mitochondrial matter, derived from the outer chromophile part of the body.

The coil so formed is of a slightly different appearance and size in different moths. If the diameter of the spermatid nucleus in a number of species be taken as 1, the ratios of the nucleus to the macromitosome in these species is as follows:

	Spermatid nucleus taken as 1.	Macromitosome, greatest length.
<i>Vanessa urticae</i> . . .	1 . . .	1.5
<i>Smerinthus populi</i> . . .	1 . . .	1.8
<i>Pieris brassicae</i> . . .	1 . . .	2.3
<i>Orgyia antiqua</i> . . .	1 . . .	1.7

A comparison of Pl. 24, fig. 22, and Pl. 24, fig. 24, of *Pieris* and *Orgyia* shows why the former should have a larger macromitosome in proportion to its nucleus than *Orgyia*; this is the difference in number and collective bulk of the mitochondrial bodies. Up to a point this ratio comparison holds good, and shows that the more numerous the mitochondrial bodies, the larger will be the macromitosome, but it should be remembered that there are also variations in the comparative sizes of the nuclei of the spermatids of the several species, a fact that must be taken into account. There is little doubt that the reason why the *Pieris* ratio is so high is partly due to the smallness of the nucleus (vide Pl. 23, fig. 22, and compare with Pl. 23, fig. 24, etc.). On the average, the nucleus is half the diameter of the macromitosome (taken in its longest measurement, for it is at this stage ovoid, Pl. 23, fig. 16). Moreover, the figures in Pl. 23, fig. 17, and Pl. 24, fig. 23, show that the ratio of the mitochondrial matter (chromophile) may differ from that of the inner substance (chromophobe), for the spireme in Pl. 24, fig. 23, is very loosely coiled.

There is a very important point which should be noted at this stage, and which is responsible for the mistaken idea (Platner) that the macromitosome (nebenkern) is derived from the spindle fibres of the spermatocyte division. I pointed out, when describing the mitochondria, that as soon as the individual mitochondrial grains began to absorb and form within them the inner chromophobe substance, their power of resisting acetic acid fixatives become diminished. Near the end of growth period, when the mitochondrial mass is large, the acetic fixed cell looks like Pl. 24, fig. 18, the remains of the mitochondria being still evident (*M.T.*). But it is when

the mitochondrial matter has separated from the chromophobe substance (Pl. 23, fig. 16, etc.), that the former again becomes distinctly visible to the eye, and I think that this renewed power of resisting acetic acid is caused by some definite but unknown change, similar to that already described just at the beginning of the growth period. The acetic acid acts so violently upon the mitochondrial matter that it produces figures like those in Text-fig. 1, after Platner and Meves. Here, then, one realises more fully the faulty technique introduced into such research by dependence on acetic acid, however much reduced, and comparison of the figures drawn in this paper from fixatives free from acetic acid with those of other observers who have used acetic acid, will show that the latter's drawings are really caricatures produced by distortion, and this remark can be readily confirmed by examining material in the fresh and with intravital stains.

There are two periods when the mitochondria of moths resist acids: (1) the pre-growth period of the spermatogonium, and (2) the period after the formation of the spireme; by "resist" I mean to signify the power to resist becoming stained and visible, not the power to resist distortion, for Meves' figures, 66, 67, 68, and 69 of Taf. XXVII (in 1B), show resistance to destruction but not to distortion. Acetic acid fixatives seem to penetrate so violently that they cause the spireme to collapse into a shapeless mass within the chromophobe substance.

Subsequent Fate of the Macromitosome.

The spermatozoon was traced up to the stage drawn in Pl. 23, fig. 17, or Pl. 24, fig. 23. At this stage the macromitosome is a distinct spireme, though I do not feel able to say whether the coil has free ends or whether it is not so provided.¹ However, as spermatozoon formation goes on, the macromitosomal spireme appears to become gradually divided into two by the impressing of the axial filament upon the

¹ See, however, my paper on the "Apyrene" spermatozoa, p. 470.

envelope of this body. As this goes on the chromophobe substance dwindles, and the spireme appears to break up partially. In Pl. 24, fig. 20, is a fairly late stage. The mitochondrial matter is filamentous, but one would hesitate to say whether the filaments were intercontinuous. In later stages of spermatozoon formation the middle region becomes so attenuated that it is quite impossible to say whether or not the macromitosome is absorbed or sloughed off. I think that the macromitosome does probably persist, but its final fate is difficult to ascertain, and I do not regard late spermatogenesis stages as suitable material for finally settling this point. The obvious course is to examine fertilisation, and to follow out the sperm after entry into the egg. Concerning these points I shall have a few remarks to offer in the discussion (p. 450).

What I have said under this heading naturally applies to the micromitosome and second centrosome as well, for all attempts at finding either of these structures in the ripe sperm have failed.

It may be that the macromitosome and micromitosome resemble the nucleus and acrosome in that they may become so condensed as to be easily overlooked, but may, nevertheless, be present, and be carried into the eggs.

The Micromitosoma of *Smerinthus populi* followed out in Material fixed in Champy.

In the primary spermatogonium the nucleus always is wrapped around, especially on one side, by a half-moon of granular substance (Pl. 23, fig. 7). This semi-lunar shaped zone is made up of minute granules quite darkly staining, and as far as one can make out not of the same size; but by choosing favourable examples it is sometimes possible to find two other bodies in the cytoplasm, one often quite near the nucleus (but almost as often isolated towards one end of the cell), which is the centrosome; the other distinctly larger and staining very sharply, which is probably the micromitosoma.

The centrosome is never, as far as I have ascertained, surrounded by a definite zone (archoplasm), and the structures mentioned by Dr. Cook are almost certainly the mitochondrial granules.

Though it is a matter of great difficulty, and I confess of some doubt, to detect these bodies (mitosome and centrosome) in the cytoplasm of the resting primary spermatogonium, their presence is indubitably confirmed when one examines spermatogonia in process of division. In Pl. 23, fig. 2, is drawn a metaphase from the side. On the left are the mitochondrial granules (*MD*), while on the mid-right of the cell are seen two bodies marked *M* which are the micromitosomata. This figure, and the drawings in Pl. 23, figs. 3, 9, and 10; in Pl. 24, fig. 18; in Pl. 25, figs. 34 and 49, seem to show that this body does divide, and apparently in the early prophases of the cell division, but I found it very difficult to make sure. I never was quite satisfied that it really did divide, and the only confirmatory evidence is that found in my figures, above mentioned. Bearing in mind that it is very rarely that one finds more than one micromitosome in the spermatocyte, and that almost without exception every spermatid has such a body, one is justified in concluding that this body really does divide. Apparently the micromitosome divides autonomously. Confirmation of this view is derived from the behaviour of the micromitosome in the spermatocyte divisions, mention of which will be made later.

Reference may be made to Pl. 23, fig. 3; Pl. 24, fig. 21, which show these bodies in material fixed in strong Flemming in which the glacial acetic acid has been reduced. In this case the body does not stain so heavily; spermatogonial mitoses show that the position occupied by the micromitosome is not definite. The most that can be said is that this body more often than not lies between the chromosomes and the equator of the spindle, rarely being found further towards the centrosome.

During the growth period of the secondary spermatogonium and spermatocyte the micromitosome, which apparently has

taken part in every cell division, lies in no definite position ; it grows a good deal, but its staining reactions do not appear to alter at all. I mention this especially because there was always the possibility that it might have become less or more densely staining in sympathy with the chromatin of the nucleus. In Pl. 23, figs. 4-8, and Pl. 24, fig. 19, the body is shown in the various positions in which one may find it. In Pl. 23, fig. 9, a metaphase of the first spermatocyte division is shown, the micromitosomata being far apart (*M.*). In fig. 18 of Pl. 24 a Flemming-fixed spermatocyte in the early prophase is shown, in order to illustrate the micromitosome (*M.*) apparently in division ; this body is constricting, and before the asters have moved one on each side of the nucleus it will have divided. In fig. 18 the micromitosome is swollen by the acetic acid of the strong Flemming solution

This cell is particularly interesting, for it appears to prove that the micromitosome does divide without the intervention of the amphiastral rays. In the case of the spermatogonial division it is fairly certain that the micromitosomata are not directly affected by the astral rays, and the same may apply in the case of the spermatocyte division.

One can find numerous cases where the micromitosomata have reached the opposite ends of the cell before the two daughter cells have begun to constrict. This seems to point to the fact that these curious bodies are separated one from the other by cytoplasmic currents. In Pl. 23, fig. 9, one focussed down upon the micromitosomata before one came to the chromosomes. In the spermatocyte anaphase the micromitosome generally appears to keep well within the zone of influence of the centrosome, as Pl. 23, fig. 10, shows, and I do not remember having seen these bodies very far removed from the aster at this period. In the second spermatocyte division (Pl. 25, fig. 34) the micromitosome behaves as in the first maturation division, and in the newly-formed spermatid always lies near the nucleus (Pl. 23, figs. 12 and 13).

When the spermatid begins to metamorphose the micromitosome may be orientated in any direction ; e. g. in Pl. 23,

fig. 13 it is below the nucleus, in Pl. 23, fig. 16 it is above, and in Pl. 23, fig. 14 it is at the side, assuming that the thick line represents the head end of a sperm (see Pl. 23, fig. 17). The mitochondria have by now run together to form the large mitosome (or "nebenkern") of Platner, or the macromitosome under my nomenclature, and the nucleus moves up near the wall of the sperm cyst wall (Pl. 23, figs. 14 and 16). The micromitosome leaves whatever position it hitherto occupied, and becomes placed between the nucleus and the macromitosomal spireme, as shown in Pl. 23, fig. 17, and in the figures in Pl. 25.

Its further history is not at all easy to follow out, for the sperm begins to lengthen and thin out, and the frequent presence of several acrosome bodies contributes to the confusion.

Though I was unable to make any smears of testes of *Smerinthus*, examination of such preparations from other species leads me to doubt whether the micromitosome always divides. I have examined a very large number of spermatids, and a few of them do not appear to possess this body; moreover, it seems that the size of the micromitosome is seldom very regular. In some cases, especially in *Vanessa*, this becomes very apparent on examining the spermatids smeared from a single nest of cells. One counts four or five spermatids with micromitosomata, and then often finds two or three quite near in which no such body can be found. All of such cases are not due to the micromitosome being hidden by the macromitosome or by the nucleus. I would not feel justified in stating that the micromitosome of one spermatid whose immediate neighbour had no such body was twice as big as the micromitosomes from a group of cells all of which possessed the body. In *Smerinthus* I can say that on the whole the micromitosomes are remarkably uniform in size and in the constancy of their presence in the developing spermatozoon. In such a form as *Euchelia* I could not find a micromitosome in any spermatogonial divisions or rest stages, and it was not until the growth-period had begun that this body

became quite clear (Pl. 25, fig. 45). *Smerinthus* is a very favourable example for the study of micromitosome, both because the individual cells are large and the cytoplasm is not crowded with coarse granules, as is especially the case with *Orgyia* and some others.

The Cell Processes of the Spermatocyte.

Not long after the beginning of the growth period, and at a stage which varies a good deal in different species, the spermatocyte shows a tendency to put out cell processes. This tendency seems correlated with the advent of the centrosome near the surface of the cell (Pl. 23, fig. 6); in Pl. 23, fig. 7, the centrosome has divided and the cell processes are beginning to appear. In Text-fig. 2 I have drawn a group of spermatocytes to show the relationship of the processes to the lumen of the cell-nest. The latter forms a sphere whose centre is hollow (*L.*) and into which the cell processes stretch. The length and character of these processes differ widely; in Pierids they are extraordinarily large and clavate, in some cases at least one half of the spermatocyte is taken up in the formation of these very large finger-like projections. In Pl. 24, fig. 22, the Pierid spermatocyte is drawn and it shows how extensive these processes are. In some cases it appears as if the processes sprung from a centre which is formed by the two centrosomes; in such examples the cell projections are arranged fan-wise, the centrosomes forming the bottom of the handle of the expanded fan. In most other species it is difficult to imagine any relationship between processes and centrosomes, as in *Smerinthus populi*. In *Euchelia*, especially in early stages, the spermatocyte projects into the lumen in the characteristic manner (not well shown in Pl. 25, fig. 45), the cell often being extraordinarily attenuated. In these cases the centrosome (at present undivided) may or may not lie in the single large cell process. Acetic fixatives are rather unfavourable, for they tend to break up these delicate organs, and I am inclined to believe that such fixatives cause the cell

processes to disappear partly or wholly, just as these solutions sometimes affect the pseudopodia of protozoa. Freshly teased preparations of testes failed to show any movement of either flagella or cell process, even though a warm stage was used.

The Spindle Bridge (Le reste fusorial).

The secondary spermatogonia and young spermatocytes and the secondary oogonia and young oocytes are connected one with another by spindle bridges. Such structures are well known and need not detain us longer than necessary to draw attention to some peculiar facts worthy of notice. In Pl. 25, fig. 46, I have depicted a nest of secondary spermatogonia of *Euchelia jacobææ*, showing the spindle bridges (*S.B.*), the mitochondria (*M.D.*), and curious interconnecting bridges of mitochondria joining the main mass of granules (*M.D.*) with the spindle remains. These peculiar interconnecting structures (*I.B.M.D.*) are always present and remarkably clear in Flemming fixing material. At this stage the spindle bridges stain very darkly with iron hæmatoxylin, showing that they are very dense. When the spermatogonia enter the growth stage as young spermatocytes the protoplasmic bridges are not at first broken, but all the cells have common spindle bridges. As the lumen appears in the middle of the nest of cells the bridges become attenuated, and a central darker part in the cell is connected to the central darker part of its fellow's spindle bridge by a paler structure. Soon the cells become as large as shown in Pl. 25, fig. 45, and towards the end of the prophase the cells are interconnected by a very small, rapidly dwindling bridge; in Pl. 25, fig. 45, the bridges are at a stage when interconnecting parts between cells (*I.P.*) are very distinct, and these parts will probably soon break asunder. The cell is left with the central dark part (*C.D.P.*) which in the male soon disintegrates. In the female moth the fate of the spindle bridge is different. I have not described the case of the female because this has been done by Miss Pauline H. Dederer in the 'Journal of Morphology,'

vol. xxvi. This observer sums up the situation in the case of the female as follows: "A transfer of material takes place from nurse-cells to the egg through connecting tubes derived from the spindle remains of the final oogonial divisions." In this paper, of which *Philosamia* is the type, Miss Dederer shows that the spindle remains in this species persist for a long time. In some cases this happens in the male also, and in all probability what Platner draws in his Pl. XIII, fig. 4, in his paper (4) is not the micromitosome but the remains of the long persistent spindle fibres. I have found similar occurrences in several species in spermatocytes about to undergo the maturation divisions. In Taf. XXVII, fig. 66 of Meves' paper there are figured two spermatids side by side, apparently joined by a bridge of staining matter. Meves says that the spermatid spindle bridge sooner or later disappears. I have been unsuccessful in my search for such spindle bridges in the spermatids of any of the species I have examined; there is often a well-marked equatorial granule (or granules).

The Probable Use of the Spindle Bridge.

In the crowded spermatogonial nests some cells are liable to get more nourishment than their fellows and would consequently grow faster than would be desirable. Where two nests touch the cells would be less well nourished than those cells bordering on the part of the nest more exposed to the nutritive fluid of the gonad. To facilitate intercommunication between cells and complete uniformity of growth the spindle bridge is retained. In the case of the female, Miss Dederer shows that the spindle bridge is also concerned in passing on nutriment. The function of the bridges is somewhat different in each sex.

The Precociously Formed Flagella.

Meves long ago described these structures, and very little remains for mention here, but I am able to add several facts

to the original description. As has been said, the advent of the centrosome, or centrosomes (if the division has taken place), at the edge of the cell (Pl. 23, figs. 5 and 6) heralds the appearance of the first cell processes. If the centrosome has not already divided it now does so, and from these two bodies there begins to grow out flagella, two from each. In *Pieris*, *Smerinthus*, and *Spilosoma* at least, the outgrowing flagella bear at their tips a remarkably large clavate structure of a definite size. In Pl. 25, fig. 44, these organs are seen just as they begin to protrude from the surface of the spermatocyte. The club-like end is, as far as I am able to ascertain, not one of the cell processes carried out in a simple manner by the growing flagellum, but really a definite organ formed on and around the end of the filament. The very tip of the outgrowing flagellum is occupied by a dark spot, at this stage quite as darkly staining as the centrosome itself, and the area of the filament between the clavate end and the centrosome stains fairly densely. The filament can be seen passing through the substance of the clubbed end, as shown in Pl. 25, fig. 50, which is drawn at a later stage when the club-shaped organ is at its largest. The terminal body (*T.B.*), the coarse, curiously vacuolated protoplasm of the clavate end (*P.R.*), and the central vacuole often present (*V.P.R.*) are shown in this figure; the filament (*F.*) is seen to pass through the clavate organ and to end in the terminal body (*T.B.*). Reference may be made to Pl. 24, figs. 19, 22, and 24, for this clavate flagellum. In Pl. 24, fig. 24 (*Orgyia*), the terminal club-like organ is small. In *Spilosoma* it is relatively huge.

By the time the second maturation division has occurred the clavate end of the flagellum is smaller, and rapidly dwindles during spermatozoon formation. When the spermatozoon is at the stage of Pl. 24, fig. 20, the clavate end is difficult to find. I believe that the terminal organ is really a store of nutritive matter, the terminal body a centre of metabolism for this matter; therefore the dwindling of the clavate end, and the later disappearance of the terminal body may be correlated with the growth of the flagellum. The clavate

organ, therefore, according to this suggestion, is an arrangement for enabling the filament to grow at both ends, the centrosome end undoubtedly assisting also; it is possible that the terminal body (*T.B.*) is in reality a part of the centrosome, detached and carried out on the tip of the filament in order to assist growth at the opposite end. The dark terminal dot is the growing tip, the clavate organ the storehouse of food matter.

The Acroblasts and Acrosome (*Smerinthus*).

After the individual mitochondrial bodies have become clearly visible, one notices other more darkly staining, slightly curved, sickle-shaped bodies, much less numerous and more definitely located. These structures are much denser than the mitochondria, as is shown by their staining reactions with iron hæmatoxylin. At the end of the growth period these darker bodies appear to have some relationship with the nucleus; the mitochondrial bodies may be scattered irregularly, but the darker bodies, which, I believe, form the acrosome of the sperm, are placed generally with their concave surface towards the nucleus. Moreover, they nearly always occupy the spaces clear of mitochondrial bodies (see Pl. 23, fig. 8, *A.B.*, 9, 10, 12, and 13).

When the maturation divisions take place, the acroblasts, as they may be called, are even more definite in their behaviour. They are almost invariably placed in a semi-circular figure near the aster, as is shown in Pl. 23, figs. 9 and 10, Pl. 25, figs. 32, 33, 43, and 48.

In some cases the acroblast, which looks solid for most of the growth period, is seen to be vesicular, only one side of the vesicle is always more solid than the other. This is shown in Text-fig. 2, 5.

The acroblasts are never quite equal in size, but the largest ones are seemingly formed by the running together end to end of two acroblasts. The latter, when not vesiculiform, are more darkly staining than when they are hemispherical. In

the newly formed spermatid these bodies occupy the position shown in Pl. 23, figs. 12 and 13. At the time the mitochondrial bodies begin to run together, the acroblasts, which are about three or four in number, gradually become vesicular. This process is quite easily followed out, and can often be seen occurring in the several acroblasts in one spermatid (see Pl. 23, figs. 14 and 15, and the figures on Pl. 25). In fact this process rarely seems to happen quite synchronously in one cell. When formed the acroblasts are quite spherical, and their wall is of equal thickness, not more bulging or thicker on one side than the other. Sometimes very small acroblasts are found (Pl. 25, fig. 39).

After the various other cell elements are arranged in final order, as shown in Pl. 23, fig. 17, the acroblasts approach, and adhere to the nucleus very often at first as shown in Pl. 23, fig. 17. In Pl. 25, figs. 39, 40, 41, and 42, the formation of the acrosome is shown. Pl. 25, fig. 41, is typical; it shows two large acroblasts adherent to the nucleus; where they touch the nucleus is a small, darkly-staining body, shown also in Pl. 25, figs. 38, 39, 40, and 42. In Pl. 25, fig. 42, the dark body is large, and the acrosome has been formed and is in its usual position. The dark dot is always touching the nucleus, and probably formed under its influence. One can sometimes find three or four acroblasts all adherent to the nucleus, each containing the dark granule. The question arises as to what occurs to the several acroblasts in such cases. I think the acrosome is finally formed by the running together of several acroblasts. This explains how such a large cap as that shown in Pl. 24, fig. 20; arises. At this stage it almost surrounds the nucleus. In Pl. 25, figs. 47 and 51, other stages are shown; the four acroblasts are together forming one large acrosomic body, and in Pl. 25, fig. 47, the running together of these structures has taken place.

It will be seen from this account that the acrosome is formed from acroblasts, which can be found in the growth stage of the spermatocyte, and which act definitely, especially in division of the cells. In Text-fig. 3 this process is shown

TEXT-FIG. 3.

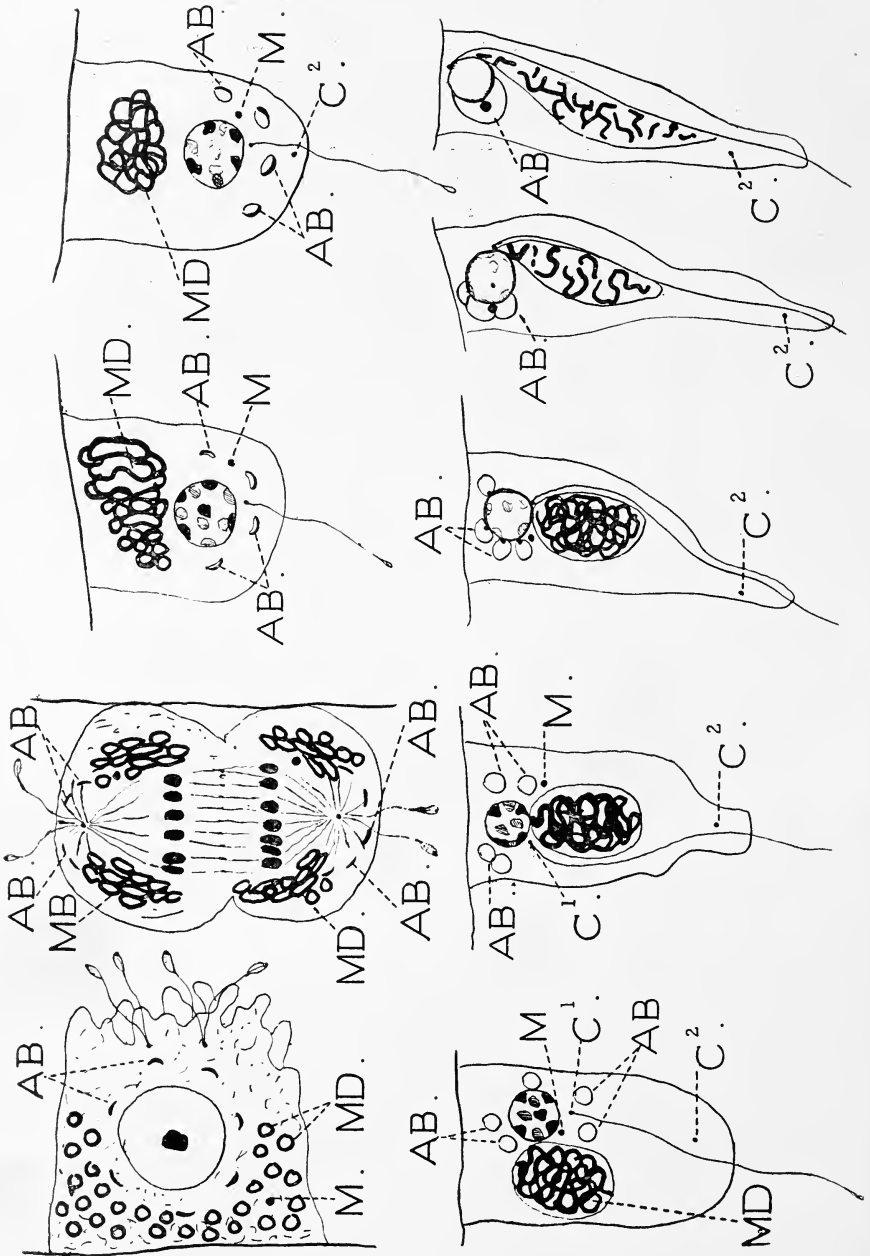

Diagrammatic scheme of the history of the acroblasts and centrosomes in spermatocyte, spermatid, and spermatozoon. For explanation see p. 463.

in progress, and in Text-fig. 4 there is drawn a semi-diagrammatic scheme to illustrate the various stages in the formation of acrosome and the rotation of the nucleus.

It is a very difficult matter to make certain in sections as to whether the acroblasts are equally divided among the daughter-cells during the maturation divisions. They are approximately divided, it is true, for the size of the acrosomes in any given cyst is the same. In *Smerinthus* there are from three to five acroblasts in the spermatid, and one can count about sixteen to twenty in the spermatocyte; in Pierids the number of acroblasts seems to be greater, but, except for the fact that they are slightly more vesiculiform, the two insects have pretty similar acroblastic bodies. In Text-fig. 2, at 5 I have drawn schematically what I believe to be the longitudinal and transverse section of the acroblast at the end of growth of the spermatocyte. In Text-fig. 5 the remarkable behaviour of the acroblasts of *Pieris* is shown during metaphase of the second maturation division. The two elements, mitochondria and acroblasts, act quite differently. The former are passive, and evidently not so easily managed in cell-division as are the latter, which collect near the aster. In Pl. 25, fig. 48, the prophase of the first maturation division is shown. This cell not only shows that the mitochondria are visibly affected by the spindle-fibres in division, for those near the fibres have run together (*X.X.*), but also establishes, as do most of my other figures, that the acroblasts have some definite relationship with the nucleus and aster. The orientation of the acroblast with the concave surface towards the nucleus is shown as well in Pl. 24, fig. 22, Pl. 25, figs. 30, 31, 32, 34, 43, and 48, and as a rule is rarely departed from. The reason for this curious relationship with the nucleus is unknown to me, but it is worthy of notice that this orientation is clearly marked from the time one can distinguish the acroblasts in the cell, and finally culminates in the attachment of these bodies upon the spermatid nucleus. The whole series of events seems to show that the acroblast is, especially in cell-division, a more tractable cell element than the mitochondrial

body, and the latter never bears the same relationship in later stages to the nucleus as the acroblastic body. In *Orgyia antiqua* the acroblasts seem to be vesiculiform, but as my material is fixed in Meves' fluid I cannot be quite sure. In Pl. 24, figs. 24 and 27, these bodies are shown, but the trace of acetic acid used seems to have abnormally affected them. They are less visible than after Champy or Flemming without acetic fixation. In *Spilosoma* the cell was too small for me to make sure of the presence of the acroblasts in the growth period, though the mitochondria could be seen.

The Mitochondria and Other Bodies in the Female.

In every way the cytoplasmic bodies in the oogonia and younger oocytes resemble the same structures in the male; this is a point which has hitherto escaped notice in the Lepidoptera, and it is one of significance. It is not till the growth period has begun that the male cell becomes different from the female. In the former I have found micromitosome, spindle bridge, and mitochondrial cloud, and these bodies are all present in the female, though they may be slightly different in some ways. In the oogonium the mitochondria are grouped just as in the spermatogonium, and the same applies to the behaviour of these bodies during the oogonial divisions. After divisions have ended, the prophases of the heterotypic division begin, and the cell looks like that drawn in Pl. 24, figs. 26 and 28. The spindle bridge at this period may be relatively enormous, as in the latter figure, and it is often surrounded by, or closely related to, the mitochondria in some way or other (Pl. 24, fig. 26); these cases vary greatly. In Pl. 24, figs. 25, 26, and 28, there is a body (*M.*) which is almost certainly the micromitosome; in both *Smerinthus* and *Pygæra* I am quite certain of its presence. If ovaries and testes are preserved and stained at the same time these bodies can readily be compared (see Pl. 23, fig. 4, and Pl. 24, fig. 25—both oocyte and spermatocyte being at contraction figure). The micromitosome of the female seems to stain less heavily

TEXT-FIG. 4.

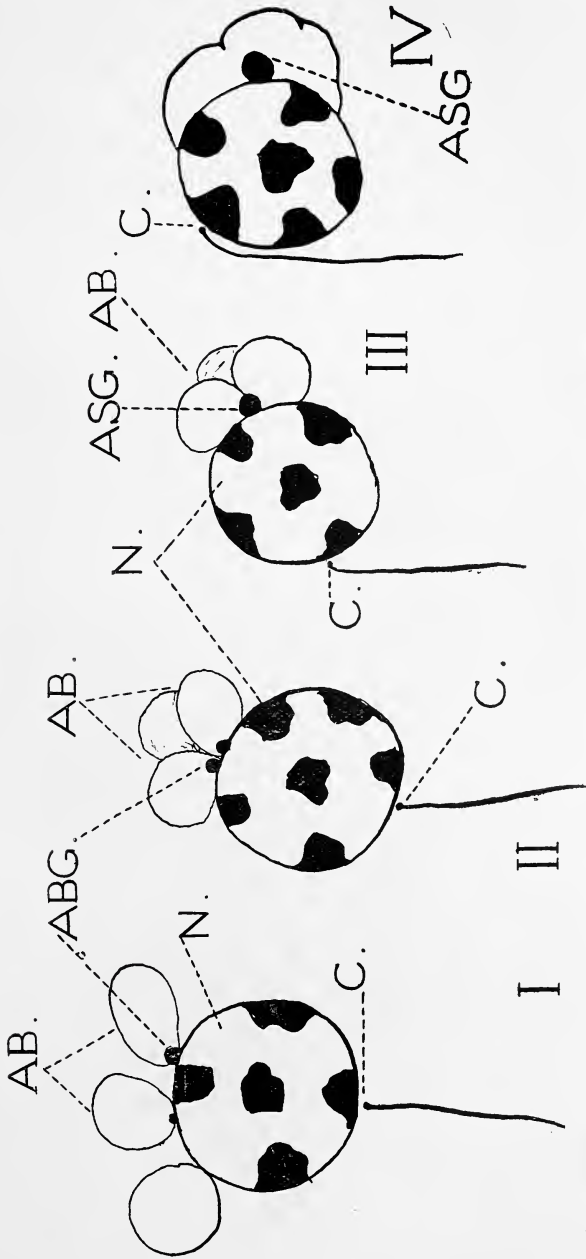

Diagrammatic scheme of the formation of the acrosome from the acroblasts. The half revolution of the centrosome resulting in the partial flexure of the sperm head is shown (see Pl. 12, figs. 47 and 51). *A.B.* Acroblast. *A.S.G.* Acrosome granule. *C.* Centrosome. *N.* Nucleus.

than that of the male, though this may be accounted for when one remembers that the fixing fluid has different amounts of tissue to penetrate in the testis than in the ovary, and length of fixation and accessibility to fixation will cause great differences in staining.

I have been unable through lack of suitable material to follow the micromitosome through oogonial divisions, but it is quite possible that the nurse-cells differ from the oocytes in that the latter may possess a micromitosome, the former not. The search I was able to make showed that this view may be true, but good enough mitoses were not available to follow this body. It is very plain in *Pygæra bucephala*, and this moth will make a good species for study, because its cells are so large. In later oocytes (Pl. 24, fig. 29) one often finds a large vacuolated body marked X, which I believe is the micromitosome; it seems to break up about this period; but my material is not extensive enough to allow me to make a definite statement.

In Pl. 24, figs. 25, 26, and 28, the centrosome and mitochondria are shown. The latter are somewhat different from those of the male; this difference may be due to the accessibility to the fixative in the female, for in later stages I know that the more peripheral spermatocytes and spermatids are differently fixed from the medullary ones. In the male the mitochondria are granular, in the female fibrous, but exactly this difference in later stages can be demonstrated in the male. (Compare Pl. 25, figs. 30 and 31.) The mitochondria of the female never become far removed from the nucleus, are always minute, never have formed within them the chromophobe medulla, and in late stages form a cap on one side of the nucleus (Pl. 24, fig. 29). Their subsequent fate in the maturation divisions and in fertilisation is unknown.

It is noticeable that the semilunar cloud of granules near the oocyte nucleus is not destroyed by acetic acid fixatives at this period, and in this way resembles the mitochondrial

TEXT-FIG. 5.

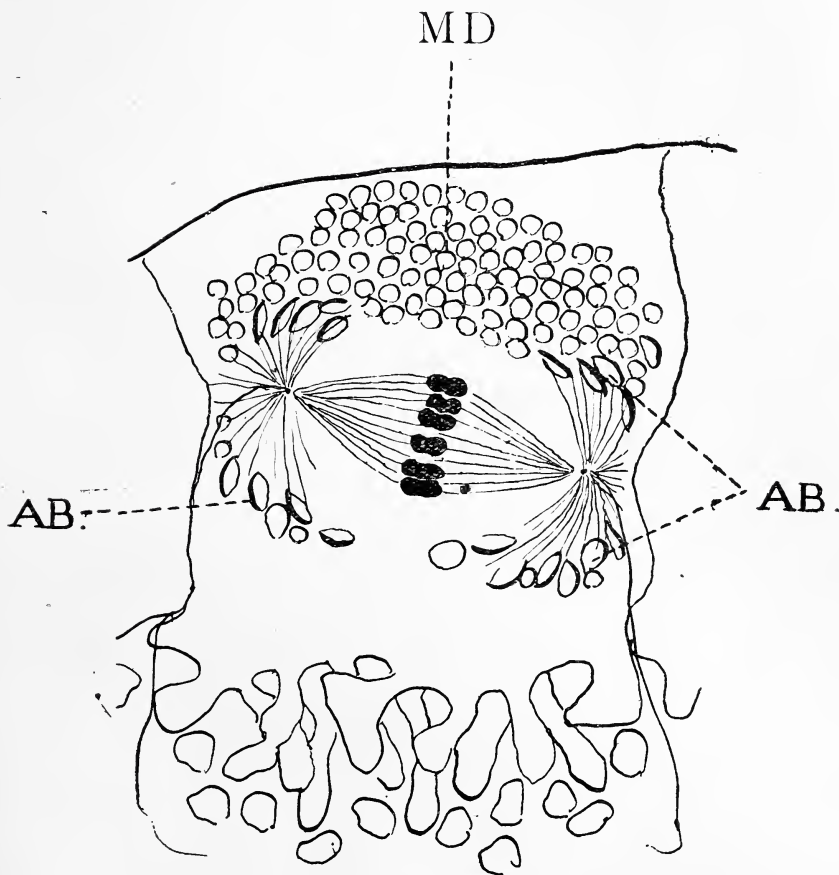

Outline drawing by camera lucida to show varying behaviour in mitosis of mitochondria (*M.D.*) and acroblasts (*A.B.*) in the first spermatocyte division of *Pieris brassicae*. The mitochondria are passive, while the acroblasts are caught up in the asters, and are orientated with their concave surface towards the chromosomes. $\times 4250$. 22

bodies in the spermatogonium and young spermatocyte (see Pl. 25, fig. 45). It is only after the formation of the chromophobe medulla that the acid completely destroys the male mitochondria.

OTHER CYTOPLASMIC BODIES.

In *Orgyia antiqua* there are numerous large granules which are drawn in Pl. 24, fig. 24, *X.G.*, and *X.M.*; these are rarely of a size, but almost always there is a very large granule (*X.G.*) which goes to one or the other daughter-cell in divisions. This large body always has a clear centre and is a constant factor; in the spermatid it becomes carried out to the end of the cell and finally sloughs off (Pl. 24, fig. 23). There are other bodies of smaller size (*X.M.*) which are probably of the same nature as the last mentioned. Besides these one finds much smaller granules (*G.*), which are very evident especially in division. For this reason *Orgyia* is unsuitable material for following out any cytoplasmic bodies except mitochondria, for there are so many granules that confusion arises. Even in the spermatogonial divisions large granules are present. One concludes that these granules are excretory in nature, and are therefore of little importance from the point of view of this paper. Were further material at my disposal it might be possible by suitable methods to detect differences in these granules, but this has not been possible with Flemming with reduced acetic acid and iron hæmatoxylin. Probably Miss Cook's "chromatin granule" in *Acronycta* sp. is an excretory granule, or at least a body of the same nature as one of those mentioned above in *Orgyia*. In nearly all spermatids in *Pieris*, *Smerinthus* and others there is a mass of excreted matter sloughed off (see Pl. 23, figs. 15 and 17; Pl. 24, figs. 23, etc.) during spermatozoon formation.

ABNORMALITIES.

Though a very large number of gonads of a several species were examined nothing abnormal in relation to the sex was

found. All larvæ and pupæ examined by me were either males or females. With regard to cytological abnormalities, one found nothing very remarkable. By means of smears¹ fixed in osmic or in formalin bichromate or in both, it is possible to find some curious facts in connection with mitoses and mitochondria. With the exception of Munson, who figures several abnormalities, observers have overlooked these exceptional stages; the reason for this is that such abnormalities can only be detected successfully in smeared preparations, which most other observers of Lepidoptera have not used. However, Pl. 25, figs. 30 and 43, were drawn from sections of *Smerinthus*. The former shows a binucleate cell, with three sets of centrosomes, and two micromitosomata; the mitochondria and acroblasts are normal; such cells seem to arise by the cell-plate not forming during a spermatogonial mitosis. The latter figure (Pl. 25, fig. 43) shows a triaster mitosis, the twenty-eight chromosomes being distributed as indicated; eight to one aster, four to another, and sixteen to the other; each aster has its acroblasts and the biggest aster has the most mitochondrial matter near it. This was a probably first maturation division and was found in a nest of second maturation divisions; it is larger than the usual spermatocyte at the end of growth period and this accounts for the delay in divisions; I take it to be a first maturation division by the fact that two of its centrosomes each had two flagella. In Pl. 25, figs. 52 and 53 are shown drawings from smears of *Vanessa testis*; the first figure shows an accessory macromitosome (*M.D.*¹), evidently formed by some mitochondria being isolated during spireme formation; the second figure shows a double cell in which one macromitosome has more matter than its share.

¹ Too much reliance cannot be placed on abnormalities found in smears, for during the process of spreading the gonad on the slide the fresh cells often either burst or run together.

Fixative.	Nucleus and centrosomes.	Mitochondria.	Micromitosome.	Acrosome.	Cytoplasm.
1. Flemming's strong solution with acetic acid	Stain very sharply	Destroyed, especially in growth period. Macromitosome collapsed	In some cases (Smerinthus) almost destroyed, in others (Euchelia) not affected	Partially destroyed and distorted. Acroblasts dissolved away	Has an appearance of having been dissolved out and roughly used.
2. Flemming's strong formula without acetic acid (Gatenby)	Stain well but not so sharply as with acetic acid added	Stain very well	Also stains well	Stains well	Good.
3. Champy	Nucleus and chromatin often badly stained. ¹ Spindle fibres rarely stain well. Effect sometimes capricious.	Very good	Very sharp	Very good	Has no shrunken dissolved out appearance.
4. Regaud (smear)	Neither nucleus nor centrosomes stained (early growth period excluded)	Very heavily stained, but often fibrous or clumped together	Fairly sharp	Does not stain	Good.

¹ Depends somewhat on washing out after fixation.

THE FIXING AND STAINING REACTIONS OF THE CELL ELEMENTS
OF SPERMATOCYTE AND SPERMATID.

In table form I have set out on p. 448 the reactions of the nucleus, centrosomes, mitochondria (macromitosome), micromitosome, and acrosome to the various fixatives. Iron hæmatoxylin and some other stains were used to judge staining power, any staining method serving to standardise a number of fixing methods.¹

These results are mainly derived from *Pieris*, *Smerinthus*, *Porthesia*, and *Vanessa*. A compromise between Fixatives 1 and 2 can be got by using reduced acetic acid, but as Champy has insisted the use of acetic is not really indicated, and constantly leads to faulty results. The micromitosome in some forms seems to be more affected than in others, and I am inclined to believe that this body is somewhat different in different species. In *Porthesia* I believe the micromitosome is constantly present, but as my material was all fixed in Flemming, the body was very vague and lightly staining. The Regaud reaction is a very useful one, for from it we know that the acroblasts are in some way different from the mitochondria. This applies also to the centrosome; the whole table of reactions shows that the acetic acid favours nucleus, centrosome, and aster. The mitochondria are different in this way, and again the acroblasts are more delicate than the mitochondria. I believe that acetic acid should never be used unless for very special purposes. A great deal of the work at present done on chromosomes is carried out with acetic fixatives; these are unnecessary and probably destroy many features of interest in the cytoplasm. Of course, in the cases where chromosomes are very small acetic acid is an advantage for it gives a sharp stain. A curious effect of Champy is sometimes to cause the nucleolus to stain very black and

¹ The time given to washing out of the material after removal from the fixative is an important factor in staining.

the chromosomes hardly at all; this might be a useful reaction in some work (see Pl. 25, fig. 48).

THE PROBABLE NATURE OF THE MICROMITOSOME.

Some observers have referred to this body as a "chromatin granule." If one stains in pyronin and methyl green the micromitosome is red, and the chromatin green.¹ Iron Hæmatoxylin is not a specific stain for chromatin, and the fact that it stains the micromitosome darkly, merely means that the latter is of a dense nature. If the micromitosome really divides autonomously it resembles the centrosome somewhat in this way, but the Regaud test shows that the centrosome will not stain where the micromitosome will. According to the Regaud reaction the latter resembles mitochondria more than chromatin, but the value of the test is doubtful. The important fact to be noticed is that very probably the micromitosome is altogether of a different nature from chromatin, and should not be loosely called a "chromatin granule." Montgomery (9) calls certain bodies he finds "chromatoid granules," which is non-committal.

DISCUSSION.

The few facts brought together in this paper show that Meves's schematic comparison of the bodies in the spermatogonium and the spermatid probably does not hold good for the Lepidoptera. In particular I have the greatest suspicion of the view at present current, that the acrosome is derived from the archoplasmic idiosome detached from the centrosomes. I believe that at present such a view cannot be entertained for a moment in *Smerinthus* or any other Lepidopteran upon which I have worked, and when the spermatogenesis of the mammal has been more carefully studied, I think that the acrosome will be found in the growth stage, as a body independent of the centrosome, at every stage of its existence.²

¹ This, however, does not show that the micromitosome is not chromatin; for in later stages (spermiogenesis) the nucleus also becomes red for a time.

² In *Helix aspersa* the acrosome has no relation to the archoplasm.

The behaviour of the mitochondrial bodies, their chromophobe and chromophile zones, and the eventual formation of the spireme, which is described here in *Lepidoptera* for the first time, have not hitherto been properly examined. Munson (6) seems to have been the latest observer to attack the problem, but none of the above structures have been correctly described. The formation of the acroblastic body at the head of the sperm, from the several acroblasts, the behaviour of these bodies in division of the cells, are all facts which have either been altogether overlooked or incorrectly described. The micromitosome has not been traced back to the secondary spermatogonium, and the division of the centrosome has been overlooked.

The fate of the middle piece (macromitosome) cannot be successfully followed out in later stages in spermatozoon formation, and until fertilisation stages have been examined after fixation in suitable media, it will be impossible to tell whether it even enters the egg. In the same way the behaviour of the mitochondria in the egg at this stage will provide interesting material for research. It can fairly be stated here that it is most unlikely that such a body as the macromitosome, bearing in mind its origin and remarkable formation, does not enter the egg, for it would then seem that all the complicated evolutions of the mitochondria were for nought. Theoretically one might suppose that three bodies at least met and fused in fertilisation—the pronuclei, the mitochondria, and the micromitosomata. We know already that the nuclei do fuse, but the case of the last two is less certain. In addition, of course, one would find observers who would wish to suggest that the two cytoplasmata (if the male does introduce cytoplasm) met and fused; but the sperm of the moth is too small for one to judge, whether or no, cytoplasm is present in any appreciable quantity.

The acroblasts and mitochondria are bodies of great interest; in the newly-formed spermatid it has been shown that each half-moon shaped acroblast becomes spherical. This evidently takes place by the absorption of a chromo-

phobe fluid similar to the same substance inside the mitochondrial body; the ultimate use of this region in the acroblast is also similar to that of the mitochondrial chromophobe zone. It enables the acroblasts to fuse readily, and is very probably in some way connected with the formation of the acrosomic granule. The latter seems to be the essential organ in the formation of the sperm head, and the acroblasts are the vehicles whereby it is secreted. From the manner in which the granule appears it is extremely likely that the nucleus is the prime factor in the secretion of this body. The manner of origin of the acroblasts is unknown to me; they can only be found with certainty at the time the spermatocyte is fairly well advanced in growth period, but one is justified in assuming that the matter or bodies from which the acroblasts originate is represented in the spermatogonium. It may be possible, with improved technique, definitely to identify acroblastic material in the latter cell; exactly what becomes of the acrosome in fertilisation is not properly understood, for the current idea that it degenerates may not be true. Instead one might be justified in assuming that the acid and alcoholic fixatives destroy it, and cause it to be invisible just as the same media do in growth stages of the male germ-cell. Until this matter has been completely examined with suitable technique we are not justified in paying no attention to the acrosomic body after entry of the sperm. It may be true that the acrosome persists in some way or other, but the point I wish to emphasise is that we cannot tell whether it does or not until we use proper methods.¹ Carnoy, Petrunkevitch and such fixatives are not suitable for this work.

It has occurred to me that the acroblasts may be mitochondrial bodies of a modified nature, but I have little evidence at present either way. The number of the acroblasts seems to vary somewhat, and they may well be mitochondria which have not absorbed the chromophobe zone.

¹ For similar view see F. Payne, 'Journ. Morph.,' vol. 28, No. 1, p. 311.

In later stages, after the assumption of the vesicular shape, the acroblasts are readily mistaken for mitochondria.

Thos. H. Montgomery, jun. (9), in his paper on the "Spermatogenesis of *Euschistus*," figures in Pl. I, fig. 1, a spermatogonium with "mitosome" and "idiosome." According to my interpretation his "mitosome" is a spindle bridge, and his "idiosome" a cloud of minute mitochondrial granules. His mitochondria in late stages I believe to be run together into threads by the acid fixatives he has used. His mitochondria possesses no chromophobe zone, they are all chromophile, and his figures of maturation divisions give the impression that the mitochondrion is being divided autonomously. If one examines Henneguy's figures of *Pyrrhocoris apterus*, stained in violet dahlia *intra vitam* ('*Les Insectes*,' p. 661), it will be seen that the mitochondria form long fibres, but that each rod consists of a number of mitochondrial grains containing the chromophobe zone. I therefore believe that the mitochondria of *Euschistus* are really like those of *Pyrrhocoris*, only Montgomery has used acetic acid and produced threads.

We now come to the question as to whether the filament or the granule is the true form of the mitochondrial body. My study of the *Lepidoptera* causes me to believe that with proper fixation the mitochondria will be found to be in the form of grains, but that the grains often tend to lie in chains, as Henneguy shows ('*Les Insectes*,' p. 661), and that brutal fixation produced by acetic acid, or by other unsuitable media causes the whole chain to coalesce. Even Champy and Flemming free from acetic often cause distortion, if not properly diluted to suit the material used.

I have at present very little evidence to offer concerning the theories of division of mitochondria, and as to whether they are the "chromosomes of the cytoplasm," as Meves would say, but I feel sure that no division of the mitochondrial body in the maturation divisions can be demonstrated with any degree of certainty. The view I take is that the mitochondrial granules are not divided individually into parts, but

are distributed whole to one or the other daughter cell. I have already shown that abnormalities may occur, and that one cell may get more than its share of the mitochondrial mass, but for Meves's conclusion that the mitochondria carry the hereditary characters of the cytoplasm we need evidence and not supposition. The view is interesting and worthy of the most careful attention.

Meves (10) claims in *Ascaris* that the mitochondria of the female fuse with those of the male, a view previously urged by Zoja (11), but, as far as I know up to the present time, nothing similar has been described elsewhere. With regard to the question of the origin of the mitochondria in the young germ-cells, I think that in moths they are already present from the segregation of these cells, being passed on permanently from parent to offspring, but in other forms there is still the question as to the origin of the mitochondrial granules from the nucleus.

We now come to a review of Meves's "apyrene" and "eupyrene" spermatozoa. Meves fully believed that the "apyrene" sperms were functional, though he only had his theory to go upon. Doncaster (5) is sceptical of the truth of Meves's conclusion that the spermatozoa of the two kinds may affect sex. The "apyrene spermien" I believe to be degenerate, and of no importance in fertilisation; those who have studied germ-cells even cursorily have noted that degeneration takes place not at one stage but at every step. Meves's "apyrene" sperms, I believe, are examples of flagging energy in cells, and are due to some cause unknown to us. I have taken testes full of "apyrene spermien" and stained fresh in osmic acid or scarlet red, and have found the walls of the testis to be full of fat cells and globules. The degeneration observed cannot be due either to a want of nourishment or a diversion of such nourishment to other sources. Whole nests of spermatogonia and oogonia in many animals are to be found in process of degeneration. In some way or other the "apyrene" chromosomes lack the energy, whatever that may be, to coalesce to form the nucleus.

Meves does not describe the acroblasts, for he has not found them, but it would be of great interest to know what happens to these structures.¹ We know that the macromitosome is apparently normal in the "apyrene" sperm. This shows that the nucleus is not concerned in the formation of this cell organ; probably the macromitosome, if I may use the expression, is "looked after" by the centrosome or centrosomes. The acroblasts, by their behaviour in growth and division, seem to rely on the nucleus; we thus get the interesting state of different cell elements being independent inter se and governed by special parts of the cell. The centrosome governs the macromitosome, the nucleus influences the acroblasts, and the centrosome keeps close to the nucleus; and so the elements are orientated correctly in the sperm. Exactly what part each plays it is quite impossible to state, and the extent in which cytoplasmic movements affect the question cannot be decided at present.

The moth or butterfly never lacks sufficient normal spermatozoa, and it is not until a great number have been formed that the "apyrene" spermatozoa become formed in any number; but in many species in later stages the abnormal spermatozoa are exclusively found in process of formation.

Von N. Divaz, in a late paper (14) on the "Spermatogenese von *Naucoris cimicoides*," treats of spermatogenesis from the spermatocyte at the end of growth stage onwards. He identifies, in the cytoplasm of the first spermatocyte, some three bodies, which he calls Archoplasma, and several chromophile bodies (Chromatophile Körperchen). Since he has partially destroyed the mitochondria with acetic fixation, his account of the formation of the macromitosome is inadequate. In Pl. I, fig. 1, he depicts, but does not mention, the mitochondria, which are in a dissolved condition. His archoplasmic corpuscles are probably acroblasts, and he figures them with a crescentic edge turned towards the nucleus, in the opposite way to that in which I found them in Lepidoptera. In the spermatid he believes that the

¹ See my paper on the "Apyrene spermatozoa."

chromatophile corpuscles join the archoplasmic bodies, and that these two categories of structures together form the acrosome. I have not examined any material of this Hemipteron, but I rather doubt this description. He does not figure the centrosomes at any stage of sperm formation till the tail is beginning to grow, and according to his figures the centrosome does not divide.

Following von Divaz there are formed in the cytoplasm two zones, peripheral and central, the latter forming the macromitosome (nebenkern). I am unable to compare this view with what I find in Lepidoptera. Divaz figures a macromitosome, but gives the name "mitochondrial body" to another structure which is not of the same nature or staining affinity as what is generally called "mitochondrial." The formation of the macromitosome and the appearance of what von Divaz calls the mitochondrial body is peculiar, and should be properly examined to ascertain its real nature, and its origin. Dr. Goldschmidt (16) lately discusses the "apyrene" spermatozoa from the fertilisation point of view, and, in agreement with the view already stated above, declares that—"We think it not unsafe to conclude from these facts that apyrene spermatozoa can not induce development, even if they enter the eggs, which, however, also seems improbable."

In the spermatogonium and early spermatocytes of moths the mitochondria appear to be dividing autonomously as they lie in the cytoplasm, but it would be impossible to come to a decision from such evidence, for the appearance of being in apparent division might be caused by the temporary fusion or apposition end-to-end of two separate mitochondrial bodies. Nevertheless I am inclined to believe that the mitochondria divide at this period by simple constriction, and some recent work which I have carried out on these bodies in the frog and the snail leads me to think such a view worthy of consideration. Future work on some form whose mitochondria¹ are

¹ In a forthcoming paper by me, two kinds of mitochondria are described in *Helix*, as well as some other constantly occurring bodies of doubtful nature.

large and not too numerous may finally settle this important question. It might be assumed that the spermatocyte mitochondrion divided twice, so that each sperm finally possessed a part of the original mitochondrion. From the method of distribution of these cell inclusions between the daughter-cells I believe that no such mathematically correct division takes place in any mitosis, and the slightly varying size of the macromitosome does not give support to this view.

SUMMARY.

(1) In *Smerinthus populi*, *Pieris brassicæ*, and a number of other species of moths and butterflies the cytoplasmic bodies have been followed out.

(2) The micromitosome has been followed from the spermatocyte back into the secondary spermatogonium. It is very probably present in the primordial germ-cell.

(3) The micromitosome has been definitely found in the female.

(4) The micromitosome seems to divide in all divisions, and I consider that it is a constant factor in the spermatids of *Smerinthus*.

(5) The probable nature and function of the micromitosome is discussed.

(6) The mitochondria have been carefully examined in the male and female germ-cell in all stages except in the maturation division of the female and in fertilisation.

(7) It has been shown that in early stages the cytoplasmic bodies of the female resemble those of the male.

(8) There is a definite period, judged to be about the beginning of growth stage, when the subsequent fate of the mitochondria in the male becomes different from that of the female.

(9) The remarkable formation of chromophobe and chromophile zones in the male mitochondrial body and the use of these zones are described.

(10) The formation of the macromitosome from the mitochondria is described.

(11) The changes undergone by the macromitosome in sperm formation are followed out.

(12) The presence of the acroblasts in the fairly early growth period of the spermatocyte is described.

(13) The complicated evolutions of these bodies in division of the cells, their subsequent fate and their probable nature are discussed.

(14) The staining and fixing reactions of the cytoplasmic bodies are fully described.

(15) A number of abnormalities have been described.

(16) The centrosome has been shown to divide in the young spermatid, and one centrosome is probably lost, but definite evidence is not forthcoming.

BIBLIOGRAPHY.

1. Meves, F.—"Ueber Centrakörper in den männlichen Geschlechtszellen von Schmetterlingen," 'Anat. Anz.,' Bd. xiv.
- 1a. ——— "Ueber den von v. La Valette St. George entdeckten Nebenkern (Mitochondrienkörper) der Samenzellen," 'Arch. f. mikr. Anat.,' Bd. lvi.
- 1b. "Ueber oligopyrene und apyrene Spermien un über ihre Entstehung nach Beobachtungen am *Paludina* un *Pygæra*," *ibid.*, Bd. lxi.
2. Cook, M. H.—"Spermatogenesis in *Lepidoptera*," 'Proc. Acad. Nat. Sci. Philadelphia,' Bd. lxii.
3. Henneguy.—(See Bibliography in 'Les Insectes.')
4. Platner, G.—"Samenbildung und Zelltheilung im Hoden der Schmetterlinge." 'Arch. f. mikr. Anat.,' xxxiii.
5. Doncaster.—'Journal of Genetics,' vols. 1, 3, and 4.
6. Munson.—"Spermatogenesis of the Butterfly, *Papilio rutulus*," 'Boston Soc. Nat. Hist.,' vol. xxxiii.
7. Wilson.—'The Cell.'
8. Hegner, R. W.—"Studies on Germ-Cells," 'Journ. Morph.,' xxvi, 1915.
9. Montgomery, T.—*Ibid.*, vol. xxii.
10. Meves.—"Über die Beteiligung der Plastochondrien an der Befruchtung des Eies von *Ascaris*," 'Arch. mik. Anat.,' Bd. 76.
11. Zoja.—"Über die fuchsinophilen Plastidulen," 'Arch. Anat. u. Entwick.,' 1891.

12. Paulmier.—'Journ. Morph.,' xv.
13. Dederer.—'Ibid.,' xxvi.
14. Von Divaz.—'Zool. Anzeig.,' 1914-1915.
15. Pantel et Sinéty.—'La Cellule,' t. 23, 1906.
16. Goldschmidt.—"The Function of the Apyrene Spermatozoa." 'Science,' Friday, October 13th, 1916.

EXPLANATION OF PLATES 23 AND 24,

Illustrating Mr. J. Bronté Gatenby's paper on "The Cytoplasmic Inclusions of the Germ-Cells."

EXPLANATION OF LETTERING.

(For × see text.)

A.B. Acroblast. *A.S.* Acrosome. *A.F.* Axial filament. *C¹*. Proximal centrosome. *C²*. Distal centrosome. *C.O.* Chromophobe zone of macromitosome. *C.P.* Cell process. *C.D.P.* Central darker part of spindle bridge. *E.P.* Equatorial plate granules. *F.* Filament. *G.* Excretory granule. *I.B.M.D.* Interconnecting bridge of mitochondrial grains. *I.P.* Intercellular part of spindle bridge. *L.M.D.* Mitochondrion elongated by pressure. *M.* Micromitosome. *M.D.* Mitochondria. *M.D.X.* Mitochondria without well-marked chromophobe medulla. *M.D.Y.* Mitochondria with chromophobe medulla well marked. *P.R.* Protoplasmic part of terminal body of flagellum. *S.B.* Spindle bridge. *S.P.* Macromitosomal spireme. *T.B.* Terminal body of axial filament. *V.* Chromophobe part of large mitochondrion formed by coalescence of several individual bodies. *X.G.* and *X.M.* Excretory grains (?).

PLATE 23 (*Smerinthus populi*).

With the exception of fig. 3, all figures drawn from material preserved in Champy and stained in iron hæmatoxylin. Drawn with camera lucida, at table level, with $\frac{1}{12}$ th oil immersion lens by Koristka and 12 compensating eyepiece. Magnification now 2250.

Fig. 1.—Primary spermatogonium showing mitochondria (*M.D.*), applied to nuclear membrane. The centrosome, and what is probably the micromitosome (*M.*), lie near.

Fig. 2.—Spermatogonial metaphase from side. On the left are the mitochondria and on the right are two equal-sized bodies which are the micromitosomata. The side of the cell drawn in more thickly is the morula-wall.

Fig. 3.—Spermatogonial anaphase from Flemming with reduced acetic acid fixation. On right is in the lower cell a micromitosome and on left are mitochondria, and in the upper cell the other micromitosome. Between the cell are three small thickenings forming an equatorial plate.

Fig. 4.—Contraction figure stage showing micromitosome (*M.*), centrosome (*C.*), mitochondria (*M.D.*), and the "reste fusorial," or spindle bridge (*S.B.*).

Fig. 5.—Young spermatocyte in growth stage showing mitochondrial cloud, micromitosome, and centrosome which has come to surface of the cell.

Fig. 6.—Later stage, showing mitochondria, micromitosome, and centrosome which has divided and from which four flagella begin to appear. Cell processes (*C.P.*) appear.

Fig. 7.—Spermatocyte with mitochondria better defined, centrosomes separated, and filaments longer. In some parts (*M.D.Y.*) the mitochondria are larger than in others (*M.D.X.*).

Fig. 8.—Almost at end of growth-period, showing well-defined mitochondria forming a crust around the nucleus. Micromitosome near top of figure. Acroblasts (*A.B.*) with concave surfaces to nucleus.

Fig. 9.—First maturation division showing arrangement of mitochondria. Micromitosomata near centrosomes. Acroblasts near poles of spindle.

Fig. 10.—First maturation anaphase, showing micromitosomata (*M.*), equatorial plate thickenings (*E.P.*), and mitochondria. Right centrosome dividing. Acroblasts orientated in the characteristic manner.

Fig. 11.—Equatorial view of first maturation division spindle showing precocious running together of mitochondria (*V.*) and the twenty-eight chromosomes.

Fig. 12.—Spermatid just after second maturation division, showing mitochondria, micromitosome (*M.*) and centrosome, which is just dividing. One centrosome keeps its connection with the axial filament. At *A.B.* are several acroblasts.

Fig. 13.—Spermatid at a little later stage; only one centrosome and five acroblasts could be found.

Fig. 14.—Spermatid showing the incipient formation of the micromitosome (*nebenkern*); on the right a continuous chord is already

formed, while on the left the mitochondria are still separate. At *A.B.* are two acroblasts.

Fig. 15.—Spermatid, with centrosomes, micromitosome, macromitosome, acroblasts, and nucleus. At *X.X.* the mitochondria have not yet completely run together, and there is no true spireme in the macromitosome. The nucleus lies towards the lumen of the spermatid group, and will have to travel around as it is doing in the next figure.

Fig. 16.—Same stage as fig. 15, only the nucleus is nearer its goal. The acroblasts are nearly spherical.

Fig. 17.—Nucleus in its definitive position. Centrosomes marked *C*¹ and *C*², the latter now having passed towards the tail, not having a definite connection with the axial filament. The acroblasts are pressed, in part, between macromitosome and nucleus. Micromitosome at *M.* The outline of the neighbouring spermatozoa is drawn at *X.Y.* One acroblast has formed the acrosomic granule.

PLATE 24.

Figs. 18, 20, 21, 25, 26, and 28 drawn at the same magnification as in Pl. I. Fig. 29 is drawn to the same scale, but has been reduced by one half. All these figures are of *S. populi*. Figs. 19, 22, 23, 24, and 27, drawn at table level with camera lucida and with a $\frac{1}{15}$ th Koristka semi-apochromatic oil immersion and compensating eyepiece 18. Magnification, 4250.

Fig. 18.—Spermatocyte of *Smerinthus populi* preserved overnight in strong Flemming, to show effect of the acetic acid. Nuclear matter has become resolved into chromosomes. The micromitosome (*M.*) is much swollen and is apparently about to divide; the amphister in is process of formation. (Compare with fig. 8, Pl. 1.)

Fig. 19.—*Spilosoma lubricipeda* preserved in strong Flemming without acetic acid. Spermatocyte near end of growth-period, from an "apyrene" group. The filaments terminate in the large clavate organ (*C.O.*).

Fig. 20.—Spermatozoon of *S. populi* well advanced in metamorphosis. Shows acrosome and granule (*A.G.*).

Fig. 21.—Metaphase of spermatogonial division in *S. populi*, showing mitochondria (*M.D.*) a micromitosome (*M.*), and the persistent nuclear membrane.

Fig. 22.—Spermatocyte of *Pieris brassicæ* at end of growth-period, showing various cell details.

Fig. 23.—Young spermatozoon of *Orgyia antiqua* (Flemming with reduced acetic acid).

Fig. 24.—Spermatocyte of *Orgyia* at end of growth-period to show mitochondria and other cell inclusions (Flemming with reduced acetic acid).

Fig. 25.—Three oocytes of *S. populi* in contraction figure stage, showing micromitosome (*M.*), spindle bridge (*S.B.*), centrosome (*C.*), and mitochondria (*M.D.*). Drawn to same scale as the spermatocyte in Pl. 23, fig. 4 (Champy).

Fig. 26.—Oogonium before contraction stage showing spindle bridge in transverse section, surrounded by mitochondrial cloud. Micromitosome (*M.*) near the upper end of the cell (Champy).

Fig. 27.—First spermatocyte division of *Orgyia antiqua* showing spindle granules (*S.G.*) and other cell structures (Flemming with reduced acetic acid).

Fig. 28.—Oogonium of *S. populi* with spindle bridge in longitudinal section. Shows also, micromitosome (*M.*), mitochondria (*M.D.*), and two centrosomes (Champy).

Fig. 29.—Oocyte of *S. populi* showing appearance of cell inclusions at later stage.

PLATE 25.

[All figures on left side of Plate 25 are drawn at table level with camera lucida, with a $\frac{1}{15}$ th Koritska semi-apochromatic oil immersion lens and compensating eye-piece 18, and in reproduction reduced by one half. In all these figures the mitochondria have been blackened in order to show them more clearly. On the right side of the Plate, figs. 43, 45, 46, 48, 49, 52, 53, 54, and 55, are at same magnification. Figs. 44, 47, 50, and 51 are twice the magnification.]

Fig. 30.—Binucleate spermatocyte near end of growth stage. It contains two micromitosomata, and has an accessory centrosome near the top of the plate. The acroblasts are also shown.

Fig. 31.—Spermatocyte to show appearance of mitochondria caused probably by fixative. The central bodies have run together to form rods.

Fig. 32.—Spermatocyte in first maturation division showing mitochondria and acroblasts.

Fig. 33.—Section through X.—X. in previous figure.

Fig. 34.—Second maturation division showing mitochondria and acroblasts.

Fig. 35.—Young spermatid, showing incipient formation of macromitosome. Acroblasts becoming spherical.

Figs. 36, 37, 38, and 39, later stages in formation of macromitosome, and acroblasts are shown.

Figs. 40, 41, and 42, show macromitosomatic spireme, and acrosome formation.

Fig. 43.—Abnormal triaster mitosis showing disposition of mitochondria and acroblasts.

Fig. 44.—Outgrowth of flagellar organ in *Pieris brassicæ*. At X, is a body whose significance has not been worked out. It may be formed by the conglomerated acroblasts, or the remains of the spindle bridge.

Fig. 45.—Three young oocytes of *Euchelia* showing the cytoplasmic bodies.

Fig 46.—Spermatogonial nests of *Euchelia* showing spindle bridge and mitochondria.

Fig. 47.—Head of sperm just after acrosome is formed. *A.G.* Acrosomic granule.

Fig. 48.—Prophase of first maturation division in *S. populi* showing undoubted effect of spindle fibres on the mitochondria and acroblasts.

Fig. 49.—From a Regaud smear showing the staining effect with iron hæmatoxylin in the first maturation division (compare with fig. 32).

Fig. 50.—Detailed drawing of clavate flagellar organ of *Pieris*.

Fig. 51.—An earlier stage than fig. 47 to show several acroblasts secreting the granule. In fig. 47 these have fused.

Figs. 52 and 53.—Two abnormal spermatid stages, showing peculiarities in the micromitosome.

Figs. 54 and 55.—Regaud smear preparations of the metamorphosing spermatid. Nucleus dotted in, though it did not stain.

EXPLANATION OF TEXT-FIGURE 3.

(See p. 440.)

Figs. 1 to 9 illustrate diagrammatically the behaviour of all the plasmatic elements found in Lepidopterous spermatogenesis. The acroblasts (*AB*) can be followed through cell division to the spermatid (Fig. 3); later they become vesicular (Figs. 4 and 5), and finally fuse to form the bladder-like body which forms the acrosomic granule. The mitochondria in Figs. 3 and 4 fuse to form the macromitosomal spireme (*MD*). The division of the centrosome (Fig. 4) and the partial revolution of the sperm head are also illustrated. The apparent fragmentation of the mitochondrial spireme in Figs. 8 and 9 may be an artefact.

**The Degenerate (Apyrene) Sperm-formation of
Moths as an Index to the Inter-relationship
of the Various Bodies of the
Spermatozoon.**

By

J. Bronté Gatenby, B.A.,

Exhibitioner of Jesus College, Oxford.

With Plate 26.

INTRODUCTORY.

IN late years much attention has been given to certain atypical spermatozoa in some insects and molluscs. On the latter especially a good many papers have appeared, and there has been much conjecture as to the function (if any) of these curious bodies.

In some molluscs (*Strombus*, Reinke (1)) the atypical sperm is a most remarkable object, and many times larger than the typical sperm.

The atypical spermatozoa have been called "apyrene" and "oligopyrene" according as to whether they were thought to contain no, or little, nuclear matter.

That in insects, and this applies to the Lepidoptera, an atypic sperm so remarkably different from the typic as is the case in many molluscs, is ever found is extremely doubtful. But it is noteworthy that in such widely different forms as Lepidoptera and Prosobranch Mollusca, an analogous dimorphism should occur. We are tempted to inquire what in common have the conditions of these forms, and why, if these apyrene spermatozoa serve a special purpose, should nearly identical conditions arise under such widely different

environments. In the Holometabola, we get remarkably varying stages of life history, for which assuredly we would look in vain in *Murex* or *Tritonium*, and, while admitting that in many Prosobranchs the case is so remarkable as to permit speculation and theory, I feel that in the Lepidoptera we cannot attach any importance to the atypical spermatozoa other than that of a degeneration product.

The special purpose of this paper is an inquiry into these degeneration products in moths and butterflies, but the apyrene sperm of the mollusc has formed the subject of a note.

I have to thank Dr. Goodrich for his kind interest and criticism. This work was carried out in the Department of Physiology, and in this connection my best thanks are due to Prof. Sherrington.

PREVIOUS WORK.

Meves (2) alone has given a good account of these atypic spermatozoa of moths. But the atypic sperms described by him (*Pygæra*) are not the only kind of apyrene formation of moths, and it has been the purpose of this paper to point out that it would be a mistake to think that apyrenes arose exclusively from the time of formation of karyomerites as seems to occur in some molluscs (1).

Quite recently H. Federley¹ (3) has reported upon the spermatogenesis of *Pygæra anachoreta*, *P. civitula*, and *P. pigra*, and has been able to describe as much as his Carnoy technique would allow. Needless to say this fixative has spoilt all cytoplasmic details except the amphiaser, and his results from the point of view of this present paper have been less successful than those of Meves. Federley has given a completely satisfactory account of the apyrene maturation divisions in so far as the behaviour of the chromosomes is concerned. This observer also gives an account of the chromosomes of the hybrids of the above species of *Pygæra*, which he has worked out well.

¹ For the loan of this paper I am indebted to Dr. J. W. Heslop Harrison.

Meves worked upon *Pygæra bucephala*, and has given a correct account of every stage, except that he has failed to note the behaviour of mitochondria in spireme formation, of the acrosome and of the centrosome. These important stages are considered in the present paper, and the material used has proved more favourable than *Pygæra*.

In the Metazoa most of the latest work has shown that the spermatid about to become a spermatozoon contains the following bodies: Nucleus, centrosome (or centrosomes), mitochondria, acroblast, and one or two basophil or siderophil bodies besides. The latter, which might have some special significance, are not dealt with here.

The special purpose of this paper is to attempt to analyse the inter-relationship of the first four bodies in the spermatid. We know that in spermiogenesis, and by this term I mean the stages from spermatid onwards, the nucleus, centrosome, acroblast, and mitochondria undergo a number of definite movements and changes which finally culminate in the production of that remarkable cell, the spermatozoon. In moths, and may be in many other forms, degenerate stages of spermatogenesis occur, and it has been by observing these stages in the former that I have attempted to come to some conclusion concerning the various functions and the various influences which together go to produce the sperm. If, in some cases, my conclusions be not clear, it is because I have found great difficulty in identifying the special cell element which might be a centre of influence for another cell body, but it will be seen that the evidence provided permits one to make tentative statements.

The technique employed was similar to that used in my previous paper (4). *Smerinthus populi* and *Pieris brassicæ* were most satisfactory forms upon which to work; in addition *Pygæra bucephala* and *Porthesia similis* were examined. The character of the apyrene or degenerate sperm-formation was found to be somewhat different in different species. Thus in my Pierid material almost, if not invariably, degeneration, or the occurrences leading to the

formation of an apyrene sperm, began after the establishment of the spermatid nucleus. In *Pygæra* the second maturation chromosomes failed to fuse at all in most cases, while, on the other hand, a transition between *Pygæra* and *Pieris* was provided by *Smerinthus* where several nuclei became formed in the spermatid from a number of successfully fused chromosomes.

The Nucleus in the Degenerate Stages.

In Pl. 26, fig. 4, is drawn a fairly typical second maturation division of the degenerate type which will lead on to the abnormal sperm. The two cells are almost constricted from each other, but the chromosomes (*C.H.*) are straggling, as if the centrosome and astral rays lacked the energy to finish anaphase and telophase. The mitochondria are normally constricting. The acroblasts are not quite normal, but are in the usual position in which they are found. The micro-mitosomata are normal. Now this figure is typical of many maturation divisions; it shows what most other degenerate stages do—that the disintegratory process seems traceable at first to the chromatin. It is almost, if not quite invariably the nucleus which, in the abnormal growing spermatocyte, shows signs of degeneration, and it is the nucleus in other stages (Pl. 26, figs. 6, 8, 10, etc.) which is the first cell element to fail. Inspection of Pl. 26, fig. 4, might lead one to believe that the centrosome is at fault, but this seems negatived when one remembers that in later stages the centrosome still has the energy to keep its position at the head of the cell, to undergo some normal changes, to form the axial filament as usual, and finally to enter into its normal relations with the mitochondrial spireme. This, at least, points to the fact that one must be careful in imputing this abnormal telophase to the amphiastral rays. In the telophase of normal mitosis the chromosomes fuse, and afterwards a new nucleus is formed. In these abnormal stages this process rarely takes place in the usual manner. The chromosomes either do not

fuse at all, or only a limited number fuse. These latter, as well as the isolated single chromosomes, endeavour to form new nuclei, and one gets the sort of cell drawn in Pl. 26, figs. 1, 2, and 6. Pl. 26, fig. 2, is quite typical. There were in the field seven abnormal nuclei, none of which had succeeded in forming a proper reticulum. In Pl. 26, fig. 6, there were some five nuclei, the two bottom ones of which were normal in appearance. In Pl. 26, fig. 1, the truth of these remarks is also illustrated; some nuclei were apparently normal, though smaller; others were abnormal. Degeneration of the nucleus takes place at every stage of spermiogenesis. Even when the nucleus of the spermatid is apparently normally formed, it may in some other way show that it is not properly functional. Pl. 26, figs. 3, 7, 8, 10, and 11, show degenerate stages in which the nucleus, though seemingly normal, fails to become attached to the centrosome, and drifts down the growing sperm. The centrosome keeps its position. In Pl. 26, fig. 13, the several nuclei formed from the number of chromosomes which failed to join up all together have undergone the usual staining change which takes place at this period, but only one nucleus has managed to keep its position at the head of the cell. In Pl. 26, fig. 12, the very darkly staining nucleus has drifted down the sperm, and has attached to it a small acrosomic granule (*G.*), which does not seem to be quite normal. In Pl. 26, fig. 9, the nuclei are normally reconstituted, but, judged from the progress of the acrosome, are late in reaching this stage. All the nuclei in this nest were unable to keep their positions at the head of the cells. The section is somewhat oblique.

With regard to the formation of the nuclei from single or fused chromosomes, every conceivable stage can be found, especially in *Smerinthus* and *Pygæra*, where failure to form a proper spermatid nucleus is common; this also applies to *Spilosoma*, but in *Pieris brassicæ* failure generally comes at the stage when the spermatid nucleus should adhere to the centrosome (Pl. 26, figs. 10 and 11, etc.). Pl. 26, fig. 13, shows what often occurs in *Smerinthus* and *Pygæra*.

A very important point to notice is that degeneration of the nucleus may occur at any stage, but in some species it tends to take place at certain special stages. It should be mentioned that in different bundles the individual spermatids all tend to reach the same stage of development, degeneration appearing at one and the same time throughout. Some spermatozoa get further than others in development, and apparent arrival at the last step of sperm-formation does not necessarily mean that the canker of degeneration may not appear later when the sperm has entered the egg. Thus development might be initiated by such spermatozoa without the male nucleus being able to fuse. But I do not believe that the so-called "apyrene" sperm could enter the egg, though the suggested effect of an "apyrene" sperm might be got by degeneration overtaking a normally constituted spermatozoon at some stage in fertilisation. If a spermatozoon entered an egg, if its nucleus began to lag, as it often does in spermiogenesis, and if the centrosome acted normally, one might possibly get development initiated, and there is no doubt that every sperm from the same bundle would act likewise. There is nothing illogical in the thought that if degeneration can overtake the sperm at any stage of spermatogenesis, it could also overtake it at any stage in fertilisation.

In Pl. 26, fig. 14, I have drawn a degeneration stage in *Pygæra bucephala*. The nuclei have shrunken into darkly staining lumps, as is usually the case when any nucleus degenerates completely. Even after this stage a partial elongation of the cell may take place.

The Mitochondria.

In my previous paper I stated that it was impossible to make out the relationship of the macromitosomal spireme (nebenkern) and the centrosome. By means of degenerate stages such as those drawn in Pl. 26, figs. 3 and 11, it is clear that the macromitosome consists of a spireme, the front free end of which is attached to the centrosome. The abnormal

sagging of the macromitosome has caused the method of fixation to the centrosome to be revealed, though how the other end of the spireme is attached I do not know. In the normal spermatid the stage drawn in Pl. 26, fig. 6, gradually passes to the stage of a tangled spireme (Pl. 26, fig. 2, etc.). Now when the spermatid begins to elongate, the attached front end of the spireme remains in its position, and the rest of the mitochondrial matter becomes "let out" or "played out" as the elongation takes place. This process has taken place normally from *C.* to *Y.* in Pl. 26, fig. 12, but somehow or other the spireme subsequently became apparently refractory (*M.*), and was left in this position, while the lower part (*Z.*) made an endeavour to form normally as the elongation went on. In Pl. 26, fig. 5, another sort of abnormal formation is shown: here the macromitosome, instead of pulling out in a smooth, even manner, came out in lumps (*M.¹-M.⁶*). In Pl. 26, fig. 3, the spireme is losing its position en masse. It seems that the retention of the spireme in its place, or at least its completely normal elongation, rarely takes place after the failure of the nucleus to act properly. This may be due to the general abnormal condition in the cell.

The Acroblast and Acrosome.

This body can almost invariably be found in the early spermatid, and in those cases where its presence cannot be ascertained until sperm-formation is well advanced, special refinements of technique may succeed in demonstrating it early. In the case of the snail I have experienced unusual difficulty in studying this body. I have found that bichromate of potash is extremely favourable for fixing the acrosome, and osmic-bichromate fixatives are indicated in this section of spermatogenesis studies. For instance, by smearing the ovotestis of *Helix* on a slide, momentarily fixing in osmic acid fumes, and then, after allowing the film to dry partially, dipping into a 2 to 5 per cent. bichromate of potash solution, an extremely intense stain of the acrosome is got if the slide is soaked long enough in the bichromate solution. My work

has not yet been carried out far enough to allow me to attack with any complete surety the view that the acrosome is derived either partly or wholly from the sphere or archoplasm, but I confess that I consider this suggestion improbable; not only because I cannot allow that the observers who espouse this view have shown clearly that such is the case, but also because the fixatives most favourable, or at least favourable enough to demonstrate archoplasm, at the same time uniformly unfavourable to acroblastic material. One result of this study of the atypical spermatozoon has been the confirmation of a suggestion advanced by me in a previous paper (4), that the acroblasts in later stages are influenced by the nuclear matter alone.

Figures have already been given to show that in the maturation divisions the acroblasts of Lepidoptera are orientated in a remarkable and special manner in relation to the chromatin, and it has been shown that this relationship is rarely departed from; a review of some of the best work on the plasmatic structures in other orders leads me to conclude that, just as in moths and butterflies, the acrosomic material is definitely and undoubtedly subservient to the nucleus at almost all stages. The acroblast (or acroblasts) is almost always found to lie in the cytoplasm in the neighbourhood of the nucleus, and sooner or later takes up its position upon the surface of the latter. Now, a very important question to solve was whether this special orientation of the acroblast upon the surface of the nucleus could be brought about by the instrumentality of any body other than the latter.

Meves, in his work on the "apyrene" spermatozoa of moths, completely overlooked the acroblasts, and my own work on the same species as he used leads me to believe that *Pygæra bucephala*¹ is not good material for this study. Pierids and Smerinthids are very favourable. It is known that in the so-called "apyrene" or atypic spermatozoon the nuclear matter fails to act normally and gradually becomes carried down

¹ I have since ascertained that in *P. bucephala* the acroblasts are difficult to discover because they so closely resemble mitochondria in size and shape.

the body of the lengthening sperm. The chromatin is thus removed from what is the head end of the spermatozoon; now, in the normal sperm the head end is formed by the acrosome. In the atypic sperm the centrosome forms the head end, and a very remarkable fact is that the acroblasts in the Lepidopterous apyrene sperm follow the chromatin down in its path along the lengthening spermatozoon. In Pl. 26, figs. 3, 5, 7, 8, 11, 12, and 13, this is shown. If the centrosome needs to be fairly near the body it influences, we would be justified in assuming that the central corpuscle does not influence the acroblasts, for they lie a considerable distance from this body. Reference to my previous paper will show that the acroblasts of moths keep close to the spermatid nucleus, and after approaching one side of the latter, fuse. The fused or partially united acroblasts secrete a granule which lengthens to form the acrosome. These events happen synchronously with the special changes in the nucleus which leads to the formation of the elongated, apparently solid, sperm nucleus; thus by the time the nucleus is elongated, the acrosome is also elongated and pointed. It has already been shown that the chromosomes in failing normally to come together to form the spermatid nucleus, often tend to form several nuclei of small and varying size. The nuclei fail to retain their position at the sperm head and drift downwards. The acroblasts almost invariably follow at the same time, and also tend to apply themselves upon the chromatic matter as they do in normal spermatogenesis. We then come to realise that though the chromosomes lack that power which normally allows them to reunite to form the spermatid nucleus, nevertheless they still are able to influence the acroblasts. Moreover, one often discovers a spermatid in which one small nucleus, probably formed from one chromosome, can be seen shepherding several acroblasts which are stuck on its surface. In these cases I do not think that a normal acrosome is found in later stages. That this attendance of the acroblasts upon the partially regenerated nuclei is not accidental, and caused by the fact that any bodies tend to become cast down the

length of the sperm together, is shown by the fact that one cannot find many straggling acroblasts (see Pl. 26, fig. 10), and that the latter are able to form an acrosome upon the surface of the larger nuclei in later stages of degeneration. Even in normal stages the steps which lead to the formation of the acrosome from the acroblasts are never exactly synchronous in a sperm nest, but they rarely vary beyond certain limits. In the spermatocyte and spermatid the acroblasts are semilunar in shape in normal stages, and this shape gives way to a vesicular one. Now the acroblasts in abnormal spermatids quite often show a tendency to shrink and become darkly staining at a stage when in normal cells the acrosomic granule is being secreted, and since these darker acroblasts are often found removed from the nuclei, it might be possible to assume that the changes leading to the formation of the acrosome are not wholly dependent upon the nucleus. This seems to be supported by the fact that the acroblasts, when not in the immediate neighbourhood of the nucleus, may be found even in normal stages of different degrees of metamorphosis towards acrosome. Another significant fact is supplied by Pl. 26, fig. 9, which shows a part of an abnormal spermatozoon-nest in which the nuclei, though normally reconstituted after the second maturation division, have failed to keep their position in the cell (see also Pl. 26, figs. 3, 5, 7, 8, 10, 11, and 12), but on drifting down have been followed by the acroblasts, which have formed complete acrosomes. The latter (A.) are normal in every degree, but the nucleus has failed to develop synchronously, and the curious condition is got of one element racing another in metamorphosis. The fact to be noted at present is that the acrosome can be formed without the synchronous steps in the nucleus. The sharp acrosome in Pl. 26, fig. 9, belongs to a stage when the nucleus is also elongated and when it has regained its affinity for nuclear stains. If the metamorphosis of the acroblasts depended absolutely upon the nucleus one would get these bodies still vesicular and just about to apply themselves to the nucleus, but instead they are now fully formed. I would interpret Pl. 26, fig. 9, as follows :

The nucleus lacked the requisite force to place itself at the head of the sperm, but retained its relationship to the acroblasts, which fused, secreted the acrosome, and gave rise to a normal structure. But that missing power, whatever it may be, still was wanting in the nucleus, and evinced itself by causing a lagging in the proper formation of the elongate sperm nucleus. This lagging, be it marked, did not affect the acrosome, which became normally formed, and so the condition in Pl. 26, fig. 9, was reached. In Pl. 26, fig. 13, each of the four nuclei is attended by a small round granule (*G.*), which is probably an acrosome, but in the cell normal acroblasts (*A.*) were still present. In Pl. 26, fig. 12, the nucleus had a granule applied upon its surface (*G.*). It is probable that if this body arises from an acroblast it is abnormal, for I have not found like stages in normal nests; in normal stages such a granule would be surrounded by semi-lunar acroblastic ring (see figures in previous paper). The question of the attachment of the acrosome upon the nucleus may now be dealt with; in the snail I find that the acrosome is embedded in the nucleus in a wedge-like manner. In some other forms, as, for instance, in the rat (after Duesberg (5)), the acrosome is plastered upon one side of the nucleus. In some other Mammalia the acrosome seems to be fixed straight across the square head of the nucleus. In fact, almost every conceivable manner of joining between these two elements can be found.

My study of Lepidopterous spermatozoa leads me to believe that the acrosome is sensitive to some influence which orientates it. Pl. 26, fig. 9, shows that each acrosome, though it has no normal nucleus to fix upon, is sensibly orientated towards the sertoli-cell or upper end of the sperm-nest. It is quite probable that the front end of this acrosome in Pl. 26, fig. 9, represents what would be the front end of the acrosome in the normal sperm. Now the acrosomes in Pl. 26, fig. 9, are not all resting upon the nucleus, and the same applies to Pl. 26, fig. 15, in which the arrow denotes the head or front end of the nest. In

Pl. 26, fig. 13, the granule (*G.*) if really an acrosome is not orientated towards the front of the nest, but in the greater number of cases in all abnormal stages the acrosome keeps towards the front end of the cell. What cell element causes this sensible orientation? Is it centrosome or nucleus? That it is not the former might be concluded from the history of the normal sperm where the centrosome is at the back of the nucleus, and in a position which one might be justified in presuming, unable to affect the acrosome. The facts of the influence of the acroblasts upon the nucleus, and of their very apparent inter-relationship leads me to believe that the nucleus might have something to do with this orientation of the acrosome in the direction of the head end, though more probably the whole question should be considered in relation with the growth of all the elongating spermatozoa in one direction, which is a fact which has already attracted attention. In the worm (*Lumbricus*) the spermatozoa grow outwards in a beautifully regular manner to form a ball, and here there is no sperm nest-wall. In several abnormal bundles of moth spermatozoa I have found that this growing outwards in a common direction by all spermatozoa is not completely perfect. In the testis the bundles of normal spermatozoa are cut across in all directions showing that this growing out of all tails in one way is a matter concerning individual bundles. I have not examined the part played by the sertoli or nurse-cells with sufficient completeness to give even a tentative statement, but I believe that this cell may be intimately concerned in the orientation of sperm and sperm elements.

The partial isolation of the acrosome from the nucleus in abnormal stages shows that the element which causes the adherence of one body upon the other is here lacking or inefficient. Just as the nucleus is often unable to adhere to the head centrosome, or vice versá, so the acrosome sometimes may lie quite near, quite completely formed, but lacking the power to become adherent. The manner by

which the fusion of acrosome and nucleus is brought about is difficult to understand. Whether it is caused by some intermediate body, or by mechanical means can only be ascertained with a very small degree of probability, but my work on the snail and other forms leads me to believe that even if adherence is brought about by some intermediate substance, the efficiency of this latter substance is improved by either the fixation of the acrosome upon the nucleus, like the ferrule of a walking-stick, or by the wedge-like embedding of the acrosome into a cavity in front of the nucleus (*Helix*). One is led to conclude that in the moth it is only after or when the nucleus of the sperm has become elongated that complete fusion with the acrosome becomes established. Pl. 26, fig. 9 seems to show that this fusion depends on the nucleus and not on the acrosome.

The Centrosome.

In the normal stages of spermatogenesis, the centrosome from which the axial filament grows, becomes applied to one side of the nucleus and in most forms becomes modified in some special manner. It may become flattened upon the nucleus, or squared off as in some mammals. In some cases it may not appear to have actual physical continuity with the nucleus. In *Lepidoptera* the centrosome becomes cushion-shaped upon the nucleus and as the latter elongates, the central corpuscle also becomes drawn out slightly. In those cases where the nucleus fails to become fixed upon the centrosome, the latter eventually forms the head of the sperm (Pl. 26, figs. 5 and 12.) As far as I can ascertain from my sections the centrosome loses its spherical shape (see Pl. 26, fig. 2) and becomes elongate as in Pl. 26, figs. 7 and 8. Meves' figures of abnormal stages support this view. One concludes from this that the centrosome per se, goes on with its slight changes even though the nucleus has drifted aside. This is in accordance with what happens in other cell elements, which appear to go on developing with at least partial independence. It is well to notice that after the

failure of the nucleus in the metamorphosis of the cell elements of the spermatid the centrosome invariably retains all the energy necessary to undergo its normal changes. One is forced to believe that the central corpuscle of all the plasmatic elements is the most resistant to those influences which cause abnormality, and this should be borne in mind in the discussions relative to any possible part played by "apyrene" spermatozoa.

DISCUSSION.

The main fact which we must keep before us in a review of the evidence provided by these abnormal stages is that it would be unwise to conclude, because one body is somewhat far removed from another, that mutual influence is so precluded. Because the centrosome lies at the head of the atypical sperm, and the abnormal nuclei and their acroblasts far down, we are not justified in at once dismissing any possibility of the one affecting the other. Nevertheless I feel that we can conclude a good deal from such evidence as we have at hand, though some suggestions must only be very tentative. I have already shown that though the nuclear matter is abnormally affected, still the acrosome may be formed, and in the same way a normal macromitosome may be developed from the granules. The tail of the sperm may be normally formed by a thinning out and elongating of the macromitosome, and otherwise, excepting the chromatin, the cell elements may be quite normal. I believe that this shows that we are concerned with two special occurrences in spermatogenesis: Firstly, the formation of the acrosome near the nucleus, and the evident inter-relationship of these bodies; and secondly, the growth of the tail filament, and the special grouping of, or formation of, an envelope from the mitochondrial granules. These two separate occurrences appear to be able to take place with independence of each other, and I think the two apparent free forces in the spermatid are respectively lodged in the nucleus and in the centrosome

The final linking up of all the occurrences in the sperm-cell and their proper consummation depends on the correct attraction between centrosome and nucleus at the time when the various cell elements become formed up in line preparatory to the elongation of the spermatid.

The growth of the sperm tail in length depends, I believe, absolutely on the head centrosome. Now the centrosome also is intimately connected with the macromitosome (nebenkern of some authors), at least in the later stages, when the elongation is taking place, and in the moths the centrosome is certainly connected with one end of the mitochondrial spireme. Yet we know quite well that in cellular division the astral rays are certainly not connected with either single mitochondria or groups of mitochondria. It therefore seems that a new relationship betwixt centrosome and mitochondria is brought about in later stages of sperm-formation. The curious and definite groupings of mitochondria around the filament in such a case as *Enteroxenos* might possibly be otherwise accounted for, but I believe the centrosome to be mainly responsible. The acroblast also offers curiously contradictory evidence; it undoubtedly (in moths, at least) becomes definitely oriented towards the nucleus in several stages of spermatogenesis, and yet in mitosis it keeps apparently completely within the zone of the astral rays, near the centrosomes. From the maturation divisions and subsequent spermiogenesis I conclude that the following inter-relationships could be demonstrated between—

- (1) Nucleus and acroblasts.
- (2) Acroblasts and centrosomes (in cell division alone).
- (3) Mitochondria and centrosome only in later stages (after spireme formation).
- (4) Centrosome and nucleus (not chromosomes) only in later stages, when both bodies become adherent one to the other. (I do not here refer to division of the cell.)

The question of the relationship of mitochondria to other cell elements in cell division I believe to be settled by some stages, especially in the prophases, where in moths the seed-

like mitochondria tend to become fused fan-wise from the zone of influence of the centrosome. It is nevertheless quite true that the mitochondria, though often so affected, almost invariably in later stages keep well outside the amphiaster. This seems to show, as well as much other such evidence does, that the mitochondrial granules are not absolutely equally, but only approximately equally divided. It is quite certain that the mitochondria are never divided in such a correct manner as the chromosomes.¹ Some stages given by me elsewhere show that this approximately even division of the mitochondria may be departed from, resulting in a very perceptibly uneven distribution. Even if the suggestion of two special capital centres of force in the spermatid be not completely substantiated, it is quite certain that spermiogenesis is the sum result of the separate workings of a number of forces, and these latter, when not working in unison, produce abnormal spermatozoa. The curious spermatogenesis of some hybrids might be traced to a want of unison in the arrangement of the elements provided by both sides. It has been suggested that the growth of the sperm-tail depends upon the head centrosome. Whether this applies to the alteration of shape in the nucleus and acrosome is, indeed, difficult to say. The nucleus, after losing its place at the sperm-head, is still able to become elongate, and the same remark applies to the acrosome.

The main conclusion is that even though certain cell elements in spermatogenesis become degenerate, others may be able to go further on with apparent semi-independence, and may even become normally formed.

The Degenerate Spermatozoon as a Probable Special Sex Determinant.

Hertwig (6) suggested that the "apyrene" spermatozoon might by fertilising an egg produce offspring of a different sex from an egg fertilised by a "eupyrene" sperm. Other

¹ See, however, E. B. Wilson on *Centrurus*, 'Nat. Acad. Sciences,' vol. 2, June, 1916.

authors have already pointed out that it has not satisfactorily been shown that the "apyrene" is able to enter the egg. The view taken in this paper is that the atypic sperm, in moths at least, has no special significance beyond the fact that it originates from a state of degeneration. I have shown in the figures in this article that almost every conceivable stage in degeneration from spermatocyte onwards can be found in lepidopterous spermatogenesis, and even if there appears to be a special, true "apyrene" sperm, which I doubt, this is because it is at one special stage that degeneration is most prone to appear. I have already pointed out (4) that degeneration cannot be due to a starved condition of the larval or pupal moth or butterfly, but exactly why degeneration should appear at all I cannot say. Nevertheless I consider it certain that the appearance of "apyrene and oligopyrene" spermatozoa is directly traceable to the same forces which cause a whole nest of primary or secondary spermatogonia to undergo degeneration. Even if subsequent research should show that fertilisation by an atypic sperm is possible, this cannot show that the latter has a special significance from the sex point of view, though it would introduce an element of very strong probability. I have already remarked, in the section dealing with the nucleus, that a sperm might be overtaken by degeneration after it had entered the egg. This matter will easily be settled by a cytological examination of enough fertilisation stages, together with a comparison between the expected and the true sex ratios in breeding experiments.

The "Apyrene" Spermatozoon of the Moths and of the Molluscs.

Among later workers on the atypical spermatogenesis of Mollusca there is a clear consensus of opinion that the "apyrene" sperm could not fertilise the egg, and this seems completely substantiated by Reinke's (1) inability to find anything but eupyrenes in the receptaculum seminis of *Strombus*.

Goldschmidt (7) advances the view that the "apyrene"

spermatozoa of moths are reaction products, probably caused by the changes in the chemical properties of the hæmolymp during metamorphosis. He says: "In the case of *Samia* it is easy to observe, without going into chemical details, that the blood in old pupæ, which produce the atypical spermatozoa, has very different properties from those in the young." It must be admitted that there may probably be some truth in this plausible explanation; but, while believing that "apyrene" spermatozoa may be caused by some subtle alteration in the hæmolymp, it is well at present to accept Goldschmidt's explanation with caution, and for the following reasons:

(1) In different larvæ and pupæ of moths and butterflies, though individuals may be sub-equal in size, the development of the spermatozoa may have reached much later stages in one than in another example. No rigid synchronism here holds good.

(2) In some forms like *Spilosoma*, all sperm-formation is finished by the time the larva is full grown. In other forms which appear at the same time and have the same sort of life cycle, sperm-formation takes place mainly in pupæ.

(3) Apyrene spermatozoa may be the first kind to reach development in the testes. Eupyrenes may only appear much later.

(4) Apyrenes and eupyrenes may be found developing side by side at what appears to be the same stage.

(5) Apyrenes appear in Molluscs where the suggestion of altered conditions of a blood fluid would not seem to apply, and where no metamorphoses takes place.

With regard to the statement in paragraph three, the following is my experiment: A number of *Pygæra bucephala* larvæ pupated in September. The testes then contained only spermatogonia and spermatocytes not quite grown to their full size. The pupæ were kept in the warm laboratory, and near the end of October it was found that the testes contained several bundles of spermatozoa and spermatids, all of which were abnormal or apyrene. About Christmas the

testes were found full of bundles of both sorts, apyrene and the normal or eupyrene metamorphosing side by side. According to Goldschmidt, I suppose the explanation of this would be that the hæmolymp in early stages favoured the formation of apyrenes, but that later in histolysis the fluid of the body became adjusted suitably for eupyrenes. Whether this explanation can be held good might be proven directly by injecting some chemical substances into the pupa, and by altering the hæmolymp provide an easy basis for comparison with what occurs in the control pupæ.

In molluscs it seems that in such a case as *Paludina*, atypic spermatozoa arise from ordinary spermatids, but in *Strombus* Reinke traces the apyrenes from special cells not to be identified as normal spermatogonia. How could Goldschmidt's explanation apply to either case in molluscs? I believe the example of the moth testis, where both sorts of spermatogenesis goes on side by side is distinctly comparable to that of the molluscs. Why does not the chemical unsuitability of the hæmolymp apply alike to all spermatid bundles?

In connection with these cases of remarkable dimorphism in spermatozoa, due to degeneration, the noteworthy case of *Nerilla* should be mentioned (Goodrich (8)). In this archiannelid the male has three genital segments: the first of these, the seventh, alone produces normal spermatozoa, but the eighth and ninth give rise to curious cells with granules; the exact category under which these cells should be placed, whether spermatogonia, spermatocytes, etc., and the manner in which the granules appear have not yet been elucidated, but there can be little doubt that the conditions leading to abortive spermatozoa in segments eight and nine are to be identified with the same forces which cause the apyrene sperm of moths to appear.

Reinke (1) has some interesting suggestions to make regarding the apyrene spermatozoa of *Strombus*. He says: "(a) They may serve as nurse-cells to the eupyrene spermatozoa after copulation and before the latter reach the seminal receptacle; (b) they may, by liberation of some substance,

stimulate the eupyrene spermatozoa or the eggs or both during fertilisation ; or by the liberation of some substance to which the eupyrene spermatozoa are negatively chemotactic, they may act as an aid in the final disposition of the latter.”

One remark naturally occurs on reading these suggestions It is that the vast majority of the Metazoa have no such noteworthy dimorphism in their spermatozoa as these Proso-branchs, and they overcome any possible difficulty in the nourishment, stimulation, and final disposition of their sperms without recourse to any atypic formations. Then why should certain molluscs depart from the usual methods in so far as to need a special new sort of sperm? Why should some other molluscs not have such special sorts of sperms? Experiments have shown that the apyrene spermatozoa degenerate sooner or later after undergoing katabolic changes in the albuminous bodies, that they are not so greatly stimulated by decaying tissue as are the eupyrene, and that the eupyrene spermatozoa live longer than the apyrene in sea-water (1). This all shows that the apyrene sperm lacks the energy of the eupyrene, and that it is in this way degenerate. For myself until further evidence of a more definite nature is brought forward I prefer to believe that these atypic spermatozoa are degeneration products produced by some altered condition in certain cells of the testis.

Whether these abnormal conditions are due to some alteration in the fluid nourishing and bathing the sperm-cells, and why these conditions should apply to some cells and not to others, are problems which in the case of the moths at least might be solved by further experiment, in the line already indicated. Finally, it should be remarked that Goldschmidt's hypothesis of altered conditions is to be regarded as more likely than any sex theory, for I feel convinced that in moths these spermatozoa arise out of a state of degeneration, and the varying conditions which are undoubtedly to be found during the metamorphosis of insects might possibly supply the disintegratory stimulus. It has already been pointed out where Goldschmidt's hypothesis seems to me to be weak.

ADDENDUM.

With regard to the matter of degeneration in the testes of moths, a very remarkable case has been brought to my notice by my friend, Dr. H. Eltringham, of New College, Oxford. A number of pupæ of the Emperor moth (*Saturnia carpini*) were purchased May, 1916, and none emerged that year. In 1917 about six moths emerged, paired, and laid fertile eggs. The rest of the pupæ failed to emerge. This June a number of the male gonads of these pupæ were sectioned, and it was found that they contained nothing except undeveloped spermatogonia and quite degenerate spermatocytes. There seems to be some correlation between the state of development of the gonads and time of emergence. The remaining pupæ do not appear to be going to emerge this year (July 29th, 1917).

SUMMARY.

(1) In Lepidoptera degeneration of cell elements take place at all stages of spermatogenesis.

(2) Degeneration of the chromosomes just after the second maturation division leads to what has been called "apyrene" spermatozoa.

(3) "Apyrene," "oligopyrene," and "eupyrene" spermatozoa are not separate kinds in Lepidoptera, but all intermediate stages are to be found.

(4) It is suggested that in Lepidoptera these terms lack the significance which has been attached to them.

(5) Degeneration may set in just when the cell elements are about to be properly orientated before spermiogenesis, and in such cases the nucleus and head centrosome fail to join. The former sinks down the lengthening sperm.

(6) The acroblasts almost always accompany the nucleus, and form a normal acrosome.

(7) In degenerate spermatids where the chromosomes fail to join up normally, the macromitosome (nebenkern) may be normally formed.

(8) The macromitosome may become normally elongated in sperms in which the nuclei are degenerate.

(9) It is suggested that the abnormal sperms are unable to bring about fertilisation.

(10) Individual nuclei can be reconstituted from separate chromosomes.

(11) At least partial inter-dependence of some cell elements is indicated by degenerate stages.

(12) Two centres of force, lodged respectively in the nucleus and in the centrosome, seem to be present.

DEPARTMENT OF PHYSIOLOGY, OXFORD;
March 19th, 1917.

BIBLIOGRAPHY.

1. Reinke, E.—“The Apyrene Spermatozoa of *Strombus biturerculatus*, Tortugas Laboratory, vol. vi.
 2. Meves.—“Ueber oligopyrene und apyrene Spermien und ueber ihre Entstehung nach Beobachtungen an *Paludina* und *Pygæra*,” ‘Arch. Mikr. Anat.’ lxi, 1903.
 3. Federly, H.—“Das Verhalten der Chromosomen bei der Spermato-genese der Schmellerlenge,” etc., ‘Zeit. f. induktive Abstau. Vererb.’ Bd. 9, 1913.
 4. Gatenby, J. Bronté.—“The Cytoplasmic Inclusions of the Germ-Cells.” Part I, Lepidoptera, ‘Quart. Journ. Micr. Sci.’ vol. 62, 1917.
 5. Duesberg, J.—“La Spermeogénèse chez le nat,” ‘Arch. Zellforsch.’ 1909.
 6. Hertwig.—“Ueber Correlation von Zellund Kerngrösse,” ‘Biol. Centrbl.’ xxiii, 1903.
 7. Goldschmidt.—‘Science,’ vol. xlv, No. 1137.
 8. Goodrich, E. G., ‘Quart. Journ. Micr. Sci.’ vol. lvii.
-

EXPLANATION OF PLATE 26,

Illustrating Mr. J. Bronté Gatenby's paper, "The Degenerate (Apyrene) Sperm-formation of Moths as an Index to the Inter-relationship of the Various Bodies of the Spermatozoon."

EXPLANATION OF LETTERING.

A. Acroblast or acrosome. C. Centrosome. C.O. Chromophobe vacuole of mitochondria. C.H. Chromosomes. F. Axial filaments. F.W. Follicle wall. G. Granule. M. Mitochondria (macromitosome). M.I. Micromitosome. N. Nucleus. W.X. Nucleus being formed from single chromosomes. X.Y.Z. Different regions in the macromitosome.

[All figures drawn from an 18-compensating eyepiece and a Koritska $\frac{1}{15}$ th semi-apochromatic oil immersion, with a camera lucida, at table level. In reproduction figures reduced by one half. Now \times circa 2000 diameters.]

PLATE 26.

Fig. 1.—Four spermatids of *Smerinthus populi* showing abnormal multinucleate condition resulting from a failure of the chromosomes to fuse up normally after second maturation division. The mitochondria in the top left-hand cell are less abnormal than those of the other cells.

Fig. 2.—Spermatid of *S. populi* showing all cell elements normal except the nucleus, which has not been reconstructed from the chromosomes. The latter, singly or in small numbers, are forming a group of separate nuclei.

Fig. 3.—Young spermatozoon of *Pieris*, quite normal except that the nucleus is falling away. At X. is the front end of the macromitosomal spireme (January).

Fig. 4.—Second maturation division of *S. populi*, showing a lagging in the chromosomes. The mitochondria are normal.

Fig. 5.—Advanced spermatozoon of *Pieris brassicæ*, showing abnormal elongation of macromitosome.

Fig. 6.—Spermatid of *Smerinthus populi* with five nuclei; otherwise quite normal.

Figs. 7, 8, 10, and 11 show in *P. brassicæ* the falling away of the nucleus in the elongating spermatids. Latter otherwise normal (January).

Fig. 9.—Oblique section of a sperm bundle of *S. populi*, showing normal acrosome formed near lagging nuclei, all of which have fallen away. Macromitosome normal.

Fig. 12.—Spermatozoon of *S. populi*, showing abnormal formation of macromitosome. From *C.* to *Y.* is normal. The part *M.* contains the main part of the mitochondrial matter, while at *Z.* there has been an attempt at elongation.

Fig. 13.—Spermatid with four nuclei, all of which stain as they do in normal stages. Cell otherwise normal, but each nucleus has a granule, which may or may not be derived from acrosomic matter. *S. populi*.

Fig. 14.—Spermatid of *Pygæra bucephala*, showing fairly normal macromitosome, but quite degenerate nucleus (October).

Fig. 15.—Mid part of bundle of metamorphosing spermatozoa of *Pieris*, showing abnormal acrosome not properly fused to the nucleus.

CONTRIBUTIONS TO THE KNOWLEDGE OF RHABDOPLEURA AND AMPHIOXUS.

By SIR RAY LANKESTER, K.C.B., M.A., LL.D., F.R.S.
London: J. & A. CHURCHILL, 7 Great Marlborough Street.

Quarterly Journal of Microscopical Science.

The SUBSCRIPTION is 42s. for the Volume of Four Numbers; for this sum (*prepaid*) the JOURNAL is sent Post Free to any part of the world.

BACK NUMBERS of the JOURNAL, which remain in print, are now sold at a uniform price of 10/6 net.

The issue of SUPPLEMENT NUMBERS being found inconvenient, and there being often in the Editor's hands an accumulation of valuable material, it has been decided to publish this Journal at such intervals as may seem desirable, rather than delay the appearance of Memoirs for a regular quarterly publication.

The title remains unaltered, though more than Four Numbers may be published in the course of a year.

Each Number is sold at 10/6 net, and Four Numbers make up a Volume.

London: J. & A. CHURCHILL, 7 Great Marlborough Street.

TO CORRESPONDENTS.

Authors of original papers published in the Quarterly Journal of Microscopical Science receive fifty copies of their communication *gratis*.

All expenses of publication and illustration are paid by the publishers.

Lithographic plates and text-figures are used in illustration. Shaded drawings intended for photographic reproduction as half-tone blocks should be executed in "Process Black" diluted with water as required. Half-tone reproduction is recommended for uncoloured drawings of sections and of Protozoa.

Drawings for text-figures should NOT be inserted in the MS., but sent in a separate envelope to the Editor.

Contributors to this Journal requiring *extra* copies of their communications at their own expense can have them by applying to the Printers,

Messrs. ADLARD & SON & WEST NEWMAN, Ltd., 23, Bartholomew Close, E.C., on the following terms:

For every four pages or less—

25 copies	5/-
50 "	6/-
75 "	6/6
100 "	7/-

Plates, 2/- per 25 if uncoloured; if coloured, at the same rate for every colour.

Prepayment by P.O. Order is requested.

ALL COMMUNICATIONS FOR THE EDITORS TO BE ADDRESSED TO THE CARE OF MESSRS. J. & A. CHURCHILL, 7 GREAT MARLBOROUGH STREET, LONDON, W.

THE MARINE BIOLOGICAL ASSOCIATION

OF THE
UNITED KINGDOM.

—:O:—
Patron—HIS MAJESTY THE KING.

President—Sir RAY LANKESTER, K.C.B., LL.D., F.R.S.

—:O:—
THE ASSOCIATION WAS FOUNDED "TO ESTABLISH AND MAINTAIN LABORATORIES ON THE COAST OF THE UNITED KINGDOM, WHERE ACCURATE RESEARCHES MAY BE CARRIED ON, LEADING TO THE IMPROVEMENT OF ZOOLOGICAL AND BOTANICAL SCIENCE, AND TO AN INCREASE OF OUR KNOWLEDGE AS REGARDS THE FOOD, LIFE CONDITIONS, AND HABITS OF BRITISH FOOD-FISHES AND MOLLUSCS."

The Laboratory at Plymouth

was opened in 1888. Since that time investigations, practical and scientific, have been constantly pursued by naturalists appointed by the Association, as well as by those from England and abroad who have carried on independent researches.

Naturalists desiring to work at the Laboratory

should communicate with the Director, who will supply all information as to terms, etc.

Works published by the Association

include the following:—'A Treatise on the Common Sole,' J. T. Cunningham, M.A., 4to, 25/-; 'The Natural History of the Marketable Marine Fishes of the British Islands,' J. T. Cunningham, M.A., 7/6 net (published for the Association by Messrs. Macmillan & Co.).

The Journal of the Marine Biological Association

is issued half-yearly, price 3/6 each number.

In addition to these publications, the results of work done in the Laboratory are recorded in the 'Quarterly Journal of Microscopical Science,' and in other scientific journals, British and foreign.

Specimens of Marine Animals and Plants,

both living and preserved, according to the best methods, are supplied to the principal British Laboratories and Museums. Detailed price lists will be forwarded on application.

TERMS OF MEMBERSHIP.

ANNUAL MEMBERS	£1 1 0	per annum.
LIFE MEMBERS	15 15 0	Composition Fee.
FOUNDERS	100 0 0	" "
GOVERNORS (Life Members of Council)	500 0 0	" "

Members have the following rights and privileges:—They elect annually the Officers and Council; they receive the Journal free by post; they are admitted to view the Laboratory at any time, and may introduce friends with them; they have the first claim to rent a table in the Laboratory for research, with use of tanks, boats, etc.; and have access to the Library at Plymouth. Special privileges are granted to Governors, Founders, and Life Members.

Persons desirous of becoming members, or of obtaining any information with regard to the Association, should communicate with—

The DIRECTOR,

The Laboratory,

Plymouth.

7527.

JAN 23 1918

New Series, No. 248 (Vol. 62, Part 4).

Price 10s. 6d. net

Subscription per volume (of 4 parts) 42s. net.

DECEMBER, 1917.

THE
QUARTERLY JOURNAL
 OF
MICROSCOPICAL SCIENCE.

EDITED BY

SIR RAY LANKESTER, K.C.B., M.A., D.Sc., LL.D., F.R.S.,

HONORARY FELLOW OF EXETER COLLEGE AND HONORARY STUDENT OF CHRIST CHURCH, OXFORD;
 MEMBER OF THE INSTITUTE OF FRANCE (ASSOCIÉ ÉTRANGER DE L'ACADEMIE DES SCIENCES);
 CORRESPONDENT OF THE IMPERIAL ACADEMY OF SCIENCES OF ST. PETERSBURG, AND OF THE
 ACADEMY OF SCIENCES OF PHILADELPHIA, AND OF THE ROYAL ACADEMY OF SCIENCES
 OF BERLIN; FOREIGN MEMBER OF THE ROYAL SOCIETY OF SCIENCES OF
 GÖTTINGEN, AND OF THE ROYAL BOHEMIAN SOCIETY OF SCIENCES, AND
 OF THE ACADEMY OF THE LINCEI OF ROME, AND OF THE AMERICAN
 ACADEMY OF ARTS AND SCIENCES OF BOSTON; ASSOCIATE OF THE
 ROYAL ACADEMY OF BRUSSELS; HONORARY MEMBER OF THE
 NEW YORK ACADEMY OF SCIENCES, AND OF THE
 CAMBRIDGE PHILOSOPHICAL SOCIETY, AND OF
 THE ROYAL PHYSICAL SOCIETY OF EDIN-

BURGH, AND OF THE
 BIOLOGICAL AND ZOOLOGICAL SOCIETIES OF PARIS, AND OF THE CALIFORNIA ACADEMY OF SCIENCES OF
 SAN FRANCISCO, AND OF THE ROYAL ZOOLOGICAL AND MALACOLOGICAL SOCIETY OF BRUSSELS;
 CORRESPONDING MEMBER OF THE SENKENBERG ACADEMY OF FRANKFURT A M;
 FOREIGN ASSOCIATE OF THE NATIONAL ACADEMY OF SCIENCES, U.S., AND MEMBER OF THE
 AMERICAN PHILOSOPHICAL SOCIETY;

HONORARY FELLOW OF THE ROYAL SOCIETY OF EDINBURGH;
 LATE DIRECTOR OF THE NATURAL HISTORY DEPARTMENTS OF THE BRITISH MUSEUM; LATE PRESIDENT OF THE
 BRITISH ASSOCIATION FOR THE ADVANCEMENT OF SCIENCE; LATE FULLERIAN PROFESSOR OF
 PHYSIOLOGY IN THE ROYAL INSTITUTION OF GREAT BRITAIN.
 LATE LINACRE PROFESSOR OF COMPARATIVE ANATOMY AND FELLOW OF MERTON COLLEGE, OXFORD;
 EMERITUS PROFESSOR OF ZOOLOGY AND COMPARATIVE ANATOMY IN UNIVERSITY COLLEGE, UNIVERSITY OF LONDON

WITH THE CO-OPERATION OF

SYDNEY J. HICKSON, M.A., F.R.S.,

BEYER PROFESSOR OF ZOOLOGY IN THE UNIVERSITY OF MANCHESTER;

GILBERT C. BOURNE, M.A., D.Sc., F.R.S.,

LINACRE PROFESSOR OF COMPARATIVE ANATOMY, AND FELLOW OF MERTON COLLEGE, OXFORD

J. GRAHAM KERR, M.A., F.R.S.,

REGIUS PROFESSOR OF ZOOLOGY IN THE UNIVERSITY OF GLASGOW;

AND

E. W. MACBRIDE, M.A., D.Sc., LL.D., F.R.S.,

PROFESSOR OF ZOOLOGY AT THE IMPERIAL COLLEGE OF SCIENCE AND TECHNOLOGY.

WITH LITHOGRAPHIC PLATES AND TEXT-FIGURES.



LONDON:

J. & A. CHURCHILL, 7 GREAT MARLBOROUGH STREET.

1917.

S

CONTENTS OF No. 248.—New Series.

MEMOIRS:

	PAGE
Notes on the Morphology of <i>Bathynella</i> and some Allied Crustacea. By W. T. CALMAN, D.Sc. (Published by permission of the Trustees of the British Museum). (With 14 Text-figures)	489
On <i>Oxnerella maritima</i> , nov. gen., nov. spec., a New Heliozoon, and Its Method of Division; with Some Remarks on the Centro- plast of the Heliozoa. By CLIFFORD DOBELL, Imperial College of Science, London, S.W. (With Plate 27)	515
“Proboscis pores” in Craniate Vertebrates, a Suggestion concerning the Premandibular Somites and Hypophysis. By EDWIN S. GOODRICH, F.R.S., Fellow of Merton College, Oxford. (With Plate 28 and 3 Text-figures)	539
The Cytoplasmic Inclusions of the Germ-Cells. Part II.— <i>Helix</i> <i>aspersa</i> . By J. BRONTÉ GATENBY, B.A., Exhibitioner of Jesus College, Oxford (Dept. of Physiology). (With Plates 29-34 and 5 Text-figures.)	555
Note on the Development of <i>Trichogramma evanescens</i> . By J. BRONTÉ GATENBY, B.A., Exhibitioner of Jesus College, Oxford	613

TITLE, INDEX, AND CONTENTS

**Notes on the Morphology of Bathynella and
some Allied Crustacea.**

By

W. T. Calman, D.Sc.

(Published by permission of the Trustees of the British Museum.)

With 14 Text-figures.

CONTENTS.

	PAGE
I. INTRODUCTORY	489
II. EXTERNAL CHARACTERS OF BATHYNELLA	490
III. INTERNAL ANATOMY OF BATHYNELLA	500
IV. DEVELOPMENT OF BATHYNELLA	502
V. THE FIRST THORACIC SOMITE IN THE SYNCARIDA AND OTHER MALACOSTRACA	502
VI. THE MANDIBULAR GROOVE IN THE SYNCARIDA	506
VII. THE DEGENERACY OF BATHYNELLA	508
VIII. THE CLASSIFICATION OF THE SYNCARIDA	509
IX. THE AFFINITIES OF THE SYNCARIDA	512
X. LIST OF PAPERS REFERRED TO	513

I. INTRODUCTORY.

The recent re-discovery of *Bathynella natans* by P. A. Chappuis (1914a, 1915)¹ throws welcome light on one of the most remarkable of living Crustacea. In the thirty years that had elapsed since its first description by Vejdovský (1882), from two specimens found in a well in Prague, this

¹ The numbers in brackets after names of authors refer to the list of papers on p. 513.

minute form had not been obtained by any other naturalist. Some eighteen years ago a re-examination of the solitary remaining specimen enabled me, in spite of its poor state of preservation, to add some details to Vejdovsky's account, and led me to the conclusion that it was allied to *Anaspides* (Calman, 1899). The scantiness of information regarding it, however, has caused most writers who have had occasion to refer to *Bathynella* in text-books or elsewhere to suspend judgment as to its affinities, and the late Geoffrey Smith (1909) omitted it altogether from his revision of the Anaspidacea. The detailed account of its structure now provided by Chappuis from the specimens found in Switzerland entirely confirms my earlier conclusions as to its systematic affinities, and enables us to say that *Bathynella* is undoubtedly a degenerate member of the Syncarida, a group of Crustacea which has persisted from Carboniferous times, and of which the only other living representatives are found in Australia and Tasmania.

Certain features in the morphology of *Bathynella* seem to me, however, to deserve somewhat more detailed consideration than they have yet received, and on this account I was particularly glad to have an opportunity of studying three specimens that M. Chappuis kindly presented to the British Museum (Natural History). From the small size of the animal and the unusual delicacy of its cuticular covering its investigation presents considerable difficulty, but I have been able in great part to confirm and in some details to amplify Chappuis' account of its external structure. Since his memoir, published in a German periodical, is likely for the present to be difficult of access for many zoologists, it seemed desirable to make the following account somewhat fuller than might otherwise have been necessary.

II. EXTERNAL CHARACTERS OF BATHYNELLA.

Size.—The specimens examined by me measure almost exactly 1 mm. in length of body, and this is also the size

given by Vejdovský for the type-specimens. Chappuis states that some of his specimens reached a length of 2 mm., but it is not quite clear that this measurement excludes the antennules. In any case *Bathynella* is one of the smallest among the Malacostraca; only some Asellota and Cunacea are no larger, and a few Tanaidæ are perhaps even a little smaller.

Body.—The body (Text-fig. 1) is subcylindrical and fully segmented, and the general aspect of the animal approaches that of the more vermiform of the Harpacticoid Copepoda. The abdomen appears to be a little more bulky than the

TEXT-FIG. 1.

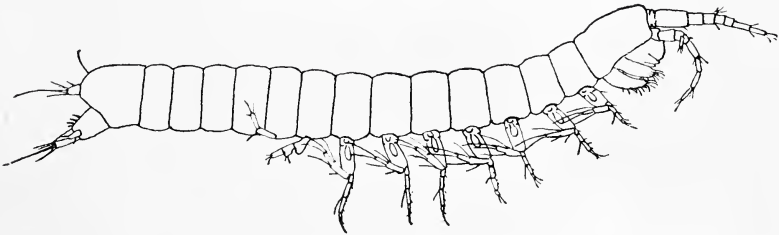
*Bathynella natans*, ♂. Lateral view.

thorax, and, according to Chappuis, it is slightly compressed from side to side. The eight thoracic and six abdominal somites are separated by well-marked grooves and appear to be freely movable, but the cuticle is almost uniformly thin, and there is difficulty in seeing the boundaries between the tergal sclerites and the articular membranes connecting them. The tergites of the posterior thoracic and the abdominal somites overlap from before backwards, but in the anterior three or four thoracic somites there is no overlapping.

Head.—The head (Text-figs. 2 and 3) is longer than wide. It is truncated in front, with no trace of a rostral projection, and behind it is sharply defined from the first thoracic somite by an articulation exactly like those that separate the thoracic somites from one another. There is no trace of eyes or of

eye-stalks. Seen from the side, the lower margin is concave in its anterior two-thirds, and in this part it overhangs the bases of the mandibles and maxillulae in a very slight pleural fold. On the side of the head a shallow groove, most clearly seen in a specimen treated with caustic potash, runs obliquely upwards and backwards, becoming almost imperceptible where it joins with its fellow across the dorsal surface. At its lower end, where it lies immediately above the basal articulation of the mandible, the integument along the floor of the

TEXT-FIG. 2.

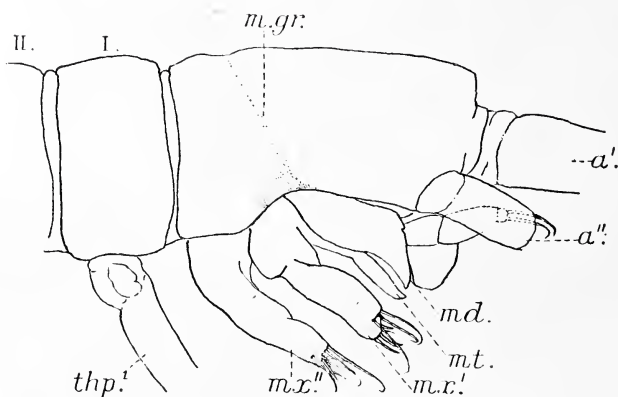

Bathynella natans, ♀. Head and anterior thoracic somites, lateral view. *a¹*. Base of antennule. *a²*. Base of antenna. *md.* Mandible. *m.gr.* Mandibular groove. *mt.* Metastoma or lower lip. *mx.¹*. Maxillula. *mx.²*. maxilla. *thp¹*. Appendage of first thoracic somite. I, II. Tergites of first and second thoracic somites.

groove is slightly thickened and stiffened, and this thickening spreads a little way in front and behind along the margin of the pleural fold. The significance of this "mandibular groove" is discussed below.

Telson.—The sixth abdominal somite is deeply incised behind in the middle line where the anus opens, and on either side of the incision, towards the dorsal side, a short appendage is articulated, subcylindrical or slightly flattened, and

bearing a group of spines and long setæ (Text-figs. 4 and 5). These appendages are not divided into two segments as Vejdoický described them, and one of the grounds for my suggestion that they might represent the caudal furca is therefore removed. I am now inclined to agree with

TEXT-FIG. 3.

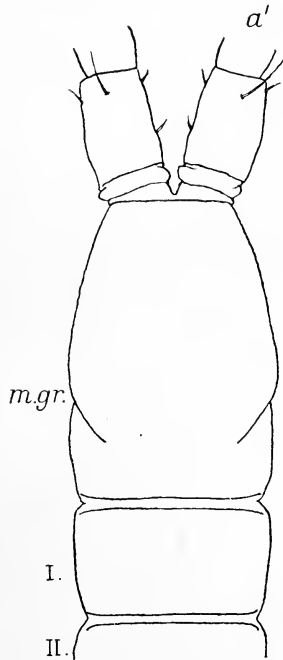

Bathynella natans, ♀. Head and anterior thoracic somites, dorsal view. *a'*. Base of antennule. *m. gr.* Mandibular groove. I, II. First and second thoracic somites.

Chappuis that they represent the two halves of a deeply divided telson, although I do not understand his argument when he says—"Da aber das Analsegment hier schon die Uropoden trägt, so ist die Deutung der 2 Schwanzplatten als Furcalglieder ausgeschlossen." In no other Syncarida does the telson show even a tendency to division, and although in

many Gammaridea the telson is split almost or quite to the base, the two parts are never set wide apart as they are in *Bathynella*.

Antennule.—The earlier accounts described the an-

TEXT-FIG. 4.

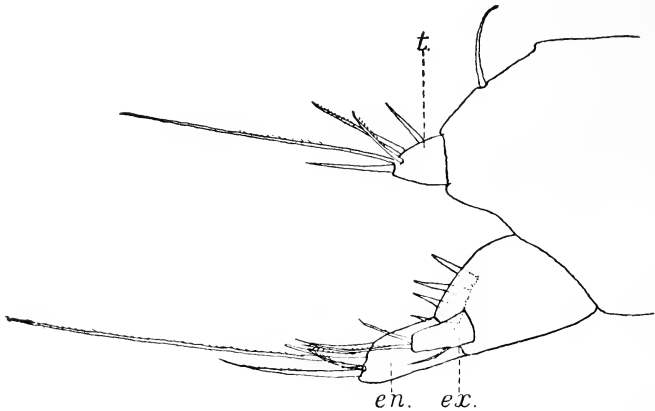

Bathynella natans, ♀. Last somite, telson, and uropod, lateral view. *en.*, *ex.* Endopodite and exopodite of uropod. *t.* One of the telson-plates.

TEXT-FIG. 5.

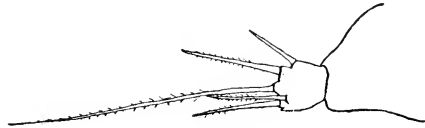

Bathynella natans, ♀. Telson-plate of right side, dorsal view.

tennule as uniramous, but Chappuis has discovered that a minute vestige of the inner ramus persists. According to his interpretation this vestige is attached to the distal end of the fifth segment. If this be so, it constitutes a very remarkable exception to the rule that the peduncle of the antennule in the Eumalacostraca consists of three segments. This rule is only infringed, as far as I know, in certain species of

Apseudes, where, according to Claus, the rami are coalesced at the base so as to form an apparent fourth segment of the peduncle. In the Phyllocarida the peduncle consists of four segments.

At first sight, the antennule of *Bathynella* (Text-fig. 6) seems to bear out Chappuis' description. On the proximal side of the vestigial inner ramus it presents three large segments following upon two extremely short basal segments, the latter together representing the first segment as figured by Vejdovský. A careful examination of these short seg-

TEXT-FIG. 6.

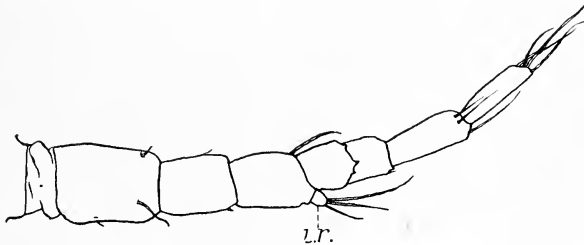

Bathynella natans, ♀. Antennule of left side, dorsal view.
 Drawn from a cleared specimen in which some of the finer setæ are missing. *i. r.* Vestige of inner ramus.

ments, however, leaves some doubt as to their being real segments of the peduncle (Text-figs. 2, 3, and 6). The proximal of the two forms a ring of chitin, not defined from the exoskeleton of the head by any articulation or line of suture, although it is overlapped above by a slight fold forming the frontal margin of the cephalic tergite. It may well be that this apparent proximal segment is simply the everted margin of the socket with which the antennule articulates. The second segment has a less firm outline than the first and the succeeding segments; its surface (in the single specimen in which I examined it closely) was irregularly folded and wrinkled, and it may be nothing more than the articular membrane of a joint that has more than the usual range of motion. At all events there appears to be no

reason for attributing any profound morphological significance to these supernumerary segments of the peduncle.

Antenna.—Chappuis points out that the peduncle consists of three segments, a short basal segment preceding the two figured by Vejdovský. In this case there can be no question that Chappuis' observation is correct, the additional segment being well defined both proximally and distally (Text-fig. 7). The character is possibly of importance, since in the other living Syncarida, as in most Malacostraca, only two segments are present. In this respect *Bathynella* agrees with the Mysidacea and many other Peracarida. The third segment

TEXT-FIG. 7.

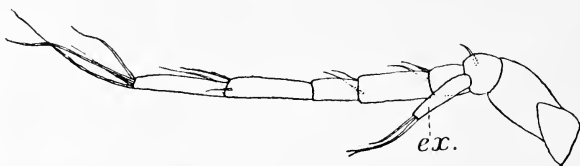

Bathynella natans, ♀. Antenna of left side, dorsal view.

bears a small unsegmented exopodite tipped with two setæ, and is followed by a flagellum of five elongated segments.

Mouth-parts.—The mandible (Text-fig. 8, *md.*) has a palp of three segments, of which the second is much the longest. The oral edge is irregularly toothed, and its proximal part, which would correspond to the molar process, is thin and sharp-edged. The lower lip (Text-fig. 2, *mt.*) is large, as in other Syncarida, and its lobes appear to terminate each in a minute inturned point.

The maxillula (Text-fig. 8, *mx.*) is incorrectly figured by Chappuis. It has two endites, the proximal small and bearing two apical setæ, the distal armed with a group of spines. A rounded distal eminence on the outer side, bearing three setæ, no doubt represents a vestigial palp. The whole appendage bears an unmistakable resemblance to that of *Koonunga* as figured by Sayce (1908, Pl. I, fig. 12). No

trace can be detected of the exite which is present in Anaspides.

The maxilla (Text-fig. 8, *m.x.*"') has three endites and a short unsegmented palp. Here also a certain resemblance to Koonunga may be traced in the fact that the endites are directed inwards, and not crowded together as they are in Anaspides.

Thoracic Appendages (Text-figs. 9 and 10).—With exception of the last pair all the thoracic limbs are similarly

TEXT-FIG. 8.

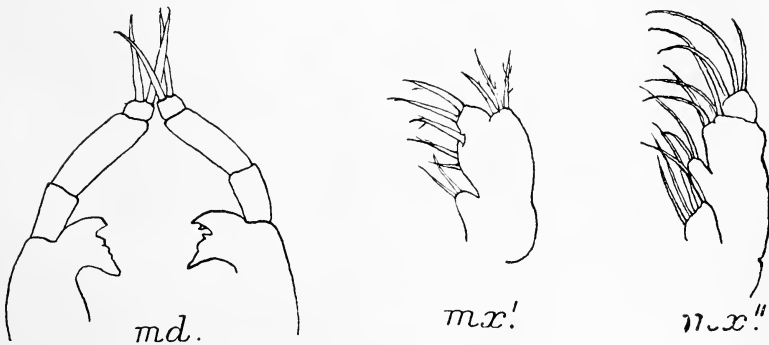

Bathynella natans, ♀. *md.* Mandibles. *mx'*. Maxillula.
mx''. Maxilla.

constructed, only the inner ramus becoming a little longer and more slender in passing backwards along the series, and the group of spines arming the terminal segment being reduced to a single claw (with a minute seta at its base) in the last three pairs. The coxopodite is short, and has two vesicular epipodites on its outer surface. The basipodite is long, and both exopodite and endopodite articulate with its distal end. The exopodite shows an incomplete line of articulation near the base and another beyond the middle of its length, where there is a well-marked "shoulder" on each side; it is not, however, distinctly divided into two segments as described by Vejdovský and myself. The endopodite consists of four segments, the precise relation of which to the

six segments present in *Anaspides* cannot be determined. From the fact that the exopodite is attached to the distal end of the second segment of the protopodite it may be inferred that this segment represents the basipodite alone, and not the coalesced basipodite and ischiopodite as it does in *Koonunga* and in the posterior legs of *Anaspides*.

The appendages of the last thoracic somite are greatly

TEXT-FIG. 10.

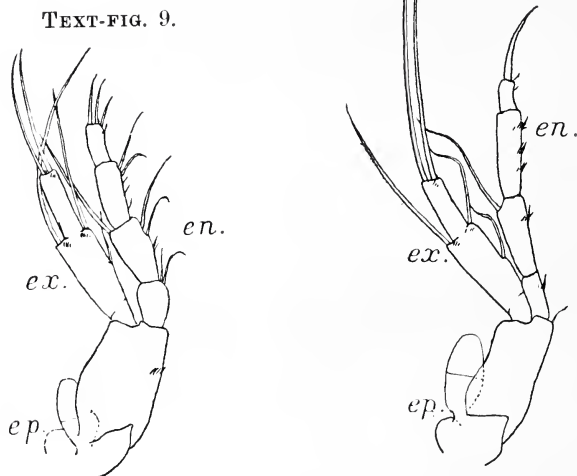

TEXT-FIG. 9.

FIG. 9.—*Bathynella natans*, ♀. Thoracic appendage of third pair.
en. Endopodite. *ep.* Epipodites. *ex.* Exopodite.

FIG. 10.—*Bathynella natans*, ♀. Thoracic appendage of sixth pair.
References as in Text-fig. 9.

reduced in size, and differ considerably in structure in the two sexes. In the female the exopodite and endopodite are short, unsegmented stumps, and a single epipodite is present. In the male (Text-fig. 1) the exopodite is reduced to a papilla, there is no epipodite, and the coxopodite is produced internally as a rounded prominence on which, or at any rate very near it, is the opening of the vas deferens.

While Vejdovský and I had only described a single series of thoracic epipodites, Chappuis has made the important discovery that *Bathynella*, like all other living Syncarida, possesses a double series of these appendages. The distal epipodites are oval vesicles (not flattened, at least in pre-

TEXT-FIG. 11.

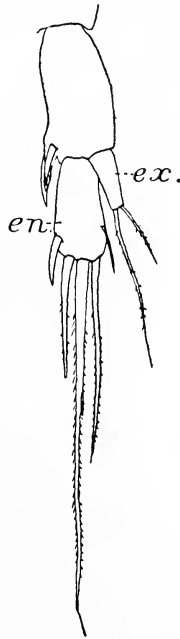

Bathynella natans, ♀. Uropod of right side, dorsal view.
en. Endopodite. *ex.* Exopodite.

served specimens) attached to the proximal segment of the limb by a narrow base. Chappuis does not describe them as showing any structural differentiation, but in a cleared specimen each is seen to be crossed by a fine suture-line about the middle of its length. In the distal half of the vesicle the cuticle is slightly thickened, forming a thimble-shaped cap, while the proximal part has the cuticle thin and flaccid. I formerly described the epipodite as "borne on a

short peduncle, from which it is separated by a transverse articulation or suture." It now appears probable that the "peduncle" was formed by the collapse of the proximal part of the epipodite in the shrivelled type-specimen. In reality there is no peduncle, the epipodite springing directly from a narrow base of attachment. The transverse suture suggests comparison with the suture-line which I described near the base of the epipodites of *Anaspides*, but in that case it is the small basal portion which is more thickened, and the distal part soft and membranous.

The epipodites of the proximal series are not constricted at the base, but form merely lobular processes of the outer surfaces of the coxopodites. They have a very delicate cuticular covering and are not divided by suture.

Abdominal Appendages.—In the abdominal region the only appendages present are those of the first and sixth somites. The former (pleopods) are short, uniramous, and consist of two segments; they present no sexual differences (Text-fig. 1). The appendages of the sixth somite (uropods) (Text-figs. 4 and 11) are very stout, with the peduncle laterally compressed, and armed with a row of spines on the inner side; the endopodite is subcylindrical, and bears a group of spines and long setæ distally; the exopodite is conical, much shorter than the endopodite, with two apical setæ.

III. INTERNAL ANATOMY OF BATHYNELLA.

As I have had no opportunity of studying the soft parts, the following notes are based solely on the observations recorded by Chappuis.

Alimentary System.—No masticatory stomach is described, a smooth muscular œsophagus extending as far as the sixth thoracic somite. This is followed by a widened portion ("Magen") reaching into the last thoracic somite, with opaque glandular walls thrown into four longitudinal folds. This may be supposed to represent at least a portion of the

mid-gut, although Chappuis applies that name to the following, still wider portion, which extends as far as the fourth abdominal somite. In this region the dorsal wall of the gut is thick and glandular, while the ventral wall is thin. The short rectum is stated also to have a glandular structure.

The entire absence of hepatic or other diverticula of the gut is a feature not paralleled in any other Malacostracan.

Circulatory System.—The short heart lies in the fourth thoracic somite, and does not exceed in diameter the vessels that come off from it in the middle line in front and behind. No ostia have been seen. While the anterior vessel is no doubt an aorta (*arteria dorsalis*, Chappuis), the posterior vessel is described as a “*vena dorsalis*” collecting the blood from the sixth abdominal somite and returning it to the heart. Such an arrangement would be very unusual, if not unique, among Crustacea, and perhaps the so-called dorsal vein should be regarded rather as a backward extension of the heart itself. In view, however, of the difficulties of investigation to which Chappuis alludes, it seems possible that a mistake has been made as to the direction of the blood-flow in this region of the body.

Excretory System.—Chappuis describes in considerable detail the remarkable structure of the maxillary gland. It consists of an end-sac (*cœlomic sac*), a looped canal extending backwards into the fourth thoracic somite, and a terminal vesicle with a slit-like opening on the outer surface of the maxilla. During life the terminal vesicle is thrown into rapid pulsation, with opening and shutting of its external aperture, by a muscle attached to its wall. This pulsating apparatus is compared by Chappuis with that found in the maxillary gland of the remarkable Copepod *Phyllognathopus* (*Belisarius*, *Viguiereella*), where it was first described by Maupas, and has recently been investigated by Chappuis himself (1914B) in specimens found living in company with *Bathynella*. The similarity, however, appears to be no more than superficial, either in structure or, probably, in function, for while the pulsating vesicle of *Bathynella* is

situated at the exit from the excretory duct, that of *Phyllognathopus* is at its inner termination, and represents, in all likelihood, a modification of the coelomic sac.

An excretory function is also ascribed to paired nephrocytes, or masses of them, in the head and body-somites, and in the same connection there is described a pair of voluminous glandular masses in the last somite, with ducts opening on the uropods.

Nervous System.—The central nervous system is remarkably bulky in comparison with the other organs. The large brain shows no trace of optic lobes. The ventral nerve-chain shows some degree of longitudinal concentration (not very fully described), and the ganglia are indistinctly defined from the connectives.

Reproductive System.—The reproductive system of both sexes is simple. The gonads lie in the abdomen, and their ducts run forwards to open to the exterior in the positions characteristic of the Malacostraca, those of the female on the sixth and those of the male on the eighth thoracic somite.

IV. DEVELOPMENT OF BATHYNELLA.

The only young stage observed by Chappuis (the size is not stated) resembled the adult, except that the last four pairs of thoracic limbs were rudimentary. The single pair of pleopods and the uropods were fully developed. This is in curious contrast to *Koonunga*, the only other Syncaridan of whose development we know anything, where Sayce (1908, p. 11) found a young specimen with all the thoracic appendages fully developed while the pleopods were still unsegmented buds.

V. THE FIRST THORACIC SOMITE IN THE SYNCARIDA AND OTHER MALACOSTRACA.

In discussing the structure of *Bathynella* in 1899 I pointed out that it possessed eight free somites in the

thoracic region instead of seven as described by Vejdovský. This conclusion is fully confirmed by Chappuis and the character is so unusual that it deserves further consideration.

I formerly stated (1899, p. 342) that "Nebalia and some Stomatopoda" agreed with *Bathynella* in having the first thoracic somite free from the head. As regards the Stomatopoda, this statement was based on a remark of Claus,¹ which appears to be true only of the larvæ. No adult Stomatopod has the tergites of the first or second thoracic somites free from the carapace, while those of the third and fourth are only indistinctly represented.²

In *Nebalia*, the carapace envelops, but remains free from, the thoracic tergites. The grooves separating these from one another are distinct, but the anterior limit of the first tergite coincides with the line along which the free carapace passes into the dorsal integument of the head-region, and it is not possible to say that the first tergite is defined from the head in the same way as it is from the following tergite. Owing to the small size of *Nebalia* it is difficult to obtain a clear view of the parts in question, but it is comparatively easy to do so in the case of the large Mysidacea of the genus *Gnathophausia*, in which also the first thoracic somite has been stated to be distinct from the head.³

If the free portion of the carapace be cut away on one side of a specimen of *Gnathophausia* (Text-fig. 12) the tergites

¹ "Bei den Squilliden bleibt übrigens die ganze Region der Kieferfüsse vom Rückenschilde getrennt, das Segment des ersten Kieferfusses geht hier unterhalb der Schildplatte in die Innenlamelle über" (Claus, 1876, p. 53).

² Giesbrecht (1910, p. 9, pl. ii, fig. 9) states that the structures here regarded as the tergites of the third and fourth somites represent respectively the tergites of the first and second and of the third and fourth somites fused together, but it is not clear on what evidence this statement is based.

³ "In Sars' figure of *Gnathophausia longispina* . . . the first thoracic segment appears to be limited in front by a definite groove, which would thus separate the cephalic and thoracic regions" (Lister, 1909, p. 436, footnote).

of the thoracic somites are easily seen. The investing cuticle, however, is almost uniformly thin, and the tergites, which are hardly to be described as sclerites, are defined from one another only by superficial grooves. In the posterior part of the thoracic region the tergites are regularly transverse, but anteriorly the median portions are pushed backwards and crowded together owing to the backward extension of the connection between the carapace and the body, which extension is visible externally on the dorsal surface of the carapace

TEXT-FIG. 12.

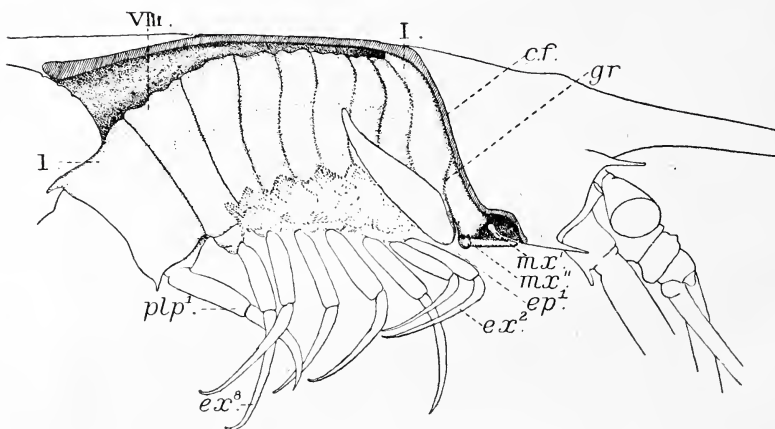

Gnathophausia zoea. Anterior region of body with free portion of carapace cut away, from right side. *c.f.* Origin of carapace-fold. *ep*¹. Epipodite of first thoracic appendage (maxilliped). *ex*², *ex*⁸. Exopodites of second and eighth thoracic appendages (that of the first is absent in this species). *gr.* Groove marking boundary between maxillary and first thoracic somites, uniting above with origin of carapace-fold. *mx'*. Palp of maxillula. *mx''*. Maxilla. *plp*¹. Pleopod of first pair. I, VIII. Tergites of first and eighth thoracic somites. I. Tergite of first abdominal somite.

as the "linguiform area" of Sars (1885, p. 22). This crowding makes it difficult to count the narrowed anterior tergites, but by careful manipulation seven of them can be distinctly seen to be continuous across the mid-dorsal line. The foremost of these, the second thoracic tergite, is defined in

front by a well-marked groove from the strip of cuticle which is reflected to become the lining membrane of the carapace. On each side this strip (Text-fig. 12, *I*) widens somewhat and becomes what is clearly the lateral portion of the first thoracic tergite. For the greater part of its length it is limited anteriorly by the fold (Text-fig. 12, *c.f.*) which marks the beginning of the free portion of the carapace. Towards its lower end this fold turns forward to run horizontally where the lateral, or pleural, margin of the carapace overhangs the bases of the mouth-parts and antenna. No considerable part of the lateral wall of the head is exposed between the origin of this pleural fold and the attachment of the appendages except in the case of the maxilla, where a short space intervenes. In front, this space is bounded by a cavity in which lies the palp of the maxillula (Text-fig. 12, *ma'*); behind, between the base of the maxilla and that of the first thoracic appendage, a shallow and inconspicuous groove (Text-fig. 12, *gr.*) can be traced running upwards for a little distance and curving forwards to join the carapace-fold. It is this short groove alone that can be definitely stated to mark the boundary between maxillary and first thoracic somites, or, in other words, between head and thorax.

With exception of the short groove just mentioned, which I have not been able to observe in any other form, the conditions found in *Gnathophausia* appear to be repeated in all those cases where the eight thoracic tergites have been stated to be free from the enveloping carapace (*Nebalia*, larval Stomatopods, larval Decapods); that is to say, the cephalothoracic tergal boundary is coincident with, and is obscured by, the origin of the carapace-fold. Further, since there is reason to believe that where the first thoracic somite is coalesced with the head, as it is in Isopoda and Amphipoda, a vestigial carapace-fold is involved in the coalescence, we arrive at the conclusion that *Bathynella* and the Anostracous Branchiopoda are the only living Crustacea¹ in

¹ Possibly the Copepoda should be added, but the case is a little obscure (cf. Calman, 1909, pp. 6 and 73).

which the carapace is entirely absent. It is this that gives special importance to the agreement between *Bathynella* and some of the genera of fossil Syncarida (*Uronectes*, *Palaeocaris*) in which the first thoracic somite is similarly free from the head.

VI. THE MANDIBULAR GROOVE IN THE SYNCARIDA.

Anaspides was originally stated to have, as *Bathynella* has, eight free thoracic somites, but I pointed out in 1896 that the supposed first thoracic somite was defined from the head not by a movable articulation like those between the following somites, but by a superficial groove in the integument, and that this groove, from its position immediately behind the mandibles, probably did not mark the cephalothoracic boundary.¹ I later expressed some uncertainty as to this interpretation, but it was strongly confirmed by the discovery that in the fossil genus *Palaeocaris* (Text-fig. 13, *A*) where eight free thoracic somites are clearly defined, a short groove is present on the side of the head, running upwards from the base of the mandible in exactly the same position as the more strongly marked groove of *Anaspides* (Calman, 1911, p. 489). To this groove, thus shown to have nothing to do with the first thoracic somite, the name of "mandibular groove" (Text-fig. 13, *m. gr.*) was given, and it is of particular interest to find it present also in *Bathynella*. In this genus the groove, although no more conspicuous than it is in *Koonunga* (Text-fig. 14) has the same relative position as, and is undoubtedly homologous with, that

¹ The "faint impressed line" described (Calman, 1896, p. 788) as running behind the mandibular groove in *Anaspides* is very ill-defined and inconstant, and no morphological significance can be attributed to it. The "horizontal groove" is not so deep or so sharply marked as the mandibular; it is still shallower in *Paranaspides*, and in *Koonunga* I can only see a doubtful trace of it. It is associated with a bulging of the side wall of the head in this region (shown, for instance, in Sayce's figures of *Koonunga*), which apparently marks the position of the maxillary gland.

TEXT-FIG. 13.

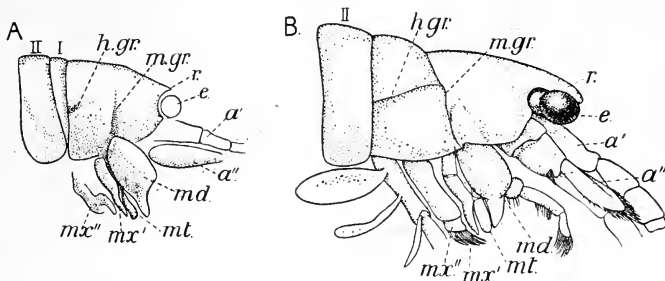

Head and anterior thoracic somites, lateral view. A. *Palaeocaris praecursor* (fossil, Coal-measures). B. *Anaspides tasmaniae*. *a'*. Antennule. *a''*. Antenna. *e*. Eye. *h. gr.* Horizontal groove. *md.* Mandible. *m. gr.* Mandibular groove. *mt.* Metastoma or lower lip. *mx'*. Maxillula. *mx''*. Maxilla. *r.* Rostrum. I, II. Tergites of first and second thoracic somites. (From 'Geol. Mag.,' 1911, by kind permission of the editor.)

TEXT-FIG. 14.

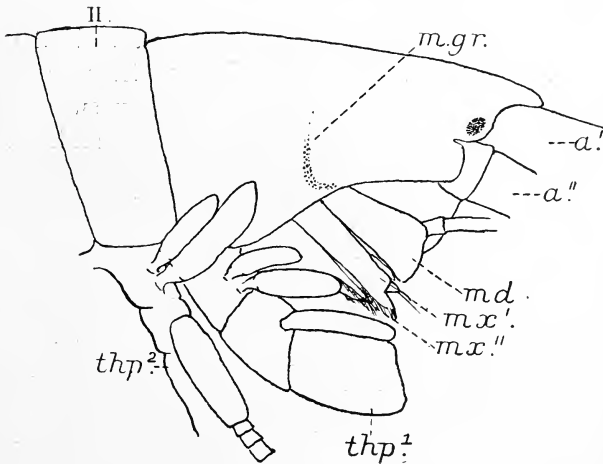

Koonunga cursor. Head and anterior thoracic somites, lateral view. *a'*. Base of antennule. *a''*. Base of antenna. *md.* Mandible. *m. gr.* Mandibular groove. *mx'*. Maxillula. *mx''*. Maxilla. *thp¹*, *thp²*. Appendages of first and second thoracic somites. II. Tergite of second thoracic somite.

of Anaspides; while, as in Palæocaris, it co-exists with a clear demarcation between the head and the first thoracic somite. As was previously pointed out this mandibular groove is, in all probability, to be identified with that named by Sars "cervical sulcus" in the Mysidacea, with the transverse cephalic groove of the Anostraca and Conchostraca, and with the anterior transverse groove of the carapace in Apus and other Notostraca. It is possible, but much less certain, that it corresponds to a part at least of the "anterior cervical groove" of Decapoda. As regards its morphological significance, its position at the limit between the naupliar and post-naupliar regions of the body suggests that it may be of great phylogenetic antiquity and importance. It is quite possible, however, that it may have rather a mechanical and functional meaning. In the Anostraca the bottom of the groove is thickened to form a more or less continuous chitinous bar connecting across the dorsal surface of the head the points of articulation of the two mandibles. The thickening is most marked, as it is in *Bathynella*, at the ends of the groove; and there can be little doubt that, whatever its origin, this groove has, at least in these two cases, the function of giving the necessary support for the articulation of the proximal condyle of the mandible.

VII. THE DEGENERACY OF BATHYNELLA.

The structure of *Bathynella*, as compared with that of its immediate allies, is obviously, in many respects, simplified or degenerate. Some of the evidences of degeneration are no doubt correlated with the habitat of the animal, particularly the absence of eyes, which is almost universal in animals that inhabit subterranean waters. It is quite likely, however, that the simplification of structure is in great part a direct consequence of unusually small size. Lankester (1880, p. 51) long ago pointed out that "the needs of a minute animal are limited as compared with those of a large one," and he enumerated as one of the causes of degeneration "excessive

reduction of size." Thus, we may suppose that the absence of diverticula of the alimentary canal and the reduction of the epipodial vesicles in *Bathynella* are due to the fact that the necessary proportion of secretory, absorptive, and respiratory surfaces can be attained without the need for out-growths that are indispensable for more bulky organisms. Apart from questions of adaptation, however, there are other ways in which size greatly influences structure. As D'Arcy Thompson (1917, p. 33) has recently reminded us, the physical and mechanical conditions of growth may be profoundly different in a small animal from what they are in a large one. For example, we find in *Bathynella* and, I believe, in all minute Crustacea, a certain clumsiness of modelling and a tendency to rounded outlines in the smaller appendages such as the mouth-parts which may be the result of the greatly increased pressure due to surface tension on strongly curved surfaces. With regard to some other characters we can only dimly guess at the mechanical principles that may be involved. It seems to be a general rule, to which *Bathynella* conforms, that in small Crustacea the setæ on the limbs are fewer in number and larger in relative size than in larger species. It is rare, in very small Crustacea, to find any of the appendages produced into long multiarticulate flagella. Where such flagella are present, as in the antennæ of the males of some Cumacea hardly larger than *Bathynella*, the segments of which they are composed are always much longer than wide. So, in the antennules and antennæ and in the thoracic exopodites of *Bathynella*, the small number of segments and their elongate form are very striking when compared with the same appendages of *Anaspides*.

VIII. THE CLASSIFICATION OF THE SYNCARIDA.

If we compare the characters of the living genera of Syncarida it is at once apparent that *Anaspides* and *Paranaspides* are closely related, while *Koonunga* and *Bathynella* differ widely from them and from one another.

There can, therefore, be no question as to the desirability of recognising the three families Anaspididæ, Koonungidæ, and Bathynellidæ. When, however, we attempt to define more closely the relationships between these families, and especially when we try to frame a scheme of classification to include the fossil genera as well, the matter becomes much more complicated.

The attractive simplicity of a dichotomous classification is always less easy to escape from and more likely to be misleading when the forms to be classified are few and the characters available for their discrimination are scanty. Such dichotomies have more than once proved a snare to the taxonomist of Crustacea¹ and they have already made their appearance in the attempts to classify the Syncarida. Thus Chappuis, in his preliminary paper on *Bathynella* (1914A, p. 47) proposed to divide the members of the group into Pleopodophora and Apleopodophora² according as they possess a full or a reduced series of abdominal appendages. In his later paper (1915, p. 172) at my suggestion, he based his division on the freedom or coalescence of the first thoracic somite, naming the groups Bathynellacea and Anaspidacea. Still more recently Vanhöffen (1916)³ has separated the genera that possess thoracic exopodites from the fossil genera in which these appendages have not yet been discovered, opposing the new name Duplicipoda to Fritsch's Simplicipoda. It would be difficult, perhaps, to find a basis of classification with less to commend it than that selected by Dr. Vanhöffen.

¹ We need only recall the false antitheses of Eñtomotraca and Malacostraca, Phyllopora and Cladocera, Edriophthalma and Podophthalma, Macrura and Brachyura. In each of these cases one of the paired groups has proved, on closer examination, to be a heterogeneous assemblage.

² Giving, by accident or by design, to the division that excludes *Bathynella* the group-name originally devised by Vejdovský (1899) for *Bathynella* alone.

³ I am again indebted to M. Chappuis for the loan of Dr. Vanhöffen's pamphlet.

I am still of opinion, for the reasons given above, that the freedom of the first thoracic somite is the most weighty morphological distinction between *Bathynella* and the other living *Syncarida*, and that it constitutes an important link between that genus and the fossil *Uronectes* and *Palæocaris*; but so long as this evidence of affinity remains unsupported by other characters I am doubtful as to the desirability of establishing a new sub-order for these three genera. It seems better to be content with a division of the *Syncarida* (or *Anaspidacea*) directly into families, following in this the example of Geoffrey Smith, although both the definitions and the contents of the families recognised by him require modification. Several of the fossil genera, such as *Nectotelson*, *Palæorchestia*, and *Gasocaris*, are so imperfectly known that it is impossible to be sure of their place in any system. *Præanaspidæ*, included by Geoffrey Smith in the family *Anaspididæ*, has proved (Calman, 1911) to be identical with *Palæocaris* which he placed in the *Gampsonychidæ*, although evidently suspecting that the two genera might be more closely related. With some changes in nomenclature recently made by Cockerell, the classification now stands as follows:

Division *Syncarida*, Packard, 1885.

Order *Anaspidacea*, Calman, 1904.

Family *Anaspididæ* (*Anaspidæ*, Thomson, 1893).

Genera *Anaspidæ*, Thomson; *Paranaspidæ*,
G. Smith.

Family *Koonungidæ*, Sayce, 1907.

Genus *Koonunga*, Sayce.

Family *Acanthotelsonidæ*, Cockerell, 1916
(= *Pleurocaridæ*, Chappuis, 1915).

Genera *Acanthotelson*, Meek and Worthen;
Pleurocaris, Calman.

Family *Bathynellidæ*, Grobben, 1904.

Genus *Bathynella*, Vejdovský.

Family *Uronectidæ*, Cockerell, 1916 (= *Gampsonychidæ*, Packard, 1885).

Genera *Uronectes*, Bronn (= *Gampsonyx*, Jordan nec Vigors = *Gampsonychus*, Burmeister); *Palæocaris*, Meek and Worthen (= *Præanaspides*, H. Woodward).

IX. THE AFFINITIES OF THE SYNCARIDA.

While the investigation of *Bathynella* throws little further light on the systematic relations of the Syncarida as a whole, a few comments may be made here on some opinions recently expressed on the subject. Geoffrey Smith, accepting the general scheme of classification adopted by me for the Malacostraca, regarded the Syncarida as standing near the direct line of descent of both Eucarida and Peracarida. He assumed, however, that the carapace, possessed by the primitive Eumalacostraca, was lost in the common ancestor of all three groups, and redeveloped independently by the Mysidacea on the one hand and by the Eucarida on the other. This assumption is not only improbable, but unnecessary. In the Carboniferous period there existed a considerable variety of Malacostraca, regarding which we know little more than that they possessed a carapace and the other characters of the "caridoid facies." It is not at all unlikely that some of these may have possessed all the characters that, in the Syncarida, we regard as primitive, and that from them may have been derived, by separate and diverging lines of descent, the present-day Syncarida, Peracarida, Eucarida, and Hoplocarida.

Other authors who have discussed the systematic position of *Anaspides* and its allies have been misled by the traditional classification of the Malacostraca into Podophthalma and Edriophthalma (or Thoracostraca and Arthrostraca), and have been unable to get rid of the idea that the group was in some way related to the "sessile-eyed" Crustacea. Thus Grobben (1904) places his group Anomostraca (a name that has no sort of claim to supersede Packard's Syncarida)

between Thoracostraca and Arthrostraca,¹ while Giesbrecht (1913) even goes so far as to include it as one of the divisions of the Arthrostraca. It may be worth while, therefore, to point out once again that the edriophthalmate orders are unmistakably linked, through the Apsseudidæ and Cumacea, with the lower Mysidacea (Lophogastridæ), and that in this series there is nowhere a place for the Syncarida. This affiliation rests on the evidence, not of one, but of a number of independent characters, which need not be recapitulated here, but which are in no way disposed of by Giesbrecht's bold assumption that the brood-pouch has been independently developed in Mysidacea, Cumacea, and Arthrostraca. As a matter of fact, although the Syncarida evidently form by themselves a division of equal rank with the Eucarida and Peracarida, the balance of characters inclines to ally them rather more closely with the former than with the latter.

X. LIST OF PAPERS REFERRED TO.

- Calman, W. T. (1896).—"On the Genus *Anaspides* and its Affinities with certain Fossil Crustacea," 'Trans. Roy. Soc., Edinburgh,' xxxviii, pp. 787-802, 2 pls.
- (1899).—"On the Characters of the Crustacean Genus *Bathynella*," 'Vejdovský,' 'Journ. Linn. Soc. Zool., xxvii, pp. 338-344, pl. xx.
- (1909). "Crustacea." In: 'A Treatise on Zoology,' edited by Sir Ray Lankester, pt. vii, fasc. 3.
- (1911).—"On some Crustacea of the Division Syncarida from the English Coal-measures," 'Geol. Mag.' (dec. v), viii, pp. 488-495, 5 text-figs.
- Chappuis, P. A. (1914A).—"Ueber die systematische Stellung von *Bathynella natans* Vejd.," 'Zool. Anz., xlv, pp. 45-47, 1 text-fig.

¹ Vanhöffen (1916) adopts Grobben's classification, but adds the remarkable opinion "dass die Ordnung [Anomostraca] keine natürliche ist, dass wohl ähnliche, aber nicht wirkliche nahe verwandte Formen in ihr vereinigt wurden."

- Chappuis, P. A. (1914 B).—“Ueber das Excretionsorgan von *Phyllognathopus vignieri*,” *ibid.*, xliv, pp. 568–572, 4 text-figs.
- (1915).—“*Bathynella natans* und ihre Stellung im System,” ‘Zool. Jahrb. Abth. Syst.’ xl, pp. 147–176, pl. iii, 17 text-figs.
- Claus, C. (1876).—‘Untersuchungen zur Erforschung der genealogischen Grundlage des Crustaceen-Systems.’ 4to, Wien.
- Cockerell, T. D. A. (1916).—“The Uropods of *Acanthotelson stimpsoni*,” ‘Journ. Washington Acad. Sci.’ vi, pp. 234–236, 1 text-fig.
- Giesbrecht, W. (1910).—“Stomatopoden. Erster Thiel,” ‘Fauna u. Flora d. Golfes v. Neapel,’ Monogr. xxxiii.
- (1913).—“Crustacea.” In: ‘Handbuch der Morphologie,’ herausg. v. Arnold Lang,’ iv, pp. 9–252, 356 text-figs.
- Grobben, K. (1904).—‘Lehrbuch d. Zoologie, begründet von C. Claus.’ 7 Aufl., 1ste Hälfte, Marburg.
- Lankester, E. Ray (1880).—‘Degeneration: A Chapter in Darwinism.’ Nature Series, London.
- Lister, J. J. (1909).—“Crustacea.” In: ‘A Student’s Text-book of Zoology,’ by Adam Sedgwick, vol. iii.
- Sars, G. O. (1885).—“Report on the Schizopoda.” ‘Rep. Voy. Challenger, Zool.’ xiii, 228 pp., 38 pls.
- Sayce, O. A. (1908).—“On *Koonunga cursor*, a Remarkable New Type of Malacostracous Crustaceans,” ‘Trans. Linn. Soc. (2) Zool.’ xi, pp. 1–16, pls. i, ii.
- Smith, Geoffrey (1909).—“On the Anaspidacea, Living and Fossil.” ‘Quart. Journ. Micr. Sci.’ 53, pp. 489–578, pls. xi, xii, text-figs.
- Thompson, D’Arey W. (1917).—‘On Growth and Form.’ Cambridge Press.
- Thomson, G. M. (1894).—“On a Freshwater Schizopod from Tasmania,” ‘Trans. Linn. Soc. (2) Zool.’ vi, pp. 285–303, pls. xxiv–xxvi.
- Vanhöffen, E. (1916).—“Die Anomotraken,” ‘Sitz. Ber. Ges. natf. Fr. Berlin.’ 1916, No. 3, pp. 137–152, 15 text-figs.
- Vejdovský, F. (1882).—‘Thierische Organismen der Brunnenwässer von Prag.’ 4to, Prag.
- (1899).—“Ueber die systematische Stellung des Brunnenkrebse *Bathynella natans*” (Czech), ‘Sitz. Ber. k. böhm. Ges. Wiss. Prag.’ 1898, No. 14.

**On *Oxnerella* *maritima*, nov. gen., nov. spec.,
a New Heliozoon, and Its Method of Division;
with Some Remarks on the Centroplast of
the Heliozoa.**

By

Clifford Dobell,

Imperial College of Science, London, S.W.

With Plate 27.

IN 1913 I found a minute and pretty heliozoon in some small tanks of sea-water in which I had been cultivating Foraminifera, *Trichosphærium*, and other marine Protozoa. For some weeks the organisms multiplied rapidly and became very abundant. I studied them alive as carefully as possible, and made a number of fixed and stained preparations in order to study their method of division in detail. I also made a number of notes and drawings at the time, but was too much occupied with other work to set them in order for publication. As the organisms seem not to have been described hitherto, and as their division presents certain features of interest, I now take the opportunity of putting my observations on record.

1. GENERAL DESCRIPTION OF THE ORGANISMS.

Morphology.—The living organisms are typical sun-animalcules of very small size. They are almost spherical, with numerous filamentar pseudopodia radiating in all directions (see Pl. 27, fig. 1). The pseudopodia are so extremely fine that no internal structure can be made out in them, save

at their somewhat thicker proximal ends. Here it can be seen that each is provided with a very slender axial rod or fibre, which passes into the centre of the animal. Although sometimes visible, with difficulty, in the living organism, the pseudopodial axes are much more easily distinguishable in fixed and stained¹ specimens (see Pl. 27, fig. 2), in which they appear as almost immeasurably fine radiating lines. In short, the pseudopodia appear to be, on a very small scale, axopodia such as are characteristic of most Heliozoa.

The axes of the pseudopodia can be traced (Pl. 27, figs. 1, 2) through a clear area in the centre of the animal to a minute corpuscle—a so-called “central granule”—in which they are rooted. This little body is not always easily seen in living specimens, on account of its very small size, and on account of the many food-bodies present in the surrounding protoplasm. But in stained preparations it is always visible (cf. Pl. 27, fig. 2), and presents various appearances which will be described below. The arrangement of the pseudopodia and “central granule” is similar to that already described in *Acanthocystis*, *Wagnerella*, and other Heliozoa.

Many of the pseudopodia of a living specimen are extremely long, attaining a length equal to three or four times the diameter of the animal's body (cf. Pl. 27, fig. 1). In fixed and stained specimens, however, they are usually much contracted, and consequently appear shorter and fewer (Pl. 27, fig. 2). During life they are studded irregularly with numerous minute granules (Pl. 27, fig. 1), which constantly stream up and down them. These streaming granules are already well known in other Heliozoa.

With the exception of the clear area surrounding the

¹ I fixed and stained the organisms in various ways. The best fixation was obtained with Bouin's fluid and Schaudinn's sublimate-alcohol; and by far the best of the stains which I tried was my alcoholic iron-alum hæmatein, which I have described elsewhere (Dobell, 1914). All the figures here reproduced were stained by this method, which for delicacy and detail can hardly be surpassed.

central granule, all the protoplasm of the body is usually closely packed with ingested food-bodies (Pl. 27, fig. 1). The protoplasm itself is colourless. There is no obvious differentiation of the cytoplasm into ectoplasm and endoplasm.

There is no contractile vacuole, no stalk, and no spicular skeleton, either external or internal; nor is a gelatinous investment present.

There is a single relatively large nucleus (Pl. 27, figs. 1, 2), which is vesicular, with a large central karyosome. The nucleus is excentrically placed, and usually ovoid, its more pointed end being directed towards the centre of the organism (Pl. 27, figs. 1, 2). Those pseudopodial axes which lie in contact with the nuclear membrane often stain more deeply than the rest, and thus appear as dark lines traversing the surface of the nucleus. (This can be seen in the nucleus shown in Pl. 27, fig. 7.)

Most specimens are not perfectly spherical, and the ingested food-bodies often project above the surface of the body, giving it an irregular contour. It is thus impossible to measure the diameter of most individuals with great accuracy. The diameter of fifty fixed and stained specimens (all nearly spherical, and not dividing), measured as nearly as possible, showed a range from about 10μ to 22μ , the mean being about 14μ .

2. SYSTEMATIC POSITION.

From the foregoing brief account of the structure of this heliozoon, it will be clear that it belongs to the group of naked forms (such as *Actinosphærium*, etc.) which constitute the order *Aphrothoraca* of R. Hertwig. Schaudinn (1896) enumerates nine genera in this order, which all differ in important particulars from the present form. *Actinolphus*, *Zooteira*, and *Wagnerella* (= *Haeckelina*) are stalked; *Actinosphærium* and *Gymnosphæra* are multinucleate, and possess sharply differentiated ectoplasm and endoplasm; *Actinophrys* is uninucleate, but possesses

no central granule; and the pseudopodia of *Monobia*, *Myxastrum*, and *Camptonema* are so different in various ways from those of the form under consideration that it is impossible to place it in any of these genera. There is no genus which combines the characters peculiar to my organisms—namely, pseudopodia with axial fibres rooted in a central granule; a single nucleus; no contractile vacuole; no distinct ectoplasm and endoplasm; no stalk.

It therefore appears necessary to introduce new generic and specific names for the present form, and I propose to call it *Oxnerella*¹ *maritima*, n. g., n. sp. It will be seen, I think, that *Oxnerella* bears much the same relation to *Gymnosphæra* that *Actinophrys* does to *Actinosphærium*; for *Actinophrys* is like a uninucleate *Actinosphærium* just as *Oxnerella* is like a uninucleate *Gymnosphæra*.

3. HABITS, HABITAT, ETC.

Of the habits of *Oxnerella* little need be said, for it does not differ in any important ways from many familiar Heliozoa. A few points are worth noting, however.

As the organisms occurred in cultures, I can only describe their behaviour in these; and it is possible that in nature their habits are different. Nevertheless, they appeared so healthy and normal that I do not suppose the differences can be very great.

The animals often float freely in the water, but display a special predilection for the surface film. Many of them were always to be found also at the bottom of the culture-tanks and on the sides, and in these situations they were generally more or less firmly attached by their pseudopodia to the substratum. When the cultures were well stocked, the organisms could be "fished" with a pipette at all levels, and were found attached to all the objects (algæ, stones, etc.) in

¹ In honour of my friend, Dr. Mieczyslav Oxner, of the Musée Océanographique, Monaco.

the aquaria. Cover-glasses suspended at varying depths in the water by means of cotton threads were generally found to have many animals adherent to them after they had been left for one or two days. As animals such as these are not able to swim in any way, their distribution through the motionless water of a tank is probably brought about somewhat as follows: They lie first of all on the bottom—a position which they always take up when removed from one vessel to another. They then creep along the bottom, and up the sides of the aquarium until they reach the surface film. They crawl along this by means of their pseudopodia, and then, becoming detached, they fall slowly towards the bottom once more, alighting upon any foreign body which they may encounter on the way. In nature, no doubt, they are much more extensively distributed by the movements of the water.

The creeping movements of an *Oxnerella* may be easily observed on a slide under the microscope. If it is not unduly compressed by a cover-glass, it will begin to move about slowly as soon as it has recovered from the shock of being mounted in the preparation. It progresses by a gentle half-gliding, half-rolling motion, dragging itself along by means of its pseudopodia.

One of the features which first attract attention on closely observing the living animal is the streaming of the minute granules on the pseudopodia—of which mention has already been made. Although this streaming is well known in other Heliozoa, the mechanism by which it is brought about is still unexplained, and the motions of the granules are really very puzzling if observed for any length of time. The “granules” are generally supposed to be little knobs or thickenings of the protoplasm of the pseudopodium—an opinion shared by Schaudinn (1896); but it is not impossible that they are really adherent foreign particles borne along by mucus currents. I have been unable to satisfy myself on this point, either in the case of *Oxnerella* or of other forms displaying the same phenomenon. I have observed that the “granules” do not all stream in the same direction, even on the same

pseudopodium. They may at times be seen to meet one another when coming from opposite directions, and, after appearing to jostle one another for a moment, travel away in opposite directions—sometimes returning along their former paths, sometimes passing one another. In such circumstances their movements appear curiously purposive, and they remind me of the equally remarkable movements of the spindle-shaped bodies (individual organisms?) in the living network of a *Labyrinthula*.

Oxnerella, like other Heliozoa, largely uses its pseudopodia for capturing its food. In the aquaria this consisted almost entirely of the swarm-spores of green algæ, which were plentiful. The living animals were generally filled with the bright green bodies of these (Pl. 27, fig. 1), in various stages of digestion, and under a low magnification themselves appeared to be green in consequence.

The water in which *Oxnerella* occurred was sent to London from Plymouth. But it is quite likely that the organisms are widely distributed and by no means uncommon in the sea, and have hitherto escaped notice on account of their minute size.

4. DIVISION.

My chief reason for describing *Oxnerella* is to enable me to record and figure in detail its method of multiplication by division. I shall therefore enter into this matter now with some particularity.

The two organs whose behaviour is of special interest in division are the nucleus and the so-called "central granule," to which the axial fibres of the pseudopodia are attached. I shall therefore begin by describing these two structures in the "resting" (i. e. not dividing) organism in greater detail.

The Nucleus.—On account of its somewhat large size and its lack of colour, the nucleus of *Oxnerella* can usually be made out quite clearly in the living organism. It lies embedded among the bright green food-bodies present in the

cytoplasm (see Pl. 27, fig. 1), and it is therefore sometimes necessary to compress the creature slightly with the cover-glass in order to see its nucleus distinctly. In the living organism the nucleus appears as a relatively large vesicle surrounded by a distinct nuclear membrane, and containing a large central karyosome (Pl. 27, fig. 1). Between the membrane and the karyosome there is a clear zone, in which I have not been able to make out any structure in the fresh state (Pl. 27, fig. 1). But in fixed and stained specimens (Pl. 27, fig. 2) not only can all the structures just described be seen, but in addition the clear zone appears filled with minute chromatin granules supported on an indistinct achromatic network. These appearances are very constant after fixation and staining in various ways, and I incline to the view that the minute granules in the clear zone are actually present—though invisible—in the living organism, and not produced by fixation.

The karyosome appears to be almost homogeneous. It stains uniformly with ordinary chromatin stains, but in iron-hæmatein preparations it usually appears rather paler in the centre than at the periphery (Pl. 27, fig. 2). It contains no granules of any sort.

As already noted, the nucleus is usually oval in outline. It may be noted further that it appears to be rigidly fixed in position. It is not possible to displace it by slight pressure; and even if pressure so great be applied to an organism as to burst it completely and set free most of its enclosed food-bodies, the nucleus still remains behind in the débris of the body. It is probable, I think, that the axial fibres of the pseudopodia which cross the nuclear membrane, and stain more deeply than the rest, are really attached to the nucleus and serve to anchor it in position (see Pl. 27, fig. 7).

The nucleus in the resting state is about 4μ – 5μ in greatest diameter, ranging from about $3\cdot3\mu$ to $5\cdot5\mu$.

The "Central Granule."—As I shall often have to refer to this important organ in the course of the ensuing descriptions, it seems desirable to give it a name. The term

“central granule” is a periphrasis which does not correctly describe its structure, nor indicate its most important functions; and for brevity, and also for other reasons which will be clear later, I propose to call the organ in question a centroplast.

In a living *Oxnerella* the centroplast is with some difficulty visible as a minute spherical corpuscle lying at the centre of the organism (Pl. 27, fig. 1). It is rather feebly refringent, and is surrounded by a clear zone of protoplasm quite free from all food-bodies or granules. The size of this zone varies a good deal in different individuals. Radiating from the centroplast and traversing the clear zone in all directions can be seen the central ends of the axial fibres of the pseudopodia.

In fixed and stained specimens all these structures can be studied in greater detail. The centroplast itself (Pl. 27, figs. 2, 5) generally appears as a minute clear sphere with a deeply-staining granule at its centre. The periphery of the sphere stains deeply, as though it were clothed with a very delicate membrane. The axial fibres, when traced through the clear zone of protoplasm towards the centroplast, appear to terminate in minute knobs or granules on its external membrane, and cannot as a rule be traced beyond this to its central granule (Pl. 27, fig. 5).

The central granule of the centroplast stains deeply with iron-hæmatein, less deeply with carmine stains. In its entirety the centroplast thus resembles a tiny nucleus with a karyosome and nuclear membrane.

If one examines with care the centroplasts of a number of different individuals, it can be seen that they do not all present the appearances just described, though these are the most usual. In certain individuals no differentiation into central granule and surrounding membrane can be discovered. The entire centroplast is a minute, deeply-staining, and homogeneous dot (Pl. 27, fig. 3), to which the pseudopodial fibres appear to be attached directly. In other specimens a very minute central granule appears to have become

differentiated in the centre of this minute darkly-staining mass (Pl. 27, fig. 4); and still other specimens show gradual transitions to the "typical" form of centroplast (Pl. 27, fig. 5). Further, organisms can also be found in which the whole centroplast seems to have greatly increased in size (Pl. 27, fig. 6). The central granule is larger, and the clear zone separating it from the membrane has also expanded. In such specimens the axial fibres seem no longer to terminate on the membrane, but to pass through it to the central granule. I believe they are actually attached to this, but from the very small size of all the structures it is hardly possible to be absolutely certain of their relations. This last condition (Pl. 27, fig. 6) affords an easy transition to that first described (Pl. 27, fig. 3).

The appearances just described strongly suggest that cyclical changes occur in the centroplast of the "resting" animal. Similar appearances have already been described and thus interpreted in *Wagnerella* (Zülzer, 1909). Comparison, moreover, with the cyclical changes described in the centrosome of the metazoan egg (Vejdovský and Mrázek, 1903) at once suggests itself. Although both the interpretation and the comparison appear to me justifiable, I am not completely convinced of their correctness; and I am at a loss to understand what function the "cyclical changes" in *Oxnerella* can subserve. I thought at one time that they might perhaps play some part preparatory to the division of the organism—for the centroplast has, as will be seen later, an important function in this process. But since the structure of the centroplast is "typical" (Pl. 27, fig. 5) immediately before division and immediately after, this seems to me improbable. There is no obvious reason why it should pass through a cycle of changes—returning finally to its original condition—during the interdivision period.

General Account of the Process of Division.—Before describing in detail the successive phases of division it will be convenient to give a brief general outline of the process.

Division is, in all cases which I have observed, an equal binary fission, resulting in the production of two small organisms exactly like the parent organism in everything save size. Although the organisms which are about to divide are usually of large size, this is not always the case. I have seen a number of quite small forms in various stages of the process. Again, most dividing organisms are filled with food-bodies, but this is not always so. Illustrations of this will be found in the figures.

During division the animal remains at rest, with all its pseudopodia completely retracted. Not until the two daughter-organisms are completely separated do the pseudopodia again make their appearance. I believe, moreover, that the animal is always attached to some substratum during division; that is to say, it does not divide while floating freely in the water. I infer this from the fact that I never obtained any division stages in organisms suspended in the water; whereas I obtained many in the organisms attached to cover-glasses floating on the surface film or placed at various levels in the aquaria. Most of the dividing organisms were found attached to the surface film.

The nucleus divides by mitosis, the centroplast playing the part of a centrosome. The whole process can really be seen at a glance by inspecting the figures (Pl. 27, figs. 8-22), but the following brief account may be given in amplification.

Prophases.—The centroplast is the first organ to divide. Immediately before division it is in the "typical" condition (Pl. 27, fig. 5), displaying a large central granule and a distinct membrane. It then becomes elongated, and the central granule divides into two (Pl. 27, fig. 7). In the early stages of division the central granule appears (see Pl. 27, fig. 7) as a minute cylindrical body with two deeply-stained polar caps—presumably halves of the original granule. A little later, however, the caps become minute spherical granules, connected by a deeply-staining strand (Pl. 27, fig. 8). This appearance is exactly comparable with that of a dividing centrosome, at the stage when the daughter-centrosomes are

united by a centrodosome. Up to this stage (Pl. 27, fig. 8) the animal remains spherical, with a few pseudopodia still visible. These are now completely retracted, and the animal becomes drawn out into an elongate form. As it does so, the daughter-centroplasts draw further apart, but still remain connected by their "centrodosome," which occupies the centre of the long axis of the body (Pl. 27, fig. 9). The dividing centroplast at this stage appears, in consequence, as a much attenuated dumb-bell. The centrodosome is an excessively fine but quite distinct line. Throughout the division of the centroplast the central ends of the axial fibres of the pseudopodia are visible, radiating through the cytoplasm exactly like the astral rays of a centrosome (Pl. 27, figs. 8, 9).

The "centrodosome" now vanishes, and the two daughter-centroplasts are seen—each surrounded by a few short "astral rays"—to occupy symmetrical positions at opposite ends of the organism.

During the early stages of the division of the centroplast the nucleus increases in size (Pl. 27, fig. 8). As the animal elongates, the nucleus gradually travels towards the middle of the body, until it finally takes up a position midway between the two daughter-centroplasts (Pl. 27, figs. 8-11). During this translocation the nucleus usually has an irregular, misshapen appearance (Pl. 27, figs. 9, 10). Sometimes, also, its karyosome becomes fragmented (Pl. 27, fig. 10). But as soon as it reaches its station between the two centroplasts, it recovers its spherical form and lies as a large and conspicuous vesicle at the very centre of the whole animal (Pl. 27, fig. 11). The karyosome now begins to diminish in size (Pl. 27, figs. 11, 12), and as it does so, the chromatin granules in the rest of the nucleus increase in size and number. These granules, therefore, are probably formed in part at the expense of the karyosome.

During these nuclear stages, the centroplasts also undergo changes. They become more or less elongated in a direction transverse to the long axis of the dividing organism (Pl. 27,

figs. 11, 12). Their central granules thus appear as short rods, sometimes slightly knobbed at the ends.¹ The length of these "rods" is different in different individuals (cf. for instance, Pl. 27, fig. 11, with Pl. 27, fig. 12).

A definite spindle now begins to make its appearance between the centroplasts. At first (Pl. 27, fig. 12) a few spindle-fibres only can be seen, stretching from the centroplasts to the nucleus. They gradually become more conspicuous and numerous, however, until a perfect spindle figure is produced, with the centroplasts at its poles—exactly like typical centrosomes (Pl. 27, figs. 13, 14). Whilst the spindle is forming, the nucleus undergoes further changes. The karyosome disappears; the chromatin granules become fainter, and chromosomes make their appearance arranged transversely across the nucleus (Pl. 27, figs. 12, 13). Meanwhile the nuclear membrane becomes less distinct, and the nucleus becomes drawn out towards the poles of the spindle, as though it were actively pulled by the spindle-fibres of the centroplasts (Pl. 27, figs. 12, 13). Finally, the nuclear membrane vanishes, the chromosomes take up their position on the equatorial plate, and a typical mitotic figure results (Pl. 27, fig. 14).

There are several details which I have not been able to make out with certainty, chiefly on account of the very small size of all the structures concerned. In the first place, the mode of origin of the chromosomes in the nucleus is extremely difficult to ascertain. The appearances are as I have just described them, and the following seems the most plausible interpretation. The chromosomes are formed chiefly (or wholly) from the substance of the karyosome—as in certain amœbæ and other Protozoa (see, for example, Dobell (1914), Jameson (1914), etc.). The "chromatin" granules surrounding the karyosome in the resting nucleus probably disinte-

¹ It is probable, I think, that this appearance should be interpreted, not as a rod with knobbed ends, but as an optical section of a disc with a thickened rim, viewed edgewise. The structure is too small, however, for me to speak with certainty.

grate, and pass on to the spindle-fibres (Pl. 27, figs. 11-14), which are very dark and granular between the "asters" and the equatorial plate (Pl. 27, fig. 14). I have found no spireme stage in the prophases, but am not prepared to deny its occurrence.

I have not succeeded in counting the chromosomes on the equatorial plate. They are extremely small and in the form of short rods so closely packed together (Pl. 27, fig. 14) that their number can only be roughly guessed. As the equatorial plate is probably in the form of a ring, and as rather more than ten chromosomes can as a rule be counted across it when presented edgewise, I estimate the chromosome number as probably about twenty-four.

There are some peculiarities in the spindle which require further notice. At all stages, after it is fully formed, it shows a differentiation into two parts, which do not stain alike. There is, first, an unstained or achromatic central area immediately surrounding the equatorial plate (Pl. 27, fig. 14), so that the whole of the middle part of the spindle may be compared with a tiny clear globe with the chromosome ring forming its equator. Secondly, there is, on either side of the clear central part, a more deeply-stained and granular portion of the spindle which resembles a truncated cone with its apex directed towards the centroplast (Pl. 27, figs. 14, 15). The cones become paler in the region of the centroplasts, and the ends of the spindle-fibres appear to be rooted partly in the central granules of the latter, and partly in their membranes (Pl. 27, fig. 14). There is no sharp demarcation between the achromatic central part of the spindle and the stainable cone-like ends, so that the two parts appear to be differentiations of one and the same structure—the spindle—rather than separate elements. They are, no doubt, respectively homologous with the so-called "polar plates" and "achromatic cones" described in the mitotic figures of *Actinosphaerium* (cf. Brauer (1894), R. Hertwig (1898)).

Metaphase.—The chromosomes on the equatorial plate now divide so that two daughter-plates are formed. It is not

possible to ascertain how the chromosomes divide, on account of their extremely small size. But since the chromosomes on the equatorial plate appear to be short rods (Pl. 27, fig. 14), and those at the metaphase smaller granules (Pl. 27, fig. 15), it seems probable that the chromosomes themselves divide by a transverse constriction into two.

Anaphases.—The daughter-groups of chromosomes now move apart, gradually passing towards the poles of the spindle (Pl. 27, figs. 16, 17, 18). As they do so, they become still more closely packed together, and individual chromosomes can no longer be resolved. In the early anaphases (Pl. 27, fig. 16) distinct spindle-fibres can be seen between the chromosome groups, but later the fibres become less distinct and more irregular (Pl. 27, figs. 17, 18). Simultaneously, the differentiated structure of the spindle becomes less distinct, and finally vanishes.

During the anaphases the centroplasts at the poles of the spindle also undergo certain changes. Their central granules are often much drawn out during the later stages, so that they appear in optical section as fairly long rodlets (Pl. 27, figs. 17, 18). These then shorten, and thicken somewhat, and they then become bent into the form of incomplete rings, open on the side nearest the spindle (Pl. 27, fig. 20). Finally, a closed ring is formed, which becomes converted into a minute, homogeneous, darkly-staining central granule in each daughter-centroplast (Pl. 27, fig. 19). All these changes occur during the late anaphases and early telophases, and they do not always synchronize with the nuclear changes. For example, Pl. 27, fig. 20, shows an earlier stage in the reconstruction of the centroplast than Pl. 27, fig. 19, though the nuclear stage in Pl. 27, fig. 19, is earlier than that in Pl. 27, fig. 20. Centroplast and nucleus are thus independent of one another to some extent at this period. I have found a good deal of variation in this respect in different individuals. In at least one specimen I have seen the centroplasts completely reconstructed, and spindle-fibres no longer visible, before the telophases had begun.

Telophases.—At the end of the anaphase stages each set of chromosomes breaks up into a ball of deeply-staining granules, with which probably a part of the substance of the spindle becomes incorporated to form the daughter-nuclei (Pl. 27, fig. 19). Between these two nuclei the spindle-fibres rapidly disappear (Pl. 27, figs. 19, 20). As reconstruction of the nuclei proceeds, a part of the chromatin becomes aggregated at the centre of each, forming the new karyosomes (Pl. 27, figs. 19, 20). The daughter-nuclei then soon assume the structure characteristic of the ordinary resting nuclei. The stages in this process will be evident from the figures without further description (Pl. 27, figs. 20–22), since they do not differ from the telophases of many other nuclear divisions—for instance, those in *Amœba glebæ*, which I have elsewhere described (Dobell, 1914).

Constriction of the protoplasmic body of the organism into two begins during the anaphases (cf. Pl. 27, figs. 17, 18), and is completed during the telophases (Pl. 27, figs. 20–22). As the two little daughter-individuals separate they gradually form their pseudopodia, the axes of which can be seen to spring from the new centroplasts (Pl. 27, fig. 22). Each animal very soon acquires the typical form of the adult, with central centroplast, excentric nucleus in close relation to it, and so on. Each daughter-organism also “inherits” about an equal share of the food-masses of its parent.

It is perhaps worthy of note that the final constriction of the body into two is preceded by a stage in which there is a narrow strand of protoplasm connecting the two organisms. (See Pl. 27, fig. 21. In later stages, before complete separation, the strand becomes much finer before it snaps.) This detail in division distinguishes some of the free-living amœbæ—e. g. *A. glebæ* and related forms—from others, in which the constriction is effected more sharply, without the persistence of a connecting strand (e. g. “*A. limax*” and related forms).

I have not been able to watch the whole process of division, from beginning to end, in the same living organism. I have

found it impossible to study the dividing nucleus in unstained specimens, on account, probably, of the small size of all the structures concerned. Elongated organisms—which are seen, in stained specimens, to be at any stages of the prophase or metaphase—complete their division in times varying from about five minutes to a quarter of an hour. These are the only living forms which I have been able to recognise as forms about to divide; and they are actually, as will be evident, already somewhat far advanced in the process. On analogy with other organisms, and from the few observations which I have been able to make, I should estimate the total time taken for division at about twenty minutes to half an hour.

5. SOME REMARKS ON THE CENTROPLAST OF THE HELIOZOA.

I propose to terminate this account of *Oxnerella* with a brief consideration of certain problems presented by the centroplast. Although this organ is probably peculiar to a small section of the Heliozoa—for it is not known to be present in any other organisms—a consideration of its functions and homologies leads to some of the fundamental problems in the morphology of the Protozoa.

The facts so far established concerning the centroplast may first be enumerated before their interpretation is discussed. They can, I think, be best reviewed in their historic order.

The centroplast appears to have been first seen in *Acanthocystis* by Grenacher (1869). He figured it, and described it as “a tiny pale corpuscle” lying at the centre of the organism. He believed, moreover, that the axial fibres of the pseudopodia were rooted to it; but he was unable, as he says, “to prove a direct connexion.” The proof was, however, soon furnished by F. E. Schulze (1874), R. Hertwig (1877), and others. All later workers have confirmed their observations, and extended them to all the Heliozoa known to possess centroplasts.

The anatomical relations of the centroplast having been

thus established, it became obvious that at least one function of this organ is skeletal; it serves as a central point of attachment, or focus, for the axial fibres of the radiating pseudopodia. But whether the centroplast possessed any other function was not apparent from its morphological relations, and had, therefore, still to be proved.

About a quarter of a century ago, the centrosome, then recently discovered by E. van Beneden, was occupying the attention of most cytologists. If an *Acanthocystis* is homologous with a metazoan cell—as it was generally supposed to be—and its nucleus homologous with the cell's nucleus; then if the centrosome is a permanent organ in the cell—as was also then generally believed—there ought clearly to be some corresponding organ in the *Acanthocystis*. And seemingly there was: there was the centroplast, already described and figured exactly like a centrosome. It was therefore almost inevitable that someone should suggest that centrosome and centroplast are homologous structures.

So far as I am aware, the first suggestion of this homology to appear in print came from Bütschli (1892). It was, however, nothing more than a suggestion based upon the striking structural similarity of the two organs—a similarity which is, as I shall try to show, somewhat misleading.

At about this time a new fact was brought to light by Sasaki. Whilst studying a new heliozoon (*Gymnosphæra albida*), he discovered that the division of the whole organism is preceded by a division of the centroplast—a fact which justified him, more than a mere structural resemblance could, in homologizing this organ with the centrosome of a metazoan cell. It should be noted that Sasaki's observation had been made and written down by him in 1891,¹ although it was not published until 1894. To the Japanese zoologist, therefore, belongs the credit, not merely of first suggesting that the centroplast is the homologue of a centrosome, but of having

¹ See footnote to Sasaki's paper (p. 45) by R. Hertwig.

discovered an important fact upon which this homology could be based.¹

Now the heliozoon studied by Sasaki (*Gymnosphaera*) is multinucleate, though it possesses but a single centroplast; and he was unable to demonstrate that this organ plays the part of a centrosome during the nuclear divisions. To this extent, therefore, the suggested homology of centroplast and centrosome remained unsupported by facts.

This deficiency was soon made good. In a brief but memorable paper, published in 1896, Schaudinn (1896A) described the division of *Acanthocystis aculeata*, a heliozoon possessing a centroplast and a single nucleus. "From this brief account," he says, "it will, I think, be clear that the nuclear division in the heliozoon investigated takes place in essentially the same way as the typical mitosis of a metazoan cell, and that the central granule [= centroplast] corresponds to the centrosome of the metazoan cell." Schaudinn published only six figures of division stages in *Acanthocystis*, leaving many gaps which he promised to fill in his full account, which was never published. He stated further that he had observed similar phenomena in *Acanthocystis turfacea*, *A. myriospina*, *Raphidiophrys*, *Sphaerastrium*, and *Heterophrys*. The division of all these forms is still unknown—or, at least, undescribed; and no full account of the division of *Acanthocystis aculeata* has ever appeared.

To my knowledge, only one partial confirmation of Schaudinn's statements has hitherto been published. I refer to Zuelzer's description of *Wagnerella* (1909). Of several different methods of nuclear division described by the authoress in this peculiar heliozoon, there is one in which the centroplast appears to behave like a centrosome.² But although

¹ Another Japanese zoologist—Watasé—put forward the same suggestion in 1894. In the same year, also, Heider demonstrated the centroplast of *Raphidiophrys*—previously described by F. E. Schulze—and emphasized its resemblance to a centrosome. Both these workers, however, knew beforehand of Sasaki's results.

² I refer to the multiple division of the "head" of the organism, whereby a brood of young is formed. I do not consider the other

the centroplast appears to divide before the nucleus, and to take up the position of a centrosome during the division of the latter, it is a curious fact—assuming the account to be correct—that the nuclear division itself is apparently a kind of amitosis. These observations do not furnish a very substantial confirmation, therefore, of Schaudinn's statement that the centroplast plays the part of a centrosome in the mitosis of the heliozoan nucleus.

It has long seemed to me desirable that the behaviour of the centroplast during the division of those Heliozoa possessing this organ should be carefully studied and described. As experience has shown, Schaudinn's brief statements and incomplete descriptions are not always to be accepted as established facts; for the magnitude of his mistakes is beginning already to rival that of his successes.

It is for this reason that I have described the division of *Oxnerella* in some detail. My own observations induce me to believe that Schaudinn's account of the division of *Acanthocystis* is almost certainly correct; and it therefore appears to me justifiable to conclude that the centroplast actually does behave during nuclear division, in those Heliozoa which possess a single nucleus, precisely like the centrosome in a typical mitosis in a metazoan cell. We have still to learn, however, the part (if any) played by the centroplast in the division of those Heliozoa which are multinucleate.

Although I follow Schaudinn up to a certain point—as just noted—I am unable to concur in his speculations. On the evidence of the observations just considered, but more especially from his observations on the origin of the centro-

methods of nuclear division in which a "centriole" is said to be present, and later to become the centroplast of a new individual. Although this is several times stated to occur, I can find no direct evidence in support of the statement, which appears to be merely an assumption based upon Schaudinn's statements about *Acanthocystis*. Accordingly, I do not think Zuelzer's assertions can be regarded as confirmations of Schaudinn's results.

plast in the young forms of *Acanthocystis* produced by budding, he was led to advance certain views, now well known, on the phylogeny of the centrosome. These views depend, for their validity, upon the assumptions (1) that his observations on the Heliozoa were correct (those relating to the buds—the most important for his speculations—have never been confirmed); (2) that the centroplast and the centrosome are homologous organs; (3) that the Protozoa, being “primitive animals,” furnish us with data for determining the phylogeny of the Metazoa. As regards the first assumption, I would merely note that the observations in question have been confirmed in part only. As regards the third, I will only say that I regard it, as I have elsewhere pointed out (1911) as wholly unjustifiable. Concerning the second assumption I shall here say a few words.

For reasons which I have given elsewhere (1911), I do not regard any single protozoon as the homologue of a metazoan cell. A single individual heliozoon—e. g. an *Oxnerella*—is, in my view, comparable with a single whole metazoon, and not with one of the cells of which it is composed. An *Oxnerella* is a whole non-cellular organism, whilst a metazoon is a similar whole organism whose body is differentiated into cells. The one displays a non-cellular, the other a cellular, morphological composition. It follows, therefore, that we have no reason to assume that those organs and structures which are peculiar to the cell must have a morphological counterpart in the individual protozoon.

Now the centroplast of *Oxnerella* and other similar Heliozoa is not an organ whose activities are limited to a transient phase in the life of the organism—the momentary process of division. It is, on the contrary, a complex structure, permanently present, which plays a skeletal part in the organism as a whole, and in connexion with its organs of locomotion and prehension, and a totally different part as an accessory to the process of division. It plays the part of a centrosome, but it does much more. On the other hand, it seems probable that the centroplast of multinucleate Heliozoa

(e. g. *Gymnosphæra*) is only skeletal in function, and plays no part in nuclear division. (This has still to be determined, but it is not easy to conceive how a single centroplast could act as centrosome to many different nuclei.) The centroplast of the Heliozoa is thus closely comparable with the blepharoplast of the Mastigophora—an organ permanently subserving a skeletal function to the organs of locomotion (the flagella), and in some forms assuming the office of centrosome at division, in others playing no part in this process (as in some trichomonads and in *Copromonas* respectively, as I have shown in two earlier papers (1909 and 1908)). To say that either the centroplast or the blepharoplast is the homologue of the metazoan centrosome, and to apply the same term to all these structures, appears to me, therefore, inadvisable. By giving so wide a connotation to the term "centrosome" we shall effect an economy in words; but we shall introduce a confusion of thought by grouping together, as the same, certain structures which are in many ways radically different. In the language of the older morphology, I would say that the centroplast and the centrosome may be analogous, but are not homologous, organs.

For these reasons, in addition to those based on general grounds, I consider that all phylogenetic speculations regarding the centrosome, based on a comparison of the Heliozoa—or any other Protozoa—with the cells of Metazoa, should be viewed with considerable scepticism. Opinions on such matters differ, and always will differ; but for my own part, such views as those of Schaudinn, and his many followers, on the "phylogeny of the centrosome," appear to be mere speculations which are not only improperly called "theories," but are even outside the limits of legitimate hypothesis.

6. DIAGNOSIS OF OXNERELLA MARITIMA.

In conclusion I will add a brief diagnosis of *Oxnerella*, which will serve at the same time as a summary of the facts recorded in previous pages.

Oxnerella maritima nov. gen., nov. spec. Aphrotho-

racan heliozoon of very small size ($10\ \mu$ to $22\ \mu$ in diameter); spherical, with numerous very fine radiate pseudopodia (axopodia) with streaming granules and with axes rooted in a centrally placed centroplast; no stalk, no contractile vacuole, no gelatinous investment, no spicular skeleton, no sharply-differentiated ectoplasm and endoplasm. Nucleus single, large, excentric; vesicular, with large central karyosome. Reproduction by equal binary fission, in which nucleus divides by mitosis, the centroplast playing the part of a centrosome. Free-floating or creeping; solitary; marine. Food chiefly vegetable matter (in cultures, swarm-spores of green algae).

REFERENCES.

- Brauer, A. (1894).—"Ueber die Encystirung von *Actinosphaerium eichhorni* Ehrbg.," 'Zeitschr. wiss. Zool.,' vol. lviii, p. 189.
- Bütschli, O. (1892).—"Ueber die sogenannten Centrialkörper der Zelle und ihre Bedeutung," 'Verhandl. naturhist.-med. Ver. Heidelberg,' vol. iv (N.F.), p. 535.
- Dobell, C. (1908).—"The Structure and Life-history of *Copromonas subtilis*, n. g., n. sp.," 'Quart. Journ. Micr. Sci.,' vol. 52, p. 75.
- (1909).—"Researches on the Intestinal Protozoa of Frogs and Toads," *ibid.*, vol. 53, p. 201.
- (1911).—"The Principles of Protistology," 'Arch. f. Protistenk.,' vol. xxiii, p. 269.
- (1914).—"Cytological Studies on Three Species of *Amœba*," *ibid.*, vol. xxxiv, p. 139.
- Grenacher, H. (1869).—"Bemerkungen über *Acanthocystis viridis*. Ehrbg. sp.," 'Zeitschr. wiss. Zool.,' vol. xix, p. 289.
- Heider, K. (1894).—"Demonstration of Sections of *Raphidiophrys*," 'Verhandl. deutsch. Zool. Ges.,' vol. iv, p. 94.
- Hertwig, R. (1877).—"Studien über Rhizopoden," 'Jena. Zeitschr.,' vol. xi, p. 324.
- (1898).—"Ueber Kerntheilung, Richtungskörperbildung und Befruchtung von *Actinosphaerium eichhorni*," 'Abh. bayr. Akad. Wiss.,' vol. xix.
- Jameson, A. P. (1914).—"A New Phytoflagellate (*Parapolytoma satura*, n. g., n. sp.) and Its Method of Nuclear Division," 'Arch. f. Protistenk.,' vol. xxxiii, p. 21.

- Sasaki, C. (1894).—"Untersuchungen über *Gymnosphæra albida*, eine neue marine Heliozoe," 'Jena. Zeitschr.', vol. xviii, p. 45.
- Schaudinn, F. (1896).—"Heliozoa," in 'Das Tierreich' (Berlin).
- (1896A).—"Ueber das Zentralkorn der Heliozoen, ein Beitrag zur Centrosomenfrage," 'Verhandl. deutsch. zool. Ges.' (Bonn), p. 113.
- Schulze, F. E. (1874).—"Rhizopodenstudien II." 'Arch. mik. Anat.', vol. x, p. 377.
- Vejdovský, F., and Mrázek, A. (1903).—"Umbildung des Cytoplasma während der Befruchtung und Zelltheilung," *ibid.*, vol. lxii, p. 431.
- Watasé, S. (1894).—"Origin of the Centrosome," 'Biol. Lect., Wood's Holl.'
- Zuelzer, M. (1909).—"Bau und Entwicklung von *Wagnerella borealis*, Mereschk.," 'Arch. f. Protistenk.,' vol. xvii, p. 135.

EXPLANATION OF PLATE 27,

Illustrating Mr. Clifford Dobell's paper on "*Oxnerella maritima*, nov. gen., nov. spec., a New Heliozoon, and Its Method of Division; with Some Remarks on the Centroplast of the Heliozoa."

[All figures depict *Oxnerella maritima*, n. g., n. sp., and are drawn to the same magnification, which is approximately 1500 diameters. Except Fig. 1, all are drawn from whole specimens fixed in Bouin's fluid and stained with alcoholic iron-alum-hæmatein. They were drawn under a Leitz 2 mm. apochromatic objective (N.A. = 1.40), with compensating oculars, using a Leitz achromatic condenser (N.A. = 1.40) with critical illumination.]

PLATE 27.

Fig. 1.—Living organism, slightly compressed to show internal structure. (The rounded masses in the cytoplasm in this and following figures are ingested swarm-spores of green algæ, in various stages of digestion.)

Fig. 2.—Similar specimen, fixed and stained.

Figs. 3-6.—Central region in different individuals, showing various appearances presented by the centroplast.

Fig. 7.—Central region and nucleus of an organism at a very early stage of division of the centroplast. Note the attachment of the nucleus to it by three of the axopodial rays.

Figs. 8-22.—Successive stages in division.

Figs. 8 and 9.—Division of centroplast.

Figs. 10-13.—Prophases.

Fig. 14.—Stage of equatorial plate.

Fig. 15.—Metaphase.

Figs. 16-18.—Anaphases.

Figs. 19-21.—Telophases.

Fig. 22.—Division complete, the two daughter-organisms completely reconstructed.

(In Figs. 15, 16, and 19 the nucleus and surrounding protoplasm only are shown.)

“Proboscis pores” in Craniate Vertebrates, a
Suggestion concerning the Premandibular
Somites and Hypophysis.

By

Edwin S. Goodrich, F.R.S.,
Fellow of Merton College, Oxford.

With Plate 28, and 3 Text-figures.

THERE is in *Amphioxus* on the roof of the buccal cavity a deep pit known as Hatschek's pit, from its discoverer. Its blind, inner end extends upwards to the right of the notochord, while the lining epithelium is continuous at the opening of the pit with the areas of thickened ciliated epithelium which spread over the roof and sides of the buccal cavity. This ciliated organ is the wheel-organ of Johannes Müller, and was shown by him to drive a current of water and food-particles into the mouth. Van Wijhe (14) has since given a detailed account of its structure. An unpaired dorsal region extends backwards so as to surround the opening of the pit, then divides into right and left tracts. The two branches run towards the velum and then down the sides of the buccal cavity, but do not meet ventrally. As shown in Text-fig. 1, finger-shaped tracts extend forwards on the inner surface of the oral hood. These structures become more complicated in older specimens. The deeply staining epithelium of which Müller's organ is composed is formed of very closely packed, narrow columnar cells, whose nuclei form several layers, and whose outer ends bear each one cilium. Good figures of these cells have been given by Langerhans (8).

Although the pit and its lining epithelium have been described by several authors—Hatschek (6), Langerhans (8), Willey (16), van Wijhe (14), Andrews (1)—the complexity of its histological elements seems to have escaped the notice of these observers, and its finer structure deserves further study. In the adult the epithelium is composed of cells roughly disposed in three layers (Pl. 28, figs. 12, 13, 14). The most superficial cells are large, with a broad end reaching to the

TEXT-FIG. 1.

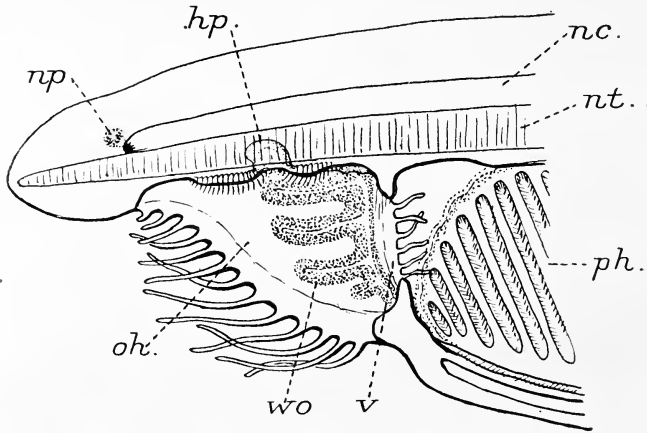

Left side-view of the head of a young *Amphioxus*. The left body-wall, oral hood, and wall of the pharynx have been cut away, exposing the right half of the wheel-organ, *w.o.* Hatschek's pit, *H.p.*, is seen by transparency. *n.c.* nerve cord. *n.p.* Olfactory pit. *nt.* Notochord. *o.h.* right oral hood. *ph.* Pharynx. *v.* Velum surrounding the true mouth.

free surface, and bearing a bunch of fine cilia generally gathered together to form a flame-like tuft. Their nuclei are pale and rounded. The middle layer is composed of narrower cells, with oval, deeply staining nuclei. Each of these cells is prolonged to the surface and beyond it into a long, narrow, stiff, rod-like extremity bearing a single stout cilium. The third and simplest variety of cell forms the deepest layer next to the basal membrane covering the organ. The peculiar rod-bearing cells are arranged in four or five transverse rows

alternating with the large ciliated cells, and also round the opening of the pit. Here the rods become shorter and shorter, until this type of cell passes into the more ordinary ciliated epithelium of the organ of Müller (Pl. 28, fig. 12).

Hatschek, who noticed the rod-bearing cells, considered the pit to be a sense-organ. But since no nerve can be traced to it, this interpretation is probably incorrect. Andrews states that in *Asymmetron* the pit secretes a mucous substance, which entangles food-particles and gets carried into the mouth. He points out its relation to the blood-vascular “glomus,” and concludes that Hatschek’s pit is a slime-secreting gland—a conclusion later supported by van Wijhe.

The story of the origin of Hatschek’s pit is one of the strangest episodes in the strange history of the development of *Amphioxus*. It is a mesoblastic structure formed from the first mesoblastic somite of the left side. Hatschek (5) studied the development of the anterior pair of pouches, and correctly described that on the right side as enlarging forwards and downwards so as to give rise to the main head-cavity of the larva. The left pouch he believed became constricted into two portions. One, taking up a position on the right and below the notochord, gave rise to Hatschek’s pit itself, while the other opened to the exterior on the left side and gave rise to the preoral pit of the larva (6). The larval preoral pit subsequently becomes drawn into the buccal cavity at metamorphosis, and acquires its definitive position in the adult by a process of shifting and overgrowth admirably depicted by Willey (15). Hatschek’s description of the early development of the pit is by no means clear, and unfortunately is published without figures (6). Some years later, Legros (9) stated that the sac on the left side of the early embryo was derived, not from a coelomic pouch, but from an invagination of the ectoderm, and that from it were developed the pit, the ciliated organ, and the anterior nephridium (Hatschek’s nephridium).¹ This interpretation of the origin of the sac

¹ This nephridium is developed neither from a mesoblastic funnel, as described by Hatschek (6), nor as an outgrowth from the second

was disproved by MacBride (11), whose results were accepted by van Wijhe (14), and since Legros has recognised his mistake the controversy may be dropped. As, however, it seemed desirable to reinvestigate the whole question, an account is here given of the development of the pit and Müller's ciliated organ from their first appearance to the adult condition.

The first pair of cœlomic sacs are given off as lateral pouches at the extreme anterior end of the archenteron, and can be seen in embryos about twenty-four hours old still in this condition (Pl. 28, fig. 3). Later the pouches become nipped off, and come to lie symmetrically on either side of the notochord (Pl. 28, fig. 2). Even in these very early stages the left may have a rather thicker wall than the right sac (Pl. 28, fig. 1). At about the 30-hour stage the right sac begins to expand, its walls thin out, and later on it expands to form the head-cavity of the larva. The left sac with its thicker wall at first remains spherical, but later becomes flattened, and takes up a position lying transversely between the notochord above and a backward prolongation of the right head-cavity below (Pl. 28, fig. 5). Its outer end now becomes applied to the ectoderm on the left side. Larvæ about fifty hours old show that an opening has been pierced at this point of contact, placing the cœlom in communication with the exterior. At the same time the large cubical cells lining the cavity acquire cilia (Pl. 28, fig. 6). In larvæ with two gill-slits the left cœlomic sac has enlarged, spreading further towards the right side, while the ectoderm round the opening has grown inwards, tending to form a depression

somite, as described by Legros (10); nor, again, from the remains of the communication of the cœlomic pouch with the gut, as alleged by MacBride (11), but from a little group of cells appearing quite early just above the mouth. Several years ago I traced these cells to a stage about thirty hours old, before the opening of the mouth; but since I was unable to find out their first origin, I refrained from publishing my results. They are the cells figured recently by Smith and Newth (Pl. 18, fig. 4), who are indeed correct in their surmise that they may represent the rudiment of the nephridium (13).

(Pl. 28, fig. 7). Eventually this depression becomes large and deep, forming the preoral pit of the larva (Pl. 28, figs. 8, 9, 10). The lining epithelium becomes modified into the thick ciliated epithelium so conspicuous in later stages, and in the adult wheel-organ developed from it. For it is this preoral pit which is converted into the organ of Müller when the buccal cavity is formed at metamorphosis. Whether the thickened ciliated epithelium lining the preoral pit is actually derived from the ectoderm and not from the Hatschek's pit it is difficult to prove for certain, since the distinction between the mesoblastic cells and the ectoblastic cells at the mouth of the pit soon becomes indefinite. Moreover, there is an unfortunate slight gap in my series between the oldest stage reared in the laboratory at Naples (51 hours) and the youngest free-swimming larva with two gill-slits I was able to obtain at Faro, and it is just at this stage that the proliferation of cells at this point begins. Nevertheless, the appearance in sections of these young larvæ has convinced me that the lining of the preoral pit is indeed of purely ectodermal origin. How, then, can we account for the presence of the rod-bearing cells in the lining of Hatschek's pit itself? As mentioned above, they appear to be a specialised form of the slender cells composing the epithelium of the preoral pit (future wheel-organ). There can be hardly any doubt that the rod-bearing cells invade Hatschek's pit from the outside, and are derived from the epithelium which grows in at the open mouth of the sac. In young larvæ they do not yet occur among the larger mesoblastic cells; but in later stages they can be seen in increasing numbers, first near the opening, and then spreading over the inner surface of the sac.

To sum up concerning the history of the ciliated wheel-organ of Müller and of Hatschek's pit in *Amphioxus*: The first pair of cœlomic sacs or somites develop as outgrowths, which soon become nipped off from the anterior end of the archenteron. They are at first symmetrical, but soon the right enlarges to form the head-cavity, while the left, remaining comparatively small and thick-walled, acquires an

opening to the exterior on the left side, in front of the mouth. The ectoderm round the opening sinks in to form a deep groove and depression—the preoral pit. The cells lining the original left coelomic sac, now known as Hatschek's pit, are broad, with a rounded nucleus and a bunch of cilia. The

TEXT-FIG. 2.

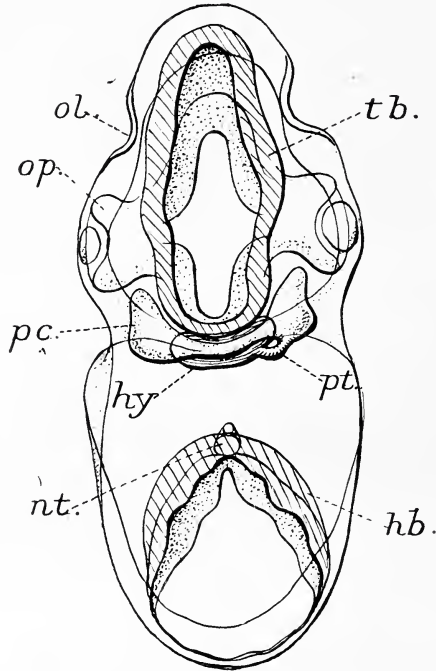

Reconstruction from transverse sections of a thick slice of the head of an embryo of *Torpedo*, 10.5 mm. long. Anterior view. *f.b.* Forebrain. *h.b.* Hindbrain. *h.y.* Hypophysis. *n.t.* Notochord. *o.l.* Olfactory sac. *o.p.* Optic cup. *p.c.* Premandibular somite. *p.t.* Premandibular tube, or canal opening into the hypophysis.

cells lining the preoral pit are probably of entirely ectodermal origin, and acquire a slender, elongated shape with an oval, deeply staining nucleus and a single flagellum. In later stages they appear to invade the pit of Hatschek, becoming specialised into the rod-bearing cells. As the larval mouth

becomes transformed into the adult mouth, and the lateral flaps of the oral hood develop, the preoral pit is carried into the buccal cavity, where it flattens out and spreads to form the ciliated organ.

Now in *Balanoglossus* the first pair of cœlomic sacs arise in essentially the same way, and acquire an opening to the exterior known as the proboscis pore. As in *Amphioxus*, so in *B. kowalevskii*, the pore is formed only on the left side. In *B. kupfferi*, however, both a right and a left pore are present. More than thirty years ago Bateson, in his important papers on the development of *Balanoglossus*, compared the opening of Hatschek's pit in *Amphioxus* with the proboscis pore (2), and further suggested that the proboscis pore and gland of *Balanoglossus* correspond to the hypophysis and pituitary gland of the Craniata. A discussion of the latter interesting suggestion would require a detailed study of the structure and development of these parts in *Balanoglossus*—a subject into which we need not enter here; but Bateson's comparison of the pores seems to be strongly supported by the facts mentioned above. The homology may, of course, be extended to the similar pores in *Cephalodiscus*, and to the water pores of Echinoderms.¹

Turning now to a comparison between *Amphioxus* and the Craniate Vertebrates. That the hypophysis is an ancient organ which must have been possessed by the ancestor of all Craniates is shown by its constant presence and uniform development. Invariably it arises as an ingrowth of ectoderm just in front of the mouth and just anterior to the front end of the archenteron.² From the wall of the latter are here

¹ A comparison with the Tunicata is much more difficult. We can hardly avoid the conclusion that the subneural gland with its ciliated duct and dorsal tubercle are homologous with the hypophysis; but of anterior cœlomic sacs and of proboscis pores in Ascidians we know nothing as yet. On the other hand, it is possible that further research may reveal traces of these organs in some of the less modified forms.

² For an excellent account of the development of the hypophysis and a review of the literature see the recent papers of E. A. Baumgartner in the 'Journal of Morphology,' vols. 26, 1915, and 28, 1916.

produced the anterior extremity of the notochord, and the lateral outgrowths which give rise to the first pair of somites or anterior premandibular cavities of Balfour. In spite of the doubts raised by Hatschek (6) and von Kupffer (7), it is now generally admitted that the proboscis cavities of *Balanoglossus*, the anterior sacs of *Amphioxus*, and the premandibular cavities of Craniates are all homologous structures representing the first pair of coelomic somites (Willey (15), MacBride (11)).

No satisfactory explanation of the origin of the hypophysis has yet been arrived at. Beard, Dohrn, and others have suggested that it represents a vestige of the original mouth, a new mouth having been developed from gill-slits. But the fundamental correspondence in the structure and relations of the mouth and associated parts in the Ascidian, *Amphioxus*, and the *Ammocoete* larva, and many other facts which need not be mentioned here, render this view in the highest degree improbable. Many authors have sought in *Amphioxus* for the homologue of the hypophysis; but, strangely enough, most of them profess to find it in the neuropore or olfactory pit of Kœlliker. For this theory, suggested by Hatschek (6), and strongly supported by Willey (15), there seems to be no justification. Since both neuropore and hypophysis coexist in the embryo Craniate, are situated widely apart, and are related to quite different regions of the brain, it is difficult to see how they could correspond to the olfactory pit. On the other hand, the much more plausible comparison of the hypophysis with the wheel-organ of *Amphioxus* has received little attention. It is true that Legros at one time maintained that Hatschek's nephridium, Hatschek's pit, and the wheel-organ correspond to the hypophysis and olfactory pit of Craniates (9); but this view was based, as already mentioned above, on erroneous observations, and has since been abandoned.

There is strong evidence to support the theory of the homology of the hypophysis with the wheel-organ of *Amphioxus* (the preoral pit of the larva). Were it not for the

excessive prolongation forwards of the notochord in Amphioxus, they would both appear as ectodermal organs situated below the brain and in front of the mouth. If we restored the bilateral symmetry of the head in Amphioxus, both the

TEXT-FIG. 3.

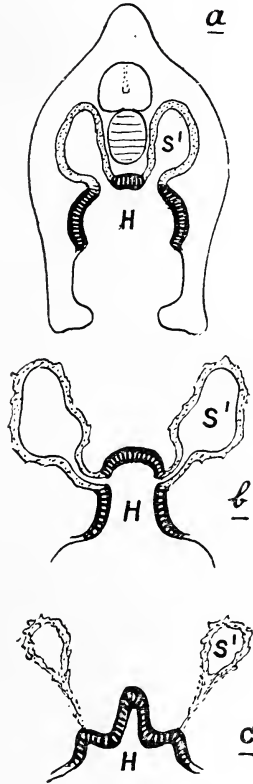

Diagrams of transverse sections through the premandibular region of the head of *a*. *Amphioxus* (restored to a bilaterally symmetrical condition). *b*. *Torpedo*. and *c*. The Reptile *Gongylus* (from the figures of Salvi). *H*. Hypophysis. *S¹*. Pre-mandibular somite, or first anterior coelomic sac.

right and the left anterior coelomic sacs would open into this ciliated depression as shown in Text-fig. 3A, and there would be two “proboscis pores.” Now the suggestion I wish to

make in this paper is that there is direct evidence of the existence of two such "proboscis pores" opening into the hypophysis of the Craniate Vertebrates. If the evidence be accepted it will, naturally, greatly strengthen the theory that the hypophysis and the wheel-organ are homologous structures.

Chiarugi, in 1898 (3), was, I believe, the first to mention a connection between the premandibular somites and the hypophysis in *Torpedo*. Since then Dohrn has carefully described this connection in embryos of *Torpedo ocellata* and *mar-morata*, and of *Raja batis* (4). It is a transient structure, but when best developed consists of a tubular extension of the premandibular somite passing downwards to the posterior wall of the hypophysis, and placing the premandibular cavity in communication with the lumen of the hypophysis (Text-fig. 3B). Just as in *Balanoglossus*, an Echinoderm, or *Amphioxus*, the anterior cœlomic sac grows towards and fuses with the ectoderm to form the "proboscis" or "water" pore, so in the Elasmobranch this tube grows out of the premandibular somite and fuses with the hypophysial ingrowth. There may be a right and a left tube, but—a significant fact—the left is usually better developed and persists longer than the right. In Text-fig. 2 a reconstruction is given from a series of sections of *Torpedo* kindly lent to me by Prof. J. P. Hill, in which Miss Fraser found the tube. In this case it appears to be developed on the right side only. Pl. 28, fig. 15, shows, on a larger scale, the opening into the cavity of the hypophysis.

Similar structures have been described in the Reptilia. Already in 1888 Ostroumoff (12) mentioned a paired connection between the premandibular somites and the hypophysis in *Phrynocephalus*, and the same structure has been independently described in detail in the embryo of *Gonylus ocellatus* by Salvi (12a).

Want of material has prevented my confirming the observations of these authors, but, in the 3-day embryo of the duck, I find the premandibular somites intimately connected

with the hypophysis. Probably, if a careful search be made, the premandibular tubes will be found to occur both in birds and in mammals.

Finally, it may be urged that all these openings, water-pores, proboscis pores, and premandibular pores are of the nature of cœlomostomes comparable to the excretory tubules in the more posterior segments of the Craniates. It may also be pointed out that the theory here advocated gives a clue to the first origin and function of the hypophysis.¹

SUMMARY.

An account is given of the complex histological structure of the epithelium lining Hatschek's pit in *Amphioxus*, and of the development of this pit and of the preoral pit from the left anterior cœlomic sac and an ectodermal ingrowth respectively. The preoral pit becomes the wheel-organ of the adult. The ciliated cells of Hatschek's pit are of mesodermal origin, but the rod-bearing cells appear to come from the ectoderm. The evidence is strongly in favour of Bateson's comparison of the opening of Hatschek's pit with the proboscis pore of *Balanoglossus* and the water-pore of Echinoderms. All these pores were originally paired. The anterior cœlomic sacs of *Amphioxus* are homologous with the premandibular somites of Craniates. As shown by Ostroumoff, Dohrn, and Salvi, these somites form tubular outgrowths opening into, or fusing with, the hypophysis—a connection comparable with the “proboscis” pores of *Enteropneusta*, *Cephalodiscus*, and *Echinodermata*. The premandibular, proboscis, and water-pores are all of the nature of cœlomostomes. It is concluded that the hypophysis of the Craniata is represented in *Amphioxus* by the wheel-organ situated in front of the true mouth, and that its original function was probably to drive food into the alimentary canal.

¹ An abstract of this paper was read at the meeting of the Linnean Society held on April 19th, 1917.

POSTSCRIPT.

Since this paper was printed I have again come across some interesting work which had unfortunately escaped my memory, but to which attention must be drawn, as it has an important bearing on the questions dealt with above. I refer to the papers on "Amia" by Phelps ('Science,' vol. ix, 1899), by Reighard and Phelps ('Journ. of Morph.,' vol. xix, 1908), and by Eycleshymer and Wilson ('Biol. Bull.,' vol. xiv, 1908), and on "Polypterus" by Kerr ('Budgett Mem.,' 1907). These authors trace the development of the adhesive or cement organ of the larva from paired diverticula of the anterior end of the archenteron. Each diverticulum becomes nipped off, and subsequently acquires an opening to the exterior. The adhesive organs of *Lepidosteus* and *Acipenser* are probably of the same nature. Now, while Kerr is unwilling to commit himself to any theory of the homology of these organs, but nevertheless indicates "the probability that they correspond with the premandibular head-cavities," Reighard and Phelps definitely compare the pouches which give rise to the adhesive organs to the so-called anterior head-cavities found by Miss Platt in *Acanthias*, and supposed to represent a pair of somites in front of the premandibular somites of Balfour. Following Neal ('Bull. Mus. Comp. Zool.,' vol. xxxi, 1898) they further homologise these anterior head-cavities with the first pair of somites in *Amphioxus* (the left one of which opens to the exterior), and suggest that they and the adhesive organs may be homologous. This comparison, however, raises a serious difficulty. If the anterior head-cavity really represents a separate segment, then the segmental correspondence between the first pair of somites in *Amphioxus* and the premandibular somites in higher vertebrates would seem not to hold good. Since no somite has been found in *Petromyzon* in front of the premandibular, we may be forced to the conclusion that the whole cephalic structure has been transposed one segment back in the *Guathostomata* (see "Segmentation and Homology," this

journal, vol. lix, 1913). Such a conclusion is by no means inadmissible, but does not appear to be necessary. As a matter of fact no definite trace of an anterior head-cavity has been seen in any other group but the Selachii (adhesive organs apart), and it is not constant even in them. On this point the very careful work of Dohrn (24) seems to me convincing. Many authors do not admit its homology with a somite (v. Wijhe, Dohrn); rather would the walls of the cavity seem to be derived from the premandibular segment, and to represent merely a specialised region of its somite.

If, then, the anterior head-cavity really belongs to the premandibular segment, and if it is represented in these Teleostome larvæ by the adhesive organ, the remarkable conclusion is reached that not only in Cephalochordates, Selachians, and Reptiles is there evidence that the first pair of somites opened on the lower surface of the head (either on or near the hypophysial depression), but that this is still the case in some Teleostomes.

LITERATURE.

1. Andrews, E. A.—“An undescribed Acraniate, *Asymmetron lucayanum*,” ‘Studies fr. Biol. Lab. John’s Hopkins Univ.’ vol. v, 1893.
2. Bateson, W.—“Development of *Balanoglossus kowalevskii*,” ‘Quart. Journ. Micro. Sci.’ vol. 25, 1885.
3. Chiarugi, G.—“Di un organo epithelioli . . . di *Torpedo ocellata*,” ‘Monitore Zool. Ital.’ vol. xi, 1898.
4. Dohrn, A.—“Studien z. Urgesch. d. Wirbeltiere,” ‘Mitth. Zool. St. Neapel,’ vol. xvii, 1904.
5. Hatschek, B.—“Studien u. Entwickl. von *Amphioxus*,” ‘Arb. Zool. Inst. Wien,’ vol. iv, 1881.
6. ——— “Mitth. über *Amphioxus*,” ‘Zool. Anz.’ vol. vii, 1884.
7. Kupffer, C. von.—“Die Entwickl. d. Kopfes von *Acipenser*,” ‘Studien,’ Heft I, Leipzig, 1893.
8. Langerhaus, P.—“Zur Anat. des *Amphioxus*,” ‘Arch. f. Mikr. Anat.’ vol. xii, 1876.

9. Legros, R.—“Cavité buccale de l'Amphioxus,” ‘Arch. d'Anat. Micr.,’ vols. i and ii, 1897-8.
10. ——— “Sur quelques points de l'anat. et du dével. de l'Amphioxus,” ‘Anat. Anz.,’ vol. xxxv, 1910.
11. MacBride, E. W.—“The Early Development of Amphioxus,” ‘Quart. Journ. Micro. Sci.,’ vol. 40, 1898.
12. Ostroumoff, A.—“Zur Entwickl. der Eidechsen,” ‘Zool. Anz.,’ vol. xi, 1888; and ‘Arb. d. naturf. Gesellschaft zu Kasan,’ vol. xix, 1888.
- 12a. Salvi, G.—“Des cavités prémandibulaires et des fassettes latérales de l'hypophyse chez les Sauriens,” ‘Bibl. Anat.,’ vol. x, 1902.
13. Smith, K. M., and Newth, H. G.—“Collar Cavities of the Larval Amphioxus,” ‘Quart. Journ. Micro. Sci.,’ vol. 62, 1917.
14. Wijhe, J. W. van.—“Beitr. z. Anat. d. Kopfreion d. Amphioxus,” ‘Petrus Camper,’ vol. i, 1902.
15. Willey, A.—“Later Larval Development of Amphioxus,” ‘Quart. Journ. Micro. Sci.,’ vol. 32, 1891.
16. ——— “Amphioxus and the Ancestry of the Vertebrates,” ‘Columbia College Series, 1894.

EXPLANATION OF PLATE 28,

Illustrating Mr. Edwin S. Goodrich's paper on “Proboscis Pores in Craniate Vertebrates, a Suggestion concerning the Premandibular Somites and Hypophysis.”

REFERENCE LETTERS OF PLATE FIGURES.

a. Elongated rod-cell. *ace.* Anterior ciliated epithelium of wheel-organ. *acg.* Anterior ciliated groove. *b.* Ciliated cell. *blv.* Blood-vessel. *ca.* Premandibular tube or canal. *cb.* Basal canal. *cHn.* Cœlom of second somite, into which projects Hatschek's nephridium. *de.* Ectoderm dorsal to preoral pit. *ebc.* Epithelium of buccal cavity. *end.* Endostyle. *ent.* Enteron. *Hn.* Hatschek's nephridium. *Hp.* Hatschek's pit. *hyp.* Hypophysis. *inf.* Infundibulum. *la.* Left aorta. *lbf.* Left buccal fold or oral hood. *lc.¹* and *lc.²* First and second left cœlomic cavities. *ls.¹* and *ls.²* First and second cœlomic sacs or somites. *m.¹* and *m.²* First and second myotomes. *nc.* Nerve cord. *np.* Neuropore. *npl.* Neural plate. *nt.* Notochord. *pce.* Posterior ciliated epithelium of wheel-organ. *peg.* Posterior ciliated groove. *pm.* Preoral muscle. *pmd.* Premandi-

bular somite. *pos.* Preoral sense-organ. *rbc.* Roof of buccal cavity. *rbf.* Right oral hood. *rc.¹* and *rc.²* Right first and second cœlomic cavities. *rs.¹* and *rs.²* Right first and second cœlomic sacs or somites. *ve.* Ectoderm ventral to preoral pit.

PLATE 28.

Figs. 1-14 are of Amphioxus.

Fig. 1.—Transverse section through anterior region and neuropore of a 24 hours' old embryo. Cam. W., 2 mm., oc. 3.

Fig. 2.—Similar section through a more advanced embryo, 24 hours old. Cam. W., 2 mm., oc. 3.

Figs. 3 and 4.—Transverse sections through an embryo 24 hours old. Fig. 3 shows the anterior somites, fig. 4 only the second pair of somites. Cam. W., 2 mm., oc. 3.

Fig. 5.—Transverse section through an embryo 30 hours old. Cam. W., 2 mm., oc. 3.

Fig. 6.—Transverse section through a larva 48 hours old, with Hatschek's pit opening to the exterior. Cam. W., 2 mm., oc. 3.

Fig. 7.—Portion of a transverse section of a larva with two open gill-slits, showing Hatschek's pit and the preoral sense-organ. Cam. W., 2 mm., oc. 3.

Fig. 8.—Transverse section of an older larva. Cam. W., 2 mm., oc. 3.

Fig. 9.—Portion of a transverse section of an older larva, showing the developing preoral pit and groove.

Fig. 10.—Section of the same larva farther forward. Cam. W., 2 mm., oc. 3.

Fig. 11.—Portion of a transverse section of the buccal region of an old larva in which the atrium has developed. Cam. W., 2 mm., oc. 2.

Fig. 12.—Longitudinal vertical section through Hatschek's pit in an adult. Cam. Z.D., oc. 2.

Fig. 13.—Transverse section through Hatschek's pit in an adult. Cam. Z.D., oc. 2.

Fig. 14.—Enlarged view of a portion of a section of the epithelium lining Hatschek's pit in the adult.

Fig. 15.—Portion of a transverse section of the head of an embryo of *Torpedo* 10.5 mm. long. The entrance of the premandibular tube or canal, *ca*, into the hypophysis is shown.

The Cytoplasmic Inclusions of the Germ-Cells.

PART II. HELIX ASPERSA.

By

J. Bronté Gatenby, B.A.,

Exhibitioner of Jesus College, Oxford.

(Dept. of Physiology.)

With Plates 29-34 and 5 Text-figures.

TABLE OF CONTENTS.

	PAGE
1. INTRODUCTORY	556
2. PREVIOUS WORK	556
3. TECHNIQUE	562
4. The Germinal Epithelium	564
5. Cell Generations in the Snail	571
6. Manner of Metamorphosis of an Indifferent Germinal Epithelial Cell into a Primary Spermatogonium	578
7. Manner of Metamorphosis of an Indifferent Germinal Epithelial Cell into an Oogonium	587
8. The Fate of the Mitochondria and Nebenkern in the Egg	589
9. Manner of Metamorphosis of an Indifferent Germinal Epithelial Cell into a Nurse or Yolk Cell	590
10. Description of the Scheme of the Ovotestis Lumen drawn in Pl. 29, fig. 1	591
11. DISCUSSION under the heads of:	
(a) Nebenkern	594
(b) Mitochondria	598
(c) The Determination of Oogonium Spermatogonium or Nurse-Cell	599
(d) The Different Male Generations in the Ovotestis	601
12. SUMMARY	605

INTRODUCTORY.

THE first part of the present series of papers (1) dealt with the cytoplasmic bodies in the gametogenesis of the Lepidoptera. In this paper I am publishing the results of a study of the cytoplasm in the hermaphrodite, *Helix aspersa*. Not only is the gametogenesis treated, but a careful study has been made of the problems surrounding the appearance of eggs, spermatozoa, nurse-cells and follicle cells from the same germinal epithelium. Special care has been taken in order to get the very best preparations of all stages, and extensive experiments were undertaken to improve the current technical fixing methods. This study proved more formidable than at first seemed probable, and some of the minor problems had to be imperfectly treated in order to keep the paper within reasonable bounds. Where such minor problems appear I have indicated in the text, and the snail still offers many attractive lines of research on germ-cells. I have to thank Dr. Goodrich for his kind and constant interest and useful criticism. This work was done in the Department of Physiology, and my warmest thanks are due to Prof. Sherrington.

PREVIOUS WORK.

Apart from the ordinary study of the formation of the gametes, the snail has provided the material for a host of studies on hermaphroditism. The ovotestis, ever since its discovery, has fascinated many observers, and the large number of papers which have appeared on the hermaphrodite gland of the Pulmonates is justified when one considers what a remarkable phenomenon is the appearance of several distinct categories of cells—sperms, eggs, and nurse-cells—from a single indifferent pavement epithelium.

Those who would study the history of our knowledge of the Helicid gametogenesis may consult AnceI's excellent memoir, wherein are mentioned the main contributions made by the large number of observers on this subject. In this paper I

only intend to review Ancel and the subsequent writers. (Bolls Lee is mentioned in the text.)

Since I have not examined embryonic stages I give Ancel's conclusions somewhat fully.

Ancel (2) describes the genital rudiment as appearing in the embryo several days before hatching. At first the mass of cells, quite solid, slowly elongates, and ultimately fuses with the hermaphrodite canal. Soon afterwards a lumen appears in the solid mass of cells, which now appear like an irregular cubical epithelium lining an opening, and these cells become covered on their outside by a layer of the mesoderm cells in which they lie. At different points inside the lumen the genital cells begin to divide mitotically, and in the region of these buds secondary, tertiary, etc., culs-de-sac make their appearance. In this way the hermaphrodite gland is built up from a solid rudiment.

The cells which line this gland consist of a single layer. Here and there some of the indifferent cells augment in volume, the chromatin lumps of the nucleus fuse with one another, and give rise to more or less round structures. Ancel calls these cells "cellules progerminatives indifferentes."

Part of the chromatin of these cells loses its affinity for nuclear stains, and the chromatin lumps become more numerous and become rounded. They are now united two by two by nuclein filaments.

All the chromatin of the indifferent progerminative cell condenses into several round bodies. The whole cell grows in size, the nucleus more than the cytoplasm. This cell is called by Ancel the male progerminative cell. The latter begins to divide indirectly, the chromosome number being forty-eight. The products of these divisions drop into the lumen of the ovotestis; they are large and pedicellate (pediculé), and have the nucleus in the larger part of the cell. These primary spermatogonia go on dividing and give rise to much smaller bodies—the secondary spermatogonia. The products of this activity soon fill the lumen of the ovotestis, and in the germinal epithelium changes take place. The

cells become arranged in two layers, and the outer layer in contact with the contents of the lumen becomes filled with grains stained with osmic acid, and the nuclei of this outer layer have their chromatin condensed into the form of crowded blocks. These cells are the nurse-cells.

When the nurse-cells are formed certain elements in the inner layer beneath the nurse-cells augment in size. They undergo the progerminative indifferent stage, but then become altered in a different manner. The chromatin lumps of the indifferent cell break up and become oriented to the periphery. The centre of the nucleus then looks clear, while all around its periphery are collected little nuclein nucleoli (sic), united one to another by chromatin filaments. In this cell it is the cytoplasm which has grown most in size. Such is the history of the oocyte. This element does not undergo division before the maturation period. Ancel does not find in *Helix* the stages of primordial ovum or oogonium described in other oogeneses.

According to Ancel the presence of nurse-cells is a *sine quâ non* for the formation of an oocyte, and is explanatory of its development.

Concerning the growth period of the oocyte Ancel writes in the following sense: The chromatin of the young oocyte condenses into the form of little nucleoli, which become disposed around the periphery of the nucleus. A network becomes established at the expense of the nuclein nucleoli, and a new network is formed afterwards from the chromatin. In an involved statement Ancel describes the appearance of parachromatic nucleoli, distinguished from the nuclein nucleoli by double staining in hæmalum and safranin.

In the oocyte at an early stage one can find filaments in the cytoplasm. These filaments are originally dispersed through the cytoplasm, but later condense towards a peripheral zone, which diminishes more and more and disappears.

During this time the whole cytoplasm takes on an alveolar appearance except at one place, where special bodies will soon put in an appearance. Hæmatoxylin or safranin prepa-

rations show that in this region one soon finds filaments of a variable size. These rods or filaments are known as "corps intracytoplasmiques." The latter seem to be either solid rods or formed of moniliform structures placed in a series.

Ancel thinks that the young spermatocytes do not contain a Nebenkern. Their cytoplasm is filled with short, colourable filaments. The Nebenkern, which appears at the expense of the cytoplasmic filaments, augments in size as these filaments disappear. At the beginning of mitosis the Nebenkern fragments and disappears. Ancel denies that the Nebenkern is related either to the nucleus, the spindle, or the "sphère attractive," and gives it as his opinion that this curious body "ne représente, à notre avis qu'une phase de l'évolution des formations intracytoplasmiques."

Elsewhere Ancel states: "Le Nebenkern ne jouerait donc aucun rôle dans les cellules; il ne serait que le produit de transformation des filaments cytoplasmiques différenciés auxquels serait dévolue une fonction spéciale."

R. Demoll (3) describes the fact that these are prophases of the heterotypic division in the female, which was overlooked by Ancel. He describes the Nebenkern somewhat better than Ancel or previous authors and considers that this body determines the sex of the differentiating cell.

Writing of the "Bukettstadium in beiden Keimzellen," Demoll gives the following: "Mit dem Ausstofen des Nebenkernes wird sowohl die Wachstumsgeschwindigkeit als auch die Genese der chromatischen Substanz für die beiden Arten von Keimzellen eine spezifische. Oder: Der Nebenkern bedingett erst die geschlechtliche Differenzierung der bis zum Bukettstadium indifferenten Keimzellen." In the discussion it will be shown that for a number of good reasons Demoll's sex determination hypothesis cannot be accepted (page 40).

Iw. Buresch (4) has also attacked the problem, but his paper contains little of interest from the point of view of the means whereby sex is determined. His work is not a great advance on that of Ancel, written many years before, while he has failed to study any cytoplasmic inclusions. Buresch

thinks the germinal epithelium is a syncytium, but as he uses Zenker for fixing this is almost certainly due to the brutality of fixation. Buresch gives a fairly good account of the generations of egg-cells, nurse-cells, etc., and shows how the presence of a large egg affects the surrounding cells.

Concerning forms other than *Helix* we have two late papers by Terni and by Schitz. The latter (5) on *Columbella* finds the Nebenkern rods in the spermatocyte at the beginning of growth, and in later stages they form a sort of palisade around the archoplasm (idiozome). In the prophases of the maturation mitoses these rods disappear. The mitochondria, before seed-like, become elongate as in the snail during mitosis. The Nebenkern in spermatogenesis becomes passed into the tail region where it "ultimately degenerates," but the author does not pay much attention to late stages.

Schitz somewhat obscurely describes the formation of an acrosome from a "grain siderophile," derived from the idiozome (archoplasm), and to support his statement quotes Champy's demonstration of the fact that in *Amphibia* the acrosome develops at the expense of one of the central corpuscles. I find it difficult to accept Schitz's claim, and his figures are not conclusive enough. The mitochondria form a sort of double sac-like structure, "enveloppant le filament axile."

Finally, Schitz speaks of the tail as "constituée par le filament axile, entouré de sa gaine mitochondriale." It will be seen that, excepting the formation of the acrosome, the fate of the Nebenkern and its behaviour throughout, according to Schitz, corresponds to what happens in *Helix*.

Tullio Terni (6) in *Geotriton* carefully describes Nebenkern and mitochondria. In divisions the Nebenkern fragments or completely loses its original character. Terni having described the fragmentation of the batonnettes proceeds to discuss the question as to the origin of the spindle. Nebenkern and idiozome seem synonymous to him, for I find "Il Nebenkern dei Gasteropodi polmonati (Idiozoma)." He says:

"Sostenendo l'origine endoidiozomica (Terni calls the batonnettes 'formazioni periidiozomiche,' and elsewhere

‘dittosomi’) del fuso centrale, vengo ad ammettere che l’idiozoma abbia un importante ufficio nella formazione del fuso stesso: forse di significato assai più profondo che non quello di una semplice azione protettiva. Non ho però dati sufficienti per definire la portata reale della partecipazione materiale dell’idiozoma alla formazione del fuso centrale; credo tuttavia che la sostanza idiozomica non si esaurisca tutta nella produzione del giovane fuso centrale.” In a footnote Terni informs the reader that in his work he could not demonstrate the existence of “due mezzi fusi periferici nella profase della prima divisione di maturazione.”

Terni definitely describes the formation of an acrosome from a part of the archoplasm. In this he is in agreement with what Schitz found in *Columbella*. As I have already said I cannot find such a process in the snail, but I am quite open to conviction that the idiozomatic body contains the future perforatorium, though before coming to a conclusion I should like to have further evidence either way. I am quite certain that in the snail the archoplasm (and its Nebenkern rods) does not approach the head of the nucleus in the way described by Schitz. In Terni’s case the nucleus seems to revolve somewhat after the acroblast has become stuck on one side. The acroblast is thus brought to the head end of the cell. Terni’s case seems very clear.

Fauré-Fremiet (7) in his comprehensive article, “Etude sur les mitochondries des Protozoaires et des Cellules Sexuelles,” gives figures and describes the mitochondria of *Helix pomatia* and *Arion rufus*.

He fails to discover the micromitochondria, overlooks the acrosome, and gives unproportionate drawings of Nebenkern rods and chondriosomes. He definitely draws the batonettes at the poles of the maturation spindle.

Though the minute cytology of the germ-cells of *Helix* has been unsuccessfully dealt with by Fauré-Fremiet, the real value of this observer’s work lies in his remarks on the Nebenkern in fresh preparations. He says: “Il m’a semblé pourtant qu’il (the Nebenkern) était beaucoup plus facilement

altéré que les mitochondries environnantes par les solvants des graisses ; les mitochondries résistent parfaitement à ceux-ci, et j'ai noté qu'un spermatozoïde d'*Arion* traité après dissociation par l'alcool et le chloroforme et coloré par la méthode de Mallory montre les deux cordons mitochondriaux se colorant par la fuchsine acide avec énergie."

TECHNIQUE.

All the earlier observers hardly without exception found that Flemming's strong formula gave the best results of any fixatives at their disposal.

Murray (8) got good results with Perenyi. Flemming's unmodified formula I consider out of date and worthless for a study of the cytoplasm. Its fault lies in the presence of acetic acid, a reagent which should never be used for work on the plasma. As I explained in my last paper, a modification, which I found best, was to cut out all the acetic acid.

Meves, in his great cytological work, used a Flemming of this sort : 15 c.c. of chromic acid of 1 per cent., containing NaCl of 1 per cent., and 3 to 4 c.c. of osmic of 2 per cent., with three or four drops of acetic acid. Benda used a Flemming with only three to six drops of acetic acid to 15 c.c. chromic and 4 c.c. osmic. I feel sure that it is dangerous to try to temporise between two fixing solutions, as nuclear and cytoplasmic, by simply cutting down the acetic. These observers retain just enough acetic acid to distort the mitochondria, and the small improvement in the appearance of the nuclei and in the penetrative power is quite outweighed by this glaring fault. As I have mentioned before, the discussion as to whether the mitochondria are rods or granules may be largely a question of acetic acid and such-like injurious reagents.

Any fixative in general use will give a passable fixation of the nucleus, but work on the cytoplasm is a very different story. In the cytoplasm we have no bodies bounded by close membranes, but structures which can be, and always are,

blasted into fragments by many so-called "admirable fixatives."

In this work on the snail I used the following fixatives:

(1) My modification of Flemming's strong formula, in which no acetic was used.

(2) The same fluid diluted one-sixth.

(3) Champy's fluid.

(4) Flemming's strong solution, in which the acetic acid was re-placed by nitric acid.

All the better-known fixatives were also tried, such as Flemming, Perenyi, corrosive sublimate, Carnoy, etc.

For staining I used the usual stains, such as Ehrlich's hæmatoxylin and eosin, Mayer's acid hæmalum, and iron alum hæmatoxylin with orange G., Bensely's acid fuchsin-methyl green, and alizarin-toluidin blue, etc.

Taking the reddish or orange alizarin or acid fuchsin as a basis, the slides were often counterstained in toluidin blue, crystal violet, methyl green, thionin, etc., and the same was done taking iron hæmatoxylin as the first stain. Some slides were mounted unstained in euparal for studying yolk.

Smears were tried, but failed to give very helpful results except for studying later stages and ripe spermatozoa.

Of the large number of fixing and staining methods used, I found that for the snail the following was the best: The animals are anæsthetised in chloroform vapour, and as soon as possible the last upper whorls of the shells are carefully broken with strong forceps or by a blow with some hard instrument. The shell is dipped in water, and the remaining pieces around the broken area are removed with forceps. The ovotestis is cut out and laid on the table and superfluous digestive gland is cut away, exposing the milk-coloured ovotestis on every side. This piece is cut in half longitudinally, and immediately thrown into a capsule of Flemming without acetic acid, diluted one-sixth with distilled water. Here the fragments are left overnight. They are washed for at least two hours in running water next morning, and then brought up from 50 per cent. alcohol and the other grades to

absolute and xylol. They are embedded as usual, cut into 6μ sections, and stained in iron alum hæmatoxylin by the long method.¹ These sections are carefully differentiated, and then tinged with orange G. or van Giesen. The mitochondria and Nebenkern are intense black and beautifully clear.

Neither Benda's, Bensely's, nor any of the other coloured stains approach such preparations for definition, and for the detail which is shown. As will be explained in another part of this series, iron hæmatoxylin is not always indicated for mitochondrial work, Bensely's acid fuchsin having been found better for some objects.

The Flemming solution, in which the acetic acid is substituted by nitric acid of 3 per cent., gives a very intense stain when used on the mitochondria.

The Germinal Epithelium.

The germinal epithelium in its indifferent condition consists of a row of flattened cells containing compressed nuclei. The epithelium is not a syncytium, as has been stated by some authors. In Pl. 30, fig. 2, is drawn at a very high power three cells of the epithelium in an indifferent state. The nucleus is an oval, flattened structure, and as it is here cut in its narrowest way it looks elongate. The chromatin is arranged in a large number of irregularly triangular lumps, which here and there are intercommunicating. The cytoplasm is not very large in volume, and consists of a wide reticulum, which in some cases can be seen to be condensed into a dark mass near one edge of the nucleus (see Pl. 30, fig. 2, Pl. 31, fig. 20, etc.).

The cells of the germinal epithelium rest upon a fibrous layer, shown by Ancel to be of mesodermal origin (Pl. 30, figs. 2, 3, and 4, *A.L.N.*, etc.). This layer contains nuclei, which vary in size very greatly. In Pl. 30, figs. 3 and 4, are drawn quite typical examples of the germinal epithelium. The germinal epithelial cells (*G.E.*) are seen resting between

¹ Iron alum ten to twelve hours, hæmatoxylin twelve to fourteen hours.

the yolk cells (*N.C.*) and the layer of Ancel (*A.L.N.*). According to the sort of sex cells in any given region the germinal epithelium is characteristic. Where rapid proliferation is taking place, where yolk cells are abundant, or where a large oocyte is present, the epithelium has a special appearance. In Pl. 30, figs. 3 and 7, and in Pl. 31, figs. 9, 11, and 12, where an oocyte is in growth, the germinal epithelial cells tend to either become atrophied or altogether pushed aside. In Text-figs. 1, 2, 3, and 4 are drawn typical portions of the ovotestis under different conditions. It will be seen that the appearance of an alveolus of the ovotestis may vary greatly. Not only does the wall differ at different stages, but the contents of the lumen are rarely the same in appearance. I believe that the varying different stages in the alveoli can be classified for different seasons of the year, though if the ovotestis is sectioned during hibernation it will be found that all the various sorts of alveoli are present.¹ Then one is led to inquire what causes individual alveoli of the ovotestis to vary so remarkably in appearance as do those drawn in Text-figs. 2 and 3. Ancel has given a description of the metamorphosis of the alveolus in the young snail, which, in view of his Flemming technique, is not very satisfactory. Unfortunately his methods did not allow him to do anything but describe the nuclei, but from his otherwise admirable description we know that the following events take place:

Firstly the male progerminative cells appear and drop into the lumen. Then the germinal epithelium becomes arranged in two layers, the inner of which remains indifferent, the outer (next to the male cells) becoming converted into nurse-cells. Thirdly, the inner layer of an indifferent nature sporadically gives rise to oocytes. That this is really what happens I have no doubt, and if one keeps this description of the sequence of events in one's memory, some difficult problems with which one meets in studying the adult ovotestis become less hard to understand.

¹ But the orders of cells differ in the seasons. This matter is dealt with in a forthcoming paper.

In the ovotestis of the hibernating snail where activity is temporarily suppressed, just as in a summer example where activity is very great, it is found that the diverticula or alveoli in the hermaphrodite gland almost always are better provided with yolk and younger cells at their upper extremity than at the lower part of the finger-like alveolus which joins the mouths of other diverticula. That is to say, the higher ones penetrate into the diverticulum, the younger and less differentiated are the elements. When one cuts a transverse section across the upper part of an alveolus one finds that the lumen is very small and is choked either with full yolk cells projecting from the walls, or closely packed with spermatogonia and young spermatocytes. It is rare to find an oocyte at these places, but it would be a mistake to think that oocytes never occur in these regions. In Text-fig. 1 is drawn the upper region of an alveolus. Just as in the young snails described by Ancel, the first cell elements to appear are almost invariably spermatogonia, but I have found several instances where an oocyte had appeared immediately after the yolk cells had been formed. In Text-fig. 1, i, the germinal epithelium has already become organised into two layers, an inner mass of yolk cells filling the lumen and the lower indifferent germinal cells (*G.E.*). At X. a germinal epithelial cell has grown in size, has lost its flattened shape and is about to become a spermatogonium. In Text-fig. 1, ii, this process has become more advanced and the nurse-cells are becoming pressed apart at X. by a number

TEXT-FIG. 1.

Fig. i.—Upper part of diverticulum of ovotestis showing yolk cells (*N.C.*) and germinal epithelium (*G.E.*). At X. are enlarged nuclei, which are in a progerminative stage. In the middle are some spermatocytes. The vacuolised tissue outside consists of mesoderm, which packs around the upper parts of the diverticula. $\times 800$. Fig. ii.—Another diverticulum cut near its upper end. At X. are some primary male cells which as yet have no definite mitochondria or Nebenkern. They will probably become spermatocytes directly. At Y. is a pale cell beginning to enter a primary spermatogonial stage. Figs. iii and iv are spermatids showing different Nebenkern batonettes (*N.K.*). M^1 . = micromitochondria. M^2 . = macromitochondria. *N.C.* = yolk cell.

TEXT-FIG. 1.

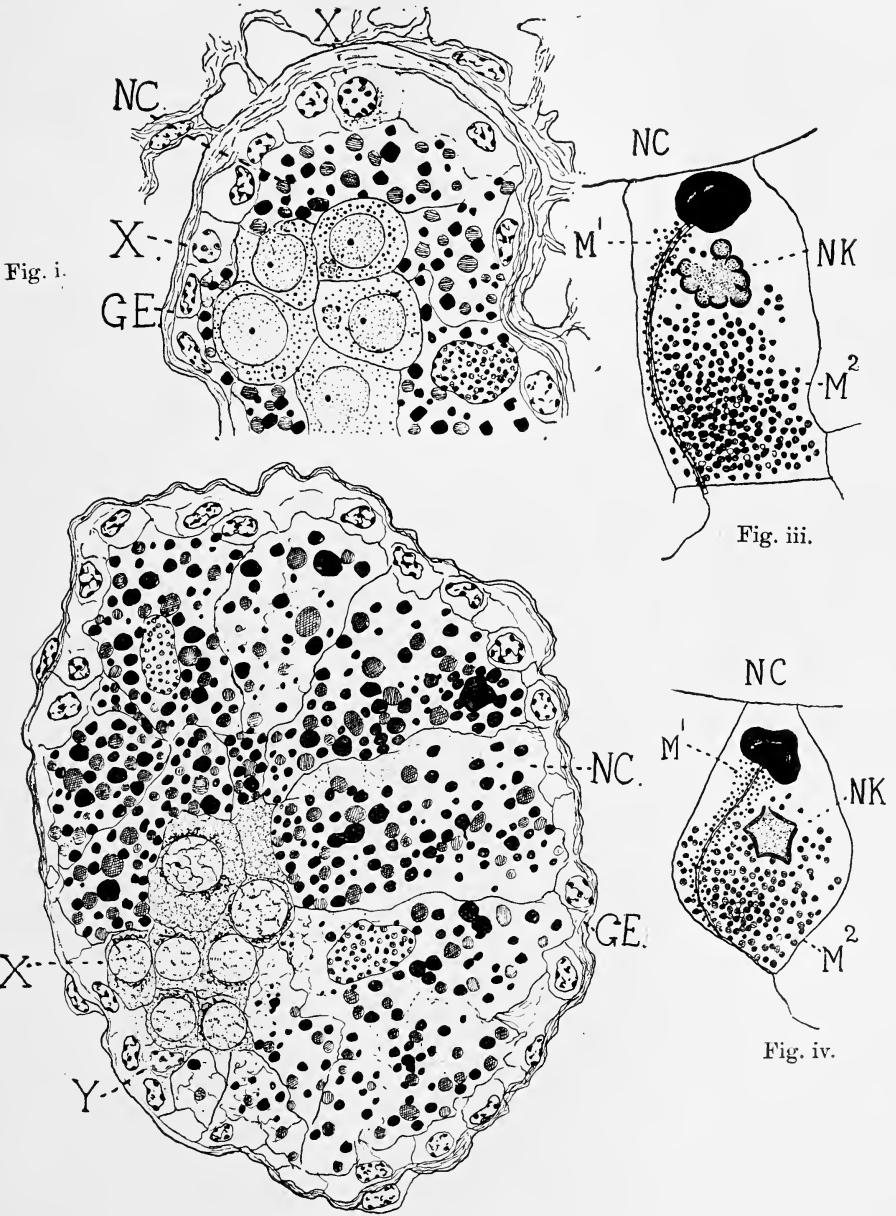

Fig. ii.

of spermatogonia. This process takes place from different parts of the alveolar wall and the lumen becomes quite choked with cells. In Text-fig. 2 is drawn a lower part of the alveolus showing that the proliferation of male cells from the walls has stopped temporarily and that the yolk cells are much reduced in size.

The consecutive stages from spermatogonium to spermatocyte are marked with figures. Quite often one finds oocytes developing beneath the yolk cells. In such a case as the group of spermatogonia marked i, in Text-fig. 2, many of the cells may go on to the growth period and ultimately form spermatozoa, but there is hardly any doubt that some remain quiescent, or keep on dividing and give rise to the very small spermatogonia with hardly any cytoplasm which are so characteristic of the lower part of the ovotestis lumen. In Text-fig. 3 another stage is reached. The yolk cells are either relatively few or small, or often not present at all, but the lumen is generally strewn with a mass formed of the flotsam and jetsam of many generations of germ-cells of ripe spermatozoa, of exhausted yolk cells or their nuclei, and of many sizes of spermatogonia; also here and there around the walls may be seen either an oocyte in process of growth, often but not always accompanied by yolk cells, or a bunch of spermatocytes, spermatids, or spermatozoa. If such a stage as the contraction figure be taken, one is struck by the fact that many sizes of cells are undergoing this nuclear change, often with a cytoplasm and nucleus varying remarkably in size. In Text-fig. 2 there is no doubt that all the cells are of

TEXT-FIG. 2.

Fig. i.—Slightly lower region than that drawn in Text-fig. 1, ii. All cells belong to the same generation. Earliest stage at 1 has just finished division. 2-7 are growth stages. 8 = spermatid. The yolk cells (*N.C.*) are beginning to become exhausted. The Nebenkern rods of this generation were semi-lunar in shape. Fig. ii.—Further down the diverticulum, where the yolk cells are more exhausted or absent. The epithelium at the figures 1-5 is beginning to produce another generation of male cells. 5 is about to enter the prophase of mitosis. 7 = spermatocyte, 8 = spermatid. The cell 2 is drawn in Pl. 31, fig. 17.

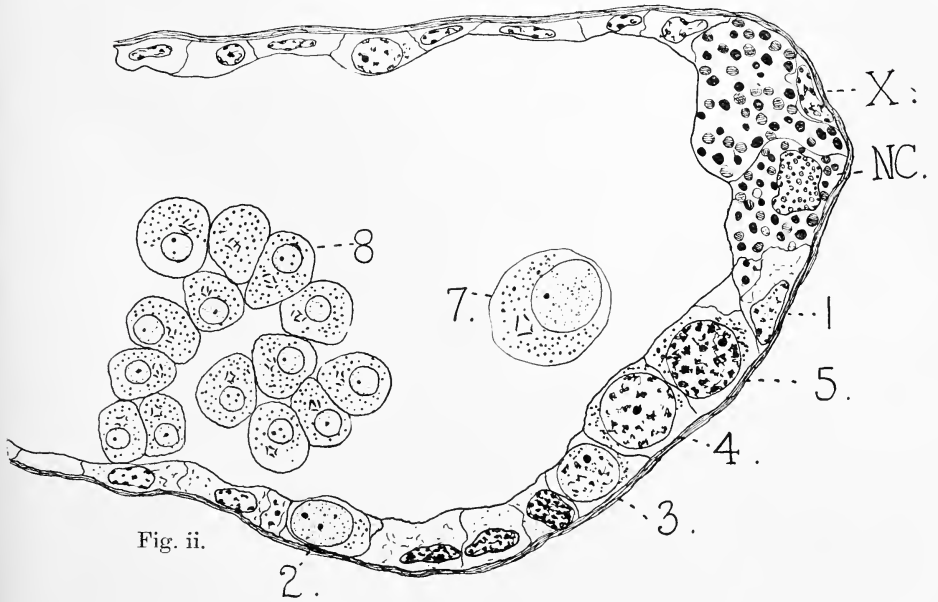
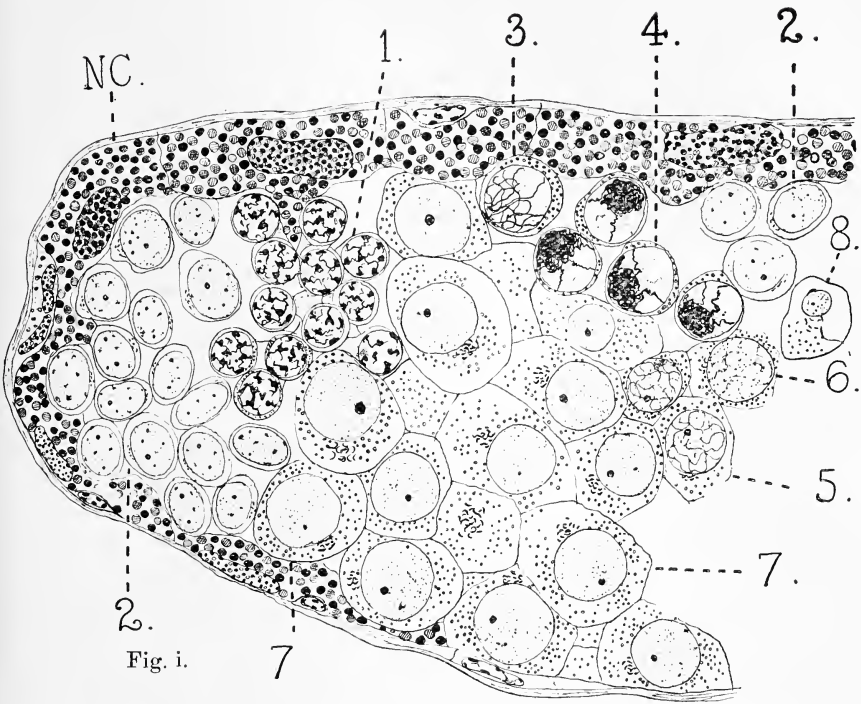

the same generation. This is never the case further down the lumen. We then come to one of the most remarkable facts which I am able to point out in this paper. It is that the spermatocytes, etc., in different parts of the lumen are of different generations and derived in a varying manner, and that they show this by their appearance, which is characteristic in every case.

If Pl. 31, figs. 10, 11, 17, 19, 20, and Pl. 32, fig. 24, be inspected it will be seen that very remarkable differences exist between the cells here drawn; all these figures are to the same scale and the cells were all found in the germinal epithelium. The same remark about differences applies to Pl. 30, fig. 6, Pl. 32, fig. 21, and Pl. 33, fig. 30. These are in a characteristic stage of the prophases of the heterotypic division, and not only do figs. 6 and 21 differ markedly in their nuclei, but the cytoplasmic inclusions are quite distinctly unlike in each example.

In the same way, if the cell divisions drawn in Pl. 32, fig. 22, Pl. 32, fig. 28, and Pl. 33, figs. 34 and 39 be compared it will be noticed that the cytoplasmic inclusions behave differently and are different in size and shape. If the spermatocyte in Pl. 32, fig. 25, be compared with that drawn in Pl. 33, fig. 32, and the spermatid in Pl. 32, fig. 24A, with that in Pl. 33, fig. 36, it will be seen that remarkable differences exist. This brief recital of some of the curious facts which are to be found in the ovotestis of *Helix* at once serve to show that the problem of the derivation of the various sex cells from the indifferent cell is a very difficult matter to understand, and one which has been inadequately treated.

I should hasten to make it quite clear that this paper does not by any means completely describe all the sorts of cells found in the ovotestis. For myself, I consider that the many months of close attention which I have devoted to this work have only served to show me that a complete explanation of all the various cell generations in the snail's gonad is not the work of months, but of years. It will need the collection of a complete series of sections of gonads for every month of

the year except the hibernatory ones.¹ I have found that properly to describe the remarkable facts concerning the origin, function, and fate of the nurse or yolk cells alone would need a separate paper, and should circumstances allow I hope to apply myself to this task.² Bolls Lee (9) was struck by the number and varying sizes of the spermatogonia in the snail. I can at present think of at least several sorts of spermatogonia; by this I mean that it is quite possible to find a large number of cells which are in the spermatogonial generation of the male cells, and which differ markedly either in their nucleus, their Nebenkern, or their mitochondria.

Cell Generations in the Snail.

The most important result of this study has been the realisation that in observing the mixed mass of cells in the lumen of the ovotestis, one deals not with one generation of male cells derived in the same way, but with several generations whose origins are in certain ways considerably different. It is not intended at this juncture to attempt any explanation of this until the various cells have been described as well as possible. From the excellent work of Bolls Lee (9) and Ancel (2), not to mention some of the older writers, we are fairly well acquainted with the appearance of the typical lumen of the ovotestis. Inspection of the text-figures will serve to show what these authors have failed to emphasise sufficiently, viz. that the appearance of the various alveoli differs greatly, not only individually, but just as importantly in the contents of the alveoli which are different at different levels.

In Pl. 32, figs. 28 and 29, and Pl. 33, figs. 30, 31, 32, 33, 34, 35, 36, and 37 I have drawn typical stages of the metamorphosis of a sperm from the loose cells lying in the open lower region of the alveolus.

The spermatogonial division is drawn in Pl. 32, fig. 28. Typically one gets small mitochondria often so small as to

¹ This has now been done.

² This paper (Part iv) has lately been finished.

be difficult to detect, and sometimes two other bodies of a larger nature can be found. One, marked *X.N.K.*, may be the Nebenkern, but it is too small to be easily made out; the other is a large granule (*S.G.*), the history and fate of which has been so ably described by Bolls Lee (9). Suffice to say, this body is quite definitely seen in Flemming-fixed material stained in iron alum hæmatoxylin, and persists for a long time in the sperm cycle. The chromosomes in these divisions are seed-like, slightly elongate, and much crowded. There are considerably more than forty, and the correct number seems to be forty-eight. As far as I can tell, the mitochondria in this form of spermatogonial division do not alter in shape during kinesis. In Pl. 32, fig. 29, I have drawn a spermatogonium just after division has finished and when the nucleus is properly reformed. At *S.B.* is a spindle bridge, at *S.G.* a siderophilous granule, towards one side of the nucleus the small mitochondria are grouped into a conical heap, and finally floating free in the cytoplasm is an apparently serrate elongated body so plain and large as to be easily drawn in with the camera lucida (*N.K.*). I feel quite sure that this is the Nebenkern. When the spireme appears and the loops become grouped to form the contraction figure the Nebenkern takes up its position where the centrosome is known to be in other cases. It should be stated that in the best preparations I have, one is unable to see a centrosome at any stage until near the maturation divisions. In Pl. 33, fig. 30, the Nebenkern (*N.K.*) appears to be broken into pieces but still has the elongate rectangular shape. The mitochondria are now becoming more loosely disposed, and by the stage drawn in Pl. 33, fig. 31, are larger and dispersed throughout the cytoplasm. The Nebenkern is now quite distinctly formed of a number of tiny intensely-staining rodlets.

By the end of the growth period the Nebenkern (Pl. 33, fig. 32) is seen to consist of elongate, slightly curved rodlets, somewhat irregularly disposed, but often placed end to end, as shown in the spermatid in Pl. 33, fig. 35.

These rods are most easily described as banana-shaped.

They lie in, or are grouped so as to enclose, an archoplasmic region near the nucleus.

Despite Bolls Lee's assertion, I must confess that I am quite unable to find a centrosome inside this archoplasm, but there is little doubt that such a body may be embedded in this mass.¹

When growth stage has finished the cell may be the size drawn in Pl. 33, fig. 33, at 4250 diameters. The first maturation prophases are in progress. The chromosomes are appearing, while the Nebenkern, as such, has disappeared. In favourable examples it is found that small rodlets are still visible here and there (*N.K.* in Pl. 33, fig. 33), and these are almost certainly parts of the scattered Nebenkern. The individual rods appear to break up into minor rodlets.

Bolls Lee (9) described in the maturation division a remarkable centrosome structure. I found this quite easily in some of my preparations, and these triradiate bodies are seen at *A.S.* The striæ figured by Lee in these bodies I did not find so marked, but as our technique was different this is not a matter of great importance.

The mitochondria are very dense and numerous. The spindle now forms, with the disappearance of the astral body (*A.S.*), and one gets a figure in which the mitochondria are heaped around the spindle and elongated in shape as if affected by some lines of force (see Pl. 33, fig. 34).

Murray (8) figures the Nebenkern fragments as grouped around the poles of the astral figure, but I am unable to come to a definite opinion on this point. I am able to say that occasionally one finds little rectangular bodies which might be the Nebenkern, but unfortunately, as the mitochondria also become elongate, it is difficult to come to a decision as to the nature of these elements. Since mitochondrial stains also tinge the Nebenkern, staining tests have so far failed. The second maturation division closely resembles the first in so far as the behaviour of the plasmatic bodies are concerned. The spermatid then appears as drawn in Pl. 33, fig. 35, when it is just beginning to metamorphose. At what is later seen

¹ Subsequent work shows that Lee is correct.

to be the front end of the cell, the nucleus is found to be covered at one side by a densely staining cap—the acroblast. Despite especial work in this connection, I have been unable to follow this body back into the spermatocyte. No staining method of which I know will discriminate between acroblast and mitochondrium, and it is obviously impossible to identify this body until it has taken up its position next to the front edge of the nuclear membrane. The spermatid,¹ besides containing the Nebenkern and the mitochondria, is seen to be provided with a cloud of granules of a smaller size lying behind the nucleus, near the locality from which the axial filament presently begins to grow. The granules (*M.*²) are hardly demonstrable till the spermatid is in the stage drawn in Pl. 33, fig. 35, but from thence onwards they are quite easily found.

As the spermatid lengthens, the nucleus becomes shaped as shown in Pl. 34, fig. 41, the acroblast lying as a thickened area laterally. In Pl. 33, fig. 36, I have carefully drawn a spermatid at this stage. The nucleus has become blackly stained with iron hæmatoxylin, while the small granules, which will be called micromitochondria, are closely grouped behind the nucleus. The other mitochondria, which, to distinguish them, will be called the macromitochondria, lie further back. At the letter *C.*² is a structure, constantly present, formed of a large and a slightly smaller granule. The larger granule is probably the second centrosome; the other might be a mitochondrial granule, but I cannot advance any definite evidence as to its nature. A stage just before this is drawn in Pl. 34, fig. 42, and the nucleus does not yet stain entirely basophil. In Pl. 34, fig. 43, a still later stage is drawn. The micromitochondria (*M.*²) are now grouped around the axial filament a good part of its way, and the centrosomic structure is still visible.

In Text-fig. 4 iii a later stage is drawn; in this preparation the two bead-like bodies in the tail of the sperm were particularly obvious.

¹ See Addendum A.

In Pl. 34, fig. 44, at a still later stage, the Nebenkern, which hitherto kept its rectangular figure, has become collapsed by the pressure of the narrowing space in which it lies, and its individual parts are better revealed. In some cases, at least, it seems that the Nebenkern elements at this stage do really enclose an archoplasmic region, or at least a denser region of the cytoplasm. In Pl. 34, fig. 44, the mitochondrial elements are becoming larger, and they now form a rough coat to the axial filament. First are seen the micromitochondria, which now form an undoubted covering, while behind is generally seen the Nebenkern. Behind this lie the macromitochondria, which are less evenly disposed than the micromitochondria. By Pl. 34, fig. 45, the micromitochondria have disappeared as such, but if the axial filament is carefully examined, it will be seen that it has increased both in thickness or bore, and in its affinity for basic dyes. Followed further down to the macromitochondrial region the filament gradually resumes its original staining powers and proportionate size. These areas of the filament are marked X, upper, Y, where the intermediate region lies, and Z, lower, where there is a slight but hardly perceptible thickening. In Pl. 33, fig. 37, at a higher power is drawn the front region of a metamorphosing sperm just before the stage described in Pl. 34, fig. 44. The disposition of the elements is quite typical, while the Nebenkern is crumpled up and is seen to consist of nine batonnettes or rods, which together formed the rectangular structure drawn in the previous figure (Pl. 33, fig. 36). In Pl. 33, fig. 37, these rods seemed to be surrounded by a clear zone.

As metamorphosis goes on the mixed-up macromitochondria and batonnettes become further and further removed from the head of the sperm, while the former of the two become somewhat larger and increasingly fewer in number. They seem to be absorbed finally into the sheath of the tail, and if anything is cast off it must be a very small portion indeed.¹

¹ A residual bead is always cast off, and it always contains some mitochondrial grains.

As the mitochondria slough down the sperm tail, the mitochondrial sheath becomes thicker and more darkly staining in the region just cleared of the chondriosomes, the natural inference being that the latter form the sheath. This seems supported by such a stage as that drawn in Pl. 34, fig. 45, at X, Y, and Z.

In the areas where the cells of the male generation are densely packed one often finds variations in Nebenkern, mitochondria, and nucleus. Without at present going into the question of the cause of these variations, whether technical or inherent in the snail, it is proposed to describe them. In Pl. 32, fig. 25, is drawn a spermatocyte near the end of growth period. The mitochondria are seen to be small, hollow spheres, scattered throughout the cytoplasm in much the same way as in the spermatocyte in Pl. 33, fig. 32.

The Nebenkern elements are much more numerous than in the cases already described, where there are generally thirty rodlets in the spermatocyte, and from six to twelve in the spermatid. In the other spermatocytes, such as that in Pl. 32, fig. 25, the rodlets are always almost completely circular, that slight curve or banana shape being here much exaggerated. The circular rodlets generally are placed as shown in Pl. 32, fig. 25, but it will be noticed that they are almost invariably placed so that their outer, thicker edge lies outermost, and their centre is in contact with the archoplasm. This is very well seen in Pl. 32, fig. 24A. Re-examination of the Nebenkern elements in Pl. 33, figs. 32, 35, and 36 shows that in this variety of cell the elements are banana-shaped, and the convex surface or back of the rodlet is turned inwards—exactly the opposite of what is found in Pl. 32, figs. 25 or 24A, etc. Now when the spermatocyte breaks into the prophase, the cell looks like Pl. 32, fig. 27. The chromosomes are appearing; the Nebenkern elements have become disposed into two groups, one on each side of the nucleus, evidently being influenced by the centrosome. Below the nucleus lie several other rods, curved so as to form a circle, but with one side especially thickened. It is quite characteristic of these

stages that at this period one has difficulty in distinguishing the mitochondria, which are sometimes quite big and ring-shaped, from the Nebenkern elements.

As will be seen on inspection of Pl. 32, fig. 24 A, the mitochondria may be quite large and appear as hollow spheres. When the cell division is in the metaphase the mitochondria and Nebenkern elements become mixed, and I am unable to say that the asters in any way affect the rodlets, as has been claimed by Murray.¹ In some cases one seems to be satisfied that the spindle-fibres do exert some influence; in others the opposite seems to be the case. In almost, if not all, metaphases I have examined, I feel with regard to this question that the Scotch verdict, "not proven," is the safest view to take. Should a specific stain either for mitochondria or for the rodlets of the Nebenkern be found, it may be possible to throw some clearer light upon this question.

In Pl. 32, fig. 22, a second maturation division is shown. The mitochondria are hollow spheres, appearing as ringlets, and here and there lie the elements of the Nebenkern, which I can positively identify. The spermatid of this small-rodlet generation almost always has a nucleus which contains a greater number of karyosomes² than the sort drawn in Pl. 33, fig. 35. The Nebenkern elements in the example drawn in Pl. 32, fig. 26, were very small, and at this stage evidently just collecting after cell division. It will be noted in all these stages except the one drawn in Pl. 32, fig. 27, that the cell is angular in shape, from the abutting neighbouring cells pressing on each side.

When the spermatid begins to metamorphose the micro-mitochondria appear, and the Nebenkern is formed as shown in Pl. 32, fig. 24 A. Curiously enough, the sperm head in the early stages of its transformation is generally irregular in

¹ I have since found that in division the batonettes do lie in the zone of the asters.

² See Pl. 34, fig. 48 *a, b, c*, where spermatid nuclei from different regions are drawn to show variation in karyosomes. The bulk of the karyosome matter does not vary much, only number.

shape—probably traceable to the cramped quarters in which the cell is forced to metamorphose.

In Text-fig. 1, iii, iv, the two extremes in these various kinds of cells are drawn. Fig. iii shows the typical Nebenkern formed of many curved rods, while fig. iv shows the typical rectangular Nebenkern formed of fewer elements.

The remarkable differences which are found in the later spermatids are illustrated in Pl. 33, figs. 37 and 40. These are not quite at the same stage, the latter being slightly younger. In this form the Nebenkern is very large and peculiar, differing most markedly from that in Pl. 33, fig. 37. This also applies to the mitochondria, which, while being larger in Pl. 33, fig. 40, and fewer. But, as will be noticed in Pl. 32, fig. 26, largeness of mitochondria and smallness of Nebenkern batonettes do not necessarily go hand in hand.

The Manner of Metamorphosis of an Indifferent Germinal Epithelial Cell into a Primary Spermatogonium.

Many of the older writers thought that the main factor of change in the epithelial nucleus was the appearance, or at least the exaggeration, of the chromatin lumps. Pl. 31, figs. 11 and 19 show this. In one case we deal with a spermatogonium (the latter), and in the other with a oogonium. But it should at once be pointed out that, from a careful study of these stages, I have concluded that the amount of real

Fig. i.—Part of the lumen less well supplied with nutriment. The epithelial cells have here and there grown into progerminative cells (*X.*), passed to the prophase of the heterotypic division (*C.F.*) and afterwards have begun to drop off (*X.Y.*). (Text-fig. 4.) At *X.* and *E.N.C.* are yolk cells in stages of disintegration. At *N.C.N.* is a bare yolk cell nucleus. At *S.N.* are many spermatogonial nuclei lying in a syncytium (*R.*), a quite characteristic occurrence in these localities of a lumen. As at *S.* and in other cells there is a distinct cloud near the nucleus. (See Pl. 31, figs. 19, 20; Pl. 32, figs. 21 and 23.) Fig. ii.—Passage of a male progerminative cell (primary spermatogonium) from its place on the germinal epithelium

TEXT-FIG. 3.

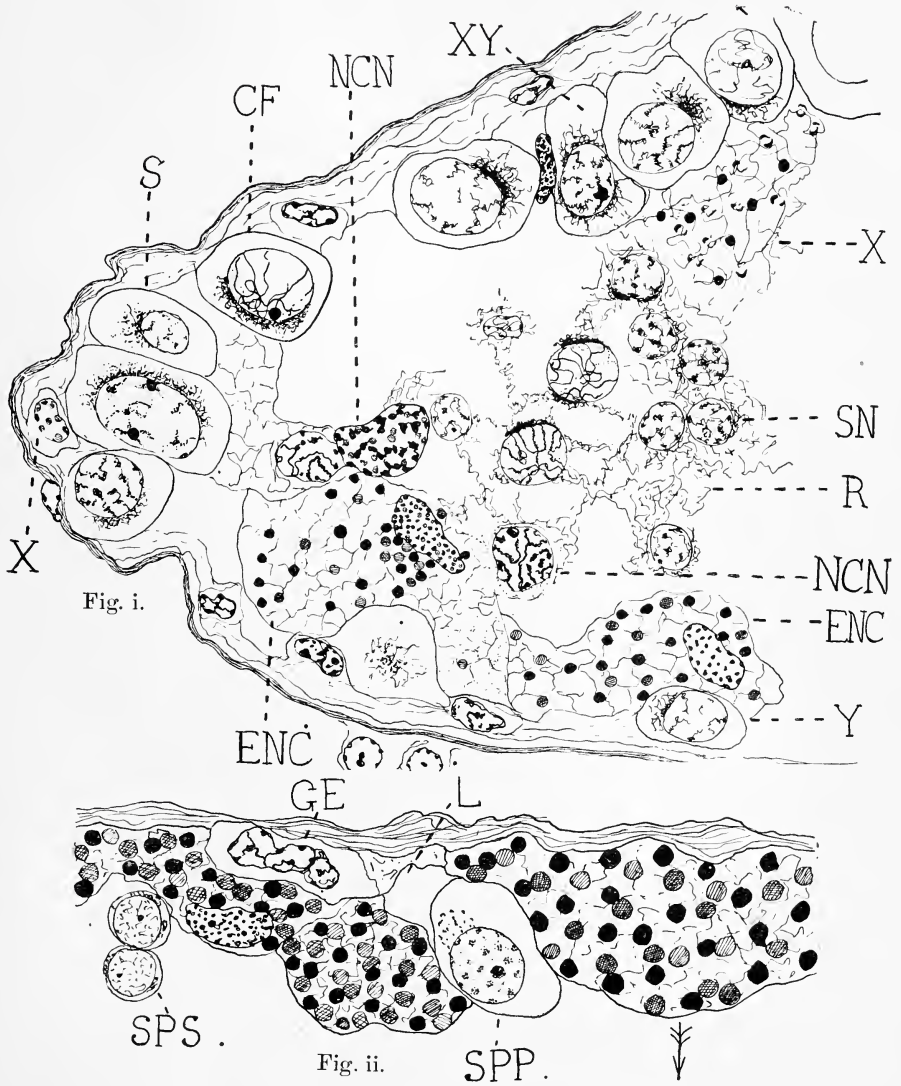

(*L.*) into the lumen of the diverticulum. At *S.P.S.* are secondary spermatogonia derived from a division of such a cell as *S.P.P.* The arrow points to the inside of the lumen.

variation is quite remarkable, and no two epithelial cells metamorphose in quite the same way.

In Pl. 30, fig. 2, the upper nucleus has to its right a small, darker area in the cytoplasm, and the same applies to the upper part of the middle nucleus in this figure. Not all cells possess this cloud—or, more correctly, I should say that I have been unable to find the cloud in every epithelial cell. The cytoplasm of the germinal epithelial cell is of the open variety, and is best seen in preparations stained in iron alum-alizarin-toluidin blue, where it is a purplish-blue in shade.

In some cases, when the cell is about to abandon its indifference, the nucleus, at first a depressed oval, becomes spherical or semi-spherical, as shown in Pl. 31, figs. 17 and 19. I believe that of the many variations which one finds, all fall roughly under three heads: In the first, one has a cell in the positions marked X. in Text-fig. 1, i, growing into fig. ii, X., in the same text-figure. Also in other cases one finds such an example as that of Text-fig. 2 at 1 and 2. While, again, one always finds cases such as that drawn in Text-fig. 3, i, X.Y., and Text-fig. 4, i, and in Pl. 29, fig. 1, at the roman figures (i, ii, iii).

In the other cases one finds the progerminative cell as in Text-fig. 3, ii, *S.P.P.* Also it seems that these arbitrary classes are linked up by other classes, such as the cell 3*b* in Pl. 29, fig. 1 (explained in "Discussion").

In every case of an epithelial cell of the snail metamorphosing into a germ-cell of either sex one finds two constant facts: one is the appearance of a fine cloud in the cytoplasm, which follows after the other—an enlargement of the nucleus. It is only by fine fixing reagents that this cloud is shown, but it has never before been described simply because the workers on the snail destroyed it with acetic acid or alcohol.

I am unable to say why this cloud, which is shown in Pl. 31, figs. 11 and 19 in a very early stage, should with absolute constancy be found to one side of the nucleus. It may be that it is on the side near which lies the centrosome if that be

present, but I am unable to advance any other opinion beyond this: I believe the cloud is formed by a growth and enlargement of the zone already indicated as being present in the cytoplasm of at least some germinal epithelial cells (Pl. 30, fig. 2, *Y.* and *X.*), which is quite possibly a conglomeration of some material around or in an attraction sphere. But so difficult is it to study these early stages that I cannot advance any evidence based on actual knowledge of this small aggregation in the cytoplasm.

One significant fact I can, however, point out: it is that the growth or the appearance of this faint cloud is subsequent upon a change in the size and often of the staining power of the nucleus. The latter moves first; the cloud then appears.

In every case the germinal nucleus at first becomes round or oval, and the chromatin lumps, before connected here and there by bridges, become spherical and isolated. After this the cloud in the cytoplasm becomes marked. From this stage onwards there is a difference in the behaviour of the kinds of male cells derived from such progerminative cells. In the case of one generation of male cells, shown in Text-fig. 3, the chromatin lumps, after some slight changes, break into a spireme, and the prophases of the heterotypic division are undergone while the cell still adheres to the germinal epithelium (*C.F.* in Text-fig. 3, *i*). The same sort of occurrence invariably happens in the oocyte, where a spireme gradually appears and the prophases take place *in situ*. But in the case of certain cells shown in Text-fig. 2, *ii*, and 3, *ii*, the behaviour of the chromatin is different. It can at once be explained that this different behaviour is due to the fact that such cells are going to undergo mitosis. For this to happen the chromatin must come into a resting stage for the formation of a reticulum, which soon breaks up into chromosomes. (See Text-fig. 2, *ii*, at 5.)

In this last cell the chromosomes are beginning to appear. It has been customary for many writers on this subject to describe minutely changes in the nucleus which herald either the formation of a spermatogonium or an oogonium, whichever

the case may be. I do not fail to recognise the splendid labours of such observers when I state that I cannot accept anything in their descriptions of such changes. There may be very slight differences, but I have failed to find any upon which one could reliably base a dogmatic statement. The differences between the individual behaviour of the chromatin in the nuclei of a number of progerminatives of the same probable future sex, are so wide as to cover the statements depending on size, staining power, and arrangement of chromatin lumps, upon which these descriptions are based.

To return to the cells which I have mentioned as about to undergo mitosis, Text-fig. 3, ii, *S.P.P.*, shows a section through a region from which male cells were appearing when the snail was killed. The cell *S.P.P.* is leaving its place in the epithelium marked *L* and is pushing out. This cell has a nucleus, oval in shape and containing its chromatin in faintly staining lumps. There is a cloud in the cytoplasm containing dark bodies (Pl. 34, fig. 49). Inspection of Text-fig. 2 at the figure 2 shows another cell, but in a different locality, free

TEXT-FIG. 4.

Fig. i.—Shows dropping off of the male cells, about to finish growth stage. At *Y* the cell is becoming detached, at *X* it is already in the lumen. The cell *Z* may belong to this generation, or from the generation to which the boquet stages (*BS*) are derived. There is generally a mixture of various generations in this lower region of the diverticulum. $\times 900$. Fig. ii.—Bichromate smear of adult sperm head. *A.* = acrosome, *N.* = nucleus, *C.* = centrosome, *M.* = mitochondrial sheath. Iron hæmatoxylin. $\times 2000$. Fig. iii.—Group of metamorphosing spermatids showing definite position of Nebenkern (*N.K.*). Also the curious arrangement of two granules (*C.*) where the hind centrosome lies. (Compare Pl. 34, fig. 44.) $\times 1000$. Fig. iv.—A spermatogonial group with Nebenkern (*N.K.*), spindle bridge (*S.B.*), mitochondria (*M.*), and a yolk cell (*NC.*). (Compare Pl. 29, figs. 1, 2, and Pl. 32, fig. 29.) Fig. v.—Several batonnettes greatly enlarged showing difference in shape and size, and in one the relations of the archoplasm (*A.R.*) with the inside of the batonnette. (See Pl. 32, figs. 24 A and 25.) Fig. vi.—The large variety of Nebenkern rod at same magnification. (See Pl. 33, fig. 36.) Fig. vii.—Three spermatogonia attached to a cell with a germinal epithelial nucleus, but with the cell granules grouped together at *X*. What these are, whether Nebenkern batonnettes or mitochondria, was not ascertained. $\times 2000$.

TEXT-FIG. 4.

Fig. i.

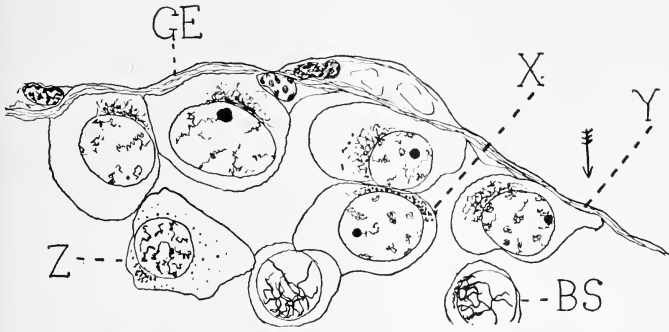

Fig. ii.

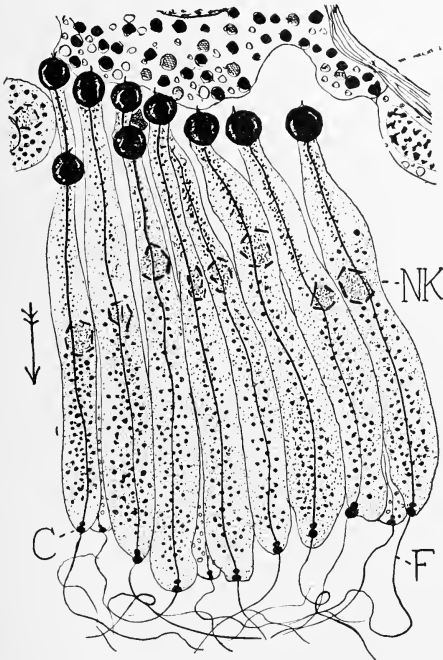
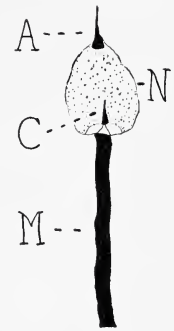

Fig. iii.



Fig. v.



Fig. vi.

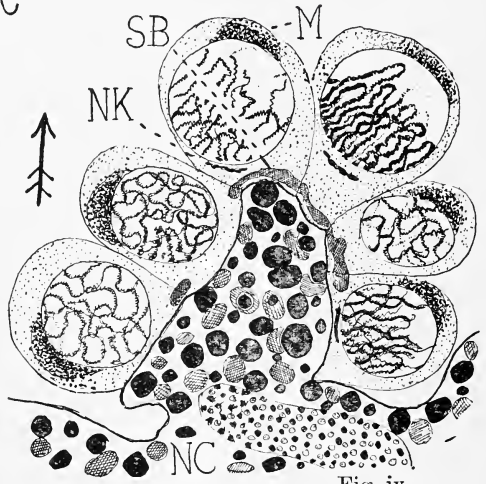

Fig. iv.

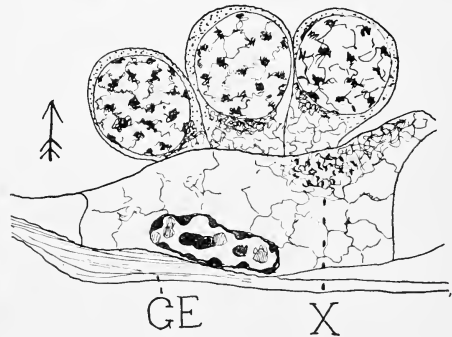

Fig. vii.

from much yolk. This cell is drawn in Pl. 31, fig. 17, at a very high power.

The nucleus has the same general appearance as in Text-fig. 3 at *S.P.P.*, though in the latter the chromatin lumps have not broken up so much as yet, as in Pl. 31, fig. 17. Both these cells will ultimately divide and give rise to some secondary cells. The answer to the question why there should be differences in these two cells, however small, is that they originate from parts of the germinal epithelium which are in a different nutritive condition. Cells like these soon divide many times and give rise to bunches of spermatogonia such as those shown in Pl. 29, fig. 1, at the outer 2, or in Text-fig. 4 at iv. The connection between the yolk cell and the male progerminative cell is sometimes severed, sometimes retained.

Now, if attention be centred on the cytoplasmic cloud in these progerminative cells it will be noted that apart from the apparent denseness of the cytoplasm which causes the cloudy appearance one finds distinct granules. These are apparently the first signs of the mitochondria. The size and number of these granules are very variable. In Pl. 31, fig. 17, they were very large and distinct.

Towards the time when the lumps of chromatin in the nucleus have fragmented to form a fine clear granular structure these cytoplasmic bodies become dispersed more and more from the zone from which they originally appeared.

The chromosomes soon appear and a cell division takes place, the cytoplasmic bodies being visible and scattered here and there around the amphiaster. As far as I have been able to ascertain, these mitochondria do not lose their rounded shape during division. Such a series of divisions finally give rise to cells such as those drawn in Text-fig. 3 at *S.P.S.*

After a division is finished, and these secondary cells have regained their resting nucleus an examination of the cytoplasm generally shows that two sets of bodies are present: one, the mitochondria, are scattered indiscriminately, the other is a dark structure lying close to the nuclear mem-

brane. In some generations of secondary spermatogonia this latter structure is not demonstrable till later. This body is the first visible sign of the Nebenkern of Pulmonates, and it may possibly have been present in the stage drawn in Pl. 31, fig. 17, but may not be plain enough to make its detection possible.

In Pl. 32, fig. 24, is drawn a spermatogonium of the generation shown in Text-fig. 2, fig. ii, at 2. The Nebenkern (*N.K.*) is quite easily seen to consist of several straight rods. In Pl. 32, fig. 29, the Nebenkern of another generation of spermatogonia is shown. The fate of the Nebenkern and mitochondria of these generations has already been followed out.

Another sort of male generation of cells appears in the following way: In Text-fig. 3, i, is drawn a lumen in which nearly all the germinal epithelial cells have thrown off their indifference and have become large peculiar cells. The epithelium from which such cells arise consists of a single layer of cells, yolk cells being either exhausted or completely absent. This is shown in the plan on Pl. 29, fig. 1, at the Roman figures i-iv.

In Pl. 31, fig. 19, the cell at ii in Pl. 29, fig. 1, is drawn at high magnification. It lies on the epithelium projecting into the lumen in a different way from Pl. 31, fig. 17.

The nucleus still has the chromatin lumps which stain somewhat lightly, and there are two nucleoli which are hollow spheres, as far as one can ascertain. At any rate, their centre does not stain so heavily as the periphery. The lumps gradually become elongated and join up to form a wide reticulum (Pl. 31, fig. 20). Now, the plasma in fig. 19 is seen to contain to one side of the nucleus, the usual zone which here and there has a granule. In the next stage the granules have become quite plain and are seen to consist of the ring-like mitochondria already described from the figures in Pl. 31. In fig. 20 the zone of thickened cytoplasm has spread right around to the opposite side of the nucleus, but as yet no distinct mitochondria have appeared on this side (*Z.*).

There is rarely any other structure to be made out in the

cytoplasm, but in a few cases one finds what seems to be an archoplasmic mass (*A.R.*) upon which may be stuck from two to four Nebenkern rods. This is so seldom found at this stage that I do not think it is the rule. The wide open reticulum now breaks into a loose spireme and a contraction figure is shown in Pl. 32, fig. 21.¹ In this cell the mitochondria were rather irregular in shape, here and there undoubtedly ring-like, but they were all collected to one side of the nucleus towards where the chromatin filaments converged. It will be noticed that the nucleoplasm in this kind of male cell generation is abnormally large for the amount of chromatin spireme. The diplotene stage and the rest of the pro-phases soon take place and the growth period begins. The Text-fig. 3, i, shows that at *X.Y.* and at other parts these cells are losing their attachment to the walls. In Text-fig. 4, i, the cell *Y.* is just falling into the lumen, while *X.* has already arrived there. The contraction figures below belong to another cell generation. In Pl. 32, fig. 23, a typical cell just after the beginning of the growth stage is shown. The attachment to the germinal epithelium consists only of a small area (*X*₁) which will soon part. The mitochondria are dispersed in the cytoplasm, and outside the nuclear membrane (at *N.K.*) is a cloud in which can be seen embedded a very large number of small Nebenkern rods. These are slightly curved. This is the usual way in which the Nebenkern appears in this generation. Pl. 32, fig. 25, is a later stage. Subsequent stages are drawn in Pl. 32, figs. 22, 25, 26, and 27, and have been described.

It seems that in this generation the nucleus after the pro-phases collapses somewhat in size, proportionate to the normal amount of chromatin contained therein. It will be noted that no spermatogonial divisions take place.

¹ Pachynema.

The Manner of Metamorphosis of an Indifferent Germinal Epithelial Cell into an Oogonium.

It has been agreed almost unanimously among workers on the ovotestis that the presence of a group of yolk cells is the determining factor in the appearance of the female cell. I consider this explanation inadequate, for it can be shown that spermatogonia appear in regions choked with yolk cells, and oogonia may appear in regions where little or no yolk is present. I feel that it would be quite a mistake to entertain the view that a yolk cell exclusively determines the awakening of an indifferent cell into the egg generation. But it might be true to say that the presence of abundant yolk was the *sine qua non* for the successful growth of an oocyte to maturity. It would also be quite true to say that in the majority of cases the transition from an indifferent cell to an egg took place behind or between some yolk cells. Despite careful observation of a large number of cases I find it difficult to formulate a statement of any differences between male and female nuclei till after the growth stage begins. This is not the case with the cytoplasm. The drawing in Pl. 30, fig. 6, was thought by me to be an oogonium in contraction stage, firstly because it was so closely embedded behind yolk cells that its exit into the lumen would have been difficult, and secondly because the epithelium in this region was seen to be producing many oocytes.

What I take to be the Nebenkern (*N.K.*) is very like that in the male cell drawn at a little later stage in Pl. 33, fig. 31, while the mitochondria are not very characteristic. The nucleus is unlike the male generation nucleus drawn in Pl. 32, fig. 21, but almost identical with that drawn in Pl. 33, fig. 30. Apropos of the statement that the spermatogonia appear in yolk regions compare Text-fig. 1, x, and especially Text-fig. 3, ii, at *S.P.P.* On the other hand, in an epithelium like that in Text-fig. 2, ii, a solitary oocyte may grow. This all shows that the matter is somewhat more complicated than at first supposed. Having shown that to the end of the pro-

phases the nucleus does not give us any very characteristic evidence we will turn to the cytoplasmic bodies. In Pl. 31, fig. 11, is drawn a cell thought to be an oogonium. I believe it to be such for the same reasons which I brought forward for fig. 6 of Pl. 30. The cytoplasmic cloud does not differ markedly from many another example known to be a male—it contains the same lumps and is isolated to one side of the nucleus in the same way. Pl. 30, fig. 6, is thought to be a later stage. A Nebenkern has appeared. Fig. 10 of Pl. 31 is a still later stage—the nucleus is losing its chromatin loops, while the mitochondrial mass looks less granular and more flocculent. At one side is an undoubted Nebenkern, but of a slightly different type, the rods being straighter. Fig. 10 of Pl. 31 really corresponds to the same stage in the male drawn Pl. 33, fig. 31.

I have already mentioned what great variation was found in the appearance of the male cells. This, I think, applies even more strongly to the case of the female cells, but a difference which seems to exist between all the female cells and the male cell is that in the latter the mitochondria are from the first to the last granular and comparatively large, while in the former the mitochondria, even if at first granular, rapidly become flocculent and lie like a cloud, as shown in Pl. 31, figs. 10 and 12, and in later stages in Pl. 30, figs. 3, 5, 7, Pl. 31, figs. 9, 13, 14. Later, the mitochondria of the egg seem to become granular, spherical, and often somewhat larger than the male, but there is then no possibility about making a mistake as to the sex at this period.

Pl. 31, figs. 12 and 9, show stages in the mitochondria. In the former figure, which is drawn one-half the size of fig. 10, the mitochondria are dispersing, not, however, from a centre as they are in fig. 9. In this figure there is a centre from which flocculent masses of mitochondria radiate. It will now be clear that the most certainly diagnostic evidence for difference between the oogonium and spermatogonium is to be found in the mitochondria, which early behave differently in either sex.

The Fate of the Mitochondria and Nebenkern in the Egg.¹

The flocculent mitochondria gradually become dispersed somewhat unevenly throughout the cytoplasm as shown in Pl. 30, figs. 3 and 7, and in Pl. 31, fig. 9. If these mitochondria be examined it will be found that they consist of masses of exceedingly fine grains (Pl. 31, fig. 13). In later stages these grains become here and there mixed up with larger granules as shown in Pl. 31, fig. 14. In a still later stage no flocculent masses remain, there being now only large mitochondria. The latter seem to be derived from the flocculent masses as shown in Pl. 31, fig. 14, and in different eggs are of different sizes as is the case with the mitochondria of the male. Soon after this, vacuoles appear in the cytoplasm and the mitochondria lie in the trabeculæ between these alveoli (Pl. 31, fig. 16). Yolk disclets sooner or later partially fill these spaces (Pl. 31, fig. 16, *Y.*), but are not to be confused with the mitochondria at any stage. In later stages the cytoplasm becomes divided into a cortical layer without yolk vacuoles, and an inner layer like that drawn in Pl. 31, fig. 16.

After the stage drawn in Pl. 31, fig. 10, the Nebenkern seems generally to become obliterated by a curtain of mitochondria, but as shown in Pl. 30, fig. 5, it may still be quite plain. Its subsequent fate is difficult to follow, for it cannot be found in every oocyte. In Pl. 31, fig. 22 (at *X.N.K.*) are round bodies which are almost certainly separate parts of the Nebenkern. I have found many oocytes showing these ring-like structures.

In later stages there appears a clearer zone near one side of the nucleus, and in this zone appear several blocks of darkly-staining matter as shown in Pl. 31, fig. 18; the two left-hand pieces are drawn at a high power in Pl. 30, fig. 8, and consist of more or less solid matter, which generally contains cavities. The nature of these structures and their con-

¹ See Addendum B.

nection, if any, with the mitochondria or Nebenkern, is unknown to me.

The Differentiation of an Indifferent Germinal Epithelial Cell into a Nurse or Yolk Cell.

It is quite usual to find small yolk granules in any indifferent epithelial cell, and when the cell becomes either an oogonium or a spermatogonium, these soon disappear at first (see Pl. 30, fig. 6). The growth of an indifferent cell into a yolk cell is accompanied by the appearance of abundant yolk disclets, and a change in the size and in the disposition of the chromatin of the nucleus. In the latter the chromatin bridges between the angular lumps if present (Pl. 30, fig. 2) become lost and the chromatin becomes formed into little round structures. Synchronously with the appearance of more and more yolk, the nucleus grows larger and larger till it may be 35μ in length.

These changes are easily noticed and have already been described well (2). A more difficult problem is what happens to the plasmatic bodies of the modified cell. Does a Nebenkern appear? What happens to the mitochondria? It is not at all easy to find answers to these questions. In Pl. 33, fig. 38, is drawn a cell with a yolk cell nucleus gathered into numerous chromatin lumps. In the cytoplasm there were no yolk disclets, but the reticulum was of the very wide kind, peculiar to yolk cells. Here and there were small masses containing mitochondria (*M.*), and to the left of the nucleus was what I took to be an attraction sphere, inside which were embedded a number of dark bodies, probably the Nebenkern. In many ways this cell is intermediate between the yolk cell and the indifferent epithelial cell. In the full yolk cell it is probably not possible to discover attraction sphere, Nebenkern, or mitochondria. But after many of the yolk discs have been absorbed by neighbouring cells, it is generally possible to discover bodies shaped like those drawn in the oocyte in Pl. 31, fig. 12, at *X.N.K.* What these are, subsequent work will be needed to show, but I have done enough

to think that modified representatives of Nebenkern and mitochondria may be found in the cytoplasm of the yolk cell.¹

After some time the yolk cells become exhausted completely, and the wide reticulum breaks up and the nuclei float out into the lumen of the ovotestis diverticulum as shown in Text-fig. 3, i, *N.C.N.*, *E.N.C.* These nuclei do not degenerate, as might be supposed. They lie there in the midst of a mass of live cells and degenerate yolk, and seem to undergo further changes which need not detain us at present, but I should say that it is my firm opinion that these nuclei regain a cytoplasm and become spermatocytes.

Description of the Scheme on Pl. 29, fig. 1.

In this figure I have united my final conclusions concerning the processes which go on in the various regions of diverticulum of the ovotestis of *Helix*. All cells have been drawn in to scale with a camera lucida, and in the majority of cases are the same as those on the other plates drawn at a higher power. Great care has been taken to show the germinal epithelium in its true state; thus, for instance, the region of the right lower edge marked by the Roman figures is the same kind as that drawn in Text-fig. 3, i. The left lower half appears also in Text-fig. 2, i, and so on.

In the following description, after mentioning each series of cells, I will indicate where they are drawn at a higher power in the other plates. If not the identical cell, I will show this by adding the letter *W.* to the bracket.

The Genesis of the Egg.

A = Differentiating germinal cell embedded in yolk cells (Pl. 31, fig. 11-*W.*).

B = Young oocyte (Pl. 30, fig. 6-*W.*).

C = Older oocyte (Pl. 30, fig. 3, 7, etc.-*W.*).

D = Older oocyte (Pl. 31, fig. 9-*W.*).

¹ More work on a dozen species of Pulmonates shows that the true yolk cells do not contain mitochondria or Nebenkern.

The Genesis of the Sperm.

In the Roman figures to the right I have indicated the sort of male cell generation in which no spermatogonial divisions take place. (See also Text-fig. 5.)

- I. Earlier stage than drawn in any other figures.
- II. Progerminative cell (Pl. 31, fig. 19).
- III. Mitochondria appearing in spermatogonium. Rare kind of Nebenkern (Pl. 31, fig. 20).
- IV. Spermatocyte, with Nebenkern just appearing (Pl. 32, fig. 23). Usual Nebenkern.
- V. End of growth stage. Cytoplasm differs greatly in size in different examples (Pl. 32, fig. 25-III).
- VI. Maturation division. Spindle curiously orientated with relation to cell, first maturation. (Second maturation drawn in Pl. 32, fig. 22-III).
- VII. Spermatid (Pl. 32, fig. 26).
- VIII. Later spermatid (Pl. 32, fig. 24 A-III).

It will be noted that on the left bottom region at the Arabic numbers 1 and 2, there is another source of male cells. The two sources of cells, marked in Arabic and in Roman numerals respectively, are often mixed indiscriminately and later stages are hard to distinguish. Thus the bouquet stages marked 3*a* are certainly derived from such a source as 1, 2, on the left, because in the generation derived directly as shown at the Roman numerals the contraction figure and other stages up to the beginning of growth take place directly on the wall (see Pl. 32, fig. 21, which was stuck on the wall, and Text-fig. 3, i).

In the case of the cells marked V 4 it was not possible to tell whether they were derived as in the Roman numerals or as in the Arabic. Thus the Roman numerals beyond VI are probably of uncertain derivation. VI itself, on account of its great size, is probably of the Roman numeral generation. Almost invariably the two generations, derived respectively from the bottom left corner at 1 and 2, and from the bottom right at the Roman numerals have a Nebenkern formed of

numerous curved elements as in Pl. 32, fig. 25. Moreover, the size of the entire spermatocyte, though not of its nucleus, varies greatly (VI, V, V-4). The spermatocytes are either crowded as in V-4 to VIII or loose as at V. Crowded spermatocytes have walls like that in Pl. 32, fig. 25, etc., loose ones like that in Pl. 32, fig. 27. Nebenkern in each may be the same. The spermatid may be a large vacuolated cell, though the sperm has the same end result.

At the Arabic numerals are drawn all the various generations which have male progerminatives which divide to give rise to secondary spermatogonia and even tertiary generations of spermatogonia.

At the mid left-hand side at 1 is a primary spermatogonium dropping into the lumen. The male progerminative cell at II on the right at the Roman numerals is derived from a different kind of epithelium with a semi-empty lumen. At 2 (left side) this primary spermatogonium gives rise to many secondary cells. Some, as at 2 *a*, go on dividing till they become very small. Others form the bunch drawn at the outer middle 2 (Text-fig. 4, iv).

By 3 the prophases of the heterotypic division have begun. One sometimes finds cells like that drawn at 3 *b*. Isolated cells like this are found in connection with a nurse-cell and may form a link between the generations at 1 in Arabic numerals and between the other in Roman. These cells, such as that at 3 *b*, seem to be primary spermatogonia which have failed to divide but have entered the prophases.

At 4 are the spermatocytes; in this generation they never vary so greatly as in the generation derived from the epithelium, as at (I, II, III) or as in the crowded cells. At 5 is a first maturation division, which can be compared with the first maturation at VI.¹ The spindles are the same size.

The following indicates where these cells are drawn at a higher power:

1 in Pl. 34, fig. 49 (*W*).

2 in Pl. 32, fig. 29.

¹ Such cells are not all so large as this example.

- 2 *b* in Pl. 32, fig. 24 (*W.*).
 2 *c* in Pl. 32, fig. 28 (*W.*).
 3 in Pl. 33, fig. 31 (*W.*).
 4 in Pl. 33, fig. 32 (*W.*).
 5 in Pl. 33, fig. 34 (*W.*).
 6 in Pl. 33, fig. 35 (*W.*).
 7 in Pl. 33, fig. 36 (*W.*).
 8 in Pl. 34, fig. 45 (*W.*).
 9 in Pl. 34, fig. 46 (*W.*).

DISCUSSION.

(*a*) Nebenkern.—Sex determiner, spindle former, degeneration product, chromidium, are only a few of the different characters supposed to be fulfilled by this curious aggregation of stick-like structures, known as the Nebenkern.

In the first place we will examine the evidence that the Nebenkern determines the sex of a differentiating cell. Demoll, tracing the Nebenkern from about the time of the "Bukett stadium" in the prophases of the heterotype divisions, thought that the subsequent development of this body was the lever which turned the cell to oogonium. It is quite true that it is at or immediately after the bouquet stage that the first definite evidence for the female sex¹ can be found, but had Demoll succeeded in following out the mitochondria he would have seen that the latter may show a differentiation towards one sex before the Nebenkern becomes in any way characteristic. Demoll's reservation that the "sex chromosome" probably influences the Nebenkern to act in a way productive of one sex or the other is interesting, but supported by no evidence.

Briefly stated, I should think the following disposed of the "Nebenkern and sex" hypothesis¹:

¹ Sex, female or male, I have used somewhat loosely instead of "metamorphosis of indifferent cell into oogonium or spermatogonium," respectively.

(1) The mitochondria in the egg are often diagnostic before the Nebenkern rods alter.

(2) The Nebenkern varies more in individual spermatogonia than between Demoll's spermatocyte and oocyte examples.

(3) The whole train of events leading to the appearance of undoubted Nebenkern and of mitochondria is so liable to variation that it would be impracticable to look to such structures as sex determiners.

(4) The Nebenkern may be late in appearance, even after the cell is undoubtedly male.

(5) Bouquet stages are not rightly to be considered as definite milestones, parallel in the sex development of either sperm or egg cells, for the bouquet stage may appear in the male at a time when it is known that the sex¹ has been determined cell generations ago. I refer in this to the secondary spermatogonia which go on dividing and which sporadically enter growth stage.

(6) The amount of Nebenkern material in the bouquet stages of the male alone varies from "none demonstrable" to a large amount.

It will be seen, therefore, that lack of proper examination and of sufficient knowledge of the Nebenkern has led Demoll to suggest a theory unsupported by evidence of any description.

What would certainly be more logical would be to say that the alteration in the Nebenkern was the result of and not the reason for the appearance of a definite sex. As far as diagnosis goes the mitochondria are better objects for building up theories, but for many reasons the last paragraph about the Nebenkern also applies to the mitochondria. As for the suggestion that the sex-chromosome guides the Nebenkern in its "choice of sex" I have no evidence either for or against. Demoll's idea that up to the appearance of the Nebenkern the cell may be considered indifferent is disproven by every species of evidence.

The only other likely suggestion as to the function of the Nebenkern is one which has been freely supported by certain

observers. It is that these rods are the condensed spindle, and that their supposed disappearance before mitosis is due to the fact that they have gone to form the astral figure.

As far as the snail is concerned I am somewhat doubtful as to the validity of this interesting suggestion. Without definitely condemning or upholding this view I think that the following facts should be borne in mind. In the Helicids:

(1) It is, if not absolutely unproven, at least extremely doubtful whether the rods do disappear¹ (Pl. 32, figs. 23 and 27).

(2) The substance of the rods differs in bulk, as also do the number of the rods. Variation in the size of the spindle is almost negligible (Figs. 24 A and 36, Figs. 25 and 32, etc.).

(3) In the prophases the rods can undoubtedly be found lying here and there in disorder, not as if they served a definite function in the formation of the amphiaster.

(4) In many spermatogonial late telophases the Nebenkern appears in a position removed from the centrosome, archoplasm, or spindle bridge. Not in any case as if it appeared to be reinstated by a condensation of any part of the amphiaster (Pl. 32, fig. 29).

(5) In numerous other animals the spindle appears and disappears without a Nebenkern (batonettes).

(6) Bolls Lee and I describe a triradiate structure from which the astral rays arise, and which is undoubtedly unrelated to the Nebenkern (Pl. 33, fig. 33).

(7) Spermatogonial generations are to be found in which the cells before entering mitosis had no definite Nebenkern.

Before the spindle-forming function of the Nebenkern can be proven all these objections must be met. I do not think any of them can be explained satisfactorily from the point of view of the observers who espouse the theory. Terni's statement already mentioned, that he did not believe that all the

¹ In a forthcoming paper I have described how to fix and stain so as to show these rods during metaphase.

idiozomatic material was taken up in the formation of the spindle, I think rather vitiates the evidence for the view that it is necessarily the Nebenkern part of the idiozome (archoplasm) which goes to form the middle spindle. Terni's material seemed to admit of clearer study of the Nebenkern than mine, because in the snail the mitochondria do not appear to become localised to one side of the cell as often happens in *Geotriton*, according to Terni. This localisation often clears the area around the Nebenkern, and assists observation. (For further evidence against the "Nebenkern spindle" view see Fauré-Frémiet, page 580 and fig. 33).

To return to the Nebenkern of *Helix aspersa*, it may be worth while to attempt to analyse some of the variations so strikingly evident.

The Nebenkern rods differ in number without a doubt; they likewise differ in size, and their shape is seldom the same. Neither the number nor the great difference in size can be the result of varying conditions of fixation. For the shape I cannot speak with such confidence. It is quite possible that some small variation either in the fixative or the condition of the cell might produce distortion of the rods. To test this I examined a great deal of material by the *intra-vitam* methods. Janus green of the strength of 1 in 30,000 and neutral red about the same strength were used. These did not give very good results. After many experiments I found that *intra-vitam* methods would not properly settle the question, because the rods of the Nebenkern never seemed to take the stain heavily enough.

I devised the following "fresh method": A small part of the ovotestis was smeared on a slide, and a little 1 per cent. permanganate of potash was added. A coverslip was then placed over this, and the preparation, after about sixty seconds, showed the cell inclusions a brown colour, and they were very easily studied. The mitochondria were remarkably clear, and were of the spherical type, not stick or rod-like. The Nebenkern was found to vary as in my drawings—rod-shaped or curved. In this permanganate method the cells are

killed instantly. I found the oocytes stained just as shown in my diagrams.

The Probable Function of the Nebenkern.

It will be seen that for some reasons I am at present unable to accept the view that the Nebenkern has anything to do with the formation of the astral figure. Terni's important paper, I feel, reinforces me in this (see especially his figures 15 to 18).

I do not find myself in a position better than that of many of my predecessors in-so-far as an analysis of the function of the Nebenkern is concerned. But I feel sure that its real rôle has not been pointed out. It seems evident that it is, in molluscs, a piece of cell mechanism as definite as the mitochondria. I have shown that, like the mitochondria, it is liable to variation in time of appearance, in size, and in its general behaviour. It generally stains like the mitochondria, it is destroyed by the fixatives which also destroy mitochondria, and it is seen best in preparations which show the latter best. I therefore think that the Nebenkern rods in *Helix* are to be classed with the two sorts of mitochondria described by me as definite plasmatic elements whose exact function is still unknown, but which have nothing to do with the amphiaster. The aster and centrosomes can be followed out best in material unfavourable for a study of the mitochondria or Nebenkern.

With regard to staining reactions, Fauré-Fremiet says: "Si l'on isole des spermatoocytes dans le sérum au chlorure de manganèse additionné de violet dahlia ou de violet de gentiane, les mitochondries se colorent assez rapidement en lilias, tandis que le Nebenkern reste quelquefois plus longtemps avant de se colorer."

b. Mitochondria.

It is not intended to discuss these bodies at length, but it may be pointed out that in the snail one finds a remarkable

phenomenon. It is the presence of two definite kinds of mitochondria, which apparently have a definite location in every sperm tail. This is a fact of cardinal importance, and seems to show that there is a division of labour or function between the mitochondria of the spermatid. The position of the micromitochondria is more definite than that of any plasmatic structure other than centrosomes or perforatorium.

Terni figures and describes his mitochondria throughout as rods, remarkably equal in size and length. He has observed fresh material, and therefore apparently this rod-like structure, which can be artificially produced in *Helix* by bad fixation, is the true state of affairs in *Geotriton*.¹

c. The Determination of Oogonium, Spermatogonium, or Nurse-Cell.

In the following, the words "determination of sex" are used for the above for convenience. I have been unable to produce any definite evidence regarding the determination of sex. This paper deals almost exclusively with the plasma, but I have come to certain conclusions with regard to this important matter. In short, I am convinced that since it is the nucleus which is the first part of the indifferent cell to begin differentiation, we are justified in believing that the nucleus is the prime factor in the production of any one sex. The nucleus enlarges, its chromatin undergoes changes, a cloud appears at the edge of the nucleus, evidently under the influence of the latter, and every step in the metamorphosis of the cytoplasm is preceded by one in the nucleus. If we saw the nucleus remaining as it was for some time, waiting till the *Nebenkern* or mitochondria appeared, we would naturally think that the latter structures, after appearing, stimulated the nucleus. As it is the other way about, I feel justified in entertaining the view that it is not the plasma,

¹ Since this paper was written I have come to the conclusion that the rod-like mitochondria (Pl. 33, fig. 34) where they occur are artefacts produced by bad fixation, but as I have not observed *Triton* I cannot venture to question Terni's results.

but the nucleus, which induces differentiation along a special path. The natural outcome of this suggestion is the word "sex-chromosome." Curiously enough, after examining many hundreds of sections I have never seen mitosis in the germinal epithelium. When I consider that I only found very few cases of divisions of the primary spermatogonia, I am reluctant to make a statement which might be injudicious, but I cannot overlook the fact that there appears to be abundant evidence that the germinal cells divide amitotically, and no evidence for mitosis. It was my desire to examine the cytoplasm of a germinal epithelial cell in mitosis, if it could be found, for at this stage many bodies become revealed.

Any evidence that one might have for believing that all nuclei in the germinal epithelium of the ovotestis are endowed with the same potentialities—that is, for maleness, femaleness, or for becoming a nurse-cell—and that this power is directed in any one of the three channels by purely external or environmental conditions, is somewhat hypothetical. The favourite view, that abundant yolk cells (nutriment) affects the decision, seems negatived by the fact that male progerminative cells can, and do, appear in areas choked with yolk. A number of cells stuck upon the germinal epithelium seemed too big to be male cells, and their cytoplasm recalled that of the spermatocyte. I was much puzzled by these, and it has occurred to me that they might be intermediates between spermatocytes and oocytes. They contained distinct *Nebenkern* batonettes of the semi-lunar type, and mitochondria of a fine nature, but not flocculent. The cells were much larger than a full-grown spermatocyte, and were located in a yolkless area of the epithelium. Could it be possible that the indifferent cell is affected by stimuli sent forth by the presence of yolk cells, by crowded spermatogonia, and by the general condition of that area in which it lies? It seems certain that the matter is complicated, and cannot be reduced to the bald statement that oocytes appear because of abundant nutrition.

I think that there are a variety of conditions which act on

the cell; the latter is, so to speak, hanging in the balance when it begins to differentiate. If the stimulus is not definite enough an intermediate might be formed, and later degenerate, as many cells do. For the moment I can think of several possible sources of stimulation. Abundant and differentiating male cells in the lumen might send the balance towards femaleness. Absence of any cells in the lumen might stimulate towards maleness. As a matter of fact, here often enters a direct contradiction of the real facts. I have several cases where a lumen, quite or almost empty, is producing either male or female cells alone. It should be said, however, that in the latter case the lumen wall still had some few yolk cells.

Finally, I believe that the nucleus of the indifferent cell may be stimulated by a variety of external agencies to tend towards one sex, and that the nucleus is the cell organ responsible for the differentiation of the plasmatic elements. I conclude that the plasmatic elements do not influence the nucleus in this matter.

d. The Different Sperm Generations in the Ototestis.

The ototestis lumen is continually giving rise to new sperm cells. The conditions of nutriment alter so much that very few of these generations arise under the same stimuli.

The number of times which the primary spermatogonium divides, and the number of times the secondary cells continue fission, depends on the nutrimental conditions of the lumen. I think that the reasons for variation of the generations are as follows:

(1) Spermatogonial divisions of variable number, leading to a variation in Nebenkern and mitochondria. It is a fact that such variation does arise through differing numbers of divisions.

(2) The conditions of nutriment profoundly affect the appearance of the plasmatic structures in spermatogonia or

male progerminatives, and are probably instrumental in checking or stimulating spermatogonial divisions.

(3) The nutrimental conditions of the wall producing a male generation is hardly ever the same.

(4) Finally, it will be seen that the spermatogonium beginning growth period may have had a very variable history. This is demonstrated by the variation in not only its plasma, but often in its nucleus.

It can safely be said that in hardly any other group are the conditions under which the male cells arise so open to variation.

Difference in the mitochondria of the various generations is principally due to the fact that a much divided line of spermatogonia contains but few mitochondrial granules. When growth begins, in every case it seems that the mitochondria increase in number by dividing; but there is some difficulty in observing this, though one knows this process must happen by the fact that spermatogonia have fewer mitochondria than spermatocytes, and the question is not merely a matter of increase of size of the granules in the growth period. Thus the spermatogonium, which has, so to speak, originated at the tail end of a large number of divisions, starts out on growth with fewer mitochondria. These divide, but never give rise to the same number of granules as one finds in other "less divided" generations; but paucity in numbers is almost always balanced by increased size of individual granules (compare Pl. 33, figs. 37 and 40).

In many of the drawings in this paper mitochondria are shown as hollow spheres, while in others they look quite solid (compare Pl. 32, figs. 25 and 26). The most natural explanation of this is, that for some reason the stain is more easily extracted out of some granules than out of others, and that all the mitochondria are really hollow spheres, though over-stains tinge the medullary zone. To test this I took a slide with "solid" mitochondria and extracted more of the stain, examining it at intervals. The half of the slide which was over-differentiated showed most of the mitochondria as hollow

spheres. But not everywhere. Those parts where the mitochondria still seemed solid were generally seen to have their cell elements slightly distorted or run together. I conclude that there is good evidence for believing that the mitochondria of *Helix* consist of an inner, somewhat chromophobe substance, and a cortical stainable area.

In Text-fig. 5 is drawn a diagrammatic scheme of the derivation of the various cell elements in the ovotestis from the indifferent epithelium. At *S.P.* 1 is the generation in which no spermatogonial divisions occur, the cell dropping into the lumen just when the growth stage has been entered. At *S.P.* 2 is a progerminative cell, which only divides once. Its elements may go on to the growth stage, or may (as at *X.*) divide again several times. At *S.P.* 3 the much-divided generation of spermatogonia is shown. At *Y.* the spermatogonia are still dividing, and have become very small. According as to the stage when the spermatogonial cells enter the growth period their cytoplasmic bodies have various more or less evident differences. The connecting link between *S.P.* 1 and *S.P.* 3 is provided by such a cell as that in *S.P.* 2, whose divisions may be curtailed. The diagram is based on evidence deduced from observation of the spermatogonia, but there is no manner of finding out how many times such a spermatogonium as that at *S.P.* 3, *Y.*, has divided.

Below *S.P.* 3 are drawn the derivations of egg, yolk cell, and follicle cell from the epithelium. The latter is not proportionate in size to any of the cell elements in the figure.

It has been shown that the number and size of the Nebenkern batonettes vary greatly. In some cases, such as the generation marked in Pl. 29, fig. 1, by Roman numerals, the large number is never reduced by spermatogonial divisions, since these do not occur. The spermatocyte, therefore, has the original large number which appeared in the progerminative cell. It seems certain that the individual batonettes do not increase in number before a spermatogonial division, so that after such a division their number is halved approximately.

TEXT-FIG. 5.

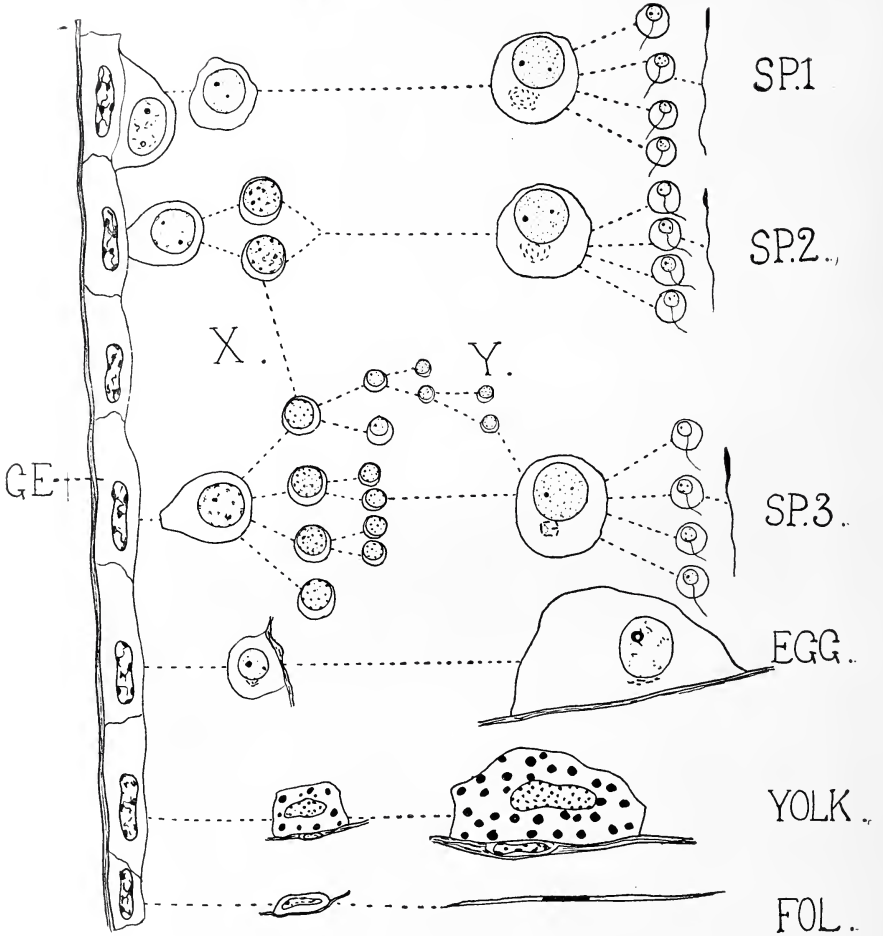

Scheme showing generations of spermatogonia (*S.P.* 1, 2, and 3). At *X.* generation 2 and 3 are interconnecting, at *Y.* are the much divided, small spermatogonia. The four small cells to the right of the spermatogonial generations are spermatids. Below are the derivations of egg, yolk cell, and follicle cell from the germinal epithelium (*G.E.*).

In the spermatogonia derived after many divisions the batonettes ultimately form the rectangular figure drawn on Pl. 34. They are fewer in number, but, as often happens with the mitochondria, generally bigger, though not invariably (compare Pl. 32, fig. 24 A, and Pl. 33, fig. 36).

Curiously enough, in different examples the archoplasm seems to be variably demonstrable, and these differences do not depend altogether on the depth of penetration of fixative, and the consequent possibility of different degrees of staining.

Murray (8) considers that the archoplasmic and batonette material are interconnecting, the rod being, as it were, a thickened edge of the idiozome. This is apparently true in some cases (see Text-fig. 4, *V.A.R.*). In others the batonette is separate. I do not think that this exceptional apparent intercommunication between idiozome and Nebenkern rods is evidence in favour of the view that the batonettes are a part of the spindle apparatus.

SUMMARY.

(1) The ovotestis of *Helix aspersa* is formed of finger-like diverticula. The latter are hollow at their lower ends, which connect to the hermaphrodite duct, while the upper ends contain more yolk, and are filled completely with metamorphosing male cells.

(2) According to the manner of derivation—that is, the nutrimental conditions of the locality from which new cells arise, and the number (if any) of times which these new cells divide—there are quite wide differences in the individual generations derived from and under such varying conditions.

(3) These differences are found in nucleus, mitochondria, Nebenkern, and general cell volume.

(4) The mitochondria vary in size and number, and such variation seems to be caused by the varying number of spermatogonial divisions in different regions of the ovotestis.

(5) In the early spermatid smaller mitochondria, the micro-mitochondria appear in an unknown way near the region from which the axial filament takes its origin from the centro-

some applied to the nucleus. These micromitochondria are about one-fourth the size of the other, or macromitochondria. No perceptible variation in size of the micromitochondria of various generations has been found.

(6) The micromitochondria form the front sheath of the sperm; the hind region of the micromitochondrial sheath intercommunicates with the macromitochondrial sheath, which follows behind.

(7) The Nebenkern does not apparently become absorbed into the substance of the mitochondrial sheath. A sloughing off appears to take place.

(8) The minute cytology of the derivation of the sperms, eggs, and nurse-cells is described.

(9) The determination of the sex of the indifferent cell seems to be brought about by a variety of causes. The explanation of femaleness by presence of yolk cells is held to be inadequate, for male progerminative cells also appear in regions choked with yolk.

(10) The probable function of the Nebenkern is discussed.

ADDENDUM A.

With regard to the body in the spermatids (Pl. 32, fig. 24 A, and Pl. 33, fig. 35) marked *P.N.A.* it has lately been found that this structure is derived from a number of grains, which in the case of *Arion* I have traced back to the young spermatocyte. In *Helix aspersa* these granules could not be found in the spermatocyte. *P.N.A.* stands for post-nuclear apparatus, from the position of this structure. The latter is fully considered in a forthcoming paper.

ADDENDUM B.

With regard to the cytoplasmic bodies in the egg, some late papers by Schaxel ('*Zool. Jahrb.*,' Bd. xxxiv, etc.) are of interest. Schaxel claims that the nucleus emits chromatin into the cytoplasm at a brief period after the prophase of the heterotypic division. He gives several stages (primary chromasie, chromasie post emission, etc.) during which the

egg is being formed. He finds no cytoplasmic bodies till after the bouquet stage, an obvious error of observation, and an error committed by Miss Beckwith ('Journ. Morph.,' xxv) as well. His figures of emission are (in *Aricia*) merely late stages in formation of the mitochondria (compare Pl. 30, fig. 3 of this paper and Schaxel's Pl. 16, figs. 9, 10, etc., in his paper 'Zool. Jahrb,' Bd. xxxiv). He overlooks the early stages of mitochondria formation, while his description of the "extra-nuclear chromatin" is apparently in some of his papers merely a misinterpretation of later stages of the formation of the mitochondria.

Miss Beckwith, in a paper quoted above, throws doubt on the "Chromatin-emission" of Schaxel. Miss Beckwith says: "There is no evidence of formed material passing through the nuclear membrane into the cytoplasm either early (Schaxel) or late (Smallwood) in the growth period." It will be seen that Schaxel's work needs confirmation. To me this observer's papers appear to be written in a partisan manner, simply to bolster up the "chromidia hypothesis" in its application to the Metazoa. For an excellent review of this matter see Dobell, 'Quart. Journ. Micr. Sci.,' vol. 53.

BIBLIOGRAPHY.

1. Gatenby, J. Bronté.—"The Cytoplasmic Inclusions of the Germ-Cells," Part I, Lepidoptera, 'Quart. Journ. Micro. Sci.,' No. 247, 1917.
2. Ancel, P.—"Histogénèse et structure de la glande hermaphrodite d'*Helix pomatia*," 'Arch. de Biol.' t. xix, 1902.
3. Demoll, R.—"Über Geschlechtsbestimmung im allgemeinen und über die Bestimmung der primären Sexualcharaktere im besondern," 'Zool. Jahrb.,' xxxiii, 1913.
4. Buresch, Iw.—"Untersuchungen über die Zwitterdrüse der Pulmonaten," 'Arch. f. Zellforsch.,' Bd. vii, 1912.
5. Schitz, Victor.—"Sur La spermatogénèse chez *Columbella rustica* L.," 'Arch. Zool. Expér.,' t. lvi, 1916.
6. Tullio, Terni.—"Condriosomi, idiozomæ formazioni perüdiozomiche nella spermatogenesi degli Anfibi," 'Arch. f. Zellforsch.,' Bd. xii, 1914.

7. Fauré-Frémiet.—“Étude sur les mitochondries des Protozoaires et des cellules sexuelles,” ‘Arch. d’Anat. micr.’ t. xi.
8. Murray, J. A.—“Contributions to a Knowledge of the Nebenkern in the Spermatogenesis of Pulmonata,” ‘Zool. Jahrb.’ Bd. xi.
9. Lee, Bolls.—“La Cellule,” ts. xi, xiii, xx, xxi, various papers on the cytology of *Helix*.

EXPLANATION OF PLATES 29-34,¹

Illustrating Mr. Bronté Gatenby’s paper on “The Cytoplasmic Inclusions of the Germ-Cells”: Part II, *Helix aspersa*.

EXPLANATION OF LETTERING.

A. Acrosome (perforatorium). *A.R.* Archoplasm (idiozome). *A.L.N.* Nucleus of Ancel’s layer (mesoderm). *A.S.* Astral sphere (from which each aster arises). *C.* Centrosome. *C.W.* Cell wall. *F.N.* Follicle nucleus. *G.E.* Germinal epithelium. *M.* Ordinary mitochondria (macromitochondria). *M².* Smaller mitochondria (micromitochondria). *N.C.* Nurse- (yolk) cells. *N.K.* Nebenkern (rods or batonnettes). *S.B.* Spindle bridge. *S.G.* Siderophilous granule. *S.P.G.* Spermatogonium. *V.A.C.* Alveoli in substance of cytoplasm of egg. Later become filled with yolk discs. *X.N.K.* Body thought to be Nebenkern rod. *Y.* Yolk disclets. (Only in certain figures, for others see text.)

All figures drawn with camera lucida, paper at table level. Koritska $\frac{1}{15}$ th semi-apochromatic oil immersion and compensating eye-pieces were almost invariably used. In most cases the figures are reduced. The arrow points to the inside of the lumen.

F.W.A. Fixation in Flemming without acetic acid. *C.* Fixation in Champy’s fluid. *S.* Bichromate osmic smear.

PLATE 29.

Fig. 1.—For an explanation see the text page 36. $\times 800$.

¹ In such a figure as that in Pl. 32, fig. 24 A, the mitochondria seen at a lower focal level have been drawn in palely, as is a usual cytological convention. In Pl. 33, fig. 33, the white line in each mitochondrial grain represents the “light.” Hollow mitochondria are as drawn in Pl. 33, fig. 40.

PLATE 30.

Fig. 2.—Germinal epithelium showing a cell of the mesoderm (AnceI's layer, *A.L.N.*) and three germinal nuclei. At *X.* and *Y.* are what are probably attraction spheres. $\times 4250$, *F.W.A.*

Fig. 3.—Oocyte lying in germinal epithelium, mitochondria beginning to disperse (*M.*). $\times 2000$, *F.W.A.*

Fig. 4.—Part of germinal epithelium showing yolk cells (*N.C.*), a germinal nucleus (*G.E.*), and a spermatogonium (*S.P.G.*). $\times 2000$, *F.W.A.*

Fig. 5.—Upper part of an oocyte showing the Nebenkern (*N.K.*) and the dark mass of mitochondria just before dispersal in cytoplasm (*M.*). $\times 2000$, *F.W.A.*

Fig. 6.—Bouquet stage of a supposed oocyte. This cell was deeply embedded in yolk like that in Pl. 29, fig. 1 A or B. $\times 4250$, *F.W.A.*

Fig. 7.—Another oocyte showing mitochondria (*M.*) dispersing and yolk being deposited (*Y.*). $\times 2000$, *F.W.A.*

Fig. 8.—Represents the two left-hand bodies marked *X.* in Pl. 31, fig. 18. $\times 4250$, *C.*

PLATE 31.

Fig. 9.—Oocyte showing dispersal of mitochondria from a centre (*c*) near the nucleus. $\times 650$, *C.*

Fig. 10.—Oocyte just after the stage drawn in Pl. 30, fig. 6. $\times 4250$, *F.W.A.*

Fig. 11.—Supposed oogonium embedded in yolk cells like that in Pl. 29, fig. 1 A or B. $\times 4250$, *F.W.A.*

Fig. 12.—Oocyte at time of dispersal of flocculent mitochondria, showing several bodies (*X.N.K.*) supposed to be Nebenkern elements $\times 2000$, *F.W.A.*

Fig. 13, 14, 15, and 16, several stages in the development of the cytoplasm of the egg. The upper white area in each figure represents the nucleus. Fig. 13 was drawn from the same egg as that in fig. 9; this was about $100\ \mu$ in length. Egg in fig. 14 was $140\ \mu$. Fig. 15 about $150\ \mu$. Fig. 16 about $120\ \mu$. $\times 2000$, *F.W.A.* and Champy.

Fig. 17.—Male progerminative cell showing development of mitochondria. $\times 4250$, *C.*

Fig. 18.—Oocyte near end of growth stage, to show the location of the bodies drawn in Pl. 30, fig. 8, at a higher power. $\times 510$, *C.*

Fig. 19.—Male progerminative cell showing appearance of cloud and granules. $\times 4250$, *C.*

Fig. 20.—Later stage. Archoplasm (*A.R.*) and Nebenkern rodlets of fairly rare type. Usual sort is shown in Pl. 32, fig. 23, and appears later. *Z.* Zone of cytoplasmic activity which has spread around the nucleus. $\times 4250$, *C.*

PLATE 32.

Fig. 21.—Bouquet stage of generation drawn in the two preceding figures. *M.* Mitochondria. $\times 4250$, *C.*

Fig. 22.—Second maturation division showing probable Nebenkern rods (*X.N.K.*) in cytoplasm mixed with mitochondria. $\times 4250$, *C.*

Fig. 23.—Later stage, showing appearance of Nebenkern (*N.K.*) and dispersal of mitochondria; at *X.* the cell is losing its place on the germinal epithelium. $\times 4250$, *C.* (Compare Text-fig. 4, i.)

Fig. 24.—Secondary spermatogonium showing Nebenkern (*N.K.*) and mitochondria. $\times 4250$, *F.W.A.*

Fig. 24 A.—Spermatid with ring-like Nebenkern (*N.K.*) and large mitochondria. $\times 4250$, *F.W.A.*

Fig. 25.—Spermatocyte near end of growth showing Nebenkern with many curved rods. $\times 4250$, *C.*

Fig. 26.—Spermatid with largish mitochondria and small curved batonettes in Nebenkern. Nucleus has large number of nucleoli. $\times 4250$, *C.* (For *P.N.A.* see Addendum A.)

Fig. 27.—Spermatocyte in prophases. Ring-like Nebenkern rods scattered somewhat haphazardly. At *X.*, *X.*, region of centrosomes. $\times 4250$, *F.W.A.*

Fig. 28.—Spermatogonial division with seed-like chromosomes. *X.N.K.* Probable Nebenkern. $\times 4250$, *F.W.A.*

Fig. 29.—Spermatogonium (secondary) with Nebenkern (*N.K.*). $\times 4250$, *F.W.A.*

PLATE 33.

(All *F.W.A.* $\times 4250$.)

Fig. 30.—Bouquet stage, showing loops radiating towards Nebenkern. Rather small example.

Fig. 31.—Growth stage of spermatocyte. Mitochondria dispersing. Nebenkern at *NK.*

Fig. 32.—Near end of growth period. Nebenkern rods banana-shaped. Between thirty and forty in number.

Fig. 33.—Prophase showing astral body (*A.S.*), which will give rise to part of the spindle. Mitochondria at this stage often rod-like. Nebenkern has lost its original disposition.

Fig. 34.—First maturation division metaphase, showing shape of mitochondria and general difficulty of detecting Nebenkern rods.

Fig. 35.—Spermatid with small mitochondria and straight or slightly curved Nebenkern rods. Nucleoli few in number. (For *P.N.A.* see Addendum A.)

Fig. 36.—Spermatid of same generation.

Fig. 37.—Later spermatid showing collapse of Nebenkern structure.

Fig. 38.—Probable nurse-cell showing nucleus and cytoplasmic bodies. No yolk disclets remain (or have been formed). The exact history of this cell is difficult to make out (see p. 591).

Fig. 39.—Spermatogonial division with few large mitochondria. Compare Pl. 32, fig. 28.

Fig. 40.—Spermatid with ring-like Nebenkern rods and large mitochondria.

PLATE 34.

Figs. 41, 42, 43, 44, 45, and 46. $\times 2000$.

Figs. 40 to 45 stages in the formation of the sperm.

Fig. 46.—Sperm from smear drawn to scale of the foregoing figures (*S.*).

Fig. 47.—Spermatid $\times 2000$, showing manner in which axial filament grows in cramped quarters. The micromitochondria keep their definite position.

Fig. 48.—Spermatid nuclei $\times 2000$, showing variations found in chromatin nucleoli. These hold good without much variation for every nucleus in the bunch of spermatids.

Fig. 49.—Male progerminative cell (primary spermatogonium) of the generation drawn in Text-fig. 3, ii, *S.P.P.* $\times 4250$.

**Note on the Development of Trichogramma
evanescens.**

By

J. Bronté Gatenby,

Exhibitioner of Jesus College, Oxford.

THE purpose of this short note is to correct some errors which were overlooked in a recent paper by me. These mistakes, which are in my text references to the figures of the development of *Trichogramma*, are as follows, and occur in my paper on "The Embryonic Development of *Trichogramma Evanescens*, a Monembryonic Egg Parasite of *Donacia Simplex*," (*Quart. Journ. Micr. Sci.*, vol. 62, part 2, February, 1917).

Page 149, line 9, "Compare p. 20" should be "compare p. 168."

Page 158, line 24, "fig. 20" to be "fig. 26."

Page 161, line 21, "fig. 8" to be "fig. 14."

Page 162, line 15, "fig. 12" to be "fig. 13."

Page 164, line 1, "varies little" to be "varies a little."

Line 6, "fig. 12 and fig. 13" to be "fig. 13 and fig. 14."

Page 165, line 5, "N." to be "N.N."

Line 30, "fig. 9" to be "fig. 15."

Page 166, line 20, "fig. 18" to be "fig. 24."

Page 170, line 5, "p. 30" to be "p. 178."

Line 17, "fig. 18" to be "fig. 24."

Line 19, "N.C.N." to be "N.C."

Line 20, "fig. 21" to be "fig. 27."

Line 22, "fig. 22" to be "fig. 28."

Line 23, insert the figures "12" after the letters
"Pl."

Page 171, line 12, "figs. 6 A and 6 B" to be "figs. 5 A
and 5 B."

Line 16, "figs. 15 A and B" to be "5 A and 5 B."

Line 25, "p. 26" to be "p. 175."

Page 179, line 28, "p. 11" to be "p. 159."

Page 184, line 27, "Extended mass of cytoplasm" to
be "Extruded mass of cytoplasm."

In the "Lettering" insert "*E.X.N.* means extruded
chromatin nucleolus."

In connection with Silvestri's excellent work on *Oophthora*
the Rev. J. Waterston, B.D., very kindly informs me that
Oophthora is a synonym for *Trichogramma*, so that the para-
sitic forms examined by Silvestri and by myself are different
species of the same genus.

INDEX TO VOL. 62,

NEW SERIES.

- Actinian larval parasitic in a Rhizostome, by C. Badham, 221
- Alcyonium digitatum*, development of, by Annie Matthews, 43
- Allis, E. Phelps, junr., on the homologies of the muscles related to the visceral arches of Fishes, 303
- Allis, junr., E. Phelps, on the labial cartilages of *Raia clavata*, 95
- Amphioxus, collar cavities of the larval, by K. M. Smith and H. G. Newth, 243
- Apyrene sperm formation of Moths, by Gatenby, 465
- Badham, Charles, on an ichthyobdellid parasite of the Australian Sand Whiting, 1
- Badham, Charles, on a larval actinian parasitic in a Rhizostome, 221
- Bathynella, morphology of, by W. T. Calman, 489
- Calman on the morphology of Bathynella and some allied Crustacea, 489
- Cartilages, so-called labial, of *Raia clavata*, by E. Phelps Allis, junr., 95
- Centroplast of Heliozoon, by Clifford Dobell, 515
- Cephalodiscus (of the Cape), development of, by J. D. F. Gilchrist, 189
- Chromosomes of *Culex pipiens*, by Monica Taylor, 287
- Crustacea allied to Bathynella, by W. T. Calman, 489
- Culex pipiens*, chromosome complex of, by Monica Taylor, 287
- Cytoplasmic inclusions of the germ-cells. Part II. *Helix aspersa*, by J. Bronté Gatenby, 555
- Development of *Alcyonium digitatum*, by Annie Matthews, 43
- Development of the Cape Cephalodiscus, by J. D. F. Gilchrist, 189
- Dobell, Clifford, on a new Heliozoon, 515
- Earth-worms, pharyngeal gland-cells of, by Stephenson, 253
- Fishes, muscles of visceral arches, by E. Phelps Allis, junr., 303
- Gatenby, J. Bronté, the cytoplasmic inclusions of the germ-cells. Part II. *Helix aspersa*, 555
- Gatenby, J. Bronté, on the cytoplasmic inclusions of the Germ-cells. Part I, Lepidoptera, 407
- Gatenby, J. Bronté, degeneratesperm formation of Moths, 465
- Gatenby, J. Bronté, note on the sex of a tadpole raised by artificial parthenogenesis, 213

- Germ-cells, cytoplasmic inclusions of. Part I. Lepidoptera, by J. Bronté Gatenby, 407
- Germ-cells of *Helix aspersa*, by J. Bronté Gatenby, 555
- Gilchrist, J. D. F., on the development of the Cape Cephalodiscus, 189
- Goodrich, Edwin S., on proboscis pores in craniate vertebrates, 539
- Harmer, Sidney F., on *Phoronis ovalis*, 115
- Heliozoon, a new, by Clifford Dobell, 515
- Helix aspersa*, germ-cells of, by J. Bronté Gatenby, 555
- Homologies of muscles of visceral arches of Fishes, by E. Phelps Allis, junr., 303
- Hypophysis and premandibular somites of Craniate vertebrates, by E. S. Goodrich, 539
- Ichthyobdellid parasite of the Australian Sand Whiting, by Charles Badham, 1
- Index to the 'Quarterly Journal of Microscopical Science,' July, 1888, to July, 1916, inclusive, separately paged in Part 1 of present volume.
- Lepidoptera, cytoplasmic inclusions of germ-cells of, 407
- Lepidosiren and Protopterus, early development of the spleen in, by G. L. Purser, 231
- Matthews, Annie, on the development of *Alyonium digitatum* 43
- Nerve fibres, nuclei of, by Henry E. Reburn, 217
- Newth, H. G., and K. M. Smith, on the collar cavities of the larval Amphioxus, 243
- Nuclei of nerve fibres, by Henry E. Reburn, 217
- Oxnerella maritima*, nov. gen. et spec., by Clifford Dobell, 515
- Parasite of the Sand Whiting (*Silago*), by Badham, 1
- Parasite, larval actinian, in a Rhizostome, by C. Badham, 221
- Parthenogenesis, tadpole raised by artificial, note on, by J. Bronté Gatenby, 213
- Pharyngeal gland-cells of Earthworms, Stephenson on, 253
- Phoronis ovalis*, by Sidney F. Harmer, 115
- Proboscis pores in Craniate vertebrates, by E. S. Goodrich, 539
- Purser, G. L., on the early development of the spleen in *Lepidosiren* and *Protopterus*, 231
- Raia clavata*, labial cartilages of, by E. Phelps Allis, junr., 95
- Reburn, Henry E., on an easy way of demonstrating the nuclei of nerve fibres, 217
- Smith, K. M., see Newth.
- Sperm formation of Moths, 465
- Spleen, early development of, in *Lepidosiren* and *Protopterus*, by G. L. Purser, 231
- Stephenson, J., on the so-called pharyngeal gland-cells of Earthworms, 253
- Tadpole raised by artificial parthenogenesis, note on, by J. Bronté Gatenby, 213
- Taylor, Monica, on the chromosome complex of *Culex pipiens*, 287

CONTRIBUTIONS TO THE KNOWLEDGE OF RHABDOPLEURA AND AMPHIOXUS.

By SIR RAY LANKESTER, K.C.B., M.A., LL.D., F.R.S.
London: J. & A. CHURCHILL, 7 Great Marlborough Street.

Quarterly Journal of Microscopical Science.

The SUBSCRIPTION is 42s. for the Volume of Four Numbers; for this sum (*prepaid*) the JOURNAL is sent Post Free to any part of the world.

BACK NUMBERS of the JOURNAL, which remain in print, are now sold at a uniform price of 10/6 net.

The issue of SUPPLEMENT NUMBERS being found inconvenient, and there being often in the Editor's hands an accumulation of valuable material, it has been decided to publish this Journal at such intervals as may seem desirable, rather than delay the appearance of Memoirs for a regular quarterly publication.

The title remains unaltered, though more than Four Numbers may be published in the course of a year.

Each Number is sold at 10/6 net, and Four Numbers make up a Volume.

London: J. & A. CHURCHILL, 7 Great Marlborough Street.

TO CORRESPONDENTS.

Authors of original papers published in the Quarterly Journal of Microscopical Science receive fifty copies of their communication *gratis*.

All expenses of publication and illustration are paid by the publishers.

Lithographic plates and text-figures are used in illustration. Shaded drawings intended for photographic reproduction as half-tone blocks should be executed in "Process Black" diluted with water as required. Half-tone reproduction is recommended for uncoloured drawings of sections and of Protozoa.

Drawings for text-figures should not be inserted in the MS., but sent in a separate envelope to the Editor.

Contributors to this Journal requiring *extra* copies of their communications at their own expense can have them by applying to the Printers,

Messrs. ADLARD & SON & WEST NEWMAN, Ltd., 23, Bartholomew Close, E.C., on the following terms:

For every four pages or less—

25 copies	5/-
50	”	6/-
75	”	6/6
100	”	7/-

Plates, 2/- per 25 if uncoloured; if coloured, at the same rate for every colour.

Prepayment by P.O. Order is requested.

ALL COMMUNICATIONS FOR THE EDITORS TO BE ADDRESSED TO THE CARE OF MESSRS. J. & A. CHURCHILL, 7 GREAT MARLBOROUGH STREET, LONDON, W.

THE MARINE BIOLOGICAL ASSOCIATION

OF THE
UNITED KINGDOM.

—:O:—
Patron—HIS MAJESTY THE KING.

President—Sir RAY LANKESTER, K.C.B., LL.D., F.R.S.

—:O:—

THE ASSOCIATION WAS FOUNDED "TO ESTABLISH AND MAINTAIN LABORATORIES ON THE COAST OF THE UNITED KINGDOM, WHERE ACCURATE RESEARCHES MAY BE CARRIED ON, LEADING TO THE IMPROVEMENT OF ZOOLOGICAL AND BOTANICAL SCIENCE, AND TO AN INCREASE OF OUR KNOWLEDGE AS REGARDS THE FOOD, LIFE CONDITIONS, AND HABITS OF BRITISH FOOD-FISHES AND MOLLUSCS."

The Laboratory at Plymouth

was opened in 1888. Since that time investigations, practical and scientific, have been constantly pursued by naturalists appointed by the Association, as well as by those from England and abroad who have carried on independent researches.

Naturalists desiring to work at the Laboratory

should communicate with the Director, who will supply all information as to terms, etc.

Works published by the Association

include the following:—'A Treatise on the Common Sole,' J. T. Cunningham, M.A., 4to, 25/-. 'The Natural History of the Marketable Marine Fishes of the British Islands,' J. T. Cunningham, M.A., 7/6 net (published for the Association by Messrs. Macmillan & Co.).

The Journal of the Marine Biological Association

is issued half-yearly, price 3/6 each number.

In addition to these publications, the results of work done in the Laboratory are recorded in the 'Quarterly Journal of Microscopical Science,' and in other scientific journals, British and foreign.

Specimens of Marine Animals and Plants,

both living and preserved, according to the best methods, are supplied to the principal British Laboratories and Museums. Detailed price lists will be forwarded on application.

TERMS OF MEMBERSHIP.

ANNUAL MEMBERS	£1 1 0	per annum.
LIFE MEMBERS	15 15 0	Composition Fee.
FOUNDERS	100 0 0	" "
GOVERNORS (Life Members of Council)	500 0 0	" "

Members have the following rights and privileges:—They elect annually the Officers and Council; they receive the Journal free by post; they are admitted to view the Laboratory at any time, and may introduce friends with them; they have the first claim to rent a table in the Laboratory for research, with use of tanks, boats, etc.; and have access to the Library at Plymouth. Special privileges are granted to Governors, Founders, and Life Members.

Persons desirous of becoming members, or of obtaining any information with regard to the Association, should communicate with—

The DIRECTOR,
The Laboratory,
Plymouth.

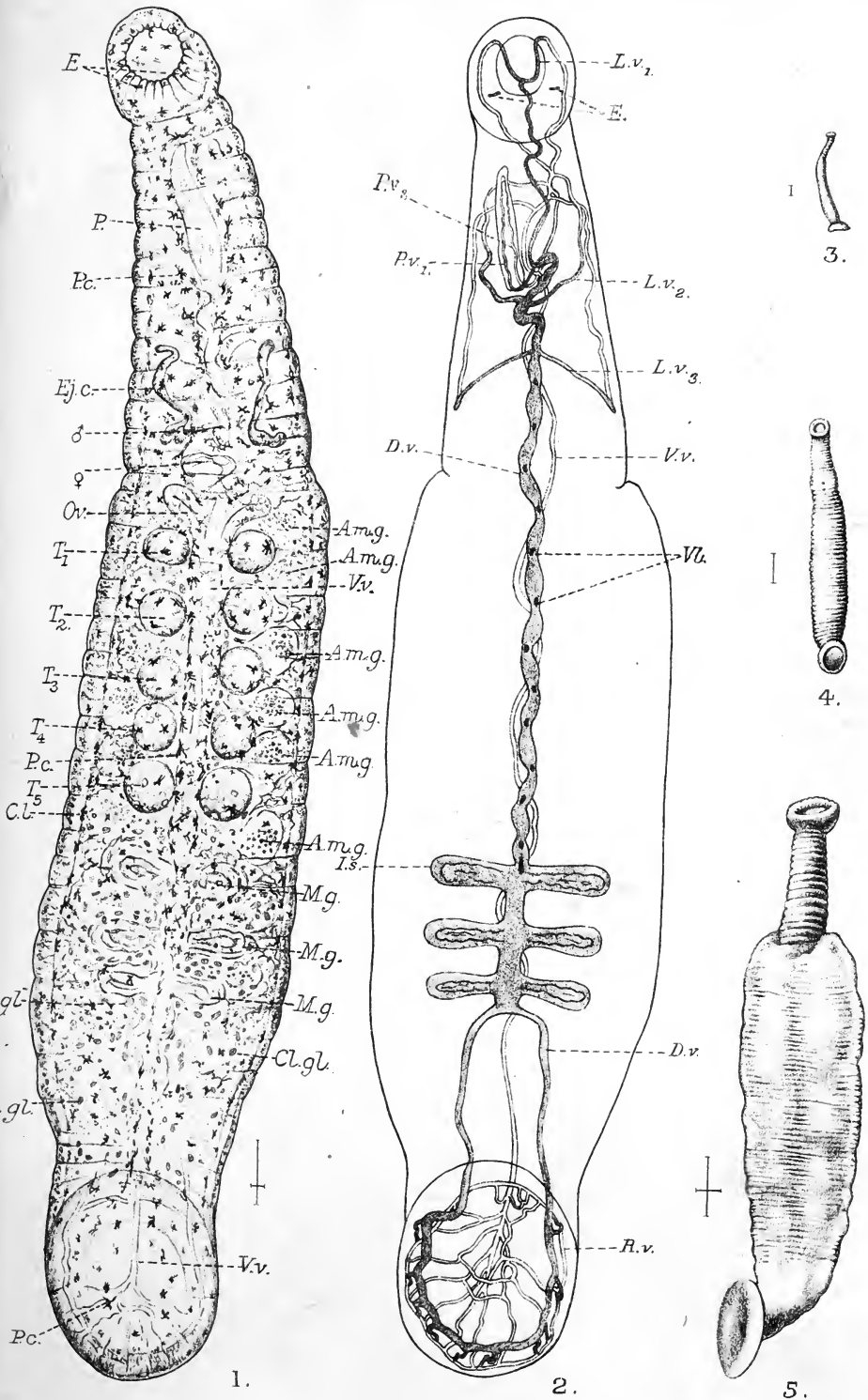



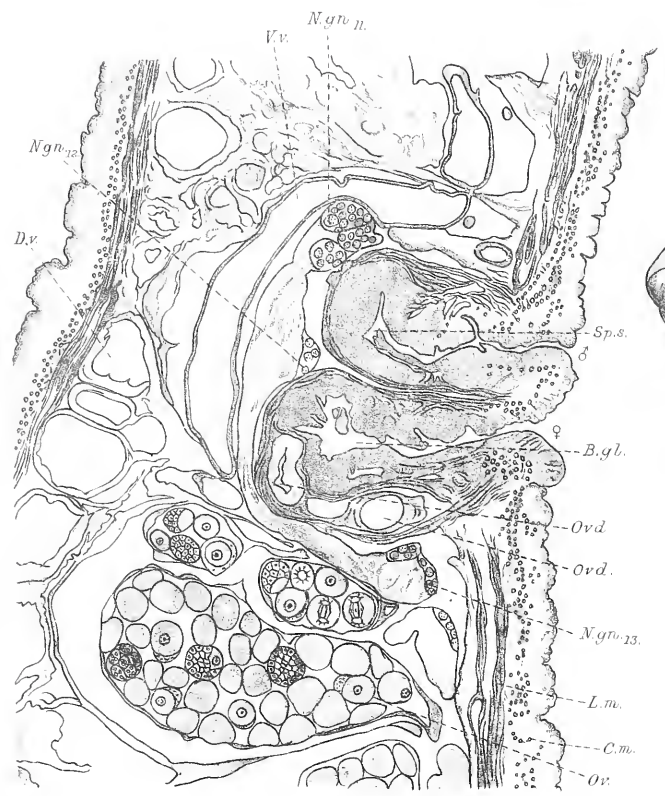

6 x 76.

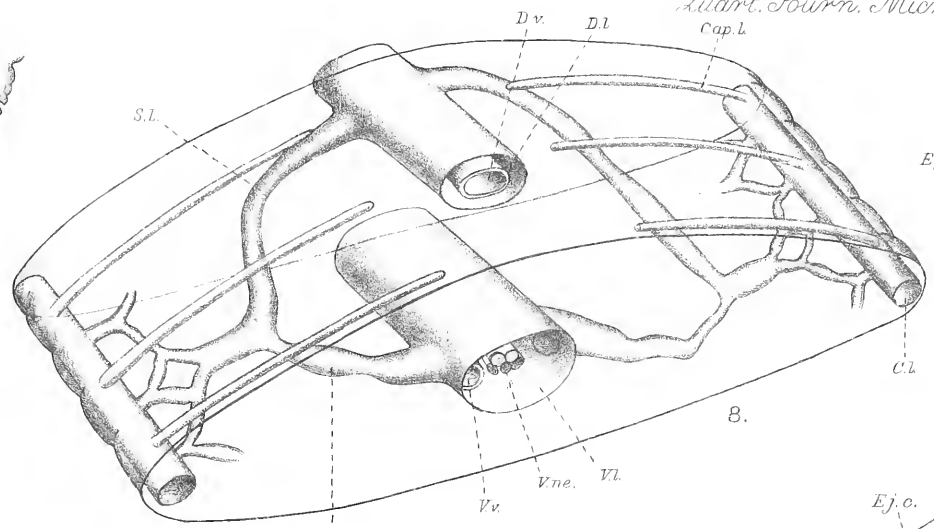

8.

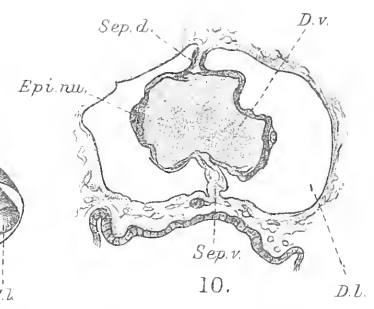

10.

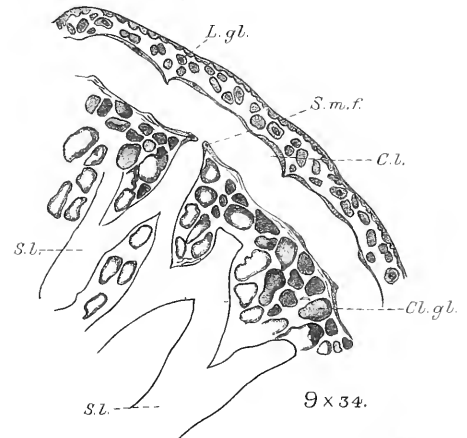

9 x 34.

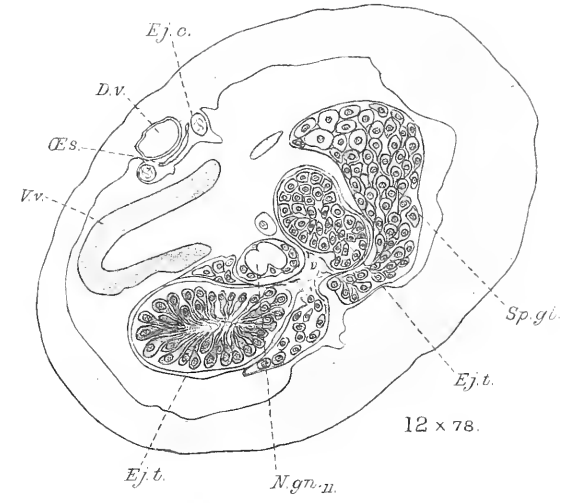

12 x 78.

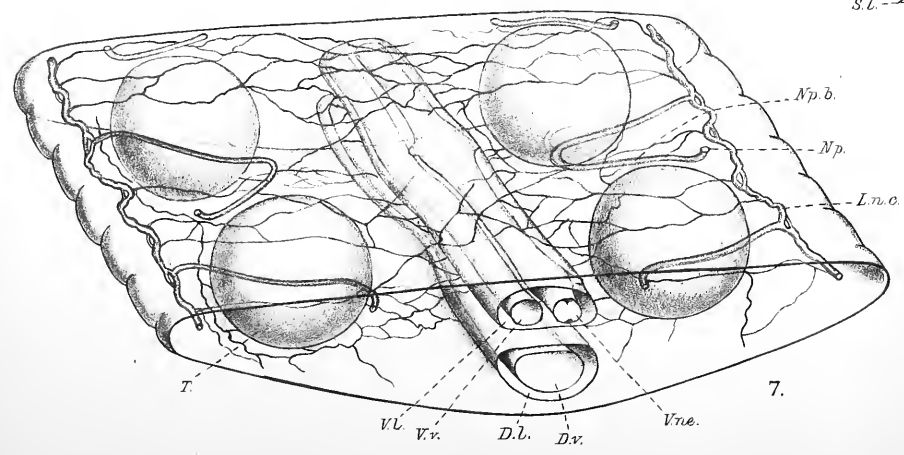

7.

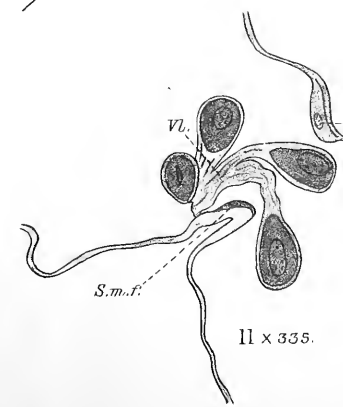

11 x 335.

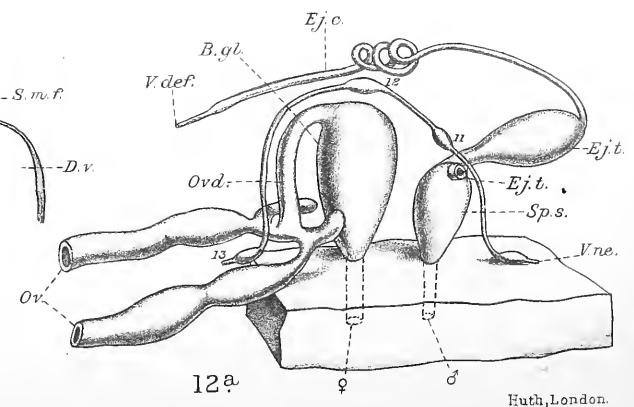

12a

♀

♂

Huth, London.

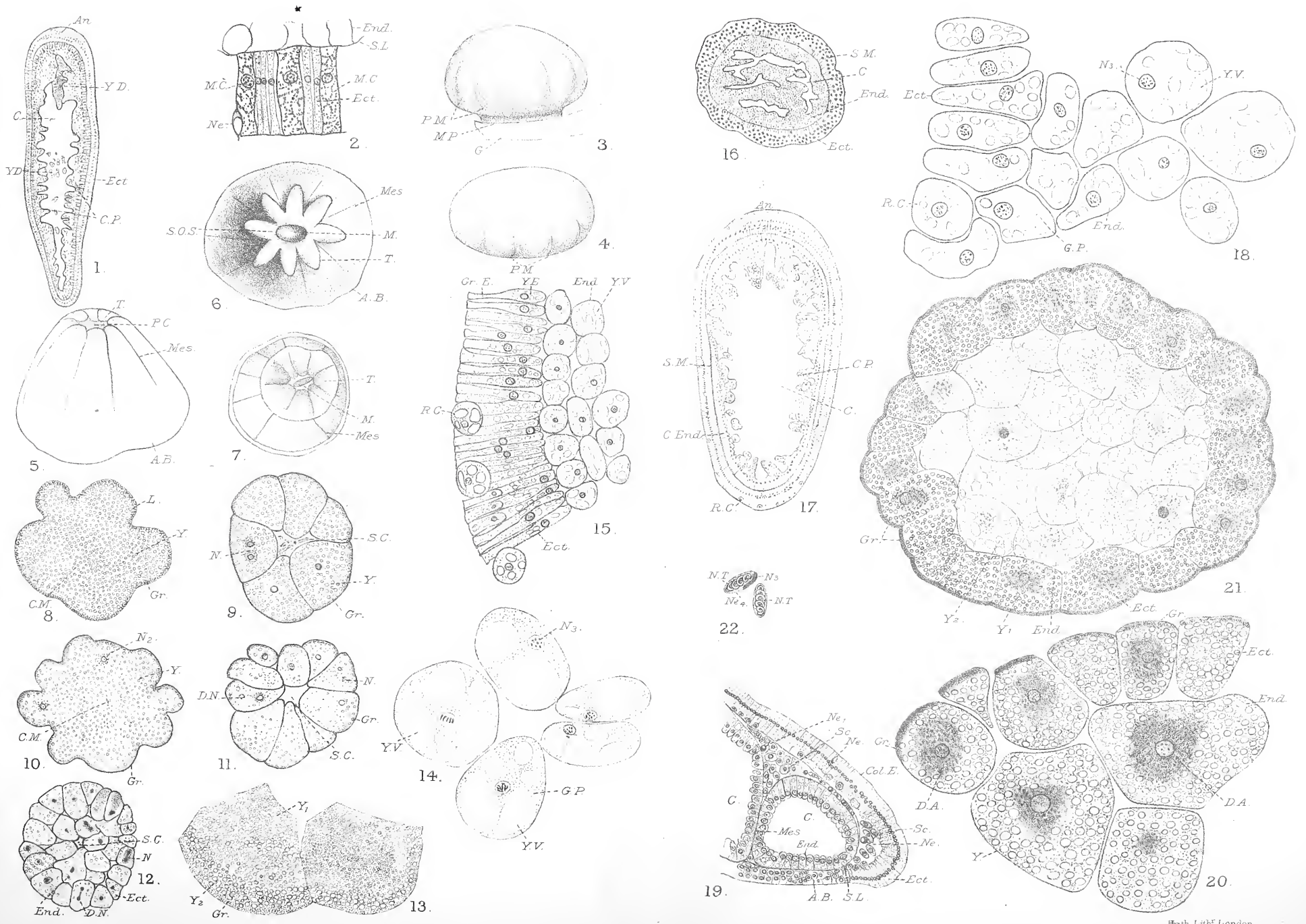

MATTHEWS—DEVELOPMENT OF ALCYONIUM.

Hath, Lith^r London.



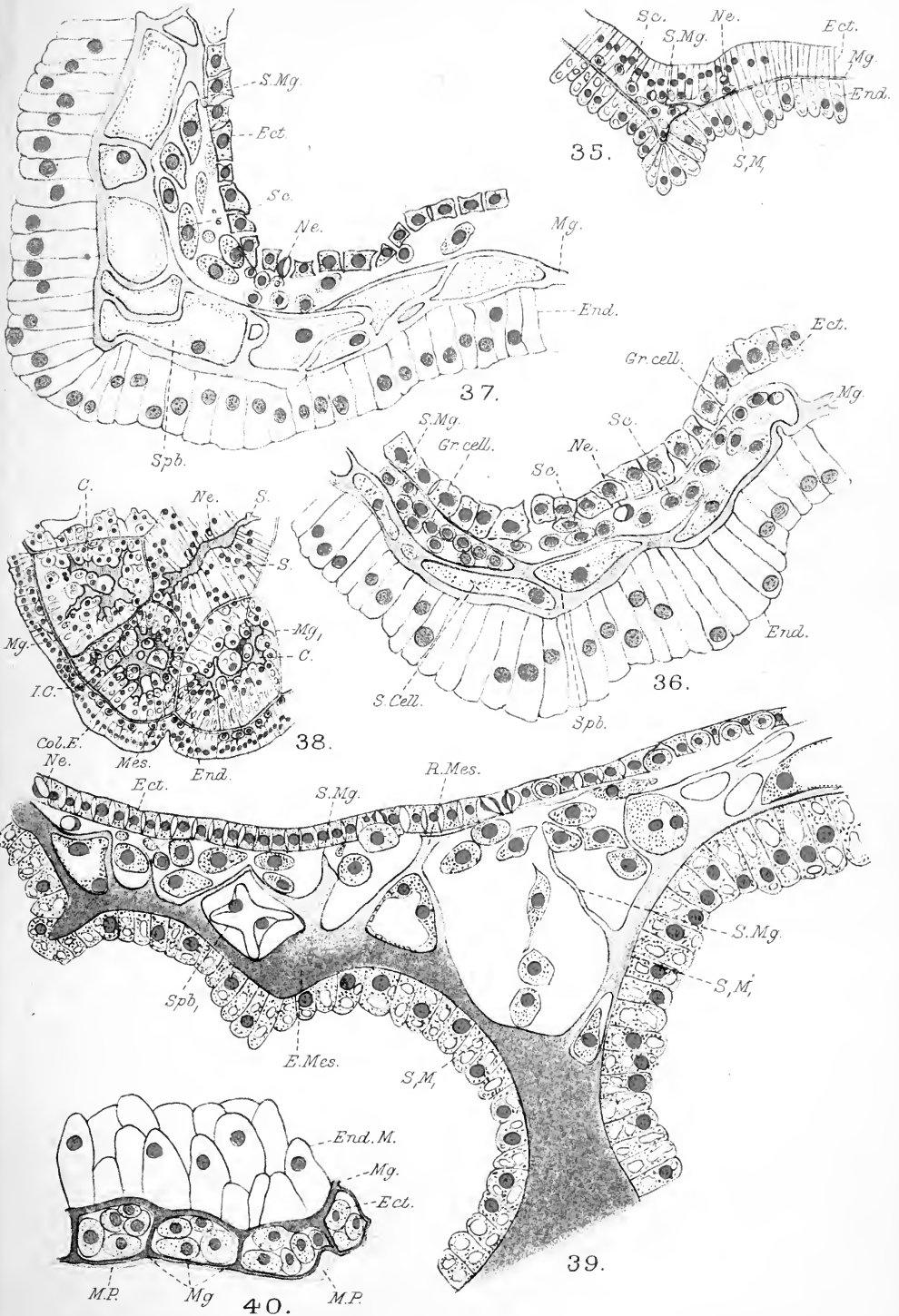

Huth, Lith. London.

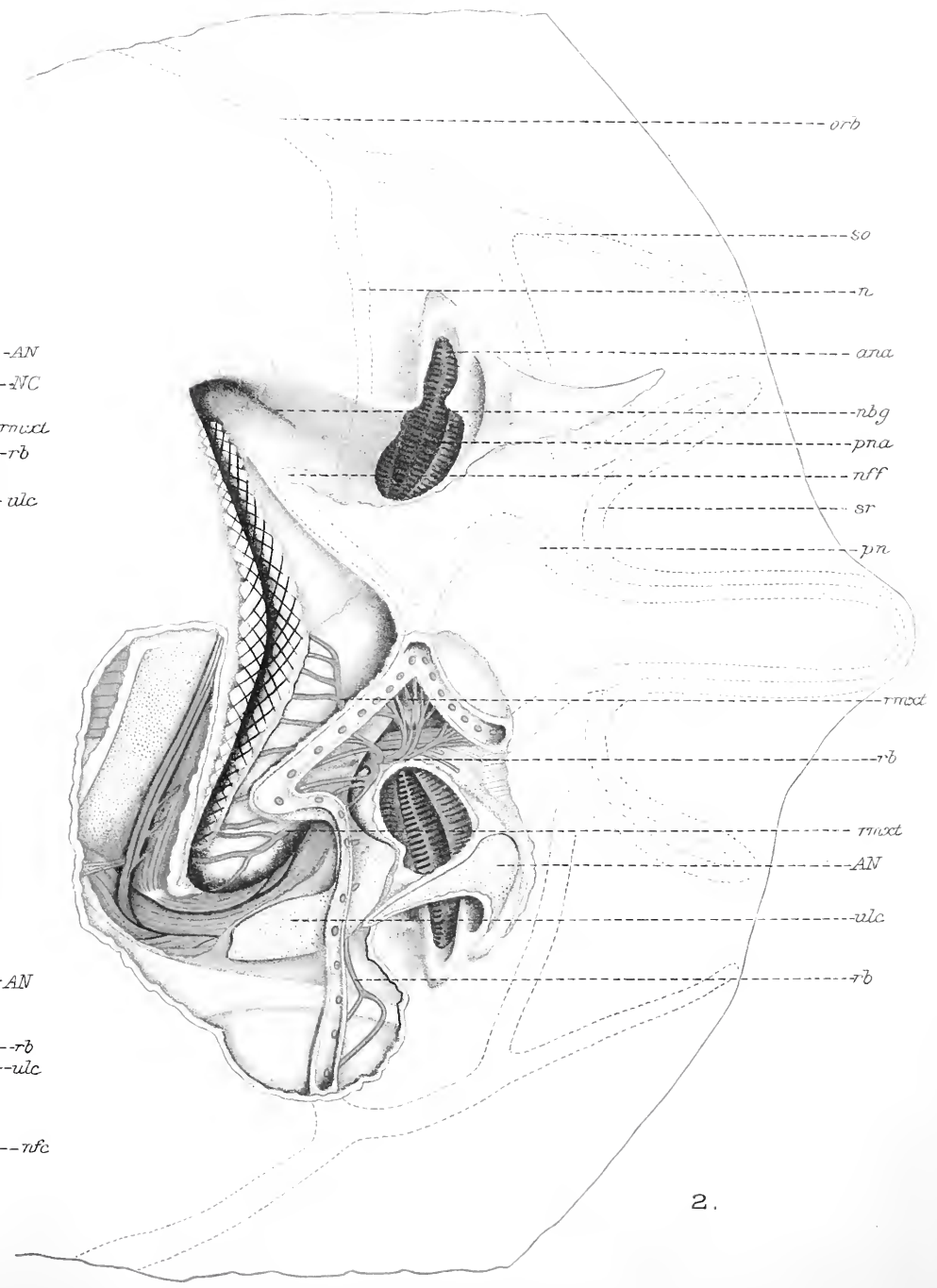
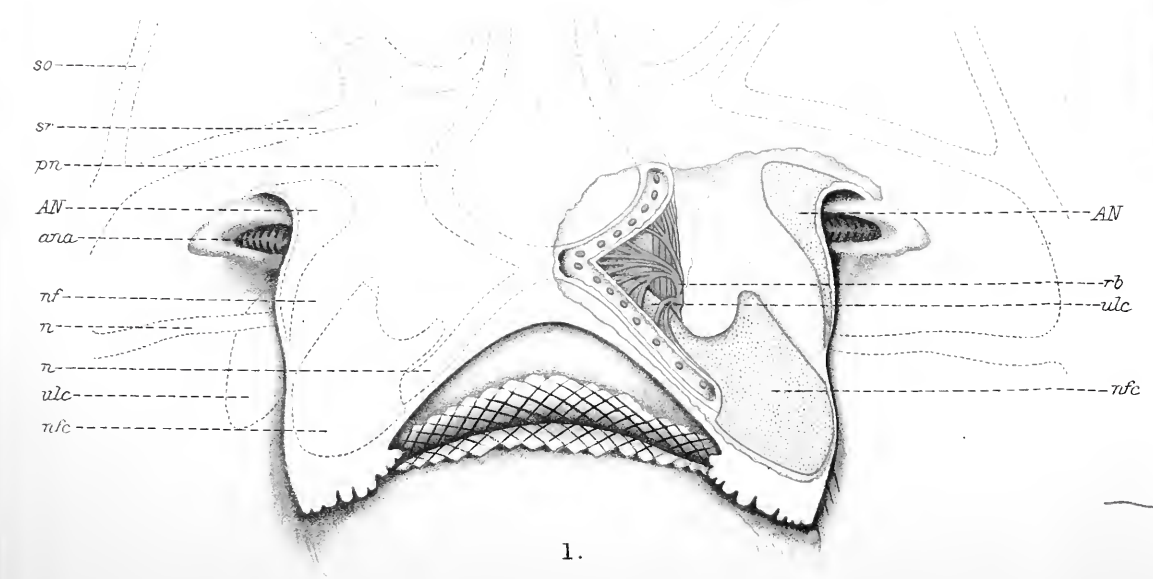
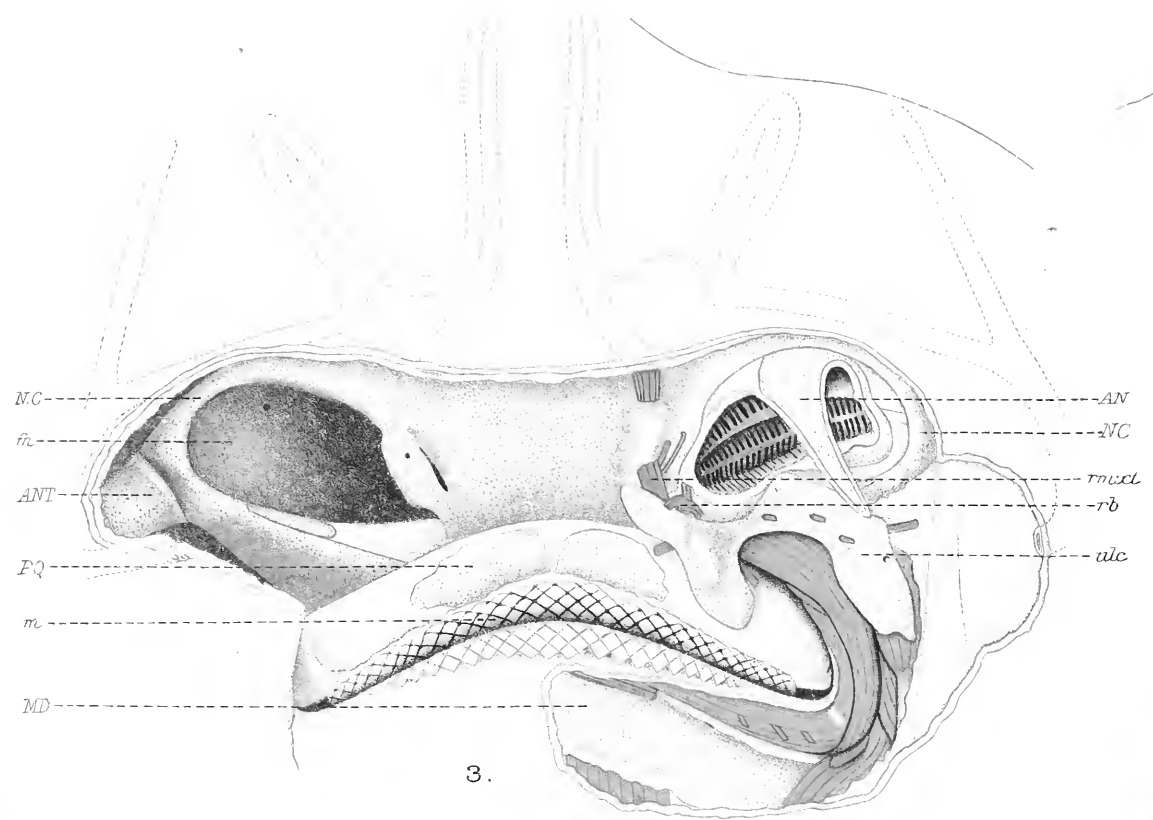

LABIAL CARTILAGES OF THE SKATE.



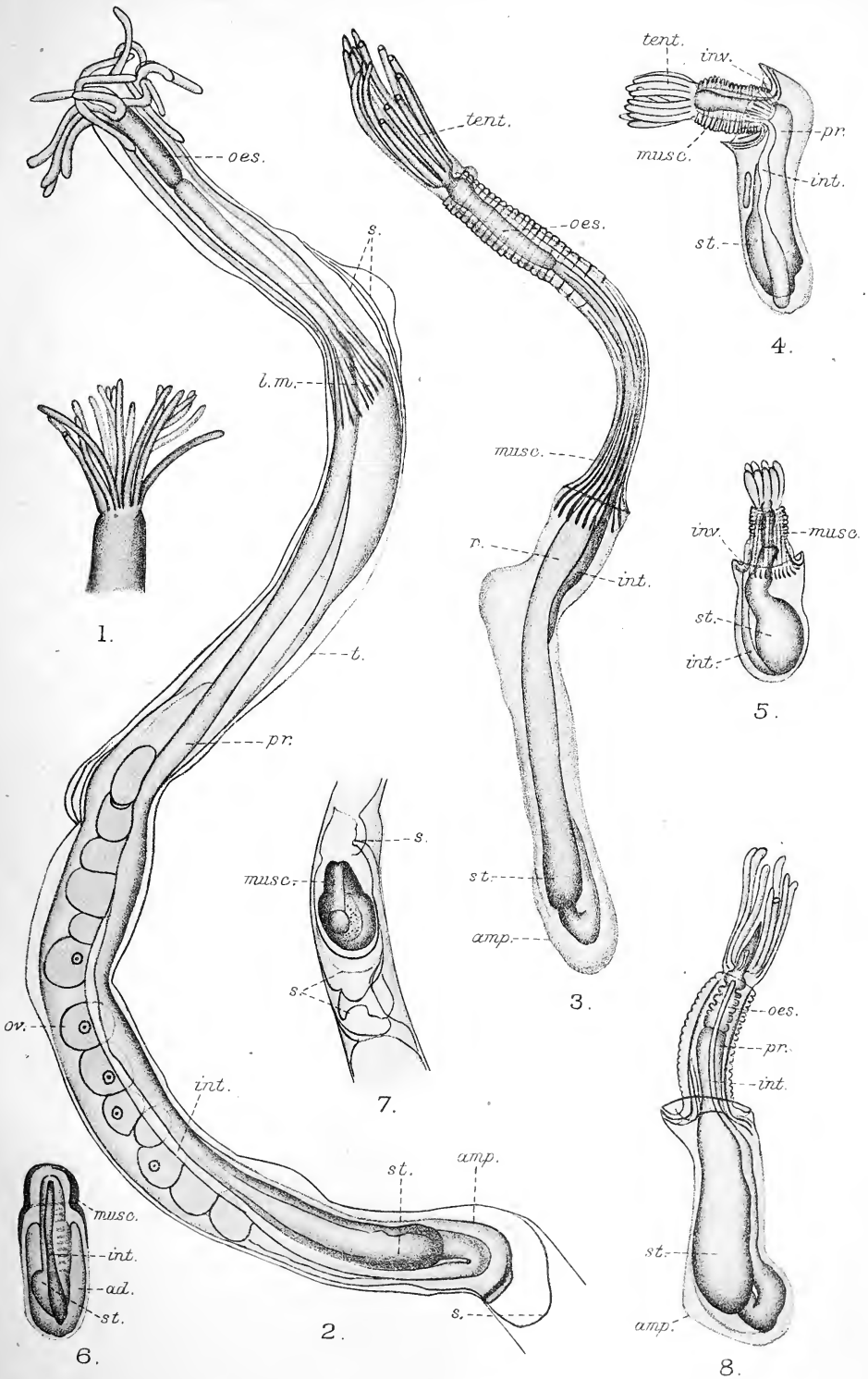

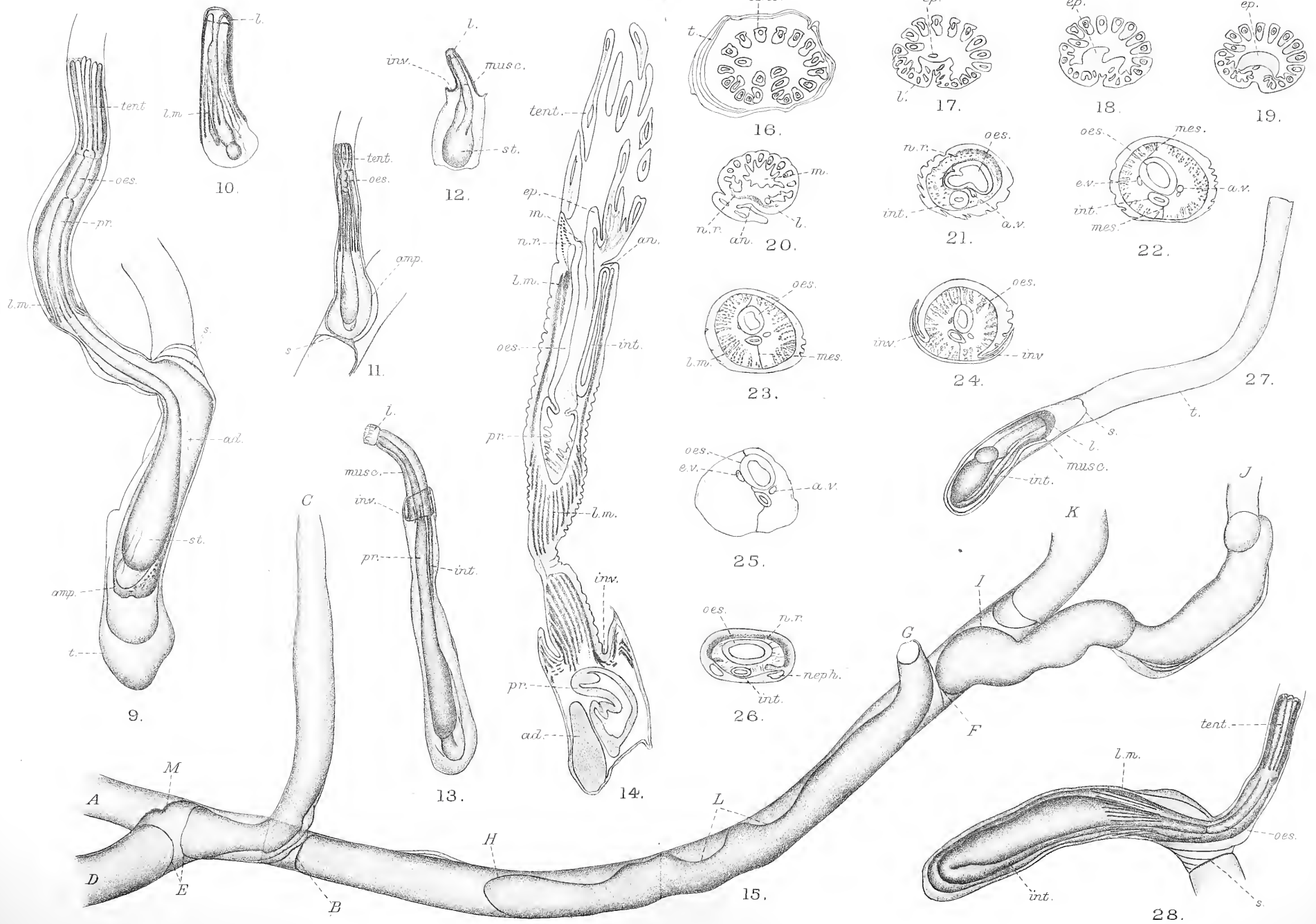

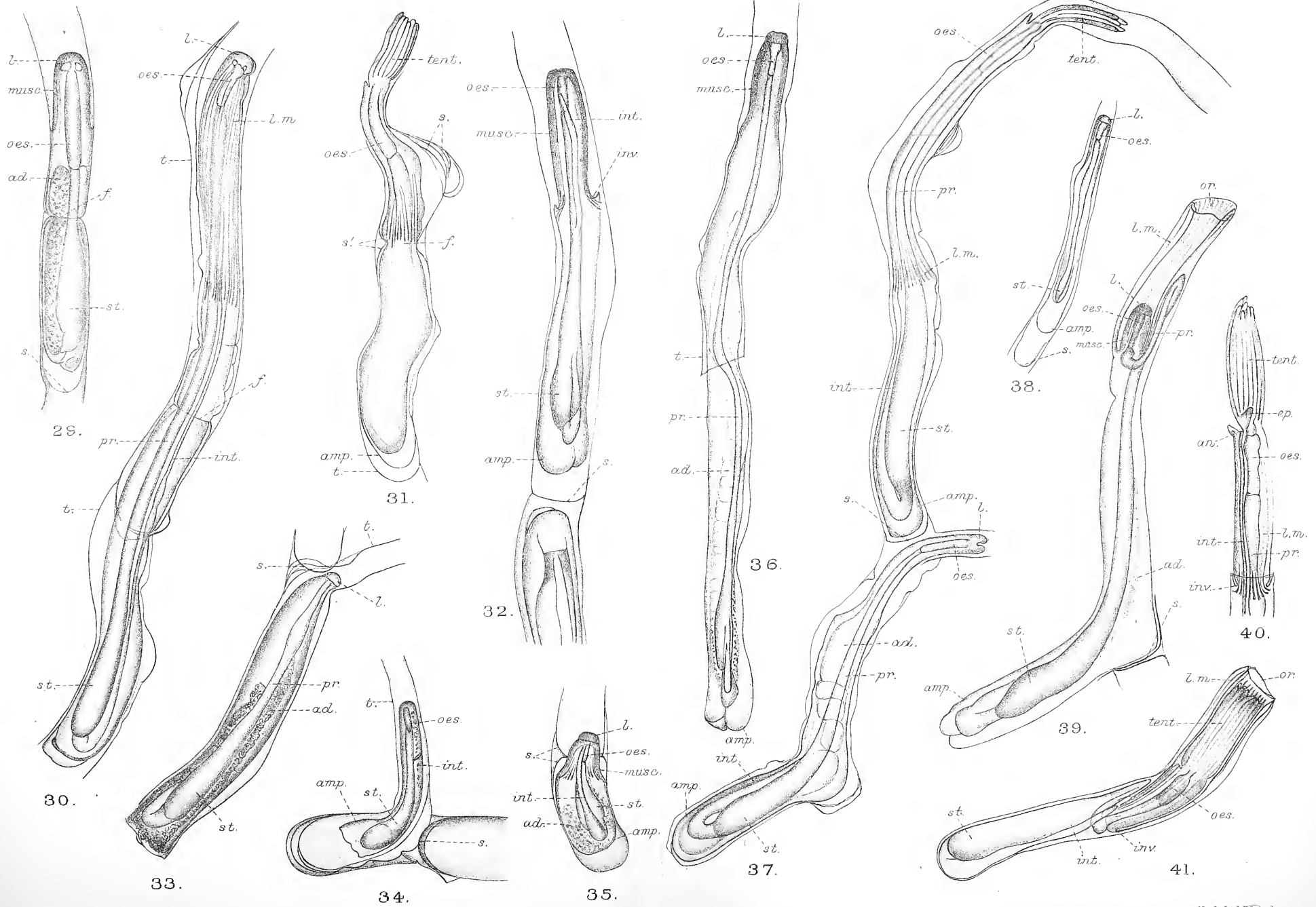

S.F. Harmer del.

Huth, Lith. London.

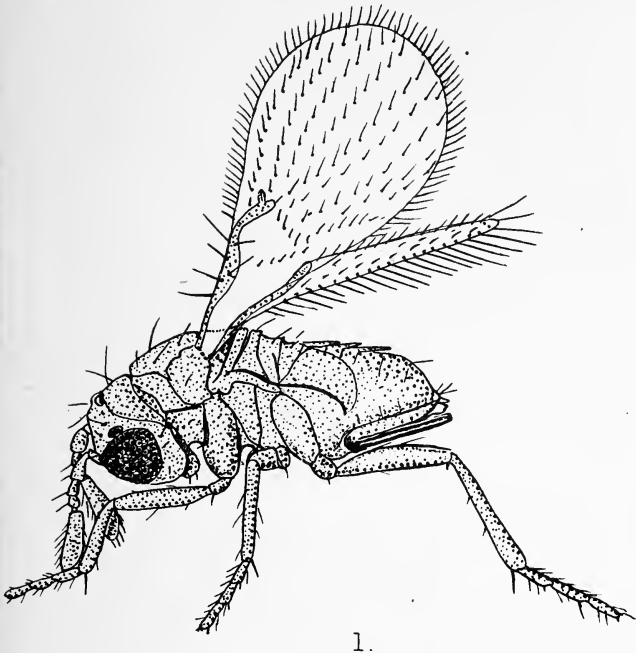

1.

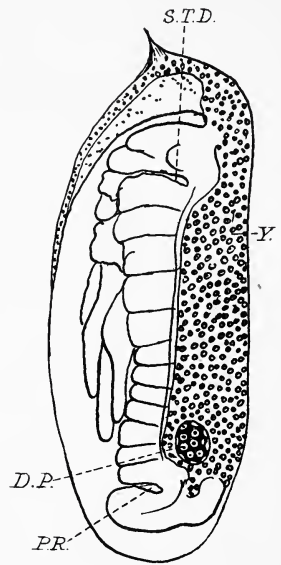

2.

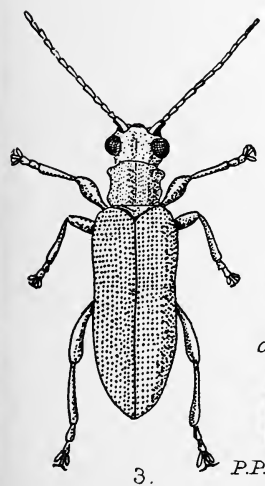

3.

P.P.

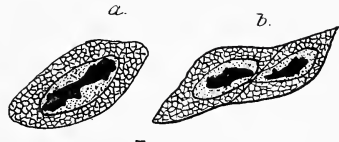

5.

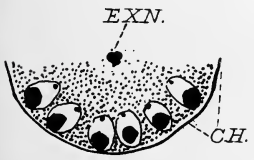

6.

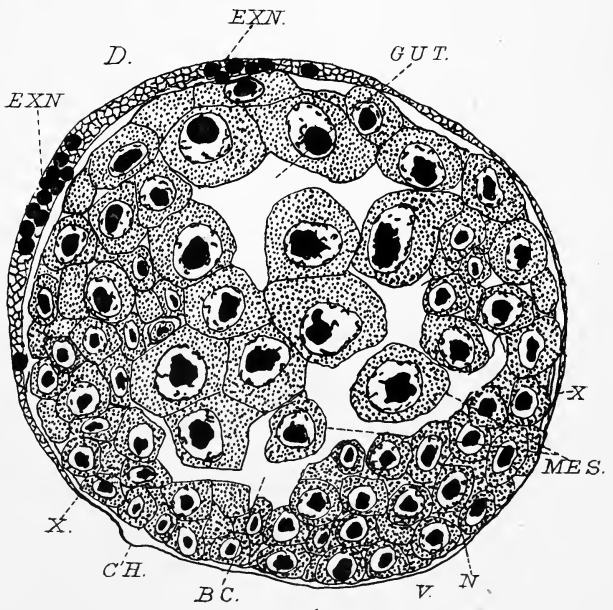

4.

Huth, London.

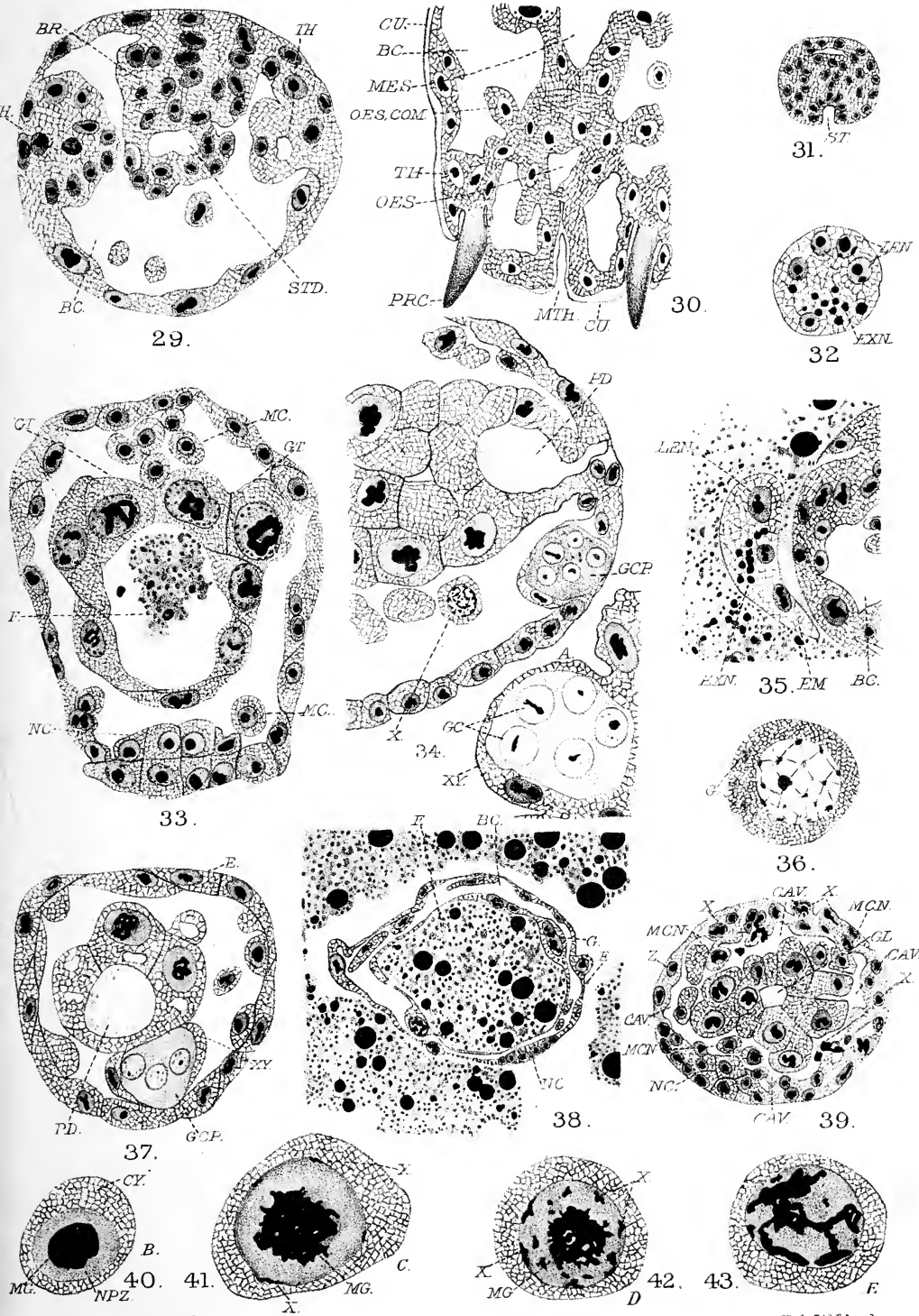

Hudl. Lith. London.

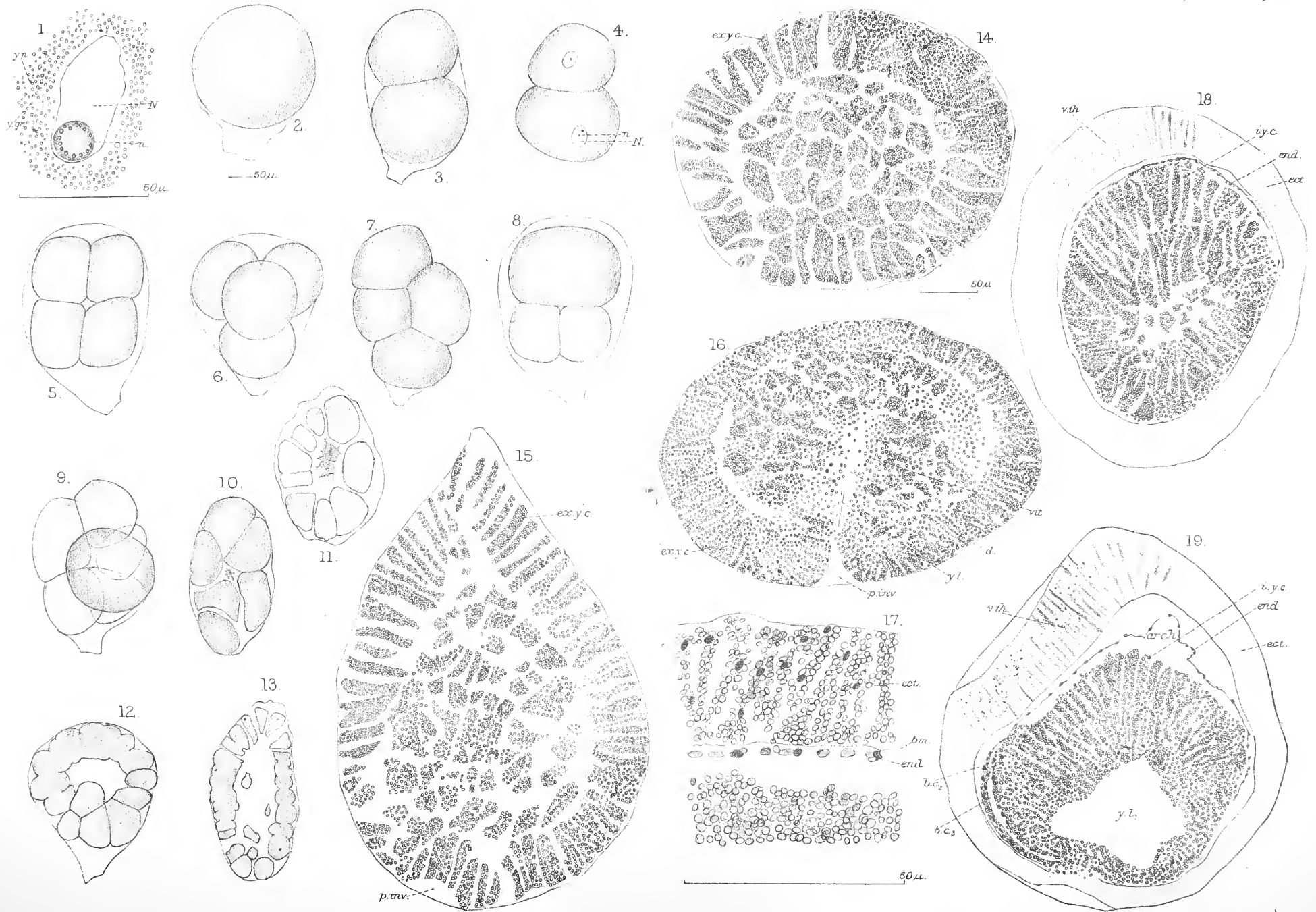

GILCHRIST—DEVELOPMENT OF CEPHALODISCUS.

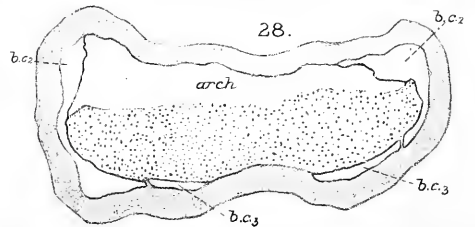
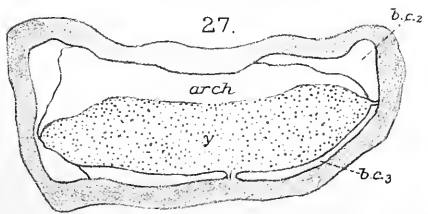
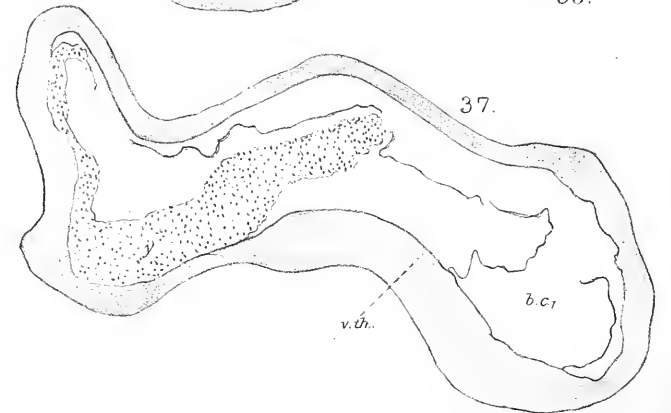
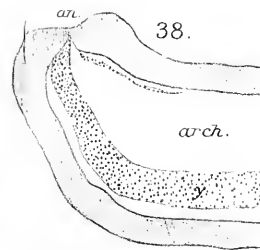
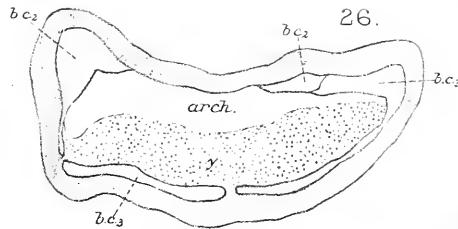
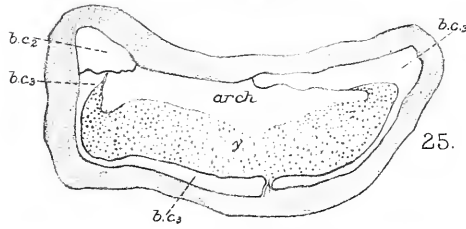
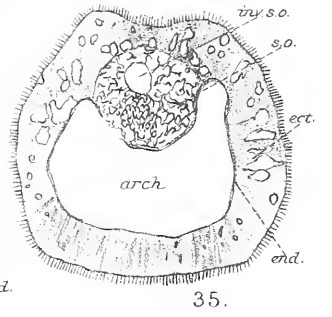
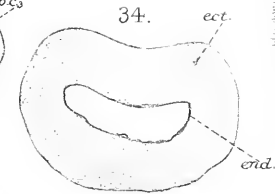
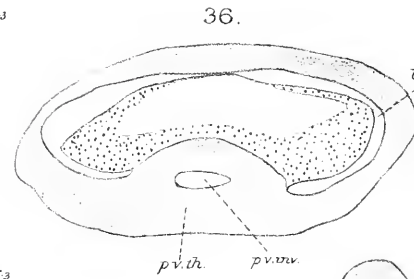
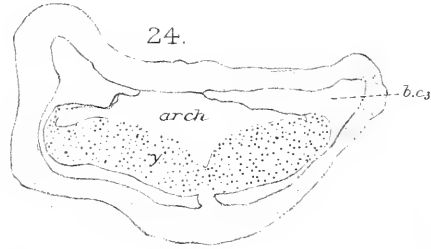
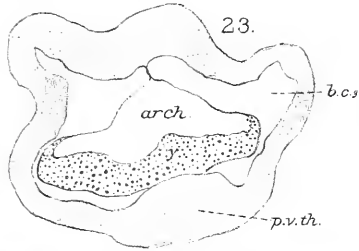
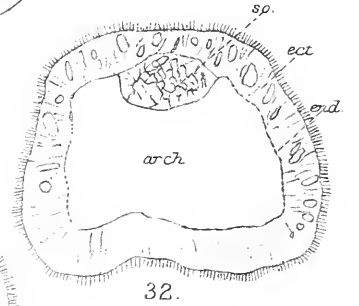
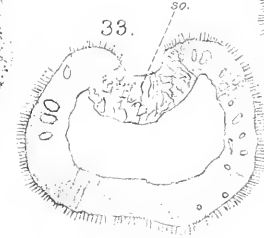
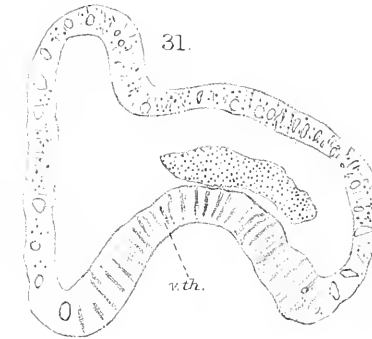
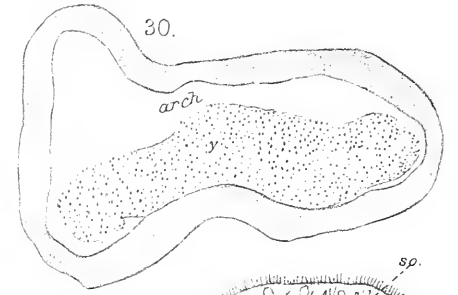
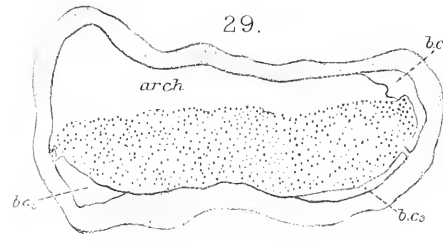
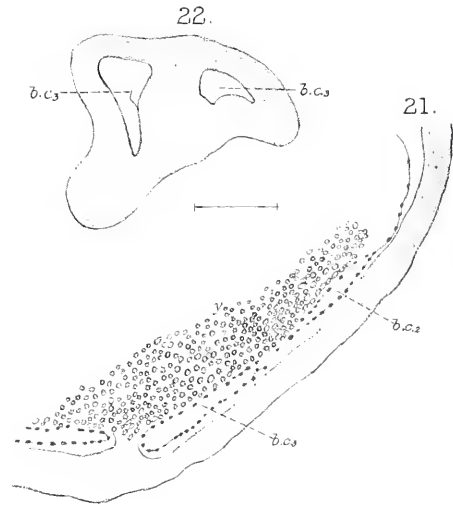

Huth, Lith. London.

GILCHRIST — DEVELOPMENT OF CEPHALODISCUS.

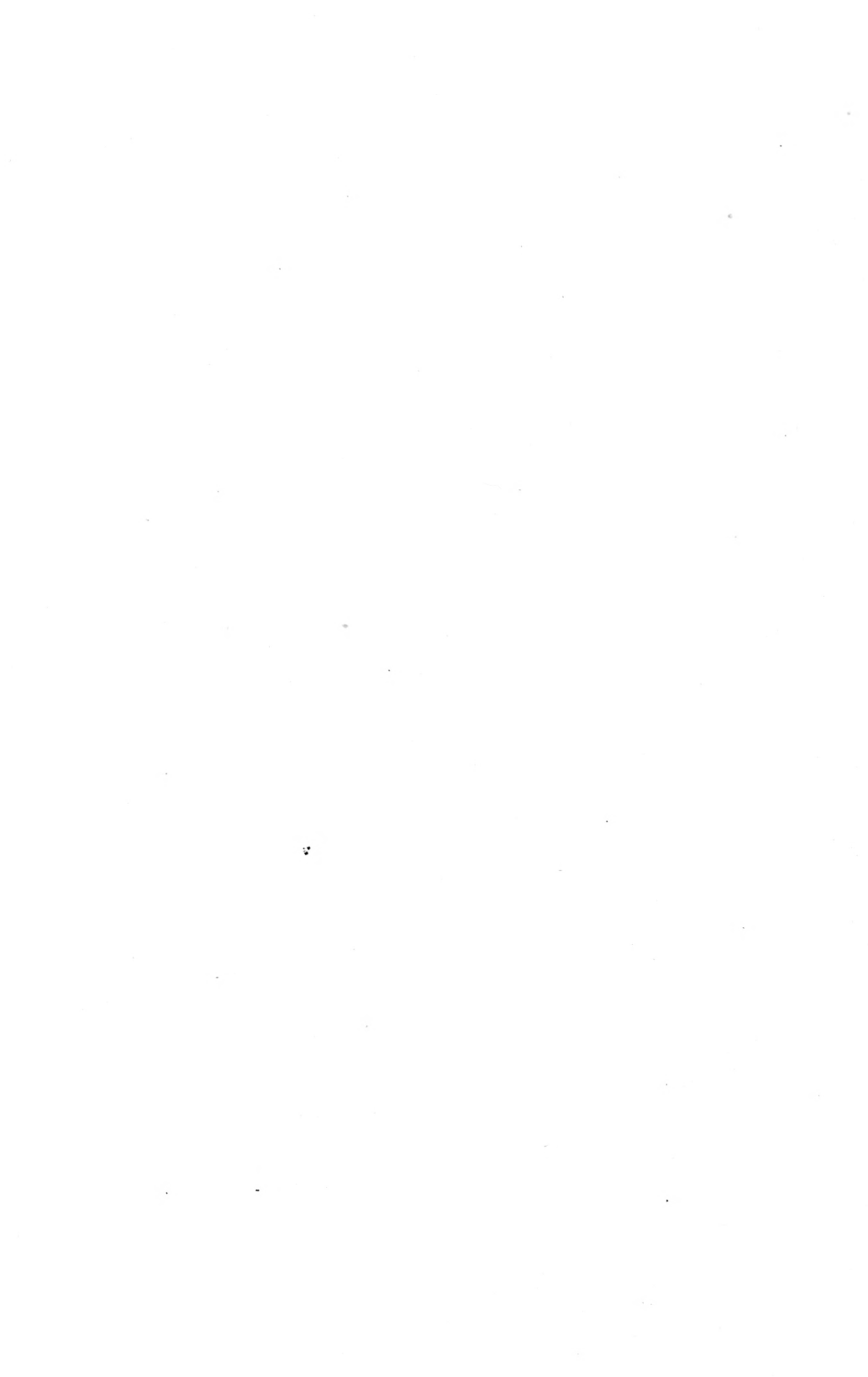

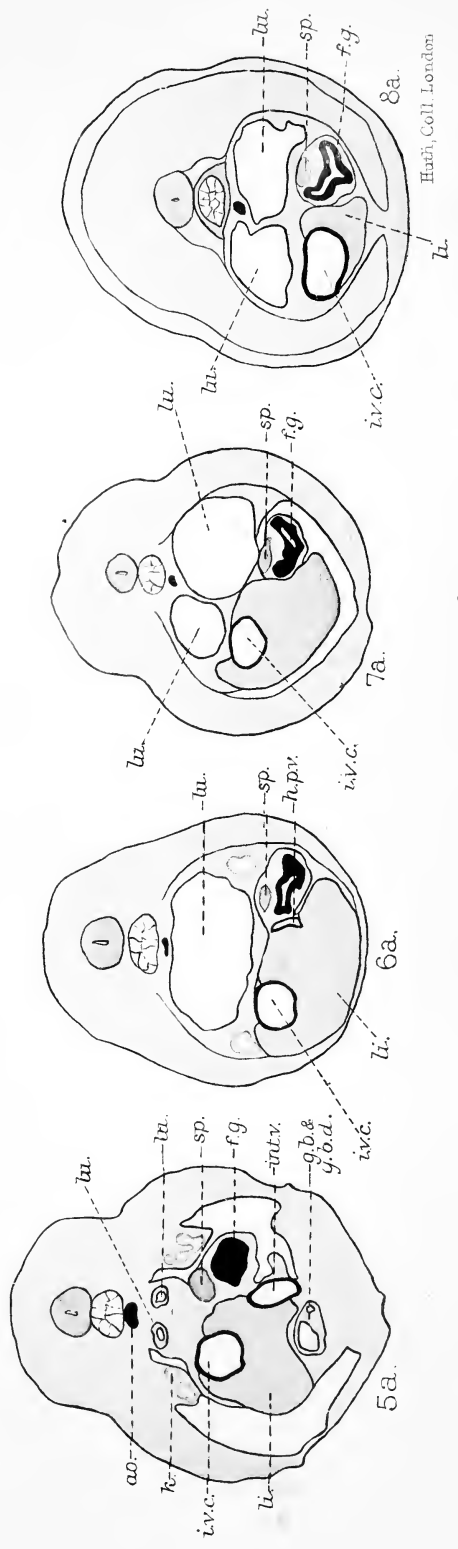
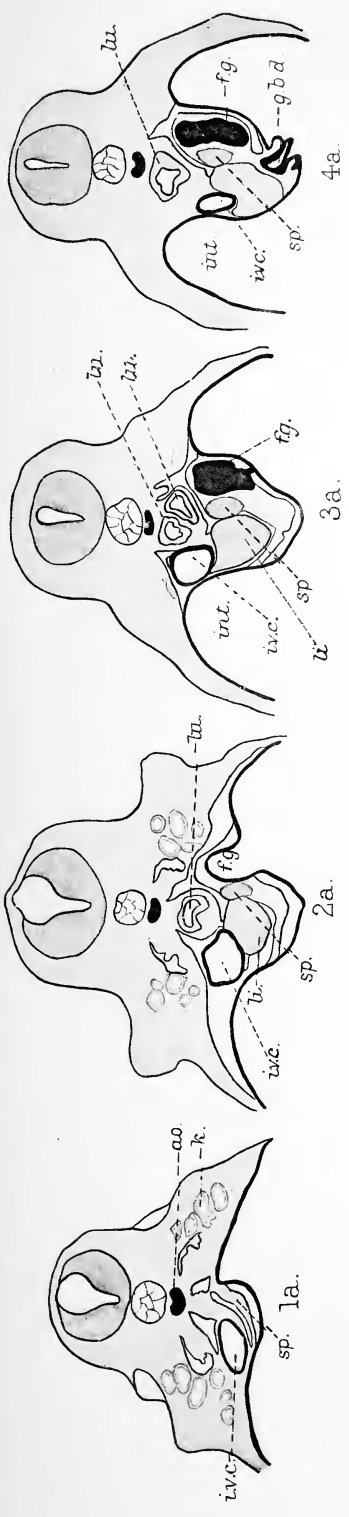

Harsh, Coll. London

PURSER—SPLEEN OF LEPIDOSIREN.



1.

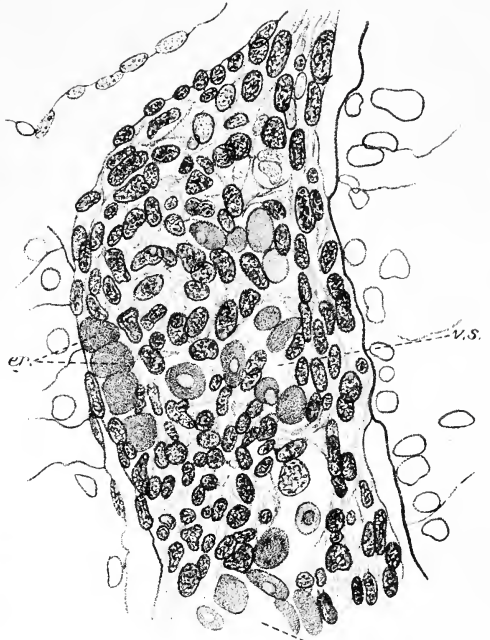

3.

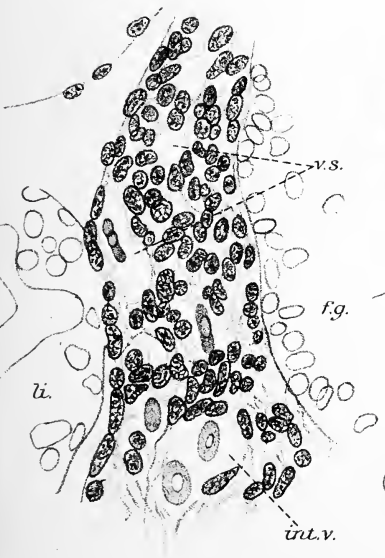

2.



4.

Huth, Lith^r London.

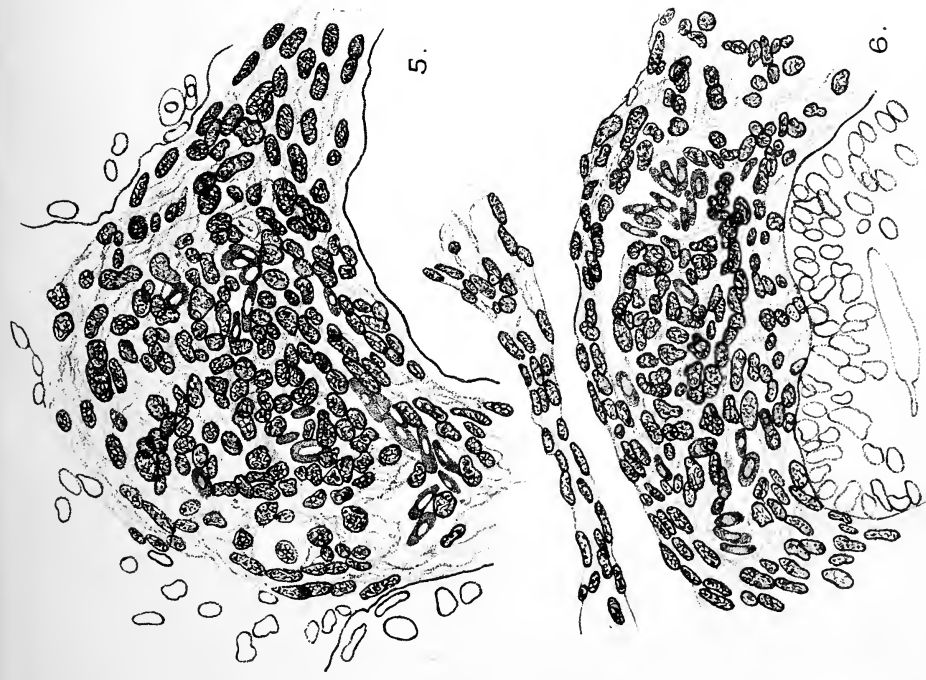

PURSER — SPLEEN OF LEPIDOSIREN.

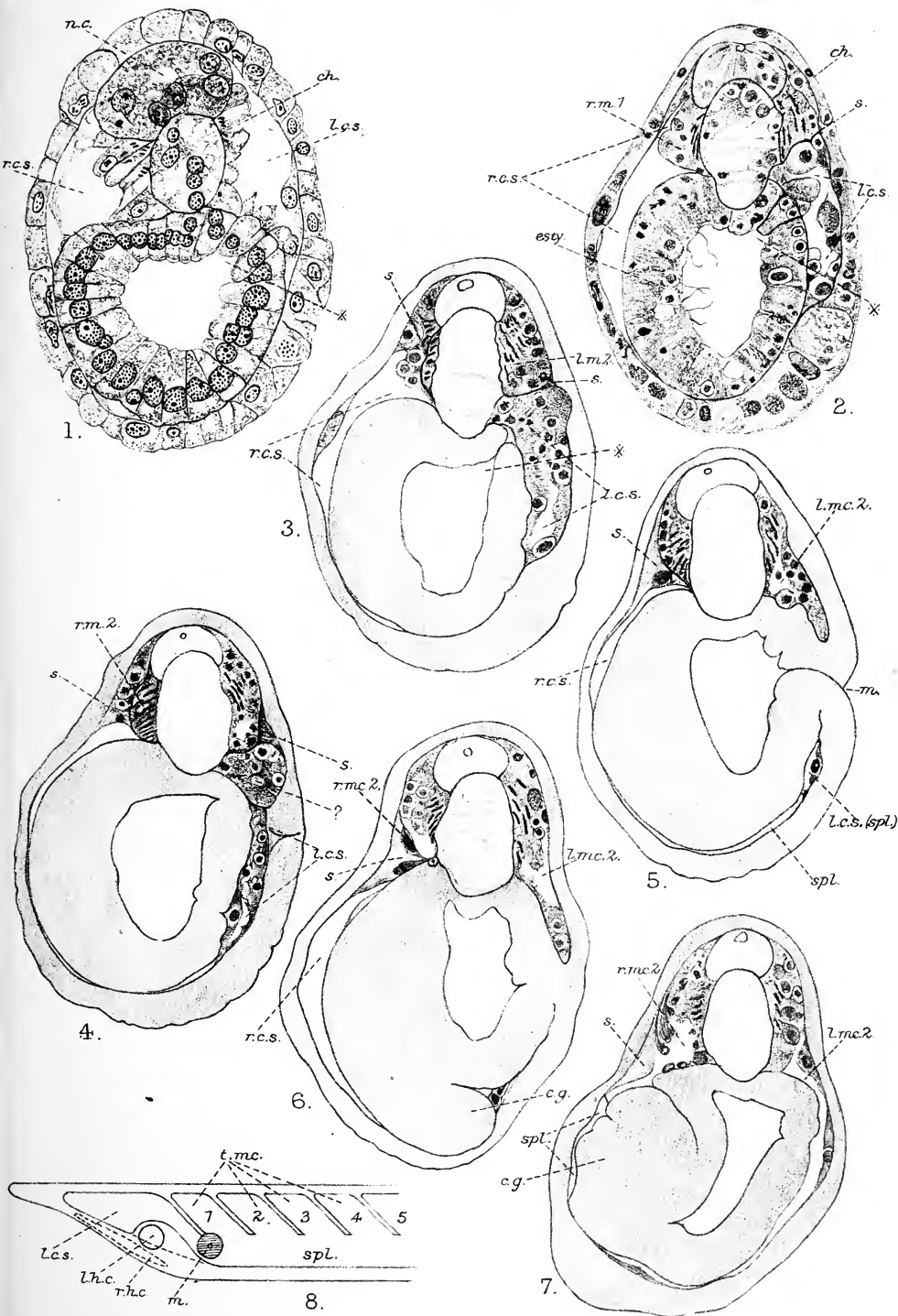

Huth Lith^r London

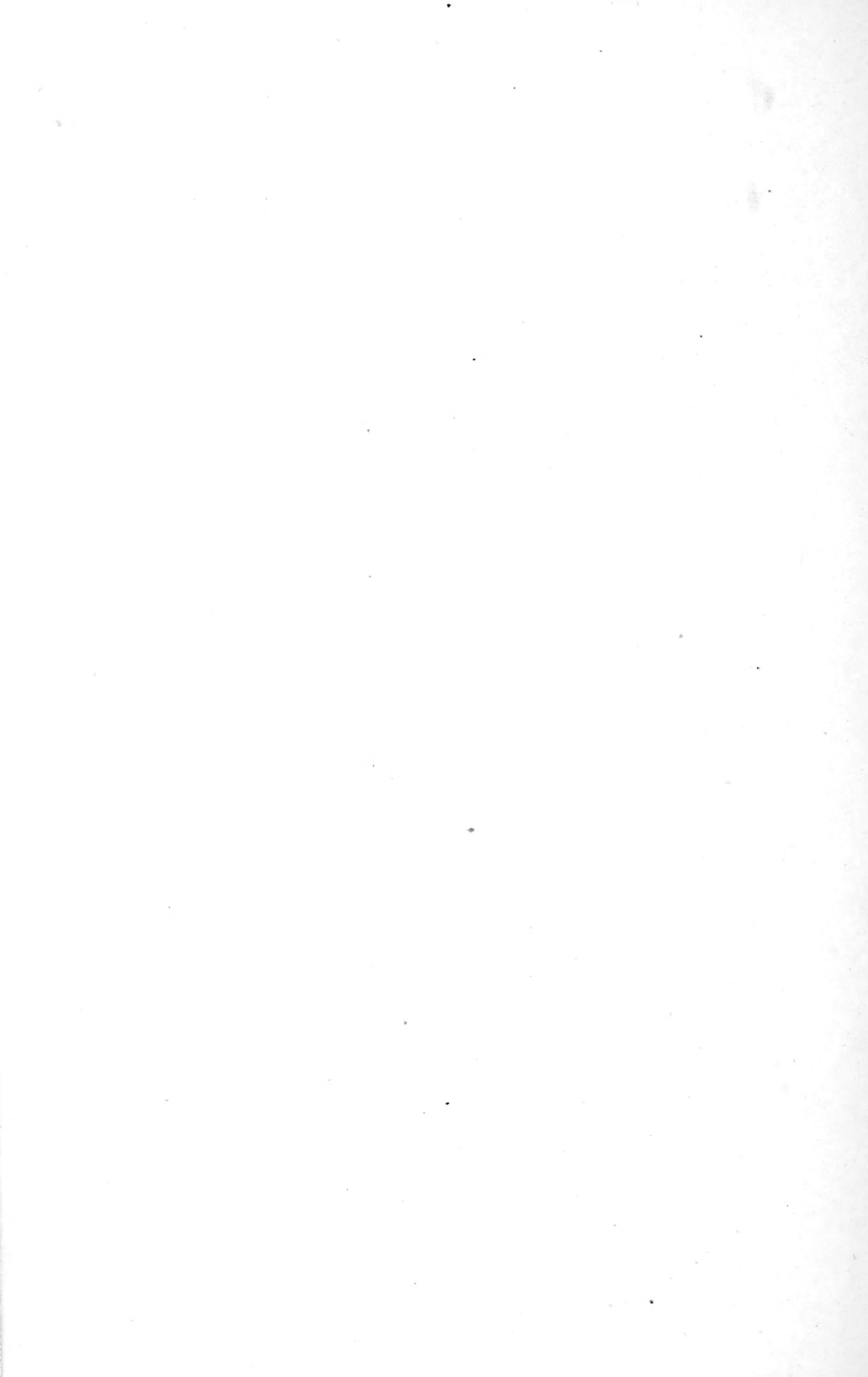

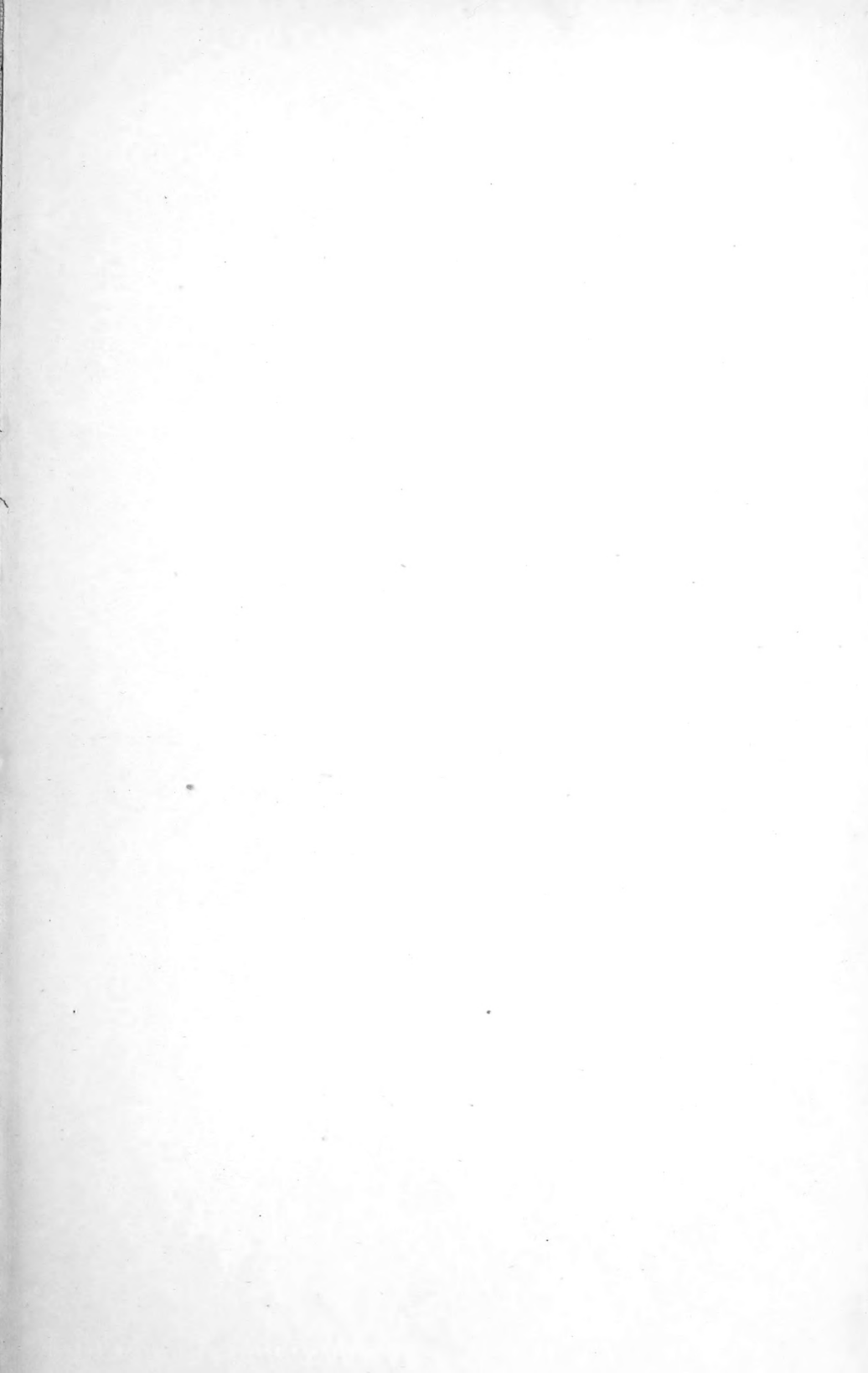

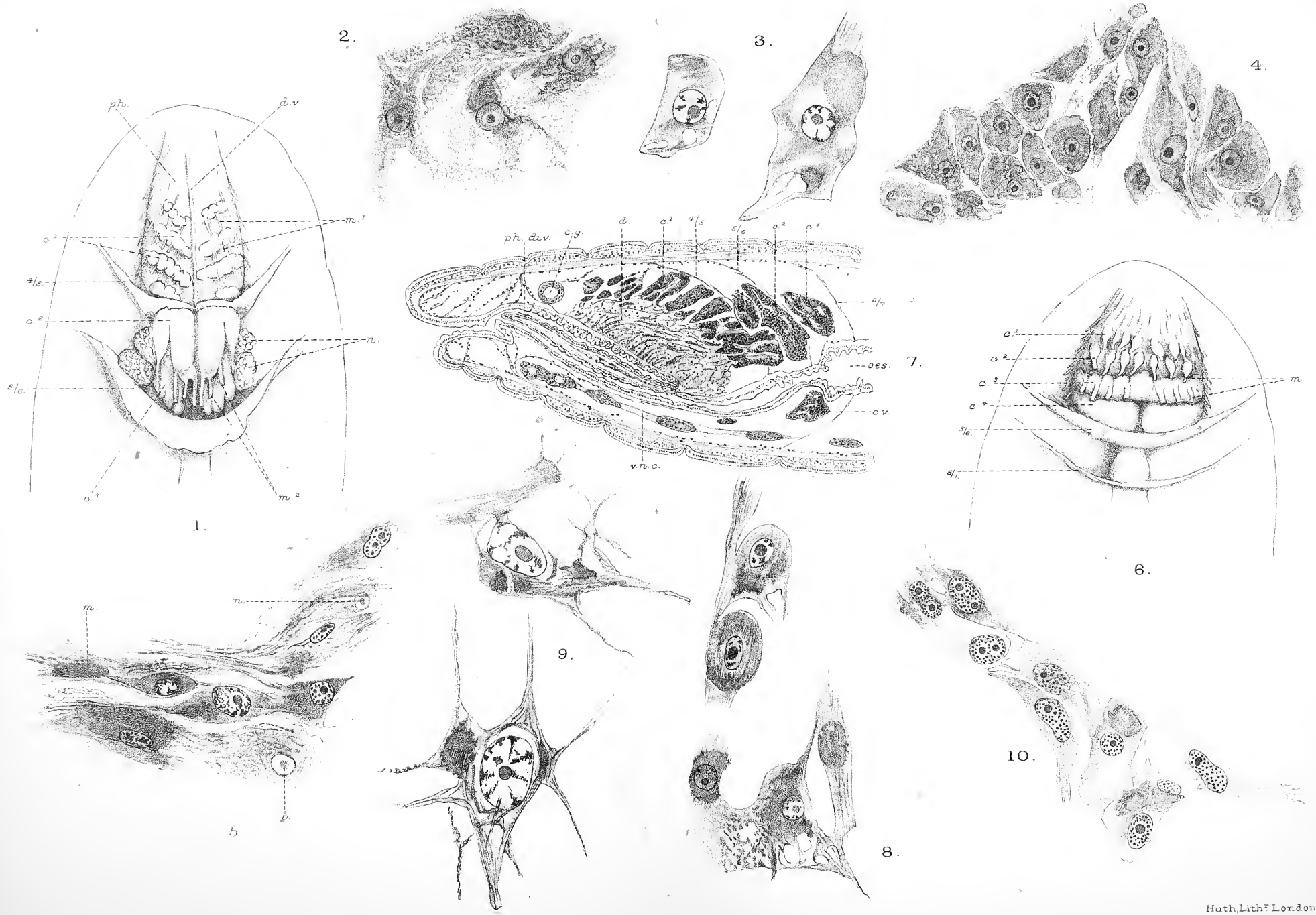

STEPHENSON-PHARYNGEAL GLAND CELLS OF EARTHWORMS.

Huth, Lith^r London.



1.

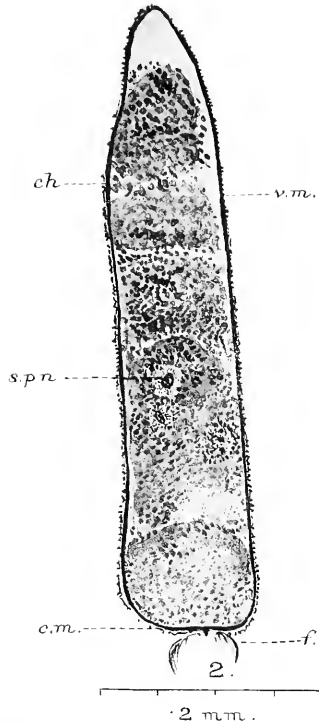

2.

2 mm.



3.

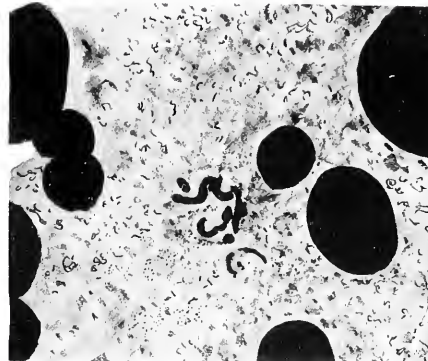

6.

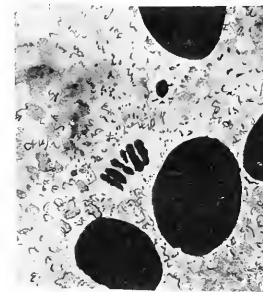

7.



8.



9.

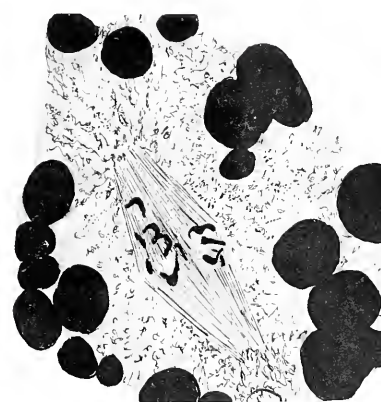

11.

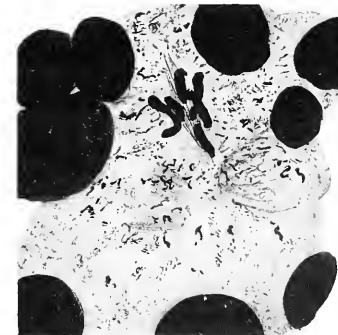

10.

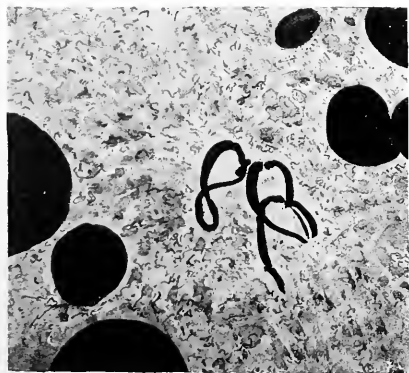

4.

01 mm.
1.

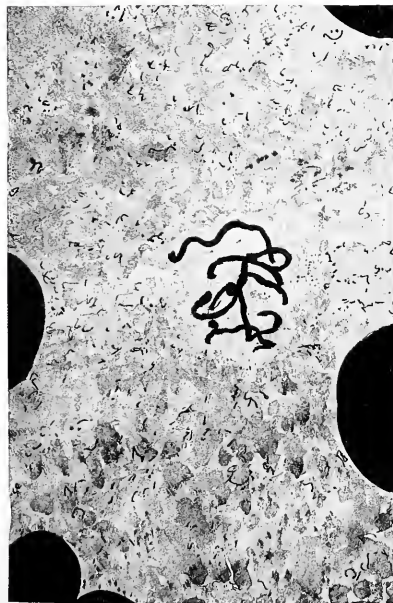

5.

03 mm.
2.

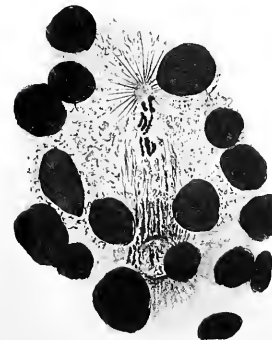

13.

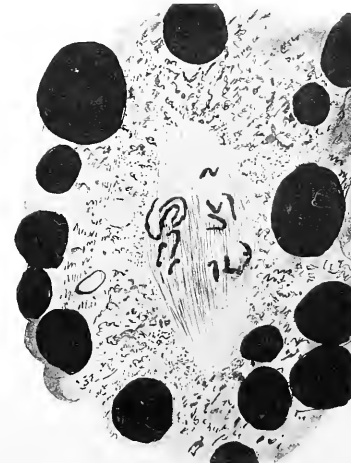

12.

01 mm.
3.

Huth coll.



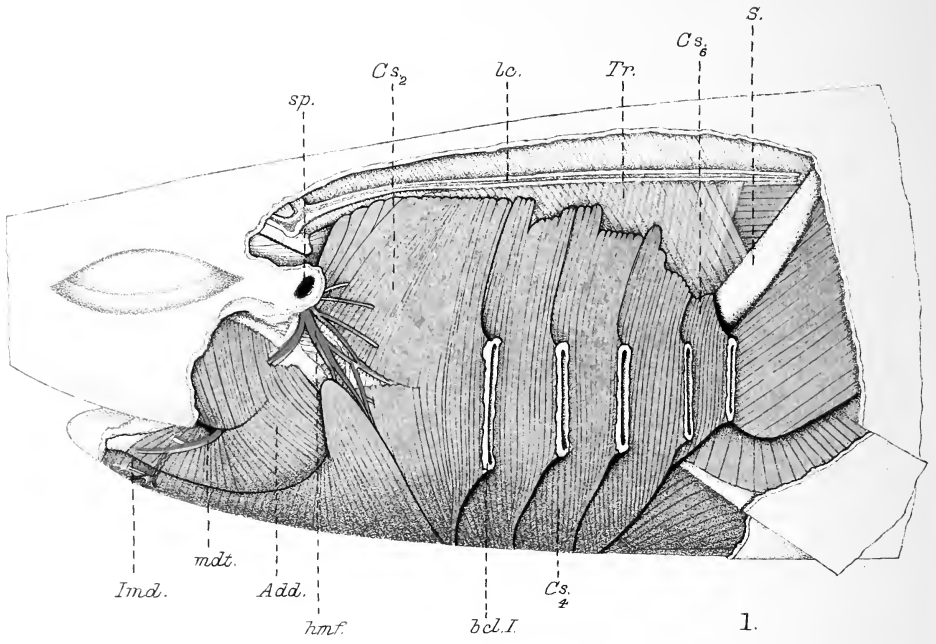

1.

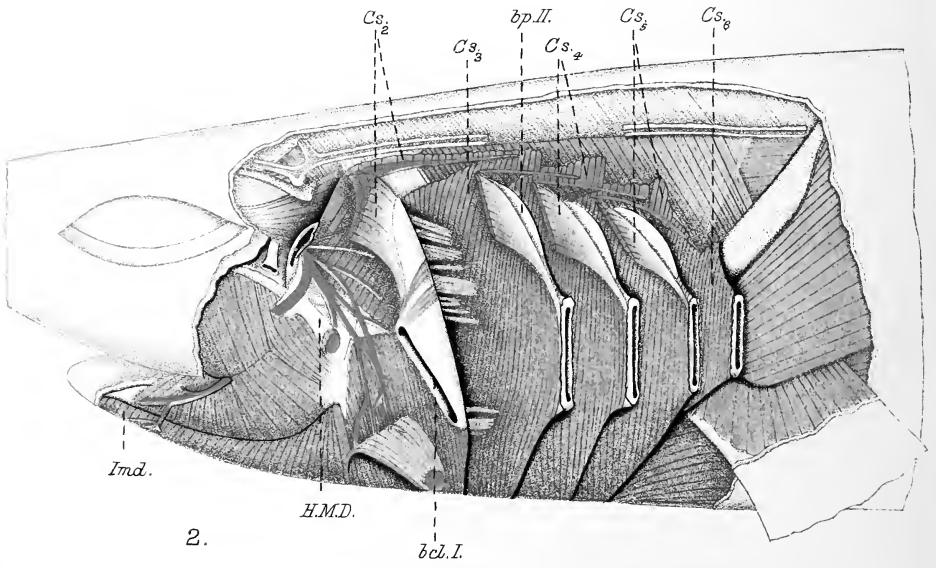

2.

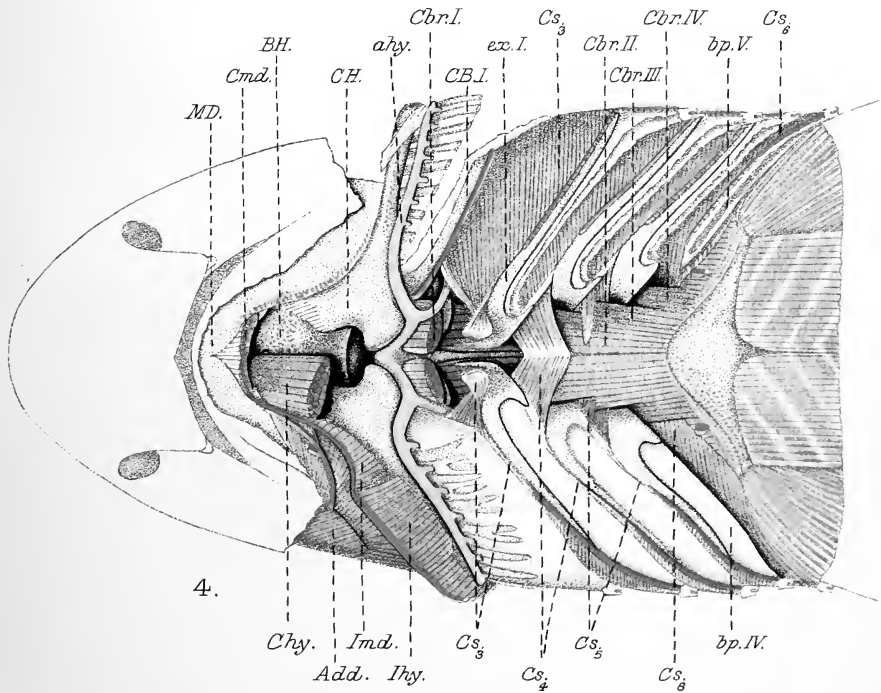
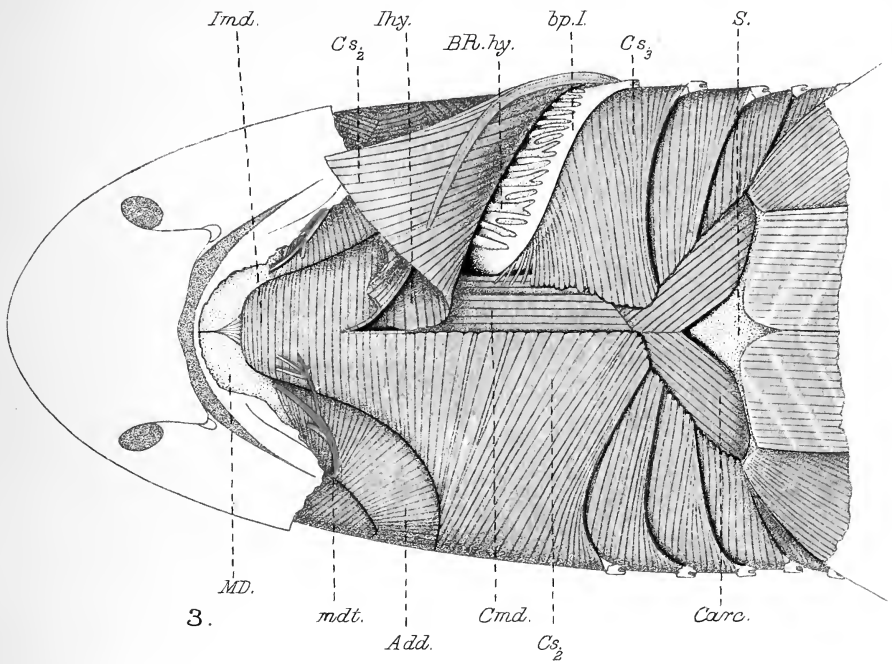

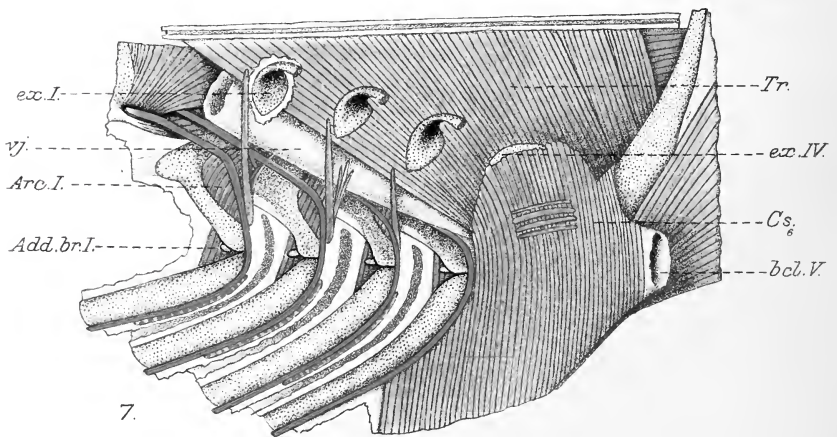
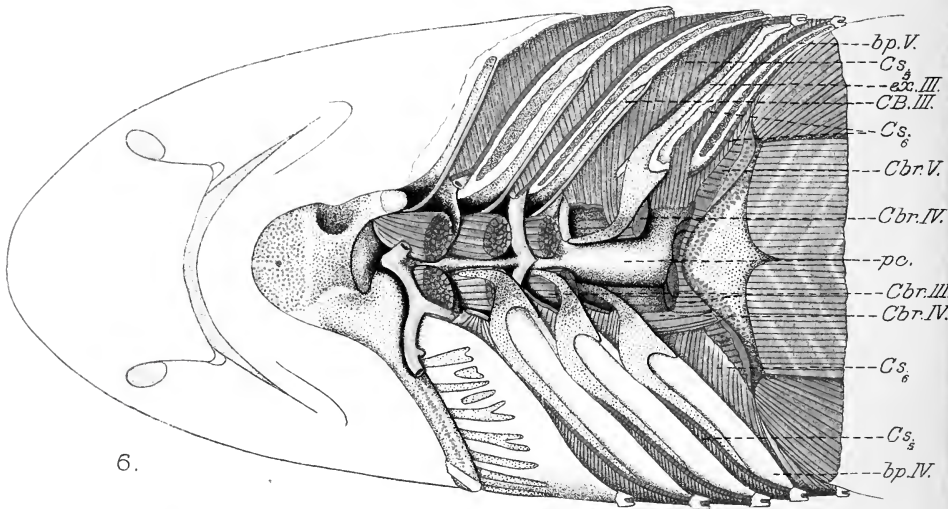
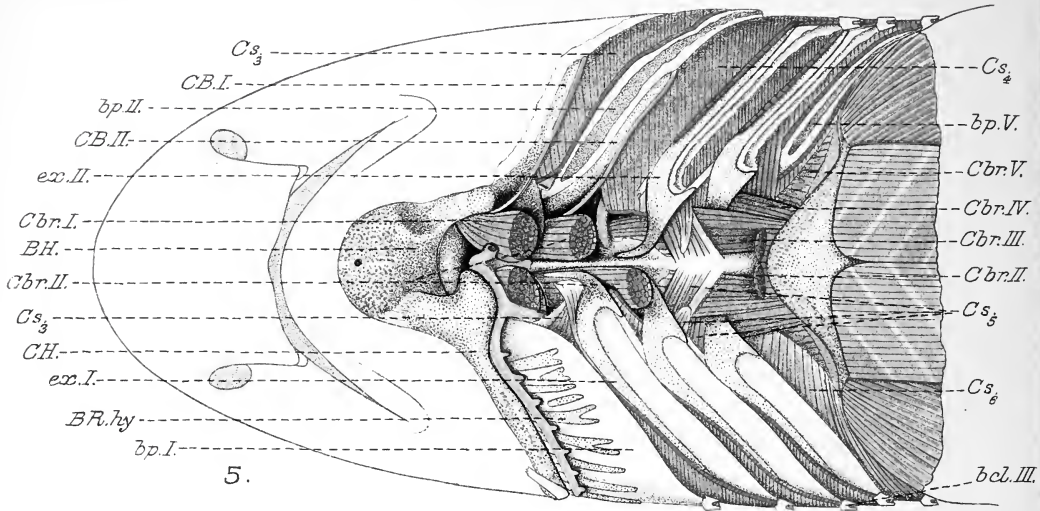





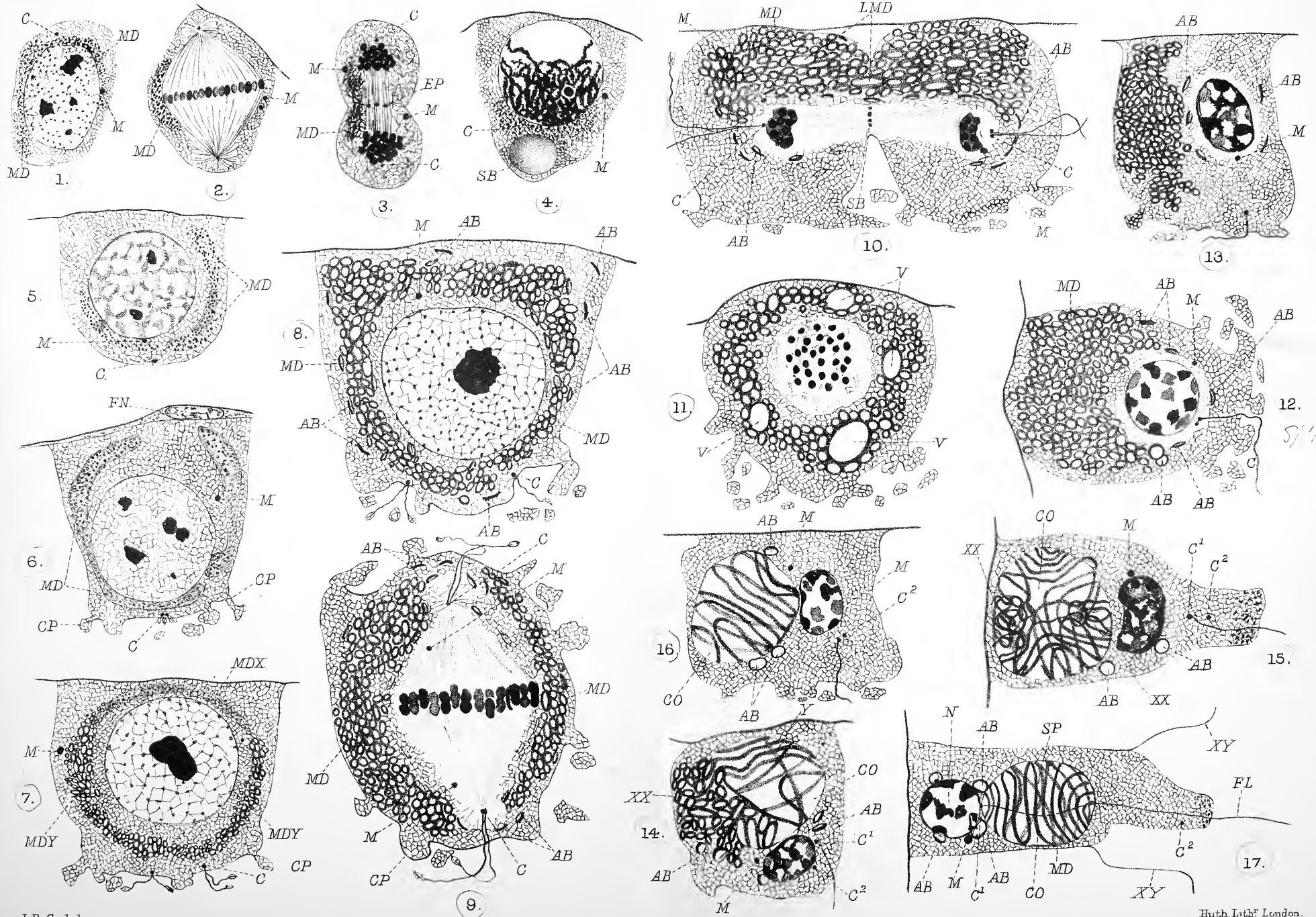

J. B. G. del.

Huth, Lithf. London.

GATENBY — LEPIDOPTEROUS GERM CELLS.

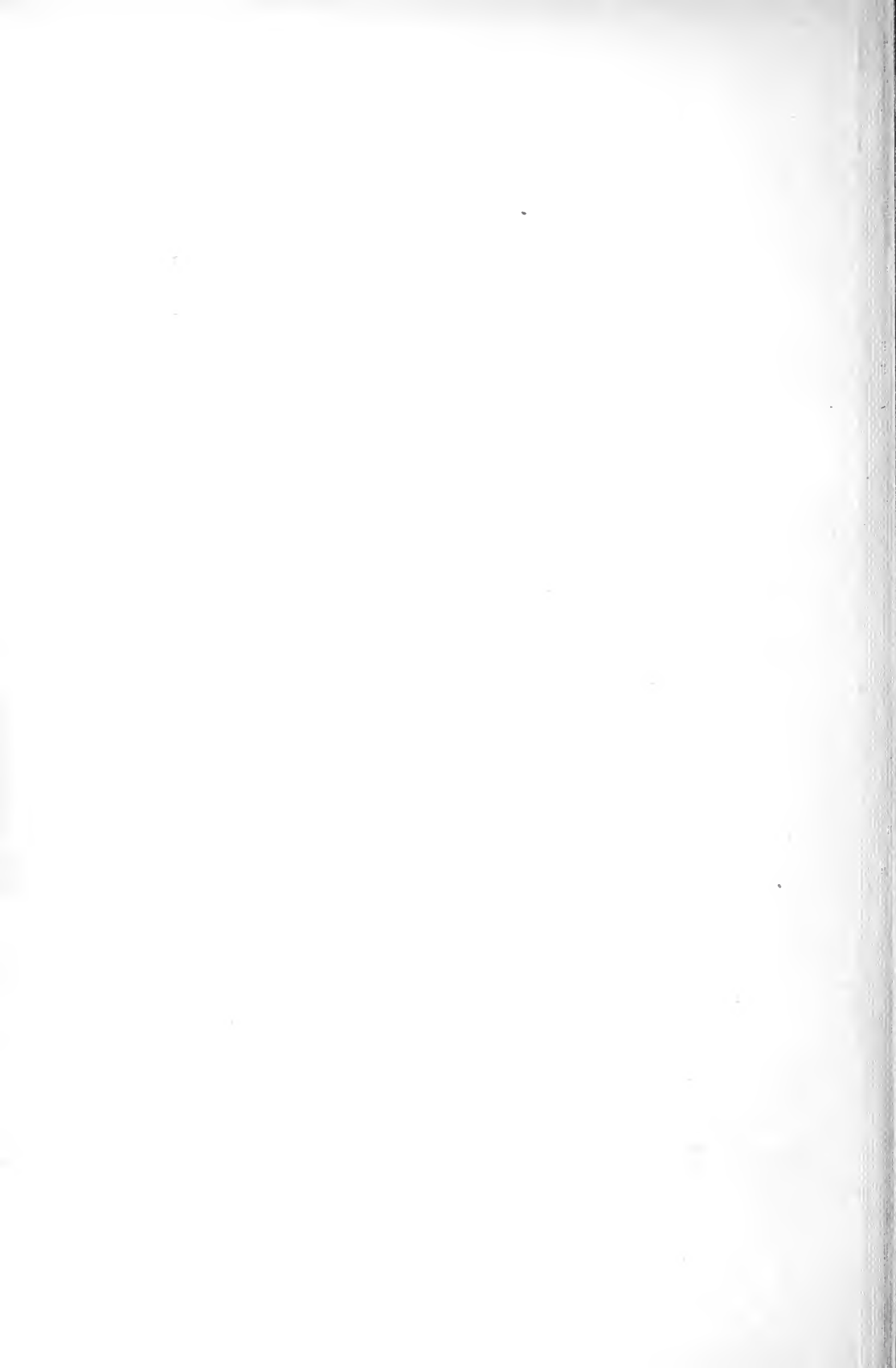



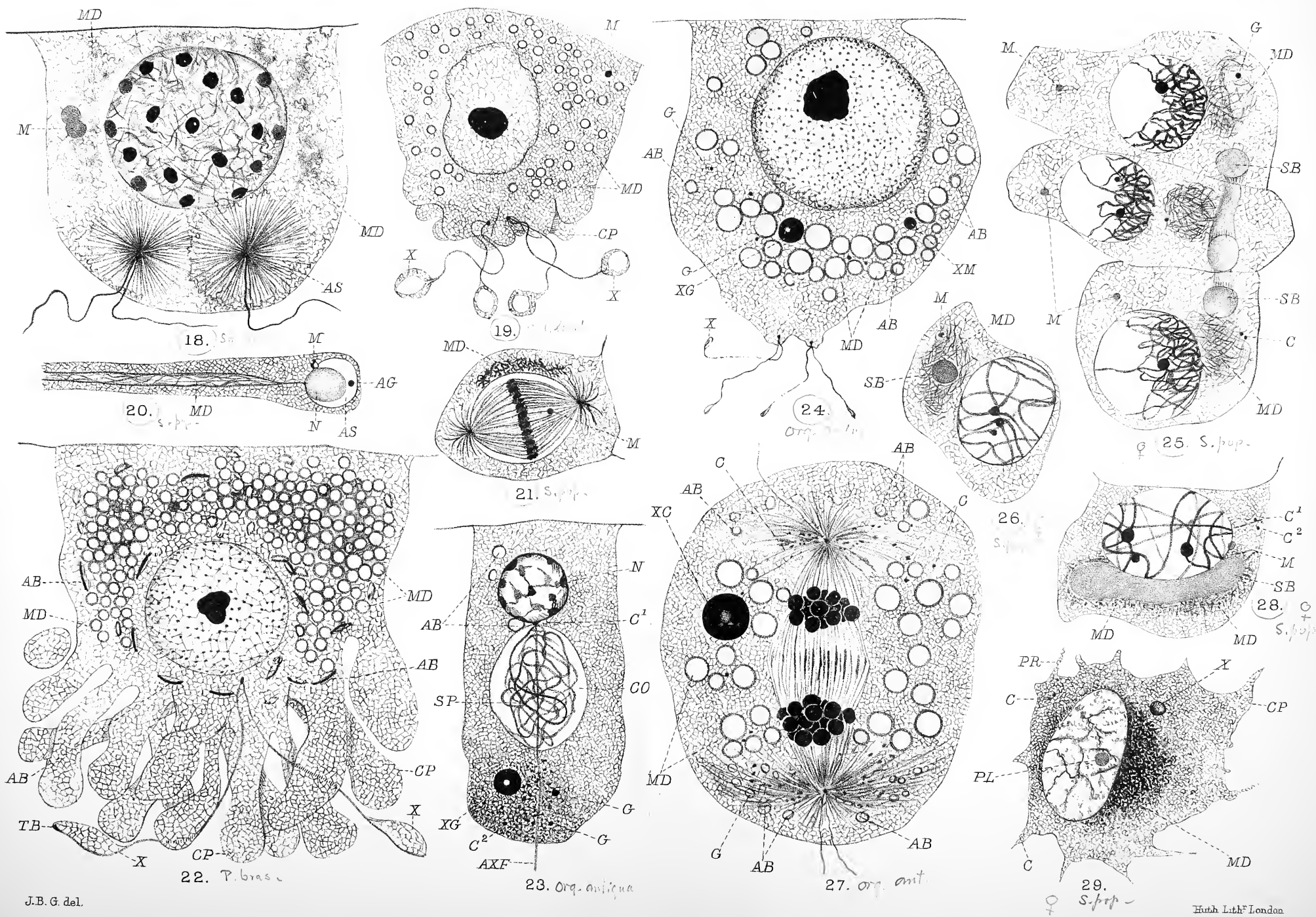

J.B.G. del.

GATENBY — LEPIDOPTEROUS GERM CELLS.

Huth Lith. London

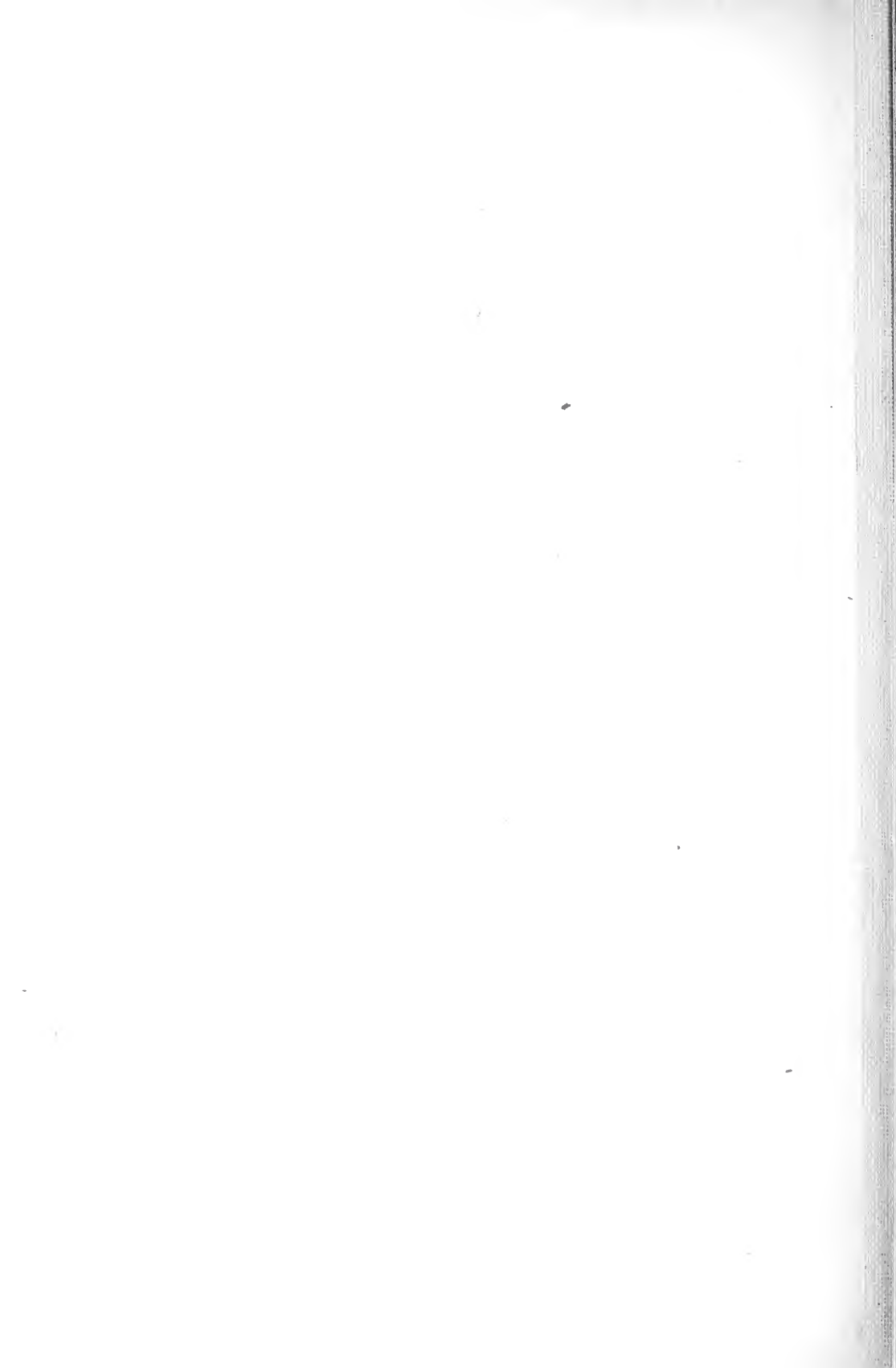



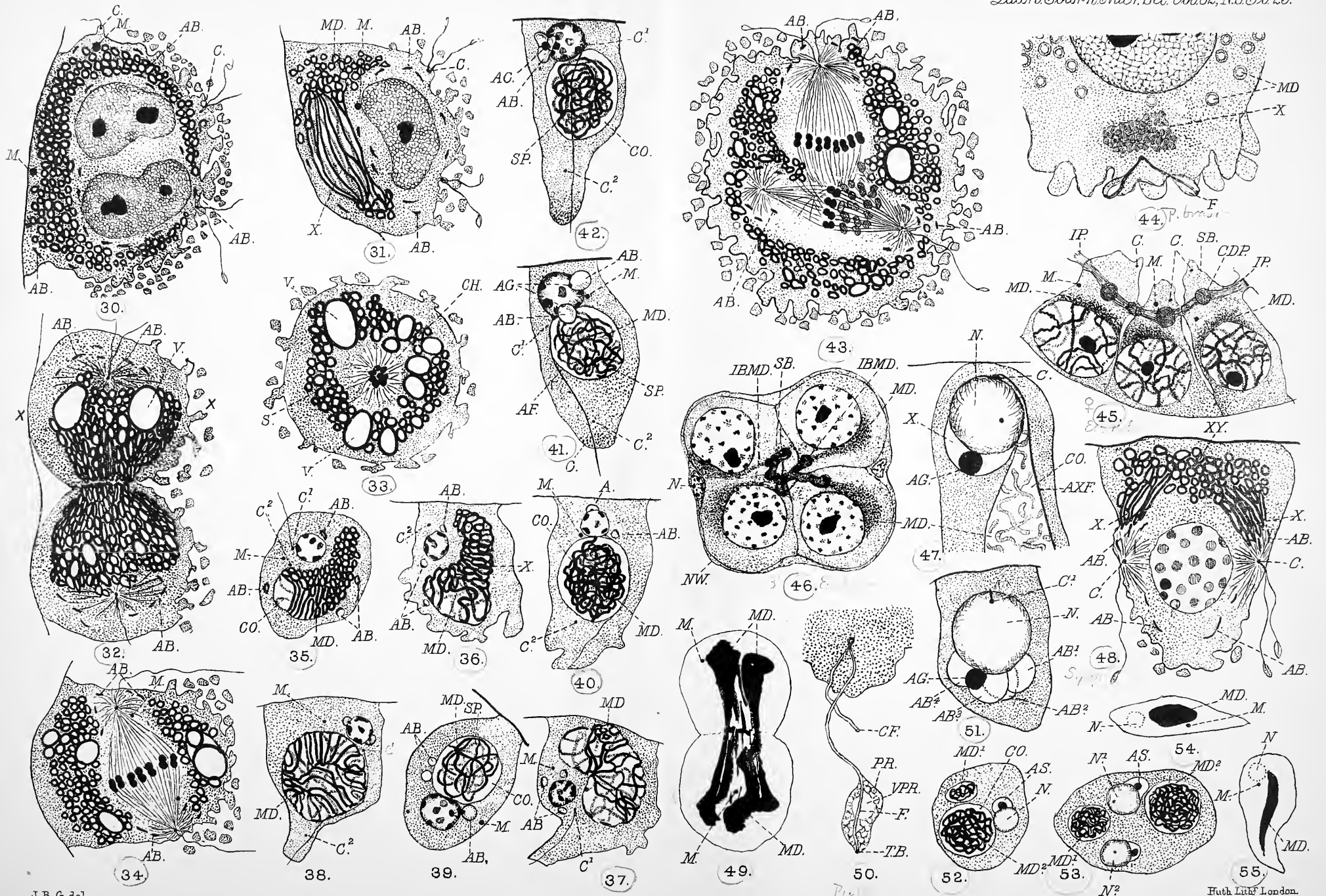

J.B.G. del.

Futh Lith London.

GATENBY — LEPIDOPTEROUS GERM CELLS.

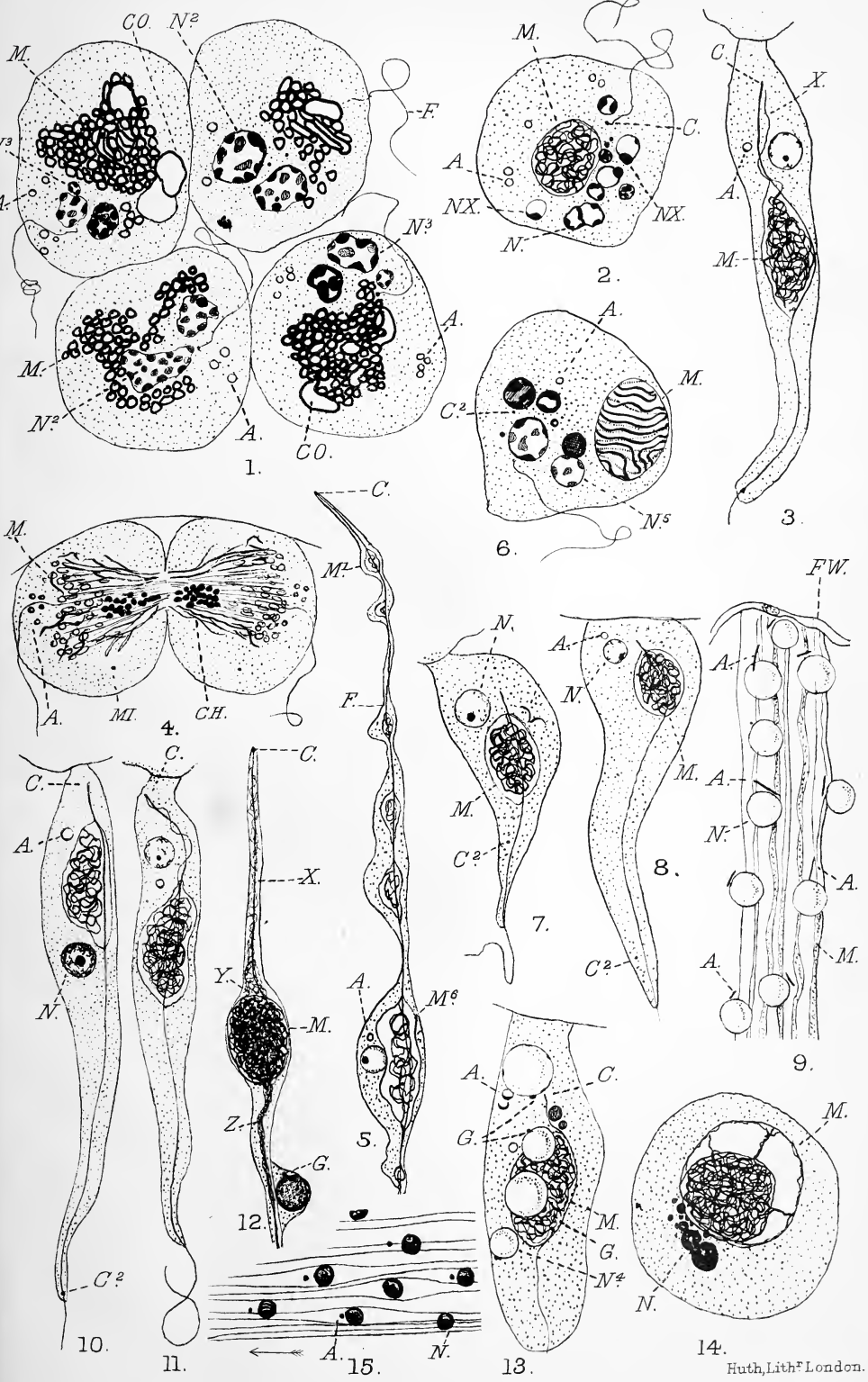

Huth, Lith^r London.

GATENBY — ABNORMAL SPERMATOZOA.

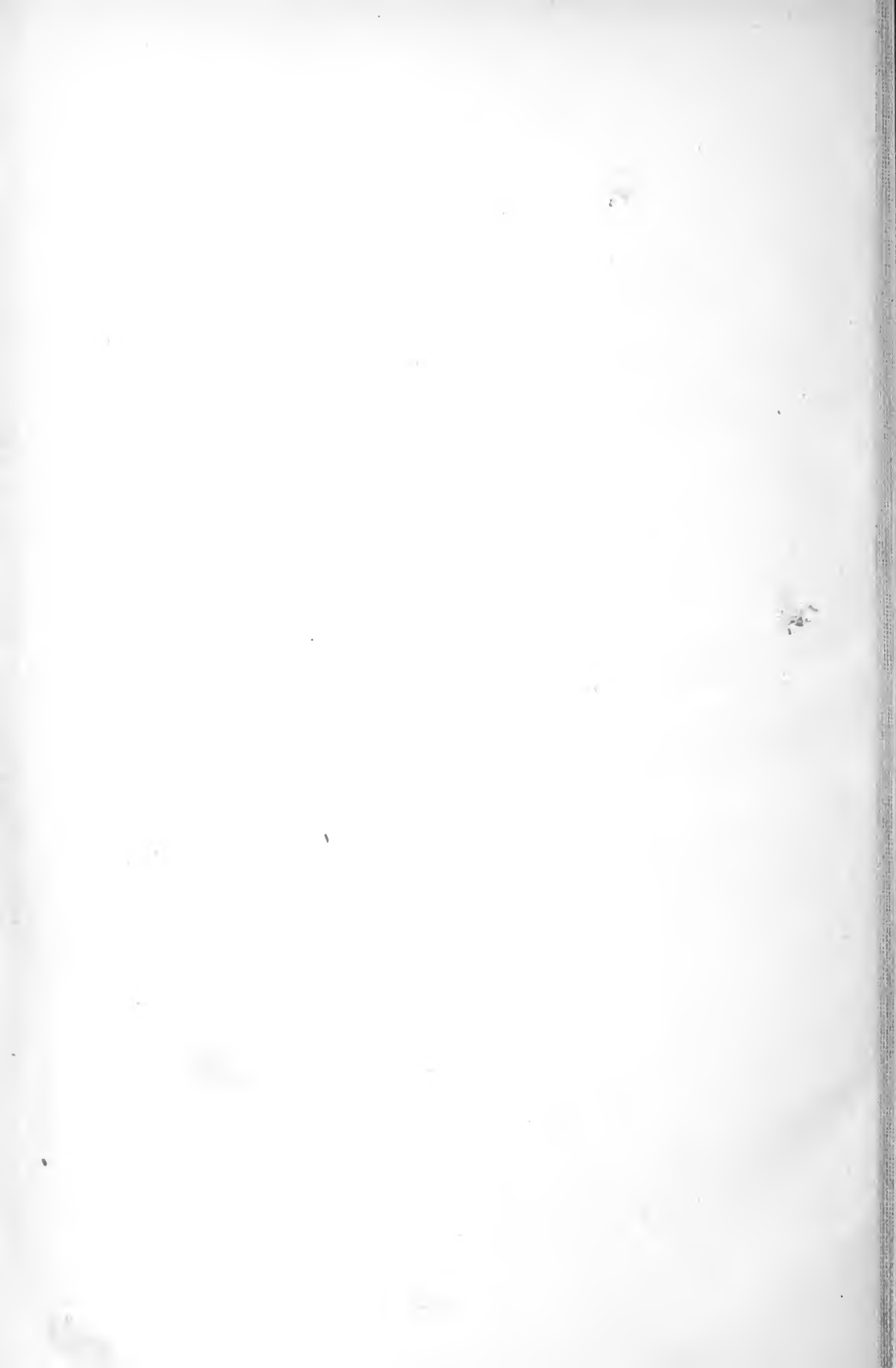

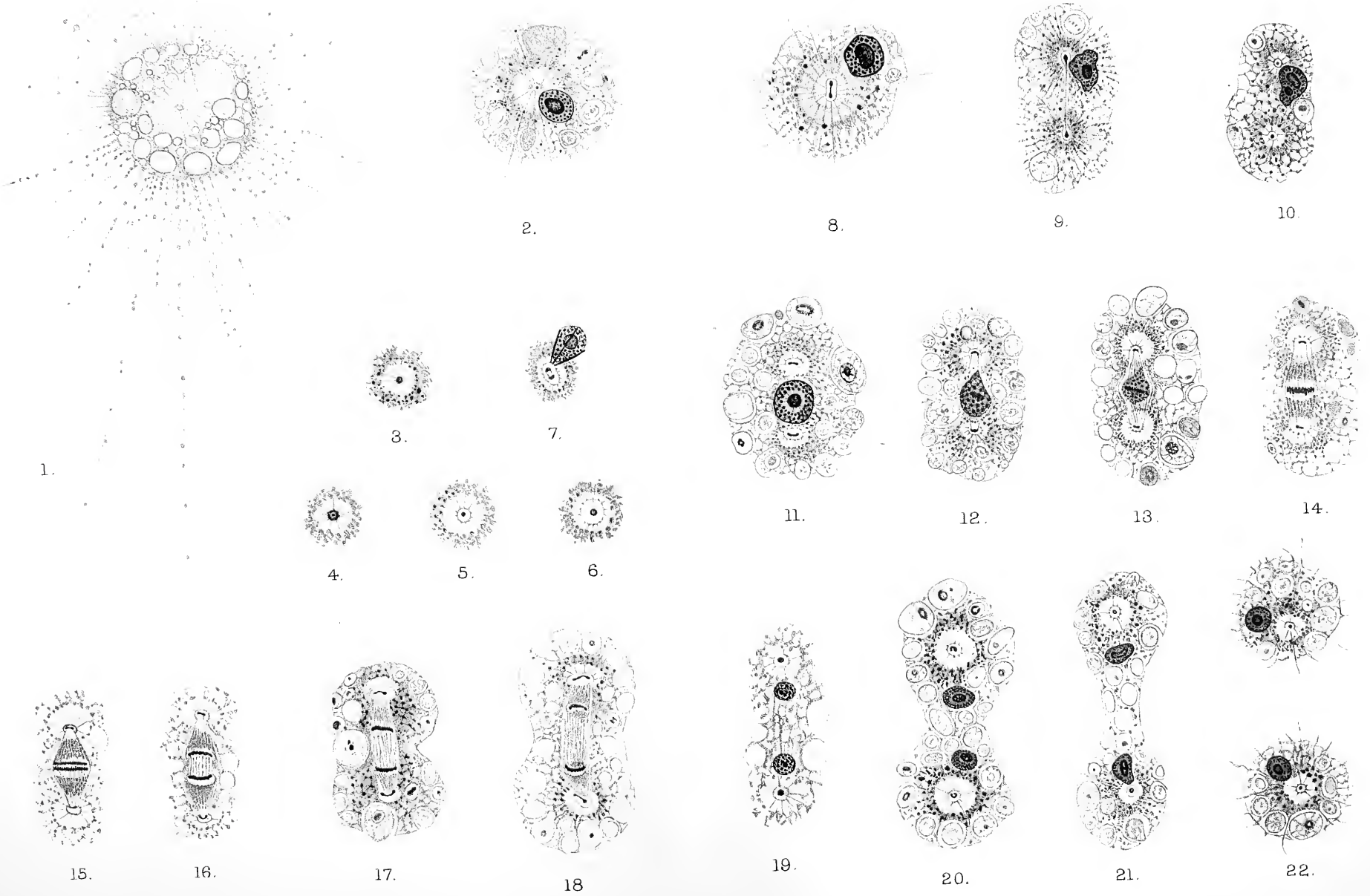

C. Dobell del.

DOBELL — OXNERELLA.

Hirt, Lith. London.



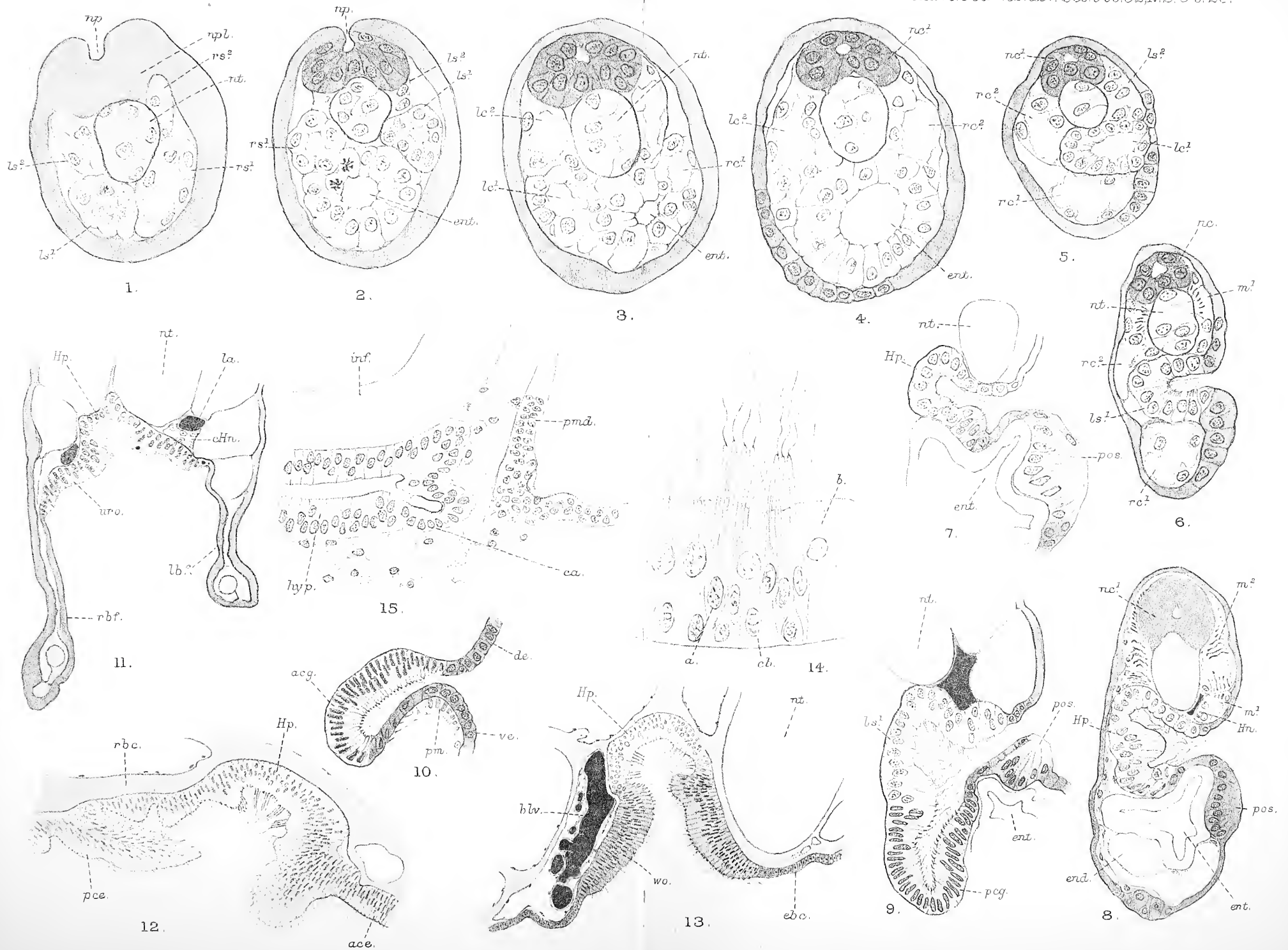

GOODRICH - PROBOSCIS PORES IN CRANIATES.

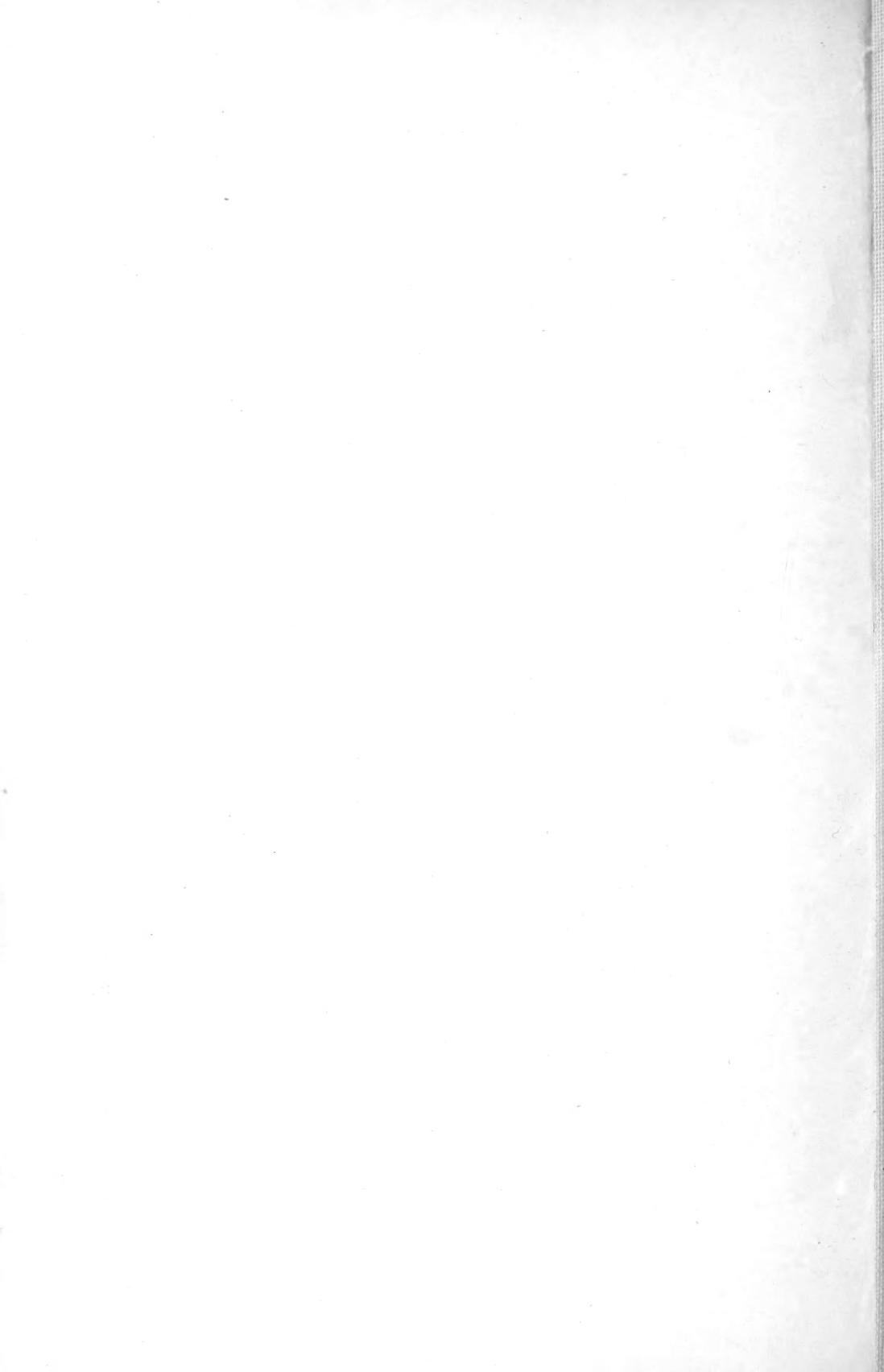

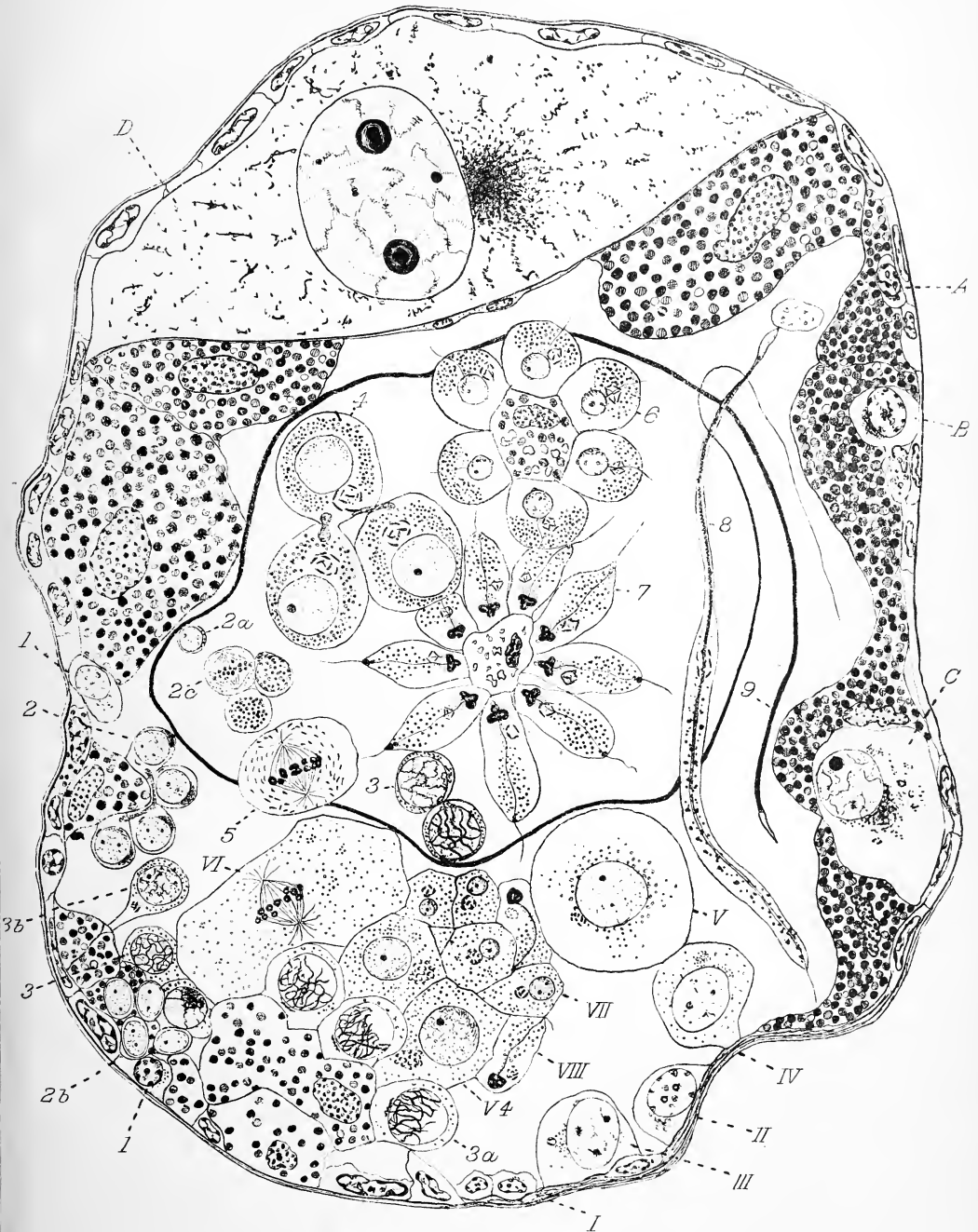
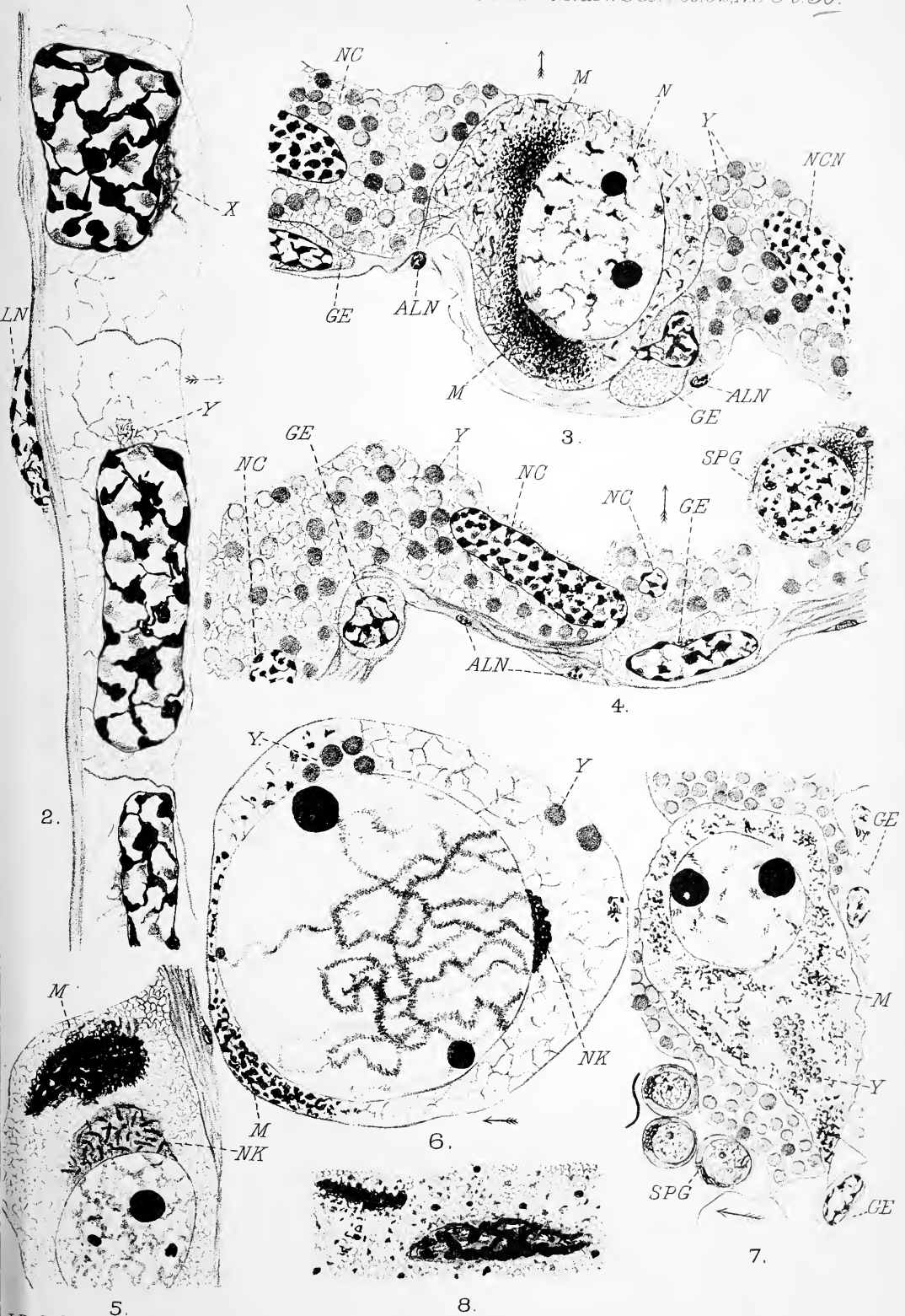

Fig. 1.

J.B.G. del.

Huth London.

GATENBY — CYTOPLASMIC INCLUSIONS OF THE GERM CELLS



J.B.G. del.

5.

8.

Hath, Lith^r London.

GATENBY-CYTOPLASMIC INCLUSIONS OF THE GERM CELLS.

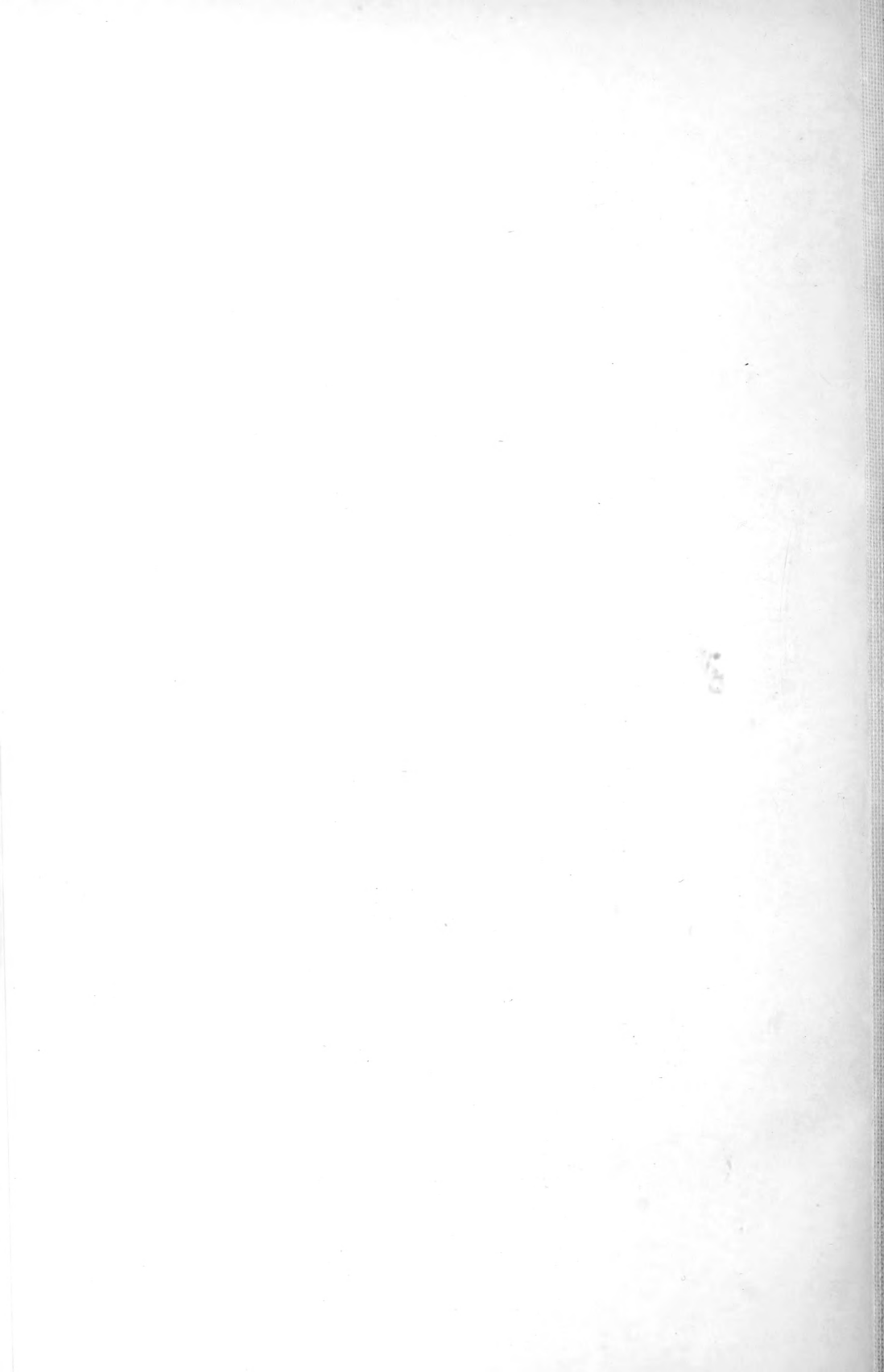

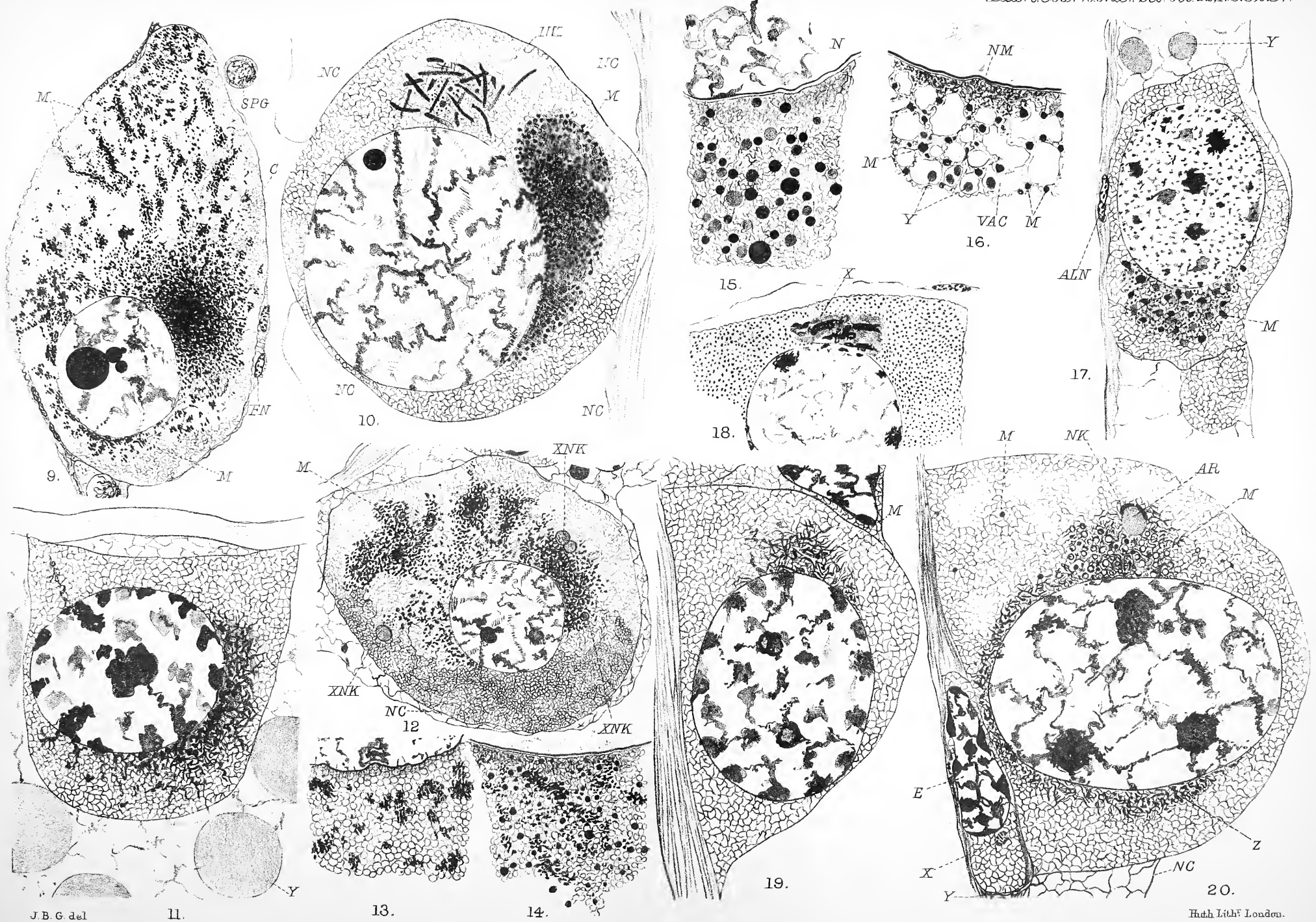

J. B. G. del.

11.

13.

14.

19.

20.

Hubb Lith^r London.

GATENBY—CYTOPLASMIC INCLUSIONS OF THE GERM CELLS.

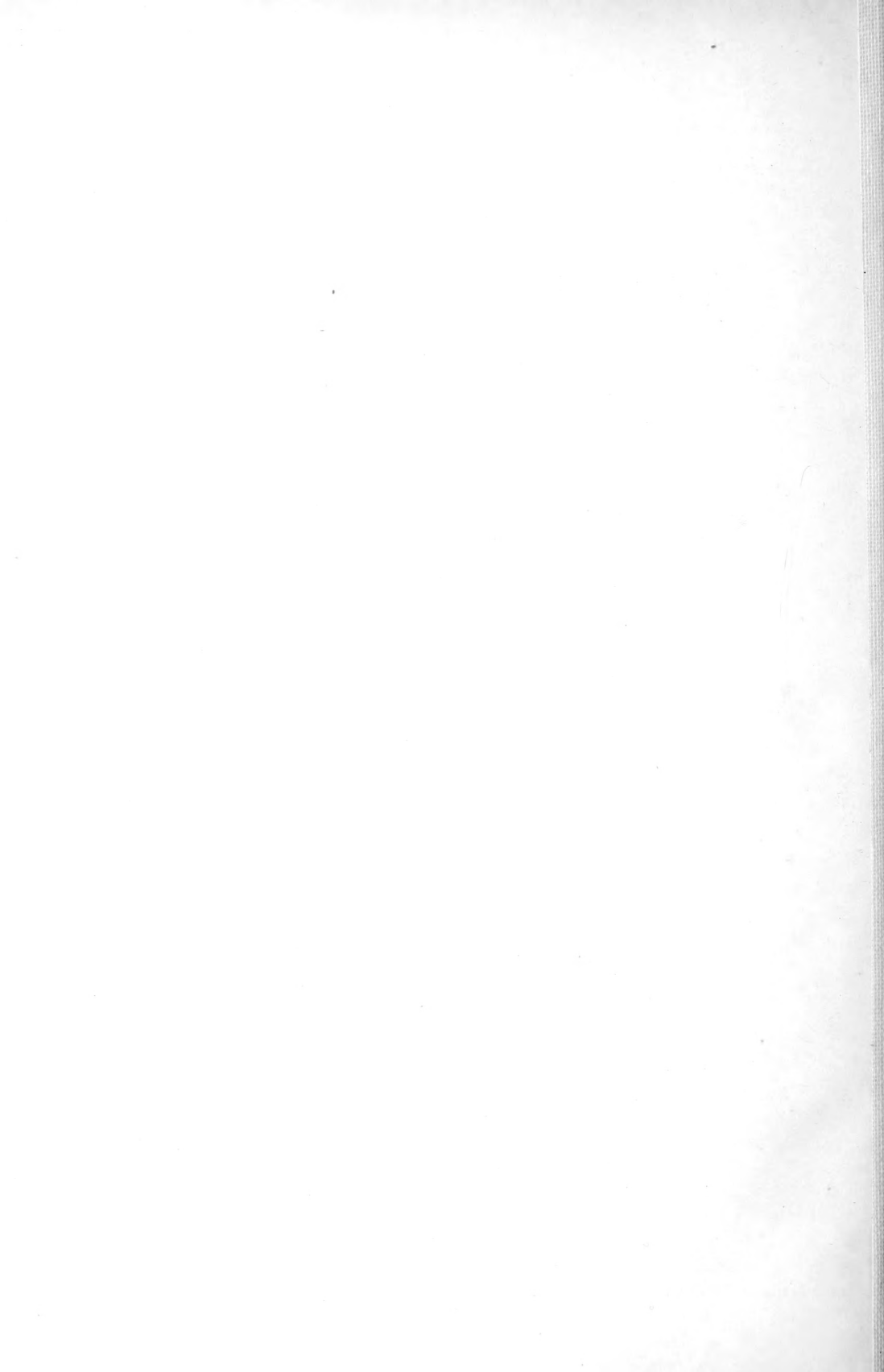

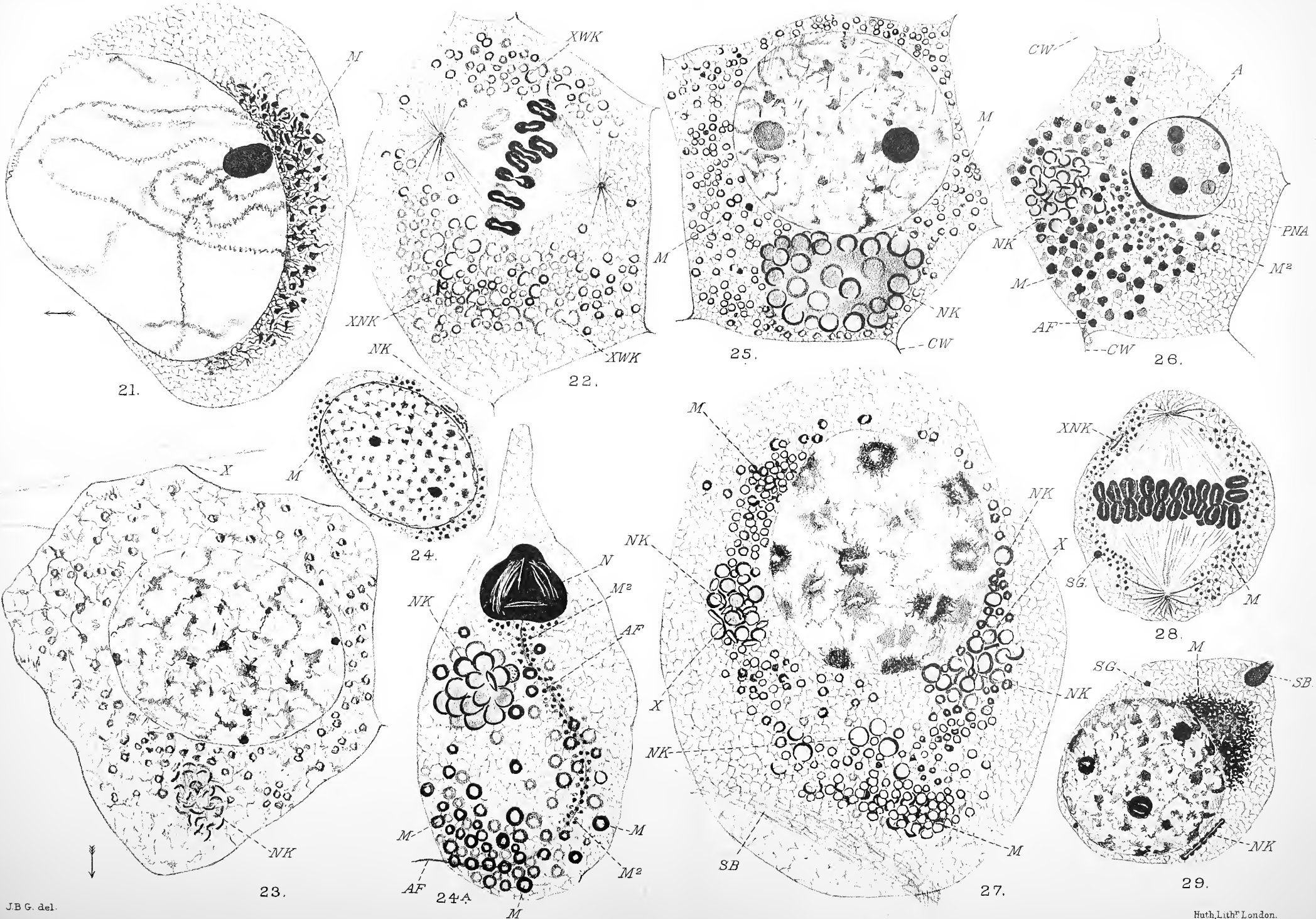

GATENBY — CYTOPLASMIC INCLUSIONS OF THE GERM CELLS.

J.B.G. del.

Huth, Lithr London.

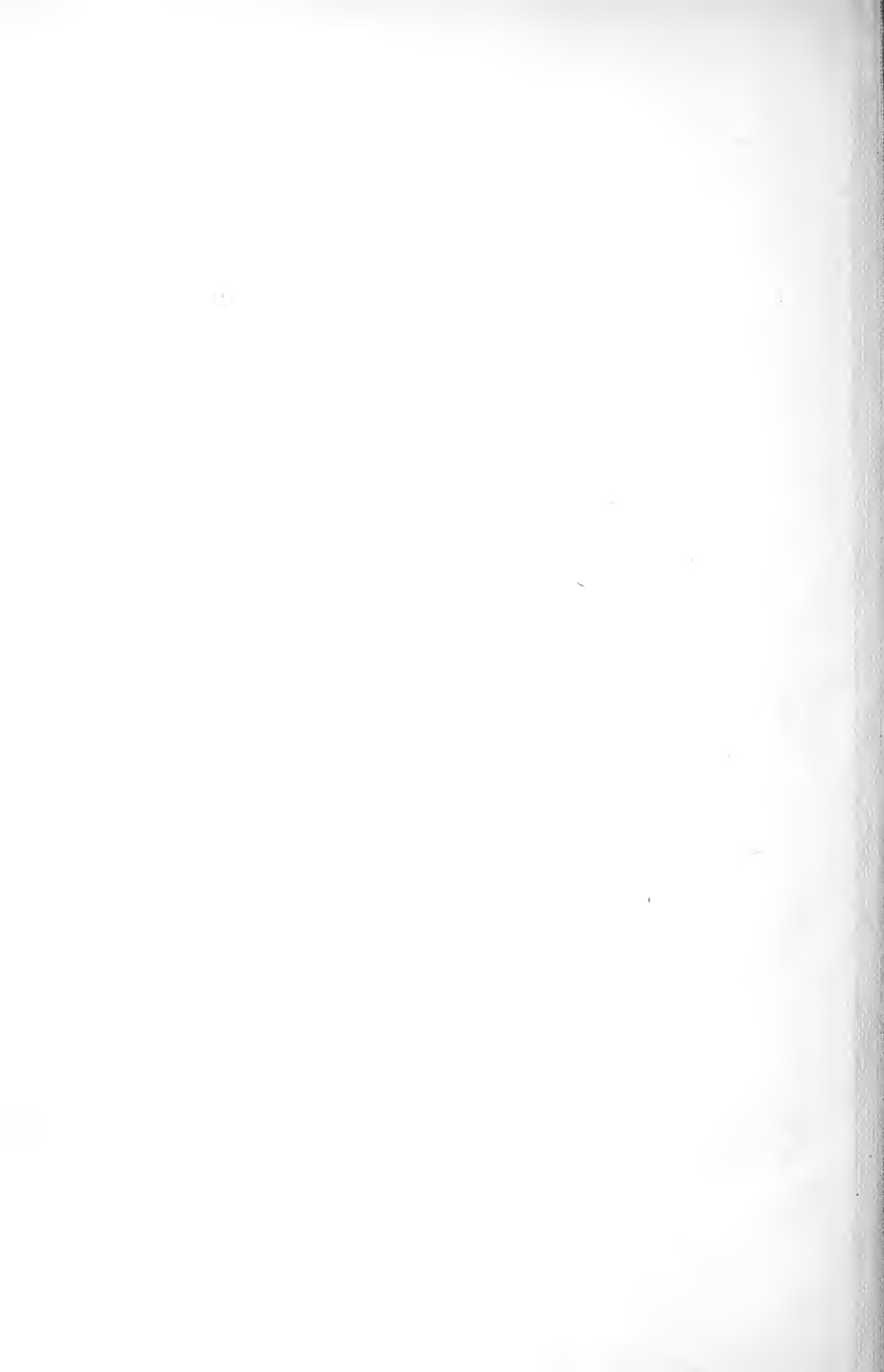

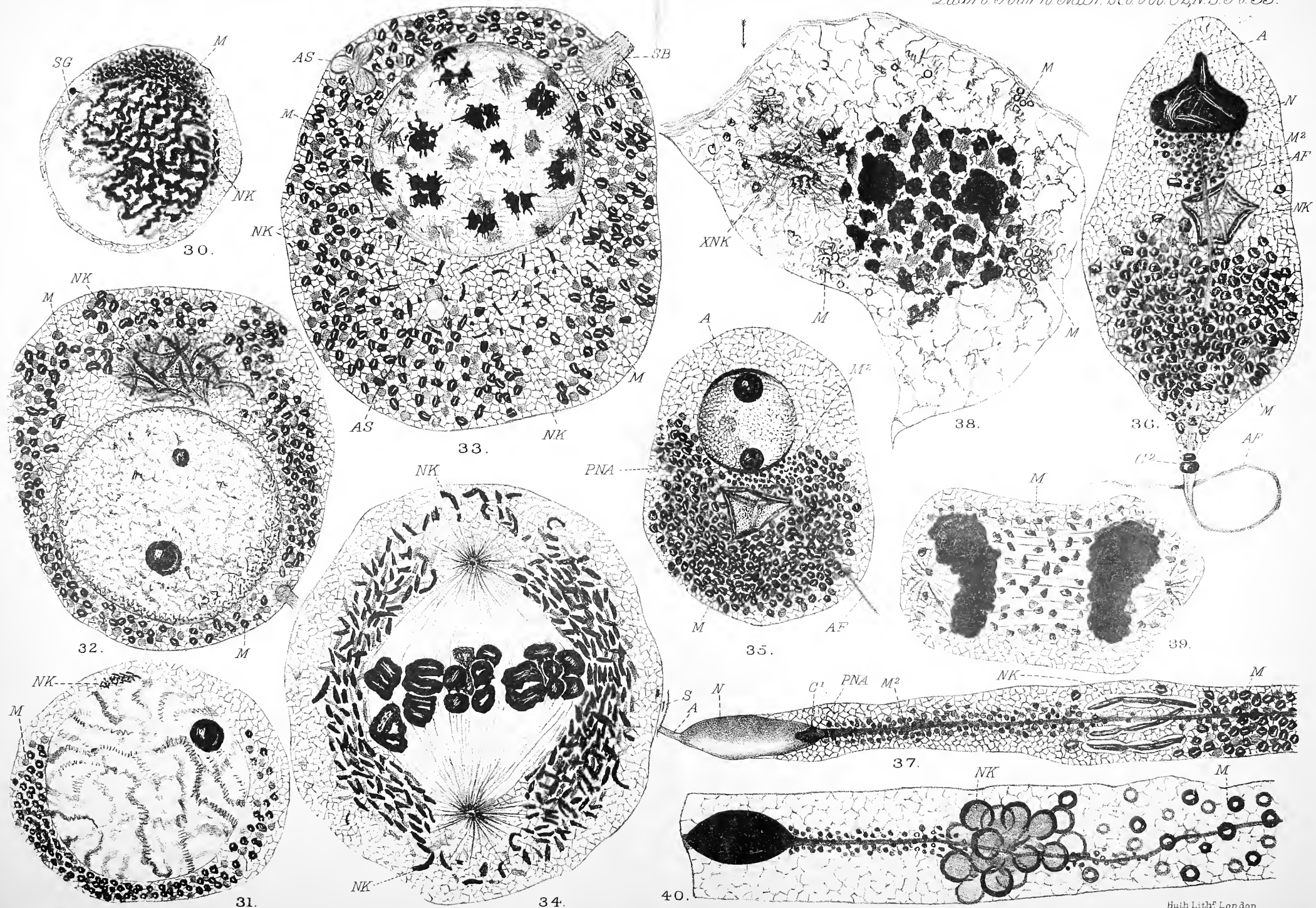

J.B.C. del.

GATENBY - CYTOPLASMIC INCLUSIONS OF THE GERM CELLS.

Huth Lith^r London

1212

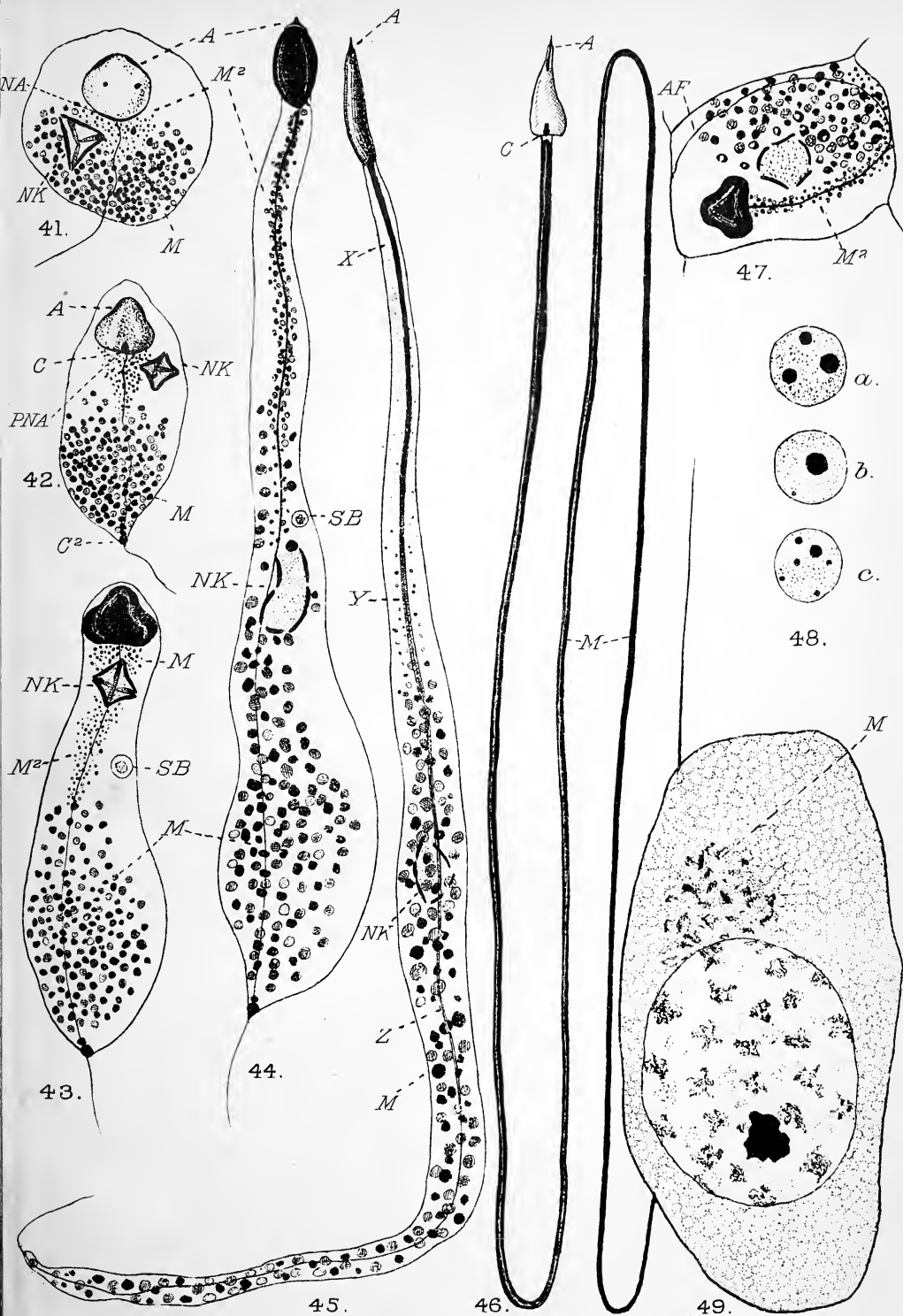

J.B.G. del.

lith, London.

GATENBY — CYTOPLASMIC INCLUSIONS OF THE GERM CELLS.

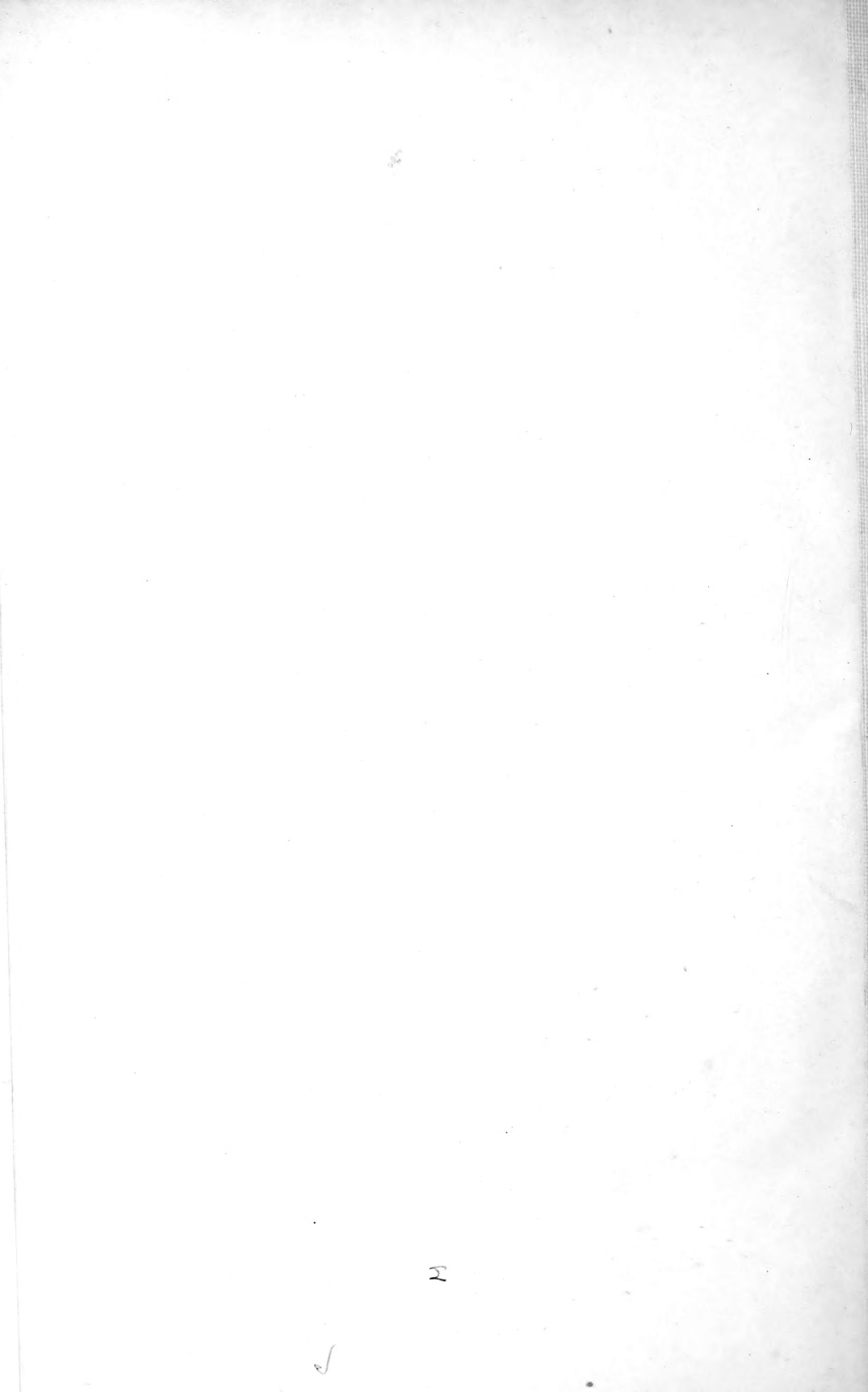



3 2044 128 439 791

Date Due

~~APR 1975~~

