

Cambridge
Physical Series

RADIO-ACTIVITY

*The Dibner Library
of the History of
Science and Technology*

SMITHSONIAN INSTITUTION LIBRARIES

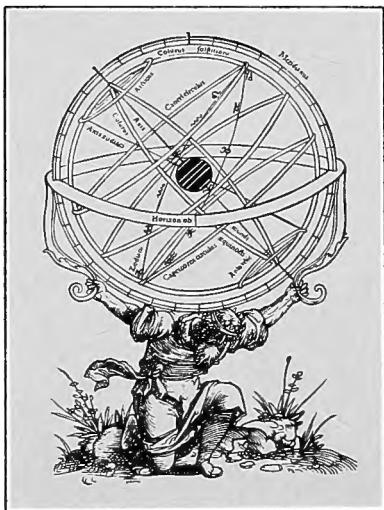

**BURNDY
LIBRARY**

Chartered in 1941

GIFT OF
BERN DIBNER

62

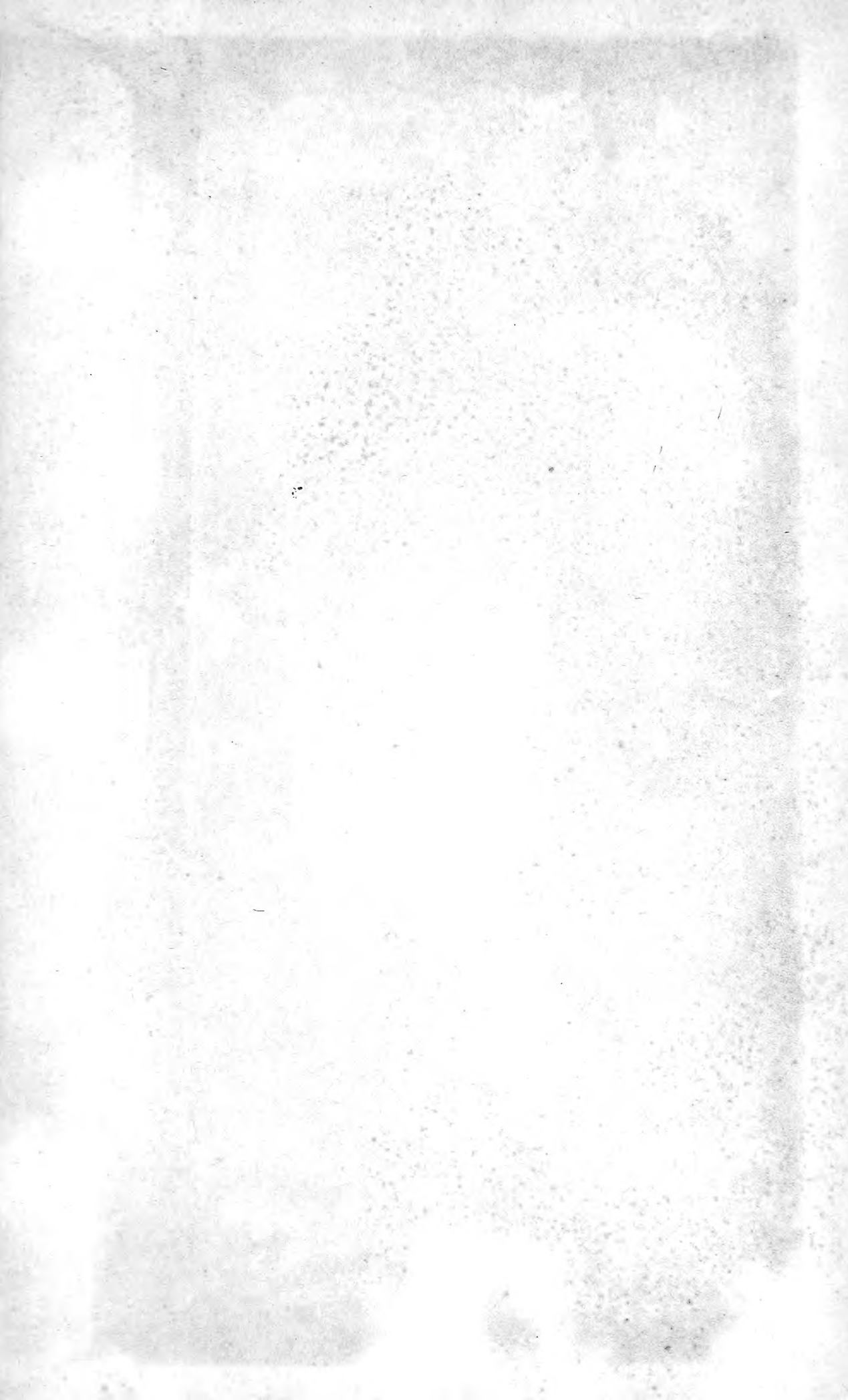

CAMBRIDGE PHYSICAL SERIES.

GENERAL EDITORS:—F. H. NEVILLE, M.A., F.R.S.
AND W. C. D. WHETHAM, M.A., F.R.S.

RADIO-ACTIVITY

London: C. J. CLAY AND SONS,
CAMBRIDGE UNIVERSITY PRESS WAREHOUSE,
AVE MARIA LANE.

AND

H. K. LEWIS,
136, GOWER STREET, W.C.



Glasgow: 50, WELLINGTON STREET.

Leipzig: F. A. BROCKHAUS.

New York: THE MACMILLAN COMPANY.

Bombay and Calcutta: MACMILLAN AND CO., LTD.

[All Rights reserved]

RADIO-ACTIVITY

BY

E. RUTHERFORD, D.Sc., F.R.S., F.R.S.C.

MACDONALD PROFESSOR OF PHYSICS, MCGILL UNIVERSITY, MONTREAL.

CAMBRIDGE
AT THE UNIVERSITY PRESS

1904

Cambridge:

PRINTED BY J. AND C. F. CLAY,
AT THE UNIVERSITY PRESS.

1
2
3
4
5
6
7
8
9
10
11
12
13
14
15
16
17
18
19
20
21
22
23
24
25
26
27
28
29
30
31
32
33
34
35
36
37
38
39
40
41
42
43
44
45
46
47
48
49
50
51
52
53
54
55
56
57
58
59
60
61
62
63
64
65
66
67
68
69
70
71
72
73
74
75
76
77
78
79
80
81
82
83
84
85
86
87
88
89
90
91
92
93
94
95
96
97
98
99
100
101
102
103
104
105
106
107
108
109
110
111
112
113
114
115
116
117
118
119
120
121
122
123
124
125
126
127
128
129
130
131
132
133
134
135
136
137
138
139
140
141
142
143
144
145
146
147
148
149
150
151
152
153
154
155
156
157
158
159
160
161
162
163
164
165
166
167
168
169
170
171
172
173
174
175
176
177
178
179
180
181
182
183
184
185
186
187
188
189
190
191
192
193
194
195
196
197
198
199
200
201
202
203
204
205
206
207
208
209
210
211
212
213
214
215
216
217
218
219
220
221
222
223
224
225
226
227
228
229
230
231
232
233
234
235
236
237
238
239
240
241
242
243
244
245
246
247
248
249
250
251
252
253
254
255
256
257
258
259
260
261
262
263
264
265
266
267
268
269
270
271
272
273
274
275
276
277
278
279
280
281
282
283
284
285
286
287
288
289
290
291
292
293
294
295
296
297
298
299
300
301
302
303
304
305
306
307
308
309
310
311
312
313
314
315
316
317
318
319
320
321
322
323
324
325
326
327
328
329
330
331
332
333
334
335
336
337
338
339
340
341
342
343
344
345
346
347
348
349
350
351
352
353
354
355
356
357
358
359
360
361
362
363
364
365
366
367
368
369
370
371
372
373
374
375
376
377
378
379
380
381
382
383
384
385
386
387
388
389
390
391
392
393
394
395
396
397
398
399
400
401
402
403
404
405
406
407
408
409
410
411
412
413
414
415
416
417
418
419
420
421
422
423
424
425
426
427
428
429
430
431
432
433
434
435
436
437
438
439
440
441
442
443
444
445
446
447
448
449
450
451
452
453
454
455
456
457
458
459
460
461
462
463
464
465
466
467
468
469
470
471
472
473
474
475
476
477
478
479
480
481
482
483
484
485
486
487
488
489
490
491
492
493
494
495
496
497
498
499
500
501
502
503
504
505
506
507
508
509
510
511
512
513
514
515
516
517
518
519
520
521
522
523
524
525
526
527
528
529
530
531
532
533
534
535
536
537
538
539
540
541
542
543
544
545
546
547
548
549
550
551
552
553
554
555
556
557
558
559
560
561
562
563
564
565
566
567
568
569
570
571
572
573
574
575
576
577
578
579
580
581
582
583
584
585
586
587
588
589
590
591
592
593
594
595
596
597
598
599
600
601
602
603
604
605
606
607
608
609
610
611
612
613
614
615
616
617
618
619
620
621
622
623
624
625
626
627
628
629
630
631
632
633
634
635
636
637
638
639
640
641
642
643
644
645
646
647
648
649
650
651
652
653
654
655
656
657
658
659
660
661
662
663
664
665
666
667
668
669
670
671
672
673
674
675
676
677
678
679
680
681
682
683
684
685
686
687
688
689
690
691
692
693
694
695
696
697
698
699
700
701
702
703
704
705
706
707
708
709
710
711
712
713
714
715
716
717
718
719
720
721
722
723
724
725
726
727
728
729
730
731
732
733
734
735
736
737
738
739
740
741
742
743
744
745
746
747
748
749
750
751
752
753
754
755
756
757
758
759
760
761
762
763
764
765
766
767
768
769
770
771
772
773
774
775
776
777
778
779
780
781
782
783
784
785
786
787
788
789
790
791
792
793
794
795
796
797
798
799
800
801
802
803
804
805
806
807
808
809
810
811
812
813
814
815
816
817
818
819
820
821
822
823
824
825
826
827
828
829
830
831
832
833
834
835
836
837
838
839
840
841
842
843
844
845
846
847
848
849
850
851
852
853
854
855
856
857
858
859
860
861
862
863
864
865
866
867
868
869
870
871
872
873
874
875
876
877
878
879
880
881
882
883
884
885
886
887
888
889
890
891
892
893
894
895
896
897
898
899
900
901
902
903
904
905
906
907
908
909
910
911
912
913
914
915
916
917
918
919
920
921
922
923
924
925
926
927
928
929
930
931
932
933
934
935
936
937
938
939
940
941
942
943
944
945
946
947
948
949
950
951
952
953
954
955
956
957
958
959
960
961
962
963
964
965
966
967
968
969
970
971
972
973
974
975
976
977
978
979
980
981
982
983
984
985
986
987
988
989
990
991
992
993
994
995
996
997
998
999
1000

J. J. THOMSON

A TRIBUTE OF MY RESPECT AND ADMIRATION

PREFACE.

IN this work, I have endeavoured to give a complete and connected account, from a physical standpoint, of the properties possessed by the naturally radio-active bodies. Although the subject is comparatively a new one, our knowledge of the properties of the radio-active substances has advanced with great rapidity, and there is now a very large amount of information on the subject scattered throughout the various scientific journals.

The phenomena exhibited by the radio-active bodies are extremely complicated, and some form of theory is essential in order to connect in an intelligible manner the mass of experimental facts that have now been accumulated. I have found the theory that the atoms of the radio-active bodies are undergoing spontaneous disintegration, extremely serviceable not only in correlating the known phenomena, but also in suggesting new lines of research.

The interpretation of the results has, to a large extent, been based on the disintegration theory, and the logical deductions to be drawn from the application of the theory to radio-active phenomena have also been considered.

The rapid advance of our knowledge of radio-activity has been dependent on the information already gained by research into the electric properties of gases. The action possessed by the radiations from radio-active bodies of producing charged carriers or ions in the gas, has formed the basis of an accurate quantitative method of examination of the properties of the radiations and of

radio-active processes, and also allows us to determine with considerable certainty the order of magnitude of the different quantities involved.

For these reasons, it has been thought advisable to give a brief account of the electric properties of gases, to the extent that is necessary for the interpretation of the results of measurements in radio-activity by the electric method. The chapter on the ionization theory of gases was written before the publication of J. J. Thomson's recent book on "Conduction of Electricity through Gases," in which the whole subject is treated in a complete and connected manner.

A short chapter has been added, in which an account is given of the methods of measurement which, in the experience of the writer and others, are most suitable for accurate work in radio-activity. It is hoped that such an account may be of some service to those who may wish to obtain a practical acquaintance with the methods employed in radio-active measurements.

My thanks are due to Mr W. C. Dampier Whetham, F.R.S., one of the editors of the Cambridge Physical Series, for many valuable suggestions, and for the great care and trouble he has taken in revising the proof sheets. I am also much indebted to my wife and Miss H. Brooks for their kind assistance in correcting the proofs, and to Mr R. K. McClung for revising the index.



MACDONALD PHYSICS BUILDINGS,

MONTREAL,

February, 1904.

TABLE OF CONTENTS.

CHAP.	PAGE
I. Radio-active Substances	1
II. Ionization Theory of Gases	28
III. Methods of Measurement	67
IV. Nature of the Radiations	90
V. Rate of Emission of Energy	149
VI. Properties of the Radiations	166
VII. Continuous Production of Radio-active Matter	178
VIII. Radio-active Emanations	197
IX. Excited Radio-activity	250
X. Radio-active Processes	293
XI. Radio-activity of the Atmosphere and of Ordinary Materials	351
. Index	383

Plate (Fig. 33) *to face p. 169*

ABBREVIATIONS OF REFERENCES TO SOME OF THE JOURNALS.

- Ber. d. deutsch. Chem. Ges.* Berichte der deutschen chemischen Gesellschaft. Berlin.
- C. R.* Comptes Rendus des Séances de l'Académie des Sciences. Paris.
- Chem. News.* Chemical News. London.
- Drude's Annal.* Annalen der Physik. Leipzig.
- Phil. Mag.* Philosophical Magazine and Journal of Science. London.
- Phil. Trans.* Philosophical Transactions of the Royal Society of London.
- Phys. Rev.* Physical Review. New York.
- Phys. Zeit.* Physikalische Zeitschrift.
- Proc. Camb. Phil. Soc.* Proceedings of the Cambridge Philosophical Society. Cambridge.
- Proc. Roy. Soc.* Proceedings of the Royal Society of London.
- Thèses-Paris.* Thèses présentées à la Faculté des Sciences de l'Université de Paris.
- Wied. Annal.* Annalen der Physik. Leipzig.

ERRATA.

page 10, line 16; for "chapter IX," read "section 217."

page 274, last line; for "36 minutes," read "21 minutes."

page 326, Radium, Second change, for "36 minutes," read "21 minutes."

CHAPTER I.

RADIO-ACTIVE SUBSTANCES.

1. Introduction. The close of the old and the beginning of the new century have been marked by a very rapid increase of our knowledge of that most important but comparatively little known subject—the connection between electricity and matter. No study has been more fruitful in surprises to the investigator, both from the remarkable nature of the phenomena exhibited and from the laws controlling them. The more the subject has been examined, the more complex does the constitution of matter appear which can give rise to the remarkable effects observed. While the experimental results have led to the view that the constitution of the atom itself is very complex, at the same time they have strongly confirmed the old theory of the discontinuous or atomic structure of matter. The study of the radio-active substances and of the discharge of electricity through gases has supplied very strong experimental evidence in support of the fundamental ideas of the existing atomic theory. It has also indicated that the atom itself is not the smallest unit of matter, but is a complicated structure made up of a number of smaller bodies.

A great impetus to the study of this subject was initially given by the experiments of Lenard on the cathode rays, and by Röntgen's discovery of the X rays. An examination of the conductivity imparted to a gas by the X rays led to a clear view of the mechanism of the transport of electricity through gases by means of charged ions. This ionization theory of gases has been shown to afford a satisfactory explanation not only of the passage of electricity through flames and vapours, but also of the

complicated phenomena observed when a discharge of electricity passes through a vacuum tube. At the same time, a further study of the cathode rays showed that they consisted of a stream of material particles, projected with great velocity, and possessing an apparent mass small compared with that of the hydrogen atom. The connection between the cathode and Röntgen rays and the nature of the latter were also elucidated. Much of this admirable experimental work on the nature of the electric discharge has been done by Professor J. J. Thomson and his students in the Cavendish Laboratory, Cambridge.

An examination of natural substances, in order to see if they gave out dark radiations similar to X rays, led to the discovery of the radio-active bodies which possess the property of spontaneously emitting radiations, invisible to the eye, but readily detected by their action on photographic plates and their power of discharging electrified bodies. A detailed study of the radio-active bodies has led to the discovery of many new and surprising phenomena which have thrown much light, not only on the nature of the radiations themselves, but also on the processes occurring in those substances. Notwithstanding the complex nature of the phenomena, the knowledge of the subject has advanced with great rapidity, and a large amount of experimental data has now been accumulated.

In order to explain the phenomena of radio-activity, a theory has been put forward which regards the atoms of the radio-active elements as suffering spontaneous disintegration, and giving rise to a series of radio-active substances which differ in chemical properties from the parent elements. The radiations accompany the breaking-up of the atoms, and afford a comparative measure of the rate at which the disintegration takes place. This theory is found to account in a satisfactory way for all the known facts of radio-activity, and welds a mass of disconnected facts into one homogeneous whole. On this view, the continuous emission of energy from the active bodies is derived from the internal energy inherent in the atom, and does not in any way contradict the law of the conservation of energy. At the same time, however, it indicates that an enormous store of latent energy is resident in the radio-atoms themselves. This store of energy has previously not been observed, on account of the impossibility of breaking up into

simpler forms the atoms of the elements by the action of the chemical or physical forces at our command.

On this theory we are witnessing in the radio-active bodies a veritable transformation of matter. This process of disintegration was investigated, not by direct chemical methods, but by means of the property possessed by the radio-active bodies of giving out specific types of radiation. Except in the case of a very active element like radium, the process of disintegration takes place so slowly, that hundreds if not thousands of years would be required before the amount transformed would come within the range of detection of the balance or the spectroscope. In radium, however, the process of disintegration takes place at such a rate that it should be possible within a limited space of time to obtain definite chemical evidence on this question. The recent discovery that helium can be obtained from radium adds strong confirmation to the theory; for helium was indicated as a probable disintegration product of the radio-active elements before this experimental evidence was forthcoming. If the production of helium by radium is completely substantiated, the further study of radio-active bodies promises to open up new and important fields of chemical enquiry.

In this book the experimental facts of radio-activity and the connection between them are interpreted on the disintegration theory. Many of the phenomena observed can be investigated in a quantitative manner, and prominence has been given to work of this character, for the agreement of any theory with the facts, which it attempts to explain, must ultimately depend upon the results of accurate measurement.

The value of any working theory depends upon the number of experimental facts it serves to correlate, and upon its power of suggesting new lines of work. In these respects the disintegration theory, whether or not it may ultimately be proved to be correct, has already been justified by its results.

2. Radio-active Substances. The term "radio-active" is now generally applied to a class of substances, such as uranium, thorium, radium, and their compounds, which possess the property of *spontaneously* emitting radiations capable of passing through plates of metal and other substances opaque to ordinary light.

The characteristic property of these radiations, besides their penetrating power, is their action on a photographic plate and their power of discharging electrified bodies. In addition, a strongly radio-active body like radium is able to cause marked phosphorescence and fluorescence on some substances placed near it. In the above respects the radiations possess properties analogous to Röntgen rays, but it will be shown that, for the major part of the radiations emitted, the resemblance is only superficial.

The most remarkable property of the radio-active bodies is their power of spontaneously and continuously radiating energy at a constant rate, without, as far as is known, the action upon them of any external exciting cause. The phenomena at first sight appear to be in direct contradiction to the law of conservation of energy, since no obvious change with time occurs in the radiating material. The phenomena appear still more remarkable when it is considered that the radio-active bodies must have been steadily radiating energy since the time of their formation in the earth's crust.

Immediately after Röntgen's discovery of the production of X rays, several scientists were led to examine if any natural bodies possessed the property of giving out radiations which could penetrate metals and other substances opaque to light. As the production of X rays seemed to be in some way connected with cathode rays, which cause strong fluorescent and phosphorescent effects on various bodies, the substances first examined were those that were phosphorescent when exposed to light. The first observation in this direction was made by Niewenglowski¹, who found that sulphide of calcium exposed to the sun's rays gave out some rays which were able to pass through black paper. A little later a similar result was recorded by H. Becquerel² for a special calcium sulphide preparation, and by Troost³ for a specimen of hexagonal blend. These results were confirmed and extended in a later paper by Arnold⁴. No satisfactory explanations of these somewhat doubtful results have yet been given, except on the view that the black paper was transparent to some of the light

¹ *C. R.* 122, p. 385, 1896.

² *C. R.* 122, p. 559, 1896.

³ *C. R.* 122, p. 564, 1896.

⁴ *Wied. Annal.* 61, p. 316, 1897.

waves. At the same time Le Bon¹ showed that, by the action of sunlight on certain bodies, a radiation was given out, invisible to the eye, but active with regard to a photographic plate. These results have been the subject of much discussion; but there seems to be little doubt that the effects are due to short ultra-violet light waves, capable of passing through certain substances opaque to ordinary light. These effects, while interesting in themselves, are of quite a distinct character from those shown by the radio-active bodies which will now be considered.

3. Uranium. The first important discovery in the subject of radio-activity was made in February, 1896, by M. Henri Becquerel², who found that a uranium salt, the double sulphate of uranium and potassium, emitted some rays which gave an impression on a photographic plate enveloped in black paper. These rays were also able to pass through thin plates of metals and other substances opaque to light. The impressions on the plate could not have been due to vapours given off by the substances, since the same effect was produced whether the salt was placed directly on the black paper or on a thin plate of glass lying upon it.

Becquerel found later that all the compounds of uranium as well as the metal itself possessed the same property, and, although the amount of action varied slightly for the different compounds, the effects in all cases were comparable. It was at first natural to suppose that the emission of these rays was in some way connected with the power of phosphorescence, but later observations showed that there was no connection whatever between them. The uranic salts are phosphorescent, while the uranous salts are not. The uranic salts, when exposed to ultra-violet light in the phosphoroscope, give a phosphorescent light lasting about .01 seconds. When the salts are dissolved in water, the duration is still less. The amount of action on the photographic plate does not depend on the particular compound of uranium employed, but only on the amount of uranium present in the compound. The non-phosphorescent are equally active with the phosphorescent compounds. The amount of radiation given out is unaltered if the active body is kept

¹ *C. R.* 122, pp. 188, 233, 386, 462. 1896.

² *C. R.* 122, pp. 420, 501, 559, 689, 762, 1086. 1896.

continuously in darkness. The rays are given out by solutions, and by crystals which have been deposited from solutions in the dark and never exposed to light. This shows that the radiation cannot be due in any way to the gradual emission of energy stored up in the crystal in consequence of exposure to a source of light.

4. The power of giving out penetrating rays thus seems to be a specific property of the element uranium, since it is exhibited by the metal as well as by all its compounds. These radiations from uranium are persistent, and, as far as observations have yet gone, are unchanged, either in intensity or character, with lapse of time. Observations to test the constancy of the radiations for long periods of time have been made by Becquerel. Samples of uranic and uranous salts have been kept in a double box of thick lead, and the whole has been preserved from exposure to light. By a simple arrangement, a photographic plate can be introduced in a definite position above the uranium salts, which are covered with a layer of black paper. The plate is exposed at intervals for 48 hours, and the impression on the plate compared. No perceptible weakening of the radiation has been observed over a period of four years. Mme Curie¹ has made determinations of the activity of uranium over a space of five years by an electric method described later, but found no appreciable variation during that period.

Since the uranium is thus continuously radiating energy from itself, without any known source of excitation, the question arises whether any known agent is able to affect the rate of its emission. No alteration was observed when the body was exposed to ultra-violet light or to ultra-red light or to X rays. Becquerel states that the double sulphate of uranium and potassium showed a slight increase of action when exposed to the arc light and to sparks, but he considers that the feeble effect observed was another action superimposed on the constant radiation from uranium. The intensity of the uranium radiation is not affected by a variation of temperature between 200° C. and the temperature of liquid air. This question is discussed in more detail later.

5. In addition to these actions on a photographic plate, Becquerel showed that uranium rays, like Röntgen rays, possess the

¹ *Thèse présentée à la Faculté des Sciences de Paris, 1903.*

important property of discharging both positively and negatively electrified bodies. These results were confirmed and extended by Lord Kelvin, Smolan and Beattie¹. The writer made a detailed comparison² of the nature of the discharge produced by uranium with that produced by Röntgen rays, and showed that the discharging property of uranium is due to the production of charged ions by the radiation throughout the volume of the gas. The property has been made the basis of a qualitative and quantitative examination of the radiations from all radio-active bodies, and is discussed in detail in chapter II.

The radiations from uranium are thus analogous, as regards their photographic and electrical actions, to Röntgen rays, but, compared with the rays from an ordinary X ray tube, these actions are extremely feeble. While with Röntgen rays a strong impression is produced on a photographic plate in a few minutes or even seconds, several days' exposure to the uranium rays is required to produce a well-marked action, even though the uranium compound, enveloped in black paper, is placed close to the plate. The discharging action, while very easily measurable by suitable methods, is also small compared with that produced by X rays from an ordinary tube.

6. The rays from uranium show no evidence of direct reflection, refraction, or polarization³. While there is no direct reflection of the rays, there is apparently a diffuse reflection set up where the rays strike a solid obstacle. This is in reality due to a secondary radiation set up when the primary rays impinge upon matter. The presence of this secondary radiation at first gave rise to the erroneous view that the rays could be reflected and refracted like ordinary light. The absence of reflection, refraction, or polarization in the penetrating rays from uranium necessarily follows in the light of our present knowledge of the rays. It is now known that the uranium rays, mainly responsible for the photographic action, are deviable by a magnetic field, and are similar in all respects to cathode rays, *i.e.* the rays are composed

¹ *Nature*, 56, 1897; *Phil. Mag.* 43, p. 418, 1897; 45, p. 277, 1898.

² *Phil. Mag.* Jan. 1899.

³ Rutherford, *Phil. Mag.* Jan. 1899.

of small particles projected at great velocities. The absence of the ordinary properties of transverse light waves is thus to be expected.

7. The rays from uranium are complex in character, and, in addition to the penetrating deviable rays, there is also given off a radiation very readily absorbed by passing through thin layers of metal foil, or by traversing a few centimetres of air. The photographic action due to these rays is very feeble in comparison with that of the penetrating rays, although the discharge of electrified bodies is mainly caused by them. Besides these two types of rays, some rays are emitted which are of an extremely penetrating character and are non-deviable by a magnetic field. These rays are difficult to detect photographically, but can be readily examined by the electric method.

8. The question naturally arose whether the property of spontaneously giving out penetrating radiations was confined to uranium and its compounds, or whether it was exhibited to any appreciable extent by other substances.

By the electrical method, with an electrometer of ordinary sensitiveness, any body which possesses an activity of the order of $1/100$ of that of uranium can be detected. With an electroscope of special construction, such as has been designed by C. T. R. Wilson for his experiments on the natural ionization of air, a substance of activity $1/10000$ and probably $1/100000$ of that of uranium can be detected.

If an active body like uranium be mixed with an inactive body, the resulting activity in the mixture is generally considerably less than that due to the active substance alone. This is due to the absorption of the radiation by the inactive matter present. The amount of decrease largely depends on the thickness of the layer from which the activity is determined.

Mme Curie made a detailed examination by the electrical method of the great majority of known substances, including the very rare elements, to see if they possessed any activity. In cases when it was possible, several compounds of the elements were examined. With the exception of thorium and phosphorus, none of the other substances possessed an activity even of the order of $1/100$ of uranium.

The ionization of the gas by phosphorus does not, however, seem to be due to a penetrating radiation like that found in the case of uranium, but rather to a chemical action taking place at its surface. The compounds of phosphorus do not show any activity, and in this respect differ from uranium and the other active bodies.

Le Bon¹ has also observed that quinine sulphate, if heated and then allowed to cool, possesses for a short time the property of discharging both positively and negatively electrified bodies. It is necessary, however, to draw a sharp line of distinction between phenomena of this kind and those exhibited by the naturally radio-active bodies. While both, under special conditions, possess the property of ionizing the gas, the laws controlling the phenomena are quite distinct in the two cases. For example, only one compound of quinine shows the property, and that compound only when it has been subjected to a preliminary heating. The action of phosphorus depends on the nature of the gas, and varies with temperature. On the other hand, the activity of the naturally radio-active bodies is spontaneous and permanent. It is exhibited by all compounds, and is not, as far as is yet known, altered by change in the chemical or physical conditions.

9. The discharging and photographic action alone cannot be taken as a criterion as to whether a substance is radio-active or not. It is necessary in addition to examine the radiations, and to test whether the actions take place through appreciable thicknesses of all kinds of matter opaque to ordinary light. For example, a body giving out short waves of ultra-violet light can be made to behave in many respects like a radio-active body. As Lenard² has shown, short waves of ultra-violet light will ionize the gas in their path, and will be rapidly absorbed in the gas. They will produce strong photographic action, and may pass through *some* substances opaque to ordinary light. The similarity to a radio-active body is thus fairly complete as regards these properties. On the other hand, the emission of these light waves, unlike that of the radiations from an active body, will depend largely on the molecular state

¹ *C. R.* 130, p. 891, 1900.

² *Drude's Annal.* 1, p. 498; 3, p. 298, 1900.

of the compound, or on temperature and other physical conditions. But the great point of distinction lies in the nature of the radiations from the bodies in question. In one case the radiations behave as transverse waves, obeying the usual laws of light waves, while in the case of a naturally active body, they consist for the most part of a continuous flight of material particles projected from the substance with great velocity. Before any substance can be called "radio-active" in the sense in which the term is used to describe the properties of the natural radio-active elements, it is thus necessary to make a close examination of its radiations; for it is unadvisable to extend the use of the term "radio-active" to substances which do not possess the characteristic radiating properties of the radio-active elements which we have described, and the active products which can be obtained from them. Some of the pseudo-active bodies will however be considered later in chapter IX.

10. Thorium. In the course of an examination of a large number of substances, Schmidt¹ found that thorium, its compounds, and the minerals containing thorium, possessed properties similar to those of uranium. The same discovery was made independently by Mme Curie². The rays from thorium compounds, like those from uranium, possess the properties of discharging electrified bodies and acting on a photographic plate. Under the same conditions the discharging action of the rays is about equal in amount to that of uranium, but the photographic effect is distinctly weaker.

The radiations from thorium are more complicated than those from uranium. It was early observed by several experimenters that the radiation from thorium compounds, especially the oxide, when tested by the electrified method, was very variable and uncertain. A detailed investigation of the radiations from thorium under various conditions was made by Owens³. He showed that thorium oxide, especially in thick layers, was able to produce conductivity in the gas when covered with a large thickness of paper, and that the amount of this conductivity could be greatly

¹ *Wied. Annal.* 65, p. 141, 1898.

² *C. R.* 126, p. 1101, 1898.

³ *Phil. Mag.* Oct. 1899.

varied by blowing a current of air over the gas. In the course of an examination¹ of this action of the air current, the writer showed that thorium compounds gave out a material emanation made up of very small particles *themselves radio-active*. The emanation behaves like a radio-active gas; it diffuses rapidly through porous substances like paper, and is carried away by a current of air. The evidence of the existence of the emanation, and its properties, is considered in detail later in chapter VIII. In addition to giving out an emanation, thorium behaves like uranium in emitting three types of radiation, each of which is similar in properties to the corresponding radiation from uranium.

11. Radio-active minerals. Mme Curie has examined the radio-activity of a large number of minerals containing uranium and thorium. The electrical method was used, and the current measured between two parallel plates 8 cms. in diameter and 3 cms. apart, when one plate was covered with a uniform layer of the active matter. The following numbers give the order of the saturation current obtained in amperes.

	<i>i</i>
Pitchblende from Johanngeorgenstadt	8.3×10^{-11}
„ Joachimstahl ...	7.0 „
„ Pzibran ...	6.5 „
„ Cornwall ...	1.6 „
Clevite ...	1.4 „
Chalcolite ...	5.2 „
Autunite ...	2.7 „
Thorite ... from 0.3 to 1.4	„
Orangite ...	2.0 „
Monazite ...	0.5 „
Xenotime ...	0.03 „
Aeschynite ...	0.7 „
Fergusonite ...	0.4 „
Samarskite ...	1.1 „
Niobite ...	0.3 „
Carnotite ...	6.2 „

Some activity is to be expected in these minerals, since they all contain either thorium or uranium or a mixture of both. An examination of the action of the uranium compounds with the

¹ *Phil. Mag.* Jan. 1900.

same apparatus and under the same conditions led to the following results :

	<i>i</i>
Uranium (containing a little carbon)	2.3×10^{-11} amperes
Black oxide of uranium	2.6 "
Green " " " "	1.8 "
Acid uranic hydrate " "	0.6 "
Uranate of sodium... " "	1.2 "
Uranate of potassium " "	1.2 "
Uranate of ammonia " "	1.3 "
Uranous sulphate " " "	0.7 "
Sulphate of uranium and potassium	0.7 "
Acetate " " " "	0.7 "
Phosphate of copper and uranium	0.9 "
Oxysulphide of uranium " "	1.2 "

The interesting point in connection with these results is that some specimens of pitchblende have four times the activity of the metal uranium; chalcocite, the crystallized phosphate of copper and uranium, is twice as active as uranium; and autunite, a phosphate of calcium and uranium, is as active as uranium. From the previous considerations, none of the substances should have shown as much activity as uranium or thorium. In order to be sure that the large activity was not due to the particular chemical combination, Mme Curie prepared chalcocite artificially, starting with pure products. This artificial chalcocite had the activity to be expected from its composition, viz. about 0.4 of the activity of the uranium. The natural mineral chalcocite is thus five times as active as the artificial mineral.

It thus seemed probable that the large activity of some of these minerals, compared with uranium and thorium, was due to the presence of small quantities of some very active substance, which was different from the known bodies thorium and uranium.

This supposition was completely verified by the work of M. and Mme Curie, who were able to separate from pitchblende by purely chemical methods two active bodies, one of which in the pure state is over a million times more active than the metal uranium.

This important discovery was due entirely to the property of radio-activity possessed by the new bodies. The only guide in their separation was the activity of the products obtained. In

this respect the discovery of these bodies is quite analogous to the discovery of rare elements by the methods of spectrum analysis. The method employed in the separation consisted in examining the relative activity of the products after chemical treatment. In this way it was seen whether the radio-activity was confined to one or another of the products, or divided between both, and in what ratio such division occurred.

The activity of the specimens thus served as a basis of rough qualitative and quantitative analysis, analogous in some respects to the indication of the spectroscope. To obtain comparative data it was necessary to test all the products in the dry state. The chief difficulty lay in the fact that pitchblende is a very complex mineral, and contains in varying quantities nearly all the known metals.

12. Radium. The analysis of pitchblende by chemical methods, using the procedure sketched above, led to the discovery of two very active bodies, polonium and radium. The name polonium was given to the first substance discovered by Mme Curie in honour of the country of her birth. The name radium was a very happy inspiration of the discoverers, for this substance in the pure state possesses the property of radio-activity to an astonishing degree.

Radium is extracted from pitchblende by the same process necessary to separate barium, to which it is very closely allied in chemical properties¹. After the removal of other substances, the radium remains behind mixed with barium. It can, however, be partially separated from the latter by the difference in solubility of the chlorides in water, alcohol, or hydrochloric acid. The chloride of radium is less soluble than that of barium, and can be separated from it by the method of fractional crystallization. After a large number of precipitations the radium can be almost completely freed from the barium.

Both polonium and radium exist in infinitesimal quantities in pitchblende. In order to obtain a few decigrammes of very active radium, it is necessary to use several tons of pitchblende, or the residues obtained from the treatment of uranium minerals. It is

¹ M. and Mme Curie and G. Bemont, *C. R.* 127, p. 1215, 1898.

thus obvious that the expense and labour involved in preparation of a minute quantity of radium are very great.

M. and Mme Curie were indebted for their first working material to the Austrian government, who generously presented them with a ton of the treated residue of uranium materials from the State manufactory of Joachimstahl in Bohemia. With the assistance of the Academy of Sciences and other societies in France, funds were given to carry out the laborious work of separation. Later the Curies were presented with a ton of residues from the treatment of pitchblende by the Société Centrale de Produits Chimiques of Paris. The generous assistance afforded in this important work is a welcome sign of the active interest taken in these countries in the furthering of purely scientific research.

The rough concentration and separation of the residues was performed in the chemical works, and there followed a large amount of labour in purification and concentration. In this manner, the Curies were able to obtain a small quantity of radium which was enormously active compared with uranium. No definite results have yet been given on the activity of pure radium but the Curies estimate that it is about one million times the activity of uranium, and may possibly be still higher. The difficulty of making a numerical estimate for such an intensely active body is very great. In the electric method, the activities are compared by noting the relative strength of the maximum or saturation current between two parallel plates, on one of which the active substance is spread. On account of the intense ionization of the gas between the plates, it is not possible to reach the saturation current unless very high voltages are applied. Approximate comparisons can be made by the use of metal screens to cut down the intensity of the radiations, if the proportion of the radiation transmitted by such a screen has been determined by direct experiment on impure material of easily measurable activity. The value of the activity of radium compared with that of uranium will however vary to some extent according to which of the three types of rays is taken as a basis of comparison.

It is thus difficult to control the final stages of the purification of radium by measurements of its activity alone. Moreover the activity of radium immediately after its preparation is only about one-fourth of its final value; it gradually rises to a maximum after

the radium salt has been kept in the dry state for about a month. For control experiments in purification, it is advisable to measure the initial rather than the final activity.

Mme Curie has utilized the coloration of the crystals of radiferous barium as a means of controlling the final process of purification. The crystals of salts of radium and barium deposited from acid solutions are indistinguishable. The crystals of radiferous barium are at first colourless, but, in the course of a few hours, become yellow, passing to orange and sometimes to a beautiful rose colour. The rapidity of this coloration depends on the amount of barium present. Pure radium crystals do not colour, or at any rate not as rapidly as those containing barium. The coloration is a maximum for a definite proportion of radium, and this fact can be utilized as a means of testing the amount of barium present. When the crystals are dissolved in water the coloration disappears.

Giesel¹ has observed that pure radium bromide gives a beautiful carmine colour to the Bunsen flame. If barium is present in any quantity, only the green colour due to barium is observed and a spectroscopic examination shows only the barium lines. This carmine coloration of the Bunsen flame is a good indication of the purity of the radium.

Since the preliminary announcement of the discovery of radium, Giesel² has devoted a great deal of attention to the separation of radium, polonium and other active bodies from pitchblende. He was indebted for his working material to the firm of P. de Haen of Hanover, who presented him with a ton of pitchblende residues. Using the method of fractional crystallization of the bromide instead of the chloride, he has been able to prepare considerable quantities of pure radium. By this means the labour of final purification of radium has been much reduced. He states that six or eight crystallizations with the bromide are sufficient to almost completely free the radium from the barium.

13. Spectrum of radium. It was of great importance to settle as soon as possible whether radium was in reality modified barium or a new element with a definite spectrum. For this purpose the Curies prepared some specimens of radium chloride,

¹ *Phys. Zeit.* 3, No. 24, p. 578, 1902.

² *Wied. Annal.* 69, p. 91, 1890. *Berichte d. d. chem. Ges.* p. 3608, 1902.

and submitted them for examination of their spectrum to Demarçay, an authority on that subject. The first specimen of radium chloride examined by Demarçay¹ was not very active, but showed, besides the lines due to barium, a very strong new line in the ultra-violet. In another sample of greater activity, the line was still stronger and others also appeared, while the intensity of the new lines was comparable with those present due to barium. With a still more active specimen which was probably nearly pure, only three strong lines of barium appeared, while the new spectrum was very bright. The following table shows the wave-length of the new lines observed for radium. The wave lengths are expressed in Angström units and the intensity of each ray is denoted by a number, the ray of maximum intensity being 16.

Wave length	Intensity	Wave length	Intensity
4826·3	10	4600·3	3
4726·9	5	4533·5	9
4699·6	3	4436·1	6
4692·1	7	4340·6	12
4683·0	14	3814·7	16
4641·9	4	3649·6	12

The lines are all sharply defined, and three or four of them have an intensity comparable with any known lines of other substances. There are also present in the spectrum two strong nebulous bands. In the visible part of the spectrum, which has not been photographed, the only noticeable ray has a wave length 5665, which is, however, very feeble compared with that of wave length 4826·3. The general aspect of the spectrum is similar to that of the alkaline earths; it is known that these metals have strong lines accompanied by nebulous bands.

The principal line due to radium can be distinguished in impure radium of activity 50 times that of uranium. By the electrical method it is easy to distinguish the presence of radium in a body which has an activity only 1/100 of uranium. With a more sensitive electrometer 1/10000 of the activity of uranium could be observed. For the detection of radium, the examination of the radio-activity is thus a process nearly a million times more sensitive than spectrum analysis.

¹ *C. R.* 127, p. 1218, 1898; 129, p. 716, 1899; 131, p. 258, 1900.

Later observations on the spectrum of radium have been made by Runge¹, Exner and Haschek², with specimens of radium prepared by Giesel. It has already been mentioned that the bromide of radium gives a characteristic pure carmine-red coloration to the Bunsen flame. The flame spectrum shows two broad bright bands in the orange-red, not observed in Demarçay's spectrum. In addition there is a line in the blue-green and two feeble lines in the violet.

14. Atomic weight of radium. Mme Curie has made successive determinations of the atomic weight of the new element with specimens of steadily increasing purity. In the first observation the radium was largely mixed with barium, and the atomic weight obtained was the same as that of barium, 137.5. In successive observations with specimens of increasing purity the atomic weights of the mixture were 146 and 175. The final value obtained recently was 225, which may be taken as the atomic weight of radium on the assumption that it is divalent.

In these experiments about 0.1 gram of pure radium chloride has been obtained by successive fractionations. The difficulty involved in preparing a quantity of pure radium chloride large enough to test the atomic weight may be gauged from the fact that only a few centigrams of fairly pure radium, or a few decigrams of less concentrated material, are obtained from treatment of about 2 tons of the mineral from which it is derived.

Runge and Precht³ have examined the spectrum of radium in a magnetic field, and have shown the existence of series analogous to those observed for calcium, barium, and strontium. These series are connected with the atomic weights of the elements in question, and Runge and Precht have calculated by these means that the atomic weight of radium should be 258—a number considerably greater than the number 225 obtained by Mme Curie by means of chemical analysis. Marshall Watts⁴, on the other hand, using another relation between the lines of the spectrum⁵, deduced the value obtained by Mme Curie. Considering that the number found

¹ *Astrophys. Journal*, p. 1, 1900. *Drude's Annal.* No. 10, p. 407, 1903.

² *Sitz. Ak. Wiss. Wien*, July 4, 1901.

³ *Phil. Mag.* April, 1903.

⁴ *Phil. Mag.* July, 1903.

⁵ Runge (*Phil. Mag.* Dec. 1903) has criticised the method of deduction employed by Marshall Watts on the ground that the lines used for comparison in the different spectra were not homologous.

by Mme Curie agrees with that required by the periodic system, it is advisable in the present state of our knowledge to accept the experimental number rather than the one deduced by Runge and Precht from spectroscopic evidence.

There is no doubt that radium is a new element possessing remarkable physical properties. The detection and separation of this substance, existing in such minute proportions in pitchblende, has been due entirely to the characteristic property we are considering, and is the first notable triumph of the study of radioactivity. As we shall see later in chapter VII, the property of radioactivity can be used, not only as a means of chemical research, but also as an extraordinarily delicate method of detecting chemical changes of a very special kind.

15. Radiations from radium. On account of its enormous activity the radiations from radium are very intense: a screen of zinc sulphide, brought near a few centigrams of radium bromide, is lighted up quite brightly in a dark room, while brilliant fluorescence is produced on a screen of platino-barium cyanide. An electroscope brought near is almost instantly discharged, while a photographic plate is immediately affected. At a distance of one metre, a day's exposure to the radium rays would produce a strong impression. The radiations from radium are analogous to those of uranium, and consist of the three types of rays: easily absorbed, penetrating, and very penetrating. Radium also gives rise to an emanation similar to that of thorium, but with a very much slower rate of decay. The radium emanation retains its activity for several weeks, while that of thorium lasts only a few minutes. The emanation obtained from a few centigrams of radium illuminates a screen of zinc sulphide with great brilliancy. The very penetrating rays of radium are able to light up an X ray screen in a dark room, after passage through several centimetres of lead and several inches of iron.

As in the case of uranium or thorium, the photographic action is mainly due to the penetrating or cathodic [rays. The radiographs obtained with radium are very similar to those obtained with X rays, but lack the sharpness and detail of the latter. The rays are unequally absorbed by different kinds of matter, the

absorption varying approximately as the density. In photographs of the hand the bones do not show out as in X ray photographs.

Curie and Laborde have shown that the compounds of radium possess the remarkable property of always keeping their temperature several degrees above the temperature of the surrounding air. Each gram of radium radiates an amount of energy corresponding to 100 gram-calories per hour. This and other properties of radium are discussed in detail in chapters v and vi.

16. Compounds of radium. When first prepared in the solid state, all the salts of radium—the chloride, bromide, acetate, sulphate, and carbonate—are very similar in appearance to the corresponding salts of barium, but in time they gradually become coloured. In chemical properties the salts of radium are practically the same as those of barium, with the exception that the chloride and bromide of radium are less soluble than the corresponding salts of barium. All the salts of radium are naturally phosphorescent. The phosphorescence of impure radium preparations is in some cases very marked.

All the radium salts possess the property of causing rapid colorations of the glass vessel which contains them. For feebly active material the colour is usually violet, for more active material a yellowish-brown, and finally black.

17. Polonium. Polonium was the first of the active substances obtained from pitchblende. It has been investigated in detail by its discoverer Mme Curie¹. The pitchblende was dissolved in acid and sulphuretted hydrogen added. The precipitated sulphides contained an active substance, which, after separation of impurities, was found associated with bismuth. This active substance, which has been named polonium, is so closely allied in chemical properties to bismuth that it has so far been found impossible to effect a complete separation. Partial separation of polonium can be made by successive fractionations based on one of the following modes of procedure :

(1) Sublimation in a vacuum. The active sulphide is more volatile than that of bismuth. It is deposited as a black substance at portions of the tube, where the temperature is between 250°

¹ *C. R.* 127, p. 175, 1898.

and 300° C. In this way polonium of activity 700 times that of uranium was obtained.

(2) Precipitation of nitric acid solutions by water. The precipitated sub-nitrate is much more active than the part that remains in solution.

(3) Precipitation by sulphuretted hydrogen in a very acid hydrochloric acid solution. The precipitated sulphides are much more active than the salt which remains in solution.

For concentration of the active substance Mme Curie¹ has made use of method (2). The process is, however, very slow and tedious, and is made still more complicated by the tendency to form precipitates insoluble either in strong or weak acids. After a large number of fractionations, a small quantity of matter was obtained, enormously active compared with uranium. On examination of the substance spectroscopically, only the bismuth lines were observed. A spectroscopic examination of the active bismuth by Demarçay and by Runge and Exner has led to the discovery of no new lines. On the other hand Sir William Crookes² states that he found one new line in the ultra-violet, while Berndt³, working with polonium of activity 300, observed a large number of new lines in the ultra-violet. These results await further confirmation.

The polonium prepared by Mme Curie differs from the other radio-active bodies in several particulars. In the first place the radiations include only very easily absorbable rays. The two penetrating types of radiation given out by uranium, thorium, and radium are absent. In the second place the activity does not remain constant, but diminishes continuously with the time. Mme Curie found that the polonium lost half its original activity in the course of eleven months.

18. The decay of the activity of polonium with time has led to the view that polonium is not a new active substance, but merely active bismuth, *i.e.* bismuth which in some way had been made active by admixture with radio-active bodies.

The activity of any product is not necessarily a proof that a radio-element is present, for it has been shown that many inactive elements become active by association with active matter.

¹ *Thèses*, Paris, 1903.

² *Proc. Roy. Soc.* May, 1900.

³ *Phys. Zeit.* 2, p. 180, 1900.

The activity of these substances, when removed from the active element, is however only transient, and decays gradually with the time. This activity is not due to the presence of the radio-element itself. For example, barium separated from radium is strongly active, although the spectroscopic examination shows no trace of the radium lines.

In order to explain this temporary activity in inactive matter it has been supposed that the non-active matter is made active by "induction" during its mixture with the active material. The underlying idea has been that inactive bodies themselves acquire the property of radio-activity. There is no evidence however that such is the case. The evidence rather points to the conclusion that the activity is due, not to any alteration of the inactive body itself, but to an admixture with it of a very small quantity of intensely active matter. The active matter that causes this so-called "induced" activity is itself a product of the disintegration of the radio-element and differs from it in chemical properties.

The subject is a complicated one, and it cannot be discussed with advantage at this stage; it will, however, be considered in detail in section 187. On the above view the active bismuth contains a small quantity of matter, which weight for weight is probably far more active than radium, but the activity of which decays with time. The active matter is allied in chemical properties to bismuth, but possesses some distinct analytical properties which allow of a partial separation. The absence of any new lines in the spectrum is to be expected if, even in the most active bismuth prepared, the active matter exists in very small quantity.

19. The discussion of the nature of polonium was renewed by the discovery of Marckwald¹ that a substance similar to polonium, of which the activity did not decay with time, could be separated from pitchblende. The method of separation from the bismuth chloride solution obtained from uranium residues was very simple. A rod of bismuth, dipped in the active solution, rapidly became coated with a black deposit, which was intensely active. This deposit was continued until the whole of the activity was removed from the solution. From 850 grammes of bismuth solution,

¹ *Ber. deutsch. chem. Ges.*, p. 2285, 1902; *Phys. Zeit.*, No. 1 b, p. 51, 1902.

0.6 gramme of active substance was obtained in this way. The activity of the matter obtained did not decay appreciably during nine months. A full chemical examination of this active matter has not yet been made, but Marckwald considers that the substance is more allied in chemical properties to tellurium than to bismuth.

The radiations from Marckwald's substance are similar to those of polonium, for no penetrating rays are present. The radiations are very intense. They have a marked photographic action, and cause many substances, like zinc oxide and the diamond, to phosphoresce brightly. The strong luminosity of the diamond under these rays can be utilized to distinguish the diamond from imitations, for glass is only slightly phosphorescent in comparison.

The identity of Marckwald's preparation with the polonium of the Curies has not yet been settled, but from the method of production and the nature of the radiations, there can be little doubt that the two substances probably contain the same active constituent. Marckwald, on the other hand, states that his preparations have preserved their activity unchanged, while the polonium of the Curies undoubtedly loses its activity in the course of a few years.

If Marckwald's preparation retains its activity unchanged for a long period, it is strong evidence in support of the presence of a new radio-element. If the activity decays, the radio-tellurium probably consists of the admixture with the tellurium of a small quantity of active matter, produced from one of the radio-elements present in pitchblende. A possible origin of polonium is discussed in section 188.

20. Other products from radio-active minerals. Besides the very active substances radium and possibly polonium, it seems extremely probable that other radio-active elements of great activity exist in minute quantity in the radio-active minerals. Although many active products have been obtained by treatment of uranium residues from pitchblende and other minerals rich in uranium and thorium, none of these products have so far been sufficiently purified to obtain a definite spectrum as in the case of radium.

Actinium. Debierne¹ has obtained from pitchblende a very active substance which he named actinium. This active substance

¹ *C. R.* 129, p. 593, 1899; 130, p. 906, 1900.

is precipitated with the iron group, and appears to be very closely allied in chemical properties to thorium, though it is many thousand times more active. It is very difficult to separate from thorium and the rare earths. Debierne has made use of the following methods for partial separation :

(1) Precipitation in hot solutions, slightly acidulated with hydrochloric acid, by excess of hyposulphite of soda. The active matter is present almost entirely in the precipitate.

(2) Action of hydrofluoric acid upon the hydrates freshly precipitated, and held in suspension in water. The portion dissolved is only slightly active. By this method titanium may be separated.

(3) Precipitation of neutral nitrate solutions by oxygenated water. The precipitate carries down the active body.

(4) Precipitation of insoluble sulphates. If barium sulphate, for example, is precipitated in the solution containing the active body, the barium carries down the active matter. The thorium and actinium are freed from the barium by conversion of the sulphate into the chloride and precipitation by ammonia.

In this way Debierne has obtained a substance comparable in activity with radium. The separation, which is difficult and laborious, has so far not been carried far enough to bring out any new lines in the spectrum. Actinium gives out easily absorbed and penetrating deviable rays like those of radium, and also a radio-active emanation¹, which is more allied to the emanation of thorium than to that of radium. The emanation has a distinctive rate of decay; it loses its activity in the course of a few seconds, while the thorium emanation loses half its activity in one minute. The distinctive character of the radiations and emanations, together with the permanence of the activity, make it very probable that actinium will prove to be a new element of very great activity.

21. Giesel² also has obtained from pitchblende a radio-active substance which in many respects is similar to the actinium of Debierne. The active substance belongs to the group of cerium

¹ *C. R.* 136, p. 446, 1903.

² *Ber. deutsch. chem. Ges.* p. 3608, 1902; p. 342, 1903.

earths, and is precipitated with them. The method of preparation of this material is the same as that employed for the separation of the rare earths. This substance is similar in radio-active behaviour to thorium, but intensely active in comparison. From the method of separation, thorium itself cannot be present except in minute quantity.

The substance gives out easily absorbed and penetrating rays and also an emanation. On account of the intensity of the emanation which it emits, Giesel has termed this active material the "emanating substance."

If a piece of paper is placed in a small closed vessel containing the active material, in a short time the paper itself becomes powerfully active. This is especially the case if it is moistened with water. The emanation lights up a zinc sulphide screen. An electric field has a marked action on the luminosity of the screen. The action is discussed in more detail in section 186.

Giesel found that the activity of the material seemed to increase slightly during the six months' interval after separation. In this respect it is similar to radium compounds, of which the activity increases for a time after separation.

Both the method of preparation and also the radiating properties of this "emanating substance" indicate that it is the same as the actinium of Debierne. Neither of these active substances has been studied in the same detail as uranium, thorium, or radium, and further comparative data on the nature of the radiations and emanations are necessary before any definite conclusion can be reached. The distinctive character of the radiations and emanations is of far more value in establishing the dissimilarity of two active bodies than differences in their chemical behaviour. This is especially the case where the active substance is present only in small quantity in inactive material.

22. The similarity of the chemical properties of actinium and thorium has led to the suggestion at different times that the activity of thorium is not due to thorium itself but to the presence of a slight trace of actinium. In view of the difference in the rate of decay of activity of the emanations of thorium and actinium, this position is not tenable. If the activity of thorium were due

to actinium, the two emanations should have identical rates of decay.

Baskerville¹, working with thorium minerals, was able to obtain thorium less active to the photographic plate than ordinary thorium. He put forward the view that thorium was a mixture of two elements, one of which was active and the other inactive. These results were probably due to the separation of the active product Th. X from the thorium (see section 119). This process would temporarily greatly reduce the activity as tested by the photographic method.

Until thorium is obtained permanently free from activity, the question whether the radio-activity is due to a small trace of very active matter, or to the thorium itself, must remain in doubt². The fact that ordinary commercial thorium and the purest chemical preparation show equal activity supports the view that the effect is not due to a radio-active impurity, but to the element itself. If the activity of thorium is due to a small trace of active matter, this active substance is certainly not radium or actinium or any other known material.

Hofmann and Zerban³ obtained a substance from pitchblende similar in radio-active properties to thorium. The activity of this product did not diminish much in four months' interval. The substance was probably the same as Debierne's actinium. They also examined the thorium minerals broggerite and cleveite, but obtained only some active residues the activity of which decreased rapidly with the time.

23. Radio-active lead. Elster and Geitel⁴ found that lead sulphate obtained from pitchblende was very active. They considered that the activity was due to admixture with radium, and by suitable treatment the lead sulphate was obtained in an inactive state.

¹ *Jour. Amer. Chem. Soc.* 23, p. 761, 1901.

² In a recent paper (*Ber. deutsch. chem. Ges.* p. 3093, 1903) Hofmann and Zerban state that they have obtained a preparation of thorium from gadolinite which was almost inactive when tested by the electric method and conclude that pure thorium is not radio-active.

³ *Ber. deutsch. chem. Ges.* p. 531, 1902.

⁴ *Wied. Annal.* 69, p. 83, 1899.

Hofmann and Strauss¹ found that lead sulphate obtained from pitchblende was active. This was not due to admixture with either uranium or radium or polonium. They gave the name of radio-active lead to the substance. This radio-active lead, in most of its reactions, resembled ordinary lead, but showed differences in the behaviour of the sulphide and the sulphate. The sulphate was very strongly phosphorescent. This sulphate apparently lost its activity with time, but recovered it in a few minutes after exposure to cathode rays in a vacuum tube.

Giesel² also was able to obtain radio-active lead, but found that the activity diminished with time, while Hofmann states that his preparations preserve their activity. It thus appears probable that radio-active lead is either one of the numerous examples of substances made active for the time by solution with radio-elements, or lead with a slight admixture of a radio-element. The peculiar action of the cathode rays in causing an increase of the photographic and electric action of radio-lead sulphate has apparently nothing whatever to do with the activity proper of the substance, but seems to be an additional effect due to the strong phosphorescence set up. The sulphide does not show any such action. The phosphorescent light probably includes some short ultra-violet light waves which are capable of ionizing the gas.

24. If elements heavier than uranium exist, it is probable that they will be radio-active. The extreme delicacy of radio-activity as a means of chemical analysis would enable such elements to be recognized even if present in infinitesimal quantities. It is probable that considerably more than the three or four radio-elements at present recognized exist in minute quantity, and that the number at present known will be augmented in the future. In the first stage of the search, a purely chemical examination is of little value, for it is not probable that the new element should exist in sufficient quantity to be detected by chemical or spectroscopic analysis. The main criteria of importance are the existence or absence of distinctive radiations or emanations, and the permanence of the radio-activity. The presence of a radio-active emanation

¹ *Ber. deutsch. chem. Ges.* p. 3035, 1901.

² *Ber. deutsch. chem. Ges.* p. 3775, 1901.

with a rate of decay different from those already known would afford strong evidence that a new radio-active body was present. The presence of either thorium or radium in matter can very readily be detected by observing the rate of decay of the emanations given out by them. When once the presence of a new radio-element has been inferred by an examination of its radio-active properties, chemical methods of separation can be devised, the radiating or emanating property being used as a guide in qualitative and quantitative analysis.

CHAPTER II.

IONIZATION THEORY OF GASES.

25. Ionization of gases by radiation. The most important property possessed by the radiations from radio-active bodies is their power of discharging bodies whether positively or negatively electrified. As this property has been made the basis of a method for an accurate quantitative analysis and comparison of the radiations, the variation of the rate of discharge under different conditions and the processes underlying it will be considered in some detail.

In order to explain the similar discharging power of Röntgen rays, the theory¹ has been put forward that the rays produce positively and negatively charged carriers throughout the volume of the gas surrounding the charged body, and that the rate of production is proportional to the intensity of the radiation. These carriers, or ions² as they have been termed, move with a uniform velocity through the gas under a constant electric field, and their velocity varies directly as the strength of the field.

Suppose we have a gas between two metal plates *A* and *B* (Fig. 1) exposed to the radiation, and that the plates are kept at a constant difference of potential. A definite number of ions will be produced per second by the radiation, and the number

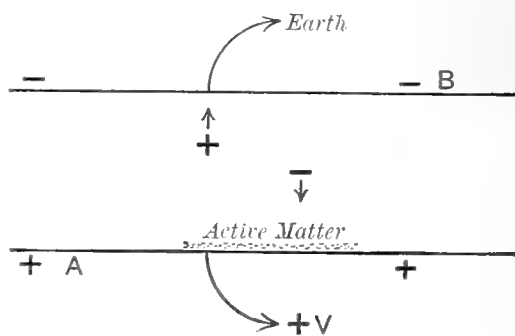

Fig. 1.

¹ J. J. Thomson and Rutherford, *Phil. Mag.* Nov. 1896.

² The word ion has now been generally adopted in the literature of the subject. In the use of this word no assumption is made that the ions in gases are the same as the corresponding ions in the electrolysis of solutions.

produced will in general depend upon the nature and pressure of the gas. In the electric field the positive ions travel towards the negative plate, and the negative ions towards the other plate, and consequently a current will pass through the gas. Some of the ions will also recombine, the rate of recombination being proportional to the square of the number present. For a given intensity of radiation, the current passing through the gas will increase at first with the potential difference between the plates, but it will finally reach a maximum when all the ions are removed by the electric field before any recombination occurs.

This theory accounts also for all the characteristic properties of gases made conducting by the rays from active substances, though there are certain differences observed between the conductivity phenomena produced by active substances and by X rays. These differences are for the most part the result of unequal absorption of the two types of rays. Unlike Röntgen rays a large proportion of the radiation from active bodies consists of rays which are absorbed in their passage through a few centimetres of air. The ionization of the gas is thus not uniform, but falls off rapidly with increase of distance from the active substance.

26. Variation of the current with voltage. Suppose that a layer of radio-active matter is spread uniformly on the lower of two horizontal plates *A* and *B* (Fig. 1). The lower plate *A* is connected with one pole of a battery of cells the other pole of which is connected with earth. The plate *B* is connected with one pair of quadrants of an electrometer, the other pair being connected with earth.

The current¹ between the plates, determined by the rate of movement of the electrometer needle, is observed at first to increase rapidly with the voltage, then more slowly, finally reaching a value which increases very slightly with a large increase in the voltage. This, as we have indicated, is simply explained on the ionization theory.

The radiation produces ions at a constant rate, and, before the electric field is applied, the number per unit volume increases

¹ A minute current is observed between the plates even if no radio-active matter is present. This has been found to be due mainly to a slight natural radio-activity of the matter composing them. (See sections 218—220.)

until the rate of production of fresh ions is exactly balanced by the recombination of the ions already produced. On application of a small electric field, the positive ions travel to the negative electrode and the negative to the positive.

Since the velocity of the ions between the plates is directly proportional to the strength of the electric field, in a weak field the ions take so long to travel between the electrodes that most of them recombine on the way.

The current observed is consequently small. With increase of the voltage there is an increase of speed of the ions and a smaller number recombine. The current consequently increases, and will reach a maximum value when the electric field is sufficiently strong to remove all the ions before appreciable recombination has occurred. The value of the current will then remain constant even though the voltage is largely increased.

This maximum current will be called the "saturation¹" current, and the value of the potential difference required to give this maximum current, the "saturation P.D."

The general shape of the current-voltage curve is shown in Fig. 2, where the ordinates represent current and the abscissae volts.

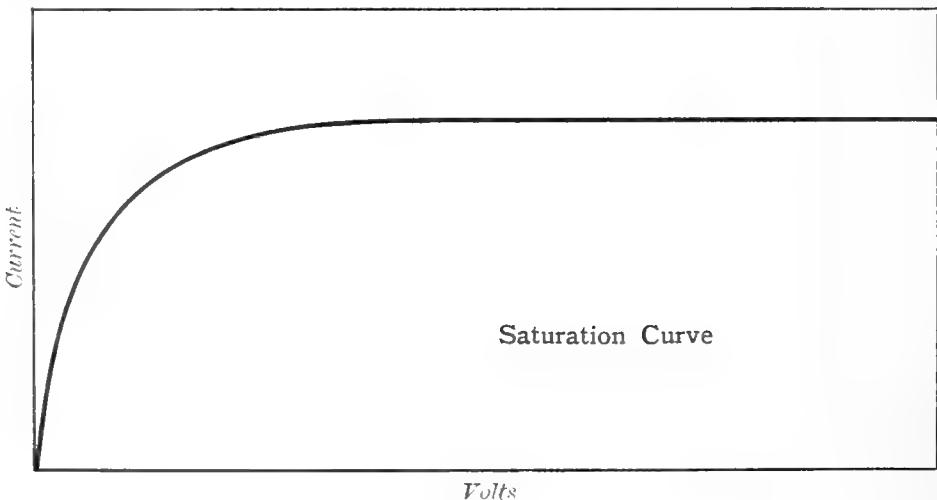

Fig. 2.

¹ This nomenclature has arisen from the similarity of the shape of the current-voltage curves to the magnetization curves for iron. Since, on the ionization theory, the maximum current is a result of the *removal* of all the ions from the gas, before recombination occurs, the terms are not very suitable. They have however now come into general use and will be retained throughout this work.

Although the variation of the current with voltage depends only on the velocity of the ions and their rate of recombination, the full mathematical analysis is intricate, and the equations, expressing the relation between current and voltage, are only integrable for the case of uniform ionization. The question is complicated by the inequality in the velocity of the ions and by the disturbance of the potential gradient between the plates by the movement of the ions. J. J. Thomson¹ has worked out the case for uniform production of ions between two parallel plates, and has found that the relation between the current i and the potential difference V applied is expressed by

$$Ai^2 + Bi = V$$

where A and B are constants for a definite intensity of radiation and a definite distance between the plates.

In certain cases of unsymmetrical ionization, which arise in the study of the radiations from active bodies, the relation between current and voltage is very different from that expressed by

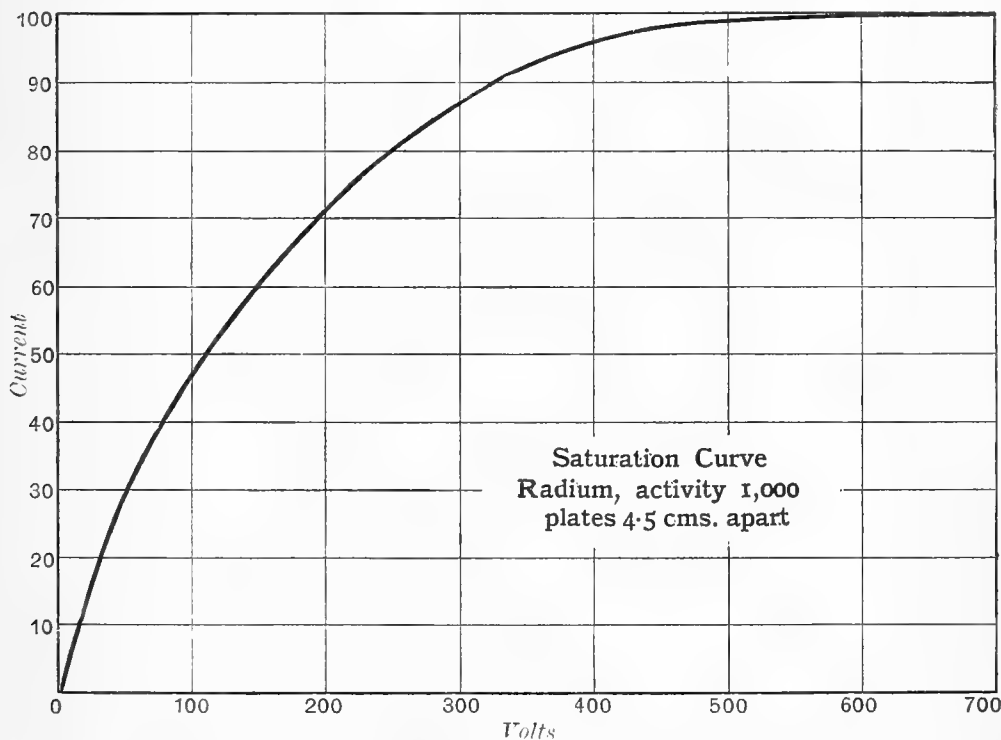

Fig. 3.

¹ *Phil. Mag.* 47, p. 253, 1899. J. J. Thomson, *Conduction of Electricity through Gases*, p. 73, 1903.

the above equation. Some of these cases will be considered in section 47.

27. The general shape of the current-voltage curves for gases exposed to the radiations from active bodies is shown in Fig. 3.

This curve was obtained for .45 grams of impure radium chloride, of activity 1000 times that of uranium, spread over an area of 33 sq. cms. on the lower of two large parallel plates, 4.5 cms. apart. The maximum value of the current observed, which is taken as 100, was 1.2×10^{-8} amperes, the current for low voltages was nearly proportional to the voltage, and about 600 volts between the plates was required to ensure approximate saturation.

In dealing with slightly active bodies like uranium or thorium, approximate saturation is obtained for much lower voltages. Tables I. and II. show the results for the current between two parallel plates distant 0.5 cms. and 2.5 cms. apart respectively, when one plate was covered with a thin uniform layer of uranium oxide.

TABLE I.

0.5 cms. apart	
Volts	Current
.125	18
.25	36
.5	55
1	67
2	72
4	79
8	85
16	88
100	94
335	100

TABLE II.

2.5 cms. apart	
Volts	Current
.5	7.3
1	14
2	27
4	47
8	64
16	73
37.5	81
112	90
375	97
800	100

The results are shown graphically in Fig. 4.

From the above tables it is seen that the current at first increases nearly in proportion to the voltage. There is no evidence of complete saturation, although the current increases very slowly for large increases of voltage. For example, in Table I. a change of voltage from .125 to .25 volts increases the current from 18 to 36% of the maximum, while a change of voltage from 100 to 335 volts increases the current only 6%. The variation of the current per volt (assumed uniform between the range of voltages considered) is thus about 5000 times greater for the former change.

Taking into consideration the early part of the curves, the current does not reach a practical maximum as soon as would be expected on the simple ionization theory. It seems probable that

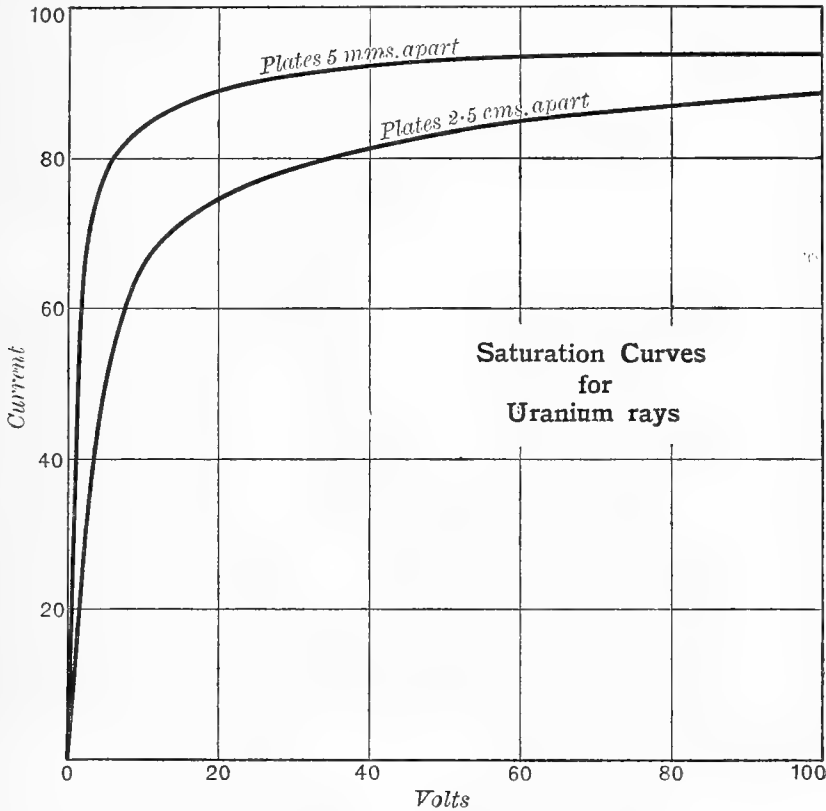

Fig. 4.

the slow increase with the large voltages is due either to an action of the electric field on the rate of production of ions, or to the difficulty of removing the ions produced near the surface of the uranium before recombination. It is possible that the presence of a strong electric field may assist in the separation of ions which otherwise would not initially escape from the sphere of one another's attraction. From the data obtained by Townsend for the conditions of production of fresh ions at low pressures by the movement of ions through the gas, it seems that the increase of current cannot be ascribed to an action of the moving ions in the further ionization of the gas.

28. The equation expressing the relation between the current and the voltage is very complicated even in the case of a uniform rate of production of ions between the plates. An approximate

theory, which is of utility in interpreting the experimental results, can however be simply deduced if the disturbance of the potential gradient is disregarded, and the ionization assumed uniform between the plates.

Suppose that the ions are produced at a constant rate q per cubic centimetre per second in the gas between parallel plates distant l cms. from each other. When no electric field is applied, the number N present per c.c., when there is equilibrium between the rates of production and recombination, is given by $q = \alpha N^2$, where α is a constant.

If a small potential difference V is applied, which gives only a small fraction of the maximum current, and consequently has not much effect on the value of N , the current i per sq. cm. of the plate, is given by

$$i = \frac{NeuV}{l},$$

where u is the sum of the velocity of the ions for unit potential gradient, and e is the charge carried by an ion. $\frac{uV}{l}$ is the velocity of the ions in the electric field of strength $\frac{V}{l}$.

The number of ions produced per second in a prism of length l and unit area of cross-section is ql . The maximum or saturation current I per sq. cm. of the plate is obtained when all of these ions are removed to the electrodes before any recombination has occurred.

Thus
$$I = q \cdot l \cdot e,$$

and

$$\frac{i}{I} = \frac{NuV}{ql^2} = \frac{uV}{l^2 \sqrt{q\alpha}}.$$

This equation expresses the fact previously noted that, for small voltages, the current i is proportional to V .

Let

$$\frac{i}{I} = \rho,$$

then

$$V = \frac{\rho \cdot l^2 \sqrt{q\alpha}}{u}.$$

Now the greater the value of V required to obtain a given value of ρ (supposed small compared with unity), the greater the potential required to produce saturation.

It thus follows from the equation that:

(1) For a given intensity of radiation, the saturation P.D. increases with the distance between the plates. In the equation, for small values of ρ , V varies as l^2 . This is found to be the case for uniform ionization, but it only holds approximately for non-uniform ionization.

(2) For a given distance between the plates, the saturation P.D. is greater, the greater the intensity of ionization between the plates. This is found to be the case for the ionization produced by radio-active substances. With a very active substance like radium, the ionization produced is so intense that very large voltages are required to produce approximate saturation. On the other hand, only a fraction of a volt per cm. is necessary to produce saturation in a gas where the ionization is very slight, for example, in the case of the natural ionization observed in a closed vessel, where no radio-active substances are present.

For a given intensity of radiation, the saturation P.D. decreases rapidly with the lowering of the pressure of the gas. This is due to two causes operating in the same direction, viz. a decrease in the intensity of the ionization and an increase in the velocity of the ions. The ionization varies directly as the pressure, while the velocity varies inversely as the pressure. This will obviously have the effect of causing more rapid saturation, since the rate of recombination is slower and the time taken for the ions to travel between the electrodes is less.

The saturation curves observed for the gases hydrogen and carbon dioxide¹ are very similar in shape to those obtained for air. For a given intensity of radiation, saturation is more readily obtained in hydrogen than in air, since the ionization is less than in air while the velocity of the ions is greater. Carbon dioxide on the other hand requires a greater P.D. to produce saturation than does air, since the ionization is more intense and the velocity of the ions less than in air.

¹ Rutherford, *Phil. Mag.* Jan. 1899.

29. Townsend¹ has shown that, for low pressures, the variation of the current with the voltage is very different from that observed at atmospheric pressure. If the increase of current with the voltage is determined for gases, exposed to Röntgen rays, at a pressure of about 1 mm. of mercury, it is found that for small voltages the ordinary saturation curve is obtained; but when the voltage applied increases beyond a certain value, depending on the pressure and nature of the gas and the distance between the electrodes, the current commences to increase slowly at first but very rapidly as the voltage is raised to the sparking value. The general shape of the current curve is shown in Fig. 5.

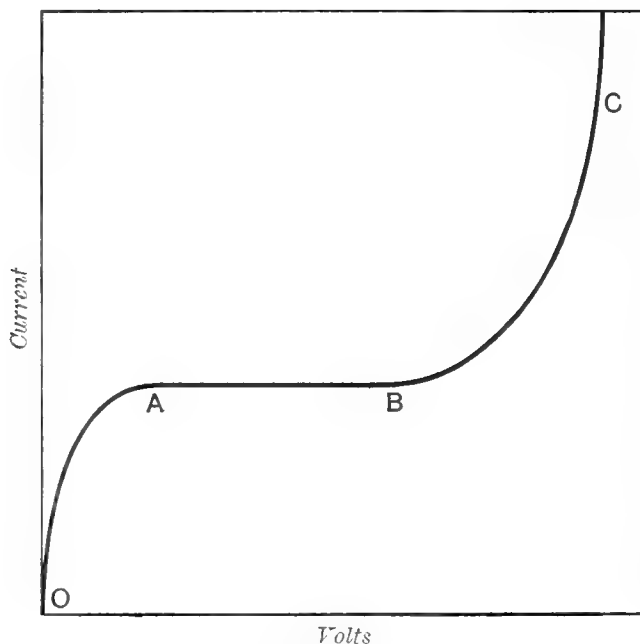

Fig. 5.

The portion OAB of the curve corresponds to the ordinary saturation curve. At the point B the current commences to increase. This increase of current has been shown to be due to the action of the negative ions at low pressures in producing fresh ions by collision with the molecules in their path. The increase of current is not observed in air at a pressure above 30 mms. until the P.D. is increased nearly to the value required to produce a spark. This production of ions by collision is considered in more detail in section 41.

¹ *Phil. Mag.* Feb. 1901.

30. Rate of recombination of the ions. A gas ionized by the radiation preserves its conducting power for some time after it is removed from the presence of the active body. A current of air blown over an active body will thus discharge an electrified body some distance away. The duration of this after conductivity can be very conveniently examined in an apparatus similar to Fig. 6.

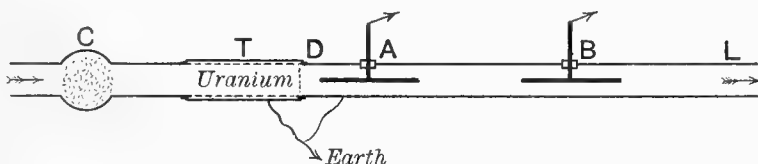

Fig. 6.

A dry current of air or any other gas is passed at a constant rate through a long metal tube TL . The current of air after passing through a quantity of cotton-wool to remove dust particles, passes over a vessel T containing a radio-active body such as uranium, which does not give off a radio-active emanation. By means of insulated electrodes A and B , charged to a suitable potential, the current through the gas can be tested at various points along the tube.

A gauze screen, placed over the cross-section of the tube at D , serves to prevent any direct action of the electric field in abstracting ions from the neighbourhood of T .

If the electric field is sufficiently strong, all the ions travel in to the electrodes at A , and no current is observed at the electrode B . If the current is observed successively at different distances along the tube, all the electrodes except the one under consideration being connected to earth, it is found that the current diminishes with the distance from the active body. If the tube is of fairly wide bore, the loss of the ions due to diffusion is small, and the decrease in conductivity of the gas is due to recombination of the ions alone.

On the ionization theory, the number dn of ions per unit volume which recombine in the time dt is proportional to the square of the number present. Thus

$$\frac{dn}{dt} = \alpha n^2,$$

where α is a constant.

Integrating this equation,

$$\frac{1}{n} - \frac{1}{N} = \alpha t,$$

if N is the initial number of ions, and n the number after a time t .

The experimental results obtained¹ have been shown to agree very well with this equation.

In an experiment similar to that illustrated in Fig. 6, using uranium oxide as a source of ionization, it was found that half the number of ions present in the gas recombined in 2.4 seconds, and that at the end of 8 seconds one-fourth of the ions were still uncombined.

Since the rate of recombination is proportional to the square of the number present, the time taken for half of the ions present in the gas to recombine decreases very rapidly with the intensity of the ionization. If radium is used, the ionization is so intense that the rate of recombination is extremely rapid. It is on account of this rapidity of recombination that large voltages are necessary to produce saturation in the gases exposed to very active preparations of radium.

The value of α , which may be termed the *coefficient of recombination*, has been determined in absolute measure by Townsend², McClung³ and Langevin⁴ by different experimental methods but with very concordant results. Suppose, for example, with the apparatus of Fig. 6, the time T , taken for half the ions to recombine after passing by the electrode A , has been determined experimentally. Then $\frac{1}{N} = \alpha T$, where N is the number of ions per c.c. present at A . If the saturation current i is determined at the electrode A , $i = NVe$ where e is the charge on an ion and V is the volume of uniformly ionized gas carried by the electrode A per second. Then $\alpha = \frac{Ve}{iT}$.

The following table shows the value of α obtained for different gases.

¹ Rutherford, *Phil. Mag.* Nov. 1897, p. 144, Jan. 1899.

² *Phil. Trans. Roy. Soc. A*, p. 157, 1899.

³ *Phil. Mag.* p. 283, March, 1902.

⁴ *Thèse présentée à la Faculté des Sciences*, p. 151, Paris, 1902.

Value of α .

Gas	Townsend	M ^c Clung.	Langevin
Air	$3420 \times e$	$3384 \times e$	$3200 \times e$
Carbon Dioxide	$3500 \times e$	$3492 \times e$	$3400 \times e$
Hydrogen ...	$3020 \times e$		

The latest determination of the value of e (see section 36) is 3.4×10^{-10} E. S. units; thus $\alpha = 1.1 \times 10^{-6}$.

Using this value, it can readily be shown from the equation of recombination that, if 10^6 ions are present per c.c., half of them recombine in about 0.9 sec. and 99% in 90 secs.

M^cClung (*loc. cit.*) showed that the value of α was approximately independent of the pressure between .125 and three atmospheres. In later observations, Langevin has found that the value of α decreases rapidly when the pressure is lowered below the limits used by M^cClung.

31. In experiments on recombination it is essential that the gas should be free from dust or other suspended particles. In dusty air, the rate of recombination is much more rapid than in dust-free air, as the ions diffuse rapidly to the comparatively large dust particles distributed throughout the gas. The effect of the suspension of small particles in a conducting gas is very well illustrated by an experiment of Owens¹. If tobacco smoke is blown between two parallel plates as in Fig. 1, the current at once diminishes to a small fraction of its former value, although a P.D. is applied sufficient to produce saturation under ordinary conditions. A much larger voltage is then necessary to produce saturation. If the smoke particles are removed by a stream of air, the current at once returns to its original value.

32. Mobility of the ions. Determinations of the mobility of the ions, *i.e.* the velocity of the ions under a potential gradient of 1 volt per cm., have been made by Rutherford², Zeleny³, and Langevin⁴ for gases exposed to Röntgen rays. Although widely different methods have been employed, the results have been very concordant and fully support the view that the ions move with a

¹ *Phil. Mag.* Oct. 1899.

² *Phil. Mag.* p. 429, Nov. 1897.

³ *Phil. Trans. A*, p. 193, 1901.

⁴ *C. R.* 134, p. 646, 1902.

velocity proportional to the strength of the field. On the application of an electric field, the ions almost instantly attain the velocity corresponding to the field and then move with a uniform speed.

Zeleny¹ first drew attention to the fact that the positive and negative ions had different velocities. The velocity of the negative ion is always greater than that of the positive, and varies with the amount of water vapour present in the gas.

The results, previously discussed, of the variation of the current with voltage and of the rate of recombination of the ions do not of themselves imply that the ions produced in gases by the radiations from active bodies are of the same size as those produced by Röntgen rays under similar conditions. They merely show that the conductivity under various conditions can be satisfactorily explained by the view that charged ions are produced throughout the volume of the gas. The same general relations would be observed if the ions differed considerably in size and velocity from those produced by Röntgen rays. The most satisfactory method of determining whether the ions are identical in the two cases is to determine the velocity of the ions under similar conditions.

In order to compare the velocity of the ions², the writer has used an apparatus similar to that shown in Fig. 6 on p. 37.

The ions were carried with a rapid constant stream of air past the charged electrode *A*, and the conductivity of the gas tested immediately afterwards at an electrode *B*, which was placed close to *A*. The insulated electrodes *A* and *B* were fixed centrally in the metal tube *L*, which was connected with earth.

For convenience of calculation, it is assumed that the electric field between the cylinders is the same as if the cylinders were infinitely long.

Let *a* and *b* be the radii of the electrode *A*, and of the tube *L* respectively, and let *V* = potential of *A*.

The electromotive intensity *X* (without regard to sign) at a distance *r* from the centre of the tube is given by

$$X = \frac{V}{r \log_e \frac{b}{a}}.$$

¹ *Phil. Mag.* July, 1898.

² *Phil. Mag.* Feb. 1899.

Let u_1 and u_2 be the velocities of the positive and negative ions for a potential gradient of 1 volt per cm. If the velocity is proportional to the electric force at any point, the distance dr traversed by the negative ion in the time dt is given by

$$dr = Xu_2 dt,$$

or

$$dt = \frac{\log_e \frac{b}{a} r dr}{Vu_2}.$$

Let r_2 be the greatest distance measured from the axis of the tube from which the negative ion can just reach the electrode A in the time t taken for the air to pass along the electrode.

Then
$$t = \frac{(r_2^2 - a^2)}{2Vu_2} \log_e \frac{b}{a}.$$

If ρ_2 be the ratio of the number of the negative ions that reach the electrode A to the total number passing by, then

$$\rho_2 = \frac{r_2^2 - a^2}{b^2 - a^2}.$$

Therefore

$$u_2 = \frac{\rho_2 (b^2 - a^2) \log_e \frac{b}{a}}{2V \cdot t} \dots\dots\dots (1).$$

Similarly the ratio ρ_1 of the number of positive ions that give up their charge to the external cylinder to the total number of positive ions is given by

$$u_1 = \frac{\rho_1 (b^2 - a^2) \log_e \frac{b}{a}}{2V \cdot t}.$$

In the above equations it is assumed that the current of air is uniform over the cross-section of the tube, and that the ions are uniformly distributed over the cross-section; also, that the movement of the ions does not appreciably disturb the electric field. Since the value of t can be calculated from the velocity of the current of air and the length of the electrode, the values of the velocities of the ions under unit potential gradient can at once be determined.

The equation (1) shows that ρ_2 is proportional to V ,—i.e. that

the rate of discharge of the electrode A varies directly as the potential of A , provided that the value of V is not large enough to remove all the ions from the gas as it passes by the electrode. This was found experimentally to be the case.

In the comparison of the velocities, the potential V was adjusted to such a value that ρ_2 was about one half, when uranium oxide was placed in the tube at L . The active substance was then removed, and an aluminium cylinder substituted for the brass tube. X rays were allowed to fall on the centre of this aluminium cylinder, and the strength of the rays adjusted to give about the same conductivity to the gas as the uranium had done. Under these conditions the value of ρ_2 was found to be the same as for the first experiment.

This experiment shows conclusively that the ions produced by Röntgen rays and by uranium move with the same velocity and are probably identical in all respects. The method described above is not very suitable for an accurate determination of the velocities, but gave values for the positive ions of about 1.4 cms. per second per volt per centimetre, and slightly greater values for the negative ions.

33. The most accurate determinations of the mobility of the ions produced by Röntgen rays have been made by Zeleny¹ and Langevin². Zeleny used a method similar in principle to that explained above. His results are shown in the following table, where K_1 is the mobility of the positive ion and K_2 that of the negative ion.

Gas	K_1	K_2	$\frac{K_2}{K_1}$	Temperature
Air, dry	1.36	1.87	1.375	13°·5 C.
„ moist	1.37	1.51	1.10	14°
Oxygen, dry	1.36	1.80	1.32	17°
„ moist	1.29	1.52	1.18	16°
Carbon dioxide, dry	0.76	0.81	1.07	17°·5
„ „ moist	0.81	0.75	0.915	17°
Hydrogen, dry	6.70	7.95	1.15	20°
„ moist	5.30	5.60	1.05	20°

¹ *Phil. Trans.* 195, p. 193, 1900.

² *C. R.* 134, p. 646, 1902, and Thesis, p. 191, 1902.

Langevin determined the velocity of the ions by a direct method in which the time taken for the ion to travel over a known distance was observed.

The following table shows the comparative values obtained for air and carbon dioxide.

	Air			CO ₂		
	K_1	K_2	$\frac{K_2}{K_1}$	K_1	K_2	$\frac{K_2}{K_1}$
Direct method (Langevin)	1.40	1.70	1.22	0.86	0.90	1.05
Current of gas (Zeleny)...	1.36	1.87	1.375	0.76	0.81	1.07

These results show that for all gases except CO₂, there is a marked increase in the velocity of the negative ion with the dryness of the gas, and that, even in moist gases, the velocity of the negative ions is always greater than that of the positive ions. The velocity of the positive ion is not much affected by the presence of moisture in the gas.

The velocity of the ions varies inversely as the pressure of the gas. This has been shown by Rutherford¹ for the negative ions produced by ultra-violet light falling on a negatively charged surface, and later by Langevin² for both the positive and negative ions produced by Röntgen rays. Langevin has shown that the velocity of the positive ion increases more slowly with the diminution of pressure than that of the negative ion. It appears as if the negative ion, especially at pressures of about 10 mm. of mercury, begins to diminish in size.

34. Condensation experiments. Some experiments will now be described which have verified in a direct way the theory that the conductivity produced in gases by the various types of radiation is due to the production of charged ions throughout the volume of the gas. Under certain conditions, the ions form nuclei for the condensation of water, and this property allows us to show the presence of the individual ions in the gas, and also to count the number present.

It has long been known that if air saturated with water-vapour is suddenly expanded, a cloud of small globules of water is formed. These drops are formed round the dust particles present in the gas,

¹ *Proc. Camb. Phil. Soc.* 9, p. 410, 1898.

² Thesis, p. 190, 1902.

which act as nuclei for the condensation of water around them. The experiments of R. von Helmholtz and Richarz¹ had shown that chemical reactions, for example the combustion of flames, taking place in the neighbourhood, affected the condensation of a steam-jet. Lenard showed that a similar action was produced when ultra-violet light fell on a negatively charged zinc surface placed near the steam-jet. These results suggested that the presence of electric charges in the gas facilitated condensation.

A very complete study of the conditions of condensation of water on nuclei has been made by C. T. R. Wilson². An apparatus was constructed which allowed a very sudden expansion of the air over a wide range of pressure. The amount of condensation was observed in a small glass vessel. A beam of light was passed into the apparatus which allowed the drops formed to be readily observed by the eye.

Preliminary small expansions caused a condensation of the water round the dust nuclei present in the air. These dust nuclei were removed by allowing the drops to settle. After a number of successive small expansions, the air was completely freed from dust, so that no condensation was produced.

Let v_1 = initial volume of the gas in the vessel,

v_2 = volume after expansion.

If $\frac{v_2}{v_1} < 1.25$ no condensation is produced in dust-free air. If however $\frac{v_2}{v_1} > 1.25$ and < 1.38 , a few drops appear. This number is roughly constant until $\frac{v_2}{v_1} = 1.38$, when the number suddenly increases and a very dense cloud of fine drops is produced.

If the radiation from an X ray tube or a radio-active substance is now passed into the condensation vessel, a new series of phenomena is observed. As before, if $\frac{v_2}{v_1} < 1.25$ no drops are formed, but if $\frac{v_2}{v_1} = 1.25$ there is a sudden production of a cloud. The water drops of which this cloud is formed are finer and more numerous the

¹ *Wied. Annal.* 40, p. 161, 1890.

² *Phil. Trans.* p. 265, 1897; p. 403, 1899; p. 289, 1900.

greater the intensity of the rays. This point at which condensation begins is very marked, and a slight variation of the amount of expansion causes either a dense cloud or no cloud at all.

It now remains to be shown that the formation of a cloud by the action of the rays is due to the productions of ions in the gas. If the expansion vessel is provided with two parallel plates between which an electric field can be applied, it is seen that the number of drops, formed by the expansion with the rays acting, decreases with increase of the electric field. The stronger the field the smaller the number of drops formed. This result is to be expected if the ions are the centres of condensation; for in a strong electric field the ions are at once carried to the electrodes, and thus disappear from the gas. If no electric field is acting, a cloud can be produced some time after the rays have been cut off; but if a strong electric field is applied, under the same conditions, no cloud is formed. This is in agreement with experiments showing the time required for the ions to disappear by recombination. In addition it can be shown that each one of the fine drops carries an electric charge and can be made to move in a strong uniform electric field.

The small number of drops produced without the action of the rays when $\frac{v_2}{v_1} > 1.25$ is due to a very slight natural ionization of the gas. That this ionization exists has been clearly shown by electrical methods (section 218).

The evidence is thus complete that the ions themselves serve as centres for the condensation of water around them. These experiments show conclusively that the passage of electricity through a gas is due to the production of charged ions distributed throughout the volume of the gas, and verify in a remarkable way the hypothesis of the discontinuous structure of the electric charges carried by matter.

This property of the ions of acting as nuclei of condensation gives a very delicate method of detecting the presence of ions in the gas. If only an ion or two is present per c.c., their presence after expansion is at once observed by the drops formed. In this way the ionization due to a small quantity of uranium held a yard away from the condensation vessel is at once made manifest.

35. Difference between the positive and negative ions.

In the course of experiments to determine the charge carried by an ion, J. J. Thomson¹ observed that the cloud formed under the influence of X rays increased in density when the expansion was about 1.31 and suggested in explanation that the positive and negative ions had different condensation points.

This difference in behaviour of the positive and negative ions was investigated in detail by C. T. R. Wilson² in the following way. X rays were made to pass in a narrow beam on either side of a plate AB (Fig. 7) dividing the condensation vessel into two equal

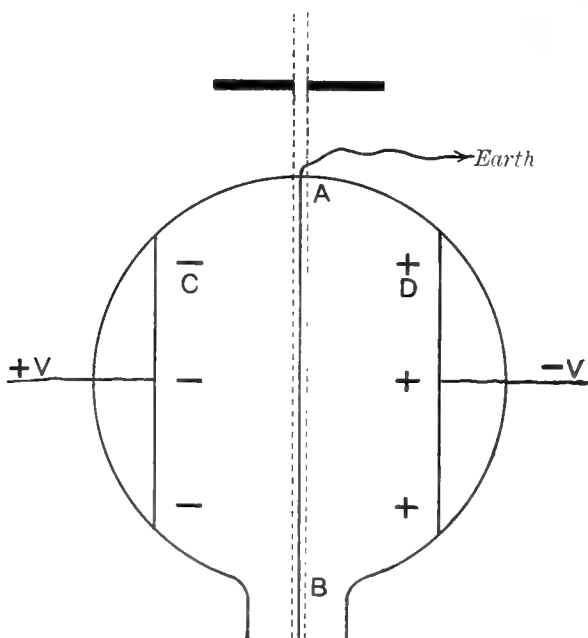

Fig. 7.

parts. The opposite poles of a battery of cells were connected with two parallel plates C and D , placed symmetrically with regard to A . The middle point of the battery and the plate A were connected with earth. If the plate C is positively charged, the ions in the space CA at a short distance from A are all negative in sign. Those to the right are all positive. It was found that condensation occurred only for the negative ions in AC when $\frac{v_2}{v_1} = 1.25$ but did not occur in AD for the positive ions until $\frac{v_2}{v_1} = 1.31$.

¹ *Phil. Mag.* p. 528, Dec. 1898.

² *Phil. Trans.* 193, p. 289, 1899.

The negative ion thus more readily acts as a centre of condensation than the positive ion. The greater effect of the negative ion in causing condensation has been suggested as an explanation of the positive charge always observed in the upper atmosphere. The negative ions under certain conditions become centres for the formation of small drops of water and are removed to the earth by the action of gravity, while the positive ions remain suspended.

With the apparatus described above, it has been shown that the positive and negative ions are equal in number. If the expansion is large enough to ensure condensation on both ions, the numbers of drops formed on the right and left of the vessel in Fig. 7 are equal in number and fall at the same rate, *i.e.* are equal in size.

Since the ions are produced in equal numbers from a gas electrically neutral, this experiment shows that the charge on positive and negative ions is equal in value but opposite in sign.

36. Charge carried by an ion. For a known sudden expansion of a gas saturated with water vapour, the amount of water precipitated on the ions can be readily calculated. The size of the drops can be determined by observing the rate at which the cloud settles under the action of gravity. From Stokes' equation, the terminal velocity u of a small sphere of radius r and density d falling through a gas of which the coefficient of viscosity is μ is given by

$$u = \frac{2}{9} \frac{dgr^2}{\mu},$$

where g is the acceleration due to gravity. The radius of the drop and consequently the weight of water in each drop can thus be determined. Since the total weight of water precipitated is known, the number of drops present is at once obtained.

This method has been used by J. J. Thomson¹ to determine the charge carried by an ion. If the expansion exceeds the value 1.31, both positive and negative ions become centres of condensation. From the rate of fall it can be shown that the drops are approximately all of the same size.

¹ *Phil. Mag.* p. 528, Dec. 1898, and March, 1903. *Conduction of Electricity through Gases*, p. 121.

The condensation vessel was similar to that employed by C. T. R. Wilson. Two parallel horizontal plates were fitted in the vessel and the radiation from an X ray tube or radio-active substance ionized the gas between them. A difference of potential V , small compared with that required to saturate the gas, was applied between the parallel plates distant l cms. from each other. The small current i through the gas is given (section 28) by

$$i = \frac{NuVe}{l},$$

where N = number of ions present in the gas,

e = charge on each ion,

u = sum of the velocities of the positive and negative ions.

Since the value of N is the same as the number of drops and the velocity u is known, the value of e can be determined.

In his last determination J. J. Thomson found that

$$\underline{e = 3.4 \times 10^{-10} \text{ electrostatic units.}}$$

A very concordant value of 3.1×10^{-10} has been obtained by H. A. Wilson¹, using a modified method of counting the drops. A check on the size of the drops, determined by their rate of fall, was made by observing the rate at which the drops moved in a strong electric field, arranged so as to act with or against gravity.

J. J. Thomson found that the charge on the ions produced in hydrogen and oxygen is the same. This shows that the nature of the ionization in gases is distinct from that occurring in the electrolysis of solutions where the oxygen ion always carries twice the charge of the hydrogen ion.

37. Diffusion of the ions. Early experiments with ionized gases showed that the conductivity was removed from the gas by passage through a finely divided substance like cotton-wool, or by bubbling through water. This loss of conductivity is due to the fact that the ions in passing through narrow spaces diffuse to the sides of the boundary, to which they either adhere or give up their charge.

A direct determination of the coefficient of diffusion of the ions

¹ *Phil. Mag.* April, 1903.

produced in gases by Röntgen rays or by the rays from active substances has been made by Townsend¹. The general method employed was to pass a stream of ionized gas through a diffusion vessel made up of a number of fine metal tubes arranged in parallel. Some of the ions in their passage through the tubes diffuse to the sides, the proportion being greater the slower the motion of the gas and the narrower the tube. Observations were made of the conductivity of the gas before and after passage through the tubes. In this way, correcting if necessary for the recombination during the time taken to pass through the tubes, the proportion R of either positive or negative ions which are abstracted can be deduced. The value of R can be mathematically expressed by the following equation in terms of K , the coefficient of diffusion of the ions into the gas with which they are mixed²,

$$R = 4 \left(0.195e^{-\frac{3.66KZ}{a^2V}} + 0.243e^{-\frac{22.3KZ}{a^2V}} + \&c. \right),$$

where

a = radius of the tube,

Z = length of the tube,

V = mean velocity of the gas in the tube.

Only the first two terms of the series need be taken into account when narrow tubes are used.

In this equation R , V , and a are determined experimentally, and K can thus be deduced.

The following table shows the results obtained by Townsend when X rays were used. Almost identical results were obtained later, when the radiations from active substances replaced the X rays.

Coefficients of diffusion of ions into gases.

Gas	K for + ions	K for - ions	Mean value of K	Ratio of values of K
Air, dry	·028	·043	·0347	1.54
„ moist	·032	·035	·0335	1.09
Oxygen, dry	·025	·0396	·0323	1.58
„ moist	·0288	·0358	·0323	1.24
Carbonic acid, dry	·023	·026	·0245	1.13
„ „ moist	·0245	·0255	·025	1.04
Hydrogen, dry	·123	·190	·156	1.54
„ moist	·128	·142	·135	1.11

¹ *Phil. Trans.* p. 129, 1899.

² Townsend, *loc. cit.* p. 139.

The moist gases were saturated with water vapour at a temperature of 15° C.

It is seen that the negative ion in all cases diffuses faster than the positive. Theory shows that the coefficients of diffusion should be directly proportional to the velocities of the ions, so that this result is in agreement with the observations on the greater velocity of the negative ion.

This difference in the rate of diffusion of the ions at once explains an interesting experimental result. If ionized gases are blown through a metal tube, the tube gains a negative charge while the gas itself retains a positive charge. The number of positive and negative ions present in the gas is originally the same, but, in consequence of the more rapid diffusion of the negative ions, more of the negative ions than of the positive give up their charges to the tube. The tube consequently gains a negative charge and the gas a positive charge.

38. A very important result can at once be deduced when the velocities and coefficients of diffusion of the ions are known. Townsend (*loc. cit.*) has shown that the equation of motion of the ions is expressed by the formula

$$\frac{1}{K} pu = -\frac{dp}{dx} + nXe,$$

where e is the charge on an ion,

n = number of ions per c.c.,

p = their partial pressure,

and u the velocity due to the electric force X in the direction of the axis of x . When a steady state is reached,

$$\frac{dp}{dx} = 0 \quad \text{and} \quad u = \frac{nXeK}{p}.$$

Let N be the number of molecules in a cubic centimetre of gas at the pressure P and at the temperature 15° C., for which the values of u and K have been determined. Then $\frac{N}{P}$ may be substituted for $\frac{n}{p}$, and, since P at atmospheric pressure is 10^6 ,

$$Ne = \frac{3 \times 10^8 \cdot u_1}{K} \text{ electrostatic units,}$$

where u_1 is the velocity for 1 volt (*i.e.* $\frac{1}{300}$ E. S. unit) per cm.

It is known that one absolute electro-magnetic unit of electricity in passing through water liberates 1.23 c.c. of hydrogen at a temperature of 15° C. and standard pressure. The number of atoms in this volume is 2.46 N , and, if e' is the charge on the hydrogen atom in the electrolysis of water,

$$2.46 Ne' = 3 \times 10^{10} \text{ E. S. units,}$$

$$Ne' = 1.22 \times 10^{10} \text{ E. S. units.}$$

Thus
$$\frac{e}{e'} = 2.46 \times 10^{-2} \frac{u_1}{K}.$$

For example, substituting the values of u_1 and K determined for moist air for the positive ion,

$$\frac{e}{e'} = \frac{2.46}{100} \times \frac{1.37}{.032} = 1.04.$$

Values of this ratio, not very different from unity, are obtained for the positive and negative ions of the gases hydrogen, oxygen, and carbon dioxide. Taking into consideration the uncertainty in the experimental values of u_1 and K , these results indicate that the *charge carried by an ion in all gases is the same and is equal to that carried by the hydrogen ion in the electrolysis of liquids.*

39. Number of the ions. We have seen that, from experimental data, Townsend has found that N , the number of molecules present in 1 c.c. of gas at 15° C. and standard pressure, is given by

$$Ne = 1.22 \times 10^{10}.$$

Now e , the charge on an ion, is equal to 3.4×10^{-10} E. S. units.

Thus
$$N = 3.6 \times 10^{19}.$$

If I is the saturation current through a gas, and q the total rate of production of ions in the gas,

$$q = \frac{I}{e}.$$

The saturation current through air was found to be 1.2×10^{-8} ampères, *i.e.* 36 E.S. units, for parallel plates, 4.5 cms. apart, when .45 gramme of radium of activity 1000 times that of uranium was spread over an area of 33 sq. cms. of the lower plate. This corresponds to a production of about 10^{11} ions per second. Assuming, for the purpose of illustration, that the ionization was uniform between the plates, the volume of air acted on by the rays was about 148 c.c., and the number of ions produced per c.c. per second about 7×10^8 . Since $N = 3.6 \times 10^{19}$, it is thus seen that, if one molecule produces two ions, the proportion of the gas ionized per second is about 10^{-11} of the whole. For uranium the fraction is about 10^{-14} , and for pure radium, of activity one million times that of uranium, about 10^{-8} . Thus even in the case of pure radium, only about one molecule of gas is acted on per second in every 100 millions.

The electrical methods are so delicate that the production of one ion per cubic centimetre per second can readily be detected. This corresponds to the ionization of about one molecule in every 10^{19} present in the gas.

40. Size and nature of the ions. An approximate estimate of the mass of an ion, compared with the mass of the molecule of the gas in which it is produced, can be made from the known data of the coefficient K of inter-diffusion of the ions into gases. The value of K for the positive ions in moist carbon dioxide has been shown to be .0245, while the value of K for the inter-diffusion of carbon dioxide with air is .14. The value of K for different gases has been found to be approximately inversely proportional to the square root of the products of the masses of the molecules of the two inter-diffusing gases; thus, the positive ion in carbon dioxide behaves as if its mass were large compared with that of the molecule. Similar results hold for the negative as well as for the positive ion, and for other gases besides carbon dioxide.

This has led to the view that the ion consists of a charged centre surrounded by a cluster of molecules travelling with it, which are kept in position round the charged nucleus by electrical forces. A rough estimate shows that this cluster consists of about 30 molecules of the gas. This idea is supported by the variation in velocity, *i.e.* the variation of the size of the negative ion, in the

presence of water vapour; for the negative ion undoubtedly has a greater mass in moist than in dry gases. At the same time it is possible that the apparently large size of the ion, as determined by diffusion methods, may be in part a result of the charge carried by the ion. The presence of a charge on a moving body would increase the frequency of collision with the molecules of the gas, and consequently diminish the rate of diffusion. The ion on this view may not actually be of greater size than the molecule from which it is produced.

The negative and positive ions certainly differ in size, and this difference becomes very pronounced for low pressures of the gas. At atmospheric pressure, the negative ion, produced by the action of ultra-violet light on a negatively charged body, is of the same size as the ion produced by X rays, but at low pressures J. J. Thomson has shown that it is identical with the corpuscle or electron, which has an apparent mass of about $1/1000$ of the mass of the hydrogen atom. A similar result has been shown by Townsend to hold for the negative ion produced by X rays at a low pressure. It appears that the negative ion at low pressure sheds its attendant cluster. The result of Langevin, that the velocity of the negative ion increases more rapidly with the diminution of pressure than that of the positive ion, shows that this process of removal of the cluster is quite appreciable at a pressure of 10 mms. of mercury.

It must thus be supposed that the process of ionization in gases consists in a removal of a negative corpuscle or electron from the molecule of the gas. At atmospheric pressure this corpuscle immediately becomes the centre of an aggregation of molecules which moves with it and is the negative ion. After removal of the negative ion the molecule retains a positive charge, and probably also becomes the centre of a cluster of new molecules.

The terms electron and ion as used in this work may therefore be defined as follows:—

The *electron* or *corpuscle* is the body of smallest mass yet known to science. It carries a negative charge of value 3.4×10^{-10} electrostatic units. Its presence has only been detected when in rapid motion, when it has, for speeds up to about 10^{10} cms. a second, an apparent mass m given by $e/m = 1.86 \times 10^7$ electromagnetic

units. This apparent mass increases with the speed as the velocity of light is approached (see section 76).

The ions which are produced in gases at ordinary pressure have an apparent size, as determined from their rates of diffusion, large compared with the molecule of the gas in which they are produced. The negative ion consists of an electron with a cluster of molecules attached to and moving with it. The positive ion consists of a molecule from which an electron has been expelled, with a cluster of molecules attached; at low pressures under the action of an electric field the electron does not form a cluster. The positive ion is always atomic in size, even at low pressure of the gas. Each of the ions carries a charge of value 3.4×10^{-10} electrostatic units.

41. Ions produced by collision. The greater part of the radiation from the radio-active bodies consists of a stream of charged particles travelling with great velocity. Of this radiation, the α particles, which cause most of the ionization observed in the gas, consist of positively charged bodies projected with a velocity about one-tenth the velocity of light. The β rays consist of negatively charged particles, which are identical with the cathode rays produced in a vacuum tube and travel with a speed about one-half the velocity of light (chapter IV.). Each of these projected particles possesses such great kinetic energy that it is able to produce a large number of ions by collision with the gas molecules in its path. No definite experimental evidence has yet been obtained of the number of ions produced by a single particle, or of the way the ionization varies with the speed, but there is no doubt that each projected body produces many thousand ions in its path before its energy of motion is destroyed.

It has already been mentioned (section 29) that at low pressures ions moving under the action of an electric field are able to produce fresh ions by collision with the molecules of the gas. At low pressures the negative ion is identical with the electron produced in a vacuum tube, or emitted by a radio-active substance.

The mean free path of the ion is inversely proportional to the pressure of the gas. Consequently, if an ion moves in an electric field, the velocity acquired between collisions increases with diminution of the pressure. Townsend has shown that fresh ions are

occasionally produced by collision when the negative ion moves freely between two points differing in potential by 10 volts. If the difference be about $V = 20$ volts, fresh ions are produced at each collision¹.

Now the energy W , acquired by an ion of charge e moving freely between two points at a difference of potential V , is given by

$$W = Ve.$$

Taking $V = 20$ volts $= \frac{20}{300}$ E. S. units, and $e = 3.4 \times 10^{-10}$, the energy W required to produce an ion by collision of the negative ion is given by

$$W = 2.3 \times 10^{-11} \text{ ergs.}$$

The velocity u acquired by the ion of mass m just before a collision is given by

$$\frac{1}{2} mu^2 = Ve,$$

and

$$u = \sqrt{\frac{2Ve}{m}}.$$

Now $\frac{e}{m} = 1.86 \times 10^7$ electromagnetic units for the electron at slow speeds (section 76).

Taking $V = 20$ volts,

$$m = 2.7 \times 10^8 \text{ cms. per sec.}$$

This is a velocity very great compared with the velocity of agitation of the molecules of the gas.

The negative ions alone are able to produce ions by collision in a weak electric field. The positive ion, whose mass is at least 1000 times greater than the electron, does not acquire a sufficient velocity to produce ions by collision until an electric field is applied nearly sufficient to cause a spark through the gas.

An estimate of the energy required to produce an ion by X rays has been made by Rutherford and McClung. The energy of the rays was measured by their heating effect, and the total number of ions produced determined. On the assumption that *all* the energy of the rays is used up in producing ions, it was found that $V = 175$

¹ Some difference of opinion has been expressed as to the value of V required to produce ions at each collision. Townsend considers it to be about 20 volts; Langevin 60 volts and Stark about 50 volts.

volts—a value considerably greater than that observed by Townsend from data of ionization by collision. The ionization in the two cases, however, is produced under very different conditions, and it is impossible to estimate how much of the energy of the rays is dissipated in the form of heat.

42. Variations are found in the saturation current through gases, exposed to the radiations from active bodies, when the pressure and nature of the gas and the distance between the electrodes are varied. Some cases which are of special importance in measurements will now be considered. With unscreened active material the ionization of the gas is, to a large extent, due to the α rays, which are absorbed in their passage through a few centimetres of air. In consequence of this rapid absorption, the ionization decreases rapidly from the surface of the active body, and this gives rise to conductivity phenomena different in character from those observed with Röntgen rays, where the ionization is in most cases uniform.

43. Variation of the current with distance between the plates. It has been found experimentally¹ that the intensity of the ionization, due to a large plane surface of active matter, falls off approximately in an exponential law with the distance from the plate. On the assumption that the rate of production of ions at any point is a measure of the intensity I of the radiation, the value of I at that point is given by $\frac{I}{I_0} = e^{-\lambda x}$, where λ is a constant, x the distance from the plate, and I_0 the intensity of the radiation at the surface of the plate. This result can be deduced theoretically on the assumption that the ionization at any point is proportional to the intensity of the radiation, and that the energy of the rays is used up in producing ions.

With an infinite plane of active matter, the intensity of the radiation would be constant for all distances from the plane if there were no absorption of the radiation in the gas.

Let q be the number of ions produced per second per unit volume when the intensity of radiation is I .

Let $I = Kq$, where K is a constant.

If ω is the average energy required to produce an ion, the

¹ Rutherford, *Phil. Mag.* Jan. 1899.

energy dI absorbed in producing ions in a layer of unit area and thickness dx at a distance x from the plane is given by

$$\begin{aligned} dI &= q\omega \cdot dx \\ &= \frac{\omega}{K} \cdot I \cdot dx. \end{aligned}$$

Integrating, $\log_e I = \frac{\omega}{K} \cdot x + A$,
where A is a constant.

Since $I = I_0$ when $x = 0$, $A = \log_e I_0$, and

$$\frac{I}{I_0} = e^{-\frac{\omega}{K} \cdot x} = e^{-\lambda x},$$

where $\lambda = \frac{\omega}{K} = \text{a constant.}$

λ will be called the *absorption constant* of the gas for the particular kind of radiation considered.

If q_0 is the rate of production of ions at the surface of the plate, $\frac{q}{q_0} = e^{-\lambda x}$.

Consider two parallel plates placed as in Fig. 1, one of which is covered with a uniform layer of radio-active matter. If the distance d between the plates is small compared with the dimensions of the plates, the ionization near the centre of the plates will be sensibly uniform over any plane parallel to the plates and lying between them. The saturation current i per unit area is given by

$$\begin{aligned} i &= \int_0^d qe' dx, \text{ where } e' \text{ is the charge on an ion,} \\ &= q_0 e' \int_0^d e^{-\lambda x} dx = \frac{q_0 e'}{\lambda} (1 - e^{-\lambda d}); \end{aligned}$$

when λd is small, *i.e.* when the ionization between the plates is nearly constant,

$$i = q_0 e' d.$$

The current is thus proportional to the distance between the plates. When λd is large, the saturation current i_0 is equal to $\frac{q_0 e'}{\lambda}$, and is independent of further increase in the value of d . In such

a case the radiation is completely absorbed in producing ions between the plates, and $\frac{i}{i_0} = 1 - e^{-\lambda d}$.

For example, in the case of a thin layer of uranium oxide spread over a large plate, the ionization is mostly produced by rays the intensity of which is reduced to half value in passing through 4.3 mms. of air; *i.e.* the value of λ is 1.6. The following table is an example of the variation of i with the distance between the plates.

Distance	Saturation Current
2.5 mms.	32
5 "	55
7.5 "	72
10 "	85
12.5 "	96
15 "	100

Thus the increase of current for equal increments of distance between the plates decreases rapidly with the distance traversed by the radiation.

The distance of 15 mms. was not sufficient to completely absorb all the radiation, so that the current had not reached its limiting value.

When more than one type of radiation is present, the saturation current between parallel plates is given by

$$i = A (1 - e^{-\lambda d}) + A_1 (1 - e^{-\lambda_1 d}) + \&c.$$

where A , A_1 are constants and λ , λ_1 the absorption constants of the radiations in the gas.

Since the radiations are unequally absorbed in different gases, the variation of current with distance depends on the nature of the gas between the plates.

44. Variation of the current with pressure. The rate of production of ions by the radiations from active substances is directly proportional to the pressure of the gas. The absorption of the radiation in the gas also varies directly as the pressure. The latter result necessarily follows if the energy required to produce an ion is independent of the pressure.

In cases where the ionization is uniform between two parallel plates, the current will vary directly as the pressure; when however

the ionization is not uniform, on account of the absorption of the radiation in the gas, the current does not decrease directly as the pressure until the pressure is reduced so far that the ionization is sensibly uniform. Consider the variation with pressure of the saturation current i between two large parallel plates, one of which is covered with a uniform layer of active matter.

Let λ_1 = absorption constant of the radiation in the gas for unit pressure.

For a pressure p , the intensity I at any point x is given by $\frac{I}{I_0} = e^{-p\lambda_1 x}$. The saturation current i is thus proportional to

$$\int_0^d p I dx = \int_0^d p I_0 e^{-p\lambda_1 x} dx = \frac{I_0}{\lambda_1} (1 - e^{-p\lambda_1 d}).$$

If r be the ratio of the saturation currents for the pressures p_1 and p_2

$$r = \frac{1 - e^{-p_1 \lambda_1 d}}{1 - e^{-p_2 \lambda_1 d}}.$$

The ratio is thus dependent on the distance d between the plates and the absorption of the radiation by the gas.

The difference in the shape of the pressure-current curves¹ is well illustrated in Fig. 8, where curves are given for hydrogen, air, and carbonic acid for plates 3.5 cms. apart.

For the purpose of comparison, the current at atmospheric pressure and temperature in each case is taken as unity. The actual value of the current was greatest in carbonic acid and least in hydrogen. In hydrogen, where the absorption is small, the current over the whole range is nearly proportional to the pressure. In carbonic acid, where the absorption is large, the current diminishes at first slowly with the pressure, but is nearly proportional to it below the pressure of 235 mms. of mercury. The curve for air occupies an intermediate position.

In cases where the distance between the plates is large, the saturation current will remain constant with diminution of pressure until the absorption is so reduced that the radiation reaches the other plate.

¹ Rutherford, *Phil. Mag.* Jan. 1899.

An interesting result follows from the rapid absorption of radiation by the gas. If the current is observed between two fixed parallel plates, distant d_1 and d_2 respectively from a large plane surface of active matter, the current at first increases with diminution of pressure, passes through a maximum value, and then diminishes. In such an experimental case the lower plate through which the radiations pass is made either of open gauze or of thin metal foil to allow the radiation to pass through readily.

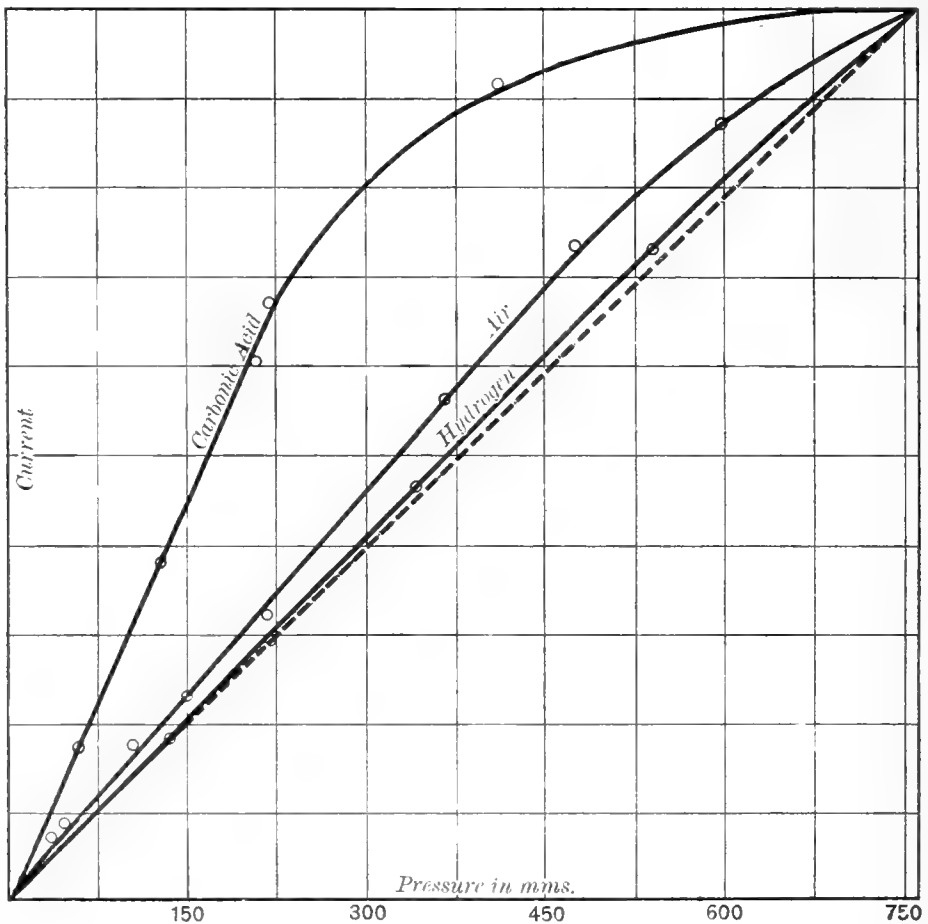

Fig. 8.

The saturation current i is obviously proportional to

$$\int_{d_1}^{d_2} p I_0 e^{-p\lambda_1 d}, \text{ i.e. to } \frac{I_0}{\lambda_1} (e^{-p\lambda_1 d_1} - e^{-p\lambda_1 d_2}).$$

This is a function of the pressure, and is a maximum when

$$\log e \frac{d_1}{d_2} = -p\lambda_1 (d_2 - d_1).$$

For example, if the active matter is uranium, $p\lambda_1 = 1.6$ for the α rays at atmospheric pressure. If $d_2 = 3$, and $d_1 = 1$, the saturation current reaches a maximum when the pressure is reduced to about $1/3$ of an atmosphere. This result has been verified experimentally.

45. Conductivity of different gases when acted on by the rays. For a given intensity of radiation, the rate of production of ions in a gas varies for different gases and increases with the density of the gas. Strutt¹ has made a very complete examination of the relative conductivity of gases exposed to the different types of rays emitted by active substances. To avoid correction for any difference of absorption of the radiation in the various gases, the pressure of the gas was always reduced until the ionization was directly proportional to the pressure, when, as we have seen above, the ionization must everywhere be uniform throughout the gas. For each type of rays, the ionization of air is taken as unity. The currents through the gases were determined at different pressures, and were reduced to a common pressure by assuming that the ionization was proportional to the pressure.

With unscreened active material, the ionization is almost entirely due to α rays. When the active substance is covered with a layer of aluminium .01 cms. in thickness, the ionization is mainly due to the β or cathodic rays, and when covered with 1 cm. of lead the ionization is solely due to the γ or very penetrating rays. Experiments on the γ rays of radium were made by observing the rate of discharge of a special gold-leaf electroscope filled with the gas under examination and exposed to the action of the rays. The following table gives the relative conductivities of gases exposed to various kinds of ionizing radiations.

With the exception of hydrogen, it will be seen that the ionization of gases is approximately proportional to their density for the α , β , γ rays of radium. The results for Röntgen rays are quite different; for example, the conductivity produced by them in methyl iodide was more than 14 times as great as that due to the rays of radium. The γ rays of radium appear to be more allied to the β rays of radium than to Röntgen rays.

¹ *Phil. Trans. A*, p. 507, 1901 and *Proc. Roy. Soc.* p. 208, 1903.

This difference of conductivity in gases is due to unequal absorptions of the radiations. The writer has shown¹ that the

Gas	Relative Density	RELATIVE CONDUCTIVITY			
		α rays	β rays	γ rays	Röntgen rays
Hydrogen	0.0693	0.226	0.157	0.169	0.114
Air	1.00	1.00	1.00	1.00	1.00
Oxygen	1.11	1.16	1.21	1.17	1.39
Carbon dioxide	1.53	1.54	1.57	1.53	1.60
Cyanogen	1.86	1.94	1.86	1.71	1.05
Sulphur dioxide	2.19	2.04	2.31	2.13	7.97
Chloroform... ..	4.32	4.44	4.89	4.88	31.9
Methyl iodide	5.05	3.51	5.18	4.80	72.0
Carbon tetrachloride	5.31	5.34	5.83	5.67	45.3

total number of ions produced by the α rays for uranium, when completely absorbed by different gases, is not very different. The following results were obtained:

Gas	Total Ionization
Air	100
Hydrogen	95
Oxygen	106
Carbonic acid	96
Hydrochloric acid gas	102
Ammonia	101

The numbers, though only approximate in character, seem to show that the energy required to produce an ion is probably not very different for the various gases. Assuming that the energy required to produce an ion in different gases is about the same, it follows that the relative conductivities are proportional to the relative absorption of the radiations.

A similar result has been found by McLennan for cathode rays. He proved that the ionization was directly proportional to the absorption of the rays in the gas, thus showing that the same energy is required to produce an ion in all the gases examined.

46. Potential Gradient. The normal potential gradient between two charged electrodes is always disturbed when the gas

¹ *Phil. Mag.* p. 137, Jan. 1899.

is ionized in the space between them. If the gas is uniformly ionized between two parallel plates, Child and Zeleny have shown that there is a sudden drop of potential near the surface of both plates, and that the electric field is sensibly uniform for the intermediate space between them. The disturbance of the potential gradient depends upon the difference of potential applied, and is different at the surface of the two plates.

In most measurements of radio-activity the material is spread over one plate only. In such a case the ionization is to a large extent confined to the volume of the air close to the active plate. The potential gradient in such a case is shown in Fig. 9. The dotted line shows the variation of potential at any point between the plates when no ionization is produced between the plates;

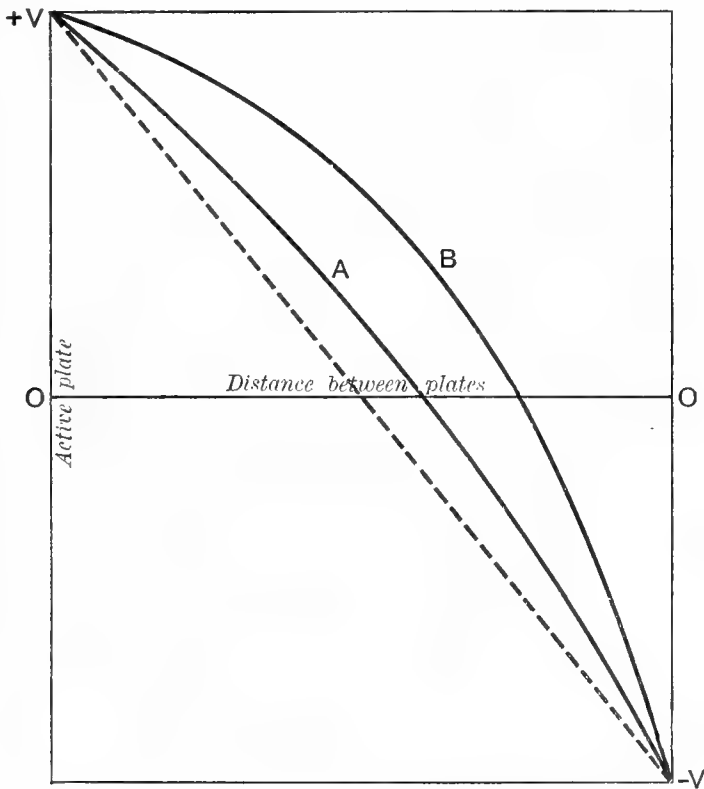

Fig. 9.

curve *A* for weak ionization, such as is produced by uranium, curve *B* for the intense ionization produced by a very active substance. In both cases the potential gradient is least near the active plate, and greatest near the opposite plate. For very

intense ionization it is very small near the active surface. The potential gradient varies slightly according as the active plate is charged positively or negatively.

47. Variation of current with voltage for surface ionization. Some very interesting results, giving the variation of the current with voltage, are observed when the ionization is intense, and confined to the space near the surface of one of two parallel plates between which the current is measured.

The theory of this subject has been worked out independently by Child¹ and Rutherford². Let V be the potential difference between two parallel plates at a distance d apart. Suppose that the ionization is confined to a thin layer near the surface of the plate A (see Fig. 1) which is charged positively. When the electric field is acting, there is a distribution of positive ions between the plates A and B .

Let n_1 = number of positive ions per unit volume at a distance x from the plate A ,

K_1 = mobility of the positive ions,

e = charge on an ion.

The current i_1 per square centimetre through the gas is constant for all values of x , and is given by

$$i_1 = K_1 n_1 e \frac{dV}{dx}.$$

By Poisson's equation

$$\frac{d^2V}{dx^2} = 4\pi ne.$$

Then

$$i_1 = \frac{K_1}{4\pi} \frac{dV}{dx} \cdot \frac{d^2V}{dx^2}.$$

Integrating

$$\left(\frac{dV}{dx}\right)^2 = \frac{8\pi i_1 x}{K_1} + A,$$

where A is a constant. Now A is equal to the value of $\frac{dV}{dx}$ when

¹ *Phys. Rev.* Vol. 12, 1901.

² *Phil. Mag.* p. 210, 1901; *Phys. Rev.* Vol. 13, 1901.

$x = 0$. By making the ionization very intense, the value of $\frac{dV}{dx}$ can be made extremely small.

Putting $A = 0$,

$$\frac{dV}{dx} = \pm \sqrt{\frac{8\pi i_1 x}{K_1}}.$$

This gives the potential gradient between the plates for different values of x .

Integrating between the limits 0 and d ,

$$V = \pm \frac{2}{3} \sqrt{\frac{8\pi i_1}{K_1}} d^{\frac{3}{2}},$$

or
$$i_1 = \frac{9V^2}{32\pi d^3} \cdot K_1.$$

If i_2 is the value of the current when the electric field is reversed, and K_2 the velocity of the negative ion,

$$i_2 = \frac{9V^2}{32\pi d^3} \cdot K_2,$$

and
$$\frac{i_1}{i_2} = \frac{K_1}{K_2}.$$

The current in the two directions is thus directly proportional to the velocities of the positive and negative ions. The current should vary directly as the square of the potential difference applied, and inversely as the cube of the distance between the plates.

The theoretical condition of surface ionization cannot be fulfilled by the ionization due to active substances, as the ionization extends some centimetres from the active plate. If, however, the distance between the plates is large compared with the distance over which the ionization extends, the results will be in rough agreement with the theory. Using an active preparation of radium, the writer has made¹ some experiments on the variation of current with voltage between parallel plates distant about 10 cms. from each other.

¹ *Phil. Mag.* Aug. 1901.

The results showed

(1) That the current through the gas for small voltages increased more rapidly than the potential difference applied, but not as rapidly as the square of that potential difference.

(2) The current through the gas depended on the direction of the electric field; the current was always smaller when the active plate was charged positively on account of the smaller mobility of the positive ion. The difference between i_1 and i_2 was greatest when the gas was dry, which is the condition for the greatest difference between the velocities of the ions.

An interesting result follows from the above theory. For given values of V and d , the current cannot exceed a certain definite value, however much the ionization may be increased. In a similar way, when an active preparation of radium is used as a source of surface ionization, it is found that, for a given voltage and distance between the plates, the current does not increase beyond a certain value however much the activity of the material is increased.

In this chapter an account of the ionization theory of gases has been given to the extent that is necessary for the interpretation of the measurements of radio-activity by the electric method. It would be out of place here to discuss the development of that theory in detail, to explain the passage of electricity through flames and vapours, the discharge of electricity from hot bodies, and the very complicated phenomena observed in the passage of electricity through a vacuum tube. This chapter was written before the publication of J. J. Thomson's recent book *Conduction of Electricity through Gases* (Cambridge University Press, 1903), to which the reader is referred for further information on this important subject.

CHAPTER III.

METHODS OF MEASUREMENT.

48. Methods of Measurement. Three general methods have been employed for examination of the radiations from radioactive bodies, depending on

- (1) The action of the rays on a photographic plate.
- (2) The ionizing action of the rays on the surrounding gas.
- (3) The fluorescence produced by the rays on a screen of platinocyanide of barium, zinc sulphide, or similar substance.

The third method is very restricted in its application, and can only be employed for intensely active substances like radium or polonium.

The photographic method has been very widely used, especially in the earlier development of the subject, but has gradually been displaced by the electrical method as a quantitative determination of the radiations became more and more necessary. In certain directions, however, it possesses distinct advantages over the electrical method. For example, it has proved a very valuable means of investigating the curvature of the path of the rays, when deflected by a magnetic or electric field, and has allowed us to determine the constants of these rays with considerable accuracy.

On the other hand, the photographic method as a general method of study of the radiations is open to many objections. A day's exposure is generally required to produce an appreciable darkening of the sensitive film when exposed to a weak source of radiation like uranium and thorium. It cannot, in consequence, be employed to investigate the radiations of those active products

which rapidly lose their activity. Moreover, W. J. Russell has shown that the darkening of a photographic plate can be produced by many agents which do not give out rays like those of the radio-active bodies. This darkening of the plate is produced under very many conditions, and very special precautions are necessary when long exposures to a weak source of radiation are required.

The main objection to the photographic method, however, lies in the fact that the radiations which produce the strongest electrical effect are very weak photographically. For example, Soddy¹ has shown that the photographic action of uranium is due almost entirely to the more penetrating rays, and that the easily absorbed rays produce in comparison very little effect. Speaking generally the penetrating rays are the most active photographically, and the action on the plate under ordinary conditions is almost entirely due to them.

Most of the energy radiated from active bodies is in the form of easily absorbed rays which are comparatively inactive photographically. These rays are difficult to study by the photographic method, as the layer of black paper which, in many cases, is necessary to absorb the phosphorescent light from active substances, cuts off at the same time most of the rays under examination. These rays will be shown to play a far more important part in the processes occurring in radio-active bodies than the rays which are more active photographically.

The electrical method, on the other hand, offers a rapid and accurate method of quantitatively examining the radiations. It can be used as a means of measurement of all the types of radiation emitted, excluding light waves, and is capable of accurate measurement over an extremely wide range. With proper precautions it can be used to measure effects produced by radiations of extremely small intensity.

49. Electrical Methods. The electrical methods employed in studying radio-activity are all based on the property of the radiation in question of ionizing the gas, *i.e.* of producing positively and negatively charged carriers throughout the volume of the gas. The discussion of the application of the ionization theory of gases to

¹ *Trans. Chem. Soc.* Vol. 81, p. 860, 1902.

measurements of radio-activity has been given in the last chapter. It has there been shown that the essential condition to be fulfilled for comparative measurements of the intensity of the radiations is that the electrical field should in all cases be strong enough to obtain the maximum or saturation current through the gas.

The electric field required to produce practical saturation varies with the intensity of the ionization and consequently with the activity of the preparations to be examined. For preparations which have an activity not more than 500 times that of uranium, under ordinary conditions, a field of 100 volts per cm. is sufficient to produce a practical saturation current. For very active samples of radium, it is often impossible to obtain conveniently a high enough electromotive force to give even approximate saturation. Under such conditions comparative measurement could be made by measuring the current under diminished pressure of the gas, when saturation is more readily obtained.

The method to be employed in the measurement of this ionization current depends largely on the intensity of the current to be measured. If some very active radium is spread on the lower of two insulated plates as in Fig. 1, and a saturating electric field applied, the current may be readily measured by a sensitive galvanometer of high resistance. For example, a weight of .45 gr. of radium chloride of activity 1000 times that of uranium oxide, spread over a plate of area 33 sq. cms. gave a maximum current of 1.1×10^{-8} amperes when the plates were 4.5 cms. apart. In this case the difference of potential to be applied to produce practical saturation was about 600 volts. Since most of the ionization is due to rays which are absorbed in passing through a few centimetres of air, the current is not much increased by widening the distance between the two plates. In cases where the current is not quite large enough for direct deflection, the current may be determined by connecting the upper insulated plate with a well insulated condenser. After charging for a definite time, say 1 or more minutes, the condenser is discharged through the galvanometer, and the current can be readily deduced.

50. In most cases, however, when dealing with less active substances like uranium or thorium, or with small amounts of active

material, it is necessary to employ methods for measuring currents much smaller than can be conveniently detected by an ordinary galvanometer. The most convenient apparatus to employ for this purpose is one of the numerous types of quadrant electrometer or an electroscope of special design. For many observations, especially where the activity of the two substances is to be compared under constant conditions, an electroscope offers a very certain and simple method of measurement. As an example of a simple apparatus of this kind, a brief description will be given of the electroscope used by M. and Mme Curie in many of their earlier observations.

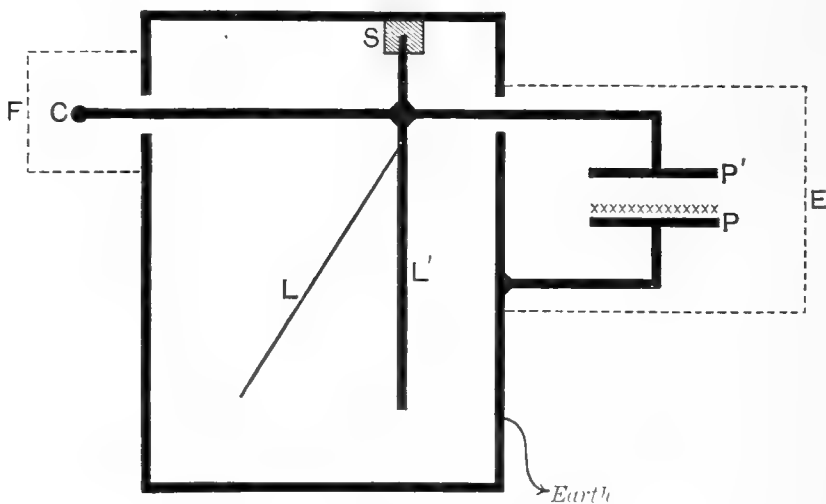

Fig. 10.

The connections are clearly seen from Figure 10. The active material is placed on a plate laid on top of the fixed circular plate P , connected with the case of the instrument and to earth. The upper insulated plate P' is connected to the insulated gold-leaf system LL' . S is an insulating support and L the gold-leaf.

The system is first charged to a suitable potential by means of the rod C . The rate of movement of the gold-leaf is observed by means of a microscope. In comparisons of the activity of two specimens, the time taken to pass over a certain number of divisions of the micrometer scale in the eyepiece is observed. Since the capacity of the charged system is constant, the average rate of movement of the gold-leaf is directly proportional to the ionization current between P and P' , *i.e.* to the intensity of the

radiation emitted by the active substance. Unless very active material is being examined, the difference of potential between P and P' can easily be made sufficient to produce saturation.

When necessary, a correction can readily be made for the rate of leak when no active material is present. In order to avoid external disturbances, the plates PP' and the rod C , are surrounded by metal cylinders, E and F , connected with earth.

51. A modified form of the gold-leaf electroscope can be used to determine extraordinarily minute currents with accuracy, and can be employed in cases where a sensitive electrometer is unable to detect the current. A special type of electroscope has been used by Elster and Geitel, in their experiments on the natural ionization of the atmosphere. A very convenient type of electroscope to measure the current due to minute ionization of the gas is shown in Fig. 11.

This type of electroscope was first used by C. T. R. Wilson¹ in his experiments of the natural ionization of air in closed vessels. A brass cylindrical vessel is taken of about 1 litre capacity. The gold-leaf system consisting of a narrow strip of gold-leaf L attached to a flat rod R is insulated inside the vessel by the small sulphur bead S , supported from the rod P . In a dry atmosphere a clean sulphur bead is almost a perfect insulator. The system is charged by a light bent rod CC' passing through the ebonite cork D . The rod C is connected to one terminal of a battery of small accumulators of 200 to 300 volts. If these are absent the system can be charged by means of a rod of sealing-wax. The charging rod CC' is then removed from contact with the gold-leaf system. The rods P and C and the cylinder are then connected with earth.

The rate of movement of the gold-leaf is observed by a reading microscope through two holes in the cylinder, covered with thin mica. In cases where the natural ionization due to the enclosed

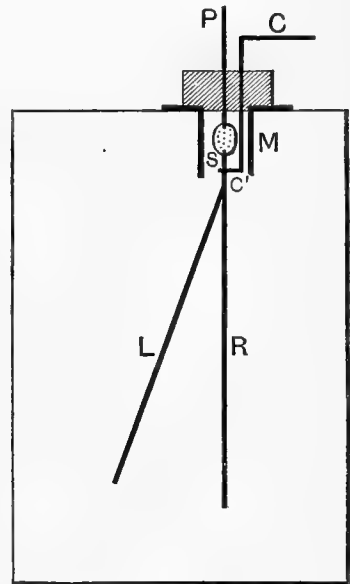

Fig. 11.

¹ *Proc. Roy. Soc.* Vol. 68, p. 152, 1901.

air in the cylinder is to be accurately measured, it is advisable to enclose the supporting and charging rod and sulphur bead inside a small metal cylinder M connected to earth, so that only the charged gold-leaf system is exposed in the main volume of the air.

In an apparatus of this kind the small leakage over the sulphur bead can be almost completely eliminated by keeping the rod P charged to the average potential of the gold-leaf system during the observation. This method has been used with great success by C. T. R. Wilson (*loc. cit.*). Such refinements, however, are generally unnecessary, except in investigations of the natural ionization of gases at low pressures, when the conduction leak over the sulphur bead is comparable with the discharge due to the ionized gas.

52. The electric capacity C of a gold-leaf system about 4 cms. long is usually about 1 electrostatic unit. If V is the decrease of potential of the gold-leaf system in volts in the time t seconds, the current i through the gas is given by

$$i = \frac{CV}{t}.$$

With a well cleaned brass electroscope of volume 1 litre, the fall of potential due to the natural ionization of the air was found to be about 6 volts per hour. Since the capacity of the gold-leaf system was about 1 electrostatic unit

$$i = \frac{1 \times 6}{3600 \times 300} = 5.6 \times 10^{-6} \text{ E.S. units} = 1.9 \times 10^{-15} \text{ amperes.}$$

With special precautions a rate of discharge of 1/10 or even 1/100 of this amount can be accurately measured.

The number of ions produced in the gas can be calculated if the charge on an ion is known. J. J. Thomson has shown that the charge e on an ion is equal to 3.4×10^{-10} electrostatic units or 1.13×10^{-19} coulombs.

Let q = number of ions produced per second per cubic centimetre throughout the volume of the electroscope,

S = volume of electroscope in cubic centimetres.

If the ionization is uniform, the saturation current i is given by $i = qSe$.

Now for an electroscope with a volume of 1000 c.c., i was equal to about 1.9×10^{-15} amperes. Substituting the values given above
 $q = 17$ ions per cubic centimetre per second.

With suitable precautions an electroscope can thus readily measure an ionization current corresponding to the production of 1 ion per cubic centimetre per second.

The great advantage of an apparatus of this kind lies in the fact that the current measured is due to the ionization inside the vessel and is not influenced by the ionization of the external air or by electrostatic disturbances. Such an apparatus is very convenient for investigating the very penetrating radiations from the radio-elements, since these rays pass readily through the walls of the electroscope. When the electroscope is placed on a lead plate 3 or 4 mms. thick, the ionization in the electroscope, due to a radioactive body placed under the lead, is due entirely to the very penetrating rays, since the other two types of rays are completely absorbed in the lead plate.

53. A modified form of electroscope, which promises to be of great utility for measuring currents even more minute than those to be observed with the type of instrument already described, has recently been devised by C. T. R. Wilson¹. The construction of the apparatus is shown in Fig. 12.

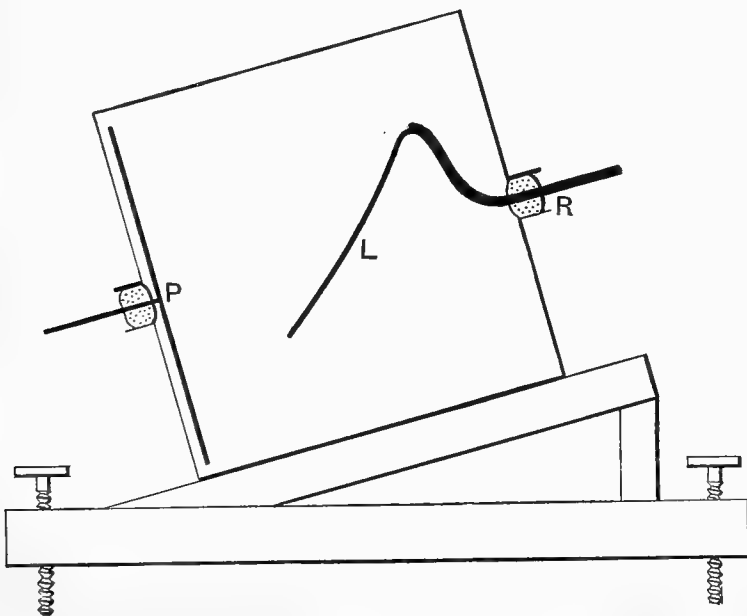

Fig. 12.

¹ *Proc. Camb. Phil. Soc.* Vol. 12, Part II. 1903.

The case consists of a rectangular brass box 4 cms. \times 4 cms. \times 3 cms. A narrow gold-leaf L is attached to a rod R passing through a clean sulphur cork. Opposite the gold-leaf is fixed an insulated brass plate P , placed about 1 mm. from the wall of the box. The movement of the gold-leaf is observed through two small windows by means of a microscope provided with a micrometer scale. The plate P is maintained at a constant potential (generally about 200 volts). The electrometer case is placed in an inclined position as shown in the figure, the angle of inclination and the potential of the plate being adjusted to give the desired sensitiveness. The gold-leaf is initially connected to the case, and the microscope adjusted so that the gold-leaf is seen in the centre of the scale. For a given potential of the plate, the sensitiveness depends on the angle of tilt of the case. There is a certain critical inclination below which the gold-leaf is unstable. The most sensitive position lies just above the critical angle. In a particular experiment Wilson found that with an angle of tilt of 30° and with the plate at a constant potential of 207 volts, the gold-leaf, when raised to a potential of one volt above the case, moved over 200 scale divisions of the eyepiece, 54 divisions corresponding to one millimetre.

In use, the rod R is connected with the external insulated system whose rise or fall of potential is to be measured. On account of the small capacity of the system and the large movement of the gold-leaf for a small difference of potential, the electroscope is able to measure extraordinarily minute currents. The apparatus is portable. If the plate P is connected to one pole of a dry pile the gold-leaf is stretched out towards the plate, and in this position can be carried without risk of injury.

54. Electrometers. Although the electroscope can be used with advantage in special cases, it is limited in its application. The most generally convenient apparatus for measurement of ionization currents through gases is one of the numerous types of quadrant electrometers. With the use of auxiliary capacities, the electrometer can be used to measure currents with accuracy over a wide range, and can be employed for practically every kind of measurement required in radio-activity.

The elementary theory of the symmetrical quadrant electrometer

as given in the text-books is very imperfect. It is deduced that the sensibility of the electrometer—measured by the deflection of the needle for 1 volt P.D. between the quadrants—varies directly as the potential of the charged needle, provided that this potential is high compared with the P.D. between the quadrants. In most electrometers however, the sensibility rises to a maximum, and then decreases with increase of potential of the needle. For electrometers in which the needle lies close to the quadrants, this maximum sensibility is obtained for a comparatively low potential of the needle. A theory of the quadrant electrometer, accounting for this action, has been recently given by G. W. Walker¹. The effect appears to be due to the presence of the air space that necessarily exists between adjoining quadrants.

Suppose that it is required to measure with an electrometer the ionization current between two horizontal metal plates *A* and *B* (Fig. 13) on the lower of which some active material has been spread. If the saturation current is required, the insulated plate *A* is connected with one pole of a battery of sufficient E.M.F. to produce saturation, the other pole being connected to earth. The insulated plate *B* is connected with one pair of quadrants of the electrometer, the other pair being earthed. By means of a suitable key *K*, the plate *B* and the pair of quadrants connected with it may be

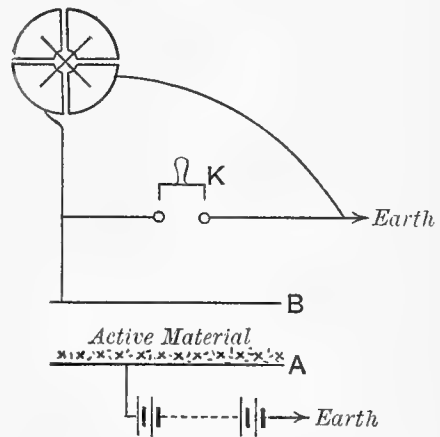

Fig. 13.

either insulated or connected with earth. When a measurement is to be taken the earth connection is broken. If the positive pole of the battery is connected with *A*, the plate *B* and the electrometer connections immediately begin to be charged positively, and the potential, if allowed, will steadily rise until it is very nearly equal to the potential of *A*. As soon as the potential of the electrometer system begins to rise, the electrometer needle commences to move at a uniform rate. Observations of the angular movement of the needle are made either by the telescope and scale

¹ *Phil. Mag.* Aug. 1903.

or by the movement of the spot of light on a scale in the usual way. If the needle is damped so as to give a uniform motion over the scale, the rate of movement of the needle, *i.e.* the number of divisions of the scale passed over per second, may be taken as a measure of the current through the gas. The rate of movement is most simply obtained by observing with a stop-watch the time taken for the spot of light, after the motion has become steady, to pass over 100 divisions of the scale. As soon as the observation is made, the plate *B* is again connected with earth, and the electrometer needle returns to its original position.

In most experiments on radio-activity only comparative measures of saturation currents are required. If these comparative measures are to extend over weeks or months, as is sometimes the case, it is necessary to adopt some method of standardizing the electrometer from day to day, so as to correct for variation in its sensibility. This is most simply done by comparing the current to be measured with that due to a standard sample of uranium oxide, which is placed in a definite position in a small testing vessel, always kept in connection with the electrometer. Uranium oxide is a very constant source of radiation, and the saturation current due to it is the same from day to day. By this method of comparison accurate observations may be made on the variation of activity of a substance over long intervals of time, although the sensibility of the electrometer may vary widely between successive measurements.

55. Construction of electrometers. As the quadrant electrometer has gained the reputation of being a difficult and uncertain instrument for accurate measurements of current, it may be of value to give some particular details in regard to the best method of construction and insulation. In most of the older types of quadrant electrometers the needle system was made unnecessarily heavy. In consequence of this, if a sensibility of the order of 100 mms. deflection for 1 volt was required, it was necessary to charge the Leyden jar connected to the needle to a fairly high potential. This at once introduced difficulties, for at a high potential it is not easy to insulate the Leyden jar satisfactorily, or to charge it to the same potential from day to day. This drawback

is to a large extent avoided in the White pattern of the Kelvin electrometer, which is provided with a replenisher and attracted disc for keeping the potential of the needle at a definite value. If sufficient trouble is taken in insulating and setting up this type of electrometer, it proves a very useful instrument of moderate sensibility, and will continue in good working order for a year or more without much attention.

Simpler types of electrometer of greater sensibility can however be readily constructed to give accurate results. The old type of quadrant electrometer, to be found in every laboratory, can readily be modified to prove a useful and trustworthy instrument. A light needle can be simply made of thin aluminium, of silvered paper or of a thin plate of mica, covered with gold-leaf to make it conducting. The aluminium wire and mirror attached should be made as light as possible. The needle should be suspended either by a fine quartz fibre or a long bifilar suspension of silk. A very fine phosphor bronze wire of some length is also very satisfactory. A magnetic control is not very suitable, as it is disturbed by coils or dynamos working in the neighbourhood. In addition, the zero point of the needle is not as steady as with the quartz or bifilar suspension.

When an electrometer is used to measure a current by noting the rate of movement of the needle, it is essential that the needle should be damped sufficiently to give a uniform motion of the spot of light over the scale. The damping requires fairly accurate adjustment. If it is too little, the needle has an oscillatory movement superimposed on the steady motion; if it is too great, it moves too sluggishly from rest and takes some time to attain a state of uniform motion. With a light needle, very little, if any, extra damping is required. A light platinum wire with a single loop dipping in sulphuric acid is generally sufficient for the purpose.

With light needle systems and delicate suspensions, it is only necessary to charge the needle to a potential of a few hundred volts to give a sensibility of several thousand divisions for a volt. With such low potentials, the difficulty of insulation of the condenser, with which the needle is in electrical connection, is much reduced. It is convenient to use a condenser such that the potential of the needle does not fall more than a few per cent. per day. The

ordinary short glass jar partly filled with sulphuric acid is, in most cases, not easy to insulate to this extent. It is better to replace it by an ebonite (or sulphur) condenser¹ such as is shown in Fig. 14.

A circular plate of ebonite about 1 cm. thick is turned down until it is not more than $\frac{1}{2}$ mm. thick in the centre. Into this circular recess a brass plate *B* fits loosely. The ebonite plate rests on another brass plate *C* connected with earth. The condenser thus formed has a considerable capacity and retains a charge for a long time. In order to make connection with the needle, a small glass vessel *D*, partly filled with sulphuric acid, is placed on the plate *B* and put in connection with the needle by means of a fine platinum wire. The platinum wire from the needle dips into the acid, and serves to damp the needle. In a dry atmosphere, a condenser of this kind will not lose more than 20 per cent. of its charge in a week. If the insulation deteriorates, it can readily be made good by rubbing the edge of the ebonite *A* with sand-paper, or removing its surface in a lathe.

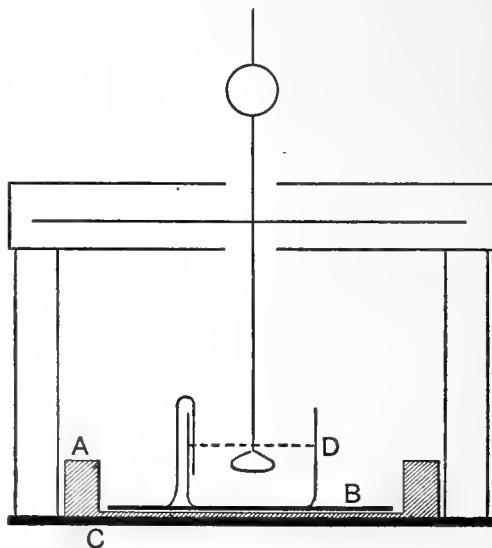

Fig. 14.

If a sufficient and steady E.M.F. is available, it is much better to keep it constantly connected with the needle and to avoid the use of the condenser altogether. If a battery of small accumulators is used, their potential can always be kept at a constant value, and the electrometer always has a constant sensibility.

56. A very useful electrometer of great sensibility has recently been devised by Dolezalek². It is of the ordinary quadrant type with a very light needle of silvered paper, spindle shaped, which lies fairly close to the quadrants. A very fine quartz suspension is

¹ Strutt, *Phil. Trans. A*, p. 507, 1901.

² *Instrumentenkunde*, p. 345, Dec. 1901.

employed. In consequence of the lightness of the needle and the nearness to the quadrants it acts as its own damper. This is a great advantage, for difficulties always arise with the wire dipping into sulphuric acid, on account of the thin film which collects after some time on the surface of the acid. This film obstructs the motion of the platinum wire dipping into the acid, and has to be removed at regular intervals. These instruments can be readily made to give a sensibility of several thousand divisions for a volt when the needle is charged to about one hundred volts. The sensibility of the electrometer passes through a maximum as the potential of the needle is increased. It is always advisable to charge the needle to about the value of this critical potential. The capacity of the electrometer is in general high (about 50 electrostatic units) but the increased sensibility more than compensates for this. The needle may either be charged by lightly touching it with one terminal of a battery, or it may be kept charged to a constant potential through the quartz suspension. The quartz fibre can be made sufficiently conducting for this purpose by dipping it into a dilute solution of calcium chloride. In addition to its great sensibility, the advantages of this instrument lie in the steadiness of the zero and in the self-damping.

57. Adjustment and screening. In adjusting an electrometer, it is important to arrange that the needle lies symmetrically with regard to the quadrants. This is best tested by observing whether the needle is deflected on charging, the quadrants all being earthed. In most electrometers there is an adjustable quadrant, the position of which may be altered until the needle is not displaced on charging. When this condition is fulfilled, the zero reading of the electrometer remains unaltered as the needle loses its charge, and the deflection on both sides of the zero should be the same for equal and opposite quantities of electricity.

The supports of the quadrants require to be well insulated. Ebonite rods are as a rule more satisfactory for this purpose than glass. In testing for the insulation of the quadrants and the connections attached, the system is charged to give a deflection of about 200 scale divisions. If the needle does not move more than one or two divisions after standing for one minute, the

insulation may be considered quite satisfactory. When a suitable desiccator is placed inside the tight-fitting electrometer case, the insulation of the quadrants should remain good for months. If the insulation of the ebonite deteriorates, it can easily be made good by removing the surface of the ebonite in a lathe.

In working with a sensitive instrument like the Dolezalek electrometer, it is essential that the electrometer and the testing apparatus should be completely enclosed in a screen of wire-gauze connected with earth, in order to avoid electrostatic disturbances. If an apparatus is to be tested at some distance from the electrometer, the wires leading to it should be insulated in metal cylinders connected to earth. The size of the insulators used at various points should be made as small as possible in order to avoid disturbances due to their electrification. In damp climates, paraffin or sulphur insulates better than ebonite. The objection to paraffin as an insulator for sensitive electrometers lies in the difficulty of getting entirely rid of any electrification on its surface. When once paraffin has been charged, the residual charge, after discharging it with a flame, continues to leak out for a long interval. All insulators should be discharged by means of a spirit-lamp or still better by leaving some uranium near them. Care should be taken not to touch the insulation when once discharged.

In accurate work it is advisable to avoid the use of gas jets or bunsen flames in the neighbourhood of the electrometer, as the flame gases are strongly ionized and take some time to lose their conductivity. If radio-active substances are present in the room, it is necessary to enclose the wires leading to the electrometer in fairly narrow tubes, connected with earth. If this is not done, it will be found that the needle does not move at a constant rate, but rapidly approaches a steady deflection where the rate of loss of charge of the electrometer and connections, due to the ionization of the air around them, is balanced by the current to be measured. This precaution must always be taken when observations are made on the very penetrating rays from active substances. These rays readily pass through ordinary screens, and ionize the air around the electrometer and connecting wires. For this reason it is impossible to make accurate measurements of small currents in a room which is used for the preparation of radio-active material.

In course of time the walls of the room become radio-active owing to the dissemination of dust and the action of the radio-active emanations.

58. Electrometer key. For work with electrometers of high sensibility, a special key is necessary to make and break from a distance the connection of the quadrants to earth in order to avoid electrostatic disturbances at the moment the current is to be measured. The simple key shown in Fig. 15 has been found very satisfactory for this purpose. A small brass rod BM , to which a string is attached, can be moved vertically up and down in a brass tube A , which is rigidly attached to a bent metal support connected to earth. When the string is released this rod makes contact with the mercury M , which fills a hole in the small block of ebonite P . The electrometer and testing vessel are connected with the mercury. When the string is pulled the rod BM is removed from the mercury and the earth connection of the electrometer system is broken. On release of the string, the rod BM falls and the electrometer is again earthed. By means of this key, which may be operated at any distance from the electrometer, the earth connection may be made and broken at definite intervals without any appreciable disturbance of the needle.

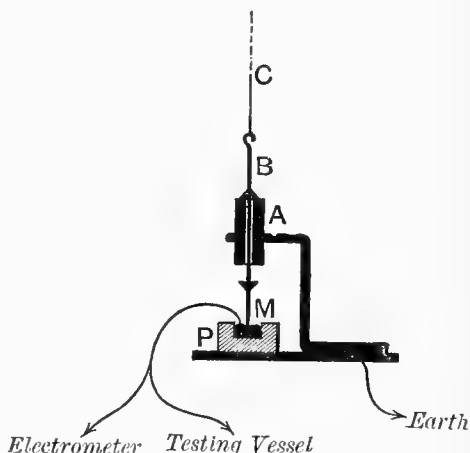

Fig. 15.

59. Testing apparatus. The arrangement shown in Fig. 16 is very convenient for many measurements in radio-activity. Two parallel insulated metal plates A and B are placed inside a metal vessel V , provided with a side door. The plate A is connected with one terminal of a battery of small storage cells, the other pole of which is earthed; the plate B with the electrometer, and the vessel V with earth. The shaded areas in the figure indicate the position of ebonite insulators. The active material to be tested is spread uniformly in a shallow groove (about 5 cms. square and 2 mms.

deep) in the brass plate *A*. In order to avoid breaking the battery connection every time the plate *A* is removed, the wire

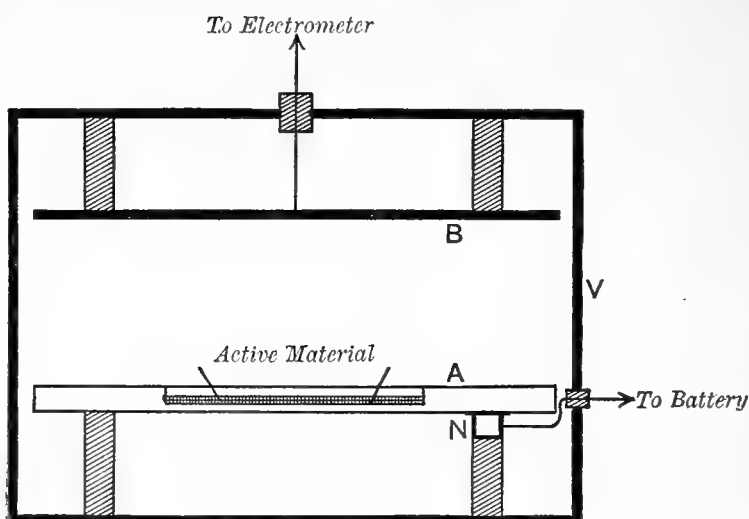

Fig. 16.

from the battery is permanently connected to the metal block *N* resting on the ebonite support. In this arrangement there is no possibility of a conduction leak from the plate *A* to *B*, since the earth-connected vessel *V* intervenes.

An apparatus of this kind is very convenient for testing the absorption of the radiations by solid screens, as well as for making comparative studies of the activity of different bodies. Unless very active preparations of radium are employed, a battery of 300 volts is sufficient to ensure saturation when the plates are not more than 5 centimetres apart. If substances are being tested which give off a radio-active emanation, the effect of the emanation can be eliminated by passing a steady current of air from a gas bag between the plates. This removes the emanation as fast as it is produced.

If a clean plate is put in the place of *A*, a small movement of the electrometer needle is always observed. If there is no radio-active substance in the neighbourhood, this effect is due to the small natural ionization of the air. We can always correct for this natural leak when necessary.

60. It is often required to measure the activity due to the emanations of thorium or radium or the excited activity produced

by those emanations on rods or wires. A convenient apparatus for this purpose is shown in Fig. 17. The cylinder *B* is connected with

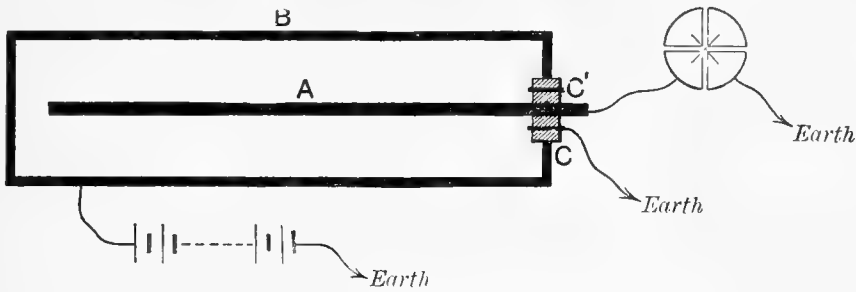

Fig. 17.

the battery in the usual way, and the central conductor *A* with the electrometer. This central rod is insulated from the external cylinder by an ebonite cork, which is divided into two parts by a metal ring *CC'* connected to earth. This ring acts the part of a guard-ring, and prevents any conduction leak between *B* and *A*. The ebonite is thus only required to insulate satisfactorily for the small rise of potential produced on *A* during the experiment. In all accurate measurements of current in radio-activity the guard-ring principle should always be used to ensure good insulation. This is easily secured when the ebonite is only required to insulate for a fraction of a volt, instead of for several hundred volts, as is the case when the guard-ring is absent.

61. For measurements of radio-activity with an electrometer, a steady source of E.M.F. of at least 300 volts is necessary. This is best obtained by a battery of small cells simply made by immersing strips of lead in dilute sulphuric acid, or by a battery of small accumulators of the usual construction. Small accumulators of capacity about one-half ampere hour can now be obtained at a moderate price, and are more constant and require less attention than simple lead cells.

In order to measure currents over a wide range, a graduated series of capacities is required. The capacity of an electrometer and testing apparatus is usually about 50 electrostatic units or $\cdot 000056$ microfarads. Subdivided condensers of mica are constructed in which capacities varying from $\cdot 001$ to $\cdot 2$ microfarads are provided. With such a condenser, another extra capacity is required to

bridge over the gap between the capacity of the electrometer and the lowest capacity of the condenser. This capacity of value about 200 electrostatic units can readily be made of parallel plates or still better of concentric cylinders. With this series of capacities, currents may be measured between 3×10^{-14} and 3×10^{-8} amperes—a range of over one million times. Still larger currents can be measured if the sensibility of the electrometer is reduced, or if larger capacities are available.

In a room devoted to electrometer measurements of radio-activity, it is desirable to have no radio-active matter present except that to be tested. The room should also be as free from dust as possible. The presence of a large quantity of dust in the air (see section 31) is a very disturbing factor in all radio-active measurements. A larger E.M.F. is required to produce saturation on account of the diffusion of the ions to the dust particles. The presence of dust in the air also leads to uncertainty in the distribution of excited activity in an electric field (see section 171).

62. Measurement of Current. In order to determine the current in the electrometer circuit by measuring the rate of movement of the needle, it is necessary to know both the capacity of the circuit and the sensibility of the electrometer.

Let C = capacity of electrometer and its connections in E.S. units.

d = number of divisions of the scale passed over per second.

D = sensibility of the electrometer measured in scale divisions for 1 volt P.D. between the quadrants.

The current i is given by the product of the capacity of the system and the rate of rise of potential.

$$\begin{aligned} \text{Thus} \quad i &= \frac{Cd}{300D} \text{ E.S. units,} \\ &= \frac{Cd}{9 \times 10^{11} D} \text{ amperes.} \end{aligned}$$

Suppose, for example,

$$C = 50, \quad d = 5, \quad D = 1000.$$

$$\text{Then} \quad i = 2.8 \times 10^{-13} \text{ amperes.}$$

Since the electrometer can readily measure a current corresponding to a movement of half a scale division per second, it is easily seen that an electrometer can measure a current of 3×10^{-14} amperes, which is considerably below the range of the most sensitive galvanometer.

The capacity of the electrometer itself must not be considered as only that of the pair of quadrants and the needle when in a position of rest. The actual capacity is very much larger than this, on account of the motion of the charged needle. Suppose, for example, the needle is charged to a high negative potential, and kept at the zero position by an external constraint. If a quantity Q of positive electricity is given to the electrometer and its connections, the whole system is raised to a potential V , such that $Q = CV$, where C is the capacity of the system. When however the needle is allowed to move, it is attracted into the charged pair of quadrants. This corresponds to the introduction of a negatively charged body between the quadrants, and in consequence the potential of the system is lowered to V' . The actual capacity C' of the system when the needle moves is thus greater than C , and is given by

$$C'V' = CV.$$

The capacity of the electrometer is thus not a constant, but depends on the potential of the needle, *i.e.* on the sensibility of the electrometer.

An interesting result of practical importance follows from the variation of the capacity of the electrometer with the potential of the needle. If the external capacity attached to the electrometer is small compared with that of the electrometer itself, the rate of movement of the needle for a constant current is, in some cases, independent of the sensibility. An electrometer may be used for several days or even weeks to give nearly equal deflections for a constant current, without recharging the needle, although its potential has been steadily falling during the interval. In such a case the decrease in sensibility is nearly proportional to the decrease in capacity of the electrometer, so that the deflection for a given current is not much altered. The theory of this action has been given by J. J. Thomson¹.

¹ *Phil. Mag.* 46, p. 537, 1898.

63. The capacity of the electrometer and its connections cannot be measured by any of the commutator methods used for the determination of small capacities, for in such cases the needle does not move, and the capacity measured is not that of the electrometer system when in actual use. The value of the capacity may, however, be determined by the method of mixtures.

Let C = capacity of electrometer and connections.

C_1 = capacity of a standard condenser.

The electrometer and its connections are charged to a potential V_1 by a battery, and the deflection d_1 of the needle is noted. By means of an insulated key, the capacity of the standard condenser is added in parallel with the electrometer system. Let V_2 be the potential of the system, and d_2 the new deflection.

Then
$$CV_1 = (C + C_1) V_2,$$

$$\frac{C + C_1}{C} = \frac{V_1}{V_2} = \frac{d_1}{d_2},$$

and

$$C = C_1 \frac{d_2}{d_1 - d_2}.$$

A simple standard capacity for this purpose can be constructed of two concentric brass tubes the diameters of which can be accurately measured. The external cylinder D (Fig. 18) is mounted

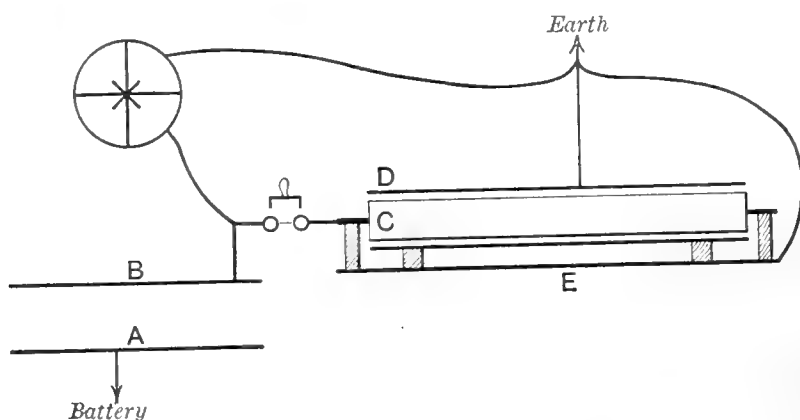

Fig. 18.

on a wooden base, which is covered with a sheet of metal or tin-foil connected to earth. The tube C is supported centrally on ebonite

rods at each end. The capacity is given approximately by the formula

$$C = \frac{l}{2 \log_e \frac{b}{a}},$$

where b is the internal diameter of D , a the external diameter of C , and l the length of the tubes.

The following method can in some cases be used with advantage. While a testing vessel is in connection with the electrometer, a sample of uranium is placed on the lower plate A . Let d_2 and d_1 be the number of divisions passed over per second by the needle with and without the standard capacity in connection.

Then
$$\frac{C + C_1}{C} = \frac{d_1}{d_2},$$

and
$$C = C_1 \frac{d_2}{d_1 - d_2}.$$

This method has the advantage that the relative capacities are expressed in terms of the motion of the needle under the actual conditions of measurement.

64. Quartz piezo-electrique. In measurements of the strength of currents by electrometers, it is always necessary to determine the sensibility of the instrument and the capacity of the electrometer and the apparatus attached thereto. By means of the quartz piezo-electrique devised by the brothers MM. J. and P. Curie¹, measurements of the current can be made with rapidity and accuracy over a wide range. These measurements are quite independent of the capacity of the electrometer and external circuit.

The essential part of this instrument consists of a plate of quartz which is cut in a special manner. When this plate is placed under tension, there is a liberation of electricity equal in amount but opposite in sign on the two sides of the plate. The plate of quartz AB (Fig. 19) is hung vertically and weights are added to the lower end. The plate is cut so that the optic axis of

¹ *C. R.* 91, pp. 38 and 294, 1880. See also Friedel and J. Curie, *C. R.* 96, pp. 1262 and 1389, 1883, and Lord Kelvin, *Phil. Mag.* 36, pp. 331, 342, 384, 414, 453, 1893.

the crystal is horizontal and at right angles to the plane of the paper.

The two faces A and B are normal to one of the binary axes (or electrical axes) of the crystal. The tension must be applied in a direction normal to the optic and electric axes. The two faces A and B are silvered, but the main portion of the plate is electrically

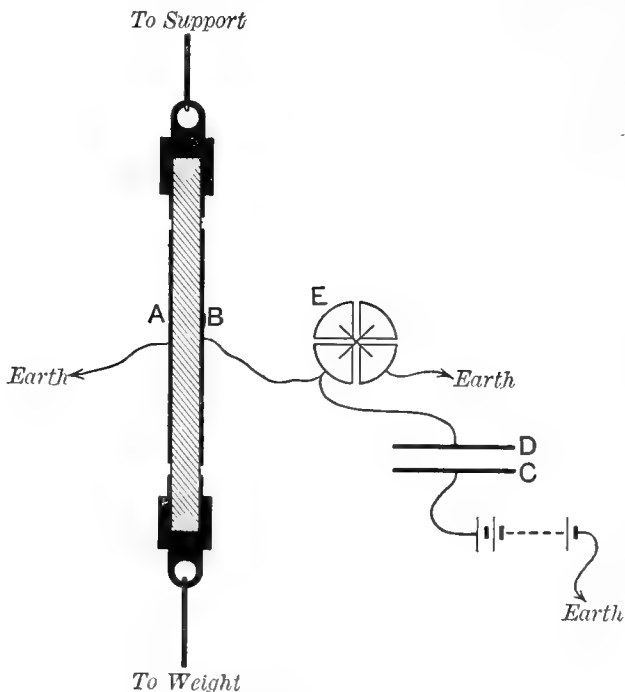

Fig. 19.

insulated by removing a narrow strip of the silvering near the upper and lower ends of the plate. One side of the plate is connected to the electrometer and to the conductor, the rate of leak of which is to be measured. The quantity of electricity set free on one face of the plate is accurately given by

$$Q = 0.063 \frac{L}{b} \cdot F,$$

where L is the length of the insulated portion of the plate, b the thickness AB , and F the weight attached in kilogrammes. Q is then given in electrostatic units.

Suppose, for example, that it is required to measure the current between the plates CD (Fig. 19), due to some radio-active material on the plate C , for a given difference of potential between C and D .

At a given instant the connection of the quadrants of the electrometer with the earth is broken. The weight is attached to the quartz plate, and is held in the hand so as to gradually apply the tension. This causes a release of electricity opposite in sign to that given to the plate D . The electrometer needle is kept at the position of rest as nearly as possible by adjusting the tension by hand. The tension being fully applied, the moment the needle commences to move steadily from zero is noted. The current between the plates CD is then given by $\frac{Q}{t}$ where t is the time of the observation. The value of Q is known from the weight attached.

In this method the electrometer is only used as a detector to show that the system is kept at zero potential. No knowledge of the capacity of the insulated system is required. With practice, measurements of the current can be made in this way with rapidity and certainty.

CHAPTER IV.

NATURE OF THE RADIATIONS.

PART I.

COMPARISON OF THE RADIATIONS.

65. The Three Types of Radiation. All the radio-active substances possess in common the power of acting on a photographic plate and of ionizing the gas in their immediate neighbourhood. The intensity of the radiations may be compared by means of their photographic or electrical action; and, in the case of the strongly radio-active substances, by the power they possess of lighting up a phosphorescent screen. Such comparisons, however, do not throw any light on the question whether the radiations are of the same or of different kinds, for it is well known that such different types of radiations as the short waves of ultra-violet light, Röntgen and cathode rays, all possess the property of producing ions throughout the volume of a gas, lighting up a fluorescent screen, and acting on a photographic plate. Neither can the ordinary optical methods be employed to examine the radiations under consideration, as they show no trace of regular reflection, refraction, or polarization.

Two general methods can be used to distinguish the types of the radiations given out by the same body, and also to compare the radiations from the different active substances. These methods are as follows:

(1) By observing whether the rays are appreciably deflected in a magnetic field.

(2) By comparing the relative absorption of the rays by solids and gases.

Examined in these ways, it has been found that there are three different types of radiation emitted from radio-active bodies, which for brevity and convenience have been termed the α , β , and γ rays.

(i) The α rays are very readily absorbed by thin metal foil and by a few centimetres of air. They have been shown to consist of positively charged bodies projected with a velocity of about $1/10$ the velocity of light. They are deflected by intense magnetic and electric fields, but the amount of deviation is minute in comparison with the deviation, under the same conditions, of the cathode rays produced in a vacuum tube.

(ii) The β rays are far more penetrating in character than the α rays, and consist of negatively charged bodies projected with velocities of the same order as the velocity of light. They are far more readily deflected than the α rays and are in fact identical with the cathode rays produced in a vacuum tube.

(iii) The γ rays are extremely penetrating, and non-deviable by a magnetic field. Their true nature is not yet known, but they are analogous in some respects to very penetrating Röntgen rays.

The three best known radio-active substances, uranium, thorium, and radium, all give out these three types of rays, each in an amount approximately proportional to its relative activity. Polonium stands alone in giving only the α or easily absorbed rays¹.

66. Deflection of the rays. The rays emitted from the active bodies thus present a very close analogy with the rays which are produced in a highly exhausted vacuum tube when an electric

¹ In an examination of uranium the writer (*Phil. Mag.* Jan. 1899) found that the rays from uranium consist of two kinds, differing greatly in penetrating power, which were called the α and β rays. Later, it was found that similar types of rays were emitted by thorium and radium. On the discovery of very penetrating rays from uranium and thorium as well as in radium, the term γ was applied to them by the writer. The word "ray" has been retained in this work, although it is now settled that the α and β rays consist of material particles projected with great velocity. The term is thus used in the same sense as by Newton, who applied it in the *Principia* to the stream of corpuscles which he believed to be responsible for the phenomenon of light. In some recent papers the α and β rays have been called the α and β "emanations." This nomenclature cannot fail to lead to confusion, since the term "radio-active emanation" has already been generally adopted in radio-activity as applying to the material substance which gradually *diffuses* from thorium and radium compounds, and itself emits rays.

discharge passes through it. The α rays correspond to the canal rays, discovered by Goldstein, which have been shown by Wien to consist of positively charged bodies projected with great velocity. The β rays are the same as the cathode rays, while the γ rays in some respects resemble the Röntgen rays. In a vacuum tube, a large amount of electric energy is expended to produce the rays, but, in the radio-active bodies, the rays are emitted spontaneously and at a rate uninfluenced by any chemical or physical agency. The α and β rays from the active bodies are projected with much greater velocity than the corresponding rays in a vacuum tube, while the γ rays are of much greater penetrating power than Röntgen rays.

The effect of a magnetic field on a pencil of rays from a radio-active substance giving out the three kinds of rays is very well illustrated in Fig. 20¹.

Some radium is placed in the bottom of a narrow cylindrical lead vessel R . A narrow pencil of rays consisting of α , β , and γ rays escapes from the opening. If a strong uniform magnetic field is applied at right angles to the plane of the paper, and directed towards the paper, the three types of rays are separated from one another. The γ rays continue in a straight line without any deviation. The β rays are deflected to the right, describing circular orbits the radius of which varies within wide limits.

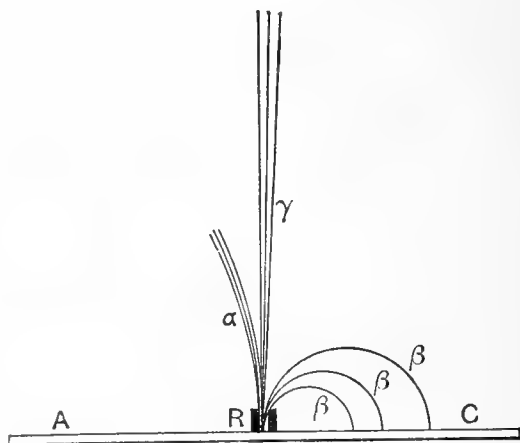

Fig. 20.

If the photographic plate AC is placed under the radium vessel, the β rays produce a diffuse photographic impression on the right of the vessel R . The α rays are bent in the direction opposite to that of the β rays and describe a portion of the arc of a circle of large radius, but they are rapidly absorbed after traversing a distance of a few centimetres from the vessel R . The amount

¹ This method of illustration is due to Mme Curie, *Thèse présentée à la Faculté des Sciences de Paris*, 1903.

of the deviation of the α rays compared with that of the β rays is much exaggerated in the figure.

67. Ionizing and penetrating power of the rays. Of the three kinds of rays, the α rays produce most of the ionization in the gas and the γ rays the least. With a thin layer of un-screened active material spread on the lower of two parallel plates 5 cms. apart, the amount of ionization due to the α , β , and γ rays is of the relative order 10,000, 100, and 1. These numbers are only rough approximations, and the differences become less marked as the thickness of the radio-active layer increases.

The average penetrating power of the rays is shown below. In the first column is given the thickness of the aluminium, which cuts each radiation down to half its value, and in the second the relative power of penetration of the rays.

Radiation	Thickness of Aluminium in cms. which cuts off half the radiation	Relative power of penetration
α rays	0.0005 cms.	1
β "	0.05 cms.	100
γ "	8 cms.	10000

The relative power of penetration is thus approximately inversely proportional to the relative ionization. These numbers, however, only indicate the order of relative penetrating power. This power varies considerably for the different active bodies.

The α rays from uranium and polonium are the least penetrating, and those from thorium the most. The β radiations from thorium and radium are very complex, and consist of rays widely different in penetrating power. Some of the β rays from these substances are much less and others much more penetrating than those from uranium, which gives out fairly homogeneous rays.

68. Difficulties of comparative measurements. It is difficult to make quantitative or even qualitative measurements of the relative intensity of the three types of rays from active substances. The three general methods employed depend upon the action of the rays in ionizing the gas, in acting on a photographic

plate, and in causing phosphorescent or fluorescent effects in certain substances. In each of these methods the fraction of the rays which is absorbed and transformed into another form of energy is different for each type of ray. Even when one specific kind of ray is under observation, comparative measurements are rendered difficult by the complexity of that type of rays. For example, the β rays from radium consist of negatively charged particles projected with a wide range of velocity, and, in consequence, they are absorbed in different amounts in passing through a definite thickness of matter. In each case, only a fraction of the energy absorbed is transformed into the particular type of energy, whether ionic, chemical, or luminous, which serves as a means of measurement.

The rays which are the most active electrically are the least active photographically. Under ordinary conditions most of the photographic action of uranium, thorium, and radium, is due to the β or cathodic rays. The α rays from uranium and thorium, on account of their weak action, have not yet been detected photographically. With active substances like radium and polonium, the α rays readily produce a photographic impression. So far the γ rays have been detected photographically from radium only. That no photographic action of these rays has yet been established for uranium and thorium is probably due merely to the fact that the effect sought for is very small, and during exposures for long intervals it is very difficult to avoid fogging of the plates owing to other causes. Considering the similarity of the radiations in other respects, there can be little doubt that the γ rays do produce some photographic action, though it is too small to observe with certainty.

These differences in the photographic and ionizing properties of the radiations must always be taken into account in comparing results obtained by the two methods. The apparent contradiction of results obtained by different observers using these two methods is found to be due to their differences in relative photographic and ionizing action. For example, with the unscreened active material, the ionization observed by the electrical method is due almost entirely to α rays, while the photographic action under the same condition is due almost entirely to the β rays.

It is often convenient to know what thickness of matter is sufficient to absorb a specific type of radiation. A thickness of

aluminium or mica of $\cdot 01$ cms. or a sheet of ordinary writing-paper is sufficient to completely absorb all the α rays. With such a screen over the active material, the effects are due only to the β and γ rays, which pass through with a very slight absorption. Most of the β rays are absorbed in 5 mms. of aluminium or 2 mms. of lead. The radiation passing through such screens consists very largely of the γ rays. As a rough working rule it may be taken that a thickness of matter required to absorb any type of rays is inversely proportional to the density of the substance, *i.e.* the absorption is proportional to the density. This rule holds approximately for light substances, but, in heavy substances like mercury and lead, the radiations are about twice as readily absorbed as the density rule would lead us to expect.

PART II.

THE β OR CATHODIC RAYS.

69. Discovery of the β rays. A discovery which gave a great impetus to the study of the radiations from active bodies was made in 1899, almost simultaneously in Germany, France, and Austria, when it was observed that preparations of radium gave out some rays deviable by a magnetic field, and very similar in character to the cathode rays produced in a vacuum tube. The observation of Elster and Geitel that a magnetic field altered the conductivity produced in air by radium rays, led Giesel¹ to examine the effect of a magnetic field on the radiations. In his experiments, the radio-active preparation was placed in a small vessel between the poles of an electromagnet. The vessel was arranged to give a pencil of rays which was approximately perpendicular to the field. The rays caused a small fluorescent patch on the screen. On exciting the electromagnet, the fluorescent zone was observed to broaden out on one side. On reversing the field, the extension of the zone was in the opposite direction. The deviation of the rays thus indicated was in the same direction and of the same order of magnitude as that for cathode rays.

S. Meyer and Schweidler² also obtained similar results. They

¹ *Wied. Annal.* 69, p. 831, 1899.

² *Phys. Zeit.* 1, pp. 90, 113, 1899.

showed, in addition, the deviation of the rays when a change occurred in the conductivity of the air under the influence of a magnetic field. Becquerel¹, a little later, showed the magnetic deflection of the radium rays by using the photographic method. P. Curie², by the electrical method, showed furthermore that the rays from radium consisted of two kinds, one apparently non-deviable and easily absorbed (now known as the α rays), and the other penetrating and deviable by a magnetic field (now known as the β rays). The ionization effect due to the β rays was only a small fraction of that due to the α rays. At a later date Becquerel, by the photographic method, showed that uranium gave out some deflectable rays. It had been shown previously³ that the rays from uranium consisted of α and β rays. The deflected rays in Becquerel's experiment consisted entirely of β rays, as the α rays from uranium produce no appreciable photographic action. Rutherford and Grier⁴, using the electric method, showed that compounds of thorium, like those of uranium, gave out beside α rays some penetrating β rays, deviable in a magnetic field. As in the case of radium, the ionization due to the α rays of uranium and thorium is large compared with that due to the β rays.

70. Examination of the magnetic deviation by the photographic method. Becquerel has made a very complete study, by the photographic method, of the β rays from radium, and has shown that they behave in all respects like cathode rays, which are known to be negatively charged particles moving with a high velocity. J. J. Thomson (*Recent Researches*, p. 136) has obtained the equation for the path of a charged particle moving in a uniform magnetic field. If a particle of mass m and charge e is projected with a velocity V , at an angle α with the direction of a field of strength H , it will describe a curved path, whose radius R of curvature is given by

$$R = \frac{mV}{He} \sin \alpha.$$

The path of the particle is a helix wound on a cylinder of radius R with the axis parallel to the field.

¹ *C. R.* 129, pp. 997, 1205. 1899.

² *C. R.* 130, p. 73, 1900.

³ Rutherford, *Phil. Mag.* January, 1899.

⁴ *Phil. Mag.* September, 1902.

When $\alpha = \frac{\pi}{2}$, *i.e.* when the rays are projected normally to the field, the particles describe circles of radius

$$R = \frac{mV}{He}.$$

The planes of these circles are normal to the field. Thus for a particular velocity V the value of R varies inversely as the strength of the field. In a uniform field the rays projected normally to the field describe circles, and their direction of projection is a tangent at the origin.

This has been verified experimentally by Becquerel for the β rays of radium, by an arrangement similar to that shown in Fig. 21.

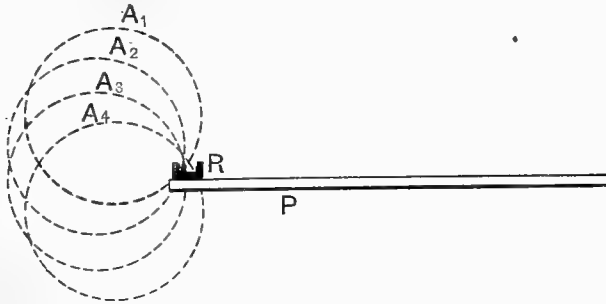

Fig. 21.

A photographic plate P , with the film downwards, is enveloped in black paper and placed horizontally in the uniform horizontal magnetic field of an electromagnet. The magnetic field is supposed to be uniform and, in the figure, is at right angles to the plane of the paper. The plate was covered with a sheet of lead, and on the edge of the plate, in the centre of the magnetic field is placed a small lead vessel R containing the radio-active matter.

On exciting the magnet, so that the rays are bent to the left of the figure, it is observed that a photographic impression is produced directly below the source of the rays, which have been bent round by the magnetic field. The active matter sends out rays equally in all directions. The rays perpendicular to the field describe circles, which strike the plate immediately under the source. A few of these rays, A_1 , A_2 , A_3 , are shown in the figure. The rays, normal to the plate, strike the plate almost normally,

while the rays nearly parallel to the plate strike the plate at nearly grazing incidence. The rays, inclined to the direction of the field, describe spirals and produce effects on an axis parallel to the field passing through the source. In consequence of this, any opaque screen placed in the path of the rays has its shadow thrown near the edge of the photographic plate.

71. Complexity of the rays. The deviable rays from radium are complex, *i.e.* they are composed of a flight of particles projected with a wide range of velocity. In a magnetic field every ray describes a path, of which the radius of curvature is directly proportional to the velocity of projection. The complexity of the radiation has been very clearly shown by Becquerel¹ in the following way.

An uncovered photographic plate, with the film upwards, was placed horizontally in the horizontal uniform magnetic field of an electro-magnet. A small, open, lead box, containing the radio-active matter, was placed in the centre of the field, on the photographic plate. The light, due to the phosphorescence of the radio-active matter, therefore, could not reach the plate. The whole apparatus was placed in a dark room. The impression on the plate takes the form of a large, diffuse, but continuous band, elliptic in shape, produced on one side of the plate.

Such an impression is to be expected if the rays are sent out in all directions, even if their velocities of projection are the same, for it can readily be shown theoretically, that the path of the rays is confined within an ellipse whose minor axis, which is at right angles to the field, is equal to $2R$, and whose major axis is equal to πR . If, however, the active matter is placed in the bottom of a deep lead cylinder of small diameter, the rays have practically all the same direction of projection, and in that case each part of the plate is acted on by rays of a definite curvature.

In this case also, a diffuse impression is observed on the plate, giving, so to speak, a continuous spectrum of the rays and showing that the radiation is composed of rays of widely different curvatures. Fig. 22 shows a photograph of this kind, obtained by Becquerel, with strips of paper, aluminium, and platinum placed on the plate.

¹ *C. R.* 130, pp. 206, 372, 810, 979. 1900.

If screens of various thickness are placed on the plate, it is observed that the plate is not appreciably affected within a certain

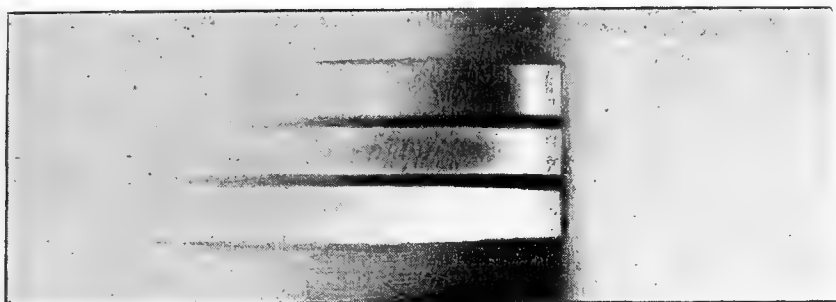

Fig. 22.

distance from the active matter, and that this distance increases with the thickness of the screen. This distance is obviously equal to twice the radius of curvature of the path of the rays, which are just able to produce an impression through the screen.

These experiments show very clearly that the most deviable rays are the most readily absorbed by matter. By observations of this kind Becquerel has determined approximately the inferior limit of the value of HR for rays which are transmitted through different thicknesses of matter.

The results are given in the table below :

Substance	Thickness in mms.	Inferior limit of HR for transmitted rays
Black paper ...	0·065	650
Aluminium ...	0·010	350
" "	0·100	1000
" "	0·200	1480
Mica ...	0·025	520
Glass ...	0·155	1130
Platinum ...	0·030	1310
Copper ...	0·085	1740
Lead ...	0·130	2610

If $\frac{e}{m}$ is a constant for all the rays, the value of HR is proportional to the velocity of the rays, and it follows from the table that the velocity of the rays which just produce an effect on the plate through ·13 mms. of lead is about 7 times that of the rays which

just produce an impression through $\cdot 01$ mms. of aluminium. It will be shown, however, in section 76, that $\frac{e}{m}$ is not a constant for all speeds, but decreases with increase of velocity of the rays. The difference in velocity between the rays is in consequence not as great as this calculation would indicate. On examination of the rays from uranium, Becquerel found that the radiation is not as complex as that from radium, but consists wholly of rays for which the value of HR is about 2000.

72. Examination of the β rays by the electric method.

The presence of easily deviable rays given off from an active substance can most readily be shown by the photographic method, but it is necessary, in addition, to show that the penetrating rays which produce the ionization in the gas are the same as those which cause the photographic action. This can be conveniently tested in an arrangement similar to that shown in Fig. 23.

The radio-active matter A is placed on a lead block B'' between the two parallel lead plates BB' . The rays pass between the parallel plates and ionize the gas between the plates PP' of the testing vessel. The magnetic field is applied at right angles to the plane of the paper. The dotted rectangle $EEEE$ represents the position of the pole piece. If a compound of radium or thorium is under investigation, a stream of air is required to prevent the diffusion of the radio-active emanations into the testing vessel. When a layer of uranium, thorium or radium compound is placed at A , the ionization in the testing vessel is due mainly to the action of the α and β rays. The α rays are cut off by adding a layer of aluminium $\cdot 01$ cm. thick over the active material. When the layer of active matter is not more than a few millimetres thick, the ionization due to the γ rays is small compared with that produced by the β rays, and may be neglected. On the application of a magnetic field at right angles to the mean

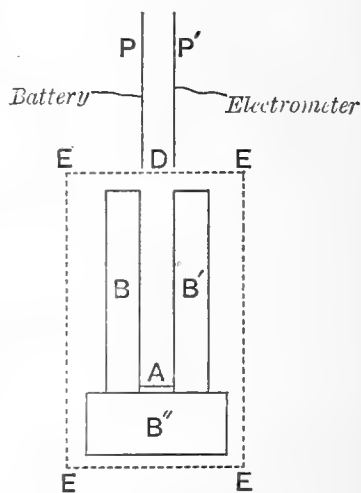

Fig. 23.

direction of the rays, the ionization in the testing vessel due to the rays steadily decreases as the strength of the field increases, and in a strong field it is reduced to a very small fraction of its original value. In this case the rays are bent so that none of them enter the testing vessel.

Examined in this way it has been found that the β rays of uranium, thorium, and radium consist entirely of rays readily deflected by a magnetic field. The rays from polonium consist entirely of α rays, the deviation of which can be detected only in very intense magnetic fields.

When the screen covering the active material is removed, in a strong magnetic field, the ionization in the vessel is mainly due to the α rays. On account of the slight deviation of the α rays under ordinary experimental conditions, a still greater increase of the magnetic field does not appreciably alter the current due to them in the testing vessel.

The action of a magnetic field on a very active substance like radium is easily shown by the electrical method, as the ionization current due to the deviable rays is large. With substances of small activity like uranium and thorium, the ionization current due to the deviable rays is very small, and a sensitive electrometer or an electroscope is required to determine the variation, in a magnetic field, of the very small current involved. This is especially the case for thorium oxide, which gives out only about $1/5$ of the amount of deviable rays that the same weight of uranium oxide gives.

73. Experiments with a fluorescent screen. The β rays from a few milligrams of pure radium bromide produce intense fluorescence in barium platino-cyanide and other substances which can be made luminous under the influence of the cathode rays. Using a centigram of radium bromide, the luminosity on a screen, placed upon it, is bright enough to be observed in daylight. With the aid of such a screen in a dark room many of the properties of the β rays may be simply illustrated and their complex nature clearly shown. A small quantity of radium is placed in the bottom of a short, narrow, lead tube open at one end. This is placed between the pole pieces of an electro-magnet, and

the screen placed below it. With no magnetic field, a faint luminosity of the screen is observed due to the very penetrating γ rays which readily pass through the lead. When the magnetic field is put on, the screen is brightly lighted up on one side over an area elliptical in shape (section 71). The direction of deviation is reversed by reversal of the field. The broad extent of the illumination shows the complex nature of the β rays. On placing a metallic object at various points above the screen, the trajectory of the rays can readily be traced by noticing the position of the shadow cast upon the screen. By observing the density of the shadow, it can readily be seen that the rays most easily deviated are the least penetrating.

Comparison of the β rays with cathode rays.

74. Means of comparison. In order to prove the identity of the β rays from active bodies with the cathode rays produced in a vacuum tube, it is necessary to show

- (1) That the rays carry with them a negative charge ;
- (2) That they are deviated by an electric as well as by a magnetic field ;
- (3) That the ratio e/m is the same as for the cathode rays.

Electric charge carried by the β rays. The experiments of Perrin and J. J. Thomson have shown that the cathode rays carry with them a negative charge. In addition, Lenard has shown that the rays still carry with them a charge after traversing thin layers of matter. When the rays are absorbed, they give up their charge to the body which absorbs them. The total amount of charge carried by the β rays from even a very active preparation of radium is, in general, small compared with that carried by the whole of the cathode rays in a vacuum tube, and can be detected only by very delicate methods.

Suppose that a layer of very active radium is spread on a metal plate connected to earth, and that the β rays are absorbed by a parallel plate connected with an electrometer. If the rays are negatively charged, the top plate should receive a negative charge increasing with the time. On account, however, of the great

ionization produced by the rays between the plates, any charge given to one of them is almost instantly dissipated. In many cases the plate does become charged to a definite positive or negative potential depending on the metal, but this is due to the contact difference of potential between the plates, and would be produced whether the rays were charged or not. The ionization of the gas is greatly diminished by placing over the active material a metal screen which absorbs the α rays, but allows the β rays to pass through with little absorption.

The rapid loss of any charge communicated to the top plate can be very much reduced, either by diminishing the pressure of the gas surrounding it or by enclosing the plate with suitable insulators. In their experiments to determine the amount of charge carried by the radium rays, M. and Mme Curie¹ used the second method.

A metal disc *MM* (Fig. 24) is connected with an electrometer by the wire *T*. The disc and wire are completely surrounded by insulating matter *ii*. The whole is surrounded by a metal envelope *EEEE* connected with earth. On the lower side of the disc, the insulator and the metallic covering are very thin. This side is exposed to the rays of the radium *R* placed in a depression in a lead plate *AA*.

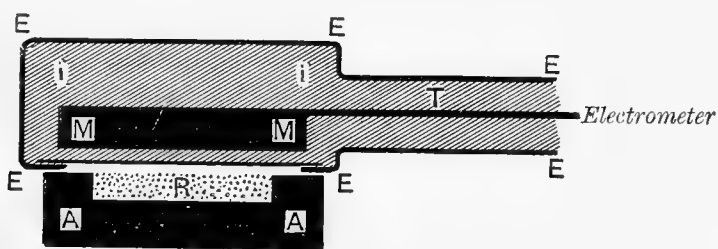

Fig. 24.

The rays of the radium pass through the metal cover and insulator with little absorption, but they are completely absorbed by the disc *MM*. It was observed that the disc received a negative charge which increased uniformly with the time, showing that the rays carry with them a negative charge. The current observed was very small. With an active preparation of radium², forming a

¹ *C. R.* 130, p. 647, 1900.

² The activity of the radium preparation was not stated in the paper.

layer 2.5 sq. cms. in area and 2 mms. thick, a current of the order of 10^{-11} amperes was observed after the rays had traversed a layer of aluminium .01 mm. thick and a layer of ebonite .3 mm. thick. The current was the same with discs of lead, copper, and zinc, and also when the ebonite was replaced by paraffin.

Curie also observed in another experiment of a similar character that the radium itself acquired a positive charge. This necessarily follows if the rays carry with them a negative charge. If the β rays alone carried with them a charge, a pellet of radium, if perfectly insulated, and surrounded by a non-conducting medium, would in the course of time be raised to a high positive potential. Since, however, the α rays carry with them a charge opposite in sign to the β rays, the ratio of the charge carried off by the two types of rays must be determined, before it can be settled whether the radium would acquire a positive or a negative charge. If, however, the radium is placed in an insulated metal vessel of a thickness sufficient to absorb all the α rays, but not too thick to allow most of the β rays to escape, the vessel will acquire a positive charge in a vacuum.

An interesting experimental result bearing upon this point has been described by Dorn¹. A small quantity of radium was placed in a sealed glass tube and left for several months. On opening the tube with a file, a bright electric spark was observed at the moment of fracture, showing that there was a large difference of potential between the inside of the tube and the earth.

In this case the α rays were absorbed in the walls of the tube, but a large proportion of the β rays escaped. The inside of the tube thus became charged, in the course of time, to a high positive potential; a steady state would be reached when the rate of escape of negative electricity was balanced by the leakage of positive electricity through the walls of the tube. The external surface of the glass would be always practically at zero potential, on account of the ionization of the air around it.

Strutt² has recently described a simple experiment to illustrate still more clearly that a radium preparation acquires a positive charge, if it is enclosed in an envelope thick enough to

¹ *Phys. Zeit.* 4, No. 18, p. 507, 1903.

² *Phil. Mag.* Nov. 1903.

absorb all the α particles, but thin enough to allow most of the β particles to escape. A sealed tube, containing the radium, was attached at one end to a pair of thin gold leaves in metallic connection with the radium, and was insulated inside a larger tube by means of a quartz rod. The air in the outer tube was exhausted as completely as possible by means of a mercury pump, in order to reduce as much as possible the ionization in the gas, and consequently the loss of any charge gained by the gold leaves. After an interval of 20 hours, the gold leaves were observed to diverge to their full extent, indicating that they had acquired a large positive charge. In this experiment Strutt used $\frac{1}{2}$ gram of radiferous barium of activity only 100 times that of uranium. It can readily be calculated that 10 milligrams of pure radium bromide would have caused an equal divergence of the leaves in a few minutes.

A determination of the amount of the charge carried off by the rays of radium has been made recently by Wien¹. A small quantity of radium, placed in a sealed platinum vessel, was hung by an insulating thread inside a glass cylinder which was exhausted to a low pressure. A connection between the platinum vessel and an electrode sealed on the external glass cylinder could be made, when required, by tilting the tube. Wien found that in a good vacuum the platinum vessel became charged to about 100 volts. The rate of escape of negative electricity from the platinum vessel containing 4 milligrams of radium bromide corresponded to 2.91×10^{-12} amperes. If the charge on each particle is taken as 1.1×10^{-20} electromagnetic units, this corresponds to an escape of 2.66×10^7 particles per second. From 1 gram of radium bromide the corresponding number would be 6.6×10^9 per second. Since some of the β rays are absorbed in their passage through the walls of the containing vessel, the actual number projected per second from 1 gram of radium bromide must be greater than the above value.

75. Determination of e/m . J. J. Thomson has shown that in their passage between the plates of a condenser the cathode rays are deflected towards the positive plate. Shortly after the discovery of the magnetic deviation of the β rays from radium,

¹ *Phys. Zeit.* 4, No. 23, p. 624, 1903.

Dorn¹ and Becquerel² showed that they also were deflected by an electrostatic field.

By observing the amount of the electrostatic and magnetic deviation, Becquerel was able to determine the ratio of e/m and the velocity of the projected particles. Two rectangular copper plates, 3.45 cms. high and 1 cm. apart, were placed in a vertical plane and insulated on paraffin blocks. One plate was charged to a high potential by means of an influence machine, and the other was connected to earth. The active matter was placed in a narrow groove cut in a lead plate parallel to the copper plates and placed midway between them. The photographic plate, enveloped in black paper, was placed horizontally above the plate containing the active substance. The large and diffuse pencil of rays thus obtained was deflected by the electric field, but the deviation amounted to only a few millimetres and was difficult to measure. The method finally adopted was to place vertically above the active matter a thin screen of mica, which cut the field into two equal parts. Thus, in the absence of an electric field, a narrow rectangular shadow was produced on the plate.

When the electric field was applied, the rays were deflected and a part of the pencil of rays was stopped by the mica screen. A shadow was thus cast on the plate which showed the direction of deviation and corresponded to the least deviable rays which gave an impression through the black paper.

If a particle of mass m , charge e , and velocity v , is projected normally to an electric field of strength X , the acceleration α is in the direction of the field, and is given by

$$\alpha = \frac{Xe}{m}.$$

Since the particle moves with a constant acceleration parallel to the field, the path of the particle is the same as that of a body projected horizontally from a height with a constant velocity and acted on by gravity. The path of the particle is thus a parabola, whose axis is parallel to the field and whose apex is at the point where the particle enters the electric field. The linear deviation

¹ *C. R.* 130, p. 1129, 1900.

² *C. R.* 130, p. 809, 1900.

d_1 of the ray parallel to the field after traversing a distance l is given by

$$d_1 = \frac{1}{2} \frac{Xe l^2}{m v^2}.$$

On leaving the electric field, the particle travels in the direction of the tangent to the path at that point. If θ is the angular deviation of the path at that point

$$\tan \theta = \frac{eXl}{mv^2}.$$

The photographic plate was a distance h above the extremity of the field. Thus the particles struck the plate at a distance d_2 from the original path given by

$$\begin{aligned} d_2 &= h \tan \theta + d_1 \\ &= \frac{Xle}{mv^2} (l/2 + h). \end{aligned}$$

In the experimental arrangement the values were

$$\begin{aligned} d_2 &= .4 \text{ cms.}; \\ X &= 1.02 \times 10^{12}; \\ l &= 3.45 \text{ cms.}; \\ h &= 1.2 \text{ cms.} \end{aligned}$$

If the radius R of curvature of the path of the same rays is observed in a magnetic field of strength H perpendicular to the rays,

$$\frac{e}{m} = \frac{V}{HR}.$$

Combining these two equations we get

$$v = \frac{X \cdot l \left(\frac{l}{2} + h \right)}{H \cdot R \cdot d_2}.$$

A difficulty arose in identifying the radiations for which the electric and magnetic deviations were determined. Becquerel estimated that the value of HR for the rays deflected by the electric field was about 1600 c.g.s. units. Thus

$$v = 1.6 \times 10^{10} \text{ cms. per second,}$$

and

$$\frac{e}{m} = 10^7.$$

Thus these rays had a velocity more than half the velocity of light, and an apparent mass about the same as the cathode ray particles, *i.e.* about 1/1000 of the mass of the hydrogen atom. The β ray is therefore analogous in all respects to the cathode ray, except that it differs in velocity. In a vacuum tube the cathode rays generally have a velocity of about 2×10^9 cms. per sec. In special tubes with strong fields the velocity may be increased to about 10^{10} cms. per sec. These charged particles behave like isolated units of negative electricity. The conception of such disembodied charges, known as electrons, has been examined mathematically among others by Larmor, who sees in this conception the ultimate basis of a theory of matter. The β rays from radium may also be considered as electrons, but when obtained from this source have velocities varying from about $1/3V$ to at least $.96V$, where V is the velocity of light, and thus have an average velocity considerably greater than that of the electrons produced in a vacuum tube. These moving electrons are, it seems, able to pass through much greater thicknesses of matter before they are absorbed than the slower electrons produced in a vacuum tube, but the difference is one merely of degree and not of kind. Electrons are thus continuously and spontaneously expelled from radium with enormous velocities. It is difficult to avoid the conclusion, that this velocity has not been suddenly impressed on the electron. Such a sudden gain of velocity would mean an immense and sudden concentration of energy on a small particle, and it is more probable that the electron has been in rapid orbital or oscillatory motion in the atom, and, by some means or other, suddenly escapes from its orbit. According to this view, the energy of the electron is not suddenly created, but is only made obvious by its escape from the system to which it belongs.

76. Variation of $\frac{e}{m}$ with the velocity of the electron.

The fact that radium throws off electrons with rates of speed varying from $1/3$ to $9/10$ the velocity of light has been utilised by Kaufmann¹ to examine whether the ratio e/m of the electrons varies with the speed. It has been shown by J. J. Thomson²,

¹ *Phys. Zeit.* 4, No. 1 b, p. 54, 1902.

² *Phil. Mag.* April, 1881.

Heaviside¹, and Searle² that, according to the electromagnetic theory, a charge of electricity in motion behaves as if it had apparent mass. For small speeds this additional electrical mass is equal to $\frac{2e^2}{3a}$ where a is the radius of the body, but it increases rapidly as the speed of light is approached. It is very important to settle whether the mass of the electron is due partly to mechanical and partly to electrical mass, or whether it can be explained by virtue of electricity in motion independent of the usual conception of mass.

Slightly different formulae expressing the variation of mass with speed have been developed by J. J. Thomson, Heaviside, and Searle. To interpret his results Kaufmann used a formula developed by M. Abraham³.

Let m_0 = mass of electron for slow speeds ;
 m = apparent mass of electron at any speed ;
 u = velocity of electron ;
 V = velocity of light.

Let $\beta = \frac{u}{V}$.

Then it can be shown that

$$\frac{m}{m_0} = 3/4 \psi(\beta) \dots\dots\dots (1),$$

where
$$\psi(\beta) = \frac{1}{\beta^2} \left[\frac{1 + \beta^2}{2\beta} \log \frac{1 + \beta}{1 - \beta} - 1 \right] \dots\dots\dots (2).$$

The experimental method employed to determine e/m and u is similar to the method of crossed spectra. Some strongly active radium was placed at the bottom of a brass box. The rays from this passed between two brass plates insulated and about 1.2 mm. apart. These rays fell on a platinum diaphragm, in which was a small tube about 0.2 mm. in diameter, which allowed a narrow bundle of rays to pass. The rays fell on a photographic plate enveloped in a thin layer of aluminium.

In the experiments the diaphragm was about 2 cms. from the active material and the same distance from the photographic plate.

¹ *Collected Papers*, Vol. 2, p. 514.

² *Phil. Mag.* October, 1897.

³ *Phys. Zeit.* 4, No. 1 b, p. 57, 1902.

When the whole apparatus was placed in a vacuum, a P.D. of from 2000 to 5000 volts could be applied between the plates without a spark. The rays were deflected in their passage through the electric field and produced what may be termed an electric spectrum on the plate.

If a magnetic field is superimposed parallel to the electric field by means of an electromagnet, a magnetic spectrum is obtained perpendicular to the electric spectrum. The combination of the two spectra gives rise to a curved line on the plate. Disregarding some small corrections, it can readily be shown that if y and z are the electric and magnetic deviations respectively,

$$\beta = \kappa_1 \frac{z}{y} \dots\dots\dots(3),$$

and

$$\frac{e}{m} = \kappa \frac{z^2}{y} \dots\dots\dots(4).$$

From these two equations, combined with (1) and (2), we obtain

$$\frac{y}{z^2 \psi \left(\kappa_1 \frac{z}{y} \right)} = \kappa_2 \dots\dots\dots(5),$$

where $\kappa, \kappa_1, \kappa_2$ are constants.

Equation (5) gives the curve that should be obtained on the plate according to the electromagnetic theory. This is compared by trial with the actual curve obtained on the plate.

In this way Kaufmann¹ found that the value of e/m decreased with the speed, showing that, assuming the charge constant, the mass of the electron increased with the speed.

The following numbers give some of the preliminary results obtained by this method.

Velocity of electron	$\frac{e}{m}$
2.36×10^{10} cms. per sec.	1.31×10^7
2.48 " "	1.17×10^7
2.59 " "	0.97×10^7
2.72 " "	0.77×10^7
2.85 " "	0.63×10^7

¹ *Nachrichten d. Ges. d. Wiss. zu Gött.*, Nov. 8, 1901.

For the cathode rays S. Simon¹ obtained a value of e/m of 1.86×10^7 for an average speed of about 7×10^9 cms. per second.

In a later paper² with some very active radium, more satisfactory photographs were obtained which allowed of accurate measurement. The given equation of the curve was found to agree satisfactorily with experiment.

The following table, deduced from the results given by Kaufmann, shows the agreement between the theoretical and experimental values, u being the velocity of the electron and V that of light.

Value of $\frac{u}{V}$	Observed value of $\frac{m}{m_0}$	Percentage difference from theoretical values
Small	1	
·732	1·34	-1·5 %
·752	1·37	-0·9 „
·777	1·42	-0·6 „
·801	1·47	+0·5 „
·830	1·545	+0·5 „
·860	1·65	0 „
·883	1·73	+2·8 „
·933	2·05	-7·8 „ ?
·949	2·145	-1·2 „
·963	2·42	+0·4 „

The average percentage error between the observed and calculated value is thus not much more than one per cent. It is remarkable how nearly the velocity of the electron has to approach the velocity of light before the value of $\frac{m}{m_0}$ becomes large. This is shown in the following table which gives the calculated values of $\frac{m}{m_0}$ for different velocities of the electron.

Value of $\frac{u}{V}$	small	·1	·5	·9	·99	·999	·9999	·999999
Calculated $\frac{m}{m_0}$ value	1·00	1·015	1·12	1·81	3·28	4·96	6·68	10·1

Thus for velocities varying from 0 to $1/10$ the velocity of light,

¹ *Wied. Annal.* p. 589, 1899.

² *Phys. Zeit.* 4, No. 1 b, p. 54, 1902.

the mass of the electron is practically constant. The increase of mass becomes appreciable at about half the velocity of light, and increases steadily as the velocity of light is approached. Theoretically the mass becomes infinite at the velocity of light, but even when the velocity of the electron only differs from that of light by one part in a million, its mass is only 10 times the value for slow speeds.

The above results are therefore in agreement with the view that the mass of the electron is altogether electrical in origin and can be explained purely by electricity in motion. The value of e/m_0 , for slow speeds, deduced from the results was 1.84×10^7 , which is in very close agreement with the value obtained by Simon for the cathode rays, viz. 1.86×10^7 .

If the electricity carried by the electron is supposed to be distributed uniformly over a sphere of radius a , for speeds slow compared with the velocity of light, the apparent mass $m_0 = \frac{2}{3} \frac{e^2}{a}$.

Therefore
$$a = \frac{2}{3} \frac{e}{m_0} \cdot e.$$

Taking the value of e as 1.13×10^{-20} , a is 1.4×10^{-13} cms.

Thus the diameter of an electron is minute compared with the diameter of an atom.

77. Absorption of the β rays by matter. The absorption of the β rays by matter can readily be investigated by noting the variation of the ionization current in a testing vessel when the active matter is covered by screens differing in material and thickness. When the active matter is covered with aluminium foil of thickness .1 mm., the current in a testing vessel such as is shown in Fig. 16, is due almost entirely to the β rays. If a uranium compound is used, it is found that the saturation current decreases with the thickness of matter traversed very nearly according to an exponential law. Taking the saturation current as a measure of the intensity of the rays, the intensity I after passing through a thickness d of matter is given by

$$\frac{I}{I_0} = e^{-\lambda d},$$

where λ is the constant of absorption of the rays in unit thickness

of matter, and I_0 is the initial intensity. For uranium rays the current is reduced to half its value after passing through about $\cdot 5$ mm. of aluminium.

If a compound of thorium or radium is examined in the same way, it is found that the current does not decrease regularly according to the above equation. Results of this kind for radium rays have been given by Meyer and Schweidler¹. The amount of absorption of the rays by a certain thickness of matter decreases with the thickness traversed. This is exactly opposite to what is observed for the α rays. This variation in the absorption is due to the fact that the β rays are made up of rays which vary greatly in penetrating power. The rays from uranium are fairly homogeneous in character, *i.e.* they consist of rays projected with about the same velocity. The rays from radium and thorium are complex, *i.e.* they consist of rays projected with a wide range of velocity and consequently with a wide range of penetrating power. The electrical examination of the deviable rays thus leads to the same results as their examination by the photographic method.

Results on the absorption of cathode rays have been given by Lenard², who has shown that the absorption of cathode rays is nearly proportional to the density of the absorbing matter, and is independent of its chemical state. If the deviable rays from active bodies are similar to cathode rays, a similar law of absorption is to be expected. Strutt³, working with radium rays, has determined the law of absorption and has found it roughly proportional to the density of matter over a range of densities varying from 0.041 for sulphur dioxide to 21.5 for platinum. In the case of mica and cardboard, the values of λ divided by the density were 3.94 and 3.84 respectively, while the value for platinum was 7.34. In order to deduce the absorption coefficient, he assumed that the radiation fell off according to an exponential law with the distance traversed. As the rays from radium are complex, we have seen that this is only approximately the case.

78. Since the β rays from uranium are fairly homogeneous, and are at the same time penetrating in character, they are more

¹ *Phys. Zeit.* pp. 90, 113, 209, 1900.

² *Wied. Annal.* 56, p. 275, 1895.

³ *Nature*, p. 539, 1900.

suitable for such a determination than the complex rays of radium. I have in consequence made some experiments with uranium rays to determine the dependence of absorption on the density. The results obtained are given in the following table: where λ is the coefficient of absorption.

Substance	λ	Density	$\frac{\lambda}{\text{Density}}$
Glass	14.0	2.45	5.7
Mica	14.2	2.78	5.1
Ebonite	6.5	1.14	5.7
Wood	2.16	.40	5.4
Cardboard	3.7	.70	5.3
Iron	44	7.8	5.6
Aluminium	14.0	2.60	5.4
Copper	60	8.6	7.0
Silver	75	10.5	7.1
Lead	122	11.5	10.8
Tin	96	7.3	13.2

It will be observed that the value of the absorption constant divided by the density is very nearly the same for such different substances as glass, mica, ebonite, wood, iron and aluminium. The divergences from the law are great, however, for the other metals examined, viz. copper, silver, lead and tin. In tin the value of λ divided by the density is 2.5 times its value for iron and aluminium. These differences show that a law for the absorption of the β rays depending only on the density does not hold for all substances. With an exception in the case of tin, the value of λ divided by the density for the metals increases in the same order as their atomic weights.

The absorption of the β rays by matter decreases very rapidly with increase of speed. For example, the absorption of cathode rays in Lenard's experiment (*loc. cit.*) is about 500 times as great as for the uranium β rays. The velocity of the β rays of uranium was found by Becquerel to be about 1.6×10^{10} cms. per sec. The velocity of the cathode rays used in Lenard's experiment was certainly not less than 1/10 of this, so that, for a decrease of speed of less than 10 times, the absorption has increased over 500 times.

79. Variation of the amount of radiation with the thickness of the layer of radiating material. The radiations are sent out equally from all portions of the active mass, but the ionization of the gas which is measured is due only to the radiations which escape into the air. The depth from which the radiations can reach the surface depends on the absorption of the radiation by the active matter itself.

Let λ be the absorption constant of the homogeneous radiation by the active material. It can readily be shown that the intensity I of the rays issuing from a layer of active matter, of thickness x , is given by

$$\frac{I}{I_0} = 1 - e^{-\lambda x},$$

where I_0 is the intensity at the surface due to a very thick layer.

This equation has been confirmed experimentally by observing the current due to the β rays for different thicknesses of uranium oxide. In this case $I = \frac{1}{2} I_0$ for a thickness of oxide corresponding to .11 gr. per sq. cm. This gives a value of λ divided by density of 6.3. This is a value slightly greater than that observed for the absorption of the same rays in aluminium. Such a result shows clearly that the substance which gives rise to the β rays does not absorb them to a much greater extent than does ordinary matter of the same density.

The value of λ will vary, not only for the different active substances, but also for the different compounds of the same substance.

PART III.

THE α RAYS.

80. The α rays. The magnetic deviation of the β rays was discovered towards the end of 1899, at a comparatively early stage in the history of radio-activity, but it was not until three years later that the true character of the α rays was disclosed. It was natural that great prominence should have been given in the early stages of the subject to the β rays, on account of their great penetrating

power and marked action in causing phosphorescence in many substances. The α rays were, in comparison, very little studied, and their importance was not generally recognized. It will, however, be shown that the α rays play a far more important part in radio-active processes than the β rays, and that the greater portion of the energy emitted in the form of ionizing radiations is due to them.

81. The nature of the α rays. The nature of the α rays was difficult to determine, for a magnetic field sufficient to cause considerable deviation of the β rays produced no appreciable effect on the α rays. It was suggested by several observers that they were, in reality, secondary rays set up by the β or cathode rays in the active matter from which they were produced. Such a view, however, failed to explain the radio-activity of polonium, which gave out α rays only. Later work also showed that the matter, which gave rise to the β rays from uranium, could be chemically separated from the uranium, while the intensity of the α rays was unaffected. These and other results show that the α and β rays are produced quite independently of one another. The view that they are an easily absorbed type of Röntgen rays fails to explain a characteristic property of the α rays, viz. that the absorption of the rays in a given thickness of matter, determined by the electrical method, increases with the thickness of matter previously traversed. It does not seem probable, that such an effect could be produced by a radiation like X rays, but the result is to be expected if the rays consist of projected bodies, which fail to ionize the gas when their velocity is reduced to below a certain value. From observations of the relative ionization produced in gases by the α and β rays, Strutt¹ suggested in 1901 that the α rays might consist of positively charged bodies projected with great velocity. Sir William Crookes², in 1902, advanced the same hypothesis. From a study of the α rays of polonium Mme Curie³ in 1900 suggested the probability that these rays consisted of bodies, projected with great velocity, which lost their energy by passing through matter.

¹ *Phil. Trans.* p. 507, 1901.

² *Proc. Roy. Soc.* 1902. *Chem. News*, 85, p. 109, 1902.

³ *C. R.* 130, p. 76, 1900.

The writer was led independently to the same view by a mass of indirect evidence which received an explanation only on the hypothesis that the rays consisted of matter projected with great velocity. Preliminary experiments with radium of activity 1000 showed that it was very difficult to determine the magnetic deviation of the α rays. When the rays were passed through slits sufficiently narrow to enable a minute deviation of the rays to be detected, the ionizing effect of the issuing rays was too small to measure with certainty. It was not until radium of activity 19,000 was obtained that it was possible to detect the deviation of these rays in an intense magnetic field. How small the magnetic deviation is may be judged from the fact that the α rays, projected at right angles to a magnetic field of 10,000 c.g.s. units, describe the arc of a circle of about 39 cms. radius, while under the same conditions the cathode rays produced in a vacuum tube would describe a circle of about .01 cm. radius. It is therefore not surprising that the α rays were for some time thought to be non-deviable in a magnetic field.

82. Magnetic deviation of the α rays. The general method employed¹ to detect the magnetic deviation of the α rays was to allow the rays to pass through narrow slits and to observe whether the rate of discharge of an electroscope, due to the issuing rays, was altered by the application of a strong magnetic field. Fig. 25 shows the general arrangement of the experiment. The rays from a thin layer of radium of activity 19,000 passed upwards through a number of narrow slits *G*, in parallel, and then through a thin layer of aluminium foil, .00034 cm. thick, into the testing vessel *V*. The ionization produced by the rays in the testing vessel was measured by the rate of movement of the leaves of a gold-leaf electroscope *B*. The gold-leaf system was insulated inside the vessel by a sulphur bead *C*, and could be charged by means of a movable wire *D*, which was afterwards earthed. The rate of movement of the gold-leaf was observed through small mica windows in the testing vessel by means of a microscope provided with a micrometer eye-piece.

In order to increase the ionization in the testing vessel, the

¹ Rutherford, *Phil. Mag.* Feb. 1903. *Phys. Zeit.* 4, p. 235, 1902.

rays passed through 20 to 25 slits of equal width, placed side by side. This was arranged by cutting grooves at regular intervals in side-plates into which brass plates were slipped. The width of the slit varied in different experiments between .042 cm. and .1 cm.

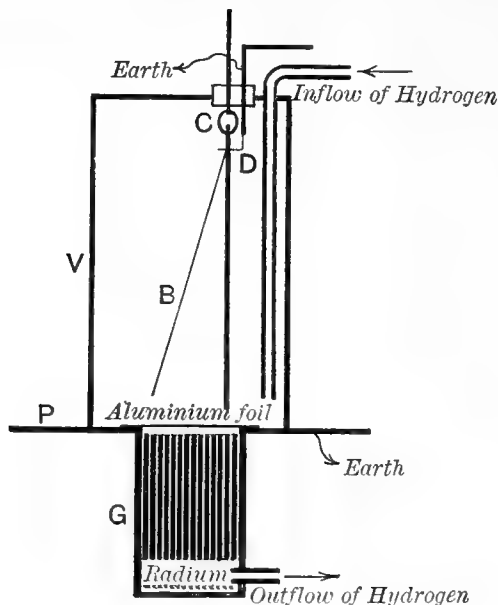

Fig. 25.

The magnetic field was applied perpendicular to the plane of the paper, and parallel to the plane of the slits. The rays are thus deflected in a direction perpendicular to the plane of the slits and a very small amount of deviation is sufficient to cause the rays to impinge on the sides of the plate where they are absorbed.

The testing vessel and system of plates were waxed to a lead plate *P* so that the rays entered the vessel *V* only through the aluminium foil. It is necessary in these experiments to have a steady stream of gas passing downwards between the plates in order to prevent the diffusion of the emanation from the radium upwards into the testing vessel. The presence in the testing vessel of a small amount of this emanation, which is always given out by radium, would produce great ionization and completely mask the effect to be observed. For this purpose, a steady current of dry electrolytic hydrogen of about 2 c.c. per second was passed into the testing vessel, streamed through the porous aluminium foil, and passed between the plates carrying the emanation with it away from the apparatus. The use of a stream of hydrogen

instead of air greatly simplifies the experiment, for it *increases* the ionization current due to the α rays in the testing vessel, and at the same time greatly *diminishes* that due to the β and γ rays. This is caused by the fact that the α rays are much more readily absorbed in air than in hydrogen, while the rate of production of ions due to the β and γ rays is much less in hydrogen than in air. The intensity of the α rays after passing between the plates is consequently greater when hydrogen is used; and since the rays pass through a sufficient distance of hydrogen in the testing vessel to be largely absorbed, the total amount of ionization produced by them is greater with hydrogen than with air.

The following is an example of an observation on the magnetic deviation:—

Pole-pieces 1.90×2.50 cms.

Strength of field between pole-pieces 8370 units.

Apparatus of 25 parallel plates of length 3.70 cms., width .70 cm., with an average air-space between plates of .042 cm.

Distance of radium below plates 1.4 cm.

					Rate of discharge of electroscope in volts per minute
(1)	Without magnetic field	8.33
(2)	With magnetic field	1.72
(3)	Radium covered with thin layer of mica to absorb all α rays	0.93
(4)	Radium covered with mica and magnetic field applied	0.92

The mica plate, .01 cm. thick, was of sufficient thickness to completely absorb all the α rays, but allowed the β rays and γ rays to pass through without appreciable absorption. The difference between (1) and (3), 7.40 volts per minute, gives the rate of discharge due to the α rays alone; the difference between (2) and (3), 0.79 volts per minute, that due to the α rays not deviated by the magnetic field employed.

The amount of α rays not deviated by the field is thus about 11% of the total. The small difference between (3) and (4) measures the small ionization due to the β rays, for they would

be completely deviated by the magnetic field. (4) comprises the effect of the γ rays together with the natural leak of the electro-scope in hydrogen.

In this experiment there was a good deal of stray magnetic field acting on the rays before they reached the pole-pieces. The diminution of the rate of discharge due to the α rays was found to be proportional to the strength of field between the pole-pieces. With a more powerful magnetic field, the whole of the α rays were deviated, showing that they consisted *entirely* of projected charged particles.

In order to determine the *direction* of deviation of the rays, the rays were passed through slits one mm. in width, each of which was half covered with a brass strip. The diminution of the rate of discharge in the testing vessel for a given magnetic field in such a case depends upon the *direction* of the field. In this way it was found that the rays were deviated in the *opposite sense* to the cathode rays. Since the latter consist of negatively charged particles, the α rays must consist of *positively* charged particles.

These results were soon after confirmed by Becquerel¹, by the photographic method, which is very well adapted to determine the character of the path of the rays acted on by a magnetic field. The radium was placed in a linear groove cut in a small block of lead. Above this source, at a distance of about 1 centimetre, was placed a metallic screen, formed of two plates, leaving between them a narrow opening paral- lled to the groove. Above this was placed the photographic plate. The whole apparatus was placed in a strong magnetic field parallel to the groove. The strength of the magnetic field was sufficient to reflect the β rays completely away from the plate. When the plate was parallel to the opening, there was produced on it an impression, due to the α rays alone, which became more and more diffuse as the distance from the opening increased. This distance should not exceed 1 or 2 centimetres on account of the absorption of the rays in air. If, during the exposure, the magnetic field is reversed for equal lengths of time, on developing the plate two images of the α rays are observed which are deflected in opposite directions. This deviation, even in a strong field, is small though quite appreciable and

¹ C. R. 136, p. 199, 1903.

is opposite in sense to the deviation observed for the β or cathodic rays from the same material.

M. Becquerel¹, by the same method, found that the α rays from polonium were deviated in the same direction as the α rays from radium; and thus that they also consist of projected positive bodies. In both cases, the photographic impressions were sharply marked and did not show the same diffusion which always appears in photographs of the β rays.

83. Electrostatic deviation of the α rays. If the rays are charged bodies, they should be deflected in passing through a strong electric field. This was found by the writer to be the case, but the electric deviation is still more difficult to detect than the magnetic deviation, as the intensity of the electric field must of necessity be less than that required to produce a spark in the presence of radium. The apparatus was similar to that employed for the magnetic deviation (Fig. 25) with this exception, that the brass sides which held the plates in position, were replaced by ebonite. Alternate plates were connected together and charged to a high potential by means of a battery of small accumulators. The discharge in the electroscop, due to the α rays, was found to be diminished by application of the electric field. With plates $\cdot 055$ cm. apart and $4\cdot 5$ cms. high, the diminution was only 7% with a P. D. of 600 volts between the slits. With a special arrangement of plates, with slits only $\cdot 01$ cm. apart, the discharge was diminished about 45% with an electric field corresponding to 10,000 volts per cm.

84. Determination of the constants of the rays. If the deviation of the rays in both an electric and magnetic field is known, the values of the velocity of the rays, and the ratio e/m of the charge of the particle to its mass can be determined by the method first used by J. J. Thomson for the cathode rays. From the equations of a moving charged body, the radius ρ of curvature of the path of the rays in a magnetic field of strength H perpendicular to the path of the rays is given by

$$H\rho = \frac{m}{e} V.$$

¹ C. R. 136, p. 431, 1903.

If the particle, after passing through a uniform magnetic field for a distance l_1 , is deviated through a small distance d_1 from its original direction,

$$2\rho d_1 = l_1^2$$

or
$$d_1 = \frac{l_1^2}{2} \frac{e}{m} \frac{H}{V} \dots\dots\dots(1).$$

If the rays pass through a uniform electric field of strength X and length l_2 with a deviation d_2 ,

$$d_2 = \frac{1}{2} \frac{X e l_2^2}{m V^2} \dots\dots\dots(2),$$

since $\frac{Xe}{m}$ is the acceleration of the particle, at right angles to its direction, and $\frac{l_2}{V}$ is the time required to travel through the electric field.

From equations (1) and (2)

$$V = \frac{d_1 l_2^2 X}{d_2 l_1^2 H},$$

and

$$\frac{e}{m} = \frac{2d_1 V}{l_1^2 H}.$$

The values of V and e/m are thus completely determined from the combined results of the electric and magnetic deviation. It was found that

$$V = 2.5 \times 10^9 \text{ cms. per sec.}$$

$$\frac{e}{m} = 6 \times 10^3.$$

On account of the difficulty of obtaining a large electrostatic deviation, these values are only approximate in character.

The results on the magnetic and electric deviation of the α rays of radium have been confirmed by Des Coudres¹, by the photographic method. Some pure radium bromide was used as a source of radiation. The whole apparatus was enclosed in a vessel which was exhausted to a low vacuum. In this way, not only was he able to determine the photographic action of the rays at a much greater distance from the source, but he was also able

¹ *Phys. Zeit.* 4, No. 17, p. 483, 1903.

to apply a stronger electric field without the passage of a spark. He found values of the constants given by

$$V = 1.65 \times 10^9 \text{ cms. per sec.}$$

$$\frac{e}{m} = 6.4 \times 10^3.$$

These values are in very good agreement with the numbers found by the electric method. The α rays from radium are complex, and probably consist of a stream of positively charged bodies projected at velocities lying between certain limits. The amount of deviation of the particles in a magnetic field will thus differ according to the velocity of the particle. The photographic results of Becquerel seem to indicate that the velocity of the rays of radium can vary only within fairly narrow limits, since the trajectory of the rays in a magnetic field is sharply marked and not nearly as diffuse as in similar experiments with the β rays.

85. Becquerel¹ has examined the amount of magnetic deviation of the α rays at different distances from the source of the rays in a very simple way. A narrow vertical pencil of the rays, after its passage through a narrow slit, fell on a photographic plate, which was inclined at a small angle to the vertical and had its lower edge perpendicular to the slit. The trajectory of the rays is shown by a fine line traced on the plate. If a strong magnetic field is applied parallel to the slit, the trajectory of the rays is displaced to the right or left according to the direction of the field. If equal times of exposure are given for the magnetic field in the two directions, on developing the plate two fine diverging lines are found traced on the plate. The distance between these lines at any point is a measure of twice the average deviation at that point, corresponding to the value of the magnetic field. By measuring the distance between the trajectories at various points, Becquerel found that the radius of curvature of the path of the rays *increased* with the distance from the slit. The product $H\rho$ of the strength of the field and the radius of curvature of the path of the rays is shown in the following table.

¹ C. R. 136, p. 1517, 1903.

Distance in mms. from the slit	$H\rho$
1	2.91×10^5
3	2.99 "
5	3.06 "
7	3.15 "
8	3.27 "
9	3.41 "

The writer (*loc. cit.*) showed that the *maximum* value of $H\rho$ for complete deviation of the α rays was 390,000. The results are thus in good agreement. Since $H\rho = \frac{m}{e} V$ these results show that the values either of V or of $\frac{e}{m}$ for the projected particles vary at different distances from the source. Becquerel considered that the rays were homogeneous, and, in order to explain the results, has suggested that the charge on the projected particles may gradually decrease with the distance traversed, so that the radius of curvature of the path steadily increases with the distance from the source. It, however, seems more probable that the rays consist of particles projected with different velocities, and that the slower particles are more quickly absorbed in the gas. In consequence of this, only the swifter particles are present some distance from the source. Before any definite conclusion can be reached, it will be necessary to determine the actual values of e/m and V for different points of the trajectory.

Becquerel states that the amount of deviation, in a given magnetic field, was the same for the α rays of polonium and of radium. This shows that the value of $\frac{m}{e} V$ is the same for the α rays from the two substances. Since the α rays from polonium are far more readily absorbed than the α rays from radium, this result would indicate that the value of $\frac{m}{e}$ is greater for the α particles of polonium than of radium. Further experimental evidence is required on this important point.

86. Mass and energy of the α particle. It has been pointed out that the α rays from radium and polonium are analogous to the Canal rays of Goldstein, for both carry a positive

charge and are difficult to deflect by a magnetic field. The experiments of Wien have shown that the velocity of projection of the Canal rays varies with the gas in the tube and the intensity of the electric field applied, but it is generally about 1/10 of the velocity of the α particle from radium. The value of e/m is also variable, depending upon the gas in the tube.

It has been shown that for the α rays of radium

$$V = 2.5 \times 10^9 \text{ and } e/m = 6 \times 10^3.$$

Now the value of e/m for the hydrogen atom, liberated in the electrolysis of water, is 10^4 . Assuming the charge carried by the α particle to be the same as that carried by the hydrogen atom, the mass of the α particle is about twice that of the hydrogen atom. If the α particle consists of any known kind of matter, this result indicates that it consists either of projected helium or hydrogen. Further evidence on this important question is given in section 202.

The α rays from all the radio-active substances and their products, such as the radio-active emanations and the matter causing excited activity, possess the same general properties and do not vary very much in penetrating power. It is thus probable that in all cases the α rays from the different radio-active substances consist of positively charged bodies projected with great velocity. Since the rays from radium are made up in part of α rays from the emanation stored in the radium, and from the excited activity which it produces, the α rays from each of these products must consist of positively charged bodies; for it has been shown that *all* the α rays from radium are deviated in a strong magnetic field.

The kinetic energy of each projected particle is enormous, compared with its mass. The kinetic energy of each α particle

$$= \frac{1}{2} m V^2 = \frac{1}{2} \frac{m}{e} V^2 e = 5.9 \times 10^{-6} \text{ ergs.}$$

Taking the velocity of a rifle bullet as 10^5 cms. per second, it is seen that, mass for mass, the energy of motion of the α rays is 6×10^8 times as great as that of the rifle bullet. In this projection of bodies atomic in size with great velocity probably lies the principal cause of the heating effects produced by radium (section 106).

87. Atomic disintegration. The radio-activity of the radio-elements is an atomic and not a molecular property. The rate of emission of the radiations depends only on the amount of the element present and is independent of its combination with inactive substances. In addition, it will be shown later that the rate of emission is not affected by wide variations of temperature, or by the application of any known chemical or physical forces. Since the power of radiating is a property of the radio-atoms, and the radiations consist for the most part of positively and negatively charged masses projected with great velocity, it is necessary to suppose that the atoms of the radio-elements are undergoing disintegration, in the course of which parts of the atom escape from the atomic system. It seems very improbable that the α and β particles can suddenly acquire their enormous velocity of projection by the action of forces existing inside or outside the atom. For example, the α particle would have to travel from rest between two points differing in potential by 5.2 million volts in order to acquire the kinetic energy with which it escapes. Thus it seems probable that these particles are not set suddenly in motion, but that they escape from an atomic system in which they were already in rapid oscillatory or orbital motion. On this view, the energy is not communicated to the projected particles, but exists beforehand in the atoms from which they escape. The idea that the atom is a complicated structure consisting of charged parts in rapid oscillatory or orbital motion has been developed by J. J. Thomson, Larmor and Lorentz. Since the α particle is atomic in size, it is natural to suppose that the atoms of the radio-active elements consist not only of the electrons in motion, but also of positively charged particles whose mass is about the same as that of the hydrogen or helium atom.

It will be shown later that only a minute fraction of the atoms of the radio-element need break up per second in order to account for the radiations even of an enormously active element like radium. The question of the possible causes which lead to this atomic disintegration and the consequences which follow from it will be discussed later in chapter X.

88. Experiments with a zinc sulphide screen. A screen

of Sidot's hexagonal blend (phosphorescent zinc sulphide) lights up brightly under the action of the α rays of radium and polonium. If the surface of the screen is examined with a magnifying glass, the light from the screen is found not to be uniformly distributed but to consist of a number of scintillating points of light. No two flashes succeed one another at the same point, but they are scattered over the surface, coming and going rapidly without any movement of translation. This remarkable action of the radium and polonium rays on a zinc sulphide screen was discovered by Sir William Crookes¹, and independently by Elster and Geitel², who observed it with the rays given out from a wire which has been charged negatively either in the open air or in a vessel containing the emanation of thorium.

In order to show the scintillations of radium on the screen, Sir William Crookes has devised a simple apparatus which he has called the "Spinthariscopes." A small piece of metal, which has been dipped in a radium solution, is fixed several millimetres away from a small zinc sulphide screen. This screen is fixed at one end of a short brass tube and is looked at through a lens fixed at the other end of the tube. Viewed in this way, the surface of the screen is seen as a dark background, dotted with brilliant points of light which come and go with great rapidity. The number of points of light per unit area to be seen at one time falls off rapidly as the distance from the radium increases, and, at several centimetres distance, only an occasional one is seen. The experiment is extremely beautiful, and brings vividly before the observer the fact that the radium is shooting out a stream of projectiles, the impact of each of which on the screen is marked by a flash of light.

The scintillating points of light on the screen are due to the impact of the α particles on its surface. If the radium is covered with a layer of foil of sufficient thickness to absorb all the α rays the scintillations cease. There is still a phosphorescence to be observed on the screen due to the β and γ rays, but this luminosity is not marked by scintillations to any appreciable extent. Sir William Crookes showed that the number of scintillations was about the same in vacuo as in air at atmospheric pressure. If the

¹ *Proc. Roy. Soc.* 81, p. 405, 1903.

² *Phys. Zeit.* No. 15, p. 437, 1903.

screen was kept at a constant temperature, but the radium cooled down to the temperature of liquid air, no appreciable difference in the number of scintillations was observed. If, however, the screen was gradually cooled to the temperature of liquid air, the scintillations diminished in number and finally ceased altogether. This is due to the fact that the screen loses to a large extent its power of phosphorescence at such a low temperature.

The scintillations are produced not only by radium and polonium, but also by a negatively charged wire made active by exposure in the open air or in a vessel containing the emanations of thorium or radium. As far as observations have yet gone, the production of scintillations appears to be a general property of the α rays from all radio-active substances. The scintillations are best shown with a zinc sulphide screen. If a screen of barium platino-cyanide is exposed to the α rays from radium, the scintillations are difficult to observe, and the luminosity is far more persistent than for a zinc sulphide screen exposed under the same conditions. The duration of the phosphorescence probably accounts for the absence of visible scintillations.

In the scintillations of zinc sulphide, we are actually witnessing the effect produced by the impact on the screen of single atoms of matter projected with enormous velocity. Each of the particles carries an amount of energy corresponding to 5.9×10^{-6} ergs. On account of the ease with which these particles are stopped, most of this energy is given up at the surface of the screen, and a portion of the energy is transformed into light. Zinc sulphide is very sensitive to mechanical shocks. Luminosity is observed if a pen-knife is drawn across the screen, or if a current of air is directed on to the screen. The disturbance effected by the impact of the α particle extends over a distance very large compared with the size of the impinging particle, so that the spots of light produced have an appreciable area. Becquerel¹ recently has made an examination of the scintillations produced by different substances and has concluded that the scintillations are due to irregular cleavages in the crystals composing the screen, produced by the action of the α rays. Scintillations can be mechanically produced by crushing a crystal. Tommasina² found that a zinc sulphide screen

¹ *C. R.* 137, Oct. 27, 1903.

² *C. R.* 137, Nov. 9, 1903.

removed from the action of the radium rays for several days, showed the scintillations again when an electrified rod was brought near it.

Although the scintillations from a particle of pure radium bromide are very numerous, they are not too numerous to be counted. Close to the radium, the luminosity is very bright, but, by using a high power microscope, the luminosity can be shown to consist of scintillations. This use of the microscope would offer a very convenient means of actually counting the number of the particles projected from the surface of the radium, if each particle gave rise to a flash of light. It is not likely, however, that this would be the case. The number of scintillations from a given mass of radium will depend upon its fineness of division, but on account of the ease with which the projected particles are absorbed, only a small portion of the total number projected from the mass of radium will escape from its surface.

89. Absorption of the α rays by matter. The α rays from the different radio-active substances can be distinguished from each other by the relative amounts of their absorption by gases or by thin screens of solid substances. When examined under the same conditions, the α rays from the active substances can be arranged in a definite order with reference to the amount of absorption in a given thickness of matter.

In order to test the amount of absorption of the α rays for different thicknesses of matter, an apparatus similar to that shown in Fig. 16, p. 82 was employed¹. A thin layer of the active material was spread uniformly over an area of about 30 sq. cms., and the saturation current observed between two plates 3.5 cms. apart. With a thin layer² of active material, the ionization between the plates is almost entirely due to the α rays. The ionization due to the β and γ rays is generally less than 1% of the total.

The following table shows the variation of the saturation current between the plates due to the α rays from radium and polonium,

¹ Rutherford and Miss Brooks. *Phil. Mag.* July 1902.

² In order to obtain a very thin layer, the compound to be tested is ground to a fine powder and then sifted through a fine gauge uniformly over the area, so that the plate is only partially covered.

with successive layers of aluminium foil interposed, each $\cdot 00034$ cm. in thickness. In order to get rid of the ionization due to the β rays from radium, the radium chloride employed was dissolved in water and evaporated. This renders the active compound, for the time, nearly free from β rays.

*Polonium.**Radium.*

Layers of aluminium	Current	Ratio of decrease for each layer	Layers of aluminium	Current	Ratio of decrease for each layer
0	100		0	100	
1	41	$\cdot 41$	1	48	$\cdot 48$
2	12.6	$\cdot 31$	2	23	$\cdot 48$
3	2.1	$\cdot 17$	3	13.6	$\cdot 60$
4	$\cdot 14$	$\cdot 067$	4	6.4	$\cdot 47$
5	0		5	2.5	$\cdot 39$
			6	$\cdot 9$	$\cdot 36$
			7	0	

The initial current with 1 layer of aluminium over the active material is taken as 100. It will be observed that the current due to the radium rays decreases very nearly by half its value for each additional thickness until the current is reduced to about 6% of the maximum. It then decays more rapidly to zero. Thus, for radium, over a wide range, the current decreases in an exponential law with the thickness of the screen,

or
$$\frac{i_t}{i_0} = e^{-\lambda t},$$

where i_t is the current for a thickness t , and i_0 the initial current. In the case of polonium, the decrease is far more rapid than would be indicated by the exponential law. By the first layer, the current is reduced to the ratio $\cdot 41$. The addition of the third layer cuts the current down to a ratio of $\cdot 17$. For most of the active bodies, the current diminishes slightly faster than the exponential law would lead one to expect, especially when the radiation is nearly all absorbed.

90. The increase of absorption of the α rays of polonium with the thickness of matter traversed has been very clearly shown in some experiments made by Mme Curie. The apparatus employed is shown in Fig. 26.

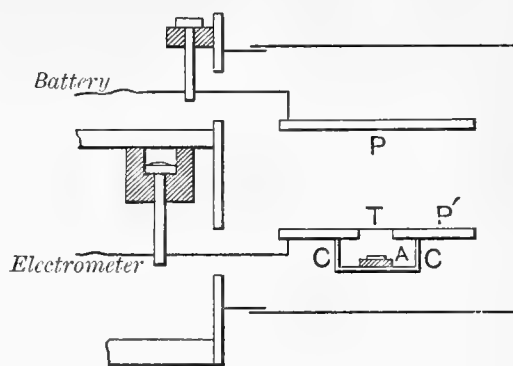

Fig. 26.

The saturation current was measured between two parallel plates PP' 3 cms. apart. The polonium A was placed in the metal box CC , and the rays from it, after passing through an opening in the lower plate P' , covered with a layer of thin foil T , ionized the gas between the plates. For a certain distance AT , of 4 cms. or more, no appreciable current was observed between P and P' . As the distance AT was diminished, the current increased in a very sudden manner, so that for a small variation of the distance AT there was a large increase of current. With still further decrease of distance the current increases in a more regular manner. The results are shown in the following table, where the screen T consisted of one and two layers of aluminium foil respectively. The current due to the rays, without the aluminium screen, is in each case taken as 100.

Distance AT in cms.	3.5	2.5	1.9	1.45	0.5
For 100 rays transmitted by one layer	0	0	5	10	25
For 100 rays transmitted by two layers	0	0	0	0	0.7

The metallic screen thus cuts off a greater proportion of the rays the greater the distance of air which the radiations traverse. The effects are still more marked if the plates PP' are close together. Results similar but not so marked are found if radium is substituted for the polonium.

It follows from these experiments that the ionization per unit volume, due to a large plate uniformly covered with the radioactive matter, falls off rapidly with the distance from the plate. At a distance of 7 or 8 cms. the α rays from uranium, thorium, or

radium have been completely absorbed in the gas, and the small ionization then observed in the gas is due to the more penetrating β and γ rays. The relative amount of the ionization observed at a distance from the source will increase with the thickness of the layer of active matter, but will reach a maximum for a layer of a certain thickness. The greater proportion of the ionization, due to unshielded active matter, is thus entirely confined to a shell of air surrounding it not more than 7 cms. in depth.

91. The α rays from different compounds of the same active element, although differing in amount, have about the same average penetrating power. Experiments on this point have been made by the writer¹ and by Owens². For the purpose of comparison of the relative power of penetration of the α rays from the different radio-elements, it is thus only necessary to determine the penetrating power for one compound of each of the radio-elements. Rutherford

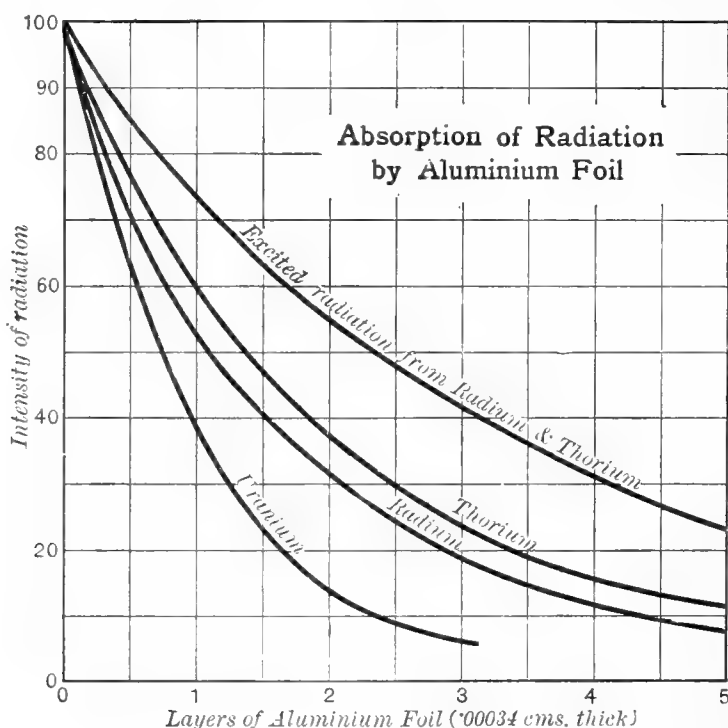

Fig. 27.

and Miss Brooks³ have determined the amount of absorption of the α rays from the different active substances in their passage through successive layers of aluminium foil .00034 cm. thick. The

¹ *Phil. Mag.* Jan. 1899.

² *Phil. Mag.* Oct. 1899.

³ *Phil. Mag.* July, 1900.

curves of absorption are given in Fig. 27. For the purpose of comparison in each case, the initial current with the bare active compound is taken as 100. A very thin layer of the active substance was used, and, in the case of thorium and radium, the emanations given off were removed by a slow current of air through the testing vessel. A potential difference of 300 volts was applied between the plates, which was sufficient to give the maximum current in each case.

Curves for the minerals organite and thorite were very nearly the same as for thoria.

For the purpose of comparison, the absorption curves of the excited radiations of thorium and radium are given, as well as the curve for the radio-elements uranium, thorium, radium, and polonium. The α radiations may be arranged in the following order, as regards their power of penetration, beginning with the most penetrating.

Thorium	}	excited radiation.
Radium		
Thorium.		
Radium.		
Polonium.		
Uranium.		

The same order is observed for all the absorbing substances examined, viz., aluminium, Dutch metal, tinfoil, paper, and air and other gases. The differences in the absorption of the α rays from the active bodies are thus considerable, and must be ascribed either to a difference of mass or of velocity of the α particles or to a variation in both these quantities.

Since the α rays differ either in mass or velocity, it follows that they cannot be ascribed to any single radio-active impurity common to all radio-active bodies.

92. Absorption of the α rays by gases. The α rays from the different radio-active substances are quickly absorbed in their passage through a few centimetres of air at atmospheric pressure and temperature. In consequence of this, the ionization of the air, due to the α rays, is greatest near the surface of the radiating body and falls off very rapidly with the distance (see section 90).

A simple method of determining the absorption in gases is shown in Fig. 28. The maximum current is measured between two parallel plates *A* and *B* kept at a *fixed* distance of 2 cms. apart, and then moved by means of a screw to different distances from the radioactive surface. The radiation from this active surface passed through a circular opening in the plate *A*, covered with thin aluminium foil, and was stopped by the upper plate. For observations on other gases besides air, and for examining the effect at different pressures, the apparatus is enclosed in an air-tight cylinder.

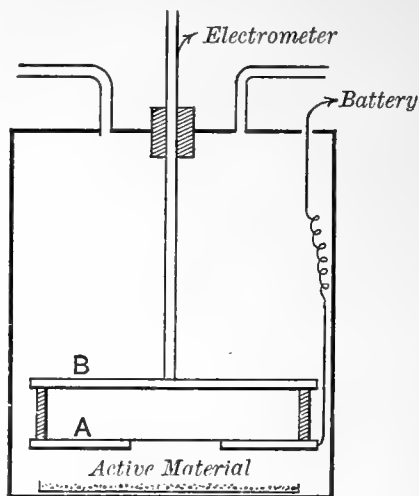

Fig. 28.

If the radius of the active surface is large compared with the distance of the plate *A* from it, the intensity of the radiation is approximately uniform over the opening in the plate *A*, and falls off with the distance x traversed according to an exponential law. Thus

$$\frac{I}{I_0} = e^{-\lambda x},$$

where λ is the "absorption constant" of the radiation for the gas under consideration¹. Let

x = distance of lower plate from active material,

l = distance between the two fixed plates.

The energy of the radiation at the lower plate is then $I_0 e^{-\lambda x}$, and at the upper plate $I_0 e^{-\lambda(l+x)}$. The total number of ions produced between the parallel plates *A* and *B* is therefore proportional to

$$e^{-\lambda x} - e^{-\lambda(l+x)} = e^{-\lambda x} (1 - e^{-\lambda l}).$$

Since the factor $1 - e^{-\lambda l}$ is a constant, the saturation current

¹ Since the ionization at any point above the plate is the resultant effect of the α particles coming from all points of the large radio-active layer, λ is not the same as the coefficient of absorption of the rays from a point source. It will however be proportional to it. For this reason λ is called the "absorption constant."

between A and B varies as $e^{-\lambda x}$, i.e. it decreases according to an exponential law with the distance traversed.

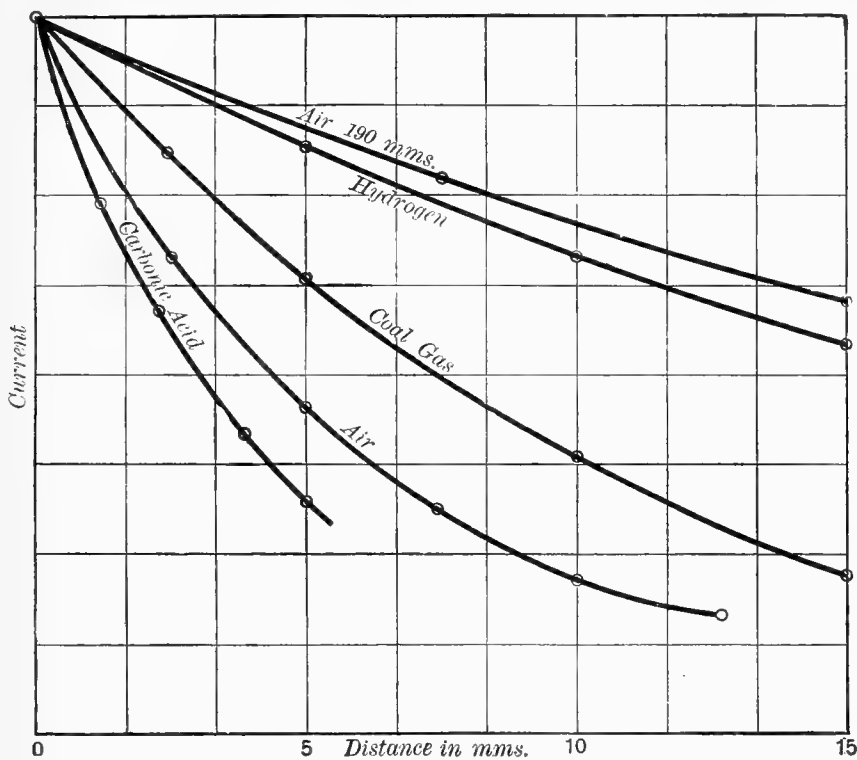

Fig. 29.

The variation of the current between A and B with the distance from a thin layer of uranium oxide is shown in Fig. 29 for different gases. The initial measurements were taken at a distance of about 3.5 mms. from the active surface. The actual values of this initial current were different for the different gases, but, for the purposes of comparison, the value is in each case taken as unity.

It will be seen that the current falls off with the distance approximately in a geometrical progression, a result which is in agreement with the simple theory given above. The distance through which the rays pass before they are absorbed is given below for different gases.

Gas	Distance in mms. to absorb half of radiation
Carbonic acid ...	3
Air	4.3
Coal-gas	7.5
Hydrogen	16

The results for hydrogen are only approximate, as the absorption is small over the distance examined.

The absorption is least in hydrogen and greatest in carbonic acid, and follows the same order as the densities of the gases. In the case of air and carbonic acid, the absorption is proportional to the density, but this rule is widely departed from in the case of hydrogen. Results for the relative absorption by air of the α rays from the different active bodies are shown in Fig. 30.

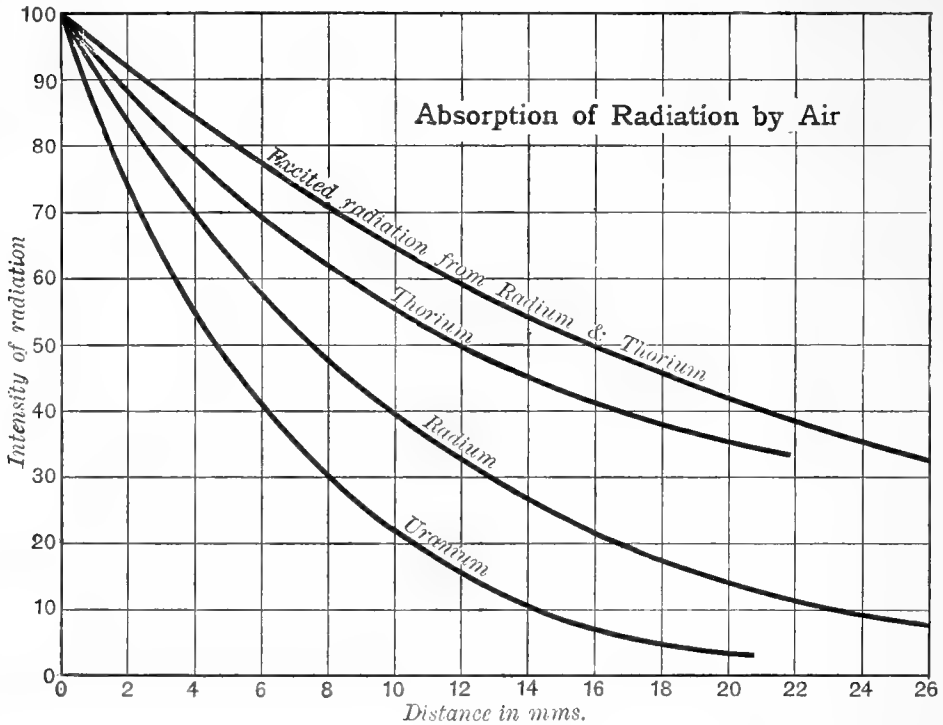

Fig. 30.

The initial observation was made about 2 mms. from the active surface, and the initial current is in each case taken as 100. The current, as in the case of uranium, falls off at first approximately in geometrical progression with the distance. The thickness of air, through which the radiation passes before the intensity is reduced to half value, is given below.

	Distance in mms.
Uranium	4.3
Radium	7.5
Thorium	10
Excited radiation from Thorium and Radium	16.5

The order of absorption by air of the radiations from the active substances is the same as the order of absorption by the metals and solid substances examined.

93. Connection between absorption and density. Since in all cases the radiations first diminish approximately according to an exponential law with the distance traversed, the intensity I after passing through a thickness x is given by $I = I_0 e^{-\lambda x}$ where λ is the absorption constant and I_0 the initial intensity.

The following table shows the value of λ with different radiations for air and aluminium.

Radiation		λ for aluminium	λ for air
Excited radiation	...	830	·42
Thorium	...	1250	·69
Radium	...	1600	·90
Uranium	...	2750	1·6

Taking the density of air at 20° C. and 760 mms. as 0·00120 compared with water as unity, the following table shows the value of λ divided by density for the different radiations.

Radiation		Aluminium	Air
Excited radiation	...	320	350
Thorium	...	480	550
Radium	...	620	740
Uranium	...	1060	1300

Comparing aluminium and air, the absorption is thus roughly proportional to the density for all the radiations. The divergence, however, between the absorption-density numbers is large when two metals like tin and aluminium are compared. The value of λ for tin is not much greater than for aluminium, although the density is nearly three times as great.

If the absorption is proportional to the density, the absorption in a gas should vary directly as the pressure, and this is found to be the case. Some results on this subject have been given by the writer (*loc. cit.*) for uranium rays between pressures of 1/4 and 1 atmosphere. Owens (*loc. cit.*) examined the absorption of the α radiation in air from thoria between the pressures of 0·5 to 3 atmospheres and found that the absorption varied directly as the pressure.

The variation of absorption with density for the projected positive particles is thus very similar to the law for the projected negative particles and for cathode rays. The absorption, in both cases, depends mainly on the density, but is not in all cases directly

proportional to it. Since the absorption of the α rays in gases is probably mainly due to the exhaustion of the energy of the rays by the production of ions in the gas, it seems probable that the absorption in metals is due to a similar cause.

94. Relation between ionization and absorption in gases. It has been shown (section 45) that if the α rays are completely absorbed in a gas, the *total* ionization produced is about the same for all the gases examined. Since the rays are unequally absorbed in different gases, there should be a direct connection between the relative ionization and the relative absorption. This is seen to be the case if the results of Strutt (section 45) are compared with the relative absorption constants (section 92).

Gas	Relative absorption	Relative ionization
Air	1	1
Hydrogen27	.226
Carbon dioxide	1.43	1.53

Considering the difficulty of obtaining accurate determinations of the absorption, the relative ionization in a gas is seen to be directly proportional to the relative absorption within the limits of experimental error. This result shows that the energy absorbed in producing an ion is about the same in air, hydrogen, and carbon dioxide.

95. Theory of the absorption of the α rays by matter.

As we have seen, experiment shows that the ionization of the gas due to the α rays from a large plane surface of radio-active matter falls off approximately according to an exponential law until most of the rays are absorbed, whereupon the ionization decreases at a much faster rate. The ionization of the gas is due to the collision of the positively charged particles with the molecules in their path. Each projected particle carries with it sufficient energy to produce, on an average, several thousand ions in its path before its velocity is reduced to a value below which it fails to ionize the gas. This minimum velocity for the α and β particles is probably about 10^8 cms. per second. More experimental data are required on the variation of the amount of ionization of the gas with the speed of the projected

particles. The experiments of Townsend¹ and Durack² point to the conclusion that the amount of ionization per unit distance passes through a maximum and then decreases as the velocity of the particle increases. For example, Townsend found that the number of ions produced by an electron moving in an electric field was small at first for weak fields, but increased with the strength of the electric field to a maximum corresponding to the production of 21 ions per cm. in air at a pressure of 1 mm. of mercury; while for a much higher velocity of about 5×10^9 cms. per second Durack found that the electrons only produce .4 ions per cm. at 1 mm. pressure. In a later paper, Durack³ showed that for the electrons from radium, which are projected with a velocity of about half the velocity of light, the corresponding number of ions per cm. of path is .19 or only about 1/100 of the maximum number observed by Townsend.

It has been shown by Des Coudres that the velocity of the cathode rays diminishes when the rays pass through thin metal foil. This is probably also true of the α and β particles produced by the active substances.

If the decrease of the ionization according to an exponential law with the distance were due only to a gradual retardation of the speed of the projected particles, it follows that the ionization per unit distance for both the α and β particles must vary as the square of the velocity of the particle. For suppose that in passing through a distance dx a particle of mass m decreases in speed from v to $v - dv$. The loss of energy of the particle is $mv dv$, and this should be proportional to the number of ions $q dx$ produced, where q is the rate of production of ions per unit length of the path. Since the ionization is assumed to fall off in an exponential law with the distance x , we get $q = q_0 e^{-\lambda x}$ where q_0 is the value of q when $x = 0$.

$$\text{Then} \quad mvdv = kq_0 e^{-\lambda x} dx,$$

where k is a constant and

$$\frac{1}{2} mv^2 = -\frac{kq_0}{\lambda} e^{-\lambda x} + A = -\frac{kq}{\lambda} + A = -\frac{kq}{\lambda},$$

¹ *Phil. Mag.* Feb. 1901.

² *Phil. Mag.* July, 1902.

³ *Phil. Mag.* May, 1903.

for $A = 0$, since $q = 0$ when $v = 0$. q should thus be proportional to v^2 . This conclusion is contrary to the experimental results, for it has been shown, at any rate for the β particles, that the ionization per unit distance *decreases* with *increase* of velocity.

The variation of ionization with distance thus cannot be due entirely to the gradual retardation of the particles. It seems probable that it is due to one of the following causes:—

(1) absorption of the projected particles in their passage through matter;

(2) neutralization of some of the charges carried by the projected particles.

It can be shown that the number of α particles which are able to produce "scintillations" on a zinc sulphide screen is diminished by the interposition of a metal screen. The hypothesis (2) seems more probable than (1), for it is difficult to see how masses, possessing such an amount of kinetic energy as the α and β particles at the moment of their expulsion, can be completely stopped by a single collision, unless the velocity of the particles has already been greatly reduced by their passage through matter. On the second hypothesis, the particles after losing their charges may still keep moving in their path with a high velocity, but it is to be expected that they would not be nearly as efficient in ionizing the gas as a charged particle of equal mass moving with the same velocity. Their existence would not be recognized by ordinary methods unless they produced an appreciable ionization by collision with the molecules. Thus, it is possible that, in addition to the α and β charged particles, there may be a stream of uncharged particles moving through the gas with great velocity, the existence of which has not yet been detected.

This gradual neutralization of the charges on the projected α particles, and the consequent inability of the particles to produce ions in their path, are probably responsible for most of the so-called "absorption" of the rays in traversing matter whether solid, liquid, or gaseous. If, in addition, the speed of the projected particles is gradually decreased by their passage through matter, as the minimum velocity required to produce ions is approached, the particles which still retain their charge will decrease in ionizing power, and,

in consequence, the number of ions produced per unit length of path will diminish far more rapidly than the law observed for higher velocities would lead us to expect. This offers an explanation of the great increase of absorption of the α rays by matter which is observed when the rays are nearly all absorbed.

PART IV.

THE γ OR VERY PENETRATING RAYS.

96. In addition to the α and β rays, the three active substances, uranium, thorium, and radium, all give out a radiation of an extraordinarily penetrating character. These γ rays are considerably more penetrating than the X rays produced in a "hard" vacuum tube. Their presence can readily be observed for an active substance like radium, but is difficult to detect for uranium and thorium unless a large quantity of active material is used.

Villard¹, using the photographic method, first drew attention to the fact that radium gave out these very penetrating rays, and found that they were non-deviable by a magnetic field. This result was confirmed by Becquerel².

Using a few milligrams of radium bromide, the γ rays can readily be detected in a dark room by the luminosity they excite in the mineral willemite or a screen of platinocyanide of barium. The α and β rays are completely absorbed by placing a thickness of 1 centimetre of lead over the radium, and the rays which then pass through the lead consist entirely of γ rays. The very great penetrating power of these rays is readily observed by noting the slight diminution of the luminosity of the screen when plates of metal several centimetres thick are placed between the radium and the screen. These rays also produce ionization in gases and are best investigated by the electrical method. The presence of the γ rays from 30 mgs. of radium bromide can be observed in an electroscope after passing through 30 cms. of iron.

¹ *C. R.* 130, pp. 1110, 1178. 1900.

² *C. R.* 130, p. 1154, 1900.

97. In an examination of the active substances by the electrical method the writer¹ found that both uranium and thorium gave out γ rays in amount roughly proportional to their activity. An electroscope of the type shown in Fig. 11 was employed. This was placed on a large lead plate .65 cm. thick, the active substance being placed in a closed vessel beneath.

The discharge due to the natural ionization of the air in the electroscope was first observed. The additional ionization due to the active substance must be that produced by rays which have passed through the lead plate and the walls of the electroscope. The following table shows that the discharge due to these rays decreases according to an exponential law with the thickness of lead traversed.

Thickness of lead	Rate of discharge
.62 cms.	100
„ + .64 cms.	67
„ + 2.86 „	23
„ + 5.08 „	8

Using 100 gr. of uranium and thorium, the discharge due to the rays through 1 cm. of lead was quite appreciable and readily measured. The results showed that the amount of γ rays was about the same for equal weights of thorium and uranium oxides. The penetrating power was also about the same as for the radium rays.

Results originally obtained with an electrometer in the place of an electroscope gave results indicating about 20 per cent. less penetrating power. The electroscopic results are probably the more accurate, but those obtained with the electrometer, as given below, serve for the purpose of comparison.

Metal	Thickness of metal to absorb half of the rays
Mercury75 cms.
Lead9 „
Tin ...	1.8 „
Copper ...	2.2 „
Zinc ...	2.5 „
Iron ...	2.5 „

¹ *Phys. Zeit.* p. 517, No. 22, 1902.

98. Connection between absorption and density. The absorption constant λ of the rays was determined from the equation $\frac{I}{I_0} = e^{-\lambda x}$ for screens of different materials. On account of the small absorption in water and glass it was difficult to determine λ with accuracy.

The results are included in the following table:—

Substance	γ rays		β rays from uranium	
	λ	$\frac{\lambda}{\text{density}}$	λ	$\frac{\lambda}{\text{density}}$
Water ...	·033	·033	—	—
Glass ...	·086	·035	14·0	5·7
Iron ...	·28	·036	44	5·6
Zinc ...	·28	·039	—	—
Copper ...	·31	·035	60	7·7
Tin ...	·38	·052	96	13·2
Lead ...	·77	·068	122	10·8
Mercury ...	·92	·068	—	—

On the right is added a comparison table for the β rays given out by uranium. It will be seen that the quotient of absorption by density is in neither case a constant, but the differences are no greater for the non-deviable penetrating rays than for the deviable rays of uranium. It is interesting to observe that the value of λ divided by the density is, for both types of rays, twice as great for lead as for glass or iron.

It will be seen from the above table that the penetrating rays from radium compared with the deviable rays of uranium pass through a thickness of glass about 160 times greater for the same reduction of intensity.

99. Nature of the rays. In addition to their great penetrating power, the γ rays differ from the α and β rays in not being deflected to an appreciable amount by a magnetic field.

It now remains to consider whether the rays are material in nature or whether they are a type of ether-pulse like Röntgen rays. In some respects the γ rays seem more closely allied to

cathode than to Röntgen rays. It is well known that Röntgen rays produce much greater ionization in gases such as sulphuretted hydrogen and hydrochloric acid gas than in air, although the differences in density are not large. For example, under the influence of X rays sulphuretted hydrogen has six times the conductivity of air, but under the cathode rays the conductivity is only slightly greater than that of air. In an experiment made by the writer, in which the testing vessel was filled with sulphuretted hydrogen, it was found that the current for the γ rays from radium was only slightly greater than it was when the vessel contained air.

Strutt¹ has recently made a detailed investigation of the relative conductivity of gases exposed to the γ rays of radium. The results have already been given in the table in section 45. He found that the relative conductivities of different gases compared with air were about the same as for the β rays of radium, but were very different from the conductivities for Röntgen rays.

The variation of absorption of these rays with density is also very similar to that of the cathode rays. On the other hand, Benoist² has shown that the relative absorption of Röntgen rays by matter depends to a large extent on the kind of rays employed. "Hard" rays give ratios quite different from "soft" rays. For penetrating Röntgen rays, the absorption of the rays by a given weight of material is a continuous and increasing function of the atomic weight.

The γ rays thus show properties with regard to absorption and ionization unlike those of X rays, but it must not be forgotten that the γ rays are of a far more penetrating character. It has not yet been shown that the properties of very penetrating X rays with regard to relative absorption and ionization are the same as those of the ordinary rays of moderate penetrating power which have so far been examined.

It will be shown later (section 194) that the γ rays, like the β rays, appear only in the last stage of the succession of chemical changes occurring in active bodies. Active products which give α rays and no β rays do not give rise to γ rays. The β and γ rays

¹ *Proc. Roy. Soc.* 72, p. 208, 1903.

² *C. R.* 132, p. 545, 1901.

appear always to go together and are present in the same proportion. The main facts known about the γ rays are summarized below:—

- (1) Great penetrating power.
- (2) Non-deviation in an intense magnetic field.
- (3) A law of absorption similar to that of cathode and β rays.
- (4) Occurrence of β and γ rays together and in the same proportion.

Three possible hypotheses may thus be considered:—

- (1) That the γ rays are very penetrating Röntgen rays.
- (2) That they consist of negatively charged particles projected with a velocity very nearly equal to that of light.
- (3) That they consist of uncharged bodies projected with great velocity.

Röntgen rays are believed to be electromagnetic pulses set up by the sudden stoppage of the cathode rays produced in a vacuum tube. Thus it is to be expected that Röntgen rays should be produced at the sudden starting as well as at the sudden stopping of electrons. Most of the β particles from the radio-elements are projected with velocities much greater than those of the cathode rays in a vacuum tube. Thus Röntgen rays of a very penetrating character should be set up, if the electron is very suddenly expelled with great velocity. This would account for the facts (1), (2) and (4), but it is at variance with (3) unless the relative conductivity of gases for a very penetrating type of X rays follows the law of conductivity of the β or cathode rays¹. Strutt has also pointed out that the proportion of γ rays to β rays from radium is much greater than the proportion of X rays to the cathode rays produced in a vacuum tube.

It has been shown that the β rays from radium are complex

¹ (Added Feb. 18, 1904.) Mr A. S. Eve of McGill University, Montreal, has recently examined the relative conductivity of some gases for very "hard" X rays after their passage through a lead screen 1.8 mms. thick, and has obtained ratios very different from those observed for "soft" rays, but approximating closely to those obtained for the γ rays. These observations remove the most serious objection which has been urged against the view that the γ rays are in reality X rays of a very penetrating type.

and include electrons travelling with a speed of more than 95 per cent. of that of light. The apparent mass of an electron would increase rapidly as the speed of light is approached, and for the velocity of light the mass should be infinite and the path unaffected by a magnetic field. It does not seem improbable that some of the β rays of radium are projected with a velocity very nearly equal to that of light, and thus it is possible that the γ rays may really consist of electrons expelled with velocities which still more nearly approach that of light. The great increase of penetrating power is to be expected on account of the rapidly increasing energy of the electron as the speed of light is approached. An objection to this hypothesis lies in the experimental observation that there appears to be no gradual passage from the stage of penetrating deviable rays to non-deviable very penetrating rays. It is also possible that the γ rays may consist of uncharged particles projected with great velocity. Such an hypothesis would account for the relative conductivity of gases and for the non-deviation of the rays in a magnetic field. It would also account for the great penetrating power of the rays, since a small uncharged particle moving through matter would probably not be absorbed as rapidly as a charged particle of the same mass and velocity. Nevertheless, sufficient experimental data are not yet available to distinguish definitely between the three hypotheses discussed above.

PART V.

SECONDARY RAYS.

100. Production of secondary rays. It has long been known that Röntgen rays, when they impinge on solid obstacles, produce secondary rays of much less penetrating power than the incident rays. This was first shown by Perrin and has been investigated in detail by Sagnac, Langevin, Townsend and others. Thus it is not surprising that similar phenomena should be observed for the radiation from radio-active substances. By means of the photographic method, Becquerel¹ has made a close

¹ *C. R.* 132, pp. 371, 734, 1286. 1901.

study of the secondary radiations produced by radio-active substances. In his earliest observations he noticed that radiographs of metallic objects were always surrounded by a diffuse border. This effect is due to the secondary rays set up by the incident rays at the surface of the screen.

The secondary rays produced by the α rays are very feeble. They are best shown by polonium, which gives out only α rays, when, in consequence, the results are not complicated by the action of the β rays. Strong secondary rays are set up at the point of impact of the β or cathodic rays. Becquerel found that the magnitude of this action depended greatly on the velocity of the rays. The rays of lowest velocity gave the most intense secondary action, while the penetrating rays gave, in comparison, scarcely any secondary effect. In consequence of the presence of this secondary radiation, the photographic impression of a screen pierced with holes is not clear and distinct. In each case there is a double photographic impression, due to the primary rays and the secondary rays set up by them.

These secondary rays are deviable by a magnetic field, and in turn produce tertiary rays and so on. The secondary rays are in all cases more readily deviated and absorbed than the primary rays, from which they arise. The very penetrating γ rays give rise to secondary rays, which cause intense action on the photographic plate. When some radium was placed in a cavity inside a deep lead block, rectangular in shape, besides the impression due to the direct rays through the lead, Becquerel observed that there was also a strong impression due to the secondary rays emitted from the surface of the lead. The action of these secondary rays on the plate is so strong that the effect on the plate is, in many cases, increased by adding a metal screen between the active material and the plate.

The comparative photographic action of the primary and secondary rays cannot be taken as a relative measure of the intensity of their radiations. For example, only a small portion of the energy of the β rays is in general absorbed in the sensitive film. Since the secondary rays are far more easily absorbed than the primary rays, a far greater proportion of their energy is expended in producing photographic action than in the case of the

primary rays. It is thus not surprising that the secondary rays set up by the β and γ rays may in some cases produce a photographic impression comparable with, if not greater than, the effect of the incident rays.

On account of these secondary rays, radiographs produced by the β rays of radium in general show a diffuse border round the shadow of the object. For this reason radiographs of this kind lack the sharpness of outline of X ray photographs.

101. Mme Curie¹ has shown by the electric method that the α rays of polonium produce secondary rays. The method adopted was to compare the ionization current between two parallel plates, when two screens of different material, placed over the polonium, were interchanged.

Screens employed	Thickness in mms.	Current observed
Aluminium ...	0.01	17.9
Cardboard ...	0.005	
Cardboard ...	0.005	6.7
Aluminium ...	0.01	
Aluminium ...	0.01	150
Tin ...	0.005	
Tin ...	0.005	126
Aluminium ...	0.01	
Tin ...	0.005	13.9
Cardboard ...	0.005	
Cardboard ...	0.005	4.4
Tin ...	0.005	

These results show that the α rays of polonium are modified in passing through matter, and that the amount of secondary rays set up varies with screens of different material. Mme Curie, using the same method, was unable to observe any such effect for the β rays of radium. The production of secondary rays by the β rays of radium is, however, readily shown by the photographic method.

¹ *Thèse présentée à la Faculté des Sciences, Paris 1903, p. 85.*

CHAPTER V.

RATE OF EMISSION OF ENERGY.

102. Comparison of the ionization produced by the α and β rays. With unscreened active material the ionization produced between two parallel plates, placed as in Fig. 16, is mainly due to the α rays. On account of the slight penetrating power of the α rays, the current due to them practically reaches a maximum with a small thickness of radio-active material. The following saturation currents were observed¹ for different thicknesses of uranium oxide between parallel plates sufficiently far apart for all the α rays to be absorbed in the gas between them.

Surface of uranium oxide 38 sq. cms.

Weight of uranium oxide in grammes per sq. cm. of surface	Saturation current in ampères per sq. cm. of surface
·0036	1.7×10^{-13}
·0096	3.2×10^{-13}
·0189	4.0×10^{-13}
·0350	4.4×10^{-13}
·0955	4.7×10^{-13}

The current has reached about half its maximum value for a weight of oxide ·0055 gr. per sq. cm. If the α rays are cut off by a metallic screen, the ionization is then mainly due to the β rays, since the ionization produced by the γ rays is small in comparison. For the β rays from uranium oxide it has been

¹ Rutherford and McClung, *Phil. Trans. A.* p. 25, 1901.

shown (section 79) that the current reaches half its maximum value for a thickness of 0.11 gr. per sq. cm.

On account of the difference in the penetrating power of the α and β rays, the ratio of the ionization currents produced by them depends on the thickness of the radio-active layer under examination. The following comparative values of the current due to the α and β rays were obtained for very thin layers of active matter¹. A weight of 1/10 gramme of fine powder, consisting of uranium oxide, thorium oxide, or radium chloride of activity 2000, was spread as uniformly as possible over an area of 80 sq. cms. The saturation current was observed between parallel plates 5.7 cms. apart. This distance was sufficient to absorb most of the α rays from the active substances. A layer of aluminium .009 cm. thick absorbed all the α rays.

	Current due to α rays	Current due to β rays	Ratio currents $\frac{\beta}{\alpha}$
Uranium ...	1	1	.0074
Thorium ...	1	.27	.0020
Radium ...	2000	1350	.0033

In the above table the saturation current due to the α and β rays of uranium is, in each case, taken as unity. The third column gives the ratio of the currents observed for equal weights of substance. The results are only approximate in character, for the ionization due to a given weight of substance depends on its fineness of division. In all cases, the current due to the β rays is small compared with that due to the α rays, being greatest for uranium and least for thorium. As the thickness of layer increases, the ratio of currents $\frac{\beta}{\alpha}$ steadily increases to a constant value.

103. Comparison of the energy radiated by the α and β rays. It has not yet been found possible to measure directly the energy of the α and β rays. A comparison of the energy radiated in the two forms of rays can, however, be made indirectly by two distinct methods.

¹ Rutherford and Grier, *Phil. Mag.* Sept. 1902.

If it is assumed that the same amount of energy is required to produce an ion by either the α or the β ray, and that the same proportion of the total energy is used up in producing ions, an approximate estimate can be made of the ratio of the energy radiated by the α and β rays by measuring the ratio of the total number of ions produced by them. If λ is the coefficient of absorption of the β rays in air, the rate of production of ions per unit volume at a distance x from the source is $q_0 e^{-\lambda x}$ where q_0 is the rate of ionization at the source.

The total number of ions produced by complete absorption of the rays is

$$\int_0^{\infty} q_0 e^{-\lambda x} dx = \frac{q_0}{\lambda}.$$

Now λ is difficult to measure experimentally for air, but an approximate estimate can be made of its value from the known fact that the absorption of β rays is approximately proportional to the density of any given substance.

For β rays from uranium the value of λ for aluminium is about 14, and λ divided by the density is 5.4. Taking the density of air as .0012, we find that

$$\lambda \text{ for air} = .0065.$$

The total number of ions produced in air is thus $154 q_0$ when the rays are completely absorbed.

Now from the above table the ionization due to the β rays is .0074 of that produced by α rays, when the β rays passed through a distance of 5.7 cms. of air.

Thus we have approximately

$$\frac{\text{Total number of ions produced by } \beta \text{ rays}}{\text{Total number of ions produced by } \alpha \text{ rays}} = \frac{.0074}{5.7} \times 154 = 0.20.$$

Therefore about 1/6 of the total energy radiated into air by a thin layer of uranium is carried by the β rays or electrons. The ratio for thorium is about 1/22 and for radium about 1/14, assuming the rays to have about the same average value of λ .

This calculation takes into account only the energy which is radiated out into the surrounding gas; but on account of the ease with which the α rays are absorbed, even with a thin layer, the

greater proportion of the radiation is *absorbed by the radio-active substance itself*. This is seen to be the case when it is recalled that the α radiation of thorium or radium is reduced to half value after passing through a thickness of about 0.0005 cm. of aluminium. Taking into consideration the great density of the radio-active substances, it is probable that most of the radiation which escapes into the air is due to a thin skin of the powder not much more than 0.001 cm. in thickness.

An estimate, however, of the relative rate of emission of energy by the α and β rays from a thick layer of material can be made in the following way:—For simplicity suppose a thick layer of radio-active substance spread uniformly over a large plane area. There seems to be no doubt that the radiations are emitted uniformly from each portion of the mass; consequently the radiation, which produces the ionizing action in the gas above the radio-active layer, is the sum total of all the radiation which reaches the surface of the layer.

Let λ_1 be the average coefficient of absorption of the α rays in the radio-active *substance itself* and σ the specific gravity of the substance. Let E_1 be the *total* energy radiated per sec. per unit mass of the substance when the absorption of the rays in the substance itself is disregarded. The energy per sec. radiated to the upper surface by a thickness dx of a layer of unit area at a distance x from the surface is given by

$$\frac{1}{2} E_1 \sigma e^{-\lambda_1 x} dx.$$

The total energy W_1 per unit area radiated to the surface per sec. by a thickness d is given by

$$\begin{aligned} W_1 &= \frac{1}{2} \int_0^d E_1 \sigma e^{-\lambda_1 x} dx \\ &= \frac{E_1 \sigma}{2\lambda_1} (1 - e^{-\lambda_1 d}) = \frac{E_1 \sigma}{2\lambda_1} \end{aligned}$$

if $\lambda_1 d$ is large.

In a similar way it may be shown that the energy W_2 of the β rays reaching the surface is given by $W_2 = \frac{E_2 \sigma}{2\lambda_2}$ where E_2 and λ_2

are the values for the β rays corresponding to E_1 and λ_1 for the α rays. It thus follows that

$$\frac{E_1}{E_2} = \frac{\lambda_1 W_1}{\lambda_2 W_2};$$

λ_1 and λ_2 are difficult to determine directly for the radio-active substance itself, but it is probable that the ratio λ_1/λ_2 is not very different from the ratio for the absorption coefficients for another substance like aluminium. This follows from the general result that the absorption of both α and β rays is proportional to the density of the substance; for it has already been shown in the case of the β rays from uranium that the absorption of the rays in the radio-active material is about the same as for non-radio-active matter of the same density.

With a thick layer of uranium oxide spread over an area of 22 sq. cms., it was found that the saturation current between parallel plates 6.1 cms. apart, due to the α rays, was 12.7 times as great as the current due to the β rays. Since the α rays were entirely absorbed between the plates and the total ionization produced by the β rays is 154 times the value at the surface of the plates,

$$\begin{aligned} \frac{W_1}{W_2} &= \frac{\text{total number of ions due to } \alpha \text{ rays}}{\text{total number of ions due to } \beta \text{ rays}} \\ &= \frac{12.7 \times 6.1}{154} = 0.5 \text{ approximately.} \end{aligned}$$

Now the value of λ_1 for aluminium is 2740 and of λ_2 for the same metal 14, thus

$$\frac{E_1}{E_2} = \frac{\lambda_1 W_1}{\lambda_2 W_2} = 100 \text{ approximately.}$$

This shows that the energy radiated from a thick layer of material by the β rays is only about 1 per cent. of the energy radiated in the form of α rays.

This estimate is confirmed by calculations based on independent data. Let m_1 , m_2 be the masses of the α and β particles respectively. Let v_1 , v_2 be their velocities.

$$\frac{\text{Energy of one } \alpha \text{ particle}}{\text{Energy of one } \beta \text{ particle}} = \frac{m_1 v_1^2}{m_2 v_2^2} = \frac{\frac{m_1}{e} v_1^2}{\frac{m_2}{e} v_2^2}.$$

Now it has been shown that for the α rays of radium

$$v_1 = 2.5 \times 10^9,$$

$$\frac{e}{m_1} = 6 \times 10^3.$$

The velocity of the β rays of radium varies between wide limits. Taking for an average value

$$v_2 = 1.5 \times 10^{10},$$

$$\frac{e}{m_2} = 1.8 \times 10^7,$$

it follows that the energy of the α particle from radium is almost 83 times the energy of the β particle. If equal numbers of α and β particles are projected per second, the total energy radiated in the form of α rays is about 83 times the amount in the form of β rays.

Evidence will be given later to show that the number of α particles projected is probably several times greater than the number of β particles; so that a still greater proportion of the energy is emitted in the form of α rays. These results thus lead to the conclusion that, from the point of view of the energy emitted, the α rays are far more important than the β rays. This conclusion is supported by other evidence which is discussed in chapter X, where it will be shown that the α rays play by far the most important part in the changes occurring in radio-active bodies, and that the β rays only appear in the last stage of the radio-active processes. From data based on the relative absorption and ionization of the β and γ rays in air, it can be shown that the γ rays carry off about the same amount of energy as the β rays.

104. Number and Energy of the α particles. It has been shown that the greater part of the energy emitted from the radio-elements in the form of ionizing radiations is due to the α rays. Rutherford and McClung (*loc. cit.*) made an estimate of the energy of the α rays, radiated into the gas from a thin layer of active matter, by determining the total number of ions produced by the complete absorption of the α rays. Taking as the value for the energy required to produce an ion in a gas

1.90×10^{-10} ergs, it was calculated that the amount of energy, radiated into the gas, from 1 gram of uranium oxide, spread over a plate in a thin layer, corresponded to 0.032 gram-calories *per year*. Taking the activity of pure radium chloride as 1,500,000 times that of uranium, the corresponding rate of emission of energy from radium is 48,000 gram-calories per year. This is an underestimate, for it includes only the energy radiated into the gas. The actual amount of energy released in the form of α rays is evidently much greater than this on account of the absorption of the α rays in the active matter itself.

It is very important to form an estimate of the total energy emitted in the form of α rays, and also of the number of α particles expelled per second from a known weight of an active substance.

Three different methods of estimating these quantities will now be considered.

Method 1. It can be deduced from the results of Wien (section 74) that the number of β particles projected from 1 gram of radium bromide is 6.6×10^9 per second. In this calculation no correction has been made for the β rays absorbed in the envelope of the active matter and in the surrounding glass tube. Assuming that about half of the β particles escape, it follows that the number of β particles projected per second from 1 gram of *radium* is about 2×10^{10} per second. Now it will be shown later, in chapter x, that probably four α particles are projected from radium for each β particle. The number of α particles projected per second is thus about 8×10^{10} . Taking the energy of each α particle (section 86) as 5.9×10^{-6} ergs, this corresponds to a rate of emission of energy from 1 gram of radium of 40 gram-calories per hour.

Method 2. In the case of an active substance in the solid or liquid state, most of the α rays emitted are absorbed in the active material. The total ionization produced by all the α rays from 1 gram of radium, when there is no absorption in the active substance itself, was experimentally deduced in the following way. A weight of 0.26 milligrams of pure radium bromide was dissolved in water and the solution, spread uniformly over a plate about 100 sq. cms. in area, was evaporated to dryness. A few

hours afterwards the activity, measured by the α rays, reached a minimum corresponding to 25% of its maximum value when in a state of radio-active equilibrium (see section 191). The saturation current between parallel plates, sufficiently far apart to absorb all the α rays in the gas between them, was measured by a galvanometer and found to be 2.6×10^{-8} amperes. In this case the film of radium bromide was so thin that the absorption of the α rays by the radium itself was very small. Taking into account that half of the α radiation from the radium was absorbed in the plate, it can readily be deduced that the total current corresponding to 1 gram of radium when in a state of radio-active equilibrium is equal to 1.2×10^{-4} electromagnetic units. Taking the charge on each ion as 1.13×10^{-20} electromagnetic units, this corresponds to the production of 10^{16} ions per second per gram¹.

Langevin² has deduced from the results of Townsend on ionization by collision, that the energy required to produce fresh ions at every collision is equal to the energy acquired by an ion moving freely between two points, which differ in potential by about 60 volts. This corresponds to an amount of energy of 6.8×10^{-11} ergs. The total rate of emission of energy on the production of 10^{16} ions per second is thus 7×10^5 ergs per second or about 60 gram-calories per hour.

Method 3. The ionization produced in the gas by the projected α particles is due to collision with the neutral molecules. The maximum number of ions produced per unit length of path will be reached when each collision results in the production of fresh ions. Now Townsend³ has shown that the maximum number of ions produced by a moving electron per cm. of its path in air at the pressure of 1 mm. of mercury is 21. On the kinetic theory of gases, it can be deduced from this result (Langevin, *loc. cit.*) that the electron ionizes every molecule in a circular cylinder whose axis is the direction of movement and whose diameter is equal to the diameter of the molecule. It follows that the electron must be of dimensions small compared with the molecule—a result which is in accordance with the experimental data. In the case of the

¹ Rutherford and Soddy, *Phil. Mag.* May 1903.

² *Thèse présentée à la Faculté des Sciences, Paris 1902, p. 85.*

³ *Phil. Mag.* p. 198, Feb. 1901.

α particles, the ionization is produced by a charged body atomic in size. It is reasonable to suppose that the *maximum* number of ions produced by the α particles per cm. of their path cannot be greater than the number of molecules in a cylinder of twice the diameter of the molecule. The maximum number of ions produced per cm. of path in air at 1 mm. pressure cannot in consequence be greater than 84. The number per cm. at atmospheric pressure and temperature will be 63,800.

Now half the α rays from radium are absorbed in traversing 0.75 cm. of air (section 92). The total number of ions produced by the rays is about the same as if the ionization at the surface of the active matter extended uniformly for a distance of 1.09 cms. The number of ions produced on an average by each α particle of radium cannot in consequence be greater than 70,000.

The total number of ions produced for 1 gram of radium is 10^{16} . This corresponds to an emission of 1.4×10^{11} α particles from 1 gram of radium per second and an emission of energy of 70 gram-calories per hour.

The approximate estimates by the three methods of the number of α particles and the rate of emission of energy from 1 gram of radium are in good agreement. It may be concluded that from 1 gram of radium:—

- (1) about 10^{11} α particles are projected per second;
- (2) the rate of emission of energy in the form of α particles is probably equal to about 50 gram-calories per hour.

These results will be found to be in harmony with the deductions drawn from the observed heat emission of radium discussed in the next section.

Since radium bromide has an activity (measured by the α rays) of about 1,500,000 times uranium, it follows that the number of α particles projected from 1 gram of thorium or uranium is only 7×10^{-7} of the number from radium.

In the following table are given the probable number of α particles projected per second and the rate of emission of energy in the form of α particles from 1 gram of each of the three radio-elements.

	Number of α particles per sec.	Emission of energy in form of α rays per hour	Emission of energy per year
Uranium ...	70000	3.5×10^{-5} gram-cal.	.3 gram-cal.
Thorium ...	70000	3.5×10^{-5} "	.3 "
Radium ...	10^{11}	50 "	4.4×10^5 gram-cal.

The rate of emission of energy in the form of β and γ rays is probably about 1 per cent. of the above values. For a thin layer of a radio-element the amount of energy radiated into the air in the form of rays is for most cases about 10 per cent. of the above values.

105. Heat emission of radium. P. Curie and Laborde¹ first drew attention to the striking result that a radium compound kept itself continuously at a temperature several degrees higher than that of the surrounding atmosphere. Thus the energy emitted from radium can be demonstrated by its direct heating effect as well as by photographic and electric means. Curie and Laborde determined the rate of the emission of heat in two different ways. In one method the difference of temperature was observed by means of an iron-constantin thermo-couple between a tube containing one gram of radiferous chloride of barium, of activity about 1/6 of pure radium, and an exactly similar tube containing one gram of pure barium chloride. The difference of temperature observed was 1.5° C. In order to measure the rate of emission of heat, a coil of wire of known resistance was placed in the pure barium chloride, and the strength of the electric current required in order to raise the barium to the same temperature as the radiferous barium was observed. In the other method, the active barium, enclosed in a glass tube, was placed inside a Bunsen calorimeter. Before the radium was introduced, it was observed that the level of the mercury in the stem remained steady. As soon as the radium, which had previously been cooled in melting ice, was placed in the calorimeter, the mercury column began to move at a regular rate. If the radium tube was removed, the movement of the mercury ceased. It was

¹ C. R. 136, p. 673, 1903.

found from these experiments that the heat emission from the 1 gram of radiferous barium, containing about $1/6$ of its weight of pure radium chloride, was 14 gram-calories per hour. Measurements were also made with 0.08 gram of pure radium chloride. Curie and Laborde deduced from these results that 1 gram of pure radium emits a quantity of heat of *about 100 gram-calories per hour*. This result was confirmed by the experiments of Runge and Precht¹ and others. As far as observation has at present gone, this rate of emission of heat is continuous and unchanged with lapse of time. Therefore, 1 gram of radium emits in the course of a day 2400, and in the course of a year, 876,000 gram-calories. The amount of heat evolved in the union of hydrogen and oxygen to form 1 gram of water is 3900 gram-calories. It is thus seen that 1 gram of radium emits *per day* nearly as much energy as is required to dissociate 1 gram of water.

In some later experiments using 0.7 gram of pure radium bromide, P. Curie² found that the temperature of the radium indicated by a mercury thermometer was 3° C. above that of the surrounding air. This result was confirmed by Giesel who obtained a difference of temperature of 5° C. with 1 gram of radium bromide. The actual rise of temperature observed will obviously depend upon the size and nature of the vessel containing the radium.

During their visit to England in 1903 to lecture at the Royal Institution, M. and Mme Curie performed some experiments with Professor Dewar, to test by another method the rate of emission of heat from radium at very low temperatures. This method depended on the measurement of the amount of gas volatilized when a radium preparation was placed inside a tube immersed in a liquefied gas at its boiling point. The arrangement of the calorimeter is shown in Fig. 31.

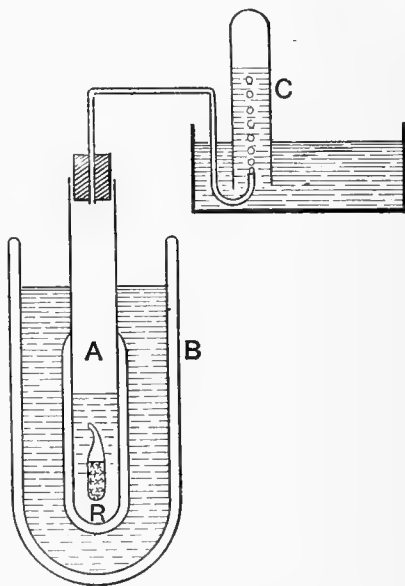

Fig. 31.

¹ *Sitz. Ak. Wiss. Berlin*, No. 38, 1903.

² *Société de Physique*, 1903.

The small closed Dewar flask *A* contains the radium in a glass tube *B*, immersed in the liquid to be employed. The flask *A* is surrounded by another Dewar bulb *B*, containing the same liquid, so that no heat is communicated to *A* from the outside. The gas, liberated in the tube *A*, is collected in the usual way over water or mercury and its volume determined. By this method, measurements were made with liquid carbon dioxide, oxygen, and liquid hydrogen. Especial interest attaches to the results with liquid hydrogen. The rate of heat emission of the radium was found to be about the same in boiling carbon dioxide and oxygen, but Dewar¹ states that it was distinctly *greater* in liquid hydrogen. This result, if confirmed, is of great interest, for it shows that while the rate of heat emission is practically unchanged between the range of temperature of liquid oxygen and carbon dioxide, the great relative drop in absolute temperature between liquid oxygen and hydrogen causes an increase in the heat emission. It will be shown in the next section that the heat emission of radium is directly connected with the radio-activity of that element. A change in the rate of heat emission must then involve a change in the radio-activity of radium. The conclusion that the heat emission of radium is greater in liquid hydrogen than at ordinary temperatures thus requires confirmation by direct measurements of the radio-activity.

The use of liquid hydrogen is very convenient for demonstrating the rate of heat emission from a small amount of radium. From 0.7 grams of radium bromide (which had been prepared only 10 days previously) 73 c.c. of gas was given off per minute.

In later experiments P. Curie (*loc. cit.*) found that the rate of emission of heat from a given quantity of radium depended upon the time which had elapsed since its preparation. The emission of heat was at first small, but after a month's interval practically attained a maximum. If a radium compound is dissolved and placed in a sealed tube, the rate of heat emission rises to the same maximum as that of an equal quantity of radium in the solid state.

106. Connection of the heat emission with the radiations. The observations of Curie that the rate of heat emission

¹ Dewar, British Association, 1903.

depended upon the age of the radium preparation pointed to the conclusion that the phenomenon of heat emission of radium was connected with the radio-activity of that element. It had long been known that radium compounds increased in activity for about a month after their preparation, when they reached a steady state. This increase of activity is due to the continuous production by the radium of the radio-active emanation or gas, which is occluded in the radium compound and adds its radiation to that of the radium proper. It thus seemed probable that the heating effect was in some way connected with the presence of the emanation. Some experiments upon this point have been made recently by Rutherford and Barnes¹. In order to measure the small amounts of heat emitted, a form of differential air calorimeter was employed. Two equal glass flasks of about 500 c.c. were filled with dry air at atmospheric pressure. These flasks were connected through a glass U-tube filled with xylene, which served as a manometer to determine any variation of pressure of the air in the flasks. A small glass tube, closed at the lower end, was introduced into the middle of each of the flasks. When a continuous source of heat was introduced into the glass tube, the air surrounding it was heated and the pressure was increased. The difference of pressure, when a steady state was reached, was observed on the manometer by means of a microscope with a micrometer scale in the eyepiece. On placing the source of heat in the similar tube in the other flask, the difference in pressure was reversed. In order to keep the apparatus at a constant temperature, the two flasks were immersed in a water bath, which was kept well stirred.

Observations were first made on the heat emission from 30 milligrams of radium bromide. The difference in pressure observed on the manometer was standardized by placing a small coil of wire of known resistance in the place of the radium. The strength of the current through the wire was adjusted to give the same difference of pressure on the manometer. In this way it was found that the heat emission per gram of radium bromide corresponded to 65 gram-calories per hour. Taking the atomic weight of radium as 225, this is equivalent to a rate of emission of heat from one gram of metallic radium of 110 gram-calories per hour.

¹ *Nature*, Oct. 29, 1903. *Phil. Mag.* Feb. 1904.

The emanation from the 30 milligrams of radium bromide was then removed by heating the radium (section 141). By passing the emanation through a small glass tube immersed in liquid air, the emanation was condensed. The tube was sealed off while the emanation was still condensed in the tube. In this way the emanation was concentrated in a small glass tube about 4 cms. long. The heating effects of the "de-emanated" radium and of the emanation tube were then determined at intervals. It was found that, after removal of the emanation, the heating effect of the radium decayed in the course of a few hours to a minimum, corresponding to about 30 per cent. of the original heat emission, and then gradually increased again, reaching its original value after about a month's interval. The heating effect of the emanation tube was found to increase for the first few hours after separation to a maximum, and then to decay regularly with the time according to an exponential law, falling to half its maximum value in about four days. The actual heat emission of the emanation tube was determined by sending a current through a coil of wire occupying the same length and position as the emanation tube.

The variation with time of the heating effect from 30 milligrams of radium and the emanation from it is shown in Fig. 32.

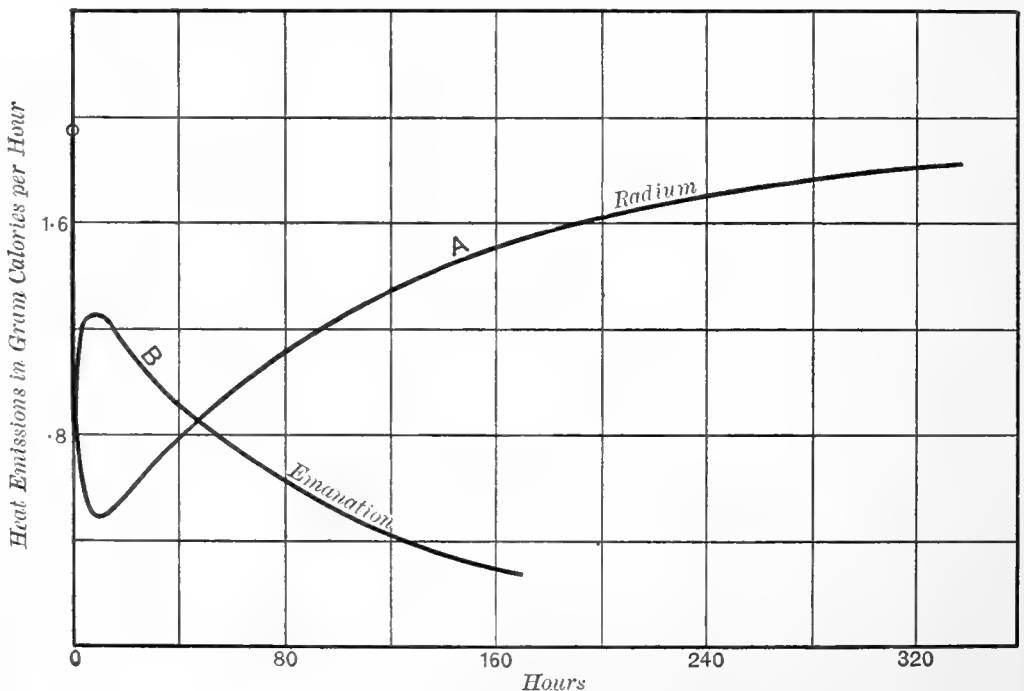

Fig. 32.

Curve *A* shows the variation of the heat emission of the radium and curve *B* of the emanation. The sum total of the rate of heat emission of the radium and the emanation together, was at any time found to be equal to that of the original radium. The maximum heating effect of the tube containing the emanation from 30 milligrams of radium bromide was 1.26 gram-calories per hour. The emanation together with the secondary products which arise from it, obtained from one gram of radium, would thus give out 42 gram-calories per hour. The emanation stored up in the radium is thus responsible for more than two-thirds of the heat emission from radium.

After removal of the emanation from radium, the activity, measured by the α rays, decays in the course of a few hours to a minimum of about 25% and then increases to its original value after about a month's interval. At the same time, the apparent activity of the emanation in a closed vessel increases to a maximum in the course of a few hours and then decays with time according to an exponential law, falling to half value in about four days. The gradual decay of the activity of the radium, after removal of the emanation, is due to the decay of the "excited activity" on the radium itself. The increase of the apparent activity of the emanation is due to the production of "excited activity" on the walls of the containing vessel. The variation in heat emission of the radium and the emanation in both cases is approximately *proportional to the activity measured by the α rays*. It is not proportional to the activity measured by the β or γ rays, for the intensity of the β and γ rays falls nearly to zero when the α radiation of the radium is at the minimum of 25 per cent. These results are thus in accordance with the view that the heat emission of radium accompanies the expulsion of α particles, and is approximately proportional to the number expelled.

107. Source of the energy. On the theory of atomic disintegration advanced in section 87, this heat is derived, not from external sources, but from the internal energy of the radium atom. The atom is supposed to be a complex system consisting of charged parts in very rapid motion, and, in consequence, contains a large

store of latent energy, which can only be manifested when the atom breaks up. For some reason, the atomic system becomes unstable, and an α particle, of mass about twice that of the hydrogen atom, escapes, carrying with it its energy of motion. Since the α particles would be practically absorbed in a thickness of radium of less than .001 cm., the greater proportion of the α particles, expelled from a mass of radium, would be stopped in the radium itself and their energy of motion would be manifested in the form of heat. The radium would thus be heated by its own bombardment above the temperature of the surrounding air. The suggestion that the heat emission of radium was connected with the expulsion of the α rays was first given by Sir Oliver Lodge¹. The energy of the expelled α particles does not account for the whole emission of heat by radium. It is evident that the violent expulsion of a part of the atom must result in intense electrical disturbances in the atom. At the same time, the residual parts of the disintegrated atom rearrange themselves to form a permanently or temporarily stable system. During this process also, energy is emitted, which is manifested in the form of heat in the radium itself.

It has already been calculated (section 104) that the emission of energy in the form of α particles, probably corresponds to about 50 gram-calories per hour for one gram of radium. The observed heat emission of radium, under conditions when the α rays are nearly all absorbed in the radium itself, is 100 gram-calories per hour per gram. On account of the uncertainty attaching to the estimate of the energy of the α rays, it is not possible to deduce with accuracy how much of the total energy emitted is due to them. The evidence, taken as a whole, points to the conclusion that a considerable fraction of the total emission of energy is due to the kinetic energy of the α rays.

Runge and Precht (*loc. cit.*) determined the heat emission of radium by means of a thermometer, (1) when the radium was in a thin tube, and (2) when it was surrounded by a lead screen several millimetres in thickness. Within the limit of accuracy of the

¹ *Nature*, April 2, 1903.

experiments (about 5%), no difference in the heat emission was observed in the two cases. The only difference between the experiments (1) and (2) is that in the latter the β rays are absorbed in the lead and add their heating effect to the radium. Since, however, the energy of the β rays is probably not more than 1% of that due to the α rays (section 103), no appreciable difference is to be expected. The experiments of Runge and Precht are quite consistent with the view that the heating effect largely depends on the energy of the α rays.

A further discussion of the heating effect of the emanation and of its secondary products is given in sections 163 and 181.

CHAPTER VI.

PROPERTIES OF THE RADIATIONS.

108. BESIDES their power of acting on a photographic plate, and of ionizing gases, the radiations from active bodies are able to produce marked chemical and physical actions in various substances. Most of these effects are due either to the α or β rays. The γ rays produce little effect in comparison. Since the β rays are similar in all respects to high velocity cathode rays, it is to be expected that they will produce effects similar in character to those produced by the cathode rays in a vacuum tube.

Phosphorescent action.

Becquerel¹ has studied the action of radium rays in producing phosphorescence in various bodies. The substance to be tested was placed above the radium in the form of powder on a very thin mica plate. Examination was made of the sulphides of calcium and strontium, ruby, diamond, varieties of spar, phosphorus and hexagonal blende. Substances like the ruby and spar, which phosphoresce under luminous rays, did not phosphoresce under the radium rays. On the other hand, those which were made luminous by ultra-violet light were also luminous under the action of radium rays. The radium rays show distinct differences from X rays. For example, a diamond which was very luminous with radium rays was unaffected by X rays. It has been mentioned previously that the α rays from Marckwald's preparation of polonium produce marked phosphorescence in the diamond. The double sulphate of

¹ *C. R.* 129, p. 912, 1899.

uranium and potassium is more luminous than hexagonal blende under X rays, but the reverse is true for radium rays; under the influence of these rays, sulphide of calcium gave a blue luminosity but was hardly affected by X rays.

The following table shows the relative phosphorescence excited in various bodies.

Substance	Without screen. Intensity	Across screen of black paper
Hexagonal blende	13·36	·04
Platino-cyanide of barium	1·99	·05
Diamond	1·14	·01
Double sulphate of Uranium and Potassium	1·00	·31
Calcium Fluoride	·30	·02

In the last column the intensity without the screen is in each case taken as unity. The great diminution of intensity after the rays have passed through black paper shows that most of the phosphorescence developed without the screen is, in the majority of cases, due to the α rays.

Bary¹ has made a very complete examination of the class of substances which become luminous under radium rays. He found that the great majority of substances belong to the alkali metals and alkaline earths. All these substances were also phosphorescent under the action of X rays.

Zinc sulphide (Sidot's blende) phosphoresces very brightly under the influence of the rays from radium and other very active substances. This was observed by Curie and Debierne in their study of the radium emanation and the excited activity produced by it. It has also been largely used by Giesel as an optical means of detecting the presence of emanations from very active substances. It is an especially sensitive means of detecting the presence of α rays, when it exhibits the "scintillating" property already discussed in section 88. In order to show the luminosity due to the α rays, the screen should be held close to the active substance, as the rays are absorbed in their passage through a few

¹ *C. R.* 130, p. 776, 1900.

centimetres of air. Zinc sulphide is also luminous under the action of the β rays, but the phosphorescence is far more persistent than when produced by the α rays.

Platino-cyanide of barium fluoresces under the action of all three kinds of rays, but is especially suitable for a study of the β and γ rays. With a decigram of radium, the luminosity on the screen can be seen at a distance of a metre from the radium. The rays produce quite an appreciable luminosity on the screen after their passage through the human body. The mineral willemite (zinc silicate) was recently found by Kunz to be an even more sensitive means of detecting the presence of the radiations than platino-cyanide of barium. It fluoresces a beautiful greenish colour, and a piece of the mineral appears quite translucent under the action of the rays. Baskerville¹ has recently shown that kunzite, a new variety of mineral spodumene discovered by Kunz², becomes luminous when exposed to the action of radium rays and retains its luminosity for some time.

Both zinc sulphide and platino-cyanide of barium diminish in luminosity after exposure for some time to the action of the rays. To regenerate a screen of the latter, exposure to solar light is necessary. A similar phenomenon has been observed by Villard for a screen exposed to Röntgen rays. Giesel made a screen of platino-cyanide of radio-active barium. The screen, very luminous at first, gradually turned brown in colour, and at the same time the crystals became dichroic. In this condition the luminosity was much less, although the active substance had increased in activity after preparation. Many of the substances which are luminous under the rays from active substances lose this property to a large extent at low temperatures.

109. Luminosity of radium compounds. All radium compounds are spontaneously luminous. This luminosity is especially brilliant in the dry haloid salts, and persists for long intervals of time. In damp air the salts lose a large amount of their luminosity, but they recover it on drying. With very active radium chloride, the Curies have observed that the light changes

¹ *Science*, Sept. 4, 1903.

² *Science*, Aug. 28, 1903.

Spectrum of Radium Bromide

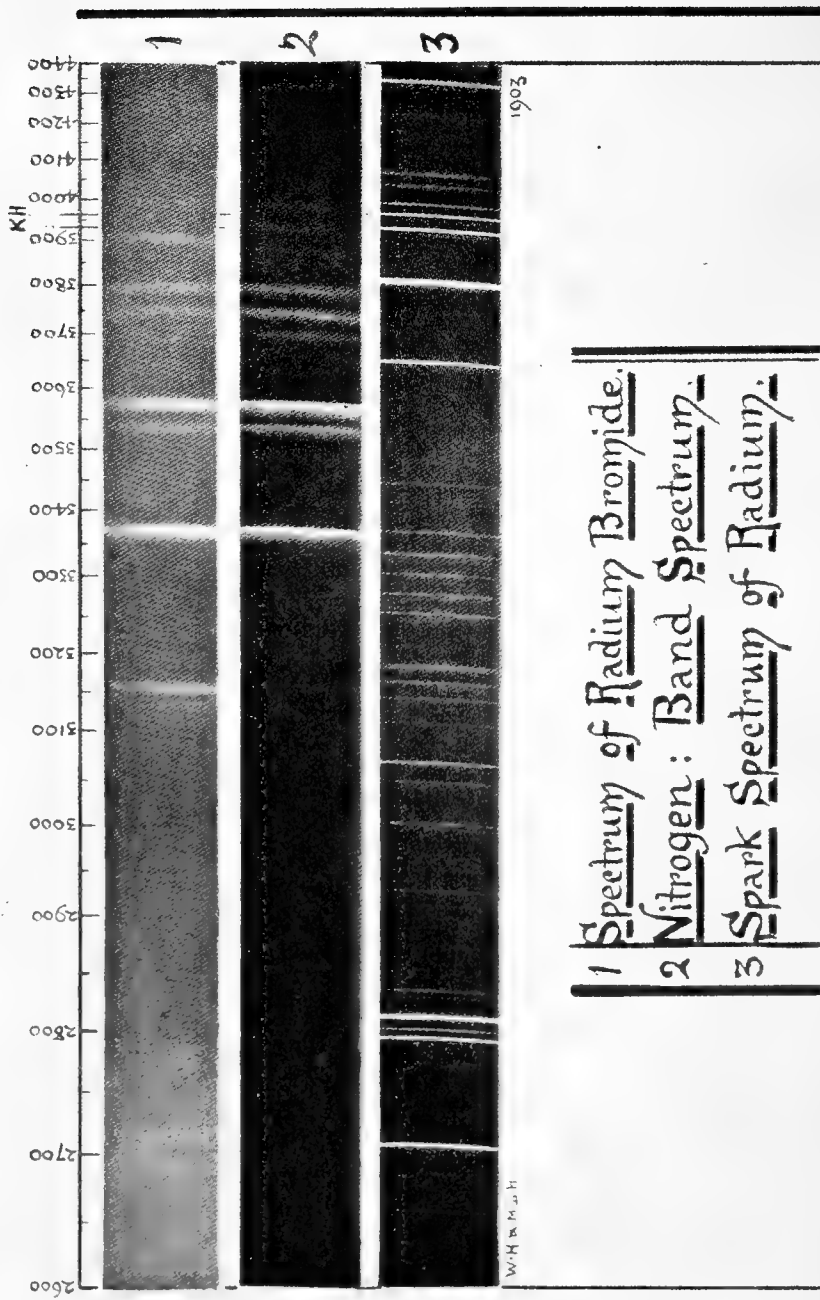

Fig. 33.

in colour and intensity with time. The original luminosity is recovered if the salt is dissolved and dried. Many inactive preparations of radiferous barium are strongly luminous. The writer has seen a preparation of impure radium bromide which gave out a light sufficient to read by in a dark room. The luminosity of radium persists over a wide range of temperature and is as bright at the temperature of liquid air as at ordinary temperatures. A slight luminosity is observed in a solution of radium, and if crystals are being formed in the solution, they can be clearly distinguished in the liquid by their greater luminosity.

110. Spectrum of the phosphorescent light of radium.

Compounds of radium, with a large admixture of barium, are usually strongly self-luminous. This luminosity decreases with increasing purity, and pure radium bromide is only very feebly self-luminous. A spectroscopic examination of the slight phosphorescent light of pure radium bromide has been made by Sir William and Lady Huggins¹. On viewing the light with a direct vision spectroscope, there were faint indications of a variation of luminosity at different points along the spectrum. In order to get a photograph of the spectrum within a reasonable time, they made use of a quartz spectroscope of special design which had been previously employed in a spectroscopic examination of faint celestial objects. After three days' exposure with a slit of $1/450$ of an inch in width, a negative was obtained which showed a number of bright lines. The magnified spectrum is shown in Fig. 33. The lines of this spectrum were found to agree not only in position but also in relative intensity with the band spectrum of nitrogen. The band spectrum of nitrogen and also the spark spectrum² of radium are shown in the same figure.

Some time afterwards Sir William Crookes and Prof. Dewar³ showed that this spectrum of nitrogen was not obtained if the radium was contained in a highly exhausted tube. Thus it

¹ *Proc. Roy. Soc.* 72, pp. 196 and 409, 1903.

² The spark spectrum of the radium bromide showed the *H* and *K* lines of calcium and also faintly some of the strong lines of barium. The characteristic lines of radium of wave-lengths 3814.59, 3649.7, 4340.6 and 2708.6, as shown by Demarçay and others are clearly shown in the figure. The strong line of wave-length about 2814 is due to radium.

³ British Assoc. 1903.

appears that the spectrum is due to the action of the radium rays either on occluded nitrogen or the nitrogen in the atmosphere surrounding the radium.

It is very remarkable that a phosphorescent light, like that of radium bromide, should show a bright line spectrum of nitrogen. It shows that radium at ordinary temperatures is able to set up radiations which are produced only by the electric discharge under special conditions.

Sir William and Lady Huggins were led to examine the spectrum of the natural phosphorescent light of radium with the hope that some indications might thereby be obtained of the processes occurring in the radium atom. Since the main radiation from radium consists of positively charged atoms projected with great velocity, radiations must be set up both in the expelled body and in the system from which it escapes. Further experiments in this direction are much to be desired at the present time.

111. Thermo-luminescence. E. Wiedemann and Schmidt¹ have shown that certain bodies after exposure to the cathode rays or the electric spark become luminous when they are heated to a temperature much below that required to cause incandescence. This property of thermo-luminescence is most strikingly exhibited in certain cases where two salts, one of which is much in excess of the other, are precipitated together. It is to be expected that such bodies would also acquire the property when exposed to the β or cathodic rays of radium. This has been found to be the case by Wiedemann². Becquerel showed that fluor-spar, exposed to the radium rays, was luminous when heated. The glass tubes in which radium is kept are rapidly blackened. On heating the tube, a strong luminosity is observed, and the coloration to a large extent disappears. The peculiarity of many of these bodies lies in the fact that the property of becoming luminous when heated is retained for a long interval of time after the body is removed from the influence of the exciting cause. It appears probable that the rays cause chemical changes in these bodies, which are permanent until heat is applied. A portion of the chemical energy is then released in the form of visible light.

¹ *Wied. Annal.* 59, p. 604, 1895.

² *Phys. Zeit.* 2, p. 269, 1901.

Physical actions.

112. Some electric effects. Radium rays have the same effect as ultra-violet light and Röntgen rays in increasing the facility with which a spark passes between electrodes. Elster and Geitel¹ showed that if two electrodes were separated by a distance such that the spark just refused to pass, on bringing near a specimen of radium the spark at once passes. This effect is best shown with short sparks from a small induction coil. The Curies have observed that radium completely enveloped by a lead screen 1 cm. thick produces a similar action. The effect in that case is due to the γ rays alone. This action of the rays can be very simply illustrated by connecting two spark-gaps with the induction coil in parallel. The spark-gap of one circuit is adjusted so that the discharge just refuses to pass across it, but passes by the other. When some radium is brought near the silent spark-gap, the spark at once passes and ceases in the other.

Hemptinne² found that the electrodeless discharge in a vacuum tube began at a higher pressure when a strong preparation of radium was brought near the tube. In one experiment the discharge without the rays began at 51 mms. but with the radium rays at 68 mms. The colour of the discharge was also altered.

Himstedt³ found that the resistance of selenium was diminished by the action of radium rays in the same way as by ordinary light.

F. Henning⁴ examined the electrical resistance of a barium chloride solution containing radium of activity 1000, but could observe no appreciable difference between it and a similar pure solution of barium chloride. This experiment shows that the action of the rays from the radium does not produce any appreciable change in the conductivity of the barium solution. The amount of radium present was too small to obtain the relative conductivity of the radium and barium solution.

Specimens of strongly active material have been employed to obtain the potential at any point of the atmosphere. The ionization due to the active substance is so intense that the body to which it

¹ *Wied. Annal.* 69, p. 673, 1899.

² *C. R.* 133, p. 934, 1901.

³ *Phys. Zeit.* p. 476, 1900.

⁴ *Wied. Annal.* p. 562, 1902.

is attached rapidly takes up the potential of the air surrounding the active substance. In this respect it is more convenient and rapid in its action than the ordinary taper or water dropper, but on account of the disturbance of the electric field by the strong ionization produced, it is probably not so accurate a method as the water dropper.

113. Effect on liquid and solid dielectrics. P. Curie¹ made the very important observation that liquid dielectrics became partial conductors under the influence of radium rays. In these experiments the radium, contained in a glass tube, was placed in an inner thin cylinder of copper. This was surrounded by a concentric copper cylinder, and the liquid to be examined filled the space between. A strong electric field was applied, and the current through the liquid measured by means of an electrometer.

The following numbers illustrate the results obtained :

Substance	Conductivity in megohms per 1 cm. ³
Carbon bisulphide ...	20×10^{-14}
Petroleum ether ...	15 "
Amyline ...	14 "
Carbon chloride ...	8 "
Benzene ...	4 "
Liquid air ...	1.3 "
Vaseline oil ...	1.6 "

Liquid air, vaseline oil, petroleum ether, amyline, are normally nearly perfect insulators. The conductivity of amyline and petroleum ether due to the rays at -17°C . was only 1/10 of its value at 0°C . There is thus a marked action of temperature on the conductivity. For very active material the current was proportional to the voltage. With material of only 1/500 of the activity, it was found that Ohm's law was not obeyed.

The following numbers were obtained :

Volts	Current
50	109
100	185
200	255
400	335

¹ C. R. 134, p. 420, 1902.

For an increase of voltage of 8 times, the current only increases about 3 times. The current in the liquid thus tends to become "saturated" as does the ordinary ionization current through a gas. These results have an important bearing on the ionization theory, and show that the radiation probably produces ions in the liquid as well as in the gas. It was also found that X rays increased the conductivity to about the same extent as the radium rays.

Becquerel¹ has recently shown that solid paraffin exposed to the β and γ rays of radium acquires the property of conducting electricity to a slight extent. After removal of the radium the conductivity diminishes with time according to the same law as for an ionized gas. These results show that a solid as well as a liquid and gaseous dielectric is ionized under the influence of radium rays.

114. Effect of temperature on the radiations. Becquerel², by the electric method, determined the activity of uranium at the temperature of liquid air, and found that it did not differ more than 1 per cent. from the activity at ordinary temperatures. In his experiments, the α rays from the uranium were absorbed before reaching the testing vessel, and the electric current measured was due to the β rays alone. P. Curie³ found that the luminosity of radium and its power of exciting fluorescence in bodies were retained at the temperature of liquid air. Observations by the electric method showed that the activity of radium was unaltered at the temperature of liquid air. If a radium compound is heated in an open vessel, it is found that the activity, measured by the α rays, falls to about 25 per cent. of its original value. This is however not due to a change in the radio-activity, but to the release of the radio-active emanation, which is stored in the radium. No alteration is observed if the radium is heated in a closed vessel where none of the radio-active products are able to escape.

¹ *C. R.* 136, p. 1173, 1903.

² *C. R.* 133, p. 199, 1901.

³ *Société de Physique*, March 2, 1900.

Chemical actions.

115. Rays from active radium preparations change oxygen into ozone^{1, 2}. Its presence can be detected by the smell or by the action on iodide of potassium paper. This effect is due to the α and β rays from the radium, and not to the luminous rays from it. Since energy is required to produce ozone from oxygen, this must be derived from the energy of the radiations.

The Curies found that radium compounds rapidly produced coloration in glass. For moderately active material the colour is violet, for more active material it is yellow. Long continued action blackens the glass, although the glass may have no lead in its composition. This coloration gradually extends through the glass, and is dependent to some extent on the kind of glass used.

Giesel² found that he could obtain as much coloration in rock-salt and fluor-spar by radium rays, as by exposure to the action of cathode rays in a vacuum tube. The coloration, however, extended much deeper than that produced by the cathode rays. This is to be expected, since the radium rays have a higher velocity, and consequently greater penetrating power, than the cathode rays produced in an ordinary vacuum tube. Goldstein observed that the coloration is far more intense and rapid when the salts are melted or heated to a red heat. Melted potassium sulphate, under the action of a very active preparation of radium, was rapidly coloured a strong greenish blue which gradually changed into a dark green.

The cause of these colorations by cathode and radium rays has been the subject of much discussion. Elster and Geitel³ observed that a specimen of potassium sulphate, coloured green by radium rays, showed a strong photo-electric action, *i.e.* it rapidly lost a negative charge of electricity when exposed to the action of ultra-violet light. All substances coloured by cathode rays show a strong photo-electric action, and, since the metals sodium and potassium themselves show photo-electric action to a very remarkable degree, Elster and Geitel have suggested that the colorations are caused by a solid solution of the metal in the salt.

¹ S. and P. Curie, *C. R.* 129, p. 823, 1899.

² Giesel, *Verhandlg. d. d. phys. Ges.* Jan. 5, 1900.

³ *Phys. Zeit.* p. 113, No. 3, 1902.

Although the coloration due to radium rays extends deeper than that due to the cathode rays, when exposed to light the colour fades away at about the same rate in the two cases.

Becquerel¹ found that white phosphorus is changed into the red variety by the action of radium rays. This action was shown to be due mainly to the β rays. The secondary radiation set up by the primary rays also produced a marked effect. Radium rays, like ordinary light rays, also caused a precipitate of calomel in the presence of oxalic acid.

Hardy and Miss Willcock² found that a solution of iodoform in chloroform turned purple after exposure for 5 minutes to the rays from 5 milligrams of radium bromide. This action is due to the liberation of iodine. By testing the effect of screens of different thicknesses, over the radium, this action was found to be mainly due to the β rays from the radium. Röntgen rays produce a similar coloration.

Hardy³ also observed an action of the radium rays on the coagulation of globulin. Two solutions of globulin from ox serum were used, one made electro-positive by adding acetic acid, and the other electro-negative by adding ammonia. When the globulin was exposed close to the radium in naked drops, the opalescence of the electro-positive solution rapidly diminished, showing that the solution became more complete. The electro-negative solution was rapidly turned to a jelly and became opaque. These actions were found to be due to the α rays of radium alone.

This is further evidence in favour of the view that the α rays consist of projected positively charged bodies of atomic dimensions, for a similar coagulation effect is produced by the metallic ions of liquid electrolytes, and has been shown by W. C. D. Whetham⁴ to be due to the electric charges carried by the ions.

116. Gases evolved from radium. Curie and Debierne⁵ observed that radium preparations placed in a vacuum tube continually lowered the vacuum. The gas evolved was always accom-

¹ *C. R.* 133, p. 709, 1901.

² *Proc. Roy. Soc.* 72, p. 200, 1903.

³ *Proc. Physiolog. Soc.* May 16, 1903.

⁴ *Phil. Mag.* Nov. 1899; *Theory of Solution*, Camb. 1902, p. 396.

⁵ *C. R.* 132, p. 768, 1901.

panied by the emanation, but no new lines were observed in its spectrum. Giesel¹ has observed a similar evolution of gas from solutions of radium bromide. Giesel forwarded some active material to Runge and Böldlander, in order that they might test the gas spectroscopically. From 1 gram of a 5 per cent. radium preparation they obtained 3.5 c.c. of gas in 16 days. This gas was found, however, to be mainly hydrogen, with 12 per cent. of oxygen. In later experiments Ramsay and Soddy² found that 50 milligrams of radium bromide evolved gases at the rate of about 0.5 c.c. per day. This is a rate of evolution about twice that observed by Runge and Böldlander. On analysing the gases about 28.9 per cent. was found to consist of oxygen, and the rest was hydrogen. The slight excess of hydrogen over that attained in the decomposition of water, they consider to be due to the action of oxygen on the grease of the stop-cocks. The radio-active emanation from radium has a strong oxidizing action and rapidly produces carbon dioxide, if carbonaceous matter is present. The production of gas is probably due to the action of the radiations in decomposing water. The amount of energy required to produce the rate of decomposition observed by Ramsay and Soddy—about 10 c.c. per day for 1 gram of radium bromide—corresponds to about 30 gram-calories per day. This amount of energy is about two per cent. of the total energy emitted in the form of heat.

Ramsay and Soddy (*loc. cit.*) have also observed the presence of helium in the gases evolved by solution of radium bromide. This important result is considered in detail in section 201.

Physiological actions.

117. Walkhoff first observed that radium rays produce burns of much the same character as those caused by Röntgen rays. Experiments in this direction have been made by Giesel, Curie and Becquerel, and others, with very similar results. There is at first a painful irritation, then inflammation sets in, which lasts from 10 to 20 days. This effect is produced by all preparations of radium, and appears to be due mainly to the α and β rays.

¹ *Ber. d. d. Chem. Ges.* 35, p. 3605, 1902.

² *Proc. Roy. Soc.* 72, p. 204, 1903.

Care has to be taken in handling radium on account of the painful inflammation set up by the rays. If a finger is held for some minutes at the base of a capsule containing a radium preparation, the skin becomes inflamed for about 15 days and then peels off. The painful feeling does not disappear for two months.

Danysz¹ found that this action is mainly confined to the skin, and does not extend to the underlying tissue. Caterpillars subjected to the action of the rays lost their power of motion in several days and finally died.

Radium rays have been found beneficial in certain cases of cancer. The effect is apparently similar to that produced by Röntgen rays, but the use of radium possesses the great advantage that the radiating source can be enclosed in a fine tube and introduced at the particular point at which the action of the rays is required. The rays have also been found to hinder or stop the development of microbes².

Another interesting action of the radium rays has been observed by Giesel. On bringing up a radium preparation to the closed eye, in a dark room, a sensation of diffuse light is observed. This effect has been examined by Himstedt and Nagel³ who have shown that it is due to a fluorescence produced by the rays in the eye itself. The blind are able to perceive this luminosity if the retina is intact, but do not do so if the retina is diseased. Hardy and Anderson⁴ have recently examined this effect in some detail. The sensation of light is produced both by the β and γ rays. The eyelid practically absorbs all the β rays, so that the luminosity observed with a closed eye is due to the γ rays alone. The lens and retina of the eye are strongly phosphorescent under the action of the β and γ rays. Hardy and Anderson consider that the luminosity observed in a dark room with the open eye (the phosphorescent light of the radium itself being stopped by black paper) is to a large extent due to the phosphorescence set up in the eyeball. The γ rays, for the most part, produce the sensation of light when they strike the retina.

¹ *C. R.* 136, p. 461, 1903.

² Aschkinass and Caspari, *Arch. d. Ges. Physiologie*, 86, p. 603, 1901.

³ *Drude's Annal.* 4, p. 537, 1901.

⁴ *Proc. Roy. Soc.* 72, p. 393, 1903.

CHAPTER VII.

CONTINUOUS PRODUCTION OF RADIO-ACTIVE MATTER.

118. Uranium X. The experiments of Mme Curie show that the radio-activity of uranium and radium is an atomic phenomenon. The activity of any uranium compound depends only on the amount of that element present, and is unaffected by its chemical combination with other substances, and is not appreciably affected by wide variations of temperature. It would thus seem probable, since the activity of uranium is a specific property of the element, that the activity could not be separated from it by chemical agencies.

In 1900, however, Sir William Crookes¹ showed that, by a single chemical operation, uranium could be obtained photographically inactive while the whole of the activity could be concentrated in a small residue free from uranium. This residue, to which he gave the name Ur X, was many hundred times more active photographically, weight for weight, than the uranium from which it had been separated. The method employed for this separation was to precipitate a solution of the uranium with ammonium carbonate. On dissolving the precipitate in an excess of the reagent, a light precipitate remained behind. This was filtered, and constituted the Ur X. The active substance Ur X was probably present in very small quantity, mixed with impurities derived from the uranium. No new lines were observed in its spectrum. A partial separation of the activity of uranium was also effected by another method. Crystallized uranium nitrate was dissolved in ether, when it was found that the uranium divided itself between the ether and water present in two unequal fractions. The small part dissolved in the water layer was found to contain practically

¹ *Proc. Roy. Soc.* 66, p. 409, 1900.

all the activity when examined by the photographic method, while the other fraction was almost inactive. These results, taken by themselves, pointed very strongly to the conclusion that the activity of uranium was not due to the element itself, but to some other substance, associated with it, which had distinct chemical properties.

Results of a similar character were observed by Becquerel¹. It was found that barium could be made photographically very active by adding barium chloride to the uranium solution and precipitating the barium as sulphate. By a succession of precipitations the uranium was rendered photographically almost inactive, while the barium was strongly active.

The inactive uranium and the active barium were laid aside; but, on examining them a year later, it was found *that the uranium had completely regained its activity, while that of the barium had completely disappeared*. The loss of activity of uranium was thus only temporary in character.

In the above experiments, the activity of uranium was examined by the photographic method. The photographic action produced by uranium is due almost entirely to the β rays. The α rays, in comparison, have little if any effect. Now the radiation from Ur X consists entirely of β rays, and is consequently photographically very active. If the activity of uranium had been measured electrically without any screen over it, the current observed would have been due very largely to the α rays, and little change would have been observed after the removal of Ur X, since only the constituent responsible for the β rays was removed. This important point is discussed in more detail in section 189.

119. Thorium X. Rutherford and Soddy², working with thorium compounds, found that an intensely active constituent could be separated from thorium by a single chemical operation. If ammonia is added to a thorium solution, the thorium is precipitated, but a large amount of the activity is left behind in the filtrate, which is chemically free from thorium. This filtrate was evaporated to dryness, and the ammonium salts driven off by

¹ *C. R.* 131, p. 137, 1900; 133, p. 977, 1901.

² *Phil. Mag.* Sep. and Nov. 1902. *Trans. Chem. Soc.* 81, pp. 321 and 837, 1902.

ignition. A small residue was obtained which, weight for weight, was in some cases several thousand times more active than the thorium from which it was obtained, while the activity of the precipitated thorium was reduced to less than one half of its original value. This active constituent was named Th X from analogy to Crookes' Ur X.

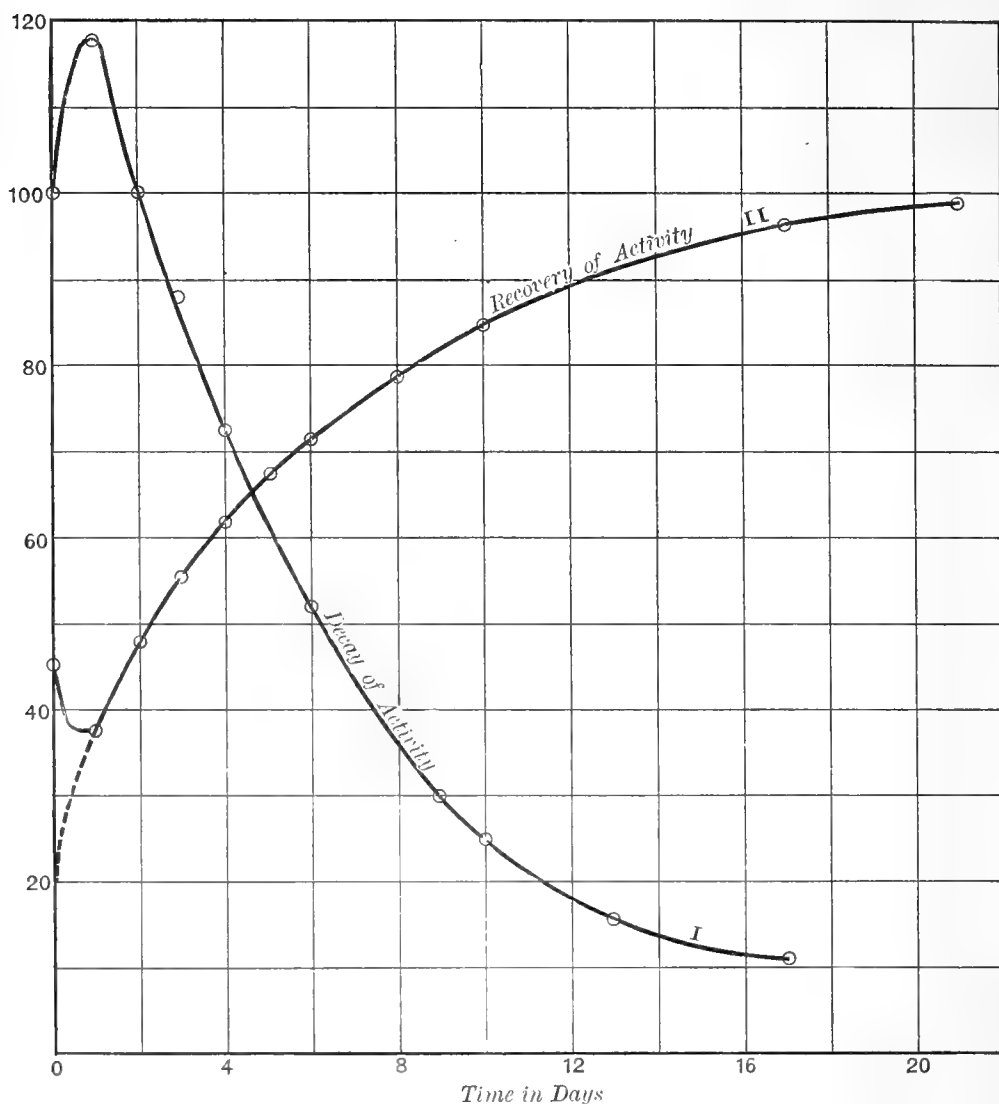

Fig. 34.

The active residue was found to consist mainly of impurities from the thorium; the Th X could not be examined chemically, and probably was present only in minute quantity. It was also found that an active constituent could be partly separated from thorium oxide by shaking it with water for some time. On

filtering the water, and evaporating down, a very active residue was obtained which was analogous in all respects to Th X.

On examining the products a month later, it was found that the *Th X* was no longer active, while the thorium had completely regained its activity. A long series of measurements was then undertaken to examine the time-rate of these processes of decay and recovery of activity.

The results are shown graphically in Fig. 34, where the final activity of the thorium and the initial activity of the Th X are in each case taken as 100. The ordinates represent the activities

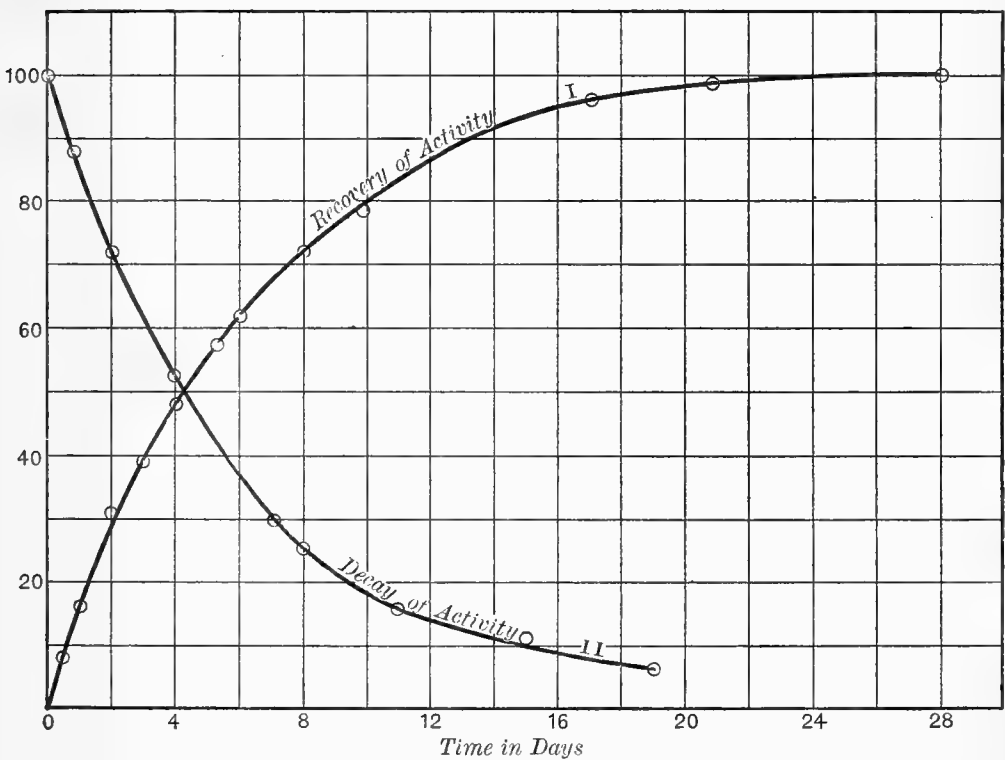

Fig. 35.

determined by means of the ionization current, and the abscissae represent the time in days. It will be observed that both curves are irregular for the first two days. The activity of the Th X increased at first, while the activity of the thorium diminished. Disregarding these initial irregularities of the curves, which will be explained in detail in section 190, it will be seen that, after the first two days, the time taken for the thorium to recover half its lost activity is about equal to the time taken by the Th X to lose

half its activity. This time in each case is about four days. The percentage proportion of the activity regained by the thorium, over any given interval, is approximately equal to the percentage proportion of the activity lost by the Th X during the same interval.

If the recovery curve is produced backwards in the normal direction to meet the vertical axis, it does so at a minimum of 25 per cent., and the above conclusions hold more accurately, if the recovery is assumed to start from this minimum. This is clearly shown by Fig. 35, where the percentages of activity recovered, reckoned from the 25 per cent. minimum, are plotted as ordinates. In the same figure the decay curve, after the second day, is shown on the same scale. The activity of the Th X decays with the time according to an exponential law, falling to half value in about four days. If I_0 is the initial activity and I_t is the activity after a time t , then

$$\frac{I_0}{I_t} = e^{-\lambda t},$$

where λ is a constant and e the natural base of logarithms. The experimental curve of the rise of activity from a minimum to a maximum value is therefore expressed by the equation

$$\frac{I_t}{I_0} = 1 - e^{-\lambda t},$$

where I_0 is the amount of activity recovered when the state of constant activity is reached, and I_t the activity recovered after a time t , and λ is the *same constant* as before.

120. Uranium X. Similar results were obtained when uranium was examined. The Ur X was separated by Becquerel's method of successive precipitations with barium. The decay of the separated activity and the recovery of the lost activity are shown graphically in Fig. 36. A more detailed discussion of this experiment is given in section 189.

The curves of decay and recovery exhibit the same peculiarities and can be expressed by the same equations as in the case of thorium. The time-rate of decay and recovery is, however, much slower than for thorium, the activity of the Ur X falling to half its value in about 22 days.

A large number of results of a similar character have been obtained from other radio-active products, separated from the

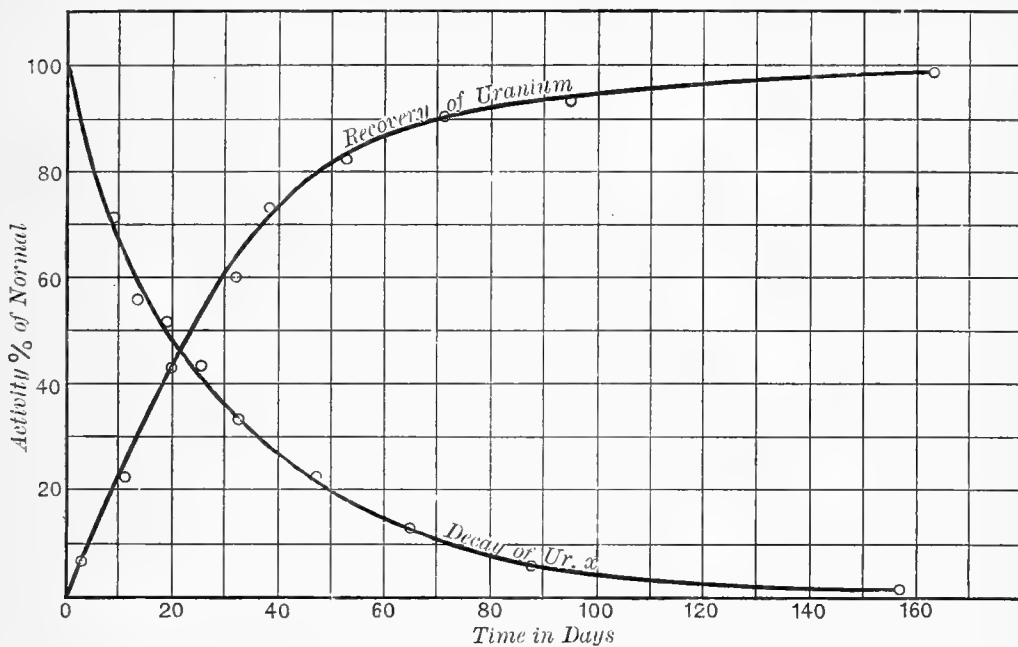

Fig. 36.

radio-elements, but the cases of thorium and uranium will suffice for the present to form a basis for the discussion of the processes that are taking place in radio-active bodies.

121. Theory of the phenomena. These processes of decay and recovery go on at exactly the same rate if the substances are removed from the neighbourhood of one another, or enclosed in lead, or placed in a vacuum tube. It is at first sight a remarkable phenomenon that the processes of decay and recovery should be so intimately connected, although there is no possibility of mutual interaction between them. These results, however, receive a complete explanation on the following hypotheses:—

- (1) That there is a constant rate of production of fresh radio-active matter by the radio-active body.
- (2) That the activity of the matter decreases according to an exponential law with the time from the moment of its formation.

Suppose that q_0 particles of new matter are produced per second from a given mass of matter. The rate of emission of energy due

to the particles produced in the time dt , is, at the moment of their formation, equal to $Kq_0 dt$ where K is a constant.

It is required to find the activity due to the whole matter produced after the process has continued for a time T .

The activity dI , due to the matter produced during the time dt at the time t , decays according to an exponential law during the time $T-t$ that elapses before its activity is estimated, and in consequence is given by

$$dI = Kq_0 e^{-\lambda(T-t)} dt,$$

where λ is the constant of decay of activity of the active matter. The activity I_t due to the whole matter produced in the time T is thus given by

$$\begin{aligned} I_t &= \int_0^T Kq_0 e^{-\lambda(T-t)} dt \\ &= \frac{Kq_0}{\lambda} (1 - e^{-\lambda T}). \end{aligned}$$

The activity reaches a maximum value I_0 when T is very great, and is then given by

$$I_0 = \frac{Kq_0}{\lambda}.$$

Thus

$$\frac{I_t}{I_0} = 1 - e^{-\lambda T}.$$

This equation agrees with the experimental results for the recovery of lost activity.

A state of equilibrium is reached when the rate of loss of activity of the matter already produced is balanced by the activity supplied by the production of new active matter. According to this view the radio-active bodies are undergoing change, but the activity remains constant owing to the action of two opposing processes. Now if this active matter can at any time be separated from the substance in which it is produced, the decay of its activity, as a whole, should follow an exponential law with the time, since each portion of the matter decreases in activity according to an exponential law with the time, whatever its age

may be. If I_0 is the initial activity of the separated product, the activity I_t after an interval t is given by

$$\frac{I_t}{I_0} = e^{-\lambda t}.$$

Thus, the two assumptions of uniform production of active matter and the decay of its activity in an exponential law from the moment of its formation satisfactorily explain the relation between the curves of decay and recovery of activity.

122. Experimental evidence. It now remains to consider further experimental evidence in support of these hypotheses. The primary conception is that the radio-active bodies are able to produce from themselves matter of chemical properties different from those of the substance that produces it, and that this process goes on at a constant rate. This new matter initially possesses the property of activity, and loses it according to a definite law. The fact that a proportion of the activity of radium and thorium can be concentrated in small amounts of active matter like Th X or Ur X does not, of itself, prove directly that a material constituent responsible for the activity has been chemically separated. For example, in the case of the separation of Th X from thorium, it might be supposed that the non-thorium part of the solution is rendered temporarily active by its association with thorium, and that this property is retained through the processes of precipitation, evaporation, and ignition, and finally manifests itself in the residue remaining. According to this view it is to be expected that any precipitate capable of removing the thorium completely from its solution should yield active residues similar to those obtained from ammonia. No such case has however been observed. For example, when thorium nitrate is precipitated by sodium or ammonium carbonate, the residue from the filtrate after evaporation and ignition is free from activity and the thorium carbonate obtained has the normal amount of activity. In fact, ammonia is the only reagent yet found capable of completely separating Th X from thorium. A partial separation of the Th X can be made by shaking thorium oxide with water owing to the greater solubility of Th X in water.

Thorium and uranium behave quite differently with regard to

the action of ammonia and ammonium carbonate. Ur X is completely precipitated with the uranium in an ammonia solution and the filtrate is inactive. Ur X is separated by ammonium carbonate, while Th X under the same conditions is completely precipitated with the thorium. The Ur X and the Th X thus behave like distinct types of matter with well-marked chemical properties quite distinct from those of the substances in which they are produced. The removal of Ur X by the precipitation of barium is probably not directly connected with the chemical properties of Ur X. The separation is probably due to the dragging down of the Ur X with the dense barium precipitate. Sir William Crookes found that the Ur X was dragged down by precipitates when no question of insolubility was involved, and such a result is to be expected if the Ur X exists in extremely minute quantity. It must be borne in mind that the actual amount of the active constituents Th X and Ur X, separated from thorium and uranium, is probably infinitesimal, and that the greater proportion of the residues is due to impurities present in the salt and the reagents, a very small amount of active matter being mixed with them.

123. Rate of production of Th X. If the recovery of the activity of uranium or thorium is due to the continuous production of new active matter, it should be possible to obtain experimental evidence of the process. As the case of thorium has been most fully investigated, a brief account will be given of some experiments made by Rutherford and Soddy¹ to show that Th X is produced continuously at a constant rate. Preliminary experiments showed that three successive precipitations were sufficient to remove the Th X almost completely from the thorium. The general method employed was to precipitate a solution of 5 grams of thorium-nitrate with ammonia. The precipitate was then redissolved in nitric acid and the thorium again precipitated as before, as rapidly as possible, so that the Th X produced in the time between successive precipitations should not appreciably affect the results. The removal of the Th X was followed by measurements of the activity of the residues obtained from suc-

¹ *Phil. Mag.* Sept. 1902.

cessive filtrates. In three successive precipitations the activities of the residues were proportional to 100, 8, 1.6 respectively. Thus two precipitations are nearly sufficient to free the thorium from Th X.

The thorium freed from Th X was then allowed to stand for a definite time, and the amount of Th X formed during that time found by precipitating it, and measuring its radio-activity. According to the theory, the activity I_t of the thorium formed in the time t is given by

$$\frac{I_t}{I_0} = 1 - e^{-\lambda t},$$

where I_0 is the total activity of Th X, when there is radio-active equilibrium.

If λt is small,

$$\frac{I_t}{I_0} = \lambda t.$$

Since the activity of Th X falls to half value in 4 days, the value of λ expressed in hours = .0072. After standing a period of 1 hour about 1/140, after 1 day 1/6, after 4 days 1/2 of the maximum should be obtained. The experimental results obtained showed an agreement as good as could be expected, with the equation expressing the result that the Th X was being produced at a constant rate.

The thorium-nitrate which had been freed from Th X was allowed to stand for one month, and then it was again subjected to the same process. The activity of the Th X was found to be the same as that obtained from an equal amount of the original thorium-nitrate. In one month, therefore, the Th X had been regenerated, and had reached a maximum value. By leaving the thorium time to fully recover its activity, this process can be repeated indefinitely, and equal amounts of Th X are obtained at each precipitation. Ordinary commercial thorium-nitrate and the purest nitrate obtainable showed exactly the same action, and equal amounts of Th X could be obtained from equal weights. These processes thus appear to be independent of the chemical purity of the substance¹.

¹ The general method of regarding the subject would be unchanged, even if it were proved that the radio-activity of thorium is not due to thorium at all but to a small constant amount of a radio-active impurity mixed with it.

The process of the production of Th X is continuous, and no alteration has been observed in the amount produced in the given time after repeated separations. After 23 precipitations extending over 9 days, the amount produced in a given interval was about the same as at the beginning of the process.

These results are all in agreement with the view that the Th X is being continuously produced from the thorium compound at a constant rate. The amount of active matter produced from 1 gram of thorium is probably extremely minute, but the electrical effects due to its activity are so large that the process of production can be followed after extremely short intervals. With a sensitive electrometer the amount of Th X produced per minute in 10 grams of thorium-nitrate gives a rapid movement to the electrometer needle. For larger intervals it is necessary to add additional capacity to the system to bring the effects within range of the instrument.

124. Rate of decay of activity. It has been shown that the activity of Ur X and Th X decays according to an exponential law with the time. This, we shall see later, is the general law of decay of activity in any type of active matter, obtained by itself, and freed from any secondary active products which it may, itself, produce. In any case, when this law is not fulfilled, it can be shown that the activity is due to the superposition of two or more effects, each of which decays in an exponential law with the time. The physical interpretation of this law still remains to be discussed.

It has been shown that in uranium and thorium compounds there is a continuous production of active matter which keeps the compound in radio-active equilibrium. The changes by which the active matter is produced must be chemical in nature, since the products of the action are different in chemical properties from the matter in which the changes take place. The activity of the products has afforded the means of following the changes occurring in them. It now remains to consider the connection between the activity at any time, and the amount of chemical change taking place at that time.

In the first place, it is found experimentally that the saturation

ionization current i_t , after the active product has been allowed to decay for a time t , is given by

$$\frac{i_t}{i_0} = e^{-\lambda t},$$

where i_0 is the initial saturation current and λ the constant of decay.

Now the saturation current is a measure of the total number of ions produced per second in the testing vessel. It has already been shown that the α rays, which produce the greater proportion of ionization in the gas, consist of positively charged particles projected with great velocity. Suppose for simplicity that each atom of active matter, in the course of its change, gives rise to one projected α particle. Each α particle will produce a certain average number of ions in its path before it strikes the boundaries or is absorbed in the gas. Since the number of projected particles per second is equal to the number of atoms changing per second, the number of atoms n_t which change per second at the time t is given by

$$\frac{n_t}{n_0} = e^{-\lambda t},$$

where n_0 is the initial number which change per second. On this view, then, the law of decay expresses the result that the number of atoms changing in unit time, diminishes according to an exponential law with the time. The number of atoms N_t which remain *unchanged* after an interval t is given by

$$\begin{aligned} N_t &= \int_t^\infty n_t dt \\ &= \frac{n_0}{\lambda} e^{-\lambda t}. \end{aligned}$$

If N_0 is the number of atoms at the beginning,

$$N_0 = \frac{n_0}{\lambda}.$$

Thus

$$\frac{N_t}{N_0} = e^{-\lambda t} \dots\dots\dots(1),$$

or the law of decay expresses the fact that the *activity of a pro-*

duct at any time is proportional to the number of atoms which remain unchanged at that time.

This is the same as the law of mono-molecular change in chemistry, and expresses the fact that there is only one changing system. If the change depended on the mutual action of two systems, the law of decay would be different, since the rate of decay in that case would depend on the relative concentration of the two reacting substances. This is not so, for there is not a single case yet observed in which the law of decay was affected by the amount of active matter present.

From the above equation (1)

$$\frac{dN_t}{dt} = -\lambda N_t,$$

or the number of systems changing in unit time is proportional to the number unchanged at that time.

In the case of recovery of activity, after an active product has been removed, the number of systems changing in unit time, when radio-active equilibrium is produced, is equal to λN_0 . This must be equal to the number q_0 of new systems supplied in unit time, or

$$q_0 = \lambda N_0,$$

and

$$\lambda = \frac{q_0}{N_0};$$

λ has thus a distinct physical meaning, and may be defined as the proportion of the total number of systems present which change per second. It has a different value for each type of active matter, but is invariable for that particular type of matter. For this reason, λ will be termed the "*radio-active constant*" of the product.

125. Influence of conditions on the rate of decay.

Since the activity of any product, at any time, may be taken as a measure of the rate at which chemical change takes place, it may be used as a means of determining the effect of conditions on the changes occurring in radio-active matter. If the rate of change should be accelerated or retarded, it is to be expected that the value of the radio-active constant λ would be increased or

decreased, *i.e.* that the decay curve would be different under different conditions.

No such effect, however, has yet been observed in any case of radio-active change, where none of the active products produced are allowed to escape from the system. The rate of decay is unaltered by any chemical or physical agency, and in this respect the changes in radio-active matter are sharply distinguished from ordinary chemical change. For example, the rate of decay of activity from any product takes place at the same rate when the substance is exposed to light as when it is kept in the dark, at the same rate in a vacuum as in air or any other gas at atmospheric pressure. Its rate of decay is unaltered by surrounding the active matter by a thick layer of lead under conditions where no ordinary radiation from outside can affect it. The activity of the matter is unaffected by ignition or chemical treatment. The material giving rise to the activity can be dissolved in acid and re-obtained by evaporation of the solution without altering the activity. The rate of decay is the same whether the active matter is retained in the solid state or kept in solution. When a product has lost its activity, resolution or heat does not regenerate it, and as we shall see later, the rate of decay of the active products, so far examined, is the same at a red heat as at the temperature of liquid air. In fact, no variation of physical or chemical conditions has led to any observable difference in the decay of activity of any of the numerous types of active matter which have been examined.

126. Effect of conditions on the rate of recovery of activity. The recovery of the activity of a radio-element with time, when an active product is separated from it, is governed by the rate of production of fresh active matter and by the decay of activity of that already produced. Since the rate of decay of the activity of the separated product is independent of conditions, the rate of recovery of activity can be modified only by a change of the rate of production of fresh active matter. As far as experiments have gone, the rate of production, like the rate of decay, is independent of chemical or physical conditions. There are indeed certain cases which are apparent exceptions to this rule. For

example, the escape of the radio-active emanations from thorium and radium is readily affected by heat, moisture and solution. A more thorough investigation, however, shows that the exception is only apparent and not real. These cases will be discussed more in detail in chapter VIII, but it may be stated here that the differences observed are due to differences in the rate of escape of the emanations into the surrounding gas, and not to differences in the rate of production. For this reason it is difficult to test the question at issue in the case of the thorium compounds, which in most cases readily allow the emanation produced by them to escape into the air.

In order to show that the rate of production is independent of molecular state, temperature, etc., it is necessary in such a case to undertake a long series of measurements extending over the whole time of recovery. It is impossible to make accurate relative comparisons to see if the activity is altered by the conversion of one compound into another. The relative activity in such a case, when measured by spreading a definite weight of material uniformly on a metal plate, varies greatly with the physical conditions of the precipitate, although the total activity of two compounds may be the same.

The following method¹ offers an accurate and simple means of studying whether the rate of production of active matter is influenced by molecular state. The substance is chemically converted into any compound required, care being taken that active products are recovered during the process. The new compound is then spread on a metal plate and compared with a standard sample of uranium for several days or weeks as required. If the rate of production of active matter is altered by the conversion, there should be an increase or decrease of activity to a new steady value, where the production of active matter is again balanced by the rate of decay. This method has the great advantage of being independent of the physical condition of the precipitate. It can be applied satisfactorily to a compound of thorium like the nitrate and the oxide which has been heated to a white heat, after which treatment only a slight amount of emanation escapes. The nitrate was converted into the oxide in a platinum crucible by treatment

¹ Rutherford and Soddy, *Phil. Mag.* Sept. 1902.

with sulphuric acid and ignition to a white heat. The oxide so obtained was spread on a plate, but no change of its activity was observed with time, showing that in this case the rate of production was independent of molecular state. This method, which is limited in the case of thorium, may be applied generally to the uranium compounds where the results are not complicated by the presence of an emanation.

No differences have yet been observed in the recovery curves of different thorium compounds after the removal of Th X. For example, the rate of recovery is the same whether the precipitated hydroxide is converted into the oxide or into the sulphate.

127. Disintegration hypothesis. In the discussion of the changes in radio-active bodies, only the active products Ur X and Th X have been considered. It will, however, be shown later that these two products are only examples of many other types of active matter which are produced by the radio-elements, and that each of these types of active matter has definite chemical as well as radio-active properties, which distinguish it, not only from the other active products, but also from the substance from which it is produced.

The full investigation of these changes will be shown to verify in every particular the hypothesis that radio-activity is the accompaniment of chemical changes of a special kind occurring in matter, and that the constant activity of the radio-elements is due to an equilibrium process, in which the rate of production of fresh active matter balances the rate of change of that already formed.

The nature of the process taking place in the radio-elements, in order to give rise to the production at a constant rate of new kinds of active matter, will now be considered. Since in thorium or uranium compounds there is a continuous production of radio-active matter, which differs in chemical properties from the parent substance, some kind of change must be taking place in the radio-element. This change, by which new matter is produced, is very different in character from the molecular changes dealt with in chemistry, for no chemical change is known which proceeds at the same rate at the temperatures corresponding to a red heat and

to liquid air, and is independent of all physical and chemical actions. If, however, the production of active matter is supposed to be the result of changes, not in the molecule, but in the *atom itself*, it is not to be expected that the temperature would exert much influence. The general experience of chemistry in failing to transform the elements by the action of temperature is itself strong evidence that wide ranges of temperature have not much effect in altering the stability of the chemical atom.

The view that the atoms of the radio-elements are undergoing spontaneous disintegration was put forward by Mr Soddy and the writer as a result of evidence of this character. The discovery of the *material* nature of the α rays added strong confirmation to the hypothesis; for it has been pointed out (section 87) that the expulsion of α particles must be the result of a disintegration of the atoms of the radio-element. Taking the case of thorium as an example, the processes occurring in the atom may be pictured in the following way. It must be supposed that the thorium atoms are not permanently stable systems, but, on an average, a constant small proportion of them—about one atom in every 10^{16} will suffice—breaks up per second. The disintegration consists in the expulsion from the atom of one or more α particles with great velocity. For simplicity, it will be supposed that each atom expels *one* α particle. It has been shown that the α particle of radium has a mass about twice that of the hydrogen atom. From the similarity of the α rays from thorium and radium, it is probable that the α particle of thorium does not differ much in mass from that of radium, and may be equal to it. After the escape of an α particle, the part of the atom left behind, which has a mass slightly less than that of the thorium atom, tends to rearrange its components to form a temporarily stable system. It is to be expected that it will differ in chemical properties from the thorium atom from which it was derived. The atom of the substance Th X is, on this view, the thorium atom minus one α particle. The atoms of Th X are far more unstable than the atoms of thorium, and one after the other they break up, each atom expelling one α particle as before. These projected α particles give rise to the *radiation* from the Th X. Since the activity of Th X falls to half its original value in about four days, on an average half of the

atoms of Th X break up in four days, the number breaking up per second being always proportional to the number present. After an atom of Th X has expelled an α particle, the mass of the system is again reduced and its chemical properties are changed. It will be shown (section 145) that the Th X gives rise to the thorium emanation, which exists as a gas, and that this in turn gives rise to matter which is deposited on solid bodies and gives rise to the phenomena of excited activity.

As a result of the disintegration of the thorium atom, there is thus a series of chemical substances produced, each of which has distinctive chemical properties. Each of these products is radioactive, and loses its activity according to a definite law. Since thorium has an atomic weight of 237, and the weight of the α particle is about 2, it is evident that, if only *one* α particle is expelled at each change, the process of disintegration could pass through a number of successive stages and yet leave behind, at the end of the process, a mass comparable with that of the parent atom.

It will be shown in chapter X that a process of disintegration, very similar to that already described for thorium, must be supposed to take place also in uranium and radium. The full discussion of this subject cannot be given with advantage until two of the most important products of thorium and radium, viz. the radio-active emanations and the matter which causes excited activity, have been considered in detail.

128. Magnitude of the changes. It can be calculated by several independent methods that, in order to account for the changes occurring in thorium, probably not more than 10^5 and not less than 10^4 atoms in each gram of thorium suffer disintegration per second. It is well known (section 39) that 1 cubic centimetre of hydrogen at atmospheric pressure and temperature contains about 2×10^{19} molecules. From this it follows that one gram of thorium contains about 10^{21} atoms. The fraction which breaks up per second thus lies between 10^{-17} and 10^{-16} . This is an extremely small ratio, and it is evident that the process could continue for long intervals of time, before the amount of matter changed would be capable of detection by the spectroscope or

by the balance. With the electroscope it is possible to detect the radiation from 10^{-5} gram of thorium, *i.e.* the electroscope is capable of detecting the ionization which accompanies the disintegration of a single thorium atom per second. The electroscope is thus an extraordinarily delicate means for detection of minute changes in matter, which are accompanied, as in the case of the radio-elements, by the expulsion of charged particles with great velocity. It is possible to detect by its radiation the amount of Th X produced in a second from 1 gram of thorium, although the process would probably need to continue thousands of years before it could be detected by the balance or the spectroscope. It is thus evident that the changes occurring in thorium are of an order of magnitude quite different from that of ordinary chemical changes, and it is not surprising that they have never been observed by direct chemical methods.

CHAPTER VIII.

RADIO-ACTIVE EMANATIONS.

129. Introduction. A most important and striking property possessed by radium, thorium, and actinium, but not by uranium or polonium, is the power of continuously emitting into the surrounding space a material emanation, which has all the properties of a radio-active gas. This emanation is able to diffuse rapidly through gases and through porous substances, and may be separated from the gas with which it is mixed by condensation by the action of extreme cold. This emanation forms a connecting link between the activity of the radio-elements themselves and their power of exciting activity on surrounding objects, and has been studied more closely than the other active products on account of its existence in the gaseous state. The emanations from the three active bodies all possess similar radio-active properties, but the effects are more marked in the case of the emanation from radium, on account of the very great activity of that element.

Thorium Emanation.

130. Discovery of the emanation. In the course of examination of the radiations of thorium, several observers had noted that some of the thorium compounds, and especially the oxide, were very inconstant sources of radiation, when examined in open vessels by the electrical method. Owens¹ found that this inconstancy was due to the presence of air currents. When a closed vessel was used, the current, immediately after the introduction of the active matter, increased with the time, and finally

¹ *Phil. Mag.* p. 360, Oct. 1899.

reached a constant value. By drawing a steady stream of air through the vessel the value of the current was much reduced. It was also observed that the radiations could apparently pass through large thicknesses of paper, which completely absorbed the ordinary α radiation.

In an investigation of these peculiar properties of thorium compounds, the writer¹ found that the effects were due to an emission of radio-active particles of some kind from the thorium compounds. This "emanation," as it was termed for convenience, possesses the properties of ionizing the gas and acting on a photographic plate, and is able to diffuse rapidly through porous substances like paper and thin metal foil.

The emanation, like a gas, is completely prevented from escaping by covering the active matter with a thin plate of mica. The emanation can be carried away by a current of air; it passes through a plug of cotton-wool and can be bubbled through solutions without any loss of activity. In these respects, it behaves very differently from the ions produced in the gas by the rays from active substances, for these give up their charge completely under the same conditions.

Since the emanation passes readily through large thicknesses of cardboard, and through filters of tightly packed cotton-wool, it does not seem likely that the emanation consists of particles of dust given off by the active matter. This point was tested still further by the method used by Aitken and Wilson, for detecting the presence of dust particles in the air. The oxide, enclosed in a paper cylinder, was placed in a glass vessel, and the dust was removed by repeated small expansions of the air over a water surface. The dust particles act as nuclei for the formation of small drops and are then removed from the air by the action of gravity. After repeated expansions, no cloud was formed, and the dust was considered to be removed. After waiting for some time to allow the thorium emanation to collect, further expansions were made but no cloud resulted, showing that for the small expansions used, the particles were too small to become centres of condensation. The emanation then could not be regarded as dust emitted from thorium.

¹ *Phil. Mag.* p. 1, Jan. 1900.

Since the power of diffusing rapidly through porous substances, and acting on a photographic plate, is also possessed by a chemical substance like hydrogen peroxide, some experiments were made to see if the emanation could be an agent of that character. It was found, however, that hydrogen peroxide is not radio-active, and that its action on the plate is a purely chemical one, while it is the *radiation* from the emanation and not the *emanation* itself that produces ionizing and photographic effects.

131. Experimental arrangements. The emanation from thorium is given off in minute quantity. No appreciable lowering of the vacuum is observed when an emanating compound is placed in a vacuum tube and no new spectrum lines are observed.

For an examination of the emanation, an apparatus similar in principle to that shown in Fig. 37 is convenient.

The thorium compound either bare or enclosed in a paper envelope was placed in a glass tube *C*. A current of air from a gasometer, after passing through a tube containing cotton-wool to remove dust particles, bubbled through sulphuric acid in the vessel *A*. It then passed through a bulb containing tightly packed cotton-wool to prevent any spray being carried over. The emana-

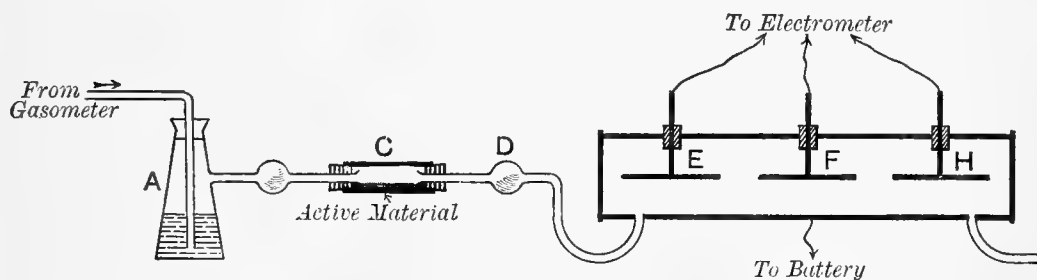

Fig. 37.

tion, mixed with air, was carried from the vessel *C* through a plug of cotton-wool *D*, which completely removed all the ions carried with the emanation. The latter then passed into a long brass cylinder, 75 cm. in length and 6 cm. in diameter. The insulated cylinder was connected with a battery in the usual way. Three insulated electrodes, *E*, *F*, *H*, of equal lengths, were placed along the axis of the cylinder, supported by brass rods passing through ebonite corks in the side of the cylinder. The current through the gas, due to the presence of the emanation, was measured by means of

an electrometer. An insulating key was arranged so that any one of the electrodes *E*, *F*, *H* could be rapidly connected with one pair of quadrants of the electrometer, the other two being always connected with earth. The current observed in the testing cylinder vessel was due entirely to the ions produced by the emanation carried into the vessel by the current of air. On substituting a uranium compound for the thorium, not the slightest current was observed. After a constant flow has passed for about 10 minutes, the current due to the emanation reaches a constant value.

The variation of the ionization current with the voltage is similar to that observed for the gas ionized by the radiations from the active bodies. The current at first increases with the voltage, but finally reaches a saturation value.

132. Duration of the activity of the emanation. The emanation rapidly loses its activity with time. This is very readily shown with the apparatus of Fig. 37. The current is found to diminish progressively along the cylinder, and the variation from electrode to electrode depends on the velocity of the flow of air.

If the velocity of the air current is known, the decay of activity of the emanation with time can be deduced. If the flow of air is stopped, and the openings of the cylinder closed, the current steadily diminishes with time. The following numbers illustrate the variation with time of the saturation current, due to the emanation in a closed vessel. The observations were taken successively, and as rapidly as possible after the current of air was stopped.

Time in seconds	Current
0	100
28	69
62	51
118	25
155	14
210	6·7
272	4·1
360	1·8

Curve *A*, Fig. 38, shows the relation existing between the current through the gas and the time. The current just before the flow of air was stopped is taken as unity. The current through

the gas, which is a measure of the activity of the emanation, diminishes according to an exponential law with the time like the activity of the products Ur X and Th X . The rate of decay is, however, much more rapid, the activity of the emanation decreasing to half value in about one minute. According to the view developed in section 124, this expresses the result that half of the

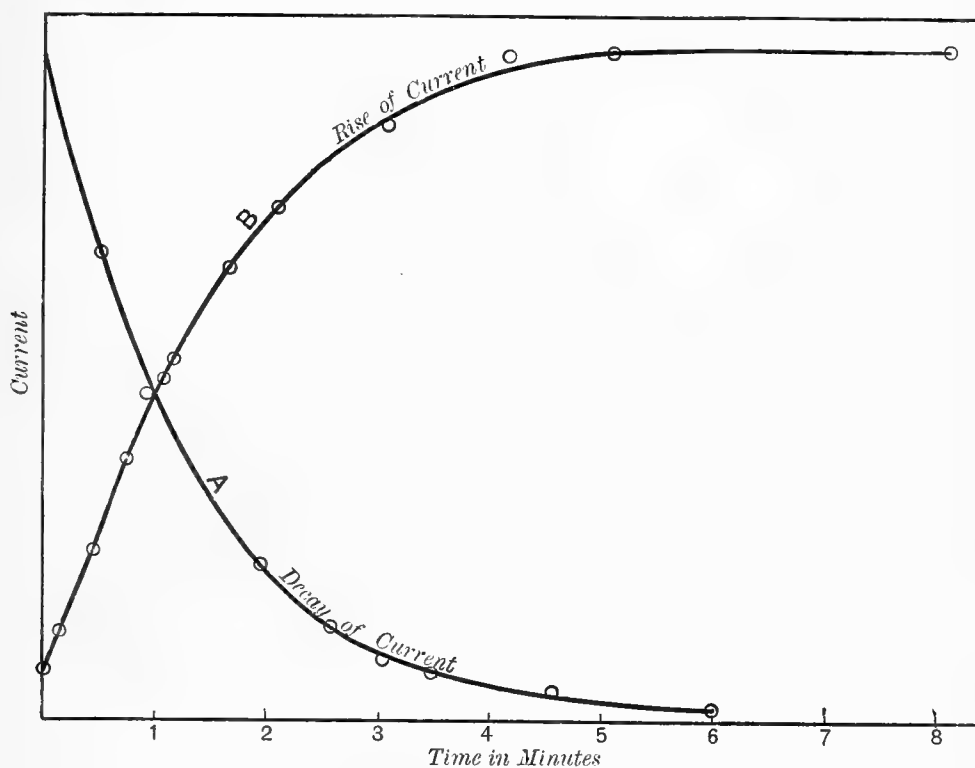

Fig. 38.

emanation particles have undergone change in one minute. After an interval of 10 minutes, the current due to the emanation is very small, showing that practically all the emanation particles present have undergone change.

The decrease of the current with time is an actual measure of the decrease of the activity of the emanation, and is not in any way influenced by the time taken for the ions produced to reach the electrodes. If the ions had been produced from a uranium compound, the duration of the conductivity for a saturation voltage would only have been a fraction of a second.

The rate of decay of the activity of the emanation is independent of the electromotive force acting on the gas. This shows that

the radio-active particles are not destroyed by the electric field. The current through the gas at any particular instant, after stoppage of the flow of air, was found to be the same whether the electromotive force had been acting the whole time or had been just applied for the time of the test.

The emanation itself is unaffected by a strong electric field and so cannot be charged. By testing the activity of the emanation after passing through long concentric cylinders, charged to a high potential, it was found that the emanation certainly did not move with a velocity greater than $\cdot 00001$ cm. per second, for a gradient of 1 volt per cm., and there was no evidence to show that it moved at all.

The rate at which the emanation is produced is independent of the gas surrounding the active matter. If in the apparatus of Fig. 37, air is replaced by hydrogen, oxygen, or carbonic acid, similar results are obtained, though the current observed in the testing vessel varies for the different gases on account of the unequal absorption by them of the radiation from the emanation.

If a thorium compound, enclosed in paper to absorb the α radiation, is placed in a closed vessel, the saturation current due to the emanation is found to vary directly as the pressure. Since the rate of ionization is proportional to the pressure for a constant source of radiation, this experiment shows that the rate of emission of the emanation is independent of the pressure of the gas. The effect of pressure on the rate of production of the emanation is discussed in more detail later in section 148.

133. Effect of thickness of layer. The amount of emanation emitted by a given area of thorium compound depends on the thickness of the layer. With a very thin layer, the current between two parallel plates, placed in a closed vessel as in Fig. 16, is due very largely to the α rays. Since the α radiation is very readily absorbed, the current due to it practically reaches a maximum when the surface of the plate is completely covered by a thin layer of the active material. On the other hand the current produced by the emanation increases until the layer is several millimetres in thickness, and then is not much altered by adding fresh active matter. This falling off of the current after a certain thickness

has been reached is to be expected, since the emanation, which takes several minutes to diffuse through the layer above it, has already lost a large proportion of its activity.

With a thick layer of thorium oxide in a closed vessel, the current between the plates is largely due to the radiation from the emanation lying between the plates. The following tables illustrate the way in which the current varies with the thickness of paper for both a thin and a thick layer.

TABLE I. *Thin Layer.*Thickness of sheets of paper $\cdot 0027$.

No. of layers of paper	Current
0	1
1	$\cdot 37$
2	$\cdot 16$
3	$\cdot 08$

TABLE II. *Thick Layer.*Thickness of paper $\cdot 008$ cm.

No. of layers of paper	Current
0	1
1	$\cdot 74$
2	$\cdot 74$
5	$\cdot 72$
10	$\cdot 67$
20	$\cdot 55$

The initial current with the unscreened compound is taken as unity. In Table I., for a thin layer of thorium oxide, the current diminished rapidly with additional layers of thin paper. In this case the current is due almost entirely to the α rays. In Table II. the current falls to $\cdot 74$ for the first layer. In this case about 26% of the current is due to the α rays, which are practically absorbed by the layer $\cdot 008$ cm. in thickness. The slow decrease with additional layers shows that the emanation diffuses so rapidly through a few layers of paper that there is little loss of activity during the passage. The time taken to diffuse through 20 layers is however appreciable, and the current consequently has decreased. After passing through a layer of cardboard 1.6 mms. in thickness the current is reduced to about one-fifth of its original value. In closed vessels the proportion of the total current, due to the emanation, varies with the distance between the plates as well as with the thickness of the layer of active material. It also varies greatly with the compound examined. In the nitrate, which gives off only a small amount of emanation, the proportion is very much smaller than in the hydroxide which gives off a large amount of emanation.

134. Increase of current with time. The current due to the emanation does not reach its final value for some time after the active matter has been introduced into the closed vessel. The variation with time is shown in the following table. The saturation current due to thorium oxide, covered with paper, was observed between concentric cylinders of 5.5 cms. and .8 cm. diameter.

Immediately before observations on the current were made, a rapid stream of air was blown through the apparatus. This removed most of the emanation. However, the current due to the ionization of the gas by the emanation, as it was carried along by the current of air, was still appreciable. The current consequently does not start from zero.

Time in seconds	Current
0	9
23	25
53	49
96	67
125	76
194	88
244	98
304	99
484	100

The results are shown graphically in Fig. 38 Curve *B*. The decay of the activity of the emanation with time, and the rate of increase of the activity, due to the emanation in a closed space, are connected in the same way as the decay and recovery curves of Th X and Ur X.

With the previous notation, the decay curve is given by

$$\frac{I_t}{I_0} = e^{-\lambda t},$$

and the recovery curve by

$$\frac{I_t}{I_0} = 1 - e^{-\lambda t},$$

where λ is the radio-active constant of the emanation.

This relation is to be expected, since the decay and recovery curves of the emanation are determined by exactly the same conditions as the decay and recovery curves of Ur X and Th X. In both cases there is:

(1) A supply of fresh radio-active particles produced at a constant rate.

(2) A loss of activity of the particles following an exponential law with the time.

In the case of Ur X and Th X, the active matter produced manifests its activity in the position in which it is formed; in this new phenomenon, a proportion of the active matter in the form of the emanation escapes into the surrounding gas. The activity of the emanation, due to a thorium compound kept in a closed vessel, thus reaches a maximum when the rate of supply of fresh emanation particles from the compound is balanced by the rate of change of those already present. The time for recovery of half the final activity is about 1 minute, the same as the time taken for the emanation, when left to itself, to lose half its activity.

If q_0 is the number of emanation particles escaping into the gas per second, and N_0 the final number when radio-active equilibrium is reached, then (section 124),

$$q_0 = \lambda N_0.$$

Since the activity of the emanation falls to half value in 1 minute

$$\lambda = 1/87,$$

and $N_0 = 87q_0$, or the number of emanation particles present when a steady state is reached is 87 times the number produced per second.

Radium Emanation.

135. Discovery of the emanation. Shortly after the discovery of the thorium emanation, Dorn¹ repeated the results and, in addition, showed that radium compounds also gave off radio-active emanations and that the amount given off was much increased by heating the compound. The radium emanation differs from the thorium emanation in the rate at which it loses its activity. It decays far more slowly, but in other respects, the emanations of thorium and radium have much the same properties. Both emanations ionize the gas with which they are mixed, and affect a photographic plate. Both diffuse readily through porous

¹ *Abh. der naturforsch. Ges. für Halle-a-S.*, 1900.

substances but are unable to pass through a thin plate of mica; both behave like a temporarily radio-active gas, mixed in minute quantity with the air or other gas in which they are conveyed.

136. Decay of activity of the emanation. Very little emanation escapes from radium chloride in the solid state, but the amount is largely increased by heating, or by dissolving the compound in water. By bubbling air through a radium chloride solution, or passing air over a heated radium compound, a large amount of emanation may be obtained which can be collected, mixed with air, in a suitable vessel.

Experiments to determine accurately the rate of decay of activity of the emanation have been made by P. Curie¹, and Rutherford and Soddy². In the experiments of the latter, the emanation mixed with air was stored over mercury in an ordinary gas holder. From time to time, equal quantities of air mixed with the emanation were measured off by a gas pipette and delivered into a testing vessel. The latter consisted of an air-tight brass cylinder carrying a central insulated electrode. A saturation voltage was applied to the cylinder, and the inner electrode was connected to the electrometer with a suitable capacity in parallel. The saturation current was observed *immediately* after the introduction of the active gas into the testing vessel, and was taken as a measure of the activity of the emanation present. The current increased rapidly with the time owing to the production of excited activity on the walls of the containing vessel. This effect is described in detail in chapter IX.

The measurements were made at suitable intervals over a period of 33 days. The following table expresses the results, the initial activity being taken as 100.

Time in hours	Relative Activity
0	100
20·8	85·7
187·6	24·0
354·9	6·9
521·9	1·5
786·9	0·19

¹ *C. R.* 135, p. 857, 1902.

² *Phil. Mag.* April, 1903.

The activity falls off according to an exponential law with the time, and decays to half value in 3.71 days. With the usual notation

$$\frac{I_t}{I_0} = e^{-\lambda t},$$

the mean value of λ deduced from the results is given by

$$\lambda = 2.16 \times 10^{-6} = 1/463000.$$

P. Curie determined the rate of decay of activity of the emanation by another method. The active matter was placed at one end of a sealed tube. After sufficient time had elapsed, the portion of the tube containing the radium compound was removed. The loss of activity of the emanation, stored in the other part, was tested at regular intervals by observing the ionization current due to the rays which passed through the walls of the glass vessel. The testing apparatus and the connections are shown clearly in Fig. 39. The ionization current is observed between the vessels *BB* and *CC*. The glass tube *A* contains the emanation.

Now it will be shown later that the emanation itself gives off only α rays, and these rays are completely absorbed by the glass envelope, unless it is made extremely thin. The rays producing ionization in the testing vessel were thus not due to the α rays from the emanation at

all, but to the β and γ rays due to the excited activity produced on the walls of the glass tube by the emanation inside it. What was actually measured was thus the decay of the excited activity derived from the emanation, and not the decay of activity of the emanation itself. Since, however, when a steady state is reached, the amount of excited activity is nearly proportional at any time to the activity of the emanation, the rate of decay of the excited

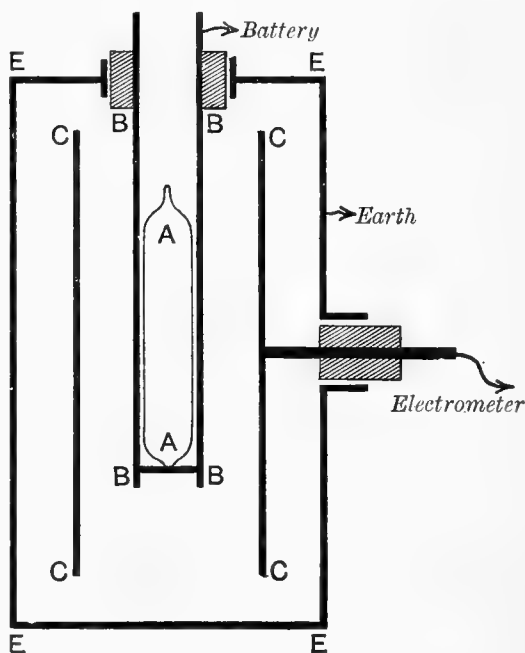

Fig. 39.

activity on the walls of the vessel indirectly furnishes a measure of the rate of decay of the emanation itself. This is only true if the emanation is placed for four or five hours in the tube before observations begin, in order to allow the excited activity time to reach a maximum value.

Using this method P. Curie obtained results similar to those obtained by Rutherford and Soddy by the direct method. The activity decayed according to an exponential law with the time falling to half value in 3.99 days.

The experiments were performed under the most varied conditions but the rate of decay was found to remain unaltered. The rate of decay did not depend on the material of the vessel containing the emanation or on the nature or pressure of the gas with which the emanation was mixed. It was unaffected by the amount of emanation present, or by the time of exposure to the radium, provided sufficient time had elapsed to allow the excited activity to reach a maximum value before the observations were begun. P. Curie¹ found that the rate of decay of activity was unaffected by exposing the vessel containing the emanation to different temperatures ranging from +450° to -180° C.

In this respect, the emanations of thorium and radium are quite analogous. The rate of decay seems to be unaffected by any physical or chemical agency, and the emanations behave in exactly the same way as the radio-active products Th X and Ur X, already referred to. The radio-active constant λ is thus a fixed and unalterable quantity for both emanations, although in one case its value is about 5000 times greater than in the other.

Emanations from Actinium.

137. Debierne² found that actinium gives out an emanation similar to the emanations of thorium and radium. The loss of activity of the emanation is even more rapid than for the thorium emanation, for its activity falls to half value in a few seconds. In consequence of the rapid decay of activity, the emanation is able to diffuse through the air only a short distance from the active matter before it loses the greater proportion of its

¹ C. R. 136, p. 223, 1903.

² C. R. 136, p. 146, 1903.

activity. Giesel has obtained an intensely active emanation from the "emanating substance." It has already been pointed out (section 21) that this "emanating substance" is probably the same as the actinium of Debierne. The emanation from actinium, like those from thorium and radium, possesses the property of exciting activity on inactive bodies. However it has not yet been studied as completely as the better known emanations of thorium and radium.

Experiments with large amounts of Radium Emanation.

138. With very active specimens of radium, a large amount of emanation can be obtained, and the electrical and photographic actions are correspondingly intense. On account of the small activity of thorium and the rapid decay of its emanation, the effects due to it are weak, and can be studied only for a few minutes after its production. The emanation from radium, on the other hand, in consequence of the slow decay of its activity, may be stored mixed with air in an ordinary gas holder, and its photographic and electrical actions may be examined several days or even weeks after, quite apart from those of the radium from which it was obtained.

It is, in general, difficult to study the radiation due to the emanation alone, on account of the fact that the emanation is continually producing a secondary type of activity on the surface of the vessel in which the emanation is enclosed. This excited activity reaches a maximum value several hours after the introduction of the emanation, and, as long as it is kept in the vessel, this excited activity on the walls decays at the same rate as the emanation itself, *i.e.* it falls to half its initial value in about 4 days. If, however, the emanation is blown out, the excited activity remains behind on the surface, but rapidly loses its activity in the course of a few hours. After several hours, the intensity of the residual radiation is very small.

These effects and their connection with the emanation are discussed more fully in chapter IX.

Giesel¹ has recorded some interesting observations of the effect of the radium emanation on a screen of phosphorescent zinc sulphide.

¹ *Ber. der deutsch. Chem. Ges.* p. 3608, 1902.

When a few centigrams of moist radium bromide were placed on a screen, any slight motion of the air caused the luminosity to move to and fro on the screen. The direction of phosphorescence could be altered at will, by a slow current of air. The effect was still further increased by placing the active material in a tube and blowing the air through it towards the screen. A screen of barium platino-cyanide or of Balmain's paint failed to give any visible light under the same conditions. The luminosity was not altered by a magnetic field, but it was affected by an electric field. If the screen were charged the luminosity was more marked when it was negative than when it was positive.

Giesel states that the luminosity was not equally distributed, but was concentrated in a peculiar ring-shaped manner over the surface of the screen. The concentration of luminosity on the negative, rather than on the positive, electrode is probably due to the excited activity, caused by the emanation, and not to the emanation itself. This excited activity (see chap. IX) in an electric field is concentrated chiefly on the negative electrode. The electric field, probably, does not act on the emanation itself but concentrates the excited activity, due to the emanation present, on to the negative electrode.

An experiment to illustrate the phosphorescence produced in some substances by the rays from a large amount of emanation is described in section 160.

139. Curie and Debierne¹ have made an examination of the emanation from radium, and the excited activity produced by it. They have examined the emanation given off from radium under very low pressures. The tube containing the emanation was exhausted to a good vacuum by a mercury pump. It was observed that a gas was given off from the radium which produced excited activity on the glass walls. This gas was extremely active, and rapidly affected a photographic plate through the glass. It caused fluorescence on the surface of the glass and rapidly blackened it, and was still active after standing ten days. When spectroscopically examined, this gas did not show any new lines, but generally those of the spectra of carbonic acid, hydrogen, and mercury.

¹ *C. R.* 132, pp. 548 and 768, 1901.

In the light of the results described in section 116, the gas, given off by the radium, was probably the non-active gases, hydrogen and oxygen, in which the active emanation was mixed in minute quantity. It will be shown later (section 163) that the energy radiated from the emanation is enormous compared with the amount of matter involved, and that the effects observed, in most cases, are produced by an almost infinitesimal amount of the emanation.

In further experiments, Curie and Debierne¹ found that many substances were phosphorescent under the action of the emanation and the excited activity produced by it. In their experiments, two

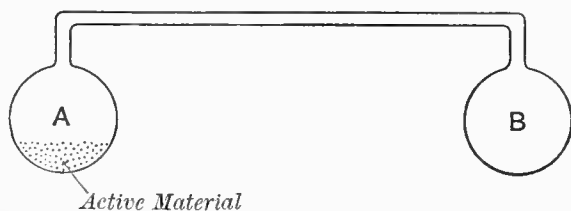

Fig. 40.

glass bulbs *A* and *B* (Fig. 40) were connected with a glass tube. The active material was placed in the bulb *A* and the substance to be examined in the other.

They found that, in general, substances that were phosphorescent in ordinary light became luminous. The sulphide of zinc was especially brilliant and became as luminous as if exposed to a strong light. After sufficient time had elapsed, the luminosity reached a constant value. The phosphorescence is partly due to the excited activity produced by the emanation on its surface, and partly to the direct radiation from the emanation.

Phosphorescence was also produced in glass. Thuringian glass showed the most marked effects. The luminosity of the glass was found to be about the same in the two bulbs, but was more marked in the connecting tube. The effect in the two bulbs was the same even if connected by a very narrow tube.

Some experiments were also made with a series of phosphorescent plates placed in the vessel at varying distances apart. With the plates 1 mm. apart, the effect was very feeble but increased directly as the distance and was large for a distance of 3 cms.

¹ *C. R.* 133, p. 931, 1901.

These effects receive a general explanation on the views already put forward. When the radium is placed in the closed vessel, the emanation is given off at a constant rate and gradually diffuses throughout the enclosure. Since the time taken for diffusion of the emanation through tubes of ordinary size is small compared with the time required for the activity to be appreciably reduced, the emanation, and also the excited activity due to it, will be nearly equally distributed throughout the vessel.

The luminosity due to it should thus be equal at each end of the tube. Even with a capillary tube connecting the two bulbs, the gas continuously given off by the radium will always carry the emanation with it and cause a practically uniform distribution.

The gradual increase of the amount of emanation throughout the tube will be given by the equation

$$\frac{N_t}{N_0} = 1 - e^{-\lambda t},$$

where N_t is the number of emanation particles present at the time t , N_0 the number present when radio-active equilibrium is reached, and λ is the radio-active constant of the emanation. The phosphorescent action, which is due partly to the radiations from the emanation and partly to the excited activity on the walls, should thus reach half the maximum value in four days and should practically reach its limit after three weeks interval.

The variation of luminosity with different distances between the screens is to be expected. The amount of excited activity deposited on the boundaries is proportional to the amount of emanation present. Since the emanation is equally distributed, the amount of excited activity deposited on the screens, due to the emanation between them, varies directly as the distance, provided the distance between the screens is small compared with their dimensions. Such a result would also follow if the phosphorescence were due to the radiation from the emanation itself, provided that the pressure of the gas was low enough to prevent absorption of the radiation from the emanation in the gas itself between the screens.

By means of this relation the emanating power of compounds which are not of equal weight can be compared.

It was found that thorium compounds varied enormously in emanating power, although the percentage proportion of thorium present in the compound was not very different. For example, the emanating power of thorium hydroxide was generally 3 to 4 times greater than that of ordinary thoria, obtained from the manufacturer. Thorium nitrate, in the solid state, had only 1/200 of the emanating power of ordinary thoria, while preparations of the carbonate were found to vary widely among themselves in emanating power, which depended upon slight variations in the method of preparation.

141. Effect of conditions on emanating power. The emanating power of different compounds of thorium and radium is much affected by the alteration of chemical and physical conditions. In this respect the emanating power, which is a measure of the rate of escape of the emanation into the surrounding gas, must not be confused with the rate of decay of the activity of the emanations themselves, which has already been shown to be unaffected by external conditions.

Dorn (*loc. cit.*) first observed that the emanating power of thorium and radium compounds was much affected by moisture. In a fuller investigation of this point by Rutherford and Soddy, it was found that the emanating power of thoria is from two to three times greater in a moist than in a dry gas. Continued desiccation of the thoria in a glass tube, containing phosphorus pentoxide, did not reduce the emanating power much below that observed in ordinary dry air. In the same way radium chloride in the solid state gives off very little emanation when in a dry gas, but the amount is much increased in a moist gas.

The rate of escape of emanation is much increased by solution of the compound. For example, thorium nitrate, which has an emanating power of only 1/200 that of thoria in the solid state, has in solution an emanating power of 3 to 4 times that of thoria. P. Curie and Debierne observed that the emanating power of radium was also much increased by solution.

Temperature has a very marked effect on the emanating power.

The writer¹ showed that the emanating power of ordinary thoria was increased three to four times by heating the substance to a dull red heat in a platinum tube. If the temperature was kept constant, the emanation continued to escape at the increased rate, but returned to its original value on cooling. If, however, the compound was heated to a white heat, the emanating power was greatly reduced, and it returned on cooling to about 10% of the original value. Such a compound is said to be "*de-emanated*." The emanating power of radium compounds varies in a still more striking manner with rise of temperature. The rate of escape of the emanation is momentarily increased even 10,000 times by heating to a dull red heat. This effect does not continue, for the large escape of the emanation by heating is in reality due to the release of the emanation stored up in the radium compound. Like thoria, when the compound has once been heated to a very high temperature, it loses its emanating power and does not regain it.

A further examination of the effect of temperature was made by Rutherford and Soddy². The emanating power of thoria decreases very rapidly with lowering of temperature, and at the temperature of solid carbonic acid it is only about 10% of its ordinary value. It rapidly returns to its original value when the cooling agent is removed.

Increase of temperature from 80° C. to a dull red heat of platinum thus increases the emanating power about 40 times, and the effects can be repeated again and again, with the same compound, provided the temperature is not raised to the temperature at which de-emanation begins. De-emanation sets in above a red heat, and the emanating power is then permanently diminished, but even long continued heating at a white heat never entirely destroys the emanating power.

142. Regeneration of emanating power. An interesting question arises whether the de-emanation of thorium and radium is due to a removal or alteration of the substance which produces the emanation, or whether intense ignition merely changes the rate of escape of the emanation from the solid into the surrounding atmosphere.

¹ *Phys. Zeit.* 2, p. 429, 1901.

² *Phil. Mag.* Nov. 1902.

It is evident that the physical properties of the thoria are much altered by intense ignition. The compound changes in colour from white to pink; it becomes denser and also far less readily soluble in acids. In order to see if the emanating power could be regenerated by a cyclic chemical process, the de-emanated thoria was dissolved, precipitated as hydroxide and again converted into oxide. At the same time a specimen of the ordinary oxide was subjected to an exactly parallel process. The emanating power of both these compounds was the same and was from two to three times greater than that of ordinary thoria.

Thus de-emanation does not permanently destroy the power of thorium of giving out an emanation, but merely produces an alteration of the amount of the emanation which escapes from the compound.

143. Rate of production of the emanation. The emanating power of thorium compounds, then, is a very variable quantity, much affected by moisture, heat, and solution. Speaking generally, increased temperatures and solution greatly increase the emanating power of both thorium and radium.

The wide differences between the emanating powers of these substances in the solid state and in solution pointed to the conclusion that the differences were probably due to the rate of escape of the emanation into the surrounding gas, and not to a variation of the rate of reaction which gave rise to the emanation. It is obvious that a very slight retardation in the rate of escape of the thorium emanation from the compound into the gas, will, on account of the rapid decay of activity of the emanation, produce great changes in emanating power. The regeneration of the emanating power of de-emanated thoria and radium by solution and chemical treatment made it evident that the original power of thorium and radium of producing the emanation still persisted in an unaltered degree.

The question whether the emanation was produced at the same rate in emanating as in non-emanating compounds can be put to a sharp quantitative test. If the rate of production of emanation goes on at the same rate in the solid compound, where very little escapes, as in the solution, where probably all escapes, the

emanation must be *occluded* in the compound, and there must in consequence be a sudden release of this emanation on solution of the compound. On account of the very slow decay of the activity of the emanation of radium, the effects should be far more marked in that compound than in thorium.

From the point of view developed in section 124, the exponential law of decay of the emanation expresses the result that N_t the number of particles remaining unchanged at a time t is given by

$$\frac{N_t}{N_0} = e^{-\lambda t},$$

where N_0 is the initial number of particles present. When a steady state is reached, the rate of production q_0 of fresh emanation particles is exactly balanced by the rate of change of the particles N_0 already present, *i.e.*

$$q_0 = \lambda N_0,$$

N_0 in this case represents the amount of emanation "occluded" in the compound. Substituting the value of λ found for the radium emanation in section 136,

$$\frac{N_0}{q_0} = \frac{1}{\lambda} = 463,000.$$

The amount of emanation stored in a non-emanating radium compound should therefore be nearly 500,000 times the amount produced per second by the compound. This result was tested in the following way¹:

A weight of .03 gr. of radium chloride of activity 1000 times that of uranium was placed in a Drechsel bottle and a sufficient amount of water drawn in to dissolve it. The released emanation was swept out by a current of air into a small gas holder and then into a testing cylinder. The initial saturation current was proportional to N_0 . A rapid current of air was then passed through the radium solution for some time in order to remove any slight amount of emanation which had not been removed initially. The Drechsel bottle was closed air-tight, and allowed to stand undisturbed for a definite time t . The accumulated emanation was then swept out as before into the testing vessel. The new ionization current represents

¹ Rutherford and Soddy, *Phil. Mag.* April, 1903.

the value of N_t the amount of emanation formed in the compound during the interval t .

In the experiment $t = 105$ minutes,
and observed value

$$\frac{N_t}{N_0} = \cdot 0131.$$

Assuming that there is no decay during the interval,

$$N_t = 105 \times 60 \times q_0.$$

Thus
$$\frac{N_0}{q_0} = 480,000.$$

Making the small correction for the decay of activity during the interval

$$\frac{N_0}{q_0} = 477,000.$$

We have previously shown that from the theory

$$\frac{N_0}{q_0} = \frac{1}{\lambda} = 463,000.$$

The agreement between theory and experiment is thus as close as could be expected from the nature of the experiments. This experiment proves conclusively that the rate of production of emanation in the solid compound is the same as in the solution. In the former case it is occluded, in the latter it escapes as fast as it is produced.

It is remarkable how little emanation, compared with the amount stored up in the compound, escapes from solid radium chloride in a dry atmosphere. One experiment showed that the emanating power in the dry solid state was less than $\frac{1}{2}\%$ of the emanating power of the solution. Since nearly 500,000 times as much emanation is stored up as is produced per second, this result showed that the amount of emanation which escaped per second was less than 10^{-8} of that occluded in the compound.

If a solid radium chloride compound is kept in a moist atmosphere, the emanating power becomes comparable with the amount produced per second in the solution. In such a case, since the rate

of escape is continuous, the amount occluded will be much less than the amount for the non-emanating material.

The phenomenon of occlusion of the radium emanation is probably not connected in any way with its radio-activity, although this property has in this case served to measure it. The occlusion of helium by minerals presents almost a complete analogy to the occlusion of the radium emanation. The helium is given off by fergusonite, for example, in part when it is heated and completely on dissolving the mineral.

144. Similar results hold for thorium, but, on account of the rapid loss of activity of the emanation, the amount of emanation occluded in a non-emanating compound is very small compared with that observed for radium. If the production of the thorium emanation proceeds at the same rate under all conditions, the solution of a solid non-emanating compound should be accompanied by a rush of emanation greater than that subsequently produced. With the same notation as before we have for the thorium emanation,

$$\frac{N_0}{q_0} = \frac{1}{\lambda} = 87.$$

This result was tested as follows: a quantity of finely powdered thorium nitrate, of emanating power 1/200 of ordinary thoria, was dropped into a Drechsel bottle containing hot water and the emanation rapidly swept out into the testing vessel by a current of air. The ionization current rose quickly to a maximum, but soon fell again to a steady value; showing that the amount of emanation released when the nitrate dissolves, is greater than the subsequent amount produced from the solution.

The rapid loss of the activity of the thorium emanation makes a quantitative comparison like that made for radium very difficult. By slightly altering the conditions of the experiment, however, a definite proof was obtained that the rate of production of emanation is the same in the solid compound as in the solution. After dropping in the nitrate, a rapid air stream was blown through the solution for 25 seconds into the testing vessel. The air stream was stopped and the ionization current immediately measured. The solution was then allowed to stand undisturbed for 10 minutes.

In that time the accumulation of the emanation again attained a practical maximum and again represented a steady state. The stream of air was blown through, as before, for 25 seconds, stopped and the current again measured. In both cases, the electrometer recorded a movement of 14.6 divisions per second. By blowing the same stream of air continuously through the solution the final current corresponded to 7.9 divisions per second or about one-half of that observed after the first rush.

Thus the rate of production of emanation is the same in the solid nitrate as in the solution, although the emanating power, *i.e.* the rate of escape of the emanation, is over 600 times greater in the solution than in the solid.

It seems probable that the rate of production of emanation by thorium, like the rate of production of Ur X and Th X, is independent of conditions. The changes of emanating power of the various compounds by moisture, heat, and solution must therefore be ascribed solely to an alteration in the rate of escape of the emanation into the surrounding gas and not to an alteration in the rate of its production in the compound.

On this view, it is easy to see that slight changes in the mode of preparation of a thorium compound may produce large changes in emanating power. Such effects have been often observed, and must be ascribed to slight physical changes in the precipitate. The fact that the rate of production of the emanation is independent of the physical or chemical conditions of the thorium, in which it is produced, is thus in harmony with what had previously been observed for the radio-active products Ur X and Th X.

Source of the Thorium Emanation.

145. Some experiments of Rutherford and Soddy¹ will now be considered, which show that the thorium emanation is produced, not directly by the thorium itself, but by the active product Th X.

When the Th X, by precipitation with ammonia, is removed from a quantity of thorium nitrate, the precipitated thorium hydroxide

¹ *Phil. Mag.* Nov. 1902.

does not at first possess appreciable emanating power. This loss of emanating power is not due, as in the case of the de-emanated oxide, to a retardation in the rate of escape of the emanation produced; for the hydroxide, when dissolved in acid, still gives off no emanation. On the other hand, the solution, containing the Th X, possesses emanating power to a marked degree. On leaving the precipitated hydroxide and the Th X for some time, it is found that the Th X decreases in emanating power, while the hydroxide gradually regains its emanating power. After about a month's interval, the emanating power of the hydroxide has nearly reached a maximum, while the emanating power of the Th X has almost disappeared.

The curves of decay and recovery of emanating power with time are found to be exactly the same as the curves of decay and recovery of activity of Th X and the precipitated hydroxide respectively, shown in Fig. 35. The emanating power of Th X, as well as its activity, falls to half value in four days, while the hydroxide regains half its final emanating power as well as half its lost activity in the same interval.

It follows from these results that the emanating power of Th X is directly proportional to its activity, *i.e.* that the rate of production of emanating particles is always proportional to the number of α particles, projected from the Th X per second. *The radiation from Th X thus accompanies the change of the Th X into the emanation.* Since the emanation has chemical properties distinct from those of the Th X, and also a distinctive rate of decay, it cannot be regarded as a vapour of Th X, but it is a distinct chemical substance, produced by the changes occurring in Th X. On the view advanced in section 127, the atom of the emanation consists of the part of the atom of Th X left behind after the expulsion of one or more α particles. The atoms of the emanation are unstable, and in turn expel α particles. This projection of α particles constitutes the radiation from the emanation, which serves as a measure of the amount of emanation present. Since the activity of the emanation falls to half value in *one* minute while that of Th X falls to half value in four days, the emanation consists of atoms, which disintegrate at intervals nearly 6000 times shorter than do the atoms of Th X.

Source of the Radium Emanation.

146. No intermediate stage—Radium X—between radium and its emanation, corresponding to the Th X for thorium, has so far been observed. The emanation from radium is probably produced directly from that element. In this respect, the radium emanation holds the same position in regard to radium as Th X does to thorium, and its production from radium can be explained on exactly similar lines.

Radiations from the Emanations.

147. Special methods are necessary to examine the nature of the radiation from the emanations, for the radiations arise from the volume of the gas in which the emanations are distributed. Some experiments to examine the radiations from the thorium emanation were made by the writer in the following way.

A highly emanating thorium compound wrapped in paper was placed inside a lead box *B* about 1 cm. deep, shown in Fig. 41. There was an opening cut in the top of the box, over which a very thin sheet of mica was waxed. The emanation rapidly diffused through the paper into the vessel, and after ten minutes reached a state of radio-active equilibrium. The penetrating power of the radiation from the emanation which passed through the thin mica window was examined by the electrical method in the usual way by adding screens of thin aluminium foil. The results are expressed in the following table:

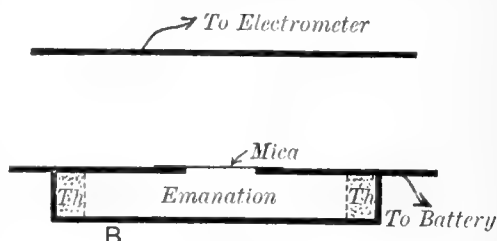

Fig. 41.

Thickness of mica window ·0015 cm.
Thickness of aluminium foil ·00034 cm.

Layers of foil	Current
0	100
1	59
2	30
3	10
4	3·2

The greater proportion of the conductivity is thus due to α rays, as in the case of the radio-active elements. The amount of absorption of these α rays by aluminium foil is about the same as that of the rays from the active bodies. No direct comparison can be made, for the α rays from the emanation show the characteristic property of increased rate of absorption with thickness of matter traversed. Before testing, the rays have been largely absorbed by the mica window, and the penetrating power has consequently decreased.

No alteration in the radiation from the emanation was observed on placing an insulated wire inside the emanation vessel, and charging it to a high positive or negative potential. When a stream of air through the vessel carried away the emanation as fast as it was produced, the intensity of the radiation fell to a small fraction of its former value.

No evidence of any β rays in the radiations was found in these experiments, although a very small effect would have been detected. After standing some hours, however, β rays began to appear. These were due to the excited activity deposited on the walls of the vessel from the emanation, and not directly to the emanation itself.

The radium emanation, like that of thorium, only gives rise to α rays. This was tested in the following way¹:

A large amount of emanation was introduced into a cylinder made of sheet copper .005 cm. thick, which absorbed all the α rays but allowed the β and γ rays, if present, to pass through with but little loss. The external radiation from the cylinder was determined at intervals, commencing about two minutes after the introduction of the emanation. The amount observed at first was extremely small, but increased rapidly and practically reached a maximum in three or four hours. Thus the radium emanation only gives α rays, the β rays appearing as the excited activity is produced on the walls of the vessel. On sweeping out the emanation by a current of air, there was no immediately appreciable decrease of the radiation. This is another proof that the emanation does not give out any β rays. In a similar way it can be shown

¹ Rutherford and Soddy, *Phil. Mag.* April, 1903.

that the emanation does not give rise to γ rays; these rays always make their appearance at the same time as the β rays.

The method of examination of the radiations from the emanations has been given in some detail, as the results are of considerable importance in the discussion, which will be given later in chapter X, of the connection between the changes occurring in radio-active products and the radiations they emit. There is no doubt that the emanations, apart from the excited activity to which they give rise, only give out α rays, consisting most probably of positively charged bodies projected with great velocity.

Effect of Pressure on the rate of production of the Emanation.

148. It has already been mentioned that the conductivity due to the thorium emanation is proportional to the pressure of the gas, pointing to the conclusion that the rate of production of the emanation is independent of the pressure, as well as of the nature of the surrounding gas. This result was directly confirmed with the apparatus of Fig. 41. When the pressure of the gas under the vessel was slowly reduced, the radiation, tested outside the window, increased to a limit, and then remained constant over a wide range of pressure. This increase, which was far more marked in air than in hydrogen, is due to the fact that the α rays from the emanation were partially absorbed in the gas inside the vessel when at atmospheric pressure. At pressures of the order of 1 millimetre of mercury the external radiation decreased, but experiment showed that this must be ascribed to a removal of the emanation by the pump, and not to a change in the rate of production. The thorium compounds very readily absorb water-vapour, which is slowly given off at low pressures, and in consequence some of the emanation is carried out of the vessel with the water-vapour.

Curie and Debierne¹ found that both the amount of excited activity produced in a closed vessel containing active samples of radium, and also the time taken to reach a maximum value, were

¹ *C. R.* 133, p. 931, 1901.

independent of the pressure and nature of the gas. This was true in the case of a solution down to the pressure of the saturated vapour, and in the case of solid salts to very low pressures. When the pump was kept going at pressures of the order of $\cdot 001$ mm. of mercury, the amount of excited activity was much diminished. This was probably not due to any alteration of the rate of escape of the emanation, but to the removal of the emanation by the action of the pump as fast as it was formed.

Since the amount of excited activity, when in a state of radio-active equilibrium, is a measure of the amount of emanation producing it, these results show that the amount of emanation present when the rate of production balances the rate of decay is independent of the pressure and nature of the gas. It was also found that the time taken to reach the point of radio-active equilibrium was independent of the size of the vessel or the amount of active matter present. These results show that the state of equilibrium cannot in any way be ascribed to the possession by the emanation of any appreciable vapour pressure; for if such were the case, the time taken to reach the equilibrium value should depend on the size of the vessel and the amount of active matter present. The results are, however, in agreement with the view that the emanation is present in minute quantity in the tube, and that the equilibrium is governed purely by the radio-active constant λ , the constant of decay of activity of the emanation. This has been seen to be the same under all conditions of concentration, pressure and temperature, and, provided the rate of supply of the emanation from the active compound is not changed, the time-rate of increase of activity to the equilibrium value will always be the same, whatever the size of the vessel or the nature and pressure of the surrounding gas.

Chemical Nature of the Emanations.

149. Earlier experiments. We shall now consider some experiments on the physical and chemical properties of the emanations themselves, without reference to the material producing them; in order to see if they possess any properties which identify them with any known kind of matter.

It was soon observed that the thorium emanation passed unchanged through acid solutions, and later the same result was shown to hold true in the case of both emanations for every reagent that was tried. Preliminary observations¹ showed that the thorium emanation, obtained in the usual way by passing air over thoria, passed unchanged in amount through a platinum tube heated electrically to the highest temperature obtainable. The tube was then filled with platinum-black, and the emanation passed through it in the cold, and with gradually increasing temperatures, until the limit was reached. In another experiment, the emanation was passed through a layer of red-hot lead-chromate in a glass tube. The current of air was replaced by a current of hydrogen, and the emanation was sent through red-hot magnesium-powder and red-hot palladium-black, and, by using a current of carbon dioxide, through red-hot zinc-dust. In every case the emanation passed through without sensible change in the amount. If anything, a slight increase occurred, owing to the time taken for the gas-current to pass through the tubes when hot being slightly less than when cold, the decay *en route* being consequently less. The only known gases capable of passing in unchanged amount through all the reagents employed are the recently discovered members of the argon family.

But another possible interpretation might be put upon the results. If the emanation were the manifestation of a type of excited radio-activity on the surrounding atmosphere, then, since from the nature of the experiments it was necessary to employ in each case as the atmosphere, a gas not acted on by the reagent employed, the result obtained might be expected. Red-hot magnesium would not retain an emanation consisting of radio-active hydrogen, or red-hot zinc-dust, an emanation consisting of radio-active carbon dioxide. The incorrectness of this explanation was shown in the following way. Carbon dioxide was passed over thoria, then through a T-tube, where a current of air met and mixed with it, both passing on to the testing-cylinder. But between this and the T-tube a large soda-lime tube was introduced, and the current of gas was thus freed from its admixed carbon dioxide, before being tested in the cylinder for the emana-

¹ Rutherford and Soddy, *Phil. Mag.* Nov. 1902.

tion. The amount of emanation found was quite unchanged, whether carbon dioxide was sent over thoria in the manner described, or whether, keeping the other arrangements as before, an equally rapid current of air was substituted for it. The theory that the emanation is an effect of the excited activity on the surrounding medium is thus excluded.

Experiments of a similar kind on the radium emanation were made later. A steady stream of gas was passed through a radium chloride solution and then through the reagent to be employed, into a testing-vessel of small volume, so that any change in the amount of emanation passing through could readily be detected. The radium emanation, like that of thorium, passed unchanged in amount through every reagent used.

Later experiments. In later experiments by Sir William Ramsay and Mr Soddy¹, the emanation from radium was exposed to still more drastic treatment. The emanation in a glass tube was sparked for several hours with oxygen over alkali. The oxygen was then removed by ignited phosphorus and no visible residue was left. When, however, another gas was introduced, mixed with the minute amount of emanation in the tube and withdrawn, the activity of emanation was found to be unaltered. In another experiment, the emanation was introduced into a magnesium lime tube, which was heated for three hours at a red heat. The emanation was then removed and tested, but no diminution in its discharging power was observed.

The emanations of thorium and radium thus withstand chemical treatment in a manner hitherto unobserved except in gases of the argon family.

150. Ramsay and Soddy (*loc. cit.*) record an interesting experiment to illustrate the gaseous nature of the emanation. A large amount of the radium emanation was collected in a small glass tube. This tube phosphoresced brightly under the influence of the rays from the emanation. The passage of the emanation from point to point was observed in a darkened room by the luminosity excited in the glass. On opening the stop-cock connecting with the Töpler pump, the slow flow through

¹ *Proc. Roy. Soc.* 72, p. 204, 1903.

the capillary tube was noticed, the rapid passage along the wider tubes, the delay in passing through a plug of phosphorous pentoxide, and the rapid expansion into the reservoir of the pump. When compressed, the luminosity of the emanation increased, and became very bright as the small bubble containing the emanation was expelled through the fine capillary tube.

Diffusion of the Emanations.

151. It has been shown that the emanations of thorium and radium behave like radio-active gases, distributed in minute amount in the air or other gas in which they are tested. With the small quantities of active material so far investigated, the emanations have not yet been collected in sufficient amount to allow the examination of their spectrum or to detect them by the balance. Although the molecular weight of the emanations cannot yet be obtained by direct chemical methods, an indirect estimate of it can be made by determining the rate of their inter-diffusion into air or other gases. The coefficients of inter-diffusion of various gases have long been known, and the results show that the coefficient of diffusion of one gas into another is, for the simpler gases, approximately inversely proportional to the square root of the product of their molecular weights. If, therefore, the coefficient of diffusion of the emanation into air is found to have a value, lying between that of two known gases *A* and *B*, it is probable that the molecular weight of the emanation lies between that of *A* and *B*.

Although the amount of emanation given off from radium is too small to be detected by volume¹, the electrical conductivity produced by the emanation in the gas, with which it is mixed, is often very large, and offers a ready means of measuring the emanation present.

Some experiments have been made by Miss Brooks and the writer² to determine the rate of the diffusion of the radium emanation into air, by a method similar to that employed by Loschmidt³

¹ See, however, p. 313 (Feb. 1904).

² Rutherford and Miss Brooks, *Trans. Roy. Soc. Canada* 1901, *Chem. News* 1902.

³ *Sitzungsber. d. Wiener Akad.* 61, II. p. 367, 1871.

in 1871, in his investigations of the coefficient of inter-diffusion of gases.

Fig. 42 shows the general arrangement. A long brass cylinder AB , of length 73 cms., and diameter 6 cms., was divided into two

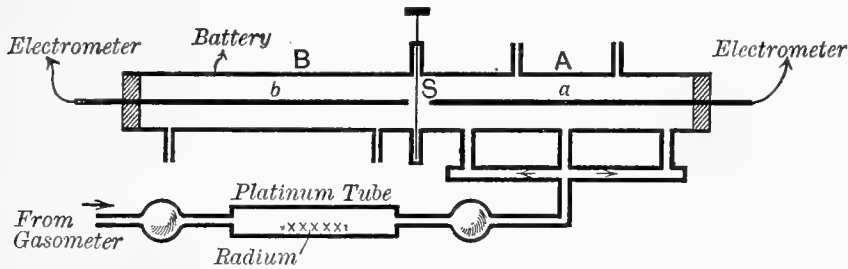

Fig. 42.

equal parts by a moveable metal slide S . The ends of the cylinder were closed with ebonite stoppers. Two insulated brass rods, a and b , each half the length of the tube, passed through the ebonite stoppers and were supported centrally in the tube. The cylinder was insulated and connected with one pole of a battery of 300 volts, the other pole of which was earthed. The central rods could be connected with a sensitive quadrant electrometer. The cylinder was covered with a thick layer of felt, and placed inside a metal box filled with cotton-wool in order to keep temperature conditions as steady as possible.

In order to convey a sufficient quantity of emanation into the half-cylinder A , it was necessary to heat the radium slightly. The slide S was closed and the side tubes opened. A slow current of dry air from a gasometer was passed through a platinum tube, in which a small quantity of a radium compound was placed. The emanation was carried with the air into the cylinder A . When a sufficient quantity had been introduced, the stream of air was stopped. The side tubes were closed by fine capillary tubes. These prevented any appreciable loss of gas due to the diffusion, but served to keep the pressure of the gas inside A at the pressure of the outside air. The three entrance tubes into the cylinder, shown in the figure, were for the purpose of initially mixing the emanation and gas as uniformly as possible.

After standing several hours to make temperature conditions steady, the slide was opened, and the emanation began to diffuse

into the tube *B*. The current through the tubes *A* and *B* was measured at regular intervals by an electrometer, with a suitable capacity in parallel. Initially there is no current in *B*, but after the opening of the slide, the amount in *A* decreased and the amount in *B* steadily increased. After several hours the amount in each half is nearly the same, showing that the emanation is nearly uniformly diffused throughout the cylinder.

It can readily be shown¹ that if

K = coefficient of diffusion of the emanation into air,

t = duration of diffusion experiments in secs.,

a = total length of cylinder,

*S*₁ = partial pressure of emanation in tube *A* at end of diffusion,

*S*₂ = partial pressure of emanation in tube *B* at end of diffusion,

then

$$\frac{S_1 - S_2}{S_1 + S_2} = \frac{8}{\pi^2} \left(e^{-\frac{\pi^2 Kt}{a^2}} + \frac{1}{9} e^{-\frac{9\pi^2 Kt}{a^2}} + \dots \right).$$

Now the values of *S*₁ and *S*₂ are proportional to the saturation ionization currents due to the emanations in the two halves of the cylinder. From this equation *K* can be determined, if the relative values of *S*₁ and *S*₂ are observed after diffusion has been in progress for a definite interval *t*.

The determination of *S*₁ and *S*₂ is complicated by the excited activity produced on the walls of the vessel. The ionization due to this must be subtracted from the total ionization observed in each half of the cylinder, for the excited activity is produced from the material composing the emanation, and is removed to the electrodes in an electric field. The ratio of the current due to excited activity to the current due to the emanation depends on the time of exposure to the emanation, and is only proportional to it for exposures of several hours.

The method generally adopted in the experiments was to open the slide for a definite interval, ranging in the experiments from 15 to 120 minutes. The slide was then closed and the currents in each half determined at once. The central rods, which had

¹ See Stefan, *Sitzungsber. d. Wien. Akad.* 63, II. p. 82, 1871.

been kept negatively charged during the experiments, had most of the excited activity concentrated on their surfaces. These were removed, new rods substituted and the current immediately determined. The ratio of the currents in the half cylinders under these conditions was proportional to S_1 and S_2 , the amounts of emanation present in the two halves of the cylinder.

The values of K , deduced from different values of t , were found to be in good agreement. In the earlier experiments the values of K were found to vary between $\cdot 08$ and $\cdot 12$. In some later experiments, where great care was taken to ensure that temperature conditions were very constant, the values of K were found to vary between $\cdot 07$ and $\cdot 09$. The lower value $\cdot 07$ is most likely nearer the true value, as temperature disturbances tend to give too large a value of K . No certain differences were observed in the value of K whether the air was dry or damp, or whether an electric field was acting or not.

152. Some experiments on the rate of diffusion of the radium emanation into air were made at a later date by P. Curie and Danne¹. If the emanation is contained in a closed reservoir, it has been shown that its activity, which is a measure of the amount of emanation present, decreases according to an exponential law with the time. If the reservoir is put in communication with the outside air through a capillary tube, the emanation slowly diffuses out, and the amount of emanation in the reservoir is found to decrease according to the same law as before, but at a faster rate. Using tubes of different lengths and diameters, the rate of diffusion was found to obey the same laws as a gas. The value of K was found to be $0\cdot 100$. This is a slightly greater value of K than the lowest value $0\cdot 07$ found by Rutherford and Miss Brooks. No mention is made by Curie and Danne of having taken any special precautions against temperature disturbances, and this may account for the higher value of K obtained by them.

They also found that the emanation, like a gas, always divided itself between two reservoirs, put in connection with one another, in the proportion of their volumes. In one experiment one reservoir was kept at a temperature of 10° C. and the other at 350° C.

¹ *C. R.* 136, p. 1314, 1903.

The emanation divided itself between the two reservoirs in the same proportion as a gas under the same conditions.

153. For the purpose of comparison, a few of the coefficients of interdiffusion of gases, compiled from Landolt and Bernstein's tables, are given below.

Gas or vapour	Coefficient of diffusion into air	Molecular weight
Water vapour ...	0·198	18
Carbonic acid gas ...	0·142	44
Alcohol vapour ...	0·101	46
Ether vapour ...	0·077	74
Radium emanation ...	0·07	?

The tables, although not very satisfactory for the purpose of comparison, show that the coefficient of interdiffusion follows the inverse order of the molecular weights. The value of K for the radium emanation is slightly less than for ether vapour, of which the molecular weight is 74. We may thus conclude that the emanation is of greater molecular weight than 74. It seems likely that the emanation has a molecular weight somewhere in the neighbourhood of 100, and is probably greater than this, for the vapours of ether and alcohol have higher diffusion coefficients compared with carbonic acid than the theory would lead us to anticipate. Comparing the diffusion coefficients of the emanation and carbonic acid into air, the value of the molecular weight of the emanation should be about 176 if the result observed for the simple gases, viz. that the coefficient of diffusion is inversely proportional to the square root of the molecular weights, holds true in the present case. On the disintegration theory developed in chapter X, it is to be expected that the atomic weight of the emanation should be slightly less than 225, the atomic weight of radium.

It is of interest to compare the value of $K = \cdot 07$ with the value of K determined by Townsend (section 37) for the gaseous ions produced in air at ordinary pressure and temperature, by Röntgen rays or by the radiations from active substances. Townsend found that the value of K in dry air was $\cdot 028$ for the positive ions

and .043 for the negative ions. The radium emanation thus diffuses more rapidly than the ions produced by its radiation in the gas, and behaves as if its mass were smaller than that of the ions produced in air, but considerably greater than that of the air molecules with which it is mixed.

It is not possible to regard the emanation as a temporarily modified condition of the gas originally in contact with the active body. Under such conditions a much larger value of K would be expected. The evidence derived from the experiments on diffusion strongly supports the view that the emanation is a gas of heavy molecular weight.

Diffusion of the Thorium Emanation.

154. On account of the rapid decay of the activity of the thorium emanation, it is not possible to determine the value of K its coefficient of diffusion into air by the methods employed for the radium emanation. The value of K has been determined by the writer in the following way. A plate C , Fig. 43, covered with thorium hydroxide, was placed horizontally near the base of a long vertical brass cylinder P . The emanation released from the thorium compound diffuses upwards in the cylinder.

Let p be the partial pressure of the emanation at a distance x from the source C . This will be approximately uniform over the cross section of the cylinder. From the general principles of diffusion we get the equation

$$K \frac{d^2 p}{dx^2} = \frac{dp}{dt}.$$

The emanation is continuously breaking up and expelling α particles. The emanation-residue gains a positive charge, and, in an electric field, is at once removed from the gas to the negative electrode.

Since the activity of the emanation at any time is always proportional to the number of particles which have not broken up, and since the activity decays with the time according to an

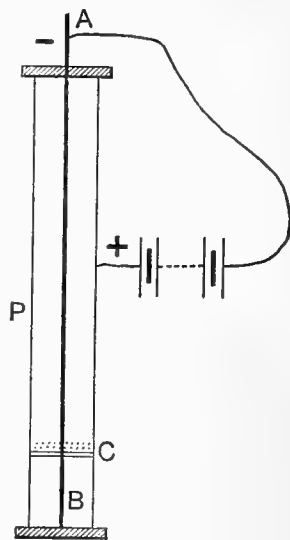

Fig. 43.

exponential law, $p = p_1 e^{-\lambda t}$ where p_1 is the value of p when $t = 0$ and λ is the *radio-active constant* of the emanation.

Then
$$\frac{dp}{dt} = -\lambda p,$$

and
$$\frac{d^2p}{dx^2} = -\lambda p.$$

Thus
$$p = A e^{-\sqrt{\frac{\lambda}{K}} \cdot x} + B.$$

Since $p = 0$ when $x = \infty$, $B = 0$.

If $p = p_0$ when $x = 0$, $A = p_0$.

Thus
$$p = p_0 e^{-\sqrt{\frac{\lambda}{K}} \cdot x}.$$

It was not found convenient in the experiments to determine the activity of the emanation along the cylinder, but an equivalent method was used which depends upon measuring the distribution of "excited activity," produced along a central rod AB , which is charged negatively.

It will be shown later (section 167) that the amount of excited activity at any point is always proportional to the amount of emanation at that point. The distribution of "excited activity" along the central rod from the plate C upwards thus gives the variation of p for the emanation along the tube.

In the experiments, the cylinder was filled with dry air at atmospheric pressure and was kept at a constant temperature. The central rod was charged negatively and exposed from one to two days in the presence of the emanation. The rod was then removed, and the distribution of the excited activity along it determined by the electric method. It was found that the amount of excited activity fell off with the distance x according to an exponential law, falling to half value in about 1.9 cms. This is in agreement with the above theory.

Since the activity of the emanation falls to half value in 1 minute, $\lambda = .0115$. The value $K = .09$ was deduced from the average of a number of experiments. This is a slightly greater value than $K = .07$, obtained for the radium emanation, but the results show that the two emanations do not differ much from one another in molecular weight.

Diffusion of the Emanation into Liquids.

155. Experiments have been made by Wallstabe¹ on the coefficient of diffusion of the radium emanation into various liquids. The radium emanation was allowed to diffuse into a closed reservoir, containing a cylinder of the liquid under observation. The cylinder was provided with a tube and a stop-cock extending beyond the closed vessel, so that different layers of the liquid could be removed. The liquid was then placed in a closed testing vessel, where the ionization current due to the escape of the emanation from the liquid was observed to rise to a maximum after several hours, and then to decay. This maximum value of the current was taken as a measure of the amount of emanation absorbed in the liquid.

The coefficient of diffusion K of the emanation into the liquid can be obtained from the same equation used to determine the diffusion of the thorium emanation into air,

$$p = p_0 e^{-\sqrt{\frac{\lambda}{K}} \cdot x},$$

where λ is the constant of decay of activity of the radium emanation and x the depth of the layer of water from the surface.

Putting $\alpha = \sqrt{\frac{\lambda}{K}}$, it was found that

$$\text{for water } \alpha = 1.6,$$

$$\text{for toluol } \alpha = .75.$$

The value of λ expressed in terms of a day as the unit of time is about .17.

Thus the value of K for the diffusion of the radium emanation into water = $.066 \frac{\text{cm.}^2}{\text{day}}$.

The value of K found by Stefan² for the diffusion of carbon dioxide into water was $1.36 \frac{\text{cm.}^2}{\text{day}}$. These results are thus in harmony with the conclusion drawn from the diffusion of the radium emanation into air, and show that the radium emanation behaves as a gas of high molecular weight.

¹ *Phys. Zeit.* 4, p. 721, 1903.

² *Wien. Sitzungsber.* 2, p. 371, 1878.

Condensation of the Emanations.

156. Condensation of the emanations. During an investigation of the effect of physical and chemical agencies on the thorium emanation, Rutherford and Soddy¹ found that the emanation passed unchanged in amount through a white-hot platinum tube and through a tube cooled to the temperature of solid carbon dioxide. In later experiments, the effects of still lower temperatures were examined, and it was then found that at the temperature of liquid air both emanations were condensed².

If either emanation is conveyed by a slow stream of hydrogen, oxygen or air through a metal spiral immersed in liquid air, and placed in connection with a testing vessel as in Fig. 37, no trace of emanation escapes in the issuing gas. When the liquid air is removed and the spiral plunged into cotton-wool, several minutes elapse before any deflection of the electrometer needle is observed, and then the condensed emanation volatilizes rapidly, and the movement of the electrometer needle is very sudden, especially in the case of radium. With a fairly large amount of radium emanation, under the conditions mentioned, a very few seconds elapse after the first sign of movement before the electrometer needle indicates a deflection of several hundred divisions per second. It is not necessary in either case that the emanating compound should be retained in the gas stream. After the emanation is condensed in the spiral, the thorium or radium compound may be removed and the gas stream sent directly into the spiral. But in the case of thorium under these conditions, the effects observed are naturally small owing to the rapid loss of the activity of the emanation with time, which proceeds at the same rate at the temperature of liquid air as at ordinary temperatures.

If a large amount of radium emanation is condensed in a glass U tube, the progress of the condensation can be followed by the eye, by means of the phosphorescence which the radiations excite in the glass. If the ends of the tube are sealed and the temperature allowed to rise, the glow diffuses uniformly throughout the

¹ *Phil. Mag.* Nov. 1902.

² *Phil. Mag.* May 1903.

tube, and can be concentrated at any point to some extent by local cooling of the tube with liquid air.

157. Experimental arrangements. A simple experimental arrangement to illustrate the condensation and volatilization of the emanation and some of its characteristic properties is shown in Fig. 44. The emanation obtained by solution or heating, from a few milligrams of radium bromide, is condensed in the glass U tube *T* immersed in liquid air. This U tube is then put into connection with a larger glass tube *V*, in the upper part of which is placed a piece of zinc sulphide screen *Z*, and in the lower part of the tube a piece of the mineral willemite. The stop-cock *A* is closed and the U tube and the vessel *V* are partially exhausted by a pump through the stop-cock *B*. This lowering of the pressure causes a more rapid diffusion of the emanation when released. The emanation does not escape if the tube *T* is kept immersed in liquid air. The stop-cock *B* is then closed, and the liquid air removed. No luminosity of the screen or the willemite in the tube *V* is observed for several minutes, until the temperature of *T* rises above the point of volatilization of the emanation. The emanation is then rapidly carried into the vessel *V*, partly by expansion of the gas in the tube *T* with rising temperature, and partly by the process of diffusion. The screen *Z* and the willemite are caused to phosphoresce brilliantly under the influence of the rays from the emanation surrounding them.

If the end of the vessel *V* is then plunged into liquid air, the emanation is again condensed in the lower end of the tube, and the willemite phosphoresces much more brightly than before. This is not due to an increase of the phosphorescence of willemite at the temperature of the liquid air, but to the effect of the rays from the emanation condensed around it. At the same time the lumin-

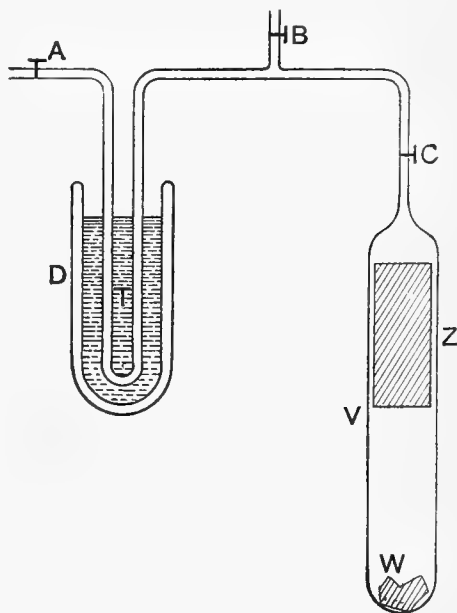

Fig. 44.

osity of the zinc sulphide gradually diminishes, and practically disappears after several hours if the end of the tube is kept in the liquid air. If the tube is removed from the liquid air, the emanation again volatilizes and lights up the screen *Z*. The luminosity of the willemite returns to its original value after the lapse of several hours. This slow change of the luminosity of the zinc sulphide screen and of the willemite is due to the gradual decay of the "excited activity" produced by the emanation on the surface of all bodies exposed to its action (chapter VIII). The luminosity of the screen is thus due partly to the radiation from the emanation and partly to the excited radiation caused by it. As soon as the emanation is removed from the upper to the lower part of the tube, the "excited" radiation gradually diminishes in the upper and increases in the lower part of the tube.

The luminosity of the screen gradually diminishes with the time as the enclosed emanation loses its activity, but is still appreciable after several weeks interval.

An apparatus of a similar character to illustrate the condensation of the radium emanation has been described by P. Curie¹.

158. Determination of the temperature of condensation. A detailed investigation was made by Rutherford and Soddy (*loc. cit.*) of the temperatures at which condensation and volatilization commenced for the two emanations. The experimental arrangement of the first method is shown clearly in Fig. 45. A slow constant stream of gas, entering at *A*, was passed through a copper spiral *S*, over 3 metres in length, immersed in a bath of liquid ethylene. The copper spiral was made to act as its own thermometer by determining its electrical resistance. The resistance temperature curve was obtained by observation of the resistances at 0°, the boiling point of liquid ethylene -103.5°, the solidification point of ethylene -169° and in liquid air. The temperature of the liquid air was deduced from the tables given by Baly for the boiling point of liquid air for different percentages of oxygen. The resistance temperature curve, for the particular spiral employed, was found to be nearly a straight line between

¹ Société de Physique, 1903.

0° and -192° C., cutting the temperature axis if produced nearly at the absolute zero. The resistance of the spiral, deduced from

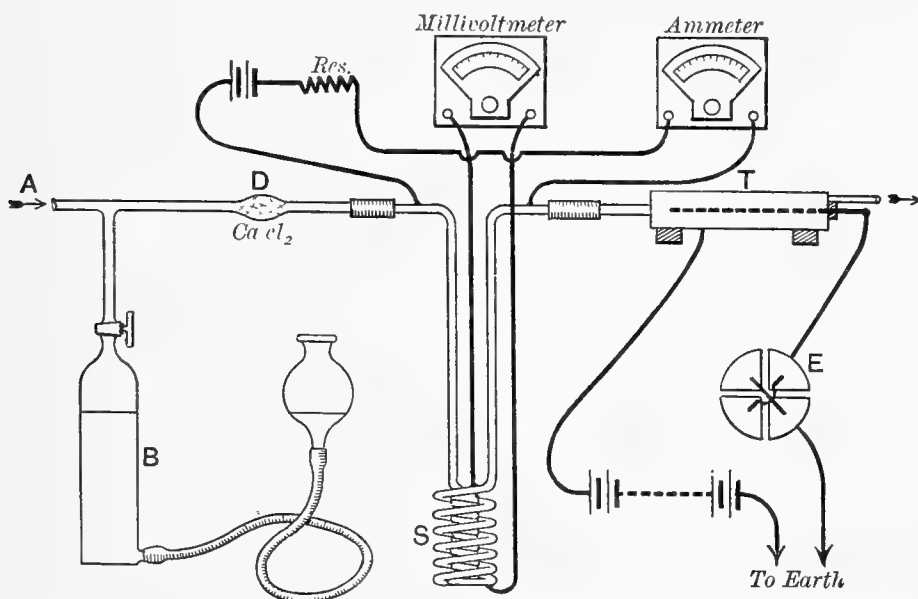

Fig. 45.

readings on an accurately calibrated Weston millivoltmeter, with a constant current through the spiral, was thus very approximately proportional to the absolute temperature. The liquid ethylene was kept vigorously stirred by an electric motor, and was cooled to any desirable temperature by surrounding the vessel with liquid air.

The general method employed for the radium emanation was to pass a suitable amount of emanation, mixed with the gas to be employed, from the gas holder *B* into the spiral, cooled below the temperature of condensation. After the emanation was condensed in the spiral, a current of electrolytic hydrogen or oxygen was passed through the spiral. The temperature was allowed to rise gradually, and was noted at the instant when a deflection of the electrometer, due to the presence of emanation in the testing vessel *T*, was observed. The resistance, subject to a slight correction due to the time taken for the emanation to be carried into the testing vessel, gave the temperature at which some of the emanation commenced to volatilize. The ionization current in the testing vessel rose rapidly to a maximum value, showing that, for a small increase of temperature, the whole of the radium emanation was volatilized. The following table gives an illustration

of the results obtained for a current of hydrogen of 1.38 cubic centimetres per second.

Temperature	Divisions per second of the electrometer
-160°	0
-156°	0
-154°·3	1
-153°·8	21
-152°·5	24

The following table shows the results obtained for different currents of hydrogen and oxygen.

	Current of Gas	T_1	T_2
Hydrogen ...	·25 c.c. per sec.	-151·3	-150
" ...	·32 " "	-153·7	-151
" ...	·92 " "	-152	-151
" ...	1·38 " "	-154	-153
" ...	2·3 " "	-162·5	-162
Oxygen ...	·34 " "	-152·5	-151·5
" ...	·58 " "	-155	-153

The temperature T_1 in the above table gives the temperature of initial volatilization, T_2 the temperature for which half of the condensed emanation had been released. For slow currents of hydrogen and oxygen, the values of T_1 and T_2 are in good agreement. For a stream of gas as rapid as 2.3 cubic centimetres per second the value of T_1 is much lower. Such a result is to be expected, for, in too rapid a stream, the gas is not cooled to the temperature of the spiral, and, in consequence, the inside surface of the spiral is above the mean temperature, and some of the emanation escapes at a temperature apparently much lower. In the case of oxygen, this effect appears for a gas stream of 0.58 cubic centimetres per second.

In the experiments on the thorium emanation, a slightly different method was necessary, on account of the rapid loss of its activity. The steady stream of gas was passed over the thorium

compound, and the temperature was observed at the instant an appreciable movement of the electrometer was observed. This gave the temperature at which a small fraction of the thorium emanation escaped condensation, and not the value T_1 observed for the radium emanation, which gave the temperature for which a small fraction of the previously condensed emanation was volatilized.

The following table illustrates the results obtained.

	Current of Gas	Temperature
Hydrogen71 c.c. per sec.	-155° C.
"	1.38 " "	-159° C.
Oxygen58 " "	-155° C.

On comparing these results with the values obtained for the radium emanation, it will be observed that with equal gas streams the temperatures are nearly the same.

A closer examination of the thorium emanation showed, however, that this apparent agreement was only accidental, and that there was, in reality, a very marked difference in the effect of temperature in the two emanations. It was found experimentally that the radium emanation was condensed very near the temperature at which volatilization commenced, and that the points of condensation and volatilization were fairly sharply defined.

On the other hand, the thorium emanation required a range of over 30° C. after condensation had started in order to ensure complete condensation. Fig. 46 is an example of the results obtained with a steady gas stream of 1.38 c.c. per sec. of oxygen. The ordinates represent the percentage proportion of the emanation uncondensed at different temperatures. It will be observed that condensation commences about -120°, and very little of the emanation escapes condensation at -155° C.

To investigate this difference of behaviour in the two emanations, a static method was employed, which allowed determinations of the two emanations to be made under comparable conditions. The emanation, mixed with a small amount of the gas to be used, was introduced into the cool spiral, which had previously been

exhausted by means of a mercury pump. The amount of emanation remaining uncondensed after definite intervals was rapidly removed by means of the pump, and was carried with a constant auxiliary stream of gas into the testing vessel.

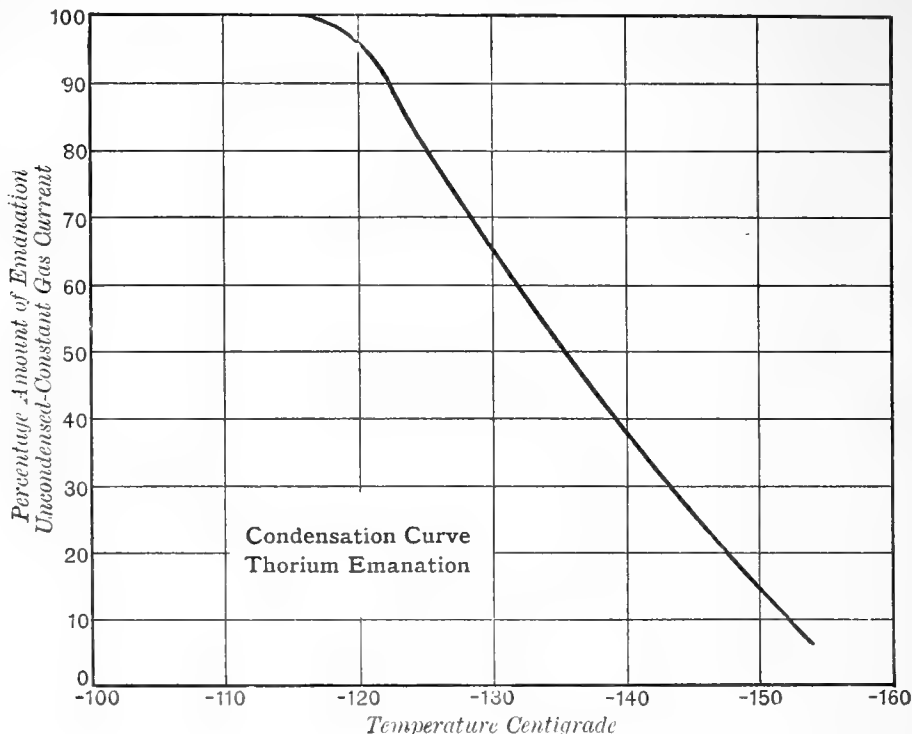

Fig. 46.

Tested in this way, it was found that the volatilization point of the radium emanation was very nearly the same as that obtained by the blowing method, viz. -150°C . With thorium, on the other hand, the condensation started at about -120°C ., and, as in the blowing method, continued over a range of about 30°C . The proportion of the emanation condensed at any temperature was found to depend on a variety of conditions, although the point at which condensation commenced, viz. -120°C ., was about the same in each case. It depended on the pressure and nature of the gas, on the concentration of the emanation, and on the time for which it was left in the spiral. For a given temperature a greater proportion of the emanation was condensed, the lower the pressure and the longer the time it was left in the spiral. Under the same conditions, the emanation was more rapidly condensed in hydrogen than in oxygen.

159. Thus there is no doubt that the thorium emanation begins to condense at a temperature higher than that at which the radium emanation condenses. The explanation of the peculiar behaviour of the thorium emanation is clear when the small number of emanation particles present in the gas are taken into consideration. It has been shown that both emanations give out only α rays. It is probable that the α particles from the two emanations are similar in character and produce about the same number of ions in their passage through the gas. The number of ions produced by each α particle before its energy is dissipated is probably about 70,000. (See section 104.)

Now in the experiment the electrometer readily measured a current of 10^{-3} electrostatic units. Taking the charge on an ion as 3.4×10^{-10} electrostatic units, this corresponds to a production in the testing vessel of about 3×10^6 ions per sec., which would be produced by about 40 expelled α particles per second. Each radiating particle cannot expel less than one α particle and may expel more, but it is likely that the number expelled by an atom of the thorium emanation is not greatly different from the number by an atom of the radium emanation.

In section 124 it has been shown that, according to the law of decay, λN particles change per second when N are present. Thus to produce 40 α particles, λN cannot be greater than 40. Since for the thorium emanation λ is $1/87$, it follows that N cannot be greater than 3500. The electrometer thus detected the presence of 3500 particles of the thorium emanation, and since in the static method the volume of the condensing spiral was about 15 c.c., this corresponds to a concentration of about 230 particles per c.c. An ordinary gas at atmospheric pressure and temperature probably contains about 3.6×10^{19} molecules per c.c. Thus the emanation would have been detected on the spiral if it possessed a partial pressure of less than 10^{-17} of an atmosphere.

It is thus not surprising that the condensation point of the thorium emanation is not sharply defined. It is rather a matter of remark that condensation should occur so readily with so sparse a distribution of emanation particles in the gas; for, in order that condensation may take place, it is probable that the particles must approach within one another's sphere of influence.

Now in the case of the radium emanation, the rate of decay is about 5000 times slower than that of the thorium emanation, and consequently the actual number of particles that must be present to produce the same number of rays per second in the two cases must be about 5000 times greater in the case of radium than in the case of thorium. This conclusion involves only the assumption that the same number of rays is produced by a particle of emanation in each case, and that the expelled particles produce in their passage through the gas the same number of ions. The number of particles present, in order to be detected by the electrometer, in this experiment, must therefore have been about 5000×3500 , *i.e.* about 2×10^7 . The difference of behaviour in the two cases is well explained by the view that, *for equal electrical effects*, the number of radium emanation particles must be far larger than the number of thorium emanation particles. It is to be expected that the probability of the particles coming into each other's sphere of influence will increase very rapidly as the concentration of the particles increases, and that, in the case of the radium emanation, once the temperature of condensation is attained, all but a small proportion of the total number of particles present will condense in a very short time. In the case of the thorium emanation, however, the temperature might be far below that of condensation, and yet a considerable portion remain uncondensed for comparatively long intervals. On this view the experimental results obtained are exactly what is to be expected. A greater proportion condenses, the longer the time allowed for condensation under the same conditions. The condensation occurs more rapidly in hydrogen than in oxygen, as the diffusion is greater in the former gas. For the same reason the condensation occurs faster the lower the pressure of the gas present. Finally, when the emanation is carried by a steady gas stream, a smaller proportion condenses than in the other cases, because the concentration of emanation particles per unit volume of gas is less in these conditions.

It is possible that the condensation of the emanations may not occur in the gas itself but at the surface of the containing vessel. Accurate observations of the temperature of condensation have so far only been made in a copper spiral, but condensation certainly

occurs in tubes of lead or glass at about the same temperature as in tubes of copper.

160. In experiments that were made by the static method with a very large quantity of radium emanation, a slight amount of escape of the condensed emanation was observed several degrees below the temperature at which most of the emanation was released. This is to be expected, since under such conditions the electrometer is able to detect a very minute proportion of the whole quantity of the emanation condensed.

Special experiments, with a large quantity of emanation, that were made with the spiral immersed in a bath of rapidly boiling nitric oxide, showed this effect very clearly. For example, the condensed emanation began to volatilize at -155°C . In 4 minutes the temperature had risen to $-153\cdot5^{\circ}$, and the amount volatilized was four times as great as at -155° . In the next $5\frac{1}{2}$ minutes the temperature had increased to $152\cdot3^{\circ}$ and practically the whole quantity, which was at least fifty times the amount at the temperature of $-153\cdot5^{\circ}$, had volatilized.

It thus seems probable that, if the temperature were kept steady at the point at which volatilization was first observed, and the released emanation removed at intervals, the whole of the emanation would in course of time be liberated at that temperature. These results also point to the probability that the condensed emanation possesses a true vapour pressure, but great refinements in experimental methods would be necessary before such a conclusion could be definitely established.

The true temperature of condensation of the thorium emanation is probably about -120°C ., and that of radium about -150°C . Thus there is no doubt that the two emanations are quite distinct from each other in this respect, and also with regard to their radio-activity, although they both possess the property of chemical inertness. These results on the temperatures of condensation do not allow us to make any comparison of the condensation points of the emanations with those of known gases, since the lowering of the condensation point of gases with diminution of pressure has not been studied at such extremely minute pressures.

161. It was found¹ that the activity of the thorium emanation decayed at the same rate, when condensed in the spiral at the temperature of liquid air, as at ordinary temperatures. This is in accord with results of a similar kind obtained by P. Curie for the radium emanation (section 136), and shows that the value of the radio-active constant is unaffected by wide variations of temperature.

Amount of Emanation from Radium and Thorium.

162. It has been shown in section 104, that 1 gram of radium emits about 10^{11} α particles per second. Since the activity due to the emanation stored up in radium, when in a state of radio-active equilibrium, is about one quarter of the whole, the number of α particles projected per second by the emanation from 1 gram of radium is about 2.5×10^{10} . It has been shown in section 143, that 463,000 times the amount of emanation produced per second is stored up in the radium. But in a state of radio-active equilibrium, the number of emanation particles breaking up per second is equal to the number produced per second. Assuming that each emanation particle in breaking up expels one α particle, it follows that the number of emanation particles, present in 1 gram of radium in radio-active equilibrium, is $463,000 \times 2.5 \times 10^{10}$, *i.e.* 1.2×10^{16} . Taking the number of hydrogen molecules in 1 c.c. of gas at atmospheric pressure and temperature as 3.6×10^{19} (section 39), the volume of the emanation from 1 gram of radium is 3.3×10^{-4} cubic centimetre at atmospheric pressure and temperature. Quite independently of any method of calculation, it is evident that the volume of the emanation is very small, for attempts made to detect its presence by its volume have so far failed. It is probable, however, from the above calculation, that, when larger quantities of radium are available for experiment, the emanation will be collected in volume sufficiently large to measure.

In the case of thorium, the maximum quantity of emanation to be obtained from 1 gram of the solid is very minute, both on account of the small activity of thorium and of the rapid break up of the emanation after its production. Since the amount of emanation,

¹ Rutherford and Soddy, *Phil. Mag.* May, 1903.

stored in a non-emanating thorium compound, is only 87 times the rate of production, while in radium it is 463,000 times, and the rate of production of the emanation by radium is about 1 million times faster than by thorium, it follows that the amount of emanation to be obtained from 1 gram of thorium is not greater than 10^{-10} of the amount from an equal weight of radium, *i.e.* its volume is not greater than 5×10^{-14} c.c. at the ordinary pressure and temperature. Even with large quantities of thorium, the amount of emanation is too small ever to be detected by its volume.

Heat Emission of the Radium Emanation.

163. It has been shown in section 106, that the radium emanation emits heat at a rapid rate and is responsible for about 70 % of the heating effect of radium. The emanation from 1 gram of radium, together with the heat effect due to the excited activity on the walls of the containing vessel, thus gives rise to an emission of heat of about 70 gram-calories per hour. This rate of heat emission decays according to an exponential law with the time, decreasing to half value in about four days. The total quantity of heat given out during the life of the emanation is $\frac{q}{\lambda}$, where q is the initial rate of heat production and λ is the radio-active constant of the emanation. Since the value of λ expressed in hours (section 136) is $1/128$ and q is 70, the total quantity of heat emitted from the emanation from 1 gram of radium is about 10,000 gram-calories. But the volume of this emanation is about 3.3×10^{-4} c.c. Thus the total heat emitted from one cubic centimetre of the emanation at standard pressure and temperature would be about 3×10^7 gram-calories. The initial rate of emission of heat is 2×10^5 gram-calories per hour or 60 gram-calories per second. This rapid emission of heat would be sufficient to heat to redness if not to melt down the tube which contains the emanation.

If the atomic weight of the emanation is taken to be about 200, it can be calculated that 1 pound weight of the emanation would initially radiate heat at the rate of about 8000 horse-power, and in the whole course of its heat emission would radiate an amount of

energy corresponding to 40,000 horse-power days. In order to obtain such an amount of emanation about 70 tons of radium would be required.

Summary of Results.

164. The investigations into the nature of the radio-active emanations have thus led to the following conclusions:—The radio-elements thorium and radium continuously produce from themselves radio-active emanations at a rate which is constant under all conditions. In some cases, the emanations continuously diffuse from the radio-active compounds into the surrounding gas; in other cases, the emanations are unable to escape from the material in which they are produced but are occluded, and can only be released by the action of solution or heat.

The emanations possess all the properties of radio-active gases. They diffuse through gases, liquids, and porous substances, and can be occluded in some solids. Under varying conditions of pressure, volume, and temperature, the emanations distribute themselves in the same way and according to the same laws as does a gas.

The emanations possess the important property of condensation under the influence of extreme cold, and by that means can be separated from the gases with which they are mixed. The radiation from the emanation is material in nature, and consists of a stream of positively charged particles projected with great velocity.

Taking all these properties into consideration, it is difficult to avoid the conclusion that the emanations are *material* and exist in the gaseous state. The emanations possess the property of chemical inertness, and in this respect resemble the gases of the argon family. The emanations are produced in minute amount; sufficient quantity has not yet been obtained to examine by ordinary chemical methods. With regard to their rates of diffusion, the emanations of both thorium and radium behave like gases of high molecular weight.

These emanations have been detected and their properties investigated by the property they possess of emitting radiations of a special character. These radiations consist entirely of α rays, *i.e.* particles, projected with great velocity, which carry a positive

charge and have a mass about twice that of the hydrogen atom. The emanations do not possess the property of permanently radiating, but the intensity of the radiations diminishes according to an exponential law with the time, falling to half value, in the case of thorium in one minute, and in case of radium in about four days. The law of decay of activity does not seem to be influenced by any physical or chemical agency.

The emanation particles gradually break up, each particle as it breaks up expelling a charged body. The emanation after it has radiated ceases to exist as such, but is transformed into a new kind of matter, which is deposited on the surface of bodies and gives rise to the phenomena of excited activity. This last property, and the connection of the emanation with it, is discussed in detail in the succeeding chapter.

CHAPTER IX.

EXCITED RADIO-ACTIVITY.

165. Excited radio-activity. One of the most interesting and remarkable properties of thorium and radium is their power of “exciting” or “inducing” temporary activity on all bodies in their neighbourhood. A substance which has been exposed for some time in the presence of radium or thorium, behaves as if its surface were covered with an invisible deposit of intensely radio-active material. The “excited” body emits radiations capable of affecting a photographic plate and of ionizing a gas. Unlike the radio-elements themselves however, the activity of the body does not remain constant after it has been removed from the influence of the exciting active material, but decays with the time. The activity lasts for several hours when due to radium and several days when due to thorium.

This property was first observed by M. and Mme Curie¹ for radium, and independently by the writer² for thorium³.

¹ *C. R.* 129, p. 714, 1899.

² *Phil. Mag.* Jan. and Feb. 1900.

³ As regards date of publication, the priority of the discovery of “excited activity” belongs to M. and Mme Curie. A short paper on this subject, entitled “*Sur la radioactivité provoquée par les rayons de Becquerel*,” was communicated by them to the *Comptes Rendus*, Nov. 6, 1899. A short note was added to the paper by Becquerel in which the phenomena of excited activity were ascribed to a type of phosphorescence. On my part, I had simultaneously discovered the emission of an emanation from thorium compounds and the excited activity produced by it, in July, 1899. I, however, delayed publication in order to work out in some detail the properties of the emanation and of the excited activity and the connection between them. The results were published in two papers in the *Philosophical Magazine* (Jan. and Feb. 1900) entitled “A radio-active substance emitted from thorium compounds” and “Radio-activity produced in substances by the action of thorium compounds.”

If any solid body is placed inside a closed vessel containing an emanating compound of thorium or radium, its surface becomes radio-active. For thorium compounds the amount of excited activity on a body is in general greater the nearer it is to the active material. In the case of radium, however, provided the body has been exposed for several hours, the amount of excited activity is to a large extent independent of the position of the body in the vessel containing the active material. Bodies are made active whether exposed directly to the action of the radio-active substance or screened from the action of the direct rays. This has been clearly shown in some experiments of P. Curie. A small open vessel *a* (Fig. 47) containing a solution of radium is placed inside a larger closed vessel *V*.

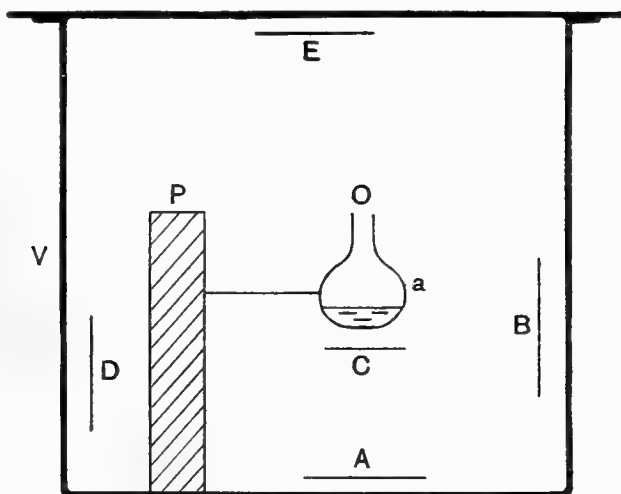

Fig. 47.

Plates *A*, *B*, *C*, *D*, *E* are placed in various positions in the enclosure. After exposure for a day, the plates after removal are found to be radio-active even in positions completely shielded from the action of the direct rays. For example, the plate *D* shielded from the direct radiation by the lead plate *P* is as active as the plate *E*, exposed to the direct radiation. The amount of activity produced in a given time on a plate of given area in a definite position is independent of the material of the plate. Plates of mica, copper, cardboard, ebonite, all show equal amounts of activity. The amount of activity depends on the area of the plate and on

the amount of free space in its neighbourhood. Excited radio-activity is also produced in water if exposed to the action of an emanating compound.

166. Concentration of excited radio-activity on the negative electrode. When thorium or radium is placed in a closed vessel, the whole interior surface becomes strongly active. In a strong electric field, on the other hand, the writer found that the activity was confined entirely to the negative electrode. By suitable arrangements, the whole of the excited activity, which was previously distributed over the surface of the vessel, can be concentrated on a small negative electrode placed inside the vessel. An experimental arrangement for this purpose is shown in Fig. 48.

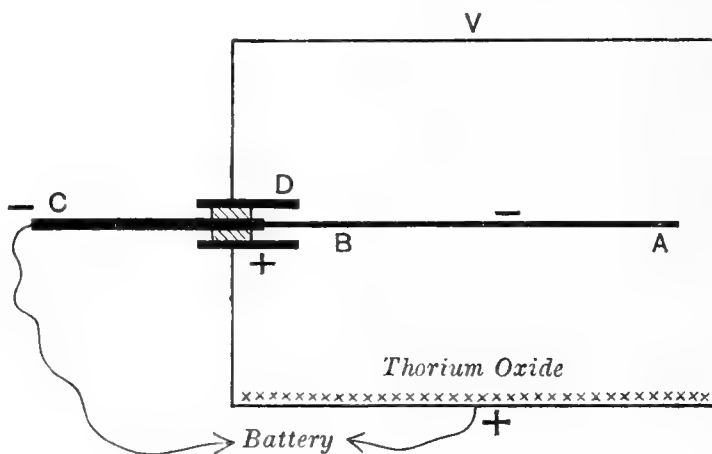

Fig. 48.

The metal vessel V containing a large amount of thoria is connected to the positive pole of a battery of about 300 volts. The wire AB to be made active is fastened to a stouter rod BC , passing through an ebonite cork inside a short cylinder D , fixed in the side of the vessel. This rod is connected with the negative pole of the battery. In this way the wire AB is the only conductor exposed in the field with a negative charge, and it is found that the whole of the excited activity is concentrated upon it.

In this way it is possible to make a short thin metal wire over 10,000 times as active per unit surface as the thoria from which the excited activity is derived. In the same way, the excited activity due to radium can be concentrated mainly on the negative

electrode. In the case of thorium, if the central wire is charged positively, it shows no appreciable activity. With radium, however, a positively charged body becomes slightly active. In most cases, the amount of activity produced on the positive electrode is not more than 5% of the corresponding amount when the body is negatively charged. For both thorium and radium, the amount of excited activity on electrodes of the same size is independent of their material.

All metals are made active to equal extents for equal times of exposure. When no electric field is acting, the same amount of activity is produced on insulators like mica and glass as on conductors of equal dimensions.

167. Connection between the emanations and excited activity. An examination of the conditions under which excited activity is produced shows that there is a very close connection between the emanation and the excited activity. If a thorium compound is covered with several sheets of paper, which cut off the α rays but allow the emanation to pass through, excited activity is still produced in the space above it. If a thin sheet of mica is waxed down over the active material, thus preventing the escape of the emanation, no excited activity is produced outside it. Uranium and polonium which do not give off an emanation are not able to produce excited activity on bodies. Not only is the presence of the emanation necessary to cause excited activity, but the amount of excited activity is always proportional to the amount of emanation present. For example, de-emanated thoria produces very little excited activity compared with ordinary thoria. In all cases the amount of excited activity produced is proportional to the emanating power. The emanation when passing through an electric field loses its property of exciting activity at the same rate as the radiating power diminishes. This was shown by the following experiment.

A slow constant current of air from a gasometer, freed from dust by its passage through cotton-wool, passed through a rectangular wooden tube 70 cms. long. Four equal insulated metal plates *A*, *B*, *C*, *D*, were placed at regular intervals along the tube. The positive pole of a battery of 300 volts was connected to a metal

plate placed in the bottom of the tube, while the negative pole was connected with the four plates. A mass of thoria was placed in the bottom of the tube under the plate *A*, and the current due to the emanation determined at each of the four plates. After passing a current of air of 0.2 cm. per second, for 7 hours along the tube, the plates were removed and the amount of excited activity produced on them was tested by the electric method. The following results were obtained.

	Relative current due to emanation	Relative excited activity
Plate <i>A</i> ...	1	1
" <i>B</i> ...	·55	·43
" <i>C</i> ...	·18	·16
" <i>D</i> ...	·072	·061

Within the errors of measurement, the amount of excited activity is thus proportional to the radiation from the emanation, *i.e.* to the amount of emanation present. The same considerations hold for the radium emanation. The emanation in this case, on account of the slow loss of its activity, can be stored mixed with air for long periods in a gasometer, and its effects tested quite independently of the active matter from which it is produced. The ionization current due to the excited activity produced by the emanation is always proportional to the current due to the emanation for the period of one month or more that its activity is large enough to be conveniently measured by an electrometer.

If at any time during the interval, some of the emanation is removed and introduced into a new testing vessel, the ionization current will immediately commence to increase, rising in the course of four or five hours to about twice its original value. This increase of the current is due to the excited activity produced on the walls of the containing vessel. On blowing out the emanation, the excited activity is left behind, and at once begins to decay. Whatever its age, the emanation still possesses the property of causing excited activity, and in amount always proportional to its activity, *i.e.* to the amount of emanation present.

These results show that the power of exciting activity on

inactive substances is a property of the radio-active emanations, and is proportional to the amount of emanation present.

The phenomenon of excited activity cannot be ascribed to a type of phosphorescence produced by the rays from the emanation on bodies; for it has been shown that the activity can be concentrated on the negative electrode in a strong electric field, even if the electrode is shielded from the direct radiation from the active substance which gives off the emanation. The amount of excited activity does not seem in any way connected with the ionization produced by the emanation in the gas with which it is mixed. For example, if a closed vessel is constructed with two large parallel insulated metal plates on the lower of which a layer of thoria is spread, the amount of the excited activity on the upper plate when charged negatively, is independent of the distance between the plates when that distance is varied from 1 millimetre to 2 centimetres. This experiment shows that the amount of excited activity depends only on the amount of emanation, emitted from the thoria; for the ionization produced with a distance of 2 centimetres between the plates is about ten times as great as with a distance of 1 millimetre.

168. If a platinum wire is made active by exposure to the emanation of thoria, its activity¹ can be removed by treating the wire with certain acids. For example, the activity is not much altered by immersing the wire in hot or cold water or nitric acid, but more than 80% of it is removed by dilute or concentrated solutions of sulphuric or hydrochloric acid. The activity has not been destroyed by this treatment but is manifested in the solution. If the solution is evaporated, the activity remains behind on the dish.

These results show that the excited activity is due to a deposit on the surface of bodies of *radio-active matter* which has definite properties as regards solution in acids. This active matter is dissolved in some acids, but, when the solvent is evaporated, the active matter is left behind. This active matter is deposited on the surface of bodies, for it can be partly removed by rubbing the body with a cloth, and almost completely by scouring the plate

¹ Rutherford, *Phil. Mag.* Feb. 1900.

with sand or emery paper. The amount of active matter deposited is extremely small, for no difference of weight has been detected in a platinum wire when made extremely active. On examining the wire under a microscope, no trace of foreign matter is observed. It follows from these results that the matter which causes excited activity is many thousand times more active, weight for weight, than radium itself.

It is convenient to have a definite name for this radio-active matter, for the term "excited activity" only refers to the radiation from the active matter and not to the matter itself. Since the matter which produces the phenomena of excited radio-activity is derived from the emanation of thorium and of radium, the name *emanation X* will be given to it. This is chosen from analogy to the active products Ur X and Th X which are continuously produced from uranium and thorium respectively. The emanation X from thorium is different in chemical and other properties from the emanation X from radium. For example, each type of matter has a distinctive rate of decay of activity, as well as some differences in solubility by acids.

On the view developed in section 127, the emanation X is the residue left behind from each atom of the emanation of thorium or of radium after one or more α particles have been expelled. The emanation X is an unstable substance, and its atoms again break up, giving rise to "excited activity," *i.e.* to the radiation from "emanation X."

The emanation X is quite distinct in chemical and physical properties from the emanation which produces it. For example, emanation X behaves as a solid, which is deposited on the surface of bodies, while the emanation exists in the gaseous state. The emanation is insoluble in hydrochloric or sulphuric acids, while emanation X is readily soluble in both.

169. Decay of the excited activity produced by thorium.

The excited activity produced in a body after a *long* exposure to the emanations of thorium, decays in an exponential law with the time, falling to half value in about 11 hours. The following table shows the rate of decay of the excited activity produced on a brass rod.

Time in hours	Current
0	100
7.9	64
11.8	47.4
23.4	19.6
29.2	13.8
32.6	10.3
49.2	3.7
62.1	1.86
71.4	0.86

The results are shown graphically in Fig. 49, Curve A.

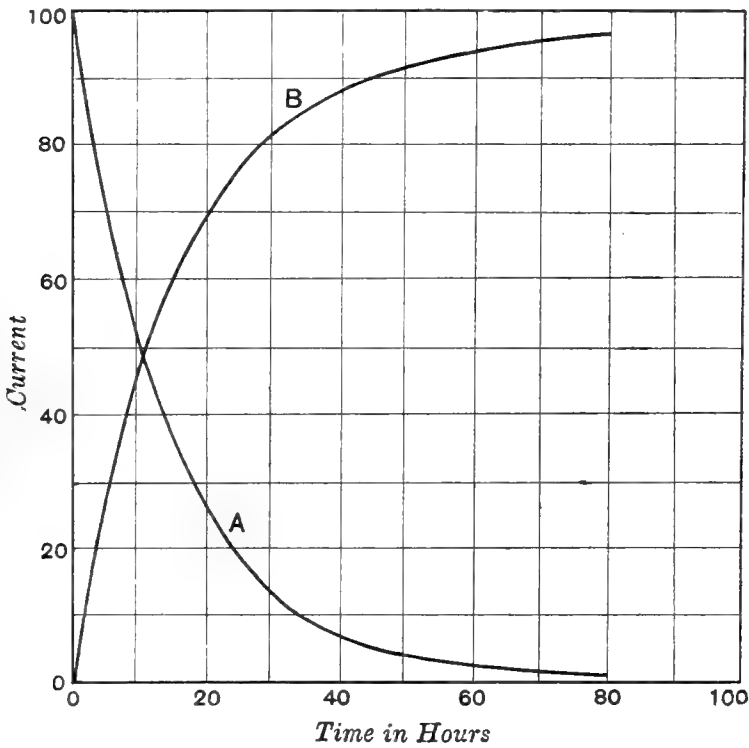

Fig. 49.

The intensity of the radiation I after any time t is given by

$$\frac{I}{I_0} = e^{-\lambda t} \text{ where } \lambda \text{ is the radio-active constant.}$$

The rate of decay of excited activity, like that of the activity of other radio-active products, is not appreciably affected by change of conditions. The rate of decay is independent of the concentration of the excited activity, and of the material of the body in which it is produced. It is independent also of the nature and pressure of the

gas in which it decays. The rate of decay is unchanged whether the excited activity is produced on the body with or without an electric field.

The amount of excited activity produced on a body increases at first with the time, but reaches a maximum after an exposure of several days. An example of the results is given in the following table. In this experiment, a rod was made the cathode in a closed vessel containing thoria. It was removed at intervals for the short time necessary to test its activity and then replaced.

Time in hours	Current
1.58	6.3
3.25	10.5
5.83	29
9.83	40
14.00	59
23.41	77
29.83	83
47.00	90
72.50	95
96.00	100

These results are shown graphically in Curve *B*, Fig. 49. It is seen that the decay and recovery curves may be represented approximately by the following equations.

$$\text{For the decay curve } A, \quad \frac{I}{I_0} = e^{-\lambda t}.$$

$$\text{For the recovery curve } B, \quad \frac{I}{I_0} = 1 - e^{-\lambda t}.$$

The two curves are thus complementary to one another; they are connected in the same way as the decay and recovery curves of Ur X, and are susceptible of a similar explanation.

The amount of excited radio-activity reaches a maximum value when the rate of supply of fresh radio-active particles balances the rate of change of those already deposited.

170. Excited radio-activity produced by a short exposure. The initial portion of the recovery curve *B*, Fig. 49, is not accurately represented by the above equation. The activity for the first few hours increases more slowly than would be

expected from the equation. This result, however, is completely explained in the light of later results. The writer¹ found that, for a *short exposure* of a body to the thorium emanation, the excited activity upon it after removal, instead of at once decaying at the normal rate, *increased* for several hours. In some cases the activity of the body increased three to four times its original value in the course of a few hours and then decayed with the time.

Some of the results obtained are shown in the following tables. Table I. is for a platinum wire exposed as cathode for 15 minutes; Table II. for aluminium foil with 41 minutes' exposure to the emanation. About 5 minutes elapsed between removal and the first observation.

TABLE I.

Time	Current
0	1
7·5 minutes	1·5
24	2·1
43	2·4
58	2·7
78	3·1
99	3·4

TABLE II.

Time	Current
0	1
21 minutes	1·6
31	1·8
57	2·0
70	2·2
91	2·5
120	2·9
160	2·9
180	2·9
22 hours	1·0
49	·21

The initial current is, in each case, taken as unity. In Table II. the activity after increasing nearly to three times its original value decreases again at about the normal rate, falling to half value in about 11 hours.

With a longer time of exposure to the emanation, the ratio of the increase after removal is much less marked. For a long interval of exposure, the activity after removal begins at once to diminish. In this case, the increase of activity of the matter deposited in the last few hours does not compensate for the decrease of activity of the active matter as a whole, and consequently the activity at once commences to decay. This increase of activity with time explains the initial irregularity in the recovery

¹ *Phys. Zeit.* 3, No. 12, p. 254, 1902. *Phil. Mag.* Jan. 1903.

curve, for the active matter deposited during the first few hours takes some time to reach its maximum activity, and the initial activity is, in consequence, smaller than would be expected from the equation.

The increase of activity on a rod exposed for a short interval in the presence of the thorium emanation has been further investigated by Miss Brooks. The curve *C* in Fig. 50 shows the variation with time of the activity of a brass rod exposed for 10 minutes in the emanation vessel filled with dust-free air. The excited activity after removal increased in the course of 3.7 hours to five times its initial value, and afterwards decayed at the normal rate.

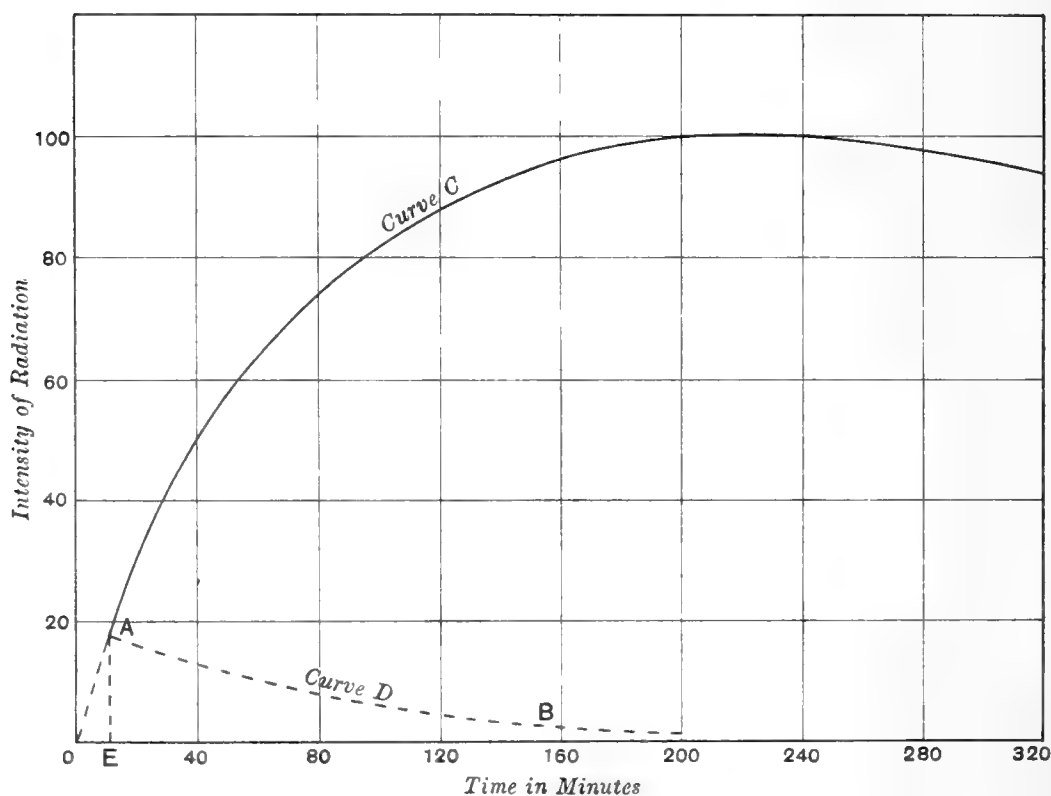

Fig. 50.

171. Effect of dust on the distribution of excited activity.

Miss Brooks, working in the Cavendish Laboratory, observed that the excited activity due to the thorium emanation appeared in some cases on the anode in an electric field, and that the distribution of excited activity varied in an apparently capricious manner. This effect was finally traced to the presence of dust in the air of the emanation vessel. For example, with an exposure of 5 minutes

the amount of excited activity to be observed on a rod depended on the time that the air had been allowed to remain undisturbed in the emanation vessel beforehand. The effect increased with the time of standing, and was a maximum after about 18 hours. The amount of excited activity obtained on the rod was then about 20 times as great as the amount observed for air freshly introduced. The activity of this rod did not increase after removal, but with fresh air, the excited activity, for a 5 minutes' exposure, increased to five or six times its initial value.

This anomalous behaviour was found to be due to the presence of dust particles in the air of the vessel, in which the bodies were made radio-active. These particles of dust, when shut up in the presence of the emanation, become radio-active. When a negatively charged rod is introduced into the vessel, a part of the radio-active dust is concentrated on the rod and its activity is added to the normal activity produced on the wire. After the air in the vessel has been left undisturbed for an interval sufficiently long to allow each of the particles of dust to reach a state of radio-active equilibrium, on the application of an electric field, all the positively charged dust particles will at once be carried to the negative electrode. The activity of the electrode at once commences to decay, since the decay of the activity of the dust particles on the wire quite masks the initial rise of the normal activity produced on the wire.

Part of the radio-active dust is also carried to the anode, and the proportion increases with the length of time during which the air has been undisturbed. The greatest amount obtained on the anode was about 60% of that on the cathode.

These anomalous effects were found to disappear if the air was made dust-free by passing through a plug of glass wool, or by application for some time of a strong electric field.

172. Decay of excited activity from radium. The excited activity produced on bodies by exposure to the radium emanation decays much more rapidly than the thorium excited activity. For short times of exposure¹ to the emanation the decay curve is very irregular. This is shown in Fig. 51.

¹ Rutherford and Miss Brooks, *Phil. Mag.* July, 1902.

It was found that the intensity of the radiation decreased rapidly for the first 10 minutes after removal, but about 15 minutes after removal reached a value which is maintained nearly constant for an interval of about 20 minutes. It then decays, following an

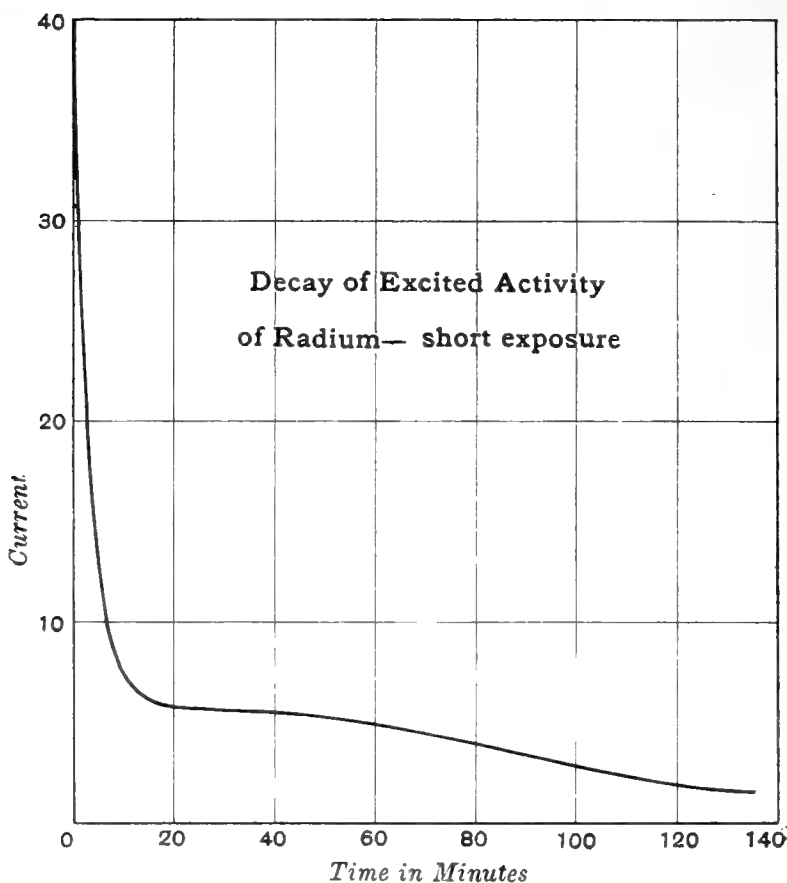

Fig. 51.

exponential law to zero, the intensity falling to half value in about 30 minutes. With longer times of exposure, the irregularities in the curve are not so marked.

Later, P. Curie and Danne¹ made a detailed investigation of the decay of excited activity for times of exposure to the emanation from 10 seconds to 6 days. The results are shown graphically in Fig. 52, where the ordinates represent the logarithm of the intensity of the radiation, and the abscissae time in hours. Curve *A* represents the decay for a long time of exposure. This decay

¹ *C. R.* 136, p. 364, 1903.

curve is unaltered for all times of exposure to the emanation greater than 24 hours.

After an interval of 2.5 hours, the logarithmic decay curve for long times of exposure is a straight line, *i.e.* the activity falls off in an exponential law with the time, falling to half value in 28 minutes. P. Curie and Danne found that for any time t

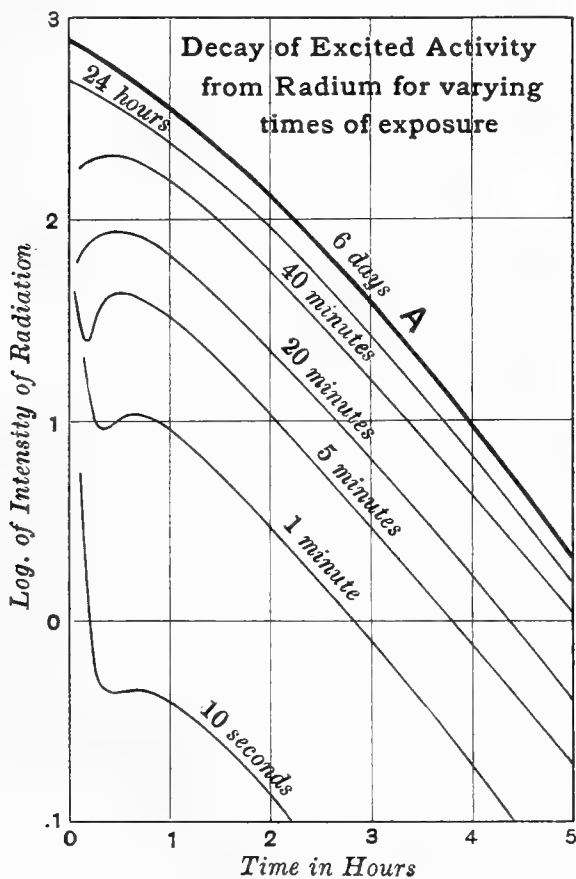

Fig. 52.

after removal the intensity I_t was given by the difference of two exponentials, *viz.*

$$\frac{I_t}{I_0} = ae^{-\lambda_1 t} - (a - 1)e^{-\lambda_2 t},$$

where $\lambda_1 = \frac{1}{2420}$ and $\lambda_2 = \frac{1}{1860}$ with the second as the unit of time. The numerical constant $a = 4.20$. The explanation of this law of decay is given in section 177.

The decay curve varies greatly with the time of exposure. For example, in an exposure of 5 minutes, the activity at first decreases

very rapidly, then passes through a minimum after 8 minutes, and increases to a maximum after 40 minutes, and after 2·5 hours decays in an exponential law to zero¹. As in the case of the excited activity from thorium, the rate of decay of the excited activity from radium is for the most part independent of the nature of the body made active. Curie and Danne (*loc. cit.*) observed that the active bodies gave off an emanation itself capable of exciting activity in neighbouring bodies. This property rapidly disappeared and was inappreciable 2 hours after removal. In certain substances like celluloid and caoutchouc, the decay of activity is very much slower than for the metals. This effect becomes more marked with increase of time of exposure to the emanation. A similar effect is exhibited by lead, but to a less marked degree. During the time the activity lasts, these substances continue to give off an emanation.

It is probable that these divergencies from the general law are not due to an actual change in the rate of decay of the true excited activity but to an occlusion of the emanation by these substances during the interval of exposure. After exposure the emanation gradually diffuses out, and thus the activity due to this occluded emanation and the excited activity produced by it decays very slowly with the time.

173. Excited radio-activity of very slow decay. M. and Mme Curie² have observed that bodies which have been exposed for a long interval in the presence of the radium emanation do not lose all their activity. The excited activity at first decays rapidly at the normal rate, falling to half value in about 30 minutes, but a residual activity always remains of the order of 1/20,000 of the initial activity. This residual activity either does not diminish at all, or so slowly that the decrease is not appreciable after an interval of six months.

¹ The writer has not observed the rise to a maximum found by Curie and Danne for the decay curves of the excited activity due to radium (see Fig. 52), but has always obtained curves of decay, for short exposures, similar to that shown in Fig. 51. This has been the case whether the excited activity has been produced on a body by the action of an electric field or not. In the experiments, a slow current of air was always passed through the testing apparatus to remove any emanation from the body made active.

² *Thesis*, Paris, 1903, p. 116.

Giesel¹ has also observed that a platinum wire which has been exposed in the presence of the radium emanation possesses residual activity, and he has shown that the radiation consists entirely of α rays. A further discussion of this residual activity and its possible connection with polonium is given later in section 188.

174. Connection between decay curves for different times of exposure. The decay of excited activity, in cases where there is no occlusion of the emanation by the substance made active, is a function only of the time of exposure. The decay curves are all intimately connected with each other, and can be theoretically deduced provided the decay curve for a *very short exposure* is accurately known.

It is supposed that the excited activity produced on a body is due to a deposit of radio-active particles. On an average a certain number of these particles will break up per second, giving rise to rays which ionize the gas. If a large number of particles is deposited, the rate of production of ions in the gas by the rays will be practically a continuous function of the time. The rate of production of ions, at any time, divided by the total number of radio-active particles deposited, will be called the *average* number of ions produced by each particle at that time.

Suppose the radio-active particles which cause excited activity are deposited at a uniform rate of q per second. The number deposited in a short time $dt = qdt$.

Let $n_0 =$ the *average* number of ions produced in the gas per second by each particle, at the instant of removal.

$n =$ the average number of ions per particle per second after an interval t .

Suppose $n = n_0 f(t)$ where $f(t)$ is a function of t such that

$$f(t) = 1 \text{ when } t = 0,$$

$$f(t) = 0 \text{ when } t = \infty,$$

$f(t)$ may in some cases pass through a maximum value greater than unity. The variation of the rate of production of ions with

¹ *Ber. deutsch. Chem. Ges.* p. 2368, 1903. *Chem. News*, Aug. 7, 1903.

time is supposed to include the effects of different kinds of radiation emitted during the succession of changes which may occur.

The number of ions produced per second after a time t by the active particles deposited for the first short interval of exposure is given by $qn_0 f(t) dt$.

The number N_t of ions produced per second at the time t by the radio-active matter deposited during the interval t is given by

$$N_t = qn_0 \int_0^t f(t) dt.$$

A steady state is reached when the rate of supply of fresh ions per second by the addition of the radio-active material is balanced by the rate of diminution of the production of ions by the excited radiation as a whole. This steady state is reached after a long interval of exposure, and the maximum rate of production of ions N_0 is given by

$$N_0 = qn_0 \int_0^\infty f(t) dt,$$

and

$$\frac{N_t}{N_0} = \frac{\int_0^t f(t) dt}{\int_0^\infty f(t) dt}.$$

If the curve of decay of the excited activity for a very short exposure is plotted with the ionization current as ordinate and time as abscissa, as in Fig. 51, the values of these integrals are at once determined from the experimental curve by measuring the area included between the curve and the ordinates erected at the points corresponding to the time limits of the integrals.

The curve of rise of excited activity can thus be deduced from the decay curve and *vice versa*.

N_1 , the rate of production of ions due to the excited radiation, after removal from the emanation for a time t_1 , is given by

$$N_1 = qn_0 \int_{t_1}^{t+t_1} f(t) dt,$$

if t is the time of exposure.

If N is the number of ions produced immediately after removal,

$$\frac{N_1}{N} = \frac{\int_{t_1}^{t+t_1} f(t) dt}{\int_0^t f(t) dt}.$$

The decay curve for any time of exposure can thus also be deduced from the curve of decay for a short exposure. For a very long interval of exposure the value N_1 at a time t after removal is given by

$$\frac{N_1}{N_0} = \frac{\int_t^{\infty} f(t) dt}{\int_0^{\infty} f(t) dt}.$$

Now the curve of rise $\frac{N_t}{N_0}$ is given by

$$\frac{N_t}{N_0} = \frac{\int_0^t f(t) dt}{\int_0^{\infty} f(t) dt}.$$

Thus

$$1 - \frac{N_t}{N_0} = \frac{N_1}{N_0}.$$

Thus the decay and rise curves are very simply connected, whatever the law of decay of the radiations. This relation may be expressed as follows: *For a long exposure, the percentage activity lost after removal for a time t is equal to the percentage of the final activity gained by a body exposed during the same interval.*

This result, which has already been shown to apply to the decay and recovery curves of Ur X, Th X, and other radio-active products, is of general application to all cases of radio-active change when the rate of supply is a constant. The connection between the decay curves of radium and thorium excited activity, for different times of exposure, can also be shown to hold equally for all types of active products.

The relation that holds between the decay and recovery curves can easily be deduced from *à priori* considerations.

Let us suppose, for example, that a body has been exposed for a long interval in a vessel containing a constant quantity of the radium emanation. The excited activity in the body will have reached a maximum value when the rate of supply is balanced by the rate of change. Suppose this body is removed and an exactly similar body immediately substituted. The sum of the excited activity on these two bodies will at any time be the same as on the single body before removal. If this were not the case, there would be a change in energy of the radiations from the radio-active system, as a whole, purely by removal of one body and substitution of another. This is contrary to the general experimental fact that the processes occurring in radio-activity are independent of control, and that the radiation from a system in radio-active equilibrium remains constant.

Thus if I_t = intensity of radiation from the excited body at any time t after removal.

I'_t = intensity of radiation from the new body exposed under the same conditions for a time t .

Then $I_t + I'_t = I_0$ where I_0 is the initial activity on the removed body.

Thus $1 - \frac{I'_t}{I_0} = \frac{I_t}{I_0}$, which is the same relation that has been developed from other considerations.

These results are particular cases of what may be termed the "conservation of radio-activity," which is discussed in detail in section 196.

175. Theory of successive changes. It has been pointed out that the excited activity produced in a body exposed for a very short interval in the presence of the thorium or radium emanations does not decay according to a simple exponential law. In the case of a body excited by the thorium emanation, the activity increases for a few hours, passes through a maximum where the activity is five to six times the initial value, and then slowly decays in an exponential law with the time, falling to half value after a further interval of 11 hours. After the maximum is reached,

the activity decays at the normal rate observed for bodies exposed for a long interval in the presence of the thorium emanation.

The increase of activity with time cannot be ascribed to a possible occlusion of the radio-active matter in the pores of the substance and a gradual passage to the surface after removal; for it has been found that a very thin sheet of aluminium foil, which absorbs very little of the radiation, exhibits the same effect as a solid plate. The effect is, however, similar in some respects to the increase of activity with time observed in a closed vessel in which the radium emanation has been introduced. This is known to be due to the production from the emanation of radio-active matter, which is deposited on the walls of the vessel and adds its radiation to that of the emanation proper. In a similar way the activity of Th X increases for the first day after separation from the thorium, and this is ascribed (see section 190) to the production of excited activity in the mass of the Th X.

The most probable explanation of the initial increase of activity with time, observed for the excited activity produced by the thorium emanation, is that there are two successive changes occurring in the emanation X of thorium after the deposit of the active matter on the surface of the body.

The theory of these secondary changes will now be considered. Let n_0 be the number of radio-active particles deposited on the body during the exposure to the emanation. The exposure is supposed to be so short that only a very small proportion of the particles have undergone change during the time of exposure. These particles are supposed to undergo change in an exponential law with the time, and the product of the first change to break up again according to the same law, but at a different rate. Let λ_1, λ_2 be the constants of the first and second changes respectively. After removal for a time t , the number n of particles remaining unchanged is given by

$$n = n_0 e^{-\lambda_1 t},$$

the number which change in the time dt at the time t is given by

$$\lambda_1 n_0 e^{-\lambda_1 t} dt.$$

Some of this number at once begin to go through the second

change, but the number which has undergone the first but not the second change at the time T after removal is given by

$$\lambda_1 n_0 e^{-\lambda_1 t} e^{-\lambda_2 (T-t)} dt.$$

The number q of particles which have undergone the first of the two changes at a time T after removal is thus given by

$$\begin{aligned} q &= \lambda_1 n_0 \int_0^T e^{-\lambda_1 T} e^{-\lambda_2 (T-t)} dt \\ &= \frac{\lambda_1 n_0}{\lambda_1 - \lambda_2} (e^{-\lambda_2 T} - e^{-\lambda_1 T}). \end{aligned}$$

Now the number of these particles breaking up in unit time is proportional to $\lambda_2 q$, and is a measure of the radiation accompanying the change (section 124).

If K is the ratio of the ionization produced in the second change to that produced in the first change, the saturation current I_t resulting from the two successive changes is given by

$$\begin{aligned} \frac{I_t}{I_0} &= \frac{\lambda_1 n_0 e^{-\lambda_1 T} + K \lambda_2 q}{\lambda_1 n_0} = e^{-\lambda_1 T} + \frac{K \lambda_2}{\lambda_1 - \lambda_2} (e^{-\lambda_2 T} - e^{-\lambda_1 T}) \\ &= e^{-\lambda_1 T} \left(1 + \frac{K \lambda_2}{\lambda_2 - \lambda_1} - \frac{K \lambda_2}{\lambda_2 - \lambda_1} e^{-(\lambda_2 - \lambda_1) T} \right), \end{aligned}$$

where I_0 is the initial value of the saturation current.

This equation will be applied later with satisfactory results in section 190, to explain the rise of activity of Th X after its separation.

176. On examination of the curve shown in Fig. 50, which shows the rise of activity of a rod exposed for ten minutes in the presence of the thorium emanation, it is seen that the curve C , showing a rise to a maximum, is roughly similar to the curves of recovery of uranium and thorium when the Ur X and Th X respectively have been removed. If the curve is produced backwards, it is seen to pass very nearly through the origin. The abscissae measure the time from the moment the rod was introduced into the emanation vessel.

If the increase of activity with time is due to a secondary change of the type already considered, it follows at once that the

total number of ions produced during the first change is not much more than one per cent. of that produced in the second change. If, for example, the initial activity be taken as due to the radiation from the first change, the activity due to the first change *alone* should fall off in an exponential law with the time, following the dotted curve *D* shown in Fig. 50. The area *EABE* serves as a comparative measure of the total number of ions produced by the first change, and this area is seen to be small compared to the corresponding area included by the main curve *C*.

There is, however, no reason to suppose that the first change is accompanied by any ionizing radiation at all. The initial activity observed is due to the fact that some of the deposited matter has undergone change before the rod is tested; for it will be shown that the experimental curve obtained can be completely deduced if the first change is supposed to take place *without any emission of ionizing rays*, but that ionizing rays are emitted in the second change.

It has been shown that after removal of the body for a time *T* the number of particles *q* which have undergone the first change but not the second change is given by

$$q = \frac{\lambda_1 n_0}{\lambda_1 - \lambda_2} (e^{-\lambda_2 T} - e^{-\lambda_1 T})$$

where λ_1 is the constant of decay in the first change and λ_2 for the second change.

Since it is supposed that only the second change gives rise to a radiation, the activity at any time *T* after removal is proportional to *q*. The value of *q* passes through a maximum when

$$\lambda_2 e^{-\lambda_2 T} - \lambda_1 e^{-\lambda_1 T} = 0,$$

i.e. when
$$\frac{\lambda_2}{\lambda_1} = e^{-(\lambda_1 - \lambda_2)T}.$$

Now it is known, from experiments for a long interval of exposure, that in the second change the activity falls to half value in 11 hours, *i.e.* $\lambda_2 = \cdot 063$, when the time is expressed in hours. Since the maximum activity is reached when $T = 220$ minutes approximately, the value of $\lambda_1 = \cdot 75$. Substituting the values of

λ_1, λ_2 in the equation for q , the theoretical value of the activity for any time T after exposure is shown in the following table. The observed experimental values are also shown. The maximum activity is taken as unity.

Time in minutes	Theoretical value of activity	Observed value of activity
15	·22	·23
30	·38	·37
60	·64	·63
120	·90	·91
220	1·00	1·00
305	·97	·96

The curve drawn from zero is thus almost in exact agreement with the equation, taking $\lambda_1 = \cdot75$.

It may thus be concluded that the matter emanation X undergoes at least two changes:—

(1) A change which is not accompanied by ionizing radiations, but in which the amount of matter undergoes change according to an exponential law with the time, falling to half value in 55 minutes.

(2) A second change, accompanied by the emission of rays, in which half the matter undergoes change in 11 hours.

The existence of such a well-marked change in the matter emanation X of thorium, not accompanied by the emission of ionizing rays, is very interesting. It will be shown later that there is strong evidence of a change of a similar character in the emanation X of radium. It may be supposed that the change consists in a rearrangement of the components of the atom which is not of such a violent character as to cause a portion of the atom to be expelled. Since there is only one changing system involved, it is to be expected that the law of change would be the same as for a monomolecular change in chemistry.

177. Secondary changes in emanation X of radium.

The decay curves of the activity produced on a rod by a short exposure to the radium emanation are of a very different character

from those observed from thorium. In the first place, there is a rapid decay of the activity to less than 1/8 of the initial value, then a very slow variation for about 20 minutes, and then a gradual decay according to an exponential law. It is not possible to explain this variation of the activity on the assumption of two changes. It is necessary to suppose that there are three, the second of which is a change not accompanied by ionizing rays.

Some evidence will first be considered of the decay of activity of a body exposed for several days in the presence of the radium emanation. P. Curie and Danne (*loc. cit.*) state that the law of decay of the activity of such a body is expressed accurately by the equation

$$\frac{I_t}{I_0} = ae^{-\lambda_1 t} - (a-1)e^{-\lambda_2 t},$$

where $\lambda_1 = \frac{1}{2420}$, $\lambda_2 = \frac{1}{1860}$, and $a = 4.20$.

Curie and Danne do not state definitely whether the law of decay holds for the first ten minutes after removal. The shape of the decay curve for short exposure suggests from theoretical considerations that there should be in addition a small but rapid initial drop of activity during the first ten minutes after removal. Such a rapid initial drop of activity has been experimentally observed by the writer.

It seems probable that the equation of P. Curie and Danne applies for the decay of excited activity starting from a time about ten minutes after removal. During that short interval the unchanged deposited matter rapidly passes through the first change, for half the matter is changed in about three minutes. At the time at which the measurements of Curie and Danne began, probably nearly all of the deposited matter had gone through the first change.

Since the decay of activity after that time can be expressed by two exponentials, it is probable that there are two further changes occurring. The view that the first of these changes is a change unaccompanied by ionizing rays, followed by another change with the emission of rays, will be found to be in very close agreement with the results of P. Curie and Danne. It has been shown that, after a short exposure for a time dt to the emanation, during

which n_0 particles were deposited on the body, the number q of particles which have passed through the first change but not the second is at any time T given by

$$q = \frac{\lambda_1 n_0}{\lambda_1 - \lambda_2} (e^{-\lambda_2 t} - e^{-\lambda_1 t})$$

$$= n_0 f(t).$$

(See section 174.)

But, since only the second change is accompanied by rays, the intensity of the radiation is always proportional to q the number unchanged, *i.e.* to $n_0 f(t)$.

It has been shown in section 174 that, for a very long exposure, the activity I_t , after removal for a time t , is given by

$$\frac{I_t}{I_0} = \frac{\int_t^\infty n_0 f(t) dt}{\int_0^\infty n_0 f(t) dt}$$

where I_0 is the initial intensity after removal. Substituting the value of $f(t)$ and integrating

$$\frac{I_t}{I_0} = \frac{\lambda_1}{\lambda_1 - \lambda_2} e^{-\lambda_2 t} - \frac{\lambda_2}{\lambda_1 - \lambda_2} e^{-\lambda_1 t}.$$

This is of the same form as the equation of the decay curve found by Curie and Danne. Substituting the values $\lambda_1 = 1/2420$, $\lambda_2 = 1/1860$, which were found by them, the value of $-\frac{\lambda_2}{\lambda_1 - \lambda_2}$ is 4.3 and of $-\frac{\lambda_1}{\lambda_1 - \lambda_2}$ is 3.3.

The experimental value found by Curie and Danne for these constants was 4.2 and 3.2 respectively. The agreement between the theory and the experiment is as close as could be expected.

There are thus three distinct changes in the emanation X of radium, *viz.*

- (1) A very rapid initial change. Half of the matter changes in about three minutes and is accompanied by ionizing rays.
- (2) A slower change, which is not accompanied by ionizing rays. Half of the matter undergoes change in 36 minutes.

(3) A third change, which is faster than the second, and is accompanied by ionizing rays. Half the matter changes in about 28 minutes.

178. Physical and chemical properties of the active matter. On account of the slow decay of the activity of emanation X of thorium, its physical and chemical properties have been more closely examined than the emanation X of radium. It has already been mentioned that the emanation X of thorium is soluble in some acids. The writer¹ found that the active matter was dissolved off the wire by strong or dilute solutions of sulphuric, hydrochloric and hydrofluoric acids, but was only slightly soluble in water or nitric acid. The active matter was left behind when the solvent was evaporated. The rate of decay of activity was unaltered by dissolving the active matter in sulphuric acid, and allowing it to decay in the solution. In the experiment, the active matter was dissolved off an active platinum wire and then equal portions of the solutions were taken at definite intervals, evaporated down in a platinum dish, and the activity of the residue tested by the electric method. The rate of decay was found to be exactly the same as if the active matter had been left on the wire. In another experiment, an active platinum wire was made the cathode in a copper sulphate solution, and a thin film of copper deposited on it. The rate of decay of the activity was unchanged by the process.

A detailed examination of the physical and chemical properties of the emanation X of thorium has been recently made by F. von Lerch², and some important and interesting results have been obtained. A solution of emanation X was prepared by dissolving the metal which had been exposed for some time in the presence of the thorium emanation. In most cases the active matter was precipitated with the metal. For example, an active copper wire was dissolved in nitric acid and then precipitated by caustic potash. The precipitate was strongly active. An active magnesium wire, dissolved in hydrochloric acid and then precipitated as phosphate, also gave an active precipitate. The activity of the precipitates

¹ *Phys. Zeit.* 3, No. 12, p. 254, 1902.

² *Drude's Annal.* Nov. 1903.

decayed at the normal rate, *i.e.* the activity fell to half value in about 11 hours.

Experiments were also made on the solubility of emanation X in different substances. A platinum plate was made active and then placed in different solutions, and the decrease of the activity observed. In addition to the acids already mentioned, a large number of substances were found to dissolve the emanation X to some extent. The active matter was however not dissolved to an appreciable extent in ether or alcohol. Many substances became active if added to the active solution of emanation X and then precipitated. For example, an active solution of hydrochloric acid was obtained by dissolving the emanation X from an active platinum wire. Barium chloride was then added and precipitated as sulphate. The precipitate was strongly active, thus suggesting that the emanation X was carried down by the barium.

179. Electrolysis of solutions. Dorn showed that, if solutions of radiferous barium chloride were electrolysed, both electrodes became temporarily active, but the anode to a greater degree than the cathode. F. von Lerch (*loc. cit.*) has made a detailed examination of the action of electrolysis on an active solution of emanation X of thorium. The active matter was dissolved off an active platinum plate by hydrochloric acid and then electrolysed between platinum electrodes. The cathode was very active, but there was no trace of activity on the anode. The cathode lost its activity at a rate much *faster* than the normal. With an amalgamated zinc cathode on the other hand, the rate of decay was normal. When an active solution of hydrochloric acid was electrolysed with an electromotive force smaller than that required to decompose water, the platinum became active and the activity decayed to half value in 4.75 hours while the normal fall is to half value in 11 hours. These results point to the conclusion that the matter emanation X is complex and consists of two parts which have different rates of decay of activity, and can be separated by electrolysis.

Under special conditions it was found possible to make the anode active. This was the case if the anion attached itself to the anode. For example, if an active hydrochloric solution was electrolysed with a silver anode, the chloride of silver formed was

strongly active and its activity decayed at a normal rate. Von Lerch found that the amount of activity obtained by placing different metals in active solutions for equal times varied greatly with the metal. For example, he found that if a zinc plate and an amalgamated zinc plate, which show equal potential differences with regard to hydrochloric acid, were dipped for equal times in two solutions of equal activity, the zinc plate was seven times as active as the other. The activity was almost removed from the solution in a few minutes by dipping a zinc plate into it. Some metals became active when dipped into an active solution while others did not. Platinum, palladium, and silver remained inactive, while copper, tin, lead, nickel, iron, zinc, cadmium, magnesium, and aluminium became active. These results strongly confirm the view that excited activity is due to a deposit of active matter which has distinctive chemical behaviour.

G. B. Pegram¹ has made a detailed study of the active deposits obtained by electrolysis of pure and commercial thorium salts. The commercial thorium nitrate obtained from P. de Haen gave, when electrolysed, a deposit of lead peroxide on the anode. This deposit was radio-active, and its activity decayed at the normal rate of the excited activity due to thorium. From solutions of pure thorium nitrate, no visible deposit was obtained on the anode, but it was, however, found to be radio-active. The activity decayed rapidly, falling to half value in about one hour. Some experiments were also made on the effect of adding metallic salts to thorium solutions and then electrolysing them. Anode and cathode deposits of the oxides or metals obtained in this way were found to be radio-active, but the activity fell to half value in a few minutes. The gases produced by electrolysis were radio-active, but this was due to the presence of the thorium emanation. The results of Pegram and von Lerch would seem to indicate that, besides those already known, other radio-active products with a distinctive rate of decay are produced during the changes occurring in thorium.

180. Effect of temperature. The activity of a platinum wire which has been exposed in the presence of the thorium

¹ *Phys. Review*, p. 424, Dec. 1903.

emanation is almost completely lost by heating the wire to a white heat. Miss F. Gates¹ found that the activity was not destroyed by the intense heat, but manifested itself on neighbouring bodies. When the active wire was heated electrically in a closed cylinder, the activity was transferred from the wire to the interior surface of the cylinder in unaltered amount. The rate of decay of the activity was not altered by the process. By blowing a current of air through the cylinder during the heating, a part of the active matter was removed from the cylinder. Similar results were found for the excited activity due to radium.

F. von Lerch (*loc. cit.*) determined the amount of activity removed at different temperatures. The results are shown in the following table for a platinum wire excited by the thorium emanation.

					Temperature	Percentage of activity removed
	Heated 2 minutes		800° C.	0
then	„ $\frac{1}{2}$ minute more		1020° C.	16
„	„ $\frac{1}{3}$ „	„	„	...	1260° C.	52
„	„ $\frac{1}{2}$ „	„	„	...	1460° C.	99

It is not possible to settle definitely from these experiments whether the active matter is actually volatilized at a high temperature or is removed by disintegration of the surface of the wire. All the metals so far tried apparently lose their activity at about the same temperature.

181. Emission of heat. It has been shown in sections 105, 106, and 163, that the radium emanation, together with the secondary products which arise from it, is responsible for about 75 per cent. of the total heat emission observed for radium. The gradual decay to a minimum of the heat emission of the radium for the first few hours after the emanation is removed is due to the gradual decay of the excited activity produced by the occluded emanation in the radium itself. In a similar way, the gradual increase of the heating effect of the separated emanation

¹ *Phys. Review*, p. 300, 1903.

for the first few hours after removal, is due to the excited activity produced by the emanation on the walls of the containing vessel.

Some experiments were recently made by H. T. Barnes and the writer¹ on the division of the heating effect of radium between the successive products of radium. For measurement of the heating effects, a pair of differential platinum thermometers, wound spirally in the inside of a glass tube, were used. The radium or its emanation, enclosed in a fine glass tube, was placed inside the platinum spiral and the rise of temperature observed.

The heating effect of 30 milligrams of radium bromide was first determined. The emanation was then removed from it by heating, and condensed in a small glass tube. The heating effect of the de-emanated radium was determined ten minutes after the removal of the emanation, and was found to have diminished to 59 per cent. of its original value. It then diminished more slowly with time to a minimum corresponding to 25 per cent. of its original value (see section 106).

The curve of diminution with time of the heating effect of radium to the minimum of 25 per cent. should be identical with the corresponding curve of diminution with time of the heating effect of the emanation tube to zero after removal of the emanation. This was found to be the case. The emanation was allowed to remain for several hours in a small glass tube in order that the excited activity should reach a maximum value. The emanation was then rapidly withdrawn from the tube, and the heating effect of the tube determined at regular intervals. There was a similar initial drop within the first 10 minutes, then a slower variation, and finally a decrease to zero according to an exponential law with the time, falling to half value in about 30 minutes.

The curve of increase of the heating effect of the emanation tube to a maximum after the introduction of the emanation was found to be complementary to the curve of decrease of the heating effect to zero after withdrawal of the emanation. It was not found possible to separate the heating effect of the emanation itself from the first rapid change in emanation X, since temperature

¹ *Phil. Mag.* Feb. 1904.

conditions did not become steady until an interval of 10 minutes after introducing or withdrawing the emanation, and in that time, the first change in emanation X was nearly completed.

The division of the heating effect amongst the radio-active products of radium is given in the following table. The activity of each product measured by the α rays is also given for comparison :

Active products	Nature of rays	Percentage proportion of total activity measured by the rays	Percentage proportion of total heating effect
Radium (freed from active products)	α rays	25	25
↓ Emanation	α rays	18	41
↓ Emanation X (first change)	α rays	15	
↓ " (second change)	No α rays	0	34
↓ " (third change)	α , β , and γ rays	42	

The heating effect of the active products is approximately proportional to their activity measured by the α rays. There can be very little doubt that the emanation supplies an amount of the heating effect proportional to its activity.

The decay curve of the activity of radium to a minimum of 25 per cent. after removal of the emanation is approximately the same as the corresponding decay curve of the activity of radium measured by the α rays.

There is no doubt that the heating effect of radium is a result of the succession of radio-active changes occurring in it. The heating effect accompanies the expulsion of α particles, and is approximately proportional to the number expelled. The time-variation of the heating effect of the radio-active products is the same as the time-variation of their activity measured by the α rays.

182. Effect of variation of E. M. F. on amount of excited activity from thorium. It has been shown that the

excited activity is confined to the cathode in a strong electric field. In weaker fields the activity is divided between the cathode and the walls of the vessel. This was tested in an apparatus¹ shown in Fig. 53.

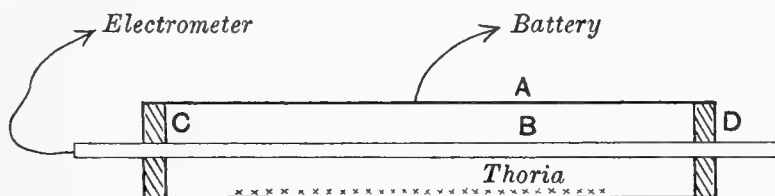

Fig. 53.

A is a cylindrical vessel of 5.5 cms. diameter, *B* the negative electrode passing through insulating ends *C*, *D*. For a potential difference of 50 volts, most of the excited activity was deposited on the electrode *B*. For about 3 volts, half of the total excited activity was produced on the rod *B*, and half on the walls of the vessel. Whatever the voltage applied, the sum of the activities on the central rod and the walls of the cylinder was found to be a constant when a steady state was reached.

When no voltage was applied, diffusion alone was operative, and in that case about 13 per cent. of the total activity was on the rod *B*. The application of an electric field has thus no influence on the sum total of excited activity, but merely controls the proportion concentrated on the negative electrode.

A more detailed examination of the variation with strength of field of the amount on the negative electrode was made in a similar manner by F. Henning². He found that in a strong electric field the amount of excited activity was practically independent of the diameter of the rod *B*, although the diameter varied between .59 mm. and 6.0 mms. With a small voltage, the amount on the negative electrode varied with its diameter. The curves showing the relation between the amount of excited activity and voltage are very similar in character to those obtained for the variation of the current through an ionized gas with the voltage applied.

The amount of excited activity reaches a maximum when all the emanation X is removed from the gas as rapidly as it is

¹ Rutherford, *Phil. Mag.* Feb. 1900.

² *Drude's Annal.* p. 562, 1902.

formed. With weaker fields, a portion diffuses to the sides of the vessel, and produces excited activity on the positive electrode.

183. Effect of pressure on distribution of excited activity. In a strong electric field, the amount of excited activity produced on the cathode is independent of the pressure down to a pressure of about 10 mms. of mercury. In some experiments made by the writer¹, the emanating thorium compound was placed inside a closed cylinder about 4 cms. in diameter, through which passed an insulated central rod. The central rod was connected to the negative pole of a battery of 50 volts. When the pressure was reduced below 10 mms. of mercury, the amount of excited activity produced on the negative electrode diminished, and was a very small fraction of its original value at a pressure of $\frac{1}{10}$ mm. Some excited activity was in this case found to be distributed over the interior surface of the cylinder. It may thus be concluded that at low pressures the excited activity appears on both anode and cathode, even in a strong electric field.

Curie and Debierne² observed that, if a vessel containing an emanating radium compound was kept pumped down to a low pressure, the amount of excited activity produced on the vessel was much reduced. In this case the emanation given off by the radium was removed by the pump with the other gases continuously evolved from the radium compound. On account of the very slow decay of activity of the emanation, the amount of excited activity produced on the walls of the vessel, in the passage of the emanation through it, was only a minute fraction of the amount produced when all the emanation given off was not allowed to escape.

184. Transmission of excited activity. The characteristic property of excited radio-activity is that it can be confined to the cathode in a strong electric field. Since the activity is due to a deposit of radio-active matter on the electrified surface, the matter must be transported by positively charged carriers. The experiments of Fehrle³ showed that the carriers of excited activity travel

¹ *Phil. Mag.* Feb. 1900.

² *C. R.* 132, p. 768, 1901.

³ *Phys. Zeit.* 3, No. 7, p. 130, 1902.

along the lines of force in an electric field. For example, if a small negatively charged metal plate was placed in the centre of a metal vessel containing an emanating thorium compound, more excited activity was produced on the sides and corners of the plate than at the central part.

A difficulty however arises in connection with the positive charge of the carrier. According to the view developed in section 127 and later in section 200, the matter emanation X, which is deposited on bodies and gives rise to excited activity, is itself derived from the emanation. The emanations of thorium and radium emit only α rays, *i.e.* positively charged particles. After the expulsion of an α particle, the residue, which is supposed to constitute the emanation X, should retain a negative charge, and be carried to the anode in an electric field. The exact opposite is however observed to be the case. The experimental evidence does not support the view that the positively charged α particles, expelled from the emanation, are directly responsible for the phenomena of excited activity; for no excited activity is produced in a body exposed to the α rays of the emanation, provided the emanation itself does not come in contact with it. It may be supposed that in gases the matter emanation X, immediately after its production, attaches itself to the positive ions, produced in the gas by the radiation, on the same sort of principle that water vapour condenses round the negative ion. The active matter is then transported by these positive carriers to the cathode. In the case of radium, there is evidence that some of the carriers of excited activity do not acquire a positive charge until they have been present in the gas for some time.

Whatever view is taken of the process by which these carriers obtain a positive charge, there can be little doubt that the expulsion of an α particle with great velocity from the atom of the emanation must set the residue in motion. On account of the comparatively large mass of this residue, which constitutes the emanation X, the velocity acquired will be small compared with that of the expelled α particle, and the moving mass will be rapidly brought to rest at atmospheric pressure by collision with the gas molecules in its path. At low pressures, however, the collisions will be so few that it will not be brought to rest until it

strikes the boundaries of the vessel. A strong electric field would have very little effect in controlling the motion of such a heavy mass, unless it has been initially brought to rest by collision with the gas molecules. This would explain why the active matter is not deposited on the cathode at low pressures in an electric field. Some direct evidence of a process of this character, obtained by Debierne on examination of the excited activity produced by actinium, is discussed in section 186.

185. The following method has been employed by the writer to determine the velocity of the positive carriers of excited activity of radium and thorium in an electric field. Suppose *A* and *B* (Fig. 54)

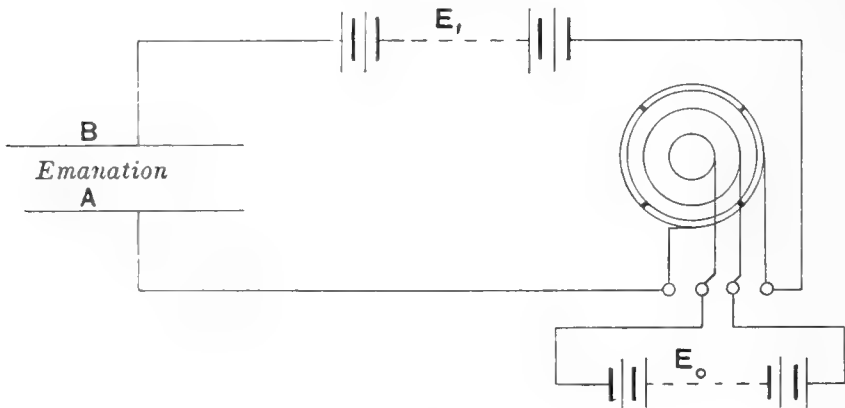

Fig. 54.

are two parallel plates exposed to the influence of the emanation, which is uniformly distributed between them. If an alternating E.M.F. E_0 is applied between the plates, the same amount of excited activity is produced on each electrode. If in series with the source of the alternating E.M.F. a battery is placed of E.M.F. E_1 less than E_0 , the positive carrier moves in a stronger electric field in one half alternation than in the other. A carrier consequently moves over unequal distances during the two half alternations, since the velocity of the carrier is proportional to the strength of the electric field in which it moves. The excited activity will in consequence be unequally distributed over the two electrodes. If the frequency of alternation is sufficiently great, only the positive carriers within a certain small distance of one

plate can be conveyed to it, and the rest, in the course of several succeeding alternations, are carried to the other plate.

When the plate B is negatively charged, the E.M.F. between the plates is $E_0 - E_1$, when B is positive the E.M.F. is $E_0 + E_1$.

Let d = distance between the plates,

T = time of a half alternation,

ρ = ratio of the excited radio-activity on the plate B to the sum of the radio-activities on the plates A and B ,

K = velocity of the positive carriers for a potential-gradient of 1 volt per centimetre.

On the assumption that the electric field between the plates is uniform, and that the velocity of the carrier is proportional to the electric field, the velocity of the positive carrier towards B is

$$\frac{E_0 - E_1}{d} K,$$

and in the course of the next half alternation

$$\frac{E_0 + E_1}{d} K$$

towards the plate A .

If x_1 is less than d , the greatest distances x_1 , x_2 passed over by the positive carrier during two succeeding half alternations is thus given by

$$x_1 = \frac{E_0 - E_1}{d} KT, \quad \text{and} \quad x_2 = \frac{E_0 + E_1}{d} KT.$$

Suppose that the positive carriers are produced at a uniform rate of q per second for unit distance between the plates. The number of positive carriers which reach B during a half alternation consists of two parts:

(1) One half of those carriers which are produced within the distance x_1 of the plate B . This number is equal to

$$\frac{1}{2} x_1 q T.$$

(2) All the carriers which are left within the distance x_1 from B at the end of the previous half alternation. The number of these can readily be shown to be

$$\frac{1}{2} x_1 \frac{x_1}{x_2} q T.$$

The remainder of the carriers, produced between A and B during a complete alternation, will reach the other plate A in the course of succeeding alternations, provided no appreciable recombination takes place. This must obviously be the case, since the positive carriers travel further in a half alternation towards A than they return towards B during the next half alternation. The carriers thus move backwards and forwards in the changing electric field, but on the whole move towards the plate A .

The total number of positive carriers produced between the plates during a complete alternation is $2dqT$. The ratio ρ of the number which reach B to the total number produced is thus given by

$$\rho = \frac{\frac{1}{2}x_1qT + \frac{1}{2}x_1\frac{x_1}{x_2}qT}{2dqT} = \frac{1}{4} \frac{x_1}{d} \frac{x_1 + x_2}{x_2}.$$

Substituting the values of x_1 and x_2 we obtain

$$K = \frac{2(E_0 + E_1)}{E_0(E_0 - E_1)} \frac{d^2}{T} \rho.$$

In the experiments the values of E_0 , E_1 , d , and T were varied, and the results obtained were in general agreement with the above equation.

The following results were obtained for thorium:

Plates 1.30 cms. apart.

$E_0 + E_1$	$E_0 - E_1$	Alternations per second	ρ	K
152	101	57	.27	1.25
225	150	57	.38	1.17
300	200	57	.44	1.24

Plates 2 cms. apart.

$E_0 + E_1$	$E_0 - E_1$	Alternations per second	ρ	K
273	207	44	.37	1.47
300	200	53	.286	1.45

The average mobility K deduced from a large number of experiments was 1.3 cms. per sec. per volt per cm. for atmospheric pressure and temperature. This velocity is about the same as the velocity of the positive ion produced by Röntgen rays in air, viz. 1.37 cms. per sec. The results obtained with the radium emanation were more uncertain than those for thorium on account of the distribution of some excited activity on the positive electrode. The values of the velocities of the carriers were however found to be roughly the same for radium as for thorium.

These results show that the carriers of the emanation X travel in the gas with about the same velocity as the positive or negative ions produced by the radiations in the gas. This shows either that the emanation X becomes attached to positive ions, or that the emanation X itself, acquiring in some way a positive charge, forms a cluster of neutral molecules which travel with it.

186. Excited activity from actinium and "emanation substance." Giesel¹ observed that the "emanating substance" gave off a large quantity of emanation, and that this emanation gave rise to a type of radiation which he termed the E rays. A narrow metal cylinder containing the active substance was placed with the open end downwards, about 5 cms. above the surface of a zinc sulphide screen. The screen was charged negatively to a high potential by an electric machine, and the cylinder connected with earth. A luminous spot of light was observed on the screen, which was brighter at the edge than at the centre. A conductor, connected with earth, brought near the luminous spot apparently repelled it. An insulator did not show such a marked effect. On removal of the active substance, the luminosity of the screen persisted for some time. This was probably due to the excited activity produced on the screen.

The results obtained by Giesel support the view that the carriers of excited activity of the "emanation substance" have a positive charge. In a strong electric field the carriers travel along the lines of force to the cathode, and there cause excited activity on the screen. The movement of the luminous zone on the approach of a conductor is due to the disturbance of the electric field.

¹ *Ber. deutsch. Chem. Gesell.* 36, p. 342, 1903.

Debierne¹ found that actinium also gave off a large amount of emanation, the activity of which decayed very rapidly with the time. At some distance from the source, the activity of the emanation fell to half value in one-and-a-half minutes. This is not very different from the rate of decay of the activity of the thorium emanation, which falls to half value in about one minute.

This emanation produces excited activity on surrounding objects, and at diminished pressure the emanation produces a uniform distribution of excited activity in the enclosure containing the emanation. No data have yet been published of the rate of decay of the excited activity produced by the emanation of actinium.

Debierne observed that the distribution of excited activity was altered by a strong magnetic field. The experimental arrangement is shown in Fig. 55. The active matter was placed at *M*, and two plates *A* and *B* were placed symmetrically with regard to the source. On the application of a strong magnetic field normal to the plane of the paper, the excited activity was unequally distributed between the plates *A* and *B*. The results showed that the carriers of excited activity were deviated by a magnetic field in the opposite sense to the cathode rays, *i.e.* the carriers were positively charged. In some cases, however, the opposite effect was obtained. Debierne considers that the excited activity of actinium is due to "ions activants," the motion of which is altered by a magnetic field. Other experiments showed that the magnetic field acted on the "ions activants" and not on the emanation.

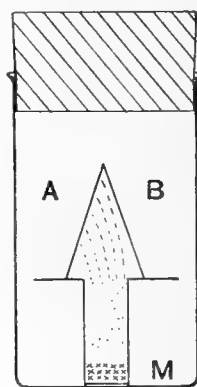

Fig. 55.

The results of Debierne thus lead to the conclusion that the carriers of excited activity are derived from the emanation and are projected with considerable velocity. This result supports the view advanced in section 184 that the expulsion of α particles from the emanation must set the part of the system left behind in rapid motion. A close examination of the mode of transference of the excited activity by actinium and the emanation substance is

¹ *C. R.* 136, pp. 446 and 671, 1903.

likely to throw further light on the processes which give rise to the deposit of active matter on electrodes.

187. Radio-active induction. In carrying out experiments on the separation of radium from pitchblende, M. and Mme Curie¹ observed that the separation of the active substance is fairly complete, if the stage of purification is not far advanced. Copper, antimony, and arsenic can be separated practically inactive, but other bodies, like lead and iron, always show slight activity. When the stage of purification is more advanced, every body separated from the active solution exhibits activity.

Debiere² showed that barium was made active by solution with actinium. The active barium removed from the actinium still preserved its activity after chemical treatment. In this way Debiere obtained barium chloride 6000 times as active as uranium. Although the activity of the barium chloride could be concentrated in the same way as the activity of radiferous barium chloride, it did not show any of the spectroscopic lines of radium. The activity however of the barium was not permanent, but decayed to about one-third of its value in three months.

Giesel showed in 1900 that bismuth could be made active by placing it in a radium solution, and suggested that polonium was in reality bismuth made active by its mixture with the radium in pitchblende. Mme Curie also found that bismuth was made active by solution with a radium compound, and succeeded in fractionating the above bismuth in the same way as polonium. In this way bismuth was obtained 2000 times as active as uranium, but the activity decreased with time. These experiments are rendered very uncertain by the difficulty of completely separating the radium from the bismuth.

Giesel³ in 1903 showed that a bismuth plate dipped in a radium solution remained active after every care had been taken to remove all traces of radium. This active bismuth gave out only α rays, and in this respect was analogous to polonium or Marekwald's radio-active tellurium. The absence of the α rays in the bismuth indicates that no radium adhered to the bismuth. The activity of

¹ *Thesis*, Paris, 1903, p. 117.

² *C. R.* 131, p. 137, 1900.

³ *Ber. deutsch. Chem. Ges.* p. 2368, 1903.

the bismuth did not decay over the period of examination, but observations were not made over sufficient lengths of time to make certain of this. There are two points of view that have been taken in regard to radio-active induction. Some have supposed that the inactive molecules of the substance themselves temporarily acquire the property of radio-activity, after admixture with a very active substance like radium or actinium. On this view the radio-active bismuth is in reality bismuth, some of the matter of which has temporarily acquired radio-active property.

On the other point of view, production of activity in inactive bodies is either due to a slight admixture of the active element, or to a removal with the substance of a radio-active product of the element. In the former case, the activity of the body is permanent; in the latter, it decays with the time, according to the same law as the decay of activity of the separated product. For example, if barium is precipitated in an uranium solution, the barium is active, and its activity decays at the same rate as the separated Ur X. In fact, the barium precipitate carried down with it the matter Ur X.

So far, however, no case has yet been observed when any body has acquired the property of radio-activity by exposure to the radiations alone of the radio-elements. The evidence at present supports the view that the activity produced in inactive bodies is due to a separation with it of an active product. The experiments of F. von Lerch, described in sections 178, 179, show that many metals are able to become active when placed in a solution of the emanation X of thorium. This activity is due to a deposit of the emanation X on the metal. The activity is removable by precipitation and also in some cases by electrolysis. In the case of solutions obtained from pitchblende, it is thus not surprising that a similar action occurs, and that many substances possess some temporary activity at the time of their separation. One or more of the numerous active products in pitchblende is precipitated with the substance, and the activity then decays with the time.

188. Possible origin of polonium. Mme Curie has not yet been able to purify polonium sufficiently to obtain any spectroscopic evidence of a new element. Giesel has consistently taken

the view, that polonium is in reality "induced" bismuth. At the same time, it has not yet been definitely settled whether Marckwald's radio-active tellurium contains the same active constituent as polonium or not. Taking the view that every case of induction is due to a removal with the inactive element of an active product of the radio-elements, some evidence will now be considered which points to the probability that polonium is a disintegration product of the element radium.

It has been pointed out that Mme Curie was able to fractionate bismuth, made active in a radium solution, in the same way as polonium, *i.e.* that the active matter in the bismuth had chemical properties similar to polonium. Giesel, in addition, showed that a platinum or bismuth plate placed in a radium solution acquired strong activity, and, like polonium, gave rise to α rays only. If the active bismuth or platinum decays at the same rate as polonium, it would be very strong evidence that polonium was a product of radium. Further experiments are, however, required on this point.

It has been mentioned that bodies exposed for a long interval in the presence of the radium emanation, always retain about 1/20,000 of their original activity. Giesel found that the residual activity of a platinum wire exposed in the presence of the radium emanation, gave out only α rays, and in that respect resembled polonium.

The writer has recently found that active matter can be dissolved by sulphuric acid from the inside of a glass tube, which has at one time contained the radium emanation. On evaporating the acid, an active deposit was left behind which gave out α and β rays. The activity of this deposit, as far as observations have yet gone, has not decayed with the time. This active substance gives out a far greater proportion of β rays than either radium or thorium. The α rays showed about the same amount of absorption in aluminium foil as the α rays from polonium, and possessed also the characteristic property exhibited by the polonium rays (section 90) of rapidly increasing absorption with thickness of matter traversed. It is thus possible that this active matter may contain polonium with another product giving rise to β rays. If it be assumed that the α rays, which are given

out by the active residue, accompany another very slow change occurring in the matter emanation X, the time taken for the activity of this product to decay to half value can be deduced from general considerations. It will be shown later, in section 195, that each of the successive changes in radium or thorium, which is accompanied by α rays, gives rise to about the same total amount of ionization. This is merely an expression of the fact that the same number of systems must undergo change in each successive product, and that each system probably expels the same number of α particles with about the same velocity. Now it was found experimentally that the ionization current due to the active residue was about $1/20,000$ of the initial ionization due to the emanation, which in its further changes had given rise to the slowly decaying active matter. Since the ionization current due to the emanation was 20,000 times that due to the active matter, its rate of change was 20,000 times faster. But the activity of the emanation decays to half value in four days, so that the activity of this other active matter would decay to half value in about 80,000 days or about 200 years.

The existence of such a slow change in the emanation X of radium probably accounts in part for the radio-activity which is produced on the walls of the laboratory in which radium preparations have been kept in open vessels. The emanation diffuses into the air and produces emanation X, which is deposited on the walls of the room, and there gives rise to a deposit of very slowly decaying matter. This activity persists in a room even though no radio-active matter has been kept in it for some time.

CHAPTER X.

RADIO-ACTIVE PROCESSES.

189. Radio-activity of uranium. It has already been shown in section 118 that a radio-active constituent Ur X can be separated from uranium by several different processes. The activity of the separated Ur X decays with the time, falling to half value in about 22 days. At the same time the uranium, from which the Ur X has been separated, gradually regains its lost activity. The law of decay of Ur X and the recovery of the lost activity of the uranium are expressed by the equations

$$\frac{I_t}{I_0} = e^{-\lambda t} \quad \text{and} \quad \frac{I_t}{I_0} = 1 - e^{-\lambda t},$$

where λ is the radio-active constant of Ur X. The constant radio-activity of uranium thus represents a state of equilibrium, where the rate of production of new active matter is balanced by the rate of change of the Ur X already produced.

The radio-active processes occurring in uranium present several points of difference from the processes occurring in thorium and radium. In the first place, uranium does not give off an emanation, and in consequence does not produce any excited activity on bodies. So far only one active product Ur X has been observed in uranium. This active product Ur X differs from Th X and the emanations, inasmuch as the radiation from it consists almost entirely of β rays. This peculiarity of the radiations from Ur X initially led to some confusion in the interpretation of observations on Ur X and the uranium from which it had been separated. When examined by the photographic method, the uranium freed from Ur X showed no photographic action, while the Ur X possessed it to an intense

degree. With the electric method, on the other hand, the results obtained were exactly the reverse. The uranium freed from Ur X showed very little loss of activity while the activity of the Ur X was very small. The explanation of these results was given by Soddy¹ and by Rutherford and Grier². The α rays of uranium are photographically almost inactive but produce most of the ionization in the gas. The β rays, on the other hand, produce a strong photographic action, but very little ionization compared with the α rays. When the Ur X is separated from the uranium, the uranium does not at first give out any β rays. In the course of time, fresh Ur X is produced from the uranium, and β rays begin to appear, gradually increasing in intensity until they reach the original value shown before the separation of the Ur X.

In order to determine the recovery curves of uranium after the separation of Ur X, it was thus necessary to measure the rate of increase of the β rays. This was done by covering the uranium with a layer of aluminium of sufficient thickness to absorb all the α rays, and then measuring the ionization due to the rays in an apparatus similar to Fig. 16.

Uranium has not yet been obtained inactive when tested by the electric method. Becquerel³ has stated that he was able to obtain inactive uranium, but in his experiments the uranium was covered with a layer of black paper, which would entirely absorb the α rays. There is no evidence that the α radiation of uranium has been altered either in character or amount by any chemical treatment. The α rays appear to be inseparable from the uranium, and it will be shown later that the other radio-active elements as well as uranium also possess a non-separable activity consisting entirely of α rays. The changes occurring in uranium must then be considered to be of two kinds, (1) the change which gives rise to the α rays and the product Ur X, (2) the change which gives rise to the β rays from Ur X.

The possibility of separating the Ur X, which gives rise to the β rays of uranium, shows that the α and β rays are produced quite independently of one another, and by matter of different chemical properties.

¹ *Trans. Chem. Soc.* 81, p. 460, 1902.

² *Phil. Mag.* Sept. 1902.

³ *C. R.* 131, p. 137, 1900.

190. Radio-activity of thorium. The radio-active processes occurring in thorium are far more complicated than those in uranium. It has been shown that a radio-active product Th X is continuously produced from the thorium. This Th X breaks up, giving rise to the radio-active emanation. This radio-active emanation, in turn, produces from itself the active matter, emanation X, which is responsible for the phenomenon of excited radio-activity. It has also been shown (section 176) that there is very strong evidence that the emanation X of thorium goes through two further changes, before the radio-active processes are at an end.

The peculiarities of the initial portions of the decay and recovery curves of Th X and thorium respectively (Curves *A* and *B*, Fig. 34, p. 180), will now be considered. It was shown that when the Th X was removed from the thorium by precipitation with ammonia, the radiation increased about 15 per cent. during the first day, passed through a maximum, and then fell off according to an exponential law, decreasing to half value in four days. At the same time the activity of the separated hydroxide decreased for the first day, passed through a minimum, and then slowly increased again, rising to its original value after the lapse of about one month.

When a thorium compound is in a state of radio-active equilibrium, the series of changes in which Th X, the emanation, and emanation X are produced go on simultaneously. Since a state of equilibrium has been reached for each of these products, the amount of each product changing in unit time is equal to the amount of that product supplied from the preceding change in unit time. Now the matter Th X is soluble in ammonia, while the matter emanation X is not. The Th X is thus removed from the thorium by precipitation with ammonia, but the emanation X is left behind with the thorium. Since the emanation X is produced from the emanation, which in turn arises from Th X, on the removal of the exciting cause Th X, the radiation due to this emanation X will decay, since the rate of production of fresh emanation X no longer balances its own rate of change. Disregarding the initial irregularity in the decay curve of emanation X (section 170), the activity of the emanation X will have decayed to half value in about 11 hours and to one quarter value at the

end of 22 hours. As soon, however, as the Th X has been separated, new Th X is produced in the thorium compound. The activity of this new Th X is not, however, sufficient to compensate at first for the loss of activity due to the change in emanation X, so that, as a whole, the activity will at first *decrease*, then pass through a minimum, then increase again.

The correctness of this point of view has been tested by Rutherford and Soddy¹ as follows: If the precipitated thorium hydroxide after the removal of Th X is put through a series of precipitations with ammonia at short intervals, the Th X is removed almost as fast as it is formed, and, at the same time, the activity of the emanation X decays.

The following table indicates the results obtained. A portion of the precipitated hydroxide was removed after each series of precipitations and its activity tested in the usual way.

	Activity of hydroxide per cent.
After 1 precipitation	46
After 3 precipitations at intervals of 24 hours	39
After 3 more precipitations at intervals of 24 hours and 3 at intervals of 8 hours	22
After 3 more each of 8 hours	24
After 6 more each of 4 hours	25

The differences in the last three numbers are not significant, for it is difficult to make accurate comparisons of the activity of thorium compounds, which have been precipitated under slightly different conditions. It is thus seen that as a result of successive precipitations, the activity is reduced to a minimum of about 25 per cent. The recovery curve of the activity of this 23 times precipitated hydroxide is shown in Fig. 56. The initial drop in the curve is quite absent, and the curve, starting from the minimum, is practically identical with the curve shown in Fig. 35, which gives the recovery curve of thorium hydroxide after the first two days. This residual activity—about 25 per cent. of the maximum—is non-separable from the thorium by any chemical process that has been tried.

The initial rise of activity of Th X, after it has been separated, will now be considered. In all cases, it was found that the activity

¹ *Trans. Chem. Soc.* 81, p. 837, 1902. *Phil. Mag.* Nov. 1902.

of the separated Th X had increased about 15 per cent. at the end of 24 hours, and then steadily decayed, falling to half value in about four days.

This peculiarity of the Th X curve follows, of necessity, from the considerations already advanced to explain the drop in the recovery curve. As soon as the Th X is separated, it at once produces from itself the emanation, and this in turn produces the emanation X. The activity due to the emanation X at first more than compensates for the decay of activity of the Th X itself. The total activity

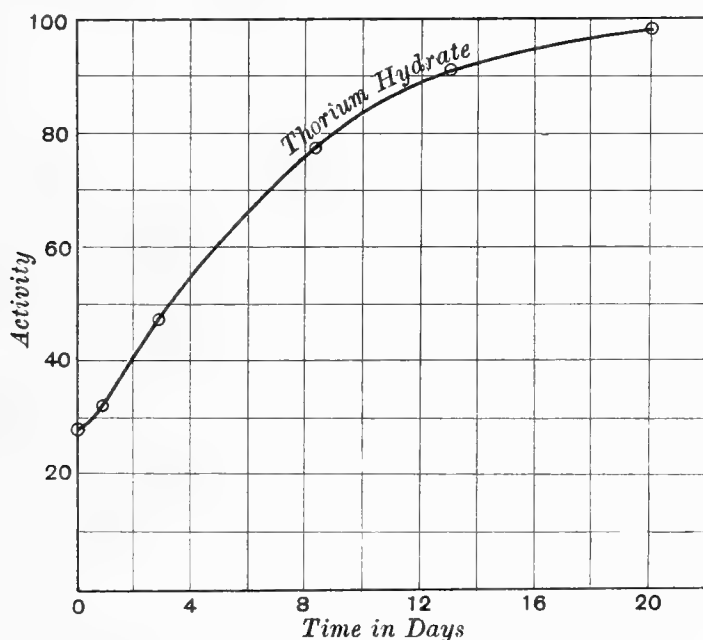

Fig. 56.

thus increases to a maximum, and then slowly decays to zero according to an exponential law with the time. The curve expressing the variation of the activity of the separated Th X with time can be deduced from the theory of successive changes already considered in section 175. In the present case there are three successive changes occurring at the same time, viz. the change of Th X into the emanation, of the emanation into emanation X, and the final changes giving rise to the activity of emanation X. Since, however, the change of the emanation into emanation X (about half changed in one minute) is far more rapid than the changes occurring in Th X or emanation X, for the purposes of calculation it may be assumed without serious error that the Th X changes at

once into emanation X. The initial change of emanation X—about half changed in 55 minutes—will also be disregarded for the same reason.

Let λ_1 and λ_2 be the constants of decay of activity of Th X and emanation X respectively. Since the activity of Th X and of emanation X falls to half value in 4 days and 11 hours respectively, the value of $\lambda_1 = \cdot 0072$ and of $\lambda_2 = \cdot 063$ where 1 hour is taken as the unit of time.

It has already been shown (section 175) that after a time t the activity I_t , of a product in which there is a secondary change, is given by

$$\frac{I_t}{I_0} = e^{-\lambda_1 t} \left(1 + \frac{K\lambda_2}{\lambda_2 - \lambda_1} - \frac{K\lambda_2}{\lambda_2 - \lambda_1} e^{-(\lambda_1 - \lambda_2)t} \right),$$

where I_0 is the intensity of the radiation immediately after separation and K the ratio of the ionization produced in the secondary change to that produced in the primary change. By comparison of this equation with the curve of variation of the activity of Th X with time shown in Fig. 57, Curve A, it is found that the value of K is about .44.

The calculated values of $\frac{I_t}{I_0}$ for different values of t are shown in the second column of the following table, and the observed values in the third column.

Time	Theoretical value	Observed value
0	1.00	1.00
.25 days	1.09	—
.5 "	1.16	—
1 "	1.15	1.17
1.5 "	1.11	—
2 "	1.04	—
3 "	.875	.88
4 "	.75	.72
6 "	.53	.53
9 "	.315	.295
13 "	.157	.152

The theoretical and observed values thus agree within the limit of error in the measurements. The theoretical curve is

shown in Curve *A*, Fig. 57 (with the observed points marked, for comparison). The curve *B* shows the theoretical curve of the decay of the activity of Th X and the emanation, supposing there is no secondary change into emanation X. Curve *C* shows the difference curve between the curves *A* and *B*, *i.e.* the proportion of the activity at different times due to the emanation X. The activity due to emanation X thus rises to a maximum about two days after removal of the Th X, and then decays with the time at the same

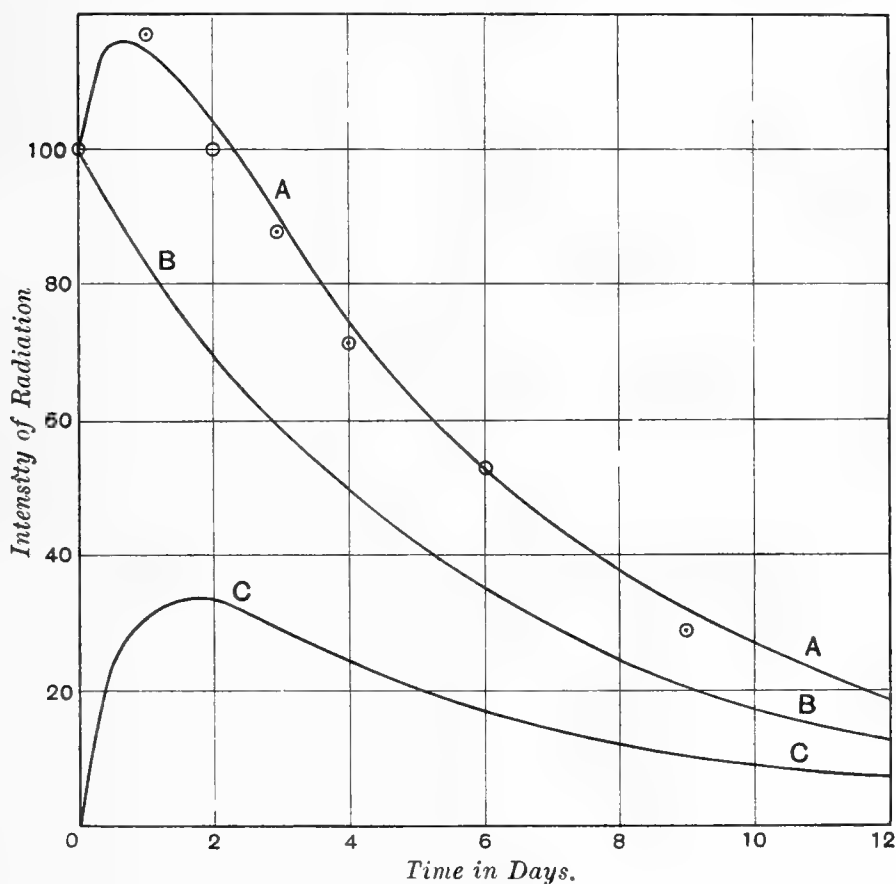

Fig. 57.

rate as the Th X itself, *i.e.* the activity falls to half amount every four days. When the value of t exceeds four days, the value of $e^{-(\lambda_2 - \lambda_1)t}$ in the theoretical equation is very small.

The equation of decay is thus expressed by

$$\frac{I_t}{I_0} = \left(1 + \frac{K\lambda_2}{\lambda_2 - \lambda_1}\right) e^{-\lambda_1 t},$$

i.e. the curve decays in an exponential law with the time.

191. Radio-activity of radium. Notwithstanding the enormous difference in their relative activities, the radio-activity of radium presents many close analogies to that of thorium. Both substances give rise to emanations which in turn produce "excited activity" on bodies in their neighbourhood. Radium, however, does not give rise to any intermediate product between the element itself and the emanation it produces, or in other words there is no product in radium corresponding to Th X in thorium.

Giesel first drew attention to the fact that a radium compound gradually increased in activity after preparation, and only reached a constant value after a month's interval. If a radium compound is dissolved in water and boiled for some time, or a current of air drawn through the solution, on evaporation it is found that the activity has been diminished. The same result is observed if a solid radium compound is heated in the open air. This loss of activity is due to the removal of the emanation by the process of solution or heating. Consider the case of a radium compound which has been kept for some time in solution in a shallow vessel, exposed to the open air, and then evaporated to dryness. The emanation which, in the state of solution, was removed as fast as it was formed, is now occluded, and, together with the emanation X which it produces, adds its radiations to that of the original radium. The activity will increase to a maximum value where the rate of production of fresh emanation balances the rate of change of that already produced.

If now the compound is dissolved or heated, the emanation escapes. Since the emanation X is not volatile and is insoluble in water, it is not removed by the process of solution or heating. Since, however, the exciting cause is removed, its activity will immediately begin to decay, and in the course of a few hours will have almost disappeared. The activity of the radium measured by the rays is then found to be about 25 per cent. of its original value. This residual activity of radium, consisting entirely of α rays, is non-separable, and has not been further diminished by chemical or physical means. Rutherford and Soddy¹ examined the effect of aspiration for long intervals through a radium chloride solution. After the first few hours the activity was found to be

¹ *Phil. Mag.* April, 1903.

reduced to 25 per cent., and further aspiration for three weeks did not produce any further diminution. The radium was then evaporated to dryness, and the rise of its activity with time determined. The results are shown in the following table. The final activity in the second column is taken as one hundred. In column 3 is given the percentage proportion of the activity recovered.

Time in days	Activity	Percentage Activity recovered
0	25.0	0
0.70	33.7	11.7
1.77	42.7	23.7
4.75	68.5	58.0
7.83	83.5	78.0
16.0	96.0	95.0
21.0	100.0	100.0

The results are shown graphically in Fig. 58.

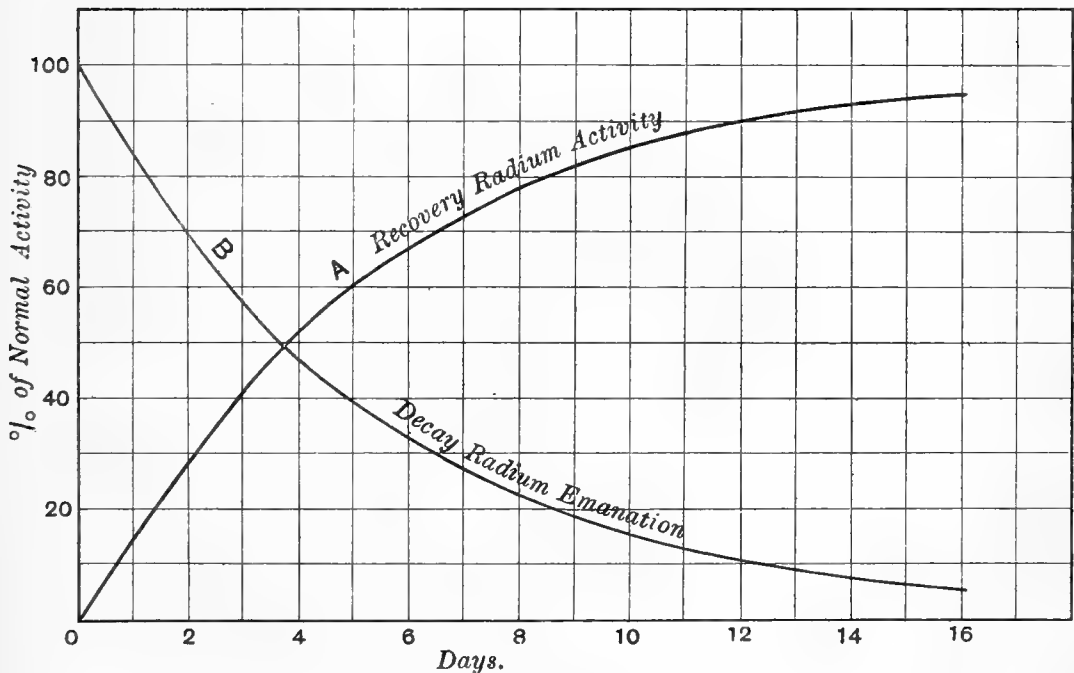

Fig. 58.

The decay curve of the radium emanation is shown in the same figure. The curve of recovery of the lost activity of radium

is thus analogous to the curves of recovery of uranium and thorium which have been freed from the active products Ur X and Th X respectively. The intensity I_t of the recovered activity at any time is given by $\frac{I_t}{I_0} = 1 - e^{-\lambda t}$, where I_0 is the final value, and λ is the radio-active constant of the emanation. The decay and recovery curves are complementary to one another.

Knowing the rate of decay of activity of the radium emanation, the recovery curve of the activity of radium can thus at once be deduced, provided all of the emanation formed is occluded in the radium compound.

When the emanation is removed from a radium compound by solution or heating, the activity *measured by the β rays* falls almost to zero, but increases in the course of a month to its original value. The curve showing the rise of β rays with time is practically identical with the curve, Fig. 58, showing the recovery of the lost activity of radium measured by the α rays. The explanation of this result lies in the fact that the β rays from radium only arise from emanation X, and that the non-separable activity of radium gives out only α rays. On removal of the emanation, the activity of the emanation X decays nearly to zero, and in consequence the β rays almost disappear. When the radium is allowed to stand, the emanation begins to accumulate, and produces in turn emanation X, which gives rise to β rays. The amount of β rays (allowing for a period of retardation of a few hours) will then increase at the same rate as the activity of the emanation, which is continuously produced from the radium.

192. If the radium allows some of the emanation produced to escape into the air, the curves of recovery will be different from that shown in Fig. 58. For example, suppose that the radium compound allows a constant fraction α of the amount of emanation, present in the compound at any time, to escape per second. If n is the number of emanation particles present in the compound at the time t , the number of emanation particles changing in the time dt is $\lambda n dt$, where λ is the constant of decay of activity of the emanation. If g is the rate of production of emanation

particles per second, the increase of the number dn in the time dt is given by

$$dn = qdt - \lambda ndt - \alpha ndt,$$

or

$$\frac{dn}{dt} = q - (\lambda + \alpha) n.$$

The same equation is obtained when no emanation escapes, with the difference that the constant $\lambda + \alpha$ is replaced by λ .

When a steady state is reached, $\frac{dn}{dt}$ is zero, and the maximum value of n is equal to $\frac{q}{\lambda + \alpha}$.

If no escape takes place, the maximum value of n is equal to $\frac{q}{\lambda}$. The escape of emanation will thus lower the amount of activity recovered in the proportion $\frac{\lambda}{\lambda + \alpha}$. If n_0 is the final number of emanation particles stored up in the compound, the integration of the above equation gives $\frac{n}{n_0} = 1 - e^{-(\lambda + \alpha)t}$.

The curve of recovery of activity is thus of the same general form as the curve when no emanation escapes, but the constant λ is replaced by $\lambda + \alpha$.

For example, if $\alpha = \lambda = 1/463000$, the equation of rise of activity is given by $\frac{n}{n_0} = 1 - e^{-2\lambda t}$, and, in consequence, the increase of activity to the maximum will be far more rapid than in the case of no escape of emanation.

A very slight escape of emanation will thus produce large alterations both in the final maximum and in the curve of recovery of activity.

A large number of experiments have been described by Mme Curie in her *Thèse présentée à la Faculté des Sciences de Paris* on the effect of solution and of heat in diminishing the activity of radium. The results obtained are in general agreement with the above view, that 75 per cent. of the activity of radium is due to the emanation and the excited activity it produces. If the emanation is wholly or partly removed by solution or heating, the activity of

the radium is correspondingly diminished, but the activity of the radium compound is spontaneously recovered owing to the production of fresh emanation. A state of radio-active equilibrium is reached, when the rate of production of fresh emanation balances the rate of change in the emanation stored up in the compound. The differences observed in the rate of recovery of radium under different conditions were probably due to variations in the rate of escape of the emanation.

193. Non-separable activity. It has been shown that, for all three radio-elements, uranium, thorium, and radium, there is a non-separable activity consisting entirely of α rays. In the case of uranium the activity is the same as the activity of the uranium, measured by the α rays, before the product Ur X, which gives rise only to β rays, is removed. In the case of thorium and radium, where the active products produced give out α rays, the non-separable activity is about 25 per cent. of the maximum activity measured by the α rays.

The existence of a non-separable activity follows from the point of view of regarding radio-active processes which has been advanced in sections 87 and 127. The three radio-elements are supposed to be undergoing atomic disintegration, which is accompanied by the expulsion of α rays. If the number of atoms which break up per second is almost infinitesimal compared with the total number present, the same number, on an average, will break up per second. The number of α particles expelled per second will thus be a constant for each radio-element. There will thus always be a non-separable activity of the radio-elements, which is an inherent property of the elements and cannot be removed from them by any chemical or physical process.

194. Radiations from the active products. Most of the changes occurring in the different radio-active products are accompanied by the emission of α rays alone. The β and γ rays appear only in the final stages of the radio-active changes.

It has been shown that the non-separable activity of the three radio-elements consists entirely of α rays. The two emanations give rise only to α rays (section 147). It also seems probable that the product Th X, if the emanation X which it produces is completely

separated from it, would give rise only to α rays. On the other hand, the activity of Ur X consists only of β rays. The changes in the matter emanation X of thorium and radium give rise to both α and β rays. It has been shown (section 176) that the emanation X of thorium goes through two changes, the first of which does not give rise to rays at all, and the second of which gives rise to α and β rays. The first change occurring in emanation X of radium gives rise to α rays but not to β rays; the second change probably does not give rise to rays at all, while the third change again includes all three kinds of rays. The absence of β rays in the first change, taking place in the emanation X of radium, can readily be shown by exposing a negatively charged wire in the presence of the radium emanation for a few minutes. The activity on removal, measured by the α rays, falls rapidly, as is shown in Fig. 51, p. 262; but the activity measured by the β rays alone is at first small, and increases for some time instead of diminishing. If α and β rays had been both given out in the first change, it is to be expected that the amount of the β radiation would initially decay at the same rate as the α radiation, but no such effect is observed.

The β and probably also the γ rays of the three radio-elements thus only appear in the last of the series of radio-active changes. It is remarkable that the last change, which is readily detected by the radio-active property, should in each of the three radio-elements be accompanied by the expulsion of a single electron with great velocity, and that all the other changes, with the exception of two that probably give rise to no rays at all, should be accompanied by the expulsion of α rays, *i.e.* of material particles atomic in size.

The polonium of Mme Curie and the radio-tellurium of Marckwald emit only α rays. Becquerel¹ states that he has detected some rays of a penetrating character from polonium by the photographic method. The writer has examined by the electric method the radiations from the active preparation of radio-tellurium, but was unable to detect any trace of γ rays. The evidence so far obtained points to the conclusion that the

¹ C. R. pp. 136, 977. 1903.

γ rays appear at the same time as the β rays, and in an amount proportional to them.

The character of the radiations from each of the radio-active products must always be taken into consideration in the interpretation of results obtained by different methods of measurement. For example, a radium compound, which has been heated in an open glass tube, after a few hours practically loses its power of exciting fluorescence on a screen of platino-cyanide of barium placed near it. This is due to the fact already mentioned, that the β and γ rays practically disappear from radium for several hours after the emanation is removed. For the same reason the radium, with a screen placed over it of sufficient thickness to absorb all the α rays, would appear, when measured by the electric method, to be almost inactive.

Since the α rays are photographically very inactive compared with the β rays, the non-separable activity of uranium, thorium, and radium, although producing marked ionization, would be almost inappreciable if tested by the photographic method. It has been stated by some observers that uranium and thorium have been obtained which showed no trace of activity. On examination of the results, however, it is found that the methods employed were not suitable to definitely settle the question. It is true that, by certain chemical processes, uranium and thorium can be obtained temporarily inactive, when tested by the photographic method, or by the electric method if the compound is covered by a screen of sufficient thickness to absorb all the α rays. If however the activity is tested electrically with unscreened active matter, there is always found to be a residual activity. In the course of time, the uranium and thorium compounds spontaneously regain the whole of their lost activity.

195. Division of the activity amongst the products.

It has been shown in section 190 that the activity of thorium hydroxide, after the removal of Th X, falls to 46 per cent. of its original value. When the Th X is removed from the thorium at short intervals, in order to allow the activity of the emanation X left behind to decay, there is a residual activity of 25 per cent. of the maximum. About 21 per cent. of the total activity is thus due to the emanation X.

This result is confirmed by observations on the increase of activity of Th X after removal. It has been shown in section 190 that the activity due to the emanation X, produced from the Th X, is equal to .44 when the activity of the Th X, together with the emanation it produces, is taken as unity. Now the activity of the separated Th X and the emanation is equal to .54 of the total. The proportion of the total activity due to emanation X is thus 24 per cent., a result which is not very different from the value of 21 per cent. obtained previously. It is difficult to make an accurate estimate of the activity of the emanation, compared with that due to the emanation X. An approximate estimate was however made in the following way.

Some thorium hydroxide enclosed in a paper envelope was placed inside a closed cylinder with an insulated central electrode kept charged negatively. After an interval of several days, a state of radio-active equilibrium was reached, and the ionization was measured:

- (1) with the thorium inside the cylinder, and
- (2) with the thorium removed.

(1) gave the ionization current due to the emanation and the emanation X on the central electrode, and (2) gave the current due to the emanation X. Taking into consideration that half of the radiation from the emanation X was absorbed in the central electrode, it was deduced that the amount of ionization produced by the emanation in the gas was not very different from that produced by the emanation X. This result points to the conclusion that the emanation and emanation X in a thorium compound supply about an equal proportion of the total activity. The relative activities of the different products are shown in the following table. The numbers must only be considered as approximate.

Residual activity of thorium	25 %.
Activity of Th X alone	21 %.
„ „ emanation alone	24 %.
„ due to first change emanation X	0 %.
„ „ second „ „ „	24 %.

Leaving out of account the first change in emanation X, which is of a character quite distinct from the others, it is seen that the activity is approximately equally divided amongst the products.

Similar results hold in the case of radium. The emanation and the residual activity of radium supply about 18 and 25 per cent. respectively of the total activity, and the rest is supplied by the changes in emanation X. These results are thus also in rough agreement with those obtained for thorium, and indicate that each change which gives rise to α rays supplies about an equal fraction of the total activity. This is an important result, for it indicates that about the same number of α particles is expelled at each change, which gives rise to α rays. This deduction is based on the observed fact that the penetrating power and consequently the ionization produced by such α particles is not very different. It therefore seems probable that, when a compound of thorium or of radium is in radio-active equilibrium, the same number of systems change per second in each of the products, and that the change in all cases but one is accompanied by the expulsion of about the same number of α particles.

196. Conservation of radio-activity. The early observations on uranium and thorium had shown that their radio-activity remained constant over the period of several years during which they were examined. The possibility of separating from uranium and thorium the active products Ur X and Th X respectively, the activity of which decayed with the time, seemed at first sight to be contradictory to this point of view. Further observation, however, showed that the total radio-activity of these bodies was not altered by the chemical processes, for it was found that the uranium and thorium from which the active products were removed, spontaneously regained their radio-activity. At any time after removal of the active product, the sum total of the radio-activity of the separated product together with that of the substance from which it has been separated is always equal to that of the original compound before separation. In cases where the active products, like Ur X and the radium emanation, decay with time according to an exponential law, this follows at once from the experimental results. If i_t is the activity of the product at any time t after separation, and I_0 the initial value, we know that $\frac{i_t}{I_0} = e^{-\lambda t}$. At the same time the activity I_t recovered during the interval t is given by

$\frac{I_t}{I_0} = 1 - e^{-\lambda t}$, where λ is the same constant as before. It thus follows that $i_t + I_t = I_0$, which is an expression of the above result. The same is also true whatever the law of decay of activity of the separated product (see section 174). For example, the activity of Th X after separation from thorium at first increases with the time. At the same time, the activity of the residual thorium compound at first decreases, and at such a rate, that the sum of the activities of the thorium and its separated product is always equal to that of the original thorium.

This principle of "conservation of radio-activity¹," as it may be termed, follows from the general result that the radio-active processes cannot in any way be changed by the action of known forces. It may be recalled that the rate of decay of the activity of a radio-active product cannot be altered by any known agency. The rate of decay is independent of the concentration of the active matter, of the pressure and of the nature of the gas in which it is placed, and is not affected by wide ranges of temperature. In the same way, it has not been found possible to alter the rate of production of active matter from the radio-elements. In addition, there is not a single case yet observed where radio-activity has been altered or destroyed in any active body or created in an inactive element.

Certain cases have been observed, which at first sight seem to indicate a destruction of radio-activity. For example, the excited radio-activity is removed from a platinum wire when heated above a red heat. It has been shown, however, by Miss Gates (section 180) that the radio-activity is not destroyed, but is deposited in unaltered amount on the colder bodies surrounding it. Thorium oxide has been shown to lose its power in emanating to a large extent by ignition to a white heat. But a close examination shows that the emanation is still being produced at the same rate, but is occluded in the compound.

The total radio-activity of a given mass of a radio-element, measured by the peculiar radiations emitted, is a quantity which can neither be increased nor diminished, although it may be manifested in a series of products which are capable of separation from

¹ Rutherford and Soddy, *Phil. Mag.* May, 1903.

the radio-element. The term "conservation of radio-activity" is thus a convenient expression of the facts known at the present time. It is quite possible, however, that further experiments at very high or very low temperatures may show that the radio-activity does vary. For example, Dewar states that the heat emission of radium seems to be rather greater in liquid hydrogen than in liquid oxygen. An increase of heat emission would probably entail an increase of the radio-activity of the radium immersed in liquid hydrogen. Accurate experiments have not, however, yet been made on the radio-activity of radium at such low temperatures.

Although no difference has been observed in the radio-activity of uranium over an interval of five years, it will be shown (section 203) that on theoretical grounds the radio-activity of a *given quantity* of a radio-element should decrease with the time. The change will, however, be so slow in uranium and thorium, that probably thousands if not millions of years must elapse before a measurable change would have taken place. In radium, however, the change takes place about one million times faster, so that a measurable alteration should be detected in the course of a few years¹. The total radio-activity of a given quantity of matter left to itself should thus decrease, but it should be constant for a *constant mass* of the radio-element. It is only in this restricted sense that the principle can be employed.

The conservation of radio-activity applies not only to the radiations taken as a whole, but also to each specific type of radiation. If the emanation is removed from a radium compound, the amount of β radiation of the radium at once commences to decrease, but this is compensated by the appearance of β rays in the radiations from the vessel in which the separated emanation is stored. At any time the sum total of the β radiations from the radium and the emanation vessel is always the same as that from the radium compound before the emanation was removed.

¹ It seems probable however that the radio-activity of radium, measured by the α rays, will increase rather than diminish for several hundred years after its separation. This is due to the fact that the increase of the activity due to the last slow change of radium (about half changed in 200 years) will probably more than compensate for the change in the radium itself. Ultimately, however, the radio-activity of the radium must decrease with time.

Similar results have also been found to hold for the γ rays. This was tested by the writer in the following way. The emanation from some solid radium bromide was released by heat, and condensed in a small glass tube which was then sealed off. The radium so treated, and the emanation tube, were placed together under an electroscope, with a screen of lead 1 cm. thick interposed in order to let through only the γ rays. The experiments were continued over three weeks, but the sum total of the γ rays from the radium and the emanation tube was, over the whole interval, equal to that of the original radium. During this period the amount of γ rays from the radium at first decreased to only a few per cent. of the original value, and then slowly increased again, until at the end of the three weeks it had nearly regained its original value, before the emanation was removed. At the same time the amount of γ rays from the emanation tube rose from zero to a maximum and then slowly decreased again at the same rate as the decay of the activity of the emanation in the tube. This result shows that the amount of γ rays from radium was a constant quantity over the interval of observation, although the amount of γ rays from the radium and emanation tube had passed through a cycle of changes.

197. Résumé of results. Before discussing the general theory advanced to account for the processes occurring in the radio-element, a brief *résumé* will be given of the more important results already described in detail in previous chapters.

The radio-activity of uranium, thorium, and radium has been shown to be maintained by the production at a constant rate of new kinds of matter, which possess temporary activity. The constant activity of the radio-elements is due to a state of equilibrium where the rate of production of new active matter compensates for the change in that already produced. In some cases, the active products possess well-defined chemical properties different from those of the parent elements and can be separated from them by chemical means. The separation of Ur X and Th X from uranium and thorium are good examples of this process. In other cases, the new products, as in the case of the thorium and radium emanations, are gaseous in character and are released from the radio-

elements by the process of diffusion. These emanations have been shown to possess the properties of gases. The radium emanation diffuses and distributes itself between two reservoirs kept at different temperatures according to the laws of gases. Both the emanations can be condensed by cold, and by that means can be removed from the other gases with which they are mixed. The emanations possess the property of being occluded in some bodies, including the radio-elements themselves, and can be liberated by heating or solution. They diffuse through porous partitions, and in general behave like chemically inert gases of high molecular weight. Other radio-active products, for example the emanations X of radium and of thorium, are not gaseous, but attach themselves to the surface of bodies and can be removed from them by solution or heating. The emanation X of thorium, for example, possesses some chemical properties which distinguish it not only from the emanation from which it is derived, but also from the other active product Th X. It is soluble in some acids and not in others. If the emanation X of thorium is removed from an active wire by solution in hydrochloric acid, the active matter attaches itself to some metals dipped in the acid but not to others, and in general possesses the properties of matter of definite chemical behaviour. The differences in the chemical and physical properties of the different products of a radio-element can be well illustrated in the case of thorium. Thorium X is soluble in ammonia, while thorium is not. Thorium X produces the emanation which is a gas, insoluble in acids but condensed by cold. This, in turn, produces the matter emanation X, which is insoluble in ammonia but soluble in hydrochloric and sulphuric acids. There can be little doubt that these active products are material in nature. They differ from ordinary matter in their power of emitting rays of a special character, and by the fact that they exist in the radio-elements in minute quantities which are, in most cases, too small to be detected by the balance or the spectroscope. Approximate estimates (section 162) can be made of the amount of these active products that are present in a radio-element when in radio-active equilibrium, and it has been shown that, except in the case of a very active body like radium, the amount is too small to be detected by ordinary chemical means.

The case of the radium emanation however is different. It can be shown (section 162) that probably the emanation exists in greater proportion in radium than radium does in pitchblende. Yet radium was detected in pitchblende by the property of radiating which it possesses, and has been isolated from it and found to be an element of well-marked chemical and physical properties. It has been estimated that 1 gram of radium in a state of radioactive equilibrium probably contains a volume of about 0.3 cubic millimetre of the emanation, measured at standard pressure and temperature. From a kilogram of radium 0.3 cubic centimetre would be produced. When larger quantities of radium are available for experiments, there can thus be little doubt that a sufficient amount of the radium emanation will be obtained to examine chemically. In fact, as will be shown in section 201, even with the small quantities of radium now available, some very important spectroscopic evidence has already been obtained, in regard to the processes occurring in the emanation.

[*Volume of the Emanation*¹.

Sir William Ramsay and Mr Soddy have kindly placed at my disposal some preliminary results of a recent investigation by them on the volume of the emanation released from radium. In these experiments, 60 milligrams of pure radium bromide were used, in which the emanation had been allowed to collect for 8 days. This emanation, freed as far as possible from all other gases, was forced into a capillary tube in which its volume was measured. The following table shows the results obtained.

	Initial volume	0.124	cubic millimetre.		
Volume after	1 day	0.027	„	„	
„	„	3 days	0.011	„	„
„	„	6 „	0.0063	„	„
„	„	9 „	0.0041	„	„
„	„	12 „	0.0011	„	„
	Final volume	0.0004	„	„	

The volume of the gas obtained shrank rapidly during the first day, then more slowly, and after the third day decreased approximately according to an exponential law with the time, decreasing

¹ Added Feb. 1, 1904.

to half value in about four days. According to the views already advanced, it is to be expected that the volume of the emanation itself should decrease according to an exponential law with the time, falling to half value in about 3·7 days. This is a result of the theory that half of the emanation at the end of 3·7 days has been transformed into the substance emanation X, which behaves as a solid and is deposited on the surface of the containing vessel. It seems not improbable that the rapid decrease, observed during the first day, may have been due to the presence, with the emanation, of another gas which was quickly absorbed either by the walls of the capillary tube or by the mercury.

It can readily be deduced that the volume of the emanation at the end of the first day is equivalent to the amount derived from 0·022 gram of pure radium in radio-active equilibrium. Taking the volume of the gas, 0·027 cubic millimetre, at the end of the first day as the true volume of emanation, it follows that the volume of the emanation to be obtained from 1 gram of radium in radio-active equilibrium is 1·2 cubic millimetres. Taking the volume observed on the third day, the corresponding value is 0·9 cubic millimetre. The calculated value of the volume of the emanation to be derived from 1 gram of radium is 0·3 cubic millimetre. The calculated value is thus of the right order of magnitude. This is an indication of the general correctness of the different methods of calculation (see sections 104 and 162) on which the theoretical determination of the volume of the emanation has been based.

It will be shown later, in section 201, that the emanation of radium produces helium from itself. The shrinkage of the volume to a very small fraction of its original value indicates that the helium produced was buried in the walls of the tube. This is to be expected if the helium consists in reality of the α particles expelled from the emanation and its products. The α particle is projected with sufficient velocity to penetrate a distance of about 0·02 millimetre into the walls of the capillary tube. It is to be expected that a portion, at least, of the buried helium should be released when the tube is strongly heated.]

Of the three types of rays from the active bodies, the α and β

rays are material in nature. The mass and velocity of the α particles, projected from radium, have been measured. They have been shown to be positively charged particles projected with a velocity of about 1/10 the velocity of light, and a mass about twice that of the hydrogen atom. The β particles carry a negative charge, and have an apparent mass about 1/1000 the mass of the hydrogen atom. They are identical in character with the cathode ray particle produced in a vacuum tube. The nature of the γ rays has not yet been determined.

The α rays play by far the most important part in radio-active processes. Most of the energy radiated in the form of ionizing rays is due to them. In addition, most of the active products emit only α rays. The β and γ rays in most cases only appear in the last stage of the radio-active processes.

The activity of most of the products decays according to an exponential law with the time. In cases where this does not hold, the activity can be shown to be due to several successive changes, the rate of each of which decays according to an exponential law but with a different radio-active constant. The rate of decay of activity has not yet been found to be in any way influenced by wide variation in chemical and physical conditions.

The activity of any product at any time (section 124), is proportional to the rate of change of the product, and is also proportional to the amount of matter left unchanged. In cases where one active product gives rise to another, the activity of the first product is, at any time, a measure of the rate of production of the second product. In other words, the radiations accompany the change of one product into another, and serve as a measure of the rate of change. This point of view at once follows if the expulsion of rays is taken to be the cause of the change from one product into another. The rate of emission of α particles is a measure of the rate of change of the first product, *i.e.* it is proportional to the rate at which the second product is produced. For example, the amount of emanation X of thorium produced in a given time by the thorium emanation is proportional to the activity of the emanation. In cases where the rate of change of the second product is rapid compared with that of the first, after sufficient interval has elapsed in order to reach a state of approximate radio-active equi-

librium, the activity of the second product is always found to vary at the same rate as that of the parent product. For example, the amount of the emanation produced by Th X is always proportional to the activity of the Th X, and decays at the same rate, *i.e.* it falls to half value in about four days. In the same way, the activity of the emanation X, produced by the radium emanation, after some hours have elapsed for conditions to become steady, is always found to be proportional to the activity of the emanation. In other words, the activity of the emanation X decays according to the same law, and at the same rate, as the radium emanation which produces it, *i.e.* to half value in a little less than four days.

The rapid rate of heat emission of radium is connected with the radio-activity of that element. More than two-thirds of the heat emission of radium is due to the radium emanation and the secondary products to which the emanation gives rise. The heat emission seems to be for the most part connected with the emission of α rays.

The total energy which would be given out by a given quantity of radium is of quite a different order of magnitude to that observed in ordinary chemical reactions.

198. Theories of radio-activity. A brief review will now be given of the working hypotheses which have served as a guide to the investigators in the field of radio-activity. These working theories have in many cases been modified or extended with the growth of experimental knowledge.

The early experiments of Mme Curie had indicated that radio-activity was an atomic and not a molecular phenomenon. This was still further substantiated by later work, and the detection and isolation of radium from pitchblende was a brilliant verification of the truth of this hypothesis.

The discovery that the β rays of the radio-elements were similar to the cathode rays produced in a vacuum tube was an important advance, and has formed a basis of several subsequent theories. J. Perrin¹, in 1901, following the views of J. J. Thomson and others, suggested that the atoms of bodies consisted of parts and might be likened to a miniature planetary system. In the

¹ *Revue Scientifique*, April 13, 1901.

atoms of the radio-elements, the parts composing the atoms more distant from the centre might be able to escape from the central attraction and thus give rise to the radiation of energy observed. In December 1901, Becquerel¹ put forward the following hypothesis, which he stated had served him as a guide in his investigations. According to the view of J. J. Thomson, radio-active matter consists of negatively and positively charged particles. The former have a mass about 1/1000 of the mass of the hydrogen atom, while the latter have a mass about one thousand times greater than the negative particle. The negatively charged particles (the β rays) would be projected with great velocity, but the larger positive particles would have much lower velocity and would form as a sort of gas (the emanation) which would deposit itself on the surface of bodies. This in turn would subdivide giving rise to rays (excited activity).

In a paper communicated to the Royal Society in June 1900, Rutherford and McClung² showed that the energy, radiated in the form of ionizing rays into the gas, was 3000 gram-calories per year for radium of activity 100,000 times that of uranium. Taking the latest estimate 1,500,000 of the activity of a pure radium compound, this would correspond to an emission of energy into the gas in the form of α rays of about 45,000 gram-calories per gram per year. The suggestion was put forward that this energy might be derived from a re-grouping of the constituents of the atom of the radio-elements, and it was pointed out that the possible energy to be derived from a greater concentration of the components of the atom was large compared with that given out in molecular reactions.

In the original papers³ giving an account of the discovery of the emanation of thorium and the excited radio-activity produced by it, the writer took the view that both of these manifestations were due to radio-active material. The emanation behaved like a gas, while the matter which caused excited activity attached itself to solids and could be dissolved in some acids but not in others. In conjunction with Miss Brooks, it was shown that the radium emanation diffused through air like a gas of heavy molecular

¹ *C. R.* 133, p. 979, 1901.

² *Phil. Trans. A*, p. 25, 1901.

³ *Phil. Mag.* Jan. and Feb. 1900.

weight. At a later date Mr Soddy and the writer showed that the radium and thorium emanations behaved like chemically inert gases, since they were unaffected by the most drastic physical and chemical treatment.

On the other hand, P. Curie, who, in conjunction with Debierne, had made a series of researches on the radium emanation, expressed dissent from this view. P. Curie¹ did not consider that there was sufficient evidence that the emanation was material in nature, and pointed out that no spectroscopic evidence of its presence had yet been obtained, and also that the emanation disappeared when contained in a sealed vessel. It was pointed out by the writer² that the failure to detect spectroscopic lines was probably a consequence of the minute quantity of the emanation present, under ordinary conditions, although the electrical and phosphorescent actions produced by this small quantity are very marked. This contention is borne out by calculations of the probable amount of the emanation released from 1 gram of radium given in section 162. P. Curie took the view that the emanation was not material, but consisted of centres of condensation of energy attached to the gas molecules and moving with them.

M. and Mme Curie have throughout taken a very general view of the phenomena of radio-activity, and have not put forward any definite theory. In Jan. 1902, they gave an account of the general working theory³ which had guided them in their researches. Radio-activity is an atomic property, and the recognition of this fact had created their methods of research. Each atom acts as a constant source of emission of energy. This energy may either be derived from the potential energy of the atom itself, or each atom may act as a mechanism which instantly regains the energy which is lost. They suggested that this energy may be borrowed from the surrounding air in some way not contemplated by the principle of Carnot.

In the course of a detailed study of the radio-activity of thorium, Mr Soddy and the writer⁴ found that it was necessary to suppose that thorium was continuously producing from itself new kinds of

¹ *C. R.* 136, p. 223, 1903.

² *Phil. Mag.* April, 1903.

³ *C. R.* 134, p. 85, 1902.

⁴ *Trans. Chem. Soc.* 81, pp. 321, 837, 1902. *Phil. Mag.* Sept. and Nov. 1902.

active matter, which possess temporary activity and differ in chemical properties from the thorium. The constant radio-activity of thorium was shown to be the result of equilibrium between the processes of production of active matter and the change of that already produced. At the same time, the theory was advanced that the production of active matter was a consequence of the disintegration of the atom. The work of the following year was devoted to an examination of the radio-activity of uranium and radium on similar lines, and it was found that the conclusions already advanced for thorium held equally for uranium and radium¹. The discovery of a condensation of the radio-active emanations² gave additional support to the view that the emanations were gaseous in character. In the meantime, the writer³ had found that the rays consisted of positively charged bodies atomic in size, projected with great velocity. The discovery of the material nature of these rays served to strengthen the theory of atomic disintegration, and at the same time to offer an explanation of the connection between the α rays and the changes occurring in the radio-elements. In a paper entitled "Radio-active Change," Mr Soddy and the writer⁴ put forward in some detail the theory of atomic disintegration as an explanation of the phenomena of radio-activity, and at the same time some of the more important consequences which follow from the theory were discussed.

In a paper announcing the discovery of the heat emission of radium, P. Curie and Laborde⁵ state that the heat energy may be equally well supposed to be derived from a breaking up of the radium atom or from energy absorbed by the radium from some external source.

J. J. Thomson in an article on "Radium," communicated to *Nature*⁶, put forward the view that the emission of energy from radium is probably due to some change within of the atom, and pointed out that a large store of energy would be released by a contraction of the atom.

Sir William Crookes⁷, in 1899, proposed the theory that the

¹ *Phil. Mag.* April, 1903.

² *Phil. Mag.* May, 1903.

³ *Phys. Zeit.* 4, p. 235, 1902. *Phil. Mag.* Feb. 1903.

⁴ *Phil. Mag.* May, 1903.

⁵ *C. R.* 136, p. 673, 1903.

⁶ *Nature*, p. 601, 1903.

⁷ *C. R.* 128, p. 176, 1899.

radio-active elements possess the property of abstracting energy from the gas. If the moving molecules, impinging more swiftly on the substance, were released from the active substance at a much lower velocity, the energy released from the radio-elements might be derived from the atmosphere. This theory was advanced again later to account for the large heat emission of radium, discovered by P. Curie and Laborde.

Fillipo Re¹ recently advanced a very general theory of matter with a special application to radio-active bodies. He supposes that the parts of the atom were originally free, constituting a nebula of extreme tenuity. These parts have gradually become united round centres of condensation, and have thus formed the atoms of the elements. On this view an atom may be likened to an extinct sun. The radio-active atoms occupy a transition stage between the original nebula and the more stable chemical atoms, and in the course of their contraction give rise to the heat emission observed.

Lord Kelvin in a paper to the British Association, 1903, has suggested that radium may obtain its energy from external sources. If a piece of white paper is put into one vessel and a piece of black paper into an exactly similar vessel, on exposure of both vessels to the light the vessel containing the black paper is found to be at a higher temperature. He suggests that radium in a similar manner may keep its temperature above the surrounding air by its power of absorption of unknown radiations.

199. Discussion of Theories. From the survey of the general hypotheses advanced as possible explanations of radio-activity, it is seen that they may be broadly divided into two classes, one of which assumes that the energy emitted from the radio-elements is derived at the expense of the internal energy of the atom, and the other that the energy is derived from external sources, but that the radio-elements act as mechanisms capable of transforming this borrowed energy into the special forms manifested in the phenomena of radio-activity. Of these two sets of hypotheses the first appears to be the most probable, and to be best supported by the experimental evidence. Up to the present not

¹ *C. R.* p. 136, p. 1393, 1903.

the slightest experimental evidence has been adduced to show that the energy of radium is derived from external sources.

J. J. Thomson (*loc. cit.*) has discussed the question in the following way:—

“ It has been suggested that the radium derives its energy from the air surrounding it, that the atoms of radium possess the faculty of abstracting the kinetic energy from the more rapidly moving air molecules while they are able to retain their own energy when in collision with the slowly moving molecules of air. I cannot see, however, that even the possession of this property would explain the behaviour of radium; for imagine a portion of radium placed in a cavity in a block of ice; the ice around the radium gets melted; where does the energy for this come from? By the hypotheses there is no change in the air-radium system in the cavity, for the energy gained by the radium is lost by the air, while heat cannot flow into the cavity from the outside, for the melted ice round the cavity is hotter than the ice surrounding it.”

The writer has recently found that the activity of radium is not altered by surrounding it with a large mass of lead. A cylinder of lead was cast 10 cms. in diameter and 10 cms. high. A hole was bored in one end of the cylinder to the centre, and the radium, enclosed in a small glass tube, was placed in the cavity. The opening was then hermetically closed. The activity was measured by the rate of discharge of an electroscope by the γ rays transmitted through the lead, but no appreciable change was observed during a period of one month.

M. and Mme Curie early made the suggestion that the radiation of energy from the radio-active bodies might be accounted for by supposing that space is traversed by a type of Röntgen rays, and that the radio-elements possess the property of absorbing them. Recent experiments (section 215) have shown that there is present at the surface of the earth a very penetrating type of rays, similar to the γ rays of radium. Even if it were supposed that the radio-elements possessed the power of absorbing this radiation, the energy of the rays is far too minute to account even for the energy radiated from an element of small activity like uranium. In addition, all the evidence so far obtained points to the conclusion that the radio-active bodies do not absorb the type of rays they

emit to any greater extent than would be expected from their density. It has been shown (section 79) that this is true in the case of uranium. Even if it were supposed that the radio-elements possess the property of absorbing the energy of some unknown type of radiation, which is able to pass through ordinary matter with little absorption, there still remains the fundamental difficulty of accounting for the peculiar radiations from the radio-elements, and the series of changes that occur in them. It is not sufficient to account for the heat emission only, for it has been shown (section 106) that the emission of heat is directly connected with the radio-activity.

In addition, the distribution of the heat emission of radium amongst the radio-active products which arise from it is extremely difficult to explain on the hypothesis that the energy emitted is borrowed from external sources. It has been shown that more than two-thirds of the heat emitted by radium is due to the emanation together with the matter emanation X, which is produced by the emanation. When the emanation is separated from the radium, its power of emitting heat, after reaching a maximum, decreases with the time according to an exponential law. It would thus be necessary on the absorption hypothesis to postulate that most of the heat emission of radium, observed under ordinary conditions, is not due to the radium itself but to something produced by the radium, the power of absorbing energy from external sources diminishes with time.

The strongest evidence against the hypothesis of absorption of external energy is that such a theory ignores the fact, that, whenever radio-activity is observed, it is always accompanied by some change which can be detected by the appearance of new products having chemical properties distinct from those of the original substances. This leads to some form of "chemical" theory, and other results show that the change is atomic and not molecular.

200. Theory of radio-active change. The processes occurring in the radio-elements are of a character quite distinct from any previously observed in chemistry. Although it has been shown that the radio-activity is due to the spontaneous and continuous production of new types of active matter, the laws which control

this production are different from the laws of ordinary chemical reactions. It has not been found possible in any way to alter either the rate at which the matter is produced or its rate of change when produced. Temperature, which is such an important factor in altering the rate of chemical reactions, is, in these cases, entirely without influence. In addition, no ordinary chemical change is known which is accompanied by the expulsion of charged atoms with great velocity. It has been suggested by Armstrong and Lowry¹ that radio-activity may be an exaggerated form of fluorescence or phosphorescence with a very slow rate of decay. But no form of phosphorescence has yet been shown to be accompanied by radiations of the character of those emitted by the radio-elements. Whatever hypothesis is put forward to explain radio-activity must account not only for the production of a series of active products, which differ in chemical and physical properties from each other and from the parent element, but also for the emission of rays of a special character. Besides this, it is necessary to account for the large amount of energy continuously radiated from the radio-elements.

The radio-elements, besides their high atomic weights, do not possess in common any special chemical characteristics which differentiate them from the elements, which do not possess the property of radio-activity to an appreciable degree. Of all the known elements, uranium, thorium, and radium possess the heaviest atomic weights, viz.: radium 225, thorium 232·5, and uranium 240.

If a high atomic weight is taken as evidence of a complicated structure of the atom, it might be expected that disintegration might occur more readily in heavy than in light atoms. At the same time, there is no reason to suppose that the elements of the highest atomic weight should be the most radio-active; in fact, radium is far more active than uranium, although its atomic weight is less. This is seen to be the case also in the radio-active products; for example, the radium emanation is enormously more active weight for weight than the radium itself, and there is every reason to believe that the emanation has an atom lighter than that of radium.

¹ *Proc. Roy. Soc.* 1903.

In order to explain the phenomena of radio-activity, Rutherford and Soddy have advanced the theory that the atoms of the radio-elements suffer spontaneous disintegration, and that each disintegrated atom passes through a succession of well-marked changes, accompanied in most cases by the emission of α rays.

A preliminary account of this hypothesis to explain special phenomena has already been given in sections 87 and 127. It will now be applied generally to the radio-elements, and the consequences, which follow from it, will be considered. It is supposed that, on an average, a definite small proportion of the atoms of each radio-element becomes unstable at a given time. As a result of this instability, an α particle is expelled with great velocity. The continuous expulsion of these α particles gives rise to the non-separable activity of the radio-elements, which has been shown to consist entirely of α rays (section 193). The expulsion of an α particle, of mass about twice that of the hydrogen atom, leaves behind it a new system lighter than the original one, and possessing chemical and physical properties quite different from those of the original element. This new system again becomes unstable, and expels another α particle. The process of disintegration, once started, proceeds from stage to stage at a definite measurable rate in each case. At each stage, with the exception of one change in thorium and one in radium which are not accompanied by rays at all, one or more α particles are projected, until the last stages are reached, when the β and γ rays appear. The term *metabolon* has been suggested as a convenient expression for each of these changing atoms, derived from the successive disintegration of the atoms of the radio-elements. Each metabolon, on an average, exists only for a limited time. In a collection of metabolons of the same kind the number N , which are unchanged at a time t after production, is given by $N = N_0 e^{-\lambda t}$ where N_0 is the original number. Now $\frac{dN}{dt} = -\lambda N$, or the fraction of the metabolons present, which change in unit time, is equal to λ . The value $1/\lambda$ may thus be taken as the *average life* of each metabolon.

The various metabolons from the radio-elements are distinguished from ordinary matter by their great instability and consequently rapid rate of change. Since a body which is radio-active

must *ipso facto* be undergoing change, it follows that none of the active products, for example, the emanations and Th X, can consist of any known kind of matter; for there is no evidence to show that inactive matter can be made radio-active, or that two forms of the same element can exist, one radio-active and the other not. For example, half of the matter constituting the radium emanation has undergone change after an interval of four days. After the lapse of about one month the emanation as such has nearly disappeared, having been transformed through several stages into other and more stable types of matter, which are in consequence difficult to detect by their radio-activity.

The following table gives the list of the active products or metabolons known to result from the disintegration of the three radio-elements. In the second column is given the value of the radio-active constant λ for each active product, *i.e.* the proportion of the active matter undergoing change per second; in the third column, the time τ required for the activity to fall to one-half, *i.e.* the time taken for half the active product to undergo change; in the third column, the nature of the rays from each active product, not including the rays from the products which result from it; in the fourth column, a few of the more marked physical and chemical properties of each metabolon.

There are two well-marked changes in uranium, five in thorium, and six in radium. It is quite probable that a closer examination of the active products may lead to the discovery of still further changes. For example, the evidence obtained by von Lerch (section 179) from the electrolysis of a solution of emanation X of thorium points to the conclusion that there is an additional change occurring in emanation X, for which the value of τ is 3 or 4 hours. The experiments of Pegram (section 179) also suggest that another radio-active product, of which the value of τ is about 3 minutes, is present in thorium. The change of thorium X into the emanation would have been difficult to detect if the product of the change had not been gaseous in character. Besides the changes mentioned above, it is thus quite possible that other and more rapid changes may be taking place which have not yet been detected.

It has been pointed out in section 188 that the fourth change

Radio-active Products	λ	τ	Nature of the Rays	Chemical and Physical Properties
URANIUM	α	Soluble in excess of ammonium carbonate Insoluble in excess of ammonium carbonate
↓ Uranium X	3.6×10^{-7}	22 days	β (and γ ?)	
↓ Final product	
THORIUM	α	Insoluble in ammonia
↓ Thorium X	2.0×10^{-6}	4 days	α (and β ?)	Soluble in ammonia
↓ Thorium Emanation	1.15×10^{-2}	1 minute	α	Behaves like a chemically inert gas of heavy molecular weight. Condenses at -120°C . Attaches itself to the surface of bodies concentrated on the cathode in an electric field Soluble in some acids and not in others. Possesses well-marked chemical properties in solution
↓ Emanation X (first change)	2.2×10^{-4}	55 minutes	no rays	
↓ Second change	1.74×10^{-5}	11 hours	α, β, γ	
↓ Final product	
...	
RADIUM	α	Behaves like a chemically inert gas of heavy molecular weight Condenses at -150°C . Attaches itself to the surface of bodies; mainly concentrated on the cathode in an electric field Soluble in some acids and not in others; volatilized at a white heat Soluble in sulphuric acid
↓ Radium Emanation	2.14×10^{-6} to 2.00×10^{-6}	3.7 to 4 days	α	
↓ Emanation X (first change)	about 4×10^{-3}	about 3 minutes	α	
↓ Second change	3.18×10^{-4}	36 minutes	no rays	
↓ Third change	4.1×10^{-4}	28 minutes	α, β, γ	
↓ Fourth change	...	200 years (?)	α, β	
↓ Final product	

in emanation X of radium may possibly be the radio-active constituent present in the polonium of Mme Curie or the radio-tellurium of Marckwald. After the disintegrated radio-atoms have undergone the succession of changes mentioned above, a final stage will be reached where the atoms are either permanently stable or change so slowly that it is difficult to detect their

presence by the property of radio-activity. Consequently, there will always be a residual inactive product or products of the changes occurring in each of the radio-elements. In addition, since the α particles, projected from the radio-elements, are material in nature and are not radio-active, they must also be considered as a residual product.

The value of τ , which may be taken as a comparative measure of the stability of the different metabolons, varies over a very wide range. The thorium emanation is the most unstable of the metabolons, and (leaving out of account the fourth change in emanation X of radium) uranium X the least unstable. The metabolons constituting uranium X are about 30,000 times as stable as the metabolons constituting the thorium emanation.

The only two metabolons of about the same stability are the metabolons constituting thorium X and the radium emanation. In each case the activity falls to half value in about four days. I consider that the approximate agreement of the numbers is a mere coincidence, and that the two types of matter are quite distinct from one another; for, if the metabolons were identical, it would be expected that the changes which follow would take place in the same way and at the same rate, but such is not the case. Moreover Th X and the radium emanation have chemical and physical properties quite distinct from one another.

201. Production of helium from radium and the radium emanation. Since the final products, resulting from a disintegration of the radio-elements, are not radio-active, they should in the course of geologic ages collect in some quantity, and should always be found associated with the radio-elements. Now the inactive products resulting from the radio-active changes are the α particles expelled at each stage, and the final inactive product or products which remain, when the process of disintegration can no longer be traced by the property of radio-activity.

Pitchblende, in which the radio-elements are mostly found, contains in small quantity a large proportion of all the known elements. In searching for a possible disintegration product common to all the radio-elements, the presence of helium in the radio-active minerals is noteworthy; for helium is only found in

the radio-active minerals and is an invariable companion of the radio-elements. In addition the presence of a light, inert gas like helium in minerals had always been a matter of surprise. The production by radium and thorium of the radio-active emanations, which behaved like chemically inert gases of the helium-argon family, suggested the possibility that one of the final inactive products of the disintegration of the radio-elements might prove to be a chemically inert gas. The discovery later of the material nature of the α rays added weight to the suggestion; for the measurement of the ratio e/m of the α particle indicated that if the α particle consisted of any known kind of matter, it must either be hydrogen or helium. For these reasons, it was suggested in 1902 by Rutherford and Soddy¹ that helium might be a product of the disintegration of the radio-elements.

Sir William Ramsay and Mr Soddy in 1903 undertook an investigation of the radium emanation, with the purpose of seeing if it were possible to obtain any spectroscopic evidence of the presence of a new substance. First of all, they exposed the emanation to very drastic treatment (section 149), and confirmed and extended the results previously noted by Rutherford and Soddy that the emanation behaved like a chemically inert gas, and in this respect possessed properties analogous to the gases of the helium-argon group.

On obtaining 30 milligrams of pure radium bromide (prepared about three months previously) Ramsay and Soddy² examined the gases, liberated by solution of the radium bromide in water, for the presence of helium. A considerable quantity of hydrogen and oxygen was released by the solution (see section 116). The hydrogen and oxygen were removed by passing the liberated gases over a red-hot spiral of partially oxidized copper-wire and the resulting water vapour by a phosphorous pentoxide tube.

The gas was then passed into a small vacuum tube which was in connection with a small U tube. By placing the U tube in liquid air, most of the emanation present was condensed, and also most of the CO₂ present in the gas. On examining the spectrum

¹ *Phil. Mag.* p. 582, 1902; pp. 453 and 579, 1903.

² *Nature*, July 16, p. 246, 1903. *Proc. Roy. Soc.* 72, p. 204, 1903.

of the gas in the vacuum tube the characteristic line D_3 of helium was observed.

This experiment was repeated with 30 milligrams of radium bromide about four months old, lent for the purpose by the writer. The emanation and CO_2 were removed by passing them through a U tube immersed in liquid air. A practically complete spectrum of helium was observed, including the lines of wave-length 6677, 5876, 5016, 4972, 4713 and 4472. There were also present three other lines of wave-length about 6180, 5695, 5455 which have not yet been identified.

In later experiments the emanation from 50 milligrams of the radium bromide was conveyed with oxygen into a small U tube, cooled in liquid air, in which the emanation was condensed. Fresh oxygen was added and the U tube again pumped out. The small vacuum tube, connected with the U tube, showed at first no helium lines when the liquid air was removed. The spectrum obtained was a new one, and Ramsay and Soddy considered it to be probably that of the emanation itself. After allowing the emanation tube to stand for four days, the helium spectrum appeared with all the characteristic lines, and in addition, three new lines present in the helium obtained by solution of the radium. These results have since been confirmed. The experiments, which have led to such striking and important results, were by no means easy of performance, for the quantity of helium and of emanation released from 50 mgrs. of radium bromide is extremely small. It was necessary, in all cases, to remove almost completely the other gases, which were present in sufficient quantity to mask the spectrum of the substance under examination. The success of the experiments has been largely due to the application to the investigation of the refined methods of gas analysis, which had been previously employed by Sir William Ramsay with so much success in the separation of the rare gases xenon and krypton, which exist in minute proportions in the atmosphere. The fact that the helium spectrum was not present at first, but appeared *after* the emanation had remained in the tube for some days, shows that the helium must have been produced from the emanation. The emanation cannot be helium itself, for in the first place, helium is not radio-active, and in the second place, the helium spectrum was not present at

first, when the quantity of emanation in the tube was at its maximum. In addition, the diffusion experiments, already discussed, point to the conclusion that the emanation is of high molecular weight. There can thus be no doubt that the helium is derived from the emanation of radium in consequence of changes of some kind occurring in it.

In order to explain the presence of helium in radium on ordinary chemical lines, it has been suggested that radium is not a true element, but a molecular compound of helium with some substance known or unknown. The helium compound gradually breaks down, giving rise to the helium observed. It is at once obvious that this postulated helium compound is of an entirely different character to any other compound previously observed in chemistry. Weight for weight, it emits during its change an amount of energy at least one million times greater than any molecular compound known (see section 205). In addition, it must be supposed that the rate of breaking up of the helium compound is independent of great ranges of temperature—a result never before observed in any molecular change. The helium compound in its breaking up must give rise to the peculiar radiations and also pass through the successive radio-active changes observed in radium.

In order to explain the production of helium and radio-activity on this view, a unique kind of molecule must thus be postulated—a molecule, in fact, which is endowed with every single property which on the disintegration theory is ascribed to the atom of the radio-elements. On the other hand, radium as far as it has been examined, has fulfilled every test required for an element. It has a well-marked and characteristic spectrum, and there is no reason to suppose that it is not an element in the ordinarily accepted sense of the term.

On the theory that the radio-elements are undergoing atomic disintegration, the helium must either be considered to exist within the radium atom, or else to be formed from its constituent corpuscles during the process of disintegration. The theory that the heavy atoms are all built up of some simple fundamental unit of matter or protyle has been advanced at various times by many prominent chemists and physicists. Prout's hypothesis,

that all elements are built up out of hydrogen, is an example of this point of view of regarding the subject.

On the disintegration theory, the changes occurring in the radio-atoms involve an actual transformation of the atoms through successive changes. This change is so slow in uranium and thorium that at least a million years would be required before the amount of change is measurable by the balance. In radium it is a million times faster, but even in that case it is doubtful whether any appreciable change would be observed by ordinary chemical methods for many years, if the possibility of such a change had not been suggested from other lines of research.

202. Amount of helium from radium. The appearance of helium in a tube containing the radium emanation may indicate either that the helium is one of the final products, which appear at the end of the series of radio-active changes, or that the helium is in reality the expelled α particle. The evidence at present points to the latter as being the more probable explanation. In the first place, the emanation diffuses like a gas of heavy molecular weight, and it appears probable that, after the expulsion of a few α particles, the atomic weight of the final product is comparable with that of the emanation. On the other hand, the value of e/m determined for the projected α particle points to the conclusion that, if it consists of any known kind of matter, it is either hydrogen or helium.

If the α particles, when released, can exist in the gaseous state, an estimate can readily be made of the volume of the total number of particles liberated per year. It has been calculated that one gram of radium expels about 10^{11} α particles per second. Since there are 3.6×10^{19} molecules in one cubic centimetre of any gas at standard pressure and temperature, the volume of the α particles released per second from 1 gram of radium is 2.8×10^{-9} c.c. and per year 90 cubic millimetres.

It has already been shown that the emanation released from 1 gram of radium in a state of radio-active equilibrium is probably about 3×10^{-4} c.c. Since the emanation passes through at least three stages, each of which gives rise to α rays, the volume of the α particles from the emanation, released from 1 gram of radium, is about one cubic millimetre.

Ramsay and Soddy state that the amount of helium, present in the gases from radium, was very minute. From the above estimates, it can readily be shown that the amount of helium liberated in the experiments described in section 201 was about 0.5 cubic millimetres. If the α particles are helium, it is to be expected that the greater portion of the helium, which is produced in a tube containing the radium emanation, would be buried in the walls of the glass tube; for the α particles are projected with sufficient velocity to penetrate some distance into the glass.

203. Rate of change of the radio-elements. Since the atoms of the radio-elements themselves are continuously breaking up, they must also be considered to be metabologs, the only difference between them and the metabologs such as the emanations, Th X and others, being their comparatively great stability and consequent very slow rate of change. There is no evidence that the process of disintegration, traced above, is reversible, and, in the course of time, a quantity of radium, uranium or thorium, left to itself must gradually be transformed into inactive matter of different kinds.

An approximate estimate of the rate of change of radio-elements can be deduced from the number of atoms breaking up per second. It has been calculated from several lines of evidence (section 104) that from 1 gram of radium about 10^{11} α particles are expelled per second. The number for uranium and thorium is about 7×10^4 .

Now it has been shown that there are at least four rapid changes in radium, each of which gives rise to α rays. In the absence of evidence of the number of α particles expelled at each change, the assumption, which seems most probable, will be made, viz., that each metabolon expels only *one* α particle. Since there are four changes in radium, the number of atoms in one gram of radium breaking up per second is 2.5×10^{10} . Now it has been shown, from data based on experimental evidence, that one cubic centimetre of hydrogen, at standard pressure and temperature, contains about 3.6×10^{19} molecules. Taking the atomic weight of radium as 225, there will be 1.8×10^{21} atoms in 1 gram of radium. The fraction λ of one gram of radium which changes is thus 1.4×10^{-11} per second and 4.4×10^{-4} per year. It thus follows that, in each gram

of radium, about half a milligram disintegrates per year. Since the amount of radium which is unchanged will diminish according to an exponential law with the time, half of a given weight of radium will be transformed in about 1500 years. Only one per cent. will remain unchanged after a lapse of about 10,000 years. In a gram of uranium or thorium, where the change takes place at about one-millionth the rate, about a million years would be required before half a milligram would be changed. All but one per cent. of the uranium and thorium would be transformed in about 10^{10} years.

This is the minimum estimate of the life of radio-elements on the assumption that one α particle is expelled at each change. A maximum limit to the life of the radio-elements can be deduced by supposing that the radium is completely disintegrated into α particles. Since the mass of the α particle is about twice that of the hydrogen atom there cannot be many more than 100 α particles produced from each atom of the radio-elements. The *maximum* estimate of the life of radium is thus about 5.0 times greater than the minimum estimate. The minimum estimate is however probably nearer the truth; for there is no evidence to show that more than one α particle is expelled at each change. The agreement between the calculated and experimental values of the volume of the emanation (see section 197) is strong evidence in support of the minimum estimate; for in the calculation only one α particle was supposed to be expelled at each change.

The changes in radium are thus fairly rapid, and a mass of radium if left to itself should in the course of a few thousand years have lost a large proportion of its radio-activity. Taking the *minimum* estimate of the life of radium, the value of λ is 4.4×10^{-4} , with a year as the unit of time. A mass of radium left to itself should thus be half transformed in 1500 years and only one-millionth part would remain after 30,000 years. Thus supposing, for illustration, that the earth was originally composed of pure radium, its activity per gram 30,000 years later would not be greater than the activity observed to-day in a good specimen of pitchblende. Even taking the maximum estimate of the life of radium, the time required for the radium to practically disappear is short compared with the probable age of the earth. We are

thus forced to the conclusion that radium is being continuously produced in the earth, unless the very improbable assumption is made, that radium was in some way suddenly formed at a date recent in comparison with the age of the earth. It has been suggested that radium may be a disintegration product of one of the radio-elements found in pitchblende. Both uranium and thorium fulfil the conditions required in a possible source of production of radium. Both are present in pitchblende, have atomic weights greater than that of radium, and have rates of change which are slow compared with that of radium. In some respects, uranium fulfils the conditions required better than thorium; for it has not been observed that minerals rich in thorium contain much radium, while on the other hand, the pitchblendes containing the most radium contain a large proportion of uranium.

If radium is not produced from uranium, it is certainly a remarkable coincidence that the greatest activity of pitchblende yet observed is about five or six times that of uranium. Since radium has a life short compared with that of uranium, the amount of radium produced should reach a maximum value after a few thousand years, when the rate of production of fresh radium—which is also a measure of the rate of change of uranium—balances the rate of change of that product. In this respect the process would be exactly analogous to the production of the emanation by radium, with the difference that the radium changes much more slowly than the emanation. But since radium itself in its disintegration gives rise to at least four changes with the corresponding production of α rays, the activity due to the radium (measured by the α rays), when in a state of radio-active equilibrium with uranium, should be about four times that of the uranium that produces it; for it has been shown that only one change has so far been observed in uranium in which α rays are expelled. Taking into account the presence of polonium and actinium in pitchblende, the activity in the best pitchblende is about the same as would be expected if the radium were a disintegration product of uranium. If this hypothesis is correct, the amount of radium in any pitchblende should be proportional to the amount of uranium present, provided the radium is not removed from the mineral by percolating water. On the other

hand it should be noticed that while the greatest amount of radium has been observed in a pitchblende rich in uranium, some pitchblendes rich in uranium contain very little radium.

The general evidence, which has been advanced to show that radium must continually be produced from some other substance, applies also to actinium, which has an activity of the same order of magnitude as that of radium. It is very remarkable that the three radio-active substances, radium, thorium and actinium, should exhibit such a close similarity in the succession of changes which occur in them. Each of them at one stage of its disintegration emits a radio-active gas, and in each case this gas is transformed into a solid which is deposited upon the surface of bodies. It would appear that, after disintegration of an atom of any of these has once begun, there is a similar succession of changes, in which the resulting systems have allied chemical and physical properties. Such a connection is of interest as indicating a possible origin of the recurrence of properties in the atoms of the elements, as exemplified by the periodic law.

204. Loss of weight of the radio-element. Since the radio-elements are continuously throwing off α particles atomic in size, an active substance, enclosed in a vessel sufficiently thin to allow the α particles to escape, must gradually lose in weight. This loss of weight will be small under ordinary conditions, since the greater proportion of the α rays produced are absorbed in the mass of the substance. If a very thin layer of a radium compound were spread on a very thin sheet of substance, which did not appreciably absorb the α particles, a loss of weight due to the expulsion of α particles might be detectable. Since $e/m = 6 \times 10^3$ for the α particle, and $e = 1.1 \times 10^{-20}$ electro-magnetic units, and 10^{11} α particles are expelled per second per gram of radium, the fraction of the mass expelled is 1.8×10^{-13} per second and 6×10^{-6} per year. There is one condition, however, under which the radium should lose in weight fairly rapidly. If a current of air is slowly passed over a radium solution, the emanation produced would be removed as fast as it was formed. Since the atom of the emanation has a mass probably not much smaller than the radium atom, the fraction of the mass removed per year should

be nearly equal to the fraction of the radium which changes per year, *i.e.* one gram of radium should diminish in weight half a milligram (section 203) per year on a maximum estimate and 1/100 of a milligram on a minimum estimate.

If it is supposed that the β particles have weight, the loss of weight due to their expulsion is very small compared with that due to the emission of α particles. Taking the estimate deduced from the observation of Wien (section 104), that 6.6×10^9 β particles are projected per second from 1 gram of radium bromide, the loss of weight would only be about 1.2×10^{-10} gram per year.

Except under very special experimental conditions, it would thus be very difficult to detect the loss of weight of radium due to the expulsion of β particles from its mass. There is, however, a possibility that radium might change in weight even though none of the radio-active products were allowed to escape. For example, if the view is taken that gravitation is the result of forces having their origin in the atom, it is possible that, if the atom were disintegrated, the weight of the parts might not be equal to that of the original atom.

A large number of experiments have been made to see if radium preparations, kept in a sealed tube, alter in weight. With the small quantities of radium available to the experimenter, no difference of weight of radium preparations with time has yet been established with certainty. Heydweiller stated that he had observed a loss of weight of radium, and Dorn also obtained a slight indication of change in weight. These results have not, however, been confirmed. Forch, later, was unable to observe any appreciable change.

205. Total emission of energy from the radio-element.

It has been shown that 1 gram of radium emits energy at the rate of 100 gram-calories per hour or 876,000 gram-calories per year. If 1 gram of radium were set apart, its radio-activity and consequent heat emission at a time t is given by $qe^{-\lambda t}$, where λ is the constant of decay of activity of radium. Thus the total heat emission from 1 gram of radium is given by $\int_0^\infty qe^{-\lambda t} = \frac{q}{\lambda}$.

Now on the minimum estimate of the life of radium, the value

of λ is 4.4×10^{-4} , and on the maximum estimate 1.76×10^{-5} when 1 year is taken as the unit of time. The total heat emission from 1 gram of radium during its life thus lies between 2×10^9 and 5×10^{10} gram-calories. The minimum estimate is probably nearer the truth than the maximum. The heat emitted in the union of hydrogen and oxygen to form 1 gram of water is about 4×10^3 gram-calories, and in this reaction more heat is given out for equal weights than in any other chemical reaction known. It is thus seen that the total energy emitted from 1 gram of radium during its changes is about one million times greater than that involved in any known molecular change. That matter is able, under special conditions, to emit an enormous amount of energy, is well exemplified by the case of the radium emanation. The total heat emission from the emanation released from 1 gram of radium, and from the secondary products, corresponds to about 10^4 gram-calories, and this amount of heat is given out as a consequence of changes in a minute volume of gas. Taking the estimate that the volume of the emanation is 3×10^{-4} cubic centimetres at standard pressure and temperature, and its atomic weight about 200, it can be calculated that 1 gram of emanation gives out during its life about 10^9 gram-calories. Quite independently of any theory, a result of the same order of magnitude can be deduced from the experiments.

Since the other radio-elements only differ from radium in the slowness of their change, the total heat emission from uranium and thorium must be of a similar high order of magnitude. There is thus reason to believe that an enormous store of latent energy is resident in the atoms of the radio-elements. This store of energy could not have been recognized if the atoms were not undergoing a slow process of disintegration. The energy emitted in radio-active changes may thus be supposed to be derived from the internal energy of the atoms. The emission of this energy does not disobey the law of the conservation of energy, for it is only necessary to suppose that, when the radio-active changes have ceased, the energy stored up in the atoms of the final products is less than that in the original atoms of the radio-elements. The difference between the energy originally possessed by the matter, which has undergone the change, and the final

inactive products which arise, is a measure of the total amount of energy released.

There seems to be no reason to suppose that the atomic energy of all the elements is not of a similar high order of magnitude. With the exception of their high atomic weights, the radio-elements do not possess any special chemical characteristics which differentiate them from the inactive elements. The existence of a latent store of energy in the atoms is a necessary consequence of the modern view developed by J. J. Thomson, Larmor, and Lorentz, of regarding the atom as a complicated structure consisting of charged parts in rapid oscillatory or orbital motion in regard to one another. The energy may be partly kinetic and partly potential, but the mere arrangement of the charged particles, which probably constitute the atom, in itself implies a large store of internal atomic energy.

It is not to be expected that the existence of this store of latent energy would have ordinarily manifested itself, since the atoms cannot be broken up into simpler forms by the physical or chemical agencies at our disposal. Its existence at once explains the failure of chemistry to transform the atoms, and also accounts for the independence of the rate of change of the radio-active processes of all external agencies. It has not so far been found possible to alter in any way the rate of emission of energy from the radio-elements. If it were ever found possible to control at will the rate of disintegration of the radio-elements, an enormous amount of energy could be obtained from a small quantity of matter.

206. Possible causes of disintegration. In order to explain the phenomena of radio-activity, it has been supposed that a certain small fraction of the radio-atoms undergoes disintegration per second, but no assumptions have been made as to the cause which produces the instability and consequent disintegration. The instability of the atoms may be supposed to be brought about either by the action of external forces or of forces inherent in the atoms themselves. It is conceivable, for example, that the application of some slight external force might cause instability and consequent disintegration, accompanied by the liberation of a large

amount of energy, on the same principle that a detonator is necessary to start some explosives. It has been shown that the number of atoms of any radio-active product which break up per second is always proportional to the number present. This law of change does not throw any light on the question, for it would be expected equally on either hypothesis. It has not been found possible to alter the rate of change of any product by the application of any known physical or chemical forces, unless possibly it is assumed that the force of gravitation which is not under our control may influence in some way the stability of the radio-atoms.

It has been suggested by J. J. Thomson¹ that the rate of disintegration of radium may be influenced by its own radiations. This, at first sight, appears very probable, for a small mass of pure radium compound is subjected to an intense bombardment by the radiations arising from it, and the radiations are of such a character that they might be expected to produce a breaking up of the atoms of matter which they traverse. If this is the case the radio-activity of a given quantity of radium should be a function of its concentration, and should be greater in the solid state than when disseminated through a large mass of matter.

I have recently tried an experiment to see if this were the case. Two glass tubes were taken, in one of which was placed a few milligrams of pure radium bromide in a state of radio-active equilibrium, and in the other a solution of barium chloride. The two tubes were connected near the top by a short cross tube and the open ends sealed off. The activity of the radium in the solid state was tested immediately after its introduction by placing it in a definite position near an electroscope made of thin metal of the type shown in Fig. 11. The increased rate of discharge of the electroscope was observed. This rate of discharge was due to the β and γ rays from the radium. By placing a lead plate 6 mms. in thickness between the radium and the electroscope, the rate of discharge observed was then due to the γ rays alone. By slightly tilting the apparatus, the barium solution flowed into the radium tube and dissolved the radium. The tube was well shaken so as to distribute the radium uniformly throughout the solution. No appreciable change of the activity measured by the γ rays was

¹ *Nature*, April 30, p. 601, 1903.

observed over the period of one month. The activity measured by the β and γ rays was somewhat reduced, but this was not due to a decrease of the radio-activity, but to an increased absorption of the β rays in their passage through the solution. The volume of the solution was at least 1000 times greater than that of the solid radium bromide, and, in consequence, the radium was subjected to the action of a much weaker radiation. I think we may conclude from this experiment that the radiations emitted by radium have little if any influence in causing the disintegration of the radium atoms.

This result is in general agreement with other observations; for it has not been observed that the decay of activity of any product is influenced by the degree of concentration of that product.

It thus seems likely that the cause of the disruption of the atoms of the radio-elements and their products is resident in the atoms themselves. According to the modern views of the constitution of the atom, it is not so much a matter of surprise that some atoms disintegrate as that the atoms of the elements are so permanent as they appear to be. In accordance with the hypothesis of J. J. Thomson, it may be supposed that the atoms consist of a number of small positively and negatively charged particles in rapid internal movement, and held in equilibrium by their mutual forces. In a complex atom, where the possible variations in the relative motion of the parts are very great, the atom may arrive at such a phase that one part acquires sufficient kinetic energy to escape from the system, or that the constraining forces are momentarily neutralised, so that the part escapes from the system with the velocity possessed by it at the instant of its release.

Sir Oliver Lodge¹ has advanced the view that the instability of the atom may be a result of radiation of energy by the atom. Larmor has shown that an electron, subject to acceleration, radiates energy at a rate proportional to the square of its acceleration. An electron moving uniformly in a straight line does not radiate energy, but an electron, constrained to move in a circular orbit with constant velocity, is a powerful radiator, for in such a case the electron is continuously accelerated towards the centre. Lodge considered

¹ Lodge, *Nature*, June 11, p. 129, 1903.

the simple case of a negatively charged electron revolving round an atom of mass relatively large but having an equal positive charge and held in equilibrium by electrical forces. This system will radiate energy, and since the radiation of energy is equivalent to motion in a resisting medium, the particle tends to move towards the centre, and its speed consequently increases. The rate of radiation of energy will increase rapidly with the speed of the electron. When the speed of the electron becomes very nearly equal to the velocity of light, according to Lodge, another effect supervenes. It has been shown (section 76) that the apparent mass of an electron increases very rapidly as the speed of light is approached, and is theoretically infinite at the speed of light. There will be at this stage a sudden increase of the mass of the revolving atom and, on the supposition that this stage can be reached, a consequent disturbance of the balance of forces holding the system together. Lodge considers it probable that, under these conditions, the parts of the system will break asunder and escape from the sphere of one another's influence.

It seems probable that the primary cause of the disintegration of the atom must be looked for in the loss of energy of the atomic system due to electro-magnetic radiation. Larmor¹ has shown that the condition to be fulfilled in order that a system of rapidly moving electrons may persist without loss of energy is that the vector sum of the accelerations towards the centre should be permanently null. While a single electron moving in a circular orbit is a powerful radiator of energy, it is remarkable how rapidly the radiation of energy diminishes if several electrons are revolving in a ring. This has recently been shown by J. J. Thomson², who examined mathematically the case of a system of negatively electrified corpuscles, situated at equal intervals round the circumference of a circle, and rotating in one plane with uniform velocity round its centre. For example, he found that the radiation from a group of six particles moving with a velocity of $\frac{1}{10}$ of the velocity of light is less than one-millionth part of the radiation from a single particle describing the same orbit with the same velocity. When the velocity is $\frac{1}{100}$ of that of light the amount of radiation

¹ Larmor, *Aether and Matter*, p. 233.

² J. J. Thomson, *Phil. Mag.* p. 681, Dec. 1903.

is only 10^{-16} of that of the single particle moving with the same velocity in the same orbit.

Results of this kind indicate that an atom consisting of a large number of revolving electrons may radiate energy extremely slowly, and yet, finally, this minute but continuous drain of energy from the atom must result either in a rearrangement of its component parts into a new system, or of an expulsion of electrons or groups of electrons from the atom.

A suggestion, due to J. J. Thomson¹, of a possible mechanism to account for the expulsion from the radio-atoms of an α particle, *i.e.* of a connected group of electrons, has recently been explained by Whetham² as follows:—"The sub-atomic corpuscles, when their velocity is changing, must radiate ethereal waves. Their energy is thus gradually diminished; and systems of revolving corpuscles, permanent while moving fast, may become unstable. As a simple example, six bodies at the corners of a plane hexagon under the influence of mutual forces may continue, while their velocity exceeds a certain limit, to revolve about a central point while keeping their relative positions. When there is no motion, however, this arrangement is impossible, and the six bodies must place themselves, five at the corners of a pentagon and one at the centre. Thus, as the velocity falls to a certain value, a sudden and explosive rearrangement occurs, during which, in the complex system constituting an atom, the ejection of parts of the system becomes possible."

207. Radio-activity and the heat of the sun and earth.

It was pointed out by Mr Soddy and the writer³ that the maintenance of the sun's heat for long intervals of time did not present any fundamental difficulty if a process of disintegration, such as occurs in the radio-elements, were supposed to be taking place in the sun. In a letter to *Nature* (July 9, 1903) W. E. Wilson showed that the presence of 3.6 grams of radium in each cubic metre of the sun's mass was sufficient to account for the present rate of emission of energy by the sun. This calculation was based on the estimate of Curie and Laborde, that one gram

¹ Prof. Thomson's paper has just appeared. *Phil. Mag.* March, 1904.

² *Quarterly Review*, p. 123, Jan. 1904.

³ *Phil. Mag.* May, 1903.

of radium emits 100 gram-calories per hour, and on the observation of Langley that each square centimetre of the sun's surface emits 8.28×10^6 gram-calories per hour. Since the average density of the sun is 1.44, the presence of radium in the sun, to the extent of 2.5 parts by weight in a million, would account for its present rate of emission of energy.

An examination of the spectrum of the sun has not so far revealed any of the radium lines. It is known, however, from spectroscopic evidence that helium is present, and this indirectly suggests the existence of radio-active matter also. It can readily be shown¹ that the absence of penetrating rays from the sun at the surface of the earth does not imply that the radio-elements are not present in the sun. Even if the sun were composed of pure radium, it would hardly be expected that the γ rays emitted would be appreciable at the surface of the earth, since the rays would be almost completely absorbed in passing through the atmosphere, which corresponds to a thickness of 76 centimetres of mercury.

In the Appendix E of Thomson and Tait's *Natural Philosophy*, Lord Kelvin has calculated the energy lost in the concentration of the sun from a condition of infinite dispersion, and concludes that it seems "on the whole probable that the sun has not illuminated the earth for 100,000,000 years and almost certain that he has not done so for 500,000,000 years. As for the future we may say, with equal certainty, that inhabitants of the earth cannot continue to enjoy the light and heat essential to their life for many million years longer, unless sources now unknown to us are prepared in the great storehouses of creation."

The discovery that a small mass of a substance like radium can emit spontaneously an enormous quantity of heat renders it possible that this estimate of the age of the sun's heat may be much increased. In a letter to *Nature* (Sept. 24, 1903) G. H. Darwin drew attention to this probability, and stated that, "The lost energy of the sun, supposed to be a homogeneous sphere of mass M and radius a , is $\frac{3}{5}\mu M^2/a$ where μ is the constant of gravitation. On introducing numerical values for the symbols in this formula, I find the lost energy to be $2.7 \times 10^7 M$ calories where

¹ See Strutt and Joly, *Nature*, Oct. 15, 1903.

M is expressed in grams. If we adopt Langley's value of the solar constant, this heat suffices to give a supply for 12 million years. Lord Kelvin used Pouillet's value for that constant, but if he had been able to use Langley's, his 100 million would have been reduced to 60 million. The discrepancy between my results of 12 million and his of 60 million is explained by a conjectural augmentation of the lost energy to allow for the concentration of the solar mass towards its central parts." Now it has been shown (section 205) that one gram of radium emits during its life an amount of heat which probably lies between 2×10^9 and 5×10^{10} gram-calories. It has also been pointed out that there is every reason to suppose that a similar amount of energy is resident in the chemical atoms of the inactive elements. It is not improbable that, at the enormous temperature of the sun, the breaking up of the elements into simpler forms may be taking place at a more rapid rate than on the earth. If the energy resident in the atoms of the elements is thus available, the time during which the sun may continue to emit heat at the present rate may be from 50 to 500 times longer than was computed by Lord Kelvin from dynamical data.

Similar considerations apply to the question of the probable age of the earth. A full discussion of the probable age of the earth, computed from its secular cooling from a molten mass, is given by Lord Kelvin in Appendix D of Thomson and Tait's *Natural Philosophy*. He has there shown that about 100 million years after the earth was a molten mass, the gradual cooling due to radiation from its surface would account for the average temperature gradient of 1.50° F. per foot, observed to-day near the earth's surface.

Some considerations will now be discussed which point to the probability that the present temperature gradient observed in the earth cannot be used as a guide to estimate the length of time that has elapsed since the earth has been at a temperature capable of supporting animal and vegetable life; for it will be shown that probably there is sufficient radio-active matter on the earth to supply as much heat to the earth as is lost by radiation from its surface. Taking the average conductivity K of the materials of the earth as $.004$ (C.G.S. units) and the temperature gradient T near

the surface as $\cdot 00037^{\circ}$ C. per cm., the heat Q in gram-calories conducted to the surface of the earth per second is given by

$$Q = 4\pi R^2 \cdot K \cdot T$$

where R is the radius of the earth.

Let X be the average amount of heat liberated per second per cubic centimetre of the earth's volume owing to the presence of radio-active matter. If the heat Q radiated from the earth is equal to the heat supplied by the radio-active matter on the earth,

$$X \cdot \frac{4}{3}\pi R^3 = 4\pi R^2 K T$$

or

$$X = \frac{3KT}{R}.$$

Substituting the values of these constants,

$$\begin{aligned} X &= 7 \times 10^{-15} \text{ gram-calorie per second} \\ &= 2 \cdot 2 \times 10^{-7} \text{ gram-calorie per year.} \end{aligned}$$

Since 1 gram of radium emits 864,000 gram-calories per year, the presence of $2 \cdot 6 \times 10^{-13}$ gram of radium per unit volume or $4 \cdot 6 \times 10^{-14}$ gram per unit mass, would compensate for the heat lost from the earth by conduction.

Now it will be shown in the following chapter that radio-active matter seems to be distributed fairly uniformly through the earth and atmosphere. In addition it has been found that all substances are radio-active to a feeble degree, although it is not yet settled whether this radio-activity may not be due mainly to the presence of a radio-element as an impurity. For example, Strutt¹ observed that a platinum plate was about 1/3000 as active as a crystal of uranium nitrate, or about 2×10^{-10} as active as radium. This corresponds to a far greater activity than is necessary to compensate for the loss of heat of the earth. A more accurate deduction, however, can be made from data of the radio-activity exhibited by matter dug out from the earth. Elster and Geitel² filled a dish of volume $3 \cdot 3 \times 10^3$ c.c. with clay dug up from the garden, and placed it in a vessel of 30 litres capacity in which was placed an electro-

¹ Strutt, *Phil. Mag.* June, 1903.

² Elster and Geitel, *Phys. Zeit.* 4, No. 19, p. 522, 1903. *Chem. News*, July 17, p. 30, 1903.

scope to determine the conductivity of the enclosed gas. After standing for several days, he found that the conductivity of the air reached a constant maximum value, corresponding to three times the normal. It will be shown later (section 218) that the normal conductivity observed in sealed vessels corresponds to the production of about 30 ions per c.c. per second. The number of ions produced per second in the vessel by the radio-active earth was thus about 2×10^6 . This would give a saturation current through the gas of 2.2×10^{-14} electro-magnetic units. Now the emanation from 1 gram of radium stored in a metal cylinder gives a saturation current of about 3.2×10^{-5} electro-magnetic units. Elster and Geitel considered that most of the conductivity observed in the gas was due to a radio-active emanation, which gradually diffused from the clay into the air in the vessel. The increased conductivity in the gas observed by Elster and Geitel would thus be produced by the emanation from 7×10^{-10} gram of radium. Taking the density of clay as 2, this corresponds to about 10^{-13} gram of radium per gram of clay. But it has been shown that if 4.6×10^{-14} gram of radium was present in each gram of earth, the heat emitted would compensate for the loss of heat of the earth by conduction and radiation. The amount of activity observed in the earth is thus about the right order of magnitude to account for the heat emission required. In the above estimate, the presence of uranium and thorium minerals in the earth has not been considered. In addition, it is probable that the total amount of radio-activity in clay was considerably greater than that calculated, for it is likely that other radio-active matter was present which did not give off an emanation.

I think we may conclude that the present rate of loss of heat of the earth might have continued unchanged for long periods of time in consequence of the supply of heat from radio-active matter in the earth. It thus seems probable that the earth may have remained for very long intervals of time at a temperature not very different from that observed to-day, and that in consequence the time during which the earth has been at a temperature capable of supporting the presence of animal and vegetable life may be very much longer than the estimate made by Lord Kelvin from other data.

208. Evolution of matter. Although the hypothesis that all matter is composed of some elementary unit of matter or protyle has been advanced as a speculation at various times by many prominent physicists and chemists, the first definite experimental evidence showing that the chemical atom was not the smallest unit of matter was obtained in 1897 by J. J. Thomson in his classic research on the nature of the cathode rays produced by an electric discharge in a vacuum tube. Sir William Crookes, who was the first to demonstrate the remarkable properties of these rays, had suggested that they consisted of streams of projected charged matter and represented—as he termed it—a new or “fourth state of matter.”

J. J. Thomson showed by two distinct methods that the cathode rays consisted of a stream of negatively charged particles projected with great velocity. The particles behaved as if their mass was only about 1/1000 of the mass of the atom of hydrogen, which is the lightest atom known. These corpuscles, as they were termed by Thomson, were found at a later date to be produced from a glowing carbon filament and from a zinc plate exposed to the action of ultra-violet light. They acted as isolated units of negative electricity, and, as we have seen, may be identified with the electrons studied mathematically by Larmor and Lorentz. Not only were these electrons produced by the action of light, heat, and the electric discharge, but they were also found to be spontaneously emitted from the radio-elements with a velocity far greater than that observed for the electrons in a vacuum tube.

The electrons produced in these different ways were all found to carry a negative charge and to be apparently identical; for the ratio e/m of the charge of the electron to its mass was in all cases the same within the limit of experimental errors. Since electrons, produced from different kinds of matter and under different conditions, were in all cases identical, it seemed probable that they were a constituent part of all matter. J. J. Thomson suggested that the atom is built up of a number of these negatively charged electrons combined in some way with corresponding positively charged bodies.

On this view the atoms of the chemical elements differ from one another only in the number and arrangement of the component electrons.

The removal of an electron from the atom does not appear to permanently affect the stability of the system, for no evidence has so far been obtained to show that the passage of an intense electric discharge through a gas results in a permanent alteration of the structure of the atom. On the other hand, in the case of the radio-active bodies, a positively charged particle of mass about twice that of the hydrogen atom escapes from the heavy radio-atom. This appears to result at once in a permanent alteration of the atom, and causes a marked change in its physical and chemical properties. In addition there is no evidence that the process is reversible.

The only direct experimental evidence of the transformation of matter has been derived from a study of the radio-active bodies. If the disintegration theory, advanced to account for the phenomena of radio-activity, is correct in the main essentials, then the radio-elements are undergoing a spontaneous and continuous process of transformation into other and different kinds of matter. The rate of transformation is slow in uranium and thorium, but is fairly rapid in radium. It has been shown that the fraction of a mass of radium which is transformed per year lies between $1/2000$ and $1/10000$ of the total amount present. In the case of uranium and thorium probably a million years would be required to produce a similar amount of change. The process of transformation in uranium and thorium is thus far too slow to be detected within a reasonable time by the use of the balance or spectroscope, but the radiations which accompany the transformation can readily be detected. Although the process of change is slow it is continuous, and in the course of ages the uranium and thorium present in the earth must be transformed into other and simpler types of matter.

Those who have considered the possibility of atoms undergoing a process of transformation, have generally thought that the matter as a whole would undergo a progressive change, with a gradual alteration of physical and chemical properties of the whole mass of substance. On the theory of disintegration this is not the case. Only a minute fraction of the matter present breaks up in unit time, and in each of the succession of stages through which the disintegrated atoms pass, there is in most cases a marked

alteration in the chemical and physical properties of the matter. The transformation of the radio-elements is thus a transformation of a part *per saltum*, and not a progressive change of the whole. At any time after the process of transformation has been in progress there will thus remain a part of the matter which is unchanged, and, mixed with it, the products which have resulted from the transformation of the remainder.

The question naturally arises whether the process of degradation of matter is confined to the radio-elements or is a universal property of matter. It will be shown in chapter XI. that all matter, so far examined, exhibits the property of radio-activity to a slight degree. It still remains to be shown, however, that the observed radio-activity is not due to the presence in the matter of a slight trace of a radio-element. If ordinary matter is radio-active, it is certain that its activity is not greater than that of uranium, and consequently that its rate of transformation must be excessively slow. There is, however, another possibility to be considered. The changes occurring in the radio-elements would probably never have been detected if the change had not been accompanied by the expulsion of charged particles with great velocity. It does not seem unlikely that an atom may undergo disintegration without projecting a part of its system with great velocity. In fact, we have seen that, even in the radio-elements, one of the series of changes in both thorium and radium is unaccompanied by ionizing rays. It may thus be possible that all matter is undergoing a slow process of transformation, which has so far only been detected in the radio-elements on account of the expulsion of charged particles during the change. This process of degradation of matter continuing for ages must reduce the constituents of the earth to the simpler and more stable forms of matter.

The idea that helium is a transformation product of radium, suggests the probability that helium is one of the more elementary substances of which the heavier atoms are composed. Sir Norman Lockyer, in his interesting book on "Inorganic Evolution," has pointed out that the spectrum of helium and of hydrogen predominates in the hottest stars. In the cooler stars the more complex types of matter appear. Sir Norman Lockyer has based

his theory of evolution of matter on evidence of a spectroscopic examination of the stars, and considers that temperature is the main factor in breaking up matter into its simpler forms. The transformation of matter occurring in the radio-elements is on the other hand spontaneous, and independent of temperature over the range examined.

CHAPTER XI.

RADIO-ACTIVITY OF THE ATMOSPHERE AND OF ORDINARY MATERIALS.

209. Radio-activity of the atmosphere. The experiments of Geitel¹ and C. T. R. Wilson² in 1900 had shown that a positively or negatively charged conductor placed inside a closed vessel gradually lost its charge. This loss of charge was shown to be due to a small ionization of the air inside the vessel. In addition, Elster and Geitel had found that a charged body exposed in the open air lost its charge rapidly, and that the rate of discharge was dependent on the locality and on atmospheric conditions. A more detailed description and discussion of these results will be given later in section 218.

In the course of these experiments Geitel had observed that the rate of discharge increased slightly for some time after the vessel had been closed. He considered that this might possibly be due to the existence of some radio-active substances in the air, which produced excited activity in the walls of the vessel and so increased the rate of dissipation of the charge. In 1901 Elster and Geitel³ tried the bold experiment of seeing if it were possible to extract a radio-active substance from the air. The experiments of the writer had shown that the excited radio-activity from the thorium emanation could be concentrated on the negative electrode in a strong electric field. This result indicated that the carriers of the radio-activity had a positive charge of electricity. Elster and Geitel therefore tried an experiment to see if positively charged

¹ *Phys. Zeit.* 2, p. 116, 1900.

² *Proc. Camb. Phil. Soc.* 11, p. 32, 1900. *Proc. Roy. Soc.* 68, p. 151, 1901.

³ *Phys. Zeit.* 2, p. 590, 1901.

carriers, possessing a similar property, were present in the atmosphere. For this purpose a cylinder of wire-netting, charged negatively to 600 volts, was exposed for several hours in the open air. This was then removed and quickly placed in a large bell-jar, inside which was placed an electroscope to detect the rate of discharge. They found that the rate of discharge was increased to a slight extent. In order to multiply the effect, a wire of about 20 metres long was exposed at some height from the ground, and was kept charged to a high potential by connecting it to the negative terminal of an influence machine. After exposure for some hours, this wire was removed and placed inside the dissipation vessel. The rate of discharge was found to be increased many times by the presence of the wire. No increase was observed if the wire had been charged positively instead of negatively. The results also showed that the radio-active matter could be removed from the wire in the same way as from a wire made active by exposure in the presence of the thorium emanation. A piece of leather moistened with ammonia was rubbed over the active wire. On testing the leather it was found to be strongly radio-active. If a long wire were used, the amount of activity obtained on the leather was comparable to that possessed by a gram of uranium oxide.

The activity produced on the wire was not permanent, but disappeared to a large extent in the course of a few hours. The amount of activity produced on a wire of given size, exposed under similar conditions, was independent of the material of the wire. Lead, iron and copper wires gave about equal effects.

The amount of activity obtained was greatly increased by exposing a negatively charged wire in a mass of air which had been undisturbed for a long time. Experiments were made in the great cave of Wolfenbüttel, and a very large amount of activity was observed. By transferring the activity to a piece of leather it was found¹ that the rays could appreciably light up a screen of barium platinocyanide in the dark. The rays also darkened a photographic plate through a piece of aluminium 0.1 mm. in thickness.

These remarkable experiments show that the excited radio-activity obtained from the atmosphere is very similar in character

¹ *Phys. Zeit.* 3, p. 76, 1901.

to the excited activity produced by the emanations of radium and thorium. No investigators have contributed more to our knowledge of the radio-activity and ionization of the atmosphere than Elster and Geitel. The experiments here described have been the starting-point of a series of researches by Elster and Geitel and others on the radio-active properties of the atmosphere which have led to a great extension of our knowledge of that important subject.

Rutherford and Allan¹ determined the rate of decay of the excited activity produced on a negatively charged wire exposed in the open air. A wire about 15 metres long was exposed in the open air, and kept charged by an influence machine to a potential of about -10000 volts. An hour's exposure was sufficient to obtain a large amount of excited activity on the wire. The wire was then rapidly removed and wound on a framework which formed the central electrode in a large cylindrical metal vessel. The ionization current for a saturation voltage was measured by means of a sensitive Dolezalek electrometer. The current, which is a measure of the activity of the wire, was found to diminish according to an exponential law with the time, falling to half value in about 45 minutes. The rate of decay was independent of the material of the wire, of the time of exposure, and of the potential of the wire.

An examination was also made of the nature of the rays emitted by the radio-active wire. For this purpose a lead wire was made radio-active in the manner described, and then rapidly wound into the form of a flat spiral. The penetrating power of the rays was tested in a vessel similar to that shown in Fig. 16. Most of the ionization was found to be due to some very easily absorbed rays, which were of a slightly more penetrating character than the α rays emitted from a wire made active by the radium or thorium emanations. The intensity of the rays was cut down to half value by about 0.001 cm. of aluminium. The photographic action observed by Elster and Geitel through 0.1 mm. of aluminium showed that some penetrating rays were also present. This was afterwards confirmed by Allan, using the electric method. These penetrating rays are probably similar in character to the β rays from the radio-elements.

¹ *Phil. Mag.* Dec. 1902.

210. The excited activity produced on the negatively charged wire cannot be due to an action of the strong electric field on the surface of the wire; for very little excited activity is produced if the wire is charged to the same potential inside a closed cylinder.

We have seen that the excited activity produced on the wire can be partially removed by rubbing, and by solution in acids, and, in this respect, it is similar to the excited activity produced in bodies by the emanations of radium and thorium. The very close similarity of the excited activity obtained from the atmosphere to that obtained from the radium and thorium emanations suggests the probability that a radio-active emanation exists in the atmosphere. This view is confirmed by a large amount of indirect evidence discussed in sections 212 and 213.

Assuming the presence of a radio-active emanation in the atmosphere, the radio-active effects observed receive a simple explanation. The emanation in the air gradually breaks up, giving rise in some way to positively charged radio-active carriers. These are driven to the negative electrode in the electric field, and there undergo a further change, giving rise to the radiations observed at the surface of the wire. The matter which causes excited activity will thus be analogous to the emanation X of radium and thorium.

Since the earth is negatively electrified with regard to the upper atmosphere, these positive radio-active carriers produced in the air are continuously deposited on the surface of the earth. Everything on the surface of the earth, including the external surface of buildings, the grass, and leaves of trees, must be covered with an invisible deposit of radio-active material. A hill or mountain peak, or any high mass of rock or land, concentrates the earth's electric field at that point and consequently will receive more excited radio-activity per unit area than the plain. Elster and Geitel have pointed out that the greater ionization of the air observed in the neighbourhood of projecting peaks receives a satisfactory explanation on this view.

If the radio-active carriers are produced at a uniform rate in the atmosphere, the amount of excited activity I_t , produced on a wire exposed under given conditions, will, after exposure for a time t , be given by $I_t = I_0(1 - e^{-\lambda t})$ where I_0 is the maximum

activity on the wire and λ is the constant of decay of the excited activity. Since the activity of a wire after removal falls to half value in about 45 minutes, the value of λ is 0.92 with one hour as the unit of time. Some experiments made by Allan are in rough agreement with the above equation. Accurate comparative results are difficult to obtain on account of the inconstancy of the radio-activity of the open air. After an exposure of a wire for several hours, the activity reached a practical maximum, and was not much increased by continued exposure.

A wire charged to a high potential in the open air abstracts the positive radio-active carriers from a large volume of air. Very little excited activity, in comparison, is produced in a closed vessel or by drawing a rapid current of the outside air through a cylinder in the centre of which a negatively charged rod is placed. In one experiment a current of air of 500 cms. per second was drawn through a cylinder of 141 litres capacity. The amount of activity produced on the negative electrode was only a few per cent. of the amount observed on the same electrode charged to the same potential in the open air.

The amount of excited activity produced on a wire, supported some distance from the surface of the earth, should increase steadily with the voltage, for the greater the potential, the greater the volume of air from which the radio-active carriers are abstracted.

The presence of radio-active matter in the atmosphere will account for a portion of the ionization of the air observed near the earth. It seems unlikely, however, that the whole of the ionization observed in the air is due to this cause alone.

211. Radio-activity of freshly fallen rain and snow.

C. T. R. Wilson¹ tried experiments to see if any of the radio-active material from the air was carried down by rain. For this purpose a quantity of freshly fallen rain was collected, rapidly evaporated to dryness in a platinum vessel, and the activity of the residue tested by placing the vessel in an electroscope. In all cases, the rate of discharge of the electroscope was considerably increased. From about 50 c.c. of rain water, an amount of activity was obtained sufficient to increase the rate of discharge of the

¹ *Proc. Camb. Phil. Soc.* 11, Pt. vi. p. 428, 1902.

electroscope four or five times, after the rays had traversed a thin layer of aluminium or gold leaf. The activity disappeared in the course of a few hours, falling to half value in about 30 minutes. Rain water, which had stood for some hours, showed no trace of activity. Tap water, when evaporated, left no active residue.

The amounts of activity obtained from a given quantity of rain water were all of the same order of magnitude, whether the rain was precipitated in fine or in large drops, by night or by day, or whether the rain was tested at the beginning or at the end of a heavy rainfall lasting several hours.

The activity obtained from rain is not destroyed by heating the platinum vessel to a red heat. In this and other respects it resembles the excited activity obtained on negatively charged wires exposed in the open air.

C. T. R. Wilson¹ obtained a radio-active precipitate from rain water by adding a little barium chloride and precipitating the barium with sulphuric acid. An active precipitate was also obtained if alum was added to the water, and the aluminium precipitated by ammonia. The precipitates obtained in this way showed a large activity. The filtrate when boiled down was quite inactive, showing that the active matter had been completely removed by precipitation. The production of active precipitates from rain water is quite analogous to the production of active precipitates from a solution containing the emanation X of thorium (see section 178).

The radio-activity of freshly fallen snow was independently observed by C. T. R. Wilson² in England, and Allan³ and McLennan⁴ in Canada. In order to obtain a large amount of activity, the surface layer of snow was removed, and evaporated to dryness in a metal vessel. An active residue was obtained with radio-active properties similar to those observed for freshly fallen rain. Both Wilson and Allan found that the activity of rain and snow decayed at about the same rate, the activity falling to half value in about 30 minutes. McLennan states that he found a smaller amount of radio-activity in the air after a prolonged fall of snow.

¹ *Proc. Roy. Soc.* Vol. 12, 1902.

² *Proc. Camb. Phil. Soc.* 12, p. 85, 1903.

³ *Phys. Rev.* 16, p. 106, 1903.

⁴ *Phys. Rev.* 16, p. 184, 1903.

Schmauss¹ has observed that drops of water falling through air ionized by Röntgen rays acquire a negative charge. This effect is ascribed to the fact that the negative ions in air diffuse faster than the positive. On this view the drops of rain and flakes of snow would acquire a negative charge in falling through the air. They would in consequence act as collectors of the positive radio-active carriers from the air. On evaporation of the water the radio-active matter would be left behind.

212. Radio-active emanations from the earth. Elster and Geitel observed that the air in caves and cellars was, in most cases, abnormally radio-active, and showed very strong ionization. This action might possibly be due to an effect of stagnant air, by which it produced a radio-active emanation from itself, or to a diffusion of a radio-active emanation from the soil. In order to test if this emanation was produced by the air itself, Elster and Geitel shut up the air for several weeks in a large boiler, but no appreciable increase of the activity or ionization was observed. In order to test if the air imprisoned in the capillaries of the soil was radio-active Elster and Geitel² put a pipe into the earth and sucked up the air into a testing vessel by means of a water pump.

The apparatus employed to test the ionization of the air is shown in Fig. 59. *C* is an electroscope connected with a wire net, *Z*. The active air was introduced into the large bell-jar of 27 litres capacity, the inside of which was covered with wire netting, *MM'*. The bell-jar rested on an iron plate *AB*. The electroscope could be charged by the rod *S*. The rate of discharge of the electroscope, before the active air was introduced, was noted. On allowing the active air to enter, the rate of discharge increased rapidly, rising in the course of a few hours in one experiment to 30 times the original value. They found that the emanation produced excited activity on the walls of the containing vessel. The air sucked up from the earth was even more active than that observed in caves and cellars. There can thus be little doubt that the abnormal activity observed in caves and cellars is due to a radio-active emanation, present in the earth, which gradually diffuses to the surface and collects in places where the air is not disturbed.

¹ *Drude's Annal.* 9, p. 224, 1902.

² *Phys. Zeit.* 3, p. 574, 1902.

The results obtained by Elster and Geitel for the air removed from the earth at Wolfenbüttel were also obtained later by Ebert and Ewers¹ at Munich. They found a strongly active emanation in the soil, and, in addition, examined the variation with time of the activity due to the emanation in a sealed vessel. After the introduction of the active air into the testing vessel, the activity was observed to increase for several hours, and then to decay, according to an exponential law, with the time, falling to half value in about 3.2 days. This rate of decay is more rapid than that observed for the radium emanation, which decays to half

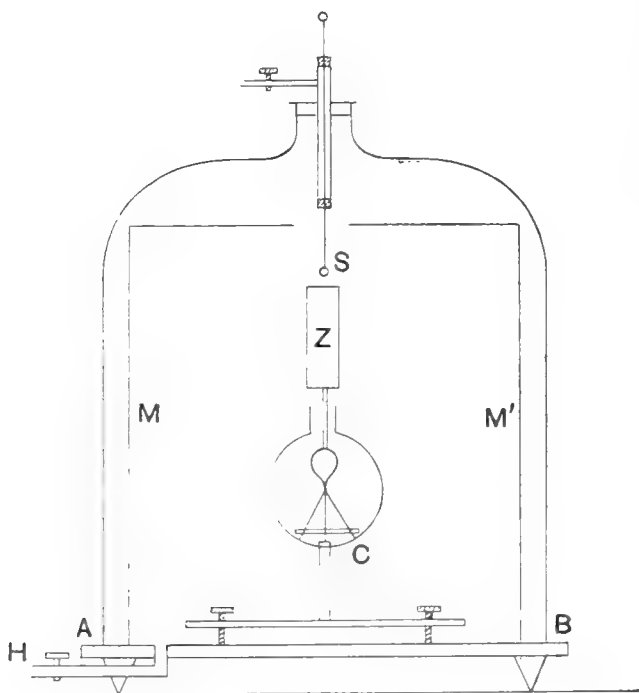

Fig. 59.

value in a little less than four days. The increase of activity with time is probably due to the production of excited activity on the walls of the vessel by the emanation. In this respect it is analogous to the increase of activity observed when the radium emanation is introduced into a closed vessel. No definite experiments were made by Ebert and Ewers on the rate of decay of this excited activity. In one experiment the active emanation, after standing in the vessel for 140 hours, was removed by sucking ordinary air

¹ *Phys. Zeit.* 4, p. 162, 1902.

of small activity through the apparatus. The activity rapidly fell to about half value, and this was followed by a very slow decrease of the activity with time. This result indicates that about half the rate of discharge observed was due to the radiation from the emanation and the other half to the excited activity produced by it.

The apparatus employed by Ebert and Ewers in these experiments was very similar to that employed by Elster and Geitel, shown in Fig. 59. Ebert and Ewers observed that when the wire net attached to the electroscope was charged negatively the rate of discharge observed was always greater than when it was charged positively. The differences observed between the two rates of discharge varied between 10 and 20 per cent. This difference in the rates of discharge for positive and negative electricity is probably connected with the presence of particles of dust or small water globules suspended in the gas. The experiments of Miss Brooks (section 171) have shown that the particles of dust present in the air containing the thorium emanation become radio-active. A large proportion of these dust particles acquire a positive charge and are carried to the negative electrode in an electric field. This effect would increase the rate of discharge of the electroscope when charged negatively. In later experiments, Ebert and Ewers observed that, in some cases, if the air had been kept in the vessel for several days, the effect was reversed, and the electroscope showed a great rate of discharge when charged positively.

J. J. Thomson¹ has observed that the magnitude of the ionization current depends on the direction of the electric field, if fine water globules are suspended in the ionized gas.

In later experiments, Ebert² found that the radio-active emanation could be removed from the air by condensation in liquid air. This property of the emanation was independently discovered by Ebert before he was aware of the results of Rutherford and Soddy on the condensation of the emanations of radium and thorium. In order to increase the amount of radio-active emanation in a given volume of air, a quantity of the active air, obtained by sucking the air from the soil, was condensed by a liquid air machine. The air was then allowed to partially evaporate, but the process was stopped

¹ *Phil. Mag.* Sept. 1902.

² *Sitz. Akad. d. Wiss. Munich*, 33, p. 133, 1903.

before the point of volatilization of the emanation was reached. This process was repeated with another quantity of air and the residues added together. Proceeding in this way, he was able to concentrate the emanation in a small volume of air. On allowing the air to evaporate, the ionization of the air in the testing vessel increased rapidly for a time and then slowly diminished. Ebert states that the maximum was reached earlier for the emanation which had been liquefied for some time than for fresh air. The rate of decay of activity of the emanation was not altered by keeping it at the temperature of liquid air for some time. In this respect it behaves like the emanations of radium and thorium.

J. J. Thomson¹ found that air bubbled through Cambridge tap water showed much greater conductivity than ordinary air. The air was drawn through the water by means of a water pump into a large gasometer, when the ionization current was tested with a sensitive electrometer. When a rod charged negatively was introduced into this conducting air it became active. After an exposure for a period of 15 to 30 minutes in the conducting gas, the rod, when introduced into a second testing vessel, increased the saturation current in the vessel to about five times the normal amount. Very little effect was produced if the rod was uncharged or charged positively for the same time. The activity of the rod decayed with the time, falling to half value in about 40 minutes. The amount of activity produced in a wire under constant conditions was independent of the material of the wire. The rays from the rod were readily absorbed in a few centimetres of air.

These effects were, at first, thought to be due to the action of the small water drops suspended in the gas, for it was well known that air rapidly drawn through water causes a temporary increase in its conductivity. Later results, however, showed that there was a radio-active emanation present in Cambridge tap water. This led to an examination of the waters from deep wells in various parts of England, and J. J. Thomson found that, in some cases, a large amount of emanation could be obtained from the well water. The emanation was released either by bubbling air through the water or by boiling the water. The gases obtained by boiling the water were found to be strongly active. A sample of

¹ *Phil. Mag.* Sept. 1902.

air mixed with the radio-active emanation was condensed. The liquefied gas was allowed to evaporate, and the earlier and last portions of the gas were collected in separate vessels. The final portion was found to be about 30 times as active as the first portion.

An examination of the radio-active properties of the active gases so obtained has been made by Adams¹. He found that the activity of the emanation decayed in an exponential law with the time, falling to half value in about 3·4 days. This is not very different from the rate of decay of the activity of the radium emanation, which falls to half value in a little less than four days. The excited activity produced by the emanation decayed to half value in about 35 minutes. The decay of the excited activity from radium is at first irregular, but after some time falls off in an exponential law, diminishing to half value in 28 minutes. Taking into account the uncertainty attaching to measurements of the very small ionization observed in these experiments, the results indicate that the emanation obtained from well water in England is similar to, if not identical with, the radium emanation. Adams observed that the emanation was slightly soluble in water. After well water had been boiled for some time and then put aside, it was found to recover its power of giving off an emanation with time. The amount obtained after standing for some time was never more than 10 per cent. of the amount first obtained. Thus it is probable that the well water, in addition to the emanations mixed with it, has also a slight amount of a permanent radio-active substance dissolved in it. Ordinary rain water or distilled water does not give off an emanation.

Bumstead and Wheeler² have recently made a very careful examination of the radio-activity of the emanation obtained from the surface water and soil at New Haven, Connecticut. The emanation, obtained from the water by boiling, was passed into a large testing cylinder, and measurements of the current were made by means of a sensitive electrometer. The current gradually rose to a maximum after the introduction of the emanation, in exactly the same way as the current increases in a vessel after the introduction of the radium emanation. The decay of activity of

¹ *Phil. Mag.* Nov. 1903.

² *Amer. Journ. Science*, 17, p. 97, Feb. 1904.

the emanations obtained from the water and soil was carefully measured, and within the limit of experimental error agreed with the decay of activity observed with the radium emanation. The identity of the emanations from the water and soil with the radium emanation was still further established by experiments on the rate of diffusion of the emanation through a porous plate. By comparative tests it was found that the coefficient of diffusion of the emanations from the water and soil was the same as for the radium emanation. In addition, by comparison of the rate of diffusion of carbonic acid, it was found that the density of the emanation was about four times that of carbonic acid, a result in good accord with that found for the radium emanation (section 153).

213. Radio-activity of constituents of the earth. Elster and Geitel¹ observed that, although in many cases the conductivity of the air was abnormally high in underground enclosures, the conductivity varied greatly for different places. In the Baumann Cave, for example, the conductivity of the air was nine times the normal, but in the Iberg Cave only three times the normal. In a cellar at Clausthal the conductivity was only slightly greater than the normal, but the excited radio-activity obtained on a negatively charged wire exposed in it was only 1/11 of the excited radio-activity obtained when the wire was exposed in the free air. It was concluded from these experiments that the amount of radio-activity in the different places probably varied with the nature of the soil. Observations were then made on the conductivity of the air sucked up from the earth at different parts of the country. The clayey and limestone soils at Wolfenbüttel were found to be strongly active, the conductivity varying from four to sixteen times the normal amount. A sample of air from the shell limestone of Würzburg and from the basalt of Wilhelmshöhe showed very little activity.

Experiments were made to see if any radio-active substance could be detected in the soil itself. For this purpose some earth was placed on a dish and introduced under a bell-jar, similar to that shown in Fig. 59. The conductivity of the air in the bell-jar

¹ *Phys. Zeit.* 4, p. 522, 1903.

increased with the time, rising to three times the normal value after several days. Little difference was observed whether the earth was dry or moist. The activity of the soil seemed to be permanent, for no change in the activity was observed after the earth had been laid aside for eight months.

Attempts were then made to separate the radio-active constituent from the soil by chemical treatment. For this purpose a sample of clay was tested. By extraction with hydrochloric acid all the calcium carbonate was removed. On drying the clay, the activity was found to be reduced, but it spontaneously regained its original activity in the course of a few days. It thus seems probable that an active product had been separated from the soil by the acid. Elster and Geitel consider that an active substance was present in the clay, which formed a product more readily soluble in hydrochloric acid than the active material itself. There seemed to be a process analogous to the separation of Th X from thorium by precipitation with ammonia.

Experiments were also made to see if substances placed in the earth acquired any radio-activity. For this purpose samples of potter's clay, whitening, and heavy spar, wrapped in linen, were placed in the earth 50 cms. below the surface. After an interval of a month, these were dug up and their activity examined. The clay was the only substance which showed any activity. The activity of the clay diminished with the time, showing that activity had been excited in it by the emanations present in the soil.

Elster and Geitel¹ have recently found that a large quantity of the radio-active emanation can be obtained by sucking air through clay. In some cases, the conductivity of the air in the testing vessel was increased over 100 times. They have also found that "fango"—a fine mud obtained from hot springs in Battaglia, Northern Italy—gives off three or four times as much emanation as clay. By treating the fango with acid, the active substance present was dissolved. On adding some barium chloride to the solution, and precipitating the barium as sulphate, the active substance was removed, and in this way a precipitate was obtained over 100 times as active, weight for weight, as the original fango. Comparisons were made of the rate of decay of the excited activity,

¹ *Phys. Zeit.* 5, No. 1, p. 11, 1903.

due to the emanation from fango, with that due to the radium emanation, and within the limit of error, the decay curves obtained were found to be identical. There can thus be little doubt that the activity observed in fango is due to the presence of a small quantity of radium. Elster and Geitel calculate that the amount of radium, contained in it, is only about one thousandth of the amount to be obtained from an equal weight of pitchblende from Joachimstahl.

The natural carbonic acid arising from great depths of old volcanic soil was also tested. The carbon dioxide was obtained from the works in the liquid state. The gas was found to show distinct activity, and was able to produce excited activity on the surface of the vessel. After an interval of 16 days the gas was again tested and found to be inactive.

These results are similar to those of J. J. Thomson, who found an active emanation in the water obtained from deep wells.

214. Effect of meteorological conditions upon the radio-activity of the atmosphere. The original experiments of Elster and Geitel on the excited radio-activity derived from the atmosphere were repeated by Rutherford and Allan¹ in Canada. It was found that a large amount of excited radio-activity could be derived from the air, and that the effects were similar to those observed by Elster and Geitel in Germany. This was the case even on the coldest day in winter, when the ground was covered deeply with snow and the wind was blowing from the north over snow-covered lands. The results showed that the radio-activity present in the air was not much affected by the presence of moisture, for the air during a Canadian winter is extremely dry. The greatest amount of excited activity on a negatively charged wire was obtained in a strong wind. In some cases the amount produced for a given time of exposure was ten to twenty times the normal amount. A cold bright day of winter usually gave more effect than a warm dull day in summer.

Elster and Geitel² have made a detailed examination of the effect of meteorological conditions on the amount of excited radio-activity to be derived from the atmosphere. For this purpose a

¹ *Phil. Mag.* Dec. 1902.

² *Phys. Zeit.* 4, pp. 137, 138. 1902.

simple portable apparatus¹ was devised by them and used for the whole series of experiments. A large number of observations were taken, extending over a period of twelve months. They found that the amount of excited activity obtained was subject to great variations. The extreme values obtained varied in the ratio of 16 to 1. No direct connection could be traced between the amount of ionization in the atmosphere and the amount of excited activity produced. They found that the greatest amount of excited activity was obtained during a fog, while the amount of ionization in the air is then small. This result, however, is not necessarily contradictory to the view that the ionization and activity of the air are to a certain extent connected. From the experiments of Miss Brooks on the effect of dust in acting as carriers of excited activity, it is to be expected that more excited activity would be obtained during a fog than in clear air. The particles of water become centres for the deposit of radio-active matter. The positive carriers are thus anchored and are not removed from the air by the earth's field. In a strong electric field, these small drops will be carried to the negative electrode and manifest their activity on the surface of the wire. On the other hand, the distribution of water globules throughout the air causes the ions in the air to disappear rapidly in consequence of their diffusion to the surface of the drops (see section 31). For this reason the denser the fog, the smaller will be the conductivity observed in the air.

Lowering the temperature of the air had a decided influence. The average activity observed below 0° C. was 1.44 times the activity observed above 0° C. The height of the barometer was found to exert a marked influence on the amount of excited activity to be derived from the air. The lower the barometer the greater was the amount of excited activity in the air. The effect of variation of the height of the barometer is intelligible, when it is considered that probably a large proportion of the radio-activity observed in the air is due to the radio-active emanations which are continuously diffusing from the earth into the atmosphere. Elster and Geitel have suggested that a lowering of the pressure of the air would cause the air from the ground to be drawn up

¹ *Phys. Zeit.* 4, p. 522, 1903.

from the capillaries of the earth into the atmosphere. This, however, need not necessarily be the case if the conditions of the escape of the emanation into the atmosphere are altered by the variation of the position of underground water or by a heavy fall of rain.

The amount of excited activity to be derived from the air on the Baltic Coast was only one-third of that observed inland at Wolfenbüttel. Experiments on the radio-activity of the air in mid-ocean would be of great importance in order to settle whether the radio-activity observed in the air is due to the emanations from the soil alone. It is to be expected that the radio-activity of the air at different points of the earth would vary widely, and would largely depend on the nature of the soil.

Some interesting experiments have been made by McLennan¹ on the amount of excited radio-activity to be derived from the air when filled with fine spray. The experiments were made at the foot of the American Fall at Niagara. An insulated wire was suspended near the foot of the Fall, and the amount of excited activity on the wire compared with the amount to be obtained on the same wire for the same exposure in Toronto. The amount of activity obtained from the air at Toronto was generally five or six times that obtained from the air at the Falls. In these experiments it was not necessary to use an electric machine to charge the wire negatively, for the falling spray kept the insulated wire permanently charged to a potential of about -7500 volts. These results indicate that the falling spray had a negative charge and electrified the wire. The small amount of the excited radio-activity at the Falls was probably due to the fact that the negatively charged drops abstracted the positively charged radio-active carriers from the atmosphere, and in falling carried them to the river below. On collecting the spray and evaporating it, no active residue was obtained. Such a result is, however, to be expected on account of the minute proportion of the spray tested compared with that present in the air.

215. A very penetrating radiation from the earth's surface. McLennan², and Rutherford and Cooke³ independently

¹ *Phys. Rev.* 16, p. 184, 1903, and *Phil. Mag.* 5, p. 419, 1903.

² *Phys. Rev.* No. 4, 1903.

³ *Americ. Phys. Soc.* Dec. 1902.

observed the presence of a very penetrating radiation inside buildings. McLennan measured the natural conductivity of the air in a large closed metal cylinder by means of a sensitive electrometer. The cylinder was then placed inside another and the space between filled with water. For a thickness of water between the cylinders of 25 cms. the conductivity of the air in the inner cylinder fell to about 63 per cent. of its initial value. This result shows that part of the ionization in the inner cylinder was due to a penetrating radiation from an external source, which radiation was partially or wholly absorbed in water.

Rutherford and Cooke observed that the rate of discharge of a sealed brass electroscope was diminished by placing a lead screen around the electroscope. A detailed investigation of the decrease of the rate of discharge in the electroscope, when surrounded by metal screens, was made later by Cooke¹. A thickness of 5 cms. of lead round the electroscope decreased the rate of discharge about 30 per cent. Further increase of the thickness of the screen had no effect. When the apparatus was surrounded by 5 tons of pig-lead the rate of discharge was about the same as when surrounded by a plate about 3 cms. thick. An iron screen also diminished the rate of discharge to about the same extent as the lead. By suitably arranging lead screens it was found that the radiation came equally from all directions. It was of the same intensity by night as by day. In order to be sure that this penetrating radiation did not arise from the presence of radio-active substances in the laboratory, the experiments were repeated in buildings in which radio-active substances had never been introduced, and also on the open ground far removed from any building. In all cases a diminution of the rate of discharge of the electroscope, when surrounded by lead screens, was observed. These results show that a penetrating radiation is present at the surface of the earth, arising partly from the earth itself and partly from the atmosphere.

This result is not unexpected, when the radio-activity of the earth and atmosphere is taken into account. The writer has found that bodies made active by exposure to the emanations from thorium and radium give out γ rays. It is then to be expected that the very similar excited radio-activity which is present in

¹ *Phil. Mag.* Oct. 1903.

the earth and atmosphere should also give rise to γ rays of a similar character.

216. Comparison of the radio-activity of the atmosphere with that produced by the radio-elements. The radio-active phenomena observed in the earth and atmosphere are very similar in character to those produced by thorium and radium. Radio-active emanations are present in the air of caves and cellars, in natural carbonic acid, and in deep well water, and these emanations produce excited radio-activity on all bodies in contact with them. The question now arises whether these effects are due to known radio-elements present in the earth or to unknown kinds of radio-active matter? The simplest method of testing this point is to compare the rates of decay of the radio-active products in the atmosphere with those of the known radio-active products of thorium and radium. A cursory examination of the facts at once shows that the radio-activity of the atmosphere is much more closely allied to effects produced by radium than to those due to thorium. The activity of the emanation released from well water, and also that sucked up from the earth, decays to half value in about 3.3 days, while the activity of the radium emanation decays to half value in an interval of 3.7 to 4 days. Considering the difficulty of making accurate determinations of these quantities, the rates of decay of the activity of the emanations from the earth and from radium agree within the limits of experimental error. Bumstead and Wheeler have shown that the emanation from the soil and surface water of New Haven is identical with the radium emanation. If the emanation from the earth is the same as that from radium, the excited activity produced should have the same rate of decay as that from radium. The emanation from well water in England approximately fulfils this condition (section 212), but an observation recorded by Ebert and Ewers (section 212) seems to show that the excited activity due to the emanation sucked up from the earth decays at a very slow rate compared with that due to radium.

On comparing the rates of decay of the excited activity derived from the atmosphere and of that produced by radium, the evidence is to some extent conflicting. The activity of a negatively charged

wire, exposed in the open air, decays according to an exponential law with the time, falling to half value in 45 minutes. On the other hand, the activity of freshly fallen rain and snow falls to half value in about 30 minutes. Now the activity of a wire, made active by exposure to the radium emanation, is at first irregular, but about an hour after removal it decays according to an exponential law with the time, falling to half value in 28 minutes. The agreement between the rates of decay of the activity of the emanation in the air and the excited activity produced on rain and snow, with the similar effects produced by radium, strongly supports the view that the radium emanation is present in the soil and atmosphere. Allan¹ has also obtained evidence to show that the rate of decay of the excited activity produced on a negatively charged wire is the resultant of the rates of decay of several types of matter which have different rates of decay. For example, the activity transferred from the active wire to a piece of leather moistened with ammonia, fell to half value in 38 minutes, while on a piece of absorbent felt treated similarly the activity fell to half value in 60 minutes. Thus it seems probable that different types of active matter are collected by the negatively charged wire, which are soluble in ammonia in different degrees. An accurate determination of the rate of decay of the excited activity from actinium would be of interest, in order to see if the activity derived from the air may be due in part to the presence of the actinium emanation.

Considering the results as a whole, there is evidence that other radio-active substances besides radium and thorium are present in the earth. There can be little doubt, however, that part of the radio-activity of the atmosphere is due to the radium emanation, which is continually diffusing into the atmosphere from the pores of the earth. Since radio-activity has been observed in the atmosphere at all points at which observations have, so far, been made, there can be little doubt that radio-active matter is distributed in minute quantities throughout the soil of the earth. The volatile emanations escape into the atmosphere by diffusion, or are carried to the surface in spring water or by the escape of underground gases, and cause the radio-active phenomena observed

¹ *Phys. Rev.* 16, p. 306, 1903.

in the atmosphere. The observation of Elster and Geitel that the radio-activity of the air is much less near the sea than inland is at once explained, if the radio-activity of the atmosphere is due mainly to the diffusion of emanations from the soil into the air above it.

The rare gases helium and xenon which exist in the atmosphere have been tested and found to be non-radio-active. The radio-activity of the air cannot be ascribed to a slight radio-activity possessed by either of these gases.

In order to account for the effect observed, it is only necessary to suppose that the radio-active substance is present in minute quantity mixed with the soil. Suppose, for the purpose of illustration, that the radio-activity of the atmosphere is due to the radium emanation escaping from the earth's surface. The air sucked from the soil in many cases shows 20 times the conductivity of ordinary air. Now it will be shown (section 218) that the natural conductivity of air observed in closed vessels corresponds to a production of about 30 ions per c.c. per second. The active air of 20 times the normal conductivity thus gives rise to about 600 ions per c.c. per second. In 100 litres of this active air the number of ions produced per second is therefore 6×10^7 . Now it has been found that the saturation current in a sealed vessel, due to the emanation from one gram of radium chloride, corresponds to a current of 2.5×10^{-5} electro-magnetic units. Taking the charge of an ion as 1.1×10^{-20} electro-magnetic units, this corresponds to a production of 2.3×10^{15} ions in the gas per second. The emanation present in 100 litres of air, of activity 20 times the normal activity, would thus correspond to the amount released by solution of 3×10^{-8} of a gram of radium chloride. A very minute amount of radium per cubic foot of soil would account for the radio-active effects observed.

217. Radio-activity of ordinary materials. It has been shown that radio-active matter seems to be distributed fairly uniformly over the surface of the earth and in the atmosphere. The very important question arises whether the small radio-activity observed is due to known or unknown radio-elements present in the earth and atmosphere, or to a feeble radio-activity of matter

in general, which is only readily detectable when large quantities of matter are present. The experimental evidence is not yet sufficient to answer this question, but undoubted proof has been obtained that many of the metals show a very feeble radio-activity. Whether this radio-activity is due to the presence of a slight trace of the radio-elements or is an actual property of the metals themselves still remains in doubt. This point will be discussed in more detail later in section 220.

Schuster¹ has pointed out that every physical property hitherto discovered for one element has been found to be shared by all the others in varying degrees. For example, the property of magnetism is most strongly marked in iron, nickel, and cobalt, but all other substances are found to be either feebly magnetic or diamagnetic. It might thus be expected on general principles that all matter should exhibit the property of radio-activity in varying degrees. On the view developed in chapter x. the presence of this property is an indication that the matter is undergoing change accompanied by the expulsion of charged particles. It does not, however, by any means follow that because the atom of one element in the course of time becomes unstable and breaks up, that, therefore, the atoms of all the other elements pass through similar phases of instability.

It has already been mentioned (section 8), that Mme Curie made a very extensive examination of most of the elements and their compounds for radio-activity. The electric method was used, and any substance possessing an activity of 1/100 of that of uranium would certainly have been detected. With the exception of the known radio-elements and the minerals containing uranium and thorium, no other substances were found to be radio-active even to that degree.

Certain substances like phosphorus² possess the property of ionizing a gas under special conditions. The air which is drawn over the phosphorus is conducting, but it has not yet been settled whether this conductivity is due merely to ions formed at the surface of the phosphorus or to ions produced by the phosphorus nuclei or emanations, as they have been termed, which are carried

¹ *British Assoc.* 1903.

² J. J. Thomson, *Conduction of Electricity through Gases*, p. 324, 1903.

along with the current of air. It does not however appear that the ionization of the gas is in any way due to the presence of a penetrating type of radiation such as is emitted by the radio-active bodies. Le Bon (section 8) observed that quinine sulphate, after being heated to a temperature below the melting point and then allowed to cool, showed for a time strong phosphorescence and was able rapidly to discharge an electroscope. The discharging action of quinine sulphate under varying conditions has been very carefully examined by Miss Gates¹. The ionization could not be observed through thin aluminium foil or gold-leaf but appeared to be confined to the surface. The current observed by an electrometer was found to vary with the direction of the electric field, indicating that the positive and negative ions had very different mobilities. The discharging action appears to be due either to an ionization of the gas very close to the surface by some short ultra-violet light waves, accompanying the phosphorescence, or to a chemical action taking place at the surface.

Thus, neither phosphorus nor quinine sulphate can be considered to be radio-active, even under the special conditions when they are able to discharge an electrified body. No evidence in either case has been found that the ionization is due to the emission of a penetrating radiation.

No certain evidence has yet been obtained that any body can be made radio-active by exposure to Röntgen or cathode rays. A metal exposed to the action of Röntgen rays gives rise to a secondary radiation which is very readily absorbed in a few centimetres of air. It is possible that this secondary radiation may prove to be analogous in some respects to the α rays from the radio-elements. The secondary radiation, however, ceases immediately the Röntgen rays are cut off. Villard² observed that a piece of bismuth produced a feeble photographic action after it had been exposed for some time to the action of the cathode rays in a vacuum. It has not however been shown that the bismuth gives out rays of a character similar to those of the radio-active bodies.

The existence of a very feeble radio-activity of ordinary matter

¹ *Amer. Phys. Soc.* Oct. 1903.

² *Société de Physique*, July, 1900.

has been deduced from the study of the conductivity of gases in closed vessels. The conductivity is extremely minute, and special methods are required to determine it with accuracy. A brief account will now be given of the gradual growth of our knowledge on this important question.

218. Conductivity of air in closed vessels. Since the time of Coulomb onwards several investigators have believed that a charged conductor placed inside a closed vessel lost its charge more rapidly than could be explained by the conduction leak across the insulating support. Matteucci, as early as 1850, observed that the rate of loss of charge was independent of the potential. Boys, by using quartz insulators of different lengths and diameters, arrived at the conclusion that the leakage must in part take place through the air. This loss of charge in a closed vessel was believed to be due in some way to the presence of dust particles in the air.

On the discovery that gases became temporary conductors of electricity under the influence of Röntgen rays and the rays from radio-active substances, attention was again drawn to this question. Geitel¹ and C. T. R. Wilson² independently attacked the problem, and both came to the conclusion that the loss of charge was due to a constant ionization of the air in the closed vessel. Geitel employed in his experiments an apparatus similar to that shown in Fig. 59. The loss of charge of an Exner electroscope, with the cylinder of wire netting *Z* attached, was observed in a closed vessel containing about 30 litres of air. The electroscope system was found to diminish in potential at the rate of about 40 volts per hour, and this leakage was shown not to be due to a want of insulation of the supports.

Wilson, on the other hand, used a vessel of very small volume, in order to work with air which could be completely freed from dust. In the first experiments a silvered glass vessel with a volume of only 163 c.c. was employed. The experimental arrangement is shown in Fig. 60.

The conductor, of which the loss of charge was to be measured, was placed near the centre of the vessel *A*. It consisted of a

¹ *Phys. Zeit.* 2, p. 116, 1900.

² *Proc. Camb. Phil. Soc.* 11, p. 52, 1900. *Proc. Roy. Soc.* 68, p. 152, 1901.

narrow strip of metal with a gold-leaf attached. The strip of metal was fixed to the upper rod by means of a small sulphur bead. The upper rod was connected to a sulphur condenser with an Exner electroscope *B* attached to indicate its potential. The gold-leaf system was initially charged to the same potential as the upper rod and condenser by means of a fine steel wire which was caused to touch the gold-leaf system by the attraction of a magnet brought near it. The rate of movement of the gold-leaf

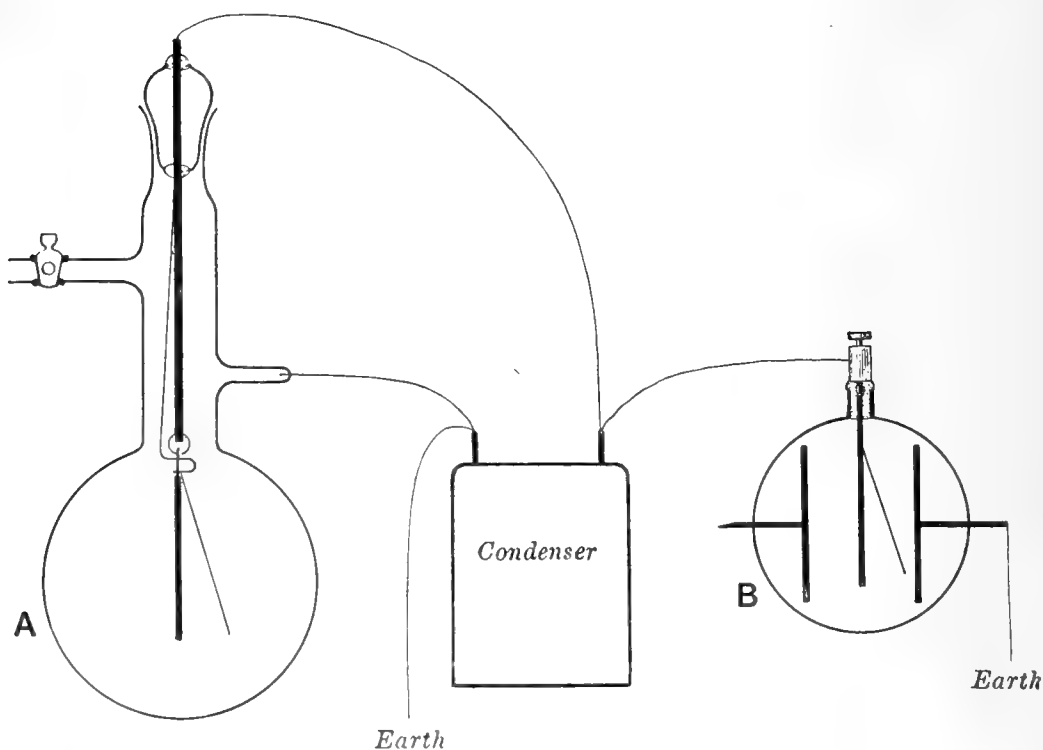

Fig. 60.

was measured by means of a microscope provided with a micrometer eye-piece. By keeping the upper rod at a slightly higher potential than the gold-leaf system, it was ensured that the loss of charge of the gold-leaf system was not in any way due to a conduction leakage across the sulphur bead.

The method employed by Wilson in these experiments is very certain and convenient when an extremely small rate of discharge is to be observed. In this respect the electroscope is able to measure with certainty a rate of loss of charge much smaller than can be measured by a sensitive electrometer.

Both Geitel and Wilson found that the leakage of the insulated system in dust-free air was the same for a positive as for a negative charge, and was independent of the potential over a considerable range. The leakage was the same in the dark as in diffuse daylight. The independence of leakage of the potential is strong evidence that the loss of charge is due to a constant ionization of the air. When the electric field acting on the gas exceeds a certain value all the ions are carried to the electrodes before recombination occurs. A saturation current is reached, and it will be independent of further increase of the electric field, provided, of course, a potential sufficiently high to cause a spark to pass is not applied.

C. T. R. Wilson has recently devised a striking experiment to show the presence of ions in dust-free air which is not exposed to any external ionizing agency. Two large metal plates are placed in a glass vessel connected to an expansion apparatus similar to that described in section 34. On expanding the air the presence of the ions is shown by the appearance of a slight cloud between the plates. These condensation nuclei carry an electric charge and are apparently similar in all respects to the ions produced in gases by X rays or by the rays from active substances.

Wilson found that the loss of charge of the insulated system was independent of the locality. The rate of discharge was unaltered when the apparatus was placed in a deep tunnel, so that it did not appear that the loss of charge was due to an external radiation. From experiments already described, however (section 215), it is probable that about 30 per cent. of the rate of discharge observed was due to a very penetrating radiation. This experiment of Wilson's indicates that the intensity of the penetrating radiation was the same in the tunnel as at the earth's surface. Wilson found that the ionization of the air was about the same in a brass vessel as in one of glass, and came to the conclusion that the air was spontaneously ionized.

Using a brass vessel of volume about 471 c.c., Wilson determined the number of ions that must be produced in air per unit volume per second, in order to account for the loss of charge of the insulated system. The leakage system was found to have a capacity of about 1.1 electrostatic units, and lost its

charge at the rate of 4.1 volts per hour for a potential of 210 volts, and 4.0 volts per hour for a potential of 120 volts. Taking the charge on an ion as 3.4×10^{-10} electrostatic units, this corresponds to a production of 26 ions per second.

Rutherford and Allan¹ repeated the results of Geitel and Wilson, using an electrometer method. The saturation current was observed between two concentric zinc cylinders of diameter 25.5 and 7.5 cms. respectively and length 154 cms. It was found that the saturation current could practically be obtained with a potential of a few volts. Saturation was however obtained with a lower voltage after the air had remained undisturbed in the cylinders for several days. This was probably due to the gradual settling of the dust originally present in the air.

Later observations of the number of ions produced in air in sealed vessels have been made by Patterson², by Harms³, and by Cooke⁴. The results obtained by different observers are shown in the following table. The value of the charge on an ion is taken as 3.4×10^{-10} electrostatic units :

Material of vessel	Number of ions produced per c.c. per second	Observer
Silvered glass ...	36	C. T. R. Wilson
Brass	26	" " "
Zinc	27	
Glass	53 to 63	Harms
Iron	61	Patterson
Cleaned brass ...	10	Cooke

It will be shown later that the differences in these results are probably due to differences in the radio-activity of the containing vessel.

219. Effect of pressure and nature of gas. C. T. R. Wilson (*loc. cit.*) found that the rate of leakage of a charged conductor varied approximately as the pressure of the air between the pressures examined, viz. 43 mms. and 743 mms. of mercury. These results point to the conclusion that, in a good vacuum, a charged

¹ *Phil. Mag.* Dec. 1902.

² *Phil. Mag.* August, 1903.

³ *Phys. Zeit.* 4, No. 1, p. 11, 1902

⁴ *Phil. Mag.* Oct. 1903.

body would lose its charge extremely slowly. This is in agreement with an observation of Crookes, who found that a pair of gold-leaves retained their charge for several months in a high vacuum.

Wilson¹ at a later date investigated the leakage for different gases. The results are included in the following table, where the ionization produced in air is taken as unity:

Gas	Relative ionization	Relative ionization
		density
Air	1.00	1.00
Hydrogen	0.184	2.7
Carbon dioxide	1.69	1.10
Sulphur dioxide... ..	2.64	1.21
Chloroform	4.7	1.09

With the exception of hydrogen, the ionization produced in different gases is approximately proportional to the density. The relative ionization is very similar to that observed by Strutt (section 45) for gases exposed to the influence of the α and β rays from radio-active substances, and points to the conclusion that the ionization observed may be due either to a radiation from the walls of the vessel or from external sources.

Patterson² examined the variation of the ionization of air with pressure in a large iron vessel of diameter 30 cms. and length 20 cms. The current between a central electrode and the cylinder was measured by means of a sensitive Dolezalek electrometer. He found that the saturation current was practically independent of the pressure for pressures greater than 300 mms. of mercury. Below a pressure of 80 mms. the current varied directly as the pressure. For air at atmospheric pressure, the current was independent of the temperature up to 450° C. With further increase of temperature, the current began to increase, and the increase was more rapid when the central electrode was charged negatively than when it was charged positively. This difference was ascribed to the production of positive ions at the surface of the iron vessel. The results obtained by Patterson render it very improbable that the ionization observed in air is due to a spontaneous ionization of the enclosed air: for it would be expected that the amount of this ionization would depend on the temperature of the gas. On

¹ *Proc. Roy. Soc.* 69, p. 277, 1901.

² *Phil. Mag.* Aug. 1903.

the other hand, the results are to be expected if the ionization of the enclosed air is mainly due to an easily absorbed radiation from the walls of the vessel. If this radiation had a penetrating power about equal to that observed for the α rays of the radio-elements, the radiation would be absorbed in a few centimetres of air. With diminution of pressure, the radiations would traverse a greater distance of air before complete absorption, but the total ionization produced by the rays would still remain about the same, until the pressure was reduced sufficiently to allow the radiation to traverse the air space in the vessel without complete absorption. With still further diminution of pressure, the total ionization produced by the radiation, and in consequence the current observed, will vary directly as the pressure.

220. Examination of ordinary matter for radio-activity.

Strutt¹, McLennan and Burton², and Cooke³, independently observed about the same time that ordinary matter is radio-active to a slight degree. Strutt, by means of an electroscope, observed that the ionization produced in a closed vessel varied with the material of the vessel. A glass vessel with a removeable base was employed and the vessel was lined with the material to be examined. The following table shows the relative results obtained. The amount of leakage observed is expressed in terms of the number of scale divisions of the eye-piece passed over per hour by the gold-leaf:

Material of lining of vessel	Leakage in scale divisions per hour
Tinfoil... ..	3·3
„ another sample	2·3
Glass coated with phosphoric acid	1·3
Silver chemically deposited on glass	1·6
Zinc	1·2
Lead	2·2
Copper (clean)	2·3
„ (oxidized)	1·7
Platinum (various samples) ...	2·0, 2·9, 3·9
Aluminium	1·4

¹ *Phil. Mag.* June, 1903. *Nature*, Feb. 19, 1903.

² *Phys. Rev.* No. 4, 1903. J. J. Thomson, *Nature*, Feb. 26, 1903.

³ *Phil. Mag.* Aug. 6, 1903. Rutherford, *Nature*, April 2, 1903.

There are thus marked differences in the leakage observed for different materials and also considerable differences in different samples of the same metal. For example, one specimen of platinum caused nearly twice the leakage of another sample from a different stock.

McLennan and Burton, on the other hand, measured by means of a sensitive electrometer the ionization current produced in the air in a closed iron cylinder 25 cms. in diameter and 130 cms. in length, in which an insulated central electrode was placed. The open cylinder was first exposed for some time at the open window of the laboratory. It was then removed, the top and bottom closed, and the saturation current through the gas determined as soon as possible. In all cases it was observed that the current diminished for two or three hours to a minimum and then very slowly increased again. In one experiment, for example, the initial current observed corresponded to 30 on an arbitrary scale. In the course of four hours the current fell to a minimum of 6.6, and 44 hours later had risen to a practical maximum of 24. The initial decrease observed is probably due to a radio-activity of the enclosed air or walls of the vessel, which decayed rapidly with the time. The decay of the excited activity produced on the interior surface of the cylinder when exposed to the air was probably responsible for a part of the decrease observed. McLennan ascribes the increase of current with time to a radio-active *emanation* which is given off from the cylinder, and ionizes the enclosed air. On placing linings of lead, tin, and zinc in the iron cylinder, considerable differences were observed both of the minimum current and also of the final maximum. Lead gave about twice the current due to zinc, while tin gave an intermediate value. These results are similar in character to those obtained by Strutt.

McLennan and Burton also investigated the effect of diminution of pressure on the current. The cylinder was filled with air to a pressure of 7 atmospheres, and allowed to stand until the current reached a constant value. The air was then allowed to escape and the pressure reduced to 44 mms. of mercury. The current was found to vary approximately as the pressure over the whole range. These results are not in agreement with the results of Patterson already described, nor with some later experiments

of Strutt. McLennan's results however point to the conclusion that the ionization was mainly due to an emanation emitted from the metal. Since the air was rapidly removed, a proportionate amount of the emanation would be removed also, and it might thus be expected that the current would vary directly as the pressure. If this is the case the current through the gas at low pressures should increase again to a maximum if time is allowed for a fresh emanation to form.

H. L. Cooke, using an electroscopic method, obtained results very similar to those given by Strutt. Cooke observed that a penetrating radiation was given out from brick. When a brass vessel containing the gold-leaf system was surrounded by brick, the discharge of the electroscope was increased by 40 to 50 per cent. This radiation was of about the same penetrating power as the rays from radio-active substances. The rays were completely absorbed by surrounding the electroscope by a sheet of lead 2 mms. in thickness. This result is in agreement with the observation of Elster and Geitel, already mentioned, that radio-active matter was present in clay freshly dug up from the earth.

Cooke also observed that the ionization of the air in a brass electroscope could be reduced to about one-third of its usual value if the interior surface of the brass was carefully cleaned. By removing the interior surface of the brass he was able to reduce the ionization of the enclosed air from 30 to 10 ions per c.c. per second. This is an important observation, and indicates that a large proportion of the radio-activity observed in ordinary matter is due to a deposit of radio-active matter on its surface. It has already been shown (sections 173 and 188) that bodies which have been exposed in the presence of the radium emanation retain a residual activity which decays extremely slowly. There can be no doubt that the radium emanation is present in the atmosphere, and the exposed surface of matter, in consequence, will become coated with an invisible film of radio-active matter, deposited from the atmosphere. On account of the slow decay of this activity it is probable that the activity of matter exposed in the open air would steadily increase for a long interval. Metals, even if they are originally inactive, would thus acquire a fairly permanent activity, but it should be possible to get rid of this

by removing the surface of the metal or by chemical treatment.

It must be borne in mind that the activity observed in ordinary matter is excessively minute. The lowest rate of production of ions yet observed is 10 per cubic centimetre per second in a brass vessel. Suppose a spherical brass vessel is taken of capacity 1 litre. The area of the interior surface would be about 480 sq. cms. and the total number of ions produced per second would be about 10^4 . Now it has been shown in section 104 that an α particle projected from radium probably gives rise to 7×10^4 ions before it is absorbed in the gas. An expulsion of one α particle every 7 seconds from the whole vessel, or of one α particle from each square centimetre of surface *per hour* would thus account for the minute conductivity observed. Even if it were supposed that this activity is the result of a breaking up of the matter composing the vessel, the disintegration of one atom per second per gram, provided it was accompanied by the expulsion of an α particle, would fully account for the conductivity observed.

Strutt¹ has recently observed that a radio-active emanation can be obtained by bubbling air through mercury. The emanation appears to be very similar in character to that emitted by radium emanation, for its activity decays to half value in 3.18 days and the excited activity to half value in 20 minutes. An emanation was also obtained by drawing air over red-hot copper.

Bumstead and Wheeler² have repeated the experiments of Strutt of bubbling air through mercury, but were unable to detect any increase of the conductivity of air, which had been circulated through hot mercury for fourteen hours, although an increase of 10 per cent. of the natural conductivity could have been detected. These results indicate that the emanation from mercury obtained in the experiments of Strutt was probably due to the presence of a minute amount of radium as an impurity.

There is not yet sufficient evidence to decide with certainty whether ordinary matter possesses the property of radio-activity. There is no doubt that, if matter possesses the property at all, it does so to a minute extent. The extreme minuteness of the

¹ *Phil. Mag.* July, 1903.

² *Amer. Jour. Science*, 17, p. 110, Feb. 1904.

radio-activity observed, and the distribution of radio-active matter throughout the constituents of the earth, render it difficult to be certain that any substance, however carefully prepared, is freed from possible radio-active impurities. A careful comparison of the rates of decay of the activity of the emanations obtained from ordinary matter, and of the excited activity, with the corresponding rates of decay of the activity of the products of the known radio-active substances, may throw some light on the question.

INDEX.

The numbers refer to the pages.

- α rays**
discovery of, 115 *et seq.*
nature of, 115 *et seq.*
magnetic deviation of, 117 *et seq.*
electrostatic deviation of, 121
velocity of, 122 *et seq.*
value of e/m for, 122
mass and energy of, 125 *et seq.*
origin of, in atomic disintegration, 126
scintillations produced by, 127
absorption of, by matter, 129 *et seq.*
increase of absorption with thickness
of matter traversed, 129 *et seq.*
relative absorption of α rays from
radio-elements, 132
absorption of, by gases, 133
connection between absorption and
density, 137
relation between ionization and ab-
sorption, 138
theory of absorption of, 138
effect of thickness of layer of radiating
matter on emission of, 149
relative ionization produced by α and
 β rays, 149
relative energy emitted in form of α
and β rays, 150 *et seq.*
number and energy of α particles
from radio-elements, 154
emission of energy from radio-ele-
ments in form of α rays, 154
connection of heat emission of radium
with α rays, 160 *et seq.*
connection of, with radio-active
changes, 193, 322
from the emanations, 222
absence of, in change in emanation
X of thorium, 270 *et seq.*
absence of, in change in emanation
X of radium, 273
non-separable activity of radio-ele-
ments consists of, 304
emission from all active products
except last change, 304
 α particles consist of helium, 331
loss of weight due to expulsion of, 335
- Abraham**
apparent mass of moving charged
body, 109
- Absorption**
law of, in gases, 56 *et seq.*
relative absorption of α , β and γ rays
by matter, 93
of β rays by solids, 112 *et seq.*
of α rays by solids, 129 *et seq.*
of γ rays by solids, 142
connection between absorption and
density for β rays, 113 *et seq.*
connection between absorption and
density for α rays, 137
connection between absorption and
density for γ rays, 143
of β rays in radio-active matter, 115
of α rays in gases, 133 *et seq.*
connection between absorption and
ionization, 138
theory of, 138
of α rays by radium, 164
of rays from the emanations, 222
of penetrating rays from the earth, 367
- Actinium**
methods of separation of, 22 *et seq.*
properties of, 23
similarity to "emanating substance"
of Giesel, 24
possible connection with radio-activity
of thorium, 25
emanation from, 208
excited activity produced by, 288
effect of magnetic field on excited
activity from, 288
- Adams**
decay of activity of emanation from
well water, 361
decay of excited activity from the
emanation, 361
- Age**
of radium, 333
of sun and earth, 343
- Allan**
increase with time of excited activity
from atmosphere, 355

Allan (*cont.*)

radio-activity of snow, 356
effect of conditions on decay of activity from air, 369

Allan and Rutherford

decay of excited activity from atmosphere, 353
ionization of air in closed vessels, 376

Anderson and Hardy

action of radium rays on eye, 177

Armstrong and Lowry

radio-activity and phosphorescence, 323

Arnold

rays from phosphorescent substances, 4

Aschkinass and Caspari

action of radium rays on eye, 177

Atmosphere

excited radio-activity from, 351 *et seq.*
radio-activity of, due to emanations, 354
diffusion of emanations into, from earth, 357
effect of temperature, pressure, &c. on radio-activity of, 364
presence of very penetrating radiation in, 366
comparison of radio-activity of, with radio-elements, 368

Atom

number of, per c.c., 51
complex nature of, 126
disintegration of, 126
number of, transformed per second, 332
changing atoms, 322 *et seq.*
possible causes of disintegration of, 338 *et seq.*
evolution of, 347 *et seq.*

Atomic weight

of radium by chemical methods, 17
from spectroscopic evidence, 18
of emanations, 232
of radio-elements and connection with radio-activity, 323 *et seq.*

 β rays

discovery of, 95
magnetic deflection of, 95 *et seq.*
complexity of, 98 *et seq.*
examination by the electrical method, 100
effect of, on a fluorescent screen, 101
charge carried by the, 102 *et seq.*
electrostatic deviation of, 106
velocity of, and value of e/m for, 106 *et seq.*
variation of e/m with velocity of, 108 *et seq.*

 β rays (*cont.*)

absorption of, 112
variation of absorption with density, 113 *et seq.*
variation of intensity of, with thickness of layer, 115
relative ionization produced by α and β rays, 149
relative energy emitted in form of α and β rays, 150 *et seq.*
phosphorescent action of, 166
physical action produced by, 171 *et seq.*
chemical action of, 174
physiological action of, 176
from Ur X, 293
from emanation X of radium, 302
appearance of, only in last of radio-active changes, 304
change of weight due to expulsion of, 336

Barium platinocyanide
phosphorescence of, under radium rays, 167
change of colour due to radium rays, 168

Barnes and Rutherford
heating effect of radium emanation, 161
connection of heating effect with radio-activity, 160 *et seq.*
heating effect of emanation, 247
heating effect of excited activity, 279
division of heating effect among active products, 279

Baskerville
activity of thorium, 25
phosphorescence of kunzite under radium rays, 168
phosphorescence produced by radium rays, 168

Beattie, Smolan and Kelvin
discharging power of uranium rays, 7

Becquerel
rays from calcium sulphide, 4
rays from uranium, 5 *et seq.*
permanence of uranium rays, 6
discharging power of uranium rays, 6
magnetic deflection of radium rays by photographic method, 96
curvature of radium rays in a magnetic field, 96 *et seq.*
complexity of radium rays, 98 *et seq.*
electrostatic deflection of β rays of radium, 106
value of e/m for β rays of radium, 107
magnetic deviation of α rays of radium and polonium, 120
trajectory of rays of radium in magnetic field, 123 *et seq.*

- Becquerel (*cont.*)
 scintillations due to cleavage of crystals, 128
 γ rays from radium, 141
 secondary rays produced by active substances, 146
 phosphorescence produced by radium rays, 166
 conductivity of paraffin under radium radiation, 173
 effect of temperature on uranium rays, 173
 chemical action of radium rays, 175
 removal of activity from uranium by precipitation with barium, 179
 recovery of activity of uranium after precipitation with barium, 179
 penetrating rays from polonium, 305
 theory of radio-activity, 317
- Bemont et M. et Mme Curie
 discovery of radium, 13
- Benoist
 variation of absorption of Röntgen rays in matter, 144
- Berndt
 spectrum of polonium, 20
- Bödländer and Runge
 evolution of gases from radium, 176
- Boys
 rate of dissipation of charge, 373
- Brooks, Miss
 variation of excited activity from thorium for short exposures, 260
 effect of dust on distribution of excited activity, 260
- Brooks and Rutherford
 absorption of α rays by matter, 129
 comparison of absorption of α rays from radio-elements, 132 *et seq.*
 diffusion of radium emanation, 228
 decay of excited activity from radium, 261
- Bumstead and Wheeler
 emanation from surface water and the soil, 361, 368
 identity of emanation from soil with radium emanation, 361
 absence of emanation in mercury, 381
- Burton and McLennan
 penetrating radiation from the earth, 366
 radio-activity of ordinary materials, 378
 emanation from ordinary matter, 379
- Canal rays
 similarity of to α rays, 92
- Capacity
 of electroscopes, 72
 of electrometers, 79, 85
- Capacity (*cont.*)
 standards of, 86
- Carbonic acid
 radio-activity of natural, 364
- Caspari and Aschkinass
 action of radium rays on eye, 177
- Cathode rays
 comparison of, with β rays, 102 *et seq.*
 absorption of, by matter, 113
see also β rays, 95 *et seq.*
- Caves
 radio-active matter present in air of, 357
 radio-activity of air of, due to emanation from the soil, 357
- Charge
 carried by the ions, 47 *et seq.*
 negative charge carried by β rays, 102 *et seq.*
 measurement of charge carried by β rays, 104 *et seq.*
 positive charge carried by α rays, 120
- Chemical nature
 of emanation, 225
 of emanation X, 275
- Chemical actions of radium rays
 production of ozone, 174
 coloration of glass and rock salt, 174
 on phosphorus, 175
 on iodoform, 175
 on globulin, 175
 evolution of hydrogen and oxygen, 176
- Child
 potential gradient between electrodes, 63
 variation of current with voltage for surface ionization, 64
- Clouds
 formation by condensation of water round ions, 43 *et seq.*
 difference between positive and negative ions in formation of, 46
- Collision
 ionization by, 54
 number of ions produced by β rays per cm. of path, 139
 total number of ions produced by collisions of α particles, 156
- Coloration
 of crystals of radiferous barium, 15
 of bunsen flame by radium, 17
 of glass by radium rays, 174
 of rock salt, fluor spar and potassium sulphate by radium rays, 174
- Concentration
 of excited activity on negative electrode, 252
 activity of radium independent of, 339

- Condensation
of water round the ions, 43 *et seq.*
of emanations, 236 *et seq.*
experimental illustration of, 237
temperature of, 238
difference between point of, for emanations of thorium and radium, 243
from air sucked up from the earth, 357
- Conductivity
of gases exposed to radiations, 28 *et seq.*
variation of, with pressure, 58 *et seq.*
variation of, with nature of gas, 61
comparison of, for gases exposed to α , β and γ rays, 61 *et seq.*
of insulators, 172
of air in closed vessels, 351, 373
increase of, with time, in a closed vessel, 351
of air in caves and cellars, 357
variation of in closed vessels with pressure and nature of gas, 376
variation of with temperature for air in closed vessels, 377
- Conservation of radio-activity
examples of, 308
- Cooke, H. L.
penetrating rays from the earth, 366
number of ions per c.c. in closed vessels, 376
radio-activity from ordinary matter, 378
- Corpuscle
(*see* Electron)
- Crookes (Sir W.)
spectrum of polonium, 20
separation of Ur X, 178
nature of α rays, 116
scintillations produced by radium, 127
spintariscope, 127
number of scintillations independent of pressure and temperature, 128
theory of radio-activity, 319
cathode rays, 347
- Crookes and Dewar
absence of nitrogen spectrum in phosphorescent light of radium at low pressures, 169
- Curie, Mme
permanence of uranium rays, 6
discovery of radio-activity of thorium, 10
radio-activity of uranium and thorium minerals, 11
relative activity of compounds of uranium, 12
coloration of radium crystals, 15
spectrum of radium, 15
nature of α rays, 116
- Curie, Mme (*cont.*)
absorption of α rays from polonium, 131
secondary radiation tested by electric method, 148
slowly decaying excited activity from radium, 264
bismuth made active by solution of barium, 289
recovery of activity of radium, 303
- Curie, P.
magnetic deviation of radium rays by electric method, 96
heat emission of radium at low temperature and variation of heat emission with age of radium, 159, 160
conductivity of dielectrics under radium rays, 172
radio-activity of radium unaffected by temperature, 173
decay of activity of radium emanation, 206 *et seq.*
discovery of excited radio-activity from radium, 250
nature of the emanation, 318
- Curie, M. et Mme
discovery of radium, 13
charge carried by radium rays, 102
luminosity of radium compounds, 168
production of ozone by radium rays, 174
coloration of glass by radium rays, 174
theory of radio-activity, 318
possible absorption by radio-elements of unknown radiations, 321
- Curie, J. et P.
quartz piezo-électrique, 87 *et seq.*
- Curie, P. et Danne
diffusion of radio-active emanation, 231
decay of excited activity from radium, 262
occlusion of radium emanation in solids, 264
- Curie, P. and Debierne
active gases evolved from radium, 210
phosphorescence produced by radium emanation, 211
distribution of luminosity, 211
rate of production of emanation independent of pressure, 224
effect of pressure on amount of excited activity, 282
- Curie, P. and Laborde
heat emission of radium, 158
origin of heat from radium, 319
- Current
through gases, 28 *et seq.*
variation of with distance between the plates, 56 *et seq.*

- Current (*cont.*)
 variation of with pressure of gas, 58 *et seq.*
 variation of, with nature of gas, 61
 measurement of, by galvanometer, 69
 measurement of, by electroscopes, 70 *et seq.*
 measurement of, by electrometer, 84
 measurement of, by quartz piezo-
 électrique, 87
 magnitude of, for one gram of radium, 156
- Danne and Curie, P.
 diffusion of radium emanation, 231
 decay of excited activity from radium, 262
 occlusion of radium emanation in solids, 264
- Danysz
 action of radium rays on skin, 177
- Darwin, G. H.
 age of sun, 343
- Debierne
 actinium, 22
 emanation from actinium, 208
 effect of magnetic field on activity excited from actinium, 288
 barium made active by actinium, 289
- Debierne and Curie
 evolution of gas from radium, 175
 active gas evolved from radium, 210
 phosphorescence produced by radium emanation, 211
 distribution of luminosity, 211
 rate of production of emanation independent of pressure, 224
 effect of pressure on excited activity, 282
- Decay
 of heating effect of emanation, 162
 of activity of Th X, 180
 of activity of Ur X, 182
 significance of law of, 189
 effect of conditions on the rate of, 190
 of activity of thorium emanation, 200
 of activity of radium emanation, 206
 excited activity due to thorium for long exposure, 256
 excited activity due to thorium for short exposure, 258
 excited activity due to radium, 261
 excited activity of slow decay due to radium, 264, 291
 excited activity from atmosphere, 351 *et seq.*
 of activity of rain and snow, 356
 of emanation from earth, 358
 differences in, of excited activity from atmosphere, 368
- Deflection
 of rays in a magnetic field, 92
 of β rays in a magnetic field, 95 *et seq.*
 of β rays in an electrostatic field, 106
 of α rays in a magnetic field, 117 *et seq.*
 of α rays in an electrostatic field, 121
 of "ions activants" in a magnetic field, 288
- Demarçay
 spectrum of radium, 16
- Des Coudres
 magnetic and electric deviation of α rays of radium, 122
 determination of e/m for α rays, 122
 velocity of cathode rays diminished in passage through matter, 139
- Dewar
 emission of heat from radium in liquid hydrogen, 160
- Dewar and Crookes
 absence of nitrogen spectrum in phosphorescent light of radium at low pressures, 169
- Dielectrics
 conduction of, under radium rays, 172
- Diffusion
 of ions, 49
 of radium emanation into gases, 228 *et seq.*
 of thorium emanation into gases, 233
 of radium emanation into liquids, 235
- Discharge
 action of rays on spark and electrodeless, 171
- Disintegration
 account of theory of, 126, 193, 323 *et seq.*
 list of products of, 326
 helium a product of, 327 *et seq.*
 rate of, in radio-elements, 332 *et seq.*
 emission of energy in consequence of, 336 *et seq.*
 possible causes of, 338 *et seq.*
 of matter in general, 347 *et seq.*
- Dissipation of charge
 in closed vessels, 351, 373
 in caves and cellars, 357
 effect of pressure and nature of gas on, 376 *et seq.*
 effect of material of vessel on, 378 *et seq.*
- Dolezalek
 electrometer, construction of, 78 *et seq.*
- Dorn
 charge carried by radium rays, 104
 electrostatic deflection of β rays from radium, 106
 discovery of radium emanation, 205
 effect of moisture on emanating power of thorium, 214
 electrolysis of radium solution, 276

- Dorn (*cont.*)
 loss of weight of radium, 336
- Durack
 ionization by collision of electrons of great velocity, 139
- Dust
 effect of, in recombination of ions, 39
 effect of, on distribution of excited activity, 260
- Earth
 amount of radium in, 344
 age of, 344
 excited activity deposited on, 354
 activity concentrated on peaks of, 354
 emanation from, 363
 very penetrating radiation from, 366
- Ebert
 condensation of emanation from the earth, 359
- Ebert and Ewers
 emanation from the earth, 358
- Electric field
 deflection of β rays by, 106
 deflection of α rays by, 121
 movement in, of carriers of excited activity, 282 *et seq.*
 action on, of carriers of excited activity from "emanating substance," 287
- Electrolysis
 separation of radio-tellurium by, 21
 of solutions of emanation X, 276
 of thorium solutions, 277
 of radium solutions, 276
- Electrometer
 description of, 74 *et seq.*
 use of, in measurements, 74
 construction of, 76 *et seq.*
 Dolezalek, 78
 adjustment and screening of, 79
 special key for, 81
 application of, to measurements of radio-activity, 81 *et seq.*
 measurement of current by, 84
 capacity of, 85
 use with quartz piezo-électrique, 87
- Electron
 definition of, 53
 identity of β rays with electrons, 102 *et seq.*, 107
 variation of apparent mass of electron with velocity, 108 *et seq.*
 evidence that mass of electron is electro-magnetic, 112
 diameter of, 112
 production of, under different conditions, 347
- Electroscope
 description of, used by Curie, 70
- Electroscope (*cont.*)
 construction of, for accurate measurements, 71
 use of, in measurements of minute currents, 71
 of C. T. R. Wilson, 73
 use of, in measuring conductivity of air in closed vessels, 373 *et seq.*
 use of, for determining radio-activity of ordinary matter, 378, 380
- Elster and Geitel
 radio-active lead, 25
 effect of magnetic field on conductivity produced in air by radium rays, 95
 scintillations produced by active substances, 127
 action of radium rays on spark, 171
 photo-electric action of body, coloured by radium rays, 174
 radio-active matter in earth, 345
 discovery of excited activity in atmosphere, 351
 emanations from the earth, 357
 radio-activity of air in caves, 362
 radio-activity of the earth, 362
 radio-activity of natural carbonic acid, 364
 variation of radio-activity in atmosphere with meteorological conditions, 364 *et seq.*
 effect of temperature and pressure on atmospheric radio-activity, 365
- Emanation
 rate of heat emission by, 158
 variation of heat emission with time, 160
 of thorium, discovery and properties, 197
 methods of measurement of, 199
 decay of activity of, 200
 effect of thickness of layer, on amount of, 202
 increase of, with time, to a maximum, 204
 of radium, 205
 decay of activity of, 206
 of actinium, properties of, 208
 of radium, phosphorescence produced by, 209 *et seq.*
 rate of emission of, 213
 effect of conditions, on rate of emission of, 214
 regeneration of emanating power, 215
 continuous rate of production of, 216 *et seq.*
 source of thorium emanation, 220
 source of radium emanation, 222
 radiations from, 222
 effect of pressure on production of, 224
 chemical nature of, 225

Emanation (*cont.*)

- experiments to illustrate gaseous nature of, 227
 - rate of diffusion of radium emanation, 228 *et seq.*
 - rate of diffusion of thorium emanation, 233
 - diffusion of, into liquids, 235
 - condensation of, 236 *et seq.*
 - temperature of condensation of, 238 *et seq.*
 - volume of, from 1 gram of radium, and thorium, 246
 - heat emission of, 247
 - connection between emanations and excited activity, 253 *et seq.*
 - effect of removal of, on activity of radium, 300
 - effect of rate of escape of, on activity of radium, 302
 - fraction of activity of radium, due to, 304
 - experimental separation, and volume of, 311 *et seq.*
 - decrease of volume of, with time, 313
 - radio-activity of atmosphere, due to emanations, 354
 - sucked up from the earth, 357
 - rate of decay of activity of, from the earth, 358
 - condensation of, from atmosphere, 359
 - in caves, 357
 - in well-water, and springs, 360
 - in natural carbonic acid gas, 364
 - from "fango," 363
 - effect of meteorological conditions on amount of, in atmosphere, 364
 - from metals, 378
- Emanation X** (*see* Excited radio-activity)
- definition of, 256
 - chemical and physical properties of, 275
 - electrolysis of, 276
 - effect of temperature on, 277
 - emission of heat by, 278
 - transmission of, to negative electrode, 282 *et seq.*
 - irregularities in decay of activity of Th X due to, 295
 - removal of, by successive precipitations, 296
 - theory of effect of production of, on activity of Th X, 295 *et seq.*

Emanating power

- measurement of, 213
 - effect of conditions on, 214
 - regeneration of, 215
- "Emanating substance" of Giesel
- separation and properties of, 23 *et seq.*
 - similarity of, to actinium, 24

"Emanating substance" of Giesel (*cont.*)

- emanation from, 209
- excited activity produced by, 287
- action of an electric field on, 287

Energy

- of α particle, 125
- of β particle, 151
- comparison of, for α and β particles, 150
- emitted from radio-elements, in form of α rays, 154
- emitted from radium in form of heat, 158 *et seq.*
- emission of, from the emanation, 161 *et seq.*, 247
- emission of, from radio-active products of radium, 278
- total emission of, from 1 gram of radio-elements, 336
- latent store of, in matter, 337

Eve

- conductivity of gases for very penetrating Röntgen rays, 145

Evolution of matter

- evidence of, 348

Ewers and Ebert

- emanation from the earth, 358

Excited radio-activity

- heat emission due to, 161 *et seq.*
- discovery and properties of, 250
- concentration of, on negative electrode, 252
- connection of, with the emanations, 253
- removal of, by acids, 255
- decay of, due to thorium, 256
- decay of, for short exposure to thorium, 259
- effect of dust on distribution of, 260
- decay of, from radium, 261
- of radium, of very slow decay, 264
- connection between decay curves of, and times of exposure, 265
- theory of successive changes to give rise to, 268
- changes in emanation X of thorium, 270 *et seq.*
- changes in emanation X of radium, 272
- physical and chemical properties of emanation X, 275
- electrolysis of active solutions, 276
- effect of temperature on, 277
- emission of heat, due to, 278
- variation with electric field, of amount of, 280
- effect of pressure on distribution of, 282
- transmission of, 282 *et seq.*
- from actinium, and "emanating substance," 287

- Excited radio-activity (*cont.*)
 possible connection of polonium and radio-tellurium with, 290 *et seq.*
 from the atmosphere, 351 *et seq.*
 concentration of, on negative electrode, 351
 decay of, 353
 due to emanation in atmosphere, 354
 distribution of, on surface of earth, 354
 concentration of, on prominences of the earth, 354
 of rain and snow, 356
 decay of, on rain and snow, 356
 due to emanation from earth, 357
 produced by emanation from tap water, 360
 effect of meteorological conditions on amount of, 364
 amount of, at Niagara Falls, 366
 rate of decay of, dependent on conditions, 368
- Exner and Haschek
 spectrum of radium, 17
- Eye
 action of radium rays on, 177
- Fehrle
 distribution of excited activity on a plate, in electric field, 282
- Fluorescence
 produced in substances by radium rays, 18
 produced in substances by radium and polonium rays, 166
- Fog
 large amount of excited activity, during, 365
- Forch
 loss of weight of radium, 336
- γ rays
 discovery of, 141
 absorption of, by matter, 142
 connection between absorption of, and density, 143
 discussion of nature of rays, 143 *et seq.*
 conservation of radio-activity measured by, 311
 measurement of radio-activity by means of, 321, 339
- Gases
 evolved by radium, 175
 presence of helium in gases from radium, 176, 327 *et seq.*
- Gates, Miss F.
 effect of temperature on excited activity, 278
 discharge of quinine sulphate, 372
- Geitel
 natural conductivity of air in closed vessels, 351, 373
- Geitel and Elster
 radio-active lead, 25
 effect of magnetic field on conductivity produced by radium rays, 95
 scintillations produced by active substances, 127
 action of radium rays on spark, 171
 photo-electric action of bodies coloured by radium rays, 174
 radio-active matter in earth, 345
 discovery of radio-active matter in atmosphere, 351
 emanations from the earth, 357
 radio-activity of air in caves, 362
 radio-activity of the soil, 362
 radio-activity of natural carbonic acid, 364
 variation of radio-activity of air, with meteorological conditions, 364 *et seq.*
 effect of temperature and pressure on radio-activity in atmosphere, 365
- Giesel
 coloration of bunsen flame by radium, 15
 separation of radium by crystallization of bromide, 15
 emanating substance, 23
 radio-active lead, 26
 magnetic deviation of β rays, 95
 temperature of radium bromide above air, 159
 decrease with time of luminosity of radio-active screen, 168
 coloration of bodies by radium rays, 174
 evolution of gases from radium, 176
 action of radium rays on eye, 177
 emanation from the emanating substance, 209
 luminosity produced by radium emanation, 209
 excited activity from emanating substance, 287
 bismuth made active by radio-active solution, 289
 activity of radium dependent on age, 300
- Glass
 coloration produced in, by radium rays, 174
 phosphorescence produced by emanation, 210
- Globulin
 action of radium rays on, 175
- Goldstein
 canal strahlen, 92
 coloration of bodies by radium rays, 174

- Grier and Rutherford
 magnetic deviation of β rays of thorium, 96
 relative current due to α and β rays, 150
 nature of rays from Ur X, 294
- Hardy
 coagulation of globulin by radium rays, 175
- Hardy and Miss Willcock
 coloration of iodoform solutions by radium rays, 175
- Hardy and Anderson
 action of radium rays on the eye, 177
- Harms
 number of ions per c.c., in closed vessel, 376
- Haschek and Exner
 spectrum of radium, 17
- Heat
 rate of emission of, from radium, 158
 emission of, from radium at low temperatures, 159
 rate of emission of, after removal of the emanation, 162
 rate of emission of, by the emanation, 162
 variation with time of heat emission of radium, and of its emanation, 162
 connection of heat emission with the radio-activity, 161
 source of heat energy, 163
 heating effect of the emanation, 247
 heating effect of emanation X, 278 *et seq.*
 proportion of heating effect, due to radio-active products, 280
 total heat emission during life of radio-elements, 336
 heating of earth by radio-active matter, 344
- Heaviside
 apparent mass of moving charged body, 109
- Helium
 produced by radium and its emanation, 327
 amount of, from radium, 331
 origin of, 331
- Helmholtz and Richarz
 action of ions on steam jet, 44
- Hemptinne
 action of rays on spark, and electrodeless discharge, 171
- Henning
 resistance of radium solutions, 171
 effect of voltage on amount of excited activity, 281
- Heydweiler
 loss of weight of radium, 336
- Himstedt
 action of radium rays on selenium, 171
- Himstedt and Nagel
 action of radium rays on eye, 177
- Hofmann and Strauss
 radio-active lead, 26
- Hofmann and Zerban
 active substance from pitchblende, 25
- Huggins, Sir W. and Lady
 spectrum of phosphorescent light of radium bromide, 169
- Hydrogen
 production of, by radium rays, 176
- Induced radio-activity (*see* Excited radio-activity)
- Induction
 radio-active, 21
 meaning, and examples of, 289
- Insulators
 conduction of, under radium rays, 172
- Iodoform
 coloration produced in, by radium rays, 175
- Ionization
 theory of, to explain conductivity of gases, 28 *et seq.*
 by collision, 36, 54
 variation of, with pressure of gas, 58 *et seq.*
 variation of, with nature of gas, 62
 comparison of, produced by rays, 93, 149
 total, produced by 1 gram radium, 154
 production of, in insulators, 172
 natural ionization of gases, 373 *et seq.*
- Ions
 in explanation of conductivity of gases, 28 *et seq.*
 rate of recombination of, 37 *et seq.*
 mobility of, 39 *et seq.*
 difference between mobility of positive and negative, 42, 43
 condensation of water around, 43 *et seq.*
 difference between positive and negative, 46
 charges carried by, 47
 diffusion of, 48 *et seq.*
 charge on ion same as on hydrogen atom, 51
 number of, produced per c.c., 52
 size and nature of, 52 *et seq.*
 definition of, 52 *et seq.*
 production of, by collision, 36, 54
 velocity acquired by, between collisions, 55
 energy required to produce, 55
 comparative number of, produced in gases, 62

- Ions (*cont.*)
 disturbance of potential gradient by movement of, 63
 number of, produced by α particle, 155
 production of, in insulators, 172
 number produced per c.c., in closed vessels, 375
- Joly
 absorption of radium rays by atmosphere, 343 (see foot-note)
- Kauffmann
 variation of e/m with velocity of electron, 108 *et seq.*
- Kelvin
 theory of radio-activity, 320
 age of sun and earth, 343, 344
- Kelvin, Smolan and Beattie
 discharging power of uranium rays, 7
- Kunz
 phosphorescence of willemite, and kunzite, 168
- Kunzite
 phosphorescence of, under radium rays, 168
- Laborde and Curie
 heat emission of radium, 19, 158
 origin of heat from radium, 319
- Langevin
 coefficient of recombination of ions, 38
 velocity of ions, 39 *et seq.*
 energy required to produce an ion, 55
 secondary radiation produced by X-rays, 146
- Larmor
 electrons and matter, 108
 structure of the atom, 126
 radiation from accelerated electrons, 340
- Lead, radio-active
 preparation of, 26
 radiations from, 26
- Le Bon
 rays from bodies exposed to sunlight, 5
 discharging power of quinine sulphate, 9, 372
- Lenard
 ionization of gases by ultra-violet light, 9
 action of ions on a steam jet, 44
 negative charge carried by Lenard rays, 102
 absorption of cathode rays proportional to the density, 113
- Lerch, von
 chemical properties of emanation X, 275
- Lerch, von (*cont.*)
 electrolysis of solution of emanation X, 276
 effect of temperature on excited activity, 278
- Lockyer
 inorganic evolution, 349
- Lodge
 connection of heat emission with α rays, 164
 instability of atoms, 340
- Lorentz
 structure of atoms, 126
- Lowry and Armstrong
 radio-activity and phosphorescence, 323
- Luminosity
 of radium compounds, 168
 change of, in radium compounds with time, 168
 spectrum of phosphorescent light from radium bromide, 169
 of radium compounds unaffected by temperature, 173
- Magnetic field
 effect of on rays, 92
 deflection of β rays by, 95 *et seq.*
 „ „ α rays by, 117 *et seq.*
 „ „ “ions activants” by, 288
- Marckwald
 preparation of radio-tellurium, 21
- Mass
 apparent mass of electron, 107 *et seq.*
 variation of mass of electron with speed, 108 *et seq.*
 of a particle, 122, 125
- Materials
 radio-activity of ordinary, 370, 378
- Matteucci
 rate of dissipation of charge in closed vessels, 373
- McClung
 coefficient of recombination of ions, 38
- McClung and Rutherford
 energy required to produce an ion, 55
 variation of current with thickness of layer of uranium, 149
 estimate of energy radiated from radio-elements, 154
 radiation of energy from radium, 317
- McLennan
 absorption of cathode rays, 62
 radio-activity of snow, 356
 excited radio-activity at Niagara Falls, 366
- McLennan and Burton
 penetrating radiation from the earth, 366

- McLennan and Burton (*cont.*)
 radio-activity of ordinary materials, 378
 emanation from ordinary matter, 379
- Mercury
 emanation from, 381
- Metabolon
 definition of, 324
 table of metabolons, 326
 radio-elements as metabolons, 332
- Meteorological conditions
 effect of, on radio-activity of atmosphere, 364
- Methods of measurement
 in radio-activity, 67 *et seq.*
 comparison of photographic and electrical, 67 *et seq.*
 description of electrical, 68 *et seq.*
- Meyer and Schweidler
 magnetic deviation of β rays by electrical method, 95
 absorption of β rays of radium by matter, 113
- Mobility
 of ions, 39 *et seq.*
- Moisture
 effect of, on velocity of ions, 40, 42
 effect of, on emanating power, 214
- Molecule
 number of, in 1 c.c. of hydrogen, 51
 molecular weight of radium emanation, 232
 molecular weight of thorium emanation, 234
- Molecular weight
 of radium emanation, 232
 of thorium emanation, 234
- Nagel and Himstedt
 action of radium rays on eye, 177
- Niewenglowski
 rays from sulphide of calcium, 4
- Number
 of molecules per c.c. of hydrogen, 51
 of ions produced in gas by active substances, 52
 of α particles emitted per gram of radium, 155
 of ions, produced per c.c. in closed vessels, 375
- Occlusion
 of emanation in thorium and radium, 217
 of radium emanation by solids, 264
- Owens
 saturation current affected by dust, 39
 effect of air currents on conductivity produced by thorium, 197
- Owens (*cont.*)
 penetrating power of rays independent of compound, 132
 absorption of α rays varies directly as pressure of gas, 137
- Oxygen
 change into ozone, by radium rays, 174
 production of from radium solutions, 176
- Ozone
 production of, by radium rays, 174
- Paraffin
 objection to as an insulator, 80
 conductivity of, under radium rays, 173
- Patterson
 number of ions per c.c. in closed vessel, 376
 natural conductivity of air due to an easily absorbed radiation, 377
 effect of temperature on natural conductivity of air, 377
- Pegram
 electrolysis of thorium solutions, 277
- Penetrating power
 comparison of for α , β and γ rays, 93
 variation in, of β rays, 98 *et seq.*
 comparison of, for α rays from radio-elements, 136
 variation of, with density for β rays, 112 *et seq.*
 variation of, with density for α rays, 137
 variation of, with density for γ rays, 143
- Penetrating radiation
 from the earth and atmosphere, 366
- Perrin
 negative charge of cathode rays, 102
 theory of radio-activity, 316
- Phosphorescence
 production of, by radium, 18
 production of, by radium and polonium rays, 166
 comparison of, produced by α and β rays, 168
 of zinc sulphide, 167
 of barium platino-cyanide, 168
 of willemite and kunzite, 168
 diminution of, with time, 168
 of radium compounds, 168
 spectrum of phosphorescent light of radium bromide, 169
 production of by heat (thermo-luminescence), 170
 produced by radium emanation in substances, 210, 227
 use of, to illustrate condensation of emanations, 237

- Phosphorus
 action of radium rays on, 175
 ionization produced by, 371
- Photo-electric action
 produced by radium rays in certain substances, 174
- Photographic
 method, advantages and disadvantages of, 67
 relative photographic action of rays, 68
- Physical action of radium rays
 on sparks, 171
 on electrodeless discharge, 171
 on selenium, 171
 on conductivity of insulators, 172
- Physical properties
 of emanation X, 275
- Physiological action of radium rays
 production of burns, 176
 effect on bacteria, 177
 effect on cancer, 177
 effect on eye, 177
- Piezo-électrique of quartz
 description of, 87
- Pitchblendes
 comparison of radio-activity of, 11
 radio-elements separated from, 13 *et seq.*
 radium continually produced from, 334
- Polarization of uranium rays
 absence of, 7
- Polonium
 methods of separation of, 19
 rays from, 20
 decay of activity of, 20
 discussion of nature of, 21
 similarity to radio-tellurium, 22
 magnetic deviation of α rays from, 121
 increase of absorption with thickness of matter traversed, 131
 phosphorescent action of rays from, 166
 possible origin of polonium and connection with radium, 290 *et seq.*
 penetrating rays from, 305
- Potential
 required to produce saturation, 30 *et seq.*
 fall of potential, to produce ions each collision, 55
 gradient, due to movement of ions, 63
- Precht and Runge
 atomic weight of radium, 17
 heating effect of radium, 164
- Pressure
 effect of, on velocity of ions, 43
- Pressure (*cont.*)
 effect of, on current through gases, 58 *et seq.*
 production of emanation, independent of, 224
 effect of, on distribution of excited activity, 282
 effect of, on natural conductivity of air in closed vessels, 376
- Products, radio-active radiations from, 304
 division of activity amongst, 306
 list of from radio-elements, 326
- Quartz piezo-électrique
 use of, in measurement of current, 37
- Quinine sulphate
 discharging power of, 9, 372
 phosphorescence of, 372
- Radiations
 emitted by uranium, 8
 emitted by thorium, 10
 emitted by radium, 18
 emitted by polonium, 20
 emitted by actinium, 23
 methods of measurement of, 67 *et seq.*
 methods of comparison of, 90
 three kinds of, 91
 analogy to rays from a Crookes tube, 92
 relative ionizing and penetrating power of, 93
 difficulties of comparative measurement of, 93 *et seq.*
 β rays, 95 *et seq.*
 α rays, 115 *et seq.*
 γ rays, 141 *et seq.*
 secondary rays, 146
 comparison of ionization of α and β rays, 149 *et seq.*
 connection of, with heat emission, 160
 phosphorescent effect of, 166
 physical actions of, 171 *et seq.*
 chemical actions of, 174 *et seq.*
 physiological actions of, 176
 from the emanation, 222
 from Ur X, 293
 non-separable activity of radio-elements consists of α rays, 304
 from different active products, 304
 conservation of energy of each specific type of, 308
- Radium
 discovery of, 13
 separation of, 13
 spectrum of, 15
 atomic weight of, 17
 radiations from, 18

Radium (*cont.*)

compounds of, 19
 nature of radiations from, 90 *et seq.*
 β rays from, 95 *et seq.*
 α rays from, 115 *et seq.*
 γ rays from, 141 *et seq.*
 secondary rays from, 147
 heat emission of, 158 *et seq.*
 production of phosphorescence by, 166 *et seq.*
 spectrum of phosphorescent light of, 169
 physical actions of, 171 *et seq.*
 chemical actions of, 174
 physiological actions of, 176
 emanation from, 205 *et seq.*
 properties of emanation from, 205 *et seq.*
 chemical nature of emanation from, 225 *et seq.*
 diffusion of emanation from, 228 *et seq.*
 condensation of emanation from, 236 *et seq.*
 amount of emanation from, 246, 312
 heat emission of emanation from, 247, 278
 excited radio-activity from, 251 *et seq.*
 decay of excited activity from, 261 *et seq.*
 successive changes in emanation X of, 272
 properties of emanation X of, 275
 heating effect due to products of, 278
 radio-active induction due to, 289
 connection of, with polonium, 291
 alteration of activity of, by removal of emanation, 300
 recovery of activity of, after removal of emanation, 301
 effect of escape of emanation on recovery of activity of, 302
 non-separable activity of, 302, 304
 radiations from active products of, 304
 division of activity amongst active products of, 306
 conservation of radio-activity of, 308
 determination of volume of emanation of and diminution with time, 313 *et seq.*
 theories of radio-activity of, 316
 discussions of theories of radio-activity of, 320
 energy of radiations, not derived from external source, 321
 theory of radio-active change, 322
 list of active products of, 326
 polonium possible product of, 326
 production of helium from, 327
 helium disintegration product of, 327
 amount of helium from, 331

Radium (*cont.*)

rate of change of, 332
 life of, 333
 origin of, 333
 possible production of, by uranium, 334
 loss of weight of, 335
 experiments to determine loss of weight of, 336
 total emission of energy from 1 gram of, 336
 possible causes of disintegration of, 338
 amount of, to account for heat of sun, 342
 possible connection of with heat of sun, 342
 probable amount of, in earth, 345
 possible connection with heat of earth, 344

Rain
 radio-activity of, 355
 decay of activity of, 356

Ramsay and Soddy
 evolution of gas from radium, 176
 chemical nature of the emanation, 227
 gaseous nature of the emanation, 227
 volume of emanation, and change with time, 313
 helium from radium emanation, 328

Re, Filippo
 theory of radio-activity, 320

Recombination
 of ions, 37 *et seq.*
 constant of, 39

Recovery
 of heating effect of radium, 162
 of activity of thorium after removal of Th X, 181
 of activity of uranium after removal of Ur X, 182
 significance of law of, 185
 effect of conditions on rate of, 191
 of activity of radium, after removal of emanation, 301

Reflection
 no evidence of direct reflection for uranium rays, 7
 diffuse reflection of rays, 7

Refraction
 no evidence of, for uranium rays, 7

Regeneration
 of emanating power, 215

Richarz and von Helmholtz
 action of ions on steam jet, 44

Runge
 spectrum of radium, 17

Runge and Precht
 atomic weight of radium, 17
 heating effect of radium, 164

- Runge and Bödlander
 evolution of gas from radium, 176
- Russell
 photographic action of substances, 68
- Saturation current
 meaning of, 30 *et seq.*
 application of, to measurements of
 radio-activity, 69
 measurement of, 82 *et seq.*
- Schmidt
 discovery of radio-activity of thorium,
 10
- Schmidt and Wiedemann
 thermo-luminescence, 170
- Schuster
 radio-activity of matter, 371
- Schweidler and Meyer
 magnetic deviation of β rays by electric
 method, 95
 absorption of β rays of radium, 113
- Scintillations
 discovery of in zinc sulphide screen,
 127
 connection of, with α rays, 127
 illustration of by spintharoscope, 127
 cause of, 128
 production of, by action of electric
 field, 128
- Searle
 apparent mass of moving charged
 body, 109
- Secondary rays
 examination of, by photographic
 method, 146
 examination of, by electrical method,
 148
- Selenium
 action of radium rays on, 171
- Simon
 value of e/m for cathode rays, 111
- Smolan, Beattie and Kelvin
 discharging power of uranium rays, 7
- Snow
 radio-activity of, 356
 decay of activity of, 356
- Soddy
 comparison of photographic and elec-
 trical action of uranium rays, 68
 nature of rays from Ur X, 294
- Soddy and Ramsay
 evolution of gas from radium, 176
 chemical nature of the emanation,
 227
 gaseous nature of the emanation, 227
 volume of the emanation, and change
 with time, 313
 helium from radium emanation, 320
- Soddy and Rutherford
 separation of Th X, 179
- Soddy and Rutherford (*cont.*)
 decay of activity of Th X, 181
 recovery of activity of thorium, freed
 from Th X, 181
 decay of activity of Ur X, 182
 recovery of activity of uranium, freed
 from Ur X, 182
 explanation of decay and recovery
 curves, 183
 rate of production of Th X, 186
 theory of decay of activity, 188
 influence of conditions on rate of
 decay and recovery of activity, 190
et seq.
 disintegration hypothesis, 194, 324
 decay of activity of radium emanation,
 206
 measurements of emanating power,
 213
 effect of temperature, moisture, and
 solution, on emanating power, 214
 regeneration of emanating power, 215
 constant rate of production of emana-
 tion of radium and thorium, 216
et seq.
 source of thorium emanation, 220
 radiations from the emanation, 222
 chemical nature of emanation, 226
 condensation of emanations of radium
 and thorium, 236 *et seq.*
 temperature of condensation of emana-
 tion, 238 *et seq.*
 effect of successive precipitations on
 activity of thorium, 296
 recovery of activity of radium, 300
 conservation of radio-activity, 309
 theory of radio-activity, 318
 theory of radio-active change, 324
- Soil
 radio-activity of, 362
 difference in activity of, 362
- Solution
 coloration of, by radium, 15
 of emanation X in acids, 275
 electrolysis of active, 276
- Source
 of the thorium emanation, 220
 of radium emanation, 222
- Spark
 action of radium rays on, 171
- Spectrum
 spark spectrum of radium, 15, 16
 flame spectrum of radium, 17
 effect of a magnetic field on spectrum
 of radium, 17
 of polonium, 20
 of phosphorescent light of radium
 bromide, 169
 of helium in radium gases and emana-
 tion, 329

- Spectrum (*cont.*)
of emanation, 329
- Spinthariscopes
description of, 127
- Springs
emanation from water of, 360
- Stark
energy to produce an ion, 55
- Strauss and Hofmann
radio-active lead, 25
- Strutt
conductivity of gases for radiation,
61, 62
negative charge carried by radium
rays, 104
absorption of β rays proportional to
density, 113
nature of α rays, 116
conductivity of gases produced by
 γ rays, 62, 144
absorption of radium rays from sun
by atmosphere, 343
radio-activity of ordinary matter, 378
emanation from mercury, 381
- Sun
effect of radium in, 342
age of, 343
- Temperature
of radium above surrounding space,
158
effect of, on intensity of radiations
from uranium and radium, 173
effect of, on luminosity, 173
rate of decay of radium emanation
unaffected by, 208
of condensation of emanations, 238
et seq.
rate of decay of thorium emanation
unaffected by, 246
effect of, on excited activity, 277
effect of, on amount of excited activity
in atmosphere, 364 *et seq.*
effect of, on natural ionization of air, 377
- Theories
of radio-activity, review of, 316
discussion of, 320
disintegration theory, 324
- Thermo-luminescence, 170
- Thomson, J. J.
relation between current and voltage
for ionized gases, 31
difference between ions as condensa-
tion nuclei, 46
charge on ion, 47
theory of electrometers, 85
path of charged particle in uniform
magnetic field, 96
apparent mass of moving charged
body, 108
- Thomson, J. J. (*cont.*)
structure of atom, 126, 347
theory of radio-activity, 319
cause of heat emission from radium,
321
possible causes of disintegration of
radium, 342
nature of electrons, 347
emanation from tap-water and deep
wells, 360
- Thomson, J. J., and Rutherford
ionization theory of gases, 28 *et seq.*
- Thorium
discovery of radio-activity of, 10
emanation from, 11
preparation of non-radio-active tho-
rium, 25
nature of radiations from, 90 *et seq.*
 β rays from, 95 *et seq.*
 α rays from, 115 *et seq.*
 γ rays from, 141 *et seq.*
rate of emission of energy by, 154
separation of Th X from, 179
recovery of activity of, 181
disintegration of thorium, 193
emanation from, 197
properties of emanation from, 198 *et*
seq.
diffusion of emanation from, 233
condensation of emanation from, 236
et seq.
excited radio-activity from, 250 *et seq.*
successive changes in emanation X of,
272
explanation of initial portion of decay
curve, 295 *et seq.*
explanation of initial portion of re-
covery curve, 295 *et seq.*
effect of successive precipitations on,
296
recovery curve after large number of
precipitations, 297
theory of decay curve of Th X, 298
non-separable activity of, 296, 304
radiations from active products of,
304 *et seq.*
division of activity amongst active
products of, 306 *et seq.*
conservation of radio-activity of, 308
et seq.
résumé of results, 311 *et seq.*
theories of radio-activity of, 316 *et seq.*
discussion of theories of radio-activity,
320 *et seq.*
source of energy of radiations, 320 *et*
seq.
theory of radio-active change, 322 *et*
seq.
table of radio-active products of, 326
rate of change of, 332 *et seq.*

- Thorium (cont.)**
 life of, 333
 total emission of energy from 1 gram of, 337
 possible causes of disintegration of, 338 *et seq.*
- Thorium X**
 methods of separation of, 179
 law of decay of activity of, 182
 law of recovery of activity of, 182
 theory to explain production of, 183
 material nature of, 185
 continuous production of, 186
 explanation of decay of activity of, 188 *et seq.*
 effect of conditions on the rate of change of, 190 *et seq.*
 disintegration hypothesis to explain production of, 193 *et seq.*
 minute amount of, produced, 195
 effect of successive separations of, on activity of thorium, 296
 theory of decay curve of, 296 *et seq.*
- Tommasina**
 scintillations produced by electrification, 128
- Townsend**
 ions by collision, 36, 54
 coefficient of recombination, 38
 diffusion of ions, 49 *et seq.*
 comparison of charge on ion with that on hydrogen atom in electrolysis, 51
 number of molecules per c.c. of gas, 51
 ionization by collision for different speeds, 139
- Transmission**
 of excited radio-activity of radium and thorium, 282 *et seq.*
 of excited radio-activity of actinium, 287
- Troost**
 rays from hexagonal blende, 4
- Uranium**
 discovery of radio-activity of, 5
 persistence of radiations of, 6
 discharging power of rays, 7
 absence of reflection, refraction and polarization, 7
 examination of uranium minerals, 11 *et seq.*
 relative activity of compounds of uranium, 12
 nature of radiation from, 90 *et seq.*
 β rays from, 95 *et seq.*
 α rays from, 115 *et seq.*
 γ rays from, 142 *et seq.*
 emission of energy by, 154
 separation of Ur X from, 179
 recovery of activity of, 182
- Uranium (cont.)**
 non-separable activity of, 294, 304
 radiations from Ur X, 293
 method of measurement of activity of Ur X, 294
 changes in, 294
 conservation of radio-activity of, 308 *et seq.*
 résumé of results, 311 *et seq.*
 theories of radio-activity, 316 *et seq.*
 discussion of theories of radio-activity, 320 *et seq.*
 source of energy of radiation, 320 *et seq.*
 theory of radio-active change, 322 *et seq.*
 table of active products, 326
 rate of change of, 332 *et seq.*
 life of, 333
 radium possible product of, 334
 total emission of energy from 1 gram of, 337
 possible causes of disintegration of, 338 *et seq.*
- Uranium X**
 separation of, by Crookes, 178
 separation of, by Becquerel, 179
 decay of activity of, 182
 recovery of activity of, 182
 theory to explain production of, 183
 material nature of, 185
 explanation of decay of activity of, 188 *et seq.*
 radiations from, 293
 method of measurement of radiations from, 294
 changes in, 294
- Velocity**
 of ions in electric field, 39 *et seq.*
 difference between, of positive and negative ions, 42 *et seq.*
 of β particle or electron, 107 *et seq.*, 110 *et seq.*
 variation of mass of electron with, 108 *et seq.*
 of α particle, 122 *et seq.*
 of transmission of carriers of excited activity, 284
- Villard**
 discovery of γ rays from radium, 141
 alteration of X ray screen with time, 168
 activity produced by cathode rays, 372
- Volume**
 of radium emanation, calculation of, 246
 of emanation, determination of, 313
 decrease of, of radium emanation, 313

- Walker, G. W.
theory of electrometer, 75
- Walkhoff
action of radium rays on skin, 176
- Wallstabe
diffusion of radium emanation into liquids, 235
- Water
emanation from, 360
decay of activity of emanation from, 361
- Water-falls
amount of excited activity produced at Niagara, 366
electrification produced near, 366
- Watts, Marshall
atomic weight of radium, 17
- Weight
loss of by radio-elements, 335
attempts to measure loss of, in radium, 336
- Wheeler and Bumstead
emanation from surface water and the soil, 361, 368
identity of emanation from soil with radium emanation, 361
absence of emanation in mercury, 381
- Whetham
effect of valency of ion on colloidal solutions, 175
possible cause of disintegration of atom, 342
- Wiedemann and Schmidt
thermo-luminescence, 170
- Wiedemann
thermo-luminescence produced by radium rays, 170
- Wien
amount of charge carried by radium rays, 105
positive charge of canal rays, 125
- Willcock, Miss, and Hardy
coloration of iodoform solution by radium rays, 175
- Willemite
phosphorescence of under radium rays, 168
use to show condensation of emanation, 237
- Wilson, W. E.
radium in sun, 342
- Wilson, H. A.
charge on ion, 48
- Wilson, C. T. R.
ions as nuclei of condensation, 44
et seq.
difference between positive and negative ions as condensation nuclei, 46
equality of charges carried by positive and negative ions, 47
construction of electroscope, 73
natural ionization of air in vessels, 351
radio-activity of rain and snow, 355, 356
loss of charge in closed vessels, 373
presence of ions in free air shown by condensation, 375
number of ions produced per c.c., 375
effect of pressure and nature of gas on ionization in sealed vessels, 376
- Zeleny
velocity of ions, 39 *et seq.*
difference of velocity of ions, 40, 42
potential gradient between electrodes, 63
- Zerban and Hofmann
active substances from pitchblende, 25
- Zinc Sulphide
scintillations produced in by α rays, 127
cause of luminosity of, 127 *et seq.*
scintillations due to cleavage of crystals, 128

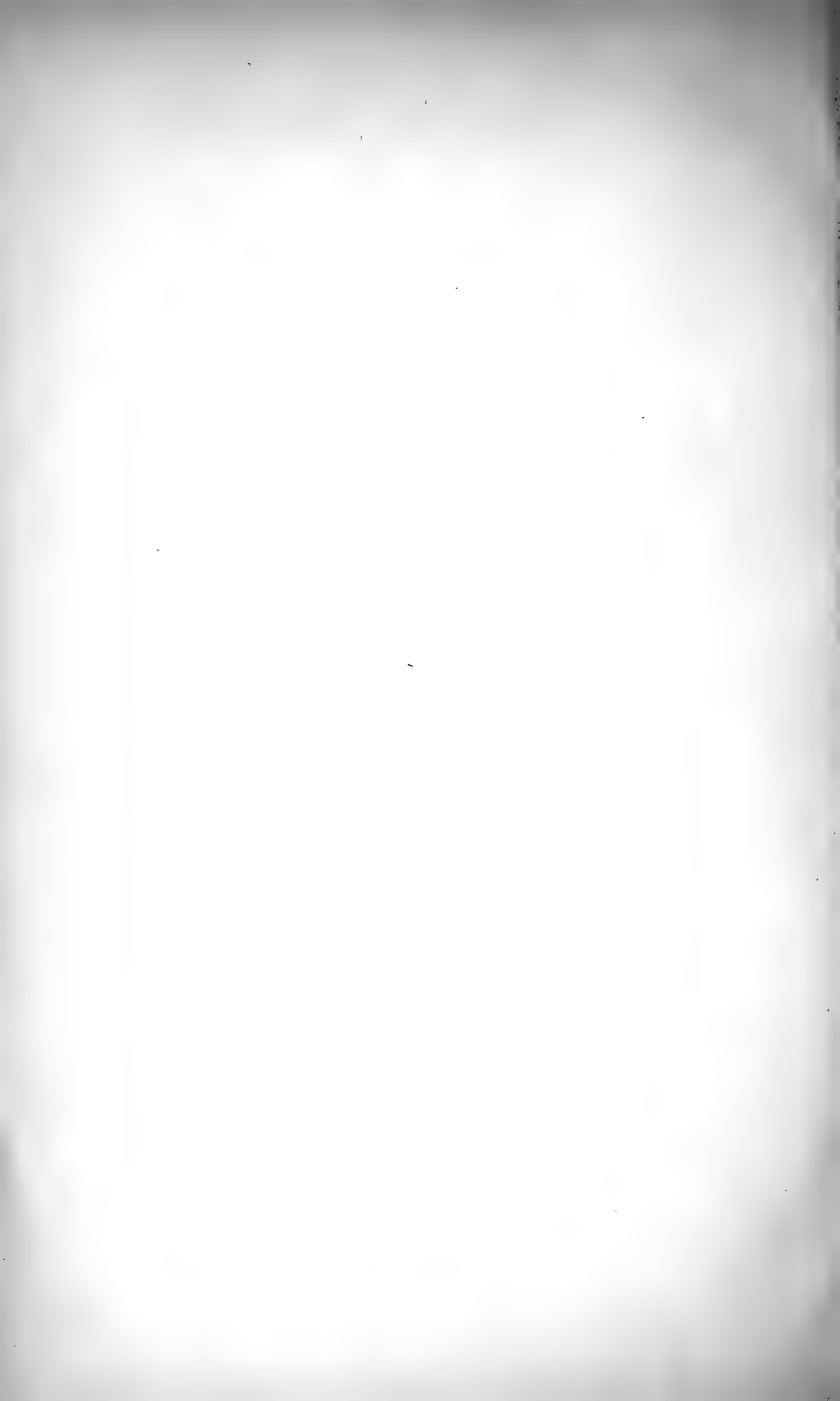

CAMBRIDGE PHYSICAL SERIES.

Conduction of Electricity through Gases. By J. J. THOMSON, D.Sc., LL.D., Ph.D., F.R.S., Fellow of Trinity College and Cavendish Professor of Experimental Physics. Demy 8vo. viii + 568 pp. 16s.

CONTENTS.

- | | | | |
|-------|---|--------|---|
| I. | Electrical Conductivity of Gases in a normal state. | IX. | Ionisation in Gases from Flames. |
| II. | Properties of a Gas when in the conducting state. | X. | Ionisation by Light. Photo-Electric Effects. |
| III. | Mathematical Theory of the Conduction of Electricity through a Gas containing Ions. | XI. | Ionisation by Röntgen Rays. |
| IV. | Effect produced by a Magnetic Field on the Motion of the Ions. | XII. | Becquerel Rays. |
| V. | Determination of the Ratio of the Charge to the Mass of an Ion. | XIII. | Spark Discharge. |
| VI. | Determination of the Charge carried by the Negative Ion. | XIV. | The Electric Arc. |
| VII. | On some Physical Properties of Gaseous Ions. | XV. | Discharge through Gases at Low Pressures. |
| VIII. | Ionisation by Incandescent Solids. | XVI. | Theory of the Discharge through Vacuum Tubes. |
| | | XVII. | Cathode Rays. |
| | | XVIII. | Röntgen Rays. |
| | | XIX. | Properties of Moving Electrified Bodies. |
| | | | Supplementary Notes. |
| | | | Index. |

Times.—"It is difficult to think of a single branch of the physical sciences in which these advances are not of fundamental importance. The physicist sees the relations between electricity and matter laid bare in a manner hardly hoped for hitherto....The workers in the field of Science are to-day reaping an unparalleled harvest, and we may congratulate ourselves that in this field at least we more than hold our own among the nations of the world."

A Treatise on the Theory of Solution, including the Phenomena of Electrolysis. By WILLIAM CECIL DAMPIER WHETHAM, M.A., F.R.S., Fellow of Trinity College. Demy 8vo. x + 488 pp. 10s. net.

Athenæum.—"The choice and arrangement of the matter included are alike excellent....Mr Whetham's book is probably the most complete and satisfactory treatise on the subject in any language and as such is sure to enjoy a wide popularity."

Nature.—"The treatment throughout is characterised by great clearness, especially in the physical and mathematical portions, so that the volume may be warmly recommended to students of chemistry."

CAMBRIDGE PHYSICAL SERIES.

CONTENTS OF MR WHETHAM'S 'SOLUTION AND ELECTROLYSIS.'

I.	Thermodynamics.	X.	Galvanic Cells.
II.	The Phase Rule.	XI.	Contact Electricity and Polarization.
III.	The Phase Rule. Two Components. Solutions.	XII.	The Theory of Electrolytic Dissociation.
IV.	Solubility.	XIII.	Diffusion in Solutions.
V.	Osmotic Pressure.	XIV.	Solutions of Colloids.
VI.	Vapour Pressures and Freezing Points.		Additions.
VII.	Theories of Solution.		Table of Electro-chemical Properties of Aqueous Solutions.
VIII.	Electrolysis.		
IX.	Conductivity of Electrolytes.		

Electricity and Magnetism: an Elementary Text-book,
Theoretical and Practical. By R. T. GLAZEBROOK, M.A., F.R.S.,
Director of the National Physical Laboratory and Fellow of Trinity
College, Cambridge. Crown 8vo. Cloth. 1—440 pp. 7s. 6d.

Athenæum.—"If the nature of the book be taken into consideration, it will be found unusually free from the influence of the examination spirit. The writing is bright and interesting, and will stimulate a desire, we think, for further study."

Guardian.—"Every schoolmaster and teacher who has under consideration the selection of a text-book for his better students should most certainly look into this book. The information is everywhere absolutely sound and reliable."

PREFACE. Some words are perhaps necessary to explain the publication of another book dealing with Elementary Electricity. A considerable portion of the present work has been in type for a long time; it was used originally as a part of the practical work in Physics for Medical Students at the Cavendish Laboratory in connexion with my lectures, and was expanded by Mr Wilberforce and Mr Fitzpatrick in one of their Laboratory Note-books of Practical Physics.

When I ceased to deliver the first year course I was asked to print my lectures for the use, primarily, of the Students attending the practical classes; the lectures on Mechanics, Heat and Light have been in type for some years. Other claims on my time have prevented the issue of the present volume until now, when it appears in response to the promise made several years ago.

Meanwhile the subject has changed; but while this is the case the elementary laws and measurements on which the science is based remain unaltered, and I trust the book may be found of service to others besides my successors at the Cavendish Laboratory.

The book is to be used in the same way as its predecessors. The apparatus for most of the Experiments is of a simple character and can be supplied at no great expense in considerable quantities.

Thus the Experiments should all, as far as possible, be carried out by the members of the class, the teacher should base his reasoning on the results actually obtained by his pupils. Ten or twelve years ago this method was far from common; the importance to a School of a Physical Laboratory is now more generally recognized; it is with the hope that the book may be of value to those who are endeavouring to put the method in practice that it is issued now.

CAMBRIDGE PHYSICAL SERIES.

Heat and Light. An Elementary Text-book, Theoretical and Practical, for Colleges and Schools. By R. T. GLAZEBROOK, M.A. Crown 8vo. 5s.

Also in separate volumes :

Heat. 230 pp. 3s.

Light. 213 pp. 3s.

Mechanics and Hydrostatics. An Elementary Text-book, Theoretical and Practical, for Colleges and Schools. By R. T. GLAZEBROOK, M.A. Crown 8vo. 8s. 6d.

Also in separate volumes :

Part I. **Dynamics.** 256 pp. 4s.

Part II. **Statics.** 182 pp. 3s

Part III. **Hydrostatics.** 216 pp. 3s.

EXTRACTS FROM PRESS NOTICES.

“Schools and Colleges will certainly benefit by adopting this book for their students.” *Nature*.

“Mr Glazebrook’s volumes on Heat and Light deal with these subjects from the experimental side and it is difficult to admire sufficiently the ingenuity and simplicity of many of the experiments without losing sight of the skill and judgment with which they are arranged.” *Saturday Review*.

“The books almost cover the advanced stages of the South Kensington prospectus and their use can certainly be recommended to all who wish to study these subjects with intelligence and thoroughness.” *Schoolmaster*.

“Mr Glazebrook’s great practical experience has enabled him to treat the experimental aspect of the book with unusual power and it is in this that the great value of the book as compared with most of the ordinary manuals consists.” *Educational Review*.

“The book is very simply and concisely written, is clear and methodic in arrangement....We recommend the book to the attention of all students and teachers of this branch of physical science.” *Educational News*.

“We wish Mr Glazebrook every success on the extension of his practical system to all the Colleges and Schools of the country. It is the only way in which the interest of the student can be awakened and the study of the subject made popular and real.” *Technical World*.

“It will be especially appreciated by teachers who possess the necessary apparatus for experimental illustrations.” *Athenæum*.

“Text-books on this subject are generally too simple or too elaborate for a conception of elementary mechanical principles. This book cannot fail to recommend itself therefore for a first course preliminary to the study of physical science. No other book presents in the same space with the same clearness and exactness so large a range of mechanical principles.” *Physical Review*.

“Marked ability has been shewn in the development of the subject of Statics in the present volume....The collected examples for students’ exercises are excellent.” *Glasgow Herald*.

CAMBRIDGE PHYSICAL SERIES.

General Editors: F. H. NEVILLE, M.A., F.R.S. and
W. C. D. WHETHAM, M.A., F.R.S.

Mechanics. By JOHN COX, M.A., F.R.S.C., Macdonald
Professor of Experimental Physics in McGill University, Montreal.
Demy 8vo. pp. xiv + 332. 9s. Net.

Athenæum.—"It may reasonably be hoped that this endeavour to bridge over the gulf which has hitherto separated theory from practice in respect of the principles of mechanics, by showing their intimate connexion, and to present the subject in a more living and attractive form, by drawing attention to the gradual stages and methods by which the early investigators discovered the laws which govern the science, will meet with the success which it deserves."

The Study of Chemical Composition. An Account of
its Method and Historical Development, with illustrative quotations.
By IDA FREUND, Staff Lecturer and Associate of Newnham College.
Demy 8vo. xvi + 650 pp. 18s. Net.

Saturday Review.—"Written from a broad, philosophical standpoint, we know of no book more suited for the student of chemistry who has attained a sound general knowledge of the science, and is now ready to appreciate a critical discussion of the methods by which the results he has learnt have been built up, thereby fitting himself for the real world of investigation on his own account."

A Treatise on the Theory of Alternating Currents.
By ALEXANDER RUSSELL, M.A., M.I.E.E.

Vol. I. Demy 8vo. pp. 408. 12s. Net.
Vol. II. In the Press.

Scotsman.—"The volume is not only rich in its own substantive teaching, but well supplied with references to the more remote authorities upon its subject. It opens an important and valuable contribution to the theoretical literature of electrical engineering."

Radio-activity. By E. RUTHERFORD, D.Sc., F.R.S., F.R.S.C.,
Macdonald Professor of Physics, McGill University, Montreal. Demy
8vo. pp. x + 400. 10s. 6d. Net.

Athenæum.—"English students have had to wait till now for any connected and detailed account of this new branch of physics from the pen of one who has a first hand knowledge of it."

Nature.—"The arrangement of the matter and its treatment are throughout admirable."

The Theory of Experimental Electricity. By
W. C. D. WHETHAM, M.A., F.R.S., Fellow of Trinity College.
Demy 8vo. 8s. Net.

CAMBRIDGE UNIVERSITY PRESS WAREHOUSE,

C. F. CLAY, MANAGER,

London: AVE MARIA LANE,

Glasgow: 50, WELLINGTON STREET.

ALSO

London: H. K. LEWIS, 136, GOWER STREET, W.C.



8/2/57

