



LIBRARY  
Connecticut State College

7

Vol. 30664  
Class 599.32 J714  
Cost Chemistry Dept.  
Date Sept 1977

599.32  
J714  
30664

599.32  
J714  
30664

599.32 J714  
30664



3 9153 00147815 7

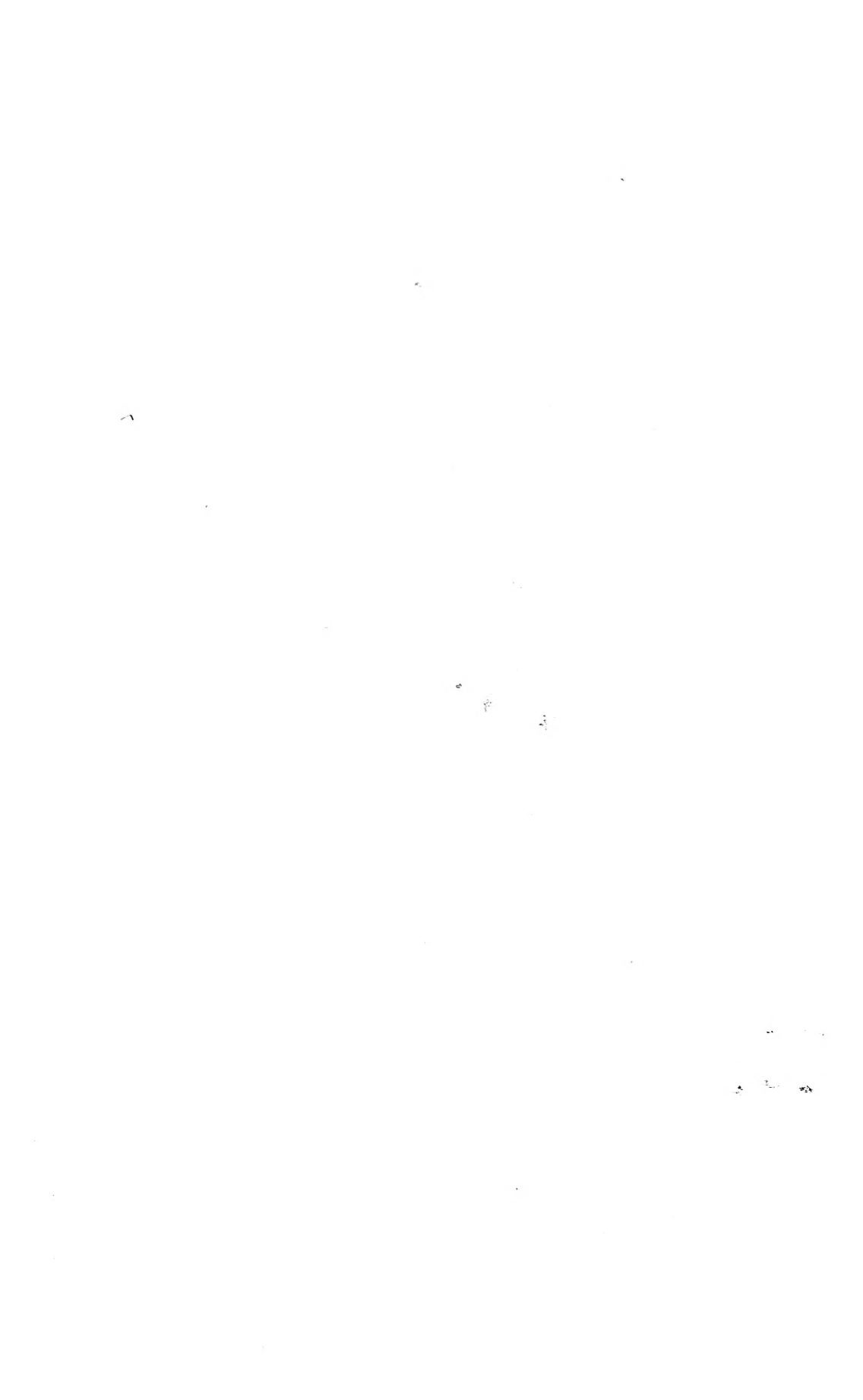





MEMOIRS  
OF  
THE WISTAR INSTITUTE OF ANATOMY AND BIOLOGY

No. 6

# THE RAT

DATA AND REFERENCE TABLES

FOR

THE ALBINO RAT  
(MUS NORVEGICUS ALBINUS)

AND

THE NORWAY RAT  
(MUS NORVEGICUS)

— Second Edition —

Revised

COMPILED AND EDITED BY  
HENRY H. DONALDSON

PHILADELPHIA

1924

5. 23  
D. 11

Copyright 1924  
HENRY H. DONALDSON  
30664  
ALL RIGHTS RESERVED

## PREFACE TO THE FIRST EDITION

For a number of studies on the growth of the mammalian nervous system made by my colleagues and myself we have used the albino rat. In the course of the work we frequently felt the need of referring to other physical characters of the rat to which the nervous system might be related. This led us to collect such data as were already in the literature and also led us to make further investigations. The facts gathered in this way have proved useful to us and are here presented in the hope that they will be useful to others also.

The plan of the presentation is simple. An introduction treats of the rat as a laboratory animal, indicates the methods of gathering the data, and also gives examples of our use of the tables. This is followed by an outline of the classification of the common rats and by a brief statement of the history of the rat since it arrived in western Europe.

The rest of the book falls into two parts. The first part deals with the domesticated albino rat—concerning which we have the larger amount of information.

The second part deals in a similar way with the wild Norway rat—the form from which the Albino has been derived. In connection with each part the several reference tables and the formulas employed for them and for the corresponding graphs, are given, and at the end of the book a list of papers on the rat is added.

In the two parts which form the body of the book the purpose is to present for the rat under normal conditions the fundamental observations—giving data and conclusions only. It is hardly necessary to add that in most directions our information is fragmentary.

For all the formulas which apply to the data coming from the laboratories of The Wistar Institute, I take pleasure in thanking my colleague, Dr. S. Hatai.

For aid in the preparation of these pages I am also much indebted to those unnamed assistants to whose lot has fallen the greater part of the computations for the tables and whose devotion to their work has added a human interest to a task otherwise monotonous.

To the many authors whose results are here briefly cited or quoted in extenso I take the opportunity to express my obligations—very sincere obligations—for experience shows that such results come only by hard labor.

Many of the illustrations have been taken from the journals in which they were originally published and my thanks are due to the editors and publishers of these journals for the privilege of reprinting the illustrations here.

During the preparation of this book my immediate colleagues have given me encouragement and aid, and I cherish the hope that, should the occasion arise, both of these will be again forthcoming to help mend the gaps and rectify the errors which a close scrutiny of these pages is certain to reveal.

*Philadelphia, 1915.*

## CONTENTS

	PAGE
Preface.....	iii
Contents.....	v
Prologue.....	vii
Introduction.....	1
Classification.....	4
Early records and migrations of the common rats.....	7

### ALBINO RAT—MUS NORVEGICUS ALBINUS

#### PART I

Chapter 1. Biology.....	15
Chapter 2. Genetics.....	34
Chapter 3. Anatomy.....	37
Chapter 4. Physiology.....	132
Chapter 5. Growth in total body weight according to age.....	172
Chapter 6. Growth of parts or systems of the body in weight.....	181
Chapter 7. Growth of parts and organs in relation to body length and in relation to age.....	201
Chapter 8. Growth in terms of water and solids.....	299
Chapter 9. Growth of chemical constituents.....	312
Chapter 10. Pathology.....	327

### NORWAY RAT—MUS NORVEGICUS

#### PART II

Chapter 11. Life history and distinguishing characters.....	335
Chapter 12. Growth in total body weight on age—aged Norways.....	342
Chapter 13. Growth in total body weight on body length.....	346
Chapter 14. Growth of organs in relation to body length.....	358
Chapter 15. Growth in terms of water and solids.....	378
Chapter 16. Captivity and domestication.....	382
Chapter 17. References to the literature.....	387
Index.....	459



## PROLOGUE

In order to get a background for studies on the growth of the nervous system of the rat, the available information on the growth of this animal was brought together and published in 1915, the first edition of this memoir. The time has now come for a revision and a word is in place concerning the changes which appear in this second edition, the significance to be attached to the method of presentation and the manner in which the data and tables can be used.

Touching the revision it suffices to say that the usual methods of elimination, correction and condensation have been followed, but nowhere are the changes made of a fundamental character.

Since 1915 our bibliography of the rat has increased by some 1300 titles, and these new contributions have furnished a considerable mass of information which has been incorporated.

Despite the fact that the aim has been to use only the best data touching any given point, and not to record the historical growth of knowledge concerning it, this second edition is inevitably larger than the first—a result to be deplored but apparently unavoidable.

In citing the new results it has been necessary to limit the entries almost entirely to fundamental data—to do more would have been to attempt an encyclopaedia.

When all is said, the question remains as to the significance and utility of the data and tables as here given. Appreciating that domestication has modifying effects, tables have been made separately for both the wild Norway and the domesticated Albino. Even as they stand these show differences between the two strains and these differences are regarded as due for the most part to the domestication of the Albino.

The pied strains, which are sometimes used for laboratory purposes, and which are also domesticated, seem to be very similar to the Albino. At the same time albinism is also a

modifying factor and we know at present several characters in which the Albino differs from the Norway or the pied varieties. While there are differences between the pied and Albino varieties which require further study, they seem to be trifling in comparison with the more conspicuous modifications which have already appeared in the domesticated albino strain—as contrasted with the wild Norway.

During the past few years several laboratories have reported Albinos of large size, even larger than the wild Norways as commonly found. Here there comes to view the increase in body size which is so common a response in mammals under domestication.

There is a change also in the physiology of the Albino. Puberty now appears earlier in the domesticated Albino, not only in comparison with the wild Norway, but also in comparison with our records of 1915. Undoubtedly there are other instances of changes of this type not yet noted. Such changes mean that there is a drift in the characters of these domesticated rats, and suggest that after a century more of domestication, records of the structure and functions of the albino rat might distinctly differ from those with which we are here presented. Such a drift is sometimes designated as orthogenesis.

Returning to the difficulties which arise in the use of the tables here given, it is pertinent to enquire as to the significance of these, when, for example, it becomes necessary to deal with a rat one hundred days old, but which has a body weight two and a half times as large as the value tabulated for that age. Plainly, the age-weight relations do not agree with the values in the table.

Without going into details, inappropriate here, it may be stated in general that such an overgrown rat will have, in the case of characters related to body length or body weight, approximately those values which go with its size, despite the fact that it is young for its size, but these in turn will be modified where they are also correlated with age.

Pursuing the matter a step further, it seems highly probable that the number of cells in the nervous system is characteristic



for the species and constant within the limits of biological variation. Hence variations in the weight of this system must depend mainly on the size of the constituent cells.

In other systems, characterized by the epithelial, glandular and connective tissues, there is probably much more latitude in the number of elements produced, but withal a concomitant variation in cell size as well.

In the growing rat there is at birth a phase in which cell multiplication is relatively active, though accompanied by the enlargement of those cells already formed.

In the nervous system cell formation comes to an end early and in the muscles it is slow after thirty days and diminishes with age probably in some of the other systems, although it persists throughout life in the epithelia. On a combination of these two processes of cell formation and cell enlargement depends the growth of the animal as a whole, accompanied, of course, by the accumulation of more or less inert material.

The overgrowth, such as was instanced earlier, appears to depend mainly on the precocious enlargement of the formed elements without a corresponding differentiation, which, if it occurred, would be accompanied by a relative change in the percentage of water and the chemical status of the tissues; since these changes are more closely correlated with the age than with the size of the rat.

While all this is in general true, nevertheless a shifting back of puberty in the female, which has been observed, indicates a real precocity of development in the ovaries and the associated structures. In this instance the chemical changes are also precocious. Thus age and size may vary widely, also age and the incidence of puberty, and hence in this latter case age and the phase of chemical development.

These statements indicate that there are fluctuations in characters both on age and on body weight, and also that there may be a drift or trend in the form and functions of the albino rat as domestication progresses.

What then is the relation of the data and reference tables to this state of affairs?

So far as these data are based on observations from our own laboratory they apply to a fairly uniform population of rats somewhat modified from time to time by food conditions. Further, it may be said that these rats show the characters commonly found in other laboratory colonies, but they represent neither the best animals nor those in the ideal condition, nor do they necessarily yield the values which will be found in Albinos ten years hence. Yet despite these defects the data and reference tables still have their uses.

The data in the reference tables reveal the form of the growth curves for the entire rat and its organs. In their essential features these growth curves are the same for rats of various sizes. The tables however have another and quite different use.

The case for the tables may be put in the following form. In a given research the test rats are compared with the controls and the differences from the controls give the amount of change. Here the controls furnish base line values, so to speak, and by them the values for the test rats are measured. In this instance reference tables are a luxury. Suppose however that two years later the same investigation is repeated and the changes in the test animals are again determined in the same way. When the two series of results are compared with each other it is important to know whether the control rats in both series agree in their characters. If, as is very possible, they do not agree, then it is a question which of the controls should be taken as the ultimate standard. This situation arises in all fields where measurements are made, and it is met by having accepted standards to which the individual measuring instruments (here the controls) are referred. It may happen then that the controls in the earlier research show a character ten per cent above the table values, while in the later research, it is ten per cent below. In any effort to collate the two series of results this difference between the controls must be taken into consideration.

Such differences may not be always significant as influencing the experimental results, but on the other hand they may be of

great importance, and recognition of them can thus facilitate the interpretation of differences found in two successive investigations or in those made in other laboratories where other strains of rats have been used. The tables and data offer then base line values to which those of the controls used in any investigation may be referred.

Further, the individuals in the group of controls, no matter how carefully chosen, will differ from the individuals in the test group. They cannot therefore be directly compared with one another for the values of any character under consideration, but the determination of their respective deviations from the corresponding table values furnishes at once a basis of comparison.

As to these table values themselves, one hastens in the first instance to disclaim the suggestion that they furnish standards of the same type as are to be had in the physical sciences. In the very nature of the case such accuracy and constancy is unattainable, for all animals at all times are in a state of flux. The data must be statistical and always carry a probable error.

Really all that can be said in the way of apology for the use of the values here given, as basal, is that "once upon a time" there was a group of albino rats living under moderately favorable conditions which had the various characters with the values here recorded.

All the present tables might therefore be replaced by new ones which would show a somewhat different series of values, and if two such sets of tables were available, the best criterion for preference would lie, I believe, in the degree to which the values given approximated a position intermediate between the values reported at the time from different laboratories and for different strains.

In discussing the use of the reference tables, emphasis has been laid on the cases in which the observed values are for one reason or another distinctly different from the table values. This is particularly common in the case of the glandular system and in the storage organs, while on the other hand, skeletal relations, such as the lengths of the limb bones to the length

of the body, show a higher degree of constancy. Indeed, when one takes at random an albino rat of moderate size and compares the values for its characters with those given for the body length or body weight in the appropriate tables, one finds to-day in the case of Albinos from our own colony a good agreement, between the observed and the table values, for a large number of characters.

On the other hand, in some characters a distinct shift has occurred. For example, the weight of the thyroid gland in rats from The Wistar Institute Colony is to-day distinctly below that given in the tables.

This compilation is therefore put forth in the hope that the reference data here given can be used to control and to make comparable the results of investigations carried out at different times and places and with different strains, and also with the hope that they may furnish a set of records by which further changes in the albino rat due to continued domestication can be measured.

The reference tables have been retained largely unaltered because the several determinations were mainly on the same series of rats—and any particular revision for one or more organs would introduce a disharmony in this group of records.

A few words touching the qualifications of the rat as a laboratory animal may be added.

The larger part of the information contained in this memoir has come from the study of the domesticated albino rat, which is a mutant from the wild Norway, but the general biology of all the color varieties of this species is similar.

The wild Norway rat is cosmopolitan and its albino variety is also found in all countries where small pets are kept. It is omnivorous, with a range of diet as wide as that of man. It breeds freely at all seasons but most actively in the spring and early fall. The litters are large and the sexes appear in about the same ratio as in man—so that control and test animals of like sex may be had from the same litter—thus giving the closest relationship.

The albino rat thrives when inbred, provided there is selection for vigor. In a revolving cage it runs long distances voluntarily—much to the advantage of its general health. To training, it responds readily.

If the life span of three years in the rat is taken as equivalent to 90 years in man, it is found that the growth changes in the nervous system occur within the same fraction of the life span (i.e., at the equivalent ages) in the two forms. What is true for the nervous system is also probably true for some of the other systems and this makes possible the cross reference of the results from the two species, with a high degree of precision.

It is now appreciated that the mammals associated with man, of which group the rat is a good example, are very responsive to environmental changes. The sensitiveness which they show and the speed with which the responses occur, require to be kept in view in all work—observational or experimental—on the living animal. This is a matter on which it is hardly possible to lay too great emphasis.

Such responsiveness is an advantage when it is sought to induce changes, but a distinct disadvantage when the constancy of the control animals is desired.

The critical periods in development are well marked, and birth, weaning and puberty, though somewhat differently spaced in the span of life, bring with them the same changes that appear in man.

Finally, in the case of the rat, the wild form, the Norway, is generally available for comparison with the domesticated Albino, and thus the modifications induced by captivity and domestication can be readily observed.

Some of the effects of domestication are already recognized, but the matter calls for further study. In this connection it is not without interest to note that the Albino rat has probably been under domestication for less than a century, whereas, by contrast, most of the common domesticated animals have been associated with man for hundreds or even thousands of years, and in most instances the wild types from which they came are either doubtful or hard to obtain.

In enumerating the qualifications of the rat as a laboratory animal, and in pointing out some of its similarities to man, it is not intended to convey the notion that the rat is a bewitched prince or that man is an overgrown rat, but merely to emphasize the accepted view that the similarities between mammals having the same food habits tend to be close, and that in some instances at least, by the use of equivalent ages, the results obtained with one form can be very precisely transferred to the other.

It is proper to recognize, however, that, considered from the laboratory standpoint, at least three major deficiencies are presented by the rat. Its small size makes some types of experimental work either difficult or impossible. Its resistance to various forms of infection, diphtheria and tuberculosis, for example, makes it unsuitable for certain classes of studies, while its susceptibility to a form of lung infection, sometimes called rat pneumonia, has proved thus far a serious obstacle to studies on senescence. It is possible that this last defect may be remediable, but the others are inherent.

In assembling this information the aim has been to give, in tabular form especially, such data as can be presented in quantitative terms and also such as are closely related to age and to the critical periods of development, since the experimental results obtained often depend in such an intimate way on the exact condition of the animal at the time of the test.

# THE RAT

## INTRODUCTION

The Norway rat, *Mus norvegicus*, is one mammal now easily obtainable both wild and as a domesticated form. This latter is represented by either the Albino or the pied rats so common in our laboratories.

The Albinos are clean, gentle, easily kept and bred, and not expensive to maintain. They are omnivorous, thriving well on table scraps. The span of life is about three years and breeding begins at about three months. Furthermore the species is cosmopolitan. The litters are large and may be had at any season. The young are immature at birth. The domesticated Albino crosses readily with the wild Norway. The rat, both wild and domesticated, takes exercise voluntarily and is susceptible to training. It is also highly resistant to the usual wound-infecting organisms. For a number of lines of study therefore, the rat is peculiarly suitable.

Through the researches of a host of investigators both in this country and abroad, there has been gathered a considerable body of data applying to the weight and size of the domesticated Albino rat and its parts, as well as some similar data applying to the wild Norway rat, the parent species. It is the body of facts so gathered that it is our purpose to present, as far as possible in tabular form.

Attention should be called to the fact that the observations presented in the tables have been made mainly on rats in the first year of life and but rarely on those which are older. It follows, from this that the data apply to the rat in its most vigorous period and do not give information that can be used for the study of old age.

Since the quantitative data appearing in the tables are biological, they naturally exhibit more or less variability and reflect

in each instance something of the conditions under which they have been obtained. It follows therefore that they must not be expected to possess the precision of physical or chemical determinations. Nevertheless, so long as the values here presented are not mistaken for absolute standards representing ideal or final determinations, they may be used with advantage.

Most of the matter presented is taken from researches already published in full, but in a few instances data from work in progress have been included also. In the latter instance the author's name is followed by (MS with date).

In a few of the tables already published, mainly from our own laboratory, it has been found necessary to make corrections, so that when the tables here printed do not agree with the originals, it is to be assumed that the changes are due to revision.

Owing to the absence of data for the normal animal or to the failure of the authors to express their results in a quantitative form, much of the literature which is cited does not appear in the text. Such papers however often contain valuable information on either the Albino or Norway rat and the citation of them in the bibliography serves to indicate the range of the studies in which this animal has been used.

Extensive reference tables have been computed for the various characters only as these appear under normal conditions, while the modifications which may be experimentally induced in these characters are merely mentioned or presented very briefly.

In a number of cases the results are represented by both graphs and tables. The purpose of the graphs is merely to furnish a general view of the form of change which occurs, while for the exact values, the tables must always be consulted. In those tables which are based on size, the body length of the rat, because it is least subject to incidental variations, is the measurement to which the others have been referred.

It is recognized however that some of the characters are functions of age and in that case it is of course necessary to know the age of the animal in order to obtain satisfactory results.



All of the longer tables are based on formulas. These formulas are those for the graphs which most closely fit the observed values—and their utility lies in giving precision to the values obtained and in making possible interpolations:—as a rule however they cannot be used for extrapolation. In this connection determinations of the normal variability are always wanted, yet although this need has been met in a measure, it is far from being satisfied.

The significance and general use of these tables has already been set forth in the Prologue and need not be dealt with here.

One use of the tables when these are based on age may however be emphasized. The comparison of the experimental results obtained on animals with the corresponding results on man has heretofore been difficult because of the absence of a good basis for comparison. We have found reason to assume that in the case of the rat the postnatal span of life of three years is approximately equivalent to the span of ninety years in man—or to put it another way, that the rat grows thirty times as fast as man. This ratio appears to hold for fractions of the span of life, as well as for the entire span. All of the data for the Albino, based on postnatal age, may therefore be compared with the corresponding data for man, if the time intervals are taken as one for the rat to thirty for man.

Finally it is desirable to explain here a seeming inconsistency in the arrangement of the material presented. In the Preface the statement is made that Part I deals with the Albino rat, while Part II deals with the Norway. So far as all of the important tables and records are concerned this statement does not need revision.

It has been found however in arranging the literature that it would prove most useful to include in Part I all of the incidental and general observations on the wild Norway, on the ground that these applied to the entire species, and to reserve for Part II the more precise data which apply to the wild Norway, as contrasted with the domesticated Albino.

The reader therefore will find in the literature cited in Part I papers referring to *M. decumanus*, *M. norvegicus* and *Epimys*

norvegicus as well as to the Albino (*M. norvegicus albinus* or var. Albino), sometimes designated the 'white' rat.

As will be pointed out in the section on The Early History of the rat, there is one more complication in this connection. Through an error, unfortunately perpetuated by some of the natural histories, the common Albino has been described as an Albino of the house rat—*Mus rattus*.

It thus happens that in some of the papers cited it is reported that the observations had been made on *Mus rattus* or *ratus* (sic), the word albino being sometimes added—sometimes omitted. In a few instances it is impossible to determine whether *M. rattus* is used for the Albino or whether the house rat was really studied.

In forming a judgment on these cases it must be kept in mind that for the last half century the house rat has been rare and hard to obtain both in western Europe and in the northern United States, so that unless the author gives good evidence for the name he has employed, it becomes highly probable that he was working with some form of the Norway. For these reasons it has been found most convenient to include also in Part I all the references to the house rat (*Mus rattus*).

#### CLASSIFICATION AND NOMENCLATURE OF THE COMMON RATS

Up to 1881 *Mus* (Linnaeus, 1758) was used as the generic designation for both the rats and mice. In 1881 Trouessart proposed the subgenus *Epimys* for the larger forms, the rats, reserving *Mus* for the smaller forms, the mice—*Mus musculus* being the type. In 1910 Miller established the use of *Epimys* for the rats. By the law of priority however *Epimys* must in turn be displaced by *Rattus* (Fischer, 1803) as pointed out by Hollister ('16).

In the pages which follow however the designation *Mus* has been retained for the rat—as the older term is well understood, while the new terms—*Epimys* and *Rattus*—are at present generally unfamiliar.

The following condensed citations of the place of the original descriptions—with some of the associated references—serve to give a brief history of the nomenclature.

MUS, Linnaeus, 1758

EPIMYS, Trouessart, 1881—Miller, 1910.

RATTUS, Fischer, 1803—Hollister, 1916.

—*norvegicus*, Erxleben (1777 descr. orig.)

—*decumanus*, Pallas (1778)

—*aquaticus*, Gessner, 1551.

Cosmopolita; ab Asia occident. in Europam a navibus translata. et inde in omnes Orbis Regiones.

—*rattus*, Linnaeus (1758 descr. orig.)

Cosmopolita; ab Asia occident., in Europam a navibus translata., et inde in omnes orbis regiones.

—*alexandrinus*, Geoffroy, (1812 (or 1829 vide Sherborn, 1897) descr. orig.)

Asia minori, Arabia, Aegyptus, Algeria, etc.

Italia, Hispania, Gallia merid.—orient. et occid., et inde in omnes orbis regiones.

Since attention was called to Erxleben's description in 1777 (Rehn, 1900) his specific name, *norvegicus*, as the designation for the common brown or Norway rat, has been used in place of *decumanus* (Pallas, 1778). The designation *norvegicus* is now well established and will be used here.

There seems no question that *Mus rattus* and *Mus r. alexandrinus* are related to one another as color varieties of the same species (de l'Isle, 1865; Millais, '05) and they are so considered in the following pages. For convenience we shall use the term Norway or Norway rat for *Mus norvegicus*—and the term House rat as a general designation for both *Mus rattus* and *M. rattus alexandrinus* unless the occasion calls for the precise name.

Albinos of the house rat have without doubt existed in the west of Europe at one time or another ever since this form overran that region (Topsell, 1658) but, despite earlier reports to the contrary, neither Albino nor pied specimens of the house rat are to be found in our larger museums.

At present Albinos of the house rat appear to be not uncommon in India (Lloyd, '12) where the house rat population is

large. In western Europe and other regions in which the house rat population is waning, a careful search by several investigators during the last decade has failed to reveal a living albino specimen.

At the present time, therefore, the Albino of *Mus norvegicus* is the only albino variety generally found. In these pages this form is designated *Mus norvegicus albinus*—when the name is given in full, but where possible the single word Albino is used for it.

When the albino variety is mentioned here the strain as commonly reared is the one meant. As a rule this strain is far removed from its wild ancestor and moderately inbred. It may be conveniently designated as the common albino strain.

In the colony at The Institute, we have in addition to this, a closely inbred strain reared by Dr. King. Strains of "extracted" Albinos are maintained in some laboratories. These latter are the Albinos descended from the  $F_2$  generation of hybrids from the wild Norway and the domesticated Albino.

During the first few generations after their appearance, these extracted Albinos show clearly certain Norway characters, which distinguish them from the rats with a longer albino ancestry. With the peculiarities of either the inbred or of the extracted strain, we are however not specially concerned.

While all Albinos breed true as to color, the composition of the gametes is undoubtedly different among them in accordance with their remote ancestry. Mudge ('10) recognizes thirteen gametic types. The gametic dissimilarity of various Albinos in respect to hair color is shown by the fact that in breeding tests (Doncaster, '06 and Mudge, '10) Albinos extracted from ancestors with characteristic differences in pigmentation will reveal their origin by producing, when crossed with the pigmented strain, characteristically pigmented descendents, the markings of which can be predicted.

We are naturally concerned with the gametic composition of the general population of Albinos constituting the different colonies to-day. As these colonies stand, the Albinos composing them do not form a strictly homozygous population.

even from the standpoint of color, since in subsequent crosses with pigmented forms they give offspring with different color markings according to their several latent characters.

On the other hand it may be fairly said that as yet we have no evidence for any correlation of the somatic characters so far studied, with those slight differences in gametic composition of the common albino strain which we can recognize. It is to be noted moreover that the difficulty which thus appears in the case of the albino rat repeats itself for other mammals also, and therefore it does not constitute a peculiarity of this animal.

#### CLASSIFICATION : REFERENCES

Alston, 1879-1882. Blasius, 1857. Doncaster, '06. Erxleben, 1777. Fischer, 1803. Geoffroy, 1812. Gesner, 1551. Hatai, '07. Hollister, '16, '16 a. l'Isle, 1865. Linnaeus, 1758, 1766. Lloyd, '12. Longman, '16. Millais, '05. Miller, '10. Mudge, '10. Pallas, 1778. Rehn, 1900. Topsell, 1658. Trouessart, 1881, 1897, '10. Tullberg, 1900.

#### EARLY RECORDS AND MIGRATIONS OF THE COMMON RATS

The common wild rats in the United States usually live in close association with man. There are two species of these, both of which have been introduced from Europe. These are *Mus rattus* (Linnaeus, 1758; 1766 = *Mus rattus rattus*, Millais, '05) together with its gray form, *Mus alexandrinus* (Geoffroy, 1812; = *Mus rattus alexandrinus*, Millais, '05) and *Mus norvegicus* (Erxleben, 1777 = *Mus decumanus*, Pallas, 1778). This last species is our common gray, brown or Norway rat. In addition to these, all of which are wild, there is a fourth form—the albino rat (*Mus norvegicus albinus*) a variety of *Mus norvegicus* (Hatai, '07) which is known at present only as a domesticated strain (Donaldson, '12 b).

*Mus rattus*—the house rat—the first species described in western Europe, is probably indigenous to India.<sup>1</sup> As now

<sup>1</sup> Fossil remains of the rat (*Mus rattus*) are reported in the pliocene in Lombardy (Cornalia, 1858) and in the quaternary at Molina di Anosa near Pisa (Forsyth Major) and again from the pleistocene cave deposits of the island of Crete (Bate, '12). This species appears in glacial times (Diluvialzeit) and in association with man in the remains of the Lake dwellers in western Germany and in Mecklenburg (Blasius, 1857). It is reported also from the diluvial deposits in Bohemia (Woldřich, 1880).

found, the melanic form of *Mus rattus* (or *Mus rattus rattus*, Millais) the 'black' rat, is more frequent in the colder latitudes, and *Mus rattus alexandrinus* (Millais) the gray form (the 'roof' or 'snake' rat) in the warmer latitudes, but the two are not sharply segregated. At the same time both of these seem more dependent on warmth, or more resistant to it, than the Norway rat.

Although we shall have little to say in the following pages about *Mus rattus*, yet it is desirable to give its history in order to obtain the proper setting for *Mus norvegicus*, at present the dominant species. The geological evidence just given indicates the very early appearance of the house rat in Europe but our records of its migrations all fall within the present era.

The history of the early migrations is of necessity vague and incomplete, and even in the later times when dates are given it must be remembered that such animals might have been present for some time without appearing in numbers sufficient to cause comment.

There is no good evidence that the Greeks or Romans before the present era were familiar with the rat as a pest, and therefore, even if present, it was probably not abundant at that period on the shores of the Mediterranean.

The history of the house rat from the earliest times to the eleventh century makes an interesting archaeological study, but the conclusions which may be drawn from the scanty records and indefinite allusions are too uncertain to be of value for our present purpose and we therefore pass directly to the later authors.

Possibly as far back as the migration of the hordes (*Völkerwanderung*, 400–1100 A. D.) and later in consequence of the increasing use of trade routes with the East, the house rat entered western Europe in appreciable numbers (Hehn, '11). It is reported to have arrived there after the twelfth century (Keller, '09, citing Theodoros Prodromos). Giraldus Cambrensis,<sup>2</sup> (1146?–1220) records several anecdotes concerning it.

<sup>2</sup> Albertus Magnus (d. 1280) is sometimes cited as having mentioned the black rat. This is not correct. A. de l'Isle (1865) has pointed out that the description in question applies to the dormouse—*Myoxus quercinus*.

As the Norway rat did not reach western Europe until 1727–1730 it follows that the European rat of the middle ages, the rat of the legends, of the Pied Piper<sup>3</sup> (1284), of the great plagues (before 1700) and of the early anathemas against vermin, was *Mus rattus*.

The species first brought to South America on the ships of the very early explorers was *Mus rattus* (Vega, 1609; de Ovalle, 1646). Pennant (1781) gives 1544 as the date of arrival in Peru.<sup>4</sup> We have also a notable instance of a plague of these rats in the Bermudas in 1615 (Lefroy, 1882).

Of the two species in question, *Mus rattus* is alone recognized by Linnaeus in his *Fauna suesica* 1746, and in his *Systema* (1758 and 1766). It does not concern us here to follow the history of *Mus rattus* in the United States further than to say that this species only (represented by the two forms) was present up to the time of the arrival of the Norway rat in North America toward the end of the eighteenth century, and that *Mus rattus*—the black rat—is still found in a number of scattered localities in the northern United States, while in the southern states, *Mus rattus alexandrinus* is much the more common. It does not appear that either of these forms has ever penetrated far into the interior of the country.

Turning to the cosmopolitan *Mus norvegicus*—the species at present established in China, Japan, India, western Europe and temperate North America—we find that the historical record of its movements, though by no means complete, has the virtue of being recent.

v. Gesner (*Historia animalium*, 1551) mentions a *Mus aquaticus* which appears to be the form now called *Norvegicus*, but apparently he himself had never seen it.

According to Pallas (1831) the Norway rat invaded Europe from the East early in the eighteenth century and was observed

<sup>3</sup> It may be noted in passing that the ancient inscriptions in Hameln relating to the Pied Piper do not mention the rat (Meinardus, 1882).

<sup>4</sup> Pennant (1781) says there were no rats in South America before the time of Blasco Mínez. Mínez is evidently a misprint for Núñez; Blasco Núñez being the first Viceroy of Peru, from 1544–1546.

in large numbers crossing the Volga in the Russian province of Astrakhan. Pallas gives 1727 as the year of this migration. In view of other dates, this can hardly be the date of the first invasion. The Norway rat reached England—probably by ships—about 1728–1730 (Donndorff, 1792) and was soon designated the ‘Hanover’ rat by those who wished to connect the misfortunes of the country with the recently established house of Hanover.

There is however no reason to suppose that the Norway rat had yet reached Germany and the name has a political rather than a scientific interest.

In 1750 the Norway rats are reported (Donndorff, 1792) to have reached eastern Prussia and in 1753 they were noticed in Paris (Donndorff, 1792). Their early distribution to other localities in Europe need not be recounted, but there is evidence that they spread rapidly and soon displaced more or less completely the *Mus rattus* which had preceded them.

This historical sketch shows that the migration of *Mus rattus* into western Europe antedated that of *Mus norvegicus* certainly by some six hundred years, but the Norway rat being the more pugnacious and powerful species has become dominant wherever it has followed the earlier form.

This dominance is undoubtedly due in part to these characters of the Norway, but it seems probable that the progressive disuse of wood as a building material has been a factor also (Przibram, '12).

We find however that in many places, both in Europe and the United States, where the house rat was thought to have been exterminated, it still survives in small numbers.

The arrival of the Norway rat on the north Atlantic seaboard of the United States is usually given as 1775 (Harlan, 1825). The exact date, though of interest, is hardly important for our present purpose.

*Mus rattus* was already in possession, but in the course of the years, how rapidly we do not know, the Norway rat became the dominant form in the northern latitudes of this country—moving along the trade routes to all points which furnish a continuous food supply and a moderate summer temperature.



In the present connection our interest in the Norway rat is due mainly to the fact that the common albino rat (*M. n. albinus*) kept as a pet or laboratory animal, and concerning which we desire all possible information, is a variety of the Norway rat. This relationship is shown not only by the usual methods of comparison, but also by the haemoglobin crystals (Reichert and Brown, '09) the shape of skull (Hatai, '07 c) and the fact that the two forms interbreed freely.

Concerning the place and time of origin of the albino strain there is little information at hand. Allusions to albino rats before the time when the Norway rat appeared in Europe clearly show that there must have been an albino strain of *Mus rattus*. What we know of the present distribution of Albinos of *Mus rattus* has been given on pages 5 and 6 in the preceding chapter.

By some curious slip however, many of the natural histories and books of reference speak of the common Albino as an Albino of *Mus rattus*. This of course is not correct, but owing to the confusion thus early introduced, it is difficult to trace the history of the present albino variety<sup>5</sup> of the Norway.

We do not know whether the common albino variety had a single or multiple origin, or whether the colonies found in Europe (Rodwell, 1858) are directly related to those now existing here. Moss, 1836, mentions Albinos in or near Bristol, England about 1822. Judging from the way in which the Albinos of other species arise, we may safely assume that the present strain is derived from one or more albino mutants or sports (Hatai, '12). These must have been captured and the albino descendents segregated and kept as pets, as at present<sup>6</sup> there is nowhere to

<sup>5</sup> Unfortunately there is one more complicating circumstance—namely, the existence of a melanic variety of *Mus norvegicus*. This melanic variety is often mistaken for *Mus rattus rattus* because of its color, and this leads to errors of statement concerning the distribution of *Mus rattus* and also concerning the ability of the two species—*rattus* and *norvegicus*—to interbreed. They are in fact mutually infertile (Morgan, '09) (*The Hagedoorns*, '17). The number of incidental allusions to this melanic variety of *norvegicus* shows its occurrence to be widespread. See: Edwards, 1871, 1872. Hamy, '06. L'Isle, 1865. Lapieque and Legendre, '11. Schäff, 1891. Webster, 1892.

<sup>6</sup> Rodwell, 1858, page 10, mentions what may have been a colony of Albinos living wild at the Ainsworth Colliery near Bury, England.

be found an established colony of Albinos living in open competition with the common Norways or with forms of *Mus rattus*, but all of the colonies are maintained practically under conditions of domestication.

In the northern United States, except along the water front of the larger ports, where the house rat arrives from time to time on vessels, we have therefore to deal almost exclusively with the Norway rat. The Norway has been in this region probably not more than a hundred and fifty years. Though living wild, it is more or less dependent on the food conditions found where man is established. The familiar Albino—*Mus norvegicus albinus*—is a sport derived from the wild Norway, and is the form on which most of the investigations here presented have been made.

It is important to note that in their general physical characters both the wild Norways and the Albinos of western Europe are similar to the corresponding forms in the United States (Donaldson, '12, and '12 a).

On the other hand the Hagedoorns ('17) report that the wild Norway in the Island of Java shows much variability.

#### EARLY RECORDS AND MIGRATIONS : REFERENCES

Albertus Magnus, b. 1206-d.1280. Barrett-Hamilton, 1892. Bate, '12. Baumgart, '04. Blasius, 1857. Borcharding, 1889. Campbell, 1892. Cantoni, 1880. Clarke, 1891. Cornalia, 1858-1871. Cornish, 1890. Donaldson, '12 b. Donndorff, 1792. Edwards, 1871, 1872. Erxleben, 1777. Fiseher, 1869. Geisenheimer, 1892. Geoffroy, 1812. Gesner, 1551. Giraldus Cambrensis, b. 1146?-d. 1220. Godman, 1826-1828. Gourlay, '07. Hagedoorn and Hagedoorn, '17. Hamy, '06. Harlan, 1825. Hatai, '07, '07 e, '12. Hehn, '11. Hossaek, '06, '07, '07 b. l'Isle, 1865. Keller, '09. Keller-Zschokke, 1892. Lagerlöf, '07. Lantz, '09. Lapicque and Legendre, '11. Lefroy, 1882. Liebe, 1891. Lindner, 1891. Linnaeus, 1746, 1758, 1766. Lloyd, '10, '12. Lönnberg, '06. Löns, '08. Luke, '17. Major (see Baumgart, '04). Meinardus, 1882. Messer, 1889. Middendorff, 1875. Millais, '04, '05. Mojsisovics, 1897. Morgan, '09. Moss, 1836. Murphy, '17. Murray, 1866. Ovalle, 1646. Pallas, 1778, 1831. Pennant, 1781. Prodromus, Theodorus (see Keller, '09). Przibram, '12. Reichert and Brown, '09. Rodwell, 1858. Schäff, 1891. Sulzer, 1774. Vega, 1609, 1688. Ward, '06. Webster, 1892. Woldrich, 1880-1884.

*General similarities in western Europe and America.* Donaldson, '12, '12 a. *Rattenkoenig.*

Ahrend, '03. Demaison, '06. Dollfus, '06. Koepert, '04.

**PART I**

ALBINO RAT—MUS NORVEGICUS ALBINUS



## CHAPTER 1

### BIOLOGY

1. Life history. 2. Span of life. 3. Puberty. 4. Period of gestation. 5. Superfecundation—Superfetation. 6. Fertility. 7. Sex ratio. 8. Recognition of sex. 9. Body weight according to sex. 10. Behavior. 11. Comparison with man.

1. *Life history.* The rat breeds at all seasons of the year, but most readily in the spring, and judging by other animals, it is probable that those born at this season tend to be more vigorous. The albino rat is born blind, hairless, with a short tail, closed ears and undeveloped limbs. It responds to contacts and olfactory and taste stimuli, utters a squeaking sound and is capable of some locomotory movements which are a combination of wriggling and paddling. The head is always searching. The young can find their way back to the mother at about ten days of age (Watson, '03).

The ears open between  $2\frac{1}{2}$  to  $3\frac{1}{2}$  days of age but there is a cellular plug in the meatus which may persist for a short time longer.

According to Wada ('23) rats can hear at from 9–12 days of age. The earlier date is exceptional. Lane ('17) reports 12 days as the earliest age at which he obtained a response.

The rat is a swimming animal. The newborn young sink. At two days they make paddling movements mostly with the forelegs, but remain below the surface. At eight days they swim with the nose above water, while previous to this they have been swimming with the nose more or less submerged.

The eyes open at from the 14th to the 17th days, most often on the 15th or 16th. King has also observed that in a given litter the eyes of the females usually open some hours before those of the males. For some seven days more, i.e., up to the time when the young rats are 21–22 days of age, they are

dependent on the mother. After this they may be weaned, although if permitted, the young will depend partly on the mother for some days longer.

This adjustment of relations fits with the fact that the female may be impregnated one or two days after casting a litter (Kirkham, '10; Kirkham and Burr, '13) and since the gestation period is about 21.5–22.5 days, this would enable the female to free herself from the first litter before the second one was born. As will be pointed out later, the gestation period may be prolonged in nursing animals.

When the young rats become habituated to independence, i.e., at about 25 days, they enter on a period of activity, the phases of which have been followed by Slonaker ('07, '12). In the cases which he observed, it was found that increasing age was accompanied by increasing activity up to the age period of 87–120 days, after which the activity declined.

On the assumption that the span of life in man is thirty times that of the albino rat (Donaldson, '06) this age of greatest activity would correspond to the age of 7.5–10 years in man.

As shown by the records of activity (Slonaker, '12) the albino rat is nocturnal. This habit can be modified more or less by feeding or by disturbance during the day time.

The measure of activity in the cases observed by Slonaker was the number of turns of the revolving cage in which the animal was kept, the cage being set in motion by the voluntary running or other movements of the animal, and the revolutions being automatically recorded. In the case of four rats kept in separate revolving cages from 30 days of age until natural death, the following records of activity were obtained (Slonaker, '12). Table 1.

This table shows not only great variability in the total performances, but also for the one female a record of over five thousand miles in a little less than three years. On the average, three-fourths of the total distance is run before the rat has reached middle life, and the last months of old age are always marked by greatly lessened activity (see Behavior—activity and exercise, page 31).

In observations on activity in other laboratories the superior performance of the female has generally appeared. Dr. Wang ('23) has pointed out that activity in the female is rhythmic and correlated with the oestrous cycle, showing a maximum at oestrus.

TABLE 1  
*Total number of miles run during life*

AGE IN MONTHS AT DEATH	RAT 1, M. MILES	RAT 4, M. MILES	RAT 2, M. MILES	RAT 3, F. MILES
25.....	1265			
26.....		1391		
32.....			2098	
34.....				5447

*Determination of age.* To determine the approximate age of a rat when the date of conception or of birth is not known, there are a few changes and events which are useful. The references for these data will be found at the appropriate places in the text.

Before birth:

Eyelids of fetus fuse at..... the 17th day

After birth:

Ears open at.....  $2\frac{1}{2}$ - $3\frac{1}{2}$  days

Incisors erupt at..... 8-10 days

Eyes open at..... 14-17 days

Hair obscures genitalia..... 16 days

1st molar erupts..... 19 days

2nd molar erupts..... 21 days

3rd molar erupts..... 35 days

Testes descend..... 40 days

Vagina opens..... 72 days

The menopause occurs at..... 15-18 months

In rats more than a year old the angle of the nasals with the frontals increases, giving a "Roman nose" effect. Under unusual care and feeding the events preceding puberty tend to come earlier and the changes characteristic of old age are deferred.

2. *Span of life.* On the assumption that dating from birth, the life span of the albino rat is three years, then such a rat may be regarded as corresponding to a man of ninety years.

So far as this assumption has been tested it appears to be a useful approximation.

Slonaker ('12, '12a) working at Leland Stanford University under the favorable climatic conditions of California, has made some direct tests.

Four albino rats living in revolving cages attained an average age of 29.5 months, while three control animals reared in stationary cages, but under conditions otherwise similar, attained an average age of 40.3 months. In all these cases, death was reported as due to 'old age.'

The average age of these seven individuals was about 34 months, while the greatest age, attained by one of the controls, was 45 months. The three controls all lived longer than any of the four in the revolving cages. It appears from this that living in the revolving cage shortened the span of life—an unexpected result.

The oldest rat reported by Slonaker would be equivalent in age to a man of 113 years.

During the last few years the oldest rats of both sexes in the Institute colony have attained three years and somewhat over—and with the present conditions it is probable that still greater ages will be reached occasionally.<sup>7</sup>

3. *Puberty—ovulation—oestrous cycle—menopause.* Sexual maturity, as indicated by the structure of the gonads, usually occurs in both males and females at the age of about two months or less.

According to Long and Evans ('22) the vagina opens at about 72 days (range 34–109 days) and ovulation begins at about 77 days (range 45–147 days). These observations are based on 200 rats.

A tendency of the females to breed at an earlier age than they did in 1915 has been noted in The Institute colony and the same has been reported from other laboratories. In a specially well

<sup>7</sup>Instances of unusual longevity occur. Thus an albino used for show purposes was kept by Mr. Harris for 4 years and 8 months and was assumed to have been about a year old when purchased in Shanghai in 1913. (Archives of The Wistar Institute.)



fed and tended group, Greenman and Duhring ('23) have had exceptional females cast their litters at 55 and 57 days of age. These rats therefore became pregnant at 33 and 35 days respectively.

In the breeding Albino it is found that impregnation most readily follows 24 hours after a litter has been cast. This accords with the time of ovulation (Kirkham, '10; Sobotta and Burekhard, '10; Kirkham and Burr, '13). During the breeding period the female ovulates at intervals of 5 days or slightly less (Long and Evans, '22), but only from April to October do the females regularly ovulate 15-24 hours after parturition.

The menopause commonly appears at the age of 15-18 months (equivalent to 38-45 years in man). Particularly good conditions of food and care tend to delay the appearance of the menopause (Greenman and Duhring '23).

*Oestrous cycle.*<sup>8</sup> Long and Evans ('22) observed the oestrous cycle to extend from three to thirteen days or more, with a well marked tendency to be about five days (4.8)—table 2.

In a later study Evans ('24 MS.) determined the proportion of the short or normal cycles in two colonies of Albinos as compared with the gray and white cross of Long and Evans, with which the original studies were made. The results are given in table 2a and show a very fair agreement among the three series.

By using the method of vaginal smears, loc. cit. p. 41, five stages in the oestrous cycle have been determined as shown in table 3.

In table 4 is given the number of hours for these several stages in a cycle of something over four days.

The fifth stage or dioestrous interval in these instances extends for 48 hours or more.

The length of the first post partum oestrous cycle when suckling is prevented, was found to be from 5-7 days, and when the young were nursed less than 12 hours, somewhat less than seven days.

<sup>8</sup> Under the title of "The oestrous cycle in the rat and its associated phenomena," Long and Evans ('22) have recorded a very complete series of observations. For this study pied rats (black and white) were used, but the results are applicable to the Albino and several of the tables and conclusions are here cited.

4. *Period of gestation.* The gestation period of the non-lactating albino rat is usually from 21–22 days.

TABLE 2  
*Table of observed instances of oestrous cycles of various lengths*

LENGTH OF CYCLE IN DAYS	NUMBER OF INSTANCES								
	92 per cent		82 per cent						
3.....	}	634	}	Average 4.6 days	}	92 per cent	Average 4.8 days		
4.....								65	789
5.....								233	
6.....								69	
7.....								60	
8.....	30								
9.....	24								
10.....	16								
11.....	22								
12.....	57								
13 and over....									
		1999	General average 5.4 days						

TABLE 2A  
*On the proportion of normal oestrous cycles occurring in two colony groups of Albinos and in the gray-white strain of Long and Evans (Evans, '24 MS.)*

SOURCE OF ANIMALS	NUMBER ANIMALS INVOLVED	FIRST OESTRUS AGE IN DAYS AVERAGE AND EXTREMES	NUMBER OF CYCLES AFTER FIRST FOUR	NUMBER OF CYCLES AFTER FIRST FOUR		PROPOR- TION OF SHORT (NORMAL) CYCLES
				Short (6 days and under)	Long (7 days and over)	
Albinos (Slonaker colony).	28	54.1 (40–67)	125	99	26	<i>per cent</i> 79.2
Albinos (Wistar colony)....	26	40.9 (36–51)	159	138	21	86.7
Gray-White cross (Long- Evans colony).....	500	47.3 (32–77)	10,000	8948	1052	89.5

Careful observations made by Long and Evans ('22) using so-called "obstetrical cages" which make possible the determination of the exact time of birth—show that 90 per cent of the gestation periods fall between  $21\frac{1}{2}$  and 22 days.

*Lengthening of gestation period.* King ('13) found that the gestation period in lactating albino rats is of normal length if the female is suckling five or less young and is carrying five or less young.

The gestation period may be prolonged from one to six days if an albino female, suckling five or less young, is carrying six or more young.

The period of gestation is always prolonged when a female is suckling six or more young. In these cases the number of young in the second litter seems to have less influence on the length of the gestation period than has the number of young suckled; but if both litters are very large the gestation period may be extended to 34 days.

In the specially well fed series of Greenman and Duhring ('23) the lengthening of the gestation period under these conditions was much reduced.

5. *Superfecundation and superfetation.* Superfecundation occurs occasionally in the albino rat and causes an interval of two, three or more days between the birth of different members of the litter (King, '13).

In rare instances ovulation takes place in the albino rat during pregnancy and superfetation occurs. In two cases of this kind litters have been produced at intervals of about two weeks (King, '13, pp. 388 and 389).

*Parturition.* The young tend to be born when the surrounding conditions are quiet. In many cases birth occurs at night or in the early hours of the morning. The act of parturition may extend from 15-30 minutes up to 24 hours. Naturally the size of the litter affects the time taken.

There is no separation of the pubic bones (Todd, '23) and the act of parturition does not appear to cause the female discomfort.

The placenta is eaten. The placenta probably furnishes a growth promoting substance to the milk, as shown for man by Hammett ('18).

6. *Fertility and birth weight.* In considering fertility it must always be kept in mind that the reproductive capacity of the

TABLE 3  
*Schematic outline of changes in the reproductive organs of the rat during the oestrous cycle of 4 days 6 hours*  
 Long and Evans, '23

STAGE	LIVING ANIMAL	HISTOLOGY OF VAGINAL MUCOSA	UTERUS	OVARY AND OVIDUCT
1. (12 hours)	Vaginal mucosa, slightly dry. Smear of epithelial cells only. Lips a little swollen. In heat toward end.	Many layered (8-12) 0.08-0.1 mm. thick. Mitoses active. Cornified layer <i>under</i> superficial layer of epithelium. No leucocytes	During Stage 1 uterus becomes distended with fluid increasing in diameter from 2.3 to 3.7 mm.	Follicles large
2.	Vaginal mucosa dry and husterless. Smear of cornified cells only. Lips swollen. In heat	7-11 layers of cells 0.08-0.1 mm. thick. Cornified layer well formed and superficial. No leucocytes. Mitoses fewer	Reaches greatest distention (5 mm.) and thinness of epithelium and then regresses to diameter of 1.8 mm. Vacuolar degeneration sometimes begins	Follicles largest. Eggs may undergo maturation
3. (2 and 3 27 hours)	As in Stage 2, but cornified material abundant (cheesy) and animal not in heat	5-9 cells thick. 0.064 mm. thick. Cornified layer loose and finally completely detached. No leucocytes. Mitoses still fewer	Diameter of uterus about 2.0 mm. Epithelium undergoing vacuolar degeneration	Ovulation. Secretion of fluid into periovarial space and oviduct

<p>4. (6 hours)</p>	<p>Vaginal mucosa slightly moist. Smear of cornified cells and leucocytes. Swelling of lips gone</p>	<p>4-8 cells thick. 0.062 mm. thick. Cornified layer gone. Many leucocytes. Mitoses increasing</p>	<p>Diameter of uterus 2.2 mm. Some vacuolar degeneration but also regeneration.</p>	<p>Young corpora lutea. Eggs in oviduct. Follicles smallest</p>
<p>5. Dioestrous interval (57 hours)</p>	<p>Vaginal mucosa moist, glistening. Smear of leucocytes and epithelial cells. Variable amount of mucus</p>	<p>4-7 cells thick. 0.042 mm. thick. Leucocytes. Mitoses not numerous</p>	<p>Diameter 1.7 mm. Epithelium undergoing regeneration</p>	<p>Follicles of various sizes. Corpora lutea continue to grow. Eggs traversing oviduct throughout early interval</p>

female is a very sensitive reaction which may be stimulated or depressed by a variety of conditions—and for this reason a rather wide range of results is to be anticipated.

At the beginning of ovulation Sobotta and Burekhard ('10) find on the average a total of thirteen ova in both fallopian tubes. In their series, Long and Evans ('22) found an average of 9.6 ova in both tubes. The largest litter we have noted in the common Albino contained eighteen. Several such litters have appeared.

The number of ova found in the oviducts is only about 90 per cent of the number of corpora lutea formed, (Long and Evans '22). Moreover, these observers found that the average size of the litters was 6.9, so that about one-third of the ova formed (9.6) failed to produce young. When, therefore, the number of

TABLE 4

*Table showing length in hours of the component parts of the oestrous cycle of the rat*

STAGE	MODE	AVERAGE
	<i>hours</i>	<i>hours</i>
One.....	12	14.2
Two and Three.....	27	38.0
Four.....	6	7.8
Five (Dioestrous).....	48	53.0

young born is considered, the foregoing relations should be held in mind. The majority of albino females do not produce more than four or five litters, although occasional animals may produce three times as many.

*Size of litters.* The usual size of the litters is indicated in table 5.

It should be noted that generally these determinations have been based on the first five litters and do not extend through the possible breeding period of the female.

The litter size does not appear to be influenced by season, (King and Stotsenburg '15). It may depend however on the position of the litter in the litter series as can be seen from table 6.

In this instance the litter size is determined for the entire breeding period and is therefore low, 6.1, as compared with the values in table 5 (King '24).

Table 6 shows that the second litter is the largest, and this agrees with common experience. Table 6 shows also the first

TABLE 5

*Showing the average size of litters for the earlier portion of the breeding period*

AUTHORS	NUMBER OF LITTERS	NUMBER OF YOUNG	AVERAGE SIZE OF LITTER	SEX RATIO, NUMBER OF MALES PER 100 FEMALES
Crampe ('84).....	394	2503	6.3	105.6
King and Stotsenburg ('15).....	1089	7619	7.0	107.5
Long and Evans ('22).....	625	4313	6.9	—

TABLE 6

*Data for entire series of litters cast by 148 stock albino females (King '24)*

LITTER SERIES	NUMBER OF LITTERS	NUMBER OF INDIVIDUALS	AVERAGE NUMBER OF YOUNG PER LITTER	MALES	FEMALES	NUMBER OF MALES TO 100 FEMALES
1	148	903	6.1	462	441	104.7 ± 4.70
2	148	992	6.7	498	494	100.8 ± 4.32
3	142	876	6.1	454	422	107.5 ± 4.88
4	128	824	6.4	402	422	95.2 ± 4.45
5	98	547	5.5	279	268	104.0 ± 5.99
6	64	344	6.4	184	160	115.0 ± 8.38
7	38	228	6.0	128	100	128.0 ± 11.37
8	23	137	5.9	72	65	110.7 ± 12.64
9	13	85	6.5	51	34	150.0 ± 22.39
10	5	22	4.4	13	9	
11	3	12	4.0	5	7	
12	3	13	4.3	8	5	
13	2	9	4.5	3	6	
1-13	815	4992	6.1	2559	2433	105.2 ± 2.00

nine litters to be of good size, but the number of young in the later litters is small. In table 6 the marked decline in litter size comes at the tenth litter where the number of young drops to 4.4, the average that is maintained until the end of the series. This means that the size of the litter after the second tends to diminish with the age of the mother. Whether this is due to

age, pure and simple, or depends on the bearing of previous litters has not been determined.

In extracted Albinos and in Norways the litter size is close to that for the stock Albinos, while in extracted Norways and in Piebalds it is somewhat higher: 6.7 and 6.8 respectively (King, '24).

Greenman and Duhring ('23) find however in their exercised and particularly well fed series, breeding at four months, the first litter to be the largest. This is possibly another instance of precocity which may be thus induced, or it may be the result of the later age at which the female bred.

*Mortality.* From a study covering five years and based on the litters from 415 rats, King ('21) determined that 1.3 per cent of the young were still born. The still born males were markedly in excess of the females (129 males to 100 females) due apparently to a greater intrinsic weakness of the male fetus.

Young are also lost during the early days of lactation, through injury or neglect. Only a small number are born dead in the case of normal mothers. Where abnormal conditions exist, the number of dead born may be high.

*Birth weight.* The birth weights as determined by King ('15) are shown in table 7 according to the increasing age of the mother and in table 8 according to the increasing body weight of the mother.

On the average the birth weight of the males exceeds by 0.3 grams that of the females.

King ('15) reaches the following conclusions: Increasing age or increasing weight of the mother (the two being correlated) give a heavier birth weight, while the increase in the number in a litter tends to diminish the individual birth weight. There is to be observed also a diminution in birth weight in those litters born of mothers below the standard size, or suffering from infectious disease.

Precise data for the birth weight require great care to secure the selection of young which have *not* suckled. This is most readily made by the use of the so-called obstetrical cage, described by Long and Evans ('22), by which the young are automat-



ically separated from the mother at birth. Rats so obtained are strictly new-born, while most rats designated as new-born have suckled, as indicated by a white patch marking the stomach.

As the result of feeding unbalanced rations to rats Zuntz ('19) concludes that both the number of litters and the num-

TABLE 7

*Showing the birth weight data for 85 litters of stock and inbred albino rats arranged according to the age of the mothers at the time that litters were cast*

AGE OF MOTHER	NUMBER OF LIT-TERS	NUMBER OF INDIVIDUALS	MALES	FEMALES	TOTAL WEIGHT OF MALES IN GRAMS	TOTAL WEIGHT OF FEMALES IN GRAMS	AVERAGE WEIGHT OF MALES IN GRAMS	AVERAGE WEIGHT OF FEMALES IN GRAMS
(1) From 90 to 120 days...	27	232	112	120	494.9	494.6	4.41	4.12
(2) From 120 to 180 days...	36	326	155	171	712.1	736.9	4.59	4.30
(3) From 180 to 330 days...	17	143	70	73	318.5	321.5	4.55	4.40
(4) From 300 to 450 days...	5	38	21	17	99.2	73.3	4.71	4.31

TABLE 8

*Showing the birth weight data for stock and inbred albino rats arranged according to the body weight of the mothers at the time that the litters were cast*

BODY WEIGHT OF FEMALES	NUMBER OF LIT-TERS	NUMBER OF INDIVIDUALS	MALES	FEMALES	TOTAL WEIGHT OF MALES IN GRAMS	TOTAL WEIGHT OF FEMALES IN GRAMS	AVERAGE WEIGHT OF MALES IN GRAMS	AVERAGE WEIGHT OF FEMALES IN GRAMS
To 175 grams.....	27	209	98	111	423.8	440.7	4.46	3.86
175 to 200 grams.....	23	222	108	114	491.3	506.8	4.55	4.47
200 to 220 grams.....	25	233	111	122	508.7	524.7	4.58	4.30
220 + grams.....	10	75	41	34	201.7	158.0	4.91	4.64

ber in the litter are reduced, but that the young which are born tend to have both normal body weight and normal composition.

7. *Sex ratio.* At the two periods of greatest reproductive activity—in the spring (March–May) and again in the autumn (September–November) the proportion of males (the sex ratio) is low.

In the first litters of young females the sex ratio tends to be higher than in the later litters—but no relation of sex ratio to size of litter has been found (King and Stotsenburg, '15).

Cuénot ('99) reports a sex ratio of 105.6, while King and Stotsenburg ('15) report 107.5—without regard to the number of the litter. This ratio is however subject to a seasonal variation. There is also a relation to the litter number as shown in table 6 (King '24).

The data in table 6 show that the sex ratio for one litter group bears, seemingly, no relation to the ratio for the group immediately preceding or following, and the differences between successive ratios, when judged by their probable error, are of little import. The ratios seem, however, to indicate that the number of males tends to increase as the litter series advances up to the ninth litter. Beyond this point the relative number of males decreases sharply, as the data for the last four litters of the series, when combined, give a sex ratio of only 107.4 males to 100 females.

For the total of 4992 albino young recorded in table 6, the sex ratio is 105.2 males to 100 females. This ratio is slightly less than that given by Cuénot, and may, perhaps, serve as a norm for sex ratio in the albino strain until a larger and more complete series of data is available.

It is to be noted that the sex ratio may vary according to strain and that within the same strain it is also subject to wide modification by selection (King, '18).

Thus in the first twenty-five generations of inbred Albinos, the first and second litters combined gave in series A a sex ratio of 121.3, while in series B the sex ratio was 85.1. These two series were from the same strain, but had been selected for the high or low sex ratio respectively (King, '18).

8. *Recognition of sex.* The recognition of sex through external characters in the young rat has been studied by Jackson ('12). He finds the male may be recognized by (1) The larger size of the genital papilla; (2) the greater anogenital distance (see table 9); (3) the absence of clearly marked nipples. (This test is applicable only up to the age of 16 days, i.e., before the

development of hair on the ventral surface); (4) small extent of the bare area just ventral to the anus (test applicable only after the 16th day).

The following is a condensed form of Jackson's table for the anogenital distance.

As a rule the descent of the testes occurs about the fortieth day of age or somewhat earlier.

9. *Body weight according to sex.* While the average weight of the females at birth is less than that of the males, yet within a few days after birth the females tend to grow more rapidly than the males and may continue so to do during the following thirty to forty days. Sometimes this leads to absolutely heavier females as shown in table 157 and table 185 (King '23) for the

TABLE 9  
*Ano-genital distance in young albino rats of various ages*

AGE	NUMBER OF EACH SEX		AVERAGE GROSS BODY WEIGHT		AVERAGE ANO-GENITAL DISTANCE	
	Male	Female	Male	Female	Male	Female
			<i>grams</i>	<i>grams</i>	<i>grams</i>	<i>grams</i>
New born.....	10	12	5.7	5.4	2.8	1.2
7 days.....	17	26	11.0	10.4	5.2	2.7
14 days.....	13	15	19.5	18.2	8.2	4.9
20 days.....	19	26	27.4	27.4	12.0	7.0
42-50 days.....	19	13	73.3	71.0	21.0	13.0

Norway rat. This relation appears to come about as a response to less favorable conditions which tend to retard the growth of the male more than that of the female. Under more favorable conditions the female still grows somewhat faster than the male during this period without however attaining or surpassing the body weight of the male.

At 100 days of age the males weigh about 12 per cent more than the females and this difference in body weight tends to increase with advancing age, up to 18 per cent or more. The sex difference is always found, but the amount of difference varies according to the strain and other conditions.

*Maximum weights.* In 1915 the maximum weights reported were male 438 grams (fat); female 359 grams (fat). In The

Institute colony a considerable number of rats of both sexes surpass these weights to-day. Moreover, exceptional rats of large size are now appearing. A male of 615 grams has been reared by Osborne and Mendel (MS.) and Ibsen ('21) reports one of 745 grams.

In the Institute colony several males over 600 grams have been raised. These results indicate a progressive reponse of the Albino to domestication and reflect also the influence of better food and care through a series of generations. Wild Norways of such body weights have not been recorded.

*Minimum weights.* Individuals under weight at birth tend to remain under weight during later growth (Dunn, '08). Under usual conditions "runts" are rare among rats, but in these the weight of the brain and of the spinal cord is low (King, '16).

10. *Behavior. Under natural conditions.* When wild Norways are confined in a wooden cage they almost always gnaw the boards of which it is made. This the domesticated Albinos do not do. When put in a tank of water the Albino rat swims. Often when unable to climb out over the side, it will dive and search for a way out below. This must be a reaction, for many generations unexercised.

Greenman and Duhring ('23) have specially described the clicking of the teeth—a sign of content—and other behavior of the gentle rats—when these are taken in the hand. They have also described the nest building of the pregnant female and the behavior of the associated male when the pair are kept in the same cage after the birth of the litter. There is no justification for the common statement that the male kills the young. When the young are killed it is the female which is usually responsible. Such rats are designated "killer" females—Stotsenburg ('23)—and these individuals often have rather definite periods for killing. The cause of this habit has not been determined, but the ovaries of these animals are of normal size (Stotsenburg, '23) so that the explanation must be sought elsewhere.

The killing is usually accomplished by a bite severing the vessels in the neck. In well tamed rats the killing of the suckling young occurs only rarely.

*Sounds.* The sounds made by the rat range from an intimate clucking used by mothers with young to small squeaks—in response to slight discomfort—rising to a high pitched scream when suffering severe pain or in great terror. Broadly speaking this last response comes most often from the wild Norways just after capture.

*Under experimental conditions.* See References.

*Activity and exercise.* When fed at midday Albinos divide the 24 hours into about 14 hours of interrupted rest and sleep and 10 hours of marked activity—from the early evening to the early morning (Szymanski, '18 a).

They are as responsive to training during the period of inactivity as during the active period (Szymanski, '18). As incentives to learning, hunger, pain, and sometimes the maternal instinct (return to the young) are effective (Szymanski, '18 b).

Richter ('22) has determined that the minor periods of activity are related to hunger, as expressed by contractions of the stomach, and Wang ('23) has found that in the female in the revolving wheel the performance—as measured by miles run—is periodic and related to the phases of the oestrous cycle (see pp. 23 and 24).

*Effects of alcohol and drugs.* See References.

*Effects of lesions of the brain and sense organs.* See References.

*Care of rats.* Greenman and Duhring ('23).

11. *Comparison with man.* When compared with man the rat shows a series of similarities which are of significance for its use as an experimental animal.

*Similarities in form relations.* The males are usually larger and heavier than the females. The females are somewhat fatter.

*The determination of the equivalent ages.* The Albino doubles its birth weight in about six days, thus in one-thirtieth the time taken by man. If a rat at three years (it is then very old) is taken as equivalent to man at ninety years, we again have a relation of 1-30 in the equivalent ages. It is assumed therefore that the rat lives thirty times as fast as man. Thus one day of rat life is equivalent to 30 days of human life (one month). When the increase in the weight of the brain, and the change

in the percentage of water in the brain is determined for the two forms at the equivalent ages, these two growth changes are found to be nearly the same in both—Donaldson ('18).

For the determination of equivalence in age among mammals Brody and Ragsdale ('22) have used the three cycles of growth—termed respectively the infantile, juvenile and adolescent cycles and have taken conception rather than birth as the point of departure. When by this method the conceptional age of the maximum of the third (adolescent) cycle is multiplied by the constant 13, it gives 36.5 months, or approximately three years as the span of life for the rat. This is in good agreement with our determinations as just given. The procedure does not yield satisfactory results in the case of man.

The menopause occurs at 15–18 months, which is equivalent to 38–45 years.

*Functional similarities.* Like man the rat is omnivorous and capable of adapting itself to a wide range of diets.

*Rate of response.* Owing to the fact that the rat is living thirty times as fast as man, its responses to all the changes in its environment are relatively very rapid. To food, drugs, and alterations in external conditions, it reacts with remarkable promptness—and while this is very favorable for some sorts of study, it makes it difficult to maintain the animal in a constant condition for any considerable length of time.

#### BIOLOGY : REFERENCES

*Life history.* Donaldson, '06. King, '13, '24. Kirkham, '10. Kirkham and Burr, '13. Lane, '17. Namiye, '09. Slonaker, '07, '12. Stewart, 1898. Wada, '23. Watson, '03. Wang, '23.

*Span of life.* Brody and Ragsdale, '22. Donaldson, '06. Mitchell, '11. Slonaker, '12, '12 a.

*Puberty, ovulation, oestrous cycle and menopause.* Greenman and Duhring, '23. Kirkham, '10. Kirkham and Burr, '13. Long and Evans, '22. Sobotta and Burekhard, '10.

*Period of gestation.* Long and Evans, '22.

*Lengthening of gestation period.* Greenman and Duhring, '23. King, '13.

*Superfecundation and superfetation.* King, '13.

*Parturition.* Hammett, '18. Todd, '23.

*Fertility.* Crampe, '84. Evans and Bishop, '23 a. Greenman and Duhring, '23. King, '15, '24. King and Stotsenburg, '15. Kolazy, 1871. Lloyd, '09 a.

Long and Evans, '22. Pearson, '10. Sobotta and Bueckhard, '10. Watson, '06 a. Zuntz, '19.

*Mortality at birth and during gestation.* King, '21. Slonaker and Card, '23. *Birth weight.* King, '15. Long and Evans, '22. Zuntz, '19.

*Sex ratio.* Cuénot, 1899. King, '11 a, '11 b. King and Stotsenburg, '15. King, '18, '21, '24. White, '14.

*Recognition of sex.* Jackson, '12.

*Body weight according to sex.* Dunn, '08. Ibsen, '21. King and Stotsenburg, '15. King, '16.

*Behavior.* a) *Under natural conditions.* Advisory Committee, '12. Bechstein, 1801. Bell, 1837-1874. Buckland, 1859. Buffon, 1749-1789. Dehne, 1855. Fischer, 1872. Greenman and Dubring, '23. Griffith, '19. Hammett, '21 g. Henneberg, '09. Hewett, '04. Kolazy, 1871. Kunkel, '19. Lambert, '10. Lantz, '10. Manouvrier, '05. Nicholls, '22. Small, 1899. Stone, '22. Stotsenburg, '23. Szymanski, '18 a. Utsurikawa, '17. Vincent and Cameron, '20. Yerkes, '16. b) *Under experimental conditions.* Allen, '04. Barber, '15. Basset, '14. Berry, '06. Brockbank, '19. Burt, '16. Carr and Watson, '08. Carr, '17, '17 a, '17 d. Cesana, '10. Dashiell, '20, '20 a. De Camp, '20. Dodson, '17. Glaser, '10. Griffith, '20, '21. Hamilton, '16. Heron, '22. Hubbert, '14, '15, '15 a. Hubbert and Lashley, '17. Hunter, '12, '13, '15. Hunter and Yarbrough, '17. Hunter, '18, '20, '22. Lashley, '12, '17, '18. Macht and Mora, '20. Macht and Finesilver, '22. Macht and Ulrich, '22. Macht and Teagarden, '23. Moore, '21. Pechstein, '21. Peterson, '17, '17 a. Reeves, '17. Richardson, '09. Richter, '22. Ruger and Ruger, '17. Ruger, '18. Simmons, '24. Small, '00, '01. Spencer, '23. Stone, '23. Szymanski, '14, '18 b, '18 c. Ulrich, '13, '20, '20 a. Vincent, '12, '13, '15, '15 a, '15 b, '15 c. Warden, '23. Watson, '03, '07, '14, '17. Watson and Watson, '13. Wiltbank, '19. Wylie, '19. Yarbrough, '21.

*Activity and exercise.* Richter, '22. Slonaker, '12. Szymanski, '18, '18 a, '18 b, '19. Wang, '23.

*Alcohol and drugs.* Arlitt, '19. Lashley, '17 a. MacDowell and Vicari, '17, '21. MacDowell, '19, '21, '22, '22 a, '22 b, '23. Macht and Bloom, '20, '21. Macht and Mora, '20 a. Macht, Bloom and Ting, '21. Macht and Ting, '22.

*Lesions of brain and sense organs.* Adams, '13. Carr, '17 b, '17 c. Franz and Lashley, '17. Lashley and Franz, '17. Lashley, '20, '21, '21 a, '22. Pearce, '17.

*Care of rats.* Greenman and Dubring, '23. Hartwell, Mottram and Mottram, '23.

*Equivalent ages.* Brody and Ragsdale, '22. Donaldson, '08, '18.

## CHAPTER 2

### GENETICS

1. General. 2. Inbreeding. 3. Coat color. 4. Inheritance: (a) Brain weight; (b) Suprarenal weight; (c) Body weight; (d) Mutations.

1. *General.* See References.

2. *Inbreeding.* Inbreeding of albino rats from males and females of the same litter, accompanied by the selection of the most vigorous litters, has been carried on for 50 generations by Dr. King. If we allow for man  $3\frac{1}{3}$  generations to a century, then this is equivalent to what has occurred in man since the year 423 A. D. Using the data for the first 25 generations, King has examined the effects of inbreeding on the growth and variability in body weight (King, '18, '18 a, '18 b and '19), and also the effect on fertility, constitutional vigor and on the sex ratio, comparison in all cases being made with the data for the stock rats in the colony at The Institute. It appears that although the general form of the growth curve for body weight is unmodified, and the sex differences are unaffected, yet the inbred rats (especially the males) are heavier, while the variability in body weight is less than in the stock rats. The inbred rats attain puberty earlier, live longer and have larger litters than do the stock rats with which they were compared. The sex ratio is not modified by inbreeding, but it was possible to select two groups from the inbreds in one of which the sex ratio was high and in the other low.

The general conclusion reached by King is that inbreeding in the rat, when accompanied by selection, may be practised without giving rise to any ill effects (King '23).

3. *Coat color.* Genetic studies on the Norway rat have been concerned mainly with the inheritance of coat color. The gray coat of the wild Norway is dominant in crosses between the wild gray and the Albino. The Albinos in the  $F_2$  generation



appear in the proportion of one Albino to three pigmented. In the  $F_2$  and in the later generations pied animals may be had and the color pattern both fixed and modified by selection (Castle, '12, '12a, and Castle and Phillips, '14).

In the spring and autumn when the hair is renewed, the color pattern of the hooded rat is often outlined in the Albino by a differential growth of the new hair.

4. *Inheritance.* (a) *Brain weight.* The inheritance of brain weight in the reciprocal crosses Norway  $\times$  Albino has been studied by Hatai ('15). The relative brain weight in the adult domesticated albino rat is from 12–15 per cent less than in the wild Norway. The  $F_1$  and  $F_2$  hybrid offspring from Norway  $\times$  Albino crosses possess brain weights intermediate between those for the respective parents. There is no evidence of segregation in the hybrid brain weight data and the pigmented extracted rats possess brain weights similar to those of the non-pigmented.

(b) *Suprarenal weight.* The inheritance of suprarenal weight in the reciprocal crosses Norway  $\times$  Albino has been studied by Donaldson, J. C. ('23). In the  $F_1$  generation, pigmented, the weight of the suprarenals is less than in the wild gray, while in the subsequent generations,  $F_2$ – $F_4$ , the weight in the extracted Albinos was less than in the extracted grays, but never as low as in the pure Albinos.

(c) *Body weight.* The inheritance of body weight has been studied by Ibsen ('22) but the results are not yet complete.

(d) *Mutations.* Mutants studied at The Institute since 1906 are ruby-eyed dilute grays: a color variety of the Norway rat that was obtained near the University of Pennsylvania in 1916 (Whiting and King, '18).

Through crossing with the albino strain, two other new color varieties of rats, fawn and sepia, were also produced.

In the colony at The Institute, Hatai obtained albino mutants from captive gray Norways (Hatai, '12), and King ('23) has obtained cream mutants, the recessive of the black eyed yellow, from a strain of blacks extracted from the Norway  $\times$  Albino cross, which had bred true since 1916.

## GENETICS : REFERENCES

*General.* Castle, '11, '12, '12 a. Castle and Phillips, '14. Castle, '15, '16, '16 a, '19. Crampe, 1884. Darwin, 1883. Donaldson, '16 c, '23. Dunn, '20. Gravenhorst, 1806. Hagedoorn, '11, '14. Hagedoorn and Hagedoorn, '17, '22. Hatai, '11 a, '17 b. Ibsen, '20. Little, '17. Lloyd, '08, '09, '11. Pearson, '11. Przibram, '07. Yerkes, '13.

*Inbreeding.* Crampe, 1883. King, '18, '18 a, '18 b, '19, '23 a. Przibram, '11. Ritzema-Bos, 1894.

*Coat color.* Bateson, '03. Castle, '12, '12 a, '14, '14 a. Castle and Phillips, '14. Castle and Wright, '15, '16. Castle, '19 a, '19 b. Crampe, 1877, 1885. Doncaster, '06. Fischer, 1874. Frédéric, '07. Haacke, 1895. Hanson and Stewart, '23. Hartwell, '23. MacCurdy and Castle, '07. Morgan, '09. Mudge, '08, '08 a, '09. Whiting and King, '18. Wright, '17.

*Color pattern.* Stewart, '23.

*Inheritance of brain weight.* Hatai, '15 c.

*Inheritance of suprarenal weight.* Donaldson, J. C., '23.

*Inheritance of body weight.* Ibsen, '22.

*Mutations.* Crew, '23. Hatai, '12. King, '23. Whiting and King, '18.

*Acquired characters.* Detlefsen, '23. Griffith, '22. Hanson, '23 a. MacDowell, '24. Przibram, '10. Ritzema-Bos, 1891.

## CHAPTER 3

### ANATOMY

1. Anatomy (gross and microscopic). 2. Embryology. 3. Bones—Connective tissue. 4. Muscles. 5. Blood vessels and lymphatics. 6. Nervous system. 7. Sense organs. 8. Integument. 9. Thoracic and abdominal viscera. 10. Uro-Genital system. 11. Exocrine glands. 12. Endocrine system.

Since it is our purpose to present mainly those results that are quantitative, there will appear several divisions of this chapter marked only by references to the literature.

Further, even in those divisions for which there are some available data it happens in many cases that the presentation of them can be better given in the chapters which treat of growth, and in such instances the reader is merely referred to the latter place of presentation. These general statements apply to the subsequent chapters as well.

1. *Anatomy*. In only two instances has the rat been used as the basis for a general presentation of mammalian anatomy. These are in the books by Martin and Moale, 1884, and Goto, 1906. The remaining references are to studies which apply to portions or systems only (see classified references—at the end of the chapter).

2. *Embryology*: (a) *Spermatogenesis*. According to Hewer ('14):

In the newborn animal, active mitosis is occurring in the testis, and at  $3\frac{1}{2}$  weeks the spermatogonia can be distinguished from the spermatocytes. No lumen begins to appear in the tubules as a rule until 7 weeks. At 8 weeks spermatids are easily distinguishable. At 9 weeks typical ripe spermatozoa are plentiful, but the fully formed epididymis contains no free spermatozoa. At 10 weeks all the tubules show active spermatogenesis; the second crop of spermatozoa is appearing, while the first crop can be seen in the epididymis.

Using rats from the Institute colony Allen ('18) finds that the first spermatocyte cells begin to differentiate between the seventh and tenth days after birth and that the first spermatozoa

are ripe between the thirty-sixth and fortieth days after birth, about the time of the descent of the testes. The diploid number of chromosomes in the sperm of the albino is 37. The haploid is 19.

(b) *Oögenesis and fertilization.* Ovulation is simultaneous in both ovaries and there is a tendency for each ovary to discharge the same number of ova. The number of young in the litter is correlated with the number discharged during one cycle, but Long and Evans ('22) found in the series of litters (averaging 6.4 young per litter) that the young represented about two thirds of the ova discharged—thus showing, from one course or another, considerable loss.

In a series of females—isolated from the males—Arai ('20) determined the number of ova present in both ovaries—between the ages of one and 947 days. The results are given in table 10 and in chart 1.

These data show a continuous decrease in the number of ova with advancing age. The largest loss occurs before the end of the suckling period. In this series the left ovary was on the average 10 per cent heavier than the right, but the number of ova on the two sides was nearly the same—being three per cent more in the right ovary. The appearance of the first corpora lutea was most closely correlated with body length—occurring between 148 and 150 mm.—equivalent in our reference tables to a body weight of 80–85 grams and an age of 62–64 days.

The ovum, after fixation with Zenker's solution containing somewhat less than the usual proportion of acetic acid, measured 60–65  $\mu$  in diameter with a nucleus about 25  $\mu$  in diameter. (Sobotta and Burckhard '10). The authors incorrectly assume that the common Albino is a variety of *Mus rattus*.

For the diameter of the living unsegmented egg Kirkham and Burr ('13) give 79 $\mu$  as a mean value.

For the volume of the ovum see table 12.

(c) *On the early stages of development.* We have the observations of Huber ('15 a). His description is as follows:

In the albino rat the segmenting ova pass from the oviduct to the uterine horn at the end of the fourth day after insemination, probably

TABLE 10

*The relation between the age and the total number of ova, and of corpora lutea*

AGE	BODY WEIGHT	BODY LENGTH	WEIGHT OF BOTH OVARIES	NUMBER OF OVA					NUMBER OF CORPORA LUTEA			
				Less than 20 $\mu$	20 to 40 $\mu$	40 to 60 $\mu$	More than 60 $\mu$	Total	Small	Large	Total	
<i>days</i>	<i>grams</i>	<i>mm.</i>	<i>mgm.</i>									
1	5.5	47		35,105				35,105				
3	7.3	52		27,870	382			28,252				
5	10.6	60		24,608	978			25,586				
7	13.9	69	1.8	20,009	974	2		20,985				
10	14.8	76	2.2	14,826	542	38		15,406				
15	20.5	83	2.4	15,083	470	323		15,976				
20	23.7	89	6.4	10,090	404	469	113	11,076				
26	30.2	95	10.8	9,663	322	275	162	10,422				
30	34.8	108	6.7	11,940	279	208	114	12,541				
36	34.9	105	5.6	8,711	152	124	62	9,049				
36	50.0	122	10.4	8,565	184	137	112	8,998				
41	58.2	131	7.4	11,671	204	59	37	11,971				
41	61.9	128	14.0	9,832	229	121	91	10,273				
46	69.5	142	14.0	9,935	156	115	60	10,266				
50	74.6	146	11.2	10,698	197	74	64	11,033				
50	75.5	144	12.9	9,689	236	98	50	10,073				
60	93.5	145	10.3	10,173	149	91	40	10,452				
64	62.7	132	7.9	9,669	189	106	66	10,030				
64	113.5	165	31.1	9,439	398	187	47	10,073	6	8	14	
70	106.3	162	42.8	6,246	197	99	64	6,606	9	22	31	
80	77.3	140	9.4	8,258	189	77	42	8,566				
80*	107.3	153	37.4	4,564	290	179	145	5,268	26	13	39	
84	125.0	165	22.2	9,406	177	85	52	9,720	2	11	13	
95	98.5	148	12.2	10,293	276	109	86	10,764				
95*	160.0	182	73.5	6,266	129	109	110	6,614	33	13	46	
100	97.8	156	13.1	6,853	133	43	39	7,068	16	7	23	
100	78.5	138	8.8	5,535	110	75	24	5,744				
110	94.3	147	18.7	5,100	176	75	41	5,392				
110	167.1	185	41.6	7,290	307	101	46	7,744	40	20	60	
140	123.0	168	49.2	8,659	243	113	62	9,077	12	17	29	
150	129.5	171	32.5	8,621	222	138	42	9,023	18	21	39	
198	142.7	171	58.1	2,468	164	100	18	2,750	33	30	63	
206*	188.5	185	54.8	7,782	155	97	32	8,066	33	23	56	
262	145.0	182	48.9	3,536	126	70	15	3,747	61	31	92	
318	155.0	189	36.5	5,460	126	87	29	5,702	53	16	69	
385	161.3	194	82.6	4,169	222	93	18	4,502	24	25	49	
454	138.7	194	33.8	4,465	160	78	56	4,759	67	26	93	
559*	198.7	200	73.5	4,729	107	37	20	4,893	27	11	38	
947	238.0	215	65.2	1,709	128	61	21	1,919	90	18	108	

\* Pregnant.

in the 12-cell to 16-cell stage. With the beginning of the fifth day, all of the ova are to be found in the uterine horn.

The following summary of the data gained by a study of the models of oviducts containing ova in stages from the pronuclear to 12-cell to 16-cell stages in which latter stage transit to the uterine horn occurs, is presented, to indicate rate of transit within the oviduct—table 11.

It will be observed that the ova approach the uterine end of the oviduct while in the 2-cell stage (see table 11); transit through the last portion of the oviduct, where the greater part of the segmentation occurs, being relatively slow.

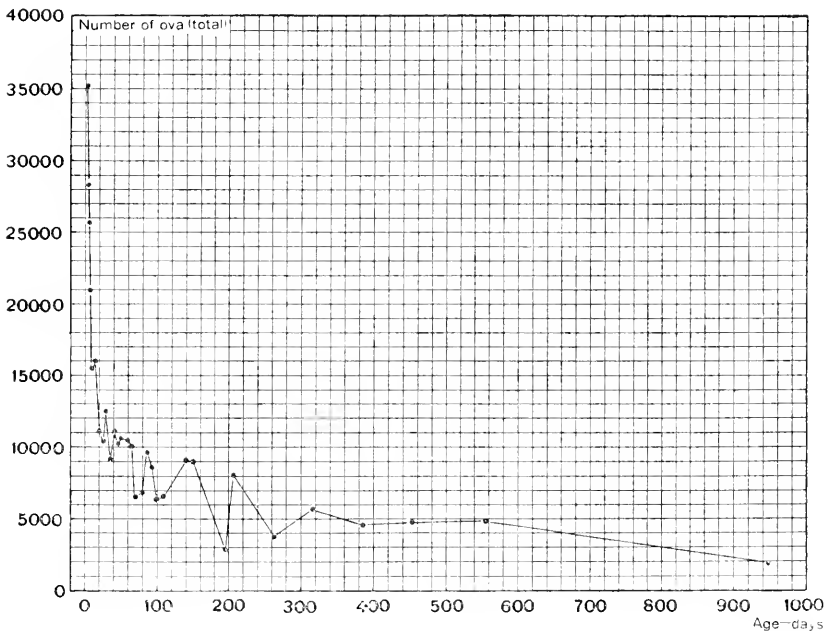

Chart 1 Showing the total number of ova in both ovaries of the albino rat at different ages.

In order to obtain the volume changes of the ova during transit through the oviduct, beginning with the pronuclear and extending to the 8-cell to 11-cell stages, reconstructions were made at a magnification of 1000 diameters, of ova presenting the stage in question. The respective volumes of these models were determined and the data reduced to the actual volumes—table 12.

The last column of table 12, giving averages, is of interest since it shows a very slight increase in the volume of the egg mass during segmentation and transit through the oviduct. Following the pronuclear stage, which, as has been seen, extends through a relatively long period

and into the beginning of the second day, by which time the ova have migrated about one-fourth of the length of the oviduct, there occur only three successive mitotic divisions, including the first segmentation division, namely mitoses resulting in 2-cell, 4-cell, and 8-cell stages while the ova are in transit in the oviduct. In making this statement it is assumed that in the successive segmentations, the several cells divide synchronously, which is not in conformity with the fact. These three mitotic divisions are spaced at intervals of about 18 hours.

TABLE 11

*Showing the distance of the ova from the fimbria at various ages. Based on table 3, Huber ('15a)*

RECORD NUMBER	SIDE RECONSTRUCTED	AGE	NUMBER OF OVA	STAGE	LENGTH OF OVIDUCT	DISTANCE OF OVA FROM FIMBRIA	RELATIVE LENGTH OF TUBE TRANSVERSED
					<i>cm.</i>	<i>cm.</i>	
106.....	R.	1 day	8	Pronuclear	3.2	0.8	0.25
59.....	R.	2 days	4	2-cell	2.29*	1.4	0.63
62.....	L.	2 days 22 hrs.	5	2-cell	2.45*	2.0	0.84
50.....	R.	3 days 1 hour	4	4-cell	2.8	2.5	0.90
51.....	L.	4 days	5	12 to 16 cell	2.86	2.86	1.00

\* Not the entire length of oviduct was available for reconstruction.

TABLE 12

*Volume of ova and embryos. Condensed from table 4 Huber ('15a)*

AGE		STAGE	AVERAGE VOLUME PER STAGE GIVEN IN CMM.
Days	Hours		
1	0	Pronuclear	0.000156
2	0	2 cell	0.000173
3	1	4 cell	0.000162
3	17	8 cell	0.000184
3	17	11 cell	0.000210

In the next following division, the fourth, the ovum passes from the oviduct to the uterine horn. Since the normal gestation period of the non-lactating albino rat is only 21 to 23 days, this slow rate of increase in volume and multiplication of cells during the first four days of development is of especial interest and is very probably to be accounted for by the inadequacy of the food supply of the ovum during its transit through the oviduct.

(d) *Later stages.* Observations have been made by Stotsenburg ('15) on the daily increase in the weight of the fetus from the 13th to the 22nd day after insemination. The data and graph are given in chapter 5, pp. 173–174.

W. Pyle '19 (MS.) reports that the giant cells—polykaryocytes—appear in the liver on the 17th day of fetal life—but by seven days after birth they have completely disappeared. In the spleen they appear at the same time as in the liver. They are abundant in the spleen during the first month after birth, diminish gradually up to 100 days, but even at later ages an occasional cell may be found.

(e) *Monsters.* Tailless rats. Occasionally tailless Albinos are born. The deficiency may be complete or partial. The Institute records show about one in seven thousand. Conrow ('15) has examined several of the complete cases and finds the defect in the vertebrae usually to involve the sacral vertebrae and in some cases to extend cephalad as far as the sixth lumbar. In rats surgically deprived of the tail at birth (Conrow, '17) the defect does not extend above the point of operation. Attempts to establish a strain of tailless rats have thus far failed. The congenitally tailless rats have notably heavy hypophyses.

Small-eyed rats. These appear now and then. This defect occurs in all grades and may be bilateral or unilateral. King (MS.) has obtained some evidence for the inheritance of this defect. The anatomical condition points to the early formation of the eye, followed by involutory changes.

*Mammary glands.* There are normally six pairs, but deficiencies sometimes occur, and Stotsenburg (MS.) has noted cases where only six of the twelve nipples were present and has been able to carry a deficiency through four generations. The defect is in the system rather than in a particular pair or group of glands, and in Stotsenburg's series is most commonly represented by absence of the upper pectorals.

A six-legged rat has been described by Conrow ('17 a).



3. *Bones and connective tissue.* In table 13 is an enumeration of the bones forming the skeleton of the rat (Conrow).

TABLE 13

*List of bones*

	Nasals.....	2	Sternum.....	6	
	Premaxillae.....	2			
	Maxillae.....	2	Shoulder	{	
	Jugals.....	2	girdle	{	
	Palatines.....	2	Scapula....	2	
	Vomer.....	1	Clavicle....	2	
	Lachrymals.....	2			
	Ethmoid.....	1	Pelvic	{	
	Frontals.....	2	girdle	{	
	Sphenoid.....	1	Ilium.....	2	
	Presphenoid.....	1	Ischium....	2	
	Parietals.....	2	Os pubis... 2		
	Squamosals.....	2			
	Interparietal.....	1	Humerus.....	2	
	Occipital.....	1	Ulna.....	2	
	Periotic capsules.....	2	Radius.....	2	
	Tympanic bones.....	2			
Skull	Ear bones	Malleus.....	2	Fore feet	{
		Incus.....	2	Carpus.....	18
		Stapes.....	2	Metacarpus..	10
	Mandible.....	2	Phalanges... 28		
Teeth.....	16	Femur.....	2		
			Tibia.....	2	
			Fibula.....	2	
			Sesamoid	{	
			bones	{	
			Patellae....	2	
			2 back of		
			Femur... 4		
Hyoid.....		1			
			Hind feet	{	
Vertebrae	Cervical.....	7	Tarsus.....	16	
	Dorsal or thoracic.....	13	Metatarsus..	10	
	Lumbar.....	6	Phalanges... 28		
	Sacral.....	4			
	Caudal..... (about)	30			
				283	
			Nails (20) omitted		
Ribs	Vertebro-sternal.....	14			
	Vertebro-costal.....	6			
	Vertebral.....	6			

*First appearance of ossification centers.* The first appearance of ossification centers and the later bone changes have been determined by R. M. Strong (MS.) and are given in table 14.

TABLE 14

*Summary of first appearances of ossification centers and of later bone changes in the albino rat (Wistar Institute Material—R. M. Strong, MS. '23).*

	AGE PERIOD					
	Prenatal		Birth		Postnatal	
	Days	Hours	Days	Hours	Days	Hours
<i>Skull:</i>						
Mandible.....	17	1				
Maxillae.....	17	1				
Frontals.....	17	1				
Premaxillae.....	17	8				
Parietals.....	17	8				
Squamosals.....	17	8				
Basiocepital.....	17	8				
Vomer.....	17	8				
Palatines.....	17	8				
Pterygoid process of Basisphenoid.	17	8				
Exocephal.....	17	8				
Lacrimals.....	18					
Nasals.....	18					
Jugals.....	18					
Interparietal.....	18	10				
Tympanic.....	18	10				
Basisphenoid.....	18	10				
Alisphenoidal process of Basisphenoid.....	19	8				
Presphenoid.....	19	9				
Supraoccipital-paired centers.....	19	9				
Alisphenoidal process united with Basisphenoid junction still distinct at.....						3
Orbitosphenoidal processes of Presphenoid.....			22	19		
In contact with Presphenoid.....						2
<i>Vertebrae:</i>						
Archae.....						
First cervical to 2nd thoracic.....	17	8				
Extended to 1st sacral.....	18	10				
In all arches.....			22	19		

TABLE 14—Continued

	AGE PERIOD					
	Prenatal		Birth		Postnatal	
	Days	Hours	Days	Hours	Days	Hours
<b>Bodies:</b>						
Fourth thoracic to sixth lumbar.....	18	10				
Extended to all thoracic and all four sacral.....	19	10				
Extended to seventh cervical and fourth caudal.....	21					
Extended to third cervical and seventh caudal.....	22	10				
Extended to first cervical with 2nd cervical doubtful.....			22	19		
Extended to all cervical and to 22nd caudal vertebrae.....					3	
Extended to 28th caudal.....					21	
<b>Sternum:</b>						
Centers I to IV.....	19	10				
V to VI (posterior).....	21					
<b>Ribs:</b>						
Ribs II to XI.....	17	1				
All ribs at.....	18	10				
<b>Limbs:</b>						
Clavicle.....	16	8				
Humerus.....	17	1				
Radius (very slight).....	17	1				
Ulna (very slight).....	17	1				
Scapula.....	17	8				
Ilium.....	17	8				
Femur.....	17	8				
Tibia.....	17	8				
Fibula.....	17	8				
Pubis.....	19	10				
Ischium.....	19	10				

TABLE 14—*Concluded*

	AGE PERIOD					
	Prenatal		Birth		Postnatal	
	Days	Hours	Days	Hours	Days	Hours
<i>Carpals</i> all had some ossification					8	
<i>Metacarpals:</i>						
Third.....	18	10				
Second and fourth.....	19	10				
Fifth.....	21					
First.....					8	
<i>Phalanges of hand:</i>						
Terminal phalanx the first to show ossification.....						
All phalanges except 1st of 1st digit..					3	
All phalanges.....					3	
<i>Tarsals:</i>						
Astragalus.....					2	
Calcaneus.....					2	
All others.....					14	
<i>Metatarsals:</i>						
Third.....	18	10				
Second and fourth.....	19	10				
Fifth.....	21					
First.....			22	19		
<i>Phalanges of foot:</i> Terminal phalanx of all five digits.....	21					
All phalanges.....					3	

In table 14A Strong compares the fetal ages in the rat and man at which the first ossification appears. In the rat the interval between the first and last instance is 5 days and 18 hours, while in man it is 56 days. The fraction of the gestation period required by the rat is slightly greater than that required by man.

Occasionally, slight differences in time of first ossification for right and left sides were found. The individuals of a litter showed only trivial variations in the time of first ossification.

Apparently the rate, time, and order of ossification are remarkably constant in the albino rat. Though only one litter was used for each stage, comparisons of successive stages and the constancy in litters seem to warrant this statement.

TABLE 14A

*Comparative table giving time of first ossification of the skull bones in the rat and man, during fetal life. (R. M. Strong, M.S., '24)*

	RAT	MAN
Mandible.....	17 days + 55 minutes	39 days
Maxilla.....	17 days + 55 minutes	39 days
Frontal.....	17 days + 55 minutes	56 days
Squamosal.....	17 days + 8 $\frac{1}{4}$ hours	56 days
Premaxillary.....	17 days + 8 $\frac{1}{4}$ hours	42 days
Parietal.....	17 days + 8 $\frac{1}{4}$ hours	56 days
Basioccipital.....	17 days + 8 $\frac{1}{4}$ hours	65 days
Exoccipital.....	17 days + 8 $\frac{1}{4}$ hours	56 days
Vomer.....	17 days + 8 $\frac{1}{4}$ hours	57 days
Palatine.....	17 days + 8 $\frac{1}{4}$ hours	57 days
Lacrimal.....	18 days	85 days
Nasal.....	18 days	57 days
Tympanic.....	18 days	65 days
Basisphenoid.....	18 days	83 days
Interparietal.....	18 days + 9 $\frac{1}{2}$ hours	57 days
Supraoccipital.....	18 days + 9 $\frac{1}{2}$ hours	55-56 days
Alisphenoid.....	18 days + 9 $\frac{1}{2}$ hours	83 days
Orbitosphenoid.....	22 days + 19 hours	83 days

*Skull.* Sutures: The following bones are more or less distinctly outlined by sutures at 525 days.

Paired: Maxillae, premaxillae, nasals, palatines, frontals, parietals, jugals, petrosals, squamosals and tympanics. The angle of the nasals with the frontals becomes more marked in old rats, giving a "Roman nose" effect.

Unpaired: The interparietal, supraoccipital, basisphenoid, and presphenoid are all more or less distinct in the same specimen. The interparietal is entirely outlined. The supraoccipital is fused with the exoccipital.

The dorsal surface of the skull of very old rats tends to become roughened. This is conspicuously so at 726 days, and

less so at 525 days. At three months a crest and fossa become well developed across the lateral portions of the parietals. Both are fully outlined at 40 days, but more evident at 54 days. They are most conspicuous in the skull at 726 days.

*Scapula.* There is little ossification in the acromion and spine at 40 days, and still much cartilage in the coracoid process at 40 days which is essentially fused with the scapula at 99 days.

*Pelvis.* Mature rats show a marked pectineal eminence and a preacetabular tubercle. These are recognizable at 46 days and the tubercle at 40 days. Sutural grooves are recognizable at the junctions of the ilium, pubis and ischium at 73 days, but only traces remain at 99 days.

TABLE 15  
*Fusion of cartilage plates (Dawson, MS. '23)*

BONES	AT ONE YEAR		AT TWO YEARS	
	Proximal	Distal	Proximal	Distal
Humerus.....	P.	A.	P.	A.
Radius.....	A.	P.	A.	P.
Ulna.....	P.	P.	P.	P.
Femur.....	P.	P.	P.	P.
Tibia.....	P.	A.	P.	A.

*Fusion of epiphyses of the long bones.* A. B. Dawson (manuscript, '24) has made observations on the fusion of the epiphyses in the various bones of rats one and two years of age.

His results on the limb bones are given in table 15. Cartilage plate present (P.), cartilage plate absent (A.).

It is apparent from this that these bones are still in a condition to increase in length after two years, and this is in harmony with the long continued skeletal growth as determined by direct measurements.

Additional information is given in table 15 A for the time of fusion in the bones which fuse early, and also a set of observations on bones from a rat 37 months old.

The proximal epiphysis of the ulna appears to be rather variable. Since this is an extra-articular epiphysis it will not

affect total length of the forelimb. The slightly delayed fusion of both proximal and distal ends of the fibula, as compared with the tibia, may explain the decided bowing of the fibula from the tibia.

*Skull measurements.* For data on the growth of the entire skeleton see Chapter 6.

TABLE 15A

(A. B. Dawson, MS. '24). *Age and sequence of fusion of the epiphyses in the long bones*

BONE	REMARKS
Humerus, distal epiphysis (capitulum and Trochlea).....	Cartilage interrupted at end of first month. Fused during second month
Radius, proximal epiphysis.....	Fused during third month
Tibia, distal epiphysis.....	Fused during third month
Fibula, distal epiphysis.....	Fused during fourth month
Ulna, proximal epiphysis.....	Fused between 25-31 months
Femur, head.....	Fused at 31 months
Femur, distal epiphysis.....	Cartilage interrupted 37 months
Tibia, proximal epiphysis.....	Cartilage interrupted 37 months
Fibula, proximal epiphysis.....	Cartilage interrupted 37 months
Humerus, proximal epiphysis.....	Cartilage interrupted 37 months
Radius, distal epiphysis.....	Cartilage complete 37 months
Ulna, distal epiphysis.....	Cartilage complete 37 months

Skull measurements have been made by Hatai ('07 c). The following description is extracted from his paper.

For this study 53 male and 51 female skulls of mature Albinos (rats more than 150 days old) were measured. These skulls had been carefully cleaned and dried at room temperature. The following measurements were made with vernier calipers: 1) the length of the entire skull; 2) the fronto-occipital length; 3) the zygomatic width; 4) the length of the nasal bone; 5) the height of the skull; 6) the width of the cranium or the squamosal distance. In every case the maximum length alone was recorded in millimeters.

The horizontal straight line joining the tip of the nasal bone to the end of the occipital bone is called the length of the entire skull. This however is not exactly equal to the sum of the length of the nasal bone and that of the fronto-occipital.

The fronto-occipital length was determined in the following way: Since the length measured with the calipers from the tip of the nasal

TABLE 16  
 Giving for both sexes the mean values for several measurements in millimeters on the cranium, together with the standard deviation and the coefficient of variation and the respective differences. Based on table 1. Itatai (07 c)

IN MILLIMETERS	MEAN		STANDARD DEVIATION		COEFFICIENT OF VARIATION		NUMBER OF RATS
	$\mu$	Difference	$\mu$	Difference	$\mu$	Difference	
Length of the entire cranium	♂	43.3±0.17	1.71±0.20	1.79±0.12	0.53±0.14	4.13±0.27	53
	♀	41.5±0.12	3.9%	1.26±0.08		3.02±0.20	51
Zygomatic width	♂	21.7±0.11	0.82±0.14	1.18±0.08	0.30±0.06	5.41±0.36	53
	♀	20.9±0.08	3.8%	0.88±0.06		4.19±0.28	51
Length of the nasal bone	♂	17.0±0.10	1.27±0.12	1.04±0.07	0.25±0.09	6.12±0.40	53
	♀	16.0±0.08	7.5%	0.79±0.05		5.05±0.34	51
Fronto-occipital length	♂	27.3±0.09	0.91±0.13	1.01±0.07	0.10±0.09	3.69±0.24	53
	♀	26.4±0.09	3.3%	0.90±0.06		3.43±0.23	51
Squamosal distance	♂	15.3±0.01	0.22±0.04	0.34±0.02	0.15±0.04	2.21±0.15	53
	♀	15.1±0.04	1.4%	0.41±0.03	-0.07±0.04	2.72±0.18	51
Height of cranium (L × W × H) <sup>‡</sup>	♂	11.5±0.05	0.35±0.07	0.53±0.03	0.15±0.04	4.58±0.30	53
	♀	11.1±0.04	3.1%	0.38±0.03		3.37±0.23	51
Cranial capacity in grams of shot	♂	16.9±0.04	0.45±0.06	0.48±0.03	0.10±0.04	2.83±0.19	53
	♀	16.4±0.04	2.7%	0.38±0.03		2.33±0.16	51
Body weight in grams	♂	10.9±0.07	0.53±0.10	0.74±0.05		6.75±0.44	53
	♀	10.4±0.07	4.9%	0.74±0.05	-0.01±0.07	7.17±0.48	51
	♂	214.9±5.32	47.54±5.98	52.89±3.76	32.4±4.09	25.08±2.68	45
	♀	167.3±2.74	22.2%	20.47±1.61		12.24±0.97	37



TABLE 17

Showing the range of variates and rate of increase for various characters according to sex Hatai ('07 c)

	MALE			FEMALE		
	Minimum	Mean*	Maximum	Maximum	Mean*	Minimum
	mm.	mm.	mm.	mm.	mm.	mm.
Length of the entire cranium.	39.4	43.3	47.4	44.5	41.5	38.9
Rate	100	100	100	100	100	100
Zygomatic width.	19.6	21.7	24.8	23.4	20.9	18.9
Rate	49.8	50.2	52.3	52.5	50.3	48.5
Length of the nasal bone.	14.7	17.0	18.7	17.8	15.7	14.4
Rate	37.3	39.2	39.3	40.0	37.7	37.0
Fronto-occipital length.	24.9	27.3	28.8	28.2	26.4	24.9
Rate	63.2	63.0	60.7	63.3	63.5	64.0
Squamosal distance.	14.6	15.3	16.2	16.2	15.1	14.4
Rate	37.0	35.3	34.1	36.4	36.2	37.0
Height of cranium	10.4	11.5	13.0	12.2	11.1	10.3
Rate	26.4	26.5	27.4	27.4	26.8	26.4

\* Taken from Table 16.

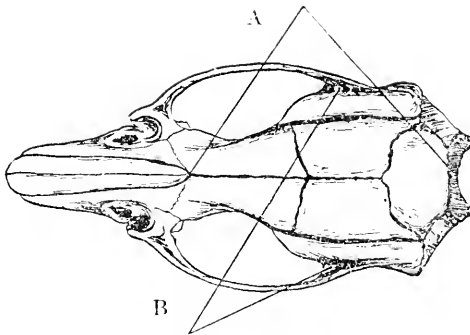

Fig. 1. A, Fronto-occipital length; B, squamosal distance.

bone to the posterior end of the inter-parietal bone is usually less than the length measured from the same point to the end of the occipital bone, both measurements were taken (see fig. 1). The difference between these two measurements was added to the length from the tip of the frontal bone to the end of the inter-parietal bone, and the sum was called the fronto-occipital length.

The width of the cranium (squamosal distance) was determined by taking the maximum distance between the two points (right and left) where the zygomatic bones rest on the lateral walls of the cranium.

The height of the skull was determined by measuring a perpendicular distance between the greatest convexity of the parietal bone in the median line and the junction line between the basi-occipital and the basi-sphenoidal bones on the ventral surface.

The cranial capacity: The skull was held vertically, with the nose downwards and was filled with fine shot (no. 11) to the upper level of foramen magnum and then the nose of the skull gently struck twice against the palm of the hand.

Although this is a simple procedure yet it needs the greatest care to produce uniform results. By practice Hatai has been able to reduce the difference between the first and second filling to less than one per cent. The cranial capacity thus determined in the terms of shot weight can be transformed into brain weight as follows: by dividing the weight of the shot in the case of the males by 5.980 and in the case of the females by 6.009. Tables 16 and 17.

The greatest difference found between the measurements of the skulls for the two sexes is in the nasal bones, which are nearly 2 per cent longer in the male skull. The greater relative length of the nasal bones in the male may be regarded as a secondary sexual character (Hatai).

*Teeth.* Addison and Appleton ('15) report as follows on the size and growth of the incisor teeth in the Albino.

The dental formula of the rat is

$$\begin{matrix} I_1^1 & C_0^0 & P_0^0 & M_3^3 \end{matrix}$$

There is only one set of teeth, and hence the dentition is monophyodont. The time of eruption of the various teeth extends over a period of  $3\frac{1}{2}$  weeks. The incisors are the first to appear, viz., at 8 to 10 days after birth. The first and second molars erupt at about the 19th and 21st days respectively, and it is after this latter period that the young animals may be weaned and are able to maintain an independent existence, as far as food is concerned. The third molars are delayed until two weeks later and do not appear until about the 35th day.

Owing to the lack of precise data, no exact comparison can be made with the eruption of the corresponding teeth in man. Nevertheless, the incisors and the first and second molars in the deciduous dentition of man do erupt at about the equivalent ages (i.e. thirty times the age in the rat) while the relation of

the age of eruption of the third molar (the "wisdom tooth") to that of the second molar is similar in the rat to that found for these teeth in the permanent dentition of man.

The incisors are permanently-growing (or rootless) teeth, while the molars have a definite limited period of development and acquire roots. A wide diastema separates the incisors from the molars as may be seen by reference to figure 1 (Addison and Appleton '15)). The incisors are strongly curved and Owen (1840-1845) has described the lower incisor as being the smaller segment of a larger circle, and the upper incisor as the larger segment of a smaller circle (verified by Hammett and Justice '23).

The lower incisor of a five months animal forms a segment of about four-fifths of a semicircle (140-145°).

The times of the early stages of development of the incisors were as follows:

- 14 day fetus—slight thickening of oral epithelium.
- 15 day fetus—distinct thickening and growth inwards of oral epithelium.
- 16 day fetus—dental ledge and beginning of flask-shaped enamel organ.
- 17 day fetus—dental papilla with crescentic enamel organ capping it.
- 19 day fetus—both ameloblasts and odontoblasts differentiated.
- New-born animal—enamel and dentine formation begun.
- 8 to 10 days—eruption of the tooth.

At birth there are blood-vessels in the enamel organ of the molar teeth (Addison and Appleton '22).

The rate at which the teeth increase in length during their formative period and prior to attrition is given in table 18.

TABLE 18

	TOTAL LENGTH OF INCISORS	
	Upper	Lower
	<i>mm.</i>	<i>mm.</i>
1 day old.....	2.3	3
4 days old.....	3.6	5
7 days old.....	5	7-8
10 days old.....	7	11

Average growth of upper incisor 0.52 mm. and of lower incisor 0.88 mm. per day.

In rats at about 30 days of age the *extrusive* growth of the superior incisor teeth amounts to about 1.9 mm. per week; of the inferior incisor teeth, to about 2.3 mm. per week. The *curvative* growth of the superior incisor teeth amounts to about 1.0 mm. per week: of the inferior incisor teeth, to about 1.6 mm. per week (Marshall '21).

Throughout life growth continues, and in the adult animal is on the average 2.2 mm. per week in the upper and 2.8 mm. per week in the lower incisor.

In a five months animal the thickness of the enamel and its constituent layers measured in the mid-line of the teeth is given in table 19.

TABLE 19

AGE: FIVE MONTHS	INCISORS	
	Upper	Lower
	$\mu$	$\mu$
Total thickness.....	100-110	140-150
Outer fibrous layer.....	30-40	20-30
Pigmented portion of outer fibrous layer.....	8-10-12	6-8
Inner plexiform layer.....	70	120-125

The interstitial growth of the dentine of the persistent teeth of the rat, as shown by azo-dyes under the microscope, amounts approximately to 0.01 mm. per day (Marshall '21).

Measurements of the incisors and skulls of animals of different ages were made and are shown in table 20.

*Displacement of incisors.* Owing to various defects and accidents, one or more of the incisor teeth are sometimes displaced so that they do not wear normally. Overgrowth of the unopposed teeth follows, sometimes causing the death of the animal.

The incisor teeth are affected by parathyroidectomy (Hammett '22). After this operation they become white, opaque and fragile. Often also they overgrow as the result of displacement.

*Adipose tissue.* Representing the so-called hibernating gland, multiocular fat masses are found in the rat (Rasmussen, '23) in all of the localities where they have been described, namely: in the cervical, scapular, axillary, thoracic, renal and inguinal regions. The proportion of fat (boiling alcohol extract) has been determined by Hatai ('17) in a series from birth to maturity (see table 166).

TABLE 20

	23 DAYS	41 DAYS	10 WEEKS	15 WEEKS	5 MONTHS	8 MONTHS	10 MONTHS
	mm.	mm.	mm.	mm.	mm.	mm.	mm.
Naso-occipital length.....	29.7	32.5	39	40	43	44	46.5
Interzygomatic width*.....	13.7	14	14.5	14.6	15.4	15.1	15.5
Upper diastema.....	7.4	9.5	10	11.4	12.3	12.5	13
Upper incisor—total length.....	12.8	15	18.3	20.3	23.3	23.7	26.2
Upper incisor—extra-alveolar length.....	5.1	5.5	7	8.4	8.7	9	9.3
Lower diastema.....	4.6	5	5.6	6	6.7	7	6.8
Lower incisor—total length.....	18.1	21.7	25.5	26.4	29.4	29.9	31.3
Lower incisor—extra-alveolar length.....	6.5	7	10.5	11.4	11.6	12	12.4

\*Same as 'squamosal distance', figure 1, p. 51.

TABLE 21

AGE	NUMBER OF MUSCLE FIBERS	NUMBER OF NUCLEI PER CUBIC MM.	AREA OF CROSS SECTION IN MM. X 37 DIAM.
Newborn.....	5919	570645	552
15 days.....	7252	357764	868
16 days (very well grown)...	7587	347343	1010
30 days.....	7625	139861	2766
420 days.....	8014	37542	11817

4. *Muscles.* Morpurgo ('98) has furnished data on the *Musc. radialis* of the albino rat; giving the number of muscle fibers and of nuclei at different ages (table 21).

5. *Blood vessels and lymphatics.* *Blood vessels.* Using six groups of rats, those of each group being similar in body weight, but neglecting sex, Dreyer, Ray and Walker ('12) have determined the relation of the area of the cross-section of the aorta (in mm.) to the area of the surface of the body and to the body

weight. The relation to body weight is not close, but the relation to the area of the body surface is good.

Table 22 gives the results of these determinations for body surface and shows that on the average—and neglecting signs—the mean deviation amounts to 1.18 per cent, while if signs are considered, it is but  $-0.27$  per cent.

The formula used for computing the area of the cross section of the aorta is  $A = W^{0.72} k$  where  $A$  is the area of the aorta;  $W^{0.72}$  the body surface based on  $W$  the weight of the body in grams, and  $k$  a constant, peculiar to the rat and having the mean value of 21.9.

TABLE 22  
*Cross section of the aorta on body area and body weight*

GROUP	NUMBER OF RATS	AVERAGE BODY WEIGHT	AVERAGE AREA OF AORTIC CROSS SECTION	CROSS SECTION CALCULATED BY FORMULA BASED ON BODY AREA	DIFFERENCE OF CALCULATED FROM OBSERVED VALUES
		<i>grams</i>	<i>sq. mm.</i>	<i>sq. mm.</i>	<i>per cent</i>
A	3	36.5	0.610	0.609	-0.16
B	4	53.5	0.793	0.802	+1.12
C	5	81.2	1.07	1.08	+0.93
D	6	129.0	1.50	1.51	+0.66
E	7	166.4	1.83	1.82	-0.55
F	2	296.0	2.85	2.75	-3.64

*Vascularity of central nervous system.* Using one hooded rat and nine Albinos, Craigie ('20) has determined the vascularity of different parts of the nervous system. Four of these rats were from The Wistar Institute and five from Toronto. Four of the total number were females. All were mature. The nervous system was injected with carmin gelatin and the total length of the injected vessels in  $\mu$  determined in a unit volume of tissue at 21 localities. There was no significant difference between the results from the Institute rats and those from Toronto.

The females however show a slightly better vascular supply—especially in the gray matter.

The mean values for total lengths in the entire series of rats are given in detail according to localities in table 1 (Craigie,

'20). From this, table 23 has been formed and the values there given are those used for chart 2. The unit volume used in table 23 is  $189\mu^2 \times 200\mu$ .

TABLE 23

*Showing linear measurements of blood vessels in  $\mu$  in different parts of the central nervous system—Standard volume  $189\mu^2 \times 200\mu$*

LOCALITY	AVERAGE PER $189\mu^2 \times 200\mu$	PROBABLE ERROR OF AVERAGE
		<i>per cent</i>
Fasc. cuneatus*	1318	3.2
Ventral funiculus	1413	2.1
Lateral funiculus	1593	2.6
Pyramidal tract	2501	2.5
Fasc. long. dors.	3041	3.2
Subst. gelat. Rolandi	4159	5.4
Nuc. mot. VII	5230	3.2
Nuc. XII	5732	3.5
Nuc. mot. V	5837	2.9
Ventral horn; cord	6430	2.7
Spinal V nucleus	6592	3.8
Deiters' nucleus	6677	2.9
Molecular layer; cerebellum†	7116	2.9
Dorsal horn; cord	7203	2.6
Inferior olive	7693	3.6
Superior olive	8008	4.0
Chief sens. V nucleus	8072	2.3
Granule layer; cerebellum†	8762	2.3
Nuc. dentatus	9089	2.7
Chief vestib. nucleus	9742	2.8
Dors. cochlear nucleus	10523	3.0

\* All the measurements for parts in the spinal cord were made in the third cervical segment.

† The measurements were made in the posteroventral region of the vermis (uvula).

As these data show, the white substance is less vascular than the gray and the efferent (motor) gray less vascular than the afferent (sensory) gray.

The vascular supply of the cerebral cortex and its several layers have also been determined by Craigie ('21), at five lo-

calities and for each of the six cortical layers. The locations for the samples are shown in figure 2.

The method and material was that used for the previous study, but the unit volume in this latter instance is  $100\mu^3$ . Table 24 condensed from table 3 (Craigie, '21) last half, gives the length of the capillaries in  $\mu$  for this unit volume. At the same time it gives the ratio of each of the values to that for the ventral

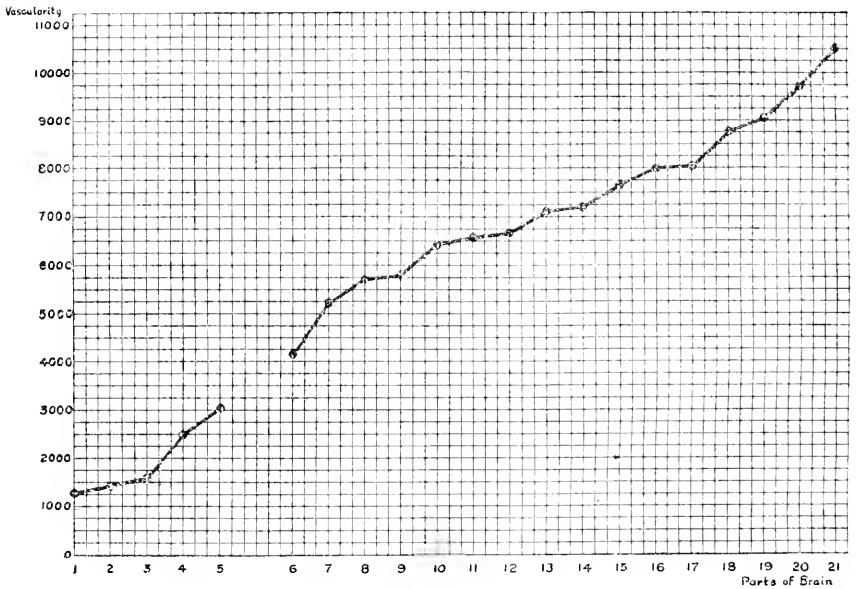

Chart 2 Graph showing the relative average vascularity in  $\mu$  of the regions studied; unit volume  $189\mu^2 \times 200\mu$ .

#### Regions

- |                                       |  |
|---------------------------------------|--|
| 1, fasciculus cuneatus                | 12, nucleus of Deiters                   |
| 2, ventral funiculus                  | 13, molecular layer of cerebellar cortex |
| 3, lateral funiculus                  | 14, dorsal horn; spinal cord             |
| 4, pyramidal tract                    | 15, inferior olive                       |
| 5, fasciculus longitudinalis dorsalis | 16, superior olive                       |
| 6, substantia gelatinosa Rolandi      | 17, chief sensory V nucleus              |
| 7, nucleus motorius VII               | 18, granule layer of cerebellar cortex   |
| 8, nucleus XII                        | 19, nucleus dentatus                     |
| 9, nucleus motorius V                 | 20, chief vestibular nucleus             |
| 10, ventral horn; spinal cord         | 21, dorsal cochlear nucleus              |
| 11, spinal V nucleus                  |  |



*Designations of areas in figure 2.*

BRODMANN'S TERM	SUGITA'S NUMBER	DESIGNATIONS OF AREAS IN FIGURE 2
Regio praecentralis.....	II	A
Regio occipitalis.....	IV	D
Regio parietalis.....	VII	B
Regio insularis.....	VIII	E
Regio temporalis.....	XI	C

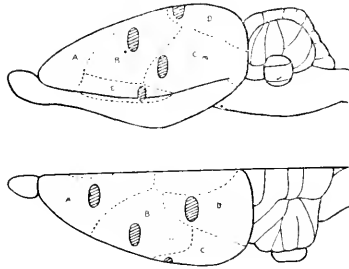

Fig. 2. Lateral and dorsal views of the left half of the brain to show the regions in which the measurements of vascularity were made. The exact location and relations of each of the areas represented is based on a comparison of figures by Fortuyn and Sugita, the names being applied in accordance with Sugita's correlation of Brodmann's terminology with these figures. Comparison with Brodmann's own figures and description seems to indicate that the anterior portion of area B is equivalent to the regio postcentralis. A, regio praecentralis; B, regio parietalis; C, regio temporalis; D, regio occipitalis; E, regio insularis.

TABLE 24

*Average vascularity of the five areas of the cerebral cortex in the unit volume 100 $\mu^3$ . For each area the datum is the average of the five laminae. The ratio of the vascularity in each area of the cortex to that of the ventral white matter and the ventral gray matter of the spinal cord, respectively, is also entered. Based on table 3, Craigie '21*

CORTICAL AREAS	LENGTH OF CAPILLARIES IN $\mu$ IN UNIT VOLUME	RATIO TO VASCULARITY OF	
		Ventral white	Ventral gray
Insular.....	3796	3.83	0.84
Praecentral.....	5054	5.11	1.12
Occipital.....	5250	5.30	1.16
Temporal.....	5259	5.31	1.17
Parietal.....	5775	5.83	1.28

funiculus (white matter) of the spinal cord ( $198\mu$ ) and the ventral horn of the spinal cord ( $900\mu$ ), both these determined for the unit volume  $100\mu^3$ .

### Vascularity

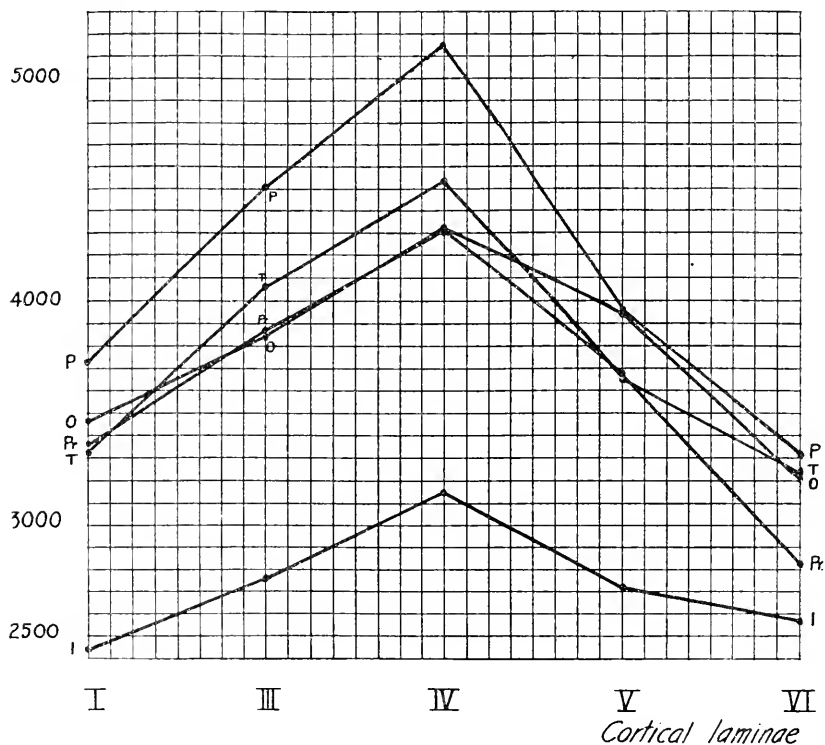

Chart 3 Showing the relative vascularity of the five cortical areas studied and of the five laminae in each. Based on table 24.

- |                                       |                             |
|---------------------------------------|-----------------------------|
| <i>I</i> , lamina zonalis             | <i>I</i> , insular area     |
| <i>III</i> , lamina pyramidalis       | <i>O</i> , occipital area   |
| <i>IV</i> , lamina granularis interna | <i>P</i> , parietal area    |
| <i>V</i> , lamina ganglionaris        | <i>Pr</i> , precentral area |
| <i>VI</i> , lamina multiformis        | <i>T</i> , temporal area    |

From these data it appears that on the average the vascular supply to the cortex is about 5.08 times that to the white matter in the ventral funiculus of the cord, and about 1.12 times that to the gray matter in the ventral horn.

The vascularity as observed for each lamina of the cortex in each area is shown in chart 3.

It is to be noted that in every area the maximum vascularity is in IV—the lamina granularis interna—and that among the areas the parietal is best supplied with blood vessels.

*Blood.* Percentage of water in the entire blood and in the serum.

The specific gravity of the blood is 1.056 (Sherrington and Copeman, 1893).

Hatai ('18) has determined the percentage of water in the entire blood of a small series of Albinos. These were from the Institute stock grown on the scrap diet and examined before the

TABLE 25

*Percentage of water in entire blood of the albino rat at different ages (revised)*

BODY WEIGHT	BODY LENGTH	AGE	SEX	PERCENTAGE OF WATER	NUMBER OF RATS
<i>grams</i>	<i>mm.</i>	<i>days</i>			
4.2	—	New born	Mixed	83.0	8
15.5	77	15	♂	86.8	4
66.4	139	45	♂	81.9	2
103.0	—	—	♀	80.1	11
139.0	—	—	♂	80.1	8
173.8	192	108	♂	79.9	2
306.9	235	365	♂	79.3	2

day's feeding. The rat was chloroformed, but before the heart ceased beating it was exposed in situ, the tip clipped away and the blood from it caught in a small glass weighing bottle. The fresh weight was immediately taken and after drying at 95°C. for a week the weight of the residue was obtained.

The results are given in table 25. These percentages are in close agreement with our earlier laboratory records.

*Percentage of water in the serum.* The data from Hatai ('18 b) are given in table 27 and the graph for these in Chart 4.

*Resistance of red cells.* The resistance of the red blood corpuscles at different ages to hypotonic solutions of sodium chloride shows fairly regular changes, Takenouchi ('19) table 26.

These changes in resistance are related to the adjustment of the red blood cells, and to the water content of the serum normally surrounding them at the different ages, Hatai ('18).

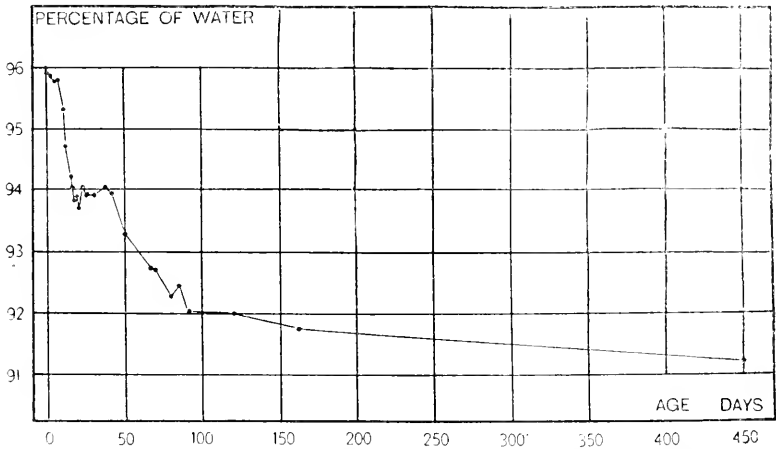

Chart 4 Showing the percentage of water in the serum of the albino rat at different ages.

TABLE 26

*Giving the concentration of the hypotonic salt solution which just produces 20 per cent hemolysis of the rat erythrocytes, based on the seven age groups*

A. Percentages according to age—Sexes combined.

B. Percentages according to age—Males and females separately, in twenty-three pairs of determinations.

AGE	A. AVERAGE PERCENTAGES			
	Sexes combined	Number of pairs	Males	Females
<i>days</i>				
1- 25	0.441	2	0.425	0.443
25- 50	0.449	8	0.452	0.459
50- 75	0.457	5	0.463	0.463
75-100	0.463	4	0.458	0.478
100-125	0.449	2	0.455	0.465
175-200	0.463	2	0.434	0.463
225-950	0.470			

The concentration of hypotonic salt solution which causes approximately 20 per cent hemolysis is 0.441 per cent for the youngest and 0.470 per cent for the oldest group. As appears

TABLE 27

*Refractive index of blood serum together with percentage of water in the serum of the albino rat at different ages. 35 groups.*

BODY WEIGHT	LENGTH	SEX	AGE	NUMBER	BLOOD SERUM				REMARKS
					Water	Sol-ids	$N_D$	$\Delta N_D$	
<i>gm.</i>	<i>mm.</i>		<i>days</i>		<i>per cent</i>	<i>per cent</i>			
5.1		Mixed.	New born.	8	95.90	4.10	1.34136	8.16	Clear.
7.0		Mixed.	3	15	95.88	4.12	1.34132	8.12	Very cloudy.
8.4		Mixed.	5	21	95.76	4.24	1.34261	9.41	Removed from mother, clear.
10.4		Mixed.	7	15	95.77	4.23	1.34266	9.46	Cloudy.
13.8		Mixed.	10	20	95.30	4.70	1.34340	10.20	Removed from mother, clear.
16.6		Mixed.	12	3	94.71	5.29	1.34454	11.34	Cloudy.
18.9		Mixed.	15	17	94.19	5.81	1.34509	11.89	Cloudy.
23.9		Mixed.	17	9	94.01	5.99	1.34575	12.55	Cloudy.
26.9		Mixed.	18	6	93.82	6.18	1.34632	13.12	Cloudy.
28.3	93	Mixed.	19	10	93.89	6.11	1.34579	12.59	Cloudy.
23.7		♀	20	3	93.70	6.30	1.34598	12.78	Cloudy.
29.8	98	Mixed.	21	4			1.34577	12.57	Cloudy.
37.0	105	Mixed.	23	8	94.03	5.97	1.34549	12.29	Cloudy.
35.9	108	Mixed.	26	9	93.92	6.08	1.34596	12.76	Clear.
47.2	115	♀	30	2	93.92	6.08	1.34568	12.48	Clear.
52.7	129	Mixed.	37	4	94.02	5.98	1.34581	12.61	Clear.
67.9	145	Mixed.	41	2	93.95	6.05	1.34619	12.99	Clear.
82.1	149	♂	44	1			1.34649	13.29	Clear.
78.9	148	Mixed.	50	3	93.27	6.73	1.34732	14.12	Clear.
	154	Mixed.	52	2			1.34727	14.07	Clear.
78.9	151	♀	60	1			1.34794	14.74	Clear.
94.9	158	Mixed.	66	6	92.74	7.26	1.34831	15.11	Clear.
109.4	164	♂	69	4	92.71	7.29	1.34836	15.16	Clear.
		Mixed.	72	3			1.34868	15.48	Clear.
		Mixed.	74	2			1.34863	15.43	Clear.
134.7	176	Mixed.	80	6	92.27	7.73	1.34873	15.53	Clear.
138.0	181	Mixed.	85	5	92.44	7.56	1.34851	15.31	Clear.
134.6	179	Mixed.	92	4	92.07	7.93	1.34959	16.39	Clear.
	192	Mixed.	100	3			1.34958	16.38	Clear.
176.5	192	♂	120	6	92.00	8.00	1.34965	16.45	Clear.
196.8	201	♂	161	2	91.75	8.25	1.35006	16.86	Clear.
		Mixed.	174	3			1.35037	17.17	Clear.
		♀	365	2			1.35123	18.03	Clear.
166.4	205	♀	450	2	91.22	8.78	1.35115	17.95	Clear.
250.0	222	Mixed.	597	2			1.35175	18.55	Clear.

in table 26 the erythrocytes of the female are less resistant than those of the male, a result which suggests that the serum of the female may contain less water than that of the male of like age.

*Refractive index of the blood serum at different ages.* The observations were made with a Pulfrich refractometer on serum obtained by centrifuging blood obtained directly from the heart. From 35 age groups the values are given in table 27 and in chart 5 (Hatai, '18 b).

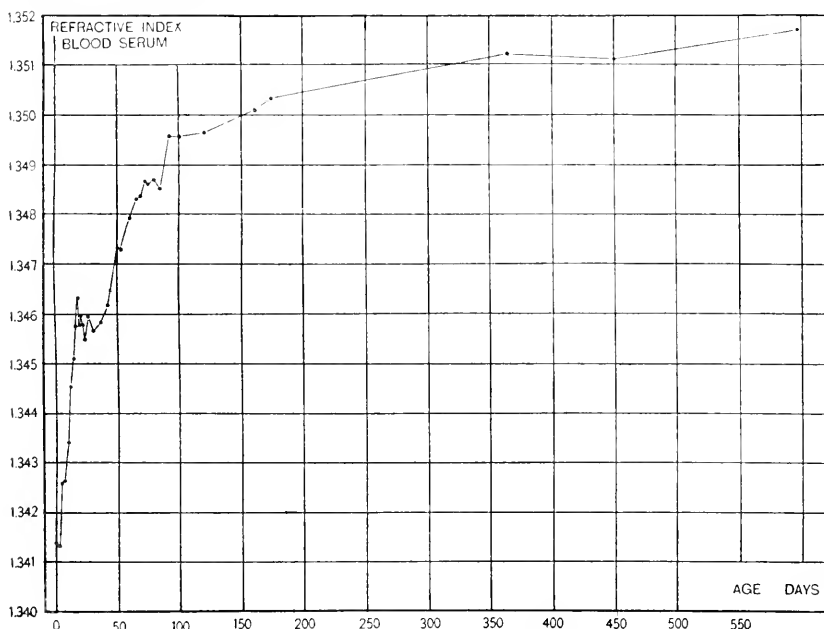

Chart 5 Showing the refractive index of blood serum at different ages.

Chart 5 shows the manner in which these values change on age. The index is slightly higher before suckling than immediately after. Three periods are recognized (1) The suckling period—to 21 days (2) From end of suckling period to puberty, at about 80 days, and (3) From puberty to the end of the record.

The percentage of water in the serum on age falls in such a manner as to give a graph which is the inverse for the increase in the refractive index—see chart 4.

Moreover when the percentage of solids in the serum is plotted on the refractive index, the relation between them is seen clearly. The refractive index, when normal, is similar in the two sexes but may be modified by fasting, defective diet, gonadectomy and disease.

Using data for the relation between the refractive index of the serum and age as determined by Hatai ('21), Hammett ('23 b) has obtained a formula (*loc. cit.*) which applies between the ages of 34 and 160 days and by the use of this formula the

TABLE 28

*The tabulated values of the refractive index of the blood serum of the albino rat on age in days*

AGE	$N_D$	AGE	$N_D$
34	1.34524	76	1.34867
36	1.34555	80	1.34880
38	1.34584	85	1.34893
40	1.34611	90	1.34905
42	1.34637	95	1.34916
44	1.34660	100	1.34926
46	1.34682	105	1.34936
48	1.34702	110	1.34946
50	1.34721	115	1.34956
52	1.34738	120	1.34967
54	1.34754	125	1.34977
56	1.34769	130	1.34986
58	1.34783	135	1.34995
60	1.34795	140	1.35003
63	1.34813	145	1.35009
66	1.34828	150	1.35012
69	1.34841	155	1.35012
72	1.34853	160	1.35007

reference values for the refractive index on age as given in table 28 were obtained.

The index of refraction is a linear function of the concentration of the solute.

The percentage of water on the refractive index of the serum where  $x$  is the refractive index and  $y$  the percentage of water is given by the formula.

$$x = \frac{1 - 0.0012445 y}{0.65607} \quad (1)$$

The values for the human serum are related to those for the Albino in the following way:

(1) The absolute value of  $N_D$  is the same in both forms—when mature.

(2) The refractive index is higher before suckling than it is immediately after.

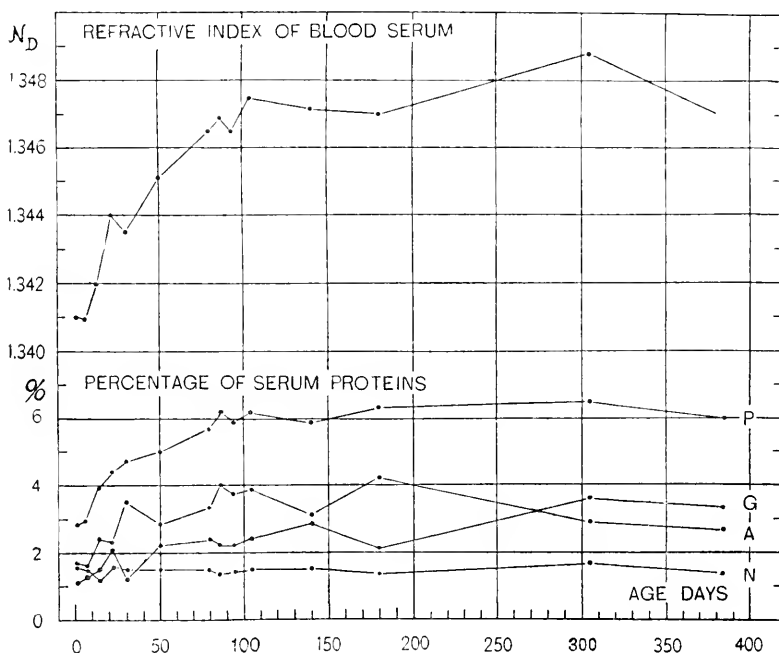

Chart 6 Changes in the refractive index and in the relative amount of serum proteins, based on the data given in table 29.

$P$  = protein.  
 $A$  = albumin.

$G$  = globulin.  
 $N$  = non-protein.

(3) After this initial fall the index increases rapidly—but from birth to puberty the values for man are higher than for the Albino.

The changes in the refractive index of the blood serum with temperature have been examined by Hammett and Teller ('22). The observations showed with rising temperature a first type (in winter rats) in which the changes in the refractive index



coincided with those in the solvent water, and a second type (in spring rats) in which the changes fall away from those of the water. This indicates a participation in the second type of other serum constituents than the water. The causes of this difference are undetermined.

TABLE 29

*Changes in refractive index as well as in the proportional amount of serum proteins in albino rats at different ages*

AGE	NUMBER OF SAM- PLS ANALYZED	BODY WEIGHT (AVERAGE)	BODY LENGTH (AVERAGE)	$N_D$	TOTAL PROTEINS	ALBUMINS	GLOBULINS	NON-PROTEIN SUB- STANCES	RELATIVE AMOUNT OF	
									Albumin	Globulin
<i>days</i>		<i>grams</i>	<i>mm.</i>		<i>per cent</i>	<i>per cent</i>	<i>per cent</i>	<i>per cent</i>		
Newborn.	1			1.34101	2.8	1.7	1.1	1.6	60.7	39.3
7	1	10.8		1.34095	2.9	1.6	1.3	1.5	55.2	44.8
14	2	18.3	82	1.34245	3.9	2.4	1.5	1.2	61.5	38.5
22	2	26.5	97	1.34399	4.4	2.3	2.1	1.6	52.3	47.7
30	5	24.7	96	1.34350	4.7	3.5	1.2	1.5	74.5	25.5
50	5	51.1	115	1.34508	5.0	2.8	2.2	1.5	56.0	44.0
80	12	80.8	144	1.34648	5.7	3.3	2.4	1.5	57.9	42.1
87	5	69.4	142	1.34694	6.2	4.0	2.2	1.3	64.5	35.5
94	7	76.8	146	1.34647	5.9	3.7	2.2	1.4	62.7	37.3
103	9	78.5	142	1.34745	6.2	3.8	2.4	1.5	61.3	38.7
140	4	130.8	171	1.34722	5.9	3.1	2.8	1.5	52.5	47.5
180	3	129.0	172	1.34700	6.3	4.2	2.1	1.3	66.7	33.3
305	6	177.9	191	1.34876	6.5	2.9	3.6	1.7	44.6	55.4
385	4	197.8	196	1.34699	6.0	2.7	3.3	1.4	45.0	55.0

To reduce the readings of the observed angle of refraction to a common base at 20°C., two formulas may be used. When the reading is made from 20°C.-35°C. then

$$I = i - 1.25 (t - 20^\circ) \quad (2)$$

When the reading is made from 17.5° - 20°C. then

$$I = i + 1.25 (20^\circ - t) \quad (3)$$

$I$  = corrected angle:  $i$  = observed angle:

1.25 = minutes rise for one degree;  $t$  = the observed temperature.

*Serum constitution.* Toyama ('19) has examined the serum for the relative abundance of the proteins at different ages. His results are brought together in table 29 and chart 6.

The change in total proteins follows the change in the refractive index of the serum, but after puberty the percentage of albumin falls, while that of globulin rises. The percentage of the non-protein bodies remains constant.

Corresponding results, though differing somewhat in detail, have been reported by Robertson ('20, p. 340).

Anti-pig natural hemolysin is found in the serum of rats of both sexes usually after 30–50 days of age. It appears more often in the female and especially during pregnancy and the first week after parturition. In males the number of cases tends to increase with lung infection (Suzuki, '20).

*Blood elements. Hemoglobin.* Reichert and Brown ('09) have determined that the hemoglobin crystals from the blood of the Norway rat are similar to those from the Albino, but the crystals from the blood of the house rat (*M. rattus*) are different.

*Weight of hemoglobin.* For the weight of hemoglobin in the entire animal, Abderhalden ('02) has reported the values given in table 30. The observations were made in September 1901—one series for the base station at Basel and the other for the elevated station at St. Moritz.

*Number.* In the adult albino rat about 7 million erythrocytes are found in blood from the heart and central vessels and 8–10 million in blood from peripheral vessels (Jolly, '06).

Jolly ('09) has given a series of determinations for the number of red cells according to age and to locality of sample—table 31.

This table 31 shows the increase in the number of erythrocytes with age and the loss in hemoglobin during the period of dependence on the mother followed by an increase later.

There is a fairly steady decrease in the "valeur globulaire" (equal to the weight of the hemoglobin divided by the number of erythrocytes) except for the period from 42–90 days—after which there is little change. The cell production in the bone

marrow is in harmony with the increase in the number of erythrocytes during the first 30 days of life (Jolly 1906, p. 634).

TABLE 30  
*Weight of hemoglobin in albino rat—Abderhalden ('02)*

NUMBER	SEX	BODY WEIGHT		WEIGHT OF HEMOGLOBIN	
		A Entire	B Without skin and alimentary tract	Absolute	Per 1000 grams body weight B
Basel					
				<i>grams</i>	<i>grams</i>
1	♀	242	192	2.10	10.98
2	♀	192	160	1.57	9.78
3	♂	146	115	1.15	10.04
4	♂	194	157	1.56	9.96
St. Moritz					
1	♀	195	158	1.67	10.58
2	♀	149	115	1.28	11.18
3	♂	225	185	2.06	11.12
4	♂	195	159	1.67	10.48

TABLE 31  
*Number of erythrocytes according to age and locality of sample*

AGE IN DAYS	CENTRAL VESSELS			PERIPHERAL VESSELS		
	Number of erythrocytes in millions	Hemoglobin (Malassez)	Valeur globulaire μ μ gm.	Number of erythrocytes in millions	Hemoglobin (Malassez)	Valeur globulaire μ μ gm.
1	2.3	10.3	44.5	3.0	12.2	41.4
3	2.5	8.8	35.6	3.0	10.7	35.4
5	2.6	8.0	30.9	3.1	9.1	29.2
8	2.6	7.9	31.0	3.1	9.2	29.3
15	3.8	8.5	22.5	4.2	9.1	21.6
21	4.1	8.5	20.8	4.4	9.5	21.7
30	4.9	10.1	20.4	5.5	10.6	19.2
42	4.9	11.8	24.2	5.6	13.8	24.6
60	5.2	12.9	25.0	6.7	14.4	21.6
90	6.2	13.9	22.6	8.5	15.5	18.2
180	7.5	13.5	18.1	8.4	15.0	17.9
365	7.5	14.2	18.8	8.9	16.0	18.1
1095	7.9	14.8	18.6	8.8	16.5	18.8

A series of determinations on the increase in the number of leucocytes with age, table 32, has been made by Jolly ('19).

TABLE 32

*Changes in the number of leucocytes with age*

According to Jolly ('19) the number of leucocytes tends to increase with age

AGE	NUMBER OF LEUCOCYTES PER MM. <sup>3</sup>	
	Central vessels	Peripheral vessels
Fetus at term.....	1366	—
1 day.....	2280	2766
8 days.....	1950	3240
15 days.....	2466	5666
30 days.....	4900	7400
60 days.....	—	6866
365 days.....	—	10000

In the rat before birth the numbers of cells have been determined by Addison and Richter (MS '23). The leucocytes and erythrocytes increase from the 18 day to the 21 day stage—while the erythroblasts decrease—table 33.

TABLE 33

*Cells in 1 mm.<sup>3</sup> of prenatal blood (Addison and Richter, MS. '23). The number of cases are in parentheses*

AGE OF FETUS	LEUCOCYTES	ERYTHROBLASTS	ERYTHROCYTES
18 day—neck.....	980 (2)	140,000 (2)	1,735,000 (1)
19 day—neck.....	1115 (2)	38,000 (2)	1,547,000 (5)
20 day—neck.....	1580 (2)	10,250 (2)	1,741,000 (3)
21 day—tail.....	1887 (2)	4,475 (2)	1,902,000 (5)

TABLE 34

*Red cells and platelets of normal albino rats (condensed from Cramer, Drew and Moltram, '22)*

NUMBER OF CASES	WEIGHT IN GRAMS	RED CELLS IN MILLIONS	PLATELETS IN MILLIONS
2	50	9.6	0.92
2	60	10.0	0.96
2	110	10.2	0.69
3	150	10.9	0.85

For the number of blood platelets in normal albino rats data are presented in table 34.

*Size.* The diameter of the erythrocytes (White, '01) is given in table 35.

In the course of development the diameter of the erythrocytes decreases up to puberty. The observations of Jolly ('23) are given in table 35 A.

TABLE 35

FOR M. DECUMANUS	DIAMETERS IN $\mu$
Determination by (Treadwell).....	6.5
Determination by (Wormley, 1888).....	7.0
Determination by (Gulliver, 1875).....	6.5

TABLE 35A

*Diameters of erythrocytes at successive ages up to three months*

AGE	DIAMETER $\mu$
17th days of gestation.....	9.7
1 day.....	8.3
8 days.....	8.0
15 days.....	7.9
30 days.....	6.7
90 days.....	6.6

TABLE 36

*Showing the percentage and size of the various forms of the wandering cells of the blood in the rat*

TYPE OF CELL	GRANULATION	PERCENTAGE OF TYPE	DIAMETERS IN $\mu$
Oxyphile.....	{ Coarse { Fine (absent)	2	10
Basophile.....		45	7-8
Hyaline.....		2	8-10
Lymphocytes.....		50	6

For the wandering cells there are data from Kanthack and Hardy ('94) tables 36 and 37.

*Blood picture.* Rivas (MS. '14) examined ten normal full grown rats using Miescher's method for the hemoglobin and Wright's stain for the cells. The blood was taken near the tip of the tail and spreads made. His results, somewhat condensed, are given in table 38.

TABLE 37

Shows the percentage and size of various forms of the wandering cells in the peritoneal fluid of the rat, Kanthack and Hardy ('94)

TYPE OF CELL	GRANULATION	PERCENTAGE OF TYPE	DIAMETERS IN $\mu$
Oxyphile.....	{ Coarse Fine	20-40 (absent)	10
Basophile*.....	{ Coarse Fine	5-10 (absent)	18
Hyaline Lymphocytes }.....		{ 65-80 }	13 6.5

\* Basophile cells in connective tissue  $23\mu$  in diameter.

TABLE 38

Normal albino rat—blood picture (Rivas MS. '14)

HEMO- GLOBIN	ERYTHRO- CYTES MILLIONS	NUMBER OF CASES	NUMBER OF LEUCO- CYTES	P.M.N.	P.M.E.	P.M.B.	S.L.	L.L.
<i>per cent</i>				<i>per cent</i>	<i>per cent</i>	<i>per cent</i>	<i>per cent</i>	<i>per cent</i>
86	8.7	3	8,133	57.0	1.12	0.28	34.6	7.0
90	7.9	3	8,467	52.5	0.60	0.30	41.7	4.9
96	8.0	4	11,450	55.9	0.90	0.20	38.2	4.8

TABLE 39

Normal albino rat—blood picture according to sex (Nowrey, MS. '21)

SEX	NUMBER OF CASES	NUMBER OF LEUCO- CYTES.	P.M.N.	P.M.E.	P.M.B.	S.L.	L.L.	L.M.	TRAN- SITION- AL	UN- CLASSI- FIED
			<i>per cent</i>	<i>per cent</i>	<i>per cent</i>	<i>per cent</i>	<i>per cent</i>	<i>per cent</i>	<i>per cent</i>	<i>per cent</i>
M.	11	9281	62.07	1.54	0.42	29.55	2.45	1.83	0.77	1.37
F.	12	8555	55.71	4.00	0.45	30.92	3.56	2.49	1.20	1.67

Nowrey (MS. '21) examined for the same purpose eleven male and twelve female normal mature albino rats at The Wistar Institute.

The males were about 163 days of age and weighed 267 grams.

The females were about 165 days of age and weighed 179 grams. Table 39.

The stain used was Wilson's modification of Romanowsky's polychrome stain.

In making the classification of the cells the neutrophilic myelocytes are included with the P.M.N. group. The transitional cells are myeloid forms often grouped as large mononuclears—transitional group.

The dividing line between the small and large lymphocytes is fixed rather arbitrarily as the size of a P.M.N. The two forms are often grouped as small mononuclears. The unclassified cells are those of such morphology that it was impossible to place them, or cells so badly broken as to be unrecognizable.

In the spring of 1916 Margot, working at The Institute, examined the blood picture in 31 normal albino rats, arranged in five age groups, sexes combined. Table 40.

TABLE 40  
*Normal albino rat—blood picture according to age (Margot MS. '16)*

AGE	BODY WEIGHT	SEX	HEMOGLOBIN	NUMBER OF ERYTHROCYTES M	NUMBER OF LEUCOCYTES	P.M.N.	P.M.E.	P.M.B.	S.L.	L.L.
<i>days</i>	<i>grams</i>		<i>per cent</i>			<i>per cent</i>	<i>per cent</i>	<i>per cent</i>	<i>per cent</i>	<i>per cent</i>
28	27.5	5 ♂ 6 ♀	82.0	6.5	7,102	54.6	0.7	0.04	34.7	10.0
46	53.6	3 ♂ 3 ♀	90.2	9.7	10,025	54.5	1.7	0.00	34.0	9.8
60	82.2	2 ♂ 4 ♀	98.3	8.8	9,143	51.7	0.9	0.01	41.7	5.7
70	103.1	2 ♂ 3 ♀	83.8	8.8	8,480	48.2	1.7	0.00	41.7	8.4
148	233.0	3 ♂	103.0	9.4	9,375	59.0	0.8	0.00	33.8	6.3

The method used by Margot was as follows: For counting both the erythrocytes and leucocytes, Thomas-Zeiss apparatus was used. For dilution 0.9 per cent NaCl solution for erythrocytes and 0.2 per cent acetic acid for leucocytes were employed. For the erythrocytes 40 squares and for leucocytes the entire field were counted. The haemoglobin determinations were made with Oliver's haemoglobinometer. In some instances a modified

Sahli instrument (Newcomer's model) was also used. The differential count was made with Wright's blood stain and the percentage values based on 500 leucocytes. In making smear preparations the drop was gently spread over the slide with a cigarette paper instead of using another slide for this purpose.

The foregoing determinations by Rivas, Nowrey and Margot have all been given because they were made several years apart, were all on rats from The Wistar Institute Colony, and all on blood from the tail.

During the interval from 1914 to 1921 the colony was in a good nutritional state, though tending to improve in this respect towards the end of the period. The relation of most interest,

TABLE 41  
*Average number of leucocytes and percentages of polymorphonuclear cells and small lymphocytes*

		AVERAGE NUMBER OF LEUCOCYTES	P.M.N.	S.L.
			<i>per cent</i>	<i>per cent</i>
Rivas, 1914	Total series, 10 rats	9,350	55	38
Margot, 1916	3 males, 148 days	9,375	59	34
Nowrey, 1921	11 males, 163 days	9,281	62	30
	12 females, 165 days	8,555	56	31

here brought out, is that between the P.M.N. and the S.L. groups. These data are summarized in table 41.

As table 41 shows, the relations of these two groups are similar in the three series and may therefore be regarded as applying to fertile and well grown albino rats in the Wistar colony. This point is noted because quite different values are reported for the normal albino rats from other laboratories.

Thus Kleineberger and Carl '12, Eyre '13, Cramer, Drew and Mottram '21 and Cramer (personal communication, '22) all give in normal albino rats percentage values for the small lymphocytes which are *about twice* those for the polymorphonuclear cells, while the records from The Institute up to 1921 show consistently a reverse relation. No explanation for this striking contradiction has yet been found, but as our data are from the same strain as was used for the other tables here given, these are the values presented.



It should be added that some recent observations (1924) on The Wistar Institute rats show a blood picture in agreement with the authors who find the percentage values for the small lymphocytes about twice those for the polymorphonuclear cells. It seems fair to conclude therefore at the moment that the blood picture may vary in the rat as indicated above, and yet the animals still breed well and grow vigorously. Why this wide variation comes about is a question for further investigation.

It should be noted in this connection that while both the leucocytes and erythrocytes in the rat increase in number from birth to maturity, in man the leucocytes show a great decrease and the erythrocytes a slight decrease—Addison ('24 MS.).

*Lymph nodes.* Concerning the arrangement of the lymph nodes, Job ('22) reports as follows:

There is a definite plan in the structure and arrangement of the lymph nodes in the rat.

There are two types: Type I where the nodular portion surrounds the sinusoidal portion, except at the hilus; and type II where the nodular and sinusoidal portions are lodged at opposite ends of the node.

In type I, where the nodular portion covers the whole of the node, except at the hilus, a peripheral sinus is present over the whole of the node; but in type II the peripheral sinus is present only over the nodular division.

A collateral circulation, that is, lymph vessels passing from the peripheral sinus over the surface of the node to the efferent vessels at the hilus, is a normal, constant structure in type II nodes.

Accessory nodes, which are the result of some special stimulus, are always type I in structure.

Frey's suggestion, that the sinusoidal feature of the node structure belongs more properly to the visceral areas, is further supported.

As to topographical arrangement, number and type, the lymph nodes of the rat are as constant as the other organs of the body, table 42.

6. *Nervous system.* (a) Central. (1) Brain.

Specific gravity 1.050–1.056, (Reichardt '06).

For brain weight see chapter 7, p. 206, and table 144.

For percentage of water see chapter 8, p. 308, and table 157.

For chemical composition see chapter 9, p. 320, and table 178.

TABLE 42

*Showing the number of pairs and location of the two types of lymph nodes*

TYPES	ELBOW: KNEE CAU- DAL—EACH ONE PAIR	CERVICAL PAIRS	THORACIC PAIRS	MESEN- TERIC PAIRS	AXILLARY PAIR	INGUINAL PAIR	LUMBAR PAIR
I	1	2	6–12	6–20	1		
II		1			1	1	1

TABLE 43

*The number of mitoses in 13 consecutive sections, each section 6.75  $\mu$  in thickness, from the brain and spinal cord of rats at different stages of development. The fetus weighed 0.78 gms. and had a crown-rump length of 17 mm. It was probably at 17.5 days of gestation. Hamilton ('01).*

STAGE OF DEVELOPMENT	BRAIN	
	Ventricular mitoses	Extra-ventricular mitoses
Fetus (17.5 days).....	2196	966
Birth.....	390	595
24 hours.....	24	386
4 days.....	115	443
	LUMBAR CORD	
	Ventricular mitoses	Extra-ventricular mitoses
Fetus (17.5 days).....	28	18
Birth.....	8	45
24 hours.....	1	13
4 days.....	8	64

For vascularity see chapter 3, page 56.

*Cell division.* Cell division in the central nervous system continues after birth but soon ceases, save in the cerebellum.

The observations of Hamilton ('01) are given in table 43.

For the first 25 days after birth Allen ('12) has obtained the results given in table 44.

*Linear dimensions.* The changes in the several diameters of the fresh cerebrum with increasing brain weight have been determined by Sugita ('17).

TABLE 44

*Showing the number of mitoses per cubic millimeter of nerve tissue in the central nervous system of the stock Albino at certain levels. The figures give the number of mitoses in ten consecutive sections at each level of the cord, in five in the largest portion of the cerebellum and in five in the cerebrum in the region of the optic chiasma. The letters (a) (b) and (c) refer to different rats of the same age.*

AGE, DAYS	CORD			CEREBELLUM	CEREBRUM
	Cervical	Thoracic	Lumbar		
1.....	208	115	259	1597	430
4.....	437	176	351	2111	447
6.....	446	236	320		193
7.....				4848	
12.....	46	75	14	839	37
20.....	00	00	00	(c) 520	
20.....	00	00	00	(b) 61	(b) 27
20.....	00	00	00	(a) 00	(a) 18
25.....	00	00	00	00	27

The measurements were made with calipers along the lines indicated in figure 3 and 3 (a).

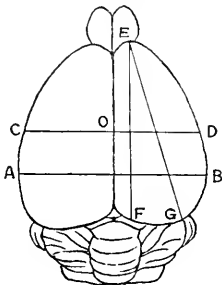

Fig. 3

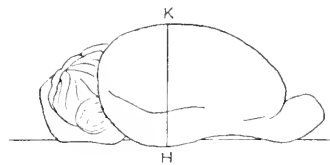

Fig. 3 a

Fig. 3. Dorsal view of the albino rat brain weighing 1.5 grams. Enlarged 1.8 diameters. To show the positions at which the two measurements for the width and the two measurements for the length were taken. AB = Width *W.B*, CD = Width *W.D*, EF = Length *L.F* and EG = Length *L.G*.

Fig. 3 a Lateral view of the albino rat brain weighing 1.5 grams. Enlarged 1.8 diameters. To show the position at which the height was measured. HK = Height *Ht*.

The values as thus obtained are given in table 45 and chart 7.

These show that while the diameters in length and width increase in a similar manner, the increase in height is slow. The details of these relations are given in the original paper (*loc. cit.*).

TABLE 45

*Giving the brain weights for each brain weight group, the cube roots of the brain weights and the linear measurements for width, length and height of the cerebrum. Albino rat*

BRAIN WEIGHT GROUP	NUMBER OF CASES	AVERAGE BRAIN WEIGHT	CUBE ROOT OF THE BRAIN WEIGHT	LINEAR MEASUREMENTS				
				W. B.	W. D.	L. G.	L. F.	Ht.
		<i>grams</i>		<i>mm.</i>	<i>mm.</i>	<i>mm.</i>	<i>mm.</i>	<i>mm.</i>
I	3	0.161	0.545	7.02	6.58	6.18	5.60	4.52
II B.	10	0.254	0.633	8.64	8.05	7.12	6.34	5.39
III	11	0.341	0.699	9.28	8.52	7.84	7.20	5.85
IV	10	0.424	0.750	10.02	9.11	8.50	7.92	6.35
V	19	0.544	0.816	10.78	10.02	9.41	8.69	6.93
VI	4	0.622	0.854	11.24	10.44	10.00	9.39	7.23
VII	7	0.769	0.916	12.05	11.10	11.09	10.59	7.91
VIII	10	0.845	0.945	12.26	11.48	11.43	10.88	8.22
IX	5	0.954	0.984	12.90	12.10	12.12	11.42	8.54
X	6	1.047	1.016	13.05	12.22	12.23	12.03	8.50
XI	6	1.156	1.049	13.50	12.61	12.61	12.35	8.94
XII	6	1.253	1.078	13.79	12.99	13.04	12.50	8.93
XIII	7	1.334	1.101	13.87	13.14	13.45	13.09	9.16
XIV	5	1.449	1.132	14.04	13.42	13.77	13.31	9.25
XV	7	1.558	1.159	14.42	13.76	14.28	13.61	9.50
XVI	9	1.662	1.184	14.44	13.62	14.93	14.10	9.34
XVII	7	1.737	1.202	14.80	14.03	15.29	14.51	9.53
XVIII	5	1.832	1.224	14.88	14.22	15.47	14.63	9.68
XIX	1	1.924	1.243	14.65	14.10	16.00	15.40	9.75
XX	3	2.037	1.267	15.39	14.62	16.65	15.30	10.02
Ratios II-XX.....		8.02	2.00	1.78	1.81	2.34	2.41	1.86

*The growth of the callosum.* The growth of the callosum in area has been followed by Suitsu ('20). The brains were fixed in formalin—treated with Weigert's rapid mordanting fluid, imbedded in parlodion, sectioned as near the median plane as possible and stained by the Kultschitzky-Wolters method. The calculated areas of the callosum obtained from this material

are given in table 46 and in chart 8 in which the observed values are also entered.

The theoretical curve in chart 8 has been computed by formula (11). When a comparison is made between the calculated area of the brain, (Suitsu, '20, p. 354) and that of the callosum, it appears that in the Albino the area of the callosum is 3.29 per cent that of the brain area—while in man it is 4.44 per cent.

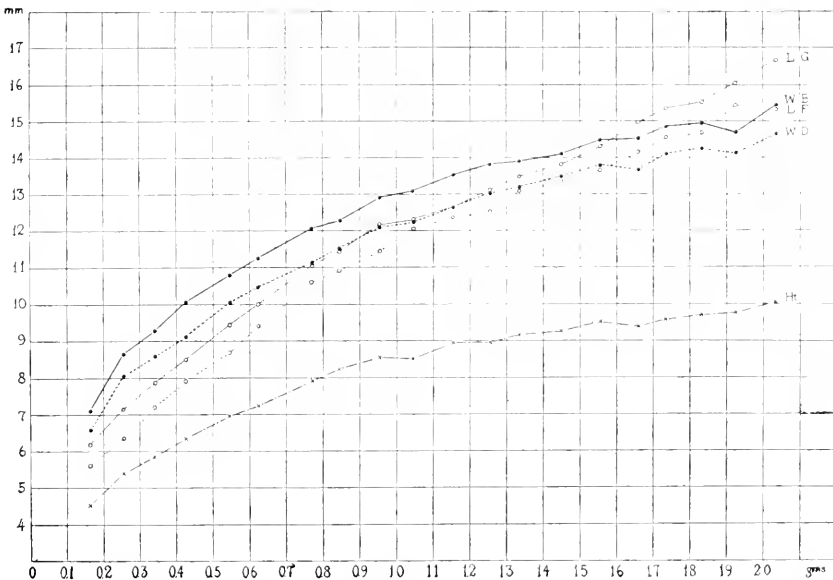

Chart 7 Giving for each brain weight group, in millimeters, on brain weight in grams, the values for the several diameters, *W.B.* and *W.D.*, width; *L.F.* and *L.G.*, length; *Ht.*, height. See equivalent designations, Figs. 3 and 3 a.

- = *W.B.*
- = *L.G.*
- - -● = *W.D.*
- - -○ = *L.F.*
- ×- - -×- - -× = *Ht.*

Using the method of equivalent ages, the fibers in the callosum of man should be well myelinated at the age of 20 months.

*Growth of the cerebral cortex in thickness (Sugita, '17 a).* On sections made in the three planes indicated in figures 4 and 5 the thickness of the cerebral cortex was determined at XIII localities as marked on the sagittal section in figure 6, on the frontal section in figure 7 and on the horizontal section in figure 8.

Beginning at birth, nineteen age groups were studied. The brains were fixed in Bouin's fluid and prepared by a uniform technique. The final measurements were corrected for the ef-

TABLE 46

*Showing the calculated callosal area at different ages of the albino rat. Data on standard body weight are taken from table 157 and the calculated callosal area determined by formula (11).*

NUMBER OF RATS	AGE	BODY WEIGHT		AREA OF CORPUS CALLOSUM		BRAIN WEIGHT—STANDARD
		Observed	Standard	Observed	Calculated from C.	
	A	B	C	D	E	F
	<i>days</i>	<i>grams</i>	<i>grams</i>	<i>mm.<sup>2</sup></i>	<i>mm.<sup>2</sup></i>	<i>grams</i>
1	Birth	4.3	4.7	1.45	1.58	0.217
2	5	6.5	7.6	2.07	2.02	0.509
3	7	9.5	9.5	2.34	2.22	0.657
4	10	7.6	13.5	2.38	2.54	0.947
5	12	27.4	14.4	3.25	2.60	0.991
6	15	15.7	16.1	2.39	2.71	1.057
7	17	21.5	17.3	2.42	2.77	1.095
8	20	31.5	19.5	2.86	2.87	1.150
9	22	29.9	21.1	2.84	2.94	1.184
10	25	26.2	23.9	3.17	3.06	1.237
11	27	27.4	25.9	3.58	3.13	1.266
12	30	29.2	29.2	3.68	3.25	1.311
13	35	27.5	35.4	3.35	3.42	1.375
14	40	59.2	42.5	4.23	3.59	1.434
15	50	75.3	59.6	4.43	3.90	1.537
16	60	76.5	80.3	4.35	4.15	1.622
17	70	75.1	104.7	3.99	4.42	1.695
18	80	103.5	132.8	4.51	4.63	1.758
19	90	100.6	150.5	4.51	4.76	1.791
20	100	101.3	165.8	4.51	4.85	1.817
21	112	133.2	181.6	4.60	4.94	1.841
22	122	134.3	193.1	4.61	5.01	1.857
23	150	159.7	218.7	4.67	5.12	1.888
24	205	220.8	250.9	5.28	5.25	1.924
25	378	274.8	279.9	5.29	5.36	1.954

fects of the treatment so as to give values which apply to the fresh cortex. These are entered in table 47 and shown graphically in chart 9. The heavy line A in chart 9 shows that the final average thickness of the cortex is nearly attained at a brain

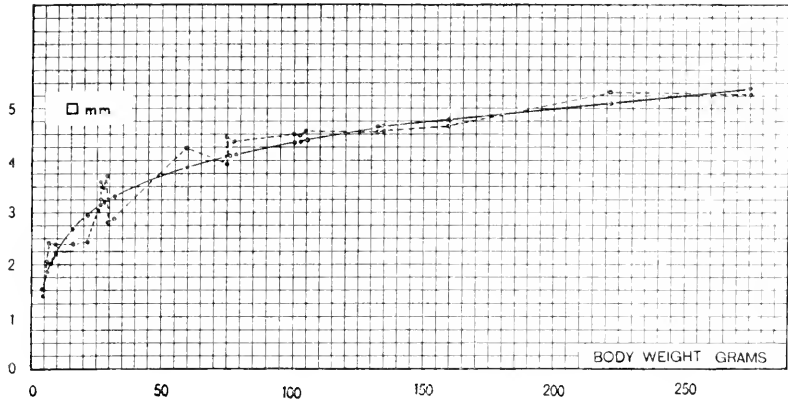

Chart 8 The continuous line represents the area of the corpus callosum according to body weight, calculated by formula (11) the broken line shows the means of the observed callosal areas. Albino rat.

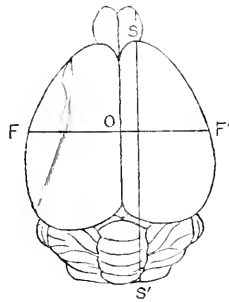

Fig. 4 Diagram of the entire brain of the albino rat seen from above, showing the levels from which the sagittal and frontal sections were taken.  $SS'$ , the sagittal section;  $FF'$ , the frontal section;  $O$ , middle point of the sagittal fissure.

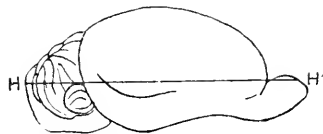

Fig. 5 Diagram of the entire brain of the albino rat, seen from the side and showing the level from which the horizontal sections were taken.  $HH'$ , horizontal section.

30664

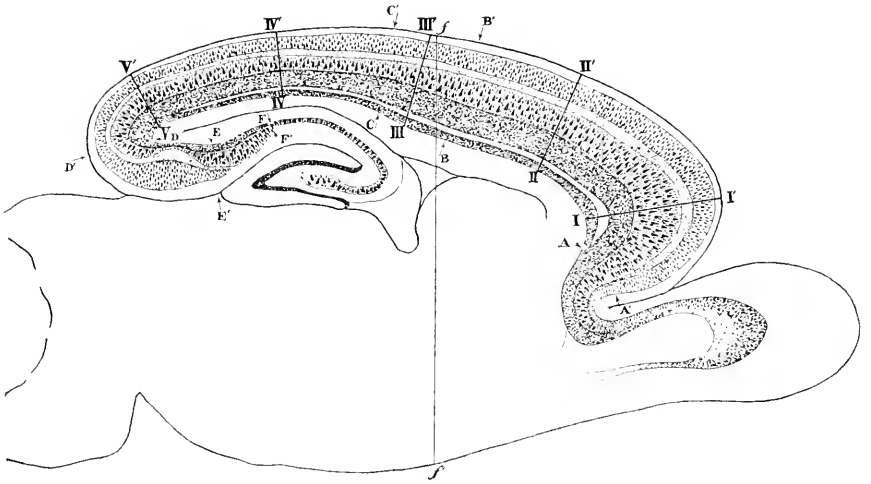

Fig. 6 Diagram of the sagittal section, from the albino rat brain weighing 1.5 grams, at about 30 days in age, showing the cell-lamination of the cortex and the localities at which the thickness of the cortex was measured. *ff'* is the level from which the frontal section was to be taken. Lines *AA'*, *BB'*, *CC'*, *DD'*, *EE'* and *FF'* indicate the borders of the areas showing different types of cell-lamination.

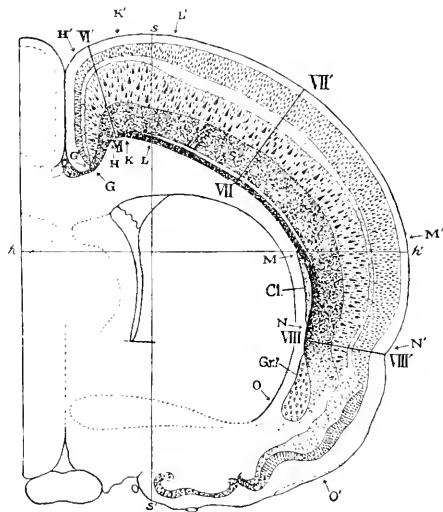

Fig. 7 Diagram of the frontal section, from the albino rat brain weighing 1.5 grams, at about 30 days in age, showing the cell-lamination of the cortex and the localities at which the thickness of the cortex was measured. *ss'*, plane in which the sagittal section was taken; *hh'*, level from which the horizontal section was taken. Lines *GG'*, *HH'*, *KK'*, *LL'*, *MM'*, *NN'* and *OO'* indicate the borders of the areas showing different types of cell-lamination. *N'* fissura rhinalis. Between *M* and *N* the claustrum—(*Cl*)—is seen. *Gr.*' marks the unidentified cell group between *NN'* and *OO'*.



weight of 1.154 grams, equivalent to 20 days of age—or the time of weaning.

*Number of cells in two layers of the cerebral cortex (computed).*  
 Using two layers, the lamina pyramidalis and the lamina ganglionaris, in a selected locality VII Figure 9 (Sugita, '18 b) determined the number of cells in a unit volume of the cortex (one-thousandth of a cubic millimeter).

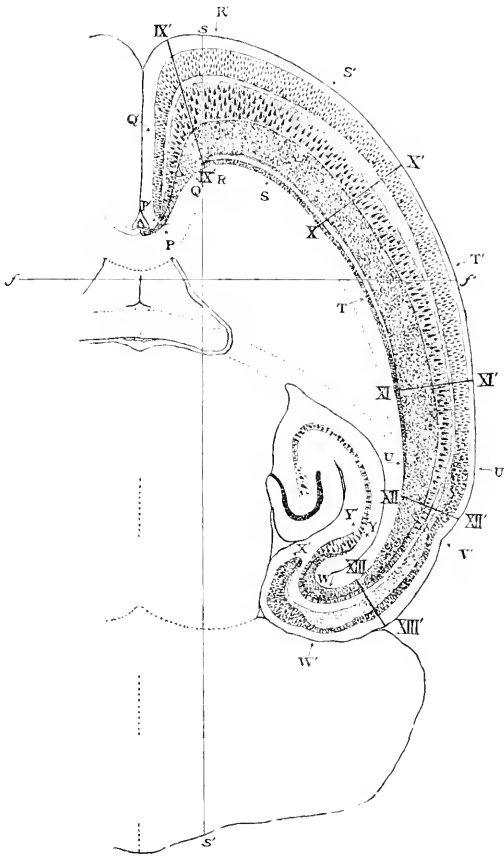

Fig. 8 Diagram of the horizontal section, from the albino rat brain weighing 1.5 grams, indicating the position of the localities measured on the section and the cortical cell-lamination. *ff* and *ss'* show respectively the levels from which the frontal and the sagittal sections were taken. The lines *PP'*, *QQ'*, *RR'*, *SS'*, *TT'*, *UU'*, *WW'*, *X'* and *YY'* indicate the borders of areas which show differences of cell-lamination and *V'* indicates the rhinal fissure.

The number thus obtained was multiplied by the number of times the unit volume was contained in the volume of the entire cortex. The final numbers computed for each of the nineteen brain weight groups made it possible to determine when the number of cells in the cortex was complete, but in the nature of

TABLE 47

*Showing the average (corrected) thickness of the cerebral cortex in the albino rat by brain weight groups*

BRAIN WEIGHT GROUP	SAGITTAL SECTION		FRONTAL SECTION	HORIZONTAL SECTION		AVERAGE		
	Brain weight	Thick-ness	Thick-ness	Brain weight	Thick-ness	Brain weight	Thick-ness	Approximate age
	<i>grams</i>	<i>mm.</i>	<i>mm.</i>	<i>grams</i>	<i>mm.</i>	<i>grams</i>	<i>mm.</i>	<i>days</i>
I	0.161	0.52	0.56					
II	0.251	0.67	0.78	0.292	0.77	0.265	0.74	B
III	0.358	0.90	1.02	0.317	0.90	0.344	0.94	2
IV	0.432	0.99	1.11	0.419	1.17	0.428	1.09	4
V	0.542	1.14	1.33	0.546	1.28	0.543	1.25	6
VI	0.639	1.29	1.55	0.631	1.41	0.636	1.42	7
VII	0.750	1.43	1.74	0.761	1.60	0.754	1.59	8
VIII	0.841	1.48	1.82	0.848	1.69	0.843	1.66	9
IX	0.964	1.55	1.86	0.939	1.77	0.956	1.73	10
X	1.040	1.59	1.84	1.054	1.86	1.045	1.76	15
XI	1.171	1.72	1.91	1.121	1.88	1.154	1.84	20
XII	1.253	1.75	1.91	1.240	1.96	1.249	1.87	
XIII	1.335	1.72	1.94	1.351	1.87	1.340	1.84	
XIV	1.445	1.70	1.99	1.455	1.94	1.448	1.88	
XV	1.554	1.76	1.97	1.566	1.89	1.558	1.87	
XVI	1.656	1.77	1.94	1.678	2.00	1.663	1.90	
XVII	1.726	1.79	1.90	1.730	1.93	1.727	1.87	
XVIII	1.839	1.86	1.97	1.823	1.99	1.833	1.94	
XIX	1.924	1.80	1.83					
XX	2.054	1.80	1.72	2.004	2.21	2.037	1.91	

the case, these numbers, based on two layers only, have a relative rather than an absolute value. The results are given in table 48.

It appears from table 48 that when the computation is based on the selected laminae, the number of cells in the cortex is complete at about 20 days, or the time of weaning.

In column D of table 48 the numbers entered are only one fifty thousandth of the computed numbers. Hence, after weaning, there are, *according to this calculation*,  $530 \times 50,000$  or 26.5 million cells in these two layers of the cerebral cortex.

*Growth in the diameters of cortical cells and their nuclei (Sugita, '18 c).* At the two localities shown in fig. 10 (a and b) the diameters of the largest cells and their nuclei in the lamina

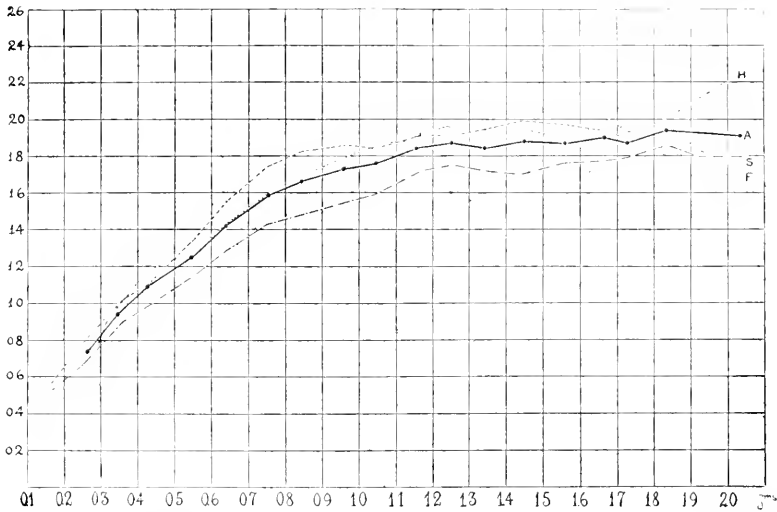

Chart 9 Giving the corrected thickness of the cerebral cortex in sagittal, frontal and horizontal sections and the general average thickness of the cortex for the three sections combined, on brain weight groups. Based on table 47.  
 ●—●—●—S. Average thickness of the cortex in sagittal section. Corrected.  
 ----F. Average thickness of the cortex in frontal section. Corrected.  
 -----H. Average thickness of the cortex in horizontal section. Corrected.  
 ●—●—●—A. General average thickness of the cortex for all three sections. Corrected.

pyramidalis and the lamina ganglionaris were measured, in material fixed in Bouin's fluid. The ten largest cells and their nuclei in each locality were measured on two diameters. The mean diameter was determined as the square root of the product of the two diameters. As in all the other measurements made on the cortex, the direct observations were corrected for the effect of the treatment so that the values here given apply to the cells in the fresh state.

Table 49 gives the mean values for each brain weight group and the same are shown graphically in chart 10.

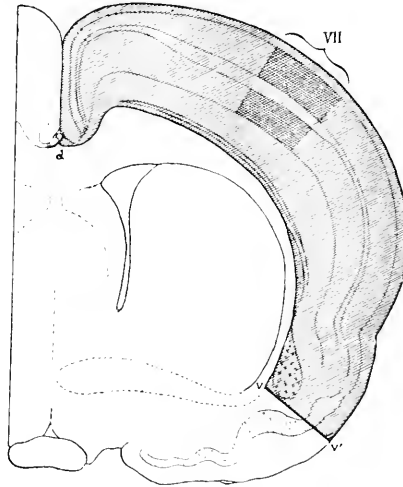

Fig. 9 Showing, by shading, the cortical area measured on the frontal section of the albino rat brain. The dorsal border (*d*) is chosen at the borderline of the corpus callosum. The ventral border (*v-v'*) was drawn perpendicular to the surface at the basal end of the cell group found near the fissura rhinalis, latero-basal to the capsula externa. The double shaded part, locality VII, indicates the areas (lamina pyramidalis and lamina ganglionaris) where the cell number and cell size were determined.

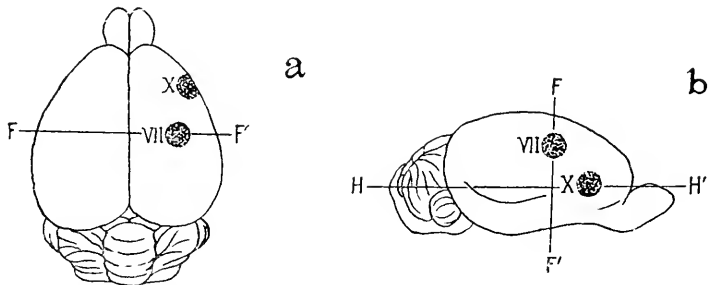

Fig. 10 Showing on the brain surface the localities at which the sizes of the pyramids and the ganglion cells were measured. *FF'* indicates the level from which the frontal section was taken and *HH'* indicates the level from which the horizontal section was taken. *VII* = locality VII; *X* = locality X. *a* = the dorsal view of an Albino brain weighing 1.5 grams. Enlarged 1.8 diameters. *b* = the lateral view of the same.

As the graphs show the cells in the L. ganglionaris complete their rapid growth between 10 and 20 days of age, while the cells in the L. pyramidalis are a little slower. In this latter

TABLE 48

Giving the computed number of nerve cells in the entire cerebral cortex, obtained on the basis of the measurements given in this series of studies. The ratio of the number of cells of each later group to that Group II (birth) is also given

BRAIN WEIGHT GROUP	A	B	C	D	E
	BRAIN WEIGHT	COMPUTED VOLUME OF CORTEX $L. F. \times W. D \times T$	SUM OF NOS. OF CELLS IN LAM. PYR. AND LAM. GANG. IN TWO UNIT VOLUMES, $K$	COMPUTED NUMBER OF CELLS IN CORTEX; * $N \times L. F \times W. D \times T \times \frac{1}{100}$	RATIO OF NUMBER OF CELLS
	<i>grams</i>	<i>mm.<sup>3</sup></i>			
II (birth)	0.251	35.97	739	265.8	1.00
III	0.358	61.81	590	364.7	1.37
IV	0.432	81.84	499	408.4	1.54
V	0.542	111.46	394	439.2	1.65
VI	0.639	144.50	305	440.8	1.66
VII	0.750	184.04	257	473.0	1.78
VIII	0.841	210.54	240	505.3	1.90
IX (10 days)	0.964	240.02	213	511.2	1.92
X	1.040	255.94	198	506.8	1.91
XI (20 days)	1.171	288.93	186	537.4	2.02
XII	1.253	304.51	171	520.7	1.96
XIII	1.335	314.03	176	552.7	2.08
XIV	1.445	329.71	165	544.0	2.05
XV	1.554	345.86	149	515.3	1.94
XVI	1.656	359.30	144	517.4	1.95
XVII	1.726	365.08	146	533.0	2.01
XVIII	1.839	397.96	138	549.2	2.07
XIX	1.924	390.39	132	515.3	1.94
XX	2.054	393.15	131	515.0	1.94
Average (Groups XI-XX).....				530.0	2.00
Average (Groups XIII-XX).....				530.2	2.00

\* As explained in (footnote 4), loc. cit. the actual number of cells contained in the computed volume of the cortex should be  $N \times L. F \times W. D \times T \times 500$ , but, for the convenience,  $1/100$  of  $N \times L. F \times W. D \times T$ , or  $1/50,000$  of the actual number of cells contained in the computed volume, was given here as the computed number of cells in the cortex.

TABLE 49

*Giving the corrected final average diameters of the nerve cells and their nuclei of the lamina pyramidalis and the lamina ganglionaris measured on the frontal and the horizontal sections of the albino rat brain. The average values of the two for each brain weight group are also given. The correction-coefficient for each brain weight group was taken from previous papers (Sugita, '17 a, '18 b.*

F = the frontal section. H = the horizontal section.

BRAIN WEIGHT GROUP	BRAIN WEIGHT	LAMINA PYRAMIDALIS		LAMINA GANGLIONARIS	
		Cell body diameter $\mu$	Nucleus diameter $\mu$	Cell body diameter $\mu$	Nucleus diameter $\mu$
	<i>grams</i>				
F I	0.161	10.3	8.1	13.6	10.9
F II					
H II (birth)	0.272	12.9	10.6	18.9	14.9
F III					
H III	0.338	15.0	12.6	20.4	16.2
F IV					
H IV	0.426	17.4	14.5	23.4	18.8
F V					
H V	0.544	18.2	15.3	24.9	19.7
F VI					
H VI	0.635	19.9	17.0	26.1	20.9
F VII					
H VII	0.756	21.3	18.1	28.1	21.9
F VIII					
H VIII	0.845	22.6	19.1	30.1	23.6
F IX					
H IX (10 days)	0.952	22.8	19.8	30.8	24.3
F X					
H X	1.047	23.7	19.7	31.3	24.4
F XI					
H XI (20 days)	1.146	23.6	19.9	31.2	24.2

TABLE 49—Continued

BRAIN WEIGHT GROUP	BRAIN WEIGHT	LAMINA PYRAMIDALIS		LAMINA GANGLIONARIS	
		Cell body diameter $\mu$	Nucleus diameter $\mu$	Cell body diameter $\mu$	Nucleus diameter $\mu$
	<i>grams</i>				
F XII H XII	1.247	24.3	20.3	31.7	24.5
F XIII H XIII	1.343	23.9	19.7	31.4	24.0
F XIV H XIV	1.450	23.3	19.3	31.5	24.2
F XV H XV	1.560	22.9	18.8	31.5	24.0
F XVI H XVI	1.667	23.0	19.1	32.4	24.6
F XVII H XVII	1.728	23.1	19.2	32.5	24.9
F XVIII H XVIII	1.831	22.7	18.8	32.8	24.6
F XIX H XIX	1.924	22.7	18.2	33.2	24.6
F XX H XX	2.029	21.6	17.5	33.5	24.6

layer the diameters of both the cells and nuclei undergo a substantial decrease from 30 days to the end of the record. Thus rapid growth of these cells in both layers is completed shortly before or shortly after weaning time. The decrease in the diameter of the pyramidal cells after the cessation of rapid growth is a phenomenon which has been observed in other cases.

In the present instance however the values have been reduced to those for the fresh cells and this makes it probable that in all these instances we are dealing with a real reduction of the

size of these cells rather than with a modification, based on age, in the response of the cells to the reagents used in their preparation.

*Olfactory bulbs : number of cells.* As an average of three counts, Holt ('17) found in one olfactory bulb of the albino rat, 62-134 days of age, the number of small cells in the molecular layer to be 1,000,000  $\pm$  2 per cent, and as an average of thirteen counts the number of mitral cells to be 76,750. The range of these counts was from 70,625 to 83,974 with  $\sigma$  4564, and P.E.M.  $\pm$  855.

The diameters of the Purkinje cells have been studied by Addison, '11.

The Albinos were from the stock colony of The Wistar Institute, reared on the scrap diet. The cerebellum was fixed in Ohlmacher's solution (King, '10) imbedded in paraffin and stained with carbol-thionine and acid fuchsin. The values for the respective diameters given in table 50 are in each instance averages of ten measurements from the largest cells found in equivalent areas at the several ages. The measurements stop at 20 days of age. After this age there is but little change in the diameters of the largest cells.

(2) *Spinal cord.* For the weight of the spinal cord see Chapter 7, p. 206, and table 144. For the percentage of water see Chapter 8, p. 308, and table 157. For the chemical composition see Chapter 9, and table 178. Cell division in the spinal cord after birth has been studied by Hamilton, '01, see table 43 and Allen ('12) see table 44.

*Peripheral—Cranio-spinal nerves.* Cranial nerves: Third nerve: Boughton ('06) studied the increase with age (body weight) in the number of myelinated fibers in the oculomotor nerve in the albino rat and measured the areas of the entire fiber and the axis in osmic preparations. The results are given in table 51.

*Fifth cranial nerve.* Nittono ('20) followed the growth in size of the neurons composing the sensory division of the tri-



geminus nerve (V) from birth to maturity—measuring the diameters of the largest myelinated fibers in both the sensory root and the first, second and third branches—and also the diameters of the largest cells in the ganglion. The results are given in table 52 and show that the fibers in the root have a greater diameter than those in the branches.

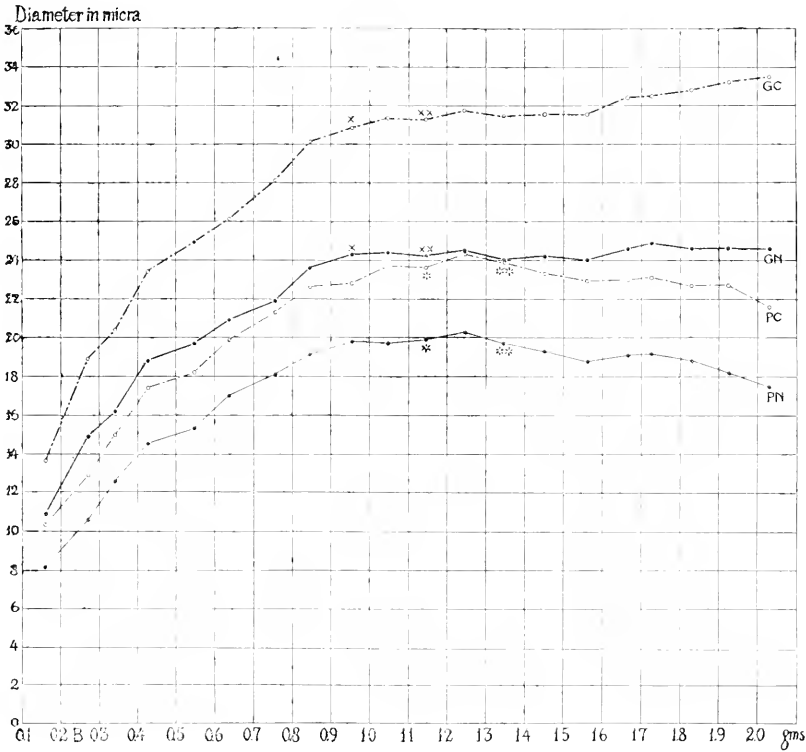

Chart 10 Showing the corrected average diameters of the cell body and the nucleus of the cortical nerve cells of the albino rat, plotted according to increasing brain weight. Based on the data in table 49. Graph *GC*, average diameter of the cell body of the ganglion cells in the lamina ganglionaris. Graph *GN*, average diameter of the nuclei of the ganglion cells in the lamina ganglionaris. Graph *PC*, average diameter of the cell body of the pyramids in the lamina pyramidalis. Graph *PN*, average diameter of the nuclei of the pyramids in the lamina pyramidalis. ×, 10 days of age. ×× and \*, 20 days of age. \*\*, 30 days of age.

The area of the axis tends to increase with age and in the fifth nerve root is on the average about half the area of the entire fiber, table 53.

TABLE 50  
*Diameters of Purkinje cells and their nuclei*

AGE IN DAYS	DIAMETERS IN $\mu$	
	Cell	Nucleus
Birth.....	12 $\times$ 7	8 $\times$ 6.3
3.....	14 $\times$ 8	8.3 $\times$ 7.4
8.....	18 $\times$ 12	11 $\times$ 8.5
10-20.....	21 $\times$ 14	12 $\times$ 9.0
	(largest) 24 $\times$ 19	

TABLE 51  
*Oculomotor nerve*

BODY WEIGHT IN GRAMS AND SEX	NUMBER OF MYELINATED FIBERS			AREAS IN $\mu^2$		PERCENTAGE OF AXIS
	Large	Small	Total	Entire fiber	Axis	
11 M.....	764		764			
14 M.....	880	38	918	13.2	6.6	50
44 M.....	885	220	1105			
51 F.....	926	227	1153			
80 F.....	887	290	1177	41.8	21.2	51
109 F.....	888	329	1217			
172 M.....	882	465	1347			
192 M.....	932	316	1248			
213 M.....	925	383	1308			
218 M.....	926	471	1397			
278 M.....	901	566	1467			
318 M.....	930	379	1309			
414 M.....	928	408	1336	56.7	27.3	48

The vertical averages for the area of the axis from the data in table 53 are:

		<i>Range</i>
First branch.....	44 per cent	40 to 48 per cent
Second branch.....	47 per cent	42 to 55 per cent
Third branch.....	48 per cent	44 to 50 per cent
Fifth nerve root.....	50 per cent	46 to 55 per cent

The largest cell bodies forming the gasserian ganglion increase in diameter from birth to about puberty, reaching their maximum size at 80–100 days, after which they remain approximately constant—table 54.

TABLE 52

Data on the diameter in  $\mu$  of the largest myelinated fibers and the axis cylinders taken from three different branches and the fifth nerve root, arranged according to age

AGE	MEAN BODY WEIGHT	DIAMETERS							
		First branch		Second branch		Third branch		Fifth nerve root	
		Entire fiber	Axis	Entire fiber	Axis	Entire fiber	Axis	Entire fiber	Axis
<i>days</i>	<i>grams</i>								
4	7.6	3.0	1.8	3.7	2.5	4.6	3.5	5.7	4.2
8	11.7	4.6	3.1	6.3	4.2	5.4	3.2	6.1	3.9
12	13.1	5.0	3.2	5.9	4.0	6.6	4.6	6.1	4.3
16	18.6	6.1	4.1	7.0	4.6	7.5	5.3	7.3	5.1
20	23.4	7.0	4.7	8.5	5.8	9.4	6.1	9.5	6.3
25	17.6	6.6	4.3	8.9	6.3	8.6	5.7	9.8	6.4
30	34.8	8.2	5.4	9.3	6.1	10.5	7.2	10.5	7.2
35	46.5	8.0	5.0	10.2	6.8	10.8	7.6	12.3	8.5
40	60.2	9.0	6.0	10.7	7.3	11.1	8.0	12.2	8.5
50	41.4	7.9	4.7	10.1	6.7	10.6	7.2	11.7	8.4
55	52.7	9.5	6.5	10.9	7.0	12.1	8.5	11.1	7.6
66	68.1	9.1	5.8	11.3	7.4	9.9	6.9	11.9	8.3
80	100.5	8.6	5.9	12.1	8.2	11.3	7.3	13.2	9.5
100	125.0	9.2	6.3	13.2	9.8	10.6	7.5	13.1	9.9
150	163.7	8.9	6.2	12.1	8.1	12.6	9.3	12.4	8.9
202	206.5	10.0	7.0	12.4	9.3	13.3	10.0	13.2	9.0
260	254.8	11.8	8.6	14.6	11.2	14.1	10.0	15.3	11.4
300	258.2	11.0	7.2	12.9	9.4	12.4	8.5	14.0	10.4
378	242.6	11.5	7.5	13.1	9.0	12.7	8.9	13.8	9.6
Averages.....		7.6	5.4	10.2	7.0	10.2	7.1	11.0	7.8
Ratios.....		1:3.8	1:4.2	1:3.5	1:3.6	1:2.8	1:2.5	1:2.4	1:2.3

The neurons in the gasserian ganglion are larger, have a higher nucleus-plasma ratio, and mature earlier than do those in the ganglion of the seventh cervical nerve. The fibers from the cells of the gasserian ganglion are absolutely less in diameter than those from the seventh cervical ganglion, despite the fact that the cell bodies of the former are larger. These differences

TABLE 53

Showing the areas of the fibers and of the axis cylinders in  $\mu^2$  in the three branches and in the fifth nerve at different ages—albino rat

MEAN BODY WEIGHT	AGE	FIRST BRANCH			SECOND BRANCH			THIRD BRANCH			FIFTH NERVE			HORI- ZONTAL AVER- AGES
		Entire fiber	Axis	Per cent of axis	Entire fiber	Axis	Per cent of axis	Entire fiber	Axis	Per cent of axis	Entire fiber	Axis	Per cent of axis	
<i>grams</i>	<i>days</i>													<i>per cent</i>
9.7	6.0	11.3	4.5	40	19.6	8.6	44	19.6	8.6	44	27.3	13.5	49	44
16.6	18.0	28.3	12.6	45	42.3	20.1	48	44.2	20.4	46	47.8	22.1	46	46
39.2	36.7	49.0	20.0	41	75.4	33.2	44	89.9	43.0	48	100.8	49.0	48	45
75.8	57.4	63.6	27.3	43	95.0	40.2	42	95.0	44.2	47	109.3	52.8	48	45
140.7	136.9	72.4	33.9	47	120.8	59.4	49	107.7	54.1	50	132.8	72.4	55	50
230.6	298.4	96.8	46.6	48	145.5	80.1	55	139.0	69.4	50	160.6	86.6	53	51
Vertical averages														
per cent.....				44		47		48		50				

TABLE 54

Average diameters in  $\mu$  of the largest cells and their nuclei in the gasserian ganglion according to the body weight of the rats, based on the full data

AGE	MEAN BODY WEIGHT	COMPUTED DIAMETERS	
		Cells	Nuclei
<i>days</i>	<i>grams</i>		
1	5.5	29.4	13.8
4	5.9	32.6	13.9
8	12.4	37.3	15.0
12	20.1	39.7	15.3
16	20.1	39.8	15.3
20	21.2	42.2	15.6
25	24.0	42.0	15.2
35	33.3	44.0	16.1
30	38.0	42.8	15.4
40	43.1	43.3	16.1
50	75.4	48.8	15.8
65	85.9	46.6	16.5
80	136.6	50.0	15.9
100	172.1	50.3	16.2
198	200.7	47.9	15.9
150	207.7	48.3	16.3
330	258.1	49.6	16.5
254	267.3	47.1	17.1
Ratios.....	1:48.6	1:1.60	1:1.24

may be related to the somewhat specialized character of the fifth nerve. See table 67.

*Eighth cranial nerve.* Droogleever Fortuyn ('14) counted 3000 myelinated fibers in the n. cochlearis of the Norway rat.

For the largest cell bodies and their nuclei in the ganglion spirale, Wada ('23) has made the determinations given in tables

TABLE 55

*Diameters of the cell bodies and their nuclei in the ganglion spirale (radial-vertical section) chart 11*

AGE	BODY WEIGHT	BODY LENGTH	DIAMETERS IN $\mu$					
			Cell body			Nucleus		
			Long	Short	Computed	Long	Short	Computed
<i>days</i>	<i>grams</i>	<i>mm.</i>						
1	5	48	11.0	10.0	10.5	8.2	7.6	7.9
3	8	56	12.0	11.1	11.5	8.2	7.8	8.0
6	11	63	13.6	12.3	12.9	8.8	8.1	8.4
9	10	58	14.3	12.8	13.6	8.9	8.2	8.5
12	13	70	14.6	13.1	13.8	8.7	8.2	8.5
15	13	75	15.7	14.1	14.9	9.1	8.4	8.7
20	29	95	19.0	17.3	18.1	10.3	10.0	10.2
25	36	104	18.5	16.9	17.7	10.2	9.9	10.1
50	59	125	18.5	16.6	17.5	10.3	9.7	10.0
100	112	159	18.1	15.7	16.9	9.8	9.2	9.5
150	183	190	18.2	15.3	16.7	9.6	8.8	9.2
257	137	175	18.5	15.3	16.8	9.9	9.4	9.6
366	181	191	18.6	15.3	16.9	9.8	9.0	9.4
546	255	213	18.6	15.3	16.9	9.7	9.0	9.4
Ratios								
1—20 days					1:1.7			1:1.3
1—546 days					:1.6			:1.2
20—546 days					:0.9			:0.9

55 and 56 and chart 11. The values for each group are averages from observations on four cochleae. Table 56 gives the analytical constants based on the measurement of 160 cells in each age group. It may be noted that at nine days—when auditory responses may appear—the cell bodies have only about two thirds of their maximum diameter. This maximum is attained at about the end of suckling (20 days) and after that period

there is some diminution in diameter. The measurements for the nucleus follow those for the cell body.

TABLE 56

*Analytical constants giving the mean, standard deviation and coefficient of variability with their respective probable errors for the diameters of the cells and their nuclei of the ganglion spirale in radial vertical section*

AGE	FOR TOTAL NUMBER OF CELLS			
	Cell Nucleus	Mean	Standard deviation	Coefficient of variability
<i>days</i>				
1	Cell	10.2 ± 0.05	0.90 ± 0.03	8.9 ± 0.33
	Nucleus	7.8 ± 0.02	0.46 ± 0.01	5.9 ± 0.22
3	Cell	11.3 ± 0.03	0.50 ± 0.02	4.4 ± 0.17
	Nucleus	7.9 ± 0.02	0.32 ± 0.01	4.1 ± 0.15
6	Cell	12.6 ± 0.04	0.68 ± 0.03	5.4 ± 0.20
	Nucleus	8.4 ± 0.03	0.48 ± 0.02	5.7 ± 0.22
9	Cell	13.1 ± 0.03	0.61 ± 0.02	4.7 ± 0.18
	Nucleus	8.5 ± 0.03	0.52 ± 0.02	6.1 ± 0.23
12	Cell	13.4 ± 0.05	0.86 ± 0.03	6.4 ± 0.24
	Nucleus	8.4 ± 0.03	0.61 ± 0.02	7.3 ± 0.28
15	Cell	14.6 ± 0.04	0.73 ± 0.03	5.0 ± 0.13
	Nucleus	8.7 ± 0.03	0.58 ± 0.02	6.7 ± 0.25
20	Cell	17.8 ± 0.06	1.17 ± 0.04	6.6 ± 0.25
	Nucleus	10.0 ± 0.02	0.40 ± 0.02	4.1 ± 0.15
25	Cell	17.3 ± 0.05	0.88 ± 0.03	5.1 ± 0.19
	Nucleus	9.9 ± 0.02	0.36 ± 0.01	3.6 ± 0.14
50	Cell	17.2 ± 0.04	0.78 ± 0.03	4.5 ± 0.17
	Nucleus	9.7 ± 0.02	0.34 ± 0.01	3.6 ± 0.14
100	Cell	16.5 ± 0.03	0.65 ± 0.02	3.9 ± 0.15
	Nucleus	9.4 ± 0.02	0.38 ± 0.01	4.0 ± 0.15
150	Cell	16.4 ± 0.03	0.79 ± 0.02	4.8 ± 0.18
	Nucleus	9.1 ± 0.02	0.42 ± 0.02	4.6 ± 0.17
257	Cell	16.6 ± 0.06	1.09 ± 0.41	6.6 ± 0.25
	Nucleus	9.5 ± 0.02	0.39 ± 0.01	4.1 ± 0.15
366	Cell	16.7 ± 0.05	1.02 ± 0.01	6.1 ± 0.22
	Nucleus	9.3 ± 0.03	0.52 ± 0.02	5.6 ± 0.21
546	Cell	16.7 ± 0.06	1.06 ± 0.04	6.4 ± 0.24
	Nucleus	9.3 ± 0.02	0.45 ± 0.02	4.9 ± 0.18

In conjunction with the studies on the ganglion spirale, Wada ('23) made, on the same material and in the same manner, a series of measurements on the largest cell bodies and their nuclei in the vestibular ganglion. The data are given in table

57 and chart 12. The analytical constants were also determined (*vide loc. cit.*). It may be noted that these cell bodies are larger than those of the ganglion spirale and that they are relatively well grown at birth. Further, the diameters tend to increase with age.

*Spinal nerves and ganglia.* For the study of the total number of fibers (in all the spinal nerves of one side) Agduhr '20 examined five specimens of the house rat, *Mus rattus*. The method

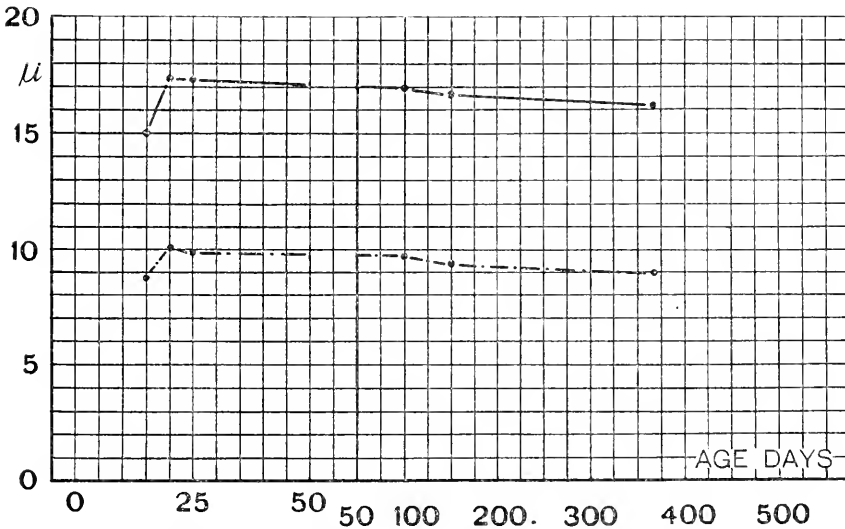

Chart 11 Showing the computed diameters of the largest cell bodies and their nuclei in the ganglion spirale—table 55.

———— Diameters of cell bodies

-----Diameters of nuclei

used was a modification of the Bielschowsky silver technic. It was assumed that by this method all of the fibers, both myelinated and unmyelinated, were stained and so counted. The data for each nerve are given separately in the original table. Table 58 shows merely the total values.

Agduhr calls attention to the increase in the number of fibers in both roots with advancing age and body weight and to the fact that in each case the number of fibers in the dorsal roots is about twice that in the ventral.

These determinations by Agduhr show an increase in the number of fibers in the spinal nerves with advancing age, and he believes that this indicates a progressive increase in the number of neurons. His conclusions are opposed to those drawn from our own earlier studies and those made at The Institute in which it was found that the number of neurons was

TABLE 57

*Diameters of the cells and their nuclei in the ganglion vestibulare in radial vertical section (chart 12)*

AGE	BODY WEIGHT	DIAMETERS					
		Cell Body			Nucleus		
		Long	Short	Computed	Long	Short	Computed
<i>days</i>	<i>grams</i>						
		21.2	19.5	20.3	12.4	11.1	11.7
1	5	23.7	22.2	22.9	12.5	11.6	12.0
3	9	24.0	22.1	23.0	12.3	11.9	11.9
6	11	24.8	23.0	23.9	12.5	11.6	12.0
9	10	24.9	23.0	23.9	12.5	11.7	12.1
12	13	24.8	23.0	23.9	12.5	11.6	12.0
15	13	25.0	23.3	24.1	12.3	11.6	11.9
20	27	25.2	23.6	24.4	12.5	11.8	12.1
25	34	25.6	23.6	24.5	12.5	11.6	12.0
50	50	25.5	23.9	24.7	12.8	11.9	12.3
100	112	25.4	23.5	24.4	12.8	11.6	12.2
150	174	25.8	23.4	24.6	12.4	11.7	12.0
260	138	26.2	24.9	25.5	12.9	11.8	12.3
367	184	26.5	24.2	25.3	12.8	11.8	12.2
546	255						
Ratios	1—367 days			1:1.3			1:1.1
	1—546 days			:1.2			:1.0
	15—367 days			:1.1			:1.0

fixed at an early stage of development. Further investigation is needed to warrant a choice between these two views.

One of the larger spinal ganglia from a cervical nerve root of an Albino weighing 140 grams was fixed in a formalin-acetic sublimate mixture (6, loc. cit., p. 3) by Hatai ('01) and cut in paraffin sections 6–7 $\mu$  thick.



Selecting cells according to size from large to small the measurements of the cell body and the nucleus were made is in table 59. The values given show the range in the size of these cells.

From a study of the diameters of the cell bodies and their nuclei in the second cervical spinal ganglion of the adult Al-

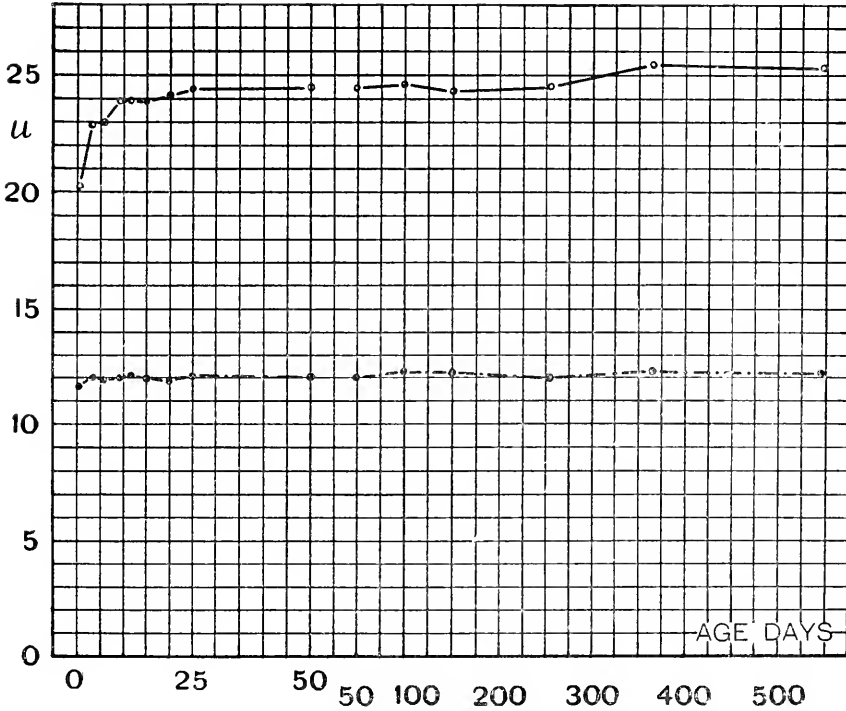

Chart 12 The diameters of the largest cell bodies and of their nuclei from the ganglion vestibulare.

———Cell bodies

- - - - -Nuclei

bino, values which apply to the mean of the entire cell "population" of this ganglion have been obtained (Hatai, '07 b). The ganglion examined was from a mature male weighing 194 grams. The ganglion was fixed in osmic acid and imbedded in paraffin. The mean values are as follows—table 60.

On the basis of these observations, formula (14 a) was devised for computing the diameter of the nucleus from the diameter of the cell body.

For a comparison with the data in table 60 see data in table 59 obtained by a different method of fixation.

TABLE 58  
*Total number of fibers in all the spinal nerves of one (left) side—Mus rattus*

BODY WEIGHT	AGE	NUMBER OF FIBERS	
		Ventral root	Dorsal root
<i>grams</i>	<i>days</i>		
	10	24,554	52,469
	30	29,258	51,338
	40	30,739	57,240
220	Mother	38,906	78,466
415	Father	53,260	94,109

TABLE 59

SERIES	NUMBER OF CELLS	AVERAGE DIAMETERS IN $\mu$	
		Cell body	Nucleus
A.....	10	55 $\times$ 46	18 $\times$ 15
a.....	10	38 $\times$ 25	15 $\times$ 14
B.....	5	26 $\times$ 23	13 $\times$ 12
b.....	5	19 $\times$ 17	10 $\times$ 10

TABLE 60

	MEAN DIAMETER	STANDARD DEVIATION	COEFFICIENT OF VARIATION
	$\mu$		
Cell body.....	28.6	14.9	18.4
Nucleus.....	13.1	1.8	13.7

Further studies on the spinal roots and ganglia were made by Hatai ('02) and ('03 b).

From a series of male Albinos the spinal ganglia with accompanying dorsal root nerves were fixed in one per cent osmic acid and cut in paraffin. The measurements on this material (Hatai, '02) are given in table 61. Incorporated in the same table

are the enumerations for the myelinated fibers in the ventral roots (Hatai, '03 b).

It was found that the number of myelinated fibers in the ventral roots diminishes from sections near the spinal cord to those near the spinal ganglion. The amount of the diminution decreases with the age (body weight) of the rat. The increase in the number of cells in the spinal ganglia from the small

TABLE 61

*Number of ganglion cells and number and size of myelinated root fibers in spinal nerves from three levels of the spinal cord at five ages (body weights)*

Results from Tables II, VI and VIII combined—Hatai ('02)  
Also data on ventral root fibers from Hatai ('03 b)

BODY WEIGHT IN GMS.		TOTAL OF MYELINATED VENTRAL ROOT FIBERS	TOTAL OF GANGLION CELLS	TOTAL OF MYELINATED DORSAL ROOT FIBERS	TOTAL COMPOSED OF MATURE FIBERS	IMMATURE FIBERS	MEAN DIAMETER IN $\mu$ . OF 20 largest DOR- SAL ROOT FIBERS ENTIRE
VI Cervical	10.3	558	10996	1998	1043	955	7.5
	24.5	1007	9793	2569	2263	306	11.6
	68.5	1302	11772	3683	3569	114	13.3
	167.0	1474	12200	4227	4173	54	13.9
	264.3	1522		4028			
IV Thoracic	10.3	286	7142	607	283	424	4.8
	24.5	434	7068	683	497	366	7.1
	68.5	561	7611	1420	1259	161	8.9
	167.0	613	7406	1522	1460	82	11.6
	264.3	772		1650			
II Lumbar	10.3	333	8315	733	303	420	5.1
	24.5	698	8200	911	678	233	8.0
	68.5	704	9514	1317	1181	136	11.3
	167.0	1028	9442	1644	1565	79	12.0
	264.3	965		2102			

to the large rats is certainly due in part to the fact that in the small animals some of the smallest ganglion cells escape enumeration.

The increase in the number of myelinated fibers in the spinal roots with advancing age is considered to be due, mainly, to progressive myelination. Both roots at maturity still contain functional fibers without myelin sheaths (Ranson, '06).

For the numerical relations of cells and fibers in the second cervical nerve data are furnished by Ranson ('06). Table 62.

When the number of myelinated fibers in the two rami on the distal side of the II cervical spinal ganglion is compared with the total number counted in the two roots—a distal excess in the number of fibers is found. This is shown in table 63. The distal excess appears to be due to branching of the fibers in their course, Ranson ('06).

TABLE 62  
*Second cervical nerve*

*Observations on normal male rats (Albinos). Osmic acid fixation—paraffin sections*

AGE IN DAYS	BODY WEIGHT	CELLS IN GANGLION	NUMBER OF MYELINATED FIBERS	
			Dorsal root	Ventral root
72.....	110	7721	2472	689
72.....	110	8116	2394	660
72.....	110		1959	590
72.....	110		2217	591
72.....	155	9343		
	161		2090	672
240 (left side)...	188	8624	2689	703
240 (right side).	188		2891	773
	302		2386	646

TABLE 63

BODY WEIGHT	IN ROOTS			DISTAL EXCESS		IN RAMI		
	Ventral	Dorsal	Sum	Absolute	Percent-age	Sum	Ventral Ramus	Dorsal Ramus
<i>grams</i>								
161.....	672	2090	2762	336	12	3098	708	2390
302.....	646	2386	3032	257	8	3289	887	2402

Enumerations of the myelinated fibers in the ventral roots of the II spinal nerve of the Albino have been made by Dunn ('12). Each record is the mean of two enumerations of rats of like age. Areas in  $\mu^2$  of the entire fiber and of the axis are given—together with the percentage value of the axis. Each entry is based on the mean of the 20 largest fibers. In this series there is a change in the relative area of the axis with age,

as well as a decrease in the total areas in the oldest group—table 64.

TABLE 64

*Giving for Albinos of different ages the numbers of myelinated fibers in the ventral root of the second cervical nerve and the areas of the fibers. Dunn ('12)*

AGE, NUMBER, SEX	WEIGHT	NUMBER FIBERS	AVERAGE AREA TEN LARGEST FIBERS IN $\mu^2$	AVERAGE AREA OF AXES IN $\mu^2$	PERCENTAGE OF AXIS
	<i>grams</i>				
7 days					
Two females....	8.59	368	17.2	10.6	61.6
Two males.....	9.33	366	22.3	13.9	62.3
14 days					
Two females....	20.92	542	38.5	18.1	47.0
Two males.....	21.33	565	32.9	15.2	46.2
36 days					
Two females....	42.24	653	78.2	31.2	40.0
Two males.....	41.93	613	80.6	31.7	39.3
75 days					
Two females....	136.70	560	115.4	49.6	43.0
Two males.....	169.55	668	116.9	52.8	45.1
132 days					
Two females....	164.26	683	136.0	59.3	43.6
Two males.....	267.00	625	141.0	63.2	44.8
180 days					
Two females....	212.50	518	168.8	75.9	44.9
Two males.....	264.80	609	201.3	98.2	48.7
270 days					
Two females....	176.91	776	261.0	133.4	51.3
Two males.....	340.05	617	216.8	107.1	49.4
640 days					
Three males....	334.47	864	170.7	78.2	45.8

The number of myelinated fibers in the peroneal nerve of the normal Albino is given from Greenman's observations ('17) in table 65.

The data are arranged in age groups and are for Albinos of normal size for their ages. In some cases the body weight at killing was below normal, owing to lung infection.

The data show approximately the same number of fibers on each side. No sex difference was found. There is an indication of a loss of fibers after 251 days. This was possibly due to lung infection.

TABLE 65

*Number of myelinated fibers in the peroneal nerve of the albino rat—sections from the middle level; based on Greenman's table 8, '17*

NUMBER OF CASES	AGE	NUMBER OF MYELINATED FIBERS		
		Right	Left	Average
	<i>days</i>			
10	150	2046	2028	2037
13	152	2036	2044	2040
2	159	2167	2133	2150
2	251	2240	2263	2251
3	335	2129	2057	2093
3	454	2020	1922	1971

TABLE 66

*Normal albinos: Sectional area of ten largest fibers in  $\mu^2$ ; relation of axis to sheath*

BODY WEIGHT	PROXIMAL END			DISTAL END		
	Entire fiber	Axis	Per cent of axis	Entire fiber	Axis	Per cent of axis
104	109.8	55.6	50.6	85.0	42.3	49.7
117	137.7	75.2	54.6	85.8	42.6	49.6
182	150.3	82.9	55.1	113.0	56.7	50.1
Average 135	132.6	71.2	53.7	94.6	47.2	49.9

In an earlier study on cross sections of the largest fibers Greenman ('13) found the percentage value of the area of the axis in osmic acid preparations to be 49.9 per cent, as given in table 66.

These areas were computed from the mean diameters of the entire fiber and of the axis. In this later study (Greenman, '17) the areas of axis and of entire fiber were obtained plani-

metrically. This method tends to give a greater value for the area of the sheath and hence to reduce the relative area of the axis, which was here found to be about 40 per cent of the entire fiber.

Using the cells and fibers from the localities shown in figure 11 a comparison has been made between the growth of the spinal ganglion cells and their fibers and the corresponding ventral horn cells and their fibers—at the level of the seventh cervical nerve (Donaldson and Nagasaka, 18). The fibers were fixed in osmic acid and the cells in Bouin's fluid. Twelve body weight groups were studied. The relations found can be best

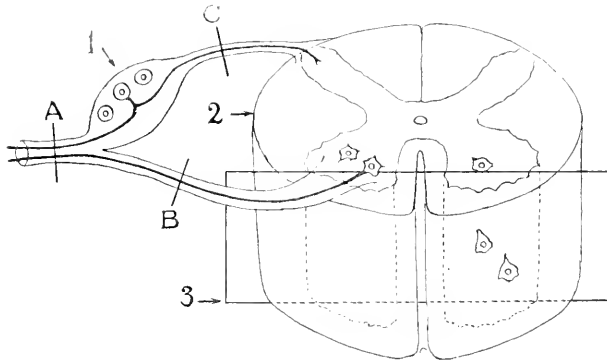

Fig. 11 A scheme of the seventh cervical segment of the spinal cord. Levels of the nerve-fiber sections: At A, section of seventh nerve; at B, section of ventral root; at C, section of dorsal root. 1. The spinal ganglion, cut in longitudinal section. 2. Transverse section of segment. 3. Plane of longitudinal section of the segment.

presented in tables 67 and 68 in which the body weight groups are reduced to four.

The ratios here given show that the increase in the diameters of the fibers has been nearly the same in all three cases. The increase of the spinal ganglion cells in diameter follows that of their fibers, while in the case of the ventral horn cells, the increase is much less than that of the ventral root fibers—as the growth in these cells is slight after puberty.

Thus within the limits here taken the ganglion cells continue to increase in diameter with the growth of the rat, while the fibers arising from them increase slightly more.

The enlargement of the ganglion cells is accompanied by a relative overgrowth of the cytoplasm. A study of the volume of these cells shows it to increase in proportion to the area of the skin to which the fibers are distributed—and the area of

TABLE 67

Comparing the diameters of the spinal ganglion cells in albino rats of different sizes with the diameters of the corresponding dorsal root fibers and of the fibers just distal to the ganglion. In the last two columns are given the respective ratios. Data condensed from tables 2 and 3 (*loc. cit.*)

AVERAGE BODY WEIGHT	AVERAGE AGE	AVERAGE DIAMETERS OF NERVE CELLS IN SPINAL GANGLION	AVERAGE DIAMETERS OF DORSAL ROOT FIBERS AT (C)	AVERAGE DIAMETERS OF FIBERS DISTAL TO THE GAN- GLION AT (A)	RATIOS	
					C:Sp. G.	A:Sp. G.
<i>grams</i>	<i>days</i>	$\mu$	$\mu$	$\mu$		
29.0	24	23.5	10.8	10.7	1:2.18	1:2.20
85.1	56	29.8	13.0	12.9	1:2.29	1:2.31
149.2	105	33.4	15.7	15.8	1:2.13	1:2.11
264.2	267	38.1	18.3	18.1	1:2.08	1:2.10
Ratios.....		1:1.6	1:1.7	1:1.7		

TABLE 68

Comparing the computed diameters of the spinal cord cells in albino rats of different sizes with the diameters of the corresponding ventral root fibers. In the last column are given the ratios. Data condensed from tables 2 and 6 (*loc. cit.*)

AVERAGE BODY WEIGHT	AVERAGE AGE	AVERAGE DIAMETERS OF SPINAL CORD CELLS, MEAN FROM TRANSVERSE AND LONGITUDINAL SECTIONS	AVERAGE DIAMETER OF VENTRAL ROOT FIBERS AT (B)	RATIOS
				B:Sp. C. C.
<i>grams</i>	<i>days</i>			
29.0	24	24.5	10.7	1:2.29
85.1	56	27.9	12.7	1:2.20
149.5	105	29.4	15.5	1:1.90
264.8	267	29.2	18.2	1:1.60
Ratios.....		1:1.2	1:1.7	

the axes of the afferent fibers also increases in proportion to the increase of skin area.

The growth of large ventral horn cells is comparatively slight and the nucleus-plasma relation remains nearly constant—but



the area of the axones of the ventral root fibers increases with the increase in the mass of muscle innervated (*loc. cit.*).

*Axis sheath relation.* In the case of the fibers in the ventral spinal roots, the dorsal roots and the seventh nerve, the percentage area of the axis, determined by the method of diameters, is shown in table 69. In all three localities the values are similar. They increase slightly after 24 days of age but after puberty approximate 50 per cent. These results agree with those previously obtained by Dunn ('12) when the relations at like ages are compared.

TABLE 69

*Giving the areas of nerve fibers and their axes in square micra—also the percentage of the total area occupied by the axis, based on groups of three*

AVERAGE BODY WEIGHT	AGE	VENTRAL ROOT FIBERS			DORSAL ROOT FIBERS			IN THE SEVENTH CERVI- CAL DISTAL TO THE SPINAL GANGLION		
		Areas		Per cent area of axis	Areas		Per cent area of axis	Areas		Per cent area of axis
		Ent. F.	Axis		Ent. F.	Axis		Ent. F.	Axis	
<i>grams</i>	<i>days</i>									
29.0	24	89.9	36.3	40	91.6	37.4	41	89.9	36.3	40
85.1	56	126.6	51.5	41	132.7	56.7	43	130.6	56.7	43
149.2	105	188.6	91.6	48	193.5	88.3	46	196.0	89.9	46
264.2	267	260.0	126.6	49	262.9	141.0	53	257.2	134.7	52

*Sympathetic.* In the course of a study intended primarily to determine whether the small myelinated fibers in the spinal accessory could be regarded as representing the fibers of the rami communicantes, Roth ('05) in a series of cervical nerves, counted on one side the number of myelinated fibers  $4 \mu$  or less in diameter, and in the corresponding ramus communicans he also counted the myelinated fibers of like size. His findings are given in table 70.

In the standard strain of the albino rat from The Institute the cell bodies in the superior cervical sympathetic ganglion grow rapidly for the first twenty-five days after birth—then more slowly. After puberty the cells are slightly larger in the female (Ping, '21)—table 71.

In the inbred strain (Dr. King) the size of both the cells and the nuclei was slightly greater in the female. On the other hand while the nuclei are but little smaller than in the standard strain, the cells have but 80 per cent of the diameter and therefore only half the volume of those in the standard strain. The nucleus-plasma ratio is correspondingly reduced.

*Technical methods.* To determine the effects of various fixatives on the brain of the rat, King ('10) carried through a series of weighings of mature rat brains which had been subjected to the action of various fixatives. A summary of his results is given in table 72.

TABLE 70

NERVE	MYELINATED FIBERS LESS THAN 4 $\mu$ IN DIAMETER IN VENTRAL ROOT		MYELINATED FIBERS LESS THAN 4 $\mu$ IN RAMUS COMMUNICANS
	Rat I	Rat II	
2nd cervical.....	130	168	None
3rd cervical.....	105	126	None
4th cervical.....	380	363	195
5th cervical.....	432	449	220

The solution of Ohlmacher ('97), the formula for which is as follows:

Absolute alcohol, 80 parts.

Chloroform, 15 parts.

Glacial acetic acid, 5 parts.

Corrosive sublimate to saturation (about 20 per cent) was found to give excellent results with the cells of the cerebral cortex.

In a later study King ('13 a) followed in some detail the effects of formaldehyde on the brain of the Albino. The conclusions reached were as follows:

1. A 4 per cent solution of formaldehyde causes a pronounced swelling in the brains of rats of all ages.

2. A solution of formaldehyde undergoes some chemical change on standing, since a solution five months old causes less swelling in the brain of the rat than does a freshly made solution.

TABLE 71

*Computed diameters of the largest cells and nuclei—on body weight—together with the nucleus plasma ratios—from the superior cervical sympathetic ganglion of the albino rat (standard strain)*

SEX	A	B	C	D	E	F NUCLEUS PLASMA RATIOS
	AGE	BODY WEIGHT	BODY LENGTH	Computed diameter in $\mu$		
				Cell	Nucleus	
	<i>days</i>	<i>grams</i>	<i>mm.</i>			
$\sigma_1$	1	5.6	50	19.5	11.4	1: 4.0
$\sigma_1$	1	6.3	51	19.8	10.2	1: 6.3
$\sigma_1$	5	9.0	63	22.1	10.7	1: 7.8
$\sigma_1$	5	11.0	65	21.3	10.5	1: 7.3
$\sigma_1$	11	14.0	73	26.4	13.1	1: 7.2
$\sigma_1$	11	15.0	77	24.9	13.1	1: 5.8
$\sigma_1$	29	16.4	82	24.8	12.2	1: 6.8
$\sigma_1$	16	18.9	83	25.3	13.1	1: 6.2
$\sigma_1$	16	19.0	81	23.1	11.2	1: 7.7
$\sigma_1$	25	23.8	93	26.6	12.6	1: 8.4
$\sigma_1$	25	25.5	95	27.3	12.7	1: 8.9
$\sigma_1$	20	29.5	99	23.6	11.8	1: 7.0
$\sigma_1$	20	31.7	102	26.4	12.5	1: 8.0
$\sigma_1$	29	40.7	112	27.1	12.0	1:10.5
$\sigma_1$	42	43.5	105	27.2	13.2	1: 7.7
$\sigma_1$	48	49.7	120	27.0	13.1	1: 7.7
$\sigma_1$	60	51.6	124	27.2	13.2	1: 7.7
$\sigma_1$	62	53.8	117	27.1	13.1	1: 7.8
$\sigma_1$	42	61.4	129	27.0	13.4	1: 7.2
$\sigma_1$	81	63.3	128	27.4	13.3	1: 7.5
$\sigma_1$	88	73.0	135	29.2	13.2	1: 9.8
$\sigma_1$	80	83.7	142	26.6	12.8	1: 7.9
$\sigma_1$	250	98.0	160	30.6	14.2	1: 9.0
$\sigma_1$	48	105.1	156	29.0	13.4	1: 9.1
$\sigma_1$	124	107.1	157	30.5	13.8	1: 9.8
$\sigma_1$	171	123.8	159	30.9	12.8	1:13.1
$\sigma_1$	570	127.1	169	33.4	14.3	1:11.7
$\sigma_1$	89	143.5	173	32.4	13.0	1:14.4
$\sigma_1$	124	151.1	174	27.1	13.0	1: 8.0
$\sigma_1$	540	151.3	184	30.7	13.4	1:11.0
$\sigma_1$	365	170.6	186	31.4	13.5	1:11.6
$\sigma_1$	365	186.0	203	29.6	13.5	1: 9.5
$\sigma_1$	171	198.2	192	27.0	13.1	1: 7.7
$\sigma_1$	250	230.0	207	36.8	15.4	1:12.6

TABLE 72  
Summary of data collected (King '10)

RAT NUMBER	SEX	BODY WEIGHT IN GRAMS	BODY LENGTH IN MM.	NORMAL WEIGHT OF FRESH BRAIN COMPUTED	SOLUTIONS USED FOR FIXATION	NUMBER HOURS SOLUTIONS ACTED	WEIGHT OF BRAIN IN GRAMS WHEN REMOVED FROM SOLUTION	PER CENT GAIN OR LOSS IN WEIGHT	WEIGHT OF BRAIN IN GRAMS AFTER REMAINING IN 70% ALCOHOL FOR 48 HOURS	PER CENT GAIN OR LOSS IN WEIGHT
1	♂	277	219	1.94	4% Formaldehyde . . .	48	2.5750	+33	1.5706	-19
2	♀	163	196	1.83	4% Formaldehyde . . .	48	2.8200	+54	1.6463	-10
3	♀	158	199	1.85	Formol-Müller (cold)	20	2.2437	+21	1.5537	-16
4	♀	129	183	1.78	4% Formaldehyde . . .	48	2.6778	+50	1.6577	-7
5	♀	164	188	1.80	Formol-Müller (warm) . . . . .	3	2.1880	+22	1.8711	+4
6	♂	187	198	1.85	Ohlmacher . . . . .	5	1.6100	-12	1.4471	-22
7	♀	137	184	1.78	Ohlmacher . . . . .	2	1.7389	-2	1.4099	-21
8	♂	160	190	1.81	{ Zenker . . . . .	6	1.8716	+3	1.6666	-8
					{ Müller . . . . .	48				
					{ Dahlgren . . . . .	4	1.9000	+3	1.7273	-7
9	♀	170	197	1.84	{ Müller . . . . .	48				
10	♂	182	186	1.79	Picro-formol . . . . .	4	1.7881	-0	1.4663	-18
11	♂	275	228	1.98	Ohlmacher . . . . .	6	1.8267	-8	1.6248	-18
12	♂	206	207	1.88	Ohlmacher . . . . .	2	1.6924	-10	1.5748	-16
13	♂	228	210	1.90	Ohlmacher . . . . .	4	1.5787	-17	1.4498	-25
14	♂	169	194	1.83	Ohlmacher . . . . .	3	1.5458	-16	1.4633	-20
15	♂	126	157	1.65	Ohlmacher . . . . .	3	1.3978	-16	1.3099	-21
16	♂	158	181	1.77	Ohlmacher . . . . .	3	1.4590	-18	1.4000	-21
17	♂	232	199	1.85	Ohlmacher . . . . .	3	1.6390	-11	1.4875	-20
18	♀	111	154	1.63	Zenker-formol . . . . .	1½	1.6040	-2	1.3297	-18
19	♀	106	159	1.66	Zenker (modified) . . . .	1¼	1.7451	+5	1.3167	-21
20	♂	6		0.30	Ohlmacher . . . . .	1	0.2523	-16	0.2074	-31
21	♀	6		0.29	Ohlmacher . . . . .	2	0.2489	-14	0.2011	-30
22	♂	108	156	1.64	2½% K <sub>2</sub> Cr <sub>2</sub> O <sub>7</sub> . . . . .	48	2.8445	+73	2.1409	+31
23	♂	88	163	1.68	2½% K <sub>2</sub> Cr <sub>2</sub> O <sub>7</sub> . . . . .	48	2.5594	+52	1.7518	+4
24	♂	162	187	1.79	Alcohol K <sub>2</sub> Cr <sub>2</sub> O <sub>7</sub> . . . . .	48	2.5073	+40	1.8885	+6
25	♂	190	207	1.88	Alcohol K <sub>2</sub> Cr <sub>2</sub> O <sub>7</sub> . . . . .	48	2.8169	+50	2.1797	+16
26	♂	174	184	1.78	Weak alcohol . . . . .	27	1.7753	-00	1.6201	-9
27	♂	168	191	1.81	Alcohol-formol . . . . .	24	1.6392	-10	1.5147	-16
28	♂	221	198	1.85	95% Alcohol . . . . .	24	1.4418	-22	1.4611	-21
29	♂	151	184	1.78	Sublimate-acetic . . . . .	1½	1.8604	+5	1.4484	-19
30	♂	213	202	1.86	Carnoy's fluid . . . . .	3	1.8192	+2	1.4077	-24
31	♂	181	194	1.82	Carnoy's fluid . . . . .	4	1.7575	-3	1.3042	-23
32	♀	141	178	1.75	Graf (5% formalin) . . . .	2½	2.1520	+23	1.7421	-00
33	♂	165	191	1.81	Graf (10% formalin) . . . .	1½	1.9283	+7	1.5994	-12
34	♀	149	184	1.77	Carnoy's fluid . . . . .	19	1.7416	-2	1.3110	-28

TABLE 72—Concluded

RAT NUMBER	SEX	BODY WEIGHT IN GRAMS	BODY LENGTH IN MM.	NORMAL WEIGHT OF FRESH BRAIN COMPUTED	SOLUTIONS USED FOR FIXATION	NUMBER HOURS SOLUTIONS ACTED	WEIGHT OF BRAIN IN GRAMS WHEN REMOVED FROM SOLUTION	PER CENT GAIN OR LOSS IN WEIGHT	WEIGHT OF BRAIN IN GRAMS AFTER REMAINING IN 70% ALCOHOL FOR 48 HOURS	PER CENT GAIN OR LOSS IN WEIGHT
35	♀	167	189	1.80	Lang's fluid.....	20	2.0670	+15	1.6794	-7
36	♂	208	203	1.86	Lang's fluid.....	4	2.0429	+10	1.7970	-3
37	♀	173	194	1.82	Marina's fluid.....	72	1.2219	-33	1.2913	-20
38	♂	197	201	1.86	Marina's fluid.....	96	1.2146	-35	1.2546	-33
39	♂	259	214	1.92	Cor. sublimate.....	4	2.0760	+8	1.4695	-23
40	♂	177	195	1.83	Cor. sublimate.....	20	2.0229	+11	1.4087	-23
41	♂	265	216	1.92	Sublimate-formol....	4	2.3315	+21	1.6565	-14
42	♂	213	203	1.86	NaCl + sublimate...	4	1.9927	+7	1.3947	-25
43	♀	213	204	1.86	Tellyesniczky.....	48	1.9643	+6	1.6372	-12
44	♀	137	177	1.74	Tellyesniczky.....	24	1.7981	+3	1.4906	-14
45	♂	196	200	1.85	NaCl + sublimate...	20	2.1549	+16	1.5074	-19
46	♀	135	179	1.75	Sublimate-formol....	20	2.0512	+17	1.3687	-22
47	♂	141	179	1.75	Cox (osmic).....	48	1.9917	+2	1.5483	-12
48	♂	150	182	1.76	Cox (osmic).....	72	2.1555	+22	1.8365	+4
49	♂	171	192	1.81	Cox (formol-acetic)..	48	1.7687	-2	1.5003	-17
50	♂	137	178	1.75	Cox (formol-acetic)..	72	1.8944	+8	1.5221	-13

3. A 4 per cent solution of formaldehyde neutralized with  $\text{Na}_2\text{CO}_3$  produces a much greater amount of swelling in the brain of the rat than does a solution that has a faintly acid reaction.

4. A strong neutralized solution of formaldehyde causes a greater percentage weight increase in the rat's brain than does a weak neutralized solution. A reverse result is obtained when the solutions are not neutralized.

5. If rats' brains are subjected to the action of a solution of formaldehyde that is kept at a constant temperature of  $36^\circ\text{C}$ ., they undergo a greater amount of swelling than is produced when the solution is kept at a temperature of 8 to  $11^\circ\text{C}$ . The maximum weight increase in the brains is reached by the end of the first day in the former case, and not until the third day in the latter case.

6. When the conditions under which the solution acts are uniform, the maximum weight increase in rats' brains subjected to the action of a 4 per cent solution of formaldehyde is attained in all cases by the third day, and there is then a gradual decrease in weight. Brains of very young animals tend to reach the maximum earlier than do those of older animals.

7. The percentage weight increase in rats' brains as the result of the action of a 4 per cent formaldehyde solution tends to be greater in the brains of young animals than in those of adults.

TABLE 73

*Percentage weight increase in rats' brains, each kept for ten weeks in 40 cc. of a neutralized solution of 4 per cent formaldehyde made five months before the experiments began (averages for three brains at each age)*

TIME SOLUTION ACTED	AGE OF RATS							
	New-born	10 days	20 days	40 days	50 days	70 days	100 days	200 days
1 day.....	29.7*	28.8	25.0	25.2	26.9*	24.5	28.3*	15.3
3 days.....	28.0	35.0*	28.3*	26.3*	26.8	27.3*	26.8	21.0*
7 days.....	27.3	33.0	27.3	25.0	25.1	25.1	25.7	18.6
2 weeks.....	23.9	31.9	27.3	24.5	25.1	25.3	26.3	18.9
3 weeks.....	23.4	31.4	28.3	24.9	25.5	24.4	25.3	19.3
4 weeks.....	22.5	30.5	26.7	24.5	24.8	25.6	26.2	19.4
10 weeks.....	17.6	27.9	26.9	24.7	25.2	25.6	25.0	19.2
Average percentage gain..	24.6	31.2	27.1	25.0	25.6	25.4	26.2	18.8

\* Maximum weight increase.

TABLE 74

*Percentage weight increase in rats' brains, each kept for ten weeks in 40 cc. of a neutralized solution of 4 per cent formaldehyde made at the time the experiments began (averages for three brains at each age)*

TIME SOLUTION ACTED	AGE OF RATS							
	New-born	10 days	20 days	40 days	50 days	70 days	100 days	200 days
1 day.....	44.4*	58.2	39.5	37.9*	39.3*	34.4	45.6*	32.4
3 days.....	42.0	64.6*	41.5*	37.6	38.5	38.6*	43.1	34.7*
7 days.....	41.5	62.1	40.1	36.4	35.6	34.1	41.1	30.9
2 weeks.....	38.0	62.9	39.7	35.9	36.1	34.9	41.0	30.8
3 weeks.....	37.7	63.4	40.0	35.7	36.9	34.3	40.4	31.2
4 weeks.....	36.1	62.8	39.9	35.5	35.4	35.7	40.5	31.6
10 weeks.....	33.9	61.4	39.4	35.5	36.1	35.5	37.7	31.8
Average percentage gain..	39.1	62.2	40.0	36.4	36.7	35.4	41.3	31.9

\* Maximum weight increase.

8. In animals of the same age the larger brain does not show a greater percentage weight increase after treatment with a solution of formaldehyde than does the smaller one.

9. A 4 per cent solution of formaldehyde extracts solids from the brains of rats of all ages. This is shown by the fact that the percentage

of solids in brains that have been subjected to the action of such a solution is always less than that found in the fresh brains of animals of the same age. Brains of very young rats lose much more of their solids than do brains of older animals.

TABLE 75

*Percentage weight increase in rats' brains, each kept for four weeks in 40 cc. of a neutralized solution of 4 per cent formaldehyde made fresh for each lot of animals killed (averages for two brains at each age)*

TIME SOLUTION ACTED	AGE OF RATS							
	New-born	10 days	20 days	40 days	50 days	70 days	100 days	200 days
1 day.....	60.4	54.7	45.8	47.6*	50.4*	44.9	44.2*	36.1
3 days.....	65.8*	58.5*	52.9*	47.4	47.7	48.8*	42.7	40.1*
7 days.....	65.4	58.5	48.3	45.6	45.1	44.2	38.3	36.2
2 weeks.....	65.1	58.4	48.9	45.3	44.8	43.2	38.6	33.0
3 weeks.....	64.8	58.2	48.9	44.7	45.2	43.9	38.8	34.7
4 weeks.....	61.7	57.8	50.4	45.1	45.4	44.9	39.3	34.9
Average percentage gain..	63.4	57.7	49.2	45.9	46.4	44.8	40.3	35.8

\* Maximum weight increase.

TABLE 76

*Percentage weight increase in rats' brains, each kept for four weeks in 40 cc. of non-neutralized solution of 4 per cent formaldehyde made fresh for each lot of animals killed (averages for two brains at each age)*

TIME SOLUTION ACTED	AGE OF RATS							
	New-born	10 days	20 days	40 days	50 days	70 days	100 days	200 days
1 day.....	34.5*	37.3	36.7	39.7*	44.2*	39.5	41.1*	32.2
3 days.....	18.6	45.1*	45.4*	39.1	42.8	42.3*	39.4	35.4*
7 days.....	9.9	37.8	38.2	35.6	38.1	34.3	33.8	30.2
2 weeks.....	3.5	30.4	34.6	31.5	32.6	31.5	29.0	26.7
3 weeks.....	0.4	25.9	30.7	28.3	30.6	29.5	27.4	24.5
4 weeks.....	-1.5	23.5	27.9	26.6	27.8	27.3	24.3	24.5
Average percentage gain..	13.1	33.3	35.6	33.5	36.0	34.1	32.5	28.9

\* Maximum weight increase.

10. Brains of animals infected with pneumonia show a slightly greater percentage weight increase when treated with a 4 per cent solution of formaldehyde than for the brains of healthy animals.

11. Even under the most favorable conditions an aqueous solution of formaldehyde is not a satisfactory fixative for the cell structures in

brain tissues, as it causes a pronounced distention of the nuclei and gives a poor preservation of the nuclear contents.

The more important data are given in tables 73, 74, 75, 76, 77.

TABLE 77

*The percentage of solids in brains of rats of various ages kept from four to eighteen weeks in solutions of 4 per cent formaldehyde (computations made from original brain weights)*

EXPERIMENTS	AGE OF RATS							
	New-born	10 days	20 days	40 days	50 days	70 days	100 days	200 days
Brains kept 18 wks. in neutralized stock solutions.	8.1	10.3	14.7	18.4	19.4	19.5		20.9
Brains kept 10 wks. in sol. 5 mos. old.....	8.1	10.1	16.5	19.4	19.4	20.5	19.7	20.5
Brains kept 10 wks. in freshly made sol.....	7.8	10.3	16.0	19.2	19.5	20.1	20.1	21.6
Brains kept 4 wks. in 40 cc. neutral sol.....	8.2	10.1	16.4	19.3	19.6	19.6	20.9	21.8
Brains kept 4 wks. in 40 cc. acid sol.....	9.6	10.9	16.7	19.3	19.1	20.7	20.1	21.1
Brains kept 4 wks. in 20 cc. neutral sol.....	9.2	9.8	16.2	19.7	20.5	19.9	20.2	21.5
Brains kept 4 wks. in 20 cc. acid sol.....	10.5	10.9	16.3	19.0	20.0	20.1	20.8	21.6
Brains kept 4 wks. in neutral sol. at temp. 26°C.	9.7	9.8	15.1	18.7	19.4	19.8	20.1	20.1
Brains kept 4 wks. in neutral sol. at temp. 8 to 11°C.....	8.3	10.6	16.3	19.2	19.0	20.1	20.1	21.7
Averages for above series.	8.6	10.6	16.3	19.2	19.6	20.1	20.3	21.2
Normal percentage of solids in rats' brains (Donaldson).....	12.2	14.6	17.5	19.5	20.9	21.1	21.3	21.6
Percentage loss of solids as result of action of formaldehyde.....	29.5	29.4	7.4	1.5	6.2	4.7	4.7	1.8

*Swelling reactions.* To determine whether slight changes in the composition of the brain could be detected by a swelling reaction, Plant ('19) tested the effect of Müller's fluid (containing 2.5 per cent potassium bichromate plus one per cent sodium sulphate). A brain immersed in this solution not only hardens,



but undergoes a regular change in weight and volume. The average percentage gain of each pair of brains in an age group at five intervals up to 75 days is given in table 78.

These data show a rapid increase in weight at seven days, followed by a slow steady loss of such a nature that after 75 days in the fluid the weight of the brain is from 23 to 35 per cent more than when fresh. Age is the main condition which

TABLE 78

*Percentages of gain of pairs of albino rat brains in Müller's fluid arranged according to age and weighed at intervals from twenty-four hours to seventy-five days*

SEX	AGE	INITIAL WEIGHT		AVERAGE PERCENTAGES OF GAIN OF BOTH BRAINS IN MÜLLERS FLUID				
		1	2	24 hours	7 days	14 days	30 days	75 days
		<i>grams</i>	<i>grams</i>					
♀	52	1.465	1.368	19.0	28.2	26.2	23.5	22.9
♀	55	1.615	1.578	20.8	32.1	28.1	26.8	25.4
♂	57	1.757	1.671	20.6	31.2	26.0	25.9	25.7
♂	59	1.635	1.519	21.2	33.1	29.9	27.0	26.7
♂	61	1.834	1.715	18.0	32.2	28.0	25.9	25.0
♀	61	1.699	1.581	20.0	29.5	27.3	24.1	23.0
♂	62	1.490	1.477	18.6	31.8	28.3	25.3	24.4
♂	62	1.662	1.656	19.3	28.2	24.6	23.1	22.7
♀	62	1.497	1.496	20.5	31.7	29.1	25.7	25.3
♂	62	1.831	1.699	20.8	32.8	30.8	28.0	27.8
♀	64	1.677	1.606	20.9	32.0	28.6	26.2	25.7
♂	67	1.651	1.587	21.7	32.6	29.7	26.6	26.4
♀	72	1.610	1.492	27.6	33.6	30.7	27.9	26.7
♂	160	1.791	1.752	25.1	37.2	35.8	32.8	32.2
♂	218	2.008	1.824	28.3	40.0	38.6	35.7	34.6

modifies this reaction. The brains of the older rats gain more and retain a greater gain at 75 days. The initial weight of the brain also affects the result, since at like age the lighter brain gains more during the early part of its stay in Müller's fluid, but this difference tends to disappear later.

The increase in the weight of the brain is due mainly to the taking up of water, but the percentage of salts deposited in the fixed tissues is much greater than that in the fixing solution. The increase of the myelin with age explains some of the differences here observed.

*Myelin formation.* Using the data in table 74 (Donaldson '15, "The Rat") Sugita ('17) has computed the weight of the dry substance in the brain of the Albino according to brain weight. The relations found are given in the solid graph in chart 13. As this shows, a period of relatively rapid increase in the solids occurs when the brain weight of 0.95 grams is reached and continues up to about 1.35 grams. These brain weights correspond to 11 and 33 days respectively. When a

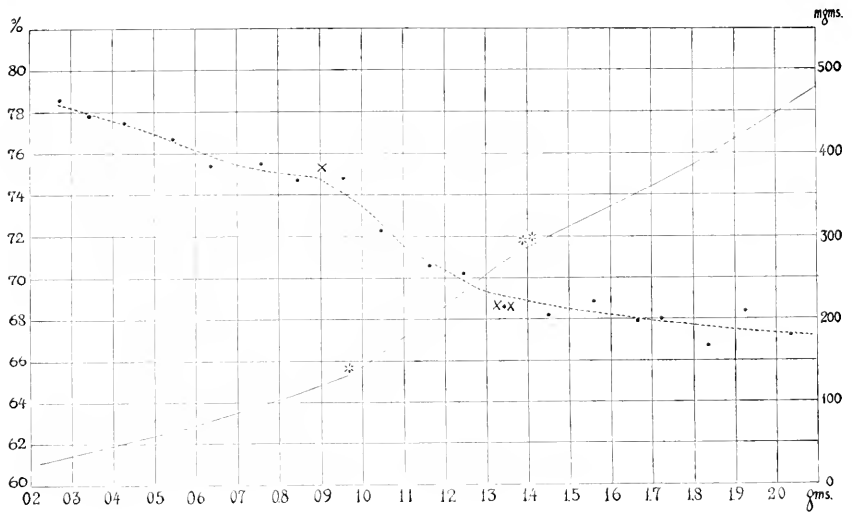

Chart 13 The dotted line shows the ratio between the initial brain weight and the weight after its dehydration and extraction in 80 per cent alcohol (for twenty-four hours) and 90 per cent alcohol (for twenty-four hours) according to a uniform procedure, plotted on the brain weight. The data were taken from table 79. The graph was drawn connecting the middle points of each pair of entries.  $\times$  and  $\times\times$  indicate the turning points in the graph.

The solid line shows the absolute weight of the solids in the brain according to the brain weight. The data were taken from table 74 in 'The Rat' (Donaldson, '15) and calculated by me. \* and \*\* indicate the turning points in the graph.

For the ratios of brain weight the scale is given on the left side of the chart and for the absolute weight of the solids the scale is given on the right side.

series of albino brains of different ages are extracted with 80 per cent alcohol for 24 hours, followed by 90 per cent alcohol for 24 hours, and the moist brain weight after treatment in deter-

mined, Sugita ('18) finds a progressive loss in weight with advancing age as indicated by the ratio to the initial brain weight—table 79, chart 13. These data show that the period of most rapid extraction approximately coincides with the period of

TABLE 79

*Giving for each brain-weight group of the normal albino rat the average initial brain-weight in the fresh condition and the brain weight after dehydration and extraction in 80 per cent alcohol (for twenty-four hours) and 90 per cent (for twenty-four hours) by a uniform procedure. The ratio of the final brain weight to the initial weight is given in the last column as a percentage value. Based on observation on 120 albino rats, sexes combined.*

BRAIN-WEIGHT GROUP	NUMBER OF CASES	BRAIN WEIGHT WHEN FRESH	BRAIN WEIGHT AFTER DEHYDRATION IN 80 AND 90 PER CENT ALCOHOL	RATIO TO THE INITIAL BRAIN WEIGHT
		<i>grams</i>	<i>grams</i>	<i>per cent</i>
II (birth)	6	0.271	0.213	78.6
III	8	0.343	0.267	77.8
IV	9	0.428	0.332	77.5
V	14	0.543	0.416	76.7
VI	5	0.636	0.479	75.4
VII	4	0.755	0.571	75.7
VIII	10	0.844	0.630	74.7
IX (10 days)	5	0.954	0.714	74.8
X	6	1.047	0.757	72.3
XI (20 days)	5	1.161	0.820	70.6
XII	5	1.245	0.874	70.2
XIII	8	1.341	0.921	68.6
XIV	5	1.449	0.989	68.2
XV	7	1.558	1.074	68.9
XVI	8	1.667	1.131	67.9
XVII	6	1.721	1.170	68.0
XVIII (90 days)	5	1.832	1.222	66.7
XIX	1	1.924	1.317	68.4
XX	3	2.037	1.369	67.2

most rapid increase in solids. As the substances extracted are largely the alcohol soluble lipoids, such as appear in the myelin sheaths, it is inferred that the interval between 11 and 33 days is one in which a rapid formation of the myelin sheaths occurs in the brain.

In his studies on myelination in the nervous system of the rat, Watson ('03) found the first evidence of myelin formation

shortly after birth—in the cervical region of the spinal cord. Myelin sheaths appear next in the cerebellum and finally in the cerebrum at about 11 days. His results are given in tabular form in table 79 a. It may be noted that the beginnings of myelination in the cerebrum as determined histologically, coincide with the beginning of the rapid increase in solids determined in other ways.

TABLE 79A  
*Order of myelination in the nervous system of the rat—Watson ('03)*

DIVISIONS	MYELINATION BEGINS:			RAPIDITY OF MYELINATION PROCESS
	Cervi- cal region	Tho- racic region	Lum- bar region	
Spinal cord				
	<i>days</i>	<i>days</i>	<i>days</i>	
Funiculus ventralis.....	2	3	3	Rapid
Funiculus lateralis.....	2	3	3-6	Rapid
Ventral roots				
Extra medullary.....	2	3	3	Very rapid
Intra medullary.....	8	8	8	Rapid
Funiculus dorsalis				
Fasiculus cuneatus.....	3	3	4-6	Rapid
Fasiculus gracilis.....	4-6	3	6	Slow
Pyramidal tract.....	6	10	11	Very slow
Dorsal roots				
Extra medullary.....	3	3	4-6	Slow
Intra medullary.....	8	8	8	Slow
Cerebellum				
	MYELINATION BEGINS:			
	<i>days</i>			
In stem of central white substance.....	8			Development more rapid than in the cerebrum
In laminae: Caudal and Dorsal.....	11			At 15, 16 and 17 days fibers reach the granular layer
In laminae: Cephalic.....	13			
In laminae: Lobus noduli.....	14			

TABLE 79A—*Continued*  
*Order of myelination in the nervous system of the rat—Watson ('03)*  
 Cerebrum

	MYELINATION BEGINS:	
	<i>days</i>	
Capsula externa.....	11	Rapid
Fibrae longitudinales dorsales.....	13	Slow
Stria olfactoria lateralis.....	14	Very rapid
Corpus striatum.....	14	Rapid
Corpus callosum.....	14	Very slow until after the 24th day
Radiations into the cortex.....	14	Development ex- tremely slow
Commissura anterior.....	17	Very slow until after the 24th day
Thalamus.....	17	Slow
Zonal layer.....	(?) (but certainly not before the 42nd day)	

7. *Sense organs. Eye.* Collins ('22) has given a few measurements on the eyeball, cornea and the lens of the rat—table 80.

TABLE 80  
*Measurements on the eye*

	DIAMETERS IN MILLIMETERS	
	Antero-posterior	Lateral
Eyeball.....	5.5	5.5
Cornea.....	Lateral	Vertical
	5.0	5.0
Lens.....	Antero-posterior	Lateral
	4.0	4.5

TABLE 81  
*Common rat—mature cochlea*

NUMBER OF TURNS IN COCHLEA	SLANT HEIGHT OF COCHLEA	DIAMETER OF SECOND WHORL	DIAMETER OF LOWEST WHORL	MAJOR AXIS OF OVAL WINDOW	LONGEST DIAMETER OF VESTIBULE	EXTREME LENGTH OF LABYRINTH
	<i>mm.</i>	<i>mm.</i>	<i>mm.</i>	<i>mm.</i>	<i>mm.</i>	<i>mm.</i>
2 $\frac{1}{4}$	2.75	1.75	2.5	1.0	2.0	5.25

TABLE 82

Summary table giving the fundamental measurements. The values are in micra, usually rounded, except in one instance where they are in degrees—Wada ('23)

Age in days.....	1	3	6	9	12	15	20	100	546
Body weight, grams.....	5	8	11	10	13	13	29	112	255
Body length, mm.....	48	56	63	58	70	75	95	159	213
Radial distance between spiral ligaments— $\mu$ (table 2)									
a I-II.....	1410	1560	1650	1635	1640	1655	1645	1663	1680
b III-IV.....	925	1025	1175	1225	1233	1235	1250	1270	1265
Average.....	1168	1293	1413	1430	1437	1445	1448	1467	1473
Radial distance between labium vestibulare and habenula perforata.....	115	114	115	118	117	122	122	122	119
Breadth of membrana basilaris (table 9)									
Inner zone.....	49	63	77	79	88	87	86	92	94
Outer zone.....	75	94	105	111	100	102	106	106	113
Total.....	124	154	182	190	188	189	193	198	207
Breadth of membrana tectoria (table 4)									
Inner zone.....	37	94	105	123	126	124	129	132	133
Outer zone.....	140	134	154	158	157	160	162	162	163
Total.....	177	228	259	281	283	284	291	294	295
Thickness (table 4).....	12	32	32	27	25	28	38	36	34
Distance from hab. perf. to foot of inner pillar (table 15).....	22	27	0	0	0	0	0	0	0
From hab. perf. to outer corner of inner pillar.....	30	38	43	42	22	18	15	14	15
Distance between the inner and outer pillars.....	10	12	18	18	42	48	58	63	63
Distance from hab. perf. to the inner corner of the outer pillar.....	40	50	61	60	63	67	72	77	78
Basal width of inner pillar (table 19).....	—	—	29	31	21	19	15	14	15
Basal width of outer pillar (table 29).....	—	—	14	18	21	20	14	15	16
Greatest height of greater epithelial ridge (table 38).....	66	53	40	40	15	50	58	55	53
Height from basal plane to surface of pillar cells (table 46).....	37	29	30	34	47	51	62	60	59
Length of inner pillar without head (table 61).....	29	25	36	39	40	43	52	49	49
Length of outer pillar without head (table 61).....	28	23	31	34	51	54	62	59	59
Height of tunnel of Corti (table 49).....	—	—	—	—	35	38	47	47	44
Length of inner hair cells.....	26	24	27	30	33	33	31	28	29
Diameters of nuclei (table 68).....	8.1	8.3	8.3	8.5	7.7	7.6	7.4	7.0	6.6
Length of outer hair cells.....	19	18	22	22	23	26	26	26	26
Diameters of nuclei (table 68).....	7.8	8.2	8.1	8.1	6.9	6.9	6.8	6.2	6.2
Height of papilla spiralis at third series of outer hair cells (table 52).....	34	24	24	28	50	58	69	67	64
Total length of Deiters' cells (table 89).....	27	26	32	36	61	66	72	75	78
Height of Hensen's supporting cells (table 55).....	35	21	20	23	51	60	75	83	86
Angle of lam. retic. with membr. basil. in degrees (table 58).....	—	—	—	—	10	13	13	15	17
Spiral ganglion (table 95).....									
Diameter—cells.....	10.5	11.5	12.9	13.6	13.8	14.9	18.1	16.9	16.9
Diameter—nuclei.....	7.9	8.0	8.4	8.5	8.5	8.7	10.2	9.5	9.4
Vestibular ganglion (table 115)									
Diameter—cells.....	20.3	22.9	23.0	23.9	23.9	23.9	24.1	24.7	25.3
Diameter—nuclei.....	11.7	12.0	11.9	12.0	12.1	12.0	11.9	12.3	12.2

The length, weight or age of the animals used are not given—the significance of the measurements therefore lies in the relations which are shown, rather than in the absolute values, though these probably apply to a full grown animal.

*Ear.* Gray ('07) gives the measurements on the mature cochlea as in table 81.

Wada ('23) has made an elaborate study of the growth of the cochlea at nine ages from birth to middle life. A summary of the fundamental measurements is given in table 82. In this summary the tables referred to are those in the original Memoir.

Wada found one rat in a litter of five which responded to auditory stimuli at nine days. The tunnel of Corti in this rat was open, while in the non-hearing litter mate, it was closed. The cell bodies in the ganglion spirale were still much below the size which they finally attain—see table 82.

TABLE 83  
*Area of skin in albino rat—Hill and Hill ('13)*

BODY WEIGHT = <i>W</i> .	AREA OF SKIN = <i>S</i> .	$S/W^{2/3}$
<i>grams</i>	<i>cm.</i> <sup>2</sup>	
50.5	131.0	9.60
62.0	162.5	10.37
76.0	171.5	9.56
82.0	194.0	10.27
129.0	251.0	9.86

#### 8. *Integument.* Myers ('21) reports as follows:

The deposit of the subcutaneous fat is most marked in the neighborhood of the milk ducts—formed and prospective. From birth to ten weeks of age, the subcutaneous fat is distributed in the same manner in both male and female rats. We believe the deposit serves as a protection against cold and as a reserve food supply. The absence in the rat of a uniformly distributed layer of protective fat may be related to the early development of hair and to the habit of living in closed spaces. In rats underfed from birth, the deposit of subcutaneous fat becomes scanty, and the development of the milk ducts is retarded.

The absolute area of the skin has been measured in square centimeters by Hill and Hill ('13) in five rats. The values are given in table 83.

The area of skin divided by (body weight, grams)<sup>2/3</sup> gives values ranging from 9.56–10.37 with a mean of 9.93. The authors conclude that the area of skin in square centimeters may be expressed approximately by (body weight, grams)<sup>2/3</sup> × 10.

*Hair.* The arrangement of the hairs is reported by E. C. Greene ('24 MS.) as follows:

The hairs on the albino rat, over the greater part of the body, are arranged in groups of nine, made up of three small groups in a row, each containing three hairs growing very close together. One hair of the middle group is coarse and corresponds to the spine in related forms. The others are fine. The hair pattern shows parallel rows with the groups of one row alternating with the groups of the next row.

In the region of the upper lip and nose the bristles are developed as long vibrissae, growing in five or six parallel rows running from the nose backwards along the upper lip. The number in a row varied from five to ten. Some of the vibrissae are longer than the whole head of the animal.

In addition to the vibrissae in the region of the nose, there are a few others, usually three just above the eye, another slightly posterior and a little below the outer corner of the eye, and two more near the corner of the mouth.

The eyelashes are very fine and short.

The palms and soles are devoid of hair but the backs of the paws are sparsely covered with short thin hair.

The hairs on the tail are reduced to three rather short bristles emerging from under the edge of each scale.

On the tip of the scrotal sac the hair is sparse and fine.

The scales on the tail are arranged in rings and of these there may be as many as 260 in large specimens. Sweat glands are present on the soles and palms—Römer (96).

9. *Thoracic and abdominal viscera.* For the combined weights of the several viscera see tables 153–156 and chart 49 (Nos. 1–21).

*Gastro-intestinal system.* In the rat both the tonsils and the gall bladder are absent. The volumes of the liver and the pancreas cells, with those of their respective nuclei, have been



determined by Morgulis ('11). The organs were fixed in Zenker's solution and imbedded in paraffin and were taken from one normal Albino—110 days old; body length 176 mm., body weight, 137.7 grams—table 84.

TABLE 84

NUMBER OF MEASUREMENTS OF CELLS	VOLUME IN $\mu^3$ OF		NUMBER OF MEASUREMENTS OF NUCLEUS	DIAMETERS OF NUCLEUS IN $\mu$
	Entire cell	Nucleus		
<i>Liver cells</i>				
100.....	5075	247.2	50	$7.56 \times 8.25$
<i>Pancreas cells</i>				
100.....	1829	94.3	40	$5.48 \times 6.00$

TABLE 85

*Volumetric data for the kidney of the albino rat at various ages. Zenker fixation; Paraffin imbedding; Stain, haematoxylin and eosin*

SEX	AGE	GROSS BODY WEIGHT	WEIGHT OF ONE KIDNEY	VOLUME OF MEDULLA IN ONE KIDNEY	VOLUME OF CORTX IN ONE KIDNEY	TOTAL NUMBER OF RENAL CORPUSCLES IN ONE KIDNEY	AVERAGE DIAMETER OF CORPUSCLES
	<i>days</i>	<i>grams</i>	<i>grams</i>	<i>cu. mm.</i>	<i>cu. mm.</i>		<i>micra</i>
F.	Newborn	5.2	0.028	3.25	9.92	{ 15,533* 10,465†	62
M.	7	10.3	0.078	6.57	19.13	{ 26,598* 19,682†	52
M.	14	11.8	0.085	14.72	29.79	24,061	53
F.	21	22.6	0.145	30.59	45.76	25,930	61
M.	49	44.6	0.249	41.35	90.43	28,583	79
F.	84	122.2	0.604	106.61	219.09	28,863	95
M.	245	207.0	0.783	130.26	374.44	28,000‡	127

\* Including renal corpuscles still in stages of formation.

† Including only fully formed corpuscles.

‡ Estimated approximately from the three preceding cases.

*Pulmonary system.* (See References: also table 146.) Miller ('19) MS. has noted the absence of cartilage in the bronchi of the rat.

10. *Uro-genital system.* See References: also tables 145, 146, 149 and 150.

*Kidneys.* Kittelson ('17) has examined the volumetric relations of the kidney at different ages, and also determined the number of renal corpuscles—table 85.

As the data show, the number of corpuscles increases from birth up to somewhere between three and seven weeks of age, after which it remains fixed—though the kidney may increase greatly in weight after this period.

The volume of the cortex is from 1.5 to 3.0 times that of the medulla, but the combined volume of these two portions represents on the average only about 50 per cent of the volume of the fresh kidney. This indicates that fixation (Zenker's fluid), with subsequent treatment, and exclusion of the capsule and pelvis have greatly reduced the measured volume. The determinations therefore represent relative rather than absolute values.

*Sex organs.* (a) Male. See tables 146, 147, and 149.

(b) Female. See tables 146 and 150.

11. *Exocrine glands.* Myers, 1916-1921, has recorded a number of observations on the structure and arrangement of the mammary glands. There are usually twelve mammary glands, six pairs, designated from the head caudad, as the 1st, 2nd and 3rd thoracic pairs, the abdominal pair and the 1st and 2nd inguinal pairs. Variations in the number of glands occur. There may be only ten or as many as fourteen. After birth there are no external indications in the male of the mammary gland areas. At birth an inguinal and a thoracic fat pad or girdle are clearly marked. These pads are similar in both sexes and are related to the loci of the mammary glands in the female (Myers and Myers, '21). The glands enlarge during the nursing period but shrink after the young are weaned. Immediately after removal of the young the glands enlarge and remain so for forty-eight hours and then return to the virgin size in from two to three weeks (Myers and Myers, '21).

12. *Endocrine system. Percentage of water.* In the normal hypophysis, thyroid and suprarenals Uno ('22) determined the percentages of water, table 86.

*Hypophysis.* Using for fixation the neutral formol—Zenker mixture of Bensley ('11) followed by paraffin imbedding, Addison ('17) has measured the diameters of the several classes of cells in the ventral glandular portion of the hypophysis of normal male albinos at various ages. The results appear in table 87.

In both the acidophile and basophile cells there is seen a cytoplasmic structure adjacent to the nucleus. This is here designated as the *macula*. It is considered by Addison ('16)

TABLE 86  
Percentages of water in the hypophysis, thyroid and suprarenals  
Male rats

AGE	BODY WEIGHT	PERCENTAGE OF WATER		
		Hypophysis	Thyroid	Suprarenals
<i>days</i>	<i>grams</i>	<i>per cent</i>	<i>per cent</i>	<i>per cent</i>
148	152	75.6	76.7	68.7
170	160	76.1	76.8	68.4
185	186	70.3 (?)	76.8	69.7

TABLE 87  
Average diameters of cells in ventral glandular portion of hypophyses of normal male albino rats at various ages; average of 10 measurements in each case

AGE	ACIDOPHILES		BASOPHILES			RESERVE CELLS
	Cell bodies	Nuclei	Cell bodies	Nuclei	Maculae	Nuclei
	$\mu$	$\mu$	$\mu$	$\mu$	$\mu$	$\mu$
<i>months</i>						
2	11.5 x 8.0	6.3 x 5.2	13.5 x 11.5	5.8 x 4.8	5.5 x 4.0	5.9 x 4.6
3	11.1 x 9.3	6.4 x 5.3	14.0 x 11.0	6.7 x 5.0	5.5 x 3.8	6.3 x 4.4
4	11.3 x 8.0	6.4 x 5.5	14.5 x 11.0	6.7 x 5.6	6.0 x 4.3	6.4 x 5.0
6	11.4 x 8.4	6.5 x 5.1	15.5 x 11.3	6.8 x 4.7	5.4 x 4.3	6.3 x 4.9
8	11.2 x 8.2	6.8 x 5.8	15.9 x 12.4	7.1 x 6.0	5.7 x 4.5	6.5 x 5.4

TABLE 88  
Average weights of the glandular and nervous lobes—in albino rats

NUMBER OF RATS	SEX	BODY WEIGHT	GLANDULAR (1)	NERVOUS (2)	RATIO OF (2) TO (1)
		<i>grams</i>	<i>mgm.</i>	<i>mgm.</i>	
5	M.	193	4.9	1.24	4.0
10	M.	229	5.6	1.24	4.5
5	F.	125	4.8	1.00	4.8
10	F.	167	6.2	1.18	5.2

to be the structure described as the Golgi apparatus. It persists after castration.

*Lobes of hypophysis.* Degener ('22) determined the weights of the lobes of the hypophysis, glandular and nervous, in the fresh state. The data are entered in table 88.

These determinations show that with increasing body weight, within each sex, the glandular lobe increases more rapidly than the nervous. As between the sexes the glandular lobe in the female is relatively larger than in the male.

*Suprarenals.* From the studies of J. C. Donaldson ('19) it appears that the left suprarenal is usually distinctly heavier than the right. The volume of the medulla relative to that of

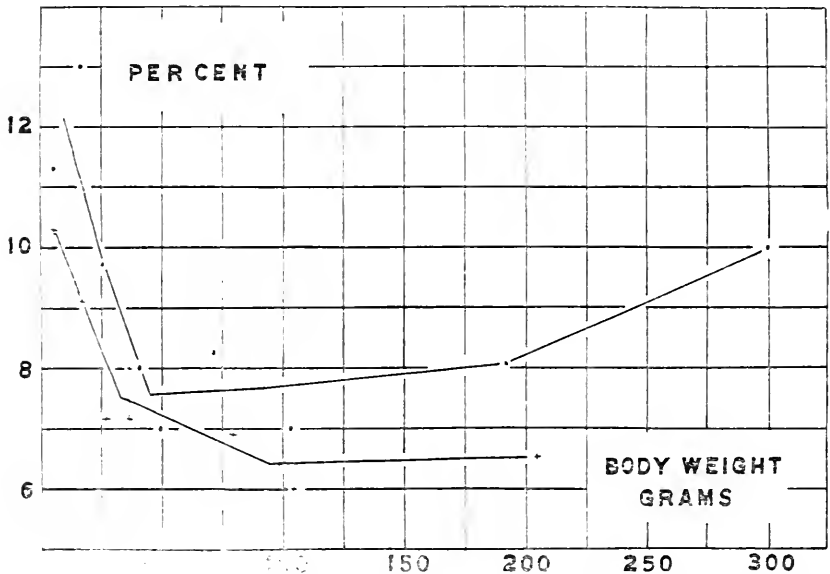

Chart 14. The change in volume of the medulla expressed as a percentage of the whole adrenal gland. Dots, •, males, individual values. Crosses, +, females, individual values.

the entire gland decreases rapidly from birth to 50–100 grams of body weight, after which it increases in the male, but remains constant in the female—chart 14.

The greater weight of the suprarenals in the female is therefore due mainly to the greater weight of the cortex.

*Thymus.* See tables 151 and 152.

*Thyroids and parathyroids.* See table 14S.

*Pancreas : Islets of Langerhans.* See table SS a.

A careful study of the number of islets of Langerhans in the pancreas has been made by M. D. Overholser (MS. '24). The

TABLE 85A

*The number of islets of Langerhans in the pancreas of the albino rat—Overholser (MS '24)*

SEX	WEIGHT	AGE	WEIGHT OF PANCREAS	TOTAL NUMBER OF ISLETS
	<i>grams</i>	<i>days</i>	<i>grams</i>	
	4.0	1		1.494
	4.5	4	0.015	1.575
	5.5	5	0.014	1.517
	6.0	2	0.012	2.002
	8.5	2	0.018	1.995
	11.5	4	0.030	2.199
	16.0	7	0.049	3.618
	17.5	14	0.035	3.417
	22.5	21	0.112	3.606
	32.5	28	0.209	9.571
	33.2	21	0.115	6.089
	40.5	17	0.086	12.628
	44.0	35	0.281	9.494
	48.0	24	0.275	8.530
	48.0	35	0.270	2.938
	49.0	28	0.295	9.090
	50.0	28	0.213	8.693
	64.0	35	0.376	9.082
	64.0	56	0.391	5.985
	64.5	49	0.388	9.784
	72.0	28	0.489	9.035
	73.0	31	0.458	6.875
	88.0	63	0.628	5.282
	109.0	40	0.620	14.579
	113.5	51	0.631	7.819
	115.0	85	0.558	8.750
	116.0	42	0.829	6.938
	118.0	58	0.832	8.329
	142.0		0.697	5.727
	144.0	80	0.678	11.126
	154.0		0.613	4.314
	164.5	70	0.599	6.461
	166.0		0.670	10.048
	169.0	65	0.859	5.962
	173.0		0.572	6.009
	175.0		0.485	8.684
	184.0		0.627	4.915
	189.0		0.639	6.636
	198.0		0.518	5.794
	198.0		0.917	6.422
	216.0		0.742	4.548
	266.0	864	0.779	7.654
	316.0		1.053	5.024
	364.0	901	0.949	4.595

islets were brought into view by the method of injection and his record according to body weight after birth is based on 44 albino rats. The gross results are given in table 88 a. The weight of the pancreas increases with body weight and also tends to be heavier in the female. The absolute number of islets is highly variable yet, in a general way, the number increases rapidly for the first twenty days—the period of dependence on the mother—then reaches and maintains rather a high value for the next thirty days, but later decreases somewhat with advancing body weight and age. There are four instances (three males and one female) of very high numbers of islets, all in animals under 80 days in age and 170 grams in body weight. These instances appear to be individual variations. As the absolute number of islets increases less rapidly than does the weight of the pancreas or that of the entire body, it follows that the islets become relatively less numerous when so compared. The absolute weights of the pancreas are in this series less than those found by Hatai ('18) in table 147, but this difference appears to be due largely to differences in the method of preparation for weighing.

## ANATOMY: REFERENCES

*Anatomy—gross and microscopic.* Akamatsu, '05. Anglas, '10?. Brisson, 1756. Flower, 1872. Goto, '06. Krause, 1876. Leydig, 1854, 1857. Martin and Moale, 1884. Meyer, 1800. Morrell, 1872. Owen, 1868. Rolleston, 1870. Waller, 1693. Wiedersheim, 1897.

*Histology.* Allen, '16, '19. Bell, '11. Bensley, '08. Bullard, '12. Drew, '23. Duesberg, '07. Gage, 1887. Gottlieb, '14. Gulliver, 1839, 1842. Hance, '17. Hartley, '07. Hatai, '02 b. Hoyer, 1890. McMunn, 1884. Macklin and Macklin, '20. Mayer and Schaeffer, '14. Miller, '22. Schäfer, '00. Solger, 1889. Zoja, 1891.

*Embryology. (a) Spermatogenesis.* Allen, '18. Benda, 1887. Brown, 1885. Duesberg, '08, '08 a, '09. Ebner, 1888, 1899. Hague, '14. Hewer, '14. Jensen, 1887. Leeuwenhoeck, 1693. Lenhossék, 1898. Meves, 1898. Montane, 1889. Regaud, 1899, '00 b, '00 c, '00 d, '00 e, '00 f, '01, '01 a, '01 b, '01 c, '03, '04. Renson, 1882. Retzius, '09. VanHoof, '11, '12. Wiedersperg, 1885. (b) *Oogenesis and fertilization.* Arai, '20. Bellonci, 1885. Blanc, 1892. Coe, '08. Huber, '15 b. Kirkham, '10. Kirkham and Burr, '13. Long, '12. Long and Evans, '22. Mark and Long, '12. Novak and Eisinger, '23. Pratt and Long, '17. Sobotta and Burckhard, '10. Tafani, 1889, 1889 a. Widakowich, '10. (c) *Earlier stages.* Balfour, 1881. Begg, '16. Cristiani, 1892. Firket, '20. Fraser,

1883. Giannelli, '11. Grosser, '09. Hoven, '14. Huber, '15, '15 a, '15 b. Klebs, 1891. Lane-Claypon, '07. Melissinos, '07. Robinson, 1892, 1892 b, 1892 c, '04. Ryder, 1888. Schultze, 1897. Selenka, 1883, 1884. Tilney and Casamajor, '17. Warren, '17. Widakowich, '09, '10 a. (d) *Later stages*. Addison and How, '21. Addison and Appleton, '22. Adloff, 1898. Askanazy, '08. Braun, 1882. Bremer, '16, '23. Brunn, 1887. Chievitz, 1885, 1890. Debeyre, '00, '04. Freund, 1892. Glas, '04. Gottschau, 1883. Helly, '01. Henneberg, 1899, '00, '05, '08, '14. Heuser, '14. Jordan, '21. Jordan and Helvestine, '23. Kölliker, 1879. Lewis, '15. Maximow, '10. Meyerheim, 1898. Myers, '16, '17, '17 a, '19. Paterson, 1890, '01. Robinson, 1889, 1892 a, 1896. Scammon, '16. Soulié, '03. Stewart, '23. Stotsenburg, '15. Strong, '21. Tandler, '02. Toyofuku, '10. Uskow, 1883. Warren, '15. Weiss, '01. Willach, 1888. Williams, 1896. Zuckerkandl, '03. (e) *Monsters*. Conrow, '15, '17, '17 a.

*Bones.* (a) *Connective tissue*. Bast, '21. Bignotti, '60. Hyrtl, 1845. Katzenstein, '03. Kohlmeyer, '06. Macklin, '17, '17 a. Morgulia and Gies, '14. Renaut, '04. Retterer, '05. Todd, '23. Weiss, '00. (b) *List of bones*. Donaldson and Conrow, '19. (c) *First appearance of ossification centers*. Strong '24. (d) *Skull measurements*. Donaldson, '12 a. Donaldson and Conrow, '19. Hansemann, '04. Hatai, '07, '07 c. (e) *Teeth*. Addison and Appleton, '15, '22. Beretta, '13. Brunn, 1880. Gingery, '23. Hammett and Justice, '23. Jordan, '23. MacGillavry, 1875, 1876. Marshall, '20, '21. Owen, 1840-1845. Terra, '11. Toverud, '23. (f) *Displacement of teeth*. Erdheim, '11. Hammett, '22. Wiedersheim, '03. (g) *Adipose tissue*. Auerbach, '02. Hammar, 1895. Mietens, '08. Poljakoff, 1888. Rasmussen, '22, '23.

*Muscles*. Alezais, '02. Kolster, '01. Meek, 1899. Morpurgo, '98, '99, '99 a. Rosenfeld, 1899. Stirling, 1883 a.

*Blood vessels and lymphatics*. Ranvier, 1896.

*Blood vessels*. Dreyer, Ray and Walker, '12. Hashimoto, '21. Keith and Flack, '07. Kent, 1893. Lemoine, '06. Meiklejohn, '14. Minot, '00. Tandler, 1899.

*Vascularity of central nervous system*. Craigie, '20, '21, '23.

*Blood*. Addison and Richter, '23. Chisolm, '11. Collip, '20 a, '20 b. Gad-Andersen, '19. Hatai, '18. Jolly and Stini, '05. Kōsaka and Seki, '21. Mat-til, '23 a. Sherrington and Copeman, 1893. Zucker and Gutman, '23.

*Percentage of water*. Hatai, '18, '18 b.

*Resistance of red cells*. Takenouchi, '19.

*Refractive index*. Hammett and Teller, '22. Hammett, '23 b. Hatai, '18 b, '21.

*Scrum constitution*. Jewett, '16. Ritzema-Bos, 1893. Robertson, '20. Rohdenburg, '20. Suzuki, '20. Toyama, '19.

*Blood elements*. Guglielmo, '14. Höber, '11. Homma, '21. Jolly, '06 a, '23. Kanthack and Hardy, 1894. Takenouchi, '19. Weidenreich, '09.

*Haemoglobin*. Abderhalden, '02. Gangee, 1898. Halliburton, 1888. Preyer, 1866, 1871. Quinquaud, 1873. Reichert and Brown, '09. Schäfer, 1898. Stirling and Brito, 1882. Welker and Williamson, '20.

*Number*. Abderhalden, '02. Addison and Richter, '23 a. Cramer, Drew and Mottram, '22, '23. Geiling and Green, '21. Jencks, '22. Jolly, '06, '09, '19. Murphy and Sturm, '19. Rous and Robertson, '17.

*Size.* Gulliver, 1875. Kanthaek and Hardy, 1894. White, '01. Wormley, 1888.

*Blood picture.* Cramer, Drew and Mottram, '21. Cramer, '22. Downey, '17 a. Eyre, '13. Furno, '11. Klieneberger and Carl, '12. Taylor, '16. Wolfert, '17.

*Lymph nodes and hemolymph nodes.* Drummond, '00. Helly, '02. Job, '15, '18, '22. Lewis, '02. Meyer, '13. Rapp, 1839. Vincent, 1897 b. Weidenreich, '02.

*Nervous system.* Craigie, '24. (a) *Brain.* Addison, '11. Bradley, '03. Cajal, 1897, '09-'11. Cameron, '04. Craigie, '20, '21, '23. Droogleever Fortuyn, '14. Dunn, '16, '17. Donaldson, '08, '09. Donaldson and Hatai, '11. Edinger, '10, '11. Flatau and Jacobsohn, 1899. Goldstein, '04. Haller, '10. Hatai, '03, '09, '09 a. Held, 1890. Hermanides and Köppen, '03. Johnston, '13, '23. King, J. L., '10. Kōsaka and Hiraiwa, '15. Lapicque, '07. Lewis, 1881. Löwy, '10. Meek, '07. Papez, '23, '23 a, '23 b. Reichardt, '06. Sugita, '18 d. Tilney and Riley, '21. Wagner, 1841. (b) *Cell Division.* Allen, '12. Hamilton, '01. (c) *Linear dimensions.* Sugita, '17. (d) *Growth of callosum.* Suitsu, '20. Zuckerkaudl, '09. (e) *Growth of cerebral cortex in thickness.* Sugita, '17 a. (f) *Number of cells in cerebral cortex—computed.* Sugita, '18 b. (g) *Growth in the diameters of cortical cells with their nuclei.* Sugita, '18 c, '18 e. (h) *Olfactory bulbs—number of cells.* Holt, '17.

*Spinal cord.* Allen, '12. Bardeleben, 1899. Bechterew, 1890. Bregmann, '15. Bullard, '12. Hamilton, '01. Lenhossek, 1889. Pontier and Gérard, '00. Ranson, '13, '14 a. Retzius, 1893. Robinson, 1892 a. Spitzka, 1886. Sterzi, '04. Stieda, 1869. Van der Vloet, '06.

*Cranial nerves.* Alexander, 1899. Bischoff, 1832. Boughton, '06. Cannieu, 1893. Hoag, '18. Meyersohn, '13. Nittono, '20. Singer and Münzer, 1888. Wada, '23. Winkler, '18.

*Spinal nerves.* Agduhr, '20. Beek, 1896. Benedicenti, 1892. Cabibbe, '04. Cajal, 1894. Donaldson, '00. Donaldson and Hoke, '05. Donaldson and Nagasaka, '18. Dunn, '12. Greenman, '13, '17. Hatai, '01, '01 a, '02, '02 a, '03, '03 b, '03 c, '03 d, '04, '07 b. Krause, 1870. Levi, '08. Ramström, '05. Ranson, '06. Stirling, 1883.

*Sympathetic system.* Apolant, 1896. Asp, 1873 a. Barteneff, 1891. Berkley, 1893, 1895. Cajal, 1893. Carpenter and Conel, '14. Fusari and Panasei, 1891. Fusari, 1894. Korolkow, 1892. Martinotti, 1889. Meiklejohn, '14 a. Ping, '21. Plosehko, 1897. Roth, '05. Stewart, '20, '20 a.

*Technical methods.* Cajal, 1889, '03. King, '10, '13 a. Ohlmacher, 1897. Turner, '04.

*Swelling reactions.* Plant, '19.

*Myelin formation.* Donaldson, '15. Sugita, '17, '18. Watson, '03.

*Sense organs.* Anderson, 1893. Asai, '08. Bulle, 1887. Collins, '22. Ebner, 1873. Gmelin, 1892. Gray, '07, '08. Greeff, '00. Hönigsehmied, 1873. Koganei, 1885. Lauber, '01. Lovén, 1868. Mayer, 1843. Münch, 1896. Schäfer, '00 a. Stahr, '03. Tello, '06. Tuckerman, 1892. Wada, '23. Wyss, 1870.

*Integument.* Calef, '00. Durham, '04. Hill and Hill, '13. Myers and Myers, '21. Römer, 1896. Spain, '15.



*Gastro-intestinal tract* (including pancreas and liver). Asher, '03, '08. Berry, '01. Brümmer, 1876. Bujard, '05, '08, '09. Custor, 1873. Cuvier, 1805. Demjanenko, '09. Edelmann, 1889. Ellenberger and Guenther, '08. Frenkel, 1892. Gillette, 1872. Hilton, '02. Home, 1807. Klein and Verson, 1871. Kupffer, 1876. Langley, 1882. Mann, Brimhall and Foster, '20. Mann, '20. Mazzarelli, 1890. Morgulis, '11. Mouret, 1895. Müller, 1830. Nicolas, 1890. Oppel, 1896-1914. Podwysozki, 1878. Ranvier, 1883, 1884, 1885, 1886. Retzius, 1841. Rubeli, 1890. Salter, 1859. Saviotti, 1869. Schmidt, 1863. Schwalbe, 1872. Severin, 1885. Stevenson, '21. Toepfer and Fleischmann, 1891. Watney, 1874. Zillinberg-Paul, '09.

*Pulmonary system*. Arnstein, 1877. Frankenhaeuser, 1879. Fuchs-Wolfing, 1898. Gegenbaur, 1892. Guieysse, 1898. Hansemann, 1895. Klein, 1875. Linser, '00. Livini, 1896. Miller, 1893. Schulze, 1871. Stewart, '23. Zumstein, 1890.

*Uro-Genital system*. Emge, '21. Gaebler, '21. Huber, '06. Kittelson, '17. Maccallum, '23. Mueller, '02. Oudemans, 1892. Rauther, '03. Waschetko, '14. (a) *Male*. Addison and Thorington, '16. Ancel and Bouin, '05. Bouin and Ancel, '04. Disselhorst, 1897, 1897 a, '04. Leydig, 1850. Loewenthal, 1897. Moore, '23 a. Myers, '16. Myers-Ward, 1898. Oslund, '23. Regaud, '00, '00 a, '01 d, '02. Regaud and Tournade, '03. Stutzmann, 1898. Tournade, '03. (b) *Female*. Arai, '20, '20 a. Beiling, '06. Belloy, 1899. Campbell and Watson, '06. Fischel, '14. Fraenkel, '05. Haldeman, '21. Harz, 1883. Kempe, '03. Kuramitsu and Loeb, '21. Loeb, '23. Schaeffer, '11. Stotsenburg, '23. Watson and Campbell '06.

*Exocrine glands*. Asp, 1873. Castellant, 1898. Falcone, 1898. DaFano, '22. Garnier, 1897. Giannelli, '14. Loewenthal, 1894, 1894 a, '00, '08. Myers, '16, '17, '17 a, '19, '19 a, '19 b. Myers and Myers, '21, '21 a. Mayer, 1894. Peters, 1890. Ranvier, 1886 a. Schickele, 1899. Smith, '20. Sutter, '19. Zumstein, 1891.

*Endocrine system* (See also Endocrine System under "Physiology"). (a) *General—Percentage of water*. Uno, '22. (b) *Hypophysis*. Addison, '16, '17. Degener, '22. Dostoiewsky, 1886. Bensley, '11. Gemelli, '05, '06 a. Gemelli, E. '03. Gentes, '03. Retzius, 1894. Stendell, '13, '14. 'Tilney, '11, '13. (c) *Suprarenals*. Bonnamour, '05. Cartier, 1890-1895. Dewitzky, '12. Donaldson, J. C., '19. Dostoiewsky, 1886 a. Elliot and Tuckett, '06. Jackson, '19. Lewis, '23. Ogata and Ogata, '17. Vincent, '10. Watson, '07. (d) *Thymus*. Hatai, '14 a. Hewer, '16. Pappenheimer, '13. Salkind, '15. (e) *Thyroid and Parathyroids*. Chandler, '23. Douglas, '15. Erdheim, '06. Hoskins, '23. Watson, '09. (f) *Pancreas: Islets of Langerhans*. Overholser, MS. '24.

## CHAPTER 4

### PHYSIOLOGY

1. The rat compared with man (a) Technique. 2. Muscles and nerves. 3. Nervous system. 4. Special senses. 5. Circulation. 6. Blood and lymph. 7. Respiration. 8. Metabolism. 9. Nutrition (a) Tests, (b) Effects on systems and functions, (c) Body temperature, (d) Calorimetry. 10. Reproduction and the sex organs. 11. Exocrine system: General. 12. Endocrine system. 13. Pineal gland. 14. Hypophysis. 15. Feeding endocrine glands.

1. *The rat compared with man.* In order to have a background for the interpretation of the physiological responses of the rat, it is desirable to indicate its relations to man. If the data for the relative weights of the different systems in the man (69.7 kilos) Bischoff ('63) are compared with those of the one year old rat (Jackson and Lowrey, '12) the relations are as in table 89.

Table 89 shows that in man the skeleton is relatively heavy. The small weight of the skin depends in part on the relative diminution of the surface area in the larger animal, man—a factor which tends to reduce the relative weight of the skin. The massive fat was weighed as one part, in the case of man, but not similarly handled in the case of the rat. Allowing for all of these differences, there remains a fair correspondence between the two forms in the proportionate weights of the musculature and the viscera.

In the case of the viscera, however, the individual organs do not stand in the same relations. I have sought to illustrate this by the data presented in table 90. Here the weights of several organs taken from the tables for the rat, tables 144, 145, 146 and 148, are transformed into those to be expected in a man of 65 kilos, if the percentage relations were those in the rat. These computations are controlled by the data for the observed weights in man, obtained from various sources.

In this comparison it appears that in man the lungs, heart, brain, spleen and thyroid are heavier, while the remaining organs

are lighter:—the most striking differences from the computed values being shown by the heavier thyroid, brain and lungs, and the lighter eyes. While the differences thus revealed are of

TABLE 89  
*Percentage weight of systems in man and albino rat*

	MAN, ♂ 69.7 KILOS	ALBINO RAT, ♂ ♀ 234.6 GRAMS
	<i>per cent</i>	<i>per cent</i>
Skeleton.....	15.9	10.9
Musculature.....	41.8	45.4
Viscera.....	10.8	13.3
Skin.....	6.9	18.0
Fat.....	18.2	—
Remainder.....	6.4	12.4
	100.0	100.0

interest, the greater significance is to be attached to the general similarities of the two forms.

*Equivalent ages.* It has already been stated that post natal growth of the rat is about thirty times as rapid as that of man,

TABLE 90  
*Weights of the organs in the rat compared with man*

ORGAN	RAT 300 GRAMS, MALE	COMPUTED FOR MAN 65 KILOS, MALE	OBSERVED MAN	
	<i>grams</i>	<i>grams</i>	<i>grams</i>	
Liver.....	13.7	$\times 217 = 2972.9$	1800	Hoffman
Kidneys (2).....	2.5	$\times 217 = 542.5$	400	Hoffman
Heart.....	1.1	$\times 217 = 238.7$	350	Hoffman
Spleen.....	0.79	$\times 217 = 171.4$	220	Hoffman
Thyroid.....	0.044	$\times 217 = 9.5$	35	Piersol
Suprarenals (2).....	0.045	$\times 217 = 9.8$	7.4	Vierordt
Lungs.....	1.7	$\times 217 = 368.9$	995	Vierordt
Eyes.....	0.33	$\times 217 = 71.6$	13.5	Vierordt
Brain.....	2.00	$\times 217 = 434.0$	1430	Vierordt

and it is conspicuously true that in the growing nervous system the degree of development attained in the rat at a given age is also attained by man when thirty times as old.

In the span of life, however, some of the major events are differently spaced. Thus suckling continues in the rat for 20–25

days, equivalent to 20–25 months in man, and puberty may occur in the rat at 50 days or later, which corresponds to 50 months, a little over four years in man.

Hatai ('17) has shown that at equivalent ages the general composition of the body in terms of water, solids, protein, fat and ash is similar in man and several other mammals.

The results serve to emphasize the well recognized similarity among mammals as a group.

(a) *Technique.* Concerning the acuteness of sensation in the rat our information is meagre. The response to some sensory stimuli, especially to sounds, is very marked—as is shown by jumping when the hands are clapped, and in some cases by an almost maniacal running and jumping—going on to exhaustion—when a bundle of keys is jingled before a cage. Vision in the albino is poor as compared with the strains having pigmented eyes. It also seems sensitive to vibration.

The emotional states of the rat are very important and play a leading rôle. There is therefore a profound difference in general condition between rats that are wild and in fear and those that are tame and gentle.

If rats are played with every day and handled, they soon come to enjoy the experience, and not only do not offer to bite, but relax when picked up, and lose all tendency to struggle in the hand. Fear and flight reactions completely disappear and the general condition of such rats differs widely, even from those that are moderately tame and can be handled without danger of their biting. Thus Hammett, ('21 i) found that when rats of this half tame group were used for removal of the thyroid apparatus, the mortality was 79 per cent, while the same operation could be made on thoroughly gentle rats, which had been handled for weeks before the event, with a mortality of only 13 per cent. Moreover, when wild Norways were used, the mortality was 90 per cent, Hammett ('22).

It is inferred from this that the best results will be obtained from operations when these are made on thoroughly tame and gentle rats. Further, it is highly probable that all physiological responses are definitely modified by the emotional state of the rat.

2. *Muscles and nerves.* The rate of movement in flight (Dubois, '98), for example, may be due in a measure to the short nerves, or the rapidity of metabolic change in muscles, or to both.

When the gastric end of a duodenal segment is taken some fifteen hours after the last feeding from a healthy male rat 80-200 days of age, and when the animal has been for at least three days in the transfer cage, and is also carefully handled and anaesthetized without undue excitement, the response of the segment

TABLE 91

*Showing the content of total nitrogen as well as non-protein nitrogen in the entire brain of the albino rat at different ages*

(a)	(b)	(c)	(d)	(e)	(f)	(g)	(h)	(i)	(j)	(k)
BODY WEIGHT	BRAIN WEIGHT	WATER IN BRAIN	SOLIDS	TOTAL NITROGEN IN ENTIRE BRAIN	NON-PROTEIN NITROGEN IN ENTIRE BRAIN	TOTAL NITROGEN TO SOLIDS	NON-PROTEIN NITROGEN TO TOTAL NITROGEN	NON-PROTEIN NITROGEN PER GRAM OF SOLIDS	MEAN AGE	NUMBER OF RATS USED
<i>grams</i>	<i>grams</i>	<i>per cent</i>	<i>grams</i>	<i>m.m.</i>	<i>m.m.</i>	<i>per cent</i>	<i>per cent</i>	<i>m/gm.</i>	<i>days</i>	
4.8	0.231	88.30	0.027	3.07	0.38	11.40	12.33	14.1	1	45
7.1	0.459	88.75	0.052	5.73	0.71	11.08	12.38	13.7	5	32
9.5	0.598	88.13	0.071	7.70	0.91	10.86	11.81	12.8	7	17
17.9	1.175	84.90	0.177	18.28	1.63	10.30	8.89	9.2	15	12
26.7	1.284	80.86	0.246	23.70	2.11	9.65	8.91	8.6	24	6
34.8	1.379	80.26	0.272	26.21	2.22	9.63	8.48	8.2	35	6
66.6	1.508	79.58	0.308	28.00	2.42	9.09	8.64	7.9	54	6
156.6	1.762	78.89	0.372	33.72	2.63	9.07	7.81	7.1	116	6
161.4	1.803	78.43	0.389	34.13	2.59	8.78	7.58	6.7	274	6
185.5	1.858	78.00	0.409	35.94	2.89	8.79	8.04	7.1	382	6

to sodium carbonate solution is fairly regular (Hatai and Hammett, '20). Segments from females should not be used.

Working with duodenal segments thus standardized, Hammett ('21a) found that in response to the stimulation by 0.1 M sodium carbonate, the segment gave nearly uniform contractions. In 66 per cent of the observations the deviation was plus or minus 5 per cent, and in 90 per cent of the observations, plus or minus 10 per cent.

Hammett ('21 b) concludes that the intestinal mechanism primarily stimulated when sodium carbonate is thus applied to the isolated duodenal segment of the rat is neural and not mus-

cular; and in the unexcited male it is through a mechanism mediated by the vagus, while in the excited rat the effect is produced through splanchnic endings or fibers.

*Exercise.* See Chapter 1, page 16.

3. *Nervous system. (a) Central.* In a study of the metabolic activity of the nervous system Hatai ('17 a) determined the

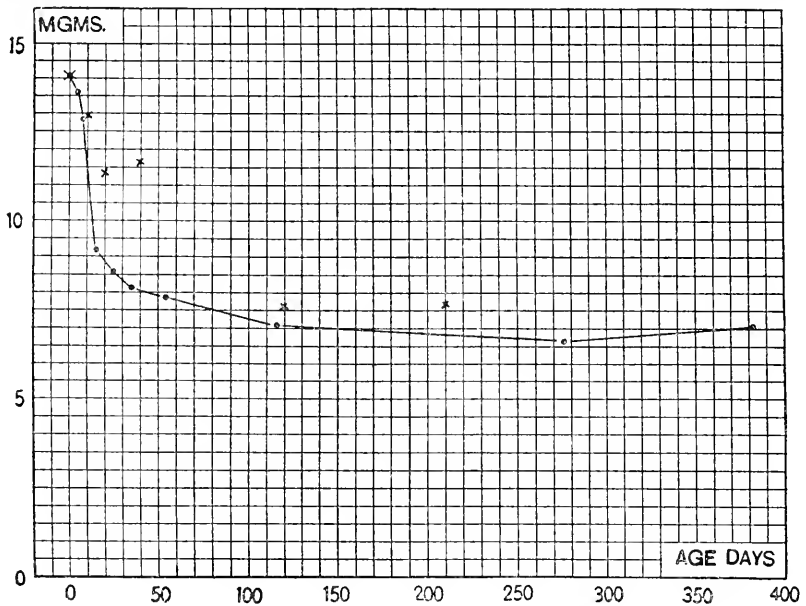

Chart 15 Showing the number of milligrams of non-protein nitrogen per gram of the dried brain at different ages. The chart shows also the proportional value of organic extractives together with inorganic salts in the brain of the albino rat, as determined by W. Koch and M. L. Koch ('13). —·— Non-protein nitrogen; × organic extractives and inorganic salts.

amount of non-protein nitrogen in the brain under normal conditions. The data appear in table 91 and chart 15.

The number of milligrams of non-protein nitrogen per gram of total solids decreases rapidly during the first 15 days, and less rapidly up to 120 days, after which age it remains nearly constant. This apparent decrease is largely due to the formation of myelin. When determined in relation to the lipid-free solids, the percentage of nitrogen is the same in the several parts of the brain and in the spinal cord.

Hatai concludes that the nitrogenous organic extractives are intimately related to the active cell substance and that the protein fraction of the brain is well saturated with metabolic products.

TABLE 92

Showing the total nitrogen as well as non-protein nitrogen in several organs of the adult albino rat

	TOTAL NITROGEN IN FRESH TISSUE	NON-PROTEIN NITROGEN PER 100 GRAMS FRESH TISSUE	NON-PROTEIN NITROGEN TO TOTAL NITROGEN	AGE
	<i>per cent</i>	<i>mgm.</i>	<i>per cent</i>	<i>days</i>
Brain.....	1.953	159	8.168	143
Testes.....	1.729	170	9.806	143
Liver.....	3.435	182	5.332	143
Kidneys.....	3.243	229	7.572	143
Blood.....	3.093	35	1.134	241

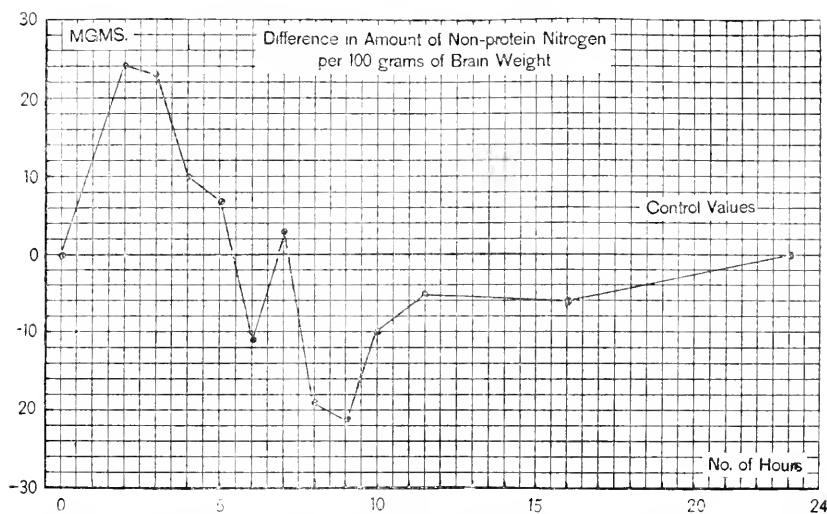

Chart 16 Showing the differences in the amount of non-protein nitrogen in the brain of test rats from that found in the controls.

For comparison, the total nitrogen and non-protein nitrogen in several organs are given in table 92.

The amount of non-protein nitrogen in the brain at intervals during twenty-four hours after feeding, has been determined by Komine ('19). Albinos of both sexes and more than 100 days old were used—table 93 and chart 16.

TABLE 93

Showing the data on the amount of non-protein nitrogen of the brain, together with several other observations during twenty-four hours after feeding

## Controls A

BODY WEIGHT	AGE	NUMBER RATS USED	BRAIN WEIGHT	WATER IN BRAIN	TOTAL NITROGEN IN BRAIN	NON-PROTEIN NITROGEN IN TOTAL NITROGEN	NON-PROTEIN NITROGEN PER 100 GRAMS BRAIN	DIFFERENCE
<i>grams</i>	<i>days</i>		<i>grams</i>	<i>per cent</i>	<i>per cent</i>		<i>mgms.</i>	
66.8	123	2	1.519	78.6	2.11	2.57	156	24
66.8	120	3	1.519	78.6	2.11	2.37	157	23
70.0	118	5	1.508	78.6	2.12	2.52	165	10
74.4	131	6	1.514	78.3	2.09	2.40	162	7
92.2	135	4	1.585	78.7	2.08	2.34	150	-11
96.3	135	6	1.590	77.9	2.09	2.33	148	3
98.6	112	3	1.573	78.7	2.13	2.36	152	-19
97.3	123	2	1.608	79.6	2.06	2.53	149	-21
99.6	161	3	1.611	78.4	2.11	2.57	163	-10
106.7	202	2	1.606	77.7	2.21	2.66	166	-5
131.6	173	2	1.670	79.2	2.22	2.20	135	-6
129.5	147	2	1.679	78.9	2.24	3.04	182	0
Average 94.5...	140	40	1.582	78.6	2.13	2.49	157	

## Tests B

NON-PROTEIN NITROGEN PER 100 GRAMS BRAIN	NON-PROTEIN NITROGEN IN TOTAL NITROGEN	TOTAL NITROGEN IN BRAIN	WATER IN BRAIN	BRAIN WEIGHT	NUMBER RATS USED	AGE	BODY WEIGHT	NUMBER OF HOURS AFTER FEEDING
<i>mgms.</i>		<i>per cent</i>		<i>grams</i>		<i>days</i>	<i>grams</i>	
180	2.88	2.16	78.4	1.590	2	123	89.1	2
180	2.84	2.22	79.0	1.533	3	120	85.9	3
175	2.72	2.21	79.6	1.548	5	118	91.5	4
169	2.64	2.16	78.4	1.533	5	131	83.0	5
139	2.25	2.13	78.8	1.623	3	135	92.5	6
151	2.40	2.16	79.0	1.590	4	135	109.5	7
133	2.24	2.08	78.0	1.675	2	112	144.4	8
128	2.31	2.15	78.6	1.549	2	123	121.6	9
153	2.48	2.19	78.1	1.615	3	161	133.1	10
161	1.70	2.23	77.9	1.701	2	202	137.8	11.5
129	2.32	2.26	78.8	1.590	3	173	133.8	16
182	3.03	2.24	78.3	1.668	2	147	116.7	20
Average 157....	2.57	2.18	78.6	1.601	35	140	111.2	8.5



Chart 16 shows the relations found. Two hours after feeding the amount of non-protein nitrogen in the brain is high. This amount diminishes almost steadily up to nine hours after feeding. It then increases up to twenty-four hours, returning to the value in the control. The relations for the percentage of non-protein nitrogen on total nitrogen are similar, and the differences in the percentage of water in the brain follow a like course.

The excitement of fighting and of electrical stimulation causes an increase in the content of non-protein nitrogen in the brain, Komine ('19 a).

*Spinal cord.* See References.

(b) *Peripheral : Degeneration, Regeneration.* Nittono ('23) reports that when the second and third branches of the trigeminal nerve are sectioned, retrogressive changes appear in the fibers after one day, and in the small cells of the ganglion between the first and second day. The degenerative processes are at their height from the 5th to the 20th day. Regenerating fibers are seen from the third to the fifth day on. Residual evidences of degeneration may be detected as late as 60 days after the operation. Similar responses, but less intense, occur on the *intact* side. For numerical data in the regenerating n. peroneus—see Greenman ('13.)

4. *Special senses.* The correlation between structure and function in the development of the special senses of the white (albino) rat has been studied by Lane ('17).

*Touch : Reactions.* Pricking with a needle, fetuses 16 mm. (crown-rump measurements) on flank, sides and snout produces slight but perceptible movements. At birth the rat responds to touch of a brush by contortion of the body—limb movements—and squeaks.

*Structural conditions.* In 16 mm. fetuses about a dozen anlagen of vibrissae are present in the snout. A reticulum formed by a few nerve fibers at the base of each vibrissa is seen. At birth there are more vibrissae, more fibers to each of them, more tactile fibers to skin.

*Equilibrium : Reactions.* In a fetus of 35 mm. the first indication of equilibrium sense appears. The rat maintains an upright position. At one day of age the rat makes awkward efforts to

right itself when turned over on the back and sometimes succeeds. Later ages showed gradual improvement in equilibration with increasing powers of coördination.

*Structural conditions.* Fetus 35 mm. Semi-circular canals well formed and ampullae innervated. Cristae acusticae have sensory and supporting cells well differentiated. Central connections of the vestibular nerve well defined. The same conditions at birth. At later ages—muscle tonus—the use of the vibrissae and sight, all aid in equilibration.

*Smell: Reactions.* Age, one day. Apparent responses to olfactory stimuli were obtained at this age—reaction time long.

Later stages: olfactory sense gradually improves from day to day.

*Structural conditions.* At one day, olfactory area contains a few differentiated sensory cells.

Later stages: a gradual perfecting of the olfactory apparatus in general.

*Taste: Reactions.* First day after birth, sense of taste uncertain. All substances appear to be disagreeable.

Later stages: Sense of taste slowly developed.

*Structural conditions.* First day after birth—taste buds not demonstrated. Dome shaped papillae are present on the anterior part of the tongue.

Later stages: by the ninth day taste buds on the sides of the circumvallate papillae are found, and a decidedly different organ in the dome shaped papillae.

*Hearing: Reactions.* No reactions to sound before the 12th day after birth. From that age on there is a gradual but rapid increase in the ability to hear.

*Structural conditions.* By the 12th or 13th day the organ of Corti is differentiated in part and the cellular plug in the external auditory meatus, which was intact for the first eleven or twelve days, is undergoing liquefaction and has become imperfect. The next few days witness the complete differentiation of the organ of hearing.

*Sight: Reactions.* No response to light was obtained before the opening of the eyes on the sixteenth or seventeenth days.

*Structural conditions.* At 12 days the rods and cones are fairly well defined, but the accessory apparatus is less complete. At the time when the eyes open the plexus of blood vessels to the lens is still present, though much reduced.

*Integument—moult.* The rat has a heavy winter and a light summer coat of hair. The winter coat is moulted in the early spring and the summer coat in the early autumn. The amount of hair at the two seasons, and according to age, has not been determined. During the moult the outline of the "hooded" pattern is sometimes revealed by the slower growth of the hair in the area of the pattern. This is more often seen in young animals.

*Semicircular canals.* When rats are rotated in a horizontal plane for ten seconds at the rate of 120 revolutions per minute, with the body fixed in a glass tube, the center of gravity of the rat centered on the rotator, and the head free, and then the rotation is suddenly stopped, ocular after-nystagmus appears. The number of seconds during which the after-nystagmus continues is given in table 94, where the data are entered according to the age of the animal (J. A. Detlefsen, MS.)

All the tests here recorded are initial, the rat having had no previous experience of this sort. Table 94 shows an evident decrease in after-nystagmus time with advancing age. In yet older rats the decrease is still more marked.

5. *Circulation.* See References.

6. *Blood and lymph.* Folin and Morris ('13) examined the blood from six full-grown rats which was collected over a little powdered potassium oxalate; the uric acid, total non-protein nitrogen and urea were determined by the methods of Folin and Denis ('13).

The figures obtained for 100 grams of blood were as follows: Uric acid, 2 mgm.; non-protein nitrogen, 38; urea, 22. This experiment was repeated twice, each time using for the analysis the mixed blood of six normal white rats, and 2.4 mgm. and 2.5 mgm. respectively of uric acid per 100 grams of blood were found. These are substantially the same figures as Folin and Denis ('13) found for normal human blood.

7. *Respiration.* Macleod ('07) has determined the CO<sub>2</sub> output at 30°C. for rats of about 170 grams in body weight, table 95.

Cramer ('08) has made corresponding observations on rats of from 40–60 grams in body weight, table 96.

TABLE 94

AGE	SECONDS OF AFTER-NYSTAGMUS																	TOTAL	MEAN
	7	8	9	10	11	12	13	14	15	16	17	18	19	20	21	22			
<i>days</i>																			
30			1		5	9	13	5	2								35		
40				2	4	13	15	6	13	2	1						56		
50		2	1	15	14	23	36	49	29	19	8	6	2	1		2	207		
60			3	18	11	20	11	8	6	4	1						82		
70		1	8	15	11	10	1										46		
80			9	22	65	58	28	25	9								216		
90		1	13	13	30	33	13	2	1								106		
100			5	10	51	99	88	74	22	4							353		
110				4	12	21	16	5	1		1	2					62		
120		1	8	28	32	28	10	2									109		
130				9	22	37	24	9	3	3							107		
140			6	4	8	10	14	15	5	5							67		
150		6	9	29	35	39	39	34	5	1							197		
160							2	3	2								7		
170		1	3	9	3												16		
180				3	4	4	3		1								15		
Total....	6	26	102	253	385	381	270	135	74	26	12	6	2	1		2	1681	11.81	

$$\text{Mean} = 11.81 \pm 0.030$$

$$\sigma = 1.82 \pm 0.021$$

$$r_{xy} = 0.38 \pm 0.014$$

$$\eta_{zy} = 0.48 \pm 0.013$$

$$\eta^2_{xy} - r^2_{xy} = 0.094 \pm 0.0096$$

8. *Metabolism. Percentage of glycogen in the liver.* Normal young albino rats of about the same size (75 grams) were kept on a diet of bread and milk and the percentage of glycogen in the liver determined by the method of Pflüger, (Cramer and Lochhead, '13) table 97.

Further observations showed that the glycogen content was relatively high 3–5 hours after a meal, but after 15 hours fell so

TABLE 95

*Excretion of carbon dioxide in grams per kilo body weight and per minute at 30°C.*

WEIGHT	NUMBER OF RATS	AVERAGE DURATION OF OBSERVATION	RECTAL TEMPERATURE OF RAT ON REMOVAL	LOSS IN WEIGHT OF RAT PER MINUTE AND KILO	AVERAGE CO <sub>2</sub> PER MINUTE AND KILOGRAM
A. In dry air					
<i>grams</i>		<i>minutes</i>	<i>°F.</i>		<i>grams</i>
204	4	38	102.3	0.061	0.0325
177	3	80	100.7	0.048	0.0313
174	2	30	101.2	0.043	0.0315
139	2	30	—	0.081	0.0290
Average of all observations.....					0.0310
B. In moist air					
209	3	170	101.7	0.036	0.0306
173	5	160	101.8	0.033	0.0280
166	1	165	—	0.027	0.0290
133	4	209	101.7	0.038	0.0345
Average of all observations.....					0.0305

TABLE 96

*Fasting rats 18-24 hours after feeding. Duration of experiment one hour*

NUMBER OF RATS	TOTAL WEIGHT	H <sub>2</sub> O DISCHARGED IN CG. CALCULATED PER RAT	CO <sub>2</sub> DISCHARGED IN CG. CALCULATED PER RAT	O <sub>2</sub> ABSORBED IN CG. CALCULATED PER RAT	CO <sub>2</sub> O <sub>2</sub>	CO <sub>2</sub> PER HOUR AND KILO IN GRAMS	O <sub>2</sub> PER HOUR AND KILO IN GRAMS	TEMPERATURE	
								In	Out
2	95	10.5	17.0	16.0	0.76	3.52	3.37	14	16
3	130	9.7	15.7	15.3	0.74	3.61	3.54	17	20
3	170	9.3	15.0	14.7	0.74	2.65	2.59	17	20
3	170	9.0	16.7	17.7	0.68	2.94	3.12	18	21

TABLE 97

*Percentage of glycogen in liver. Data arranged according to increasing liver weight*

WEIGHT OF LIVER	LIVER GLYCOGEN	WEIGHT OF LIVER	LIVER GLYCOGEN	WEIGHT OF LIVER	LIVER GLYCOGEN
<i>grams</i>	<i>per cent</i>	<i>grams</i>	<i>per cent</i>	<i>grams</i>	<i>per cent</i>
3.8	0.3	4.7	1.4	5.1	1.0
3.8	0.4	4.7	2.6	5.1	1.4
4.5	1.0	4.7	3.0	5.3	1.1
4.6	2.7	4.8	3.4	5.5	1.0
4.7	1.0	4.9	2.2	8.9*	2.2
4.7	1.1	4.9	2.2		

\* Pregnant.

low that it could not be accurately determined. A series of observations is given in table 98.

TABLE 98  
*Disappearance of glycogen after feeding. Normal young albino rats. (Cramer and Lochhead, '13)*

HOURS AFTER LAST MEAL	WEIGHT OF LIVER	LIVER GLYCOGEN	DIET
	<i>grams</i>	<i>per cent</i>	
3	3.7	0.66	Meat
	5.8	1.68	Bread and milk
	4.4	3.58	Bread and milk, fasting 24 hours previous to last meal
7	4.5	0.51	Bread and milk
	4.5	2.43	Bread and milk
	4.8	2.24	Bread and milk
	4.5	1.52	Bread and milk
17	4.8	<0.2	Meat
24	3.8	<0.2	Bread and milk
	2.6	<0.2	Bread and milk

A study of the nitrogen excretion has been made by Hatai ('05); Chicago colony: Ration—"Uneda Biscuit" and water—table 99.

From observations on 89 male rats at different ages and weights as in table 99, the following results were obtained:

1. The total amount of urine increases with the weight up to 120 grams, then decreases very decidedly. From 180 grams it again increases up to 220 grams, beyond which weight it remains rather constant. A diminution of urine in animals between 120 and 180 grams, or approximately 70–125 days old, seems to be a normal phenomenon rather than mere statistical variation. Whether or not this is a phenomenon of adolescence needs further investigation. It must be noted, however, that puberty in the rat begins at about seventy days after birth. The smaller animals excrete a relatively greater quantity of urine than the larger animals.

2. The total amount of nitrogen is quite independent of the amount of urine, and increases constantly and continuously throughout life. The smaller rats, however, excrete a relatively greater quantity than the larger animals.

3. The percentage value of urinary nitrogen is 91 per cent of the total in the case of smaller animals, and 89 per cent in the case of the larger.

4. The total amount of nitrogen eliminated by the rat during twenty-four hours at different weights may be determined with a high degree of accuracy by the formula (40).

For the nitrogen exchange in normal albino rats, the average values for three 3 day periods are given according to increasing body weight in table 100 (Cramer and Pringle, '10).

TABLE 99

*Showing the average amount of urine, feces, and nitrogen per day. Male rats alone were used. Average values for body weight groups*

BODY WEIGHT	NUMBER OF ANIMALS	URINE	FECES	NITROGEN IN URINE	NITROGEN IN FECES	TOTAL NITROGEN
<i>grams</i>		<i>cc.</i>	<i>mgm.</i>	<i>mgm.</i>	<i>mgm.</i>	<i>mgm.</i>
38	8	5.7	216	46	3	49
53	7	10.4	135	68	5	73
70	8	12.8	223	96	8	104
85	5	12.6	329	94	13	107
99	6	11.8	264	120	9	129
106	6	16.8	305	117	11	128
116	5	18.3	318	134	11	145
127	4	16.7	460	121	16	137
144	5	16.3	256	144	9	153
156	5	14.5	503	149	16	165
162	4	13.2	394	148	20	168
178	4	12.5	412	168	18	186
191	3	14.9	229	181	12	193
207	4	16.4	496	174	20	194
220	2	21.0	475	182	26	208
239	4	18.2	566	187	20	207
266	4	22.1	639	229	27	256
298	5	18.5	731	260	29	289
333	3	20.9	919	279	27	306
370	3	15.0	637	277	29	306

These observations show that the nitrogen in the urine increases with the increase in body weight, while that in the feces and that retained, diminish.

The distribution of nitrogen in the urine has been studied by Ordway and Morris ('13) in young rats—two males and one female—and their results are given in table 101.

Folin and Morris ('13) have made similar studies in older rats and their determinations are given in tables 193 and 150.

It will be seen from examination of the average results that the percentage composition of rat urine differs but little from that of human urine.

TABLE 100  
*Nitrogen exchange in normal albino rats. Diet of bread and milk—*  
*Cramer and Pringle ('10)*

PERIOD	WEIGHT	WEIGHT OF NITROGEN			
		Urine	Feces	Retention	In food
<i>days</i>	<i>grams</i>	<i>grams</i>	<i>grams</i>	<i>grams</i>	<i>grams</i>
3	187	0.728	0.113	0.239	1.08
3	192	0.766	0.102	0.212	1.08
3	217	0.881	0.077	0.122	1.08

TABLE 101  
*The protein metabolism in normal young rats. Analyses of urine. Ordway*  
*and Morris ('13)*

	MALE Initial weight 42.7 grams Final weight 41.0 grams Duration 9 days		MALE Initial weight 46.5 grams Final weight 51.5 grams Duration 15 days		FEMALE Initial weight 42.5 grams Final weight 39.0 grams Duration 10 days	
	Average for 24 hours	Average	Average for 24 hours	Average	Average for 24 hours	Average
	<i>m.m.</i>	<i>per cent</i>	<i>m.m.</i>	<i>per cent</i>	<i>m.m.</i>	<i>per cent</i>
Total N.....	45.6	100.0	29.1	100.0	21.0	100.0
Urea N.....	32.5	71.3	22.2	76.3	16.5	78.6
Ammonia N.....	4.1	9.0	2.02	7.0	1.89	9.0
Uric acid N.....	0.16	0.35	0.14	0.48	0.05	0.24
Creatinine N. (C <sub>1</sub> )...	0.49	1.08	0.40	1.37+	0.34	1.42
Creatinine N. + Creatine N. (C <sub>1</sub> + C <sub>2</sub> ).....	0.53	1.16	0.42	1.44	0.44	2.1

TABLE 102  
*Female rat weighing 290 grams. Average of 5 days*

	MILLIGRAMS PER 24 HOURS	PER CENT
Total N.....	173.50	100.00
Urea N.....	143.20	77.30
Ammonia N.....	9.10	5.20
Uric Acid N.....	0.69	0.40
Creatinine N.....	4.50	2.65
Creatinine + Creatine N.....	4.70	2.71



This conclusion is questioned by Hunter, Givens and Guion ('14) who worked with wild Norways having body weights of about 100 grams or less. Their data are given in table 104.

TABLE 103  
*Male rat weighing 197 grams. Average of 6 days*

	MILLIGRAMS PER 24 HOURS	PER CENT
Total N.....	123.00	100.00
Urea N.....	105.90	84.00
Ammonia N.....	6.70	5.30
Uric Acid N.....	0.52	0.41
Creatinine N.....	2.90	2.30
Creatinine + Creatine N.....	3.00	2.38

They conclude that owing to the simultaneous high output of allantoin the urine of rats contains the same products of purine metabolism as that of other rodents, and contains them in the same proportions.

TABLE 104  
*Protein metabolism in normal young rats*

EXPERIMENT NUMBER	NUMBER OF ANI- MALS	WEIGHT OF ANI- MALS	DAYS OF EXPERI- MENT	TOTAL NITROGEN	PURINE-ALLANTOIN N					PERCENTAGE OF SAME AS			URICOLYTIC INDEX	PURINE COEFFI- CIENT
					Allantoin	Uric acid	Bases	Sum	Per cent of total N	Allantoin	Uric acid	Bases		
					grams	mgm.	mgm.	mgm.	mgm.					
8	11	0.86	1-4	2.32	132	3.4	2.9	138.3	6.0	95.4	2.5	2.1	97	40
9	16	2.0	1-2	3.77	192	8.5	6.8	207.3	5.5	92.6	4.1	3.3	96	52
10	21	2.5	1-2	1.75	88	4.2	2.5	94.7	5.3	93.0	4.4	2.6	96	19
Average..									5.6	93.7	3.7	2.7	96	37

The high output of uric acid is accordingly merely an expression of the fact that the whole purine metabolism, like the protein metabolism or energy exchange, of so small an animal is pitched at a far higher level than that of man.

Observations on the excretion of total nitrogen and uric acid in normal albinos fed during the experimental period on a thin

soup of cracker crumbs and warm water (Morris and Rees, '23), are recorded in table 105.

The salt metabolism of the pregnant rat has been followed by Toverud ('23) and his results are given in table 106.

TABLE 105  
*On total nitrogen and uric acid excretion in albino rats*

	FIRST SERIES											
	Rat A (170 grams)		Rat B (158 grams)		Rat C (172 grams)		Rat D (255 grams)		Rat X (310 grams)		Rat Y (165 grams)	
	Total nitrogen	Uric acid	Total nitrogen	Uric acid	Total nitrogen	Uric acid	Total nitrogen	Uric acid	Total nitrogen	Uric acid	Total nitrogen	Uric acid
	<i>mgm.</i>	<i>mgm.</i>	<i>mgm.</i>	<i>mgm.</i>	<i>mgm.</i>	<i>mgm.</i>	<i>mgm.</i>	<i>mgm.</i>	<i>mgm.</i>	<i>mgm.</i>	<i>mgm.</i>	<i>mgm.</i>
Foreperiod:												
1st day...	78.8	1.20	84.0	0.98	63.8	0.63						
2nd day...	78.0	1.00	102.0	1.12	82.5	0.78	124.5	1.24	129.0	2.22	139.5	2.18
3rd day...	73.5	1.34	111.0	1.22	84.8	0.63	136.5	1.02	130.5	2.22	102.0	1.38
Average day	76.8	1.18	99.0	1.11	77.0	0.68	130.5	1.13	130.0	2.22	121.0	1.78
	SECOND SERIES											
	Rat A (157 grams)		Rat B (150 grams)		Rat C (165 grams)		Rat D (244 grams)					
	<i>mgm.</i>	<i>mgm.</i>	<i>mgm.</i>	<i>mgm.</i>	<i>mgm.</i>	<i>mgm.</i>	<i>mgm.</i>	<i>mgm.</i>				
Foreperiod:												
1st day...	115.5	0.96	92.3	1.09	73.5	0.65	132.0	0.88				
2nd day...	99.8	1.00	108.0	0.55	103.5	0.71	111.0	1.09				
3rd day...	114.0	0.95	112.5	0.98	123.0	0.83	147.0	1.18				
Average day	109.8	0.97	104.3	0.87	100.0	0.73	130.0	1.05				

TABLE 106  
*General salt metabolism—rat—pregnant female—on normal diet. Experiment continued four days*

INITIAL WEIGHT	GAIN IN WEIGHT	FOOD INTAKE PER 24 HOURS	CONSTITUENTS EXAMINED	AVERAGE INTAKE PER 24 HOURS	AVERAGE EXCRETION IN 24 HOURS IN		BALANCE	ABSORPTION	RETENTION
					Urine	Feces			
<i>grams</i>	<i>grams</i>	<i>grams</i>		<i>mgm.</i>	<i>mgm.</i>	<i>mgm.</i>	<i>mgm.</i>	<i>per cent</i>	<i>per cent</i>
180	5	5.9	Ca	31.4	2.42	20.5	+ 8.48	35.5	27.0
			Mg	12.3	4.35	6.7	+ 1.25	55.5	10.2
			P	39.3	12.50	9.7	+ 17.10	75.5	43.5

TABLE 107  
*Food intake: Daily consumption of calories*

EXPERIMENTS	NUMBER OF RATS EMPLOYED	PERIOD	AVERAGE DAILY CONSUMPTION IN CALORIES PER 100 GRAMS LIVE WEIGHT	
			Without milk	With milk
		<i>days</i>		
IV	12	27	49.1	51.5
V	16	21	48.7	49.7
VI	18	24	48.4	50.7
VII	8	21	48.6	47.7

TABLE 108  
*Food intake per week*

BODY WEIGHT	(1) WITHOUT BUTTER-FAT	(2) WITH BUTTER-FAT
<i>grams</i>	<i>grams</i>	<i>grams</i>
50	28.7	—
60	35.0	32.0
70	40.0	37.6
80	45.0	40.0
90	49.0	43.0
100	52.0	44.0
110	55.0	48.0
120	59.0	51.0
130	62.6	55.0
140	65.0	57.0
150	66.0	59.6
160	68.7	62.5
170	72.0	65.0
180	73.0	68.0
190	75.0	70.8
200	74.0	74.0
210	73.5	78.7
220	73.0	79.0
230		78.0
240		81.0
250		80.0
260		80.0
270		82.0
280		86.0
290		87.0
300		86.0

(a) *Bio-chemistry.* See References.

*Food intake.* For obvious reasons general statements concerning the food intake are unsatisfactory, but the following citations will serve to give some idea of the weight of food consumed under various conditions.

For growing rats, weighing about 40 grams at the beginning of the test, and about 80 grams at the end, and fed several different diets, each with and without milk, Hopkins ('12) reports the daily consumption of calories as given in table 107.

TABLE 109  
*Group A (Controls) Kojima ('17 c). All the weights given are in grams*

WEEK	WEEK ENDING	TOTAL WEIGHT OF GROUP	NUMBER OF RATS	AMOUNT OF FOOD CONSUMED	AMOUNT OF FOOD CONSUMED PER KILO OF BODY WEIGHT
	1916				
I	February 4	1175	6	580	493.6
II	February 11	1182	6	580	490.6
III	February 18	1180	6	580	491.5
IV	February 25	1043	5	520	498.5
V	March 3	1055	5	525	497.6
VI	March 10	1050	5	540	514.2
VII	March 17	1040	5	{ M. 476 R. 312	{ M. 457.7 R. 300.0
VIII	March 24	1050	5	{ M. 489 R. 326	{ M. 465.7 R. 310.4

M. = lean meat; R = rusks.

From weeks I-VI they were fed with "melox"; during weeks VII and VIII with lean meat (60 per cent) and rusks (40 per cent).

Osborne and Mendel ('15 a) report as shown in table 108 the rate of food intake in grams per week of male rats fed with edestin or casein plus protein-free milk, (1) without butter-fat (2) plus butter-fat. Each gram has a value of about five calories.

In table 109 are given the data from Kojima ('17 c) for rats weighing about 200 grams.

The data in table 108 show a consumption of about 7 grams per diem for a rat of 100 grams body weight and McCollum (MS.) reports the same. At 200 grams the intake is from 11 grams, table 108, to 14 grams, table 109. The relative weight of the

food consumed decreases with the increase in body weight (table 108). Age also is probably a modifying factor, though this has not been studied. In feeding under the usual conditions allowance for wastage must be made.

Tabular records for the very important studies from the laboratories of Osborne and Mendel, McCollum and many others on the modifications of body growth by the use of various diets are reluctantly omitted because of the general plan of presenting in these pages data for the normal rat only.

The literature given under "Physiology: References" at the end of the chapter contains the citations by authors and dates grouped in accordance with the following scheme.

9. *Nutrition—general. Quantitative deficiency.*

(a) *Tests with:* Proteins, Fats, Carbohydrates, Salts, Vitamines.

(b) *Effects on systems and functions.* (a) Osseous system, (a) Reproductive system; (b) Reproductive function.

(c) *Body temperature.* Using the mercurial thermometer in the rectum, Pembrey ('95) reports a body temperature of  $37.5^{\circ}\text{C}$ . in adult Albinos. Macleod ('07) by the same method finds a range of  $37.5$ – $38.5^{\circ}\text{C}$ . with a mean of  $37.9^{\circ}\text{C}$ .; Congdon ('12) also by the same method a temperature of  $37.9^{\circ}\text{C}$ . in the young; in the adult, when reared at  $16^{\circ}\text{C}$ ., a temperature of  $36.2^{\circ}\text{C}$ . and when reared at  $33^{\circ}\text{C}$ ., of  $37.2^{\circ}\text{C}$ .

The newborn rat is very responsive to changes in the external temperature. Temperature regulation is established at about 10 days of age—but is never perfect, even at maturity. The female has a somewhat higher temperature than the male, the excess for the female amounting to  $0.74^{\circ}\text{C}$ . in rats about 25 days old (Bierens de Haan, '22). There is a tendency for the body temperature to rise in the afternoon.

Graham and Hutchison ('14) using the thermoelectric method of Philips and Demuth, obtained the following ranges according to changes in the external temperature—table 110.

Bierens de Haan ('22) found the morning temperatures of young albino rats to be as in table 111.

These observations show an increase in body temperature with an increase in room temperature up to 30°C. at the rate of 0.7°C. for the body in response to 5°C. increase in the room temperature.

TABLE 110

EXTERNAL TEMPERATURE	BODY TEMPERATURE (C)	
	High	Low
5°C.....Series (a)	36.1	21.1
.....Series (b)	34.9	19.0
21°C.....	38.7	32.4
37°C.....	41.8	32.9

On change of surrounding temperature the adjustment of the caloric output lags. Thus rats brought from a cold to a warm room have a *higher* body temperature than rats habituated to the warm room, Przibram (Personal, 1923).

The rat therefore regulates but poorly its body temperature and is somewhat poikilothermous.

TABLE 111

*Body temperature according to room temperature*

TEMPERATURE OF ROOM (CONSTANT)	AGE ON FIRST DAY OF EXPERIMENT	NUMBER OF INDIVIDUALS (ONE BROOD EACH)	BODY TEMPERATURE MEASURED DURING	DIFFERENCE IN BODY TEMPERATURE FOR 5° ROOM TEMPERATURE
	<i>days</i>		<i>days</i>	
10°C.	24	8	34.8°C. (4)	0.7°C.
15°	24	8	35.5° (4)	0.7°
20°	25	6	36.2° (4)	0.7°
25°	24	6	36.8° (4)	0.7°
30°	23	7	37.5° (4)	0.3°
35°	23	5	37.8° (2)	

(d) *Calorimetry.* According to the experiments of Hill and Hill ('13) a fasting rat of 100 grams gives out approximately 20 calories per day. The ratio H/W (H = total heat; W = body weight) is fairly constant above 90 grams in body weight, i.e. the fasting heat production is directly proportional to the body weight.

In relation to the body surface  $H/W$  ( $W^3$  = relative body surface) the heat production is high in group 1—young active animals with a relatively large body surface; lowest in group 2—90–130 grams in body weight; and somewhat higher in group 3—see table 112 which gives:

- (I) The weight of the rat after 24 hours fast.
- (II) The temperature of the calorimeter during the experiment.
- (III) The time of year.
- (IV) The heat production for relative areas calculated per body weight (grams)<sup>3</sup> i.e.  $H/W^3$ .
- (V) The heat production calculated per body weight (grams)  $H/W$ .

In animals living together the heat production per gram is less than in the same animals living separately, and it has been observed that when living together the rats grow faster (Hopkins, '13) than when living alone.

For the direct determinations of the area of the skin (Hill and Hill, '13) see page 121.

10. *Reproduction and the sex organs.* The relations between fertility and nutrition are very evident in the rat and the existence of a dietary factor essential for reproduction has been postulated, Evans and Bishop ('22 d).

Przibram has found that rats put in the cold room early in the autumn and then removed to a warm room breed from then throughout the winter, thus avoiding the interruption to breeding from November to January, which occurs under the usual conditions. Constancy of (moderate) temperature is in general favorable to continuous reproduction.

In the immature female the vagina is closed by a membrane. This usually breaks down just before the first oestrus. Table 113 gives the data on these relations and also the length of the first four oestrous cycles (Long and Evans '22).

The later oestrous cycles are about five days in length (4.6–4.8). In each cycle four stages are recognized (Long and Evans, '22)

TABLE 112  
*Heat production per 24 hours in rats fasting 24 hours before the beginning of the experiment*  
 Weight in grams: Heat production in gram-calories—24 hours

Group 1:												
Weight of animal	50.5	62	70	71	76	78	82	87.5				
Temperature	14°	14°	14°	14°	15.5°	13°	15°	14°				
Time of year	Aug.	Aug.	Dec.	Dec.	Aug.	Dec.	Aug.	Oct.				
H/W <sup>3</sup>	1234	1540	1279	1297	1500	1437	1497	1530				
H/W	325	390	311	314	355	337	345	345				
Group 2:												
Weight of animal	96	103	103	117	118	118	122.5	124	127	129	129	129
Temperature	14.5°	14°	14°	14°	13.2°	14°	12.8°	13°	14.5°	14°	15°	15°
Time of year	Oct.	Nov.	Aug.	Nov.	Sept.	Nov.	Sept.	Nov.	Oct.	Nov.	Aug.	Aug.
H/W	1048	843	967	834	980	940	1194	960	1170	917	1035	1035
H/W	229	180	206	171	200	192	241	193	233	182	205.5	205.5
Group 3:												
Weight of animal	133	133	136	143	148	152	153.5	158	175	191	235	235
Temperature	14.5°	12.4°	15°	15°	12.8°	11°	14.5°	12°	13.5°	15°	12°	12°
Time of year	Oct.	Sept.	Oct.	Oct.	Sept.	Oct.	Oct.	Nov.	Nov.	Oct.	Sept.	Sept.
H/W	1126	1115	1158	1000	1055	1122	945	1100	1162	1160	1152	1152
H/W	221	219	206	192	200	211	177	204	208	202	187	187



and in the previous tables 2, 2a, 3, and 4 these have been given, together with a description of the vaginal smear which characterizes each stage.

The sexual behavior of the young male has been studied in great detail by Stone ('22).

Long and Evans ('22, pp. 70-74) also describe the behavior during mating. There is left in the vagina, after copulation, a so-called vaginal plug, formed by the male. This may remain in place from 12-24 hours and is a trustworthy sign of insemination.

At about the 14th day of pregnancy a deposit of blood may be seen in the upper part of the floor of the vagina. This occurs only at this phase and persists some three days. It is known as

TABLE 113

*Age in days at opening of vagina and at first ovulation, and length in days of first four oestrous cycles in a group of 200 rats.*

	RANGE	AVERAGE
Age at opening.....	34th-109th day	72nd day of life
Age at first ovulation.....	45th-147th day	77th day of life
Length of first cycle.....	3-37 days	10 days
Length of second cycle.....	3-25 days	9 days
Length of third cycle.....	4-26 days	8.5 days
Length of fourth cycle.....	3-23 days	7.3 days

the "placental sign" and is the earliest infallible sign of pregnancy which may be detected in the living animal.

In the series studied by Long and Evans ('22) there were found for one ovulation 5.2 corpora lutea in one ovary or 10.4 in both. The average number of eggs was 9.6 in both oviducts and the average number of young born 7. Thus there has been a loss at each step between ovulation and parturition.

*Weight of ovaries during gestation and lactation.* The changes in the weight of the ovaries during gestation and lactation have been followed by Stotsenburg ('23). The change in weight during gestation for rats weighing 200 grams is illustrated by chart 17.

The changes in the weight of the ovaries during lactation are shown in chart 18.

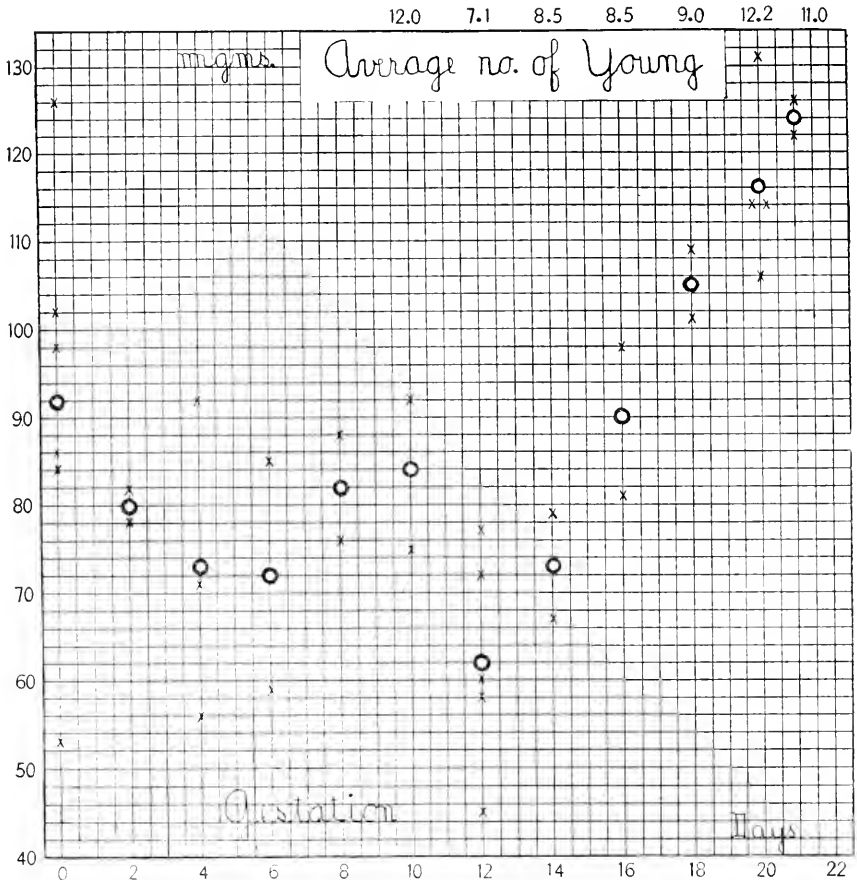

Chart 17 Giving in milligrams the weight of both ovaries at twelve periods during gestation. The mean value for each period is indicated by a heavy circle—the individual values by a cross. Days entered below and the average number of fetuses above. The mean ovulating weight of the ovaries is 49 mgm.

The values which appear in these charts depend mainly on the number and size of the corpora lutea. For a discussion of these structures see Long and Evans ('22).

When the young are removed from the mother at birth the ovaries fail to show the loss in weight which occurs during the later days in normal lactation.

In another series of 52 cases, Evans and Bishop ('23) determined that 69 per cent of the discharged ova were implanted and that of these latter about 9 per cent were resorbed. Out of three series, 4.2 per cent were born dead.

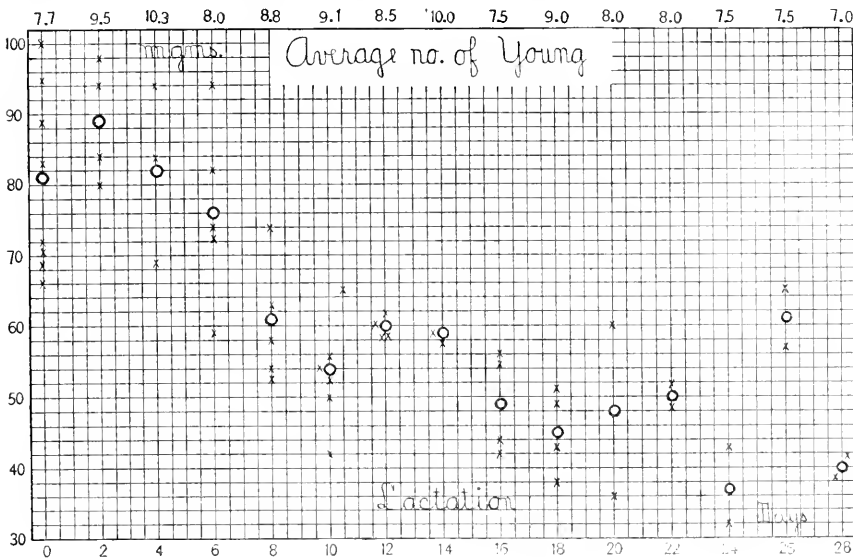

Chart 18 Giving in milligrams the weight of both ovaries at fifteen intervals during lactation. The mean value for the period is indicated by a heavy circle. The individual values by a cross. Days entered below and the average number of young above. The mean ovulating weight of the ovaries is 49 mgm.

In the Institute colony about 2 per cent of the young are dead at birth—a proportion similar to that found in man—but the ratio of the dead born males is 129 to 100 females, King ('21).

The number of litters born is only slightly less (97.5 per cent) than that to be expected from the “placental sign.” Of the litters born, about 86 per cent were successfully suckled, and at weaning the mothers were 6.4 per cent heavier than at littering, Evans and Bishop ('23).

*Sex organs: (a) Male.* See References.

(b) *Female.* The placenta is not permeable for adrenalin (Shimidzu '20) but is permeable for all basic dyes tested by Shimidzu ('22) while among fifteen acid dyes eight penetrated the placenta. Permeability is determined by the colloidal state of the dye in the serum.

During the several stages of oestrus and during all the phases of the reproductive cycle, the female reproductive organs all show concomitant modifications.

The contractions of the longitudinal muscles of the uterus, in relation to the phases of the oestrus cycle, have been studied by Blair ('23) using the method of Kehrer ('07). The mean

TABLE 114  
*Mean contraction rates of uterus*  
D = dioestrous interval. O = oestrous

SIX GROUPS	RATE PER HOUR					
	Maximal contractions		Submaximal contractions		All contractions	
	D.	O.	D.	O.	D.	O.
Adults : both methods.....	41.4	25.6	31.6	33.6	73.0	59.2
Number of experiments....	24	36	24	36	24	36

contraction rate for the maximal contractions was slower during oestrus than during the dioestrus. The rate for the submaximal contractions varied widely, but the mean rate was little affected by the phases of the cycle. The average values for six groups of tests are given in table 114.

11. *Exocrine system. General.*

(a) *Mammary function.* See References.

(b) *Feeding exocrine glands.* See References.

12. *Endocrine glands.*

(a) *General.* See References.

(b) *Testes.* See References.

(c) *Ovaries.* See References.

(d) *Suprarenals.* The possible change in the weight of the suprarenals during pregnancy and lactation has been examined by J. C. Donaldson ('24). The results are given in table 115.

From this study the author concludes as follows:

1. No increase in weight of the adrenal glands during pregnancy and lactation occurs in normal albino rats free from visible signs of disease.

2. An increase in weight of the adrenal glands occurs in unmated rats suffering from gross pathological lesions represented by lung infections and infections of the middle ear.

3. A further increase in weight of the adrenals occurs during pregnancy in rats suffering from pathological conditions.

The adrenals increase in weight several fold in animals starved from 10-12 days, Vincent and Hollenberg, '20.

TABLE 115

*Percentage deviations in the weight of the adrenals of pregnant and lactating albino rats. Based on body weight. Values in table 148 used as a standard*

GROUPS	NUMBER OF CASES	MEAN BODY WEIGHT	MEAN BODY LENGTH	MEAN WEIGHT OF BOTH ADRENALS	MEAN PERCENTAGE DEVIATION	PROBABLE ERROR OF THE MEAN
		<i>grams</i>	<i>mm.</i>	<i>mgm.</i>		
Healthy controls.....	29	166	187	44.7	+2.67	±1 87
Pregnant and lactating....	29	168	188	45.3	+1.86	±2 34
Pathological controls.....	48	179	191	47.9	+ 6.4	±1 89
Pregnant and lactating....	51	221	203	57.8	+11.8	±1 98

(e) *Thyroid and parathyroids.* The amount of intestine contracting substances in the thyroid of the rat according to age has been studied by Hammett and Tokuda ('21). The duodenal segments, prepared with precautions determined by Hatai and Hammett ('20), were standardized in a solution containing 0.25 cc. of M/10 Na<sub>2</sub>CO<sub>3</sub> and the shortening induced by a like concentration of thyroid extract was expressed as a percentage of the standard value. The results are presented in table 116 and chart 19.

In general the extract produces an increasing amount of contraction up to about 150 days of age—after which the effect diminishes rapidly. The response is more marked for the male than for the female. There are however significant high values at birth, weaning, puberty and during rapid growth—the female leading. It is concluded that these changes in the thyroid ex-

tract are particular expressions of general changes in the organism in which the thyroid participates.

The influence of the parathyroid and thyroid tissue on the creatinine-creatine balance in incubated extracts of muscle tissues has been followed by Hammett ('21). His results indicate

TABLE 116

*The age and sex distribution of the animals the thyroid extracts of which were tested, together with the averages of the intestine-contracting power of the extracts according to the individual age groups*

MALES				FEMALES			
(1) Age	(2) Number of tests	(3) Number of rats	(4) Contraction in terms of M/10 Na <sub>2</sub> CO <sub>3</sub>	(5) Age	(6) Number of tests	(7) Number of rats	(8) Contraction in terms of M/10 Na <sub>2</sub> CO <sub>3</sub>
<i>days</i>			<i>per cent</i>	<i>days</i>			<i>per cent</i>
New-born	3	15	73.8	New-born	4	31	86.5
10-11	3	9	41.0	10-11	2	10	64.0
15	3	6	47.2	14-15	2	6	92.9
20	3	6	56.8	21-22	2	4	72.2
25	3	6	43.4	25	2	3	111.6
30	3	6	83.9	30	2	3	45.0
40	3	3	41.3	39	2	2	52.9
50	3	3	63.0	50-52	3	3	83.3
60	3	3	70.5	54-55	3	3	63.9
70	4	4	75.9	60	2	2	86.1
79-80	3	3	167.5	70	2	2	72.1
90	2	2	119.8	75	2	2	72.1
100	1	1	121.4	81-83	3	3	105.0
125	3	3	138.6	90	3	3	99.5
150	3	3	228.8	100	3	3	101.7
200	3	3	101.7	125	1	1	95.0
460	1	1	38.1	150	4	4	164.6
500	2	2	59.2	300	4	4	38.6
520	1	1	68.4				

that the addition of parathyroid tissue to extracts of muscle tissue, in acid, neutral or alkaline mixtures, directly *retards* the increase of creatinine formation normally occurring under these conditions. The addition of thyroid tissue to similar extracts is without effect.

*Removal of the thyroid plus the parathyroids, and of the parathyroids alone.* Hammett 1921-1924 has made a series of obser-

vations on the effects of thyroparathyroidectomy and of parathyroidectomy. A condensed summary of the more important results is here presented. The groups from which the entire thyroid apparatus had been removed are briefly designated as "Thypars" and those from which the parathyroids alone had been removed as "Parathys."

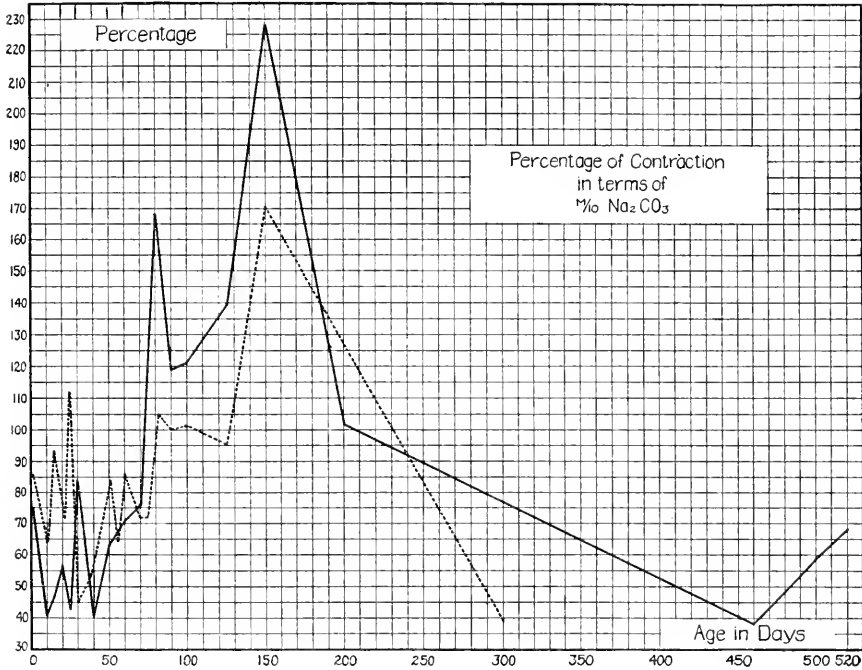

Chart 19 Showing the changes in the intestine-contracting power of equivalent amounts of thyroid extracts from male and female albino rats according to age.

In the series of studies now complete, the operation was made at 100 days of age and the animals were killed at 150 days. In a less complete series, still in progress, the operation was made at 75 days and the killing as before, at 150 days. Unless otherwise stated, the conclusions are based on rats operated at 100 days of age. Condensed data table 117.

As previously noted (p. 134) these operations, both of which involve removal of the parathyroids, were accompanied by the

smallest post-operative mortality when carefully tamed and gentle rats were used. The effects observed were all measured in relation to litter mate controls of the respective test animals.

*Effect on body length, body weight and tail length* (Hammitt, '23 and '24), "Thypars." The growth of the body in weight was the most retarded. The retardation was more marked in the females. A lesser retardation of gross growth occurred when the thyroid apparatus was removed at 75 days.

"Parathys." The same effects were observed, but to a lesser degree, in the rats operated at 100 days. In those from which the parathyroids were removed at 75 days the gross growth of the males was more retarded than was that of the females. Table 117.

*Effects on growth and composition of the long bones* (Hammitt, '23, '24). In the "Thypars" there is retardation of growth of humerus and femur in length and weight. Ossification is retarded and dessication is produced. The humerus is more affected than the femur. The calcium of the ash is not affected in the males but is decreased in the females. In both sexes the magnesium and phosphorus tend to be increased.

In the "Parathys" there is retardation of growth in length and weight of the long bones, but to a lesser degree than in the "Thypars." No disturbance in the percentage of ash, water or organic matter is caused in the males. In the females ossification is retarded. In the males there is no change in calcium content of the ash, but the magnesium and phosphorus increase. In the females the latter occurs, together with a decrease in calcium.

*Effect on the incisor teeth* (Hammitt, '22). "Thypars." Defects of the incisor teeth do not usually occur.

"Parathys." (Operation at 75 days). Fragility, leading to the breaking off of the tooth; a change from the normal semi-translucency to a pathological snowy white opacity, together with a tendency to loss of pigment and to overgrowth due to displacement, all occur frequently.

These effects, not found in the "Thypars," from which the parathyroids were also removed, are interpreted as "expression of a summation of stimulation of metabolism."



*Effect on the growth of the brain and spinal cord (Hammett, '23).*  
 In "Thypars" there is a marked retardation of the growth of the brain and cord. The inhibition of the growth of the brain is much greater than that of the cord. The results are more marked in the female than in the male. Table 117.

In "Parathys" there appears a slight but significant retardation of the growth of the cord and of the female brain. The growth

TABLE 117

*The relative per cent increments of the body and the several organs from 100 to 150 days of age using the controls = 100 per cent, as base*

MALES			FEMALES		
Part	Thypars	Parathys	Part	Thypars	Parathys
B. L.....	35.2	64.0	B. L.....	24.5	47.2
B. W.....	31.0	57.1	B. W.....	-28.2	20.7
T. L.....	37.2	63.9	T. L.....	19.4	49.3
Brain.....	20.5	108.3	Brain.....	3.4	89.8
Cord.....	51.9	90.8	Cord.....	53.7	87.6
Testis.....	51.2	109.2	Ovary.....	-236.3	-90.3
Epidid.....	65.0	97.2	Uterus.....	-107.7	-31.1
Hypop.....	162.2	58.4	Hypop.....	66.7	60.2
Adrenals.....	-123.0	18.1	Adrenals.....	-124.7	-3.9
Pancreas.....	-42.0	86.5	Pancreas.....	-124.5	72.8
Thymus.....	-157.2	-46.3	Thymus.....	-556.2	-321.2
Thyroid.....		63.9	Thyroid.....		47.3
Heart.....	-26.7	76.9	Heart.....	-48.4	78.2
Lungs.....	-21.9	25.7	Lungs.....	-47.8	80.6
Liver.....	-43.5	63.0	Liver.....	18.0	57.3
Kidneys.....	-39.1	33.8	Kidneys.....	-82.8	23.5
Spleen.....	-38.1	139.1	Spleen.....	-121.1	128.1
Submax.....	0.6	130.5	Submax.....	0.5	209.4
Eyeballs.....	83.5	100.6	Eyeballs.....	50.4	75.5

of the male brain is not retarded. In general the inhibition is very much less than that caused by the loss of the thyroid secretion, but the effect on the females is greater than that on the males.

*Effect on the reproductive system (Hammett, '23).* "Thypars." In males the growth of the testes and epididymis is slightly retarded.

In females the ovaries and uterus not only stop growing, but actually retrogress and lose weight. The ovaries are the more affected.

“Parathys.” The males are not affected. The effects in the females are similar to those in the “Thypars” but in less degree. Table 117.

*Effect on the glands of internal secretion (Hammitt, '23).* “Thypars.” In the male the growth of the hypophysis is accelerated. Absolute cessation of growth and a high degree of retrogression is shown by the adrenals, pancreas and thymus. The thymus is most affected.

In the female the growth of the hypophysis is retarded, but the other glands are affected as in the male.

“Parathys.” In the male there is retardation of growth in the hypophysis, adrenals, pancreas and thyroid. The thymus shows a considerable degree of retrogression. In the female the effects are similar, but more marked than those in the male, except in the case of the hypophysis—table 117.

*Effect on the viscera (Hammitt, '22 and '23).* “Thypars.” In the male there is absolute inhibition and also retrogression in the growth of the heart, lungs, liver, kidneys and spleen. Growth in the submaxillaries is stopped.

In the female the effects are as in the male, except in the case of the liver. The retrogressive changes are more marked in the female.

“Parathys.” In both sexes there is inhibition only, except in the spleen and submaxillary, which grow excessively.

*Effect on the refractive index and water content of the blood serum (Hammitt, '23).* “Thypars.” Male rats show a decrease in the water content of the serum and an increase in the refractive index of such a nature as to allow the conclusion that a true partial desiccation of the serum has occurred without a great alteration in the nature or distribution of the refractive solutes.

In female rats the operation produces a state of partial inanition, the effect of which on the serum is to counterbalance the desiccatory effect of the thyroid loss when growth in body weight occurs after such a loss.

“Parathys.” The effects are the same for both sexes. There is no alteration in the concentration of total solids of the blood serum which appears when the rats are 150 days old. There is a

change in the nature or the distribution of the refractive substances aside from the solvent water. This change is in the same direction and of approximately the same degree in the two sexes.

*Effect on reproduction (Hammett, '22).* Studies have been made of the reproductive ability of thyroidless albino rats. It was found that conception occurred when male "thypars" or "parathys" were mated with female "thypars" or "parathys."

When the thyroid apparatus was removed from young rats 45 or 56 days of age, there was no apparent inhibition of function of the internal secretion of the gonads (stimulation to development of the secondary sexual characteristics; stimulation to sexual activity; preparation of the uterine mucosa for nidation).

The formation, maturation and discharge of the gametes were however disturbed by the loss or deficiency of the thyroid secretion, as were the reproductive processes subsequent to gonadal participation. This is shown by the increased sterility, greater age at breeding, high birth mortality, high mortality during and after weaning, the smaller number of rats in the litters, and the failure of the rats to thrive during the nursing period, as do the young of normal mothers.

13. *Pineal gland.* See References.

14. *Hypophysis.* The influence of diet on the extracts of the hypophysis and the thyroid, tested against the intestinal strip, was studied by Degener ('22). The diets used were oatmeal, vegetables (fresh), meat and the standard diet plus potassium iodide. The extract of the entire control hypophysis causes a relaxation of the strip; with the oatmeal and vegetable diets it causes a contraction. In the controls the extract of the glandular portion alone causes contraction, that of the nervous portion alone, relaxation. The experimental diets which are effective produce an extract of the entire gland similar in reaction to that of the glandular portion alone.

The extract of the thyroid gland was not modified in its action by diet.

*Excitement and starvation.* The effect of general excitement or fighting on the secretion of the several ductless glands, as indicated

by the reaction of an intestinal strip to the extracts, has been tested by Uno ('22). The extracts of the test thyroid and the test suprarenals were not modified. The extract of the test hypophysis however caused a contraction of the strip, the response characteristic for the glandular portion of the hypophysis, while that from the control glands caused a relaxation.

After starvation for 10–12 days the thyroid is greatly increased in weight behaving under these conditions like the adrenal; Vincent and Hollenberg, '20.

15. *Feeding endocrine glands.*

(a) *General.* See References.

(b) *Hypophysis.* See References.

(c) *Thyroid.* As the result of feeding small quantities of fresh sheep thyroid to rats, Cramer and Krause ('13) found a unique condition of the carbohydrate metabolism.

Owing to the inhibition of the glycogenic function, the liver contains only traces of glycogen. There is no glycosuria and the tolerance for glucose is only slightly diminished. The action of the thyroid on protein metabolism is effected partly through its action on carbohydrate metabolism, for the distribution of the nitrogen constituents of the urine is very similar to that observed after withdrawal of carbohydrates from the diet.

As the results of feeding thyroid preparations to young rats, Cameron ('23) reports that the principal organs, heart, liver, kidneys, adrenals, spleen, lymph glands and pancreas, hypertrophy; fat disappears. The animals' thyroid ceases to grow. Muscle does not develop at the usual rate. The growth rate diminishes. Cessation of the feeding of the thyroid is followed by a return to the normal.

(d) *Suprarenals.* See References.

#### PHYSIOLOGY: REFERENCES

- Rat compared with man.* Biscoff, 1863.  
*Equivalent ages.* Donaldson, '06, '08, '10, '18. Hatai, '17.  
*Technique.* Hammett, '21 i, '22. Osborne and Mendel, '12 d. Woithe, '07.  
*Muscles and nerves.* Dubois, 1898. Engelmann, 1877. Hammett, '21 a, '21 b, '22. Hatai and Hammett, '20. Lee, '10.

*Exercise.* Donaldson, '11. Hatai, '15. Keith and Mitchell, '23. Kocher, '16.

*Nervous system. Central:* Hammett, '23 c. Hatai, '07 a, '08, '15 a, '17. *Brain:* Bianchi, '22. Ferrier, 1886. Hatai, '04 a. Komine, '19, '19 a. Mills, 1897. Ranson, '03. Schäfer, 1900. Watson, '05 c.

*Degeneration.* Nicholson, '23. Nittono, '23. Ranson, '04, '06, '09, '14, '14 b.

*Regeneration.* Greenman, '13, '16. Morpurgo, '23. Tournade, '13.

*Special senses.* Bogardus and Henke, '11. Hunter, '14. Kreidl and Yanase, '07. Lane, '17. Vincent, '12, '13, '15, '15 a, '15 b.

*Circulation.* Barcroft, '23. Happ, '22. Rattone and Mondino, 1888, 1888 a, 1889, 1889 a.

*Blood and lymph.* Addison and Thorington, '18. Becht and Luckhardt, '16. Cramer, Drew and Mottram, '21. Downey, '17, '18. Emmel, '22. Emmel and Walker, '22. Erdély, '05. Folin and Denis, '13. Folin and Morris, '13. Hammett, Nowrey and Müller, '22. Hammett and Nowrey, '22. Jones and Rous, '17. Mattill, '21. Murphy and Morton, '15. Pappenheimer, '17. Robertson, '12. Rywosch, '07. Scott, '23, '23 a. Suzuki, '20. Trommsdorf, '09. Zilva, '19 a.

*Respiration.* Barcroft and Barcroft, '23. Bert, 1878. Boycott and Damant, '08. Boycott, Damant and Haldane, '08. Cramer, '08. Hill and Macleod, '03. MacArthur and Jones, '17. Macleod, '07. Pembrey, 1895. Pembrey and Spriggs, '04. Prince, '17.

*Metabolism.* Abelin, '22. Ackroyd, '14. Astaschewsky, 1877. Basch, 1870. Basler, '09. Bohlen, 1894. Carlier, '05. Cooper, '23. Copeman and Hake, '08. Cramer, '08. Cramer and Lochhead, '13. Cramer and Pringle, '10. Cunningham, '20. Drasch, 1886. Eimer, 1869. Ellenberger, '06. Elliott and Barclay-Smith, '04. Falk, Noyes and Sugiura, '22. Faure, and Soula, '13. Folin and Morris, '13. Gage, '23. Goldmann, '09. Gruetzner, 1875, 1878, 1894, 1898, '05. Gulick, '22. Hatai, '05, '17 a. Hohmeier, '01. Hunter, Givens and Guion, '14. Jolyet and Chaker, 1875. Langley, 1879. Langley and Sewall, 1879. McMaster, '22. Macleod, '07. Mattges and Marquardsen, 1898. Mills, Dorst, Mynchenberg and Nakayama, '23. Mitchell, Shonle, and Grindley, '16. Morris and Rees, '23. Oliver, '21. Ordway and Morris, '13. Osborne and Mendel, '14 e. Paneth, 1888, 1888 a. Ranvier, 1887, 1888, 1894. Schiff, 1859. Toverud, '23. Vignes, '13. Zawarykin, 1883.

*Biochemistry.* Burnett, '18. Clifford, '21, '22. Cramer and Pringle, '10 a. Cramer and Lochhead, '13. Emmett and Luros, '19 a. Fisher, '23 a. Funk, Harrow and Paton, '23. Hammett, '21 f, '22, '22 a, '23 a, '24 b. Hammett and Nowrey, '22 a. Hanson, '21. Hatai and Hammett, '20. Hopkins and Dixon, '22. Hunter, Givens, and Guion, '14. Koch and Voegtlin, '16. Kreidl and Neumann, '08. Levine, McCollum and Simmonds, '22. Lewis and Root, '20. McCollum, '09. MacDonald, '22. Mellanby, '08. Mitchell, Nevens and Kendall, '22. Moulton, '23. Myers and Fine, '15. Nicolaier, '02. Noyes, Sugiura and Falk, '23. Osborne, Wakeman and Ferry, '19. Rohd  and Jones, '09. Shanks, '23. Shimidzu, '22. Sugiura, Noyes and Falk, '23. Zilva, '20, '20 a. Zucker and Gutman, '22.

*Food intake.* Hopkins, '12. Kojima, '17. Osborne and Mendel, '15 a.

*General nutrition.* Abderhalden, '19. Aron, '12, '13. Bond, '22. Brüning, '14 a. Czermak, 1895. Damon, '23. Daniels and Nichols, '17. Daniels and Loughlin, '18. Falta and Noeggerath, '05. Ferry, '20. Givens and Cohen, '18. Hale, '23. Hawk, Fishback and Bergeim, '19. Hoffman, '23. Hogan, '16, '17 a, '18. Jacob, '06. Johns, Finks and Paul, '20. Johns and Finks, '20 a. Lane-Clayton, '09. McCollum and Davis, '15 a, '15 c, '15 d, '15 e, '15 f. McCollum, Simmonds and Pitz, '16 a, '16 c, '16 f, '17, '17 a, '17 b. McCollum, '17. McCollum, '18. McCollum, Simmonds and Parsons, '18 a, '19 a. McCollum and Simmonds, '18 b. Mitchell and Mendel, '21. Nelson, Heller and Fulmer, '23. Osborne and Mendel, '11, '11 a, '12 a, '12 e, '12 e, '13 a, '14, '16 a, '16 e, '17 a, '17 d, '17 e, '18, '18 d, '19 b, '21 c. Pacini and Russell, '18. Palmer and Kennedy, '21. Richardson and Green, '16, '17, '17 a. Sherman, Rouse, Allen and Woods, '21. Steenbock, Kent and Gross, '18. Steenbock, '23. Sugiura and Benedict, '18, '19.

*Quantitative deficiency.* Brüning, '14. Jackson, '16, '17, '21. Jackson and Stewart, '19, '20. Noë, 1900. Reed, '21. Slonaker and Card, '23 a, '23 b.

*Tests with proteins.* Aekroyd and Hopkins, '16. Asayama, '16. Bateman, '16. Cajori, '20, '21. Eddy and Eckman, '23. Emmett and Luros, '19. Finks and Johns, '21, '21 a. Folin and Morris, '13. Frank and Schittenheim, '12. Gardiner, '06. Hawk, '23. Hogan, '17. Johns, Finks and Paul, '19. Johns and Finks, '20. McCollum and Davis, '15. McCollum, Simmonds and Pitz, '16 d, '16 e. McCollum, Simmonds and Parsons, '19, '21, '21 a, '21 b, '21 c, '21 d. Maynard, Fronda and Chen, '23. Mendel, '13. Mignon, '23. Mitchell, '18. Morgan. Newbecker and Bridge, '23. Osborne and Mendel, '11 b, '12, '12 f, '12 g, '13, '14 a, '14 c, '15 a, '15 c, '16 c, '16 d, '17, '18 b, '18 e. Osborne, '13. Osborne, Mendel and Ferry, '19. Osborne and Mendel, '19 c, '19 e, '20, '21 b, '21 e, '22, '23 a. Sure, '20, '20 a, '21, '22, '22 a. Totani, '16. Underhill, '15. Wang, '21. *Fats.* Drummond and Halliburton, '19. Drummond, Golding, Zilva and Coward, '20. Funk and Macallum, '16. Halliburton and Drummond, '17. Halliburton, Drummond and Cannan, '19. Tysan, '17. McCollum and Davis, '13 a, '14, '15 b. Mackay, '21. Osborne and Mendel '12 b, '13 b, '14 b, '15, '15 b. Osborne and Wakeman, '15. Osborne and Mendel, '16 b, '20 f. *Carbohydrates.* Carlson, Hektoen and LeCount, '16. Drummond, '16. Mattill, '23. Osborne and Mendel, '21 a. Palladin and Riskaltchouk, '16. Smith and Carey, '23. *Salts.* Daniels and Rich, '18. Daniels and McClurg, '19. Forbes and Keith, '14. Gevaerts, '01. Gregersen, '11. McCollum and Davis, '13. Miller, '23. Osborne and Mendel, '18 a. Spriggs, '07. Steenbock, Hart, Sell and Jones, '23. *Vitamins.* Bethke, Steenbock and Nelson, '23, Cook, '13. Coward and Drummond, '20, '21, '22. Cramer, '20, '22, '23. Damon, '21. Daniels and Loughlin, '20, '20 a. Davis and Outhouse, '21. Denton and Kohman, '18. Drummond, '18. Drummond and Coward, '20, '20 a, '20 b. Drummond, Coward and Watson, '21. Dutcher, Kennedy and Eckles, '20. Dutcher and Outhouse, '23. Eddy and Stevenson, '20. Eddy, '21. Eddy, Heft, Stevenson and Johnson, '21. Emmett and Luros, '19 b, '20. Emmett and Stockholm, '20. Emmett, '21, '22. Emmett and Peacock, '23. Findlay and Mackenzie, '22. Funk and Macallum, '15, '16 a. Funk, '16 a. Funk and Dubin, '20, '21, '21 a. Funk and Paton, '22. Ghose, '22. Goldblatt and Soames, '23 a. Harden and Zilva, '18. Hawk, Smith and Bergeim, '21, '21 a, '21 b.

Heller, '23. Hopkins, '12. Hopkins and Neville, '12. Hopkins and Chick, '19. Hopkins, '20, '20 a. Kennedy and Palmer, '22. Kennedy and Dutcher, '22. McCollum and Davis, '14 a. McCollum, Simmonds and Pitz, '16, '16 b. McCollum and Pitz, '17. McCollum and Simmonds, '18, '22. Macallum, '19. MacDonald and McCollum, '21. Mendel, '22. Morgan, '23, '23 a. Morgan and Stephenson, '23. Nelson, Fulmer and Cessna, '21. Nelson, Lamb and Heller, '22. Niemes and Wacker, '22. Orton, McCollum and Simmonds, '22. Osborne and Mendel, '17 c, '18 c, '19, '19 a, '19 d. Osborne and Wakeman, '19. Osborne and Mendel, '20 a, '20 b, '20 c, '20 d, '20 e. Osborne and Leavenworth, '21. Osborne and Mendel, '21, '22 a, '22 b. Osborne, Mendel and Cannon, '22 a, '22 b. Osborne and Mendel, '23. Osborne, Mendel and Cannon, '23. Richardson, '21. Rose and Macleod, '22. Santos, '22. Sell and Nelson, '21. Sherman, Macleod and Kramer, '20. Sherman and Smith, '22. Sherman and Grose, '23. Sherman and Kramer, '23. Stammers, '21, '22. Steenbock, '18. Steenbock, Boutwell and Kent, '18. Steenbock and Gross, '19. Steenbock and Boutwell, '20, '20 a, '20 b. Steenbock and Gross, '20. Steenbock, Sell and Boutwell, '21. Steenbock, Sell and Buell, '21. Steenbock and Sell, '22. Steenbock, Jones and Hart, '23. Steenbock and Nelson, '23. Steenbock, Sell and Jones, '23, '23 a. Steenbock, Sell and Nelson, '23, '23 a. Stephenson, '20. Williams, '21. Wilson, '22. Zilva and Miura, '21.

*Effects on systems, organs and functions.* Allen, '19 a. Donaldson, '11 a. Gross, '23. Hartwell, '23. Hunt, '10. Jackson, '16, '17. Kittelson, '20. Lipschütz, '18. Morgulis, '11. Osborne, Mendel, Park and Darrow, '23. Revilliod, '08. Sherman and Crocker, '22. Sherman and Muhlfeld, '22. Siperstein, '21. Watson, '05, '07 e, '07 f. *Osseous system.* Gies and Perlzweig, '15. Korenevsky, '23. Korenevsky and Carr, '23. Osborne, Mendel and Park, '23. Robison, '23. Toverud, '23. *Reproductive system.* Evans and Bishop, '23 c. Macomber, '23. Reynolds and Macomber, '21. *Reproductive function.* Hart and Steenbock, '19. Hewer, '14. Mitchell, '22. Watson, '07. *Body temperature.* Bierens de Haan, '22. Bierens de Haan and Przibram, '22. Congdon, '12. Graham and Hutchison, '14. Hill, '13. Macleod, '07. Pembrey, 1895. Pitts, 1898. Przibram, '17, '23, '23 a. *Calorimetry.* Hill and Hill, '13. Hopkins, '13. Lusk, '19. Pedotti, '21. Richet, 1891. Tangl, '13.

*Reproduction and the sex organs.* Brumpt, '07. Carmichael and Marshall, '07. Corner and Hurni, '18. Corner and Warren, '19. Cuénot, 1899. Daels, '08. Evans and Bishop, '22, '22 a, '22 d, '23 b, '23 c. Fischel, '14. Freyer, '21. Hammett, '22 f. Heape, '00. Herring, '20. Ishii, '20, '22. Iwanoff, '03, '07. King, '16 a. Königstein, '07. Loew, '03. Lombroso and Bolaffio, '09. Long and Quisno, '16. Long, '19. Long and Evans, '20, '20 f, '22. Mattill and Conklin, '20. Mattill and Stone, '23. McCartney, '23. Osborne, Mendel and Ferry, '17. Palmer and Kennedy, '23. Przibram, '17. Reynolds and Macomber, '21. Scott and Evans, '21. Shimidzu, '20, '22. Slonaker and Card, '18, '23 c. Sobotta, '10. Steinach, '10. Stone, '22.

*Weight of ovaries during gestation and lactation.* Evans and Bishop, '23. King, '21. Long and Evans, '22. Stotsenburg, '23. *Male.* Iwanoff, '00. Moore, '23. Walker, '11. *Placenta.* Evans and Bishop, '22 b. *Uterus.* Blair, '23. Evans and Bishop, '22 c. Ogata, '21. Shimidzu, '20, '22. Tate and Clark, '22.

*Exocrine system: General.* Hashimoto, '22, '22 a. Laguesse and Castellant, 1898. Walker, '10, '10 a.

*Mammary function.* Frank and Unger, '11. Freyer and Evans, '23. Gage and Gage, '09. Hart, Nelson and Pitz, '18. Hartwell, '21, '21 a, '22. Kuramitsu and Loeb, '21 a. Loeb and Kuramitsu, '21. Lombroso and Bolaffio, '09. Maeder, '22. Myers, '19 a. Sutter, '21.

*Feeding exocrine glands.* Eddy, '16. Marine, '15.

*Endocrine system: General.* Biedl, '13. Degener, '22. Gies, '17. Goldmann, '09, '12. Hammett, '21. Itagaki, '17 b. Kojima, '17. McCartney, '23 a. Mingazzini, '01. Moore, '19, '19 a, '21. Sand, '19. Uno, '22. *Testes.* Barnabo, '13. Fisher, '23. Loisel, '04. Mattill and Carman, '23. Romeis, '21, '22. Steinach, 1894. Steinach and Holzknecht, '16. *Castration.* Donaldson and Hatai, '11 a. Gies and Miller, '17. *Transplantation.* Steinach, '11, '12. Yatsu, '21.

*Ovaries.* Bouin, 1899. Itagaki, '17, '17 a.

*Spaying.* Doncaster and Marshall, '10.

*Transplantation.* Marshall and Jolly, '07, '08. Steinach, '13. Stotsenburg, '17. Wiesner, '23.

*Suprarenals.* Brown-Séguard, 1856. Collip, '20. DaCosta, '13. Cow, '19. Cramer, '19. Cristiani and Cristiani, '02, '02 a, '02 b, '02 c, '02 d. Donaldson, J. C., '24. Harley, 1858 a, 1858 b. Kuriyama, '18 d. Poll, 1898, 1899. Schäfer, '08. Shimidzu, '20. Stewart and Rogoff, '18. Strehl and Weiss, '01. Vincent, 1897, 1897 a. Vincent and Hollenberg, '20. Wiesel, 1899, 1899 a. *Removal.* Boinet, 1895, 1895 a, 1895 b, 1895 c, 1896, 1897, 1897 a. Catan, Houssay and Mazzocco, '21. Harley, 1857, 1858. Jaffe and Marine, '23. Kuriyama, '18 e. Philipeaux, 1856. Scott, '23. Schwarz, '10.

*Thyroid and parathyroid.* Carlson, Rooks and McKie, '12. Cristiani, 1893 a, 1893 b, 1895, '00. Degener, '22. Exner, '20. Hammett, '21 d, '21 e. Hammett and Tokuda, '21. Hatai and Hammett, '20. Hohlbaum, '12. Hunt and Seidell, '09. Leischner and Köhler, '11. Leopold, '08. Loeb, '20. Tsuji, '20. Uno, '22. Vincent and Jolly, '05, '06. Watson, '04, '06. *Removal.* Cramer and M'Call, '18. Cristiani, 1893. Erdheim, '06 a, '07, '11, '11 a, '11 b. Gies, '14. Hammett, '21 c, '22, '22 c, '22 d, '22 e, '22 f, '23, '23 b, '23 c, '23 d, '23 e, '23 f, '23 h, '23 i, '24, '24 a, '24 c. Iselin, '08, '11. Korenchevsky, '22 a. Leischner, '07. Olds, '10. Schiff, 1884, 1884 a. Toyofuku, '11.

*Pineal.* Foà, '14.

*Hypophysis.* Degener, '22. Flower, Forkner, Kellum, Walker, Smith and Evans, '23. Gemelli, '06. Goetsch and Cushing, '13. Kojima, '17 a. Larson, '19, '20. Robertson and Burnett, '15. Schäfer, '09, '11.

*Thymus.* Jacobson, 1817. Pappenheimer, '14, '14 a, '14 b. Takenouchi, '19 a.

*Feeding endocrine glands. General.* Cameron, '23. Cleghorn, '01. Gies and Miller, '15. Gies and Heft, '17. Gudernatsch, '15 a, '18. Hewer, '14. Hoskins, '16. Kojima, '17 c. Schäfer, '12. Sisson and Finney, '20.

*Hypophysis.* Aldrich, '12. Behrenroth, '14. Evans and Long, '22. Goetsch, '16. Lewis and Miller, '13. Marinus, '19. Sandri, '08. Smith, '23.



*Thyroid.* Bircher, '10 a. Cameron and Carmichael, '20, '21, '21 a. Cameron and Moore, '21. Cameron and Sedziak, '21. Cameron and Carmichael, '22. Cameron, '23. Chidester, '12. Cramer and Krause, '13. Cramer and M'Call, '17, '19. Fordyce, '12. Gudernatsch, '15. Herring, '17, '17 a, '19. Hewitt, '14, '14 a, '20. Hoshimoto, '20. Kojima, '16, '17 b. Kuriyama, '17, '18, '18 a, '18 b. Peiser, '06.

*Suprenals.* Hoskins and Hoskins, '16.

## CHAPTER 5

### GROWTH IN TOTAL BODY WEIGHT ACCORDING TO AGE

1. Introduction. 2. Growth before birth. 3. Growth between birth and maturity. 4. Weight-length ratio. 5. Modifications of growth in total body weight and organs. 6. Senescence.

1. *Introduction.* Under the general caption of growth several series of data are grouped in this chapter and in the four chapters which follow it. The chapter heads explain the several groupings and show that some data are presented according to age and other data according to some bodily measurement.

The reasons for this procedure will be evident in each instance. The effort has been made to gather as much of the data as possible under the caption of growth as this seemed the best way to make the records available for reference.

The following tables present the size, weight and composition of the albino rat and some of its parts, under conditions which may be considered normal.

As regards absolute measurements, it must be borne in mind that the Albino is very responsive to external conditions as represented by food, housing, temperature, exercise, and incidental disturbances, especially light and noises.

No two colonies today are kept under more than approximately similar conditions and it follows that the average size of the animals from different colonies varies. The conditions just noted also appear to influence the relative weights of some of the viscera. For these reasons, each set of determinations will be accompanied by a statement, as complete as possible, concerning the special conditions surrounding the animals on which the observations were made.

2. *Growth before birth.* For the data on growth during the first few days of fetal life, see Chapter 3, Embryology, early stages, p. 38, Huber ('15 a) and other references there given.

At about the 13th day after insemination the fetus is large enough to be directly weighed and from this date to birth the growth has been followed.

TABLE 118

*Showing the mean weights of the fetuses at ten ages during gestation and at birth Stotsenburg ('15)*

AGE IN DAYS	NUMBER OF FETUSES	AVERAGE WEIGHT OF FETUSES IN GRAMS	RATE OF INCREASE IN WEIGHT
			<i>per cent</i>
13.....	34	0.040	
14.....	44	0.112	179
15.....	37	0.168	50
16.....	44	0.310	83
17.....	21	0.548	77
18.....	43	1.000	83
19.....	30	1.580	58
20.....	25	2.630	65
21.....	42	3.980	51
22.....	10	4.630	16
Strictly new born ....	37	4.680	

TABLE 119

*Giving the crown-rump length of fetus in millimeters. Scrap diet only. The fetuses here measured are part of those used for Table 118*

SERIAL NUMBER	AGE IN DAYS	NUMBER IN LITTER	AVERAGE WEIGHT OF FETUS	AVERAGE CROWN-RUMP LENGTH	RANGE OF LENGTH
			<i>grams</i>	<i>mm.</i>	<i>mm.</i>
42.....	14	8	0.093	9.5	9.0-10.0
43.....	15	12	0.107	9.4	9.0-10.0
37.....	15	8	0.218	12.1	12.0-12.5
41.....	16	11	0.322	13.0	12.5-13.0
40.....	17	7	0.525	16.3	16.0-17.0
36.....	18	9	0.947	19.1	18.0-21.0
37.....	19	8	1.490	22.7	20.5-24.0
35.....	20	10	2.510	27.7	24.0-32.0
34.....	21	9	4.070	36.7	35.0-39.0
44.....	22	10	4.630	39.2	36.0-41.0*

\* This method of measurement gives a less length than the nose-anus method commonly used for the new born.

In a series of 38 females, each of which had already born one litter, Stotsenburg ('15) has observed exactly the time of insemination and then weighed the fetuses at the ages given in

table 118. Before weighing the membranes were removed and in some instances the crown-rump length was measured (table 119). The graph representing the growth before birth from the

Fetus of albino rat

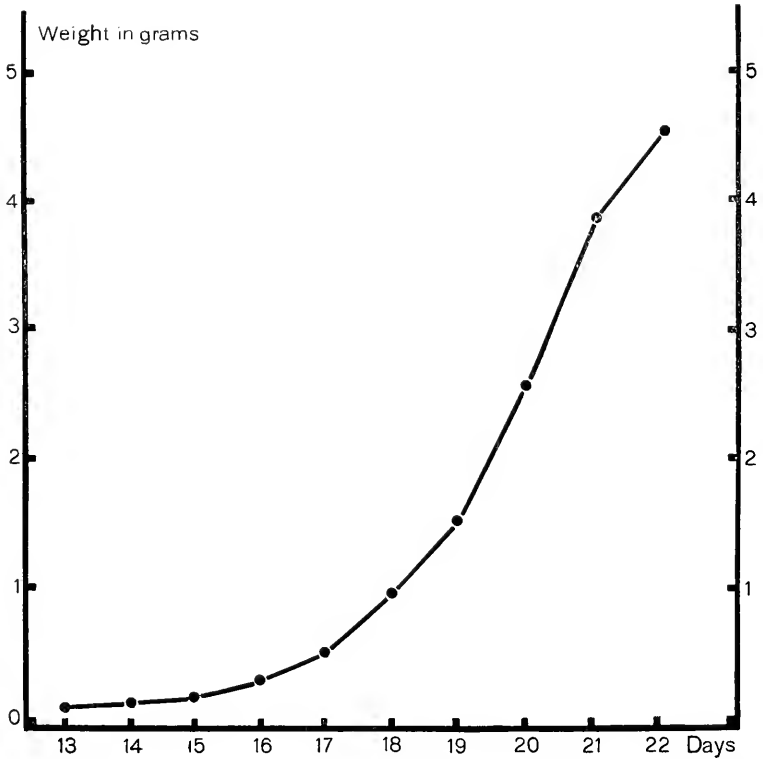

Chart 20 Shows the course of fetal growth from the 13th to the 22nd day gestation. The data are given in table 118.

13th day on is given in chart 20 the interval used for one day being two-fifths of that used for 1 gram.

3. *Growth between birth and maturity.* The first observations were made at the University of Chicago by Donaldson, Dunn and Watson ('06) on stock rats fed mainly on milk-soaked bread with corn as a staple. The values before fourteen days of age were obtained from weighing different litters, each litter being

weighed only once. The original values at birth and for the first ten days were plainly too high and have been replaced by new data (Donaldson, '15). After the 14th day the weighing of 19 males and 17 females was made at frequent intervals, so long as the animals kept in good condition.

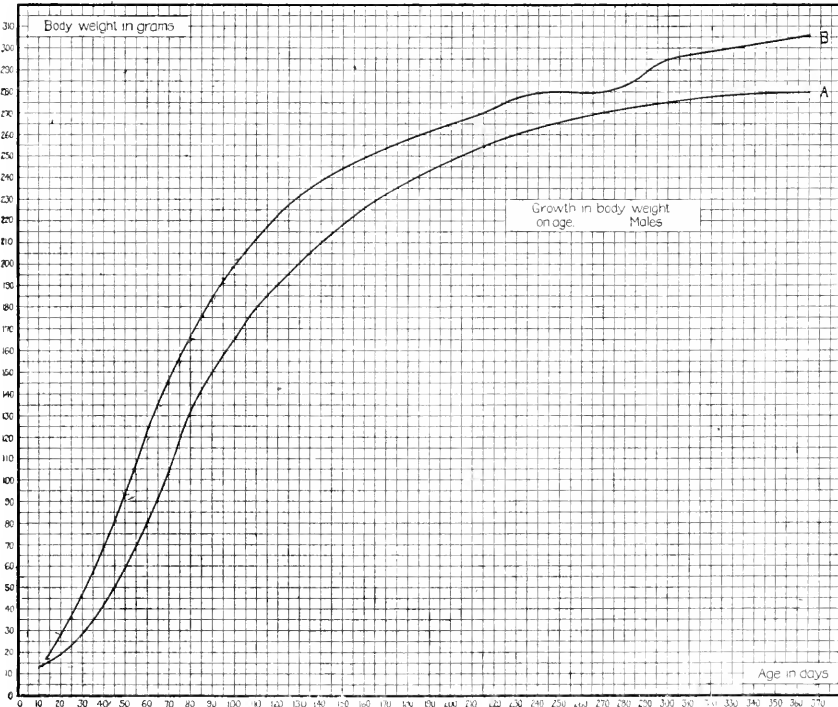

Chart 21 Growth in body weight on age. Male albino rat. A. Observations of Donaldson, Dunn and Watson ('06). See table 157. B. Observations of King ('15). Data from two series combined. See table 121.

Watson's ('05) observations show that mated females gain in weight about 0.03 per cent per diem faster than the unmated.

Using the data for graphs A in charts 21 and 22 Hatai has determined the graph for which formulas (41) and (42) give the values for the male, and formulas (43) and (44) the values for the female for this special series. By the use of these formulas the body

weights have been computed for each day of age from 10 days on—see table 157.

The values given for the first ten days of age in table 157 have been obtained from a revised series of direct observations Donaldson ('15).

The weight at birth as here given, is for rats that have suckled.

Using a group of 148 males and 158 females, composed of animals which were specially well cared for and fed, Greeman

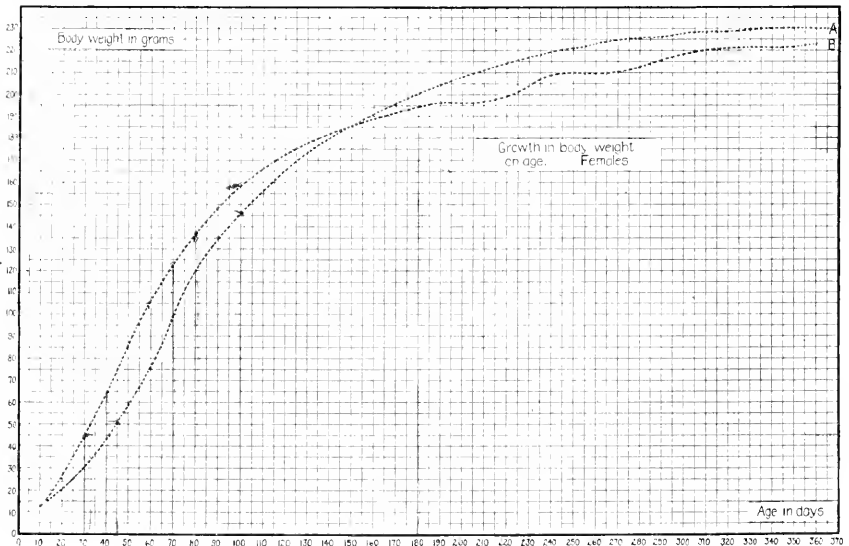

Chart 22 Growth of body weight on age. Female albino rat. A. Observations of Donaldson, Dunn and Watson ('06). See table 157. B. Observations of King ('15). Data from two series combined. See table 121.

and Duhring ('23, page 4, chart no. 1) have recorded a growth curve for the males which after a hundred days shows higher values than those just given. At 350 days this special group surpasses our male values by 65 grams and the curve is still rising.

In the case of the females the superior treatment and food produce animals which are about 15 grams heavier at 100 days and about 18 grams heavier at 350 days. As so often happens the greater response is given by the males—table 157 a.

Finally at The Institute, King ('15 a) has conducted two series of observations (1912-1913) (1913-1915) on the increase in body weight with age in stock Albinos. There were 23 males and 23 females in the first series and 27 of each sex in the second. The records for the two series have been combined. The observations extend from 13-485 days and the weighings were made

TABLE 120

*Data on thirteen litters of stock albino rats, showing the increase in the weight of the body with age*

AGE IN DAYS	MALES				FEMALES			
	Body weight in grams			Num- ber of individ- uals	Body weight in grams			Num- ber of individ- uals
	Average	Lowest	Highest		Average	Lowest	Highest	
13.....	17.2	13	21	50	15.7	13	20	67
30.....	48.5	41	60	50	45.7	39	57	50
60.....	122.9	64	170	50	107.1	66	153	50
90.....	184.8	103	238	50	148.0	95	178	39
120.....	223.2	146	284	50	173.4	125	212	42
151.....	244.8	169	307	50	186.3	147	225	45
182.....	258.4	172	343	50	196.5	147	245	42
212.....	268.0	176	366	48	197.3	136	245	42
243.....	279.7	194	355	44	209.6	141	256	43
273.....	280.9	202	349	41	210.8	158	254	38
304.....	296.1	198	379	36	219.1	165	262	38
334.....	300.8	238	385	33	222.4	170	276	35
365.....	306.1	245	377	28	223.1	176	276	31
395.....	314.1	246	381	24	220.5	175	284	31
425.....	312.2	243	397	23	215.8	169	271	30
455.....	323.9	249	414	15	220.2	196	264	18
485.....	326.0	255	437	12	234.7	197	324	13

at the ages given in table 120. These rats received a "scrap" diet (i.e., a diet composed of selected table scraps).

In chart 21 the record for the males is given by graph B and in chart 22 the record for the females by graph B.

Table 121 gives also the coefficient of variation in body weight for each sex. The average value for the coefficient of variation is for males 13.6 and for females 12.1. In table 141 the fraternal variability for each sex is recorded. As there shown, the fraternal variability is for both sexes less than that for the general population.

TABLE 121

*Giving the increase in body weight with age—stock Albinos. Mean of two series—King (15 a) and giving also the coefficients of variation with their probable errors. The Wistar Institute Colony.*

Age in days	MALES			FEMALES		
	Number of individuals	Average body weight	Coefficient of variation	Number of individuals	Average body weight	Coefficient of variation
		<i>grams</i>			<i>grams</i>	
13	50	17.2	11.8±0.795	50	15.7	11.4±0.768
30	50	48.5	10.2±0.687	50	45.7	11.0±0.741
60	50	122.9	17.0±1.140	50	107.1	15.7±1.050
90	50	184.8	14.8±0.998	39	148.0	12.5±0.951
120	50	223.2	13.4±0.903	42	173.4	10.3±0.755
151	50	244.8	13.3±0.896	45	186.3	10.4±0.735
182	50	258.4	14.2±1.220	42	196.5	12.3±0.903
212	48	268.0	14.0±0.964	42	197.3	12.4±0.910
243	44	279.7	13.9±0.998	43	209.6	12.6±0.910
273	41	280.9	13.4±0.997	38	210.8	11.5±0.890
304	36	296.1	14.0±1.110	38	219.1	10.3±0.795
334	33	300.8	13.7±1.130	35	222.4	10.8±0.870
365	28	306.1	13.0±1.160	31	223.1	10.7±0.910
395	24	314.1	12.6±1.220	31	220.5	11.5±0.984
425	23	312.2	13.4±1.320	30	215.8	10.9±0.944
455	15	323.9	13.6±1.670	18	220.2	8.9±0.998
485	12	326.0	15.0±2.060	13	234.7	13.4±1.770

TABLE 122

*Giving in grams the values obtained by dividing the body weight by body length in millimeters. Based on data in table 144*

BODY LENGTH	RATIO		BODY LENGTH	RATIO		BODY LENGTH	RATIO	
	Male	Female		Male	Female		Male	Female
<i>mm.</i>			<i>mm.</i>			<i>mm.</i>		
50	0.10	0.10	110	0.32	0.34	180	0.76	0.82
55	0.11	0.11	120	0.36	0.38	190	0.86	0.92
60	0.13	0.13	130	0.41	0.44	200	0.97	1.05
70	0.16	0.17	140	0.47	0.50	210	1.10	1.19
80	0.20	0.21	150	0.53	0.56	220	1.24	1.34
90	0.24	0.25	160	0.60	0.64	230	1.40	1.52
100	0.28	0.29	170	0.67	0.71	240	1.58	1.73
						250	1.79	1.97

4. *Weight-length ratio.* Using the values for body weight and body length, as given in table 144 the weight value for a running



millimeter has been determined for each sex, table 122—at a series of selected body lengths; values for intervening lengths may be had by interpolation. After 60 mm. in body length the ratio for the female is higher than that for the male. By the use of this table it can be determined whether a given rat is emaciated or fat.

5. *Modifications of growth in total body weight and organs.* The foregoing data on growth on age represent the usual results under moderately favorable conditions. By improvement in the food and other conditions, more rapid and greater final growth can be obtained (Greenman and Duhring, '23). Most investigators at the present time carry a series of litter controls with which their test rats are compared, and this should be done wherever possible. It is to be kept in mind that the usual results run much closer to the maximum than to the minimum, i. e., it is much easier to retard and reduce the growth of the rat than it is to accelerate or increase it. Thus, in a sense, slight gains are equivalent to large losses.

Body growth is better after lecithin feeding (Hatai, '03 a) and with various forms of abundant and varied diets. Increased growth occurs in spayed females (Stotsenburg, '13) due in part to the formation of fat.

Bearing young increases the body weight of the female (J. B. Watson, '05). Some young, undersized at birth, also grow more rapidly than their litter mates (King, '16). Exercise improves growth (Donaldson 'MS.).

Body growth is poorer under starvation conditions and with all forms of defective, deficient or monotonous diets. Isolated animals grow less well than those kept together. Disturbed surroundings, visitors or change of the caretaker cause arrests in growth or even losses in weight.

The effect on body growth of the removal of the thyroid and parathyroid glands (Hammett, '23) is given on page 162.

Body growth is not affected by castration (Stotsenburg, '09) nor by either single or double "isolation" of the ovaries within the rat, despite the fact that in double isolation the ovaries are much

atrophied, while in single isolation the surviving ovary is hypertrophied—Stotsenburg ('17).

6. *Senescence*. In the colony at the Institute albino rats rarely live more than 40 months. Commonly lung disease (rat pneumonia) is the immediate cause of death. After two years the animals tend to become slow and decrepit. They eat less, sleep much and the hair become thin, rough and dry. The angle between the nasal and frontal bones is increased, giving the "roman nose" effect. The female usually ceases to breed at 18 to 20 months. The end of the breeding time in the males is not known. The loss in body weight in old animals is very marked, but whether body length is also diminished is not known.

As shown in table 156 and chart 49—Nos. 1–21 the relative weights of the organs decrease with advancing age, but just how great this decrease may be in rats, three years old or older, has yet to be determined.

#### GROWTH IN TOTAL BODY WEIGHT ACCORDING TO AGE: REFERENCES

*Introduction*. Przilbram, '22.

*Growth before birth*. Huber, '15 a. Stotsenburg, '15.

*Growth between birth and maturity*. Donaldson, '06, '12 c, '15. Donaldson, Dunn and Watson, '06. Dunn, '08. Ferry, '13. Greenman and Duhring, '23. Jackson, '13, King, '15, '15 a. Robertson, '08. Watson, '05.

*Modifications of growth in total body weight and in organs*. Donaldson, '11 a. Greenman and Duhring, '23. Hammett, '23. Hart and McCollum, '13, '14. Hatai, '03 a, '04 a, '07 a, '08, '13 a, '15, '15 b. Henn, '20. Jackson, '15, '15 a, '15 b. Jackson and Stewart, '18, '19, '20. King, '16. Kudo, '21, '21 a. Morgulis, '11. Osborne and Mendel, '14 d, '15 d, '16. Paul, '06. Reed, '21. Slonaker and Card, '23. Smith and Ascham, '22. Stewart, '16, '18, '19. Stotsenburg, '09, '13, '17. Watson, '06, '06 a, '06 b. Watson and Gibbs, '06. Watson and Lyon, '06. Watson, '07 a, '07 b, '07 c, '07 d, '10, '12. Watson, J. B., '05.

*Senescence*. Ruzicka, '22.

## CHAPTER 6

### GROWTH OF PARTS AND SYSTEMS OF THE BODY IN WEIGHT

1. Larger divisions. 2. Systems. 3. Teeth. 4. Blood. 5. Fat.

1. *Larger divisions.* The relative growth of the component parts (head, trunk and limbs) and of the systems (integument ligamentous skeleton, musculature and viscera) has been studied by Jackson and Lowrey ('12).

The rats were reared at the University of Missouri and fed daily with wheat bread soaked in whole milk—a supply of chopped corn being kept constantly in the cages. In addition fresh beef was given once a week. The rats were well grown except at five months and one year, when both sexes were somewhat low in body weight—the deficiency being most marked in the females.

The report of the work by Jackson and Lowrey ('12) is given largely in their own words.

The method of dissection was as follows. The animal was taken in the morning before feeding and killed by chloroform. The gross body weight, and the lengths of body and tail were recorded. The head (with skin) was then removed (just posterior to the foramen magnum and anterior to the larynx) and weighed. In the meantime, the trunk was suspended and the blood (unmeasured) was allowed to escape. Then the viscera were carefully removed and weighed individually (including brain, spinal cord, eyeballs, thyroid, thymus, heart, lungs, liver, spleen, stomach and intestines, both with contents and empty, suprarenals, kidneys and gonads). Urine was estimated if present. The extremities were separated at the shoulder and hip joints and weighed with skin. The skin (including ears, claws and adherent subcutaneous tissue) was next removed and weighed. The trunk weight was estimated by subtracting the weight of the head and extremities from the net body weight.

Then the musculature with skeleton was weighed, the few remaining additional structures (genitalia, large vessels, pharynx and oesophagus, larynx and trachea, and masses of fat connected with the musculature)

having been carefully removed. Finally the musculature was carefully dissected off and the skeleton, including bones, cartilages and ligaments, was weighed. This weight, subtracted from that of the skeleton and musculature together, gives the weight of the musculature, including the tendons. Evaporation was reduced to a minimum by keeping the various structures in a closed moist container, so far as possible. *The net body weight, which is the gross body weight minus contents of stomach, intestines and urinary bladder, was used as the basis in calculating the percentage weights.* The percentages therefore differ slightly from those calculated upon the gross body weight. The difference is not of material importance in the case of the albino rat, however, as the intestinal and other contents do not average more than 5 per cent of the body at the ages observed (excepting at 6 weeks, where the average was about 8 per cent). The observations were grouped at seven ages, chosen for the following reasons. At one week the weight at birth has about doubled. At three weeks it has about doubled again, and this moreover is the age at which the animal is usually weaned. At six weeks the body weight has again about doubled, and the animal is well established upon its permanent diet. Ten weeks represents the age of puberty, and the body weight of six weeks has again about doubled. At one year the body weight has again nearly doubled, and this represents nearly the adult weight. Five months was arbitrarily selected as the time when the body weight is approximately half way between those of ten weeks and one year. While therefore observations are not available for the various intermediate age periods, these are sufficiently close together so that no important change in the relative weights of the constituent parts is likely to be overlooked. Moreover, on account of the variations at the different ages in the body weights, these form a fairly continuous series; and the relative weights of the various constituent parts are apparently more closely correlated with the body weight than with the age.

The relative weights of the component parts examined are given in table 123 (modified from table 2, p. 455, loc. cit.).

The authors point out that the maximum relative weight is shown by the head at one week, by the forelimbs at three weeks, by the hind limbs at five months and by the trunk at a year—the wave of most active growth thus passing from the head caudad with advancing age.

The body weights in table 123 are for the rats—three or less of each sex at each age—on which the percentage weights of the fore and hind limbs were determined. The values for the head and the trunk are based on a series of twenty or more rats for each sex at each age.

2. *Systems.* The relative growth of the various systems is also given for the integument, ligamentous skeleton, musculature and viscera. The method of preparing each system and the series of organs here comprising the viscera have been previously noted (p. 182). The following table 124 is based on table 4 (loc. cit., p. 460) to which has been added the average values of the net body weights.

It is to be noted that the percentages in tables 123 and 124 are based on the "net body weight" of the rats. According to Jackson and Lowrey this is about 95 per cent of the gross weight,

TABLE 123

*Albino rat—Average percentage weight of head, trunk and extremities all with skin, at various ages—sexes combined (Jackson and Lowrey, '12)*

AGE, DAYS	BODY WEIGHT NET	HEAD	FORE-LIMBS	HIND-LIMBS	TRUNK
	<i>grams</i>	<i>per cent</i>	<i>per cent</i>	<i>per cent</i>	<i>per cent</i>
0.....	5.4	21.65	7.39	9.45	61.51
7.....	11.6	23.70	8.92	11.97	55.41
21.....	25.5	20.22	9.25	14.87	55.66
42.....	79.2	11.80	6.72	14.94	66.54
70.....	141.9	9.56	5.32	15.59	69.53
150.....	190.7	9.42	5.87	15.64	69.07
365.....	222.2	9.29	4.76	14.63	71.32

and this factor can be used therefore to transform net into gross weight.

Jackson and Lowrey conclude (p. 472) that their data indicate no noteworthy differences between the sexes in the relative weights of the various parts and systems, and that the body of the albino rat has practically reached the adult proportions in several of its component parts and systems at the age of ten weeks.

Corresponding observations, though less extensive, made on the Norway rat are given in chapter 13.

*The Skeleton.* (a) *Ligamentous Skeleton.* Since the values for the skeleton as given in table 124 were obtained by the dissection of the soft parts from the bones it is evident that the "ligamentous skeleton" thus prepared would have a greater weight than the "cartilaginous skeleton" prepared by maceration.

Owing to the completeness of the preparation by the latter method, it was deemed desirable to study the skeleton in this way and some of the data obtained for the cartilaginous skeleton by Donaldson and Conrow ('19) are here introduced.

(b) *Cartilaginous skeleton.* *Weight of entire cartilaginous skeleton.* Using a 2 per cent solution of the commercial gold dust washing powder ("gold dust washing powder" consists of about

TABLE 124

*Average percentage weights of integument, ligamentous skeleton, musculature, viscera and remainder. Based on Jackson and Lowrey ('12), table 4. For the corresponding absolute weights see table 125*

AGE IN DAYS	SEX AND NUMBER	BODY WEIGHT	PERCENTAGE VALUES—SEXES COMBINED FOR				
			Integument	Ligamentous skeleton	Musculature	Viscera	Remainder
		<i>grams</i>					
0.....	{ M. 9 F. 9 }	4.7	19.8	17.3	24.4	18.1	20.4
7.....	{ M. 8 F. 11 }	10.1	25.9	18.5	22.8	19.2	13.6
21.....	{ M. 7 F. 6 }	24.8	22.4	16.6	26.9	21.3	12.8
42.....	{ M. 6 F. 8 }	64.5	20.9	14.0	32.7	20.4	12.0
70.....	{ M. 5 F. 5 }	130.5	18.7	11.7	41.1	16.0	12.5
150.....	{ M. 6 F. 7 }	184.3	18.1	11.5	42.6	14.8	13.0
365.....	{ M. 4 F. 2 }	234.6	18.0	10.9	45.4	13.3	12.4

45 per cent sodium carbonate, 30 per cent soap powder, and 25 per cent water), the skeletons of some 106 Albinos have been carefully prepared at The Institute (Donaldson and Conrow, '19). The animals were reared on a scrap diet.

The weight of the skeleton is given in relation to the body weight. The value for the body used here is that normal to the body length (see table 144) when the observed body weight is less than that to be expected—but the observed body weight is used when that is above the normal for the body length. In

the case of old rats undergoing senile loss of body weight the *maximum body weight* is the one used.

The weight of the teeth is included with that of the skeleton but the weight of the nails is excluded.

The data are for both sexes combined.

TABLE 125

*Shows for the series of body weights of the albino rat by Jackson and Lowrey ('12) the absolute weights of integument, ligamentous skeleton, musculature, viscera and remainder determined by the use of the percentage values given in the preceding table 124.*

AGE IN DAYS	MEAN BODY WEIGHTS	SEX NUMBER	INTEGUMENT	LIGAMEN-TOUS SKELETON	MUSCULA-TURE	VISCERA	REMAINDER
			<i>grams</i>	<i>grams</i>	<i>grams</i>	<i>grams</i>	<i>grams</i>
0	Average						
	M. + F.						
	5.11	M. 9	1.00	0.87	1.19	0.90	1.15
	4.27	F. 9	0.85	0.75	1.09	0.79	0.79
	4.69		0.93	0.81	1.15	0.85	0.97
7	10.47	M. 8	2.79	1.93	2.40	2.00	1.36
	9.83	F. 11	2.33	1.70	2.24	1.90	1.30
	10.10		2.62	1.87	2.30	1.94	1.37
21	26.91	M. 7	6.35	4.20	7.45	5.71	3.23
	22.31	F. 6	4.69	3.97	5.78	4.77	3.08
	24.78		5.55	4.11	6.67	5.28	3.17
42	60.10	M. 6	12.14	9.08	19.41	12.86	6.67
	67.80	F. 8	14.51	8.95	22.37	13.36	8.61
	64.50		13.48	9.03	21.09	13.16	7.74
70	143.60	M. 5	26.14	15.94	57.15	23.26	21.11
	117.50	F. 5	22.56	14.34	49.91	18.68	11.99
	130.50		24.40	15.27	53.64	20.88	16.31
150	218.70	M. 6	41.99	22.84	93.38	29.96	25.52
	154.80	F. 7	26.62	18.73	65.94	24.30	19.20
	184.30		33.36	21.38	78.51	27.28	23.77
365	260.20	M. 4	44.75	25.50	120.99	33.83	35.13
	183.50	F. 2	35.78	24.22	79.46	25.32	18.72
	234.60		42.23	25.57	106.51	31.20	29.09

*Correction for sex.* For a given body weight the female as compared with the male as a standard has slightly shorter and lighter bones. For a given body length, slightly heavier bones. The exact values for correction cannot be given at present, but in making any allowance for sex, it must be remembered that the table data are for the sexes combined, and hence intermediate in value.

The moist or fresh determinations here recorded were made just after preparation. The room dried values mentioned later

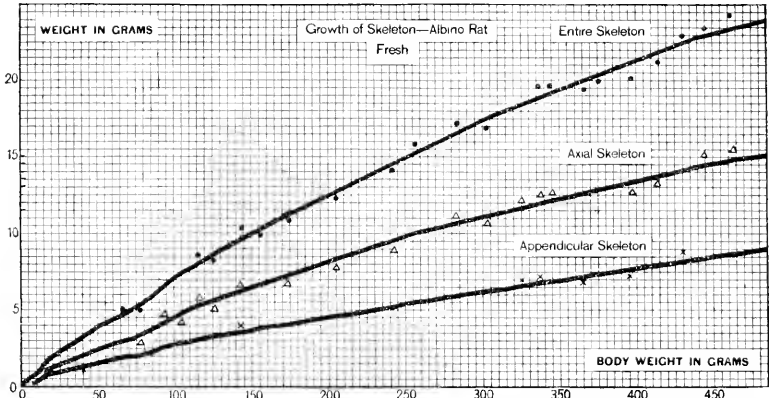

Chart 23 Absolute fresh weight of entire skeleton, axial skeleton, and appendicular skeleton in grams, on the body weight (albino rat). Table 126.

● Entire skeleton. Δ Axial skeleton. × Appendicular skeleton.

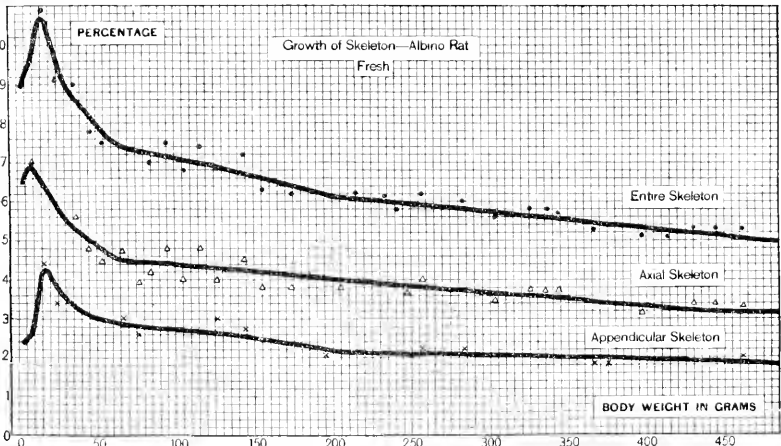

Chart 24 Relative fresh weight of entire skeleton, axial skeleton, and appendicular skeleton, on body weight (albino rat). Table 126.

● Entire skeleton. Δ Axial skeleton. × Appendicular skeleton.

are for material kept in the laboratory in open but dust free vessels at 17°–23°C. for thirty days, while the oven dried values are for material heated to 96°C. for seven days before weighing.



The data on the percentage of water in the skeleton and its parts are given in chapter 8.

Some selected results, entered in forty-two body weight groups, appear in tables 126–131 and Charts 23, 24 and 25.

Table 126 gives the fresh weights of the entire skeleton and its main divisions on body weight—Charts 23 and 24.

If the percentage weight of the “ligamentous” skeleton for the extremes of body weight as given in table 124 is compared with that for the “cartilaginous” skeleton, table 126, it appears that at a body weight of five grams the cartilaginous skeleton represents only 53 per cent of the value for the ligamentous skeleton, while at 235 grams it represents about the same or 55 per cent. Roughly then the proportional weight of the ligamentous is nearly twice that of the cartilaginous skeleton, obtained by this method of maceration. We shall not attempt to adjust these two sets of values, but in table 127 are given the factors for correction of the macerated (cartilaginous) skeleton by which the effect of the maceration can be corrected and the true weight can be fairly approximated.

It appears from this table that the loss in fresh weight drops from about 16 per cent at birth to about 7.5 per cent at a body weight of 100 grams, and after a body weight of 200 grams the weight of the macerated may be below that of the unmacerated bones—from 4.5 to 3.5 per cent. When, however, the oven-dried weights of these same bones are compared, it is seen that while the losses after oven-drying follow the same course as was followed in the case of the fresh bones, yet the values run very consistently—about 3 to 3.4 per cent (on the average) below those for the fresh bones.

As the long bones of the limbs are most readily prepared, and as their condition appears to indicate that of the skeleton in general, several tables giving data for them are presented. Table 128 and Chart 25 give the absolute weight of the fresh limb bones on body weight. The corresponding weights for the room

TABLE 126

*Absolute and relative fresh weights of entire skeleton, axial skeleton, and appendicular skeleton, on body weight. From smoothed graphs in charts 23 and 24*

BODY WEIGHT	FRESH SKELETON WEIGHT	WEIGHT OF FRESH SKELETON ON BODY WEIGHT	AXIAL FRESH WEIGHT	FRESH AXIAL ON FRESH BODY WEIGHT	APPENDICULAR FRESH WEIGHT	FRESH APPENDICULAR ON BODY WEIGHT
<i>grams</i>	<i>grams</i>	<i>per cent</i>	<i>grams</i>	<i>per cent</i>	<i>grams</i>	<i>per cent</i>
5	0.46	9.20	0.34	6.70	0.12	2.50
10	0.99	9.90	0.69	6.87	0.30	3.03
15	1.59	10.61	0.98	6.53	0.61	4.08
20	2.06	10.30	1.24	6.20	0.82	4.10
25	2.40	9.60	1.48	5.90	0.92	3.70
30	2.70	9.01	1.68	5.59	1.02	3.42
35	3.06	8.73	1.87	5.33	1.19	3.40
40	3.39	8.47	2.08	5.20	1.31	3.27
45	3.69	8.20	2.26	5.03	1.43	3.17
50	4.00	8.00	2.44	4.88	1.56	3.12
55	4.27	7.77	2.62	4.77	1.65	3.00
60	4.54	7.57	2.76	4.60	1.78	2.97
65	4.83	7.43	2.94	4.53	1.89	2.90
70	5.16	7.37	3.15	4.50	2.01	2.87
75	5.48	7.30	3.35	4.47	2.13	2.83
80	5.82	7.27	3.55	4.44	2.27	2.83
85	6.12	7.20	3.75	4.41	2.37	2.79
90	6.48	7.20	3.96	4.40	2.52	2.80
95	6.81	7.17	4.18	4.40	2.63	2.77
100	7.10	7.10	4.39	4.39	2.71	2.71
110	7.71	7.01	4.79	4.35	2.92	2.66
120	8.33	6.94	5.16	4.30	3.17	2.64
130	8.93	6.87	5.55	4.27	3.38	2.60
140	9.48	6.77	5.91	4.22	3.57	2.55
150	10.00	6.67	6.30	4.20	3.70	2.47
160	10.51	6.57	6.69	4.18	3.82	2.39
170	11.00	6.47	7.02	4.13	3.98	2.34
180	11.47	6.37	7.33	4.07	4.14	2.30
190	11.84	6.23	7.66	4.03	4.18	2.20
200	12.34	6.17	8.00	4.00	4.34	2.17
210	12.81	6.10	8.38	3.99	4.43	2.11
220	13.31	6.05	8.71	3.96	4.60	2.09
230	13.80	6.00	8.99	3.91	4.81	2.09
240	14.35	5.98	9.34	3.89	5.01	2.09
250	14.83	5.93	9.63	3.85	5.20	2.08
270	15.80	5.85	10.21	3.78	5.59	2.07
290	16.76	5.78	10.79	3.72	5.97	2.06
310	17.58	5.67	11.22	3.62	6.36	2.05
330	18.48	5.60	11.85	3.59	6.63	2.01
350	19.32	5.52	12.36	3.53	6.96	1.99
370	20.02	5.41	12.65	3.42	7.37	1.99
390	20.94	5.37	13.22	3.39	7.72	1.98
410	21.61	5.27	13.53	3.30	8.08	1.97
430	22.32	5.19	13.89	3.23	8.43	1.96
450	22.95	5.10	14.40	3.20	8.55	1.90
470	23.55	5.01	14.95	3.18	8.60	1.83
485	24.20	4.99	15.37	3.17	8.83	1.82

TABLE 127

*Factors for correction*

*Percentage of loss in weight of bones after macerating in 2 per cent "Gold Dust Washing Powder." Based on the combined data for the humerus and femur. Entered according to body weight for each sex*

BODY WEIGHT	LOSS—MALES		LOSS—FEMALES	
	Fresh	Oven-dried	Fresh	Oven-dried
<i>grams</i>	<i>per cent</i>	<i>per cent</i>	<i>per cent</i>	<i>per cent</i>
5	15.85	12.85	15.70	12.70
10	14.30	11.40	14.40	11.40
15	13.40	10.45	13.45	10.45
20	12.35	9.10	12.65	9.50
25	11.70	8.50	11.95	8.75
30	11.05	8.00	11.35	8.25
35	10.65	7.60	10.85	7.80
40	10.20	7.20	10.40	7.40
45	9.85	6.90	10.00	7.00
50	9.50	6.70	9.65	6.65
55	9.30	6.35	9.30	6.40
60	9.00	6.05	8.95	6.10
65	8.70	5.85	8.65	5.80
70	8.55	5.65	8.50	5.55
75	8.35	5.40	8.25	5.25
80	8.20	5.15	8.05	5.00
85	8.05	4.95	7.85	4.70
90	7.85	4.70	7.65	4.55
95	7.70	4.60	7.45	4.35
100	7.50	4.40	7.30	4.15
110	7.20	4.10	7.00	3.75
120	7.00	3.80	6.70	3.40
130	6.70	3.50	6.40	2.95
140	6.50	3.15	5.80	2.30
150	6.20	2.60	5.35	1.85
160	5.80	2.25	4.95	1.45
170	5.40	1.90	4.55	1.15
180	5.10	1.55	4.15	0.70
190	4.70	1.30	3.90	0.50
200	4.45	1.05	3.60	0.25
210	4.20	0.75	3.45	0.08
220	4.00	0.55		
230	3.80	0.35		
240	3.60	0.20		
250	3.45	0.10		

dried bones are given in table 129. Table 130 gives the absolute length of the fresh limb bones on body weight—also Chart 25a and table 131 gives the same on body length.

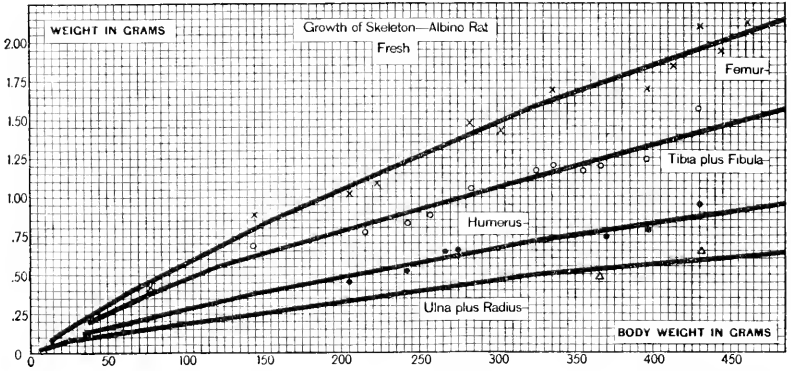

Chart 25 Absolute weight of the fresh limb bones, on body weight (albino rat). Table 128.

× Femur. ○ Tibia plus fibula. ● Humerus. Δ Ulna plus radius.

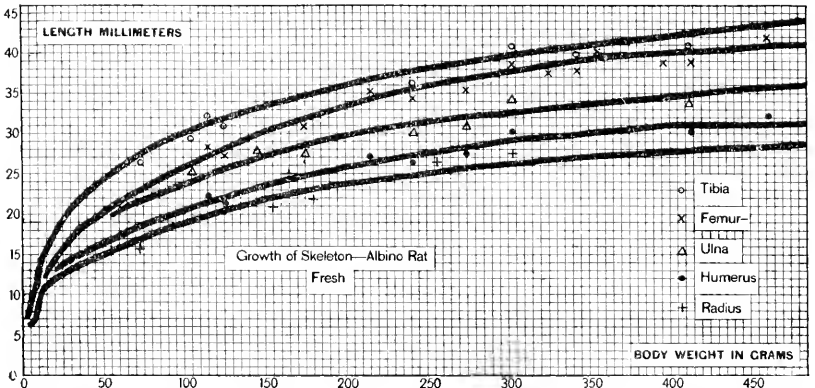

Chart 25a. Length of fresh limb bones in millimeters, on body weight (albino rat.) Table 130.

○ Tibia. × Femur. Δ Ulna. ● Humerus. + Radius.

In the original paper (*loc. cit.*) the weight and lengths of these bones, when room dried or oven dried, are also given. It will be sufficient here however to introduce a series of corrections to be applied for each change in state—table 132.

TABLE 128

*Absolute weight of fresh limb bones, on body weight. Values taken from smoothed graphs in chart 25.*

BODY WEIGHT	HUMERUS (2)	ULNA PLUS RADIUS (2)	FEMUR (2)	TIBIA PLUS FIBULA (2)
<i>grams</i>	<i>grams</i>	<i>grams</i>	<i>grams</i>	<i>grams</i>
5	0.03	0.02	0.03	0.03
10	0.05	0.03	0.05	0.05
15	0.07	0.05	0.10	0.10
20	0.09	0.07	0.14	0.12
25	0.11	0.08	0.16	0.14
30	0.12	0.09	0.19	0.17
35	0.13	0.09	0.22	0.19
40	0.14	0.10	0.25	0.21
45	0.15	0.11	0.29	0.24
50	0.17	0.12	0.31	0.26
55	0.18	0.13	0.34	0.28
60	0.19	0.13	0.37	0.30
65	0.20	0.14	0.40	0.33
70	0.22	0.14	0.43	0.35
75	0.23	0.15	0.45	0.38
80	0.24	0.16	0.48	0.39
85	0.25	0.16	0.50	0.41
90	0.26	0.17	0.53	0.43
95	0.27	0.18	0.55	0.45
100	0.28	0.19	0.57	0.47
110	0.30	0.20	0.62	0.52
120	0.33	0.21	0.67	0.55
130	0.35	0.23	0.72	0.58
140	0.37	0.24	0.78	0.61
150	0.39	0.26	0.83	0.63
160	0.41	0.27	0.87	0.66
170	0.43	0.28	0.92	0.69
180	0.45	0.30	0.96	0.72
190	0.47	0.31	1.00	0.75
200	0.49	0.33	1.04	0.77
210	0.50	0.34	1.08	0.80
220	0.52	0.35	1.13	0.83
230	0.54	0.37	1.17	0.86
240	0.56	0.38	1.22	0.89
250	0.58	0.39	1.26	0.92
270	0.61	0.42	1.35	0.98
290	0.65	0.45	1.43	1.03
310	0.69	0.48	1.52	1.08
330	0.72	0.50	1.60	1.14
350	0.75	0.52	1.68	1.20
370	0.78	0.54	1.75	1.25
390	0.81	0.56	1.82	1.30
410	0.84	0.57	1.88	1.36
430	0.87	0.59	1.95	1.41
450	0.91	0.61	2.02	1.47
470	0.94	0.62	2.09	1.53
485	0.96	0.64	2.14	1.57

TABLE 129

*Absolute weight of room-dried limb bones, on body weight. No chart*

BODY WEIGHT	HUMERUS (2)	ULNA PLUS RADIUS (2)	FEMUR (2)	TIBIA PLUS FIBULA (2)
<i>grams</i>	<i>grams</i>	<i>grams</i>	<i>grams</i>	<i>grams</i>
5	0.007	0.005	0.007	0.008
10	0.013	0.010	0.012	0.014
15	0.021	0.018	0.028	0.033
20	0.030	0.028	0.044	0.043
25	0.040	0.035	0.053	0.054
30	0.047	0.041	0.067	0.070
35	0.052	0.045	0.082	0.082
40	0.060	0.052	0.098	0.095
45	0.067	0.060	0.120	0.113
50	0.079	0.067	0.134	0.127
55	0.088	0.076	0.153	0.142
60	0.095	0.079	0.172	0.159
65	0.102	0.088	0.192	0.178
70	0.115	0.092	0.211	0.193
75	0.124	0.101	0.229	0.214
80	0.133	0.110	0.250	0.225
85	0.141	0.112	0.268	0.240
90	0.150	0.122	0.291	0.258
95	0.160	0.131	0.310	0.276
100	0.170	0.140	0.329	0.295
110	0.188	0.153	0.370	0.337
120	0.213	0.164	0.410	0.368
130	0.233	0.182	0.452	0.399
140	0.251	0.193	0.502	0.427
150	0.267	0.211	0.540	0.446
160	0.281	0.221	0.572	0.473
170	0.297	0.230	0.613	0.500
180	0.312	0.247	0.643	0.528
190	0.328	0.257	0.674	0.553
200	0.344	0.274	0.703	0.568
210	0.353	0.284	0.733	0.591
220	0.369	0.294	0.768	0.614
230	0.384	0.311	0.799	0.638
240	0.400	0.321	0.834	0.662
250	0.416	0.330	0.861	0.686
270	0.439	0.357	0.927	0.733
290	0.469	0.383	0.987	0.774
310	0.501	0.411	1.052	0.815
330	0.523	0.431	1.112	0.864
350	0.547	0.449	1.170	0.912
370	0.571	0.469	1.224	0.952
390	0.595	0.489	1.280	0.997
410	0.620	0.499	1.325	1.047
430	0.644	0.519	1.380	1.090
450	0.675	0.540	1.433	1.138
470	0.700	0.552	1.490	1.190
485	0.717	0.571	1.528	1.227

TABLE 130

*Absolute length of fresh limb bones in millimeters, on body weight. Values taken from the smoothed graphs in chart 25 a*

BODY WEIGHT	HUMERUS	ULNA	RADIUS	FEMUR	TIBIA
<i>grams</i>	<i>mm.</i>	<i>mm.</i>	<i>mm.</i>	<i>mm.</i>	<i>mm.</i>
5	7.0	8.0	6.4	7.4	7.0
10	10.2	11.8	9.0	11.0	12.0
15	12.0	14.0	11.1	12.9	15.6
20	12.9	15.5	12.0	14.4	17.9
25	13.7	16.5	12.6	15.7	19.3
30	14.3	17.4	13.2	16.8	20.7
35	14.8	18.2	13.7	17.9	21.7
40	15.4	18.8	14.2	18.7	22.4
45	15.8	19.2	14.6	19.5	23.3
50	16.5	19.6	15.0	20.1	24.0
55	16.8	19.9	15.5	20.9	24.9
60	17.5	20.3	16.0	21.5	25.5
65	17.8	20.9	16.3	22.0	26.2
70	18.3	21.2	16.7	22.7	26.8
75	18.7	21.7	17.2	23.2	27.5
80	19.0	22.0	17.6	23.9	28.0
85	19.4	22.6	18.0	24.4	28.5
90	19.8	22.9	18.4	24.8	29.0
95	20.1	23.2	18.6	25.4	29.6
100	20.5	23.7	18.9	25.8	29.8
110	21.2	24.5	19.5	26.8	30.7
120	21.7	25.2	20.2	27.7	31.6
130	22.4	25.9	20.8	28.7	32.2
140	22.9	26.6	21.3	29.5	32.8
150	23.6	27.1	21.8	30.2	33.4
160	24.0	27.7	22.2	31.0	33.9
170	24.6	28.3	22.7	31.6	34.5
180	25.0	28.8	23.1	32.2	34.9
190	25.4	29.3	23.4	32.8	35.5
200	25.8	29.8	23.8	33.4	36.0
210	26.1	30.2	24.1	34.0	36.5
220	26.5	30.6	24.3	34.6	37.0
230	26.9	30.9	24.6	35.0	37.3
240	27.1	31.2	24.8	35.5	37.7
250	27.5	31.5	25.0	36.0	38.1
270	28.3	32.0	25.5	36.8	38.8
290	28.9	32.3	26.0	37.4	39.5
310	29.4	32.8	26.3	38.0	40.0
330	29.8	33.2	26.7	38.7	40.5
350	30.0	33.6	27.0	39.2	41.0
370	30.3	34.0	27.2	39.7	41.5
390	30.7	34.4	27.5	39.9	41.9
410	31.0	34.9	27.8	40.2	42.4
430	31.0	35.2	28.0	40.4	43.0
450	31.2	35.6	28.3	40.7	43.3
470	31.3	36.0	28.5	41.0	43.8
485	31.3	36.2	28.6	41.2	44.1

TABLE 131

*Absolute length of fresh limb bones in millimeters, on body length.*

BODY LENGTH	HUMERUS	ULNA	RADIUS	FEMUR	TIBIA
<i>mm.</i>	<i>mm.</i>	<i>mm.</i>	<i>mm.</i>	<i>mm.</i>	<i>mm.</i>
47.5	7.0	7.5	6.2	6.4	7.0
50.0	7.1	7.7	6.5	6.8	7.3
52.5	7.3	7.8	6.7	7.2	7.6
55.0	7.6	8.1	6.8	7.6	8.0
57.5	8.0	8.6	7.1	7.9	8.5
60.0	8.6	9.3	7.4	8.3	9.0
62.5	9.4	10.0	8.0	8.9	9.7
65.0	10.1	10.7	8.6	9.6	10.9
67.5	10.5	11.4	9.2	10.2	11.9
70.0	10.9	12.3	9.8	10.6	12.8
72.5	11.1	12.9	10.3	11.1	13.7
75.0	11.3	13.3	10.6	11.5	14.4
77.5	11.6	13.6	10.9	11.9	15.2
80.0	11.9	14.0	11.1	12.4	15.8
82.5	12.2	14.4	11.4	12.8	16.3
85.0	12.4	14.8	11.6	13.2	16.8
87.5	12.7	15.2	11.8	13.6	17.3
90.0	13.0	15.6	12.1	14.0	17.8
92.5	13.3	16.0	12.3	14.5	18.3
95.0	13.6	16.4	12.4	14.9	18.7
100.0	14.1	17.2	12.9	15.7	19.5
105.0	14.7	17.8	13.4	16.6	20.3
110.0	15.1	18.3	13.8	17.3	21.1
115.0	15.6	18.8	14.3	18.2	21.8
120.0	15.9	19.1	14.7	19.0	22.7
125.0	16.3	19.5	15.1	19.8	23.6
130.0	16.8	19.9	15.4	20.7	24.5
135.0	17.2	20.4	15.8	21.5	25.3
140.0	17.9	20.9	16.3	22.2	26.3
145.0	18.4	21.6	16.9	23.2	27.1
150.0	19.0	22.1	17.5	24.2	27.9
155.0	19.9	23.0	18.2	25.1	28.8
160.0	20.6	23.9	18.8	26.1	29.7
165.0	21.2	24.8	19.5	27.0	30.5
170.0	22.0	25.3	20.1	28.0	31.4
175.0	22.8	26.1	20.8	29.0	32.2
180.0	23.3	26.9	21.4	29.9	33.1
185.0	24.0	27.8	22.0	30.8	33.9
190.0	24.9	28.6	22.8	31.8	34.7
195.0	25.8	29.5	23.6	32.8	35.6
200.0	26.3	30.3	24.2	33.7	36.4
210.0	27.6	31.5	25.4	35.6	38.0
220.0	28.9	32.8	26.3	37.5	39.6
230.0	30.2	34.0	27.3	39.2	41.2
240.0	31.3	35.0	28.2	40.5	42.6
250.0	32.2	36.1	29.1	41.8	44.2



The fact that these bones continue to increase in length nearly as long as the rat lives, implies a condition which makes possible this continued growth, as shown in table 131.

Table 132 gives the data by which determinations of length in any of the three states can be transformed.

TABLE 132

*Percentage losses in the length of long bones on drying. Mean values for rats above 100 grams in body weight*

AMOUNT OF CHANGE	AVERAGE PERCENTAGE LOSS IN LENGTH ON DRYING				
	Humerus	Ulna	Radius	Femur	Tibia
	<i>per cent</i>	<i>per cent</i>	<i>per cent</i>	<i>per cent</i>	<i>per cent</i>
Fresh to room dried: loss.....	0.6	0.4	0.4	0.7	0.5
Room dried to oven dried: loss.....	0.3	0.2	0.2	0.3	0.2
Fresh to oven dried: loss.....	0.9	0.6	0.6	1.0	0.7

TABLE 133

*The mean weight in grams of the crania in each body weight group of the four series of albino rats from Paris, London, Philadelphia, Vienna (based on table 4, Donaldson '12 a). Each weight group is based on six cases, three males and three females.*

BODY WEIGHT GROUP	WEIGHT OF CRANIA IN GRAMS			
	London	Paris	Philadelphia	Vienna
<i>grams</i>				
125.....	0.89	1.03	1.05	1.00
175.....	1.23	1.27	1.41	1.40
225.....	1.52	1.52	1.51	1.73
275.....	1.79		1.87	2.10
325.....			2.15	

For the corresponding weights of the Norway crania see table 191.

(c) *Weight of cranium.* Determinations of the weight of the cranium dried at room temperature have been made, Donaldson ('12a). By the cranium is meant the skull with upper teeth, minus the mandible with lower teeth and minus the ear bones. The mean weights are given in table 133. These crania were preserved originally in weak alcohol.

TABLE 134

*Absolute weight of cranium—fresh, room-dried, and oven-dried—on body weight.  
Values from the smoothed graphs in chart 26.*

BODY WEIGHT	FRESH	ROOM-DRIED	OVEN-DRIED
<i>grams</i>	<i>grams</i>	<i>grams</i>	<i>grams</i>
5	0.19	0.04	0.04
10	0.32	0.09	0.08
15	0.42	0.14	0.13
20	0.51	0.20	0.18
25	0.61	0.24	0.22
30	0.67	0.27	0.25
35	0.72	0.32	0.29
40	0.78	0.36	0.33
45	0.83	0.41	0.37
50	0.89	0.45	0.41
55	0.94	0.49	0.45
60	1.00	0.54	0.49
65	1.05	0.58	0.53
70	1.11	0.63	0.57
75	1.17	0.66	0.60
80	1.22	0.71	0.65
85	1.28	0.76	0.69
90	1.33	0.80	0.73
95	1.39	0.85	0.77
100	1.44	0.89	0.81
110	1.56	0.96	0.87
120	1.67	1.01	0.92
130	1.75	1.06	0.97
140	1.83	1.12	1.02
150	1.92	1.18	1.08
160	2.00	1.23	1.12
170	2.08	1.29	1.18
180	2.17	1.35	1.23
190	2.24	1.40	1.28
200	2.32	1.47	1.34
210	2.41	1.51	1.38
220	2.50	1.56	1.42
230	2.56	1.61	1.47
240	2.62	1.67	1.52
250	2.69	1.72	1.57
270	2.82	1.83	1.67
290	2.96	1.93	1.76
310	3.09	2.02	1.84
330	3.22	2.11	1.92
350	3.34	2.20	2.01
370	3.44	2.29	2.09
390	3.55	2.38	2.17
410	3.66	2.47	2.25
430	3.77	2.57	2.34
450	3.88	2.65	2.42
470	3.97	2.72	2.48
485	4.01	2.74	2.50

The weight of the cranium at 42 body weights has also been determined by Donaldson and Conrow ('19) and the results are given in table 134 and Chart 26.

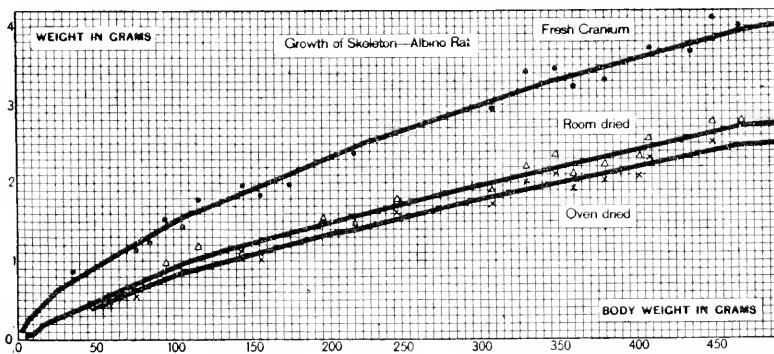

Chart 26 Absolute weight of the cranium—fresh, room-dried and oven-dried—on body weight (albino rat). Table 134.

● Fresh. Δ Room dried. × Oven dried.

TABLE 135

Absolute and relative weight of the fresh mandibles. The relative weights are based on the weight of the cranium, taken from table 134

BODY WEIGHT	CRANIUM WEIGHT	MANDIBLES WEIGHT	PER CENT WEIGHT OF MANDIBLES ON CRANIUM
<i>grams</i>	<i>grams</i>	<i>grams</i>	
5	0.19	0.033	17.37
10	0.32	0.075	23.44
15	0.42	0.110	26.19
20	0.51	0.140	27.45
25	0.61	0.168	27.54
30	0.67	0.193	28.81
35	0.72	0.218	30.28
40	0.78	0.238	30.51
45	0.83	0.258	31.08
50	0.89	0.278	31.24
75	1.17	0.378	32.31
100	1.44	0.470	32.64
150	1.92	0.643	33.49
200	2.32	0.790	34.05
250	2.69	0.908	33.75
300	3.02	1.002	33.17
350	3.34	1.083	32.43
400	3.60	1.161	32.25
450	3.88	1.240	31.96

As it is sometimes important to recover the weight of the cranium when it has been destroyed by dissection, table 135 is introduced giving the weight of the two mandibles with teeth,

both absolute and as a percentage of the cranium. Thus by getting the weight of the fresh mandibles in any case it is possible by the aid of table 135 to compute approximately the weight of the cranium. After 100 grams this percentage relation varies but slightly, though it tends to increase up to a body weight of 200 grams, after which it slowly diminishes.

TABLE 136

*Showing growth changes in the blood in rats of increasing age (body weight). Sexes combined—based on tables I and II, Chisolm ('11)*

NUMBER OF ANIMALS	AGE	BODY WEIGHT (ROUNDED)	LENGTH OF BODY	Hb	O <sub>2</sub> CAPACITY		BLOOD VOLUME	
					Total	Per kilo body weight	Total	Per kilo body weight
	<i>days</i>	<i>grams</i>	<i>mm.</i>	<i>per cent</i>	<i>cc.</i>	<i>cc.</i>	<i>cc.</i>	<i>cc.</i>
2	1	4		89.0	0.0411	11.59	0.249	70.3
5	2	5	47	72.0	0.0466	9.79	0.350	73.5
3	8	10	59	50.3	0.0485	4.83	0.522	52.0
9	16	13	72	63.0	0.0639	4.99	0.544	42.5
3	21	14	82	49.0	0.0773	5.44	0.863	60.4
3	28	14	84	44.7	0.0891	6.17	1.070	74.4
9		37	112	76.0	0.3730	10.00	2.620	70.0
8		57	134	84.6	0.5630	9.92	3.610	63.7
8		66	140	85.1	0.6490	9.88	4.120	62.7
12		75	144	79.9	0.7220	9.60	4.940	65.7
15		86	148	82.4	0.8600	10.02	5.670	66.0
8		95	155	84.0	0.9550	10.02	6.070	63.9
8		106	159	82.4	1.0270	9.74	6.810	64.5
11		115	166	92.5	1.2130	10.51	6.970	60.5
9		125	169	92.6	1.2410	9.89	7.260	57.9
8		146	178	89.1	1.4460	9.92	8.870	60.8
8		165	180	92.0	1.6630	10.10	9.890	59.3
7		194	189	92.4	1.9880	10.28	11.820	61.0
10		227	201	89.9	2.1860	9.68	13.180	58.2
8		268	206	85.4	2.2300	8.36	14.150	53.0

3. *Teeth.* For the data on the growth of the incisor teeth (Addison and Appleton, '15), see chapter 3, pp. 53 and 54.

4. *Blood.* By means of a formula (21) based on his observations, Chisolm ('11) was able to compute the volume of the blood in rats of different body weights (Table 136). Hatai (MS '14) has added two formulas (21 a) (21 b) based on that of

Chisolm and giving results somewhat closer to the observations when the determinations are made according to sex.

These three formulas have been transformed in turn from volume to weight by using as a factor 1.056—the specific gravity of the blood—and three formulas for blood weight (22) (22 a) (22 b) have been thus obtained. These last have been used to compute the weight of the blood as given in table 146. Table 136 here given presents Chisolm's data on the other growth changes in the blood.

Abderhalden ('02) found that the percentage of haemoglobin is higher in the smaller—younger—rats than in the larger—older—ones.

TABLE 137

*Showing the weight of haemoglobin per kilo of body weight. Three to five rats in each group*

NUMBER OF GROUPS	CORRECTED* BODY WEIGHT	HAEMOGLOBIN PER KILO
	<i>grams</i>	<i>grams</i>
7	166	9.56
10	121	9.57
15	68	9.77
10	37	10.36

\* The corrected body weights are without skin and intestines. These values are therefore about 75 per cent of the gross body weight values.

The results are of the same order as those for the weight of blood but have not been corrected for the change in the percentage of water, table 137.

5. *Fat.* Boycott and Damant ('08, '08a) have recorded the proportion of fat in rats of both sexes and of increasing body weights.

The total fat was determined in healthy animals living under ordinary laboratory conditions as to food. No details given. The fat was estimated by Leathes' modification of Liebermann's methods which is easily applicable to the entire carcasses of animals. The figures, given as percentages of fatty acid on the crude weight of the animal, represent therefore masked as well as anatomical fat.

From table 138 based on body weight, it appears that the proportion of fat tends to be greater in the heavier animals, and from the tables based on the data grouped according to sex, it appears that the females have a somewhat larger percentage of fat than do the males. The values for the fatty acids can be transformed into those for fat by multiplying by 1.046.

The proportion of fat (boiling alcohol extract) has been determined also by Hatai ('17) in a series ranging from birth to maturity (see table 166).

TABLE 138

*Giving the proportion of fat (fatty acids) with increasing age (body weight). Based on table A, Boycott and Damant ('08 a)*

NUMBER AND SEX		BODY WEIGHT	PERCENTAGE OF FATTY ACIDS		
M.	F.		Maximum	Minimum	Average
		<i>grams</i>			
15	10	20-49	9.2	0.85	4.1
8	7	50-99	6.1	1.00	4.0
19	25	100-149	16.1	0.80	6.1
11	17	150-199	14.6	1.30	7.6
7	2	200-247	9.7	1.30	5.8
<i>Eighty-three rats arranged according to sex</i>					
Males	41		11.3	0.8	4.4
Females	42		16.1	1.0	5.6

## GROWTH OF PARTS AND SYSTEMS OF THE BODY IN WEIGHT:

## REFERENCES

- Larger divisions.* Barry, '20. Jackson and Lowrey, '12. Jackson, '15 b.  
*Systems.* Donaldson, '11, '11 c. Donaldson and Hatai, '11, '11 a. Donaldson, '12, '12 a. Jackson and Lowrey, '12. Osterud, '21.  
*Ligamentous skeleton.* Donaldson and Conrow, '19. Jackson, '21.  
*Cartilagenous skeleton.* Donaldson and Conrow, '19.  
*Weight of cranium.* Donaldson, '12 a. Donaldson and Conrow, '19.  
*Teeth.* Addison and Appleton, '15. Hammett and Justice, '23. MacGillivray, 1875. Meyerheim, 1898.  
*Blood.* Abderhalden, '02. Chisolm, '11.  
*Fat.* Boycott and Damant, '08, '08 a. Hatai, '17.

## CHAPTER 7

### GROWTH OF PARTS AND ORGANS IN RELATION TO BODY LENGTH AND IN RELATION TO AGE

1. Introduction. 2. Measurements—Methods of Examination—Graphs 3. Body length on body weight: Body weight on body length: Tail length on body length (a) Body weight per millimeter of length. 4. Organs with early rapid growth. 5. Organs with a nearly uniform growth. 6. Organs with a sinuous graph of growth. 7. Variability. 8. General tables: Entire body on age: Prenatal—Postnatal: Increase in length and weight of parts and organs on body length. 9. Weight of thymus on age. 10. Weights of viscera. 11. Values for other characters linked with age. 12. Formulas.

1. *Introduction.* The organs, the growth of which has been followed are tail (length), brain, spinal cord, eyeballs, heart, kidneys, liver, spleen, lungs, blood, alimentary tract, testes, ovaries, hypophysis, suprarenals, thyroid and thymus.

The foregoing were presented in the first edition of this book. In the present edition there have been added from the Institute laboratory full tables on the epididymis, pancreas, stomach and submaxillary glands, together with crude data on the lens, pineal and prostate gland, and from other laboratories we have determinations (Osterud, MS.) of the growth of the parts of the female reproductive tracts. In addition, there are given tables on the growth in weight of the parts of the brain (Sugita, '17). The growth of the skeleton and its parts (Donaldson and Conrow, '19) has been considered on pages 183-198.

All the observations were made on stock Albinos from the colony at The Wistar Institute, except those for the total blood, which are based on the records of Chisolm, '11, and those for the parts of the female reproductive tract (Osterud, MS.).

The mean values for the several organs were in each instance charted and with these as a guide a theoretical graph was found which could be expressed by a formula or a series of formulas. All the formulas were devised by Dr. Hatai.

To present the results in a convenient form the organs have been grouped in the text according to the manner of their growth, and in most cases the description is accompanied by a chart showing the original data and the graph based on these data.

In each case reference is made to the formula or formulas on which the graph is based, but as a matter of convenience, the formulas utilized for the graphs are grouped in the section entitled "Formulas," pp. 282-298.

The charts serve to show the form of the graph of growth in each instance, but the precise weight values of the organs are to be read from the tables. For those who desire to find the weight of an organ in a rat of any body length or body weight a series of values—computed by the aid of the appropriate formulas—are given in tables 144-150 inclusive and in 152 and 153.

In making these tables the determinations for the corresponding body weights for each millimeter of length in each sex were first made by formulas (5a) and (5b) and the body weights so obtained were then used in computing the weights of the several organs.

In table 151 for the thymus however, it was found necessary to enter the weight values of the organ according to the age of the rat.

In table 152 the computed weight of the thymus on body weight is given on the assumption that the *body weights are normal to age* in conformity with the data in table 157.

2. *Measurements.—Methods of examination and graphs.* Unless otherwise stated the following determinations were made on stock Albinos taken from the colony at The Wistar Institute. The animals were killed with chloroform twenty hours after the last feeding and were dissected according to a fixed procedure.

3. *Body length on body weight.* Technic: Immediately after killing the rat was laid on its back and gently extended—the tail being drawn out straight. With jointed calipers the distance from the tip of the nose to the tip of the tail was taken and its values in millimeters found by applying the points to a scale. Next the distance from the tip of the nose to the center of the anus was found and its value in millimeters determined in the



same way. These measurements give first the total length, second, the body length and by the difference, the tail length.

Chart 27 gives the body length on the body weight. The data used are given in table 144. The values were computed by formula (4) and then corrected for each sex. The graphs show

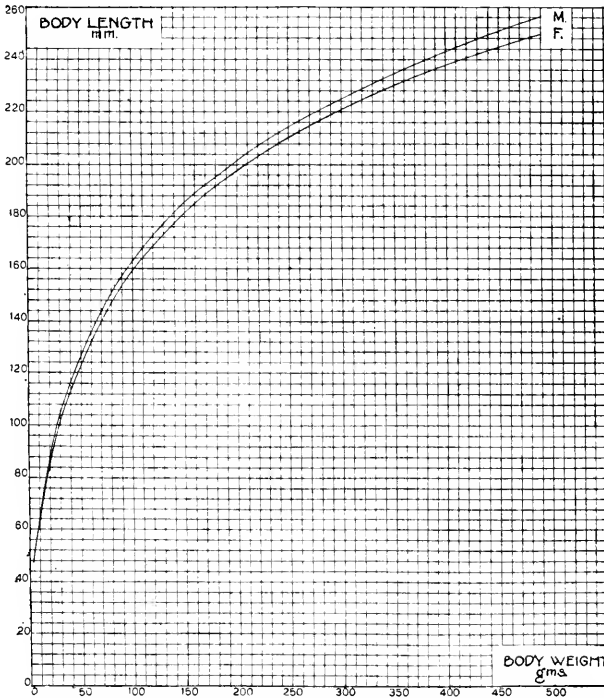

Chart 27 Giving for the males and females respectively the body length on the body weight. Formula (4): table 144.

that for a given body weight the male has the greater body length. Donaldson '09; Donaldson and Hatai '11.

*Body weight on body length.* The entire rat was next weighed to one-tenth of a gram. The weight thus obtained was *not* corrected for the contents of the alimentary canal—which according to Jackson and Lowrey ('12) amounts to about 5 per cent of the “gross” body weight. The uncorrected value is the gross body weight and the corrected, the “net” body weight of the

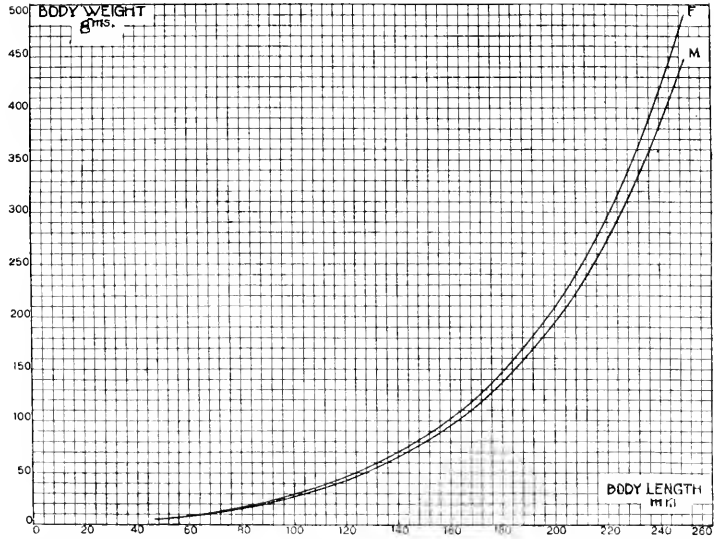

Chart 28 Giving for the males and females respectively the body weight on the body length. Formulas (5 a) and (5 b), table 144.

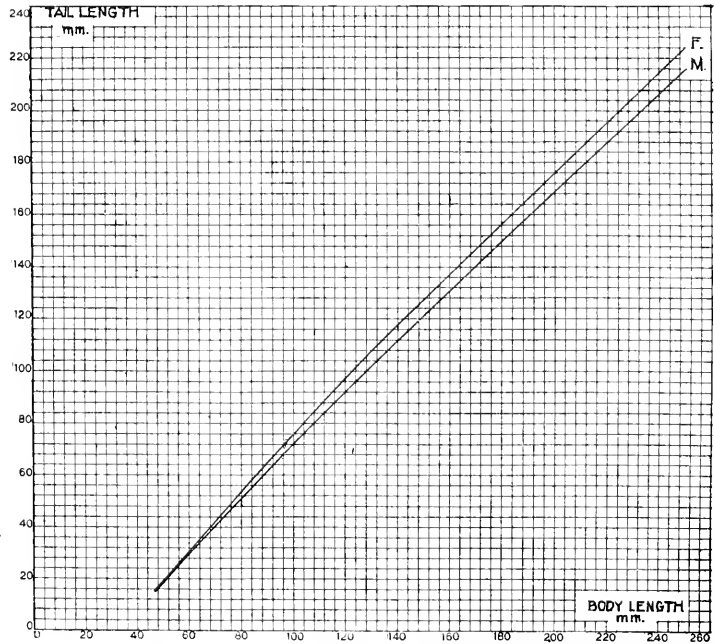

Chart 29 Giving the length of tail in millimeters on the body length, males, females. Formulas (7) and (8), table 144.

authors. In gravid females a correction was made however by subtracting the weight of the uterus and fetuses from the observed value. The weight of the body on the body length is given in chart 28.

The body weight values for each millimeter of body length in each sex are given in table 144. The graphs were computed by formulas (5a) and (5b), and show that for a given body length the female has a greater body weight. Donaldson '09, Donaldson and Hatai, '11.

*Tail length on body length.* The method of obtaining the tail length has been given under body length. The values for the graphs in chart 29 and for table 144 were determined by formulas

TABLE 139

*Ratio of body length (B) divided by tail length (T) in rats reared at different temperatures (Przibram, '23)*

EXTERNAL TEMPERATURE	RATIO B/T
35°	1.55
30°	1.57
25°	1.65
20°	1.67
15°	1.68
10°	1.73

(7) and (8). The tail is generally shorter than the body but in the female is relatively longer than in the male. It seems probable that six or seven of the caudal vertebrae are not formed till after birth.

The relative length of the tail is modified by external temperature which in turn modifies the internal temperature. Low temperatures decrease the growth of the tail while high temperatures increase it. Thus the ratio of the body length divided by the tail length is modified as in table 139 (Przibram, '22 A-D).

It is possible also that the greater relative length of the tail in the female may be related to the higher body temperature in the female (Przibram, '22 B).

(a) *Body weight per millimeter of body length.* The relation between body weight and body length is shown by dividing the weight by the length and thus getting the weight per running millimeter—table 122.

These determinations show that after the middle of the suckling period, at about nine days of age, the values for the female exceed those for the male, and this excess tends to increase as the body length increases.

4. *Organs with an early rapid growth. Brain weight on body weight.* *Technic:* The rat was first eviscerated—this leaves in the brain a minimal amount of blood. The bones of the skull were removed from above. Care was taken to preserve the paraflocculi which lie in bony pockets.

The brain was severed from the cord by a section at the level of the first cervical nerve—coinciding as a rule with the tip of the calamus as seen from the dorsal aspect. The brain was then raised from the floor of the cranium—the nerves being clipped close to the base. The hypophysis was not included. Care was taken to obtain the olfactory bulbs entire. Thus prepared the brain was dropped into a small glass stoppered weighing bottle in which it was weighed to the tenth of a milligram. In this instance, as in the case of all of the other organs, the dissection was made under a glass hood to protect the operator from all drafts which might dry the organ during its preparation. The values for the graph, males only, chart 30 and for table 144 were computed by formulas (9) and (10) corrected for sex.

The graph for the male alone is given. As will be seen from table 144, for the same body length the female has a slightly lighter brain and this deficiency increases to about 1.5 per cent when the female is of the same body weight.

*Spinal cord weight on body weight.* *Spinal cord—Technic:* Following the removal of the brain (*vide ante*) the spinal cord was exposed by removing the arches of the vertebrae from neck to sacrum. The filum terminale was found and the cord raised—so that the roots of the spinal nerves could be clipped close to the cord. The mass thus removed with meninges—was placed in a glass stoppered weighing bottle and weighed to the tenth of a

milligram. The values for the graph, males only, in chart 30 and for table 144 were computed by formula (13), corrected for sex. Donaldson ('08), ('09); Hatai, ('09a).

For convenience the graph for the spinal cord is given on the same chart as that for the brain. The graph for the male only is entered. For the same body length as the male the spinal cord in the female is about 5 per cent heavier, and for the same body weight, about 2 per cent heavier. Donaldson ('08, '09); Hatai ('09 a).

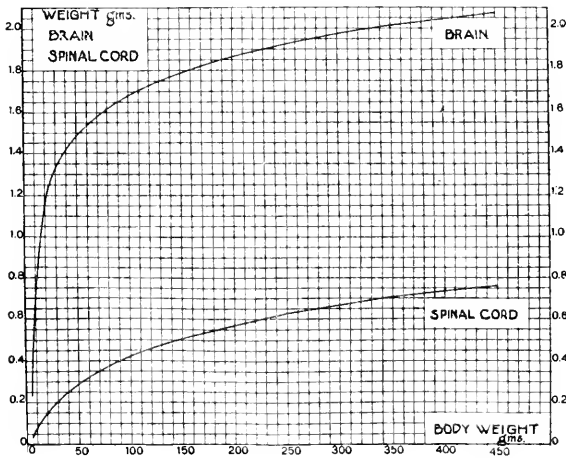

Chart 30 Giving the brain weight on the body weight. Males only. Formulas (9) and (10), table 144. Also spinal cord weight on the body weight. Males only. Formula (13), table 144.

*Weight of parts of the brain.* The change in the weight of the parts of the brain has been reported by Sugita ('17) table 140.

*Technic:* The olfactory bulbs were severed by a slightly oblique cut just caudad to the gray cap. The cerebellum was separated by section of the peduncles close to the stem. The stem was divided from the cerebrum by a section cephalad to the anterior quadrigemina.

*Weight of both eyeballs on body weight.* *Technic:* Care being taken to remove the muscle attachments, both eyes were weighed in a closed weighing bottle. The graph is based on rats studied

by Jackson ('13). His results have been corroborated by studies on the stock Albinos from the colony of the Wistar Institute, Hatai ('13). The values for the graph in chart 31 and those given in table 144 are based on formula (15). The graph for the male only is entered, but the values for the female are like those for the male of the same body weight. Under unfavorable nutritional conditions the weight of the eyeballs follows the age rather than the body weight. Hatai (MS '14).

TABLE 140

*Giving for ten ages the total brain weights and their ratios, the weights of the parts and the ratios of parts to their respective initial weights at birth, in the albino rat brain*

NUMBER OF CASES	AGE	TOTAL BRAIN WEIGHT		CEREBRUM		CEREBELLUM		STEM		OLFACTORY BULBS	
		Observed	Ratio	Observed	Ratio	Observed	Ratio	Observed	Ratio	Observed	Ratio
		<i>days</i>	<i>grams</i>		<i>grams</i>		<i>grams</i>		<i>grams</i>		<i>grams</i>
	B	0.236	1.0	0.150	1.0	0.008	1.0	0.073	1.0	0.005	1.0
4	4	0.482	2.0	0.338	2.3	0.023	2.9	0.105	1.4	0.016	3.2
3	5	0.503	2.1	0.349	2.3	0.026	3.3	0.113	1.5	0.015	2.0
2	20	1.153	4.9	0.817	5.4	0.126	15.8	0.171	2.3	0.039	7.8
3	35	1.355	5.7	0.870	5.8	0.197	23.4	0.248	3.4	0.040	8.0
4	50	1.469	6.2	0.974	6.5	0.197	23.4	0.258	3.5	0.040	8.0
3	60	1.531	6.5	0.959	6.4	0.226	28.3	0.278	3.8	0.068	13.6
2	70	1.612	6.8	1.033	6.9	0.215	26.9	0.331	4.5	0.033	6.6*
5	90	1.779	7.5	1.121	7.5	0.244	30.5	0.337	4.6	0.077	15.4
4	150	1.933	8.2	1.191	8.0	0.275	34.4	0.373	5.1	0.094	18.8

\* The olfactory bulbs are very variable in weight. Undeveloped bulbs like the above sometimes occur.

5. *Organs with a nearly uniform growth after the first very early phase of rapid growth—heart, kidneys, liver, spleen, lungs, (blood), alimentary tract, stomach, pancreas, submaxillaries, thyroid, hypophysis and suprarenals.*

In case of all of the organs to be described the preparation was carried on beneath a glass hood to prevent drying. The organ was weighed in a small glass stoppered bottle and the weight was taken to a tenth of a milligram.

*The weight of the heart on body weight.* Technic: The heart was removed after cutting all its vessels close to their proximal ends.

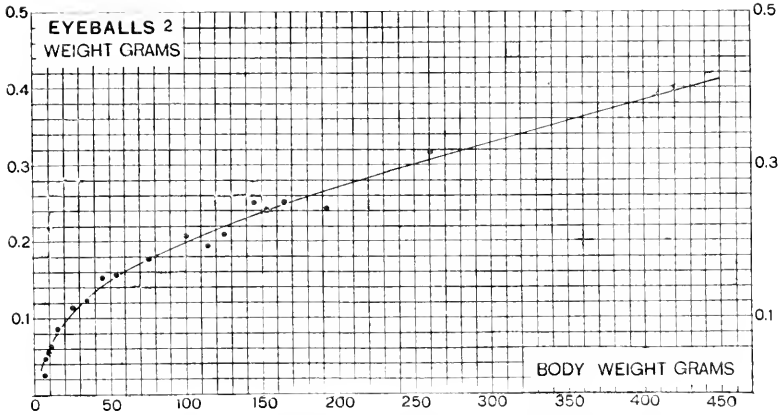

Chart 31 Showing the weight of eyeballs of the male albino rat according to body weight. The observed weights are represented by 149 male rats (Jackson). Table 144, formula (15).

• Observed weight. — Calculated weight.

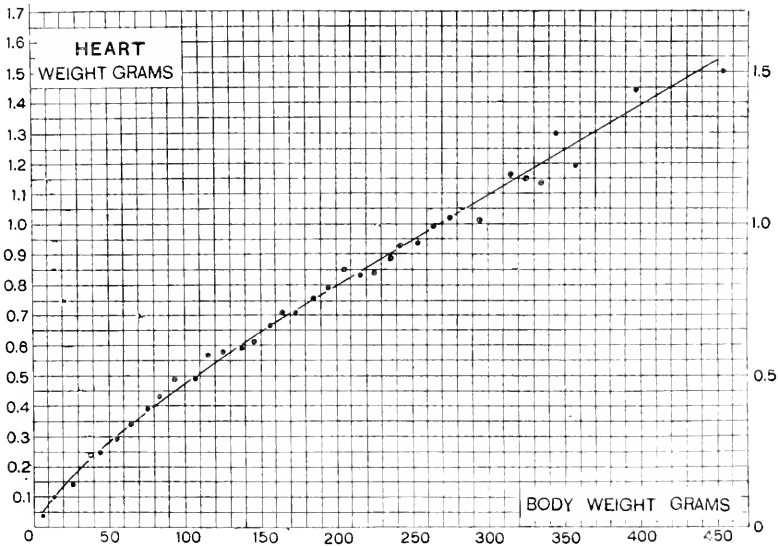

Chart 32 Showing the heart weight of the male albino rat according to body weight. The observed weights are represented by 134 male rats. Table 145 formula (16).

• Observed weight. — Calculated weight.

It was then opened by longitudinal slits through its walls and the clots removed from the cavities thus exposed.

The graph given in chart 32 and the values in table 145 have been determined by formula (16).

The weight of the heart is closely correlated with that of the body and no difference according to sex has been noted. Hatai ('13); Jackson ('13).

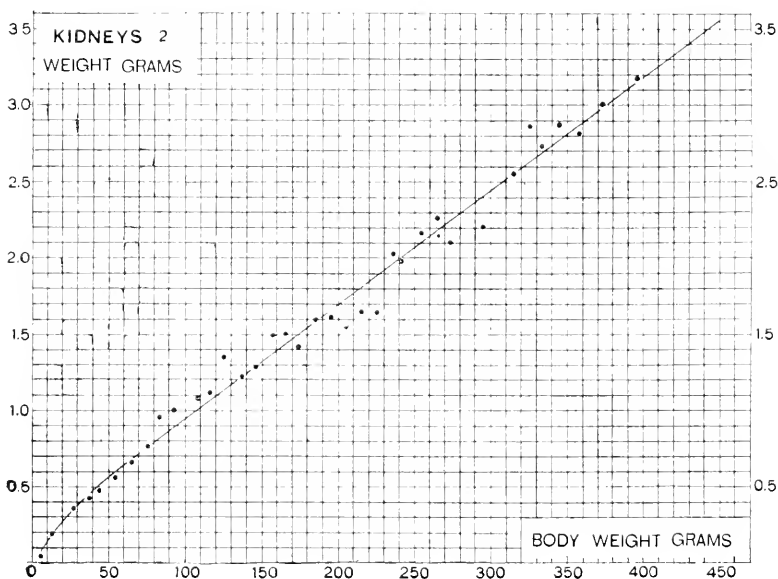

Chart 33 Showing the weight of kidneys of the male albino rat according to body weight. The observed weights are represented by 136 male rats. Table 145, formula (17).

• Observed weight. — Calculated weight.

*Weight of both kidneys on body weight.* Technic: All vessels were cut close to the hilum and any superficial fat removed.

The graph given in chart 33 and the values in table 145 were determined by formula (17).

No sex difference was observed but the graph represents the determinations for the male only. Hatai ('13); Jackson ('13).

*Weight of the liver on the body weight.* Technic: The vessels were cut close to their entrance into the liver and the blood in the



larger vessels gently pressed out. The graph given in chart 34 and the values in table 145 were determined by formula (18).

No sex difference in the weight of the liver has been noted—but the graph is given for the males only. Considerable variability is to be expected in the weight of an organ with such complex functions as those of the liver and this appears. A heavy

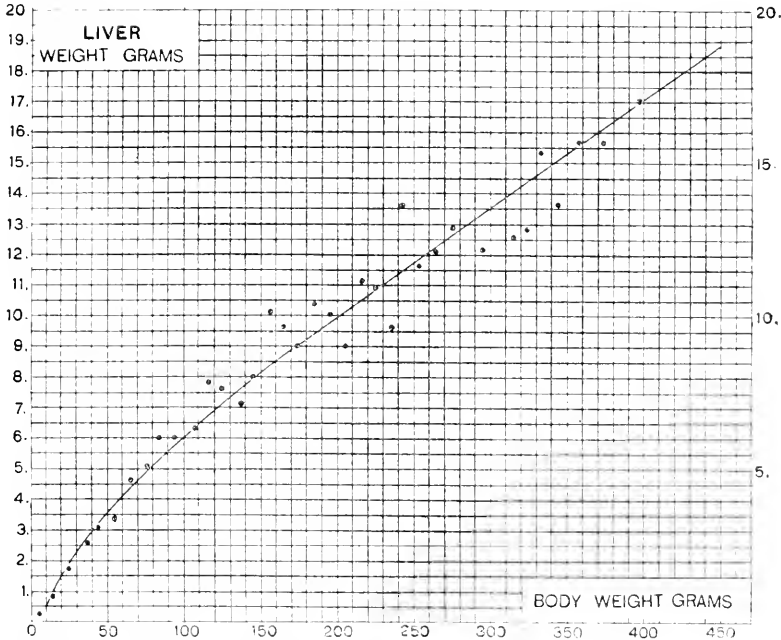

Chart 34 Showing the weight of liver of the male albino rat according to body weight. The observed weights are represented by 136 male rats. Table 145, formula (18).

• Observed weight. — Calculated weight.

liver usually accompanies a heavy spleen (Hatai). Hatai ('13); Jackson ('13).

The liver should be removed as soon as possible after killing as it tends to gain weight by the absorption of blood. Further, the animal should have had no food for the previous 12–20 hours as the liver tends to enlarge during digestion (Rous and McMaster, '24).

*The weight of the spleen on the body weight.* Technic: The vessels were cut close to the hilum. The determination of the weight of the spleen is complicated by the occurrence of "enlarged spleens"—so called. These differ from the normal by being often several times the normal weight, darker in color, soft to the touch and showing on the surface dark or grayish patches. Spleens with these characters plainly marked were not used. The graph in chart 35 and the values in table 145 were determined by formula (19). No sex difference was observed but

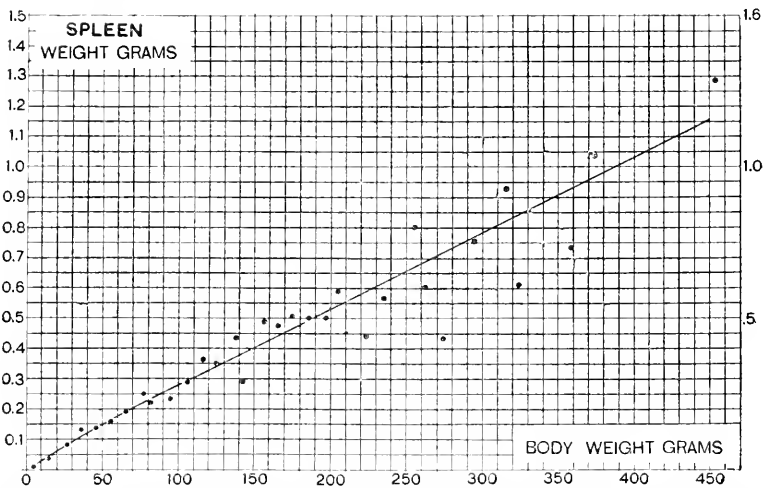

Chart 35 Showing the weight of spleen of the male albino rat according to body weight. The observed weights are represented by 87 male rats. Table 145, formula (19).

• Observed weight. — Calculated weight.

the graph is based on male records only. Hatai ('13); Jackson ('13).

*The weight of both lungs on the body weight.* Technic: The lungs are severed from the trachea and the portion of the esophagus usually taken out with them is removed. After the first three months of life the lungs of the rat are often infected. Such infected lungs may be highly altered—but are always abnormally heavy. The endeavor has been made to exclude infected lungs from the series—but doubtless some have been used. The

graph in chart 36 and the values in table 146 were determined by formula (20). No sex difference has been noted but the graph is based on male data alone. Hatai ('13); Jackson ('13).

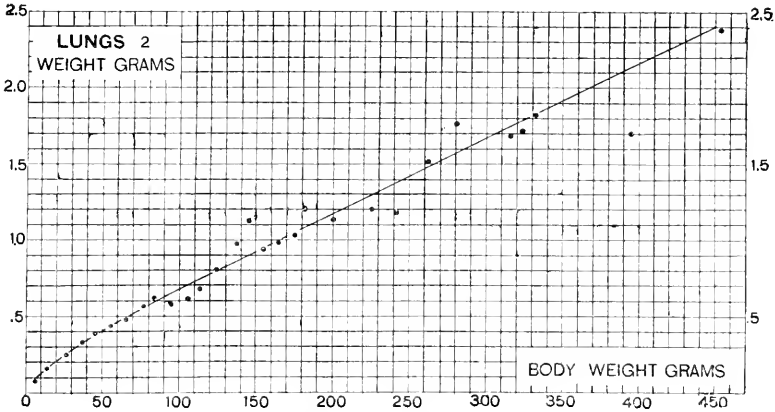

Chart 36 Showing the weight of lungs of the male albino rat according to body weight. The observed weights are represented by 90 male rats. Table 146, formula (20). • Observed weight. — Calculated weight.

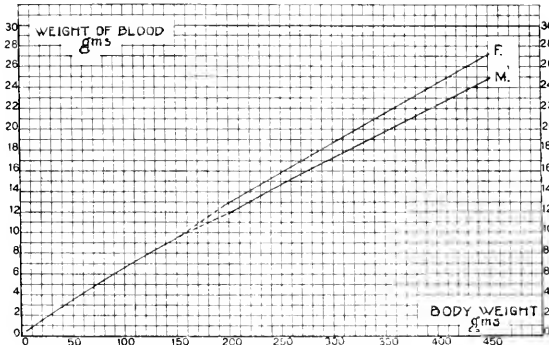

Chart 37 Giving weight of total blood on body weight. Males, females. Formulas (22), (22 a), and (22 b), table 146.

*Weight of the total blood on body weight.* Technic: The observations on this relation were made by Chisolm '11 on Albinos and pied rats. His methods are given in the paper cited above (pp. 207–208) and depend on determinations of the oxygen capacity. Chisolm's formulas have been revised by Hatai

(MS '14). The graph in chart 37 and the values in table 146 have been determined by formulas (22), (22 a), and (22 b). The data are for both sexes. Chisolm ('13); Jolly and Stini ('05).

*The weight of the alimentary tract on body weight.* Technic: The digestive tube from the level of the diaphragm to the anus was removed in its entirety—the pancreas, mesentery and small masses of fat being left adherent. The stomach and the large intestine were cut open and the contents removed while gentle

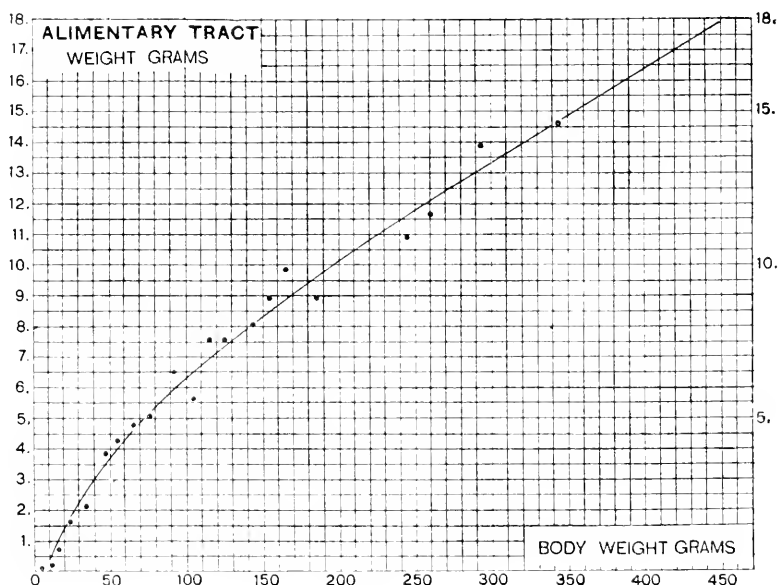

Chart 38 Showing the weight of alimentary tract of the male albino rat according to body weight. The observed weights are represented by 112 (Jackson) rats below 50 grams in body weight, and 82 (Wistar) rats above 50 grams in body weight. Table 146, formula (23).

• Observed weight. — Calculated weight.

pressure on the small intestine—exerted from above downwards—served to expel what it contained. The records are based on one series examined by Jackson ('13) and another series from The Wistar Institute colony. All are males. The graph in chart 38 and the values in table 146 were determined by formula (23). Sexes combined. Hatai ('13); and Jackson ('13).

*The weight of the stomach on body weight—Hatai ('18).* Technic: The stomach is separated at the pyloric end where a deep constriction is clearly shown. The esophagus is cut close to the stomach—within a few millimeters. As soon as the stomach is removed, it is cut along the entire length and the contents are carefully removed by means of either the dull side of a knife or forceps. This can be easily done without injuring the stomach for the purpose of recording its weight.

The graph in chart 39 and the values in table 147 were determined by formulas (24) and (24a). On account of the peculiarity of the growth before weaning two formulas were necessary.

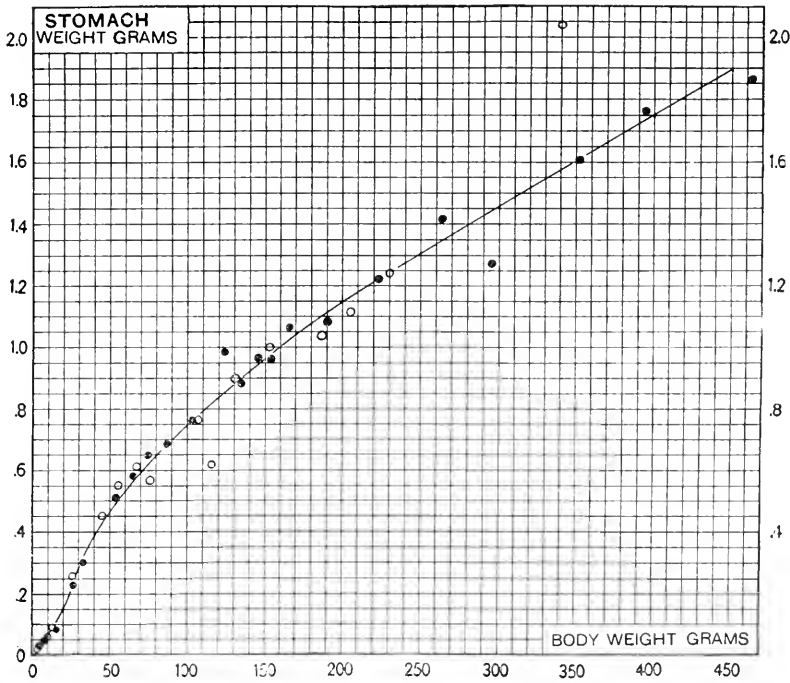

Chart 39 Showing the weight of the stomach of the albino rat according to body weight. The observed weights are represented by 152 male rats and 107 female rats, entered according to the groups given in table 147, formulas (24) and (24 a).  
 • Observed weight, male.      ○ Observed weight, female.  
 — Calculated weight.

*The weight of the pancreas on body weight—Hatai, '18. Technic:*

The pancreas is rather difficult to isolate from the surrounding structures such as omentum, lymphatic nodules, fat, etc. It is advisable to work first on young rats of about twenty-five days of age. In this state immediately after death the pancreas can be easily distinguished from the surrounding structures by its characteristic pinkish gray color. My own method is to cut the pancreas together with omentum from the line of attachment along the stomach and intestine. The adipose tissue can then be easily torn off by gentle pulling from the more solid pancreatic tissue. The omentum and lymphatic nodules may be removed by means of sharp scissors. In the adult rat the pancreas looks gray or grayish pink immediately after death. Some practice with younger rats is advisable before removing the pancreas from the older animals.

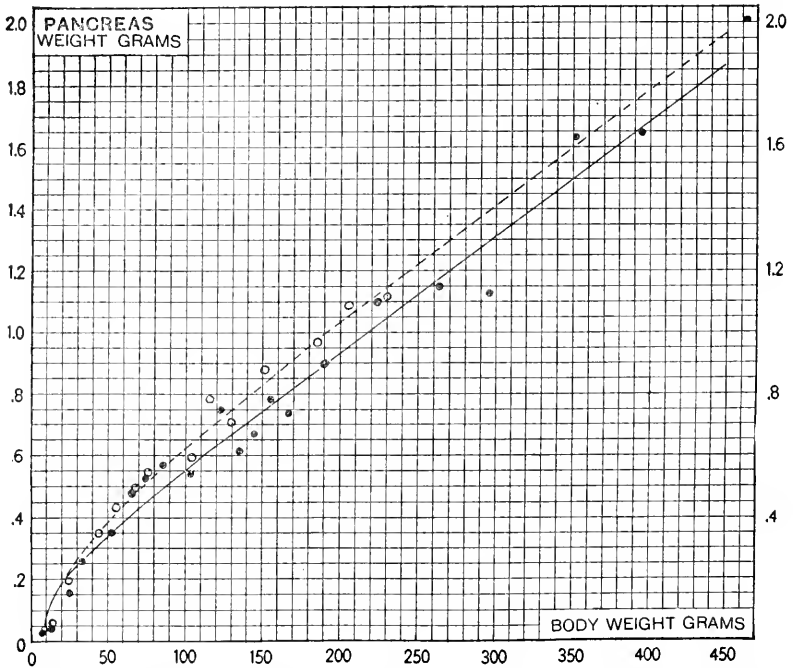

Chart 40 Showing the weight of the pancreas of the albino rat according to body weight. The observed weights are represented by 152 male rats and 107 female rats entered according to the groups given in table 147 and formulas (25) and (25 a).

- Observed weight, male.
- ◊ Observed weight, female.
- Calculated weight, male.
- Calculated weight, females.

There is a clear sex difference, the female having the heavier pancreas. Owing to the difficulty of dissection in the young rat the values between birth and 10 grams are not entered in table 147. The graph in chart 40 and the values in table 147 have been determined by formulas 25 and (25a).

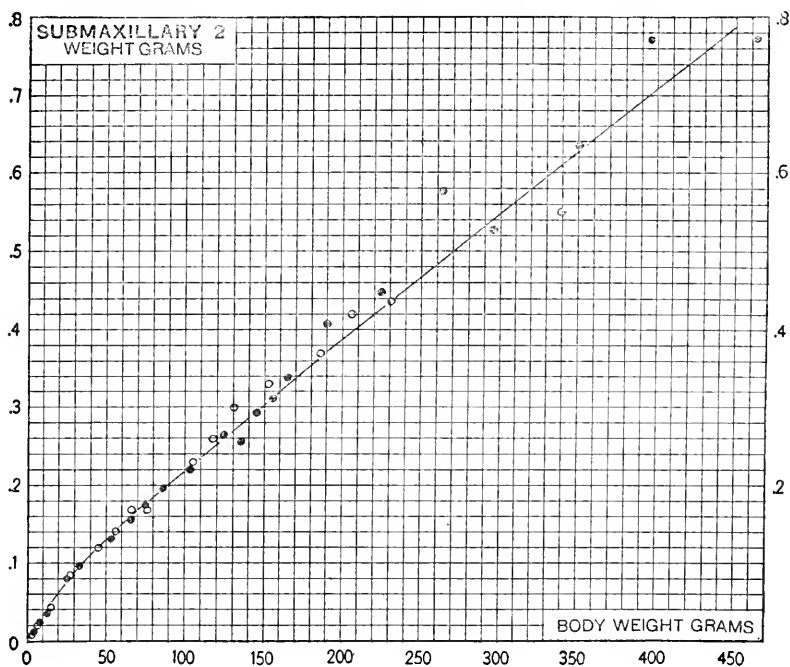

Chart 41 Showing the weight of submaxillary glands (2) of the albino rat according to body weight. The observed weights are represented by 152 male rats and 107 female rats, entered according to the groups given in table 147, formula 26.

- Observed weight, male.
- Observed weight, female.
- Calculated weight.

*The weight of the submaxillaries (2) on body weight.* Technic: These glands are easily isolated on account of their definite outline as well as their tough texture. Two or more lymphatic nodules are found beside the submaxillaries. These are to be excluded and are easily removed with sharp scissors. The graph in chart 41 and the values in table 147 have been determined by formula (26). Hatai '18.

The form of the graph is similar to that for most of the visceral organs. The relation between the weight of the submaxillaries and that of the body is, after 25 grams in body weight, practically linear. There is no indication of a sex difference so far as the weight is concerned.

*Weight of the thyroid gland on body weight.* Technic: Several minute muscles nearly the color of the gland must be removed

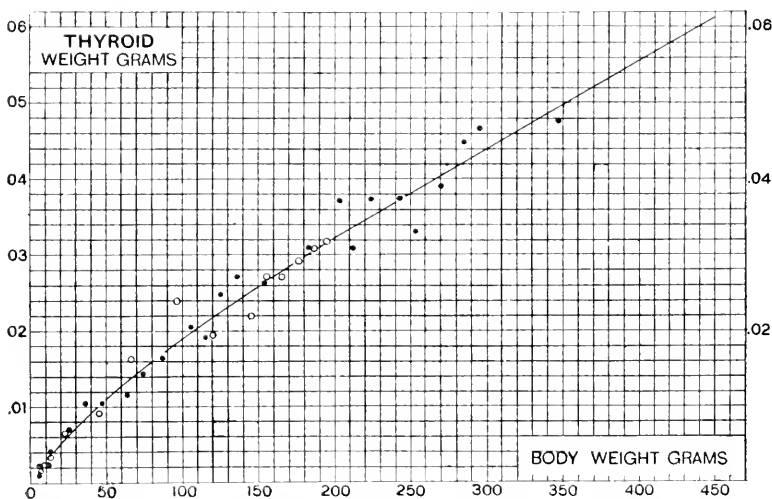

Chart 42 Showing the weight of thyroid gland of the albino rat according to body weight. The observed weights are represented by 42 (Jackson) female rats below 50 grams in body weight, and 49 (Wistar) male rats above 50 grams in body weight; and 36 (Jackson) female rats below 50 grams in body weight, and 27 (Wistar) female rats above 50 grams in body weight. Table 148, formula (39)

• Observed weight male. — Calculated weight for both sexes. ◦ Observed weight, female.

before weighing. The data are from observations by Jackson ('13), as well as from those made at The Wistar Institute. A study of the data has not revealed any difference according to sex and the graph therefore is for both sexes combined. The graph in chart 42 and the values in table 148 have been determined by formula (39). Hatai ('13); Jackson ('13).

*The weight of the hypophysis on body weight.* Technic: After the removal of the brain, the hypophysis is readily picked up



from the floor of the skull with a small forceps. It is weighed as removed.

At about 40–50 days of age there appears a difference in the weight of the hypophysis according to sex and with advancing age this difference tends to increase. The female has the heavier

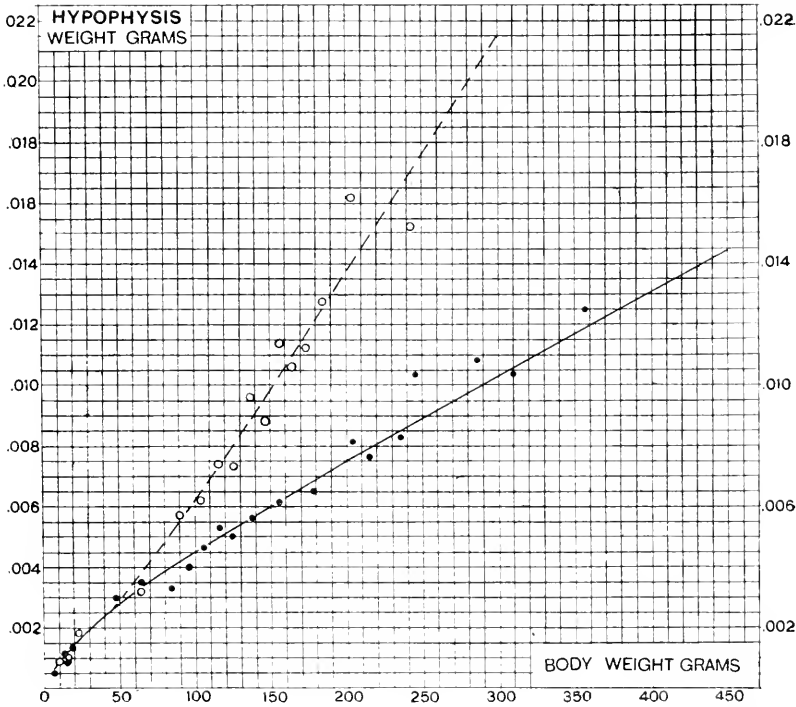

Chart 43 Showing the weight of hypophysis of the albino rat according to body weight. The observed weights are represented by 78 male and 80 female rats. Table 148, formulas (35) and (36).

- Observed weight, male.
- Observed weight, female.
- Calculated weight, male.
- Calculated weight, female.

hypophysis. The graph for the male in chart 43 and the values for the male in table 148 have been determined by formula (35). The graph for the female and the corresponding tabular values by formulas (35) and (36). Hatai ('13).

*The weight of the suprarenals on body weight.* *Technic:* The suprarenals are usually imbedded within some fat tissue—but

with a little practice they may be dissected out cleanly. At about 40–50 days of age there appears a difference in the weight of the suprarenals according to sex and with advancing age this difference tends to increase. The female has the heavier supra-

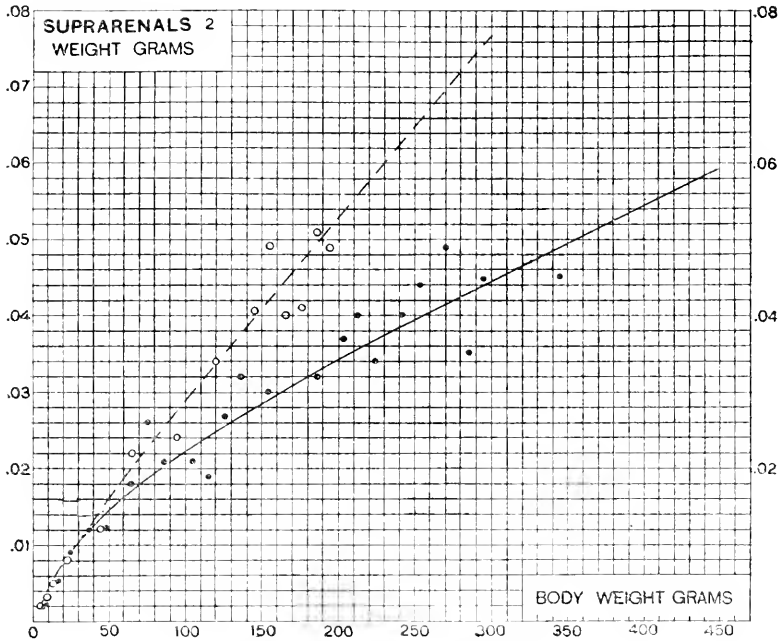

Chart 44 Showing the weight of suprarenals of the albino rat according to body weight. The observed weights are represented by 92 (Jackson) male rats below 50 grams in body weight, and 53 (Wistar) male rats above 50 grams in body weight; and 84 (Jackson) female rats below 50 grams in body weight, and 29 (Wistar) female rats above 50 grams in body weight. Table 148, formulas (37) and (38).

- Observed weight, male.
- Observed weight, female.
- Calculated weight, male.
- - - - Calculated weight, female.

renals. The graph for the male in chart 44 and the values for the male in table 148 have been determined by formula (37). The graph for the female and the corresponding tabular values, by formula (38). Hatai ('13); Jackson ('13).

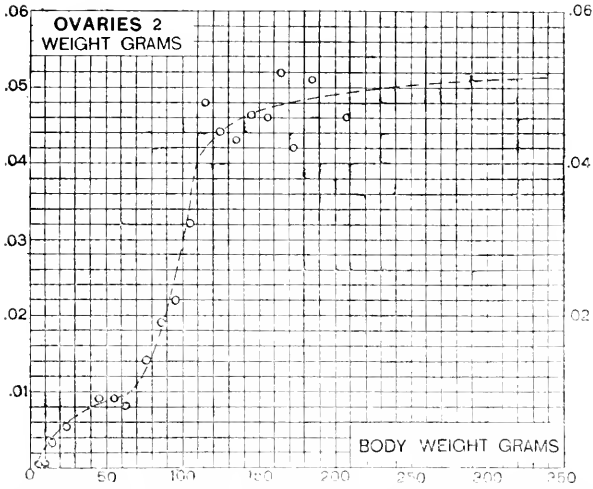

Chart 45 Showing the weight of ovaries of the unmated female albino rat according to body weight. The observed weights are represented by 136 (Jackson) rats. Table 146, formulas (32), (33) and (34).

• Observed weight.      - - - - Calculated weight.

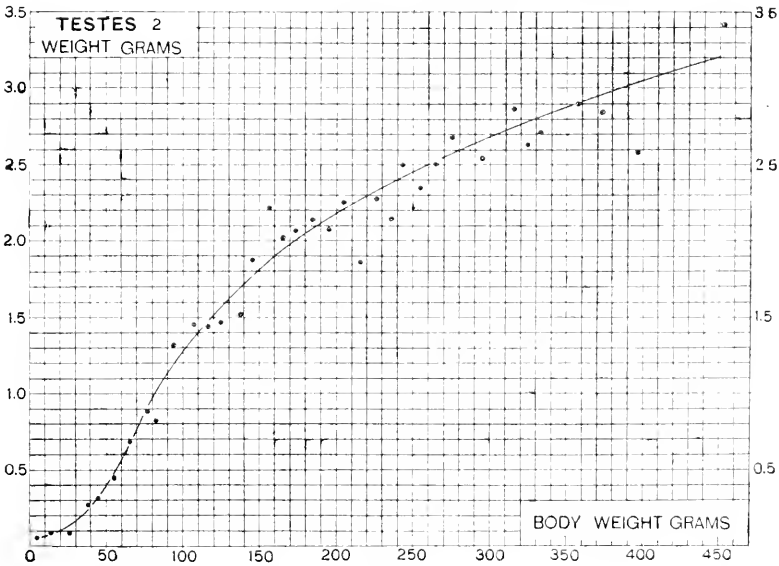

Chart 46 Showing the weight of testes of the male albino rat according to body weight. The observed weights are represented by 121 male rats. Table 146, formulas (27), (28) and (29).

• Observed weight.      — Calculated weight.

6. The third group of the organs here considered is formed by those the growth of which is represented by a sinuous graph in which the most marked rise appears shortly before puberty. These organs, so far as examined, are the ovaries, the testes, epididymis and the thymus.

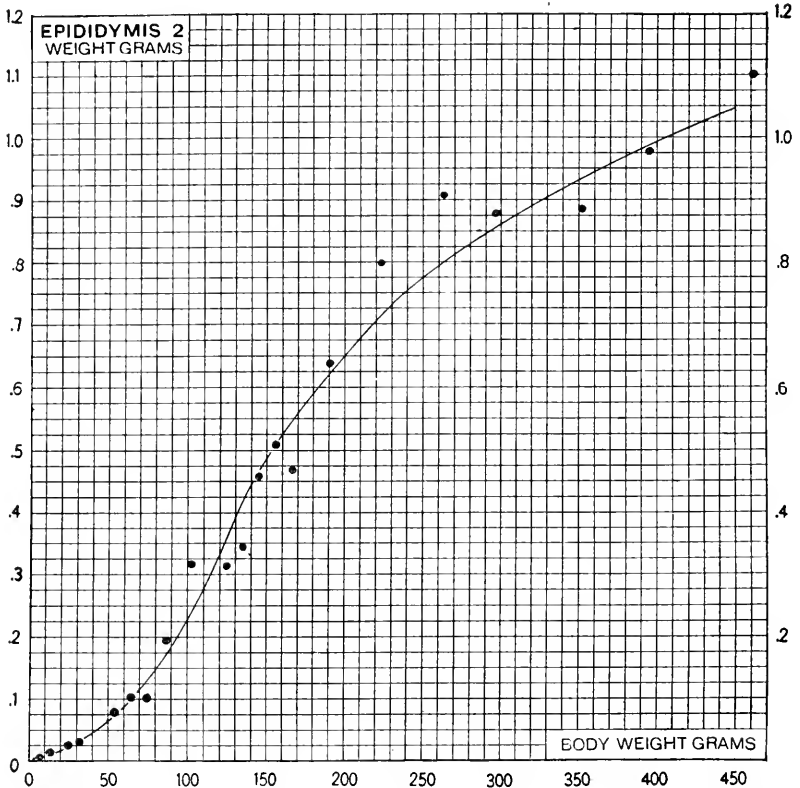

Chart 47 Showing the weight of epididymides of the male albino rat according to body weight. The observed weights are represented by 152 rats entered according to the groups given in table 147, formulas (30) and (31).

• Observed weight.

— Calculated weight.

*The weight of both ovaries on the body weight.* *Technic:* The ovaries must be carefully dissected from their capsules and from

the end of the fallopian tube. When the animal is small it is sometimes necessary to do this under a dissecting microscope. The data collected by Jackson ('13), for unmated females, are those used. The graph in chart 45 and the values in table 146 have been determined by formulas (32), (33), and (34). Hatai ('13, '14a); Jackson ('13).

*The weight of both testes on body weight.* Technic: The epididymis (2) was removed before the testes were weighed. The graph in chart 46 and the values in table 146 were determined by formulas (27) (28) and (29). Hatai ('13); Jackson ('13).

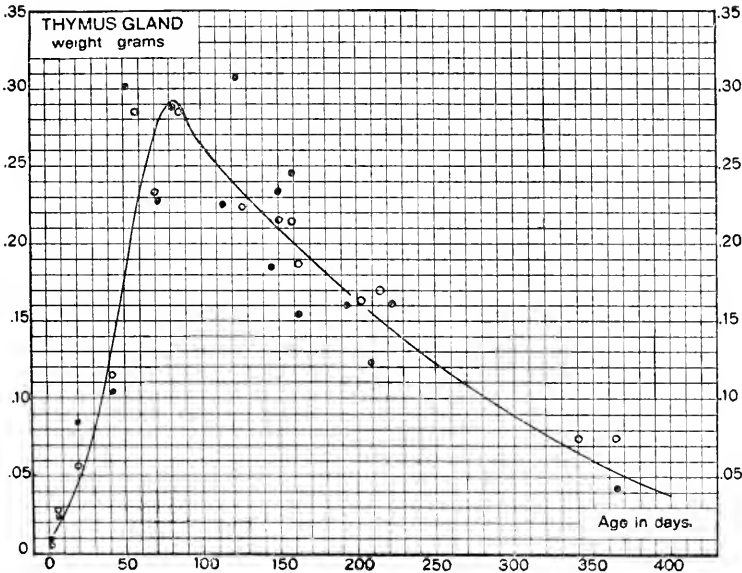

Chart 48 Showing the weight of the thymus of the albino rat according to age. The observed weights are represented by 229 males (164 Jackson and 64 Wistar) and 207 females (179 Jackson and 28 Wistar). Table 15, formulas (45) and (46).

Observed weight, • male, ◦ female, — Computed weight.

*The weight of both epididymides.* Technic: The epididymis of the adult rats is usually surrounded by a mass of fat. To separate the adipose tissue the caudal end of the organ is held

firmly with strong forceps and then along the entire length of the epididymis this tissue is cut away with sharp scissors, care being taken not to injure the organ itself. A complete isolation of the fat is impossible, but the organ can be so nearly freed that the adhering particles do not modify the results.

The graph in chart 47 and the values in table 147 were determined by the formulas (30) and (31). (Hatai, '18).

*Weight of thymus on age.* In the case of the thymus the data are more useful when presented according to age than when presented according to body weight.

*Technic:* In preparing the thymus care must be taken to dissect away the large lymph glands as well as the fat lying about it. The records by Jackson ('13) have been combined with those from The Wistar Institute. The graph in chart 48 and the values in table 151 have been determined by the formulas (45) and (46). No weight difference according to sex has been noted. Hatai ('14); Jackson ('13).

7. *Variability. Variation in body weight and organ weight.* In table 141 Jackson ('13) gives a series of determinations of the coefficient of variation for body weight on a litter basis and in age groups. The animals were selected by the method of "random sampling." These values are to be compared with those determined by King—table 121.

For the same animals as were used in table 141 Jackson ('13) also gives for the several organs the coefficients of variation (table 142) and the coefficients of correlation with the body weight (table 143).

8. *General tables.* The tables which are not represented by charts in the text are usually short and have been introduced where they are mentioned, but as a matter of convenience all of those which are so represented are here grouped together as general tables under the following heads:

Tables for the increase in the weight of the entire body, brain and spinal cord on age—tables 157, and 157 a.

TABLE 141

*Coefficient of variation in body weight for total population by the ordinary method, and on litter basis (fraternal variation) estimated by various methods (Jackson, '13).*

	SEX	NEW-BORN	7 DAYS	20 DAYS	6 WEEKS	10 WEEKS	5 MONTHS
Total population..... (ordinary method)	Male	13.6*	16.9*	24.4**	20.8**	18.8*	18.5*
	Female	9.9*	13.7*	29.4*	24.2*	16.8*	15.3*
Litter basis..... (average of litters calculated by ordinary method)	Male	7.0	6.1	5.7	6.6	5.8	7.4
	Female	4.4	5.4	4.0	5.9	12.0	10.4
Litter basis..... (calculated from Yule's formula)	Male	6.8	7.6	6.8	7.1	6.1	8.1
	Female	5.2	4.4	4.5	7.9	12.2	9.3
Litter basis..... (from Kellogg's formula)	Male	7.3	8.4	6.0	7.2	6.7	8.5
	Female	5.2	4.5	4.1	8.5	12.0	9.0

\* For net body weight.

\*\* For gross body weight, larger series.

TABLE 142

*Coefficients of variation in organ weights, albino rat at different ages. Arranged according to mean values in the last column (Jackson, '12)*

	0 DAYS	7 DAYS	21 DAYS	42 DAYS	70 DAYS	150 DAYS	AVERAGE
Brain.....	12		7	12			10
Eyeballs.....	16	15	13	8	11	9	12
Head.....	10	11	15	10	14	13	12
Total body.....	12	16	28	21	20	19	19
Lungs.....	23	17	24	19	21		21
Kidneys.....	24	22	34	15	17	19	22
Heart.....	18	20	34	30	18	21	24
Liver.....	22	19	41	19	33	25	26
Suprarenals.....	24	20	33	22	21	39	26
Testes.....	25	18	30	27	35	41	29
Thymus.....	31	32	43	50	25	22	34
Spleen.....	39	34	51	26	38	19	34
Intestinal canal (plus contents)	38	29	42	30			35
Ovaries.....			42	47	51	33	43
Average of viscera	23	22	31	24	26	24	25

Tables for the increase in the length of the tail, in the weight of the entire body, and in the weight of several of the viscera according to body length—tables 144–148 and 152.

Also a series of crude tables giving the directly observed weights of a series of small organs on body weight and age—tables 149 and 150.

Jackson ('13) and others have called attention to discrepancies between their observed values and those in table 148.

TABLE 143

*Coefficients of correlation of organ weights with the body weight: albino rat at different ages. Arranged according to mean values in the last column (Jackson, '13)*

	0 DAYS	7 DAYS	21 DAYS	42 DAYS	70 DAYS	150 DAYS	AVERAGE
Head.....	0.76	0.89	0.93	0.95	0.75	0.85	0.86
Kidneys.....	0.70	0.79	0.96	0.92	0.90	0.91	0.86
Liver.....	0.76	0.76	0.97	0.84	0.74	0.87	0.83
Lungs.....	0.74	0.80	0.87	0.94	0.62		0.80
Brain.....	0.69		0.78	0.88			0.78
Heart.....	0.58	0.50	0.91	0.97	0.86	0.84	0.78
Testes.....	0.67	0.75	0.95	0.75	0.48	0.88	0.75
Ovaries.....			0.73	0.64	0.82	0.81	0.75
Intestinal canal (plus contents)..	0.29	0.59	0.84	0.76			0.62
Thymus.....	0.67	0.74	0.89	0.90	0.51	-0.09	0.60
Spleen.....	0.54	0.44	0.97	0.50	0.41	0.46	0.55
Eyeballs.....	0.67	0.52	0.67	0.31	0.22	0.32	0.45
Suprarenals.....	0.51	0.13	0.58	0.41	0.41	0.35	0.40
Average.....	0.63	0.63	0.85	0.75	0.62	0.70	0.70

On careful consideration it appears that the values in the tables are those characteristic for the special strain which was used, and the original table values have therefore been retained unaltered. That other strains may give other values is of course to be recognized and also the high variability of these organs, especially the endocrine glands, must always be kept in mind.

Table 151 for the weight of the thymus—is based not on body length but on age.

Weight of all the viscera combined—table 153.



Tables giving the values for characters other than body weight, linked with age—tables 151 and 157.

For the most part the tables are preceded by a slight descriptive heading only. Reference is made to the corresponding charts in connection with which all the details concerning them have been noted.

*Tables showing the increase in the weight of the entire body with age.*

Growth before birth—Stotsenburg ('15) tables 118 and 119, chart 20.

Postnatal growth in body weight is recorded in tables 157, charts 21 and 22, and 157 A.

*The body weights in table 157 are those which were used for our so-called "standard curve of growth" as shown in charts 21A and 22a.*

The data in table 157A are those on which the graph published by Greenman and Duhring ('23) is based. They are here tabulated because they represent the age-body weight relations now found in the colony of The Wistar Institute and in general are decidedly above those used for our standard curve of growth. These high values are the result of special care and feeding, coupled with selection, and surpass those commonly obtained under the usual conditions.

*Tables giving characters other than body weight which depend primarily on age.*

Table 157 gives the percentage of water in the brain and in the spinal cord for each sex from birth to 365 days. These values have been computed by formulas (47)–(49a) and (50)–(52d). The graphs corresponding to these data for the males are given in chart 55.

Table 151 gives the values for the weight of the thymus—sexes combined—from birth to 400 days. The values have been computed by formulas (45) and (46). The graph corresponding to these data is given in chart 48.

The five tables 144–148 which follow have been worked out on the basis of body length by the use of the appropriate formulas. The details touching the organs represented, as well as the corresponding graphs, are given earlier in this chapter.

TABLE 144

Giving for each sex the tail length and the weights of the brain, spinal cord and both eyeballs for each millimeter of body length. See Charts 27, 28, 29, 30 and 31

MALES						FEMALES				
Body length	Tail length	Body weight	Weight in gms.		Both eye-balls	Tail length	Body weight	Weight in gms.		Both eye-balls
			Brain	Spinal cord				Brain	Spinal cord	
mm.	mm.	gms.			gms.	mm.	gms.			gms
47	14.9	4.9	0.226	0.033	0.029	15.4	4.7	0.211	0.033	0.028
48	15.8	4.9	0.226	0.033	0.029	16.6	4.7	0.214	0.033	0.028
49	16.9	5.0	0.232	0.034	0.030	17.8	4.9	0.217	0.034	0.029
50	18.0	5.1	0.238	0.034	0.031	19.0	5.0	0.222	0.035	0.029
51	19.2	5.2	0.252	0.035	0.031	20.2	5.1	0.227	0.035	0.030
52	20.4	5.3	0.266	0.036	0.032	21.5	5.3	0.255	0.036	0.032
53	21.6	5.4	0.280	0.037	0.033	22.7	5.5	0.283	0.038	0.034
54	22.7	5.6	0.300	0.038	0.034	23.9	5.8	0.323	0.041	0.036
55	23.9	5.8	0.320	0.040	0.036	25.2	6.2	0.361	0.041	0.039
56	25.0	6.1	0.358	0.043	0.039	26.4	6.5	0.398	0.048	0.041
57	26.2	6.4	0.395	0.046	0.041	27.6	6.9	0.433	0.051	0.044
58	27.3	6.8	0.431	0.049	0.044	28.8	7.2	0.468	0.054	0.046
59	28.5	7.1	0.465	0.052	0.046	30.0	7.6	0.500	0.057	0.049
60	29.6	7.5	0.498	0.055	0.048	31.2	8.0	0.532	0.061	0.051
61	30.7	7.9	0.530	0.059	0.050	32.3	8.4	0.564	0.064	0.053
62	31.9	8.2	0.561	0.062	0.052	33.5	8.7	0.594	0.068	0.055
63	33.0	8.6	0.591	0.065	0.054	34.7	9.1	0.624	0.071	0.057
64	34.1	9.0	0.621	0.068	0.056	35.9	9.5	0.652	0.074	0.059
65	35.2	9.4	0.650	0.071	0.058	37.0	9.9	0.679	0.077	0.061
66	36.3	9.8	0.678	0.075	0.060	38.2	10.3	0.703	0.081	0.063
67	37.4	10.1	0.695	0.078	0.062	39.4	10.8	0.726	0.084	0.065
68	38.5	10.6	0.711	0.081	0.064	40.5	11.2	0.772	0.088	0.067
69	39.6	11.0	0.761	0.084	0.066	41.7	11.6	0.811	0.091	0.068
70	40.7	11.4	0.803	0.088	0.068	42.8	12.0	0.846	0.095	0.070
71	41.8	11.8	0.840	0.091	0.069	43.9	12.5	0.876	0.098	0.072
72	42.9	12.2	0.872	0.094	0.071	45.1	12.9	0.901	0.101	0.073
73	44.0	12.7	0.901	0.098	0.073	46.2	13.4	0.929	0.105	0.075
74	45.1	13.1	0.928	0.101	0.074	47.3	13.9	0.952	0.108	0.077
75	46.2	13.6	0.952	0.104	0.076	48.5	14.3	0.974	0.112	0.078
76	47.2	14.0	0.974	0.107	0.077	49.6	14.8	0.994	0.115	0.080
77	48.3	14.5	0.995	0.111	0.079	50.7	15.3	1.013	0.119	0.082
78	49.4	15.0	1.015	0.114	0.081	51.8	15.8	1.031	0.122	0.083
79	50.4	15.4	1.033	0.117	0.082	52.9	16.3	1.047	0.126	0.085
80	51.5	15.9	1.051	0.121	0.084	54.0	16.8	1.064	0.129	0.086

TABLE 144—Continued

MALES						FEMALES				
Body length	Tail length	Body weight	Weight in gms.		Both eye-balls	Tail length	Body weight	Weight in gms.		Both eye-balls
			Brain	Spinal cord				Brain	Spinal cord	
<i>mm.</i>	<i>mm.</i>	<i>gms.</i>			<i>gms.</i>	<i>mm.</i>	<i>gms.</i>			<i>gms.</i>
81	52.6	16.4	1.067	0.124	0.085	55.1	17.3	1.079	0.133	0.088
82	53.6	16.9	1.083	0.128	0.087	56.3	17.9	1.093	0.136	0.089
83	54.7	17.4	1.098	0.131	0.088	57.4	18.4	1.107	0.140	0.091
84	55.7	18.0	1.112	0.134	0.090	58.5	19.0	1.121	0.143	0.093
85	56.8	18.5	1.126	0.138	0.091	59.5	19.5	1.134	0.147	0.094
86	57.8	19.0	1.139	0.141	0.093	60.6	20.1	1.146	0.150	0.095
87	58.9	19.6	1.152	0.144	0.094	61.7	20.7	1.159	0.154	0.097
88	59.9	20.1	1.165	0.148	0.095	62.8	21.2	1.170	0.158	0.098
89	61.0	20.7	1.177	0.151	0.097	63.9	21.8	1.181	0.161	0.100
90	62.0	21.3	1.188	0.155	0.098	65.0	22.4	1.193	0.165	0.101
91	63.0	21.9	1.200	0.158	0.100	66.1	23.1	1.203	0.168	0.103
92	64.1	22.4	1.211	0.162	0.101	67.2	23.7	1.214	0.172	0.104
93	65.1	23.0	1.221	0.165	0.102	68.2	24.3	1.224	0.176	0.105
94	66.2	23.7	1.231	0.168	0.104	69.3	25.0	1.234	0.179	0.107
95	67.2	24.3	1.242	0.172	0.105	70.4	25.6	1.244	0.183	0.108
96	68.2	24.9	1.252	0.175	0.107	71.4	26.3	1.253	0.186	0.109
97	69.2	25.6	1.261	0.179	0.108	72.5	27.0	1.262	0.190	0.111
98	70.3	26.2	1.271	0.182	0.109	73.6	27.7	1.271	0.194	0.112
99	71.3	26.9	1.280	0.186	0.111	74.6	28.4	1.280	0.197	0.114
100	72.3	27.5	1.289	0.189	0.112	75.7	29.1	1.289	0.201	0.115
101	73.3	28.2	1.298	0.193	0.113	76.8	29.8	1.298	0.205	0.116
102	74.3	28.9	1.307	0.197	0.115	77.8	30.5	1.306	0.209	0.118
103	75.4	29.6	1.315	0.200	0.116	78.9	31.3	1.314	0.212	0.119
104	76.4	30.3	1.323	0.204	0.117	79.9	32.0	1.322	0.216	0.120
105	77.4	31.1	1.332	0.207	0.119	81.0	32.8	1.330	0.220	0.122
106	78.4	31.8	1.340	0.211	0.120	82.0	33.6	1.338	0.223	0.123
107	79.4	32.5	1.348	0.214	0.121	83.1	34.4	1.346	0.227	0.124
108	80.4	33.3	1.356	0.218	0.123	84.1	35.2	1.354	0.231	0.126
109	81.4	34.1	1.363	0.221	0.124	85.2	36.0	1.361	0.235	0.127
110	82.4	34.9	1.371	0.225	0.125	86.2	36.9	1.368	0.238	0.128
111	83.4	35.7	1.378	0.228	0.126	87.3	37.7	1.376	0.242	0.130
112	84.4	36.5	1.386	0.232	0.128	88.3	38.6	1.383	0.246	0.131
113	85.4	37.3	1.393	0.236	0.129	89.4	39.5	1.390	0.250	0.132
114	86.4	38.2	1.400	0.239	0.130	90.4	40.3	1.397	0.253	0.134
115	87.4	39.0	1.407	0.243	0.132	91.4	41.3	1.404	0.257	0.135
116	88.4	39.9	1.414	0.246	0.133	92.5	42.2	1.411	0.261	0.136

TABLE 144- Continued

MALES						FEMALES				
Body length	Tail length	Body weight	Weight in gms.		Both eye-balls	Tail length	Body weight	Weight in gms.		Both eye-balls
			Brain	Spinal cord				Brain	Spinal cord	
<i>mm.</i>	<i>mm.</i>	<i>gms.</i>			<i>gms.</i>	<i>mm.</i>	<i>gms.</i>			<i>gms.</i>
117	89.4	40.8	1.421	0.250	0.134	93.5	43.1	1.418	0.265	0.138
118	90.4	41.6	1.428	0.254	0.136	94.5	44.1	1.424	0.268	0.139
119	91.4	42.6	1.435	0.257	0.137	95.6	45.0	1.431	0.272	0.140
120	92.4	43.5	1.442	0.261	0.138	96.6	46.0	1.438	0.276	0.142
121	93.4	44.4	1.448	0.265	0.140	97.6	47.0	1.444	0.280	0.143
122	94.4	45.4	1.455	0.268	0.141	98.7	48.0	1.450	0.284	0.144
123	95.4	46.3	1.461	0.272	0.142	99.7	49.1	1.457	0.287	0.146
124	96.4	47.3	1.468	0.276	0.143	100.7	50.1	1.463	0.291	0.147
125	97.4	48.3	1.474	0.279	0.145	101.7	51.2	1.469	0.295	0.148
126	98.4	49.3	1.480	0.283	0.146	102.8	52.3	1.476	0.299	0.150
127	99.3	50.4	1.487	0.287	0.147	103.8	53.4	1.482	0.303	0.151
128	100.3	51.4	1.493	0.290	0.149	104.8	54.5	1.488	0.307	0.153
129	101.3	52.5	1.499	0.294	0.150	105.8	55.6	1.494	0.310	0.154
130	102.3	53.6	1.505	0.297	0.151	106.8	56.8	1.500	0.314	0.155
131	103.3	54.7	1.511	0.301	0.153	107.9	58.0	1.506	0.318	0.157
132	104.2	55.8	1.517	0.305	0.154	108.9	59.2	1.512	0.322	0.158
133	105.2	56.9	1.523	0.309	0.155	109.9	60.4	1.518	0.326	0.159
134	106.2	58.1	1.529	0.312	0.157	110.9	61.6	1.523	0.330	0.161
135	107.2	59.3	1.535	0.316	0.158	111.9	62.9	1.529	0.334	0.162
136	108.2	60.5	1.541	0.320	0.160	112.9	64.2	1.535	0.338	0.164
137	109.1	61.7	1.546	0.323	0.161	114.0	65.5	1.540	0.341	0.165
138	110.1	62.9	1.552	0.327	0.162	115.0	66.8	1.546	0.345	0.166
139	111.1	64.1	1.558	0.331	0.164	116.0	68.1	1.552	0.349	0.168
140	112.1	65.4	1.563	0.335	0.165	117.0	69.5	1.557	0.353	0.169
141	113.0	66.7	1.569	0.338	0.166	118.0	70.9	1.563	0.357	0.171
142	114.0	68.0	1.575	0.342	0.168	119.0	72.3	1.568	0.361	0.172
143	115.0	69.3	1.580	0.346	0.169	120.0	73.7	1.574	0.365	0.174
144	115.9	70.7	1.586	0.349	0.171	121.0	75.2	1.579	0.369	0.175
145	116.9	72.1	1.591	0.353	0.172	122.0	76.7	1.585	0.373	0.177
146	117.9	73.5	1.597	0.357	0.173	123.0	78.2	1.590	0.377	0.178
147	118.8	74.9	1.602	0.361	0.175	124.0	79.7	1.595	0.380	0.180
148	119.8	76.3	1.607	0.365	0.176	125.0	81.3	1.601	0.384	0.181
149	120.8	77.8	1.613	0.368	0.178	126.0	82.8	1.606	0.388	0.182
150	121.7	79.3	1.618	0.372	0.179	127.0	84.4	1.611	0.392	0.184
151	122.7	80.8	1.623	0.376	0.181	128.0	86.1	1.616	0.396	0.186
152	123.7	82.4	1.629	0.380	0.182	129.0	87.7	1.622	0.400	0.187

TABLE 141—Continued

MALES						FEMALES				
Body length	Tail length	Body weight	Weight in gms.		Both eye-balls	Tail length	Body weight	Weight in gms.		Both eye-balls
			Brain	Spinal cord				Brain	Spinal cord	
<i>mm.</i>	<i>mm.</i>	<i>gms.</i>			<i>gms.</i>	<i>mm.</i>	<i>gms.</i>			<i>gms.</i>
153	124.6	83.9	1.634	0.383	0.183	130.0	89.4	1.627	0.404	0.189
154	125.6	85.5	1.639	0.387	0.185	131.0	91.1	1.632	0.408	0.190
155	126.5	87.1	1.644	0.391	0.186	132.0	92.9	1.637	0.412	0.192
156	127.5	88.7	1.649	0.395	0.188	133.0	94.6	1.642	0.416	0.193
157	128.5	90.4	1.654	0.398	0.189	134.0	96.4	1.647	0.420	0.195
158	129.4	92.1	1.659	0.402	0.191	135.0	98.3	1.652	0.424	0.196
159	130.4	93.8	1.664	0.406	0.192	136.0	100.1	1.657	0.428	0.198
160	131.3	95.6	1.670	0.410	0.194	137.0	102.0	1.662	0.432	0.200
161	132.3	97.3	1.675	0.414	0.196	137.9	103.9	1.667	0.436	0.201
162	133.3	99.2	1.680	0.417	0.197	138.9	105.9	1.672	0.440	0.203
163	134.2	101.0	1.685	0.421	0.199	139.9	107.9	1.677	0.444	0.204
164	135.2	102.8	1.690	0.425	0.200	140.9	109.9	1.682	0.448	0.206
165	136.1	104.7	1.695	0.429	0.202	141.9	111.9	1.687	0.452	0.208
166	137.1	106.7	1.699	0.433	0.203	142.9	114.0	1.692	0.456	0.209
167	138.0	108.6	1.704	0.436	0.205	143.9	116.1	1.697	0.460	0.211
168	139.0	110.6	1.709	0.440	0.207	144.9	118.3	1.702	0.464	0.213
169	139.9	112.6	1.714	0.444	0.208	145.9	120.5	1.707	0.468	0.215
170	140.9	114.8	1.719	0.448	0.210	146.8	122.7	1.711	0.472	0.216
171	141.8	116.7	1.724	0.452	0.212	147.8	125.0	1.716	0.476	0.218
172	142.8	118.9	1.729	0.456	0.213	148.8	127.3	1.721	0.480	0.220
173	143.7	121.0	1.734	0.459	0.215	149.8	129.6	1.726	0.484	0.222
174	144.7	123.2	1.738	0.463	0.217	150.8	132.0	1.731	0.488	0.223
175	145.6	125.4	1.743	0.467	0.218	151.8	134.4	1.735	0.492	0.225
176	146.6	127.7	1.748	0.471	0.220	152.7	136.8	1.740	0.496	0.227
177	147.5	130.0	1.753	0.475	0.222	153.7	139.3	1.745	0.500	0.229
178	148.5	132.3	1.757	0.479	0.224	154.7	141.9	1.750	0.504	0.231
179	149.4	134.6	1.762	0.483	0.225	155.7	144.4	1.754	0.508	0.232
180	150.4	137.0	1.767	0.486	0.227	156.7	147.1	1.759	0.512	0.234
181	151.3	139.5	1.771	0.490	0.229	157.6	149.7	1.764	0.516	0.236
182	152.3	142.0	1.776	0.494	0.231	158.6	152.4	1.768	0.520	0.238
183	153.2	144.5	1.781	0.498	0.233	159.6	155.2	1.773	0.524	0.240
184	154.1	147.0	1.785	0.502	0.234	160.6	158.0	1.778	0.528	0.242
185	155.1	149.6	1.790	0.506	0.236	161.5	160.8	1.782	0.532	0.244
186	156.0	152.3	1.795	0.510	0.238	162.5	163.7	1.787	0.536	0.246
187	157.0	155.0	1.799	0.513	0.240	163.5	166.6	1.791	0.540	0.248
188	157.9	157.7	1.804	0.517	0.242	164.5	169.6	1.796	0.544	0.250

TABLE 144—Continued

MALES						FEMALES				
Body length	Tail length	Body weight	Weight in gms.		Both eye-balls	Tail length	Body weight	Weight in gms.		Both eye-balls
			Brain	Spinal cord				Brain	Spinal cord	
mm.	mm.	gms.			gms.	mm.	gms.			gms.
189	158.9	160.5	1.808	0.521	0.244	165.4	172.6	1.801	0.548	0.252
190	159.8	163.3	1.813	0.525	0.246	166.4	175.7	1.805	0.552	0.254
191	160.7	166.2	1.818	0.529	0.248	167.4	178.8	1.810	0.556	0.256
192	161.7	169.1	1.822	0.533	0.250	168.4	182.0	1.814	0.560	0.258
193	162.6	172.0	1.827	0.537	0.252	169.3	185.2	1.819	0.564	0.261
194	163.6	175.0	1.831	0.541	0.254	170.3	188.5	1.823	0.569	0.263
195	164.5	178.1	1.836	0.545	0.256	171.3	191.9	1.828	0.573	0.265
196	165.4	181.2	1.840	0.548	0.258	172.2	195.3	1.832	0.577	0.267
197	166.4	184.3	1.845	0.552	0.260	173.2	198.7	1.837	0.581	0.269
198	167.3	187.5	1.849	0.556	0.262	174.2	202.2	1.841	0.585	0.272
199	168.3	190.8	1.854	0.560	0.264	175.1	205.8	1.846	0.589	0.274
200	169.2	194.1	1.858	0.564	0.266	176.1	209.4	1.850	0.593	0.276
201	170.1	197.4	1.863	0.568	0.268	177.1	213.1	1.855	0.597	0.278
202	171.1	200.8	1.867	0.572	0.271	178.0	216.8	1.859	0.601	0.281
203	172.0	204.3	1.872	0.576	0.273	179.0	220.7	1.864	0.605	0.283
204	172.9	207.8	1.876	0.579	0.275	180.0	224.5	1.868	0.609	0.286
205	173.9	211.4	1.880	0.583	0.277	180.9	228.4	1.872	0.613	0.288
206	174.8	215.0	1.885	0.587	0.280	181.9	232.4	1.877	0.617	0.290
207	175.7	218.7	1.889	0.591	0.282	182.9	236.5	1.881	0.621	0.293
208	176.7	222.5	1.894	0.595	0.284	183.8	240.6	1.886	0.625	0.295
209	177.6	226.3	1.898	0.599	0.288	184.8	244.8	1.890	0.630	0.298
210	178.5	230.2	1.903	0.603	0.289	185.8	249.1	1.894	0.634	0.301
211	179.5	234.1	1.907	0.607	0.291	186.7	253.4	1.899	0.638	0.303
212	180.4	238.1	1.911	0.611	0.294	187.7	257.8	1.903	0.642	0.306
213	181.3	242.2	1.916	0.615	0.296	188.7	262.3	1.908	0.646	0.308
214	182.3	246.3	1.920	0.619	0.299	189.6	266.9	1.912	0.650	0.311
215	183.2	250.5	1.924	0.623	0.301	190.6	271.5	1.916	0.654	0.314
216	184.1	254.7	1.929	0.626	0.304	191.5	276.2	1.921	0.658	0.317
217	185.0	259.1	1.933	0.630	0.306	192.5	281.0	1.925	0.662	0.319
218	186.0	263.5	1.937	0.634	0.309	193.5	285.8	1.929	0.666	0.322
219	186.9	267.9	1.942	0.638	0.312	194.4	290.8	1.934	0.670	0.325
220	187.8	272.5	1.946	0.642	0.314	195.4	295.8	1.938	0.675	0.328
221	188.8	277.1	1.950	0.646	0.317	196.3	300.9	1.942	0.679	0.331
222	189.7	281.8	1.955	0.650	0.320	197.3	306.1	1.947	0.683	0.334
223	190.6	286.5	1.959	0.654	0.322	198.3	311.3	1.951	0.687	0.337

TABLE 144—Concluded

MALES						FEMALES				
Body length	Tail length	Body weight	Weight in gms.		Both eye-balls	Tail length	Body weight	Weight in gms.		Both eye-balls
			Brain	Spinal cord				Brain	Spinal cord	
<i>mm.</i>	<i>mm.</i>	<i>gms.</i>			<i>gms.</i>	<i>mm.</i>	<i>gms.</i>			<i>gms.</i>
224	191.5	291.4	1.963	0.658	0.325	199.2	316.7	1.955	0.691	0.340
225	192.5	296.3	1.968	0.662	0.328	200.2	322.1	1.960	0.695	0.343
226	193.4	301.3	1.972	0.666	0.331	201.1	327.7	1.964	0.699	0.346
227	194.3	306.4	1.976	0.670	0.334	202.1	333.3	1.968	0.703	0.349
228	195.3	311.5	1.981	0.673	0.337	203.0	339.0	1.972	0.707	0.352
229	196.2	316.8	1.985	0.677	0.340	204.0	344.8	1.977	0.712	0.355
230	197.1	322.1	1.989	0.681	0.343	205.0	350.7	1.981	0.716	0.359
231	198.0	327.5	1.993	0.685	0.346	205.9	356.7	1.985	0.720	0.362
232	198.9	333.0	1.998	0.689	0.349	206.9	362.8	1.989	0.724	0.365
233	199.9	338.6	2.002	0.693	0.352	207.8	369.0	1.994	0.728	0.369
234	200.8	344.3	2.006	0.697	0.355	208.8	375.3	1.998	0.732	0.372
235	201.7	350.0	2.010	0.701	0.358	209.7	381.7	2.002	0.736	0.375
236	202.6	355.9	2.014	0.705	0.361	210.7	388.2	2.006	0.740	0.379
237	203.6	361.9	2.019	0.709	0.365	211.6	394.9	2.011	0.744	0.383
238	204.5	367.9	2.023	0.713	0.368	212.6	401.6	2.015	0.749	0.386
239	205.4	374.1	2.027	0.717	0.371	213.5	408.4	2.019	0.753	0.390
240	206.3	380.3	2.031	0.721	0.375	214.5	415.4	2.023	0.757	0.393
241	207.3	386.6	2.036	0.725	0.378	215.4	422.4	2.028	0.761	0.397
242	208.2	393.1	2.040	0.729	0.382	216.4	429.6	2.032	0.765	0.401
243	209.1	399.6	2.044	0.733	0.385	217.3	436.9	2.036	0.769	0.405
244	210.0	406.3	2.048	0.737	0.389	218.3	444.3	2.040	0.773	0.409
245	210.9	413.1	2.052	0.741	0.392	219.2	451.9	2.044	0.777	0.413
246	211.9	419.9	2.057	0.745	0.396	220.2	459.5	2.049	0.782	0.417
247	212.8	426.9	2.061	0.748	0.400	221.1	467.3	2.053	0.786	0.421
248	213.7	434.0	2.065	0.752	0.403	222.1	475.2	2.057	0.790	0.425
249	214.6	441.2	2.069	0.756	0.407	223.1	483.3	2.061	0.794	0.429
250	215.5	448.5	2.073	0.760	0.411	224.0	491.5	2.065	0.798	0.433

TABLE 145

*Giving for each sex the weights of body, heart, both kidneys, liver and spleen—for each millimeter of body length. See Charts 32, 33, 34 and 35*

MALES						FEMALES				
Body length	Body weight	Heart	Both kidneys	Liver	Spleen	Body weight	Heart	Both kidneys	Liver	Spleen
mm.	gms.	gms.	gms.	gms.	gms.	gms.	gms.	gms.	gms.	gms.
47	4.9	0.031	0.046	0.21	0.009	4.7	0.030	0.046	0.20	0.008
48	4.9	0.031	0.047	0.21	0.009	4.7	0.030	0.046	0.20	0.008
49	5.0	0.032	0.048	0.22	0.009	4.9	0.032	0.048	0.21	0.009
50	5.1	0.033	0.049	0.22	0.009	5.0	0.033	0.050	0.22	0.009
51	5.2	0.033	0.052	0.22	0.010	5.1	0.034	0.052	0.23	0.009
52	5.3	0.034	0.055	0.23	0.010	5.3	0.035	0.055	0.23	0.009
53	5.4	0.035	0.058	0.23	0.010	5.5	0.036	0.062	0.24	0.011
54	5.6	0.036	0.064	0.24	0.011	5.8	0.038	0.070	0.25	0.012
55	5.8	0.038	0.070	0.25	0.012	6.2	0.042	0.081	0.27	0.014
56	6.1	0.041	0.078	0.26	0.014	6.5	0.044	0.088	0.28	0.015
57	6.4	0.043	0.086	0.28	0.015	6.9	0.047	0.097	0.30	0.017
58	6.8	0.046	0.095	0.29	0.017	7.2	0.049	0.103	0.32	0.018
59	7.1	0.049	0.101	0.31	0.018	7.6	0.052	0.112	0.34	0.020
60	7.5	0.052	0.110	0.33	0.020	8.0	0.056	0.119	0.36	0.022
61	7.9	0.055	0.117	0.35	0.021	8.4	0.058	0.127	0.38	0.023
62	8.2	0.057	0.123	0.37	0.023	8.7	0.061	0.132	0.40	0.025
63	8.6	0.060	0.130	0.40	0.024	9.1	0.064	0.139	0.43	0.026
64	9.0	0.063	0.137	0.42	0.026	9.5	0.067	0.145	0.45	0.028
65	9.4	0.066	0.143	0.45	0.027	9.9	0.069	0.151	0.48	0.029
66	9.8	0.069	0.150	0.48	0.029	10.3	0.072	0.157	0.52	0.031
67	10.1	0.071	0.154	0.50	0.030	10.8	0.076	0.165	0.59	0.033
68	10.6	0.074	0.162	0.56	0.032	11.2	0.079	0.171	0.63	0.034
69	11.0	0.077	0.168	0.61	0.033	11.6	0.081	0.176	0.68	0.036
70	11.4	0.080	0.173	0.66	0.035	12.0	0.084	0.182	0.73	0.037
71	11.8	0.083	0.179	0.71	0.036	12.5	0.087	0.188	0.79	0.039
72	12.2	0.085	0.184	0.75	0.038	12.9	0.090	0.194	0.83	0.040
73	12.7	0.089	0.191	0.81	0.039	13.4	0.093	0.200	0.89	0.042
74	13.1	0.091	0.194	0.85	0.041	13.9	0.097	0.206	0.94	0.044
75	13.6	0.095	0.203	0.91	0.042	14.3	0.099	0.211	0.98	0.045
76	14.0	0.097	0.207	0.95	0.044	14.8	0.102	0.217	1.03	0.047
77	14.5	0.100	0.214	1.00	0.046	15.3	0.105	0.223	1.09	0.048
78	15.0	0.104	0.220	1.06	0.047	15.8	0.109	0.229	1.14	0.050
79	15.4	0.106	0.224	1.10	0.049	16.3	0.112	0.235	1.19	0.051
80	15.9	0.109	0.230	1.15	0.050	16.8	0.115	0.241	1.24	0.053



TABLE 145—Continued

MALES						FEMALES				
Body length	Body weight	Heart	Both kidneys	Liver	Spleen	Body weight	Heart	Both kidneys	Liver	Spleen
<i>mm.</i>	<i>gms.</i>	<i>gms.</i>	<i>gms.</i>	<i>gms.</i>	<i>gms.</i>	<i>gms.</i>	<i>gms.</i>	<i>gms.</i>	<i>gms.</i>	<i>gms.</i>
81	16.4	0.112	0.236	1.20	0.052	17.3	0.118	0.246	1.28	0.055
82	16.9	0.115	0.242	1.24	0.053	17.9	0.121	0.253	1.34	0.057
83	17.4	0.118	0.247	1.29	0.055	18.4	0.124	0.258	1.39	0.058
84	18.0	0.122	0.254	1.35	0.057	19.0	0.128	0.265	1.44	0.060
85	18.5	0.125	0.259	1.40	0.059	19.5	0.131	0.270	1.49	0.062
86	19.0	0.128	0.265	1.44	0.060	20.1	0.134	0.277	1.54	0.064
87	19.6	0.131	0.271	1.50	0.062	20.7	0.138	0.283	1.59	0.065
88	20.1	0.134	0.277	1.54	0.064	21.2	0.141	0.288	1.64	0.067
89	20.7	0.138	0.283	1.59	0.065	21.8	0.144	0.294	1.69	0.069
90	21.3	0.141	0.289	1.64	0.067	22.4	0.147	0.300	1.74	0.071
91	21.9	0.145	0.296	1.69	0.069	23.1	0.151	0.307	1.79	0.073
92	22.4	0.147	0.300	1.74	0.071	23.7	0.155	0.313	1.84	0.075
93	23.0	0.151	0.306	1.79	0.072	24.3	0.158	0.319	1.89	0.076
94	23.7	0.155	0.313	1.84	0.075	25.0	0.162	0.326	1.95	0.078
95	24.3	0.158	0.319	1.89	0.076	25.6	0.165	0.332	1.99	0.080
96	24.9	0.161	0.325	1.94	0.078	26.3	0.169	0.339	2.05	0.082
97	25.6	0.165	0.332	1.99	0.080	27.0	0.172	0.344	2.10	0.084
98	26.2	0.168	0.338	2.05	0.082	27.7	0.176	0.352	2.15	0.086
99	26.9	0.172	0.345	2.09	0.084	28.4	0.180	0.359	2.21	0.088
100	27.5	0.175	0.350	2.14	0.086	29.1	0.183	0.365	2.26	0.090
101	28.2	0.178	0.357	2.19	0.088	29.8	0.187	0.372	2.31	0.092
102	28.9	0.182	0.364	2.24	0.090	30.5	0.190	0.378	2.36	0.094
103	29.6	0.186	0.370	2.29	0.092	31.3	0.194	0.386	2.41	0.097
104	30.3	0.189	0.377	2.34	0.094	32.0	0.198	0.392	2.46	0.099
105	31.1	0.193	0.384	2.40	0.096	32.8	0.202	0.400	2.52	0.101
106	31.8	0.197	0.390	2.45	0.098	33.6	0.206	0.407	2.57	0.103
107	32.5	0.200	0.397	2.50	0.100	34.4	0.209	0.414	2.63	0.106
108	33.3	0.204	0.404	2.55	0.102	35.2	0.213	0.421	2.68	0.108
109	34.1	0.208	0.411	2.61	0.105	36.0	0.217	0.428	2.73	0.110
110	34.9	0.212	0.419	2.66	0.107	36.9	0.221	0.436	2.79	0.113
111	35.7	0.216	0.426	2.71	0.109	37.7	0.225	0.444	2.84	0.115
112	36.5	0.219	0.433	2.77	0.112	38.6	0.229	0.451	2.90	0.117
113	37.3	0.223	0.440	2.82	0.114	39.5	0.234	0.459	2.96	0.120
114	38.2	0.227	0.448	2.88	0.116	40.3	0.237	0.466	3.01	0.122
115	39.0	0.231	0.455	2.93	0.118	41.3	0.242	0.475	3.07	0.125
116	39.9	0.235	0.463	2.98	0.121	42.2	0.246	0.483	3.13	0.127
117	40.8	0.239	0.471	3.04	0.123	43.1	0.250	0.491	3.18	0.130

TABLE 145—Continued

MALES						FEMALES				
Body length	Body weight	Heart	Both kidneys	Liver	Spleen	Body weight	Heart	Both kidneys	Liver	Spleen
<i>mm.</i>	<i>gms.</i>	<i>gms.</i>	<i>gms.</i>	<i>gms.</i>	<i>gms.</i>	<i>gms.</i>	<i>gms.</i>	<i>gms.</i>	<i>gms.</i>	<i>gms.</i>
118	41.6	0.243	0.478	3.09	0.126	44.1	0.254	0.499	3.24	0.133
119	42.6	0.248	0.486	3.15	0.128	45.0	0.258	0.507	3.29	0.135
120	43.5	0.252	0.494	3.20	0.131	46.0	0.263	0.515	3.35	0.138
121	44.4	0.256	0.502	3.26	0.133	47.0	0.267	0.524	3.41	0.141
122	45.4	0.260	0.510	3.32	0.136	48.0	0.272	0.532	3.47	0.143
123	46.3	0.264	0.518	3.37	0.139	49.1	0.276	0.542	3.53	0.146
124	47.3	0.269	0.526	3.43	0.141	50.1	0.281	0.550	3.59	0.149
125	48.3	0.273	0.535	3.49	0.144	51.2	0.285	0.559	3.65	0.152
126	49.3	0.277	0.543	3.54	0.147	52.3	0.290	0.568	3.71	0.155
127	50.4	0.282	0.553	3.61	0.150	53.4	0.295	0.578	3.77	0.158
128	51.4	0.286	0.561	3.66	0.152	54.5	0.299	0.587	3.83	0.161
129	52.5	0.291	0.570	3.72	0.155	55.6	0.304	0.596	3.89	0.164
130	53.6	0.295	0.579	3.78	0.158	56.8	0.309	0.606	3.96	0.167
131	54.7	0.300	0.588	3.84	0.161	58.0	0.314	0.616	4.02	0.170
132	55.8	0.305	0.598	3.90	0.164	59.2	0.319	0.626	4.09	0.173
133	56.9	0.309	0.607	3.96	0.167	60.4	0.324	0.635	4.15	0.177
134	58.1	0.314	0.617	4.03	0.171	61.6	0.328	0.645	4.21	0.180
135	59.3	0.319	0.626	4.09	0.174	62.9	0.334	0.656	4.28	0.183
136	60.5	0.324	0.636	4.15	0.177	64.2	0.339	0.666	4.35	0.187
137	61.7	0.329	0.646	4.22	0.180	65.5	0.344	0.677	4.41	0.190
138	62.9	0.334	0.656	4.28	0.183	66.8	0.349	0.687	4.48	0.194
139	64.1	0.338	0.666	4.34	0.186	68.1	0.354	0.698	4.54	0.197
140	65.4	0.344	0.676	4.41	0.190	69.5	0.360	0.709	4.61	0.201
141	66.7	0.349	0.687	4.47	0.193	70.9	0.365	0.720	4.68	0.204
142	68.0	0.354	0.697	4.54	0.197	72.3	0.370	0.732	4.75	0.208
143	69.3	0.359	0.708	4.60	0.200	73.7	0.376	0.743	4.82	0.212
144	70.7	0.364	0.719	4.67	0.204	75.2	0.382	0.755	4.89	0.216
145	72.1	0.370	0.730	4.74	0.208	76.7	0.387	0.767	4.97	0.220
146	73.5	0.375	0.741	4.81	0.211	78.2	0.393	0.779	5.04	0.224
147	74.9	0.380	0.752	4.88	0.215	79.7	0.399	0.791	5.11	0.228
148	76.3	0.386	0.764	4.95	0.219	81.3	0.405	0.803	5.19	0.232
149	77.8	0.391	0.775	5.02	0.223	82.8	0.410	0.815	5.26	0.236
150	79.3	0.397	0.787	5.09	0.227	84.4	0.416	0.828	5.33	0.240
151	80.8	0.403	0.799	5.16	0.230	86.1	0.422	0.841	5.41	0.244
152	82.4	0.409	0.812	5.24	0.235	87.7	0.428	0.854	5.48	0.248
153	83.9	0.414	0.824	5.31	0.239	89.4	0.435	0.867	5.56	0.253

TABLE 145—Continued

MALES						FEMALES				
Body length	Body weight	Heart	Both kidneys	Liver	Spleen	Body weight	Heart	Both kidneys	Liver	Spleen
<i>mm.</i>	<i>gms.</i>	<i>gms.</i>	<i>gms.</i>	<i>gms.</i>	<i>gms.</i>	<i>gms.</i>	<i>gms.</i>	<i>gms.</i>	<i>gms.</i>	<i>gms.</i>
154	85.5	0.420	0.836	5.38	0.243	91.1	0.441	0.880	5.64	0.257
155	87.1	0.426	0.849	5.46	0.247	92.9	0.447	0.894	5.72	0.262
156	88.7	0.432	0.862	5.53	0.251	94.6	0.453	0.908	5.80	0.266
157	90.4	0.438	0.875	5.61	0.255	96.4	0.460	0.922	5.88	0.271
158	92.1	0.444	0.888	5.68	0.260	98.3	0.467	0.937	5.96	0.276
159	93.8	0.450	0.901	5.76	0.264	100.1	0.473	0.951	6.04	0.281
160	95.6	0.457	0.916	5.84	0.269	102.0	0.480	0.965	6.12	0.285
161	97.3	0.463	0.929	5.92	0.273	103.9	0.486	0.980	6.21	0.290
162	99.2	0.470	0.944	6.00	0.278	105.9	0.493	0.996	6.29	0.295
163	101.0	0.476	0.958	6.08	0.283	107.9	0.500	1.011	6.38	0.301
164	102.8	0.483	0.971	6.16	0.287	109.9	0.507	1.026	6.47	0.306
165	104.7	0.489	0.986	6.24	0.292	111.9	0.514	1.042	6.55	0.311
166	106.7	0.496	1.002	6.33	0.298	114.0	0.522	1.058	6.64	0.316
167	108.6	0.502	1.016	6.41	0.302	116.1	0.529	1.074	6.73	0.322
168	110.6	0.510	1.032	6.50	0.308	118.3	0.536	1.091	6.82	0.327
169	112.6	0.517	1.047	6.58	0.313	120.5	0.544	1.108	6.92	0.333
170	114.7	0.524	1.063	6.67	0.318	122.7	0.551	1.125	7.01	0.339
171	116.7	0.531	1.079	6.76	0.323	125.0	0.559	1.142	7.10	0.344
172	118.9	0.538	1.096	6.85	0.329	127.3	0.567	1.160	7.20	0.350
173	121.0	0.545	1.112	6.94	0.334	129.6	0.575	1.178	7.29	0.356
174	123.2	0.553	1.129	7.03	0.340	132.0	0.583	1.196	7.39	0.362
175	125.4	0.560	1.145	7.12	0.345	134.4	0.591	1.214	7.49	0.368
176	127.7	0.568	1.163	7.22	0.351	136.8	0.599	1.232	7.59	0.375
177	130.0	0.576	1.181	7.31	0.357	139.3	0.607	1.251	7.69	0.381
178	132.3	0.584	1.198	7.40	0.363	141.9	0.615	1.271	7.79	0.387
179	134.6	0.591	1.216	7.50	0.369	144.4	0.624	1.290	7.89	0.394
180	137.0	0.599	1.234	7.60	0.375	147.1	0.632	1.311	8.00	0.401
181	139.5	0.607	1.253	7.70	0.381	149.7	0.641	1.330	8.10	0.407
182	142.0	0.616	1.272	7.80	0.388	152.4	0.650	1.351	8.21	0.414
183	144.5	0.622	1.291	7.90	0.394	155.2	0.659	1.372	8.32	0.421
184	147.0	0.632	1.310	8.00	0.400	158.0	0.668	1.393	8.43	0.428
185	149.6	0.641	1.330	8.10	0.407	160.8	0.677	1.414	8.54	0.435
186	152.3	0.649	1.350	8.21	0.414	163.7	0.686	1.436	8.65	0.443
187	155.0	0.658	1.370	8.31	0.421	166.6	0.696	1.458	8.77	0.450
188	157.7	0.667	1.391	8.42	0.428	169.6	0.705	1.481	8.88	0.458
189	160.5	0.676	1.412	8.53	0.435	172.6	0.715	1.503	9.00	0.465
190	163.3	0.685	1.433	8.64	0.442	175.7	0.725	1.526	9.12	0.473

TABLE 145—Continued

MALES						FEMALES				
Body length	Body weight	Heart	Both kidneys	Liver	Spleen	Body weight	Heart	Both kidneys	Liver	Spleen
<i>mm.</i>	<i>gms.</i>	<i>gms.</i>	<i>gms.</i>	<i>gms.</i>	<i>gms.</i>	<i>gms.</i>	<i>gms.</i>	<i>gms.</i>	<i>gms.</i>	<i>gms.</i>
191	166.2	0.694	1.455	8.75	0.449	178.8	0.734	1.550	9.23	0.481
192	169.1	0.704	1.477	8.86	0.456	182.0	0.744	1.574	9.36	0.489
193	172.0	0.713	1.499	8.98	0.464	185.2	0.755	1.598	9.48	0.497
194	175.0	0.722	1.521	9.09	0.471	188.5	0.765	1.622	9.60	0.505
195	178.1	0.732	1.544	9.21	0.479	191.9	0.776	1.648	9.73	0.514
196	181.2	0.742	1.568	9.33	0.487	195.3	0.786	1.673	9.86	0.522
197	184.3	0.752	1.591	9.45	0.495	198.7	0.797	1.699	9.99	0.531
198	187.5	0.762	1.615	9.57	0.503	202.2	0.808	1.725	10.12	0.540
199	190.8	0.772	1.640	9.69	0.511	205.8	0.819	1.752	10.25	0.549
200	194.1	0.782	1.664	9.82	0.519	209.4	0.830	1.779	10.39	0.558
201	197.4	0.793	1.689	9.94	0.528	213.1	0.841	1.806	10.52	0.567
202	200.8	0.803	1.714	10.07	0.536	216.8	0.853	1.834	10.66	0.577
203	204.3	0.814	1.740	10.20	0.545	220.7	0.865	1.863	10.80	0.586
204	207.8	0.825	1.767	10.33	0.554	224.5	0.876	1.891	10.94	0.596
205	211.4	0.836	1.793	10.46	0.563	228.4	0.888	1.920	11.09	0.606
206	215.0	0.847	1.820	10.59	0.572	232.4	0.900	1.950	11.23	0.616
207	218.7	0.859	1.848	10.73	0.581	236.5	0.913	1.980	11.38	0.626
208	222.5	0.870	1.876	10.87	0.591	240.6	0.925	2.011	11.53	0.636
209	226.3	0.882	1.904	11.01	0.600	244.8	0.938	2.042	11.68	0.647
210	230.2	0.894	1.933	11.15	0.610	249.1	0.951	2.074	11.84	0.657
211	234.1	0.905	1.962	11.29	0.620	253.4	0.964	2.106	11.99	0.668
212	238.1	0.918	1.992	11.44	0.630	257.8	0.977	2.138	12.15	0.679
213	242.2	0.930	2.023	11.59	0.640	262.3	0.990	2.171	12.31	0.691
214	246.3	0.942	2.053	11.74	0.650	266.9	1.004	2.205	12.47	0.702
215	250.5	0.955	2.084	11.89	0.661	271.5	1.018	2.239	12.64	0.713
216	254.7	0.968	2.115	12.04	0.671	276.2	1.032	2.274	12.80	0.725
217	259.1	0.981	2.148	12.20	0.683	281.0	1.046	2.310	12.97	0.737
218	263.5	0.994	2.180	12.35	0.694	285.8	1.060	2.345	13.14	0.749
219	267.9	1.007	2.213	12.50	0.704	290.8	1.075	2.382	13.32	0.762
220	272.5	1.021	2.247	12.67	0.716	295.8	1.090	2.419	13.50	0.774
221	277.1	1.034	2.281	12.84	0.727	300.9	1.105	2.457	13.67	0.787
222	281.8	1.048	2.316	13.00	0.739	306.1	1.120	2.495	13.86	0.800
223	286.5	1.062	2.350	13.17	0.751	311.3	1.135	2.533	14.04	0.813
224	291.4	1.077	2.386	13.34	0.763	316.7	1.151	2.573	14.23	0.826
225	296.3	1.091	2.423	13.51	0.775	322.1	1.167	2.613	14.41	0.840
226	301.3	1.106	2.460	13.69	0.788	327.7	1.183	2.654	14.61	0.854
227	306.4	1.121	2.497	13.87	0.801	333.3	1.200	2.695	14.80	0.868

TABLE 145—Concluded

MALES						FEMALES				
Body length	Body weight	Heart	Both kidneys	Liver	Spleen	Body weight	Heart	Both kidneys	Liver	Spleen
<i>mm.</i>	<i>gms.</i>	<i>gms.</i>	<i>gms.</i>	<i>gms.</i>	<i>gms.</i>	<i>gms.</i>	<i>gms.</i>	<i>gms.</i>	<i>gms.</i>	<i>gms.</i>
228	311.5	1.136	2.535	14.05	0.813	339.0	1.216	2.737	15.00	0.882
229	316.8	1.152	2.574	14.23	0.826	344.8	1.233	2.780	15.20	0.896
230	322.1	1.167	2.613	14.41	0.840	350.7	1.250	2.823	15.40	0.911
231	327.5	1.183	2.652	14.60	0.853	356.7	1.268	2.867	15.61	0.926
232	333.0	1.199	2.693	14.79	0.867	362.8	1.285	2.912	15.82	0.941
233	338.6	1.215	2.734	14.99	0.881	369.0	1.303	2.957	16.03	0.956
234	344.3	1.232	2.776	15.18	0.895	375.3	1.321	3.004	16.24	0.972
235	350.0	1.248	2.818	15.38	0.909	381.7	1.340	3.050	16.46	0.988
236	355.9	1.265	2.861	15.58	0.924	388.2	1.358	3.098	16.68	1.004
237	361.9	1.283	2.905	15.79	0.939	394.9	1.377	3.147	16.91	1.021
238	367.9	1.300	2.949	15.99	0.954	401.6	1.397	3.196	17.14	1.037
239	374.1	1.318	2.995	16.20	0.969	408.4	1.416	3.246	17.37	1.054
240	380.3	1.336	3.040	16.42	0.984	415.4	1.436	3.297	17.61	1.072
241	386.6	1.354	3.086	16.63	1.000	422.4	1.456	3.349	17.84	1.089
242	393.1	1.372	3.134	16.85	1.016	429.6	1.477	3.401	18.08	1.107
243	399.6	1.391	3.182	17.07	1.032	436.9	1.497	3.455	18.33	1.125
244	406.3	1.410	3.231	17.30	1.049	444.3	1.518	3.509	18.58	1.143
245	413.1	1.429	3.280	17.53	1.066	451.9	1.540	3.564	18.83	1.162
246	419.9	1.449	3.330	17.76	1.083	459.5	1.561	3.620	19.09	1.181
247	426.9	1.469	3.381	17.98	1.100	467.3	1.583	3.677	19.35	1.200
248	434.0	1.489	3.433	18.23	1.118	475.2	1.606	3.734	19.61	1.220
249	441.2	1.509	3.486	18.47	1.136	483.3	1.628	3.794	19.88	1.240
250	448.5	1.530	3.539	18.72	1.154	491.5	1.652	3.853	20.15	1.260

TABLE 146

Giving for each sex the weights of body, lungs, blood, alimentary tract and gonads (testes and ovaries) for each millimeter of body length. See Charts 36, 37, 38, 45 and 46

Body length	MALES					FEMALES				
	Body weight	Lungs	Blood	Alimen. tract	Testes	Body weight	Lungs	Blood	Alimen. tract	Ovaries
	gms.	gms.	gms.	gms.	gms.	gms.	gms.	gms.	gms.	gms.
47	4.9	0.078	0.44	0.14	0.004	4.7	0.078	0.41	0.14	0.0006
48	4.9	0.079	0.44	0.14	0.004	4.7	0.079	0.41	0.14	0.0006
49	5.0	0.080	0.45	0.15	0.004	4.9	0.080	0.43	0.15	0.0008
50	5.1	0.081	0.45	0.15	0.004	5.0	0.081	0.44	0.15	0.0009
51	5.2	0.082	0.46	0.15	0.004	5.1	0.082	0.45	0.15	0.0009
52	5.3	0.083	0.47	0.16	0.006	5.3	0.084	0.47	0.16	0.0010
53	5.4	0.085	0.48	0.16	0.006	5.5	0.086	0.49	0.16	0.0011
54	5.6	0.087	0.50	0.17	0.007	5.8	0.090	0.51	0.18	0.0013
55	5.8	0.090	0.51	0.18	0.007	6.2	0.094	0.54	0.19	0.0015
56	6.1	0.093	0.53	0.19	0.009	6.5	0.097	0.56	0.20	0.0016
57	6.4	0.096	0.56	0.20	0.011	6.9	0.102	0.60	0.22	0.0019
58	6.8	0.101	0.59	0.21	0.013	7.2	0.105	0.62	0.23	0.0020
59	7.1	0.104	0.61	0.22	0.016	7.6	0.109	0.65	0.24	0.0022
60	7.5	0.108	0.64	0.24	0.019	8.0	0.113	0.68	0.25	0.0024
61	7.9	0.112	0.67	0.25	0.023	8.4	0.117	0.71	0.27	0.0025
62	8.2	0.115	0.69	0.26	0.026	8.7	0.120	0.73	0.27	0.0026
63	8.6	0.119	0.73	0.27	0.031	9.1	0.124	0.76	0.28	0.0028
64	9.0	0.123	0.76	0.28	0.036	9.5	0.128	0.79	0.30	0.0029
65	9.4	0.127	0.79	0.29	0.041	9.9	0.131	0.82	0.31	0.0031
66	9.8	0.130	0.82	0.30	0.047	10.3	0.135	0.85	0.34	0.0032
67	10.1	0.133	0.84	0.31	0.050	10.8	0.139	0.89	0.41	0.0034
68	10.6	0.138	0.88	0.39	0.051	11.2	0.143	0.92	0.47	0.0035
69	11.0	0.141	0.91	0.44	0.052	11.6	0.146	0.95	0.52	0.0036
70	11.4	0.145	0.93	0.50	0.053	12.0	0.150	0.98	0.58	0.0037
71	11.8	0.148	0.96	0.55	0.054	12.5	0.154	1.02	0.64	0.0039
72	12.2	0.152	0.99	0.60	0.055	12.9	0.157	1.04	0.69	0.0040
73	12.7	0.155	1.03	0.67	0.057	13.4	0.161	1.08	0.76	0.0041
74	13.1	0.159	1.06	0.72	0.058	13.9	0.165	1.12	0.82	0.0042
75	13.6	0.163	1.10	0.78	0.060	14.3	0.169	1.13	0.87	0.0043
76	14.0	0.166	1.12	0.83	0.061	14.8	0.173	1.18	0.93	0.0044
77	14.5	0.170	1.16	0.89	0.063	15.3	0.177	1.22	0.99	0.0046
78	15.0	0.174	1.20	0.95	0.065	15.8	0.180	1.25	1.04	0.0047
79	15.4	0.177	1.23	1.00	0.067	16.3	0.184	1.29	1.10	0.0048
80	15.9	0.181	1.26	1.05	0.069	16.8	0.188	1.33	1.16	0.0049

TABLE 146—Continued

MALES						FEMALES				
Body length	Body weight	Lungs	Blood	Alimen. tract	Testes	Body weight	Lungs	Blood	Alimen. tract	Ovaries
<i>mm.</i>	<i>gms.</i>	<i>gms.</i>	<i>gms.</i>	<i>gms.</i>	<i>gms.</i>	<i>gms.</i>	<i>gms.</i>	<i>gms.</i>	<i>gms.</i>	<i>gms.</i>
81	16.4	0.185	1.30	1.11	0.071	17.3	0.192	1.36	1.21	0.0050
82	16.9	0.189	1.33	1.17	0.073	17.9	0.196	1.40	1.28	0.0051
83	17.4	0.193	1.37	1.22	0.076	18.4	0.200	1.44	1.33	0.0052
84	18.0	0.197	1.41	1.29	0.078	19.0	0.204	1.48	1.39	0.0053
85	18.5	0.201	1.45	1.34	0.081	19.5	0.208	1.52	1.44	0.0054
86	19.0	0.204	1.48	1.39	0.084	20.1	0.212	1.56	1.50	0.0055
87	19.6	0.209	1.52	1.45	0.087	20.7	0.216	1.60	1.56	0.0056
88	20.1	0.212	1.56	1.50	0.089	21.2	0.220	1.63	1.61	0.0057
89	20.7	0.216	1.60	1.56	0.093	21.8	0.224	1.68	1.67	0.0058
90	21.3	0.221	1.64	1.62	0.096	22.4	0.228	1.72	1.73	0.0058
91	21.9	0.225	1.68	1.68	0.100	23.1	0.233	1.76	1.79	0.0059
92	22.4	0.228	1.72	1.73	0.103	23.7	0.237	1.81	1.85	0.0060
93	23.0	0.232	1.76	1.78	0.107	24.3	0.241	1.85	1.90	0.0061
94	23.7	0.237	1.81	1.85	0.112	25.0	0.246	1.90	1.96	0.0062
95	24.3	0.241	1.85	1.90	0.116	25.6	0.250	1.94	2.02	0.0063
96	24.9	0.245	1.89	1.96	0.120	26.3	0.254	1.98	2.08	0.0064
97	25.6	0.250	1.94	2.02	0.125	27.0	0.259	2.03	2.14	0.0065
98	26.2	0.254	1.98	2.07	0.130	27.7	0.264	2.08	2.20	0.0066
99	26.9	0.258	2.02	2.13	0.135	28.4	0.268	2.13	2.25	0.0067
100	27.5	0.262	2.06	2.18	0.140	29.1	0.273	2.17	2.31	0.0067
101	28.2	0.267	2.11	2.24	0.145	29.8	0.277	2.22	2.37	0.0068
102	28.9	0.271	2.16	2.30	0.151	30.5	0.282	2.27	2.42	0.0069
103	29.6	0.276	2.21	2.35	0.157	31.3	0.287	2.32	2.49	0.0070
104	30.3	0.280	2.25	2.41	0.163	32.0	0.291	2.37	2.54	0.0071
105	31.1	0.285	2.31	2.47	0.171	32.8	0.296	2.42	2.60	0.0071
106	31.8	0.290	2.35	2.53	0.177	33.6	0.301	2.47	2.66	0.0072
107	32.5	0.294	2.40	2.58	0.184	34.4	0.306	2.53	2.72	0.0073
108	33.3	0.299	2.45	2.64	0.192	35.2	0.311	2.58	2.78	0.0074
109	34.1	0.304	2.51	2.70	0.200	36.0	0.316	2.63	2.84	0.0075
110	34.9	0.309	2.56	2.76	0.208	36.9	0.321	2.69	2.90	0.0075
111	35.7	0.314	2.61	2.82	0.216	37.7	0.326	2.74	2.96	0.0076
112	36.5	0.319	2.66	2.88	0.225	38.6	0.332	2.80	3.02	0.0077
113	37.3	0.324	2.72	2.93	0.234	39.5	0.337	2.86	3.09	0.0078
114	38.2	0.329	2.78	3.00	0.244	40.3	0.342	2.91	3.14	0.0078
115	39.0	0.334	2.83	3.05	0.253	41.3	0.348	2.98	3.21	0.0079
116	39.9	0.339	2.89	3.11	0.264	42.2	0.353	3.04	3.27	0.0080
117	40.8	0.345	2.95	3.17	0.275	43.1	0.358	3.09	3.33	0.0081

TABLE 146—Continued

MALES						FEMALES				
Body length	Body weight	Lungs	Blood	Alimen. tract	Testes	Body weight	Lungs	Blood	Alimen. tract	Ovaries
<i>mm.</i>	<i>gms.</i>	<i>gms.</i>	<i>gms.</i>	<i>gms.</i>	<i>gms.</i>	<i>gms.</i>	<i>gms.</i>	<i>gms.</i>	<i>gms.</i>	<i>gms.</i>
118	41.6	0.349	3.00	3.23	0.285	44.1	0.364	3.16	3.39	0.0081
119	42.6	0.355	3.06	3.29	0.298	45.0	0.369	3.22	3.45	0.0082
120	43.5	0.361	3.12	3.35	0.309	46.0	0.375	3.28	3.51	0.0083
121	44.4	0.366	3.18	3.41	0.321	47.0	0.381	3.35	3.58	0.0084
122	45.4	0.372	3.24	3.47	0.335	48.0	0.387	3.41	3.64	0.0084
123	46.3	0.377	3.30	3.53	0.348	49.1	0.393	3.48	3.71	0.0085
124	47.3	0.383	3.36	3.59	0.362	50.1	0.399	3.54	3.77	0.0086
125	48.3	0.389	3.43	3.66	0.377	51.2	0.405	3.61	3.83	0.0086
126	49.3	0.394	3.49	3.72	0.392	52.3	0.411	3.68	3.90	0.0087
127	50.4	0.401	3.56	3.78	0.408	53.4	0.418	3.75	3.96	0.0088
128	51.4	0.406	3.63	3.84	0.424	54.5	0.424	3.82	4.03	0.0089
129	52.5	0.413	3.69	3.91	0.442	55.6	0.430	3.89	4.09	0.0089
130	53.6	0.419	3.76	3.97	0.460	56.8	0.437	3.97	4.15	0.0090
131	54.7	0.425	3.83	4.04	0.478	58.0	0.444	4.04	4.22	0.0091
132	55.8	0.431	3.90	4.10	0.497	59.2	0.450	4.12	4.29	0.0091
133	56.9	0.437	3.97	4.16	0.516	60.4	0.457	4.19	4.36	0.0092
134	58.1	0.444	4.05	4.23	0.537	61.6	0.464	4.27	4.42	0.0093
135	59.3	0.451	4.12	4.30	0.559	62.9	0.471	4.35	4.49	0.0093
136	60.5	0.458	4.20	4.36	0.581	64.2	0.478	4.43	4.56	0.0094
137	61.7	0.464	4.27	4.43	0.604	65.5	0.485	4.51	4.63	0.0095
138	62.9	0.471	4.35	4.49	0.627	66.8	0.492	4.59	4.70	0.0099
139	64.1	0.477	4.42	4.56	0.651	68.1	0.499	4.67	4.77	0.0102
140	65.4	0.485	4.50	4.63	0.677	69.5	0.507	4.76	4.84	0.0106
141	66.7	0.492	4.58	4.70	0.704	70.9	0.515	4.84	4.91	0.0110
142	68.0	0.499	4.66	4.76	0.731	72.3	0.522	4.93	4.98	0.0115
143	69.3	0.506	4.74	4.83	0.759	73.7	0.530	5.01	5.05	0.0120
144	70.7	0.514	4.83	4.90	0.790	75.2	0.538	5.11	5.13	0.0126
145	72.1	0.521	4.92	4.97	0.821	76.7	0.546	5.20	5.20	0.0132
146	73.5	0.529	5.00	5.04	0.853	78.2	0.554	5.29	5.27	0.0139
147	74.9	0.536	5.09	5.11	0.885	79.7	0.562	5.38	5.35	0.0147
148	76.3	0.544	5.17	5.18	0.918	81.3	0.571	5.48	5.42	0.0155
149	77.8	0.552	5.27	5.26	0.955	82.8	0.579	5.57	5.50	0.0164
150	79.3	0.560	5.36	5.34	0.991	84.4	0.587	5.67	5.57	0.0173
151	80.8	0.568	5.45	5.40	1.031	86.1	0.596	5.77	5.65	0.0184
152	82.4	0.577	5.54	5.48	1.055	87.7	0.605	5.86	5.72	0.0195
153	83.9	0.585	5.64	5.55	1.078	89.4	0.614	5.97	5.80	0.0207



TABLE 146—Continued

MALES						FEMALES				
Body length	Body weight	Lungs	Blood	Alimen- tract	Testes	Body weight	Lungs	Blood	Alimen- tract	Ovaries
<i>mm.</i>	<i>gms.</i>	<i>gms.</i>	<i>gms.</i>	<i>gms.</i>	<i>gms.</i>	<i>gms.</i>	<i>gms.</i>	<i>gms.</i>	<i>gms.</i>	<i>gms.</i>
154	85.5	0.593	5.73	5.63	1.102	91.1	0.623	6.07	5.88	0.0219
155	87.1	0.602	5.83	5.70	1.125	92.9	0.632	6.18	5.96	0.0233
156	88.7	0.610	5.92	5.77	1.148	94.6	0.641	6.28	6.04	0.0247
157	90.4	0.619	6.03	5.85	1.173	96.4	0.651	6.39	6.12	0.0262
158	92.1	0.628	6.13	5.93	1.196	98.3	0.661	6.50	6.20	0.0279
159	93.8	0.637	6.23	6.00	1.219	100.1	0.670	6.61	6.28	0.0296
160	95.6	0.646	6.34	6.08	1.243	102.0	0.680	6.72	6.46	0.0314
161	97.3	0.655	6.44	6.16	1.265	103.9	0.690	6.83	6.44	0.0334
162	99.2	0.665	6.55	6.24	1.290	105.9	0.700	6.95	6.53	0.0344
163	101.0	0.675	6.66	6.32	1.313	107.9	0.711	7.07	6.62	0.0377
164	102.8	0.684	6.77	6.40	1.335	109.9	0.721	7.18	6.70	0.0400
165	104.7	0.694	6.88	6.48	1.358	111.9	0.731	7.30	6.78	0.0411
166	106.7	0.704	7.00	6.56	1.382	114.0	0.742	7.43	6.87	0.0419
167	108.6	0.714	7.11	6.65	1.404	116.1	0.753	7.55	6.96	0.0425
168	110.6	0.725	7.23	6.73	1.428	118.3	0.764	7.68	7.05	0.0431
169	112.6	0.735	7.34	6.81	1.450	120.5	0.776	7.81	7.14	0.0435
170	114.7	0.746	7.47	6.90	1.473	122.7	0.787	7.93	7.23	0.0439
171	116.7	0.756	7.58	6.98	1.495	125.0	0.799	8.07	7.32	0.0443
172	118.9	0.768	7.71	7.07	1.519	127.3	0.811	8.20	7.41	0.0446
173	121.0	0.778	7.83	7.16	1.541	129.6	0.822	8.33	7.50	0.0449
174	123.2	0.790	7.96	7.25	1.564	132.0	0.835	8.47	7.60	0.0452
175	125.4	0.801	8.09	7.33	1.586	134.4	0.847	8.61	7.69	0.0455
176	127.7	0.813	8.22	7.43	1.609	136.8	0.859	8.75	7.78	0.0457
177	130.0	0.824	8.36	7.52	1.632	139.3	0.872	8.89	7.88	0.0459
178	132.3	0.836	8.49	7.61	1.654	141.9	0.885	9.04	7.98	0.0462
179	134.6	0.848	8.62	7.70	1.675	144.4	0.898	9.19	8.07	0.0464
180	137.0	0.860	8.76	7.79	1.698	147.1	0.911	9.34	8.18	0.0466
181	139.5	0.873	8.90	7.89	1.721	149.7	0.925	9.49	8.28	0.0468
182	142.0	0.886	9.05	7.98	1.743	152.4	0.938	10.22	8.38	0.0469
183	144.5	0.898	9.19	8.08	1.765	155.2	0.952	10.39	8.48	0.0471
184	147.0	0.911	9.26	8.17	1.787	158.0	0.967	10.56	8.58	0.0473
185	149.6	0.924	9.33	8.27	1.809	160.8	0.981	10.73	8.69	0.0474
186	152.3	0.938	9.40	8.37	1.832	163.7	0.995	10.90	8.79	0.0476
187	155.0	0.951	9.50	8.47	1.854	166.6	1.010	11.07	8.90	0.0477
188	157.7	0.965	9.64	8.57	1.876	169.6	1.025	11.25	9.01	0.0479
189	160.5	0.979	9.80	8.68	1.898	172.6	1.040	11.43	9.12	0.0480
190	163.3	0.993	9.95	8.78	1.920	175.7	1.055	11.62	9.23	0.0482

TABLE 146—Continued

MALES						FEMALES				
Body length	Body weight	Lung.	Blood	Alimen. tract	Testes	Body weight	Lungs	Blood	Alimen. tract	Ovaries
mm.	gms.	gms.	gms.	gms.	gms.	gms.	gms.	gms.	gms.	gms.
191	166.2	1.008	10.11	8.88	1.942	178.8	1.071	11.80	9.34	0.0483
192	169.1	1.022	10.27	8.99	1.964	182.0	1.087	11.99	9.45	0.0484
193	172.0	1.037	10.43	9.09	1.985	185.2	1.103	12.18	9.56	0.0485
194	175.0	1.052	10.59	9.20	2.007	188.5	1.119	12.38	9.68	0.0487
195	178.1	1.067	10.76	9.31	2.030	191.9	1.136	12.58	9.80	0.0488
196	181.2	1.083	10.93	9.42	2.051	195.3	1.153	12.78	9.92	0.0489
197	184.3	1.098	11.10	9.53	2.073	198.7	1.170	12.98	10.03	0.0490
198	187.5	1.114	11.27	9.64	2.094	202.2	1.188	13.18	10.15	0.0491
199	190.8	1.131	11.45	9.76	2.117	205.8	1.206	13.39	10.28	0.0492
200	194.1	1.147	11.63	9.87	2.138	209.4	1.223	13.61	10.40	0.0493
201	197.4	1.164	11.81	9.99	2.159	213.1	1.242	13.82	10.53	0.0494
202	200.8	1.181	11.99	10.11	2.181	216.8	1.260	14.04	10.65	0.0495
203	204.3	1.198	12.18	10.23	2.203	220.7	1.279	14.26	10.78	0.0496
204	207.8	1.215	12.36	10.35	2.224	224.5	1.298	14.48	10.91	0.0497
205	211.4	1.233	12.56	10.47	2.246	228.4	1.317	14.71	11.04	0.0498
206	215.0	1.251	12.75	10.59	2.267	232.4	1.337	14.94	11.17	0.0499
207	218.7	1.269	12.95	10.71	2.289	236.5	1.357	15.18	11.31	0.0500
208	222.5	1.288	13.15	10.84	2.311	240.6	1.378	15.42	11.44	0.0501
209	226.3	1.307	13.35	10.97	2.332	244.8	1.398	15.66	11.58	0.0502
210	230.2	1.326	13.46	11.10	2.354	249.1	1.419	15.90	11.72	0.0503
211	234.1	1.346	13.76	11.23	2.375	253.4	1.441	16.15	11.86	0.0504
212	238.1	1.365	13.98	11.36	2.397	257.8	1.462	16.41	12.00	0.0505
213	242.2	1.386	14.19	11.49	2.418	262.3	1.484	16.66	12.14	0.0506
214	246.3	1.406	14.41	11.63	2.439	266.9	1.507	16.92	12.29	0.0507
215	250.5	1.426	14.63	11.76	2.461	271.5	1.530	17.19	12.44	0.0508
216	254.7	1.447	14.85	11.90	2.482	276.2	1.553	17.45	12.59	0.0508
217	259.1	1.469	15.08	12.04	2.503	281.0	1.576	17.73	12.74	0.0509
218	263.5	1.490	15.31	12.18	2.525	285.8	1.600	18.00	12.89	0.0510
219	267.9	1.512	15.54	12.32	2.546	290.8	1.624	18.28	13.05	0.0511
220	272.5	1.534	15.78	12.47	2.567	295.8	1.648	18.57	13.21	0.0512
221	277.1	1.557	16.02	12.62	2.588	300.9	1.673	18.85	13.36	0.0512
222	281.8	1.580	16.26	12.77	2.609	306.1	1.705	19.15	13.53	0.0513
223	286.5	1.603	16.55	12.91	2.630	311.3	1.724	19.44	13.69	0.0514
224	291.4	1.627	16.76	13.07	2.652	316.7	1.751	19.74	13.85	0.0515
225	296.3	1.651	17.02	13.22	2.673	322.1	1.777	20.05	14.02	0.0516
226	301.3	1.675	17.27	13.38	2.694	327.7	1.804	20.36	14.19	0.0516
227	306.4	1.700	17.54	13.54	2.715	333.3	1.831	20.67	14.36	0.0517

TABLE 146—Concluded

MALES						FEMALES				
Body length	Body weight	Lungs	Blood	Alimen. tract	Testes	Body weight	Lungs	Blood	Alimen. tract	Ovaries
<i>mm.</i>	<i>gms.</i>	<i>gms.</i>	<i>gms.</i>	<i>gms.</i>	<i>gms.</i>	<i>gms.</i>	<i>gms.</i>	<i>gms.</i>	<i>gms.</i>	<i>gms.</i>
228	311.5	1.725	17.80	13.74	2.736	339.0	1.859	20.99	14.54	0.0518
229	316.8	1.751	18.07	13.86	2.757	344.8	1.887	21.31	14.71	0.0519
230	322.1	1.777	18.34	14.02	2.778	350.7	1.916	21.64	14.89	0.0519
231	327.5	1.803	18.62	14.19	2.799	356.7	1.945	21.97	15.07	0.0520
232	333.0	1.830	18.90	14.35	2.820	362.8	1.975	22.31	15.26	0.0521
233	338.6	1.857	19.19	14.52	2.841	369.0	2.005	22.65	15.44	0.0522
234	344.3	1.885	19.47	14.68	2.862	375.3	2.035	23.00	15.63	0.0522
235	350.0	1.913	19.77	14.87	2.883	381.7	2.067	23.35	15.82	0.0523
236	355.9	1.941	20.07	15.05	2.904	388.2	2.098	23.71	16.01	0.0524
237	361.9	1.970	20.37	15.23	2.926	394.9	2.130	24.08	16.21	0.0524
238	367.9	2.000	20.68	15.41	2.946	401.6	2.163	24.45	16.41	0.0525
239	374.1	2.030	20.99	15.59	2.967	408.4	2.196	24.82	16.61	0.0526
240	380.3	2.060	21.30	15.78	2.988	415.4	2.230	25.20	16.82	0.0526
241	386.6	2.090	21.62	15.97	3.009	422.4	2.264	25.58	17.02	0.0527
242	393.1	2.122	21.95	16.16	3.030	429.6	2.298	25.98	17.23	0.0528
243	399.6	2.153	22.27	16.35	3.051	436.9	2.334	26.37	17.45	0.0529
244	406.3	2.186	22.61	16.55	3.072	444.3	2.369	26.77	17.66	0.0529
245	413.1	2.219	22.95	16.75	3.093	451.9	2.406	27.18	17.88	0.0530
246	419.9	2.251	23.28	16.95	3.113	459.5	2.443	27.60	18.10	0.0531
247	426.9	2.285	23.64	17.15	3.134	467.3	2.480	28.02	18.33	0.0531
248	434.0	2.320	23.99	17.36	3.155	475.2	2.518	28.45	18.55	0.0532
249	441.2	2.354	24.35	17.57	3.176	483.3	2.557	28.89	18.79	0.0532
250	448.5	2.390	24.71	17.78	3.197	491.5	2.597	29.32	19.02	0.0533

TABLE 147

Giving for each sex the weights of body, stomach, pancreas, both submaxillaries and epididymis for each millimeter of body length. Charts 39, 40, 41 and 47

MALES						FEMALES			
Body length	Body weight	Stomach	Pancreas	Both submaxillaries	Epididymis (2)	Body weight	Stomach	Pancreas	Both submaxillaries
mm.	grams	grams	grams	grams	grams	grams	grams	grams	grams
47	4.9				0.0047	4.7			
48	4.9	0.030	(0.017)*	0.017	0.0047	4.7	0.029	(0.017)*	0.016
49	5.0	0.030		0.017	0.0047	4.9	0.030		0.017
50	5.1	0.031		0.017	0.0047	5.0	0.030		0.017
51	5.2	0.031		0.018	0.0047	5.1	0.031		0.017
52	5.3	0.032		0.018	0.0049	5.3	0.032		0.018
53	5.4	0.032		0.019	0.0049	5.5	0.033		0.019
54	5.6	0.034		0.019	0.0049	5.8	0.035		0.020
55	5.8	0.035		0.020	0.0051	6.2	0.037		0.022
56	6.1	0.036		0.021	0.0052	6.5	0.039		0.023
57	6.4	0.038		0.022	0.0053	6.9	0.041		0.024
58	6.8	0.041		0.024	0.0055	7.2	0.043		0.025
59	7.1	0.042		0.025	0.0057	7.6	0.045		0.026
60	7.5	0.045		0.026	0.0059	8.0	0.048		0.028
61	7.9	0.047		0.027	0.0061	8.4	0.051		0.029
62	8.2	0.049		0.028	0.0063	8.7	0.053		0.030
63	8.6	0.052		0.030	0.0066	9.1	0.055		0.031
64	9.0	0.055		0.031	0.0068	9.5	0.058		0.033
65	9.4	0.057		0.032	0.0071	9.9	0.061		0.034
66	9.8	0.060		0.034	0.0073	10.3	0.064	0.063	0.035
67	10.1	0.062	0.056	0.035	0.0074	10.8	0.067	0.078	0.037
68	10.6	0.066	0.072	0.036	0.0077	11.2	0.070	0.087	0.038
69	11.0	0.069	0.082	0.037	0.0080	11.6	0.073	0.095	0.039
70	11.4	0.072	0.091	0.038	0.0083	12.0	0.076	0.102	0.040
71	11.8	0.075	0.098	0.040	0.0086	12.5	0.080	0.110	0.042
72	12.2	0.078	0.105	0.041	0.0089	12.9	0.083	0.115	0.043
73	12.7	0.082	0.112	0.042	0.0092	13.4	0.087	0.122	0.044
74	13.1	0.085	0.118	0.043	0.0095	13.9	0.092	0.128	0.046
75	13.6	0.089	0.124	0.045	0.0100	14.3	0.095	0.132	0.047
76	14.0	0.092	0.129	0.046	0.0103	14.8	0.099	0.138	0.048
77	14.5	0.097	0.134	0.047	0.0107	15.3	0.104	0.143	0.049
78	15.0	0.101	0.140	0.049	0.0111	15.8	0.108	0.147	0.051
79	15.4	0.105	0.144	0.050	0.0114	16.3	0.113	0.152	0.052
80	15.9	0.109	0.148	0.051	0.0119	16.8	0.117	0.156	0.053

\* Initial value for pancreas computed

TABLE 117—Continued

MALES						FEMALES			
Body length	Body weight	Stomach	Pancreas	Both submaxillaries	Epididymis (2)	Body weight	Stomach	Pancreas	Both submaxillaries
<i>mm.</i>	<i>grams</i>	<i>grams</i>	<i>grams</i>	<i>grams</i>	<i>grams</i>	<i>grams</i>	<i>grams</i>	<i>grams</i>	<i>grams</i>
81	16.4	0.113	0.153	0.052	0.0123	17.3	0.122	0.161	0.055
82	16.9	0.118	0.157	0.054	0.0128	17.9	0.128	0.165	0.056
83	17.4	0.123	0.161	0.055	0.0133	18.4	0.133	0.169	0.057
84	18.0	0.129	0.166	0.056	0.0138	19.0	0.139	0.174	0.059
85	18.5	0.134	0.170	0.058	0.0142	19.5	0.144	0.178	0.060
86	19.0	0.139	0.174	0.059	0.0148	20.1	0.150	0.182	0.062
87	19.6	0.145	0.179	0.060	0.0154	20.7	0.160	0.188	0.063
88	20.1	0.150	0.182	0.062	0.0159	21.2	0.167	0.192	0.064
89	20.7	0.160	0.186	0.063	0.0166	21.8	0.176	0.197	0.066
90	21.3	0.169	0.189	0.065	0.0172	22.4	0.185	0.202	0.067
91	21.9	0.178	0.194	0.066	0.0179	23.1	0.195	0.207	0.069
92	22.4	0.185	0.198	0.067	0.0184	23.7	0.203	0.212	0.070
93	23.0	0.193	0.202	0.069	0.0191	24.3	0.211	0.217	0.072
94	23.7	0.203	0.206	0.070	0.0199	25.0	0.220	0.222	0.073
95	24.3	0.211	0.210	0.072	0.0200	25.6	0.228	0.227	0.075
96	24.9	0.219	0.213	0.073	0.0214	26.3	0.237	0.232	0.076
97	25.6	0.228	0.218	0.075	0.0222	27.0	0.245	0.237	0.078
98	26.2	0.235	0.221	0.076	0.0230	27.7	0.254	0.243	0.079
99	26.9	0.244	0.225	0.078	0.0240	28.4	0.262	0.248	0.081
100	27.5	0.251	0.229	0.079	0.0247	29.1	0.270	0.253	0.083
101	28.2	0.260	0.233	0.081	0.0257	29.8	0.278	0.258	0.084
102	28.9	0.268	0.237	0.082	0.0266	30.5	0.286	0.262	0.086
103	29.6	0.276	0.241	0.084	0.0276	31.3	0.295	0.268	0.087
104	30.3	0.284	0.244	0.085	0.0287	32.0	0.302	0.273	0.089
105	31.1	0.292	0.249	0.087	0.0298	32.8	0.310	0.278	0.091
106	31.8	0.300	0.252	0.088	0.0308	33.6	0.319	0.283	0.092
107	32.5	0.307	0.256	0.090	0.0319	34.4	0.327	0.289	0.094
108	33.3	0.316	0.260	0.092	0.0332	35.2	0.335	0.294	0.096
109	34.1	0.324	0.264	0.093	0.0345	36.0	0.342	0.299	0.097
110	34.9	0.332	0.268	0.095	0.0358	36.9	0.351	0.305	0.099
111	35.7	0.340	0.273	0.097	0.0371	37.7	0.359	0.310	0.101
112	36.5	0.347	0.277	0.098	0.0384	38.6	0.367	0.315	0.103
113	37.3	0.355	0.281	0.100	0.0398	39.5	0.375	0.321	0.105
114	38.2	0.363	0.285	0.102	0.0414	40.3	0.382	0.326	0.106
115	39.0	0.371	0.289	0.104	0.0428	41.3	0.391	0.332	0.108
116	39.9	0.379	0.293	0.105	0.0444	42.2	0.399	0.337	0.110
117	40.8	0.387	0.298	0.107	0.0461	43.1	0.406	0.342	0.112

TABLE 147—Continued

MALES						FEMALES			
Body length	Body weight	Stomach	Pancreas	Both submaxillaries	Epididymus (2)	Body weight	Stomach	Pancreas	Both submaxillaries
<i>mm.</i>	<i>grams</i>	<i>grams</i>	<i>grams</i>	<i>grams</i>	<i>grams</i>	<i>grams</i>	<i>grams</i>	<i>grams</i>	<i>grams</i>
118	41.6	0.394	0.302	0.109	0.0476	44.1	0.415	0.348	0.114
119	42.6	0.402	0.306	0.111	0.0495	45.0	0.422	0.354	0.116
120	43.5	0.410	0.311	0.113	0.0512	46.0	0.430	0.359	0.118
121	44.4	0.417	0.315	0.115	0.0531	47.0	0.438	0.365	0.120
122	45.4	0.425	0.320	0.117	0.0551	48.0	0.446	0.371	0.122
123	46.3	0.433	0.324	0.118	0.0570	49.1	0.454	0.377	0.124
124	47.3	0.440	0.328	0.120	0.0591	50.1	0.462	0.382	0.126
125	48.3	0.448	0.333	0.122	0.0613	51.2	0.470	0.388	0.128
126	49.3	0.456	0.338	0.124	0.0634	52.3	0.478	0.394	0.130
127	50.4	0.464	0.343	0.126	0.0659	53.4	0.486	0.400	0.132
128	51.4	0.472	0.347	0.128	0.0681	54.5	0.494	0.406	0.134
129	52.5	0.480	0.352	0.130	0.0707	55.6	0.502	0.412	0.136
130	53.6	0.487	0.357	0.133	0.0734	56.8	0.510	0.419	0.139
131	54.7	0.495	0.362	0.135	0.0759	58.0	0.518	0.425	0.141
132	55.8	0.503	0.367	0.137	0.0787	59.2	0.526	0.431	0.143
133	56.9	0.511	0.372	0.139	0.0815	60.4	0.534	0.437	0.145
134	58.1	0.519	0.377	0.141	0.0844	61.6	0.542	0.444	0.148
135	59.3	0.527	0.382	0.143	0.0875	62.9	0.550	0.450	0.150
136	60.5	0.535	0.388	0.146	0.0907	64.2	0.559	0.457	0.153
137	61.7	0.543	0.393	0.148	0.0939	65.5	0.567	0.463	0.155
138	62.9	0.550	0.398	0.150	0.0972	66.8	0.575	0.470	0.157
139	64.1	0.558	0.403	0.152	0.1006	68.1	0.583	0.476	0.160
140	65.4	0.566	0.409	0.155	0.1042	69.5	0.591	0.483	0.162
141	66.7	0.574	0.414	0.157	0.1080	70.9	0.599	0.490	0.165
142	68.0	0.582	0.420	0.160	0.1118	72.3	0.608	0.497	0.167
143	69.3	0.590	0.425	0.162	0.1156	73.7	0.616	0.504	0.170
144	70.7	0.598	0.431	0.165	0.1200	75.2	0.624	0.511	0.173
145	72.1	0.606	0.437	0.167	0.1243	76.7	0.633	0.518	0.175
146	73.5	0.615	0.443	0.170	0.1286	78.2	0.641	0.526	0.178
147	74.9	0.623	0.449	0.172	0.1332	79.7	0.649	0.533	0.181
148	76.3	0.631	0.455	0.175	0.1377	81.3	0.658	0.540	0.184
149	77.8	0.639	0.461	0.178	0.1428	82.8	0.666	0.547	0.186
150	79.3	0.647	0.467	0.180	0.1478	84.4	0.675	0.555	0.189
151	80.8	0.655	0.474	0.183	0.1530	86.1	0.684	0.563	0.192
152	82.4	0.664	0.480	0.186	0.1586	87.7	0.692	0.570	0.195
153	83.9	0.672	0.486	0.188	0.1639	89.4	0.701	0.578	0.198
154	85.5	0.681	0.493	0.191	0.1697	91.1	0.709	0.586	0.201

TABLE 147—Continued

Body length	MALES					FEMALES			
	Body weight	Stomach	Pancreas	Both submaxillaries	Epididymis (2)	Body weight	Stomach	Pancreas	Both submaxillaries
	<i>mm.</i>	<i>grams</i>	<i>grams</i>	<i>grams</i>	<i>grams</i>	<i>grams</i>	<i>grams</i>	<i>grams</i>	<i>grams</i>
155	87.1	0.689	0.500	0.194	0.1756	92.9	0.718	0.594	0.204
156	88.7	0.697	0.506	0.197	0.1817	94.6	0.727	0.602	0.207
157	90.4	0.706	0.513	0.200	0.1881	96.4	0.736	0.610	0.210
158	92.1	0.714	0.520	0.203	0.1947	98.3	0.745	0.618	0.214
159	93.8	0.723	0.527	0.206	0.2015	100.1	0.754	0.626	0.217
160	95.6	0.732	0.534	0.209	0.2087	102.0	0.763	0.635	0.220
161	97.3	0.740	0.541	0.212	0.2167	103.9	0.772	0.643	0.224
162	99.2	0.749	0.549	0.215	0.2236	105.9	0.781	0.652	0.227
163	101.0	0.758	0.556	0.219	0.2356	107.9	0.790	0.661	0.231
164	102.8	0.766	0.563	0.222	0.2470	109.9	0.799	0.670	0.234
165	104.7	0.775	0.571	0.225	0.2585	111.9	0.808	0.678	0.237
166	106.7	0.785	0.579	0.228	0.2707	114.0	0.818	0.688	0.241
167	108.6	0.793	0.586	0.232	0.2818	116.1	0.827	0.697	0.245
168	110.6	0.802	0.594	0.235	0.2935	118.3	0.836	0.706	0.248
169	112.6	0.811	0.602	0.239	0.3047	120.5	0.846	0.716	0.252
170	114.7	0.821	0.611	0.242	0.3164	122.7	0.855	0.725	0.256
171	116.7	0.829	0.619	0.246	0.3273	125.0	0.865	0.735	0.260
172	118.9	0.839	0.627	0.249	0.3390	127.3	0.875	0.744	0.264
173	121.0	0.848	0.636	0.253	0.3499	129.6	0.885	0.754	0.268
174	123.2	0.858	0.644	0.257	0.3610	132.0	0.894	0.764	0.272
175	125.4	0.867	0.653	0.260	0.3721	134.4	0.904	0.774	0.276
176	127.7	0.877	0.662	0.264	0.3834	136.8	0.914	0.785	0.280
177	130.0	0.886	0.671	0.268	0.3943	139.3	0.924	0.795	0.284
178	132.2	0.896	0.680	0.272	0.4053	141.9	0.934	0.806	0.288
179	134.6	0.905	0.689	0.276	0.4158	144.4	0.944	0.816	0.293
180	137.0	0.915	0.698	0.280	0.4267	147.1	0.955	0.827	0.297
181	139.5	0.925	0.708	0.284	0.4378	149.7	0.965	0.838	0.301
182	142.0	0.935	0.718	0.289	0.4486	152.4	0.975	0.849	0.306
183	144.5	0.945	0.728	0.293	0.4592	155.2	0.986	0.860	0.311
184	147.0	0.955	0.737	0.297	0.4695	158.0	0.997	0.872	0.315
185	149.6	0.965	0.748	0.301	0.4801	160.8	1.007	0.883	0.320
186	152.3	0.975	0.758	0.306	0.4909	163.7	1.018	0.895	0.325
187	155.0	0.985	0.768	0.310	0.5014	166.6	1.029	0.907	0.330
188	157.7	0.996	0.779	0.315	0.5117	169.6	1.040	0.919	0.335
189	160.5	1.006	0.790	0.320	0.5223	172.6	1.051	0.931	0.340
190	163.3	1.017	0.801	0.324	0.5326	175.7	1.062	0.943	0.345

TABLE 147—Continued

Body length	MALES					FEMALES			
	Body weight	Stomach	Pancreas	Both submaxillaries	Epididymis (2)	Body weight	Stomach	Pancreas	Both submaxillaries
	<i>mm.</i>	<i>grams</i>	<i>grams</i>	<i>grams</i>	<i>grams</i>	<i>grams</i>	<i>grams</i>	<i>grams</i>	<i>grams</i>
191	166.2	1.027	0.812	0.329	0.5429	178.8	1.073	0.956	0.350
192	169.1	1.038	0.823	0.334	0.5530	182.0	1.084	0.968	0.355
193	172.0	1.049	0.834	0.338	0.5630	185.2	1.096	0.981	0.360
194	175.0	1.059	0.845	0.343	0.5731	188.5	1.107	0.994	0.366
195	178.1	1.071	0.857	0.349	0.5835	191.9	1.119	1.008	0.371
196	181.2	1.082	0.869	0.354	0.5934	195.3	1.131	1.021	0.377
197	184.3	1.093	0.881	0.359	0.6032	198.7	1.143	1.035	0.382
198	187.5	1.104	0.893	0.364	0.6131	202.2	1.155	1.048	0.388
199	190.8	1.115	0.906	0.369	0.6231	205.8	1.167	1.062	0.394
200	194.1	1.127	0.919	0.375	0.6328	209.4	1.179	1.076	0.400
201	197.4	1.138	0.931	0.380	0.6423	213.1	1.191	1.091	0.406
202	200.8	1.150	0.944	0.386	0.6520	216.8	1.203	1.105	0.412
203	204.3	1.162	0.957	0.392	0.6618	220.7	1.216	1.120	0.418
204	207.8	1.173	0.971	0.397	0.6712	224.5	1.229	1.135	0.424
205	211.4	1.185	0.984	0.403	0.6808	228.4	1.241	1.150	0.431
206	215.0	1.197	0.998	0.409	0.6902	232.4	1.254	1.166	0.437
207	218.7	1.210	1.012	0.415	0.6996	236.5	1.267	1.181	0.444
208	222.5	1.222	1.026	0.421	0.7090	240.6	1.280	1.197	0.450
209	226.3	1.235	1.041	0.427	0.7184	244.8	1.294	1.213	0.457
210	230.2	1.247	1.055	0.434	0.7276	249.1	1.307	1.230	0.464
211	234.1	1.260	1.070	0.440	0.7366	253.4	1.321	1.246	0.471
212	238.1	1.273	1.085	0.446	0.7458	257.8	1.334	1.263	0.478
213	242.2	1.286	1.101	0.453	0.7548	262.3	1.348	1.280	0.485
214	246.3	1.299	1.116	0.460	0.7638	266.9	1.363	1.297	0.493
215	250.5	1.312	1.132	0.467	0.7726	271.5	1.377	1.315	0.500
216	254.7	1.325	1.148	0.473	0.7813	276.2	1.391	1.333	0.508
217	259.1	1.339	1.164	0.480	0.7904	281.0	1.405	1.351	0.515
218	263.5	1.352	1.181	0.487	0.7990	285.8	1.420	1.369	0.523
219	267.9	1.366	1.197	0.494	0.8076	290.8	1.435	1.388	0.531
220	272.5	1.380	1.215	0.502	0.8163	295.8	1.450	1.407	0.539
221	277.1	1.394	1.232	0.509	0.8246	300.9	1.465	1.426	0.547
222	281.8	1.408	1.249	0.517	0.8331	306.1	1.480	1.445	0.556
223	286.5	1.422	1.267	0.524	0.8414	311.3	1.495	1.465	0.564
224	291.4	1.437	1.285	0.532	0.8499	316.7	1.511	1.485	0.573
225	296.3	1.451	1.304	0.540	0.8580	322.1	1.527	1.505	0.581
226	301.3	1.466	1.322	0.548	0.8663	327.7	1.543	1.526	0.590
227	306.4	1.481	1.341	0.556	0.8744	333.3	1.559	1.547	0.599



TABLE 117—*Concluded*

Body length	MALES					FEMALES			
	Body weight	Stomach	Pancreas	Both submaxillaries	Epididymis (2)	Body weight	Stomach	Pancreas	Both submaxillaries
	<i>mm.</i>	<i>grams</i>	<i>grams</i>	<i>grams</i>	<i>grams</i>	<i>grams</i>	<i>grams</i>	<i>grams</i>	<i>grams</i>
228	311.5	1.496	1.360	0.564	0.8824	339.0	1.575	1.568	0.608
229	316.8	1.511	1.380	0.573	0.8904	344.8	1.592	1.589	0.617
230	322.1	1.527	1.400	0.581	0.8983	350.7	1.608	1.611	0.627
231	327.5	1.542	1.420	0.590	0.9060	356.7	1.625	1.633	0.636
232	333.0	1.558	1.440	0.599	0.9138	362.8	1.642	1.656	0.646
233	338.6	1.574	1.461	0.607	0.9215	369.0	1.660	1.678	0.656
234	344.3	1.590	1.482	0.616	0.9290	375.3	1.677	1.702	0.666
235	350.0	1.606	1.504	0.625	0.9366	381.7	1.695	1.725	0.676
236	355.9	1.623	1.525	0.635	0.9439	388.2	1.713	1.749	0.686
237	361.9	1.640	1.548	0.644	0.9514	394.9	1.731	1.774	0.696
238	367.9	1.657	1.570	0.654	0.9586	401.6	1.749	1.798	0.707
239	374.1	1.674	1.593	0.664	0.9659	408.4	1.768	1.823	0.718
240	380.3	1.691	1.616	0.674	0.9729	415.4	1.787	1.849	0.729
241	386.6	1.708	1.639	0.683	0.9799	422.4	1.806	1.874	0.740
242	393.1	1.726	1.663	0.694	0.9869	429.6	1.825	1.900	0.751
243	399.6	1.744	1.688	0.704	0.9936	436.9	1.844	1.927	0.763
244	406.3	1.762	1.712	0.715	1.0004	444.3	1.864	1.954	0.774
245	413.1	1.781	1.737	0.725	1.0073	451.9	1.884	1.981	0.786
246	419.9	1.799	1.762	0.736	1.0136	459.5	1.904	2.009	0.798
247	426.9	1.818	1.788	0.747	1.0202	467.3	1.925	2.037	0.810
248	434.0	1.837	1.815	0.758	1.0267	475.2	1.946	2.066	0.823
249	441.2	1.856	1.841	0.769	1.0329	483.3	1.967	2.095	0.836
250	448.5	1.875	1.868	0.781	1.0392	491.5	1.988	2.125	0.848

TABLE 148

Giving for each sex the weights of body, hypophysis, suprarenals and thyroid for each millimeter of body length. See Charts 42, 43 and 44

MALES					FEMALES			
Body length	Body weight	Hypophysis	Suprarenals	Thyroid	Body weight	Hypophysis	Suprarenals	Thyroid
mm.	gms.	gms.	gms.	gms.	gms.	gms.	gms.	gms.
50	5.1	0.0005	0.0017	0.0015	5.0	0.0005	0.0017	0.0014
51	5.2	0.0005	0.0017	0.0015	5.1	0.0005	0.0017	0.0015
52	5.3	0.0005	0.0017	0.0015	5.3	0.0005	0.0018	0.0015
53	5.4	0.0005	0.0018	0.0016	5.5	0.0006	0.0019	0.0016
54	5.6	0.0005	0.0019	0.0016	5.8	0.0006	0.0021	0.0017
55	5.8	0.0006	0.0021	0.0017	6.2	0.0006	0.0024	0.0018
56	6.1	0.0006	0.0023	0.0018	6.5	0.0006	0.0026	0.0019
57	6.4	0.0006	0.0025	0.0018	6.9	0.0007	0.0028	0.0020
58	6.8	0.0007	0.0027	0.0019	7.2	0.0007	0.0030	0.0021
59	7.1	0.0007	0.0029	0.0020	7.6	0.0007	0.0032	0.0022
60	7.5	0.0007	0.0031	0.0021	8.0	0.0008	0.0034	0.0023
61	7.9	0.0008	0.0034	0.0022	8.4	0.0008	0.0036	0.0024
62	8.2	0.0008	0.0035	0.0023	8.7	0.0008	0.0038	0.0025
63	8.6	0.0008	0.0037	0.0024	9.1	0.0009	0.0040	0.0026
64	9.0	0.0009	0.0039	0.0025	9.5	0.0009	0.0042	0.0027
65	9.4	0.0009	0.0041	0.0026	9.9	0.0009	0.0044	0.0028
66	9.8	0.0009	0.0043	0.0027	10.3	0.0009	0.0045	0.0029
67	10.1	0.0009	0.0045	0.0028	10.8	0.0010	0.0048	0.0030
68	10.6	0.0010	0.0047	0.0030	11.2	0.0010	0.0049	0.0031
69	11.0	0.0010	0.0049	0.0031	11.6	0.0010	0.0051	0.0032
70	11.4	0.0010	0.0050	0.0032	12.0	0.0011	0.0053	0.0033
71	11.8	0.0011	0.0052	0.0033	12.5	0.0011	0.0055	0.0034
72	12.2	0.0011	0.0054	0.0034	12.9	0.0011	0.0056	0.0035
73	12.7	0.0011	0.0056	0.0035	13.4	0.0012	0.0058	0.0037
74	13.1	0.0011	0.0057	0.0036	13.9	0.0012	0.0060	0.0038
75	13.6	0.0012	0.0059	0.0037	14.3	0.0012	0.0062	0.0039
76	14.0	0.0012	0.0061	0.0038	14.8	0.0012	0.0064	0.0040
77	14.5	0.0012	0.0063	0.0039	15.3	0.0013	0.0065	0.0041
78	15.0	0.0013	0.0064	0.0041	15.8	0.0013	0.0067	0.0042
79	15.4	0.0013	0.0066	0.0042	16.3	0.0013	0.0069	0.0044
80	15.9	0.0013	0.0067	0.0043	16.8	0.0014	0.0070	0.0045
81	16.4	0.0013	0.0069	0.0044	17.3	0.0014	0.0072	0.0046
82	16.9	0.0014	0.0071	0.0045	17.9	0.0014	0.0074	0.0047
83	17.4	0.0014	0.0072	0.0046	18.4	0.0014	0.0076	0.0049

TABLE 148—Continued

MALES					FEMALES			
Body length	Body weight	Hypophysis	Supra-renals	Thyroid	Body weight	Hypophysis	Supra-renals	Thyroid
<i>mm.</i>	<i>gms.</i>	<i>gms.</i>	<i>gms.</i>	<i>gms.</i>	<i>gms.</i>	<i>gms.</i>	<i>gms.</i>	<i>gms.</i>
84	18.0	0.0014	0.0074	0.0048	19.0	0.0015	0.0078	0.0050
85	18.5	0.0015	0.0076	0.0049	19.5	0.0015	0.0079	0.0051
86	19.0	0.0015	0.0078	0.0050	20.1	0.0015	0.0081	0.0052
87	19.6	0.0015	0.0079	0.0051	20.7	0.0016	0.0083	0.0054
88	20.1	0.0015	0.0081	0.0052	21.2	0.0016	0.0084	0.0055
89	20.7	0.0016	0.0083	0.0054	21.8	0.0016	0.0086	0.0056
90	21.3	0.0016	0.0084	0.0055	22.4	0.0017	0.0087	0.0058
91	21.9	0.0016	0.0086	0.0056	23.1	0.0017	0.0089	0.0059
92	22.4	0.0017	0.0087	0.0058	23.7	0.0017	0.0091	0.0060
93	23.0	0.0017	0.0089	0.0059	24.3	0.0017	0.0093	0.0062
94	23.7	0.0017	0.0091	0.0060	25.0	0.0018	0.0094	0.0063
95	24.3	0.0017	0.0093	0.0062	25.6	0.0018	0.0096	0.0064
96	24.9	0.0018	0.0094	0.0063	26.3	0.0018	0.0098	0.0066
97	25.6	0.0018	0.0096	0.0064	27.0	0.0019	0.0100	0.0067
98	26.2	0.0018	0.0098	0.0066	27.7	0.0019	0.0101	0.0069
99	26.9	0.0019	0.0099	0.0067	28.4	0.0019	0.0103	0.0070
100	27.5	0.0019	0.0101	0.0068	29.1	0.0020	0.0105	0.0072
101	28.2	0.0019	0.0103	0.0070	29.8	0.0020	0.0106	0.0073
102	28.9	0.0020	0.0104	0.0071	30.5	0.0020	0.0108	0.0075
103	29.6	0.0020	0.0106	0.0073	31.3	0.0021	0.0110	0.0076
104	30.3	0.0020	0.0108	0.0074	32.0	0.0021	0.0112	0.0078
105	31.1	0.0021	0.0109	0.0076	32.8	0.0021	0.0114	0.0079
106	31.8	0.0021	0.0111	0.0077	33.6	0.0022	0.0117	0.0081
107	32.5	0.0021	0.0113	0.0079	34.4	0.0022	0.0119	0.0082
108	33.3	0.0021	0.0114	0.0080	35.2	0.0022	0.0121	0.0084
109	34.1	0.0022	0.0116	0.0082	36.0	0.0023	0.0123	0.0085
110	34.9	0.0022	0.0118	0.0083	36.9	0.0023	0.0126	0.0087
111	35.7	0.0022	0.0120	0.0085	37.7	0.0023	0.0128	0.0089
112	36.5	0.0023	0.0121	0.0086	38.6	0.0024	0.0130	0.0090
113	37.3	0.0023	0.0123	0.0088	39.5	0.0024	0.0133	0.0092
114	38.2	0.0024	0.0125	0.0090	40.3	0.0024	0.0135	0.0094
115	39.0	0.0024	0.0126	0.0091	41.3	0.0025	0.0138	0.0096
116	39.9	0.0024	0.0128	0.0093	42.2	0.0025	0.0140	0.0097
117	40.8	0.0025	0.0130	0.0095	43.1	0.0025	0.0143	0.0099
118	41.6	0.0025	0.0132	0.0096	44.1	0.0026	0.0145	0.0101
119	42.6	0.0025	0.0134	0.0098	45.0	0.0026	0.0148	0.0102
120	43.5	0.0026	0.0135	0.0100	46.0	0.0027	0.0150	0.0104

## GROWTH OF PARTS AND ORGANS

TABLE 148—Continued

MALES					FEMALES			
Body length	Body weight	Hypoph- ysis	Supra- renals	Thyroid	Body weight	Hypoph- ysis	Supra- renals	Thyroid
<i>mm.</i>	<i>gms.</i>	<i>gms.</i>	<i>gms.</i>	<i>gms.</i>	<i>gms.</i>	<i>gms.</i>	<i>gms.</i>	<i>gms.</i>
121	44.4	0.0026	0.0137	0.0101	47.0	0.0027	0.0153	0.0106
122	45.4	0.0026	0.0139	0.0103	48.0	0.0027	0.0156	0.0108
123	46.3	0.0027	0.0141	0.0105	49.1	0.0028	0.0159	0.0110
124	47.3	0.0027	0.0142	0.0106	50.1	0.0028	0.0161	0.0111
125	48.3	0.0027	0.0144	0.0108	51.2	0.0029	0.0164	0.0113
126	49.3	0.0028	0.0146	0.0110	52.3	0.0029	0.0167	0.0115
127	50.4	0.0028	0.0148	0.0112	53.4	0.0030	0.0170	0.0117
128	51.4	0.0029	0.0150	0.0114	54.5	0.0031	0.0173	0.0119
129	52.5	0.0029	0.0152	0.0116	55.6	0.0031	0.0176	0.0121
130	53.6	0.0029	0.0154	0.0117	56.8	0.0032	0.0179	0.0123
131	54.7	0.0030	0.0155	0.0119	58.0	0.0033	0.0182	0.0125
132	55.8	0.0030	0.0157	0.0121	59.2	0.0034	0.0185	0.0127
133	56.9	0.0031	0.0159	0.0123	60.4	0.0035	0.0188	0.0129
134	58.1	0.0031	0.0161	0.0125	61.6	0.0035	0.0191	0.0131
135	59.3	0.0031	0.0163	0.0127	62.9	0.0036	0.0195	0.0133
136	60.5	0.0032	0.0165	0.0129	64.2	0.0037	0.0198	0.0135
137	61.7	0.0032	0.0167	0.0131	65.5	0.0038	0.0201	0.0137
138	62.9	0.0033	0.0169	0.0133	66.8	0.0039	0.0204	0.0139
139	64.1	0.0033	0.0171	0.0135	68.1	0.0040	0.0208	0.0142
140	65.4	0.0034	0.0173	0.0137	69.5	0.0041	0.0211	0.0144
141	66.7	0.0034	0.0175	0.0139	70.9	0.0042	0.0215	0.0146
142	68.0	0.0034	0.0177	0.0141	72.3	0.0043	0.0218	0.0148
143	69.3	0.0035	0.0179	0.0143	73.7	0.0044	0.0222	0.0150
144	70.7	0.0035	0.0181	0.0146	75.2	0.0045	0.0226	0.0153
145	72.1	0.0036	0.0183	0.0148	76.7	0.0046	0.0230	0.0155
146	73.5	0.0036	0.0185	0.0150	78.2	0.0047	0.0233	0.0158
147	74.9	0.0037	0.0187	0.0152	79.7	0.0048	0.0237	0.0160
148	76.3	0.0037	0.0189	0.0155	81.3	0.0049	0.0241	0.0162
149	77.8	0.0038	0.0192	0.0157	82.8	0.0050	0.0245	0.0164
150	79.3	0.0038	0.0194	0.0159	84.4	0.0051	0.0249	0.0167
151	80.8	0.0039	0.0196	0.0161	86.1	0.0052	0.0253	0.0169
152	82.4	0.0039	0.0198	0.0164	87.7	0.0053	0.0257	0.0172
153	83.9	0.0040	0.0200	0.0166	89.4	0.0055	0.0261	0.0175
154	85.5	0.0040	0.0203	0.0169	91.1	0.0056	0.0266	0.0177
155	87.1	0.0041	0.0205	0.0171	92.9	0.0057	0.0270	0.0180
156	88.7	0.0041	0.0207	0.0173	94.6	0.0058	0.0274	0.0182
157	90.4	0.0042	0.0210	0.0176	96.4	0.0060	0.0279	0.0185

TABLE 148—Continued

MALES					FEMALES			
Body length	Body weight	Hypophysis	Supra-renals	Thyroid	Body weight	Hypophysis	Supra-renals	Thyroid
<i>mm.</i>	<i>gms.</i>	<i>gms.</i>	<i>gms.</i>	<i>gms.</i>	<i>gms.</i>	<i>gms.</i>	<i>gms.</i>	<i>gms.</i>
158	92.1	0.0042	0.0212	0.0179	98.3	0.0061	0.0283	0.0188
159	93.8	0.0043	0.0214	0.0181	100.1	0.0062	0.0288	0.0190
160	95.6	0.0044	0.0217	0.0184	102.0	0.0064	0.0293	0.0193
161	97.3	0.0044	0.0219	0.0186	103.9	0.0065	0.0297	0.0196
162	99.2	0.0045	0.0222	0.0189	105.9	0.0067	0.0302	0.0199
163	101.0	0.0045	0.0224	0.0191	107.9	0.0068	0.0307	0.0201
164	102.8	0.0046	0.0226	0.0194	109.9	0.0070	0.0312	0.0204
165	104.7	0.0046	0.0229	0.0197	111.9	0.0071	0.0317	0.0207
166	106.7	0.0047	0.0231	0.0200	114.0	0.0073	0.0322	0.0210
167	108.6	0.0048	0.0234	0.0202	116.1	0.0074	0.0327	0.0213
168	110.6	0.0048	0.0236	0.0205	118.3	0.0076	0.0333	0.0216
169	112.6	0.0049	0.0239	0.0208	120.5	0.0077	0.0338	0.0219
170	114.7	0.0050	0.0242	0.0211	122.7	0.0079	0.0343	0.0222
171	116.7	0.0050	0.0244	0.0214	125.0	0.0081	0.0349	0.0225
172	118.9	0.0051	0.0247	0.0217	127.3	0.0082	0.0355	0.0228
173	121.0	0.0052	0.0250	0.0220	129.6	0.0084	0.0360	0.0232
174	123.2	0.0052	0.0252	0.0223	132.0	0.0086	0.0366	0.0235
175	125.4	0.0053	0.0255	0.0226	134.4	0.0088	0.0372	0.0238
176	127.7	0.0054	0.0258	0.0229	136.8	0.0089	0.0378	0.0241
177	130.0	0.0054	0.0261	0.0232	139.3	0.0091	0.0384	0.0245
178	132.3	0.0055	0.0264	0.0235	141.9	0.0093	0.0390	0.0248
179	134.6	0.0056	0.0266	0.0238	144.4	0.0095	0.0396	0.0251
180	137.0	0.0056	0.0269	0.0242	147.1	0.0097	0.0402	0.0255
181	139.5	0.0057	0.0272	0.0245	149.7	0.0099	0.0409	0.0258
182	142.0	0.0058	0.0275	0.0248	152.4	0.0101	0.0415	0.0262
183	144.5	0.0059	0.0278	0.0252	155.2	0.0103	0.0422	0.0266
184	147.0	0.0059	0.0281	0.0255	158.0	0.0105	0.0429	0.0269
185	149.6	0.0060	0.0284	0.0258	160.8	0.0108	0.0435	0.0273
186	152.3	0.0061	0.0287	0.0262	163.7	0.0110	0.0442	0.0277
187	155.0	0.0062	0.0291	0.0265	166.6	0.0112	0.0449	0.0280
188	157.7	0.0063	0.0294	0.0269	169.6	0.0114	0.0457	0.0284
189	160.5	0.0063	0.0297	0.0272	172.6	0.0117	0.0464	0.0288
190	163.3	0.0064	0.0300	0.0276	175.7	0.0119	0.0471	0.0292
191	166.2	0.0065	0.0304	0.0280	178.8	0.0121	0.0479	0.0296
192	169.1	0.0066	0.0307	0.0284	182.0	0.0124	0.0486	0.0300
193	172.0	0.0067	0.0310	0.0287	185.2	0.0126	0.0494	0.0304

TABLE 148—Continued

MALES					FEMALES			
Body length	Body weight	Hypophysis	Supra-renals	Thyroid	Body weight	Hypophysis	Supra-renals	Thyroid
<i>mm.</i>	<i>gms.</i>	<i>gms.</i>	<i>gms.</i>	<i>gms.</i>	<i>gms.</i>	<i>gms.</i>	<i>gms.</i>	<i>gms.</i>
194	175.0	0.0068	0.0314	0.0291	188.5	0.0129	0.0502	0.0308
195	178.1	0.0068	0.0317	0.0295	191.9	0.0131	0.0510	0.0312
196	181.2	0.0069	0.0321	0.0299	195.3	0.0134	0.0518	0.0317
197	184.3	0.0070	0.0324	0.0303	198.7	0.0136	0.0526	0.0321
198	187.5	0.0071	0.0328	0.0307	202.2	0.0139	0.0535	0.0325
199	190.8	0.0072	0.0331	0.0311	205.8	0.0142	0.0543	0.0330
200	194.1	0.0073	0.0335	0.0315	209.4	0.0145	0.0552	0.0334
201	197.4	0.0074	0.0338	0.0319	213.1	0.0148	0.0560	0.0339
202	200.8	0.0075	0.0342	0.0323	216.8	0.0150	0.0569	0.0343
203	204.3	0.0076	0.0346	0.0328	220.7	0.0153	0.0579	0.0348
204	207.8	0.0077	0.0350	0.0332	224.5	0.0155	0.0588	0.0352
205	211.4	0.0078	0.0354	0.0336	228.4	0.0159	0.0597	0.0357
206	215.0	0.0079	0.0358	0.0341	232.4	0.0162	0.0606	0.0362
207	218.7	0.0080	0.0362	0.0345	236.5	0.0166	0.0616	0.0367
208	222.5	0.0081	0.0366	0.0350	240.6	0.0169	0.0626	0.0372
209	226.3	0.0082	0.0370	0.0355	244.8	0.0172	0.0636	0.0377
210	230.2	0.0083	0.0374	0.0359	249.1	0.0175	0.0646	0.0382
211	234.1	0.0084	0.0378	0.0364	253.4	0.0179	0.0656	0.0387
212	238.1	0.0086	0.0382	0.0369	257.8	0.0182	0.0667	0.0392
213	242.2	0.0087	0.0387	0.0374	262.3	0.0186	0.0677	0.0398
214	246.3	0.0088	0.0391	0.0379	266.9	0.0189	0.0688	0.0403
215	250.5	0.0089	0.0395	0.0384	271.5	0.0193	0.0699	0.0408
216	254.7	0.0090	0.0400	0.0389	276.2	0.0196	0.0710	0.0414
217	259.1	0.0092	0.0404	0.0394	281.0	0.0200	0.0721	0.0420
218	263.5	0.0093	0.0409	0.0399	285.8	0.0204	0.0733	0.0425
219	267.9	0.0094	0.0414	0.0404	290.8	0.0208	0.0744	0.0431
220	272.5	0.0095	0.0418	0.0410	295.8	0.0212	0.0756	0.0437
221	277.1	0.0097	0.0423	0.0415	300.9	0.0216	0.0768	0.0443
222	281.8	0.0098	0.0428	0.0421	306.1	0.0220	0.0781	0.0449
223	286.5	0.0099	0.0433	0.0426	311.3	0.0224	0.0793	0.0455
224	291.4	0.0101	0.0438	0.0432	316.7	0.0228	0.0805	0.0461
225	296.3	0.0102	0.0443	0.0437	322.1	0.0232	0.0818	0.0467
226	301.3	0.0103	0.0448	0.0443	327.7	0.0237	0.0831	0.0474
227	306.4	0.0105	0.0453	0.0449	333.3	0.0242	0.0845	0.0480
228	311.5	0.0106	0.0458	0.0455	339.0	0.0246	0.0858	0.0486
229	316.8	0.0108	0.0464	0.0461	344.8	0.0250	0.0872	0.0493
230	322.1	0.0109	0.0469	0.0467	350.7	0.0255	0.0885	0.0500

TABLE 148—Concluded

MALES					FEMALES			
Body length	Body weight	Hypophysis	Supra-renals	Thyroid	Body weight	Hypophysis	Supra-renals	Thyroid
<i>mm.</i>	<i>gms.</i>	<i>gms.</i>	<i>gms.</i>	<i>gms.</i>	<i>gms.</i>	<i>gms.</i>	<i>gms.</i>	<i>gms.</i>
231	327.5	0.0111	0.0474	0.0473	356.7	0.0259	0.0899	0.0507
232	333.0	0.0112	0.0480	0.0480	362.8	0.0264	0.0914	0.0513
233	338.6	0.0114	0.0485	0.0486	369.0	0.0269	0.0928	0.0520
234	344.3	0.0115	0.0491	0.0493	375.3	0.0274	0.0943	0.0527
235	350.0	0.0117	0.0497	0.0499	381.7	0.0279	0.0958	0.0535
236	355.9	0.0118	0.0503	0.0506	388.2	0.0284	0.0973	0.0542
237	361.9	0.0120	0.0509	0.0512	394.9	0.0290	0.0989	0.0549
238	367.9	0.0122	0.0514	0.0519	401.6	0.0295	0.1005	0.0557
239	374.1	0.0123	0.0521	0.0526	408.4	0.0300	0.1021	0.0564
240	380.3	0.0125	0.0527	0.0533	415.4	0.0306	0.1037	0.0572
241	386.6	0.0127	0.0533	0.0540	422.4	0.0311	0.1053	0.0580
242	393.1	0.0129	0.0539	0.0548	429.6	0.0317	0.1070	0.0588
243	399.6	0.0130	0.0546	0.0555	436.9	0.0323	0.1087	0.0596
244	406.3	0.0132	0.0552	0.0562	444.3	0.0329	0.1105	0.0604
245	413.1	0.0134	0.0559	0.0570	451.9	0.0335	0.1122	0.0613
246	419.9	0.0136	0.0565	0.0577	459.5	0.0341	0.1140	0.0621
247	426.9	0.0138	0.0572	0.0585	467.3	0.0347	0.1158	0.0630
248	434.0	0.0140	0.0579	0.0593	475.2	0.0353	0.1177	0.0638
249	441.2	0.0142	0.0586	0.0601	483.3	0.0359	0.1196	0.0647
250	448.5	0.0144	0.0593	0.0609	491.5	0.0366	0.1251	0.0656

*Weight of other organs*

*Prostate gland.* The prostate gland is invested by a fibrous coat which contains a large amount of lipoid like substance. All non-glandular structures can be easily separated from the glandular tissue by pulling off this fibrous coat. The glandular tissue alone was weighed. (Hatai MS). Table 149.

TABLE 149

*Weights of prostate gland, lens (2) and pineal gland on body weight. (Hatai '23, MS.). Males 182 cases—Females 107 cases, in groups of six or more*

MALES					FEMALES			
Body weight	Age	Prostate	Lens (2)	Pineal	Pineal	Lens (2)	Age	Body weight
<i>grams</i>	<i>days</i>	<i>mgms.</i>	<i>mgms.</i>	<i>mgms.</i>	<i>mgms.</i>	<i>mgms.</i>	<i>days</i>	<i>grams</i>
4.1	0	0.5	5.2	0.5	0.3	4.6	0	4.1
5.3	0	0.5	6.1	0.4	—	—	—	—
7.1	3	1.5	10.7	0.4	0.5	9.2	3	7.1
13.1	12	3.1	19.8	0.6	0.5	20.3	12	13.6
21.0	14	3.7	22.7	0.6	—	—	—	—
25.7	25	11.5	33.9	0.6	0.7	32.8	27	26.3
32.5	29	10.7	36.2	0.7	0.8	41.7	41	45.1
52.6	48	19.1	48.5	0.8	0.8	46.5	47	55.4
65.5	46	21.9	49.1	1.0	0.9	46.0	45	65.8
75.0	48	25.8	50.7	1.0	—	—	—	—
87.4	55	33.1	42.3	1.0	1.0	53.3	51	76.3
102.7	74	62.9	61.6	1.0	0.9	74.3	71	104.9
124.4	72	72.1	64.6	0.8	1.0	67.5	68	116.5
135.3	70	88.8	63.3	1.1	0.9	64.7	70	130.3
144.9	99	129.8	69.2	1.1	1.2	71.9	92	151.1
155.7	118	154.2	70.5	1.1	—	—	—	—
166.5	79	146.1	57.6	1.4	—	—	—	—
183.1	125	194.7	83.2	1.1	—	—	—	—
189.7	92	211.2	77.0	1.5	—	—	—	—
200.2	77	162.2	64.5	1.5	—	—	—	—
223.2	179	265.9	73.9	1.6	—	—	—	—
262.5	239	447.7	—	1.5	—	—	—	—
266.4	248	392.6	102.5	1.6	—	—	—	—
295.5	363	369.9	114.3	1.4	1.4	106.4	393	187.4
350.8	460	541.9	119.3	1.4	1.3	104.5	335	205.4
394.5	503	660.8	108.6	1.1	1.3	114.9	433	229.6
460.8	664	574.4	130.3	1.6	0.9	92.7	654	339.7



TABLE 150

*Weights of ovaries, tubes, uterus and vagina—on body weight and age—observed values (Osterud, MS.)*

BODY WEIGHT	AGE	BODY LENGTH	ABSOLUTE WEIGHTS OF			
			Ovaries	Tubes	Uterus	Vagina
<i>grams</i>	<i>days</i>	<i>mm.</i>	<i>grams</i>	<i>grams</i>	<i>grams</i>	<i>grams</i>
4.8	0	49	0.0008	0.0008	0.0014	0.0009
7.6	4	57	0.0009	0.0008	0.0028	0.0014
12.3	9	71	0.0014	0.0015	0.0060	0.0030
18.1	15	81	0.0026	0.0025	0.0127	0.0074
24.4	19	93	0.0052	0.0034	0.0196	0.0127
30.0	26	100	0.0092	0.0044	0.0206	0.0169
35.0	33	109	0.0145	0.0039	0.0177	0.0227
43.0	33	116	0.0102	0.0042	0.0195	0.0191
51.3	42	123	0.0104	0.0051	0.0294	0.0247
59.1	47	130	0.0123	0.0054	0.0348	0.0250
65.7	51	132	0.0135	0.0064	0.0410	0.0363
72.3	58	136	0.0135	0.0074	0.0593	0.0434
79.5	61	141	0.0168	0.0093	0.1182	0.0629
87.2	67	147	0.0185	0.0097	0.1149	0.0603
99.2	70	156	0.0297	0.0124	0.1615	0.0878
114.0	81	162	0.0435	0.0139	0.1938	0.0953
133.0	94	170	0.0470	0.0162	0.2881	0.1044
156.0	131	181	0.0411	0.0155	0.3390	0.0972
185.0	165	188	0.0635	0.0200	0.4206	0.1322
207.0	171	193	0.0564	0.0150	0.2994	0.1137
263.0	276	214	0.0593	0.0218	0.2880	0.1165

*Lens.* The eyeballs are removed as usual: carefully cut with small sharp scissors and the lens gently pressed out. The lens is surrounded by aqueous humor which is removed by lightly rolling lens over filter paper. Too much rolling is dangerous because the lens surface can be injured. The lens thus freed from adherent liquid is placed with its mate in a previously weighed bottle and weighed. The growth of the lens is more precocious and relatively much greater than that of the eyeball. (Hatai MS). (Table 149.)

*Pineal gland.* After removal of the overlying bone and pushing aside the vessels, the pineal is picked up with a very fine forceps and the peduncles severed. On account of its small size and the effect of slight differences in the adherent moisture, the absolute weights for this organ are the least trustworthy of any. As compared with the other endocrine glands, the growth of the pineal is very small. (Hatai MS). (Table 149.)

*Weights of parts of the female reproductive tract (Osterud MS).* This study was based on 155 females; of these 125 were virgin and the remainder had given birth to one litter. Under precautions to prevent drying, the ovaries and tubes were isolated by severing the tubes close to the tip of the uterine horn.

These were dissected apart, and separated from extraneous tissue. The uterus and vagina were similarly isolated and then were separated by transection of the latter in a plane just missing the tip of the cervix. The weights were taken in closed bottles. The values obtained are given in table 150.

When the data on the weight of the ovaries are compared with those in table 146 it is seen that they tend to run high, especially for the heavy body weights. This difference would suggest the formation of a larger number of corpora in the series examined by Osterud.

9. *Weight of thymus on age: Table 151. On length: table 152.*

TABLE 151

*Giving the weight of the thymus in grams—sexes combined—for the first 400 days of life. See Chart 48*

AGE IN DAYS	WEIGHT OF THYMUS	AGE IN DAYS	WEIGHT OF THYMUS	AGE IN DAYS	WEIGHT OF THYMUS	AGE IN DAYS	WEIGHT OF THYMUS
B.	0.008						
1	0.008	11	0.026	21	0.048	31	0.083
2	0.010	12	0.028	22	0.051	32	0.087
3	0.012	13	0.029	23	0.054	33	0.091
4	0.015	14	0.031	24	0.057	34	0.095
5	0.017	15	0.034	25	0.061	35	0.100
6	0.018	16	0.036	26	0.064	36	0.104
7	0.020	17	0.038	27	0.067	37	0.109
8	0.021	18	0.040	28	0.071	38	0.114
9	0.022	19	0.043	29	0.075	39	0.118
10	0.024	20	0.046	30	0.079	40	0.123

TABLE 151—*Concluded*

AGE IN DAYS	WEIGHT OF THYMUS	AGE IN DAYS	WEIGHT OF THYMUS	AGE IN DAYS	WEIGHT OF THYMUS	AGE IN DAYS	WEIGHT OF THYMUS
41	0.128	76	0.285	111	0.252	146	0.215
42	0.133	77	0.286	112	0.251	147	0.214
43	0.139	78	0.288	113	0.250	148	0.213
44	0.144	79	0.289	114	0.249	149	0.212
45	0.149	80	0.290	115	0.247	150	0.211
46	0.154			116	0.246		
47	0.160	81	0.290	117	0.245	160	0.201
48	0.165	82	0.291	118	0.244	170	0.191
49	0.171	83	0.291	119	0.243	180	0.182
50	0.176	84	0.290	120	0.242	190	0.172
		85	0.290			200	0.164
51	0.181	86	0.289	121	0.241		
52	0.187	87	0.288	122	0.240	210	0.155
53	0.192	88	0.287	123	0.239	220	0.147
54	0.198	89	0.285	124	0.238	230	0.138
55	0.203	90	0.283	125	0.237	240	0.130
56	0.208			126	0.236	250	0.123
57	0.213	91	0.281	127	0.234		
58	0.218	92	0.278	128	0.233	260	0.115
59	0.224	93	0.276	129	0.232	270	0.108
60	0.229	94	0.273	130	0.231	280	0.102
		95	0.270			290	0.095
61	0.233	96	0.269	131	0.230	300	0.089
62	0.238	97	0.268	132	0.229		
63	0.243	98	0.266	133	0.228	310	0.082
64	0.247	99	0.265	134	0.227	320	0.077
65	0.251	100	0.264	135	0.226	330	0.071
66	0.255			136	0.225	340	0.066
67	0.259	101	0.263	137	0.224	350	0.061
68	0.263	102	0.262	138	0.223		
69	0.267	103	0.261	139	0.222	360	0.056
70	0.270	104	0.260	140	0.221	370	0.051
		105	0.259			380	0.047
71	0.273	106	0.257	141	0.220	390	0.043
72	0.276	107	0.256	142	0.219	400	0.039
73	0.278	108	0.255	143	0.218		
74	0.281	109	0.254	144	0.217		
75	0.283	110	0.253	145	0.216		

TABLE 152

*Weights of thymus for each sex and at each millimeter of body length*

MALES			FEMALES	
Body length	Body weight	Weight of thymus	Body weight	Weight of thymus
<i>mm.</i>	<i>grams</i>	<i>grams</i>	<i>grams</i>	<i>grams</i>
47	4.9	0.007	4.7	0.007
48	4.9	0.007	4.7	0.007
49	5.0	0.007	4.9	0.007
50	5.1	0.007	5.0	0.008
51	5.2	0.008	5.1	0.008
52	5.3	0.008	5.3	0.008
53	5.4	0.008	5.5	0.008
54	5.6	0.008	5.8	0.010
55	5.8	0.010	6.2	0.012
56	6.1	0.011	6.5	0.015
57	6.4	0.012	6.9	0.015
58	6.8	0.015	7.2	0.016
59	7.1	0.015	7.6	0.017
60	7.5	0.016	8.0	0.017
61	7.9	0.016	8.4	0.018
62	8.2	0.017	8.7	0.020
63	8.6	0.017	9.1	0.020
64	9.0	0.018	9.5	0.020
65	9.4	0.020	9.9	0.021
66	9.8	0.020	10.3	0.021
67	10.1	0.021	10.8	0.021
68	10.6	0.021	11.2	0.022
69	11.0	0.022	11.6	0.023
70	11.4	0.022	12.0	0.024
71	11.8	0.023	12.5	0.025
72	12.2	0.024	12.9	0.026
73	12.7	0.025	13.4	0.026
74	13.1	0.026	13.9	0.027
75	13.6	0.027	14.3	0.027
76	14.0	0.028	14.8	0.028
77	14.5	0.028	15.3	0.028
78	15.0	0.029	15.8	0.031
79	15.4	0.031	16.3	0.032
80	15.9	0.032	16.8	0.033
81	16.4	0.034	17.3	0.034
82	16.9	0.036	17.9	0.034

TABLE 152—*Concluded*

MALES			FEMALES	
Body length	Body weight	Weight of thymus	Body weight	Weight of thymus
<i>mm.</i>	<i>grams</i>	<i>grams</i>	<i>grams</i>	<i>grams</i>
83	17.4	0.038	18.4	0.035
84	18.0	0.039	19.0	0.037
85	18.5	0.040	19.5	0.038
86	19.0	0.041	20.1	0.040
87	19.6	0.043	20.7	0.043
88	20.1	0.044	21.2	0.044
89	20.7	0.046	21.8	0.046
90	21.3	0.048	22.4	0.048
91	21.9	0.050	23.1	0.050
92	22.4	0.052	23.7	0.052
93	23.0	0.054	24.3	0.054
94	23.7	0.056	25.0	0.055
95	24.3	0.057	25.6	0.057
96	24.9	0.059	26.3	0.059
97	25.6	0.061	27.0	0.060
98	26.2	0.063	27.7	0.061
99	26.9	0.065	28.4	0.063
100	27.5	0.067	29.1	0.065
110	34.9	0.095	36.9	0.099
120	43.5	0.127	46.0	0.133
130	53.6	0.159	56.8	0.171
140	65.4	0.196	69.5	0.203
150	79.3	0.229	84.4	0.247
160	95.6	0.253	102.0	0.273
170	114.7	0.278	122.7	0.291
180	137.0	0.291	147.1	0.266
190	163.3	0.266	175.7	0.232
196	181.2	0.251	195.3	0.171
200	194.1	0.241		
210	230.2	0.197		
219	267.9	0.118		

10. *Weights of viscera.* Using the data in tables 145–148 the total weight of the viscera comprising the heart, hypophysis, intestines, kidneys (2), liver, lungs (2), pancreas, spleen, stomach, submaxillaries (2), suprarenals (2) and thyroid has been determined for a series of body weights—table 153.

*Relative percentage weights of viscera and organs (Donaldson, '23).* All viscera (12).<sup>9</sup> See list, table 153.

From table 153 we may compute the percentage weights of all the (12) viscera for a series of selected body weights. The data are entered in table 154.

When the percentage weight at birth is taken as unity, the relative percentage values at the selected body weights may be determined. These for all the viscera are entered in table 155 and the corresponding graphs are given in chart 49-1.<sup>10</sup>

The graphs show a maximum relative value at 25 grams, while at 400 grams this value is about that found at birth. Whether the sex difference here shown is significant is a question.

*Individual viscera and other organs (20).* Proceeding in the same manner as in the case of all the viscera, the relative percentage weights have been determined separately for each of the twenty organs at each of the selected body weights, and these are entered in table 156.

When the relative percentage weight shows a maximum before 25 grams of body weight, this is also entered. The organs have been listed in table 156 first, in the order of the increasing final relative weight (males) for those organs which do not show a post-natal maximum, and second, in the order of the body

<sup>9</sup> The term "viscera" as generally used, is one of convenience, and it is desirable to note that the list of organs here used as viscera differs from that of Jackson and Lowrey ('12) by containing the submaxillaries and hypophysis and by lacking the brain, spinal cord, eyeballs, thymus and gonads.

The alimentary tract of Jackson and Lowrey includes the stomach, pancreas and intestinal tract. This list differs from theirs in naming these parts separately. This list of organs differs also from that used in table 73 (The Rat, '15) in containing the submaxillaries and in lacking the gonads and the thymus, while the alimentary tract, as given in table 73, is equivalent to the pancreas and intestinal tract combined. The data for the weight of the intestinal tract are still in manuscript form.

<sup>10</sup> In this and the subsequent charts of this series the scale on the base line changes at 50 grams; the entry for which is put in twice. Before 50 grams one division has the value of 5 grams—after 50 grams, the value of 20 grams.

TABLE 153

*Weight of viscera: Includes Heart, Hypophysis, Intestines, Kidneys (2), Liver, Lungs (2), Pancreas, Spleen, Stomach, Submaxillaries (2), Suprarenals (2), Thyroid.*

MALES				FEMALES		
Body length	Body weight	Weight of viscera	Percentage on body weight	Percentage on body weight	Weight of viscera	Body weight
<i>mm.</i>	<i>grams</i>	<i>grams</i>			<i>grams</i>	<i>grams</i>
47	4.9	0.531	10.8	11.0	0.518	4.7
50	5.1	0.563	11.0	11.3	0.564	5.0
55	5.8	0.664	11.5	11.6	0.718	6.2
60	7.5	0.892	11.9	11.9	0.955	8.0
65	9.4	1.143	12.2	12.2	1.212	9.9
70	11.4	1.640	14.4	15.1	1.812	12.0
75	13.6	2.249	16.5	17.0	2.433	14.3
80	15.9	2.833	17.8	18.2	3.063	16.8
85	18.5	3.456	18.7	18.9	3.676	19.5
90	21.3	4.059	19.0	19.2	4.299	22.4
95	24.3	4.673	19.2	19.2	4.930	25.6
100	27.5	5.291	19.2	19.2	5.583	29.1
105	31.1	5.936	19.1	19.0	6.232	32.8
110	34.9	6.584	18.8	18.7	6.904	36.9
115	39.0	7.246	18.6	18.4	7.604	41.3
120	43.5	7.927	18.2	18.0	8.297	46.0
125	48.3	8.641	17.9	17.7	9.039	51.2
130	53.6	9.364	17.5	17.3	9.801	56.8
135	59.3	10.135	17.1	16.9	10.601	62.9
140	65.4	10.924	16.7	16.4	11.428	69.5
145	72.1	11.743	16.3	16.0	12.308	76.7
150	79.3	12.620	15.9	15.6	13.207	84.4
155	87.1	13.520	15.5	15.3	14.170	92.9
160	95.6	14.462	15.1	14.9	15.165	102.0
165	104.7	15.453	14.8	14.5	16.225	111.9
170	114.7	16.513	14.4	14.2	17.362	122.7
175	125.4	17.614	14.0	13.8	18.546	134.4
180	137.0	18.795	13.7	13.4	19.797	147.1
185	149.6	20.033	13.4	13.1	21.139	160.8
190	163.3	21.361	13.1	12.8	22.562	175.7
195	178.1	22.759	12.8	12.5	24.070	191.9
200	194.1	24.241	12.5	12.3	25.683	209.4
205	211.4	25.835	12.2	12.0	27.403	228.4
210	230.2	27.529	12.0	11.7	29.246	249.1
215	250.5	29.330	11.7	11.5	31.210	271.5
220	272.5	31.252	11.5	11.3	33.321	295.8
225	296.3	33.248	11.2	11.0	35.559	322.1
230	322.1	35.513	11.0	10.8	37.981	350.7
235	350.0	37.874	10.8	10.6	40.579	381.7
240	380.3	40.413	10.6	10.4	43.385	415.4
245	413.1	43.125	10.4	10.3	46.375	451.9
250	448.5	46.029	10.3	10.1	49.604	491.5

weights at which the post-natal maximum appears. The graph for each organ appears in the corresponding chart (chart 49, nos. 2-21). Where the graphs for the two sexes are similar, only that for the male has been drawn.

TABLE 154  
*Weight of viscera (12)*

BODY WEIGHT	MALES		FEMALES	
	Weight of viscera (12)	Percentage on body weight	Percentage on body weight	Weight of viscera (12)
<i>grams</i>	<i>grams</i>			<i>grams</i>
4.9	0.534	10.89	11.12	0.545
25.0	4.808	19.23	19.24	4.811
50.0	8.872	17.74	17.73	8.865
100.0	14.942	14.94	14.94	14.944
200.0	24.784	12.39	12.41	24.816
300.0	33.574	11.19	11.23	33.678
400.0	42.050	10.51	10.76	43.059

TABLE 155  
*Relative percentage weight of viscera*

BODY WEIGHT	MALES	FEMALES
	Relative per cent	Relative per cent
<i>grams</i>		
4.9	1.00	1.00
25.0	1.76	1.68
50.0	1.64	1.55
100.0	1.38	1.31
200.0	1.14	1.08
300.0	1.03	0.98
400.0	0.97	0.92

By the use of the data in these tables and charts it is possible to obtain a picture of the organ composition of the rat at various body weights. In this series the body weights up to 250 grams are normal for age—as given in table 157.

For the details of the relations the original paper (Donaldson, '23) should be consulted, but it may be pointed out here that the phase of rapid growth in an organ coincides with the coming of



TABLE 156  
*Relative percentage weight of organs on body weight*

BODY WEIGHT	LUNGS		HYPOPHYSIS		THYROID		BLOOD		SUBMAXILLARIES	
	Males	Females	Males	Females	Males	Females	Males	Females	Males	Females
<i>grams</i>										
4.7-5.1	1.00	1.00	1.00	1.00	1.00	1.00	1.00	1.00	1.00	1.00
6.2	—	—	—	—	—	—	—	—	—	1.03
25.0	0.62	0.57	0.78	0.71	0.87	0.90	0.84	0.87	0.85	0.85
50.0	0.50	0.47	0.61	0.57	0.76	0.79	0.79	0.81	0.74	0.74
100.0	0.42	0.39	0.50	0.62	0.66	0.68	0.73	0.75	0.62	0.62
200.0	0.37	0.35	0.41	0.69	0.56	0.58	0.67	0.75	0.56	0.56
300.0	0.35	0.33	0.38	0.71	0.51	0.53	0.63	0.72	0.53	0.53
400.0	0.34	0.32	0.36	0.73	0.48	0.50	0.62	0.70	0.50	0.50
BODY WEIGHT	EYEBALLS		KIDNEYS		HEART		BRAIN		SPINAL CORD	
4.7-4.9	1.00	1.00	1.00	1.00	1.00	1.00	1.00	1.00	1.00	1.00
7.5	1.08	—	1.59	—	—	—	—	—	—	—
8.0	—	1.07	—	—	—	1.09	—	—	—	—
9.4	—	—	—	—	1.11	—	—	—	—	—
9.9	—	—	—	1.56	—	—	—	—	—	—
11.4	—	—	—	—	—	—	1.52	—	1.15	—
12.0	—	—	—	—	—	—	—	1.58	—	1.13
25.0	0.73	0.70	1.38	1.34	1.03	1.00	1.09	1.11	1.06	1.03
50.0	0.49	0.50	1.17	1.12	0.89	0.88	0.65	0.65	0.85	0.83
100.0	0.34	0.33	1.01	0.97	0.76	0.73	0.36	0.34	0.62	0.60
200.0	0.24	0.23	0.91	0.88	0.64	0.63	0.20	0.20	0.43	0.42
300.0	0.19	0.18	0.87	0.84	0.59	0.58	0.14	0.14	0.34	0.33
400.0	0.15	0.15	0.85	0.82	0.56	0.55	0.11	0.11	0.27	0.26
BODY WEIGHT	PANCREAS		SPLEEN		SUPRARENALS		LIVER		VISCERA	
4.7-5.1	—	—	1.00	1.00	1.00	1.00	1.00	1.00	1.00	1.00
5.8	—	—	—	—	1.10	—	—	—	—	—
6.2	—	—	—	—	—	1.14	—	—	—	—
11.4	1.00	—	—	—	—	—	—	—	—	—
12.0	—	1.00	—	—	—	—	—	—	—	—
15.9	1.18	—	—	—	—	—	—	—	—	—
16.8	—	1.09	—	1.88	—	—	—	—	—	—
18.5	—	—	1.80	—	—	—	—	—	—	—
25.0	1.08	1.04	1.72	1.82	1.15	1.11	1.81	1.81	1.76	1.68
50.0	0.85	0.90	1.67	1.76	0.89	0.97	1.67	1.66	1.64	1.55
100.0	0.70	0.73	1.56	1.65	0.67	0.85	1.41	1.41	1.38	1.31
200.0	0.60	0.61	1.50	1.59	0.52	0.78	1.17	1.17	1.14	1.08
300.0	0.56	0.55	1.44	1.53	0.45	0.75	1.06	1.06	1.03	0.98
400.0	0.53	0.52	1.44	1.53	0.41	0.74	0.99	0.99	0.97	0.92

TABLE 156—Concluded

BODY WEIGHT	INTESTINAL TRACT		STOMACH		THYMUS		GONADS		EPIDIDYMIDES
	Males	Females	Males	Females	Males	Females	Testes	Ovaries	Males
<i>grams</i>									
4.7-4.9	1.00	1.00	1.00	1.00	1.00	1.00	1.00	1.00	1.00
7.5	—	—	—	—	1.50	—	—	—	—
8.0	—	—	—	—	—	—	—	3.00	—
9.9	—	—	—	—	—	1.57	—	—	—
11.4	—	—	—	—	1.36	—	5.75	—	0.78
14.3	—	—	—	—	—	1.36	—	—	—
15.9	—	—	—	—	—	—	5.38	—	—
25.0	4.27	3.77	1.43	1.41	1.68	1.57	6.08	2.19	0.90
29.1	—	3.81	—	—	—	—	—	—	—
31.1	4.34	—	—	—	—	—	—	—	—
34.9	—	—	1.56	—	—	—	—	—	—
36.9	—	—	—	1.53	—	—	—	—	—
50.0	4.13	3.61	1.50	1.49	2.10	2.10	9.96	2.00	1.33
53.6	—	—	—	—	2.14	—	—	—	—
56.8	—	—	—	—	—	2.14	—	—	—
62.9	—	—	—	—	—	—	—	1.00	—
100.0	3.46	3.08	1.23	1.22	1.86	1.92	16.25	3.00	2.55
122.7	—	—	—	—	—	—	—	4.00	—
178.0	—	—	—	—	—	—	—	—	3.67
200.0	2.79	2.44	0.94	0.92	0.84	0.57	13.58	1.95	3.63
300.0	2.46	2.16	0.78	0.79	—	—	11.18	2.00	3.22
400.0	2.26	1.98	0.71	0.70	—	—	9.58	1.00	2.71

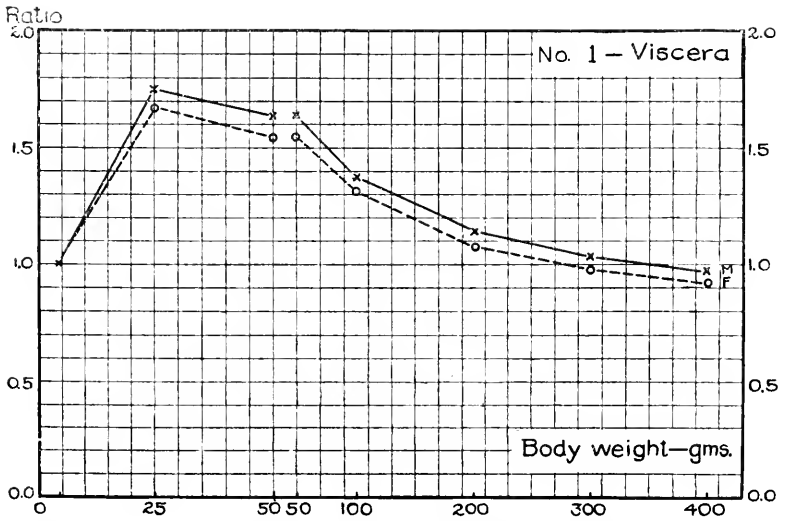

Chart 49—no. 1. Showing the relative percentage values for the weight of the viscera at a series of selected body weights. x—x, males; o-----o, females. Table 155 (12 organs).

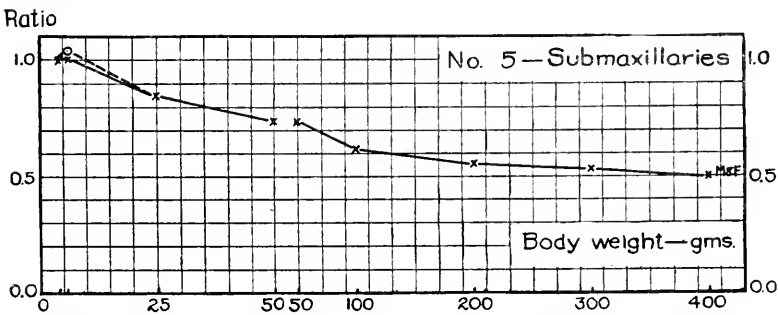
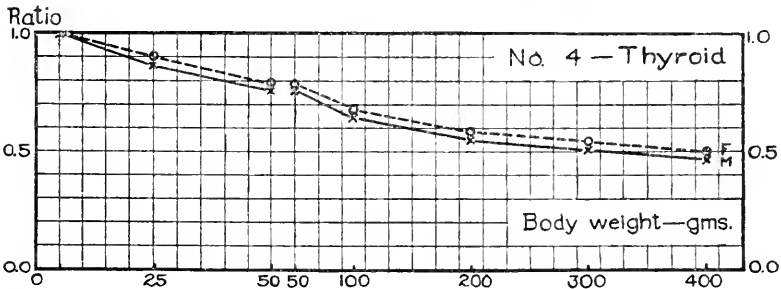
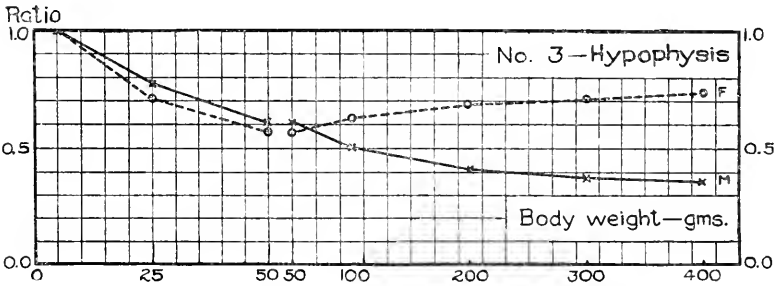
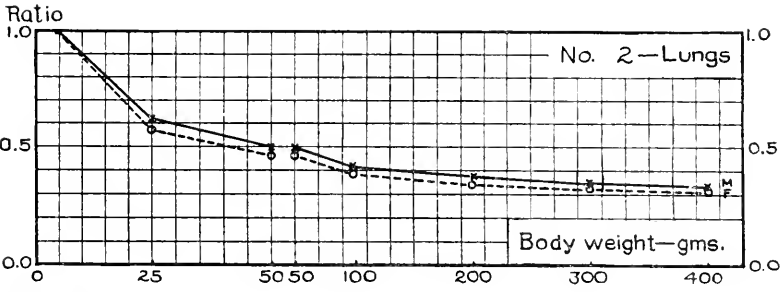
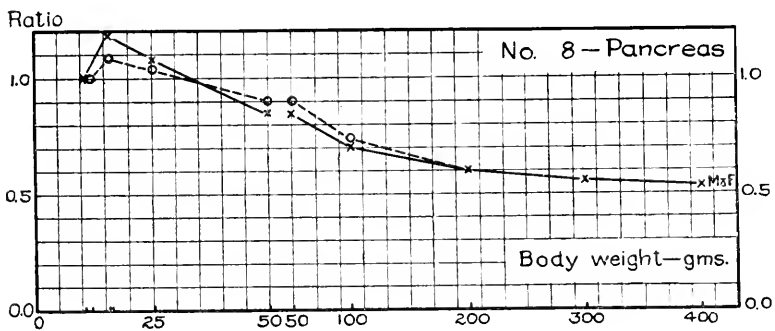
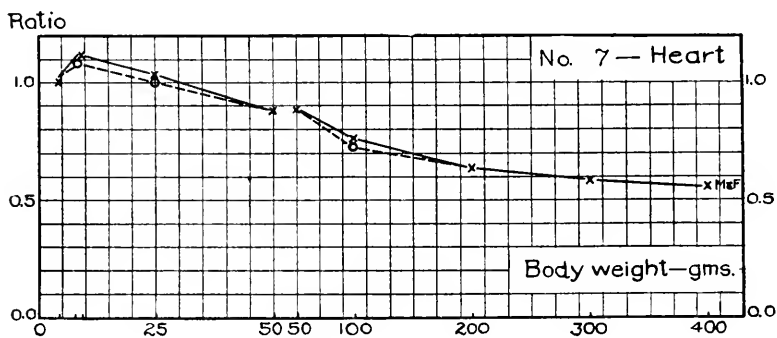
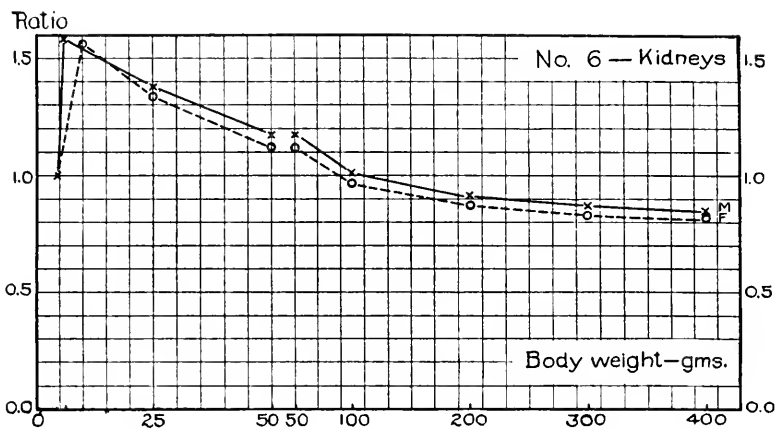
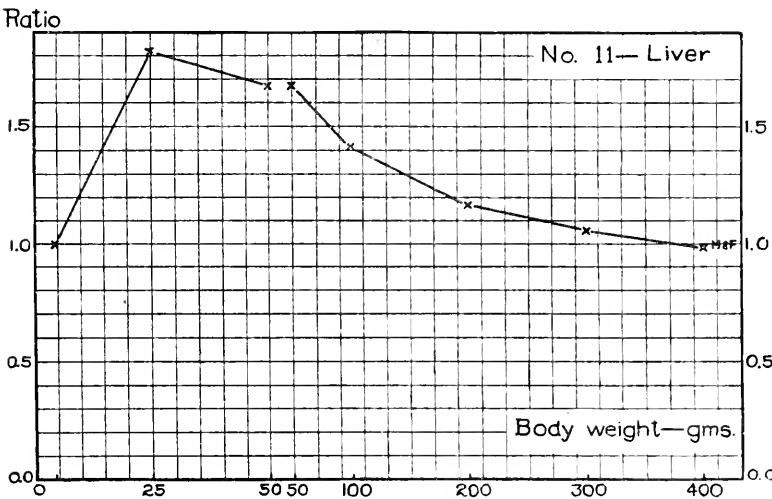
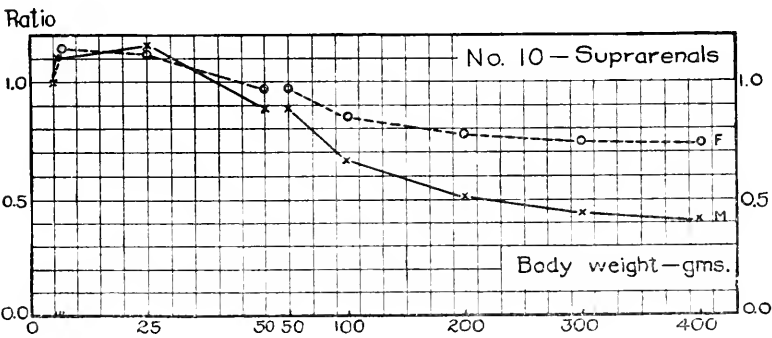
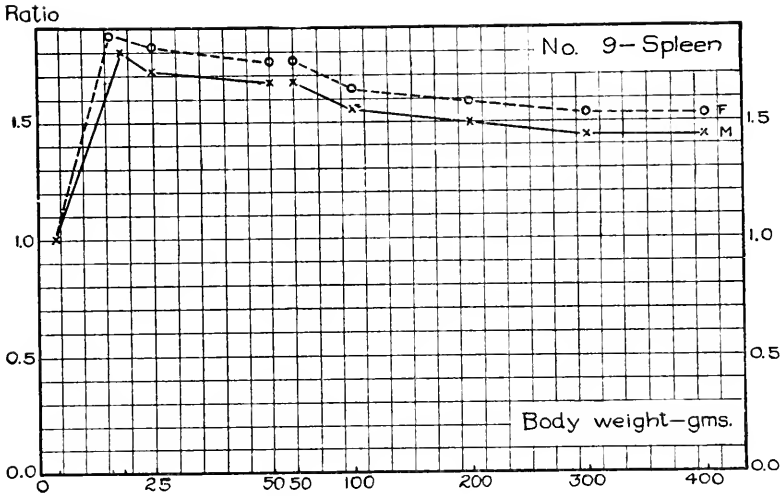

Chart 49—nos. 2-5. Showing the changes in the relative percentage weights of the lungs, hypophysis, thyroid and submaxillaries—based on the data in table 153. x——x, males; o-----o, females.



Charts 49—nos. 6-8. Showing the changes in the relative percentage weights of the kidneys, heart and pancreas—based on the data in table 156. x———x, males; o-----o, females.



Charts 49—nos. 9-11. Showing the changes in the relative percentage weights of the spleen, suprarenals and liver—based on the data in table 156. x—x, males; o-----o, females.

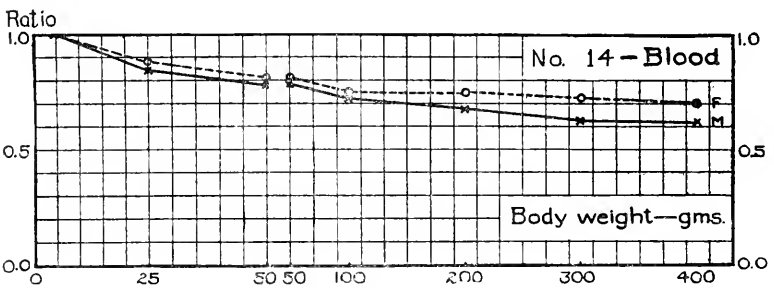
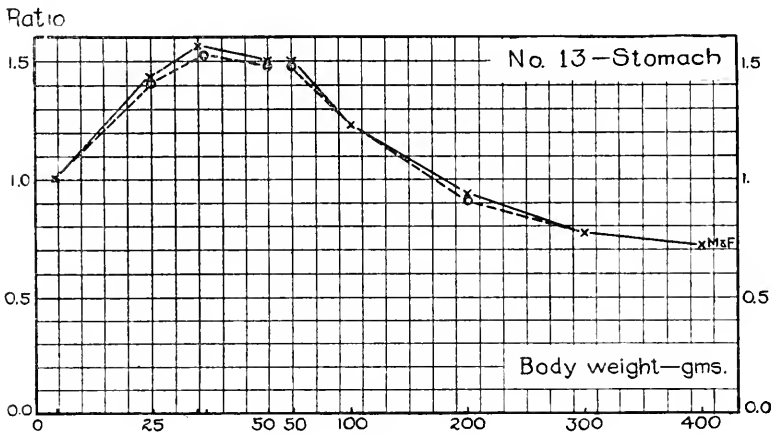
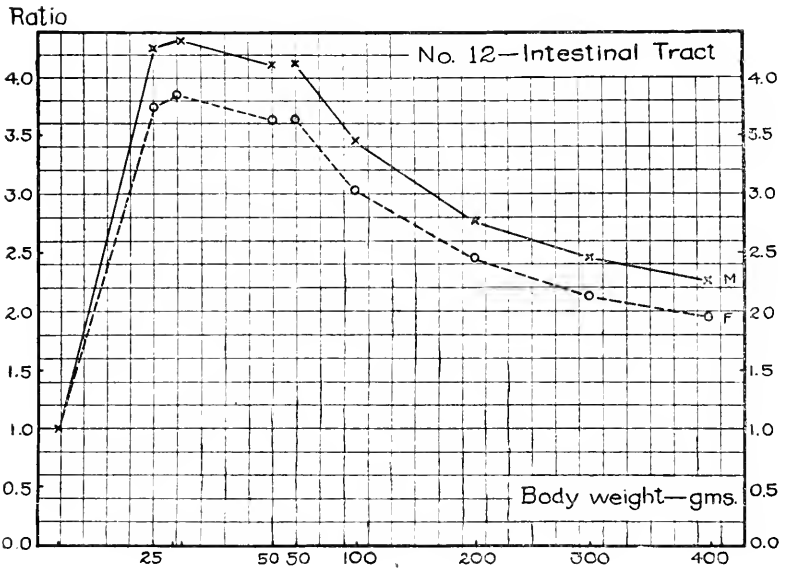

Chart 49—nos. 12-14. Showing the changes in the relative percentage weights of the intestinal tract, stomach and blood—based on the data in table 156. x———x, males; o-----o, females.

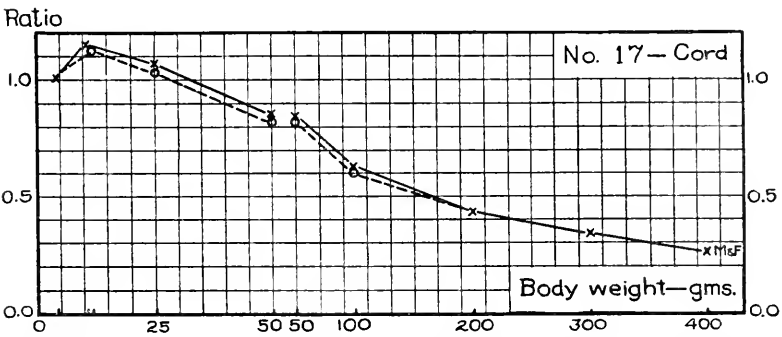
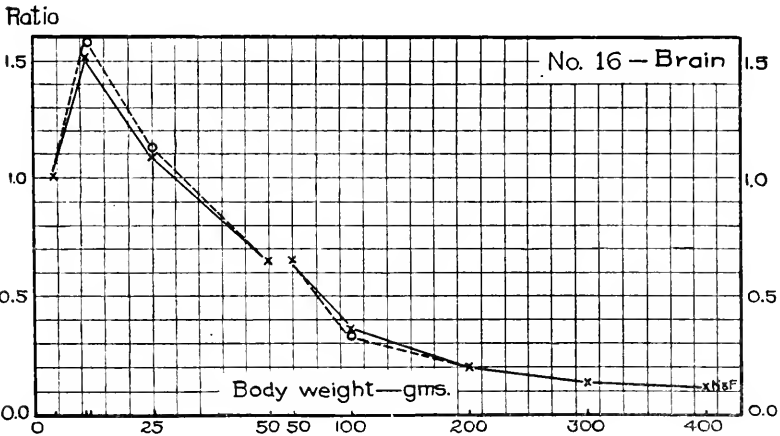
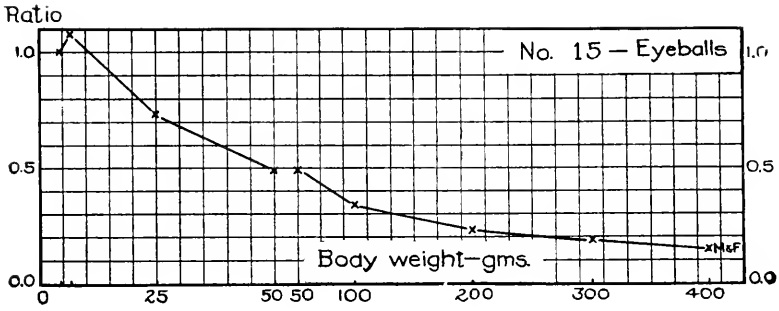

Chart 49—nos. 15-17. Showing the changes in the relative percentage weights of the eyeballs, brain, and spinal cord—based on the data in table 156. x——x, males; o-----o, females.

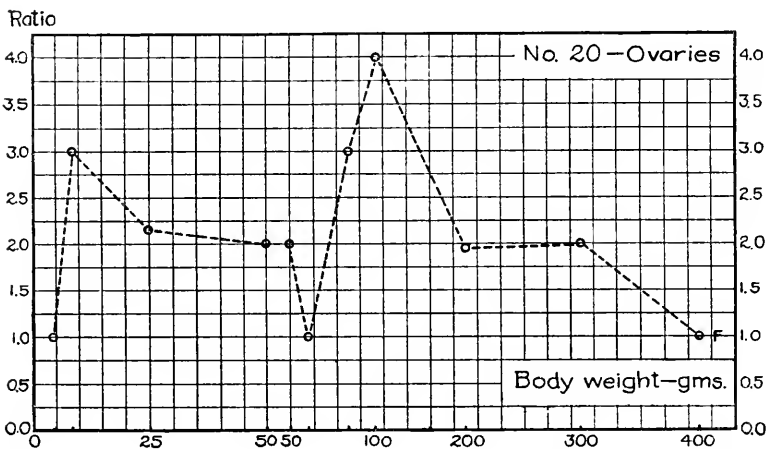
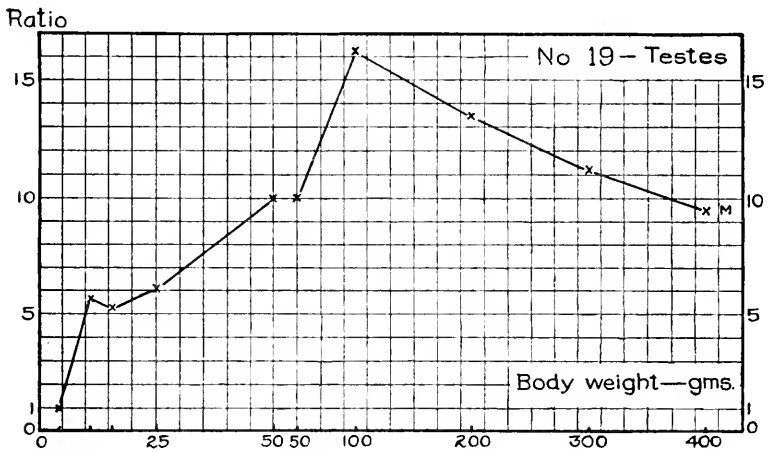
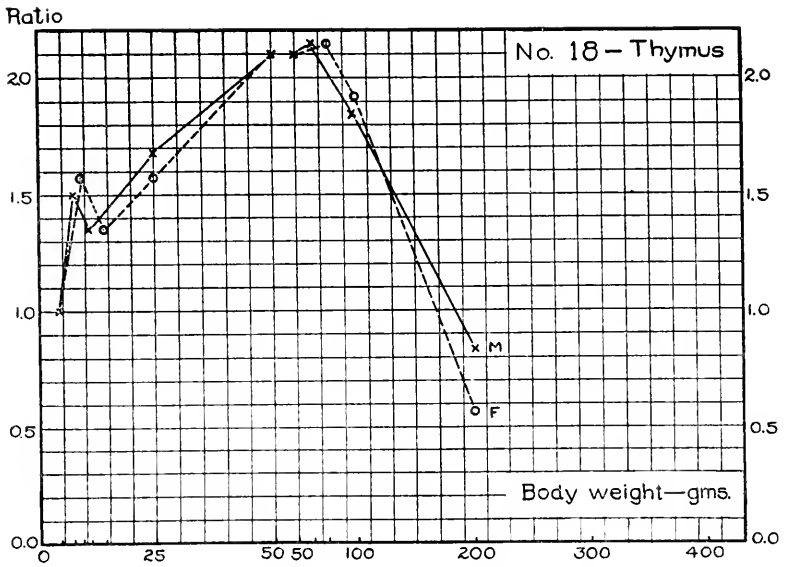

Chart 49—nos. 18-20. Showing the changes in the relative percentage weights of the thymus, testes and ovaries—based on the data in table 156. x———x, males; o-----o, females.



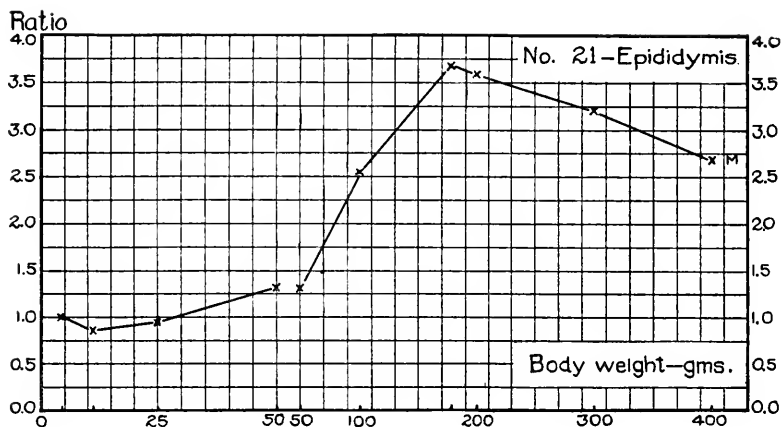

Chart 49—no. 21. Showing the changes in the relative percentage weights of the epididymides—based on the data in table 156. x———x, males; o-----o, females.

the organ into full function: that the relatively heavy viscera depend for their high weight mainly on the liver and intestines, and that the relative percentage weights of the blood and the endocrine glands are similar, suggesting that although the relative weight of the blood diminishes, its relations to the organs contributing to it are maintained. These changes in the organ composition of the rat require attention when interpreting its physiological responses.

11. *Values for other characters linked with age.* Table 157 contains the data for the “standard” body weight on age, for the weight of the brain and of the spinal cord and the percentages of water in them.

12. *Formulas.* Formulas have been devised mainly by Dr. Hatai for computing the length or weight of the body and of its several parts, systems or organs, also for expressing the values of other characters.

Three incidental formulas (1) (2) (3) have been given in the preceding pages.

Of the remaining formulas for the Albino—Group I—are given first, then those for the Norway—Group II. In Group I there are two divisions.

TABLE 157

*Giving the percentage of water in the brain and in the spinal cord for each sex, on age.  
See Chart 55*

AGE IN DAYS	MALES					FEMALES				
	Body weight gms.	Brain weight gms.	Per cent of water brain	Cord weight gms.	Per cent of water cord	Body weight gms.	Brain weight gms.	Per cent of water brain	Cord weight gms.	Per cent of water cord
1	4.7	0.217	88.00	0.033	86.75	4.6	0.213	88.00	0.033	86.75
2	5.5	0.290	87.95	0.038	86.42	5.4	0.269	87.95	0.037	86.42
3	5.9	0.333	87.90	0.041	86.08	5.8	0.323	87.90	0.041	86.08
4	6.4	0.395	87.85	0.046	85.74	6.3	0.373	87.85	0.045	85.74
5	6.9	0.442	87.83	0.050	85.41	6.8	0.421	87.83	0.050	85.41
6	7.6	0.509	87.79	0.056	85.07	7.5	0.492	87.79	0.056	85.07
7	8.5	0.581	87.70	0.064	84.73	8.4	0.564	87.70	0.064	84.73
8	9.5	0.657	87.50	0.072	84.40	9.4	0.645	87.50	0.073	84.40
9	10.5	0.708	87.30	0.081	84.06	10.4	0.697	87.30	0.082	84.06
10	11.8	0.840	87.05	0.091	83.73	11.6	0.811	87.05	0.091	83.73
11	13.5	0.947	86.72	0.104	83.40	13.0	0.909	86.72	0.102	83.40
12	13.9	0.969	86.26	0.106	82.98	13.7	0.940	86.26	0.107	82.96
13	14.4	0.991	85.82	0.110	82.57	14.4	0.979	85.82	0.112	82.52
14	14.9	1.021	85.39	0.114	82.17	15.1	1.003	85.40	0.117	82.10
15	15.5	1.037	84.97	0.118	81.77	15.8	1.031	84.98	0.122	81.68
16	16.1	1.057	84.58	0.122	81.39	16.5	1.048	84.59	0.127	81.28
17	16.7	1.077	84.19	0.126	81.00	17.3	1.079	84.20	0.133	80.88
18	17.3	1.095	83.82	0.131	80.63	18.1	1.099	83.82	0.138	80.49
19	18.0	1.112	83.46	0.135	80.26	18.9	1.118	83.47	0.142	80.11
20	18.7	1.131	83.12	0.139	79.90	19.8	1.140	83.13	0.148	79.73
21	19.5	1.150	82.80	0.144	79.55	20.7	1.159	82.82	0.154	79.47
22	20.3	1.169	82.49	0.149	79.21	21.6	1.177	82.51	0.160	79.02
23	21.1	1.184	82.19	0.154	78.87	22.5	1.195	82.21	0.165	78.67
24	22.0	1.202	81.91	0.159	78.54	23.4	1.208	81.93	0.170	78.33
25	22.9	1.219	81.64	0.165	78.22	24.4	1.226	81.66	0.176	78.00
26	23.9	1.237	81.39	0.169	77.90	25.4	1.241	81.41	0.182	77.67
27	24.9	1.252	81.15	0.175	77.59	26.5	1.251	81.17	0.187	77.36
28	25.9	1.266	80.93	0.179	77.29	27.5	1.269	80.95	0.193	77.06
29	27.0	1.282	80.72	0.186	77.00	28.6	1.282	80.74	0.198	76.76
30	28.1	1.297	80.53	0.193	76.71	29.7	1.297	80.55	0.204	76.47
31	29.2	1.311	80.35	0.198	76.43	30.9	1.310	80.37	0.210	76.19
32	30.4	1.324	80.19	0.204	76.16	32.0	1.322	80.21	0.216	75.92
33	31.6	1.338	80.04	0.210	75.90	33.2	1.334	80.07	0.221	75.66
34	32.8	1.351	79.91	0.215	75.64	34.4	1.346	79.94	0.227	75.40
35	34.1	1.363	79.79	0.221	75.39	35.7	1.358	79.82	0.233	75.16
36	35.4	1.375	79.69	0.227	75.15	37.0	1.369	79.72	0.239	74.92
37	36.8	1.389	79.60	0.233	74.91	38.3	1.380	79.63	0.245	74.69

TABLE 157—Continued

AGE IN DAYS	MALES					FEMALES				
	Body weight <i>gms.</i>	Brain weight <i>gms.</i>	Per cent of water brain	Cord weight <i>gms.</i>	Per cent of water cord	Body weight <i>gms.</i>	Brain weight <i>gms.</i>	Per cent of water brain	Cord weight <i>gms.</i>	Per cent of water cord
37	38.1	1.399	79.52	0.239	74.68	39.6	1.391	79.55	0.250	74.47
38	39.6	1.411	79.46	0.245	74.46	40.9	1.400	79.49	0.255	74.26
39	41.0	1.423	79.42	0.251	74.25	42.3	1.411	79.45	0.261	74.06
40	42.5	1.434	79.39	0.257	74.04	43.7	1.422	79.42	0.267	73.86
41	44.1	1.446	79.36	0.264	73.95	45.1	1.432	79.39	0.272	73.78
42	45.7	1.457	79.34	0.269	73.87	46.6	1.441	79.37	0.278	73.72
43	47.3	1.468	79.32	0.276	73.74	48.1	1.451	79.35	0.284	73.60
44	48.9	1.478	79.30	0.281	73.62	49.6	1.460	79.33	0.289	73.50
45	50.6	1.488	79.28	0.288	73.50	51.1	1.468	79.31	0.294	73.39
46	52.3	1.498	79.26	0.293	73.39	52.7	1.478	79.29	0.300	73.30
47	54.1	1.507	79.24	0.299	73.28	54.3	1.487	79.27	0.306	73.21
48	55.9	1.518	79.22	0.305	73.17	55.9	1.495	79.25	0.311	73.12
49	57.7	1.527	79.21	0.311	73.07	57.5	1.503	79.24	0.316	72.05
50	59.6	1.537	79.19	0.317	72.97	59.2	1.512	79.23	0.322	72.97
51	61.5	1.546	79.17	0.323	72.88	60.9	1.520	79.21	0.327	72.88
52	63.4	1.555	79.15	0.329	72.79	62.6	1.528	79.19	0.332	72.79
53	65.4	1.563	79.14	0.334	72.69	64.3	1.535	79.18	0.338	72.69
54	67.4	1.572	79.12	0.340	72.60	66.1	1.543	79.16	0.343	72.60
55	69.5	1.581	79.10	0.346	72.51	67.9	1.551	79.14	0.348	72.51
56	71.6	1.589	79.08	0.352	72.43	69.7	1.558	79.12	0.353	72.43
57	73.7	1.597	79.07	0.358	72.35	71.6	1.565	79.11	0.359	72.35
58	75.9	1.606	79.05	0.363	72.27	73.4	1.573	79.09	0.364	72.27
59	78.1	1.614	79.04	0.369	72.19	75.3	1.580	79.08	0.370	72.19
60	80.3	1.622	79.02	0.375	72.11	77.3	1.587	79.06	0.375	72.11
61	82.5	1.629	79.00	0.380	72.04	79.2	1.594	79.04	0.380	72.04
62	84.9	1.637	78.99	0.386	71.97	81.2	1.601	79.02	0.385	71.97
63	87.2	1.644	78.97	0.391	71.91	83.2	1.607	79.01	0.389	71.91
64	89.6	1.652	78.96	0.397	71.84	85.2	1.614	78.99	0.394	71.84
65	92.0	1.659	78.94	0.402	71.77	87.3	1.621	78.98	0.399	71.77
66	94.5	1.666	78.93	0.407	71.71	89.4	1.627	78.97	0.404	71.72
67	97.0	1.673	78.92	0.413	71.65	91.5	1.633	78.96	0.409	71.66
68	99.5	1.681	78.90	0.418	71.60	93.6	1.639	78.94	0.414	71.61
69	102.1	1.688	78.89	0.424	71.54	95.8	1.645	78.93	0.419	71.54
70	104.7	1.695	78.88	0.429	71.48	98.0	1.651	78.92	0.424	71.50
71	107.3	1.702	78.87	0.434	71.43	100.2	1.657	78.91	0.429	71.45
72	110.0	1.709	78.85	0.439	71.38	102.4	1.663	78.89	0.433	71.41
73	112.7	1.715	78.84	0.445	71.32	104.7	1.669	78.88	0.438	71.36
74	115.5	1.722	78.82	0.450	71.27	107.0	1.675	78.86	0.442	71.32

TABLE 157--Continued

AGE IN DAYS	MALES					FEMALES				
	Body weight <i>gms.</i>	Brain weight <i>gms.</i>	Per cent of water brain	Cord weight <i>gms.</i>	Per cent of water cord	Body weight <i>gms.</i>	Brain weight <i>gms.</i>	Per cent of water brain	Cord weight <i>gms.</i>	Per cent of water cord
75	118.3	1.729	78.81	0.455	71.22	109.3	1.681	78.85	0.447	71.27
76	121.1	1.735	78.80	0.460	71.18	111.6	1.687	78.84	0.451	71.23
77	124.0	1.741	78.79	0.465	71.13	114.0	1.692	78.83	0.456	71.19
78	126.8	1.746	78.77	0.470	71.09	116.4	1.698	78.82	0.460	71.15
79	129.8	1.752	78.76	0.475	71.04	118.8	1.703	78.81	0.465	71.11
80	132.8	1.758	78.75	0.480	71.00	121.3	1.709	78.80	0.469	71.07
81	134.7	1.762	78.74	0.483	70.96	122.6	1.712	78.79	0.471	71.03
82	136.5	1.765	78.73	0.486	70.92	124.0	1.715	78.78	0.474	71.00
83	138.4	1.769	78.72	0.488	70.89	125.4	1.717	78.77	0.476	70.96
84	140.2	1.772	78.71	0.491	70.85	126.8	1.720	78.76	0.479	70.93
85	142.0	1.776	78.70	0.494	70.81	128.1	1.723	78.75	0.481	70.89
86	143.7	1.779	78.69	0.497	70.78	129.5	1.726	78.74	0.483	70.86
87	145.5	1.782	78.68	0.499	70.74	130.8	1.728	78.73	0.485	70.83
88	147.2	1.785	78.67	0.502	70.71	132.1	1.731	78.72	0.488	70.80
89	148.9	1.788	78.66	0.504	70.67	133.4	1.733	78.71	0.490	70.77
90	150.5	1.791	78.65	0.507	70.64	134.6	1.736	78.70	0.492	70.74
91	152.1	1.794	78.64	0.509	70.61	135.8	1.738	78.69	0.494	70.72
92	153.7	1.797	78.63	0.511	70.58	137.1	1.740	78.68	0.496	70.69
93	155.3	1.799	78.62	0.514	70.56	138.3	1.743	78.67	0.497	70.67
94	156.9	1.802	78.61	0.516	70.53	139.4	1.745	78.66	0.499	70.64
95	158.4	1.805	78.60	0.518	70.50	140.6	1.747	78.65	0.501	70.62
96	160.0	1.807	78.59	0.520	70.48	141.8	1.749	78.64	0.503	70.60
97	161.4	1.810	78.58	0.522	70.45	142.9	1.751	78.63	0.505	70.58
98	162.9	1.812	78.57	0.525	70.43	144.0	1.752	78.62	0.506	70.55
99	164.3	1.815	78.56	0.527	70.40	145.1	1.754	78.61	0.508	70.53
100	165.8	1.817	78.55	0.529	70.38	146.2	1.756	78.60	0.510	70.51
101	167.2	1.819	78.54	0.531	70.36	147.3	1.758	78.59	0.512	70.49
102	168.6	1.821	78.53	0.533	70.34	148.3	1.760	78.58	0.514	70.47
103	170.0	1.824	78.53	0.534	70.32	149.4	1.762	78.58	0.515	70.46
104	171.3	1.826	78.52	0.536	70.30	150.4	1.764	78.57	0.517	70.44
105	172.7	1.828	78.51	0.538	70.28	151.4	1.766	78.56	0.519	70.42
106	174.0	1.830	78.50	0.540	70.26	152.4	1.768	78.55	0.520	60.41
107	175.3	1.832	78.49	0.541	70.25	153.4	1.770	78.54	0.522	70.40
108	176.6	1.833	78.48	0.543	70.23	154.4	1.772	78.53	0.523	70.38
109	177.9	1.835	78.47	0.544	70.22	155.3	1.774	78.52	0.525	70.37
110	179.1	1.837	78.46	0.546	70.20	156.3	1.775	78.51	0.526	70.36
111	180.4	1.839	78.45	0.547	70.19	157.2	1.776	78.50	0.527	70.35
112	181.6	1.841	78.44	0.549	70.17	158.2	1.778	78.49	0.528	70.34

TABLE 157—Continued

AGE IN DAYS	MALES					FEMALES				
	Body weight <i>gms.</i>	Brain weight <i>gms.</i>	Per cent of water brain	Cord weight <i>gms.</i>	Per cent of water cord	Body weight <i>gms.</i>	Brain weight <i>gms.</i>	Per cent of water brain	Cord weight <i>gms.</i>	Per cent of water cord
113	182.8	1.842	78.44	0.550	70.15	159.1	1.779	78.49	0.530	70.32
114	184.0	1.844	78.43	0.552	70.14	160.0	1.781	78.48	0.531	70.31
115	185.2	1.846	78.42	0.553	70.13	160.9	1.782	78.47	0.532	70.30
116	186.4	1.848	78.41	0.555	70.12	161.8	1.783	78.46	0.533	70.29
117	187.5	1.849	78.40	0.556	70.11	162.6	1.785	78.46	0.535	70.28
118	188.7	1.851	78.40	0.558	70.09	163.5	1.786	78.45	0.536	70.27
119	189.7	1.852	78.39	0.559	70.08	164.3	1.788	78.45	0.538	70.26
120	190.9	1.854	78.38	0.561	70.07	165.2	1.789	78.44	0.539	70.25
121	192.0	1.855	78.37	0.562	70.06	166.0	1.790	78.43	0.540	70.25
122	193.1	1.857	78.37	0.563	70.06	166.8	1.791	78.43	0.541	70.24
123	194.1	1.858	78.36	0.564	70.05	167.6	1.793	78.42	0.542	70.24
124	195.2	1.860	78.36	0.565	70.05	168.4	1.794	78.42	0.543	70.23
125	196.2	1.861	78.35	0.566	70.04	169.2	1.795	78.41	0.544	70.23
126	197.3	1.862	78.34	0.567	70.03	170.0	1.796	78.40	0.545	70.23
127	198.3	1.863	78.33	0.569	70.03	170.7	1.798	78.39	0.546	70.23
128	199.3	1.865	78.33	0.570	70.02	171.5	1.799	78.39	0.546	70.22
129	200.3	1.866	78.32	0.572	70.02	172.3	1.801	78.38	0.547	70.22
130	201.2	1.867	78.31	0.573	70.01	173.0	1.802	78.37	0.548	70.22
131	202.2	1.868	78.30	0.574	70.01	173.7	1.803	78.36	0.549	70.22
132	203.2	1.870	78.30	0.575	70.01	174.5	1.804	78.36	0.550	70.22
133	204.1	1.871	78.29	0.576	70.00	175.2	1.804	78.35	0.551	70.22
134	205.1	1.873	78.29	0.577	70.00	175.9	1.805	78.35	0.552	70.22
135	206.0	1.874	78.28	0.578	70.00	176.6	1.806	78.34	0.553	70.22
136	206.9	1.875	78.27	0.579	70.00	177.3	1.807	78.33	0.554	70.22
137	207.8	1.876	78.26	0.580	70.00	178.0	1.808	78.32	0.555	70.22
138	208.7	1.877	78.26	0.580	70.00	178.6	1.809	78.32	0.555	70.22
139	209.6	1.878	78.25	0.581	70.00	179.2	1.810	78.31	0.556	70.22
140	210.5	1.879	78.24	0.582	70.00	179.9	1.811	78.30	0.557	70.22
141	211.3	1.880	78.24	0.583	70.00	180.6	1.812	78.30	0.558	70.22
142	212.2	1.881	78.23	0.584	70.00	181.2	1.813	78.29	0.559	70.22
143	213.0	1.882	78.23	0.584	70.00	181.8	1.813	78.29	0.559	70.22
144	213.9	1.883	78.22	0.585	70.00	182.5	1.814	78.28	0.560	70.22
145	214.7	1.884	78.22	0.586	70.00	183.1	1.815	78.28	0.561	70.22
146	215.5	1.885	78.21	0.587	70.00	183.7	1.816	78.27	0.562	70.22
147	216.3	1.886	78.21	0.588	70.00	184.3	1.817	78.27	0.562	70.22
148	217.1	1.887	78.20	0.588	70.00	184.9	1.817	78.26	0.563	70.22
149	217.9	1.887	78.20	0.589	70.00	185.5	1.818	78.26	0.564	70.22
150	218.7	1.888	78.19	0.590	70.00	186.1	1.819	78.25	0.565	70.22

TABLE 157—Concluded

AGE IN DAYS	MALES					FEMALES				
	Body weight <i>gms.</i>	Brain weight <i>gms.</i>	Per cent of water brain	Cord weight <i>gms.</i>	Per cent of water cord	Body weight <i>gms.</i>	Brain weight <i>gms.</i>	Per cent of water brain	Cord weight <i>gms.</i>	Per cent of water cord
160	226.0	1.898	78.14	0.598	70.00	191.6	1.827	78.20	0.572	70.22
170	232.6	1.905	78.12	0.605	70.00	196.5	1.834	78.18	0.578	70.22
180	238.6	1.911	78.11	0.610	69.99	201.0	1.839	78.17	0.583	70.22
190	243.9	1.917	78.11	0.616	69.99	204.9	1.845	78.17	0.588	70.22
200	248.6	1.922	78.10	0.620	69.97	208.4	1.849	78.17	0.592	70.20
210	252.9	1.927	78.09	0.624	69.94	211.6	1.853	78.16	0.595	70.19
220	256.8	1.931	78.08	0.628	69.91	214.4	1.857	78.15	0.598	70.16
230	260.2	1.934	78.06	0.631	69.88	217.0	1.860	78.13	0.601	70.13
240	263.3	1.937	78.04	0.634	69.84	219.2	1.863	78.11	0.603	70.10
250	266.1	1.940	78.01	0.636	69.79	221.2	1.865	78.08	0.605	70.05
260	268.5	1.943	77.98	0.639	69.74	223.0	1.866	78.05	0.607	70.00
270	270.7	1.945	77.95	0.641	69.70	224.5	1.868	78.02	0.609	69.96
280	272.5	1.946	77.92	0.642	69.65	225.8	1.869	77.99	0.610	69.91
290	274.2	1.948	77.88	0.643	69.60	226.9	1.870	77.96	0.611	69.87
300	275.5	1.949	77.84	0.644	69.54	227.9	1.871	77.92	0.612	69.82
310	276.7	1.950	77.80	0.645	69.48	228.7	1.872	77.88	0.613	69.77
320	277.7	1.950	77.75	0.646	69.42	229.3	1.872	77.83	0.613	69.71
330	278.5	1.951	77.70	0.647	69.36	229.8	1.873	77.78	0.614	69.66
340	279.1	1.952	77.65	0.648	69.30	230.1	1.874	77.73	0.615	69.60
350	279.6	1.953	77.59	0.648	69.23	230.3	1.874	77.67	0.615	69.54
360	279.8	1.954	77.53	0.649	69.16	230.4	1.875	77.61	0.616	69.47
365	279.9	1.954	77.50	0.649	69.13	230.4	1.875	77.58	0.616	69.44

The first division comprises the formula based on size (body length and body weight). The second division comprises the formulas based on age. These formulas have been kept simple in order to facilitate their use. This condition has made it sometimes necessary to have different formulas for the different parts of the same series of data, but this was deemed more desirable than a reduction in the number of the formulas at the price of greater complexity.

After the formula there follows in parenthesis the number by which it is designated in the text, and every formula, whether it be general or subsidiary, is thus numbered, each subsidiary formula carrying the number of the general formula to which it is related, followed by a distinguishing letter. A catalog of the formulas, given in detail later, is here presented.

TABLE 157A

*Body weight on age. Data used for graph by Greenman and Duhring ('23). These rats had been given exercise and were specially well cared for and fed*

MALES			FEMALES	
Age	Number of rats	Body weight	Number of rats	Body weight
<i>days</i>		<i>grams</i>		<i>grams</i>
Birth	129	5.39	140	5.12
1	118	5.96	136	5.55
2	120	6.42	139	6.30
3	125	7.24	155	7.00
4	130	8.33	137	8.06
5	134	9.47	137	8.92
6	134	10.67	152	10.21
7	115	11.90	125	11.37
8	126	13.61	138	12.95
9	122	14.65	140	14.31
10	137	15.47	157	14.90
11	131	16.97	134	16.58
12	127	18.13	133	17.01
13	126	18.80	139	18.02
14	116	20.44	126	19.15
15	111	21.64	124	20.09
22	51	26.43	69	26.38
25	56	32.98	56	32.25
30	45	41.83	54	39.22
37	35	54.50	39	50.44
52	32	80.85	37	73.63
67	30	112.04	33	102.23
82	25	145.73	31	137.05
97	22	169.02	29	157.85
120	52	240.40	69	179.58
150	68	263.92	80	191.72
182	108	289.61	115	198.67
212	107	303.32	109	209.36
242	106	318.88	106	220.51
272	104	328.70	108	224.61
295	100	337.05	104	235.65
325	95	338.46	104	238.82
356	95	341.46	94	246.14
384	83	349.06	85	254.25
415	79	353.86	84	256.62
450	70	369.32	87	263.84

## CATALOG OF FORMULAS

## GROUP I. ALBINOS

*First division: Formulas based on size*

- Body length on body weight (4).  
 Body weight on body length (5), (5 a), (5 b).  
 Body weight on brain weight (6).  
 Tail length on body length (7), (8).  
 Brain weight on body weight (9), (10).  
 Area of callosum on body weight (11).  
 Cranial capacity on body weight (12).  
 Spinal cord weight on body weight (13).  
 Diameters of ganglion cell and nucleus (14), (14 a).  
 Weight of both eyeballs on body weight (15).  
 Weight of heart on body weight (16).  
 Weight of both kidneys on body weight (17).  
 Weight of liver on body weight (18).  
 Weight of spleen on body weight (19).  
 Weight of both lungs on body weight (20).  
 Volume of blood on body weight (21), (21 a), (21 b).  
 Weight of blood on body weight (22), (22 a), (22 b).  
 Weight of alimentary tract on body weight (23).  
 Weight of stomach on body weight (24), (24 a).  
 Weight of pancreas on body weight (25), (25 a).  
 Weight of submaxillaries on body weight (26).  
 Weight of both testes on body weight (27), (28), (29).  
 Weight of epididymides on body weight (30), (31).  
 Weight of both ovaries on body weight (32), (33), (34).  
 Weight of hypophysis on body weight (35), (36).  
 Weight of both suprarenals on body weight (37), (38).  
 Weight of thyroid on body weight (39).  
 Weight of nitrogen on body weight (40).

*Second division: Formulas based on age in days*

- Body weight on age (41), (42), (43), (44).  
 Weight of thymus on age (45), (46).  
 Percentage of water in brain—on age (47), (48), (49), (49 a).  
 Percentage of water in spinal cord—on age (50), (51), (52), (52 a), (52 b), (52 c), (52 d).

## GROUP II. NORWAYS

*First division: Formulas based on size*

- Body length on body weight (53).  
 Body weight on body length (54), (55).  
 Tail length on body length (56), (57).  
 Brain weight on body weight (58).  
 Cranial capacity on body weight (59).  
 Spinal cord weight on body weight (60).  
 Spinal cord weight on brain weight (61).



GROUP I. ALBINOS

FIRST DIVISION: FORMULAS BASED ON SIZE

BODY LENGTH ON BODY WEIGHT, (DONALDSON, '09)

*Body length (sexes combined) = 143 log (Bd. wt. + 15) - 134 (4).*

A study of tables 1 and 2 in the investigations by Donaldson ('09) shows that for a given body weight the body length of the male is about 2.2 per cent greater than that of the female. If then the value found by this formula for any body weight is increased by 1.1 per cent of itself the sum obtained represents the body length for the male. If on the contrary, the value found is decreased by 1.1 per cent of itself, the difference obtained represents the body length for the corresponding female.

BODY WEIGHT ON BODY LENGTH (DONALDSON, '09)

By transposing formula (4) we obtain

$$\text{Body weight (sexes combined)} = 10^{\frac{Bd.l.+134}{143}} - 15 \quad (5)$$

As the body length for a given body weight is for the male 1.1 per cent above the value in (5) and for the female 1.1 per cent below the value in (5) two new formulas have been made for the male and female respectively—thus

$$\text{Body weight:—male} = 10^{\frac{(100 Bd. l. - 1.1 Bd. l.) + 13400}{14300}} - 15 \quad (5a)$$

$$\text{Body weight:—female} = 10^{\frac{(100 Bd. l. + 1.1 Bd. l.) + 13400}{14300}} - 15 \quad (5b)$$

By use of formulas (5 a) and (5 b) the body weights corresponding to body lengths from 70–250 mm. have been computed for each sex and the values obtained are those entered in the accompanying tables.

To illustrate the procedure with a formula of this sort the following example is given.

To compute the body weight for a body length of 150 mm. (male) by the following formula (5 a).

$$\text{Body weight (male)} = 10^{\frac{(100 Bd. l. - 1.1 Bd. l. + 13400)}{14300}} - 15$$

Transpose 15 from right hand side to the left and take the logarithm of both sides. We have

$$\log (Bd. wt. + 15) = \log 10 \times \frac{(100 \times 150 - 1.1 \times 150) + 13400}{14300}$$

$$1 \times \frac{15000 - 165 + 13400}{14300} = 1.9745$$

Thus 1.9745 is equivalent to the logarithm of body weight plus 15. Therefore body weight + 15 = 94.3 (anti-logarithm of 1.9745). Finally, body weight = 94.3 - 15 = 79.3 grams.

The above procedure is that to be followed with other formulas of the same type.

BODY WEIGHT ON BRAIN WEIGHT (DONALDSON, '08)

$$\text{Body weight (sexes combined)} = 8.7 + 10^{\frac{Br. wt. - 0.554}{0.569}} \quad (6)$$

TAIL LENGTH ON BODY LENGTH (HATAI, MS '14)

$$\text{Tail length: male} = 0.852 \text{ Bd. l.} + 38.8 (\log \text{ Bd. l.}) - 90.5 \quad (7)$$

$$\text{Tail length:—female} = 0.874 \text{ Bd. l.} + 43.2 (\log \text{ Bd. l.}) - 98.1 \quad (8)$$

Formulas (7) and (8) were used for table 144.

BRAIN WEIGHT ON BODY WEIGHT (HATAI, '09 a, p. 172)

For the brain weight of sexes combined, the following formulas have been obtained:—

$$\text{Brain weight (sexes combined)} = 1.56 \log (Bd. wt.) - 0.87 \quad (9)$$

$$[5 < Bd. wt. < 10 \text{ gms.}]$$

$$\text{Brain weight (sexes combined)} =$$

$$0.569 \log (Bd. wt. - 8.7) + 0.554 \quad (10)$$

$$Bd. wt. > 10 \text{ gms.}]$$

For a given body weight the average brain weight in the male was found to be 1.5 per cent more than in the female, hence the determinations of brain weight on body weight by formulas (9) and (10) give final values which must be increased by 0.75 per cent to represent the male brain and decreased by 0.75 per cent to represent the female brain weight. By using this procedure the data on brain weight given in table 144 were obtained.

AREA OF CALLOSUM (SUITSU, '20)

The theoretical curve, about which the observations cluster, is represented by the continuous line in chart 8 and was computed by means of the formula:

$$y = 0.184 + 0.0003 x + 2.08 \log x \quad (11)$$

in which  $y$  is the area of the callosum in the sagittal section, in millimeters, and  $x$  the weight of the body, in grams. This formula is based on the general formula  $y = a + bx + c \log x$ , already published by Hatai ('11).

CRANIAL CAPACITY (DONALDSON, '12)

For the cranial capacity expressed in cc. the formula for sexes combined is

*Cranial capacity in cc. =*

$$1.02 \log Bd. wt. - 0.00027 Bd. wt. - 0.596 \quad (12)$$

$$[80 < Bd. wt. < 300]$$

SPINAL CORD WEIGHT ON BODY WEIGHT (DONALDSON, '09)

*Spinal cord wt. (sexes combined) =*

$$0.585 \log (Bd. wt. + 21) - 0.795 \quad (13)$$

In the female the spinal cord is about 2 per cent heavier than in the male, therefore when using formula (13) the values obtained require to be increased by 1 per cent to represent the weight of the spinal cord in the female and to be diminished by

1 per cent to represent its weight in the male. By using this procedure, the data on the weights of the spinal cord in table 144 have been obtained.

DIAMETER OF SECOND CERVICAL SPINAL GANGLION CELL NUCLEUS ON  
DIAMETER OF CELL BODY (HATAI, '07 b)

Correlation between diameter of cell body and diameter of nucleus in  $\mu$  - in spinal ganglion cells of second cervical nerve.

*Diameter of nucleus in  $\mu$  =*

$$12.2939 \left\{ 1.0252 + 0.3564 \left( \frac{x}{l} \right) - 0.0758 \left( \frac{x}{l} \right)^2 \right\} \quad (14)$$

where x is the diameter of the cell in  $\mu$  and l is a half range of the variates.

As the value of l is 10, the formula (14) may be transformed by a series of steps here omitted, to read

$$D n = 12.6 + 4.3 \left\{ \frac{D c b - 29}{20} \right\} - 0.9 \left\{ \frac{D c b - 29}{20} \right\}^2 \quad (14 a)$$

Where D n = Diameter of nucleus in  $\mu$ .  
and D c b = Diameter of cell body in  $\mu$ .

See table 60.

WEIGHT OF BOTH EYEBALLS ON BODY WEIGHT (HATAI, '13, p. 112)

*Weight of both eyeballs (sexes combined) =*

$$0.000428 \text{ Bd. wt. } + 0.098 \log \text{ Bd. wt. } - 0.041 \quad (15)$$

Formula (15) was used for table 144.

WEIGHT OF HEART ON BODY WEIGHT (HATAI, '13)

*Weight of heart (sexes combined) =*

$$0.0026 (\text{Bd. wt. } + 14) + 0.249 \log (\text{Bd. wt. } + 14) - 0.336 \quad (16)$$

Formula (16) was used for table 145.

WEIGHT OF BOTH KIDNEYS ON BODY WEIGHT (HATAI, '13)

*Weight of both kidneys (sexes combined) =*

$$0.00718 (Bd. wt. - 3) + 0.132 \log (Bd. wt. - 3) - 0.009 \quad (17)$$

Formula (17) was used for table 145.

WEIGHT OF LIVER ON BODY WEIGHT (HATAI, '13)

*Weight of liver (sexes combined) =*

$$0.0303 (Bd. wt. + 5) + 3.340 \log (Bd. wt. + 5) - 3.896 \quad (18)$$

$$[Bd. wt. > 10]$$

Formula (18) was used for obtaining the values given in table 145 for body weights of 10 grams or above. For body weights below 10 grams the weights have been determined by graphic interpolation—using the crude records as a basis.

WEIGHT OF SPLEEN ON BODY WEIGHT (HATAI, '13)

*Weight of spleen (sexes combined) =*

$$0.00245 Bd. wt. + 0.0301 \log (Bd. wt.) - 0.025 \quad (19)$$

Formula (19) was used for table 145

WEIGHT OF BOTH LUNGS ON BODY WEIGHT (HATAI, '13)

*Weight of both lungs (sexes combined) =*

$$0.00471 (Bd. wt. + 2) + 0.122 \log (Bd. wt. + 2) - 0.056 \quad (20)$$

Formula (20) was used for table 146.

VOLUME OF THE BLOOD ON BODY WEIGHT (CHISOLM, '11) AND HATAI (MS '14)

$$Blood volume (sexes combined) = \frac{Bd. wt.^{0.9}}{10.1} = 0.099 (Bd. wt)^{0.9} \quad (21)$$

$$[5 < Bd. wt. < 150]$$

*Blood volume (males) =*

$$\begin{aligned} & 0.099 (Bd. wt.)^{0.9} - 0.03 \times 0.099 (Bd. wt.)^{0.9} \quad (21 a) \\ & = 0.09603 (Bd. wt.)^{0.9} \\ & [150 < Bd. wt. < 350] \end{aligned}$$

*Blood volumes (females) =*

$$\begin{aligned} & 0.099 (Bd. wt.)^{0.9} + 0.06 \times 0.099 (Bd. wt.)^{0.9} \quad (21 b) \\ & = 0.10494 (Bd. wt.)^{0.9} \\ & (150 < Bd. wt. < 350) \end{aligned}$$

By using the factor 1.056 for the specific gravity of the blood corresponding formulas for the *blood weight on body weight* have been obtained as follows: Hatai (MS '14).

*Blood weight (sexes combined) =*

$$\begin{aligned} & 0.099 (Bd. wt.)^{0.9} \times 1.056 \text{ or } = 0.1045 (Bd. wt.)^{0.9} \quad (22) \\ & (5 < Bd. wt. < 150) \end{aligned}$$

*Blood weight (males) =*

$$\begin{aligned} & 0.1045 (Bd. wt.)^{0.9} - 0.03 \times 0.1045 (Bd. wt.)^{0.9} \quad (22 a) \\ & = 0.101365 (Bd. wt.)^{0.9} \\ & (150 < Bd. wt. < 350) \end{aligned}$$

*Blood weight (females) =*

$$\begin{aligned} & 0.1045 (Bd. wt.)^{0.9} + 0.06 \times 0.1045 (Bd. wt.)^{0.9} \quad (22 b) \\ & = 0.11077 (Bd. wt.)^{0.9} \\ & (150 < Bd. wt. < 350) \end{aligned}$$

These formulas (22) (22 a) and (22 b) for blood weight have been used for table 146.

WEIGHT OF ALIMENTARY TRACT ON BODY WEIGHT (HATAI, '13)

*Weight of alimentary tract (sexes combined) =*

$$0.0245 \text{ Bd. wt.} + 4.720 \log (\text{Bd. wt.} + 7) - 5.753 \quad (23)$$

Formula (23) was used for table 146.

WEIGHT OF THE STOMACH ON BODY WEIGHT (HATAI '18)

*Weight of stomach (sexes combined) =*

$$0.00375 \text{ Bd. wt.} + 0.00016666 \text{ Bd. wt.}^2 + 0.0073 \\ 4 < \text{Bd. wt.} < 20 \quad (24)$$

$$0.00204 \text{ Bd. wt.} + 0.631 \log \text{Bd. wt.} - 0.7130 \\ \text{Bd. wt.} \geq 20 \quad (24 \text{ a})$$

WEIGHT OF THE PANCREAS ON BODY WEIGHT (HATAI, '18)

In the pancreas a sex difference is distinctly shown. The pancreas in the female is heavier than in the male; consequently the growth of the pancreas in weight is treated separately according to sex and is represented by the following formulas (25), (25 a).

Some later observations by Hammett ('23) indicate that this sex relation may be reversed in certain strains.

It is evident from the limits stated that the formulas do not apply to the body weight which is less than 10 grams, and furthermore that the pancreas of the female between 10 and 20 grams in body weight is represented by the formula employed for the male rats.

WEIGHT OF THE PANCREAS ON BODY WEIGHT (HATAI, '18)

$$\text{Male} = 0.048 + 0.0036 (\text{Bd. wt.} - 9) + 0.09 \log (\text{Bd. wt.} - 9) \\ \text{Bd. wt.} \geq 10 \quad (25)$$

*Female* =  $10 < \text{Bd. wt.} < 20$  Formula (25) is used.

$$\text{Female} = 0.00339 \text{ Bd. wt.} + 0.248 \log \text{Bd. wt.} - 0.2091 \\ \text{Bd. wt.} \geq 20 \quad (25 \text{ a})$$

## WEIGHT OF THE SUBMAXILLARIES ON BODY WEIGHT (HATAI, '18)

*Weight of submaxillaries (2) (Males and females)*

$$= 0.00152 (Bd. wt. + 5) + 0.0542 \log (Bd. wt. + 5) - 0.0524 \\ Bd. wt. \bar{\leq} 5 \quad (26)$$

## WEIGHT OF BOTH TESTES ON BODY WEIGHT (HATAI, '13)

$$Wt. of testes = 0.022 - 0.00992 Bd. wt. + 0.00127 Bd. wt.^2 \quad (27) \\ [4 < Bd. wt. < 10]$$

$$= 0.043 - 0.000966 Bd. wt. + 0.000163 Bd. wt.^2 \quad (28) \\ [10 < Bd. wt. < 80]$$

$$= 2.910 \log Bd. wt. - 4.520 \quad (29) \\ [Bd. wt. > 80]$$

For the weight of the testes for body weights of 4–10 grams the values were obtained by formula (27), while formulas (28) and (29) were used for obtaining the values for body weights of 10 grams or over. Formulas (27) (28) and (29) were used for table 146.

## WEIGHT OF BOTH EPIDIDYMIDES—ON BODY WEIGHT (HATAI, '18)

Owing to the presence of two distinct phases of growth two formulas were used. Formula (30) for body weights up to 100 grams and formula (31) for body weights above this. Table 147.

*Weight of epididymis (2)*

$$0.003 + 0.00024 Bd. wt. + 0.00002 Bd. wt.^2 \\ Bd. wt. \bar{\leq} 100 \quad (30)$$

$$1.65 \log Bd. wt. - 0.000762 Bd. wt. - 2.9945 \\ Bd. wt. \geq 100 \quad (31)$$



WEIGHT OF BOTH OVARIES ON BODY WEIGHT (HATAI, '13)

*Weight of both ovaries* =

$$= 0.00781 \log \text{Bd. wt.} - 0.0047 \quad (32)$$

(Phase 1) [Bd. wt. < 65]

$$= 0.0425 - 0.00121 \text{Bd. wt.} + 0.0000108 \text{Bd. wt.}^2 \quad (33)$$

(Phase 2) [65 < Bd. wt. < 110]

$$= 0.007 \log (\text{Bd. wt.} - 105) + 0.0352 \quad (34)$$

(Phase 3) [Bd. wt. > 110]

Formulas (32) (33) (34) were used for table 146.

WEIGHT OF HYPOPHYSIS ON BODY WEIGHT (HATAI, '13)

In the case of the hypophysis a separate formula for each sex is required.

*Weight of hypophysis (male)* =

$$0.0000257 (\text{Bd. wt.} + 3) + 0.0014 \log (\text{Bd. wt.} + 3) - 0.00097 \quad (35)$$

Formula (35) is also used for the female up to 50 gms. in body weight then

*Weight of hypophysis (female)* =

$$0.00205 + 0.000081 \text{Bd. wt.} - 0.00196 \log (\text{Bd. wt.}) \quad (36)$$

[Bd. wt. > 50]

Formulas (35) and (36) were used for table 148 in accordance with the restrictions indicated.

WEIGHT OF BOTH SUPRARENALS ON BODY WEIGHT (HATAI, '13)

In the case of the suprarenals a separate formula for each sex is required.

$$\begin{aligned} & \text{Weight of both suprarenals (male)} = \\ & 0.0000855 (Bd. wt. + 3) + 0.0113 \log (Bd. wt. + 3) - 0.0093 \quad (37) \end{aligned}$$

Formula (37) is also used for the female up to 30 gms. in body weight, then

$$\begin{aligned} & \text{Weight of both suprarenals (female)} = \\ & 0.00023 Bd. wt. + 0.00388 \log (Bd. wt.) - 0.002 \quad (38) \\ & [Bd. wt. > 30] \end{aligned}$$

Formulas (37) and (38) were used for table 146 in accordance with the restrictions indicated.

#### WEIGHT OF THYROID ON BODY WEIGHT (HATAI, '13)

$$\begin{aligned} & \text{Weight of thyroid (sexes combined)} = \\ & 0.0000973 (Bd. wt. + 27) + 0.0139 \log (Bd. wt. + 27) - 0.0226 \quad (39) \end{aligned}$$

Formula (39) was used for table 146.

#### WEIGHT OF NITROGEN ON BODY WEIGHT (HATAI, '05)

To determine the amount of nitrogen eliminated by the rat during twenty-four hours at different body weights.

$$N = 10^{\frac{2.33 + (3 \times \log Bd. wt.)}{4}} \quad \text{or} \quad \log N = \frac{2.33 + (3 \times \log Bd. wt.)}{4} \quad (40)$$

where  $N$  = total nitrogen in milligrams and  $Bd. wt.$  = body weight in grams.

Formula (40) is based on the data in table 99.

### GROUP I. ALBINOS

#### SECOND DIVISION: FORMULAS BASED ON AGE

##### BODY WEIGHT ON AGE FROM 10-365 DAYS, HATAI (MS '14)

The formulas (41) (42) (43) (44) apply only the series of data published by Donaldson, Dunn and Watson, ('06).

*Body weight on age in days—males =*

$$11.199 + 0.0475 \text{ Age} + 0.0184 \text{ Age}^2 \quad (41)$$

$$[10 < \text{Age} < 80]$$

$$= 488 \log \text{Age} - 0.52 \text{ Age} - 678.2 \quad (42)$$

$$[80 < \text{Age} < 365]$$

*Body weight on age in days—mated females =*

$$8.071 + 0.367 \text{ age} + 0.0131 \text{ Age}^2 \quad (43)$$

$$[10 < \text{Age} < 80]$$

$$= 343 \log \text{Age} - 0.41 \text{ Age} - 498.8 \quad (44)$$

$$[80 < \text{Age} < 365]$$

Formulas (41) (42) (43) (44) were used for table 157.

WEIGHT OF THYMUS ON AGE (HATAI, '14)

*Weight of thymus—sexes combined =*

$$0.01 \times 10^{1.1 \{ 1.1884 + 0.5665 \left( \frac{\text{age}}{55} - 1 \right) - 0.5651 \left( \frac{\text{age}}{55} - 1 \right)^2 \}} \quad (45)$$

$$[\text{Age} < 95]$$

*Weight of thymus =*

$$0.3903 - 0.00139 (\text{age}) + 0.00000128 (\text{age})^2 \quad (46)$$

$$[\text{Age} > 95]$$

Formulas (45) (46) were used for table 151.

PERCENTAGE OF WATER IN BRAIN (DONALDSON, '16)

The formulas do not apply to rats under ten days of age.

*Percentage of water in brain—(male) =*

$$92.122 - 0.614 \text{ Age} + 0.00739 \text{ Age}^2 \text{ (Phase 1)} \quad (47)$$

$$[10 < \text{Age} < 40]$$

$$= 82.756 - 2.103 \log \textit{Age} \quad (\textit{Phase 2}) \quad (48)$$

$$[40 < \textit{Age} < 160]$$

$$= 77.671 + 0.00537 \textit{Age} - 0.000016 \textit{Age}^2 \quad (\textit{Phase 3}) \quad (49)$$

$$[160 < \textit{Age} < 365]$$

To transform any determination for the male into that for the female, the value for the male at a given age (see formulas (47) (48) (49)) is modified by a *plus* correction (Hatai).

$$\textit{Correction (to be added)} = 0.0555 \log (\textit{age} + 3) - 0.0606 \quad (49 \textit{ a})$$

$$[10 < \textit{Age} < 365]$$

The foregoing (47)–(49 a) replace the formulas given in the paper by Donaldson ('10).

Formulas (47) (48) (49) (49 a) were used for table 157.

#### PERCENTAGE OF WATER IN SPINAL CORD (DONALDSON '16)

The formulas do not apply under 10 days of age. The data for the first ten days are from direct observations.

*Percentage of water in spinal cord—male =*

$$87.976 - 0.494 \textit{Age} + 0.00364 \textit{Age}^2 \quad (\textit{Phase 1}) \quad (50)$$

$$[10 < \textit{Age} < 40]$$

$$= 100.3 + 0.0548 \textit{Age} - 17.7 \log \textit{Age} \quad (\textit{Phase 2}) \quad (51)$$

$$[40 < \textit{Age} < 150]$$

$$= 62.186 - 0.0121 \textit{Age} + 4.434 \log \textit{Age} \quad (\textit{Phase 3}) \quad (52)$$

$$[150 < \textit{Age} < 365]$$

To obtain from the values for the male at different ages the corresponding value for the female, several corrections are required and these differ according to age.

From ten to fifty days the following correction formula (52 a) is used:

$$\textit{Correction (to be subtracted)} = 0.0006 \textit{Age}^2 - 0.036 \textit{Age} + 0.3 \quad (52 \textit{ a})$$

The values thus obtained are subtracted from the computed values for the male at the corresponding ages.

From fifty to sixty-five days no correction is made.

From sixty-five days to one hundred and thirty-five days, correction is made according to the formula (52 b).

$$\begin{aligned} \text{Correction (to be added)} &= 0.823 \log (\text{Age} + 1) - 0.000542 \\ &\quad (\text{Age} + 1) - 1.4616 \end{aligned} \quad (52 \text{ b})$$

From one hundred and thirty-five to one hundred and sixty-five days the correction is uniform thus:

$$\text{Correction (to be added)} = 0.22 \quad (52 \text{ c})$$

From one hundred and sixty-five to three hundred and sixty-five days correction is made by the following formula:

$$\text{Correction (to be added)} = 0.22 + 0.0005 (\text{Age} - 165) \quad (52 \text{ d})$$

The foregoing (50)–(52 d) replace the formulas given in the paper by Donaldson, '10.

Formulas (50)–(52 d) were used for table 157.

## GROUP II. NORWAYS

### FIRST DIVISION: FORMULAS BASED ON SIZE

#### BODY LENGTH ON BODY WEIGHT—NORWAY (DONALDSON AND HATAI, '11)

$$\text{Body length (sexes combined)} = 159 \log (\text{Bd. wt.} + 18) - 165 \quad (53)$$

The body length for the male is 0.4 per cent above the value given by formula (53) and that for the female 0.4 per cent below. Formula (53) with above corrections was used for graphs in chart 61.

#### BODY WEIGHT ON BODY LENGTH (DONALDSON AND HATAI, '11)

By transforming formula (53) and introducing the correction for sex we obtain:

(1) For the male

$$\begin{aligned} \text{Body weight} &= 10^{0.0000629 (Bd. l. \times 100 - [(Bd. l. \times 100 \times 0.004] + 16500)} - 18 & (54) \\ &= 10^{0.0000629 (Bd. l. \times 99.6 + 16500)} - 18 \end{aligned}$$

(2) For the female

$$\begin{aligned} \text{Body weight} &= 10^{0.0000629 (Bd. l. \times 100 + [(Bd. l. \times 100 \times 0.004] + 16500)} - 18 & (55) \\ &= 10^{0.0000629 (Bd. l. \times 100.4 + 16500)} - 18 \end{aligned}$$

Formulas (54) (55) were used for table 187.

TAIL LENGTH ON BODY LENGTH, NORWAY (HATAI, MS '14)

(1) For the male

$$\text{Tail length} = 0.824 \text{ Bd. l.} + 39.1 (\log. \text{ Bd. l.}) - 92.6 \quad (56)$$

(2) For the female.

$$\text{Tail length} = 0.824 \text{ Bd. l.} + 43.1 \log (\text{Bd. l.}) - 98.4 \quad (57)$$

Formulas (56) (57) were used for table 187.

BRAIN WEIGHT ON BODY WEIGHT, NORWAY (DONALDSON AND HATAI, '11)

*Brain weight (sexes combined)*

$$= 0.825 \log (\text{Bd. wt.} - 4) + 0.233 \quad (58)$$

This formula applies only to rats 5 grams or more in body weight. To obtain the weights for the male the values given by the formula are increased by 1 per cent, and to obtain the weights for the female, they are decreased by 1 per cent.

Formula (58) with corrections mentioned above was used for table 187.

CRANIAL CAPACITY ON BODY WEIGHT, NORWAY (DONALDSON, '12)

*Cranial capacity in cc. (sexes combined) =*

$$0.00105 \text{ Bd. wt.} + 0.548 \log \text{Bd. wt.} + 0.476 \quad (59)$$

$$[80 < \text{Bd. wt.} < 380]$$

SPINAL CORD WEIGHT ON BODY WEIGHT, NORWAY (DONALDSON AND HATAI, '11)

*Spinal cord weight (sexes combined) =*

$$0.724 \log (Bd. wt. + 30) - 1.082 \quad (60)$$

To obtain the weights for the male the values given by the formula are increased by 0.15 per cent, and to obtain the weights for the female they are decreased by 0.15 per cent.

Formula (60) with corrections mentioned above was used for table 187.

SPINAL CORD WEIGHT ON BRAIN WEIGHT (SEXES COMBINED), NORWAY  
(DONALDSON AND HATAI '11)

$$Spinal\ cord\ wt. = 0.724 \log \left( 10^{\frac{Br. wt. - 0.233}{0.825}} + 34 \right) - 1.082 \quad (61)$$

For the Norway we have no extensive data based on age—hence there are no formulas based on age.

GROWTH OF PARTS AND ORGANS IN RELATION TO BODY LENGTH  
AND IN RELATION TO AGE: REFERENCES

*Introduction.* Chisolm, '11. Donaldson and Conrow, '19, Sugita, '17.

*Body length relations.* Donaldson, '06. '09. Donaldson and Hatai, '11. Ferry, '13.

*Body length on body weight.* Donaldson, '09. Donaldson and Hatai, '11.

*Body weight on body length.* Donaldson, '09. Donaldson and Hatai, '11. Jackson and Lowrey, '12.

*Tail length on body length.* Przibram, '22 a, '22 b, '22 c, '22 d. Przibram and Wiesner, '22. Przibram, '23.

*Organs with early rapid growth—Brain, cord, eyes.* Donaldson, '08, '09, '11, '11 c. Donaldson and Hatai, '11 a. Donaldson, '12. Donaldson, Hatai and King, '15. Donaldson, '17, '18, '18 a. Donaldson and Nagasaka, '18. Hatai '07 a, '08, '09 a, '13 a. Jackson, '13. Watson, '05. Ziehen, '06.

*Weight of parts of brain.* Hatai, '13. Jackson, '13. Stewart, '18 a. Sugita, '17.

*Organs with a nearly uniform growth.* Chisolm, '11. Degener, '22. Hatai, '13, '14 a, '18. Jackson, '13. Jolly and Stini, '05. Kittelson, '17, '20. Rous and McMaster, '24.

*Organs with a sinuous graph of growth.* Hatai, '13, '14, '14 a, '18. Jackson, '13.

*Variability.* Jackson, '13.

*Entire body on age. Prenatal.* Stotsenburg, '15. *Postnatal.* Donaldson, '06. Greenman and Duhring, '23. Hatai, '03 a, '04 a, '23.

*Weight of thymus on age.* Hatai, '14.

*Weight of viscera.* Jackson and Lowrey, '12.

*Relative weights of individual viscera.* Donaldson, '23 b.

*Formulas.* Chisolm, '11. Donaldson, '08, '09. Donaldson and Hatai, '11. Donaldson, '12, '16. Hatai, '05, '07 b, '07 c, '09 a, '10, '10 a, '11, '13, '14, '18.



## CHAPTER 8

### GROWTH IN TERMS OF WATER AND SOLIDS

1. In the body as a whole. 2. In the larger divisions of the body and the organs. 3. In the brain and spinal cord. 4. Corrections.

1. *In the body as a whole.* 2. *In the larger divisions of the body and the organs.* Data on this head have been published by Lowrey ('13) and are here presented.

With the exception of one of the old rats the animals used for table 158 were reared at the University of Missouri. They were fed on chopped corn with a daily ration of bread soaked in whole milk and once a week a small quantity of fresh beef was given them. All were sound except some of the older animals which suffered from infected lungs—but not to such a degree as to affect their general nutrition of vigor. Table 158 is based on table 1, Lowrey ('13). The data for the two sexes are combined. In the original the range of the observations is given and also the number of animals used in each instance. In the present table the ranges are omitted and the number of animals is given for the body weight (net) only. The other determinations for the systems and organs were based on about the same number of animals as were used for the body weight, except in the case of testes where the numbers are about half as large. The oldest animals were somewhat under one year of age.

In table 158 the percentage data are given for the dry substance. Here in table 159 they are transformed to the percentage of water.

To supplement table 159 the graphs in chart 50 show the relations of the percentage of dry substance in the entire body and its principal parts.

The growth of dry substance is most marked during the active growing period, from birth to 75–100 days.

TABLE 158

Giving the percentage weight of the dry substance in the integument, skeleton (ligamentous), musculature, viscera and remainder in terms of the dry substance of the entire body, Lowrey '13.

AGE IN DAYS	NUMBER OF ANIMALS	ABSOLUTE WEIGHT OF DRY SUBSTANCE ENTIRE BODY*	PERCENTAGE WEIGHT OF DRY SUBSTANCE OF ENTIRE BODY REPRESENTED BY				
			Skin	Skeleton (ligamentous)	Musculature	Viscera	Remainder
0.....	7	0.494	21.2	24.3	23.8	22.5	8.1
7.....	10†	1.830	27.9	20.2	18.2	13.9	19.9
20.....	9	7.320	28.3	18.7	19.6	13.0	20.4
42.....	10	17.300	24.0	19.8	26.0	14.6	15.6
70.....	7†	42.400	23.3	16.3	30.0	12.1	18.3
150.....	10	60.600	23.4	17.1	31.7	11.8	16.0
365 (?)..	2	84.300	22.9	17.5	35.3	9.4	14.9

\* The fresh weights at the several ages are those given under body weight (net) table 159.

† Skeleton and musculature not separately determined in one instance.

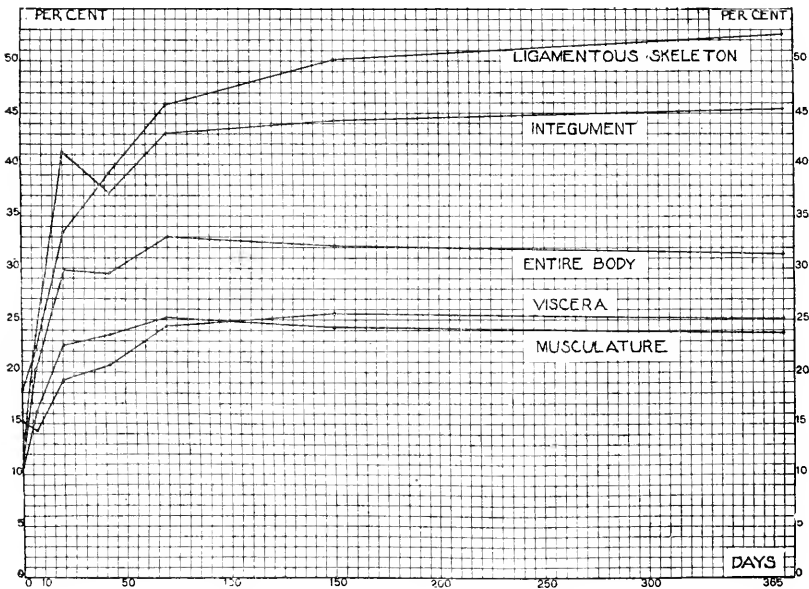

Chart 50 Giving the percentage of dry substance in the body as a whole and in the several systems at different ages. Lowrey ('13).

(a) *Percentage of water in the cartilaginous skeleton and its parts (Donaldson and Conrow, '19).* The data are presented in tables 160-163 and in charts 51-54.

The observations of Lowrey, just cited, give the percentage of water in the ligamentous skeleton. It is desirable however

TABLE 159

*Percentages of water in the entire body—in several of the systems and in some organs. Observations at seven ages. See Chart 50.*

AGE IN DAYS	BODY (NET)			INTEGUMENT		LIGAMENTOUS SKELETON		MUSCULATURE	
	Number of animals	Average fresh weight	Average per cent of water	Average fresh weight	Average per cent of water	Average fresh weight	Average per cent of water	Average fresh weight	Average per cent of water
		<i>grams</i>		<i>grams</i>		<i>grams</i>		<i>grams</i>	
0.....	15	4.200	88.3	0.880	87.7	0.660	81.9	1.100	89.3
7.....	10	9.100	79.9	2.180	76.6	1.710	77.9	2.020	83.8
20.....	9	24.500	70.1	5.020	58.9	4.090	66.7	6.400	77.4
42.....	10	61.300	70.5	11.040	62.9	8.610	60.8	18.730	76.5
70.....	7	126.700	67.0	20.020	57.0	14.840	54.1	51.500	74.8
150.....	10	182.400	67.8	32.200	55.8	20.020	49.6	76.920	75.7
365 (?)	2	267.500	68.5	37.780	54.5	23.180	47.4	125.000	76.2
		ALL VISCERA*		EYEBALLS		HEART		LUNGS	
0.....		0.780	84.8	0.023	92.6	0.025	86.2	0.077	81.4
7.....		1.760	85.8	0.066	89.6	0.061	85.6	0.169	84.2
20.....		5.090	80.9	0.110	85.6	0.135	82.0	0.236	81.1
42.....		12.170	79.3	0.162	84.7	0.412	79.0	0.404	80.9
70.....		20.900	75.6	0.267	83.0	0.625	78.4	0.791	80.8
150.....		26.570	74.4	0.279	81.0	0.714	78.8	1.354	81.0
365 (?)		31.750	74.9	0.340	79.8	0.934	77.6	2.806	81.6
		LIVER		SPLEEN		KIDNEYS		TESTES	
0.....		0.234	80.6			0.038	86.7		
7.....		0.307	79.4	0.041	85.7	0.123	85.5		
20.....		1.200	75.7	0.076	82.8	0.322	82.8	0.106	87.1
42.....		3.541	75.8	0.273	80.2	0.832	79.7	0.568	86.7
70.....		6.617	74.5	0.588	79.9	1.320	79.2	1.653	87.6
150.....		9.236	74.3	0.666	79.4	1.728	78.0	2.425	87.8
365 (?)		9.959	74.0	0.722	77.4	2.294	77.1	2.044	87.0

\* "All viscera" comprises the series of organs used by Jackson and Lowrey ('12). See note 9, page 264

to present the corresponding observations on the cartilaginous skeleton, where the soft parts are more completely removed, taking account at the same time of the modification of the percentage of water produced by the macerating fluid which was used.

TABLE 160

*A. Percentage of water in oven-dried entire skeleton on age in days. B. Percentage of water in oven-dried entire skeleton and appendicular skeleton, on body weight. Values taken from the smoothed graphs in chart 51.*

AGE	A		B	
	Percentage of water-skeleton	Body weight	Percentage of water-skeleton	Percentage of water-appendicular skeleton
<i>days</i>		<i>grams</i>	<i>per cent</i>	<i>per cent</i>
0	79.2	5	79.1	79.1
5	77.0	10	76.0	76.0
10	73.5	15	72.4	72.0
15	69.6	20	69.0	67.1
20	66.0	25	65.4	64.0
25	62.0	30	63.1	62.2
30	58.0	35	61.2	60.4
35	54.4	40	59.1	58.6
40	52.4	45	57.1	56.8
45	50.8	50	55.2	55.0
50	49.0	55	53.2	53.2
55	47.2	60	52.0	52.0
60	46.0	65	50.7	50.6
65	44.8	70	49.4	49.1
70	43.8	75	48.1	48.0
75	42.8	80	46.8	46.6
80	41.8	85	45.6	45.2
85	40.8	90	44.4	44.0
90	40.0	95	43.1	42.5
95	38.8	100	41.8	41.2
100	38.2	110	39.4	38.8
110	37.9	120	38.8	37.0
120	37.6	130	38.4	35.3
130	37.4	140	38.1	34.8
140	37.2	150	37.9	34.2
150	36.9	160	37.6	33.7
160	36.7	170	37.4	33.2
170	36.5	180	37.1	32.6
180	36.2	190	36.8	32.1
190	36.0	200	36.6	31.6
200	35.9	230	35.6	31.1
230	35.2	260	35.1	30.7
260	35.1	290	34.9	30.3
290	34.9	320	34.7	30.1
320	34.7	350	34.5	29.6
350	34.5	380	34.2	29.2
380	34.2	410	34.1	28.7
410	34.1	440	34.0	28.3
440	34.0	480	33.6	28.0
480	33.6			

TABLE 161

*Percentage of water in oven-dried cranium and vertebrae, on body weight. Values taken from the smoothed graphs in chart 52.*

BODY WEIGHT	CRANIUM	VERTEBRAE
<i>grams</i>	<i>per cent</i>	<i>per cent</i>
5	80.1	80.1
10	76.8	76.8
15	72.4	70.5
20	68.4	68.4
25	64.0	66.8
30	60.4	65.1
35	58.2	63.4
40	56.3	61.8
45	54.8	60.0
50	53.1	58.4
55	52.0	56.8
60	51.0	54.8
65	50.1	53.6
70	49.2	52.1
75	48.3	50.5
80	47.4	49.4
85	46.4	48.1
90	45.6	47.1
95	44.8	46.0
100	44.0	44.8
110	43.4	42.0
120	43.2	39.6
130	42.9	38.2
140	42.7	38.0
150	42.4	38.0
160	42.2	37.9
170	42.1	37.7
180	42.0	37.5
190	42.0	37.4
200	41.8	37.3
210	41.6	37.2
220	41.4	37.0
230	41.3	36.9
240	41.2	36.8
250	41.2	36.7
270	41.0	36.4
290	40.8	36.1
310	40.5	36.0
330	40.2	35.6
350	40.1	35.4
370	40.0	35.1
390	39.7	34.8
410	39.5	34.5
430	39.3	34.2
450	39.1	33.8
470	38.8	33.4
485	38.7	33.1

TABLE 162

Percentage of water in oven-dried humerus, ulna plus radius, and bones of fore feet, on body weight. Values taken from the smoothed graphs in chart 53.

BODY-WEIGHT	HUMERUS (2)	ULNA PLUS RADIUS (2)	BOTH FORE FEET
<i>grams</i>	<i>per cent</i>	<i>per cent</i>	<i>per cent</i>
5	79.8	73.8	80.1
10	75.8	70.0	74.0
15	72.2	66.0	68.0
20	69.1	62.8	61.2
25	66.3	60.1	58.4
30	64.5	57.4	56.0
35	62.7	54.8	53.8
40	60.8	52.4	51.6
45	58.9	50.4	49.2
50	57.0	48.2	47.0
55	55.2	46.0	44.8
60	54.0	43.9	42.4
65	52.8	41.8	40.1
70	51.6	39.5	38.0
75	50.4	37.8	36.0
80	49.2	36.7	34.6
85	48.1	35.6	33.2
90	46.8	34.3	31.8
95	45.6	33.1	30.4
100	44.4	32.0	28.8
110	42.2	29.7	26.8
120	40.6	28.3	26.0
130	39.0	27.3	25.0
140	37.6	26.3	24.1
150	37.3	25.3	23.4
160	37.0	25.0	22.9
170	36.6	24.6	22.5
180	36.2	24.3	22.1
190	36.0	24.0	22.0
200	35.6	23.6	21.6
210	35.2	23.2	21.2
220	34.8	22.9	20.9
230	34.6	22.7	20.6
240	34.2	22.5	20.4
250	34.1	22.3	20.1
270	34.0	22.0	19.9
290	33.7	21.7	19.5
310	33.4	21.3	19.4
330	33.2	20.9	19.3
350	33.0	20.5	19.2
370	32.7	20.2	19.2
390	32.5	19.9	19.1
410	32.2	19.5	19.0
430	32.0	19.2	18.9
450	31.9	18.7	18.8
470	31.6	18.3	18.8
485	31.4	18.0	18.8

TABLE 163

Percentage of water in oven-dried femur, tibia plus fibula, and bones of hind feet, on body weight. Values taken from the smoothed graphs, in chart 54.

BODY WEIGHT	FEMUR (2)	TIBIA PLUS FIBULA (2)	BOTH HIND FEET
<i>grams</i>	<i>per cent</i>	<i>per cent</i>	<i>per cent</i>
5	80.7	76.6	83.2
10	77.2	73.4	77.2
15	74.0	70.1	72.4
20	71.1	66.8	67.8
25	69.2	64.4	64.4
30	67.6	62.4	60.4
35	65.8	60.6	58.1
40	64.0	58.8	56.0
45	62.2	56.8	54.0
50	60.4	55.1	51.9
55	58.6	53.2	49.8
60	57.3	51.4	47.6
65	56.0	50.2	45.0
70	54.8	49.2	43.2
75	53.4	48.1	41.2
80	52.1	47.0	39.4
85	50.9	46.0	37.6
90	49.6	44.8	35.8
95	48.2	43.6	33.8
100	47.0	42.4	32.0
110	45.2	40.4	28.4
120	43.8	38.4	26.7
130	42.4	36.8	26.0
140	40.9	35.6	25.2
150	40.2	34.9	24.8
160	39.5	34.1	24.1
170	38.8	33.3	23.2
180	38.4	32.5	22.5
190	38.1	32.2	22.2
200	37.9	32.1	21.9
210	37.6	32.0	21.5
220	37.5	31.9	21.1
230	37.3	31.7	20.7
240	37.2	31.6	20.4
250	37.2	31.4	20.1
270	36.9	31.2	19.6
290	36.6	30.9	19.3
310	36.4	30.6	19.2
330	36.1	30.3	19.1
350	36.0	30.1	19.0
370	35.7	29.9	18.9
390	35.4	29.5	18.8
410	35.2	29.2	18.8
430	35.0	28.9	18.6
450	34.8	28.8	18.5
470	34.5	28.4	18.4
485	34.4	28.1	18.4

No attempt is made to harmonize in detail these two series of values but the correction coefficients for reducing the observed values in the macerated cartilaginous skeleton to the true values are given in table 127.

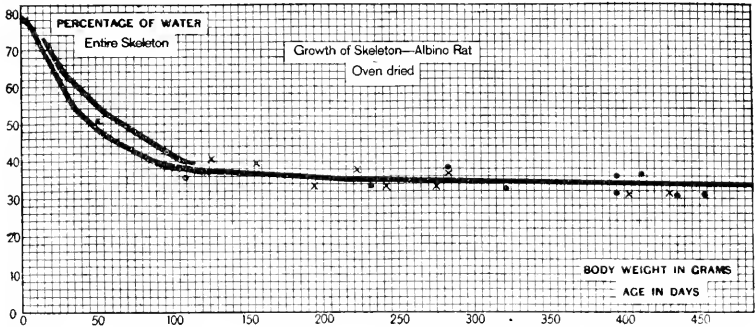

Chart 51 Percentage of water in the entire skeleton—oven dried—on age and on body weight (albino rat). Table 160.

• Age. × Body weight.

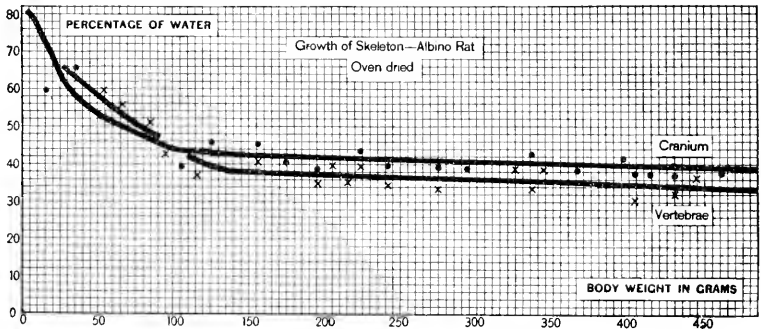

Chart 52 Percentage of water in the oven-dried cranium and in the vertebrae, on body weight (albino rat). Table 161.

• Cranium. × Vertebrae.

Examination of the tables giving the percentages of water in the different bones shows considerable differences especially after the early stages. These differences appear to be related to differences in the density of the osseous tissue and to the presence of cavities, as in the humerus and femur.



(b) Correction for the percentage of water after maceration. At birth the oven-dried macerated bones show 0.6 per cent less water than those mechanically cleaned. This deficiency increases at the rate of 0.04 per cent for each 5 grams in body weight up

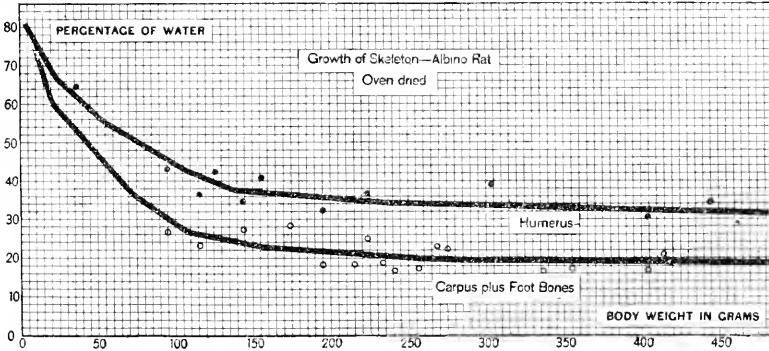

Chart 53 Percentage of water in the oven-dried bones of fore limb, on body weight (albino rat). Table 162.

• Humerus. ○ Carpus plus foot bones. The graph for the ulna plus radius coincides nearly with that for the carpus, and is therefore omitted.

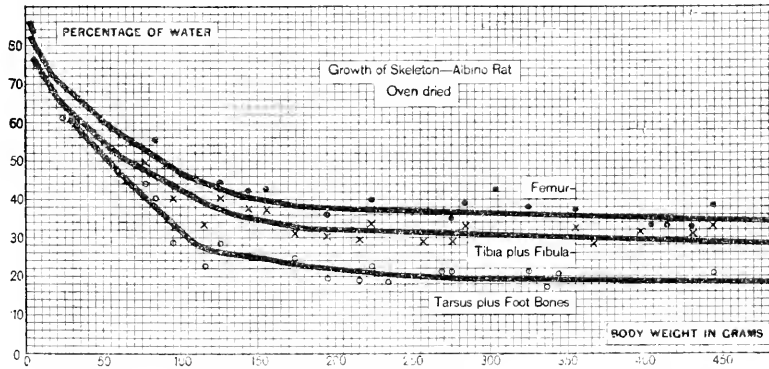

Chart 54 Percentage of water in the oven-dried bones of hind limb, on body weight (albino rat). Table 163.

• Femur. × Tibia and fibula. ○ Tarsus and foot bones.

to 150 grams. At this body weight it amounts to 1.8 per cent and this deficiency persists in the heavier rats. The true percentage of water can therefore be approximated by applying these corrections to the values in the tables.

*On the percentage value of the loss in weight on passing from the room dried to the oven dried condition.* In general the loss of water in passing from the room-dried to the oven-dried state is about 8.3 per cent of the room-dried value, and the oven-dried weight is therefore 91.7 per cent of the room-dried. Table 164 gives the several values, according to the part of the skeleton, as determined for the four body-weight groups which have been selected.

3. *Percentage of water in the brain and spinal cord.* Using stock rats from the colony at The Institute, the percentage of

TABLE 164

*The percentage in weight lost by room-dried bones after oven drying at 96°C. Based on the averages of the percentages as determined for each of the forty-two groups*

	ENTRIES 1-6, BODY WEIGHT 4-50	ENTRIES 7-12, BODY WEIGHT 50-100	ENTRIES 13-28, BODY WEIGHT 100-300	ENTRIES 29-42, BODY WEIGHT 300-500	AVERAGE FOR ALL BODY WEIGHTS
	<i>per cent</i>	<i>per cent</i>	<i>per cent</i>	<i>per cent</i>	<i>per cent</i>
Entire skeleton.....	8.38	8.26	8.38	8.35	8.34
Axial skeleton.....	8.24	8.62	8.23	8.38	8.37
Appendicular skeleton....	8.64	7.79	8.45	8.26	8.28
Shoulder girdle and fore limbs.....	9.74	8.10	8.35	8.13	8.58
Pelvic girdle and hind limbs.....	8.67	7.77	8.55	8.40	8.35
Cranium with teeth.....	8.64	9.13	8.83	8.89	8.87
Humerus (2).....	8.33	7.54	8.33	8.19	8.10
Ulna and radius (2).....	8.33	7.72	8.24	8.17	8.11
Femur (2).....	7.89	7.60	8.48	8.48	8.11
Tibia and fibula (2).....	7.65	7.75	8.55	8.17	8.00

water has been determined for the brain and spinal cord by Donaldson ('16). The values obtained by this study replace those previously published (Donaldson '10). The methods of removal are given on page 206. The rats were reared on a scrap diet. The fresh brain or cord was weighed in a closed bottle, then dried at 90°-95°C. until the dried weight was constant—and the difference taken as the amount of water.

By the use of formulas (47)-(49a) for the brain and formulas (50)-(52d) for the spinal cord, the values for table 157 after 10 days of age, were obtained and also those for the respective

graphs in chart 55. The data for the first 10 days are from direct observations. The percentage of water in the brain and spinal cord is linked with age and is not readily modified by nutritive conditions, nevertheless lung disease tends to lower the percentage of water in both the brain and the cord. King ('11). Degener ('22).

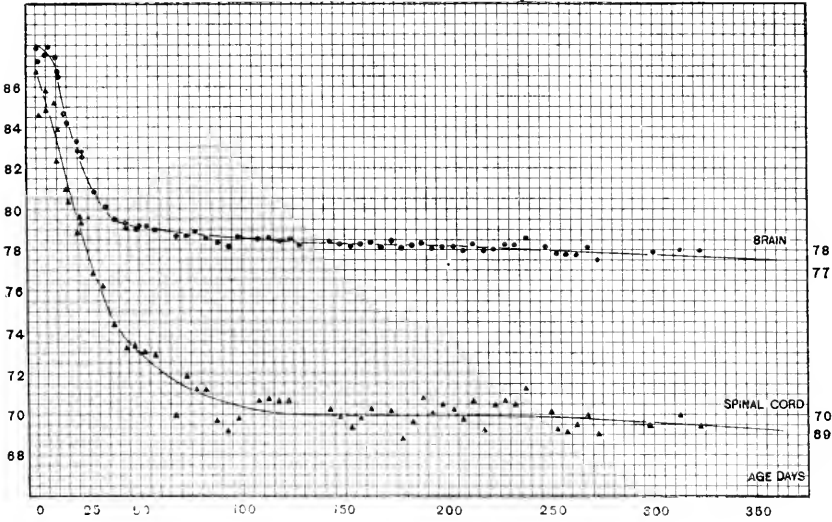

Chart 55 Showing the percentage of water on age in the central nervous system of the male albino rat. The upper graph gives the values for the water in the brain as determined by the formulas (Hatai—in 'The Rat,' Donaldson, 1915). The lower graph gives the corresponding values for the spinal cord determined in the same way. The small black dots indicate for the brain the corrected (observed) values for the several age groups, and these corrected values form the data on which the formulas have been based. The small black triangles have a like significance in relation to the spinal cord, (Donaldson '16). Formulas: Brain: (47)-(49 a), spinal cord: (50)-(52 d). Table 157.

4. *Correction for the percentage of water according to the absolute brain weight in each sex. Body weight normal to age.* Brains low in weight for the body weight on age (as shown in table 157) tend to have a *higher* percentage of water than appears there. Similarly, brains high in weight tend to have a *lower* percentage of water. When using table 157 for reference, correction may be made for the absolute brain weight at a given age when this

weight deviates from the table value. The correction factor is the same for both sexes and for a difference + or - of 0.001 gram in brain weight is respectively - or + 0.0013 per cent of water. The computed correction for the percentage of water is added to the table value in the case of a small (light) brain and subtracted in the case of a large (heavy) brain. These corrections do not apply to brains from rats less than 20 days of age, nor to excessive differences (more than  $\pm 15$  per cent) in brain weight. By the same procedure correction may be made for the percentage of water in the spinal cord according to its absolute weight. Table 165 gives the factors to be used.

*Body weight not normal to age.* Finally there is the not infrequent instance of body weights which depart widely from those for given ages in table 157. Where this departure is in excess the

TABLE 165

*Albino rat. Change in the percentage of water for each 0.001 gram of spinal cord weight as obtained from the comparison of the light and heavy cords in the same age group*

PHASE	AGE IN DAYS	CORRECTION FACTOR	
		Males	Females
1	10-58	0.010	0.008
2	58-365	0.009	0.007

absolute brain weight is that to be expected for the body weight. In this instance the percentage of water in the brain or cord characteristic for the age is to be taken as the basal value and corrected according to the deviation in the weight of the brain or cord by the use of the respective correction factors given under "Body weight normal to age."

A corresponding procedure applies in the case of rats with body weights low for age.

*Correction according to sex.* According to table 157 after 28 days of age the brain—and after 62 days the spinal cord also, weigh less in the female than in the male of like age.

When a comparison of the respective percentages of water is made after these limiting ages it is found that this is higher in both the brain and the cord of the female.

In this instance therefore the smaller nervous system (of the female) at a given age has a somewhat higher percentage of water, thus agreeing with the relations found between the small and large nervous systems within each sex at body weights normal to age.

Taking the male as the standard the relations found for the female are

Brain weight             $-0.001$  gram =  $+ 0.001$  percentage of water

Spinal cord weight    $-0.001$  gram =  $+ 0.008$  percentage of water

As will be noted these values are close to those for the correction factors within each sex.

#### GROWTH IN TERMS OF WATER AND SOLIDS: REFERENCES

*In the body as a whole.* Lowrey, '13. Hatai, '17.

*In the larger divisions.* Lowrey, '13.

*In Skeleton.* Donaldson and Conrow, '19. Lowrey, '13.

*In brain and spinal cord. Corrections and correction factors.* Cavazzani and Muzzioli, '12. Donaldson, '10, '11 a, '11 b, '16, '16 a, '16 b. King, '11. Weisbach, 1868.

## CHAPTER 9

### GROWTH OF CHEMICAL CONSTITUENTS

1. In the body as a whole. 2. Osseous system. 3. In the nervous system.

1. *In the body as a whole.* For the body as a whole Hatai ('17) has made a determination of its composition in terms of proteins,

TABLE 166  
*Giving the chemical composition of the albino rat—Hatai ('17)*

	AGE IN DAYS							
	Birth	7	15	22	28	35	42	294
Body, grams.....	4.3	10.2	13.5	24.9	47.3	52.5	65.8	277.5
Water, per cent.....	87.2	79.8	72.9	70.6	69.6	70.6	69.4	65.3
Solids, grams.....	0.6	2.1	3.7	7.3	14.4	15.5	20.1	96.4
Percentages of solids.....	12.8	20.2	27.1	29.4	30.4	29.4	30.6	34.7
Percentage of solids in								
Residue.....	56.9	42.0	39.9	38.8	38.6	44.9	44.4	44.5
Per cent of moist weight.	7.3	8.5	10.8	11.4	11.7	13.2	13.6	15.5
Fat.....	14.2	35.4	39.2	36.6	37.7	25.9	27.1	16.5
Per cent of moist weight.	1.8	7.2	10.6	10.8	11.5	7.6	8.3	5.7
Organic extract.....	16.4	12.8	12.8	14.8	13.8	18.6	16.9	28.2
Per cent of moist weight.	2.1	2.6	3.5	4.3	4.2	5.5	5.2	9.8
Soluble salts.....	6.6	4.6	3.0	3.2	3.3	1.5	2.7	2.5
Per cent of moist weight.	0.8	0.9	0.8	0.9	1.0	0.4	0.8	0.8
Fixed salts.....	5.9	5.2	5.2	6.7	6.5	9.2	8.9	8.3
Per cent of moist weight.	0.7	1.0	1.4	2.0	2.0	2.7	2.7	2.9

fat, organic extract and salts, at eight ages. The results are given in table 166 and Chart 56.

The following paragraphs define the terms used in table 166.

*Residue.* The residue is represented by the solids from which all the organic substances soluble in both boiling alcohol and in water, as well as the salts have

been removed. Thus the residue as here defined represents practically all the protein substances.

*Fat.* Fat is represented by the substances soluble in boiling alcohol from which the water soluble organic extractives and salts have been removed.

*Organic extractives.* All water soluble substances from which the salts were removed are called the organic extractives.

*Soluble salts.* The salts here designated were obtained from all the extractives with both water and alcohol.

*Fixed salts.* The solids from which fat, organic extractives and soluble salts had been removed were incinerated and the ash thus obtained is here called the fixed salts. Thus these fixed salts are practically all salts present in the osseous system.

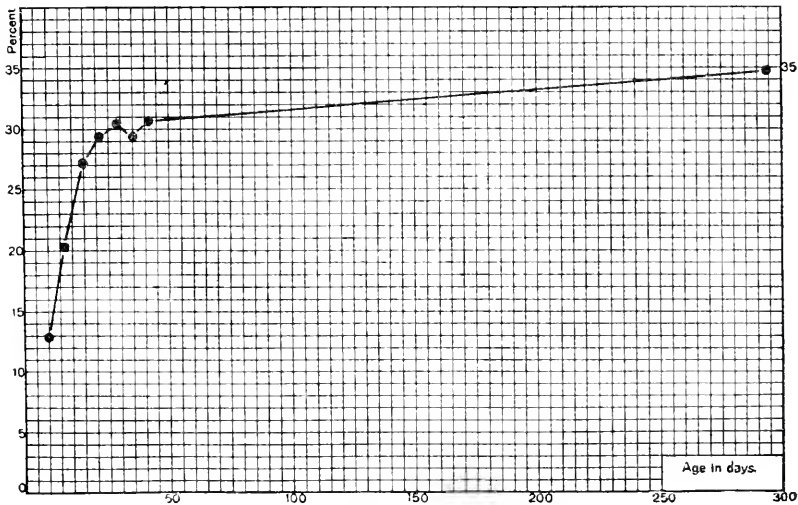

Chart 56. Showing the growth of the dry substance (solids) as a percentage of body weight, in the albino rat during the first third of its life span. Data in table 166. To be compared with the corresponding graph in chart 50.

Using the data for fat given in table 166, Moulton ('23) has computed the percentages of water and of ash in Hatai's series—on a fat free basis—including also observations by Zuntz ('18) at birth, and Inaba ('11) at maturity. These values are of course increased under such conditions.

In a study of the effect of antenatal feeding on the weight and composition of the young, Korenchevsky and Carr ('23a) used the following diets:

D 1, consisting of milk, cabbage, oats, bran and white bread.

N 2, containing a liberal amount of fat-soluble factor in the form of butter and cod-liver oil, 0.52 per cent Ca and 0.5 per cent P (in fresh diet).

-A, a diet similar to N 2, but deficient in fat-soluble factor, the only source of fat being cotton seed oil, and containing only 0.25 per cent Ca in the fresh diet.

TABLE 167  
*Average weights of mothers*

NUMBER OF MOTHERS	DIETS OF MOTHERS		WEIGHT OF MOTHERS	
	Before conception	During pregnancy	Four weeks before littering	After littering
14	N 2	N 2	grams 179	grams 212
16	D 1	-A or D 1	149	171

TABLE 168  
*Average weight and composition of the young at birth*

DIETS OF MOTHER		AVERAGE WEIGHT*		IN YOUNG						
Before conception	During pregnancy	Of one fresh young	Of one dry young	H <sub>2</sub> O per cent	Ca per cent		P per cent		N per cent	
					Fresh	Dry	Fresh	Dry	Fresh	Dry
N 2	N 2	grams 4.71	grams 0.64	86.31	0.31	2.26	0.30	2.12	1.60	11.70
N 2	N 2	4.90	0.68	86.32	0.30	2.19	0.32	2.34	1.65	12.06
D 1	-1	4.64	0.66	85.97	0.35	2.49	0.35	2.49	1.73	12.33
D 1	D 1 or -A	4.70	0.66	86.24	0.31	2.25	0.30	2.18	1.65	11.99

\* The figures in these two columns represent the weights of the young after removal of stomach and intestines.

Their results appear in tables 167 and 168.

In the course of a study on the influence of diet on the teeth and bones, Toverud ('23) has determined the inorganic constituent in newborn rats from normal mothers,—table 169.

In connection with a study of the phosphorus compounds in the Albino after ovariectomy Heymann ('04) has recorded the P<sub>2</sub>O<sub>5</sub> distribution in the normal rat (see Keith and Forbes, '14). His data for the normal appear in table 170.



(a) *Organs and tissues.* Hatai ('17) has determined the total nitrogen as well as the non-protein nitrogen in several organs of the adult albino—table 171.

TABLE 169

*Inorganic constituents in new born rats from normal mothers. Average of two rats (Toverud '23)*

ASH ON BODY WEIGHT	Ca ON BODY WEIGHT	Ca ON ASH	P ON BODY WEIGHT	P ON ASH	Mg ON BODY WEIGHT	Mg ON ASH
<i>per cent</i>	<i>per cent</i>	<i>per cent</i>	<i>per cent</i>	<i>per cent</i>	<i>per cent</i>	<i>per cent</i>
1.576	0.2705	17.16	0.267	16.88	0.0218	1.395

TABLE 170

*Giving the distribution of phosphorus in the albino rat (Heymann, '04)*

	TISSUES, PER CENT OF DRY SUBSTANCE				BONES, PER CENT TOTAL P <sub>2</sub> O <sub>5</sub>		BONES AND TISSUES TOTAL P <sub>2</sub> O <sub>5</sub>
	Lecithin P <sub>2</sub> O <sub>5</sub>	Nuclein P <sub>2</sub> O <sub>5</sub>	Phosphate P <sub>2</sub> O <sub>5</sub>	Total P <sub>2</sub> O <sub>5</sub>	Fresh substance	Dry substance	Per cent of total body weight
Normal . . . .	0.4760	0.0559	2.4479	2.9798	21.2690	24.0556	1.9819
Normal . . . .					18.1665	22.8105	1.2980
Normal . . . .	0.3242	0.0649	1.6490	1.9830*	17.0315	19.2083	?
Normal . . . .	0.3608	0.0979	1.5430	2.0018	17.5724	19.9277	1.3795

\* Apparently erroneous since the sum of the figures for nuclein, lecithin and phosphate phosphorus is 2.0381 per cent.

TABLE 171

*Showing the total nitrogen as well as non-protein nitrogen in several organs of the adult albino rat*

	TOTAL NITROGEN IN FRESH TISSUE	NON-PROTEIN NITROGEN PER 100 GRAMS FRESH TISSUE	NON-PROTEIN NITROGEN TO TOTAL NITROGEN	AGE
	<i>per cent</i>	<i>mgm.</i>	<i>per cent</i>	<i>days</i>
Brain . . . . .	1.953	159	8.168	143
Testes . . . . .	1.729	170	9.806	143
Liver . . . . .	3.435	182	5.332	143
Kidneys . . . . .	3.243	229	7.572	143
Blood . . . . .	3.093	35	1.134	241

Calcium in the blood has been determined on three normal adult rats, Toverud ('23), table 172.

*Composition of milk.* By carefully collecting the stomach contents immediately after ingestion from albino rats 1-14 days

old, Hatai ('17) has sought to determine the composition of the milk in this animal. The average results are given in table 173.

2. *Osseous system.* The gross chemical composition of the humerus and femur in the male and female albinos, at two ages has been determined by Hammett ('23). Tables 174 and 175 show the values with the statistical constants.

TABLE 172  
*Calcium in blood serum. Three male mature rats on a mixed diet*

RAT	CALCIUM IN 100 CC. OF SERUM	
	<i>mgm.</i>	
C	11.1	
D	11.1	
E	12.0	

TABLE 173  
*Composition of rat milk (Hatai '17)*

	COMPOSITION			
	Water	Solids	As per cent of solids	As per cent of moist weight
	<i>per cent</i>	<i>per cent</i>		
	54.3	45.7		
Solids comprise:				
Residue.....			22.1	10.1
Fat.....			69.1	31.6
Organic Extracts.....			5.3	2.4
Salts : Soluble.....			2.0	0.9
Salts : Fixed.....			1.5	0.7
Total.....			100.0	45.7
Total ash.....			3.5	1.6
Ash in lipid-free solids.....			11.1	
Ash in residue.....			6.2	

The differences according to age are evident. The differences according to sex are in part at least to be referred to the more rapid development of the female.

In a study on the salt content of the bones (Hammett, '23) found the relations in the normal humerus and femur to be as in table 176.

With regard to the data in this table 176 Hammett ('23 g) makes the following comment :

At 100 days of age the percentage value of calcium, magnesium, and phosphorus of the humerus ash is practically the same as that of

TABLE 174

*The statistical data of the gross chemical composition of the humerus and femur of the normal male rats in terms of fresh weight at two ages*

	FRESH WEIGHT	DRY WEIGHT	H <sub>2</sub> O		ORGANIC MATTER		ASH	
<i>100 days of age, 11 rats</i>								
Humerus								
	<i>grams</i>	<i>grams</i>	<i>grams</i>	<i>per cent</i>	<i>grams</i>	<i>per cent</i>	<i>grams</i>	<i>per cent</i>
M.....	0.1847	0.1100	0.0747	40.70	0.0397	21.49	0.0703	37.81
S. D.....	0.0272	0.0132	0.0079	2.06	0.0059	1.18	0.0138	1.93
P. E. M...	0.0055	0.0027	0.0016	0.42	0.0012	0.24	0.0028	0.39
C. V.....	14.73	12.00	10.58	5.05	14.86	5.49	19.63	5.10
Femur								
M.....	0.4050	0.2342	0.1709	42.68	0.0884	21.74	0.1457	35.58
S. D.....	0.0644	0.0522	0.0147	3.41	0.0165	0.69	0.0358	2.87
P. E. M...	0.0131	0.0106	0.0030	0.69	0.0034	0.14	0.0073	0.58
C. V.....	15.90	22.29	8.60	8.00	18.67	3.17	24.57	8.05
<i>150 days of age, 11 rats</i>								
Humerus								
M.....	0.2398	0.1548	0.0849	35.68	0.0525	21.47	0.1031	42.85
S. D.....	0.0257	0.0211	0.0086	3.13	0.0072	1.33	0.0153	2.41
P. E. M...	0.0052	0.0043	0.0017	0.64	0.0015	0.27	0.0031	0.49
C. V.....	10.72	13.63	10.13	8.78	13.71	6.19	14.84	5.62
Femur								
M.....	0.5300	0.3361	0.1939	36.72	0.1222	23.06	0.2140	40.21
S. D.....	0.0612	0.0469	0.0192	2.50	0.0143	0.95	0.0342	2.80
P. E. M...	0.0124	0.0095	0.0039	0.51	0.0029	0.19	0.0069	0.57
C. V.....	11.55	13.95	9.90	6.81	11.70	4.12	15.98	6.96

the femur, notwithstanding the markedly heavier ash and greater absolute amount of the three constituents in the latter. There is, however, a slight but valid superiority in the percentage of phosphorus exhibited by the femur. Since this is present in both sexes, and is shown in all the groups, it is undoubtedly significant.

At 100 days of age no significant sex difference is exhibited in the percentage of magnesium and phosphorus. The percentage of calcium in the ash of both bones, however, is greater in the females than in the males. This sex difference is an accompaniment of the more advanced state of ossification of the bones in the females as shown by their higher percentage of ash. (Hammett '24 a)

TABLE 175

*The statistical data of the gross chemical composition of the humerus and femur of normal female rats at two ages*

	FRESH WEIGHT	DRY WEIGHT	H <sub>2</sub> O		ORGANIC MATTER		ASH	
<i>100 days of age, 10 rats</i>								
Humerus								
	<i>grams</i>	<i>grams</i>	<i>grams</i>	<i>per cent</i>	<i>grams</i>	<i>per cent</i>	<i>grams</i>	<i>per cent</i>
M. . . . .	0.1732	0.1110	0.0623	36.07	0.0380	21.92	0.0729	42.01
S. D. . . . .	0.0144	0.0121	0.0052	2.80	0.0035	0.46	0.0087	2.46
P. E. M. . . . .	0.0031	0.0026	0.0011	0.60	0.0007	0.10	0.0019	0.53
C. V. . . . .	8.31	10.90	8.35	7.77	9.21	2.11	11.93	5.87
Femur								
M. . . . .	0.3818	0.2388	0.1431	37.65	0.0849	22.23	0.1539	40.12
S. D. . . . .	0.0422	0.0337	0.0152	3.32	0.0099	0.79	0.0241	2.86
P. E. M. . . . .	0.0090	0.0072	0.0032	0.80	0.0021	0.17	0.0051	0.61
C. V. . . . .	11.05	14.11	10.62	8.83	11.66	3.57	15.66	7.13
<i>150 days of age, 11 rats</i>								
Humerus								
M. . . . .	0.2090	0.1433	0.0657	31.58	0.0472	22.59	0.0962	45.83
S. D. . . . .	0.0308	0.0231	0.0085	2.02	0.0068	0.69	0.0166	2.17
P. E. M. . . . .	0.0063	0.0047	0.0017	0.41	0.0014	0.14	0.0034	0.44
C. V. . . . .	14.74	16.12	12.94	6.40	14.41	3.04	17.26	4.74
Femur								
M. . . . .	0.4584	0.3064	0.1521	33.44	0.1058	23.13	0.2006	43.43
S. D. . . . .	0.0752	0.0576	0.0193	2.29	0.0164	0.88	0.0418	2.63
P. E. M. . . . .	0.0153	0.0117	0.0039	0.47	0.0033	0.18	0.0085	0.54
C. V. . . . .	16.40	18.80	12.69	6.85	15.50	3.82	20.84	6.06

At 150 days of age the identity of the humerus and femur ash in calcium and magnesium percentage, the superiority of the femur in percentage of phosphorus, and the higher percentage of calcium in the bones of the females are shown, as at 100 days of age, and are similarly interpretable.

TABLE 176  
*Statistical data of the calcium, magnesium, and phosphorus content of the ash of the humerus and femur at two ages*

HUMERUS		FEMUR											
Ash	Calcium	Magnesium	Phosphorus	Ash	Calcium	Magnesium	Phosphorus						
<i>Male rats</i>													
100 days old, 11 rats													
<i>gm.</i>	<i>mg.</i>	<i>per cent</i>	<i>mg.</i>	<i>per cent</i>	<i>gm.</i>	<i>mg.</i>	<i>per cent</i>						
M.....	0.0703	26.30	0.600	0.85	12.91	18.34	0.1457	54.45	37.32	1.258	0.86	27.03	18.54
S. D.....	0.0138	5.19	0.133	0.05	2.65	0.33	0.0358	13.61	0.31	0.381	0.06	6.69	0.27
P. E. M.....	0.0028	1.06	0.027	0.01	0.54	0.07	0.0073	2.77	0.06	0.077	0.01	1.36	0.05
C. V.....	19.63	19.74	22.20	6.13	20.53	1.79	24.57	25.00	0.83	30.28	7.49	24.73	1.43
150 days old, 11 rats													
M.....	0.1031	38.73	0.899	0.86	18.87	18.25	0.2140	80.38	37.53	1.754	0.82	39.92	18.32
S. D.....	0.0153	5.88	0.199	0.09	3.09	0.58	0.0342	13.22	0.57	0.279	0.08	6.58	0.58
P. E. M.....	0.0031	1.20	0.041	0.02	0.63	0.12	0.0069	2.69	0.12	0.057	0.02	1.34	0.12
C. V.....	14.84	15.18	22.15	10.58	16.39	3.20	15.98	16.45	1.52	15.89	9.73	16.48	3.13
<i>Female rats</i>													
100 days old, 10 rats													
<i>gm.</i>	<i>mg.</i>	<i>per cent</i>	<i>mg.</i>	<i>per cent</i>	<i>gm.</i>	<i>mg.</i>	<i>per cent</i>						
M.....	0.0729	27.57	0.605	0.84	13.47	18.47	0.1539	57.99	37.66	1.291	0.84	28.56	18.57
S. D.....	0.0087	4.20	0.051	0.06	1.58	0.15	0.0241	9.37	0.37	0.178	0.05	4.44	0.20
P. E. M.....	0.0019	0.90	0.011	0.01	0.34	0.03	0.0051	2.00	0.08	0.038	0.01	0.95	0.04
C. V.....	11.93	15.25	8.48	6.60	11.75	0.81	15.66	16.16	0.98	13.82	5.62	15.53	1.07
150 days old, 11 rats													
M.....	0.0962	36.36	0.826	0.85	17.60	18.29	0.2006	75.85	37.76	1.703	0.85	37.01	18.45
S. D.....	0.0166	5.84	0.60	0.16	3.22	0.78	0.0418	15.92	0.48	0.429	0.10	8.36	0.50
P. E. M.....	0.0034	1.19	0.12	0.050	0.66	0.16	0.0085	3.21	0.10	0.087	0.02	1.70	0.10
C. V.....	17.26	16.06	29.69	18.94	18.31	4.27	20.84	20.99	1.26	25.20	12.25	22.59	4.92

The sex differences in absolute amounts of ash, and of calcium, magnesium, and phosphorus of the ash at both ages are too small to be individually valid, yet the consistency of the direction of deviation shows that the bones of the females at 100 days of age have absolutely greater amounts of ash, calcium, magnesium, and phosphorus than do those of the males, and that at 150 days the conditions are reversed. The correctness of this supposition is supported by the fact that the rate of growth of the humerus and femur in the male rats during the period of observation is greater than that of the females in weight, length, water, organic matter, ash, calcium, magnesium, and phosphorus.

There is apparently a slight difference between the results given in table 176 and those obtained when the diaphysis alone is analysed (Toverud, '23) table 177 (1). This latter table contains also the corresponding data (2) for the molar teeth and (3) for the incisors.

TABLE 177

*Inorganic constituents of the femur and teeth (Toverud, '23)*

(1) Analysis of bones (Diaphysis of femur).

Average from three mature rats—two males, one female—fed on normal mixed diet.

(2) Analysis of molar teeth.

(3) Analysis of incisor teeth.

ASH OF DRY BONE	Ca OF DRY BONE	Ca OF ASH	P OF DRY BONE	P OF ASH	Mg OF DRY BONE	Mg OF ASH
<i>per cent</i>	<i>per cent</i>	<i>per cent</i>	<i>per cent</i>	<i>per cent</i>	<i>per cent</i>	<i>per cent</i>
(1) 67.5	26.0	39.0	11.9	17.8	0.51	0.75
Dry teeth	Dry teeth		Dry teeth		Dry teeth	
(2) 78.4	30.7	39.6	14.5	18.6	0.46	0.61
(3) 78.5	28.9	36.8	14.9	19.1	1.67	2.12

On a calcium deficient diet a decrease in total ash and calcium oxide occurs in all the tests made, Toverud ('23). The occurrence of this change in the permanent molar teeth is especially worthy of note.

3. *In the nervous system.* With the purpose of following the changes in the chemical constituents of the brain with advancing age, Koch, W. and M. L. ('13 a) have made a series of observations and to these have been added also observations on one spinal cord at 120 days. The results are given in tables 178 and 179.

In chart 57 are given the graphs for the absolute weights of the more important chemical constituents of the brain plotted on age (see table 179).

*Ord of the albino rat.*  
(Inserted for comparison.)

TABLE 175  
*Chemical composition of the brain of the albino rat at different ages. Duplicate analyses*

Age in days.....	1	10	20	40	120	210	120
Body weight in grams.....	5.5	12	20	43	112.3	182	112.3
Moist weight of one brain in grams.....	0.250	0.860	1.228	1.397	1.368	1.667	0.365
Solids in per cent.....	10.420	14.700	17.500	20.100	20.580	21.600	27.100
Dry weight of one brain in grams.....	0.026	0.127	0.215	0.233	0.282	0.358	0.099
Number of brains in sample.....	100	40	48	37	34	31	90

*Constituents in per cent of solids*

Proteins.....	58.20	56.40	53.90	52.70	48.70	48.10	47.20	48.00	48.50	32.80
Phosphatides.....	14.80	10.60 (?)	21.10	21.70	20.00	23.20	21.90	21.30	22.00	25.30
Cerebrosides.....	*	*	3.10	2.90	6.30	5.50	6.60 (?)	8.40	8.40†	12.50
Sulphatides.....	1.50	0.73 (?)	2.60	2.40	2.70	2.40	3.50	3.60	4.50	7.00
Organic extractives.....	16.50	19.30	15.10	13.80	13.80	15.90	9.70	9.80	9.80†	7.60
Inorganic constituents.....	9.00	13.00	5.70	4.80	8.00	4.90	11.10	8.90	6.80	14.80
Cholesterol (undetermined)†.....	0.96	1.04	0.72	0.83	0.69	0.70	0.58	0.57	0.58	0.45
Total sulphur.....	1.82	1.92	1.28	1.48	1.66	1.55	1.40	1.44	1.39	1.44

*Distribution of sulphur in per cent of total S*

Protein S.....	31.1	30.0	48.6	44.2	57.5	65.1	62.4	61.2	62.4	63.8	53.6
Lipoid S.....	3.2	2.8	2.2	6.1	6.7	7.5	10.1	12.8	12.5	15.6	30.9
Neutral S.....	49.1	47.3	45.1	45.4	29.7	17.0	19.3	19.2	18.3	14.5	10.3
Inorganic S.....	16.6	19.9	4.1	4.3	6.1	8.7	8.2	6.8	6.8	6.1	5.1

*Distribution of phosphorus in per cent of total P*

Protein P.....	13.3	13.0	13.9	6.0	5.8	9.9	7.5	7.4	7.3	6.8	5.6
Lipoid P.....	33.2	33.8	36.1	52.2	53.5	56.1	58.5	65.8	62.3	67.6	77.4
Water Sol. P.....	53.5	53.6	50.0	41.8	40.7	34.0	34.0	26.8	30.4	25.6	17.0

\* Cerebrosides not determined in brains at birth and 10 days. Probably none present at this age.

† By difference. ? Indicates doubtful result. ‡ Taken from preceding entry.

TABLE 179

*Absolute weights, in milligrams, of the constituents of a single brain of the albino rat at different ages (prepared from Table 178)*

	AGE IN DAYS					
	1	10	20	40	120	210
Moist weight of one brain in grams.....	0.250	0.860	1.280	1.380	1.600	1.670
Solids in per cent....	10.420	12.500	17.500	20.340	21.650	21.900
Dry weight of one brain in grams.....	0.026	0.107	0.224	0.281	0.347	0.365

*Absolute weights in milligrams*

Proteins (1)‡.....	15.14*	60.45†	119.40*	136.00*	165.20*	177.00†
Phosphatides (2)....	3.95	13.16	47.90	61.30	74.95	80.30
Cerebrosides (3)....			6.70	16.60	29.15	30.66
Sulphatides (4)....	0.38	2.78	5.60	7.20	12.30	16.40
Organic extrac- tives.....	4.65	16.16	32.60	41.70	33.80	35.80
Inorganic constit- uents.....						
Cholesterol unde- termined (5)....	1.87	(14.45)	11.70	18.20	31.60	24.80
Total sulphur.....	0.26	0.90	1.57	1.54	1.94	2.12
Total phosphorus....	0.48	1.60	3.72	4.30	4.93	5.07

*In absolute weight in milligrams of sulphur*

Protein S (1S)§.....	0.079	0.398	0.885	0.982	1.199	1.352
Lipoid S (4).....	0.008	0.054	0.111	0.149	0.246	0.330
Neutral S (6).....	0.125	0.409	0.449	0.279	0.363	0.307
Inorganic S (7).....	0.047	0.039	0.122	0.130	0.132	0.129

*In absolute weight in milligrams of phosphorus*

Protein P (1P).....	0.064	0.215*	0.220	0.374	0.360	0.345
Lipoid P (2).....	0.161	0.558	1.964	2.464	3.160	3.427
Water sol. P (8)....	0.260	0.826	1.532	1.462	1.410	1.298

\* Record from average: duplicate analyses.

† Record from one analysis.

‡ Figures in parentheses in this section refer to Chart III. See original.

§ Figures in parentheses in this and the following sections refer to Chart IV. See original.



*Nitrogen Content.* Using trichloroacetic acid for extracting water soluble organic substances from nerve tissue, Hatai ('17 a) has determined the content of total nitrogen and of non-protein nitrogen in the entire brain of the Albino at different ages. The data are arranged in table 180.

In chart 58 a graph is presented for the non-protein nitrogen per gram of dried brain at different ages.

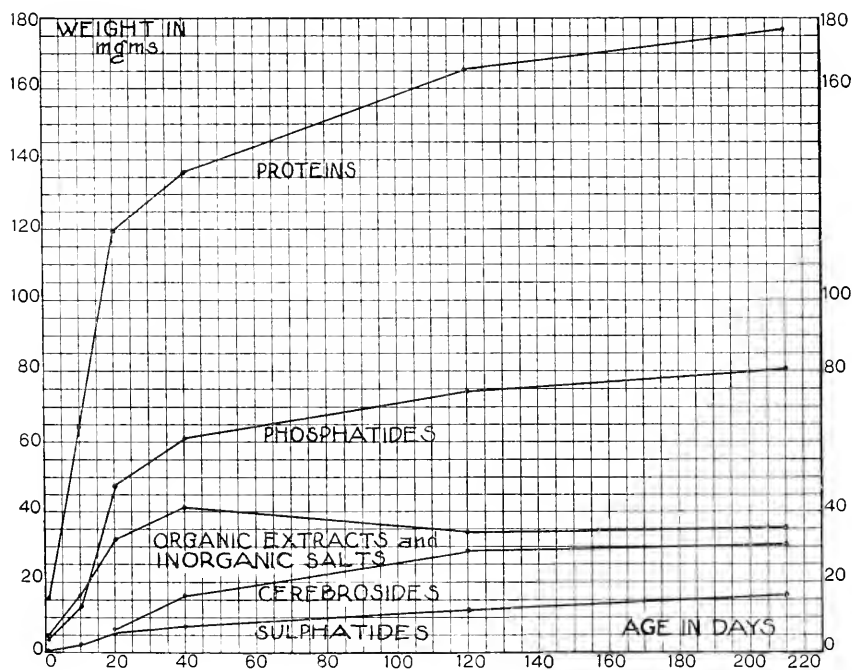

Chart 57. Giving in milligrams the absolute weight of the more important chemical constituents of the brain. Plotted on age. Table 179.

Hatai ('17 a) followed at two ages the distribution of nitrogen in the three divisions of the brain and in the spinal cord. His results are given in tables 181 and 182.

When the lipoids have been removed (Hatai, '17 a) it appears that in the several divisions of the nervous system the relation between the protein nitrogen and the nitrogen content of the extractives is nearly constant as shown in table 183.

TABLE 180

Showing the content of total nitrogen as well as non-protein nitrogen in the entire brain of the albino rat at different ages

(a)	(b)	(c)	(d)	(e)	(f)	(g)	(h)	(i)	(j)	(k)
BODY WEIGHT	BRAIN WEIGHT	WATER IN BRAIN	SOLIDS	TOTAL NITROGEN IN ENTIRE BRAIN	NON-PROTEIN NITROGEN IN ENTIRE BRAIN	TOTAL NITROGEN TO SOLIDS	NON-PROTEIN NITROGEN TO TOTAL NITROGEN	NON-PROTEIN NITROGEN PER GRAM OF SOLIDS	MEAN AGE	NUMBER OF RATS USED
grams	grams	per cent	grams	mgm.	mgm.	per cent	per cent	mgm.	days	
4.8	0.231	88.30	0.027	3.07	0.38	11.40	12.33	14.1	1	45
7.1	0.459	88.75	0.052	5.73	0.71	11.08	12.38	13.7	5	32
9.5	0.598	88.13	0.071	7.70	0.91	10.86	11.81	12.8	7	17
17.9	1.175	84.90	0.177	18.28	1.63	10.30	8.89	9.2	15	12
26.7	1.284	80.86	0.246	23.70	2.11	9.65	8.91	8.6	24	6
34.8	1.379	80.26	0.272	26.21	2.22	9.63	8.48	8.2	35	6
66.6	1.508	79.58	0.308	28.00	2.42	9.09	8.64	7.9	54	6
156.6	1.762	78.89	0.372	33.72	2.63	9.07	7.81	7.1	116	6
161.4	1.803	78.43	0.389	34.13	2.59	8.78	7.58	6.7	274	6
185.5	1.858	78.00	0.409	35.94	2.89	8.79	8.04	7.1	382	6

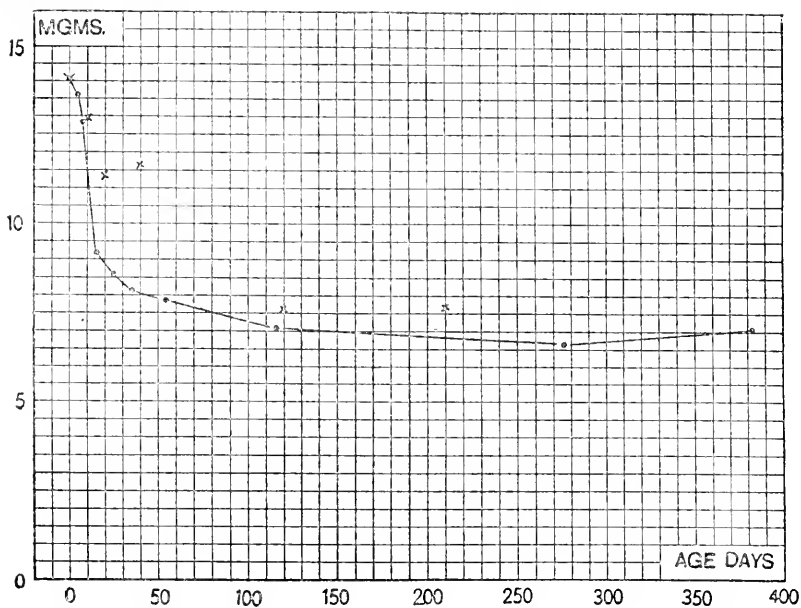

Chart 58. Showing the number of milligrams of non-protein nitrogen per gram of the dried brain at different ages. The chart shows also the proportional value of organic extractives together with inorganic salts in the brain of the albino rat, as determined by W. Koch and M. L. Koch ('13). —•— Non-protein nitrogen, × organic extractives and inorganic salts.

TABLE 181

*Showing the nitrogen content in the non-proteins, the amino acids, the urea and the ammonia in four different parts of the central nervous system of the albino rat*

ALBINO RAT	MILLIGRAMS OF NITROGEN PER GRAM OF TOTAL SOLIDS					
	106 days old				One year old	
	Non-proteins	Amino acids	Urea	Ammonia	Non-proteins	Amino acids
Cerebellum.....	8.61	3.62	0.98	0.93	7.08	2.74
Cerebrum.....	8.53	3.67	0.57	0.77	6.98	3.06
Stem.....	6.04	2.91	0.65	0.58	4.86	1.74
Spinal cord.....	5.26	2.38	0.47	0.53	4.08	1.48

TABLE 182

*Showing the water content, the total nitrogen in solids, lipoids in solids and also nitrogen content in lipoids in different parts of the central nervous system*

ALBINO RAT	106 DAYS OLD				ONE YEAR OLD	
	Water	Nitrogen to total solids	Lipoids to total solids	Lipoid nitrogen to total nitrogen	Water	Nitrogen to total solids
	<i>per cent</i>	<i>per cent</i>	<i>per cent</i>	<i>per cent</i>	<i>per cent</i>	<i>per cent</i>
Cerebellum.....	79.36	10.10	42.13	17.63	78.41	9.18
Cerebrum.....	79.38	9.51	42.36	17.22	78.38	9.09
Stem.....	75.16	7.75	55.03	19.90	73.14	7.06
Spinal cord.....	72.23	6.38	62.03	20.11	69.00	5.90

TABLE 183

*Showing percentage of nitrogen in the various nitrogenous organic extractives in relation to the lipoid free solids (protein) in different parts of the central nervous system, together with the percentage of water*

ALBINO RAT 106 DAYS OLD	PERCENTAGE OF NITROGEN TO PROTEIN NITROGEN				PERCENTAGE OF WATER TO LIPOID-FREE DIVISION
	Non-proteins	Amino acids	Urea	Ammonia	
Cerebellum.....	10.34	4.35	1.17	1.11	86.92
Cerebrum.....	10.49	4.51	0.70	0.94	86.99
Stem.....	9.72	4.68	1.05	0.94	87.06
Spinal cord.....	10.33	4.67	0.93	1.04	87.26
Averages.....	10.22	4.55	0.96	1.01	87.06

The value for the percentage of water (table 183) is similar in the several divisions and nearly as high as that in the brain and cord at birth. Thus the water-solids relation is not significantly altered in older rats, if the lipoids are excluded from consideration. These results further confirm the conclusion of Donaldson ('16) that the reduction of the percentage of water in the nervous system with advancing age is due mainly to the accumulation of myelin in it.

#### GROWTH IN CHEMICAL CONSTITUENTS: REFERENCES

*In the body as a whole.* Buckner and Peter, '22. Bunge, '02. Cameron, '14. Hatai, '17. Heymann, '04. Inaba, '11. Korenchevsky and Carr, '23 a. Lander, '15. Lund, Shaw and Drinker, '21. McCollum, '09. Mendel and Daniels, '12. Pembrey and Spriggs, '04.

*Osseous system.* Hammett, '23 g. Toverud, '23.

*In the nervous system.* von Bibra, 1854. Hatai 17 a. Koch, M. L., '13. Koch and Mann, '09. Koch and Koch, '13, '13 a.

## CHAPTER 10

### PATHOLOGY

1. General. 2. Rat diseases. 3. Toxicology. 4. References to Literature.

1. *General.* In the various studies on the pathology of the rat there are, of course, some data, which might be tabulated or charted. It has been thought best, however, to adhere to our general plan of treating in detail the data for the normal animal only and the presentation in this chapter is therefore mainly to a series of references, including those on the Norway as well as the Albino, classified according to the subheads there given.

Touching the value of the rat for pathological studies the following citations are given.

The value of the rat as an experimental animal was impressed upon one of us five years ago when studying, in association with Dr. F. B. Mallory, the lesions produced by a typhoid-like organism, Danyysz virus, or *B. typhi murium*. The likeness between these histological changes and those occurring in typhoid fever in man were striking (Mallory and Ordway, '09).

The intimate relation of the rat to man, as an intermediary host in certain diseases, the similar omnivorous character of its diet, the natural occurrence and experimental production of morbid conditions similar to those occurring in man make the rat not only an important animal to study in its relation to the public health, as has been done so ably by the United States Public Health and Marine Hospital service, but in its relation to general and special problems of disease, from the physiological and the chemical, as well as from the anatomical and histological point of view (Ordway and Morris, '13).

2. *Rat diseases.* The commonest ailment is a lung infection, often designated as "rat pneumonia." Studies on this have been made by Hektoen '16; Tunnicliff '16; Jones '22 and a number of others.

This disease occurs in the wild Norway as well as in the Albino. It seems less frequent in Albinos allowed to exercise, but is

very commonly present in all rats over two years of age. In some colonies middle ear infection frequently occurs and produces disequilibrium and circular movements. Such rats when held up by the tail execute a spinning movement. This is diagnostic. In the Institute colony at present middle ear disease is found in about one per cent of the animals.

These two ailments are the most common ones observed. From time to time animals come to autopsy with organs missing on one side and other defects, both congenital and acquired, but a detailed study of these has yet to be made.

3. *Toxicology.* The studies of Hammett and Nowrey ('22 b) show that with advancing age there is a progressive diminution in the resistance of the albino rat to death from arsenic poisoning. A dose of 11 mgm. per kilo or over of arsenic trioxide is fatal to young rats of 60 to 90 days of age. By the time the animals have reached the age of 120 to 150 days a dose of 9 mgm. is fatal. When they are 210 to 240 days old, 8 mgm. is the amount which produces death within 24 hours in the average animal.

These differences in susceptibility with age are attributable in large part to differences in metabolic rates.

It is to be noted also that the proportional weight of the abdominal and thoracic viscera *decreases* in nearly the same proportion that the fatal dose decreases.

#### PATHOLOGY: REFERENCES

*Pathology general.* Advisory Committee, '12 a. Alexander, '01. Ascher, '10. Aumann, '12. Aunett, '08. Bainbridge, '09. Berthelot and Bertrand, '12. Bircher, '11. Bradley and Sansum, '14. Carini, '15. Czerny, 1890. Davis, '16. Dobell, '13. Emmett and Allen, '20. Hirschfelder, Hart and Kucera, '20. Klein, '02, '06. Kulyosha, 1899. Langhans and Wegelin, '19. McCollum, Simmonds and Kinney, '22. McCoy, '08 a. Mallory and Ordway, '09. Merezchkovski, '03. Mereshkowsky and Sarin, '09. Metschnikoff and Roux, 1891. Nerking, '09. Nierenstein, '12. Noguchi, '19. Ochsner and Thompson, '10. Ophüls, '11. Ordway and Morris, '13. Osborne and Mendel, '17b. Pappenheimer and Larimore, '23. Reed, '00. Rous and Jones, '16. Safford, '18. Schern, '09. Schilling, '00. Schürmann, '08. Smith, '21. Suzuki, '04. Tartakovski, '02. Tenbroeck, '18. Trautmann, '06. Wherry, '08 b. Wiener, '02. Wobach, Chapman and Stevens, '15. Xylander, '06.

*Malformations.* Conrow, '15, '17, '17 a.

*Pathology experimental.* Akaiwa, '19, '19 a. Amoss and Haselbauer, '18. Boyenval, '22. Brown, '15. Brown and Pearce, '19, '19 a. Bullock, Curtis and Rohdenburg, '20. Charrin and Roger, 1890. Dragstedt and Cooper, '23. Duval, 1890. Edie, Moore and Roaf, '10. Finlay, '24. Flexner and Noguchi, '06. Funk, '16. Graham and Hutchison, '14. Hagan, '22. Hatai, '18 a. Hektoen, '14. Horton, '05. Jellinek, '23. Kohman, '20. Kolmer, Yui and Tyau, '13. Koppányi, '23, '23 a, '23 b. Larson and Bell, '15. Levene and Muhlfeld, '23. Levin, '07. Lewis and Margot, '14. Loeb, '18, '18 a, '21. Longcope, '22. McCollum, Simmonds, Shipley and Park, '21 c. Macklin, '19. Meller, '23. Mereshkowsky, '12, '12 a. Mitchell and Group, '19. Montgomery, '23. Moore, Nierenstein and Todd, '07. Murphy and Sturm, '23. Nittono, '23. Oliver, '15. Opie and Alford, '15, '15 a. Oslund, '24. Pappenheimer, '17 a. Parsons, '20. Pearce and Brown, '18, '19, '21. Philippeaux, 1867. Plimmer and Thomson, '08. Podwysozki, 1886. Przibram, '22, '23 b. Read, '19. Remlinger, '04. Rowland, '11. Scott, Duncan and Barcroft, '23. Souza and McCollum, '20. Steffenhagen, '10. Voegtlin and Lake, '19. Walter, '23. Woolley, DeMar and Clark, '15. Zlocisti, '17.

*Endocrine glands.* Bircher, '10, '11 a. Burget, '17. McCarrison, '14, '14 a. McClendon and Williams, '23. Messerli, '14. Stoland, '12.

*Radiation.* Bagg, '22. Baldwin, '23. Bergonié and Tribondeau, '04. Cramer and Drew, '23. Goldblatt and Soames, '23, '23 b. Hanson, '23. Hewer, '16 a. Hume and Smith, '23. Mottram and Russ, '21. Mottram, Cramer and Drew, '22. Mottram and Cramer, '23. Murphy, '14. Murphy, Liu and Sturm, '22. Russ and Chambers, '13. Sheets and Funk, '22. Taylor, Witherbee and Murphy, '19. Warren and Whipple, '23. Zilva, '19.

*Pharmacology.* Barbour and Maurer, '20. Bonar and Sollmann, '22. Chandler, '19. Hammett, '21. Hammett, Nowrey and Müller, '22. Hammett and Nowrey, '22. Hatcher, '09. Hildebrandt, '22. Kinney and McCollum, '23. Kolmer, '21. Kuriyama and Mendel, '17. Macht and Bloom, '20 a. Oliver, '22. Raiziss, Kolmer and Gavron, '19. Schwartz, '21. Schwartz and Alsborg, '23. Thomson and Cushny, '10. Voegtlin and Smith, '20. Voegtlin, Leonard and Dyer, '23.

*Toxicology.* Arlitt and Wells, '17. Bordas, '04. Cooper, '23 a. Gies, '20. Hammett, Müller and Nowrey, '22 a. Hammett and Nowrey, '22 b. Hanson and Handy, '23. Lake, '18. Langlois and Loir, '02. Loeb, '13. Lewis, '23 a. Macht, '23. Martin, 1895. Mavrojannis, '03. Oppenheimer and Spaeth, '22. Roth, '18. Salant, Rieger and Treuthardt, '14. Schamberg, Kolmer and Raiziss, '20. Schwartz, '20, '22, '22 a, '22 b, '22 c. Sollmann, '21. Swain and Bateman, '09. Symes and Gardner, '15. Underhill and Kapsinow, '22. Voegtlin and Dunn, '23. Willberg, '14.

*Intestinal flora and fauna.* Cheplin and Rettger, '20. Distaso and Sugden, '19. Hegner, '23. Hull and Rettger, '14. Jungano, '09. Kessel, '23. Lynch, '15, '15 a. Rettger, '15. Rettger and Cheplin, '21.

*Parasites.* Adie, '06. Bahr, '06. Bancroft, 1894. Baylis, '22. Bayon, '12 a. Bullock and Rohdenburg, '12. Campana, '11. Cleland, '06, '19. Coles, '14. Cornwall and Patton, '14. Currie, '10. Dean, '03. Enders, '23. Fantham, '06. Giglio-Tos, '00. Hall, '16. Hopwood, '22. Hurler, '12. Kusama, Kasai and Kobayashi, '18, '19. Loghem, '08. Mallory and Ordway, '09. Mil-

ler, '08. Moll, '11. Morpurgo, '01, '02. Regnault, 1891. Robinson, '13. Rose-nau, '01. Sangiorgi, '14. Stevens, '23. Stiles and Crane, '10. Stiles and Hasall, '10. Swellengrebel and Hoesen, '15. Trautmann, '12. Trautmann, H., '12. Wasielewski and Senn, '00. Webel, '14. Weber, 1894. Wiener, '02, '03. Yokogawa, '22.

*Fleas.* Advisory Committee, '17. Bacot, '14. Buckley, '08. Jürgens, '03. Rothschild, '06. Shipley, '08. Uriarte, '05.

*Trypanosomes.* Beckwith and Reich, '21. Bruce, Hamerton, Bateman and Mackie, '10. Chick and Martin, '11. Laveran and Mesnil, '00, '00 a, '00 b, '01. Minchin and Thomson, '11, '15. Pound, '05. Rabinowitsch and Kempner, 1899. Reynolds and Schoening, '18. Roudsky, '11. Sabrazès and Muratet, '05. Steffan, '21. Taliaferro, '21, '21 a, '23. Taliaferro and Taliaferro, '22. Terry, '05.

*Pulmonary disease.* Hektoen, '16. Jones, '22, '22 a. Mitchell, '12. Lange and Simmonds, '23. Ori, '12. Poppe, '13. Tunnicliff, '16.

*Middle ear infection.* Droogleever Fortuyn, '18.

*Leprosy.* Bayon, '11, '12, '12 b, '12 c. Brinckerhoff, '10. Bull, '07. Chapin, '12. Dean, '05. Duval, '10, '11. Duval and Gurd, '11, '11 a. Duval and Wellman, '12. Duval and Harris, '13. Hollmann, '12. Jadassohn, '13. Le-boeuf, '12. McCoy, '08. Marchoux, '10, '11, '12. Marchoux and Sorel, '12, '12 a, '12 b, '12 c. Priestley, '13. Rabinowitsch, '03. Tidswell and Cleland, '12. Wherry, '08, '08 a, '08 c. Wolbach and Honeij, '14. Zinsser and Carey, '12.

*Plague.* Advisory Committee, '12 b. Bacot and Martin, '14. Bannerman, '06. Blue, '08, '10. Chick and Martin, '11. Creel, '13, '15. Edington, '01. Galli-Valerio, '02. Gauthier and Raybaud, '03. Herzog, '05. Hossack, '07 a. India Plague Commission, '08. Kister, '06. Klein, '03. Koch, 1898. Liston '05, '05 a. Lloyd, '08. Loghem and Swellengrebel, '14. McCoy, '10. Martini, '01. Miyajima, '02. Petrie, '10. Reports on Plague Investigations in India, '06. Rowland, '12. Shadwell and Hennessy, '11. Thompson, '06. Tiraboschi, '02, '04, '04 a.

*Tumors and cancer.* Alstyne and Beebe, '13. Bashford and Murray, '00. Beatti, '17. Bennett, '14. Bullock and Rohdenburg, '13, '15. Bullock and Cramer, '13. Bullock, '15. Burnett, '16. Calkins, '16. Cramer and Pringle, '10. Cramer, '23 a. DaFano, '21. Eiselsberg, 1890. Fibiger, '13, '13 a, '13 b, '14. Flexner and Jobling, '07, '08. Freund, '11. Funk, '15. Gay, '09. Gaylord, '06. Hilario, '15. Jensen, '08. Joannovics, '12. Lambert, '11. Levin, '08, '10, '10 a, '11. Lewin, '12, '12 a. Loeb, '01, '02, '02 a, '03, '03 a, '04, '07, '16. Loeb and Fleisher, '16. Loeb, '17. McCoy, '09 a, '10 a. Medigreceanu, '10, '10 a. Moreschi, '09. Morris, '14. Murphy, Hussey, Sturm and Nakahara, '21. Murray, '22. Nicholson, '12. Ordway and Morris, '13. Robertson and Burnett, '13, '16. Roffo, '18, '20. Rohdenburg and Bullock, '16. Rous, '11, '14. Russell, '23, '23 a. Sittenfeld, '12. Sweet, Corson-White and Saxon, '13, '15. Taylor, '15. Uhlenhuth and Weidanz, '09. Weil, '13, '16. Woglom, '15, '16. Woolley and Wherry, '11.

*Rickets and osteoporosis.* Goldblatt, '23. Gutman and Franz, '22. Hess, McCann and Pappenheimer, '21. Hess, '22, '22 a. Hess, Pappenheimer and Weinstock, '22. Hess and Unger, '22. Hess, Unger and Pappenheimer, '22,



'22 b, '22 c. Hess, Unger and Steiner, '22. Hess, '23. Hess and Weinstock, '23. Hess, Weinstock and Tolstoi, '23. Jackson and Carleton, '23. Kauffman, Creekmur and Schultz, '23. Korenchevsky, '21, '22. Kramer and Howland, '22. McCann and Barnett, '22. McClendon, '22, '22 a, '22 b. McCollum, Simmonds, Parsons, Shipley and Park, '21. McCollum, Simmonds, Shipley and Park, '21, '21 a, '21 b, '22, '22 a, '22 b. McCollum, Simmonds and Becker, '22. McCollum, Simmonds, Becker and Shipley, '22. McCollum, Simmonds and Kinney, '22 a. Mellanby, '19. Morpurgo, '00, '00 a, '05, '06, '06 a, '07, '07 a, '07 b, '08. Pappenheimer, McCann, Zucker and Hess, '21. Pappenheimer, '22. Pappenheimer, McCann, and Zucker, '22, '22 a. Park, Shipley, McCollum and Simmonds, '22. Powers, Park, Shipley and McCollum, '22. Powers, Park, Shipley, McCollum and Simmonds, '22. Sherman and Pappenheimer, '21, '21 a. Shipley, McCollum and Simmonds, '21. Shipley, Park, McCollum and Simmonds, '21, '21 a. Shipley, Park, McCollum, Simmonds and Parsons, '21. Shipley, Park, Powers, McCollum and Simmonds, '21. Shipley, '22, '22 a. Shipley, Park, McCollum and Simmonds, '22, '22 a. Stephenson and Clark, '20. Weichselbaum, '09. Zucker, Johnson and Barnett, '22. Zucker and Barnett, '23.

*Pellagra*. McCollum and Simmonds, '17, '17 a, '17 b, '18 a. McCollum, Simmonds and Parsons, '18, '19 b. Sundwall and Francis, '17.

*Xerophthalmia*. Bulley, '19. Emmett, '20. Knapp, '08. Lambert and Yudkin, '23. McClendon and Shuck, '23. McCollum, Simmonds and Becker, '22. Mori, '22, '22 a, '23. Osborne and Mendel, '21 d. Powers, Park, and Simmonds, '22, '23. Wason, '21. Yudkin, '22. Yudkin and Lambert, '22, '22 a, '23.

*Beri beri*. Hofmeister, '22, '22 a.

*Rat bite*. Adachi, '21. Blake, '16. Cook, 1886. Evans, '03. Futaki, Takaki, Taniguchi and Osumi, '16, '17. Ido, Hoki, Ito and Wani, '17. Ido, Ito, Wani and Okuda, '17. Irisawa, 1897. Ishiwara, Ohtawara and Tamura, '17. Kaneko and Okuda, '17. Kitagawa and Mukoyama, '18. Kusama, Kobayashi and Kasai, '19 a. Maruyama, '01. Miura and Toriyama, 1897. Miyake, 1899. Nagatomi and Miyake, 1898. Noguchi, '17. Schottmüller, '14. Tileston, '16.



**PART II**  
**NORWAY RAT**  
**WILD—CAGED—DOMESTICATED**



## CHAPTER 11

### LIFE HISTORY AND DISTINGUISHING CHARACTERS NORWAY RAT

1. Introduction.
2. Life history.
3. Comparison of Norway with Albino.
4. Similarities of Norways and Albinos in western Europe and United States.

1. *Introduction.* To obtain more complete information concerning the rat it is important to note differences which may appear between the domesticated Albino and the wild Norway. Since the wild Norway represents the parent stock it might seem proper to use that form as the standard and to record the deviations of the Albino from it. As a matter of fact however our information with regard to the Albino is so much the more complete that the best results will follow from using it as the standard, despite that fact that zoologically it is but a variety of the Norway.

The wild Norway rat has special value as a form with which the effect of domestication can be systematically studied. It must always be remembered in this connection however that only a limited series of observations can be made on the strictly wild Norway. Many of the observations here to be presented are on the caged and partially domesticated strains, and since this treatment tends to modify several characters in the wild Norway, care will be taken to state clearly just which strain of Norway was used for observation.

2. *Life history.* As regards behavior, the Norway rat is very responsive to sounds, gnaws its cage, burrows when opportunity offers, is hard to handle and appears fierce because usually in a state of terror, yet after some days in a cage, mature rats occasionally become quite docile. On occasion it swims and dives.

The Hagedoorns ('17) note that when taken at weaning the Norways (in Java) are readily tamed. The half grown animals resist taming, while the full grown, even if caught wild, tend to be more responsive. They also note the appearance of waltzing

rats, similar to waltzing mice in behavior, but as viable as their normal litter-mates and able to hear.

*Mus norvegicus* when mature weighs 300-500 grams. Larger animals sometimes appear and our records show one male (cage bred and continually petted) which attained a maximum of 750 grams. The males in any series tend to be some 20 per cent heavier than the litter mate females.

The color above ranges from light gray or orange to brown and dark gray, usually with more or less white or light gray on the ventral surfaces. Melanic sports occasionally occur (see p. 11, note 5). *Mus norvegicus* is distinguished from *Mus rattus*, the house rat, by the following superficial characters: larger size; blunter head; smaller ears which are thicker and more covered with hair; tail shorter than body; claws usually relatively dull. Its movements are less rapid. Commonly the female Norway has twelve, sometimes fourteen nipples, while the house rat has very constantly ten.

As will be evident, the data which follow were largely obtained from caged or partially domesticated animals. For the most part however, they probably represent what would be found in the strictly wild state.

*Span of life.* The span of life of the Norway rat is not known. It seems probable that it is between three and four years, though here and there individuals may live somewhat longer. Norway rats may breed at all seasons, but best in the spring.

*Period of gestation.* 21 days Lantz ('09); 23.5-25.5 days Miller ('11). The latter periods are possibly due to the effect of nursing on gestation, see p. 21.

*Number of litters.* Miller ('11) reports seven litters in seven months from a single pair, and estimates that, in general, five to six litters may be easily reared by a single pair in a year.

*Number of young in a litter.* Climate and station appear as general modifying influences. Larger litters are reported from northern Europe than from India (Lantz, '09).

Crampe ('84) obtained an average of 10.4 in fourteen litters.

Zuschlag ('03) states that among the rats examined at Copenhagen in 1899, fetuses to the number of 14 were found four times

and he himself in 1902 examined one female bearing 16. Donaldson (MS '09) also noted in a rat taken in Paris, 16 fetuses.

The India Plague Commission reports ('08) that the average number of fetuses found in females was 8.1 from a total of 12,000 Norway rats.

According to Lantz ('10) the maximum size of litters recorded in England (Field) are 17, 19, 22 and 23; in India however, 14.

The maximum numbers just given as recorded in England are not trustworthy as they represent merely the number of young found in a single nest. Since two different litters are sometimes reared in the same nest the inference from the number in the nest to the number in the litter is not convincing. Lantz ('09) assumes the average litter (in north temperate latitudes) to be about 10. This is what Miller ('11) (*vide infra*) and Crampe ('84) (*vide supra*) found.

Miller ('11) observed in a group of eight litters 7-12 young in a litter, with an average of 10.5.

Recently King ('23) has studied the litter size and sex ratio in a series of caged Norways undergoing domestication.

In this instance 309 litters were examined.

In the Norway, as in the albino strain, the first litter cast is relatively small and the next two litters tend to be the largest of the series cast. In later litters the number of young gradually decreases, dropping to an average of 4.8 in the final litter of the series (table 184). The 309 litters cast by Norway females contain an average of 6.0 young: the data for the albino strain gives an average of 6.1 young per litter (table 6). The average size of the litter is therefore practically the same in the two forms; but as litter production in the albino strain is greater than that in the Norway strain, it appears that domestication has increased the fertility of the rat, as it has of many other animals (Darwin, '75).

*Weight at birth.* King ('23) found before suckling the weight at birth to be 5.34 grams for the males and 5.09 grams for the females.

*Sex ratio.* Lantz ('09) and others state that among trapped animals the males are in excess. Donaldson ('12) found the same in trapped series taken in Paris and London. In a small series trapped in Vienna however, the females were in excess.

These observations however do not indicate the sex ratio at birth.

For the total of 1862 Norway young recorded by King ('24) in table 184 the sex ratio is but 85.8 males to 100 females. This ratio is in accord with the only other sex ratio for the Norway strain that has as yet been determined, namely, the ratio of 82.1 males to 100 females found by Miller in five litters comprising fifty-one young. The sex ratio for the Norway strain is  $19.4 \pm 3.34$  points lower than that found for the stock albino strain (table 6), thus indicating that there is a significant difference between the two strains as regards the relative proportions of the sexes in the young at birth.

TABLE 184

*Data for entire series of litters cast by 88 Norway females, born and reared in captivity*

LITTER SERIES	NUMBER OF LITTERS	NUMBER OF INDIVIDUALS	AVERAGE NUMBER OF YOUNG PER LITTER	MALES	FEMALES	NUMBER OF MALES TO 100 FEMALES
1	88	462	5.2	223	239	93.3 $\pm$ 5.86
2	84	547	6.5	253	294	86.0 $\pm$ 4.96
3	63	410	6.5	190	220	86.3 $\pm$ 5.75
4	39	229	5.9	106	123	86.1 $\pm$ 7.69
5	20	128	6.4	58	70	82.8 $\pm$ 9.91
6	10	62	6.2	21	41	51.2 $\pm$ 9.26
7	5	24	4.8	9	15	60.0 $\pm$ 17.17
1-7	309	1862	6.0	860	1002	85.8 $\pm$ 2.68

It may be objected that the sex ratio found in this series of Norways is due to the effects of captivity on the breeding females.

Data obtained in later generations of these Norways make this explanation seem improbable, and indicate that the low sex ratio in the Norways is probably normal for the strain.

*Opening of eyes.* Miller ('11) found the eyes to open at 16 or 17 days and also states that the young are weaned during the sixth week. Observations at The Institute are in agreement with these statements.

*Suckling.* The lactation period tends to be longer in the Norway than in the Albino. The range is wide but about five weeks seems to be the normal suckling period in the caged Norway. (King MS).



In King's Norways the average age at which these Norway females, as a group, began breeding was about eight months. In later generations a number of females have cast litters when from four to five months of age. In captivity the menopause in the Norway strain comes when the females are about twenty months old, though several females have cast litters when nearly two years old.

3. *Comparison of the Norway with the Albino.* To determine how the wild Norway form, as trapped in Philadelphia, differs from the albino rats in the colony at The Institute, a comparison has been made between the two forms in respect of body length, body weight, brain weight, spinal cord weight and the percentage of water in both the brain and the spinal cord (Donaldson and Hatai, '11) as well as the weights of several of the parts and viscera. (Jackson and Lowrey, '12; Hatai, '14a.)

In addition to the familiar facts that the wild Norway rat is more difficult to handle, more successful in escaping from cages and much more given to gnawing than is the Albino, that it grows bigger, breeds later, and has a longer sexual life (Crampe, '84) it is now possible to make several further statements.

At birth the caged Norway is somewhat heavier than the stock Albino (King, '15, table 1 '24) but in their relative body length and the relative weights of the brain and spinal cord, as well as in the percentage of water in these two divisions of the central nervous system, they are approximately alike at this age.

The marked differences between the two forms appear later, during the period of rapid growth. Grouping together the general differences subsequently found, we may say that the wild Norway rat is absolutely heavier, relatively slightly longer, has a relatively heavier brain and a heavier spinal cord, and since for the same body weight as a given Albino it is younger it has, when so compared, a higher percentage of water in the central nervous system.

For the same age however, the percentages of water are *nearly* alike; the percentage in the Norway rat being a trifle higher (Donaldson and Hatai, '11). The relative weights of the ovaries, testes and suprarenals are also greater (C. Watson, '07; Hatai,

'14). These plus characters of the Norway tend to disappear when the Norway is subjected to domestication.

The deviations of the wild Norway may be expressed in another way. When the body weights of Norway and Albino are the same:

The wild Norway rat has a greater body length; a greater brain weight; a greater spinal cord weight; a higher percentage of water in the central nervous system; heavier ovaries, testes and suprarenals, but a smaller hypophysis.

When the body lengths are the same:

The Norway rat has a smaller body weight; a greater brain weight; a greater spinal cord weight; a higher percentage of water in the central nervous system; heavier ovaries, testes and suprarenals, but a smaller hypophysis.

Speaking generally therefore, we may say that when compared with the domesticated Albino, the wild Norway rat weighs more, is longer and possesses a nervous system in which both the brain and spinal cord are relatively larger.

These differences taken together indicate that the *albino rat* has grown less well, and it seems most natural to attribute the lack of growth to the whole set of conditions summed up in the word 'domestication.'

The most marked difference in structure thus far described between the two forms is in the relative weight of the central nervous system. That this is due to the effects of domestication seems highly probable, in view of the observations of Darwin ('83), Lopicque and Girard ('07) and Donaldson ('23).

There are still other observations which belong here. In a study on the weight of some of the ductless glands of the Norway and of the albino rat according to sex and variety, Hatai ('14 a) an examination was made of the suprarenals, hypophysis, thyroid and gonads in both forms. The conclusions reached are given in Chapter 14.

4. *Similarity of the Norways and Albinos of western Europe to those of the United States.* It is to be noted in this connection that so far as tests have been made, the albino rats found in Western Europe are similar to those found in America. For the

Albinos from Vienna, Paris and London, the determinations were made by Donaldson ('12), and Chisolm ('11) has reported on the relation of body length to body weight in albino and pied rats in London. Chisolm compares his determinations of length with those by Donaldson ('09) and when correction is made for the slight difference in the methods of measurements, the two sets of results agree nicely.

It is also true that the wild Norways of western Europe seem to be similar to those of the United States (Donaldson, '12 a).

On the other hand the Hagedoorns ('17) report great differences among the wild Norways in Java, as shown by color, size and skull characters.

#### LIFE HISTORY—NORWAY RAT: REFERENCES

*Life History.* Crampe, 1884. Donaldson and Hatai, '11. Donaldson, '12. Hagedoorn and Hagedoorn, '17. Lantz, '09. Miller, '11.

*Gestation period.* Lantz, '09. Miller, '11.

*Number of litters.* Miller, '11.

*Number in litter.* Crampe, 1884. Darwin, 1875. King, '23, '24. Lantz, '09, '10. Zuschlag, '03.

*Weight at birth.* King, '23.

*Sex ratio.* Donaldson, '12. King, '24. Lantz, '09.

*Opening of eyes and suckling.* Miller, '11.

*Comparison of Norway with Albino.* Crampe, 1884. Darwin, 1883. Donaldson and Hatai, '11. Donaldson, '23. Hatai, '14 a. Jackson and Lowrey, '12. King, '15. Lapieque and Girard, '07. Watson, '07.

*Similarities of Norways and Albinos in western Europe and United States.* Chisolm, '11. Donaldson, '09, '12, '12 a. Hagedoorn and Hagedoorn, '17.

## CHAPTER 12

### GROWTH IN TOTAL BODY WEIGHT ON AGE—CAGED NORWAYS

All data on the growth of the Norway rat must necessarily be obtained from caged animals, and although it is recognized that captivity modifies the form and functions of the animal, there is apparently no way to escape this dilemma. The growth on age of the first generation ( $F_1$ ) of Norway rats in captivity is given by Dr. King ('23)—table 185 and charts 59 and 60.

Graphs for the body weights of stock Albinos are also given in these charts.

The coefficients of variation have been determined for this series of Norways and in table 186 these are compared with corresponding coefficients for the Albino.

These observations reveal the following relations:

Though less heavy at birth, yet from the first few days up to the fortieth day of postnatal life Norway females have an average body weight greater than that of the males. After forty days of age the males, as a rule, are heavier than the females at all age periods. This revelation of the precocity in the growth of the female is thought to be due to a greater retardation of growth in the male, owing to the excited condition in which these gray rats live during the earlier generations in captivity, and to the fact that males are more responsive to conditions, both favorable and unfavorable, than are females.

These  $F_1$  Norway rats do not show the marked acceleration in body growth during early life that is characteristic of the albino strain. Increase in body weight progresses at a fairly uniform rate in both sexes until the animals are approaching senescence, the increase in the adult state being greater in the males than in the females (charts 59 and 60).

Albino rats are much heavier than these Norway rats during adolescence and early maturity; in later life the body weights of the Norways exceed those of the Albinos (charts 59 and 60), and (King '23, chart 1, p. 85).

TABLE 185

*Data for eighteen litters of  $F_1$  Norway rats, showing the increase in the weight of the body with age*

AGE IN DAYS	MALES				FEMALES			
	Body weight in grams			Number individuals	Body weight in grams			Number individuals
	Average	Lowest	Highest		Average	Lowest	Highest	
13	15.4	12	21	51	16.3	12	21	59
30	33.4	26	41	51	37.0	27	45	59
60	81.9	49	144	51	75.2	47	110	59
90	115.9	68	201	51	100.5	70	152	59
120	148.6	70	245	51	122.6	77	184	59
151	176.1	87	284	51	142.0	98	201	56
182	195.9	110	300	51	153.5	111	256	54
212	218.4	128	330	51	172.1	117	272	50
243	235.4	140	374	50	189.3	133	278	52
273	253.5	154	379	50	204.2	131	327	51
304	265.5	156	380	50	209.8	123	301	47
334	276.7	170	395	50	221.5	128	345	49
365	287.3	184	428	48	232.8	152	344	47
395	297.4	185	442	48	242.3	135	383	47
425	312.2	200	457	47	247.5	156	380	43
455	322.3	188	471	47	260.5	172	359	44
486	332.0	226	459	46	257.9	182	382	43
516	335.0	226	476	43	264.1	163	373	37
547	345.6	231	486	41	261.5	173	375	36
578	358.0	233	516	39	266.5	168	360	34
608	361.8	231	518	38	271.9	184	339	31
639	369.9	236	540	37	279.7	190	367	30
670	374.5	240	546	37	284.4	210	355	26
700	364.2	243	518	34	283.4	200	376	25
730	362.1	231	505	27	278.9	197	341	19

It seems probable that the slow growth of the Norways during early life is characteristic for the strain, and that the acceleration in the growth of the Albinos is one of the results of domestication.

Norway rats show a high degree of variability in body weight at all age periods (table 186). In early life the females are

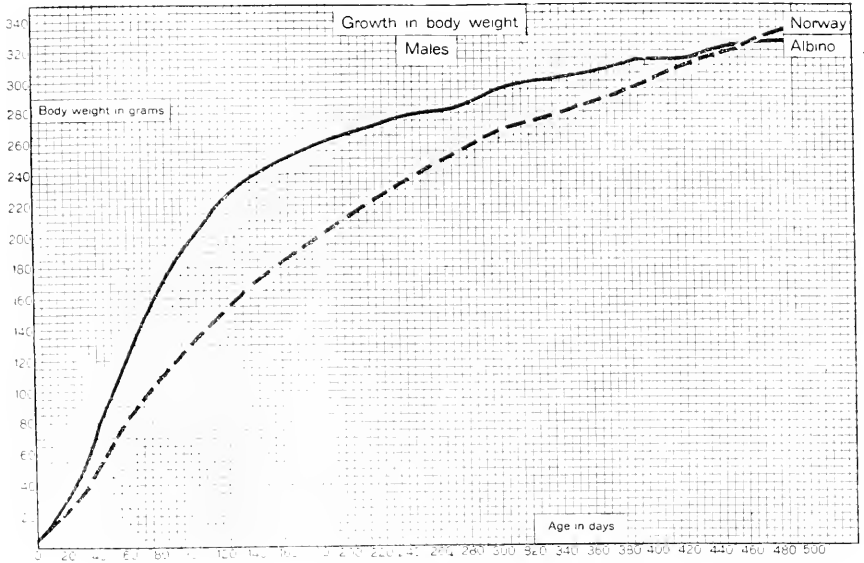

Chart 59 Graphs showing the growth in body weight of Norway and of stock albino males (data in table 1, and in table 3 of a previous paper; King, '15 a).

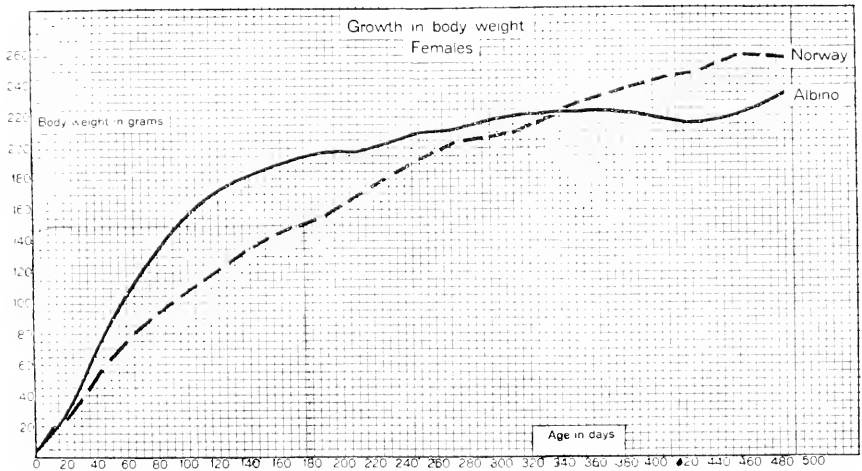

Chart 60 Graphs showing the growth in body weight of Norway and of stock albino females (data in table 1, and in table 3 of a previous paper; King, '15 a).

somewhat more variable than the males, but in the adult state the males tend to be more variable.

TABLE 186

*Showing the coefficients of variation with their probable error for the body weights at different ages of a series of Norway rats (51 males and 59 females), and of a series of stock albino rats (50 males and 67 females).*

AGE IN DAYS	NORWAY SERIES		ALBINO SERIES	
	Males	Females	Males	Females
13	12.2±0.82	14.6±0.90	11.8±0.79	11.4±0.76
30	13.0±0.86	17.3±1.07	10.2±0.68	11.0±0.74
60	24.1±1.60	19.8±1.22	17.0±1.14	15.7±1.05
90	26.2±1.74	16.9±1.04	14.8±0.99	12.5±0.95
120	28.2±1.88	16.0±0.99	13.4±0.90	10.3±0.75
151	24.2±1.61	16.6±1.03	13.3±0.89	10.4±0.73
182	23.4±1.55	17.8±1.13	14.2±1.22	12.3±0.90
212	21.8±1.45	17.9±1.20	14.0±0.96	12.4±0.91
243	23.7±1.60	18.2±1.26	13.9±0.99	12.6±0.91
273	22.4±1.50	19.1±1.27	13.4±0.99	11.5±0.89
304	21.5±1.45	19.9±1.38	14.0±1.11	10.3±0.79
334	19.8±1.33	20.6±1.40	13.7±1.13	10.8±0.87
365	19.5±1.33	20.4±1.41	13.0±1.16	10.7±0.91
395	19.5±1.34	22.3±1.54	12.6±1.22	11.5±0.98
425	17.6±1.22	21.1±1.47	13.4±1.32	10.9±0.94
455	19.2±1.32	18.9±1.35	13.6±1.67	8.9±0.99
486	17.3±1.21	19.5±1.41	15.0±2.06	13.4±1.77
516	17.4±1.26	18.3±1.43		
547	16.7±1.24	19.4±1.54		
578	18.3±1.39	16.4±1.34		
608	17.1±1.32	15.3±1.28		
639	17.4±1.36	15.8±1.37		
670	17.5±1.39	14.2±1.32		
700	17.7±1.36	11.9±1.14		
730	19.4±1.79	13.9±1.52		

Norway rats at all age periods are much more variable in body weight than are albino rats (table 186).

## CHAPTER 13

### GROWTH IN TOTAL BODY WEIGHT ON BODY LENGTH AND GROWTH IN THE WEIGHT OF PARTS AND SYSTEMS OF THE BODY

1. Total body weight between birth and maturity on body length. 2. Growth of parts. 3. Growth of systems. 4. Weight of cranium.

1. *Total body weight between birth and maturity on body length—wild Norway rats. Body length on body weight.* From the study of 282 male and 318 wild female Norway rats, trapped in Philadelphia, measurements have been taken for body weight and body length (Donaldson and Hatai, '11).

The values for body length—sexes combined—on body weight are given by formula (53.) In chart 61 the corresponding graph is given and for comparison the graph for the body length of the Albino is also drawn (see formula 4).

At 450 grams the body length of the wild Norway is about 4 per cent above that of the Albino.

It has been found that for a given body weight, the body length is in the male Norway 0.4 per cent above the mean, and in the female 0.4 per cent below (Donaldson and Hatai, '11, p. 425).

Table 187 contains values for body weights and for the tail length and the weights of the brain and the spinal cord computed by the formulas devised by Hatai.

*Body weight on body length.* When the formula (53) is transformed so as to give the body weight for a given body length and the correction for sex is included, we have for the males formula (54) and for the females formula (55). In chart 62 are given the graphs for both sexes. As in the case of the Albino, the body weight for the male is slightly below that for the female of like body weight.



*Tail length on body length.* The tail length on the body length has been determined by Hatai (MS '14) and is represented by formulas (56) and (57) for the male and female respectively. As can be seen by consulting table 187, the males have the shorter tails—a relation which is somewhat less marked than that found for the Albino. In chart 63 are given the corresponding graphs.

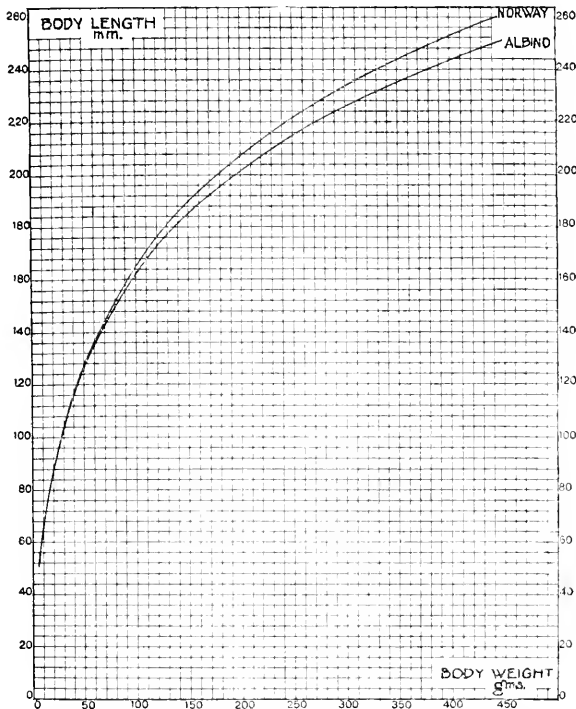

Chart 61 Norway rat—Giving body length on the body weight. Males only. Formula (53), table 187. Inserted for comparison is the corresponding graph for the male Albino (see formula (4)).

*Weight-length ratios.* In table 188 are given the values for the Norway obtained by dividing the body weight by the body length, as these appear in table 187. The ratios in table 188 are consistently smaller than those for the Albino (table 122) as the Norway is longer for a given body weight. Further, the values for the two sexes in the Norway are more alike than in the Albino.

348 GROWTH IN TOTAL BODY WEIGHT ON BODY LENGTH

TABLE 187

*Gives the tail length, body weight, brain weight and spinal cord weight for each millimeter of body length of the male and female Norway rat respectively.*

*See charts 61, 62, 63 and 64.*

MALES					FEMALES			
Body length	Tail length	Body weight	Weight of		Tail length	Body weight	Weight of	
			Brain	Spinal cord			Brain	Spinal cord
<i>mm.</i>	<i>mm.</i>	<i>gms.</i>	<i>gms.</i>	<i>gms.</i>	<i>mm.</i>	<i>gms.</i>	<i>gms.</i>	<i>gms.</i>
50	15.0	4.4		0.031	16.0	4.6		0.032
51	16.2	4.8		0.034	17.2	4.9		0.035
52	17.3	5.1	0.270	0.037	18.4	5.2	0.307	0.038
53	18.5	5.4	0.367	0.040	19.6	5.6	0.393	0.041
54	19.6	5.8	0.443	0.043	20.8	5.9	0.462	0.044
55	20.8	6.1	0.508	0.046	21.9	6.3	0.522	0.047
56	21.9	6.5	0.563	0.049	23.1	6.6	0.574	0.050
57	23.0	6.8	0.611	0.052	24.3	7.0	0.620	0.053
58	24.1	7.2	0.655	0.055	25.4	7.4	0.661	0.056
59	25.3	7.6	0.694	0.058	26.5	7.7	0.698	0.059
60	26.4	7.9	0.730	0.061	27.7	8.1	0.732	0.063
61	27.5	8.3	0.763	0.064	28.8	8.5	0.763	0.066
62	28.6	8.7	0.794	0.067	29.9	8.9	0.793	0.069
63	29.7	9.1	0.823	0.070	31.1	9.3	0.820	0.072
64	30.8	9.5	0.850	0.074	32.2	9.7	0.846	0.075
65	31.9	9.9	0.875	0.077	33.3	10.1	0.871	0.078
66	32.9	10.3	0.900	0.080	34.4	10.5	0.894	0.082
67	34.0	10.7	0.923	0.083	35.5	10.9	0.916	0.085
68	35.1	11.1	0.944	0.086	36.6	11.3	0.937	0.088
69	36.2	11.5	0.965	0.090	37.7	11.8	0.957	0.091
70	37.2	11.9	0.985	0.093	38.8	12.2	0.977	0.095
71	38.3	12.4	1.005	0.096	39.9	12.6	0.995	0.098
72	39.4	12.8	1.023	0.099	41.0	13.1	1.013	0.101
73	40.4	13.3	1.041	0.103	42.1	13.5	1.031	0.104
74	41.5	13.7	1.059	0.106	43.1	14.0	1.048	0.108
75	42.5	14.2	1.075	0.109	44.2	14.5	1.064	0.111
76	43.6	14.7	1.092	0.113	45.3	14.9	1.080	0.114
77	44.6	15.1	1.107	0.116	46.4	15.4	1.095	0.118
78	45.7	15.6	1.123	0.119	47.4	15.9	1.110	0.121
79	46.7	16.1	1.138	0.123	48.5	16.4	1.124	0.125
80	47.7	16.6	1.152	0.126	49.5	16.9	1.138	0.128
81	48.8	17.1	1.166	0.129	50.6	17.4	1.152	0.131
82	49.8	17.6	1.180	0.133	51.7	17.9	1.166	0.135

TABLE 187—Continued

MALES					FEMALES			
Body length	Tail length	Body weight	Weight of		Tail length	Body weight	Weight of	
			Brain	Spinal cord			Brain	Spinal cord
<i>mm.</i>	<i>mm.</i>	<i>gms.</i>	<i>gms.</i>	<i>gms.</i>	<i>mm.</i>	<i>gms.</i>	<i>gms.</i>	<i>gms.</i>
83	50.8	18.1	1.194	0.136	52.7	18.5	1.179	0.138
84	51.9	18.7	1.207	0.140	53.8	19.0	1.192	0.142
85	52.9	19.2	1.220	0.143	54.8	19.6	1.204	0.145
86	53.9	19.7	1.232	0.146	55.8	20.1	1.216	0.149
87	54.9	20.3	1.245	0.150	56.9	20.7	1.229	0.152
88	55.9	20.8	1.257	0.153	57.9	21.2	1.240	0.156
89	57.0	21.4	1.269	0.157	59.0	21.8	1.252	0.159
90	58.0	22.0	1.281	0.160	60.0	22.4	1.264	0.163
91	59.0	22.5	1.292	0.164	61.0	23.0	1.275	0.166
92	60.0	23.1	1.303	0.167	62.1	23.6	1.286	0.170
93	61.0	23.7	1.315	0.171	63.1	24.2	1.297	0.173
94	62.0	24.3	1.325	0.174	64.1	24.8	1.307	0.177
95	63.0	25.0	1.336	0.178	65.1	25.4	1.318	0.180
96	64.0	25.6	1.347	0.181	66.1	26.1	1.328	0.184
97	65.0	26.2	1.357	0.185	67.2	26.7	1.338	0.188
98	66.0	26.9	1.368	0.189	68.2	27.4	1.348	0.191
99	67.0	27.5	1.378	0.192	69.2	28.0	1.358	0.195
100	68.0	28.2	1.388	0.196	70.2	28.7	1.368	0.198
101	69.0	28.8	1.398	0.199	71.2	29.4	1.378	0.202
102	70.0	29.5	1.408	0.203	72.2	30.1	1.388	0.206
103	71.0	30.2	1.417	0.207	73.2	30.8	1.397	0.209
104	72.0	30.9	1.427	0.210	74.2	31.5	1.406	0.213
105	73.0	31.6	1.436	0.214	75.2	32.2	1.416	0.217
106	73.9	32.3	1.446	0.218	76.2	33.0	1.425	0.220
107	74.9	33.1	1.455	0.221	77.2	33.7	1.434	0.224
108	75.9	33.8	1.464	0.225	78.2	34.5	1.443	0.228
109	76.9	34.6	1.473	0.229	79.2	35.2	1.452	0.232
110	77.9	35.3	1.482	0.232	80.2	36.0	1.460	0.235
111	78.8	36.1	1.491	0.236	81.2	36.8	1.469	0.239
112	79.8	36.9	1.499	0.240	82.2	37.6	1.477	0.243
113	80.8	37.7	1.508	0.244	83.2	38.4	1.486	0.247
114	81.8	38.5	1.517	0.247	84.2	39.3	1.494	0.250
115	82.7	39.3	1.525	0.251	85.2	40.1	1.503	0.254
116	83.7	40.2	1.534	0.255	86.2	40.9	1.511	0.258
117	84.7	41.0	1.542	0.259	87.2	41.8	1.519	0.262
118	85.6	41.9	1.550	0.262	88.1	42.7	1.527	0.266

TABLE 187—Continued

MALES					FEMALES			
Body length	Tail length	Body weight	Weight of		Tail length	Body weight	Weight of	
			Brain	Spinal cord			Brain	Spinal cord
<i>mm.</i>	<i>mm.</i>	<i>gms.</i>	<i>gms.</i>	<i>gms.</i>	<i>mm.</i>	<i>gms.</i>	<i>gms.</i>	<i>gms.</i>
119	86.6	42.7	1.558	0.266	89.1	43.6	1.535	0.269
120	87.6	43.6	1.567	0.270	90.1	44.5	1.543	0.273
121	88.5	44.5	1.575	0.274	91.1	45.4	1.551	0.277
122	89.5	45.4	1.583	0.278	92.1	46.3	1.559	0.281
123	90.5	46.3	1.591	0.281	93.0	47.3	1.567	0.285
124	91.4	47.3	1.599	0.285	94.0	48.2	1.575	0.289
125	92.4	48.2	1.606	0.289	95.0	49.2	1.582	0.292
126	93.4	49.2	1.614	0.293	96.0	50.2	1.590	0.296
127	94.3	50.2	1.622	0.297	96.9	51.2	1.598	0.300
128	95.3	51.1	1.630	0.301	97.9	52.2	1.605	0.304
129	96.2	52.1	1.637	0.305	98.9	53.2	1.613	0.308
130	97.2	53.2	1.645	0.308	99.8	54.2	1.620	0.312
131	98.1	54.2	1.652	0.312	100.8	55.3	1.627	0.316
132	99.1	55.3	1.660	0.316	101.8	56.4	1.635	0.320
133	100.0	56.3	1.667	0.320	102.7	57.5	1.642	0.324
134	101.0	57.4	1.675	0.324	103.7	58.6	1.649	0.328
135	101.9	58.5	1.682	0.328	104.7	59.7	1.657	0.332
136	102.9	59.6	1.689	0.332	105.6	60.9	1.664	0.336
137	103.8	60.7	1.697	0.336	106.6	62.0	1.671	0.339
138	104.8	61.9	1.704	0.340	107.5	63.2	1.678	0.343
139	105.7	63.0	1.711	0.344	108.5	64.3	1.685	0.347
140	106.7	64.2	1.718	0.348	109.5	65.6	1.692	0.351
141	107.6	65.4	1.725	0.352	110.4	66.8	1.699	0.355
142	108.6	66.6	1.732	0.356	111.4	68.0	1.706	0.359
143	109.5	67.8	1.739	0.360	112.3	69.3	1.713	0.363
144	110.5	69.1	1.746	0.363	113.3	70.6	1.720	0.368
145	111.4	70.4	1.753	0.367	114.2	71.9	1.727	0.372
146	112.3	71.6	1.760	0.371	115.2	73.2	1.733	0.376
147	113.3	72.9	1.767	0.375	116.1	74.5	1.740	0.380
148	114.2	74.3	1.774	0.379	117.1	75.9	1.747	0.384
149	115.2	75.6	1.781	0.384	118.0	77.2	1.754	0.388
150	116.1	77.0	1.788	0.388	119.0	78.6	1.760	0.392
151	117.0	78.3	1.794	0.392	119.9	80.0	1.767	0.396
152	118.0	79.7	1.801	0.396	120.9	81.5	1.774	0.400
153	118.9	81.2	1.808	0.400	121.8	82.9	1.780	0.404

TABLE 187—Continued

MALES					FEMALES			
Body length	Tail length	Body weight	Weight of		Tail length	Body weight	Weight of	
			Brain	Spinal cord			Brain	Spinal cord
<i>mm.</i>	<i>mm.</i>	<i>gms.</i>	<i>gms.</i>	<i>gms.</i>	<i>mm.</i>	<i>gms.</i>	<i>gms.</i>	<i>gms.</i>
154	119.8	82.6	1.815	0.404	122.8	84.4	1.787	0.408
155	120.8	84.1	1.821	0.408	123.7	85.9	1.793	0.412
156	121.7	85.6	1.828	0.412	124.7	87.4	1.800	0.416
157	122.6	87.1	1.835	0.416	125.6	89.0	1.807	0.420
158	123.6	88.6	1.841	0.420	126.6	90.6	1.813	0.424
159	124.5	90.1	1.848	0.424	127.5	92.1	1.819	0.429
160	125.4	91.7	1.854	0.428	128.4	93.8	1.826	0.433
161	126.4	93.3	1.861	0.432	129.4	95.4	1.832	0.437
162	127.3	94.9	1.867	0.436	130.3	97.1	1.839	0.441
163	128.2	96.6	1.874	0.441	131.3	98.7	1.845	0.445
164	129.1	98.2	1.880	0.445	132.2	100.5	1.851	0.449
165	130.1	99.9	1.887	0.449	133.1	102.2	1.858	0.453
166	131.0	101.6	1.893	0.453	134.1	104.1	1.864	0.458
167	131.9	103.4	1.899	0.457	135.0	105.7	1.870	0.462
168	132.8	105.1	1.906	0.461	135.9	107.5	1.877	0.466
169	133.8	106.9	1.912	0.465	136.9	109.4	1.883	0.470
170	134.7	108.7	1.918	0.469	137.8	111.3	1.889	0.474
171	135.6	110.6	1.925	0.474	138.8	113.1	1.895	0.478
172	136.5	112.4	1.931	0.478	139.7	115.1	1.901	0.483
173	137.5	114.3	1.937	0.482	140.6	117.0	1.908	0.487
174	138.4	116.3	1.944	0.486	141.5	119.0	1.914	0.491
175	139.3	118.2	1.950	0.490	142.5	121.0	1.920	0.495
176	140.2	120.2	1.956	0.494	143.4	123.0	1.926	0.499
177	141.1	122.2	1.962	0.499	144.3	125.1	1.932	0.504
178	142.1	124.2	1.968	0.503	145.3	127.2	1.938	0.508
179	143.0	126.3	1.975	0.507	146.2	129.3	1.944	0.512
180	143.9	128.4	1.981	0.511	147.1	131.5	1.949	0.516
181	144.8	130.5	1.987	0.515	148.1	133.7	1.955	0.520
182	145.7	132.7	1.993	0.520	149.0	135.9	1.962	0.525
183	146.7	134.9	1.999	0.524	149.9	138.1	1.968	0.529
184	147.6	137.1	2.005	0.528	150.8	140.4	1.974	0.533
185	148.5	139.3	2.011	0.532	151.8	142.8	1.980	0.537
186	149.4	141.6	2.017	0.536	152.7	145.1	1.986	0.542
187	150.3	144.0	2.023	0.541	153.6	147.5	1.992	0.546
188	151.2	146.3	2.029	0.545	154.5	149.9	1.998	0.550
189	152.2	148.7	2.035	0.549	155.5	152.4	2.004	0.554
190	153.1	151.1	2.042	0.553	156.4	154.9	2.010	0.559

TABLE 187—Continued

MALES					FEMALES			
Body length	Tail length	Body weight	Weight of		Tail length	Body weight	Weight of	
			Brain	Spinal cord			Brain	Spinal cord
<i>mm.</i>	<i>mm.</i>	<i>gms.</i>	<i>gms.</i>	<i>gms.</i>	<i>mm.</i>	<i>gms.</i>	<i>gms.</i>	<i>gms.</i>
191	154.0	153.6	2.047	0.557	157.3	157.4	2.016	0.563
192	154.9	156.1	2.053	0.562	158.2	160.0	2.022	0.567
193	155.8	158.6	2.059	0.566	159.1	162.6	2.028	0.572
194	156.7	161.2	2.065	0.570	160.1	165.2	2.034	0.576
195	157.6	163.8	2.071	0.575	161.0	167.9	2.039	0.580
196	158.5	166.4	2.077	0.579	161.9	170.6	2.045	0.584
197	159.4	169.1	2.083	0.583	162.8	173.4	2.051	0.589
198	160.4	171.8	2.089	0.587	163.7	176.2	2.057	0.593
199	161.3	174.6	2.095	0.592	164.7	179.1	2.063	0.597
200	162.2	177.4	2.101	0.596	165.6	181.9	2.069	0.602
201	163.1	180.2	2.107	0.600	166.5	184.9	2.074	0.606
202	164.0	183.1	2.112	0.604	167.4	187.8	2.080	0.610
203	164.9	186.0	2.118	0.609	168.3	190.9	2.086	0.615
204	165.8	189.0	2.124	0.613	169.2	193.9	2.092	0.619
205	166.7	192.0	2.130	0.617	170.2	197.0	2.098	0.623
206	167.6	195.0	2.136	0.622	171.1	200.2	2.103	0.628
207	168.5	198.1	2.142	0.626	172.0	203.4	2.109	0.632
208	169.4	201.3	2.148	0.630	172.9	206.6	2.115	0.636
209	170.3	204.4	2.153	0.635	173.8	209.9	2.120	0.641
210	171.2	207.7	2.159	0.639	174.7	213.2	2.126	0.645
211	172.1	210.9	2.165	0.643	175.6	216.6	2.132	0.649
212	173.1	214.3	2.171	0.647	176.6	220.1	2.138	0.654
213	174.0	217.7	2.177	0.652	177.5	223.5	2.143	0.658
214	174.9	221.1	2.182	0.656	178.4	227.1	2.149	0.662
215	175.8	224.5	2.188	0.660	179.3	230.7	2.155	0.667
216	176.7	228.1	2.194	0.665	180.2	234.3	2.160	0.671
217	177.6	231.6	2.199	0.669	181.1	238.0	2.166	0.675
218	178.5	235.3	2.205	0.673	182.0	241.8	2.171	0.680
219	179.4	239.0	2.211	0.678	182.9	245.6	2.177	0.684
220	180.3	242.7	2.217	0.682	183.8	249.4	2.183	0.689
221	181.2	246.5	2.222	0.686	184.8	253.3	2.188	0.693
222	182.1	250.3	2.228	0.691	185.7	257.3	2.194	0.697
223	183.0	254.2	2.234	0.695	186.6	261.3	2.199	0.702
224	183.9	258.2	2.239	0.699	187.5	265.4	2.205	0.706
225	184.8	262.2	2.245	0.704	188.4	269.6	2.211	0.710
226	185.7	266.3	2.251	0.708	189.3	273.8	2.216	0.715
227	186.6	270.4	2.256	0.713	190.2	278.1	2.222	0.719

TABLE 187—Concluded

MALES					FEMALES			
Body length	Tail length	Body weight	Weight of		Tail length	Body weight	Weight of	
			Brain	Spinal cord			Brain	Spinal cord
<i>mm.</i>	<i>mm.</i>	<i>gms.</i>	<i>gms.</i>	<i>gms.</i>	<i>mm.</i>	<i>gms.</i>	<i>gms.</i>	<i>gms.</i>
228	187.5	274.6	2.262	0.717	191.1	282.4	2.227	0.724
229	188.4	278.8	2.268	0.721	192.0	286.8	2.233	0.728
230	189.3	283.1	2.273	0.726	192.9	291.3	2.238	0.732
231	190.2	287.5	2.279	0.730	193.8	295.8	2.244	0.737
232	191.1	292.0	2.285	0.734	194.7	300.4	2.250	0.741
233	192.0	296.5	2.290	0.739	195.6	305.1	2.255	0.746
234	192.9	301.0	2.296	0.743	196.5	309.8	2.261	0.750
235	193.8	305.7	2.301	0.748	197.4	314.6	2.266	0.754
236	194.7	310.4	2.307	0.752	198.3	319.5	2.272	0.759
237	195.5	315.1	2.312	0.756	199.2	324.4	2.277	0.763
238	196.4	320.0	2.318	0.761	200.1	329.4	2.283	0.768
239	197.3	324.9	2.324	0.765	201.1	334.5	2.288	0.772
240	198.2	329.9	2.329	0.769	202.0	339.7	2.294	0.776
241	199.1	334.9	2.335	0.774	202.9	344.9	2.299	0.781
242	200.0	340.1	2.340	0.778	203.8	350.2	2.305	0.785
243	200.9	345.3	2.346	0.783	204.7	355.6	2.310	0.790
244	201.8	350.5	2.351	0.787	205.6	361.1	2.316	0.794
245	202.7	355.9	2.357	0.791	206.5	366.7	2.321	0.799
246	203.6	361.3	2.363	0.796	207.4	372.3	2.327	0.803
247	204.5	366.8	2.368	0.800	208.3	378.0	2.332	0.807
248	205.4	372.4	2.374	0.805	209.2	383.8	2.337	0.812
249	206.3	378.1	2.379	0.809	210.1	389.7	2.343	0.816
250	207.2	383.9	2.385	0.813	211.0	395.7	2.349	0.821
251		389.7	2.390	0.818		401.7	2.354	0.825
252		395.6	2.396	0.822		407.9	2.359	0.830
253		401.6	2.401	0.827		414.1	2.365	0.834
254		407.7	2.407	0.831		420.4	2.370	0.838
255		413.9	2.412	0.835		426.9	2.376	0.843
256		420.2	2.418	0.840		433.4	2.381	0.847
257		426.5	2.423	0.844		440.0	2.386	0.852
258		433.0	2.429	0.849		446.7	2.392	0.856
259		439.6	2.434	0.853		453.5	2.397	0.861
260		446.2	2.440	0.858		460.4	2.403	0.865

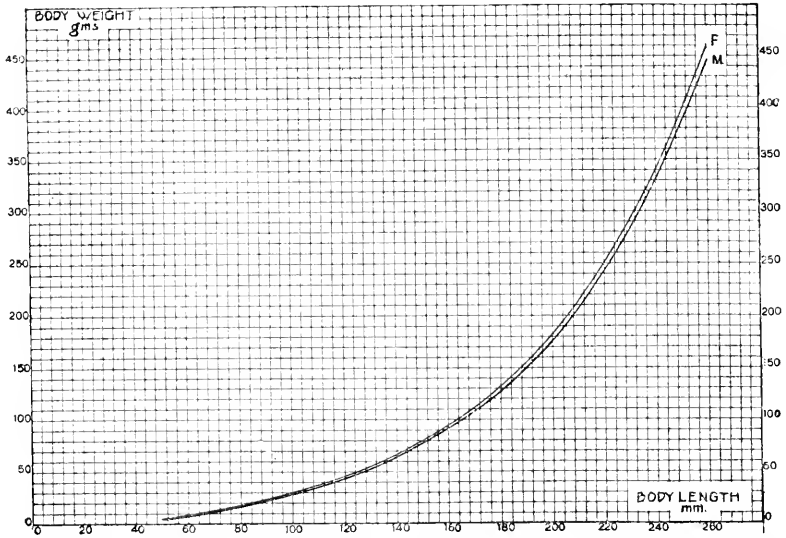

Chart 62 Giving the body weight on body length for both males and females. Formulas (54) and (55), table 187.

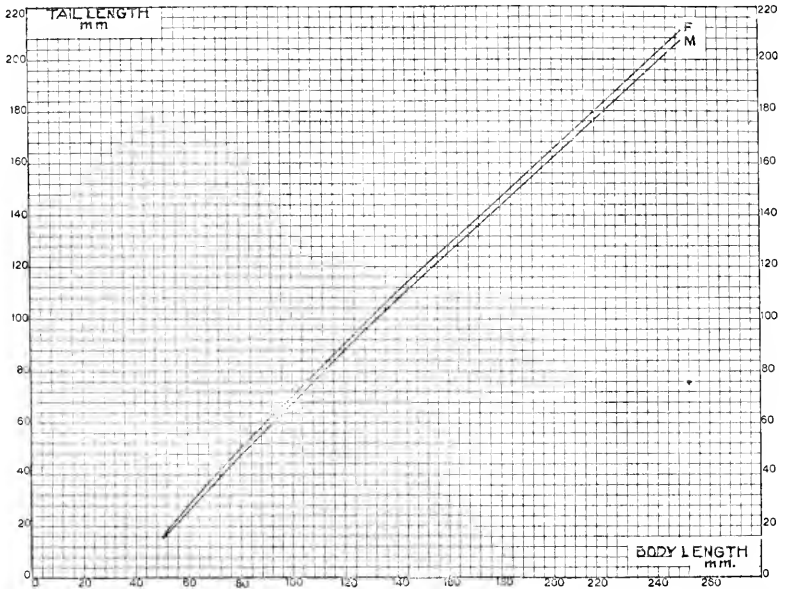

Chart 63 Norway rat—giving the tail length on the body length. Males and females. Formulas (56), (57), table 187.



This is probably an effect of domestication on the Albino. The explanation of the use of this table has been given on page 179 in connection with the corresponding table 122 for the Albino.

2. *Growth of parts of the body.* For the general conditions under which these observations were made by Jackson and Lowrey ('12), see pp. 181-182.

TABLE 188

*Giving in grams the values obtained by dividing the body weight by the body length in millimeters. Based on data in table 187*

BODY LENGTH	RATIO		BODY LENGTH	RATIO		BODY LENGTH	RATIO	
	Male	Female		Male	Female		Male	Female
<i>mm.</i>			<i>mm.</i>			<i>mm.</i>		
50	0.09	0.09	120	0.36	0.37	190	0.80	0.82
55	0.11	0.11	130	0.41	0.42	200	0.89	0.91
60	0.13	0.14	140	0.46	0.47	210	0.99	1.02
70	0.17	0.17	150	0.51	0.52	220	1.10	1.13
80	0.21	0.21	160	0.57	0.59	230	1.23	1.27
90	0.24	0.25	170	0.64	0.65	240	1.37	1.41
100	0.28	0.29	180	0.71	0.73	250	1.54	1.58
110	0.32	0.33				260	1.72	1.77

TABLE 189

*Norway rat—Percentage weights of head, trunk and extremities. Sexes combined (Jackson and Lowrey, '12)*

SEX	NET BODY WEIGHT	HEAD	FORE LIMBS	HIND LIMBS	TRUNK
	<i>grams</i>	<i>per cent</i>	<i>per cent</i>	<i>per cent</i>	<i>per cent</i>
M.....	65.0	14.66	5.95	13.88	65.51
M.....	95.4	12.17	5.83	15.34	66.66
F.....	107.5	10.18	5.58	15.81	68.43
M.....	164.0	9.27	5.24	14.94	70.55
F.....	254.0*	7.85	5.02	13.68	73.45

\*Including gravid uterus, which weighed 13.76 grams.

Five Norways only were examined, these having been trapped in barns at the University of Missouri. They were probably living on grain. As will be seen by reference to table 189 the smallest of these, a male, weighed 65 grams and was therefore probably about seven weeks old. The percentage relations of the several parts of the body are given in table 189.

On comparing the relative values here given with those for the albino rat (see p. 183) it appears that for corresponding body weights in the Albino the average values for the fore limbs and hind limbs are low, while those for the trunk are high—a relation which might be expected in view of the greater body length of the Norway—see tables 123 and 189.

TABLE 190

Norway rat—Percentage of total body weight represented by the weight of integument, ligamentous skeleton, musculature, viscera and remainder (Jackson and Lowrey, '12)

SEX	NET BODY WEIGHT	INTEGUMENT	LIGAMEN-TOUS SKELETON	MUSCULATURE	VISCERA	REMAINDER
	<i>grams</i>	<i>per cent</i>	<i>per cent</i>	<i>per cent</i>	<i>per cent</i>	<i>per cent</i>
M.....	65.0	18.42	13.15	35.39	23.40	9.64
M.....	95.4	19.29	13.85	38.57	23.21	5.08
F.....	107.5	20.37	13.86	42.14	17.51	6.12
M.....	164.0	17.35	13.29	41.66	20.95	6.75
F.....	254.0*	19.41	10.16	44.21	16.22	10.00

\*Including gravid uterus, which weighed 13.76 grams.

TABLE 191

The mean weight in grams of the crania in each body weight group of the four series of wild Norway rats from Paris, London, Philadelphia, Vienna (based on table 1 Donaldson, '12 a.) Each weight group is based on six cases, 3 males and 3 females

BODY WEIGHT GROUP	WEIGHT OF THE CRANIA IN GRAMS			
	London	Paris	Philadelphia	Vienna
<i>grams</i>				
125.....	1.17	1.27	1.13	1.10
175.....	1.58	1.58	1.34	1.37
225.....	1.84	1.91	1.71	1.70
275.....	2.25	2.17	2.14	1.90
325.....	2.69	2.60	2.40	2.27
375.....	3.13	2.98	2.86	2.48

For the corresponding weights of the albino crania see table 133.

3. *Growth of systems.* When the values for the five entries in table 190 are compared with the last four in table 124 for the albino rat, it is noted that in the Norway the values for the musculature and viscera are high, while that for the “remainder” is low. This last difference is due possibly to the smaller amount

of fat in the Norway. At the same time there is other evidence to show that for the same body weight as the Albino, both the trunk and the viscera of the Norway are heavier, as here found.

4. *Weight of cranium.* (Donaldson, 12a). Determinations of the weight of the cranium dried at room temperature have been made. By the cranium is meant the skull with upper teeth, minus the mandible with lower teeth and the ear bones. The mean weights are given in table 191. On comparing the values here given for the wild Norway with those for the Albino, table 133, p. 195, it is evident that for a given body weight the wild Norway has the heavier cranium.

GROWTH IN TOTAL BODY WEIGHT ON BODY LENGTH AND GROWTH  
IN THE WEIGHT OF PARTS AND SYSTEMS OF THE BODY:

REFERENCES

*Total body weight between birth and maturity on body length.* Donaldson and Hatai, '11. Donaldson, '12, '12 a.

*Body length on body weight.* Donaldson and Hatai, '11.

*Growth of parts.* Jackson and Lowrey, '12.

*Growth of systems.* Jackson and Lowrey, '12.

*Weight of cranium.* Donaldson, '12 a.

## CHAPTER 14

### GROWTH OF ORGANS—WILD NORWAY

1. Brain weight on body weight, (a) Comparison with albino, (b) Cranial capacity. 2. Spinal cord weight on body weight. 3. Size and shape of cerebrum, (a) Comparison with Albino. 4. Growth of cortex—thickness, (a) Comparison with Albino. 5. Growth of cortex—volume, (a) Comparison with Albino. 6. Number of cortical cells, (a) Comparison with Albino. 7. Size of cortical cells, (a) Comparison with Albino. 8. Size of sympathetic cells. 9. Weight of eyeballs. 10. Weights of ductless glands and gonads.

1. *Brain weight on body weight.* Donaldson and Hatai ('11). The direct determinations of the weight of the brain have been made on 232 males and 278 females—table 187. The general formula (58) expresses the relation of brain weight on body weight for the sexes combined.

It applies however only to rats with a body weight above 5 grams.

It has been found however (Donaldson and Hatai, '11, p. 428) that the weight of the male brain is one per cent above the mean for the two sexes, and that of the female, one per cent below.

As a consequence, each value gotten by the foregoing computations has been corrected by adding one per cent to the value found to give the weight for the male brain and by subtracting one per cent to obtain the weight for the female brain.

Chart 64 gives the graph for the male brain weight on the body weight and the corresponding graph (male) for the Albino is also drawn for comparison. The marked difference in the brain weight of the two forms is clearly shown.

(a) *Comparison with the albino.* Utilizing the data in tables 144 and 187 and using those for the albino male as the standards in each instance, it is found that the brain weight of the Norway male exceeds that of the Albino for the same body weight or body length by the percentages given in table 192.

It may be noted in passing that the same comparison of the data between the birth and the end of the suckling period (i.e., 25 grams or 100 mm.) shows an even greater excess in favor of the Norway.

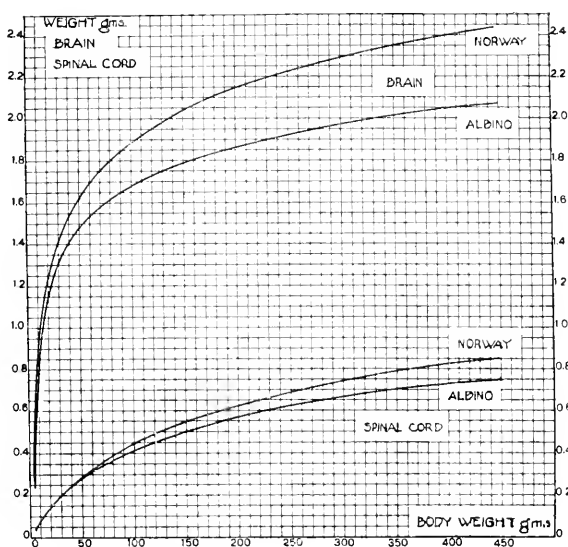

Chart 64 Norway rat, giving brain weight on the body weight. Males only. With corresponding graph for the Albino inserted for comparison. Formula 58, table 187. Also the spinal cord weight on the body weight. Males only. With the corresponding graph for the Albino inserted for comparison. Formula 60, table 187.

TABLE 192

Giving the percentages by which the brain weight of the Norway rat exceeds that of the Albino for the like body weight or body length

BODY LENGTH	PERCENTAGE EXCESS OF NORWAY BRAIN	BODY WEIGHT	PERCENTAGE EXCESS OF NORWAY BRAIN
<i>mm.</i>		<i>grams</i>	
100	7.7	25	6.1
125	9.2	50	9.2
150	10.5	100	11.0
175	11.9	200	15.0
200	13.1	300	16.4
250	15.1	400	17.4

(b) *Cranial capacity.* Formula (59) gives the cranial capacity on the body weight—a useful datum in many instances.

2. *Spinal cord weight on body weight—table 187.* In the case of the spinal cord, the computation was made for the sexes combined by the aid of formula (60). Here again there is a difference according to sex, the male spinal cord exceeding the female by 0.2 per cent, and the value for both sexes combined, by 0.1 per cent. Corrections similar to those applied to the brain have been

TABLE 193

*Giving the brain weight for each brain weight group, the cube root of the brain weight and the linear measurements for width, length and height of the cerebrum. Norway rat. W. B. = Width AB, W. D = Width CD, L. G = Length EG, L. F = Length EF (see figure 12). Ht. = Height HK (see figure 13)*

BRAIN WEIGHT GROUP	NUMBER OF CASES	BRAIN WEIGHT	CUBE ROOT OF THE BRAIN WEIGHT	W. B.	W. D.	L. G.	L. F.	Ht.
		<i>grams</i>		<i>mm.</i>	<i>mm.</i>	<i>mm.</i>	<i>mm.</i>	<i>mm.</i>
N XI	9	1.161	1.051	13.86	12.69	12.63	12.18	8.83
N XII	0							
N XIII	2	1.356	1.107	14.20	12.98	13.60	13.05	9.45
N XIV	12	1.436	1.128	14.45	13.21	13.71	13.24	9.31
N XV	5	1.536	1.154	14.77	13.39	14.18	13.48	9.28
N XVI	8	1.644	1.180	14.91	13.65	14.24	13.62	9.61
N XVII	8	1.743	1.204	15.10	13.92	14.54	13.88	9.97
N XVIII	4	1.836	1.225	15.17	14.20	15.00	14.32	9.98
N XIX	3	1.965	1.252	15.68	14.28	15.23	14.68	10.08
N XX	5	2.033	1.267	15.70	14.34	15.52	14.74	10.02
N XXI	4	2.164	1.293	16.25	14.94	15.92	15.12	10.18
N XXII	1	2.266	1.314	16.60	14.90	15.15	15.70	10.35
N XXIII	1	2.345	1.329	16.55	15.65	16.30	15.50	10.25

made in this case also. Chart 64 gives the graph for the male spinal cord on body weight and the corresponding graph (male) for the Albino is also drawn for comparison.

Formula (61) gives the spinal cord weight (sexes combined) on the brain weight—sexes combined.

3. *Size and shape of the cerebrum—Sugita ('18).* As in the case of the Albino, five diameters of the cerebrum were measured along the lines indicated in figures 12 and 13. The data are presented in table 193 and in chart 65.

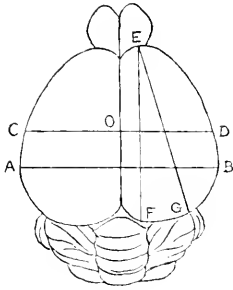

Fig. 12

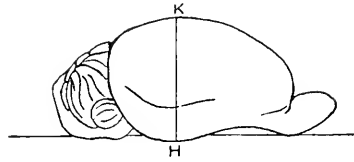

Fig. 13

Fig. 12 Dorsal view of the Norway rat brain weighing 1.64 grams—enlarged 1.8 diameters. To show the positions at which the two measurements for the width and the two measurements for the length were taken.

Fig. 13 Lateral view of the Norway rat brain weighing 1.64 grams—enlarged 1.8 diameters. To show the position at which the height was measured.

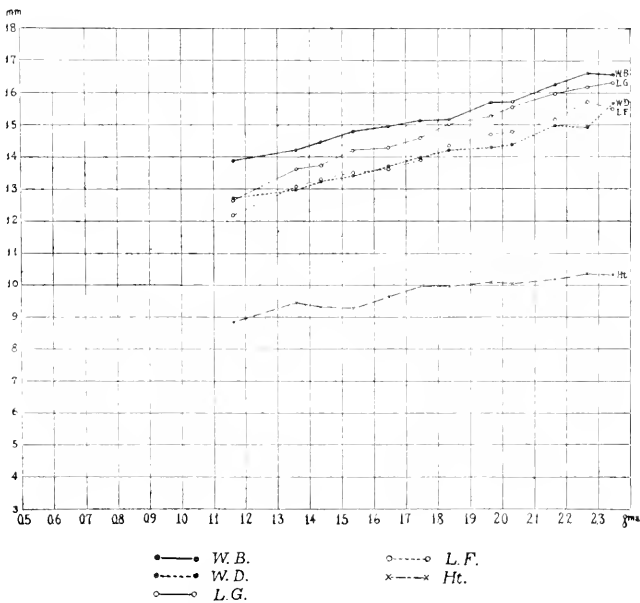

Chart 65 Giving the average values of the five diameters of the Norway rat cerebrum for each brain weight group. See legend, Chart 7.

(a) Comparison with Albino. The first records in table 193 are for brains weighing 1.16 grams from animals approximately

fifteen days of age. Examination shows that the longitudinal diameters increase more rapidly than do the transverse—but comparison with the relations found in the Albino shows that the change in the form of the brain with age is less marked in the Norway—so that the Norway brain always has a rounder appearance. Furthermore, inspection of the exposed brain in the Norway shows the tips of the frontal lobes to be distinctly more rounded in them than in the Albino. The difference in the form of the cerebrum in the two strains can be brought out by comparing the linear measurements for mature brains of the same weight—table 194.

TABLE 194

*Brain diameters of Norway and Albino compared. For the designations see Table 193*

	BRAIN WEIGHT	DIAMETERS IN MILLIMETERS				
		W.B.	W.D.	L.G.	L.F.	Ht.
	<i>grams</i>					
Norway.....	2.033	15.70	14.34	15.52	14.74	10.02
Albino.....	2.037	15.39	14.62	16.65	15.30	10.02

4. *Growth of the cerebral cortex in thickness—wild Norway rat—Sugita ('18a).* The method of study here used was the same as that for the Albino and both the planes for the sections and the localities at which the measurements were made correspond to those shown in figures 6, 7 and 8.

The body weights were all above 17 grams. The measurements on eleven brain weight groups, when corrected for the fresh condition, give the values entered in table 195.<sup>11</sup>

The cortex of the Norway rat attains nearly its full thickness when the brain weighs 1.54 grams, corresponding to a body weight of 42 grams and an age of 36 days—chart 66. The average thickness at maturity is about 2.05 mm. thus exceeding that of the Albino at a like brain weight by some 8 per cent.

(a) *Comparison with Albino.* The relations of the cortical thicknesses are quite similar among themselves to those shown

<sup>11</sup> The measurement for the frontal section is lacking in the last group—table 195 and in chart 66.



TABLE 195

Showing the average corrected thickness of the cerebral cortex in the wild Norway rat for each brain weight group.

BRAIN WEIGHT GROUP	SAGITTAL SECTION		FRONTAL SECTION	HORIZONTAL SECTION		GENERAL AVERAGE	
	Brain weight	Thickness	Thickness	Brain weight	Thickness	Brain weight	Thickness
	<i>grams</i>	<i>mm.</i>	<i>mm.</i>	<i>grams</i>	<i>mm.</i>	<i>grams</i>	<i>mm.</i>
N XI	1.164	1.61	1.88	1.164	1.87	1.164	1.79
N XII							
N XIII	1.369	1.73	1.96	1.343	2.08	1.360	1.92
N XIV	1.430	1.84	1.95	1.447	2.09	1.436	1.96
N XV	1.537	1.82	2.04	1.520	2.24	1.532	2.03
N XVI	1.629	1.88	2.08	1.663	2.19	1.640	2.05
N XVII	1.739	1.94	2.07	1.747	2.15	1.742	2.05
N XVIII	1.829	1.93	2.08	1.843	2.26	1.834	2.09
N XIX	1.972	1.97	2.00	1.953	2.25	1.965	2.07
N XX	2.052	1.87	1.96	2.018	2.08	2.041	1.97
N XXI	2.172	1.99	2.08	2.156	2.34	2.166	2.14
N XXII							
N XXIII	2.345	1.86	—	2.345	2.22	2.345	2.04

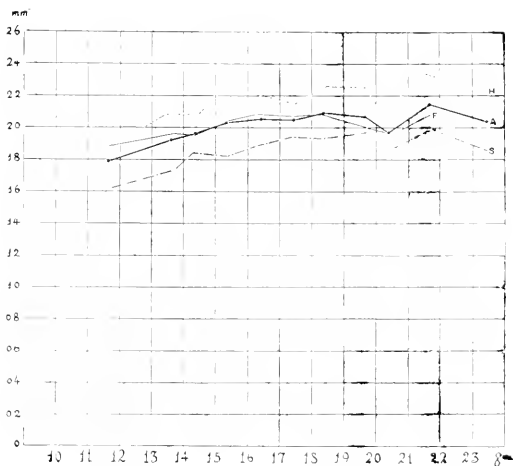

Chart 66 Giving the corrected thickness of the cortex in the sagittal, frontal and horizontal sections and the general average thickness for each brain weight group. Based on table 195. Norway rat. ······S, Average thickness of the cortex in sagittal section. Corrected. ————F, Average thickness of the cortex in frontal section. Corrected. - - - - -H, Average thickness of the cortex in horizontal section. Corrected. ·—·—· A, General average thickness of the cortex of three kinds of sections. Corrected.

by the Albino—save that the occipital cortex is relatively thicker in the Norway. This difference appears to depend on the defective development of the visual apparatus in the Albino. Table 196.

TABLE 196

*A comparison of the cortical thicknesses at each locality and on the average, in the adult Norway and the albino brains of the same absolute weight. The measurements used here are average values of Groups XXVI–N XX and Groups XVI–XX respectively, taken from tables 4 to 6 (Sugita, '18a) and tables 6 to 8 (Sugita, '17a). The corresponding brain weights are 1.844 grams in the Norway and 1.815 grams in the Albino. The thickness of the Albino cortex is always taken as the standard for computing the percentage differences*

SECTIONS	LOCALITIES	THICKNESS OF THE CORTEX		CORTEX OF THE NORWAY RAT EX- CEEDS BY
		Norway rat	Albino rat	
		<i>mm.</i>	<i>mm.</i>	<i>per cent</i>
Sagittal	Locality I	2.84	2.80	1.4
	II	2.06	1.92	7.3
	III	1.82	1.74	4.6
	IV	1.51	1.36	10.0
	V	1.37	1.19	15.1
	Average.....	1.92	1.80	6.7
Frontal	Locality VI	2.11	1.84	14.8
	VII	2.28	2.18	4.6
	VIII	1.73	1.59	8.9
	Average.....	2.04	1.87	9.1
Horizontal	Locality IX	3.09	3.08	0.3
	X	2.23	2.06	8.2
	XI	2.10	2.04	3.0
	XII	1.90	1.71	11.1
	XIII	1.63	1.27	28.3
	Average.....	2.19	2.03	8.0
General average.....	2.05	1.90	8.0	

5. *Growth of the cerebral cortex in volume—wild Norway rat—Sugita ('18a).* Employing the same initial measurements as were made on the albino (p. 84) the relative volume of the cortex in the Norway rat has been computed and in table 197 is compared with that in the Albino on the basis of like brain weights.

(a) *Comparison with Albino.* Although the values given in columns G and H, table 197 are relative, they show how the volume of the cortex increases with brain weight in each strain, and the

TABLE 197

Showing the computed volume for the entire cerebral cortex of the Norway rat brain, calculated by the formula:  $L.F. \times W. D \times T \times C$  for each brain weight group,  $C$  being a fixed coefficient used to convert the computed volume of the Norway cortex so as to make it comparable with that of the Albino ( $C = 1.036$ ). The computed volume of the cerebrum is quoted from my previous presentation (Sugita, '18). These values are paired with the corresponding values for the cortical volume of the Albino and the ratios between them calculated

NORWAY RATS							ALBINO RAT	
A	B	C	D	E	F	G	H	I
Brain weight group	Brain weight	Com- puted volume of cerebrum $L.G \times W.D \times H.t.$	$L.F$ in fresh brain	$W.D$ in fresh brain	$T.*$ average cortical thickness	$L.F \times W.D \times T \times C$ Com- puted volume of cortex	Corre- sponding computed volume of the Albino cortex, of the same group number	Ratio of cortical volume of the Norway to that of the Albino
	grams	mm. <sup>3</sup>	mm.	mm.	mm.	mm. <sup>3</sup>	mm. <sup>3</sup>	
N XI	1.163	156	12.2	12.7	1.75	281.00	288.93	0.973
N XII							304.51	
N XIII	1.369	182	13.1	13.0	1.85	326.51	314.03	1.040
N XIV	1.430	185	13.2	13.2	1.90	343.09	329.71	1.040
N XV	1.537	194	13.5	13.4	1.93	361.83	345.86	1.046
N XVI	1.629	203	13.6	13.7	1.98	382.32	359.30	1.064
N XVII	1.739	218	13.9	13.9	2.01	402.47	365.08	1.102
N XVIII	1.829	226	14.3	14.2	2.01	423.00	397.96	1.063
N XIX	1.972	241	14.6	14.3	1.99	430.57	390.39	1.103
N XX	2.052	249	14.7	14.4	1.94	425.59	393.15	1.083
N XXI	2.172	264	15.1	14.9	2.04	475.66		
Average (Groups N XIII-N XX).....						386.92	361.94	1.069

\*T, here entered, is the mean value of  $T_s$  and  $T_f$ , previously given in tables 11 and 13 and is not the general average thickness of the cortex of the sagittal, frontal and horizontal sections formerly presented in my fourth paper in this series (Sugita, '18 a).

relation between the volume in the Norway and in the Albino at like brain weights. As a result of the greater thickness and area of the Norway cortex the volume exceeds that of the Albino by about 7 per cent.

6. *The computed number of cells in two layers of the cerebral cortex—wild Norway rat—Sugita (18a).* Proceeding in the same manner as in the case of the Albino, see p. 83 the computed number of nerve cells in the cortex of the Norway rat was obtained at different brain weights. The data are arranged in table 198.

TABLE 198

*Giving the computed number of nerve cells in two layers of the entire cerebral cortex of the Norway rat brain, obtained on the basis of the measurements given in this series of studies. These values are made to be comparable with the corresponding values of the computed number of nerve cells in the cortex of the albino rat brains of like brain weight groups. (See table 48)*

NORWAY RATS						ALBINO RAT
A	B	C	D	E	F	G
Brain weight group	Brain weight	Computed volume of cortex $L \cdot F \times W \cdot D \times T \times C$	Sum of numbers of cells in lam. pyr. and lam. gang. in two unit volumes, $N$	Computed number of cells in entire cortex* $N \times L \cdot F \times W \cdot D \times T \times C \times \frac{1}{100}$	Ratio of number of cells in the Norway to that in the Albino	Corresponding computed number of cells in the Albino, of the same group number
	grams	mm. <sup>3</sup>				
N XI	1.163	281.00	181	508.6	0.946	537.4
N XII						520.7
N XIII	1.369	326.51	166	542.0	0.981	552.7
N XIV	1.430	343.09	160	548.9	1.009	544.0
N XV	1.537	361.83	144	521.0	1.011	515.3
N XVI	1.629	382.32	138	527.6	1.020	517.4
N XVII	1.739	402.47	132	531.3	0.997	533.0
N XVIII	1.829	423.00	131	554.1	1.009	549.2
N XIX	1.972	430.57	127	546.8	1.061	515.3
N XX	2.052	425.59	123	523.5	1.016	515.0
N XXI	2.172	475.66	112	532.7		
Average (Groups N XIII-N XX).....				536.9	1.013	530.2

\*As remarked in a note to table 48 the number given in this column corresponds to 1/100 of  $N \times L \cdot F \times W \cdot D \times T$ , or 1/50,000 of the actual number of cells contained in the computed volume of the cortex.

(a) *Comparison with Albino.* On examining table 198 column E, it is seen that the number of nerve cells in the cortex is nearly complete at a brain weight of 1.37 grams (Group N. XIII) while in the Albino this condition was reached at a brain weight of 1.17 grams (Group N. XI). As the last line in table 198 shows, the

computed number in the Norway exceeds that in the albino by 1.3 per cent. This may be considered as practical equality, so that the number of nerve cells in the cortex of the two forms is the same, as was suggested by Donaldson and Hatai ('11). It is of interest to note that the maximum number is found in both forms at a brain weight of 1.829 gms. This corresponds to about 100 days of age in the albino. Thus a loss of cortical cells in later life is clearly indicated.

7. *Growth in the diameters of the cortical cells and their nuclei—Sugita ('18c)*. Following the same methods which were employed for the Albino (figures 9 and 10) the growth of the largest cells in unit areas of the lamina pyramidalis and the lamina ganglionaris of the cortex of the Norway rat has been determined and the results are given in table 199 and in chart 67.

(a) *Comparison with Albino*. If the anomalous value for the nuclei in the cells in the lamina ganglionaris of the heaviest brain is excluded from the discussion, we find approximately the same growth relations in the Norway which have been recorded for the Albino. Rapid growth comes to an end at the weaning time and after this the cells of the lamina ganglionaris continue to increase somewhat in diameter while those in the lamina pyramidalis diminish. There are however some differences. As the data show (chart 67) the end of the rapid growing period in the ganglion cells appears in the Norway a little after the corresponding period in the pyramidal cells—whereas in the Albino these relations are reversed. The cells in both layers are larger in the Norway than in the Albino. When these are compared in size for like brain weights the relations found are as in table 200.

8. *Cells in superior cervical sympathetic ganglion: Ping ('21a) Norway rat*. Using 85 individuals of which 22 were cage bred at The Institute and 63 were caught wild about Philadelphia, Ping ('21a) examined the growth of the largest cells in the superior cervical sympathetic ganglion.

These cells grow rapidly during the first 25 days after birth and then more slowly, but on *like* body weight there is no sex difference in cell size. There are somewhat more cells pigmented than in the Albino—especially in the older animals—but the amount of pig-

TABLE 199

Giving the corrected final average diameters of the nerve cells and their nuclei in the lamina pyramidalis and the lamina ganglionaris measured on the frontal and the horizontal sections of the Norway rat brain. The average values of the two for each brain weight group are also given. The correction-coefficient for each brain weight group was taken from the previous papers (Sugita, '18 a, '18 b). F = frontal section. H = horizontal section

BRAIN WEIGHT GROUP	BRAIN WEIGHT	CORRECTION-COEFFICIENT	LAMINA PYRAMIDALIS		LAMINA GANGLIONARIS	
			Cell body diameter	Nucleus diameter	Cell body diameter	Nucleus diameter
	<i>grams</i>		$\mu$	$\mu$	$\mu$	$\mu$
F N XI	1.164	1.34	23.8	20.1	32.7	25.0
H N XI	1.164	1.30	23.0	19.1	31.8	24.2
	<i>1.164</i>		<i>23.4</i>	<i>19.6</i>	<i>32.3</i>	<i>24.6</i>
F N XIII	1.369	1.33	23.9	19.8	33.0	25.5
H N XIII	1.343	1.39	24.2	20.3	33.4	25.6
	<i>1.356</i>		<i>24.1</i>	<i>20.1</i>	<i>33.2</i>	<i>25.6</i>
F N XIV	1.430	1.35	24.0	19.7	34.2	25.5
H N XIV	1.447	1.36	24.2	20.3	33.5	25.9
	<i>1.439</i>		<i>24.1</i>	<i>20.0</i>	<i>33.9</i>	<i>25.7</i>
F N XV	1.546	1.40	23.9	20.2	34.2	26.2
H N XV	1.520	1.42	24.5	20.5	34.5	26.4
	<i>1.533</i>		<i>24.2</i>	<i>20.4</i>	<i>34.4</i>	<i>26.3</i>
F N XVI	1.629	1.40	23.8	19.3	34.7	25.9
H N XVI	1.663	1.34	23.2	19.2	33.5	25.2
	<i>1.646</i>		<i>23.5</i>	<i>19.3</i>	<i>34.1</i>	<i>25.6</i>
F N XVII	1.739	1.37	23.8	19.5	35.1	26.7
H N XVII	1.747	1.35	23.4	19.3	33.5	25.7
	<i>1.743</i>		<i>23.6</i>	<i>19.4</i>	<i>34.3</i>	<i>26.2</i>
F N XVIII	1.820	1.32	23.2	19.0	36.7	27.8
H N XVIII	1.843	1.39	23.8	19.7	34.0	26.0
	<i>1.836</i>		<i>23.5</i>	<i>19.4</i>	<i>35.4</i>	<i>26.9</i>
F N XIX	1.072	1.33	22.5	18.8	38.0	27.9
H N XIX	1.053	1.34	23.6	19.8	35.7	26.5
	<i>1.063</i>		<i>23.1</i>	<i>19.3</i>	<i>36.8</i>	<i>27.2</i>
F N XX	2.052	1.36	23.1	18.9	38.3	28.5
H N XX	2.018	1.32	23.9	19.0	35.6	25.0
	<i>2.035</i>		<i>23.5</i>	<i>19.0</i>	<i>37.0</i>	<i>26.8</i>
F N XXI	2.172	1.39	23.5	19.2	39.6	28.1
H N XXI	2.156	1.34	23.5	18.9	34.8	26.0
	<i>2.164</i>		<i>23.5</i>	<i>19.1</i>	<i>37.2</i>	<i>27.1</i>
F N XXIII	2.345	1.26	22.0	17.2	38.8	24.6
H N XXIII	2.345	1.28	22.6	17.4	36.8	24.1
	<i>2.345</i>		<i>22.3</i>	<i>17.3</i>	<i>37.8</i>	<i>24.4*</i>

\*See note on table 6. (Sugita, '18 c).

ment in a given cell is not much greater. The cells are distinctly smaller than in the standard Albino (Ping, '21) of like body weight but a trifle larger than those in the inbred Albino (Ping, '21). The values are given in table 201.

A comparison of size has been made between these cells in the Norway and in two strains of Albinos—the standard strain

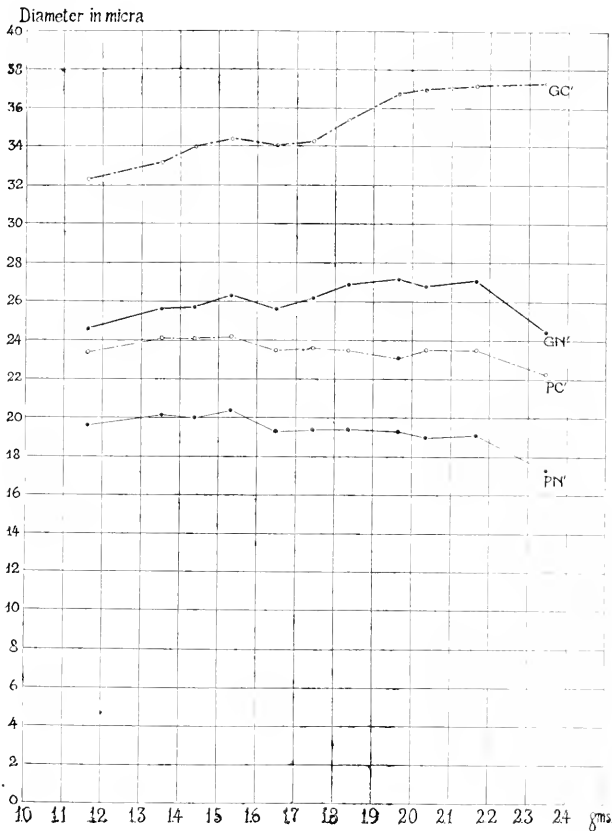

Chart 67 Showing the corrected average diameters of the cell body and the nucleus of the cortical nerve cells of the Norway rat, plotted according to increasing brain weight. Based on the data in table 199. Graph GC', average diameter of the cell body of the ganglion cells in the lamina ganglionaris. Graph GN', average diameter of the nucleus of the ganglion cells in the lamina ganglionaris. Graph PC', average diameter of the cell body of the pyramids in the lamina pyramidalis. Graph PN', average diameter of the nucleus of the pyramids in the lamina pyramidalis.

and the inbred strain of King—both reared at The Institute. The relations for two body weights are given in table 202.

TABLE 200

*Comparison of diameters of cortical cells in the Norway and the albino rats. The data used here are the averages in Groups XIII to XX and in Groups N XIII to N XX, taken from tables 3 and 8. Sugita, ('18 c). Differences in diameter and in volume are calculated here, the data of the Albino being taken as the standard of comparison*

	AVERAGE BRAIN WEIGHT	PYRAMIDS		GANGLION CELLS	
		Cell body	Nucleus	Cell body	Nucleus
	<i>grams</i>	$\mu$	$\mu$	$\mu$	$\mu$
Albino.....	1.691	22.9	18.8	32.4	24.9
Norway.....	1.694	23.7	19.6	34.9	26.3
Difference in diameter.....		3.5%	4.2%	7.7%	5.6%
Difference in volume.....		10.9%	13.1%	24.9%	17.8%

TABLE 201

*Giving according to body weight the computed diameters of the largest cells and nuclei in the superior cervical sympathetic ganglion, of the Norway rat. Sexes separated. Data condensed. Thirteen groups*

FORTY-THREE MALES				FORTY-TWO FEMALES			
Number of cases	Body weight average	Computed diameter		Computed diameter		Body weight average	Number of cases
		Nucleus	Cell	Cell	Nucleus		
	<i>grams</i>	$\mu$	$\mu$	$\mu$	$\mu$	<i>grams</i>	
1	6	9.9	17.2	16.5	9.6	6	1
3	15	12.9	22.8	22.5	12.5	14	3
5	35	12.4	23.4	23.2	11.7	28	2
3	76	13.0	25.5	25.2	13.0	31	1
3	104	13.1	26.5	24.3	12.7	51	8
2	117	13.2	27.1	26.0	13.0	73	2
3	157	13.3	26.1	24.9	13.0	103	4
3	186	13.4	27.9	28.3	13.3	157	4
5	220	13.6	29.7	27.7	13.0	179	6
4	244	14.0	31.3	26.6	12.8	192	3
3	276	13.5	33.3	27.8	12.7	214	3
5	323	14.0	33.0	31.6	13.7	227	2
3	385	13.7	31.0	32.1	13.9	258	3

The differences which appear in table 202 are worthy of note and especially striking is the small size of the cells in the Norway (at 200 grams) compared with that for the standard Albinos.



TABLE 202

Giving the diameters and nucleus-plasma ratios of the standard, inbred and Norway rats according to body weight, based on previous tables. In each instance the values given are for the two sexes combined

STRAIN	BODY WEIGHT	DIAMETERS		NUCLEUS-PLASMA RATIO
		Cells	Nucleus	
	<i>grams</i>	$\mu$	$\mu$	
Standard.....	145	28.9	13.2	1 : 9.5
Inbred.....	144	24.5	13.2	1 : 5.4
Norway.....	146	28.0	13.1	1 : 8.8
Standard.....	200	34.1	14.5	1 : 12.0
Inbred.....	206	25.4	13.3	1 : 5.9
Norway.....	203	28.0	13.1	1 : 8.8

TABLE 203

The weight of both eyeballs in wild Norway rats—on body length, together with weight of the eyeballs in the albino (table 144) on a body weight similar to the observed body weight Norway and to the body weight (Norway) as given in table 187 on the observed body length

NUMBER OF CASES	AVERAGE BODY LENGTH OBSERVED	AVERAGE BODY WEIGHT		AVERAGE WEIGHT OF BOTH EYE-BALLS		
		Observed	In table	Norway observed	Albino	
					On observed Norway body weight	On Norway body weight on observed body length in table
Males						
	<i>mm.</i>	<i>grams</i>	<i>grams</i>	<i>grams</i>	<i>grams</i>	
4	168	117	105	0.229	0.212	0.202
4	191	172	154	0.242	0.252	0.239
3	213	226	218	0.244	0.288	0.281
3	223	270	254	0.260	0.313	0.304
3	240	321	330	0.282	0.342	0.347
2	237	358	315	0.311	0.362	0.340
Females						
4	134	67	59	0.147	0.166	0.158
4	191	158	157	0.247	0.242	0.242
6	208	222	207	0.262	0.284	0.275
8	221	275	253	0.277	0.316	0.303
3	229	332	287	0.325	0.348	0.323

TABLE 204

Showing the weights (grams) of the thyroid gland in the two sexes of the Norway compared with those in the corresponding sexes of the albino rat

Thyroid gland

Body weight	MALES			FEMALES			
	Number	Norway observed	Albino calculated	Albino calculated	Norway observed	Number	Body weight
69	1	0.015	0.014	0.015	0.014	3	73
117	4	0.022	0.021	0.022	0.025	2	122
174	4	0.029	0.029	0.030	0.034	6	183
226	17	0.033	0.035	0.035	0.028	15	224
278	15	0.031	0.042	0.041	0.042	10	272
319	10	0.050	0.046	0.049	0.078	3	342
375	1	0.046	0.053				
Avg. 223	52	0.032	0.034	0.032	0.037	39	203

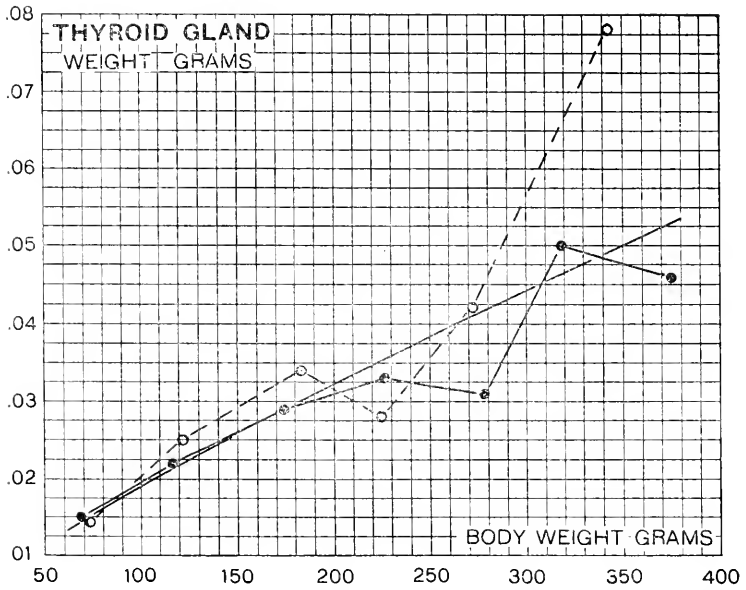

Chart 68 Showing the weight of the thyroid in the two sexes of the Norway compared with those in the albino rat.

Males • ——— • Norway, observed ○ - - - - ○ Females  
 Albino, calculated ——— Both sexes.

TABLE 205

Showing the weights (grams) of the hypophysis in the two sexes of the Norway compared with those in the corresponding sexes of the albino rat

Hypophysis

MALES				FEMALES			
Body weight	Number	Norway observed	Albino calculated	Albino calculated	Norway observed	Number	Body weight
186	1	0.0065	0.0071	0.0123	0.0071	4	182
226	14	0.0071	0.0082	0.0157	0.0086	9	225
281	15	0.0085	0.0097	0.0195	0.0095	4	273
315	1	0.0100	0.0107				
Avg. 252	31	0.0080	0.0089	0.0158	0.0084	17	227

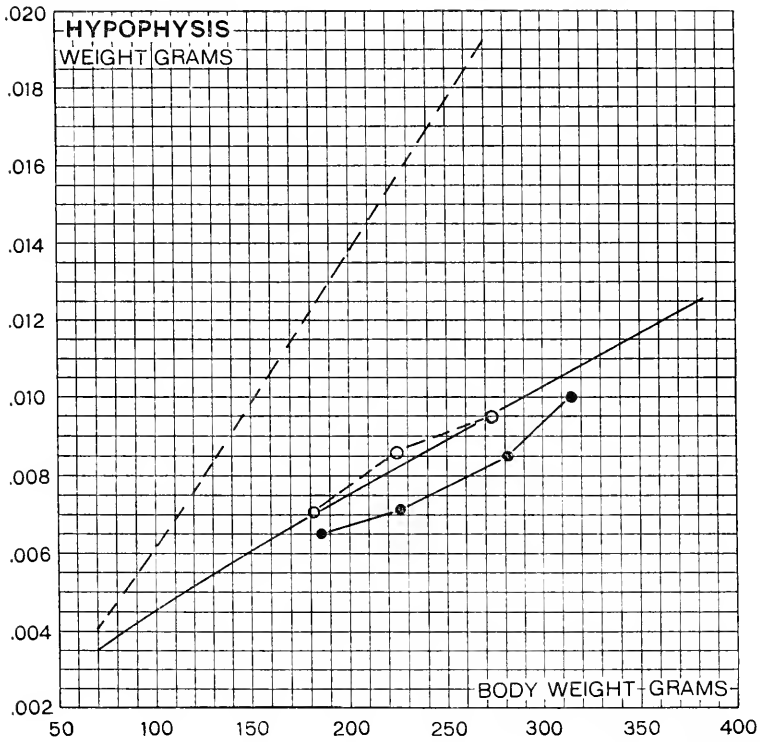

Chart 69 Showing the weight of the hypophysis in the two sexes of the Norway compared with those in the corresponding sexes of the albino rat.

Males •——• Norway, observed °-----° Females  
 Males ——— Albino, calculated - - - - - Females

TABLE 206

Showing the weights (grams) of the suprarenal glands in the two sexes of the Norway compared with those in the corresponding sexes of the albino rat  
Suprarenal glands

MALES				FEMALES			
Body weight	Number	Norway observed	Albino calculated	Albino calculated	Norway observed	Number	Body weight
69	1	0.026	0.018	0.021	0.037	4	67
117	4	0.065	0.025	0.035	0.069	3	126
175	5	0.083	0.031	0.049	0.093	6	183
226	17	0.075	0.037	0.059	0.109	15	224
278	15	0.081	0.042	0.070	0.128	10	272
319	10	0.088	0.047	0.086	0.137	5	340
375	1	0.079	0.052				
Avg. 223	53	0.071	0.036	0.053	0.096	43	202

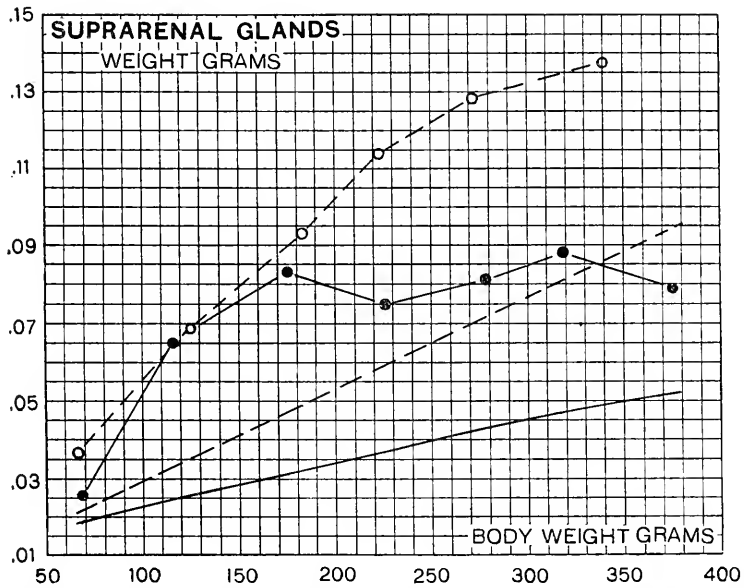

Chart 70 Showing the weight of the suprarenal glands in the two sexes of the Norway compared with those in the corresponding sexes of the albino rat.

Males • ——— • Norway, observed ○ ——— ○ Females  
Males ——— Albino, calculated ——— Females

9. *Weight of eyeballs—wild Norway.* A manuscript by Jackson ('11) furnishes a short series of data for the weight of the eyeballs—table 203.

Although the records in this table are few in number they show that for like body weights the eyeballs in the wild Norway are lighter than those in the Albino.

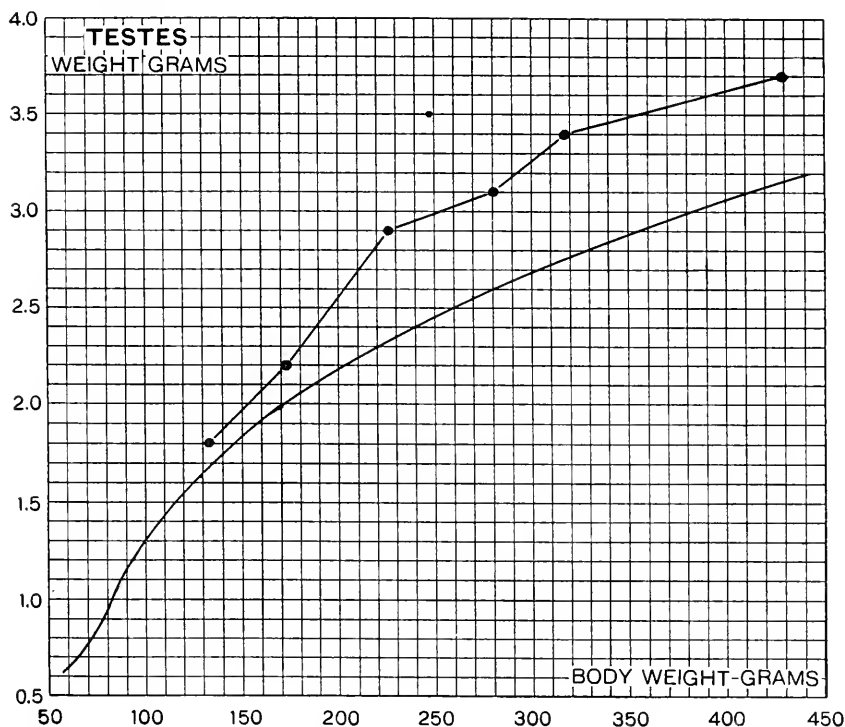

Chart 71 Showing the weight of the testes of the Norway rat compared with that of the albino rat.

Norway, observed • — • Albino, calculated —

10. *Weights of the ductless glands and gonads.* Some observations on these organs have been made by Hatai (14a) but more extensive data are needed. In this connection emphasis is put on the fact that the animals examined must be strictly wild and must not have been caged even for a few days—as the ductless glands tend to be very responsive to caging.

TABLE 207

Showing the weights (grams) of the sex glands—testes and ovaries—in the two sexes of the Norway compared with those in the corresponding sexes of the albino rat  
Sex glands

MALES				FEMALES			
Body weight	Number	Norway observed	Albino calculated	Albino calculated	Norway observed	Number	Body weight
				0.010	0.007	4	67
133	5	1.8	1.7	0.045	0.036	5	126
172	11	2.2	2.0	0.048	0.073	7	180
226	16	2.9	2.3	0.050	0.075	21	221
280	17	3.1	2.6	0.051	0.098	12	272
317	8	3.4	2.8	0.052	0.063	6	337
429	10	3.7	3.1				
Avg. 260	67	2.9	2.4	0.043	0.059	55	201

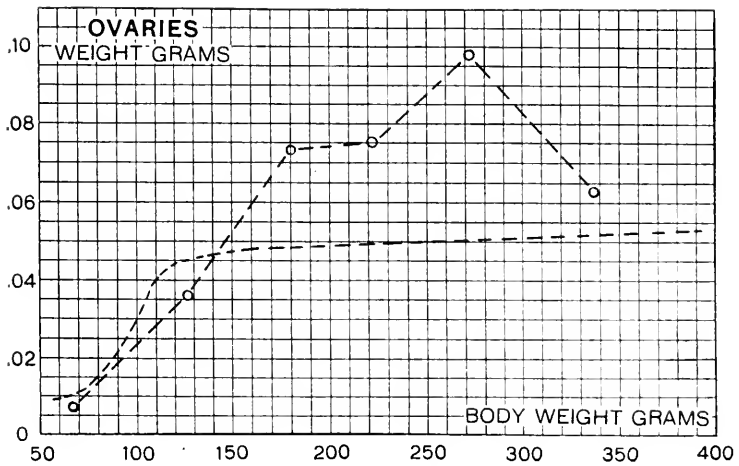

Chart 72 Showing the weight of the ovaries of the Norway compared with that of the albino rat.

Norway, observed ◦ - - - - - ◦ Albino, calculated - - - - -

*Thyroid.* On body weight the thyroid in the wild Norway is similar in weight to that in the albino, save for the last entry for the female. The sexes are alike. Table 204 and chart 68.

*Hypophysis.* The data for the hypophysis are meagre, but a they stand, they show the hypophysis of the male Norway a

slightly less in weight than that of the albino, while that of the female Norway is much below the weight of the hypophysis in the female albino and only a little above that of the male Norway. This serves to put the hypophysis weight in the female albino in high relief—table 205 and chart 69.

*Suprarenals.* The weight of the suprarenal glands in both sexes of the wild Norway runs above that for the corresponding sex in the albino—and to about the same degree—as the data in the table show. The data for this gland are not satisfactory in detail, but the general relations above indicated are trustworthy. The suprarenal weight is particularly modified by caging and domestication—table 206: chart 70. (Watson, C., '07 b.)

*Testes.* The testes are consistently heavier in the wild Norway—table 207 and chart 71.

*Ovaries.* In the case of the ovaries no valid conclusion can be drawn. As the Norway female does not breed until it is much older than the Albino, which accounts in part for the difference in the size of the ovaries up to 180 grams, and after that the wild Norways had in all probability been actively breeding while the Albinos with which they are compared were for the most part prevented from breeding—table 207 and chart 72.

#### GROWTH OF ORGANS—WILD NORWAY: REFERENCES

- Brain weight on body weight.* Donaldson and Hatai, '11.  
*Size and shape of cerebrum.* Sugita, '18.  
*Growth of cortex—thickness.* Sugita, '18 a.  
*Growth of cortex—volume.* Sugita, '18 a.  
*Number of cortical cells.* Sugita, '18 a.  
*Comparison with Albino.* Donaldson and Hatai, '11.  
*Size of cortical cells.* Sugita, '18 c.  
*Size of sympathetic cells.* Ping, '21 a.  
*Weight of eyeballs.* Jackson, '11.  
*Weight of ductless glands, including testes and ovaries.* Hatai, '14 a. Watson, C., '07 b.

## CHAPTER 15

### GROWTH IN TERMS OF WATER AND SOLIDS

1. Percentage of water in the blood. 2. Refractive index of serum. 3. Percentage of water in the brain and spinal cord.

1. *Percentage of water in the blood.* Hatai (MS '15) has determined the percentage of water in the blood of a small series of Norways.

The Norways had been recently caught and were examined before the day's feeding. The rat was chloroformed, but before the heart ceased beating it was exposed in situ, the tip clipped away and the blood from it caught in a small glass weighing bottle. The fresh weight was immediately taken and after drying at 95°C. for a week the weight of the residue was obtained. The results are given in table 208.

2. *Refractive index of blood serum in the wild Norway rat.* Hatai '18. The method of this determination has been given on page 64. The data are presented in table 209.

The values tend to increase with body length, here taken as an index of age. The refractive index here found is slightly below that for the Albino of the same body length. But when thus compared the Norway is probably younger, so that if it were possible to correct for age the values for the two forms might come closer together.

3. *Percentage of water in the brain and spinal cord.* Since the percentage of water in the nervous system is most closely linked with age, a precise determination in the case of the Norway rat is wanting, as the age is usually unknown. However from Norways born in captivity from trapped females we obtain the percentages according to age, given in table 210. It is to be noted that these Norways grew less rapidly than the Albinos of corresponding age, (Donaldson and Hatai '11). This observation agrees with that of King ('23).



TABLE 208

Giving the percentage of water in the blood of the Norway rat, *Hatai* (MS., '15)

SEX	NUMBER OF CASES	BODY WEIGHT, GRAMS		PERCENTAGE OF WATER IN BLOOD	
		Range	Mean	Range	Mean
M.....	5	114-169	144	79.02-82.05	80.34
M.....	6	173-440	243	79.92-81.53	80.52
F.....	4	103-190	148	79.82-80.35	80.05
F.....	5	199-304	271	79.52-81.77	80.82

TABLE 209

Refractive index of blood serum of the wild Norway rats of different body lengths

BODY LENGTH	SEX	NUMBER	BLOOD SERUM		REMARKS
			$N_D$	$\Delta N_D$	
<i>mm.</i>					
136	Mixed.	2	1.34658	13.38	
159	♀	1	1.34726	14.06	
194	♂	1	1.34872	15.52	
240	Mixed.	2	1.34985	16.65	
243	♂	1	1.35019	16.99	Slight hemolysis.
256	♂	1	1.34985	16.65	
Average....			1.34874		

TABLE 210

Showing the percentage of water in the brain and spinal cord of the Norway rat at different ages (sexes combined), (Donaldson and Hatai, '11)

NUMBER OF CASES	AGE IN DAYS	BODY WEIGHT	PERCENTAGE OF WATER	
			Brain	Spinal cord
		<i>grams</i>		
5.....	1	5.1	88.2	87.0
3.....	10	12.2	86.9	83.3
8.....	13	18.1	85.3	82.5
6.....	15	17.7	84.5	81.0
11.....	16	26.1	82.8	79.4
10.....	19	25.5	81.5	77.8
7.....	25	32.6	80.9	76.7
4.....	40	35.8	79.2	74.3
5.....	47	38.5	79.3	74.0

For Norways trapped in Philadelphia and killed shortly after capture, we obtain, according to body weight, sexes combined, the percentage values of water in brain and spinal cord which are given in table 211.

TABLE 211

*Giving the percentage of water in the brain and spinal cord of the Norway rat according to body weight (sexes combined). Based on Donaldson and Hatai, '11, tables 11 and 14*

BODY WEIGHT IN GRAMS	NUMBER OF CASES (SEXES COMBINED)	PERCENTAGE OF WATER (SEXES COMBINED)	
		Brain	Spinal cord
195.....	7	78.4	71.3
205.....	8	78.4	71.7
215.....	14	78.6	71.7
225.....	13	78.6	70.8
235.....	16	78.5	71.4
245.....	14	78.7	71.5
255.....	12	78.5	71.5
265.....	14	78.3	70.1
275.....	11	78.3	70.3
285.....	15	78.3	70.4
295.....	9	78.6	71.0
305.....	11	78.6	70.1
315.....	11	78.4	70.0
325.....	12	78.0	69.3
335.....	10	78.2	70.3
345.....	9	78.2	69.7
355.....	3	78.3	70.7
365.....	8	78.1	68.0
375.....	7	78.3	71.2
385.....	5	78.0	69.6
395.....	3	78.3	69.8
405.....	2	78.0	69.0
415.....	5	78.4	70.2
425.....	2	78.0	69.0
435.....			
445.....	6	78.5	69.6
455.....	1	78.0	69.0
465.....	1	78.0	67.0

A comparison of the values for the Norways and Albinos shows that the percentage of water in the Norways tends to run above that in the Albinos—being +0.37 per cent for the brain and +0.73 per cent for the spinal cord.

In considering the data in table 211 it must be remembered that while the percentage of water in the brain and spinal cord is primarily a function of age, yet at the same time body weight is rather poorly correlated with age. This certainly accounts for some of the irregularities which appear in this table.

The slightly higher percentage of water in the Norway nervous system is probably due in part to the greater mass of cytoplasmic substance as indicated by the slightly greater size of the cell bodies in the Norway.

#### GROWTH IN TERMS OF WATER AND SOLIDS: REFERENCES

*Refractive index of serum.* Hatai, '18.

*Percentage of water in the nervous system—brain and spinal cord.* Donaldson and Hatai, '11. King, '23.

## CHAPTER 16

### CAPTIVITY AND DOMESTICATION

1. *Summary of observed changes.* Characters in which: (a) Wild Norways differ from domesticated Albinos (b) Caged and domesticated Norways differ from domesticated Albinos (c) Albinos given exercise tend to return to the Norway type.

It has been already pointed out that the albino rat is a domesticated form. To compare with it we have the pigmented Norway, which may be either wild or captive, and at the same time more or less domesticated. Captivity, represented by caging, implies physical restraint, while domestication is a matter of adjustment in behavior. For convenience, however, animals captive for several generations and more or less adjusted may be designated as domesticated, while in the first phases of captivity they may be designated as caged. The differences which appear in the composition of the two forms are referred to albinism and to domestication.

Thus far there is but one character of the Albino—the very heavy hypophysis in the female—which appears characteristic of the albino rat as an Albino, but even this character may not be due to albinism in the general sense as it does not appear in the females of the albino rabbit or guinea pig.

The other characters by which the Albino differs from the Norway are apparently the results of caging and domestication. The proof for such conclusions can be had if domestication in the Norway can be made to induce the changes which appear in the Albino or if feralization of the Albino can cause it to reassume the characters of the Norway. The later process—feralization of the Albino—is difficult to accomplish, but the domestication of the Norway presents no insuperable obstacles, though it is only now in process of accomplishment at The Institute in the hands of Dr. King.

It is possible then at the present moment to indicate:

(a) Various characters in which the wild Norway differs from the domesticated Albino.

(b) Those characters which in the caged or domesticated Norway tend to become like those of the domesticated albino and

(c) Those which—when the Albino is given some of the conditions of the wild life—exercise for instance—tend to return to the Norway type.

(a) Characters in which the wild Norway differs from the domesticated Albinos. The wild Norway is more excitable and much more savage. They gnaw their cages. The body weight is less for a given body length, hence it is a slighter animal. The skeleton is relatively heavier, also the suprarenals (both sexes) and the testes and ovaries. On the other hand the thyroid is of like weight and the hypophysis distinctly lighter, in both sexes—this difference being most marked in the female. The brain and the spinal cord are both heavier than in the Albino. The relations are illustrated by the data in table 212.

Table 212 shows that for a given body weight the wild Norway has a heavier brain both in males and in females. In all groups the difference is more marked in the males, and increases with body weight. All the foregoing relations are found in the case of the spinal cord, only the difference between the sexes is in each group more marked than in the case of the brain.

In the Norways, as compared with the Albinos, the absolute differences in weight between the sexes is distinctly greater in the case of the brain, but much less in the case of the spinal cord. This brings it about that while the cord in the Norway differs but slightly in weight according to sex, there is in the Albino a distinct sex difference—the female albino having a heavier cord than the male.

As a result of these relations it is evident that the reduction in weight due to domestication has in the Albino affected the male more than the female in both the brain and spinal cord, and that in the latter case the reduction in the male has been carried so far that the female cord is the *heavier*. This reduction in the weight of the brain and cord is accompanied by a slight

diminution in the percentage of water in these parts. Such would come about if the cytoplasmic (protein) portion of the neurons was most altered, and comparison of the size of the cell bodies of the neurons in the central nervous system shows them to be smaller in the Albino than in the Norway, while the number of neurons, so far as tested, is the same in both forms.

TABLE 212

*Giving the difference in the weights of the brain and spinal cord for the wild Norway as compared with the domesticated Albino rat at a series of selected body weights*

BODY WEIGHT	VARIETY	BRAIN WEIGHT		ABSOLUTE DIFFERENCE	CORD WEIGHT		ABSOLUTE DIFFERENCE
		Males	Females		Males	Females	
<i>grams</i>		<i>grams</i>	<i>grams</i>	<i>grams</i>	<i>grams</i>	<i>grams</i>	<i>grams</i>
25	N.	1.336	1.309	-0.027	0.178	0.177	-0.001
	A.	1.253	1.234	-0.019	0.176	0.179	+0.003
	% Diff.	+6.6%	+6.1%		+1.1%	-1.1%	
50	N.	1.621	1.590	-0.031	0.296	0.295	-0.001
	A.	1.485	1.462	-0.023	0.286	0.290	+0.004
	% Diff.	+9.1%	+8.7%		+3.5%	+1.7%	
100	N.	1.887	1.850	-0.037	0.449	0.448	-0.001
	A.	1.682	1.657	-0.025	0.415	0.428	+0.013
	% Diff.	+12.2%	+11.6%		+8.2%	+4.7%	
200	N.	2.145	2.103	-0.042	0.628	0.628	0.000
	A.	1.867	1.839	-0.028	0.571	0.583	+0.012
	% Diff.	+14.8%	+14.1%		+10.0%	+7.7%	
300	N.	2.295	2.250	-0.045	0.742	0.741	-0.001
	A.	1.971	1.941	-0.030	0.665	0.678	+0.013
	% Diff.	+16.4%	+15.9%		+11.6%	+9.3%	
400	N.	2.400	2.353	-0.047	0.826	0.824	-0.002
	A.	2.044	2.015	-0.029	0.733	0.748	+0.015
	% Diff.	+17.4%	+16.7%		+12.7%	+10.2%	

In the case of the cells of the superior cervical sympathetic ganglion however the cells in the Norway are slightly smaller and show a smaller nucleus-plasma ratio.

(b) Characters in which the caged and domesticated Norways differ from the domesticated Albino. In this presentation it is to

be remembered that the domestication of the Norway has been carried on by Dr. King for only a few generations, and at the moment it is but the  $F_3$  which is under observation. Many of the statements to be made in this paragraph probably apply to the wild Norway also, but the full application of them must await further observations. Domesticated Norways become progressively less timid and easier to handle. They still gnaw their cages. The growth curve which in the early generations lags behind that of the Albino up to maturity tends in later generations to become more like that of the Albino. The time of suckling thus far continues somewhat longer in the Norway and the time of breeding, which in the earliest generations was at seven or eight months, appears earlier. The number of litters tends to be less than in the Albino, but the number of young per litter is about the same. The sex ratio is very low. The eyes open at 17 days.

Caging and domestication increase the body weight, but reduce the weight of the brain and spinal cord and the weights of the suprarenals and gonads. The hypophysis and thyroid are not conspicuously modified.

(c) Characters which in the Albino given exercise tend to return to the Norway type. Turning out Albinos to live the wild life in hopes that the descendents might be later examined, after a series of generations, has not been successful, though tried in several places. The liberated Albinos fail to establish themselves. In view of this result it has seemed best to try the effect of one of the elements of the wild life, namely, exercise.

When Albinos are permitted to exercise in a revolving cage within a single lifetime, the weight length relations become similar to those of the wild Norway. The percentage weight of the musculature increases. The brain increases slightly in weight, but there is no clear change in the weight of the spinal cord. The percentage of water in both of these parts is however slightly increased. The suprarenals and gonads are increased in weight, while the hypophysis tends to the relations found in the wild Norway. The viscera, except the spleen, are also increased in weight.

All of the foregoing results are from stock Albinos given exercise from about forty days of age on and do not indicate how the descendents of such rats would grow in subsequent generations. Studies on the effect of exercise through a series of generations are, however, now in progress.



## CHAPTER 17

### REFERENCES TO THE LITERATURE

#### 1. Introduction. 2. Subject references

1. *Introduction.* The list of references which follows does not claim to be complete and in several directions is intentionally selective. For example, many bacteriological investigations in which the rat has been used are omitted, as are also a large number of descriptive papers belonging to the earlier zoölogical literature. To this list of omissions belong about a dozen titles which do not appear to be accessible in any of the larger libraries of the United States; the printing of such titles was therefore regarded as superfluous.

On the other hand, it has been my intention to include the titles of all the papers which record anatomical investigations and physiological studies, so far as these were generally available.

At the outset of such a plan one meets with the difficulty that the rat has been used in many cases where the fact is not stated in the title of the paper, and moreover in other instances it is only one of several animals which have been examined or tested.

In the selection of the titles of this class the plan has been to include everything which gave information—no matter how restricted—that applied to the rat. Of course it is inevitable under these circumstances that some papers should have been overlooked.

In accordance with the general plan of the book we have included papers not only on the wild Norway and the domesticated Albino, but also on both forms of the house rat, *Mus rattus rattus* and *Mus rattus alexandrinus*.

The specific names and designations as given by the authors are quoted without comment but can be revised by reference to the foregoing section on nomenclature. Now and then I have permitted myself an annotation when this was pertinent.

Thus far the statements apply to the literature which follows and which is arranged alphabetically by authors' names and under authors, by date.

2. *Subject references.* It was desirable at the same time to present some sort of a subject classification, and this has been done in the following manner.

At the end of each chapter, references to the literature bearing on the subject of the chapter are given by author's name and date. The full reference appears in the list at the end of the volume. The chapter lists contain not only the citations in the text, but also other references which have not been cited there. The presentation is not uniform but dictated by the arrangement of the chapter. Where possible, the references are given in alphabetical order without subdivisions, but where it will be of advantage to have the references grouped according to the sub-headings, this is done, although under this plan the same reference may appear under more than one sub-heading.

## REFERENCES TO THE LITERATURE

ENTRIES CLOSED FEBRUARY, 1924

- ABDERHALDEN, EMIL** 1902 Über den Einfluss des Höhenklimas auf die Zusammensetzung des Blutes. *Zeitschr. für Biol.*, Bd. 43, S. 125-194.
- 1919 Studien über den Einfluss der Art der Nahrung auf das Wohlbefinden des einzelnen Individuums, seine Lebensdauer, seine Fortpflanzungsfähigkeit und das Schicksal der Nachkommenschaft. *Archiv für die Gesamte Physiol.*, Bd. 175, S. 187-326.
- ABELIN, J.** 1922 Beiträge zur Kenntnis der physiologischen Wirkung der proteingenen Amine. Vegetatives Nervensystem und Stoffwechsel. *Biochem. Zeitschr.*, Bd. 129, S. 1-49.
- ACKROYD, H.** 1914 On the purine metabolism of rats. *Biochem. J.*, vol. 8, pp. 434-437.
- ACKROYD, HAROLD AND HOPKINS, F. G.** 1916 Feeding experiments with deficiencies in the amino-acid supply: arginine and histidine as possible precursors of purines. *Biochem. J.*, vol. 10, pp. 551-576.
- ADACHI, K.** 1921 Flagellum of the microorganism of rat-bite fever. *J. of Exper. Med.*, vol. 33, pp. 647-651.
- ADAMS, HENRY F.** 1913 A set of blind white rats which could not learn the maze. *J. Animal Behavior*, vol. 3, pp. 300-302.
- ADDISON, W. H. F.** 1911 The development of the Purkinje cells and of the cortical layers in the cerebellum of the albino rat. *J. Comp. Neurol.*, vol. 21, pp. 459-481.
- 1916 The Golgi apparatus in the cells of the distal glandular portion of the hypophysis. *Proc. of Am. Assoc. of Anatomists in Anat. Record*, vol. 11, pp. 317-318.
- 1917 Cell changes in the hypophysis of the albino rat after castration. *Jour. Comp. Neur.*, vol. 28, pp. 441-463.
- ADDISON, W. H. F. AND APPLETON, J. L.** 1915 The structure and growth of the incisor teeth of the albino rat. *J. of Morphol.*, vol. 26, pp. 43-96.
- ADDISON, W. H. F. AND THORINGTON, J. M.** 1916 The behavior of the interstitial cells of the testis towards vital dyes. *Proc. of Am. Assoc. of Anatomists in Anat. Record*, vol. 11, pp. 318-319.
- 1918 The behavior of the phagocytic cells of the peritoneal fluid toward particulate matter. *Anat. Record*, vol. 14, pp. 467-478.
- ADDISON, W. H. F. AND HOW, H. W.** 1921 The development of the eyelids of the albino rat, until the completion of disjunction. *Am. Jour. Anat.*, vol. 29, pp. 1-27.
- ADDISON, W. H. F. AND APPLETON, J. L.** 1922 The vascularity of the enamel-organ in the developing molar of the albino rat. *Am. Jour. Anat.*, vol. 31, pp. 161-189.
- ADDISON, W. H. F. AND RICHTER, M. N.** 1923 On the red blood cells of the new-born albino rat. *Proc. Am. Assoc. of Anatomists in Anat. Record*, vol. 25, p. 116.
- 1923 a The numerical relations of the erythroblasts and leucocytes in the blood of the pre-natal and neonatal albino rat. *Quart. J. of Exper. Physiol.*, (Suppl. vol.) p. 45. Abstracts of the Proc. of the XIth Internat. Physiol. Congress held in Edinburgh, July 23-27th.
- ADIE, J. R.** 1906 Note on a leucocytozoön found in *Mus rattus* in the Panjab. *Journ. Trop. Med.*, vol. 9, pp. 325-326.
- ADLOFF, PAUL** 1898 Zur Entwicklungsgeschichte des Nagetiergebisses. Inaug.-Diss. Universität Rostock, Gustav Fischer, Jena. Figs. 77-81 inclusive.
- ADVISORY COMMITTEE** See REPORTS ON PLAGUE INVESTIGATIONS
- ADVISORY COMMITTEE:** 1912 Observations on the breeding of *Mus rattus* in captivity. *J. Hyg., Plague Suppl.* 1, pp. 193-206.
- 1912 a The immunity of the wild rat in India. *J. Hyg., Plague Suppl.* II, 7th Report on Plague Investigations in India, pp. 229-265.
- 1912 b Experimental plague epidemics among rats. *J. Hyg., Plague Suppl.* II, 7th Report on Plague Invest. in India, pp. 292-299.
- ADVISORY COMMITTEE (GLOSTER, T. H. AND WHITE, F. N.)** 1917 Epidemiological observations in the united provinces of Agra and Oudh 1911-1912. *J. of Hygiene, Plague Suppl.* V., Tenth report on "Plague investigation in India," pp. 793-899. Observations in the rats and fleas of Lucknow, p. 820, Cawnpore, p. 828, Ballia, p. 842, Jhansi, p. 860 and Banda, p. 862.
- AHREND** 1903 Beitrag zur Geschichte des sog. "Rattenkönigs." *Natur. u. Haus.*, Bd. 11, S. 371-373.
- AKAIWA, HACHIRO** 1919 A quantitative study of wound healing in the rat. I. Cell movements and cell layers during wound healing. *J. of Med. Research*, vol. 40, pp. 311-351.
- 1919 a A quantitative study of wound healing in the rat. II. Cell growth during wound healing. *J. of Med. Research*, vol. 40, pp. 371-413.
- AKAMATSU, KUNITARO** 1905 On the brown rat. *Zool. Mag. (In Japanese)* Tokio, vol. 17, no. 203.
- ALBERTUS, MAGNUS** 1206-1280 B. Alberti Magni, Opera Omnia, edited by August Borgnet—38 vols., 1890-1899, Paris. See vol. 12, 1891 p. 420. *Mus*

- "quod nos ratum vocamus," in Lib. xxii De Animalibus, Tract II, n. 78.
- ALDRICH, T. B. 1912 On feeding young white rats the posterior and the anterior parts of the pituitary gland. *Am. J. Physiol.*, vol. 31, pp. 94-101.
- ALEXANDER, GUSTAV 1899 Zur Anatomie des Ganglion vestibulare der Säugethiere. *Sitzungsber. der Kaiser. Akad. der Wiss., Math.-naturw. Classe*, Bd. 108, Abt. 3, S. 449-465. Zusammenfassung 5-6; Figures 10-11, *Mus rattus* (!)
- ALEXANDER, G. 1900-1901 The rat; its sanitary relationships. *San. Jour. Glasg.*, 1900-1901, n.s., vol. 7, pp. 477-487.
- ALEZAIS, H. 1902 Les adducteurs de la cuisse chez les rongeurs. *J. de l'Anat. et de la Physiol.*, T. 38, pp. 1-13.
- ALLEN, EZRA 1912 The cessation of mitosis in the central nervous system of the albino rat. *J. Comp. Neurol.*, vol. 22, pp. 547-568.
- 1916 Studies on cell division in the albino rat (*Mus norvegicus* var. *alba*). II. Experiments on technique, with description of a method for demonstrating the cytological details of dividing cells in brain and testis. *Anat. Record*, vol. 10, pp. 565-589.
- 1918 Studies on cell division in the albino rat (*Mus norvegicus* var. *alba*). III. Spermatogenesis: The origin of the first spermatocytes and the organization of the chromosomes, including the accessory. *Jour. Morph.*, vol. 31, pp. 133-185.
- 1919 A technique which preserves the normal cytological conditions in both germinal and interstitial tissue in the testis of the albino rat (*Mus norvegicus albinus*). *Anat. Record*, vol. 16, pp. 25-35
- 1919a Degeneration in the albino rat testis due to a diet deficient in the Water-soluble vitamine, with a comparison of similar degeneration in rats differently treated and a consideration of the Sertoli tissue. *Anat. Rec.*, vol. 16, pp. 93-117.
- ALLEN, JESSIE B. 1904 The associative processes of the guinea-pig. A study of the psychical development of an animal with a nervous system well medullated at birth. *Jour. Comp. Neur.*, vol. 14, pp. 293-359.
- ALSTON, EDWARD R. 1879-1882 *Biologia Centrali Americana. Mammals*, p. 141.
- AMOSS, HAROLD L. AND HASELBAUER, PETER 1918. The rat and poliomyelitis: an experimental study. *J. of Exper. Med.*, vol. 28, pp. 429-434.
- ANSEL, P. AND BOUIN, P. 1905 La glande interstitielle du testicule et la défense de l'organisme. II. Hypertrophie ou atrophie partielle de la glande interstitielle dans certaines conditions expérimentales. *Compt. rend. de Soc. de Biol. T.* 58, pp. 554-555. Rats blanc et cobayes.
- ANDERSON, R. J. 1893 The lens in an albino rat. *Internat. Monats. f. Anat. u. Phys.*, vol. 10, pp. 65-67.
- ANGLAS, J. 1910 Les animaux de laboratoire. La Souris (Anatomic et dissection). Vigot Frères, Paris.
- APOLANT, HUGO 1896 Ueber die sympathischen Ganglienzellen der Nager. *Arch. f. mikr. Anat.*, Bd. 47, S. 461-471, S. 466, rats mentioned—mostly rabbits.
- ARAI, HAYATO 1920 On the postnatal development of the ovary (albino rat), with especial reference to the number of ova. *Am. Jour. Anat.*, vol. 27, pp. 405-462.
- 1920 a On the cause of the hypertrophy of the surviving ovary after semi-spaying (albino rat) and on the number of ova in it. *Am. Jour. Anat.*, vol. 28, pp. 59-79.
- ARLITT, ADA H. AND WELLS, H. G. 1917 The effect of alcohol on the reproductive tissues. *J. of Exp. Med.*, vol. 26, pp. 769-778.
- ARLITT, A. H. 1919 The effect of alcohol on the intelligent behavior of the white rat and its progeny. *Psychol. Monog.*, vol. 26, no. 4.
- ARNSTEIN, C. 1877 Zur Kenntnis der quergestreiften Muskulatur in den Lungenvenen. *Med. Centrabl.*, 15 Jahrg., S. 692-694. Extended to veins of small caliber in the rat.
- ARON, HANS 1912 Weitere Untersuchungen über die Beeinflussung des Wachstums durch die Ernährung. *Verhandl. der 29th Versamml. der Gesellsch. f. Kinderheilk.* in der Abt. für Kinderheilkunde der 84 Versamml. der Gesellsch. deut. Naturforscher und Aerzte in Münster. Bergmann, Wiesbaden.
- 1913 *Biochemie des Wachstums des Menschen und der höheren Tiere.* (In OPPENHEIMER, CARL, *Handbuch der Biochemie des Menschen und der Tiere—Ergänzungsband*, S. 610-674. Fischer, Jena.)
- ASAI, K. 1908 Die Blutgefäße des häutigen Labyrinthes der Ratte. Beiträge zur vergleichenden Anatomie des inneren Ohres. *Anat. Hefte*, Bd. 36, S. 711-728.
- ASAYAMA, C. 1916 Feeding experiments with kynurenine acid. *Biochem. J.*, vol. 10, pp. 466-472.
- ASCHER, L. 1910 Beitrag zur Kenntnis der Rattenkrätze. *Arch. f. Dermat. u. Syph.*, Wien u. Leipz., Bd. 101, S. 211-220. 2 pl.
- ASHER, LEON AND ERDELY, A. 1903 Ueber die Beziehung zwischen Bau und Function des lymphatischen Apparates des Darmes. *Centrabl. f. Physiol.*, Bd. 16, S. 705-709.
- ASHER, LEON 1908 Des Verhalten des Darmepithels bei verschiedenen funktionellen Zuständen. *Ztschr. f. Biol.*, Bd. 51, S. 115-126.
- ASKANAZY, M. 1908 Die Teratomie nach ihrem Bau, ihrem Verlauf, ihrer Genese und im Vergleich zum experimentellen Teratoid. *Verh. deutsch. path. Ges.*, Bd. 11, S. 39-82.

- ASP, GEORG A. 1873 Bidrag till spottkörtlarnes mikroskopiska anatomi. S. 128, 1 pl. J. C. Frenckell & Son, Helsingfors.
- 1873 a Om nervernas ändingsätt i spottkörtlana. (Ueber die Endigungsweise der Nerven in den Speicheldrüsen.) Nord. med. Ark., Bd. 5, no. 5, S. 1-9.
- ASTASCHEWSKY, P. 1877 Ueber die diastatische Wirkung des Speichels bei verschiedenen Tieren. Centralbl. f. d. med. Wiss., S. 531-534. S. 533, saliva of rat remarkably active.
- AUERBACH, MAX 1902 Das braune Fettgewebe bei schweizerischen und deutschen Nagern und Insektivoren. Arch. f. Mikr. Anat., Bd. 60, S. 291-338.
- AUMANN 1912 Vergleichende Untersuchungen über die Wirksamkeit bakterieller und chemischer Rattenvertilgungsmittel. Centralbl. f. Bakteriol., 1 Abt., Bd. 63, S. 212-221.
- AUNETT, H. E. 1908 Virus for the destruction of rats and mice. Brit. M. J., Lond., vol. 2, p. 1524.
- B**ACOT, A. 1914 A study of the bionomics of the common rat fleas and other species associated with human habitations, with special reference to the influence of temperature and humidity at various periods of the life history of the insect. J. Hyg., Plague Suppl. III, pp. 447-654.
- BACOT, A. W. AND MARTIN, C. J. 1914 Observations on the mechanism of the transmission of plague by fleas. J. Hyg., Plague Suppl. III, 8th Report on Plague Invest. in India, pp. 423-440.
- BAGG, H. J. 1922 Disturbances in mammalian development produced by radium emanation. Am. Jour. Anat., vol. 30, pp. 133-161.
- BAHR, L. 1906 Ueber das Vorkommen von Trichinen bei der Ratte. Zeitschr. Infektionskr. parasit. Krankh. Hyg. Haustiere, Bd. 2, S. 62-65.
- BAINBRIDGE, F. A. 1909 On the bacterial nature and efficiency of certain rat viruses. J. Path. and Bacteriol., vol. 13, pp. 457-466.
- BALDWIN, W. M. 1923 The increased absorption of X-rays by vitally stained white rats. J. of Exper. Med., vol. 37, pp. 357-364.
- BALFOUR, FRANCIS M. 1881 A treatise on comparative embryology. Macmillan & Co., London. Rat, page 200. Atrophy of alantois. Extreme tenuity of decidua reflexa. Page 201, fig. 149, section through placenta—from Huxley.
- BANCROFT, T. L. 1894 On the whip-worm of the rat's liver. J. and Proc. Roy. Soc. N. South Wales, 1893, Sydney, 1894, xxvii, 86-90, 2 pl.
- BANNERMAN, W. B. 1906 The spread of plague in India. J. Hyg., vol. 6, pp. 179-211.
- BARBER, ALDA GRACE 1915 The localization of sound in the white rat. J. of Animal Behavior, vol. 5, pp. 292-311.
- BARBOUR, HENRY G. AND MAUREL, L. L. 1920 Tyramine as a morphine antagonist. J. of Pharmacol. and Exp. Therapeutics, vol. 15, pp. 305-330.
- BARCROFT, J. 1923 The circulation in the spleen. Abstracts of Communications to the XIth Internat. Physiol. Congress held at Edinburgh, July 23rd-27th.
- BARCROFT, J. AND BARCROFT, H. 1923 Observations on the taking up of carbon monoxide by the haemoglobin in the spleen. J. of Physiol., vol. 58, pp. 138-144.
- BARDELEBEN, KARL VON 1899 Handbuch der Anatomie, vol. 4, Centralnervensystem, I Teil, von Prof. Dr. Th. Ziehen., p. 12. Spinal cord weight; rat (Ranke).
- BARNABO, VALENTINO 1913 Ulteriori ricerche sperimentali sulla secrezione interna testicolare. Policlin., vol. 20, pp. 165-192.
- BARRETT-HAMILTON, G. E. H. 1892 Mus alexandrinus in Ireland. The Zoologist, vol. 16, p. 75.
- BARRY, LEE W. 1920 The effects of inanition on the pregnant albino rat, with especial reference to the changes in the relative weights of the various parts, systems, and organs of the offspring. Proc. Am. Assoc. of Anatomists in Anat. Record, vol. 18, p. 221.
- BARTENEFF, L. 1891 On the distribution of the nerves in the plexus of the small intestine. Inaug.-Diss. 32 pp., 1 pl. (in Russian).
- BASCH, S. VON 1870 Die ersten Chyluswege und die Fettresorption. Sitz. d. k. Akad. d. Wiss. math.-naturw. Cl. Wien., Bd. 62, Abt. 2, S. 617-634. 1 pl.
- BASHFORD, E. T. AND MURRAY, J. A., ET AL. 1900 General results of propagation of malignant new growths. The Imp. Cancer Research Fund, 3rd Scien. Report, pp. 262-283.
- BASLER, A. 1909 Beiträge zur Kenntnis der Bewegungsvorgänge des Blinddarminhalt. Arch. f. d. ges. Physiol., Bd. 128, S. 251-276, 9 text figures.
- BASSET, GARDNER C. 1914 Habit formation in a strain of albino rats of less than normal brain weight. Behavior monographs, vol 2, no. 4, serial number 9.
- BAST, T. H. 1921 Studies on the structure and multiplication of bone cells facilitated by a new technique. Am. J. of Anatomy, vol. 29, pp. 139-158.
- BATE, DOROTHEA M. A. 1912 On a new species of mouse and other rodent remains from Crete. Geol. Mag. Dec., V. vol. ix, no. 573, pp. 4-6. Epimys (Mus) rattus from the pleistocene cave deposits of Crete.
- BATEMAN, W. G. 1916 The digestibility and utilization of egg proteins. J. of Biol. Chem., vol. 26, pp. 272.
- BATESON, W. 1903 The present state of knowledge of color heredity in mice and rats. Proc. Zool. Soc., London, vol. 2, p. 71.

- BAUMGART, MARTIN 1904 Vergleichende Untersuchungen über *Mus rattus* und *Mus decumanus* und über die Ursachen der Verdrängung der Hausratte durch die Wanderratte. Inaug.-Diss. Philos. Fak. Zürich.
- BAYLIS, H. A. 1922 Observations on certain cestodes of rats, with an account of a new species of *Hymenolepis*. *Parasitology*, vol. 14, pp. 1-8.
- BAYON, H. 1911 Demonstration of specimens relating to the culture of the leprosy bacillus. *Brit. M. J.* part 2, pp. 1269-1272.
- 1912 Demonstration of acid-fast germs cultivated from cases of leprosy. *Tr. Soc. Trop. M. and Hyg.*, vol. 5, pp. 103-105. Authors mentioned in text; no tables—rats.
- 1912 a The experimental transmission of the spirochaete of European relapsing fever to rats and mice. *Parasitology* (Suppl. to the *J. Hyg.*) vol. 5, pp. 135-149, 3 figs.; experiments on white rats pp. 142-145; results summarized, not tabulated.
- 1912 b The culture and identification of the germ of leprosy and the relationship of the human disease to rat leprosy. *Tr. Soc. Trop. M. and Hyg.*, vol. 5, pp. 158-167.
- 1912 c On the transmission of leprosy to animals by direct inoculation. *Brit. M. J.*, part 1, pp. 424-426.
- BEATTI, M. 1917 Tumores espontáneos de ratas salvajes. *Semana méd.*, Buenos Aires, T. 24, pp. 643-661.
- BECHSTEIN, J. M. 1891 Gemeinnützige Naturgeschichte Deutschlands nach allen drey Reichen. Zweite Ausgabe, vol. 1, Säugethiere, pp. 931-952. Leipzig.
- BECHT, FRANK C. AND LUCKHART, ARNO B. 1916 The origin of the antibodies of the lymph. *Am. J. of Physiol.*, vol. 40, pp. 366-371.
- BECHTEREW, W. VON 1890 Ueber die verschiedenen Lagen und Dimensionen der Pyramidenbahnen beim Menschen und den Thieren und über das Vorkommen von Fasern in denselben welche sich durch eine frühere Entwicklung auszeichnen. *Neurol. Centralbl.*, S. 738-741.
- BECK, WILHELM 1896 Über den Austritt des N. Hypoglossus und N. Cervicalis Primus aus dem Centralorgan beim Menschen und in der Reihe der Säugethiere unter besonderer Berücksichtigung der dorsalen Wurzeln. *Anat. Hefte*, Bd. 6, S. 251-344. *Mus rattus*, p. 312.
- BECKWITH, T. D. AND REICH, W. W. 1921 The variation in the size of *trypanosoma brucei* according to the host. *Proc. of the Soc. for Exper. Biol. & Med.*, vol. 18, pp. 316-317.
- BEGG, ALEXANDER S. 1916 The origin of the posterior portion of the vena cava inferior in the white rat. *Proc. of Am. Assoc. of Anatomists in Anat. Rec.*, vol. 10, pp. 181-182.
- BEHRENSROTH, ERICH 1914 Ueber die Einwirkung des Hirnanhangsextraktes auf den Blutdruck des Menschen nebst Bemerkungen über einige Injektionsversuche am wachsenden Tier. *Deutsch. Arch. f. klin. Med.*, Bd. 113, S. 393-401.
- BELLING, KARL 1906 Beiträge zur makroskopischen und mikroskopischen Anatomie der Vagina und des Uterus der Säugetiere. *Archiv. f. mikr. Anat.*, Bd., 67, S. 573-637. *Mus decumanus*, S. 588.
- BELL, E. T. 1911 The intersitial granules of striated muscle and their relation to nutrition. *Internat. Monat. f. Anat. u. Physiol.*, vol. 28, pp. 297-347.
- BELL, THOMAS 1837-1847 British quadrupeds including the cetacea. John van Voorst, London; 2nd ed., pp. 310-320. Both *rattus* and *decumanus*: excellent pictures of each.
- BELLONCI, G. 1855 Del fuso direzionale e della formazione di un globulo polare nell'ovulo ovarico di alcuni mammiferi. *Atti della R. Accad. dei Lincei*, Ser 4. *Rendiconti*, pp. 285-286.
- BELLOU, G. 1899 Recherches sur l'origine des corps jaunes de l'ovaire chez le rat et le cochon d'Inde. *Compt. rend. de l'Ass. d. Anat. Première session*, Paris, pp. 47-52.
- BENDA, CARL 1887 Untersuchungen über den Bau des funktionirenden Samenkanälchens einiger Säugethiere und Folgerungen für die Spermatogenese dieser Wirbelthierklasse. *Archiv f. mikr. Anat.*, Bd. 30, S. 49-110. Rat, pp. 53 and 66.
- BENEDICENTI, A. 1892 Recherches sur les terminaisons nerveuses dans la muqueuse de la trachée. *Résumé de l'Auteur. Arch. ital. de biol.*, T. 17, pp. 46-48.
- BENNETT, CHARLES B. 1914 The cholesterol content of cancers in rats. *J. Biol. Chem.*, vol. 17, pp. 13-14.
- BENSLEY, R. R. 1908 Professor Prenant's theory of the nature of the granule cells of Paneth. *Anat. Rec.*, vol. 2, pp. 92-95.
- BERETTA, ARTHUR 1913 La normale dentatura dei Roditori in rapporto alle anomalie dentali in questi osservate. *Stomatol.*, vol. 10, no. 2 and 3.
- BERGONIE ET TRIBONDEAU 1904 Action des rayons x sur les testicules du rat blanc. *C. R. Soc. de Biol.*, T. 2.
- BERKLEY, H. J. 1893 The intrinsic pulmonary nerves by the silver method. *J. Comp. Neur.*, vol. 3, pp. 107-111, 1 pl. *Mus decumanus*.
- 1895 The intrinsic pulmonary nerves in mammalia. *Johns Hopkins Hosp. Rep. (Baltimore)*, vol. 4, pp. 72-78 (240-246), 1 pl.
- BERRY, C. S. 1906 The imitative tendency of white rats. *J. Comp. Neur. and Psychol.*, vol. 16, pp. 333-361.
- BERRY, R. J. A. 1901 The true caecal apex, or the vermiform appendix: Its minute and comparative anatomy. *J. of Anat. and Physiol.*, vol. 35, p. 92.
- BERT, PAUL 1878 La pression barométrique; recherches de physiologie expérimentale. G. Masson, Paris. Some observations on rats.

- BERTHELOT, A. AND BERTRAND, D. M. 1912 Sur quelques propriétés biochimiques du bacillus aminophilus intestinalis. *Compt. Rend. T.* 154, pp. 1826-1828. The authors find that rats fed on a milk diet are not affected by either *Proteus vulgaris* or *B. aminophilus intestinalis* when given separately, but if the two organisms are given simultaneously, the rats may develop a fatal diarrhoea in from 4 to 8 days.
- BETHKE, R. M., STEENBOCK, H. AND NELSON, M. T. 1923 Fat-soluble vitamins. XV. Calcium and phosphorus relations to growth and composition of blood and bone with varying vitamin intake. *J. of Biol. Chem.*, vol. 58, pp. 71-103.
- BIANCHI, L. 1922 The mechanism of the brain and the function of the frontal lobes. *Trans. by J. H. MacDonald, Edinburgh. Rat.* page 96.
- BIBRA, ERNST VON 1854 Vergleichende Untersuchungen über das Gehirn des Menschen und der Wirbelthiere. Bassermann and Mathy, Mannheim. Hausratte—*Mus rattus*, S. 22.
- BIEDL, ARTHUR 1913 *Innere Sekretion*. 2 vols. Urban and Schwarzenberg, Berlin.
- BIERENS DE HAAN, J. A. 1922 Die Körpertemperatur junger Wanderratten (*Mus decumanus*) und ihre Beeinflussung durch die Temperatur der Aussenwelt. *Archiv für Ent. der Organismen*, Bd. 50, S. 1-12.
- BIERENS DE HAAN, J. A. AND PRZIBRAM, HANS 1922 Erniedrigung der Körpertemperatur junger Wanderratten (*Mus decumanus*) durch chemische Mittel und ihr Einfluss auf die Schwanzlänge. *Archiv für Ent. der Organismen*, Bd. 50, S. 13-40.
- BIGNOTTI, G. 1900 Sul tarso del *Mus decumanus*. *Monit. zool. ital.*, vol. 11, suppl. pp. 17-19.
- BIRCHER, E. 1910 Experimenteller Beitrag zum Kropfherz. *Med. Klin.*, Bd. 6.
- 1910 a Zur Wirkung der Thyreodintabletten auf das Knochenwachstum. *Arch. f. klin. Chir.*, Bd. 91.
- BIRCHER, EUGEN 1911 Die kretinische Degeneration (Kropf, endemischer Kretinismus und Taubstummheit) in ihrer Beziehung zu anderen Wissensgebieten. *Fortschr. d. Naturwissen. Forschung*, Bd. 2, S. 273-338, p. 289, figures of the normal and abnormal thyroid of the rat. All references by name only.
- 1911 a Weitere Beiträge zur experimentellen Erzeugung des Kropfes. Die Kropfätiologie ein colloid-chemisches Problem. *Ztschr. f. exper. Path. u. Therap.*, Bd. 9.
- BISCHOFF, E. 1863 Einige Gewichts und Trocken-Bestimmungen der Organe des menschlichen Körpers. *Ztschr. f. rat. Med.*, Bd. 20, S. 75-118.
- BISCHOFF, T. L. W. 1832 *Nervii accessorii Willisii anatomia et physiologia*. 104 pp., 6 pl. 4°. Heidelbergae, typ. Reichardianis.
- BLAIR, EDWARD W. 1923 The contraction rate of the excised rat uterus with reference to the oestrous cycle. *Am. J. of Physiol.*, vol. 65, pp. 223-228.
- BLAKE, FRANCIS G. 1916 The etiology of rat-bite fever. *J. of Exp. Med.*, vol. 23, pp. 39-60.
- BLANC, LOUIS 1892 Sur un ovule à deux noyaux observé dans l'ovaire de *Mus decumanus*. *Ann. de la société Linnéenne de Lyon, Nouv. Sér.*, T. 20, pp. 73-80.
- BLASIUS, J. H. 1857 *Fauna der Wirbelthiere Deutschlands und der angrenzenden Länder von Mitteleuropa*. Bd. 1, Säugethiere. Braunschweig Viehweg. Descriptions of the several species of rats.
- BLUE, RUPERT 1908 The underlying principles of anti-plague measures. *Calif. State J. Med.*, vol. 6, pp. 271-277.
- 1910 Rodents in relation to the transmission of bubonic plague. Found in "The rat and its relation to the public health," pp. 145-152. Treasury Dept. Pub. Health and Mar. Hosp. Service of U. S. Government Printing Office, Wash., D. C.
- BOGARDUS, E. S. AND HENKE, F. G. 1911 Experiments on tactual sensations in the white rat. *J. Animal Behavior*, vol. 1, pp. 125-137.
- BOHLEN, F. 1894 Ueber die elektromotorischen Wirkungen der Magenschleimhaut. *Arch. f. d. ges. Physiol.*, Bd. 57, S. 97-122.
- BOINET, ED. 1895 Résistance à la fatigue de 11 rats décapsulés depuis cinq et six mois. *Compt. rend. Soc. de biol.*, Paris, S. 47, pp. 273-274.
- 1895 a Ablation des capsules vraies et accessoires chez le rat d'égoût. *Compt. Rend. Soc. de Biol.*, S. 47, pp. 498-500.
- 1895 b Nouvelles recherches sur la résistance à la fatigue de rats décapsulés. *C. R. Soc. de Biol.*, T. 47, p. 325.
- 1895 c Action comparée de la fatigue et de la décapsulation sur la toxicité des extraits musculaires du rat. *C. R. Soc. de Biol.*, T. 47, p. 646.
- 1896 Maladie d'Addison expérimentale chez le rat d'égoût. *C. R. Soc. de Biol.*, T. 48, p. 164.
- 1897 Diminution de résistance des rats doublement décapsulés à l'action toxique de diverses substances. *C. R. Soc. de Biol.*, p. 466.
- 1897 a Dix nouveaux cas de maladie d'Addison expérimentale chez le rat d'égoût. *C. R. Soc. de Biol.*, 8th and 15th of May, pp. 439 and 473.
- BONAR, M. L. AND SÖLLMANN, TORALD 1922 The effects of some new local anesthetics. (Para-aminobenzoyl dinormal butyl-aminoethanol and propanol; and diethyl amino-propyl diphenyl amino-carbinol). *J. of Pharmacology & Exp. Therapeutics*, vol. 18, pp. 467-489.
- BOND, MURIEL 1922 A modification of basal diet for rat feeding experiments. *Biochem. J.*, vol. 16, pp. 479-481.

- BONNAMOUR, S. 1905 Modifications histologiques de la capsule surrénale dans certains états physiologiques (hibernation, inanition) et pathologiques expérimentaux (diphthérie, rage). C. R. de l'Assoc. des Anatomistes (Int. Congr. Anat. Geneva), T. 7, pp. 87-93.
- BORCHERDING, FR. 1889 Über das Vorkommen der Hausratte, *Mus rattus* L., im nordwestlichen Deutschland. *Zoolog. Garten*, 30 Jahrg., S. 92-93.
- BORDAS, F. 1904 Résistance des rats à l'intoxication arsenicale. *Compt. rend. Acad. d. Sc., Par.*, T. 138, p. 836.
- BORNET, AUGUST See Albertus Magnus.
- BOUGHTON, T. H. 1906 The increase in the number and size of the medullated fibers in the oculomotor nerve of the white rat and of the cat at different ages. *J. Comp. Neur. and Psychol.*, vol. 16, pp. 153-165.
- BOUIN, P. 1899 Atrésie des follicules de Graaf et formation de faux corps jaunes (note préliminaire). *Bibl. Anat.*, T. 7, pp. 296-300.
- BOUIN, P. AND ANCEL, P. 1904 La glande interstitielle chez le vieillard, les animaux âgés et des infantiles expérimentaux. *Compt. rend. de Soc. de biol.*, T. 56, pp. 282-284.
- BOYCOTT, A. E. AND DAMANT, G. C. C. 1908 Experiments on the influence of fatness on susceptibility to caisson disease. *J. Hyg. Cambr.*, vol. 8, pp. 445-456. Pp. 447-459, tables and notes on experiments with rats giving sex, body weight and fatty acids.  
1908 a. A note on the total fat of rats, guinea-pigs and mice. *J. Physiol.*, vol. 37, pp. 25-26.
- BOYCOTT, A. E., DAMANT, G. C. C. AND HALDANE, J. S. 1908 The prevention of compressed air illness. *J. Hyg. Cambr.*, vol. 8, p. 342-443.
- BOYENVAL, LOUIS 1922 Les phénomènes d'ovitamineose sont-ils modifiés par l'administration d'histamine chez le rat blanc? *Archives Internat. de Pharmacodynamie et de Thérapie*, T. 26, pp. 359-365.
- BRADLEY, H. C. AND SANSUM, W. D. 1914 Some anaphylactic reactions. *J. of Biol. Chem.*, vol. 18, pp. 497-506.
- BRADLEY, O. CHARNOCK 1903 On the development and homology of the mammalian cerebellar fissures. *J. Anat. and Physiol.*, vol. 37, pp. 112-130. *Cerebellum: Mus decumanus*, figs. 38, 39, 40 and 41.
- BRAND, JOHN 1842 Observations on popular antiquities: chiefly illustrating the origin of our vulgar customs, ceremonies and superstitions. Vol. 3, pp. 99 and 110 for rats. Charles Knight & Co., London.
- BRUNN, M. 1882 Entwicklungsvorgänge am Schwanzende bei einigen Säugethieren mit Berücksichtigung beim Menschen. *Arch. f. Anat. u. Physiol., Anat. Abt.*, S. 207-241. Taf. XII, XIII. Rat among animals used.
- BREGMANN, L. E. 1915 Neue Untersuchungen zur Kenntnis der Pyramidenbahn. 1. Der Anteil der Pyramide am Rückenmarksquerschnitt bei verschiedenen Tieren und seine Entwicklung beim Menschen. *Anat. Anz.*, Bd. 48, S. 75-80.
- BREMER, J. L. 1916 The interrelations of the mesonephros, kidney, and placenta in different classes of animals. *Proc. Am. Assoc. of Anatomists in Anat. Record*, vol. 10, pp. 185-187.  
1923 Pancreatic ducts and pancreatic bladders. *Am. J. of Anatomy*, vol. 31, pp. 289-318.
- BRINCKERHOFF, WALTER R. 1910 Rat leprosy. Found in "The rat and its relation to the public health." Pp. 49-53. Treasury Dept. Pub. Health and Mar. Hospit. Service of the U. S. Government Printing Office, Wash., D. C.
- BRISSON, A. D. 1756 Le règne animal divisé en IX classes, etc. 4<sup>e</sup> Paris. P. 168, description of *Mus rattus*—many references.
- BROCKRANK, THOMAS W. 1919 Redintegration in the albino rat. *Behavior Monographs*, vol. 4, no. 2, serial number 18, Johns Hopkins Univ.
- BRODY, SAMUEL AND RAGSDALE, A. C. 1922 The equivalence of age in animals. *J. of General Physiol.*, vol. 5, pp. 205-214.
- BROWN, HERBERT H. 1885 On spermatogenesis in the rat. *Quart. J. Micr. Sc.*, London, vol. 25, pp. 343-369.
- BROWN, WADE H. 1915 Concerning changes in the biological properties of *Trypanosoma lewisi* produced by experimental means, with especial reference to virulence. *J. of Exper. Med.*, vol. 21, pp. 345-364.
- BROWN, WADE H. AND PEARCE, LOUISE 1919 Chemotherapy of trypanosome and spirochete infections. Biological series I. The toxic action of N-Phenylglycine amide-p-arsonic acid. *J. of Exper. Med.*, vol. 30, pp. 417-436.  
1919 a. Chemotherapy of trypanosome and spirochete infections. Biological series IV. The action of N-Phenylglycineamide-p-Arsonic acid upon spirochete infections. *J. of Exper. Med.*, vol. 30, pp. 483-496.
- BROWN-SÉQUARD, E. 1856 Recherches expérimentales sur la physiologie et la pathologie des capsules surrénales. *Arch. gén. de méd.* S. 2 (ser. 5, vol. 8) pp. 385-401; 572-598 (Oct. and Nov.). Experiments chiefly on rabbits; but mentions another physiologist's observations on rats, p. 595.
- BRUCE, DAVID, HAMERTON, A. E., BATEMAN, H. R. AND MACKIE, F. P. 1910 Trypanosomic diseases of domestic animals in Uganda. *Proc. of Royal Soc. Series B*, vol. 82, pp. 468-479.
- BRÜMMER, JOHANNES 1876 Anatomische und histologische Untersuchungen über den zusammengesetzten Magen verschiedener Säugethiere. Tafeln



- I-V. Deutsche Ztschr. f. Thiermed., Bd. 2, S. 158-298 and 299-319.
- BRUMPT, E. 1907 Phénomènes de la parturition chez le rat blanc. Bull. de la Soc. Zool. de France, T. 32, pp. 50-52.
- BRÜNING, HERMANN 1914 Experimentelle Studien über die Entwicklung neugeborener Tiere bei langedauernder Trennung von der Säugenden Mutter und nachheriger verschiedenartiger künstlicher Ernährung (Rats). Jahrb. f. Kinderheilk., Bd. 80, S. 65-85. 6 fig. in text (tables and graphs important).
- 1914 a Untersuchungen über das Wachstum von Tieren jenseits der Säuglingsperiode bei verschiedenartiger künstlicher Ernährung (Rat). Jahrb. Kinderheilk., Bd. 79, S. 305-319. 2 text figs., tables (important).
- BRUNN, A. VON 1880 Notiz über unvollkommene Schmelzentwicklung auf den Mahlzähnen der Ratte—*M. decumanus*. Arch. f. mikr. Anat., Bd. 17, S. 241-242.
- 1887 Ueber die Ausdehnung des Schmelzorganes und seine Bedeutung für die Zahnbildung. Arch. f. mikr. Anat., Bd. 29, S. 367-383.
- BUCKLAND, FRANCIS T. 1859 Curiosities of natural history. Rudd and Carleton, N. Y. Rats, pp. 87-205.
- BUCKLEY, C. F. 1905 The rat and the flea. Pacific M. J. San Fran., vol. 51, pp. 159-164.
- BUCKNER, G. DAVIS AND PETER, A. M. 1922 The mineral content of the normal white rat during growth. J. of Biol. Chem., vol. 54, pp. 5-9.
- BUFFON, GEORGE LOUIS LE CLERC, COMTE DE 1749-1789 Histoire naturelle, générale et particulière. Paris, T. 7, 1758, pp. 278-308; T. 8, 1760, pp. 206-218.
- BUJARD, EUG. 1905 Sur les villosités intestinales. Bibl. anat., vol. 14, p. 236.
- 1909 Etude des types appendicéiels de la muqueuse intestinale, en rapport avec les régimes alimentaires. Morphologie comparée. Sitomorphoses naturelles et expérimentales. Internat. Monatschr. f. Anat. u. Physiol., T. 26, pp. 101-192. Plates VI-X, Rats, pp. 123-124.
- BUJARD, E. 1908 Villosités intestinales. Types anatomiques. Variations expérimentales. Anat. Anz., Ergänzungsheft, Bd. 32, S. 212-222.
- BULL, R. J. 1907 Leprosy-like disease of a rat. Intercolon. M. J. Australas, Melbourne, vol. 12, pp. 263-267.
- BULLARD, H. H. 1912 On the interstitial granules and fat droplets of striated muscle. Am. J. Anat., vol. 14, pp. 1-46.
- BULLARD, PEARL B. 1912 A comparative study of the three principal regions of the spinal cord in a series of mammals. Am. J. Anat., vol. 14, pp. 73-105.
- BULLE, HERMANN 1887 Beiträge zur Anatomie des Ohrs. Archiv f. mikr. Anat., Bd. 29, S. 237-264. Rat. S. 245.
- BULLEY, ELSIE C. 1919 Note on xerophthalmia in rats. Biochem. Jour., vol. 13, pp. 103-106.
- BULLOCK, F. D. AND ROHDENBURG, G. L. 1912 Cell proliferation and parasites in rats. Jour. Exper. Med., vol. 16, pp. 527-531.
- 1913 Primary sarcoma of the liver of the rat originating in the wall of a parasitic cyst. J. Med. Research, vol. 28 (n.s. vol. 23) pp. 477-481.
- 1915 Tumor-like growths in the rat stomach following irritation. Proc. of the Soc. for Exper. Biol. and Med., vol. 12, pp. 161-162.
- BULLOCK, F. D., CURTIS, M. R. AND ROHDENBURG, G. L. 1920 A preliminary report on the experimental production of sarcoma of the liver of rats. Proc. of Soc. for Exper. Biol. and Med., vol. 18, pp. 29-30.
- BULLOCK, W. E. AND CRAMER, W. 1913 Contributions to the biochemistry of growth. On the lipoids of transplantable tumors of the mouse and the rat. Proc. R. Soc., London, vol. 87 B, pp. 236-239.
- BULLOCK, W. E. 1915 Heterologous transplantation of mouse tumors in rats. Lancet, vol. 1, p. 701.
- BUNGE, C. 1902 Physiologie und pathologie chemistry. 2nd Ed. (edited by E. A. Starling) P. Blakiston's Son & Co., Phila.
- BURGET, G. E. 1917 Attempts to produce experimental thyroid hyperplasia. Am. J. Physiol., vol. 44, pp. 492-503.
- BURNETT, THEODORE C. 1916 Note on a toxic nucleoprotein obtained from rat carcinoma. Proc. of Soc. for Exper. Biol. and Med., vol. 14, pp. 63-64.
- 1918 The activation of muscle catalase by liver. Am. J. Physiol., vol. 46, pp. 63-66.
- BURTT, HAROLD E. 1916 A study of the behavior of the white rat by the multiple-choice method. J. of Animal Behavior, vol. 6, pp. 222-246.
- CABIBBE, GIACOMO 1904 Histologische Untersuchungen über die Nervenendigungen in den Sehnen und im Perinysium der Ratte und des Meerschweinchens. Monatsh. f. Psychiat. u. Neurol., Bd. 15, S. 81-89. 3 figs.
- CAJAL, S. RAMON Y 1889 Neuvas aplicaciones de metodo de coloración de Golgi. Gac. med. Catal., vol. 12, pp. 6-8.
- 1893 Sur les ganglions et plexus nerveux de l'intestin. Compt. rend. soc. de biol., ser. 9, T. 5, pp. 217-223, Paris. 3 figs.
- 1894 Les nouvelles idées sur la structure du systeme nerveux. Dr. Azoulay, Paris.
- 1897 Leyes de la morfología y dinamismo de las células nerviosas. Rev. trimestr. Microgr., T. 2, pp. 1-28.

- 1903 Un sencillo método de coloración del retículo protoplásmico y sus efectos en los diversos centros nerviosos de vertebrados é invertebrados. *Rev. trimestr. Microgr.*, T. 7, pp. 129-221, fig. 33.
- 1909, 1911 *Histologie du système nerveux de l'homme et des vertébrés*. 2 vols. A. Maloine. Paris. For rat (vol. 1) figs. 19, 113, 123, 189, 190; (vol. 2) figs. 20, 21, 46, 246.
- CAJORI, F. A. 1920 Some nutritive properties of nuts: their proteins and content of water-soluble vitamine. *J. of Biol. Chem.*, vol. 43, pp. 583-606.
- 1921 Some nutritive properties of nuts. II. The pecan nut as a source of adequate protein. *J. of Biol. Chem.*, vol. 49, pp. 389-397.
- CALEF, A. 1900 *Studio istologico e morfologico di un'appendice epitheliale del pelo nella pelle del Mus decumanus var. albino e del Sus scrofa*. *Anat. Anz.*, vol. 17, pp. 509-517.
- CALKINS, GARY N. 1916 The effects of cancer tissue, embryonic tissue, and normal tissue on the vitality of protozoa. *Didinium nasutum* III. *J. of Cancer Research*, vol. 1, pp. 399-414.
- CAMERON, A. T. 1914 Contributions to the biochemistry of iodine. I. The distribution of iodine in plant and animal tissues. *J. Biol. Chem.*, vol. 18, pp. 335-350. Rat pp. 364-365.
- CAMERON, A. T. AND CARMICHAEL, J. 1920 Contributions to the biochemistry of iodine. III. The comparative effects of thyroid and iodide feeding on growth in white rats and in rabbits. *J. Biol. Chem.*, vol. 45, pp. 69-100.
- 1921 Contributions to the biochemistry of iodine. IV. The effect of thyroxin on growth in white rats and in rabbits. *J. Biol. Chem.*, vol. 46, pp. 35-52.
- 1921 a The comparative effects of parathyroid and thyroid feeding on growth and organ-hypertrophy in the white rat. *Am. J. Physiol.*, vol. 58, pp. 1-6.
- CAMERON, A. T. AND SEDZIAK, F. A. 1921 The effect of thyroid feeding on growth and organ-hypertrophy in adult white rats. *Am. J. Physiol.*, vol. 58, pp. 7-13.
- CAMERON, A. T. AND MOORE, ANDREW 1921 The effect of thyroid feeding on rats on a vitamin-deficient diet. *Trans. Royal Soc. Canada*, section V, pp. 29-36.
- CAMERON, A. T. AND CARMICHAEL, J. 1922 Acceleration of growth and regression of organ-hypertrophy in young rats after cessation of thyroid feeding. The production of tetany in rats by thyroid feeding. *Trans. of the Royal Soc. of Canada—3rd series*,—vol. 16, pp. 57-70.
- CAMERON, A. T. 1923 Results of feeding endocrine preparations to young white rats. *Abstracts of Communications to the XIth Internat. Physiol. Congress held at Edinburgh, July 23rd-27th, 1923*.
- CAMERON, JOHN 1904 On the presence and significance of the superior commissure throughout the vertebrata. *J. of Anat. and Physiol.*, vol. 38, pp. 275-292.
- CAMPANA, ROBERTO 1911 I bacilli acidi nei topi in Mancuria; ed altri studi. *Clin. dermosifilopat. d. r. Univ. di Roma*, vol. 29, pp. 47-50.
- CAMPBELL, J. MACNAUGHT 1892 On the appearance of the brown rat (*Mus decumanus* Pallas) on Ailsa Craig. *Ann. of Scott. Nat. Hist.* I. no. 2 pp. 132-134.
- CAMPBELL, MALCOLM AND WATSON, CHALMERS 1906 The minute structure of the uterus of the rat with a note on the influence of a meat diet on it. *J. of Physiol., Proc. of the Physiol. Soc.*, vol. 34, pp. xiv-xvii.
- CANNIEU, ANDRÉ 1893 Recherches sur le nerf auditif, ses rameaux et ses ganglions. *Revue biol. du Nord de la France*, Année, VI, pp. 87-153. Rat among animals used.
- CANTONI, ELVEZIO 1880 Elenco generale dei mammiferi soggetti ad albinismo. *Società Ital. di scienze naturali*, T. 23, pp. 1-31, page 12. Full notes on Albinos of *Mus decumanus*. 17th century references. Notes on Albinos of *Mus rattus*. Full references to all the older literature.
- CARINI, A. 1915 Corps de Graham-Smith dans les hématis du *Mus decumanus*. *Bull. Soc. Path. Exot.*, T. 8, pp. 103-104.
- CARLIER, E. W. 1905 Concerning the secretion of ferments by the liver cells and some of the changes observable in them during digestion. *La Cellule*, T. 22, pp. 431-454.
- CARLSON, A. J., ROOKS, J. R. AND MCKIE, J. F. 1912 Attempts to produce experimental hyperthyroidism in mammals and birds. *Am. J. Physiol.*, vol. 30, pp. 129-159. Rats pp. 145-147.
- CARLSON, A. J., HEKTOEN, L. AND LECOUNT, E. R. 1916 The effects of commercial glucose when fed to white rats. *J. Am. Chem. Soc.*, vol. 38, pp. 930-936.
- CARMICHAEL, E. S. AND MARSHALL, F. H. A. 1907 The correlation of the ovarian and uterine functions. *Proc. Roy. Soc. S. B.* vol. 79, pp. 387-394. Rats—4 experiments.
- CARPENTER, F. W. AND CONEL, J. L. 1911 A study of of ganglion cells in the sympathetic nervous system, with special reference to intrinsic sensory neurones. *J. Comp. Neur.* vol. 24, pp. 269-281.
- CARR, HARVEY AND WATSON, J. B. 1908 Orientation, in the white rat. *J. Comp. Neur. and Psychol.* vol. 18, pp. 27-44.
- CARR, HARVEY 1917 The distribution and elimination of errors in the maze. *J. of Animal Behavior*, vol. 7, pp. 145-159.
- 1917 a Maze studies with the white rat. I. Normal animals. *J. of Animal Behavior*, vol. 7, pp. 259-275.
- 1917 b Maze studies with the white rat. II, Blind animals. *J. of Animal Behavior*, vol. 7, pp. 277-294.

- 1917 c Maze studies with the white rat. III. Anosmic animals. *J. of Animal Behavior*, vol. 7, pp. 295-306.
- 1917 d The alternation problem. *J. of Animal Behavior*, vol. 7, pp. 365-384.
- CARTIER, E. W. W. 1890-1895 Note on structure of suprarenal body in rat. *Proc. of Scottish Micros. Soc.*, London and Edinburgh, vol. 1, p. 169.
- CASTELLANT, J. 1898 *Topographie des glandes de Brünner*. *Bibliographie Anat.*, T. 6, pp. 226-236.
- CASTLE, W. E. 1911 Heredity. Chapter 6. D. Appleton & Co., N. Y.
- 1912 Some biological principles of animal breeding. *Am. Breeders Mag.*, vol. 3, pp. 270-282.
- 1912 a The inconstancy of unit characters. *Am. Naturalist*, vol. 46, pp. 352-362.
- CASTLE, W. E. AND PHILLIPS, J. C. 1914 Piebald rats and selection. An experimental test of the effectiveness of selection and of the theory of gametic purity in Mendelian crosses. *Carnegie Inst. Wash.*, no. 195.
- CASTLE, W. E. 1914 Some new varieties of rats and guinea pigs and their relation to problems of color inheritance. *Am. Naturalist*, vol. 48, pp. 65-73.
- 1914 a Yellow varieties of rats. *Am. Naturalist*, vol. 48, p. 254.
- 1915 Some experiments in mass selection. *Am. Naturalist*, vol. 49, pp. 713-726.
- CASTLE, W. E. AND WRIGHT, SEWALL 1915 Two color mutations of rats which show partial coupling. *Science*, N. S., vol. 42, no. 1075, pp. 193-195. August 6th.
- CASTLE, W. E. 1916 Is selection or mutation the more important agency in evolution? *Scientific Monthly*, January, pp. 91-98.
- 1916 a Variability under inbreeding and cross-breeding. *Am. Naturalist*, vol. 50, pp. 178-183.
- CASTLE, W. E. AND WRIGHT, SEWALL 1916 Studies of inheritance in guinea-pigs and rats. Part III. Further studies of piebald rats and selection, with observations on gametic coupling. pp. 163-192. *Pub. of Carnegie Inst. of Wash.*, Wash., D. C. No. 241.
- CASTLE, W. E. 1919 Studies of heredity in rabbits, rats and mice. *Pub. by Carnegie Institution of Wash.*, no. 288, 56 pp.
- 1919 a Piebald rats and selection, a correction. *Am. Naturalist*, vol. 53, pp. 370-376.
- 1919 b Piebald rats and the theory of genes. *Proc. of the Nat. Acad. of Sciences*, vol. 5, pp. 126-130.
- CATAN, A., HOUSSAY, B. A. AND MAZZOCCO, P. 1921 Métabolisme hydrocarboné chez les animaux sans surrénals. *Compt. Rendus des Séances de la Soc. de Biol.*, T. 84, pp. 164-166.
- CAVAZZANI, E. AND MUZZIOLI, M. 1912 Contribution à l'étude de l'eau dans les organismes. *Arch. ital. Biol.*, vol. 57, pp. 473-480.
- CESANA, G. 1910 Lo sviluppo ontogenico degli atti riflessi (Rat). *Arch. di Fisiol.*, vol. 9, pp. 1-120, 43 figs.—full tables.
- CHANDLER, SIMON B. 1923 Conditions affecting the histology of the parathyroid gland of the albino rat. *Proc. Am. Assoc. of Anatomists in Anat. Record*, vol. 25, p. 122.
- CHANDLER, W. L. 1919 The physiological action of nitro-benzene vapor on animals. *Cornell Univ. Exp. Station Memoir* 20, pp. 411-472. Rats on p. 446.
- CHAPIN, C. W. 1912 An acid-fast organism resembling the bacillus of human leprosy cultivated from the tissues of a leprosy rat. *Pub. health rep. U. S. Mar. Hosp. Serv.*, vol. 27, par 1, p. 161.
- CHARIN AND ROGER 1890 Contribution à l'étude expérimentale du surmenage, son influence sur l'infection. *Arch. de Physiol. Norm. et Path.*, T. 2, pp. 273-283.
- CHEPLIN, HARRY A. AND RETTGER, LEO F. 1920 Studies on the transformation of the intestinal flora, with special reference to the implantation of *Bacillus acidophilus*. I. Feeding experiments with albino rats. *Proc. of the Nat. Acad. of Sciences*, vol. 6, pp. 423-426.
- CHICK, HARRIETTE AND MARTIN, C. J. 1911 The fleas common on rats in different parts of the world and the readiness with which they bite man. *J. Hyg.*, vol. 11, pp. 122-136.
- CHIDESTER, F. E. 1912 Experiments with desiccated thyroid, thymus and suprarenals. *Science*, vol. 36, no. 932, November 8th.
- CHIEVITZ, J. H. 1885 Beiträge zur Entwicklungsgeschichte der Speicheldrüsen. *Arch. f. Anat. u. Entwicklungsgesch.*, S. 401-436. 1 pl.
- 1890 Untersuchungen über die Entwicklung der Area und Fovea centralis retinae. *Archiv für Anat. u. Physiol.*, Anat. Abth., S. 332-366. S. 356—albino rat.
- CHISOLM, R. A. 1911 On the size and growth of the blood in tame rats. *Quart. J. Exper. Physiol.*, vol. 4, pp. 207-229.
- CLARKE, W. E. 1891 Black and Alexandrine rats at Leith (*M. rattus* and *alexandrinus*). *Ann. of Scott. Nat. Hist.*, vol. 3, p. 36.
- CLLGHORN, ALLEN 1901 The effect of castration and testicular extract on growth and activity. Given at Boston Soc. of Medical Sciences, December 17th.
- CLELAND, J. B. 1906 The haemogregarine of mammals (*H. balfouri*) and some notes on rats. *Journ. Trop. Med.* vol. 9, p. 296.
- 1919 The protozoal parasites of rats and mice. *Proc. Roy. Soc. New South Wales, Sydney*, vol. 52, pp. 110-116.
- CLIFFORD, W. M. 1921 The distribution of carnosine in the animal kingdom. *Biochem. J.*, vol. 15, pp. 725-735.
- 1922 The effect of cold storage on the carnosine content of muscle. *Biochem. J.*, vol. 16, pp. 341-343.
- COE, W. R. 1908 The maturation of the egg of the rat. *Science*, vol. 27, no. 690, March 20th, p. 444.

- COLES, A. C. 1914 Blood parasites found in mammals, birds and fishes in England. *Parasitology*, vol. 7, pp. 17-61.
- COLLINS, E. TREACHER 1922 Arboreal life and the evolution of the human eye. Lea and Febiger, Phila. and N. Y., 108 pp.
- COLLIP, J. B. 1920 Antagonism of inhibitory action of adrenalin and depression of cardiac vagus by a constituent of certain tissue extracts. *Am. J. of Physiol.*, vol. 53, pp. 343-354.
- 1920 a Osmotic pressure of serum and erythrocytes in various vertebrate types as determined by the cryoscopic method. With a note on the effect of freezing on the arterial blood of the rat. *J. of Biol. Chem.*, vol. 12, pp. 207-212.
- 1920 b Effect of dilution on the osmotic pressure and the electrical conductivity of whole blood, blood serum, and corpuscles. *J. of Biol. Chem.*, vol. 42, pp. 213-220.
- CONGDON, E. D. 1912 The surroundings of the germ plasma. III. The internal temperature of warm-blooded animals (*Mus decumanus*, *M. musculus*, *Myoxus glis*) in artificial climates. *Archiv. f. Entwicklungsmech. d. Organ.*, vol. 33, pp. 703-715.
- CONROW, SARA B. 1915 Taillessness in the rat. *Anat. Record*, vol. 9, pp. 777-783.
- 1917 Further observations on taillessness in the rat. *Anat. Rec.*, vol. 12, pp. 155-159.
- 1917 a A six-legged rat. *Anat. Rec.*, vol. 12, pp. 365-370.
- COOK, F. C. 1913 The importance of food accessories as shown by rat-feeding experiments. *Science*, p. 675. November 7.
- COOPER, ETHEL F. 1923 The distribution of the vitamin A in the urine and the digestive secretions (man, dog). *Proc. Am. Physiol. Soc. in Am. J. of Physiol.*, vol. 63, p. 425.
- 1923 a The toxicity of the alcoholic extract of ox bile when fed to white rats. *Am. J. of Physiol.*, vol. 65, pp. 363-367.
- COPEMAN, S. M. AND HAKE, H. W. 1908 A study of the variations in the secretion of hydrochloric acid in the gastric contents of mice and rats as compared with the human subject, in cancer. *Proc. R. Soc. London*, vol. 80, B. pp. 444-462.
- CORNALIA, EMILE 1858-1871 Mammifères fossiles de Lombardie, Milan—being 2nd Series in *Paléontologie Lombarde par l'Abbie Antoine Stoppani*. 4°. pp. 38-40. *Mus rattus*.
- CORNER, G. W. AND HURNI, FELIX H. 1918 The non-effect of corpus luteum preparations on the ovulation cycle of the rat. *Am. J. Physiol.*, vol. 46, pp. 483-486.
- CORNER, G. W., AND WARREN, S. L. 1919 Influence of the ovaries upon the production of artificial deciduomata; confirmatory studies. *Anat. Record*, vol. 16, pp. 168-169.
- CORNISH, THOM 1890 Black rat in Cornwall. *Zoologist*, vol. 13, p. 450.
- CORNWALL, J. W. AND PATTON, W. S. 1914 Some observations on the salivary secretion of the commoner bloodsucking insects and ticks. *Indian J. of Medical Research*, vol. 2, pp. 569-593.
- COW, DOUGLAS 1919 Adrenalin and pituitrin—A study in interaction and interrelation. *J. Physiol.*, vol. 52, pp. 301-314.
- COWARD, KATHARINE H. AND DRUMMOND, J. C. 1920 Researches on the fat-soluble accessory substance. IV. Nuts as a source of vitamin A. *Biochem. J.*, vol. 14, pp. 665-667.
- 1921 The formation of vitamin A in living plant tissues. *Biochem. J.*, vol. 15, pp. 530-539.
- 1922 On the significance of vitamin A in the nutrition of fish. *Biochem. J.*, vol. 16, pp. 631-636.
- CRAIGIE, EDWARD HORNE 1920 On the relative vascularity of various parts of the central nervous system of the albino rat. *Jour. Comp. Neur.*, vol. 31, pp. 429-464.
- 1921 The vascularity of the cerebral cortex of the albino rat. *Jour. Comp. Neur.*, vol. 33, pp. 193-212.
- 1923 Changes in the vascularity of the brain between birth and maturity. *Proc. Am. Assoc. of Anat. in Anat. Record*, vol. 25, p. 106.
- 1924 An introduction to the finer anatomy of the central nervous system—based upon that of the albino rat. MS.
- CRAMER, W. 1908 The gaseous metabolism in rats inoculated with malignant new growths. *Third Scien. Report Imp. Cancer Research Fund*, pp. 427-433.
- CRAMER, W. AND PRINGLE, HAROLD 1910 Contributions to the biochemistry of growth. The total nitrogen metabolism of rats bearing malignant new growths. *Proc. R. Soc., London*, vol. 82 B, pp. 307-315.
- 1910 a Contributions to the biochemistry of growth. Distribution of nitrogenous substances in tumors and somatic tissues. *Proc. Royal Soc. B.*, vol. 82, pp. 315-320.
- 1913 Carbohydrate metabolism in its relation to the thyroid gland. The effect of thyroid feeding on the glycogen-content of the liver and on the nitrogen distribution in the urine. *Proc. of the Royal Soc. B.*, vol. 86, pp. 550-560.
- CRAMER, W. AND LOCHHEAD, J. 1913 Contributions to the biochemistry of growth. The glycogen content of the liver of rats bearing malignant new growths. *Proc. of the Royal Soc., B.*, vol. 86, pp. 302-307.
- CRAMER, W., AND M'CALL, R. 1917 Carbohydrate metabolism in relation to the thyroid gland. II. The effect of thyroid-feeding on the gaseous metabolism. *Quart. J. of Exper. Physiol.*, vol. 11, pp. 59-76.
- 1918 Carbohydrate metabolism in relation to the

- thyroid gland. III. The effect of thyroidectomy in rats on the gaseous metabolism. *Quart. J. Exper. Physiol.*, vol. 12, pp. 81-95.
- 1919 Carbohydrate metabolism in relation to the thyroid gland. IV. The effect of thyroid feeding on the gaseous metabolism of thyroidectomised rats. *Quart. J. Exper. Physiol.*, vol. 12, pp. 97-109.
- CRAMER, W. 1919 Observations on the functional activity of the suprarenals in health and disease. *Scient. Rep. Imp. Cancer Research Fund*, vol. 6, pp. 1-21.
- 1920 On glandular adipose tissue, and its relation to other endocrine organs and to the vitamine problem. *Brit. J. of Exper. Pathol.*, vol. 1, pp. 184-196.
- 1922 On vitamin underfeeding. *British J. of Exper. Pathol.*, vol. 3, pp. 298-306.
- 1923 On the mode of action of vitamins. *Lancet*, vol. 1, p. 1046.
- 1923 a Dietary deficiencies and the growth of cancer. Eighth Scientific Report of the Imperial Cancer Research Fund.
- CRAMER, W., DREW, A. H. AND MOTTRAM, J. C. 1921 On the function of the lymphocyte and of lymphoid tissue in nutrition, with special reference to the vitamin problem. *The Lancet*, vol. 2.
- 1922 On blood platelets; their behaviour in "vitamin A" deficiency and after "radiation," and their relation to bacterial infections. *Proc. of the Royal Soc. B.*, vol. 93, pp. 449-467.
- 1923 On the behaviour of platelets in vitamin A deficiency and on the technique of counting them. *British J. of Exper. Pathol.*, vol. 4 p. 37.
- CRAMER, W. AND DREW, A. H. 1923 The effect of light on the organism. *British J. of Exper. Pathol.*, vol. 4, pp. 271-282.
- CRAMPE, HUGO 1877 Kreuzungen zwischen Wanderratten verschiedener Farbe. *Landwirths. Jahrb.*, Bd. 6, S. 384.
- 1883 Zucht-Versuche mit zahmen Wanderratten I. Resultate der Zucht in Verwandtschaft. *Landwirths. Jahrb.*, Bd. 12.
- 1884 Zucht-Versuche mit zahmen Wanderratten. II. Resultate der Kreuzung der zahmen Ratten mit wilden. *Landwirths. Jahrb.*, Bd. 13.
- 1885 Die Gesetze der Vererbung der Farbe. *Landwirths. Jahrb.*, Bd. 14, S. 53.
- CREEL, R. H. 1913 The rat—its habits and their relation to antiplague measures. Reprint no. 119 from Public Health Report, pp. 3-7. p. 4 Speaks of hybrid between *Alexandrinus* and *Norvegicus*. p. 5 Remarkable case of gnawing. p. 6 Bionomics—McCoy.
- 1915 The migratory habits of rats with special reference to the spread of plague. Reprint no. 278 from the Public Health Reports, pp. 3-8. Marked rats released at a center—New Orleans. Within 18 days these rats were found at distances up to 4 miles from the point of release.
- CREW, F. A. E. 1923 A mutant of the old English rat. *J. of Heredity*, vol. 14, pp. 221-222. *Mus rattus rattus*—brookei, Bristol, 1920. White and fawn with black eyes.
- CRISTIANI, H. 1892 L'inversion des feuilletts blastodermiques chez le rat albinos. *Arch. de Phys. norm. et pathol.*, T. 24 (S. 5, T. 4).
- 1893 De la thyroïdectomie chez le rat pour servir à la physiologie de la glande thyroïde. *Arch. de physiol. norm. et pathol.*, 5th series, T. 5, pp. 39-46.
- 1893 a Remarques sur l'anatomie et la physiologie des glandes et glandules thyroïdiennes chez le rat. *Arch. de physiol. norm. et pathol.*, 5th series, T. 5, pp. 164-168.
- 1893 b Des glandules thyroïdiennes accessoires chez la souris c le compagnol. *Arch. de physiol. norm. et pathol.*, 5th series, T. 5, pp. 279-283.
- 1895 De la greffe thyroïdienne en général et de son évolution histologique en particulier. *Arch. de physiol. norm. et pathol.*, 5th series, T. 7 (T. 27), pp. 65-76.
- 1900 Développement des greffes thyroïdienne; analogie avec le développement embryonnaire du corps thyroïde et avec la formation du goître hyperplasique. *Compt. rend. Soc. de Biol.*, Paris, T. 52, pp. 967-969.
- CRISTIANI, H. AND CRISTIANI, A. 1902 Recherches sur les capsules surrénales (Planche I.) *J. de physiol. et de path. gen.*, T. 4, pp. 837-844.
- 1902 a De la greffe des capsules surrénales (Planche II). *J. de physiol.*, T. 4, pp. 982-997.
- 1902 b Rôle prépondérant de la substance médullaire des capsules surrénales dans la fonction de ces glandes. *Compt. rend. Soc. de Biol.*, T. 54, pp. 710-711.
- 1902 c Histologie pathologique des greffes de capsules surrénales. *Compt. rend. Soc. de Biol.*, T. 54, pp. 811-814.
- 1902 d De l'insuffisance fonctionnelle des greffes de capsules surrénales. *Compt. rend. Soc. de Biol.*, T. 54, pp. 1124-1126.
- CUÉNOT, L. 1899 Sur la détermination du sexe chez les animaux. *Bull. sci. de la France et de la Belgique*, S. 32.
- CUNNINGHAM, R. S. 1920 Studies on absorption from serous cavities. III. The effect of dextrose upon the peritoneal mesothelium. *Am. J. Physiol.*, vol. 53, pp. 488-494.
- CURRIE, DONALD H. 1910 Bacterial diseases of the rat other than plague. Found in "The rat and its relation to the public health," pp. 55-57. Treasury Dept. Pub. Health and Mar. Hosp. Service of the U. S. Government Printing Office, Wash., D. C.
- CUSTOR, J. 1873 Ueber die relative Grösse des Darmcanals und der hauptsächlichsten Körpersysteme beim Menschen und bei Wirbelthieren. *Diss.* Berlin.

- CUVIER, G. 1805 *Léçons d'Anatomie comparée*. Paris. T. iii, p. 383. In the rat family the stomach presents two divisions.
- CZERMAK, NICOLAY 1895 Ernährungsweg einer epithelialen Zelle. *Anat. Anz.*, vol. 11, S. 547-550, 1 Abb.
- CZERNY, ADALBERT 1890 Ueber Rückbildungsvorgänge an der Leber. *Archiv f. mikr. Anat.*, Bd. 35, S. 87-103. *Rat*, S. 88 and 101.
- DACOSTA, A. C. 1913 Recherches sur l'histo-physiologie des glandes surrénales. *Archives de Biol.*, T. 28, pp. 111-196.
- DAELS, F. 1908 On the relations between the ovaries and the uterus. *Surg., Gynec. and Obst.*, vol. 6, pp. 153-159.
- DAFANO, C. 1921 On Golgi's apparatus of transplantable tumor cells. Seventh Scien. Report of The Imperial Cancer Research Fund.  
1922 On Golgi's internal apparatus in different physiological conditions of the mammary gland. *J. of Physiol.*, vol. 56, pp. 459-476.
- DAMON, SAMUEL R. 1921 Bacteria as a source of the water-soluble B vitamine. *J. of Biol. Chem.*, vol. 48, pp. 379-384.  
1923 Some observations in regard to growth-promoting substances of bacterial origin. *J. of Biol. Chem.*, vol. 56, pp. 895-902.
- DANIELS, AMY L. AND NICHOLS, NELL B. 1917 The nutritive value of the soy bean. *J. of Biol. Chem.*, vol. 32, pp. 91-102.
- DANIELS, AMY L. AND LOUGHLIN, R. 1918 Feeding experiments with peanuts. *J. of Biol. Chem.*, vol. 33, pp. 295-301.
- DANIELS, AMY L. AND RICH, JEAN K. 1918 The rôle of inorganic sulfates in nutrition. *J. of Biol. Chem.*, vol. 36, pp. 27-32.
- DANIELS, AMY L. AND McCLURG, N. I. 1919 Influence of high temperatures and dilute alkalies on the antineuritic properties of foods. *J. of Biol. Chem.*, vol. 37, pp. 201-213.
- DANIELS, AMY L. AND LOUGHLIN, ROSEMARY 1920 Note on the fat-soluble growth-promoting substance in lard and cotton-seed oil. *J. of Biol. Chem.*, vol. 42, pp. 359-362.  
1920 a A deficiency in heat-treated milks. *J. of Biol. Chem.*, vol. 44, pp. 381-397.
- DARWIN, CHARLES 1883 *Animals and plants under domestication*. Vol. 2, p. 65. Varieties of cross-bred rats.
- DASHIELL, J. F. 1920 The need for analytical study of the maze problem. *Psychobiology*, vol. 2, pp. 181-186.  
1920 a Some transfer factors in maze learning by the white rat. *Psychobiology*, vol. 2, pp. 329-350.
- DAVIS, DAVID J. 1916 On certain relations of the lower animals to human disease. *Science*, vol. 44, Sept. 8th, pp. 337-347. *Rat*—pp. 339 and 340.
- DAVIS, MARGUERITE AND outhouse, JULIA 1921 Effect of a ration low in fat soluble "A" on the tissues of rats. *Am. J. Diseases of Children*, vol. 21, pp. 307-311.
- DEAN, GEORGE 1903 A disease of the rat caused by an acid-fast bacillus. *Centralbl. f. Bakteriol. u. Parasitenk.*, Bd. 34, part 1, S. 222-224.  
1905 Further observations on a leprosy-like disease of the rat. *J. Hyg.*, vol. 5, pp. 99-112.
- DEBEYRE, ALBERT 1900 Bourgeons pancréatiques multiples sur le conduit hépatique primitif. *C. R. Soc. Biol. Paris*, T. 52, pp. 705-706.  
1904 Développement du pancréas chez le rat: bibliographie. Lille, Masson, (in his *Les bourgeons pancréatiques accessoires tardifs* pp. 15-28).
- DE CAMP, J. E. 1920 Relative distance as a factor in the white rat's selection of a path. *Psychobiology*, vol. 2, pp. 245-253.
- DEGENER, JYDA MAY 1922 Studies on the effect of diet on the weight of the hypophysis and thyroid gland of the albino rat, and on the action of their extracts on the isolated small intestine. *Am. J. Physiol.*, vol. 60, pp. 107-118.
- DEHNE, A. 1855 *Mus decumanus*, Pallas: Die Wanderatte u. ihre Varietäten. *Allg. deutsche Naturhist. Zeit. n. f.*, Bd. 1, S. 169-174.
- DEMAISON, L. 1906 Sur les rois de rats. *Feuille jeune. Natural* (4) Ann. 37, p. 38.
- DEMANENKO, K. 1909 Das Verhalten des Darmepithels bei verschiedenen funktionellen Zuständen. *Ztschr. f. Biol.*, Bd. 52, S. 153-188. (Zweite Mitt. nebst Bemerkung von Leon Asher.)
- DENTON, MINNA C. AND KOHMAN, EMMA 1918 Feeding experiments with raw and boiled carrots. *J. of Biol. Chem.*, vol. 36, pp. 249-263.
- DETLEFSEN, J. A. 1923 Are the effects of long-continued rotation in rats inherited? *Proc. of the Am. Philos. Soc.*, vol. 62, pp. 292-300.
- DEWITZKY, W. 1912 Beiträge zur Histologie der Nebennieren. *Ziegler's Beiträge*, Bd. 52, pp. 431-443.
- DIMOCK, JAMES F. See *Giraldus Cambrensis*.
- DISSELHORST, RUDOLF 1897 Die accessorischen Geschlechtsdrüsen der Wirbeltiere. Eine vergleichend-anatomische Untersuchung. *Arch. f. wissensch. u. prakt. Thierh.*, Bd. 23.  
1897 a Die accessorischen Geschlechtsdrüsen der Wirbeltiere, mit besonderer Berücksichtigung des Menschen. viii, S. 279, 16 pl. 8°. J. F. Bergmann, Wiesbaden.  
1904 Ausführapparat und Anhangsdrüsen der Männlichen Geschlechtsorgane. In Oppel, A., "Lehrbuch der Vergleichenden Mikroskopischen Anatomie der Wirbeltiere." Vierter Teil. Gustav Fischer. Jena. *Rodentia—Mus decumanus*, S. 263-282.

- DISTASO, A. AND SUGDEN, J. H.** 1919 Enterointoxication—its causes and treatment. *Biochem. J.*, vol. 13, pp. 153-163.
- DOBELL, CLIFFORD** 1913 Somerecent work on mutation in micro-organisms. *J. of Genetics*, vol. 2, pp. 201-220.
- DODSON, J. D.** 1917 Relative values of reward and punishment in habit formation. *Psychobiology*, vol. 1, pp. 231-276.
- DOLLFUS, ADRIEN** 1906 Les rois de rats. Feuille jeun. *Natural* (4) Ann. 36, pp. 174-175, 185-188.
- DONALDSON, H. H.** 1900 The functional significance of the size and shape of the neurone. *J. Nerv. and Ment. Dis.*, vol. 27, no. 10.
- DONALDSON, H. H. AND HOKE, G. W.** 1905 On the areas of the axis cylinder and medullary sheath as seen in cross sections of the spinal nerves of vertebrates. *J. Comp. Neur. and Psychol.*, vol. 15, pp. 1-16.
- DONALDSON, H. H.** 1906 A comparison of the white rat with man in respect to the growth of the entire body. *Boas Anniversary Volume*, pp. 5-26. G. E. Stechert & Co., N. Y.
- 1908 A comparison of the albino rat with man in respect to the growth of the brain and of the spinal cord. *J. Comp. Neur. and Psychol.*, vol. 18, pp. 345-392.
- 1909 On the relation of the body length to the body weight and to the weight of the brain and of the spinal cord in the albino rat (*Mus norvegicus* var. *albus*). *J. Comp. Neur. and Psychol.*, vol. 19, pp. 155-167.
- 1910 On the percentage of water in the brain and in the spinal cord of the albino rat. *J. Comp. Neur. and Psychol.*, vol. 20, pp. 119-144.
- 1911 On the influence of exercise on the weight of the central nervous system of the albino rat. *J. Comp. Neur.*, vol. 21, pp. 129-137.
- 1911 a The effect of underfeeding on the percentage of water, on the ether-alcohol extract, and on medullation in the central nervous system of the albino rat. *J. Comp. Neur.*, vol. 21, pp. 139-145.
- 1911 b An interpretation of some differences in the percentage of water found in the central nervous system of the albino rat and due to conditions other than age. *J. Comp. Neur.*, vol. 21, pp. 161-176.
- 1911 c Studies on the growth of the mammalian nervous system. *J. Nerv. and Ment. Dis.*, vol. 38, pp. 257-266.
- DONALDSON, H. H. AND HATAI, S.** 1911 A comparison of the Norway rat with the albino rat in respect to body length, brain weight, spinal cord weight and the percentage of water in both the brain and the spinal cord. *J. Comp. Neur.* vol. 21, pp. 417-458.
- 1911 a Note on the influence of castration on the weight of the brain and spinal cord in the albino rat and on the percentage of water in them. *J. Comp. Neur.*, vol. 21, p. 155-160.
- DONALDSON, H. H.** 1912 A comparison of the European Norway and albino rats (*Mus norvegicus* and *Mus norvegicus albinus*) with those of North America in respect to the weight of the central nervous system and to cranial capacity. *J. Comp. Neur.*, vol. 22, pp. 71-97.
- 1912 a On the weight of the crania of Norway and albino rats from three stations in western Europe and one station in the United States. *Anat. Record*, vol. 6, pp. 53-63.
- 1912 b The history and zoological position of the albino rat. *J. Acad. Nat. Sc. Phila.*, vol. 15, 2nd series, pp. 365-369.
- 1912 c An anatomical analysis of growth. *Trans. 15th Internat. Cong. Hyg. and Demography*, Wash., D. C., Sept. 23-28.
- 1915 The Rat. Reference tables and data for the albino rat (*Mus norvegicus albinus*) and the Norway rat (*Mus norvegicus*). *Memoirs of The Wistar Institute of Anatomy and Biology*, no. 6, pp. 1-278.
- DONALDSON, H. H., HATAI, S. AND KING, H. D.** 1915 Postnatal growth of the brain under several experimental conditions. *Studies on the albino rat. J. of Nervous and Mental Disease*, vol. 42, pp. 797-801.
- DONALDSON, H. H.** 1916 The relation of myelin to the loss of water in the mammalian nervous system with advancing age. *Proc. of the Nat. Acad. of Sciences*, vol. 2, pp. 350-356.
- 1916 a A preliminary determination of the part played by myelin in reducing the water content of the mammalian nervous system (albino rat). *Jour. Comp. Neur.*, vol. 26, pp. 443-451.
- 1916 b A revision of the percentage of water in the brain and the spinal cord of the albino rat. *Jour. Comp. Neur.*, vol. 27, pp. 77-115.
- 1916 c Experiment on the feralization of the albino rat. *Year Book no. 15 of the Carnegie Institution of Washington (for 1916)* pp. 200-201.
- 1917 Growth changes in the mammalian nervous system. *The Harvey Lectures*, series 12, 1916-1917, pp. 133-150. Pub., by J. B. Lippincott Co., Philadelphia.
- DONALDSON, H. H. AND NAGASAKA, G.** 1918 On the increase in the diameters of nerve-cell bodies and of the fibers arising from them during the later phases of growth (albino rat). *Jour. Comp. Neur.*, vol. 29, pp. 529-552.
- DONALDSON, H. H.** 1918 A comparison of growth changes in the nervous system of the rat with corresponding changes in the nervous system of man. *Proc. of the Nat. Acad. of Sciences, of U. S.*, vol. 4, pp. 280-283.
- 1918 a Introduction to the "Comparative studies on the growth of the cerebral cortex, by Dr. Naoki, Sugita." Parts I and II in *Jour. Comp. Neur.*, vol. 28; Parts III to VIII in *Jour. Comp. Neur.* vol. 29.

- DONALDSON, H. H. AND CONROW, SARA B. 1919 Quantitative studies on the growth of the skeleton of the albino rat. *Am. Jour. Anat.*, vol. 26, pp. 237-314.
- DONALDSON, H. H. 1923 On the effect of captivity or domestication on the brain weight of some mammals. *Proc. Am. Assoc. of Anatomists in Anat. Record*, vol. 25, p. 126.
- 1923 a On the cranial capacity of the guinea-pig—wild and domesticated. *Schweizer Archiv für Neurol. und Psychiatric*, Bd. 13, pp. 205-222.
- 1923 b On changes in the relative weights of the viscera and other organs from birth to maturity—albino rat. *Am. J. of Physiol.*, vol. 67, pp. 1-21.
- DONALDSON, JOHN C. 1919 The relative volumes of the cortex and medulla of the adrenal gland in the albino rat. *Am. Jour. Anat.*, vol. 25, pp. 291-298.
- 1923 Note on the weight of the adrenals in crosses between the albino and the wild Norway rat (*Mus norvegicus*). *Proc. of the Soc. for Exper. Biol. and Med.*, vol. 21, pp. 157-160.
- 1924 The influence of pregnancy and lactation on the weight of adrenal glands in the albino rat. *Am. J. of Physiol.*, vol. 68, pp. 517-522.
- DONCASTER, L. 1906 On the inheritance of coat color in rats. *Proc. Cambridge Philos. Soc.*, vol. 13, pp. 215-228.
- DONCASTER, L. AND MARSHALL, F. H. A. 1910 The effects of one-sided ovariectomy on the sex of the offspring. *Jour. Genetics*, vol. 1, pp. 70-72.
- DONNDORFF, J. A. 1792 *Zoologische Beiträge zur XIII Ausgabe des Linnéschen Natursystem*. 2 vols. Leipzig. Bd. 1, Die Säugethiere, S. 427.
- DOSTOLEWSKY, A. 1886 Ueber den Bau der Vorderlappen des Hirnanhangs. *Arch. f. mikr. Anat.*, Bd. 26, S. 592-598.
- 1886 a Ein Beitrag zur mikroskopischen Anatomie der Nebennieren bei Säugethiern. *Archiv f. mikr. Anat.*, Bd. 27, S. 272-296. *Rat*, p. 279 and 287.
- DOUGLAS, MACKENZIE 1915 The histology of the thyroid in animals fed on various diets. *Jour. Path. and Bact.*, vol. 19, pp. 341-348.
- DOWNEY, HAL 1917 Reactions of blood and tissue cells to acid colloidal dyes under experimental conditions. *Anat. Rec.*, vol. 12, pp. 429-450.
- 1917 a Histocytes and macrophages and their relations to the cells of normal blood in animals stained intra vitam with acid colloidal dyes. *Proc. of Am. Assoc. of Anat. in Anat. Record*, vol. 11, pp. 350-355.
- 1918 Further studies on the reactions of blood and tissue-cells to acid colloidal dyes. *Anat. Record*, vol. 15, pp. 103-133.
- DRAGSTEDT, L. R. AND COOPER, ETHEL F. 1923 Parabiosis in the study of deficiency diseases. *Am. J. of Physiol.*, vol. 67, pp. 48-56.
- DRASCH, O. 1886 Zur Frage der Regeneration und der Aus- und Rückbildung der Epithelzellen. *Sitz. d. k. Akad. d. Wiss. math.-naturw. Cl. Wien*. Bd. 93, Abt III, S. 200-213, 1 pl.
- DREW, A. H. 1923 Growth and differentiation in tissue cultures. Eighth Scientific Report of the Imperial Cancer Research Fund.
- DREYER, G., RAY, W. AND WALKER, AINLEY, E. W. 1912 The size of the aorta in warm-blooded animals and its relationship to the body weight and to the surface area expressed in a formula. *Proc. Roy. Soc. London*, series B, vol. 86, pp. 39-56. See Table IV.
- DROOGLEEVER-FORTUYN, A. B. 1914 Cortical lamination of the hemispheres of some rodents. *Mus decumanus* (Pall), p. 260, Figures 18-22. *Arch. Neurol. & Path.*, London County Asylum, vol. 6, pp. 221-351.
- 1918 Some remarks about the nervus octavus in three tame rats with inflammation of the internal ear. *Psych. en Neurol. Bladen* (Feestbundel Winkler), pp. 211-257.
- DRUMMOND, J. C. 1916 The growth of rats upon artificial diets containing lactose. *Biochem. J.*, vol. 10, p. 89.
- 1918 A study of the water-soluble accessory growth promoting substance. II. Its influence upon the nutrition and nitrogen metabolism of the rat. *Biochem. J.*, vol. 12, pp. 25-41.
- DRUMMOND, J. C. AND HALLIBURTON, W. D. 1919 Fats and fatty acids as food. IV. Feeding experiments on animals. *J. Physiol.*, vol. 52, pp. 339-343.
- DRUMMOND, J. C. AND COWARD, K. H. 1920 Researches on the fat-soluble accessory substance. III. Technique for carrying out feeding tests for vitamin A (fat-soluble A). *Biochem. J.*, vol. 14, pp. 661-664.
- 1920 a Researches on the fat-soluble accessory substance. V. The nutritive value of animal and vegetable oils and fats considered in relation to their colour. *Biochem. J.*, vol. 14, pp. 668-677.
- 1920 b Researches on the fat-soluble accessory factor (vitamin A). VI. Effect of heat and oxygen on the nutritive value of butter. *Biochem. J.*, vol. 14, pp. 734-739.
- DRUMMOND, J. C., GOLDING, J., ZILVA, S. S. AND COWARD, K. H. 1920 The nutritive value of lard. *Biochem. J.*, vol. 14, pp. 742-753.
- DRUMMOND, J. C., COWARD, K. H. AND WATSON, A. F. 1921 Researches on vitamin A. VII. Notes on the factors influencing the value of milk and butter as sources of vitamin A. *Biochem. J.*, vol. 15, pp. 540-552.
- DRUMMOND, W. B. 1900 On the structure and functions of haemolymph glands. *J. of Anat. and Phys.*, vol. 34, pp. 198-222.
- DUBOIS, E. 1898 Ueber die Abhängigkeit des Hirngewichtes von der Körpergrösse bei den Säugethiern. *Archiv für Anthropologie*, Bd. 25.



- DEESBERG, J. 1907 Die Mitochondrien-Apparat in den Zellen der Wirbeltiere und Wirbellosen. Arch. f. mikr. Anat., Bd. 71, S. 284-296.
- 1908 Les divisions des spermatoocytes chez le rat (*Mus decumanus* Pall., variété albinos). Arch. f. Zellforsch., T. 1.
- 1908 a La Spermatogénèse chez le rat (*Mus decumanus* Pall., Variété albinos) Mémoire présenté pour l'obtention du titre de docteur spécial en sciences anatomiques, Université de Liège, Wilhelm Engelmann. Leipzig. Also (b) Arch. f. Zellforsch., T. 2, pp. 137-180.
- 1909 Note complémentaire sur la spermatogénèse du rat. Arch. f. Zellforsch., T. 3, pp. 533-562.
- DUNN, ELIZABETH H. 1908 A study in the gain in weight for the light and heavy individuals of a single group of albino rats. Proc. Assoc. Am. Anat. in Anat. Record, vol. 2, pp. 109-110.
- 1912 The influence of age, sex, weight and relationship upon the number of medullated nerve fibers and on the size of the largest fibers in the ventral root of the second cervical nerve of the albino rat. J. Comp. Neur., vol. 22, pp. 131-157.
- DUNN, E. H. 1916 The size of the medullated axons of the Purkinje cerebellar neurons in the albino rat. Proc. of Am. Assoc. of Anatomists in Anat. Record, vol. 10, p. 196.
- 1917 Primary and secondary findings in a series of attempts to transplant cerebral cortex in the albino rat. Jour. Comp. Neur., vol. 27, pp. 565-582.
- DUNN, L. C. 1920 Linkage in mice and rats. Genetics, vol. 5, pp. 325-343.
- DURHAM, FLORENCE M. 1904 On the presence of tyrosinases in the skins of some pigmented vertebrates. Proc. Roy. Soc., vol. 74, pp. 310-313.
- DUTCHER, R. A., KENNEDY, CORNELIA AND ECKLES, C. H. 1920 The influence of the diet of the cow upon the fat soluble and water soluble vitamins of cow's milk. Science, vol. 52, no. 1355, December 17th, pp. 588-589.
- DUTCHER, R. A. AND OUTHOUSE, JULIA 1923 The vitamin content of raisins, dried raisin seeds and raisin seed oil. Proc. of the Soc. for Exper. Biol. and Med., vol. 20 pp. 450-451.
- DUVAL, C. W. 1910 The cultivation of the leprosy bacillus and the experimental production of leprosy in the Japanese dancing mouse. J. Exper. Med., vol. 12, pp. 649-665.
- 1911 Notes on the biology of *B. leprae*. N. Orl. M. and S. J., vol. 63, pp. 549-559.
- DUVAL, C. W. AND GURD, F. B. 1911 Experimental immunity with reference to the bacillus of leprosy. Part I. A study of the factors determining infection in animals. J. Exper. Med., vol. 14, pp. 181-195.
- 1911 a Studies on the biology of and immunity against the bacillus of leprosy: with a consideration of the possibility of specific treatment and prophylaxis. Arch. Int. Med., vol. 7, pp. 230-245.
- DUVAL, C. W. AND WELLMAN, CREIGHTON 1912 A new and efficient method of cultivating bacillus leprae from the tissues; with observations on the different strains of acid-fast bacilli found in leprosy lesions. J. Am. M. Ass., vol. 58, p. 1427.
- DUVAL, C. W. AND HARRIS, W. H. 1913 Further studies upon the leprosy bacillus: its cultivation and differentiation from other acid-fast species. J. Med. Research, vol. 26 (n.s. 21), pp. 165-198.
- DUVAL, M. 1890 L'ectoplacenta de la souris et du rat. C. R. Soc. Biol. Paris, ser. 9, T. 2, pp. 567-568.
- EBNER, V. VON 1873 Die acinösen Drüsen der Zunge und ihre Beziehungen zu den Geschmacksorganen. Leuschner und Lubensky, Graz., 66 pp., 2 pl.
- 1888 Zur Spermatogenese den Säugethieren. Archiv. f. mikr. Anat., Bd. 31, S. 236-292. Tafel XV, XVI, XVII (Rat).
- 1899 Ueber die Teilung der Spermatoocyten beider Säugethieren. Ber. d. Akad. d. Wiss., Wien, Math.-nat. wiss. Klasse, Bd. 108.
- EDDY, WALTER H. 1916 The isolation of a growth-producing substance from sheep pancreas. J. Biol. Chem., vol. 27, pp. 113-126.
- EDDY, WALTER H. AND STEVENSON, H. C. 1920 Studies in the vitamin content. J. Biol. Chem., vol. 43, p. 295.
- EDDY, W. H., HEFT, HATTIE L., STEVENSON, HELEN C. AND JOHNSON, RUTH 1921 Studies in the vitamin content. II. The yeast test as a measure of vitamin B. J. of Biol. Chem., vol. 47, pp. 249-275.
- EDDY, WALTER H. 1921 The vitamin manual. Williams & Wilkins Co., Baltimore.
- EDDY, W. H., AND ECKMAN, RENA S. 1923 The supplementary protein value of peanut flour. J. of Biol. Chem., vol. 55, pp. 119-129.
- EDELMANN, RICHARD 1889 Vergleichend anatomische und physiologische Untersuchungen über eine besondere Region der Magenschleimhaut (Cardiadrüsen-region) bei den Säugethieren. Deutsche Ztschr. f. Tiermed., Bd., 15, S. 165-214.
- EDIE, E. S., MOORE, BENJAMIN AND ROAF, H. E. 1910 Studies on glycosuria: (A) Considerations of modes of production of glycosuria, and the carbohydrate, oxygen and carbon-dioxide equilibrium in the tissue-cell. (B) Respiration under low oxygen percentages and under high carbon-dioxide percentages in the respired air. (C) Anaesthetic glycosuria. (D) Feeding experiments with pancreas and intestinal mucosa in pancreatic glycosuria. Bio-Chemical J., vol. 5, p. 348.
- EDINGER, L. 1910 Ueber die Einteilung des Cerebellums. Anat. Anz., Bd. 35, S. 319-323.
- 1911 Vorlesungen über den Bau der Nervösen Zentralorgane des Menschen und der Tiere. F. C. W. Vogel, Leipzig, 8th Ed., Bd. 1.

- EDINGTON, A. 1901 Rattenpest. *Centrabl. f. Bacter.*, Bd. 29, p. 889.
- EDWARDS, A. MILNE 1871 Melanism in *Mus decumanus*. *Ann. Soc. Nat. Hist.*, Bd. 15, art. 7.  
1872 Note sur la variété mélanienne du surmulot (*Mus decumanus*). *Ann. des. Se. Nat. Zool.*, 5th ser. T. 15.
- EIMER, G. H. TH. 1869 Die Wege des Fettes in der Darmschleimhaut bei seiner Resorption. *Arch. f. pathol. Anat.*, Bd. 48, S. 119-177, pl. 4 and 5.
- EISELSBERG, VON 1890 Ueber einen Fall von erfolgreicher Transplantation eines Fibrosarkoms bei Ratten. *Wiener klin. Wochenschr.*, no. 48.
- ELLENBERGER, W. 1906 Zum Mechanismus der Magenverdauung. *Arch. f. d. ges. Physiol.*, vol. 114, pp. 93-107. Critique of A. Scheunert, *ibid.*, p. 64.
- ELLENBERGER, WILHELM AND GUENTHER, G. 1908 Grundriss der vergleichenden Histologie der Haus- säugetiere. *Berl. Percy*, 3rd ed. rev. and enlarged.
- ELLIOTT, T. R. AND BARCLAY-SMITH, E. 1904 Antiperistalsis and other muscular activities of the colon. *J. Physiol.*, vol. 31, pp. 272-304. Rat: pp. 283-287. Fig. 3.
- ELLIOTT, T. R. AND TUCKETT, J. 1906 Cortex and medulla in the suprarenal glands. *J. Physiol.*, vol. 34, pp. 332-369.
- EMGE, LUDWIG A. 1921 A cytological study of the kidney cell in long continued hyperfunction with relation to hypertrophy and the mitochondrial apparatus. *Stanford Univ. Pub.—Univ. Series—Medical Sciences*, vol. 1, no. 2, pp. 107-124.
- EMMEL, V. E. 1922 The azurophile granulation of the lymphoid cells of the blood during digestion and fasting and in relation to the tributaries of the venous system. *Proc. Am. Assoc. of Anat. in Anat. Record*, vol. 23, p. 16.
- EMMEL, V. E. AND WALKER, J. E. 1922 The percentage of polychromasia in the blood of the rat as correlated with gestation, lactation, and the oestrous cycle. *Proc. Am. Assoc. of Anat. in Anat. Record*, vol. 23, p. 17.
- EMMETT, A. D. 1920 The fat-soluble A vitamine and xerophthalmia. *Science*, vol. 52, August 13th, pp. 157-158.  
1921 Standardized methods for the study of vitamins. *J. of Industrial and Engineering Chemistry*, vol. 13, page 1104.  
1922 The vitamins and their relationship to health and disease. *Therapeutic Gazette* of November and December 1921, and January 1922.
- EMMETT, A. D. AND ALLEN, F. P. 1920 Pathogenesis due to vitamine deficiency in the rat. *J. Biol. Chem.*, vol. 41, p. liii *Proc.*
- EMMETT, A. D. AND LUCAS, G. O. 1919 Is lactalbumin a complete protein for growth? *J. Biol. Chem.*, vol. 38, pp. 147-159.
- 1919 a The stability of lactalbumin toward heat. *J. Biol. Chem.*, vol. 38, pp. 257-265.  
1919 b The absence of fat-soluble A vitamine in certain ductless glands. *J. Biol. Chem.*, vol. 38, pp. 441-447.  
1920 Water-soluble vitamins. I. Are the anti-neuritic and the growth-promoting water-soluble B vitamins the same? *J. Biol. Chem.*, vol. 43, pp. 265-286.
- EMMETT, A. D. AND STOCKHOLM, MABEL 1920 Water-soluble vitamins. II. The relation of the anti-neuritic and water-soluble B vitamins to the yeast growth-promoting stimulus. *J. Biol. Chem.*, vol. 43, pp. 287-294.
- EMMETT, A. D. AND PEACOCK, GAIL 1923 Does the chick require the fat-soluble vitamins? *J. of Biol. Chem.*, vol. 56, pp. 679-693.
- ENDERS, HOWARD E. 1923 The life-history and development of the mite, *Myobia musculi*, Schrank. *Proc. Am. Soc. Zool. in Anat. Record*, vol. 24, p. 373.
- ENGELMANN, TH. W. 1877 Vergleichende Untersuchungen zur Lehre von der Muskel- und Nervenletrizität. *Arch. f. d. ges. Physiol.*, Bd. 15, S. 116-148.
- ERDHEIM, JAKOB 1906 Zur Anatomie der Kiemenderivate bei Ratte, Kaninchen und Igel. *Anat. Anz.*, Bd. 29, S. 609-623. Rats. pp. 610-616, Fig. p. 621.  
1906 a Tetania parathyreopriva. *Mitt. a. d. Grenzgeb. d. Med. u. Chir.*, vol. 16, pp. 632-744.  
1907 Tetania parathyreopriva. *Med. Press and Circ.*, vol. 83, pp. 91-93.  
1911 Ueber den Kalkgehalt des wachsenden Knochens und des Callus nach der Epithelkörperchen- exstirpation. *Frankfurt. Ztschr. f. Path.*, Bd. 7, S. 175-230.  
1911 a Zur Kenntnis der parathyreopriven Dentinveränderung. *Frankfurt Ztschr. f. Path.*, Bd. 7, S. 238-248. Figs. Rats. No tables.  
1911 b Ueber die Dentinverkalkung im Nagezahn bei der Epithelkörperchen- transplantation. *Frankfurt. Ztschr. f. Path.* Bd. 7, S. 295-342.
- ERDÉLYI, A. 1905 Untersuchungen über die Eigenschaften und die Entstehung der Lymphe. Fünfte Mitt. Über die Beziehungen zwischen Bau und Funktion des lymphatischen Apparates des Darmes. Taf. III. *Ztschr. f. Biol.*, Bd. 46, S. 119-152. Tabulation of numbers of lymphocytes.
- ERXLIEBEN, JO. CHRIST P. 1777 *Systema regni animalis*. *Classis I. Mammalia*. *Lipsiae*. p. 381. *Mus norvegicus*: original description.
- EVANS, H. M. AND LONG, J. A. 1922 Characteristic effects upon growth, oestrus and ovulation induced by the intraperitoneal administration of fresh anterior hypophyseal substance. *Proc. of the Nat. Acad. of Sciences*, vol. 8, pp. 38-39.
- EVANS, H. M. AND BISHOP, K. S. 1922 On the relations between fertility and nutrition. I. The ovulation

- rhythm in the rat on a standard nutritional régime. *J. of Metabolic Research*, vol. 1, pp. 319-331.
- 1922 a On the relations between fertility and nutrition. II. The ovulation rhythm in the rat on inadequate nutritional régimes. *J. of Metabolic Research*, vol. 1, pp. 335-356.
- 1922 b On an invariable and characteristic disturbance of reproductive function in animals reared on a diet poor in fat soluble vitamine A. *Proc. of Am. Assoc. of Anatomists in Anat. Record*, vol. 23, pp. 17-18.
- 1922 c Oestrus and ovulation in the rat, from a large group of animals on a standard diet. *Proc. of Am. Assoc. of Anatomists in Anat. Record*, vol. 23, pp. 18-19.
- 1922 d On the existence of a hitherto unrecognized dietary factor essential for reproduction. *Science*, N. S., vol. 56, no. 1458, December 8th.
- 1923 On the relations between fertility and nutrition. III. The normal reproductive performance of the rat. *J. of Metabolic Research*, vol. 3, pp. 201-232.
- 1923 a Independence of the oestrous or heat hormone from that causing "oestrous" structural changes in the vaginal mucosa of the rat. *Proc. Am. of Assoc. of Anatomists in Anat. Record*, vol. 25, p. 128.
- 1923 b The cause of reproductive upset in dietary deficiencies due to lack of vitamine A. *Proc. Am. Assoc. of Anatomists in Anat. Record*, vol. 25, p. 129.
- 1923 c On the relations between fertility and nutrition. IV. The production of sterility with nutritional régimes adequate for growth and its cure with other foodstuffs. *J. of Metabolic Research*, vol. 3, pp. 233-316.
- EVANS, W. A. 1901-1903 A fever following rat bite. *Tr. Chicago Path. Soc.*, 1901-3, vol. 5, pp. 298-303.
- EXNER, H. V. 1920 Adrenal functions in white rats. *Dublin J. Med. Science*, April, pp. 79-89.
- EYRE, J. W. H. 1913 The elements of bacteriological technique. W. B. Saunders Co., Philadelphia.
- FALCONE, CESARE 1898 Contribution à l'histogénèse et à la structure des glandes salivaires. *Monitore zool. ital.* T. 9, pp. 11-27. 1 plate.
- FALK, K. G., NOYES, HELEN M. AND SUGIURA, K. 1922 Studies on enzyme action. XX. The protease actions of malignant human and rat tumor extracts at different hydrogen ion concentrations and in the presence of various salts. *J. of Biol. Chem.*, vol. 53, pp. 75-102.
- FALTA, W. AND NOEGGERATH, C. T. 1905 Fütterungsversuche mit künstlicher Nahrung. *Beiträge z. chem. Physiol. u. Pathol.*, Bd. 7, S. 313-322.
- FANTHAM, H. B. 1906 *Piroplasma muris* Fant., from the blood of the white rat, with remarks on the genus *Piroplasma*. *Quart. J. micr. Sc.*, vol. 50, pp. 493-516.
- FAURE, CH. AND SOULA, C. 1913 Étude de la protéolyse de la substance nerveuse. Relations entre la protéolyse et la chromatolyse fonctionnelles des centres dans la fatigue. Note préliminaire. *Compt. Rend. Soc. d. Biol., Paris*, T. 74, pp. 350-352.
- FERRIER, DAVID 1886 The functions of the brain. 2nd ed. Smith, Elder & Co., London. *Rat*, pp. 261-262.
- FERRY, EDNA L. 1913 The rate of growth of the albino rat. *Anat. Record*, vol. 7, pp. 433-441.
- 1920 Nutrition experiments with rats. A description of methods and technic. *J. Lab. Clin. Med.*, vol. 5, pp. 735-745.
- FIBIGER, J. 1913 Ueber eine durch Nematoden (*Spiroptera* sp.n.) hervorgerufene papillomatöse und carcinomatöse Geschwulstbildung im Magen der Ratte. *Berl. Klin. Wochenschr.*, L. S. 289-298.
- 1913 a The nematode (*Spiroptera* sp.n.) and its capacity to develop papillomatous and carcinomatous tumors in the ventricle of the rat. *Hosp.-Tid. Kobenh.*, 5 R., 6, 417; 449, 6 pl., 473. Discussion, pp. 441-448.
- 1913 b Untersuchung über eine Nematode (*Spiroptera* sp.n.) und deren Fähigkeit, papillomatöse und carcinomatöse Geschwulstbildungen im Magen der Ratte hervorzurufen. *Zeitschr. f. Krebsforsch.*, Berl., Bd. 13, S. 217-280, 14 pl.
- FINDLAY, GEORGE M. AND MACKENZIE, RONALD. 1922 Opsonins and diets deficient in vitamins. *Biochem J.*, vol. 16, pp. 574-577.
- FINKS, A. J. AND JOHNS, CARL O. 1921 Studies in nutrition. VIII. The nutritive value of the proteins of tomato seed press cake. *Am. J. Physiol.*, vol. 56, pp. 404-407.
- 1921 a Studies in nutrition. IX. The nutritive value of the proteins from the Chinese and Georgia velvet beans. *Am. J. Physiol.*, vol. 57, pp. 61-67.
- FINLAY, G. F. 1924 The effect of different species' lens antisera on pregnant mice and rats and their progeny. *British J. of Exper. Biol.*, vol. 1, pp. 201-213.
- FIRKET, JEAN 1920 On the origin of germ cells in higher vertebrates. *Anat. Record*, vol. 18, pp. 309-316.
- FISCHEL, ALFRED 1914 Zur normalen Anatomie und Physiologie der weiblichen Geschlechtsorgane von *Mus decumanus* sowie über die experimentelle Erzeugung von Hydro- und Pyosalpinx. *Arch. f. Entwicklungsmech. d. Organ.*, Bd. 39, S. 578-616.
- FISCHER, G. 1803 *Rattus* (misprinted *Ruttus*). Das Nationalmuseum der Naturgeschichte zu Paris, Bd. 2, S. 128.
- FISCHER, J. VON 1869 Die Säugethiere des St. Petersburg Governments. *Zool. Garten*. Bd. 10.
- FISCHER, J. VON 1872 Calculation of possible progeny of one pair of rats in ten years. *Zool. Garten*, pp. 125-126. (48, 319, 698, 843, 030, 344, 720 Rats.)

- 1874 Beobachtungen über Kreuzungen verschiedener Farbenspielarten innerhalb einer Species. Zool. Garten, Bd. 15.
- FISHER, N. F. 1923 The influence of the gonad hormones on the seminal vesicles. *Am. J. of Physiol.*, vol. 64, pp. 244-251.
- 1923 a Preparation of insulin. *Am. J. of Physiol.*, vol. 67, pp. 57-64.
- FLATAU, E. AND JACOBSON, L. 1899 Handbuch der Anatomie und vergleichenden Anatomie des Centralnervensystems der Säugetiere. S. Karger—Berlin. *Mus rattus*—Ratte S. 370-382.
- FLEXNER, SIMON AND NOGUCHI, H. 1906 The effect of eosin upon tetanus toxin and upon tetanus in rats and guinea-pigs. *J. Exp. Med.*, vol. 8, pp. 1-7.
- FLEXNER, SIMON AND JOBLING, J. W. 1907 Metaplasia and metastasis of a rat tumor. *Proc. Soc. Exp. Biol. and Med.*, vol. 5, pp. 52-53.
- FLEXNER, S. AND JOBLING, J. W. 1908 Further notes on a rat tumor. *Proc. Soc. Exper. Biol. and Med.*, vol. 5, p. 91.
- FLOWER, C. F., FORKNER, C. E., KELLCUM, W. E., WALKER, A. T., SMITH, P. E., AND EVANS, H. M. 1923 Separation of the principle in the anterior hypophysis affecting ovulation from that controlling general body growth. *Proc. Am. Assoc. of Anatomists in Anat. Record*, vol. 25, p. 107.
- FLOWER, W. H. 1872 Lectures on the comparative anatomy of the Mammalia. *Med. Times and Gaz.*, vol. 1 and vol. 2. For rat, see vol. 2, p. 115.
- FOÀ, C. 1914 Nouvelles recherches sur la fonction de la glande pinéale. *Arch. ital. de biol.*, Turin, T. 61, pp. 79-92.
- FOLIN, OTTO AND MORRIS, J. LUCIEN 1913 The normal protein metabolism of the rat. *J. Biol. Chem.*, vol. 14, pp. 509-515. Metabolism like that of man.
- FORBES, E. B. AND KEITH, M. HELEN 1914 A review of the literature of phosphorous compounds in animal metabolism. *Ohio Agr. Exp. Station*, Technical series, bull. no. 5. See p. 332 and p. 506—valuable bibliography with abstracts.
- FORDYCE A. D. 1912 Changes in thyroid gland under thyroid feeding. *Edinburgh Med. J.*, n.s., vol. 9, pp. 55-62.
- FRAENKEL, L. 1905 Vergleichend histologische Untersuchungen über das Vorkommen drüsiger Formationen in interstitiellen Eierstocksgewebe (glande interstitielle de l'ovaire). *Arch. f. Gynäk.*, Bd. 75, S. 443-507.
- FRANK, FRANZ AND SCHITTENHEIM, A. 1912 Ueber die Brauchbarkeit tief abgebauter Eiweisspräparate für die Ernährung. *Therap. Monatsb.*, Bd. 26, S. 112-117.
- FRANK, ROBERT T. AND UNGER, A. 1911 An experimental study of the causes which produce the growth of the mammary gland. *Corpus luteum*—rats and rabbits. *Arch. Intern. Med.*, vol. 7, p. 812. Also in *Proc. N. Y. Path. Soc.*, Series II, no. 1 and 2, pp. 4-8.
- FRANKENHAUSER, CONSTANTIN 1879 Untersuchungen über den Bau der Tracheo-bronchialschleimhaut. *Diss. von Dorpat*, 120 pp., 1 plate. St. Petersburg.
- FRANZ, S. I. AND LASHLEY, K. S. 1917 The retention of habits by the rat after destruction of the frontal portion of the cerebrum. *Psychobiology.*, vol. 1, pp. 3-18.
- FRASER, A. 1883 On the inversion of the blastodermic layers in the rat and mouse. *Proc. Roy. Soc.* no. 223.
- FRÉDÉRIC, J. 1907 Beiträge zur Frage des Albinismus. *Ztschr. f. Morphol. u. Anthrop.*, Bd. 10, no. 2.
- FRENKEL, MOÏSE 1892 Du tissu conjonctif dans le lobule hépatique de certains mammifères. *Compt. rend. soc. de biol. Année 44* (ser. 9, v. 4), pp. 38-39.
- FREUND, PAULA 1892 Beiträge zur Entwicklungsgeschichte der Zahnanlagen bei Nagethieren. *Arch. f. mikr. Anat.*, Bd. 39, S. 525-556.
- 1911 Über experimentelle Erzeugung teratoider Tumoren bei der weissen Ratte. *Inaug.-Diss.* München.
- FREYER, MARY E. AND EVANS, H. M. 1923 Participation of the mammary gland in the changes of pseudo-pregnancy in the rat. *Proc. Am. Assoc. of Anatomists in Anat. Record*, vol. 25, p. 108.
- FREYER, M. G. 1921 On the cause of the effects produced by stimulation of the cervical canal in the rat. *Proc. of Am. Assoc. of Anatomists in Anat. Record*, vol. 21, pp. 57-58.
- FUCHS-WOLFRING, SOPHIE 1898 Ueber den feineren Bau der Drüsen des Kehlkopfes und der Luftröhre. *Arch. f. mikr. Anat.*, Bd. 52, S. 735-762. Rat, pp. 755-759, 1 plate.
- FUNK, CASIMIR 1915 The transplantation of tumors to foreign species. *J. of Exper. Med.*, vol. 21, pp. 571-573.
- 1916 The nature of the disease due to the exclusive diet of oats in guinea pigs and rabbits. *J. Biol. Chem.*, vol. 25, p. 416.
- 1916 a The study of certain dietary conditions bearing on the problem of growth in rats. *J. Biol. Chem.*, vol. 27, pp. 1-14.
- FUNK, CASIMIR AND MACALLUM, A. B. 1915 Studies on growth. II. On the probable nature of the substance promoting growth in young animals. *J. of Biol. Chem.*, vol. 23, pp. 413-421.
- 1916 Studies on growth. III. The comparative value of lard and butter fat in growth. *J. Biol. Chem.*, vol. 27, pp. 51-62.
- 1916 a Studies on growth. IV. The action of yeast fractions on the growth of rats. *J. Biol. Chem.*, vol. 27, pp. 63-70.
- FUNK, CASIMIR AND DUBIN, HARRY E. 1920 The vitamin requirements of the rat on diets rich in

- protein, carbohydrate, and fat, respectively. *Science*, N. S., vol. 52, no. 1349, November 5th.
- 1921 The vitamins of yeast and their rôle in animal nutrition. *Proc. of the Soc. for Exper. Biol. and Med.*, vol. 19, pp. 15-17.
- 1921 a Vitamine requirements of certain yeasts and bacteria. *J. of Biol. Chem.*, vol. 48, pp. 437-443.
- FUNK, CASIMIR AND PATON, JULIA B. 1922 Studies on vitamins B. and D. *J. of Metabolic Research*, vol. 1, pp. 737-775.
- FUNK, CASIMIR, HARROW, B. AND PATON, J. B. 1923 Extraction of vitamins from yeast and rice polishings with various water-miscible solvents. *Proc. of the Soc. for Exper. Biol. and Med.*, vol. 20, pp. 423-424—also *J. of Biol. Chem.* vol. 57, pp. 153-162.
- FURNO, A. 1911 Beiträge zur Kenntnis der vergleichenden Hämatologie der Spezialleukozyten-Granulationen einiger Laboratoriums-Säugetiere. *Folia Haematologica*, I Teil—Archiv—Bd. 11, S. 219-252.
- FUSARI, R. AND PANASCI, A. 1891 Les terminaisons des nerfs dans la muqueuse et dans les glandes serueuses de la langue des mammifères. Résumé originel des auteurs. *Arch. ital. de biol.*, T. 14, pp. 240-246, pl. 1.
- FUSARI, ROMEO 1894 Terminaisons nerveuses dans divers épithéliums. (Note lue à l'Académie des sciences naturelles et médicales de Ferrare dans la séance du 28 Mai 1893). *Arch. ital. de biol.*, T. 20, pp. 279-287. Observations mainly on the white rat.
- FUTAKI, K., TAKAKI, F., TANIGUCHI, T. AND OSUMI, S. 1916 The cause of rat-bite fever. *J. of Exp. Med.*, vol. 23, pp. 249-250.
- 1917 *Spirochaeta Morsus Muris*, n. sp., the cause of rat-bite fever. *J. of Exper. Med.*, vol. 25, pp. 33-44.
- GAD-ANDERSEN, K. L. 1919 Concentration of ammonia in blood. Comparison with concentration of ammonia in different secretions and tissues, especially muscle tissue. *J. Biol. Chem.*, vol. 39, pp. 267-271. Rat muscle—page 270.
- GAEBLER, OLIVER H. 1921 Bladder epithelium in contraction and distention. *Anat. Rec.*, vol. 20, pp. 129-154.
- GAGE, S. H. AND GAGE, S. P. 1909 Coloration of the milk in lactating animals and staining of the growing adipose tissue in the suckling young. *Anat. Rec.*, vol. 3, p. 203.
- GAGE, SIMON H. 1923 I. Determining the part of the alimentary canal which absorbs fat. II. Testing the digestion, absorption and assimilation of the pure fatty acids by the aid of Sudan III. *Proc. Am. Assoc. of Anatomists in Anat. Record*, vol. 25, p. 130.
- GAGE, SUSANNA P. 1887 Ending and relation of the muscular fibers in the muscles of minute animals (mouse, mole, rat and English sparrow). *Abstr. Proc. Amer. Soc. Micro.*, pp. 1-2.
- GALLI-VALERIO, BRUNO 1902 The part played by the fleas of rats and mice in the transmission of bubonic plague. *Journ. trop. Med.*, vol. 5, pp. 33-36.
- GAMGEE, ARTHUR 1898 Article "Hemoglobin" in E. A. Schäfer's *Textbook of Physiology*, vol. I, pp. 193-194. Small haemoglobin content and rapid crystallization in rat's blood, p. 206. Oxyhaemoglobin in rat's blood highly insoluble.
- GARDINER, FREDERICK 1905 On the influence of an excessive meat diet on the skin of rats. *Proc. of the Physiol. Soc. in Jour. Physiol.*, vol. 34.
- GARNIER, CHARLES 1897 Les filaments basaux des cellules glandulaires. Note préliminaire. *Bibliog. Anat.*, T. 5, pp. 278-289, 13 fig.
- GAUTHIER, J. C. AND RAYBAUD, A. 1903 Sur le rôle des parasites du rat dans la transmission de la peste. *C. R. Soc. de Biol.*, T. 54, p. 1497.
- GAY, F. P. 1909 A transmissible cancer of the rat considered from the standpoint of immunity. *J. Med. Research*, vol. 20, p. 175.
- GAYLORD, H. R. 1906 Endemisches Vorkommen von Sarkomen in Ratten. *Zeitschr. f. Krebsforschung*, Bd. 4, S. 679.
- GEGENBAUR, CARL 1892 Die epiglottis. Vergleichend anatomische Studie fol. 69 pp., 2 plates and 15 cuts in text. In *Festschr. Albert von Koelliker*. W. Engelmann, Leipzig.
- GEILING, E. M. K. AND GREEN, H. H. 1921 Studies in the regeneration of blood. *Proc. of the Soc. for Exper. Biol. and Med.*, vol. 18, p. 191.
- GEISENHEYMER, L. 1892 Zum Vorkommen der Hausratte, *Mus rattus* L. *Naturwiss. Wochenschr.* Bd. 7, S. 96-97.
- GEMELLI, AGOSTINO 1905 Nuovo contributo alla conoscenza della struttura dell'ipofisi dei mammiferi *Rivista di Fisica e Matematica*, vol. 12, pp. 136-145; pp. 235-247; pp. 338-346; pp. 419-431.
- 1906 Contributo alla fisiologia dell'ipofisi. *Arch. di fisiol.*, vol. 3, pp. 108-112.
- 1906 a Ulteriori osservazioni sulla struttura dell'ipofisi. *Anat. Anz.*, vol. 28, pp. 613-628, 14 figures.
- GEMELLI, EDOARDO 1903 Nuove ricerche sull'anatomia e sull'embriologia dell'ipofisi. *Boll. della soc. medico-chir. di Pavia*. Anno 1903, pp. 177-222, 5 pl.
- GEMELLI, EDOARDO after 1904 = GEMELLI, (FRA) AGOSTINO
- GENTES, L. 1903 Note sur la structure du lobe nerveux de l'hipophyse. *Compt. rend. Soc. de Biol.*, T. 55, pp. 1559-1561. Rat among other animals.
- GEOFFROY SAINT-HILAIRE, ÉTIENNE 1812 *Mus alexandrinus*. *Descr. Égypt.* II, p. 733, 1812 (1829). *Atlas*, p. V, fig. 1, 1899.

- GESNER, C. VON 1551 *Conradi Gesneri medici Tigurini Historiae Animalium Lib I de Quadrupedibus Viviparis*. Tiguri Christ Froscoverum Anno 1551, p. 829. De majore domestico mure quem vulgo rattum vocant.
- GEVAERTS, JACQUES 1901 Diète sous phosphore. *La Cellule*, T. 18, pp. 7-33.
- GHOSE, S. N. 1922 The examination of some Indian foodstuffs for their vitamin content. *Biochem. J.*, vol. 16, pp. 35-41.
- GIANNELLI, I. 1911 Nuovo contributo allo studio dello sviluppo dei pancreas nei mammiferi. *Att. Accad. Sc. Med. Nat. Ferrara*.
- 1914 Sul distacco delle isole di Langerhans dalla ghiandola pancreatica, e sui loro rapporti nell'interno di questa con i tubuli ghiandolari. *Monitore Zool. Ital.*, T. 25, pp. 30-47.
- GIES, WILLIAM J. 1914 Studies of internal secretions in their relation to the development and condition of the teeth. I. Effects of thyro-parathyroidectomy and thymectomy. *Trans. of the Dental Soc. of the State of New York*, pp. 105-131. Also printed in the *Dental Cosmos* for March, 1915.
- GIES, WILLIAM J. AND MILLER, EDGAR G. 1915 Studies of internal secretions in their relation to the development and condition of the teeth. 2. Effects of feeding glandular tissues, preparations, and extracts. *Trans. of the Dental Soc. of the State of New York*, pp. 161-188.
- GIES, WILLIAM J. AND PERLZWEIG, W. A. 1915 Studies of the influence of unbalanced diets on dentition. 2. A chemical study of nutritive factors in the development of teeth and bones, with special reference to the influence of hydrochloric and  $\beta$  hydroxybutyric acids, and the effect of dietary deficiencies of calcium and phosphorus. *Trans. of the Dental Soc. of the State of New York*, pp. 192-223.
- GIES, WILLIAM J. AND HEFT, HATTIE L. 1917 Studies of internal secretions in their relation to the development and condition of the teeth. 3. Further observations on effects of feeding glandular tissues and preparations. *Trans. of the Dental Soc. of the State of New York*, pp. 112-130.
- GIES, WILLIAM J. AND MILLER, EDGAR G. 1917 Studies of internal secretions in their relation to the development and condition of the teeth. 4. Effects of castration. *Trans. of the Dental Soc. of the State of New York*, pp. 131-143.
- GIES, WILLIAM J. 1917 Studies of internal secretions in their relation to the development and condition of the teeth. 5. A summary of miscellaneous findings. *Trans. of the Dental Soc. of the State of New York*, pp. 107-111.
- 1920 Experimental studies of the validity of advertised claims for products of public importance in relation to oral hygiene or dental therapeutics. Part II. Tests of the relative toxicity of potassium chlorate after intravenous injection into albino rats. *J. of Dental Research*, vol. 2, pp. 511-529.
- GIGLIO-TOS, E. 1900 Un parasite intranucléaire dans les reins du rat des égouts. *Arch. ital. de Biol.*, T. 34, p. 36.
- GILLETTE 1872 Description et structure de la tunique musculaire de l'oesophage chez l'homme et chez les animaux. *J. de l'anat. et physiol.*, T. 8, pp. 617-644.
- GINGERY, I. M. 1923 The vascularity of the enamel organ in mammals: a comparative study. *Proc. An. Assoc. of Anatomists in Anat. Record*, vol. 25, p. 137.
- GIRALDUS CAMBRENSIS (1146?-1220) 1861-1891 *Opera* (8 vols.) Vol. 5, 1867, vol. 6, 1868, edited by James F. Dimmock, M. A. Published under the direction of the Master of the Rolls. Longmans, Green, London.
- GIVENS, M. H. AND COHEN, BARNETT 1918 The antiscorbutic property of desiccated and cooked vegetables. *J. Biol. Chem.*, vol. 36, pp. 127-145.
- Rats, p. 131.
- GLAS EML 1904 Über die Entwicklung und Morphologie der inneren Nase der Ratte. *Anat. Hefte*, Bd. 25, S. 275-341.
- GLASER, OTTO C. 1910 The formation of habits at high speed. *Jour. Comp. Neur.*, vol. 20, pp. 165-184.
- GMELIN 1892 Morphologie der Papilla vallata und foliata. *Archiv f. mikr. Anat.*, Bd. 40, S. 1-28.
- GODMAN, JOHN D. 1826-1828 *American natural history*. 3 v., 8°. H. C. Carey and I. Lea, Phila. Pt. 1. Mastology.
- GOETSCH, EMLAND CUSHING, HARVEY 1913 The pars anterior and its relation to the reproductive glands. *Proc. Soc. Exper. Biol. and Med.*, vol. 11, pp. 26-27.
- GOETSCH, EMIL 1916 The influence of pituitary feeding upon growth and sexual development. An experimental study. *Johns Hopkins Hosp. Bull.*, vol. 27, pp. 1-58.
- GOLDBLATT, HARRY 1923 A study of the relation of the quantity of fat-soluble organic factor in the diet to the degree of calcification of the bones and the development of experimental rickets in rats. *Biochem. J.*, vol. 17, pp. 298-326.
- GOLDBLATT, HARRY AND SOAMES, K. M. 1923 A study of rats on a normal diet irradiated daily by the mercury vapour quartz lamp or kept in darkness. *Biochem. J.*, vol. 17, pp. 294-297.
- 1923 a Studies on the fat-soluble growth-promoting factor. *Biochem. J.*, vol. 17, pp. 446-453.
- 1923 b The supplementary value of light rays to a diet graded in its content of fat-soluble organic factor. *Biochem. J.*, vol. 17, pp. 622-629.
- GOLDMANN, E. E. 1909 Die äussere und innere Secretion des gesunden und kranken Organismus im Lichte der vitalen Färbung. *Beitr. z. klin. Chir.*, Bd. 64, S. 192.

- 1912 Die äussere und innere Sekretion des gesunden und kranken Organismus im Lichte der vitalen Färbung. Beitr. z. klin. Chir., Bd. 78, S. 1-108.
- GOLDSTEIN, K. 1901 Zur vergleichenden Anatomie der Pyramidenbahn. Anat. Anz., Bd. 24, S. 451.
- GOTO, SEITARO 1906 A laboratory guide of zoology (In Japanese). 2 vols. Kinkodo, Japan. See vol. 2, pp. 297-373—white rat (*Mus rattus*, × *Mus decumanus*).
- GOTTLIEB, B. 1914 Die vitale Färbung der kalkhaltigen Gewebe. Anat. Anz., Bd. 46, S. 179-194.
- GOTTSCHAU, M. 1883 Structure und embryonale Entwicklung der Nebennieren bei Säugethieren. Arch. f. Anat. u. Physiol., Anat. Abthlg., fig. 12.
- GOURLAY, C. A. 1907 Notes on the rats of Dacca, Eastern Bengal. Records of the Indian Museum, Calcutta, vol. 1, pp. 263-266. Relative numbers of *Mus rattus* and *Nesokia bengalensis*. Measurements on both good.
- GRAHAM, L. W. AND HUTCHINSON, R. H. 1911 The influence of experimental trypanosomiasis upon the body temperature of white rats. Am. J. of Trop. Dis. and Prev. Med., vol. 1, pp. 760-775.
- GRAVENHORST, J. L. C. 1803 Ueber Bastard-Erzeugung. Voigt's Magazin, Bd. 11, S. 193-217.
- GRAY, ALBERT A. 1907 and 1908 The labyrinth of animals, including mammals, birds, reptiles and amphibians. 2 vol., 450 pp. J. & H. Churchill.
- GREEFF, R. 1900 Die mikroskopische Anatomie des Sehnerven und der Netzhaut. Graefe-Saemisch Handbuch der Gesamten Augenheilkunde, Bd. 1, chapter 5. Page 108, fig. 34. Stäbchen der Ratte. Härtung in Osmiumsäure; Zupfpräparat. Verg. wie in Fig. 30. Die Ratte besitzt die feinsten bisher bekannten Stäbchen; die Dicke beträgt 0.75  $\mu$ . Das Aussenglied ist etwa 3 mal so lang als das Innenglied.
- GREENMAN, M. J. 1913 Studies on the regeneration of the peroneal nerve of the albino rat: number and sectional areas of fibers: area relation of axis to sheath. J. Comp. Neur., vol. 23, pp. 479-513.
- 1916 Regeneration of peripheral nerves. J. of Nervous and Mental Disease, vol. 43, pp. 62-67.
- 1917 The number, size and axis-sheath relation of the large myelinated fibers in the peroneal nerve of the inbred albino rat—under normal conditions, in disease and after stimulation. Jour. Comp. Neur., vol. 27, pp. 403-420.
- GREENMAN, M. J. AND DÜHRING, F. L. 1923 Breeding and care of the albino rat for research purposes. Published by The Wistar Institute, Phila., Pa.
- GREGENSEN, J. P. 1911 Untersuchungen über den Phosphorstoffwechsel. Zeit. physiol. Chem., Bd. 71, S. 49-99.
- GRIFFITH, COLEMAN R. 1919 A possible case of instinctive behavior in the white rat. Science, vol. 50, no. 1285, pp. 166-167, August 15th.
- 1920 The behavior of white rats in the presence of cats. Psychobiology, vol. 2, pp. 19-28.
- 1921 An experimental study of equilibration in the white rat. Proc. Am. Psychol. Assoc. in Psychol. Bull., vol. 18, pp. 100-101.
- 1922 Are permanent disturbances of equilibration inherited? Science, vol. 56, no. 1459, December 15th, pp. 676-678.
- GROSS, LOUIS 1923 The effects of vitamin-deficient diets on the adrenaline equilibrium in the body. Biochem. J., vol. 17, pp. 569-578.
- GROSSER, O. 1909 Vergleichende Anatomie und Entwicklungsgeschichte der Eihäute und der Placenta mit besonderer Berücksichtigung des Menschen. Wien und Leipzig.
- GRÜTZNER, P. 1875 Neue Untersuchungen über die Bildung u. Ausscheidung des Pepsins. Breslau. 1878 Ueber Bildung und Ausscheidung von Fermenten. Arch. f. d. ges. Physiol., Bd. 16, S. 105-123. 1894 Zur Physiologie der Darmbewegung. Deutsche med. Wechnschr., Bd. 20, S. 897-898. 1898 Ueber die Bewegung des Darminhaltes. Arch. f. d. ges. Physiol., Bd. 71, S. 492-522. 1905 Ein Beitrag zum Mechanismus der Magenverdauung. Arch. f. d. ges. Physiol., Bd. 106, S. 463-522. (13 text figures.)
- GUDERNATSCH, J. F. 1915 Feeding experiments on rats. Anat. Record, vol. 9, pp. 78-80. In full in Am. J. Physiol., vol. 36, pp. 370-379.
- 1915 a Feeding experiments on rats. III. A further contribution to the knowledge of organs with an internal secretion. Am. J. Physiol., vol. 36, pp. 370-379.
- 1918 Feeding rats on glands of internal secretion. Proc. of Am. Assoc. of Anatomists in Anat. Record, vol. 14, pp. 35-36.
- GUGLIELMO, GIOVANNI 1914 Sul meccanismo di formazione del nucleo anulare dei leucociti polimorfi nel topo e nel ratto. Monitore Zool. Ital., T. 25, pp. 47-49.
- GUEYSSE, A. 1898 Sur quelques points d'anatomie des muscles des appareil respiratoire. J. de l'anat. et physiol., T. 34, pp. 419-432. 5 figs. Rat p. 423.
- GULICK, ADDISON 1922 The influence of a beri-beri diet upon the metabolic rate of the white rat. Proc. Am. Physiol. Soc., in Am. J. of Physiol., vol. 59, pp. 483-481.
- GULLIVER, GEORGE 1839 Observations on the muscular fibers of the oesophagus and heart in some of the Mammalia. Part 1. Proc. Zool. Soc., vol. 7, pp. 124-129. *Mus decumanus*, p. 126. 1842 Observations on the muscular fibers of the oesophagus and heart in some of the Mammalia. Part 2. Proc. Zool. Soc., vol. 10, pp. 63-72. *Mus decumanus*, p. 70. 1875 Observations on the sizes and shapes of the red corpuscles of the blood of vertebrates, with drawings of them to a uniform scale, and extended

- and revised tables of measurements. *Proc. Zool. Soc., London*, pp. 474-494.
- GUTMAN, M. B. AND FRANZ, V. K. 1922 Observations on the inorganic phosphate of blood in experimental rickets of rats. *Proc. of Soc. for Exper. Biol. and Med.*, vol. 19, pp. 171-174.
- HAAECKE V. W. 1895 Ueber Wesen Uraschen, und Vererbung von Albinismus, etc. *Biol. Centralbl.*, Bd. 15.
- HAGAN, WILLIAM A. 1922 The susceptibility of mice and rats to infection with bacillus abortus. *J. of Exper. Med.*, vol. 36, pp. 727-733.
- HAGEDOORN, A. C. AND HAGEDOORN, A. L. 1917 Rats and evolution. *Am. Naturalist*, vol. 51, pp. 385-418.
- HAGEDOORN, A. L. 1911 The interrelation of genetic and non-genetic factors in development. *Verh. d. naturf. Verein Brünn*, vol. 49, pp. 1-18.
- HAGEDOORN, A. L. AND HAGEDOORN, A. C. 1914 Studies on variation and selection. *Ztschr. f. indukt. Abstammungs u. Vererbungsl.*, vol. 11, pp. 145-183.
- 1922 Species crosses in rats. *Ztschr. für Induktive, Abstammungs und Vererbungslehre*, Bd. 29, pp. 97-121.
- HAGUE, FLORENCE S. 1914 Numerical relation of spermatozoa to Sertoli cells. *Kansas Univ. Science Bull.* vol. 9, no. 11, pp. 131-139. Whole series vol. 19, no. 11.
- HALDEMAN, K. O. 1921 The method of opening of the vagina in the rat. *Proc. of Am. Assoc. of Anat. in Anat. Record*, vol. 21, p. 60.
- HALE, WORTH 1923 The rôle of bread in nutrition. *Industrial and Engineering Chemistry*, vol. 15, pp. 1221-1224.
- HALL, MAURICE C. 1916 Nematode parasites of mammals of the orders rodentia, lagomorpha, and hyracoidea. *Proc. of the U. S. Nat. Museum*, vol. 50, pp. 1-258.
- HALLER, B. 1910 Zur Ontogenie der Grosshirnrinde der Säugetiere. *Anat. Anz.*, Bd. 37, S. 282-293. 4 figures. *Rat*, p. 285.
- HALLIBURTON, W. D. 1888 On the haemoglobin crystals of rodents' blood. *Quart. J. Microscop. Science*, vol. 28, pp. 181-199. *Rat*, pp. 192, 193, 194.
- HALLIBURTON, W. D. AND DRUMMOND, J. C. 1917 The nutritive value of margarines and butter substitutes with reference to their content of the fat-soluble accessory growth substance. *J. of Physiol.*, vol. 51 pp. 235-251.
- HALLIBURTON, W. D., DRUMMOND, J. C. AND CANNAN, R. K. 1919 The direct replacement of glycerol in fats by higher polyhydric alcohols. Part II. The value of synthetic mannitol olive oil as a food. *Biochem. J.*, vol. 13, pp. 301-305.
- HAMILTON, ALICE 1901 The division of differentiated cells in the central nervous system of the white rat. *J. Comp. Neur.*, vol. 11, pp. 297-320.
- HAMILTON, G. V. 1916 A study of perseverance reactions in primates and rodents. *Behavior Monographs*, vol. 3, no. 2, serial number 13, Johns Hopkins Univ.
- HAMMAR, J. A. 1895 Zur Kenntniss des Fettgewebes. *Arch. f. Mikr. Anat.*, Bd. 45, S. 512-574.
- HAMMETT, F. S. 1918 The effect of the maternal ingestion of desiccated placenta upon the rate of growth of breast-fed infants. *J. of Biol. Chem.*, vol. 36, pp. 569-573.
- 1921 Changes in the endocrine glands of a tumor-bearing female albino rat. *Endocrinology*, vol. 5, pp. 216-220.
- 1921 a The duodenal segment of the albino rat as a standard reagent for the study of tissue extracts and other substances. *Am. J. Physiol.*, vol. 55, pp. 404-413.
- 1921 b The intestinal mechanism primarily stimulated by sodium carbonate (albino rat). *Am. J. Physiol.*, vol. 55, pp. 414-421.
- 1921 c Studies of the thyroid apparatus. I. The stability of the nervous system as a factor in the resistance of the albino rat to the loss of the parathyroid secretion. *Am. J. Physiol.*, vol. 56, pp. 196-204.
- 1921 d Studies of the thyroid apparatus. III. The action of thyroxin on the isolated intestinal segment. *Am. J. Physiol.*, vol. 56, pp. 386-389.
- 1921 e Studies of the thyroid apparatus. IV. The influence of parathyroid and thyroid tissue on the creatinine-creatinine balance in incubated extracts of muscle tissue of the albino rat. *J. of Biol. Chem.*, vol. 48, pp. 143-152.
- 1921 f Creatinine and creatine in muscle extracts. II. The influence of the reaction of the medium on the creatinine-creatinine balance in incubated extracts of muscle tissue of the albino rat. *J. of Biol. Chem.*, vol. 48, pp. 133-141.
- 1921 g Temperament and bodily constitution. *J. of Comp. Psychol.*, vol. 1, pp. 489-494.
- HAMMETT, F. S. AND TOKUDA, K. 1921 Studies of the thyroid apparatus. II. The changes in the amount of intestine-contracting substances of the thyroid of the albino rat according to age. *Am. J. of Physiol.*, vol. 56, pp. 380-385.
- HAMMETT, F. S. AND NOWREY, J. E. 1922 The erythropoietic action of germanium dioxide. II. The source of the erythrocythemia produced by germanium dioxide in the albino rat. *J. of Exper. Med.*, vol. 35, pp. 507-513.
- 1922 a The rôle of the sodium and the carbonate ions and of the change in the sodium-calcium ratio in the contraction of the isolated duodenal segment of the albino rat. *Am. J. Physiol.*, vol. 60, pp. 48-51.



- 1922 b Changes with advancing age in the resistance of the albino rat to arsenic. *J. of Pharmacol. and Exper. Therapeutics*, vol. 19, pp. 331-335.
- HAMMETT, F. S., NOWREY, J. E. AND MÜLLER, J. H. 1922 The erythropoietic action of germanium dioxide. *Jour. Exper. Med.*, vol. 35, pp. 173-180.
- 1922 a The relative toxicity of germanium and arsenic for the albino rat. *J. of Pharmacol. and Exper. Therapeutics* vol. 19, pp. 337-342.
- HAMMETT, F. S. AND TELLER, IDA 1922 Changes in the refractive index of the blood serum of the albino rat with temperature. *J. of Biol. Chem.*, vol. 50, pp. 47-54.
- HAMMETT, FREDERICK S. 1922 The rôle of the change in hydrogen-ion concentration in the motor activities of the small intestine. *Am. J. Physiol.*, vol. 60, pp. 52-58.
- 1922 a Creatinine and creatine in muscle extracts. III. Concerning the presence of enzymes in muscle tissue which have creatine and creatinine as their substrates. *J. of Biol. Chem.*, vol. 53, pp. 323-337.
- 1922 b Studies of the thyroid apparatus. V. The significance of the comparative mortality rates of parathyroidectomized wild Norway rats and excitable and non-excitable albino rats. *Endocrinology*, vol. 6, pp. 221-229.
- 1922 c Studies of the thyroid apparatus. VI. The response of the submaxillary glands of the albino rat to thyroparathyroidectomy and to parathyroidectomy. *Am. Jour. Anat.*, vol. 31, pp. 103-107.
- 1922 d Studies of the thyroid apparatus. VII. A differential effect of thyroparathyroidectomy and parathyroidectomy on the incisor teeth of the albino rat. *Am. J. of Physiol.*, vol. 62, pp. 197-220.
- 1922 e Studies of the thyroid apparatus. VIII. On the alleged exogenous source of the poisons giving rise to tetania parathyreopriva. *Am. J. of Physiol.*, vol. 63, pp. 151-154.
- 1922 f Studies of the thyroid apparatus. XI. The effect of thyroparathyroidectomy on reproduction in the albino rat. *J. of Metabolic Research*, vol. 2, pp. 417-427.
- 1923 Studies of the thyroid apparatus. IX. The effects of the loss of the thyroid and parathyroid glands at 100 days of age on the growth in body length, body weight and tail length of male and female albino rats. *Am. J. of Physiol.*, vol. 63, pp. 218-244.
- 1923 a Creatinine and creatine in muscle extracts. IV. Concerning the formation of creatine from methyl guanidine in muscle. *J. of Biol. Chem.*, vol. 55, p. 323.
- 1923 b Studies of the thyroid apparatus. X. The refractive index and water content of the blood serum of male and female albino rats thyroparathyroidectomized and parathyroidectomized at 100 days of age. *Am. J. of Physiol.*, vol. 64, pp. 467-480.
- 1923 e Studies of the thyroid apparatus. XII. The effect of thyroparathyroidectomy and parathyroidectomy at one hundred days of age on the growth of the brain and spinal cord of male and female albino rats. *Jour. Comp. Neur.*, vol. 35, pp. 313-335.
- 1923 d Studies of the thyroid apparatus. XIII. The effects of thyroparathyroidectomy and parathyroidectomy at 100 days of age on the growth of the reproductive system of male and female albino rats. *Am. Jour. Anat.*, vol. 32, pp. 37-51.
- 1923 e Studies of the thyroid apparatus. XIV. The effects of thyroparathyroidectomy and parathyroidectomy at 100 days of age on the growth of the glands of internal secretion of male and female albino rats. *Am. Jour. Anat.*, vol. 32, pp. 53-74.
- 1923 f Studies of the thyroid apparatus. XV. The growth of the heart, lungs, liver, kidneys, spleen, submaxillary glands and eyeballs in male and female albino rats thyroparathyroidectomized and parathyroidectomized when 100 days of age. *Am. Jour. Anat.*, vol. 32, pp. 75-94.
- 1923 g Studies of the thyroid apparatus. XVII. The effect of thyroparathyroidectomy and parathyroidectomy at 100 days of age on the Ca, Mg, and P content of the ash of the humerus and femur of male and female albino rats. *J. of Biol. Chem.*, vol. 57, pp. 285-303.
- 1923 h Studies of the thyroid apparatus. XVIII. The differential development of the albino rat from 100 to 150 days of age and the influence of thyroparathyroidectomy and parathyroidectomy thereon. *Am. J. of Physiol.*, vol. 67, pp. 29-47.
- 1923 i The thyroid gland and development. *J. of Heredity*, vol. 14, pp. 291-296.
- HAMMETT, F. S. AND JUSTICE, ELIZABETH S. 1923 The geometrical symmetry of growth of the upper incisors of the albino rat. *Anat. Rec.*, vol. 26, pp. 141-144.
- HAMMETT, F. S. 1924 Studies of the thyroid apparatus. XIX. The effects of the loss of the thyroid and parathyroid glands at 75 days of age on the gross growth of the albino rat. *Am. J. of Physiol.*, vol. 68, pp. 1-23.
- 1924 a Studies of the thyroid apparatus. XVI. The growth of the humerus and femur of male and female albino rats thyroparathyroidectomized and parathyroidectomized when 100 days of age. *Jour. Exp. Zool.*, vol. 39, pp. 465-501.
- 1924 b Creatinine and creatine in muscle extracts. V. A comparison of the rate of creatinine formation from creatine in extracts of brain and muscle tissue. *J. of Biol. Chem.*, vol. 59, pp. 347-351.
- 1924 c Studies of the thyroid apparatus. XX. The effect of thyroparathyroidectomy and parathyroidectomy at seventy-five days of age on the growth of the brain and spinal cord of male and female albino rats. *Jour. Comp. Neur.*, vol. 37.

- HAMM, E. T. 1906 Sur la variété nègre du *Mus decumanus* observée au Muséum de Paris. *Bull. du Mus. d'hist. nat.*, T. 12, pp. 87-89.
- HANCOCK, ROBERT T. 1917 The fixation of mammalian chromosomes. *Anat. Record*, vol. 12, pp. 371-387, p. 380—Cat, rat, guinea-pig, pig, rabbit, bat and mouse.
- HANSEMANN, DAVID 1895 Ueber die Poren der normalen Lungenalveolen. *Sitz. d. Preuss. Akad. d. Wiss.*, pp. 999-1001 1 plate. Also *Math. u. naturw. Mitt. d. k. Preuss. Akad. d. Wiss.*, Bd. 9, S. 451-454
- HANSEMANN, VON 1901 Ueber abnorme Rattenschädel. *Arch. Anat. Physiol. physiol. Abt.*
- HANSON, FRANK B. 1923 The effects of X-rays on the albino rat. *Proc. of Am. Soc. of Zool. in Anat. Record*, vol. 24, p. 415.  
1923 a Modifications in the albino rat following treatment with alcohol fumes and X-rays; and the problem of their inheritance. *Proc. of Am. Philos. Soc.*, vol. 62, pp. 301-310.
- HANSON, FRANK B., AND HANDY, VIRGINIA 1923 The effects of alcohol fumes on the albino rat: introduction and sterility data for the first treated generation. *Am. Naturalist*, vol. 57, pp. 532-544.
- HANSON, FRANK B. AND STEWART, DOROTHY R. 1923 A study of albino rats carrying factors for agouti and the hooded pattern. *Washington Univ. Studies*, vol. 11, pp. 71-88.
- HANSON, SAMUEL 1921 On the rapidity of absorption of colloidal gold from the peritoneal cavity. *Proc. of Am. Assoc. of Anatomists in Anat. Record*, vol. 21, pp. 65-66.
- HAPP, WILLIAM M. 1922 Occurrence of anemia in rats on deficient diets. *Johns Hopkins Hosp. Bull.*, vol. 33, pp. 163-172.
- HARDEN, A. AND ZILVA, S. S. 1915 Accessory factors in the nutrition of the rat. *Biochem. J.*, vol. 12, p. 408.
- HARLAN, RICHARD 1825 *Fauna Americana*. Being a description of the mammiferous animals inhabiting North America—Philadelphia. p.148—*M. Rattus*—description.
- HARLEY, GEORGE 1857 Report on meeting of the Pathological Society. November 28, 1857, giving report of Dr. Harley on "Rats from which the suprarenal capsules had been removed." *Med. Times and Gaz.*, N. S., vol. 15 (O. S., vol. 36), pp. 564-565.  
1858 Living specimen of a rat from which both the suprarenal capsules and the spleen had been removed. *Tr. Path. Soc. Lond.*, vol. 9, p. 401.  
1858 a An experimental inquiry into the function of the suprarenal capsules, and their supposed connection with bronzed skin (in 2 parts). *Brit. and For. M.-Chir. Rev.*, vol. 21, pp. 204-221; 498-510.  
1858 b Diseased suprarenal capsule, removal by operation from an apparently healthy animal. *Tr. Path. Soc., Lond.*, vol. 9, pp. 401-402. (This volume is a report of the season of 1857-58.)
- HART, E. B. AND MCCOLLUM, E. V. 1913 The influence of restricted rations on growth. *Proc. Soc. Biol. Chemists*, vol. 3, pp. 38-39.  
1914 Influence on growth of rations restricted to the corn or wheat grain. *J. Biol. Chem.*, vol. 19, pp. 373-395.
- HART, E. B., NELSON, V. E. AND PITZ, W. 1918 Synthetic capacity of the mammary gland. I. Can this gland synthesize lysine? *J. Biol. Chem.*, vol. 36, pp. 291-307.
- HART, E. B. AND STEENBOCK, H. 1919 Maintenance and reproduction with grains and grain products as the sole dietary. *J. Biol. Chem.*, vol. 39, pp. 209-233.
- HARTWELL, G. A. 1921 The effect of diet on mammary secretion. *Biochem. J.*, vol. 15, pp. 140-162.  
1921 a Excess protein and mammary secretion. *Biochem. J.*, vol. 15, pp. 563-574.  
1922 Mammary secretion III. 1. The quality and quantity of dietary protein. 2. The relation of protein to other dietary constituents. *Biochem. J.*, vol. 16, pp. 78-105.  
1923 Note on the colour changes in rats' fur produced by alterations in diet. *Biochem. J.*, vol. 17, pp. 547-548.
- HARTWELL, G. A., MOTTRAM, E. C. AND MOTTRAM, V. H. 1923 The technique of breeding rats for feeding experiments. *Biochem. J.*, vol. 17, pp. 208-215.
- HARZ, W. 1883 Beiträge zur Histologie des Ovariums der Säugetiere. *Arch. f. mikr. Anat.*, Bd. 22, S. 374-407.
- HASHIMOTO, H. 1921 The heart in the experimental hyperthyroidism with special reference to its histology. *Endocrinology*, vol. 5, pp. 579-606.  
1922 The secretory action of the pancreas in relation to the thyroid gland. I. The effect of thyroid feeding in rats upon the secretory action of the pancreas. *Am. J. Physiol.*, vol. 60, pp. 357-364.  
1922 a The secretory action of the pancreas in relation to the thyroid gland. II. The effect of thyroidectomy in rats upon the secretory action of the pancreas. *Am. J. Physiol.*, vol. 60, pp. 365-370.
- HATAI, S. 1901 The finer structure of the spinal ganglion cells in the white rat. *J. Comp. Neur.*, vol. 11, pp. 1-24.  
1901 a On the presence of the centrosome in certain nerve cells of the white rat. *J. Comp. Neur.*, vol. 11, pp. 25-39.  
1902 Number and size of the spinal ganglion cells and dorsal root fibers in the white rat at different ages. *J. Comp. Neur.*, vol. 12, pp. 107-124.  
1902 a Preliminary note on the presence of a new group of neurones in the dorsal roots of the spinal nerves of the white rat. *Biol. Bull.*, vol. 3, pp. 140-142.

- 1902 b On the origin of neuroglia tissue from the mesoblast. *J. Comp. Neur.*, vol. 12, pp. 291-296.
- 1903 The finer structure of the neurones in the nervous system of the white rat. Decennial Pub., Univ. of Chicago, vol. 10, pp. 3-14.
- 1903 a The effect of lecithin on the growth of the white rat. *Am. J. Physiol.*, vol. 10, pp. 57-66.
- 1903 b On the increase in the number of medullated nerve fibers in the ventral roots of the spinal nerves of the growing white rat. *J. Comp. Neur.*, vol. 13, pp. 177-183.
- 1903 c On the nature of the pericellular network of nerve cells. *J. Comp. Neurol.*, vol. 13, pp. 139-147.
- 1903 d The neurokeratin in the medullary sheaths of the peripheral nerves of mammals. *J. Comp. Neurol.*, vol. 13, pp. 149-156.
- 1904 A note on the significance of the form and contents of the nucleus in the spinal ganglion cells of the foetal rat. *J. Comp. Neur. and Psychol.*, vol. 14, pp. 27-48.
- 1904 a The effect of partial starvation on the brain of the white rat. *Am. J. Physiol.*, vol. 12, pp. 116-127.
- 1905 The excretion of nitrogen by the white rat as affected by age and body weight. *Am. J. Physiol.*, vol. 11, pp. 120-132.
- 1907 On the zoological position of the albino rat. *Biol. Bull.*, vol. 12, pp. 266-273.
- 1907 a Effect of partial starvation followed by a return to normal diet, on the growth of the body and central nervous system of albino rats. *Am. J. Physiol.*, vol. 18, pp. 309-320.
- 1907 b A study of the diameters of the cells and nuclei in the second cervical spinal ganglion of the adult albino rat. *J. Comp. Neur. and Psychol.*, vol. 17, pp. 469-491.
- 1907 c Studies on the variation and correlation of skull measurements in both sexes of mature albino rats (*Mus norvegicus* var. *albus*). *Am. J. Anat.*, vol. 7, pp. 423-441.
- 1908 Preliminary note on the size and condition of the central nervous system in albino rats experimentally stunted. *J. Comp. Neur. and Psychol.*, vol. 18, pp. 151-155.
- 1909 A comparison of the albino with the gray rats in respect to the weight of the brain and spinal cord. *Proc. of Assoc. of Am. Anat. in Anat. Record*, vol. 3, p. 245.
- 1909 a Note on the formulas used for calculating the weight of the brain in the albino rats. *J. Comp. Neur. and Psychol.*, vol. 19, pp. 169-173.
- 1910 A mathematical treatment of some biological problems. *Biol. Bull.*, vol. 18, pp. 126-130.
- 1910 a DeForest's formula for "An unsymmetrical probability curve." *Anat. Record*, vol. 4, pp. 281-290.
- 1911 An interpretation of growth curves from a dynamical standpoint. *Anat. Record*, vol. 5, pp. 373-382.
- 1911 a The Mendelian ratio and blended inheritance. *Am. Naturalist*, vol. 45, pp. 99-106.
- 1912 On the appearance of albino mutants in litters of the common Norway rat, *Mus norvegicus*. *Science*, n.s. vol. 35, no. 909, pp. 875-876, May 31.
- 1913 On the weights of the abdominal and the thoracic viscera, the sex glands, ductless glands and the eyeballs of the albino rat (*Mus norvegicus albinus*) according to body weight. *Am. J. Anat.*, vol. 15, pp. 87-119.
- 1913 a The effect of castration, spaying or semi-spaying on the weight of the central nervous system and of the hypophysis of the albino rat; also the effect of semi-spaying on the remaining ovary. *J. Exper. Zool.*, vol. 15, pp. 297-314.
- 1914 On the weight of the thymus gland of the albino rat (*Mus norvegicus albinus*) according to age. *Am. J. Anat.*, vol. 16, pp. 251-257.
- 1914 a On the weight of some of the ductless glands of the Norway and of the albino rat according to sex and variety. *Anat. Record*, vol. 8, pp. 511-523.
- 1915 The growth of organs in the albino rat as affected by gonadectomy. *J. Exper. Zool.*, vol. 18, pp. 1-67.
- 1915 a Growth of the body and organs in albino rats fed with a lipid-free ration. *Anat. Record*, vol. 9, pp. 1-20.
- 1915 b On the influence of exercise on the growth of organs in the albino rat. *Anat. Record*, vol. 9, pp. 647-665.
- 1915 c On the brain weights of rats descended from the cross between the wild Norway (*Mus norvegicus*) and the domesticated albino (*Mus norvegicus albinus*). *Jour. Comp. Neur.*, vol. 25, pp. 555-566.
- 1917 Changes in the composition of the entire body of the albino rat during the life span. *Am. J. Anatomy*, vol. 21, pp. 23-37.
- 1917 a Metabolic activity of the nervous system. I. The amount of non-protein nitrogen in the central nervous system of the normal albino rat. *Jour. Comp. Neur.*, vol. 28, pp. 361-378.
- 1917 b On the condition of the albino rats on East Key and Garden Key in the Dry Tortugas. Year Book No. 16 of the Carnegie Institution of Washington, pp. 179-182.
- 1918 On the weight of the epididymus, pancreas, stomach, and of the submaxillary glands of the albino rat (*Mus norvegicus albinus*) according to body weight. *Am. Jour. Anat.*, vol. 24, pp. 71-89.
- 1918 a On several effects of feeding small quantities of Sudan III to young albino rats. *Jour. Exp. Zool.*, vol. 26, pp. 101-117.
- 1918 b The refractive index of the blood serum of the albino rat at different ages. *J. Biol. Chem.*, vol. 35, pp. 527-552.
- HATAI, S. AND HAMMETT, F. S. 1920 Four factors causing changes in the type of response of the isolated intestinal segment of the albino rat (*Mus*

- norvegicus albinus) to sodium carbonate. *Am. J. Physiol.*, vol. 53, pp. 312-322.
- HATCHER, ROBERT A. 1909 The absorption, excretion, and destruction of strophanthin. *Am. J. Physiol.*, vol. 23, pp. 303-323.
- HAWK, P. B., FISHBACK, H. R. AND BERGEIM, O. 1919 Compressed yeast as food for the growing organism. *Am. J. Physiol.*, vol. 48, pp. 211-220.
- HAWK, P. B., SMITH, C. A. AND BERGEIM, O. 1921 The vitamin content of honey and honey comb. *Am. J. Physiol.*, vol. 55, pp. 339-348.
- 1921 a The nutritive value of yeast in bread. *Am. J. Physiol.*, vol. 56, pp. 33-39.
- 1921 b The addition of yeast to a milk diet. *Proc. of the Soc. for Exper. Biol. and Med.*, 114th meeting, March 16, vol. 18, p. 168.
- HAWK, P. B. 1923 The value of gelatine and gelatine preparations in the diet of man. *Proc. of the Soc. for Exper. Biol. and Med.*, vol. 20, pp. 269-270.
- HEAPE, WALTER 1900 The "sexual season" of mammals and the relation of the "pro-oestrus" to menstruation. *Quart. J. Micr. Science*, vol. 44, pp. 1-70.
- HEGNER, R. W. 1923 The effects of changes in diet on the incidence, distribution and numbers of certain intestinal protozoa of rats. *Am. J. of Hygiene*, vol. 3, p. 180.
- HEHN, VIKTOR 1911 Kulturpflanzen und Haustiere in ihrem Uebergang aus Asien nach Griechenland und Italien sowie in das übrige Europa. Achte auflage. Historisch-linguistische Skizzen, Berlin, Gebrüder Borntraeger.
- HEKTOEN, LUDVIG 1914 The formation of antibodies in rats fed on pure vegetable proteins. *J. Infect. Disease*, vol. 15, p. 279.
- 1916 Observations on pulmonary infection in rats. *Trans. of the Chicago Pathol. Soc.*, October, pp. 105-108.
- HELLD, H. 1890 Der Ursprung des tiefen Markes der Vierhügelregion. *Neurol. Centralbl.*, Bd. 9, S. 481-483.
- HELLER, V. G. 1923 Studies on yeast. V. The vitamin B content of yeast. *J. of Biol. Chem.*, vol. 55, pp. 385-398.
- HELLY, KONRAD 1901 Zur Pankreasentwicklung der Säugethiere. *Archiv für Mikr. Anat.*, Bd. 57, S. 271-335.
- 1902 Haemolymphdrüsen. *Ergebn. d. Anat. u. Entw.-Gesch.*, Bd. 12, p. 207.
- HENN, SAMUEL CHESTER 1920 The effect of splenectomy upon growth in the young. *Am. J. Physiol.*, vol. 52, pp. 562-580.
- HENNEBERG, B. 1899 Die erste Entwicklung der Mammarorgane bei der Ratte. *Anat. Hefte*, Wiesb., Bd. 13, S. 1-68.
- 1900 Verhalten der Umbilicalarterien bei den Embryonen von Ratte und Maus. *Anat. Anz.*, Bd. 17, S. 321-324.
- 1905 Beitrag zur Kenntnis der lateralen Schilddrüsenanlage. *Anat. Hefte*, Bd. 28, S. 287-302.
- 1908 Beiträge zur Entwicklung der Ohrmuschel. *Anat. Hefte*, Bd. 36, S. 109-187.
- 1910 Über die Bedeutung der Ohrmuschel. *Anat. Hefte*, Bd. 40, S. 95-147.
- 1914 Beitrag zur Entwicklung der äusseren genitalorgane beim Säugetier. Erster Teil. *Anat. Hefte*, Bd. 50, S. 425-498.
- HERMANIDES, S. R. AND KÖPPEN, M. 1903 Über die Furchen und über den Bau der Grosshirnrinde bei den Säugethieren insbesondere über Lokalisation des motorischen Centrums und der Schregion. *Archiv für Psychiatric und Nervenkrankh.* Bd. 37, S. 616-634.
- HERON, WILLIAM T. 1922 Studies of the reliability of the problem box and the maze with human and animal subjects. I. The reliability of the inclined plane problem box as a method of measuring the learning ability of the rat. *Comp. Psychol. Monographs*, vol. 1, serial no. 1.
- HERRING, P. T. 1917 The effect of thyroid feeding on the weight of the suprarenals and on their adrenalin content. *Quart. J. Exper. Physiol.*, vol. 11, pp. 47-57.
- 1917 a The action of thyroid upon the growth of the body and organs of the white rat. *Quart. J. Exper. Physiol.*, vol. 11, pp. 231-253.
- 1919 The adrenalin content of the suprarenals of the female white rat, and the changes brought about by thyroid feeding and other conditions. *Quart. J. Exper. Physiol.*, vol. 12, pp. 115-123.
- 1920 The effect of pregnancy upon the size and weight of some of the organs of the body. *Brit. Med. J.*, vol. 2, Dec. 11th, page 886.
- HERZOG, MAXIMILLAN 1905 Zur Frage der Pestverbreitung durch Insecten. Eine neue Species von Rattenfloh. *Zeitschr. Hyg. Infektionskrankh.*, Bd. 51, S. 268-282.
- HESS, A. F., McCANN, G. F. AND PAPPENHEIMER, A. M. 1921 Experimental rickets in rats. II. The failure of rats to develop rickets on a diet deficient in vitamin A. *J. Biol. Chem.*, vol. 47, pp. 395-409.
- HESS, ALFRED F., UNGER, L. J. AND PAPPENHEIMER, A. M. 1922 Spontaneous cure of rickets in rats. *Proc. of Soc. for Exper. Biol. and Med.*, vol. 19, pp. 236-238.
- 1922 b Experimental rickets in rats. III. The prevention of rickets in rats by exposure to sunlight. *J. of Biol. Chem.*, vol. 50, pp. 77-82.
- 1922 c Experimental rickets in rats. VII. The prevention of rickets by sunlight, by the rays of the mercury vapor lamp, and by the carbon arc lamp. *J. of Exp. Med.*, vol. 36, pp. 427-446.

- HESS, ALFRED F., UNGER, L. J. AND STEINER, J. M. 1922 Experimental rickets in rats. VIII. The effect of roentgen rays. *J. of Exper. Med.*, vol. 36, pp. 447-452.
- HESS, A. F., PAPPENHEIMER, A. M. AND WEINSTOCK, M. 1922 A study of light waves in relation to their protective action in rickets. *Proc. of the Soc. for Exper. Biol. and Med.*, vol. 20, pp. 14-16.
- HESS, ALFRED F. 1922 The influence of light in the prevention and cure of rickets. *Lancet*, vol. 2, p. 367.
- 1922 a Newer aspects of the rickets problem. *Jour. Am. Med. Assoc.*, vol. 78, p. 1177.
- HESS, A. F. AND UNGER, L. J. 1922 Use of the carbon arc light in the prevention and cure of rickets. *J. Am. Med. Assoc.*, vol. 78, p. 1596.
- HESS, A. F. AND WEINSTOCK, MILDRED 1923 A study of light waves in their relation to rickets. *J. of Am. Med. Assoc.*, vol. 80, pp. 687-690.
- HESS, A. F., WEINSTOCK, M. AND TOLSTOI, E. 1923 The influence of the diet during the pre-experimental period on the susceptibility of rats to rickets. *J. of Biol. Chem.*, vol. 57, pp. 731-740.
- HESS, A. F. 1923 The therapeutic value of egg yolk in rickets. *Proc. of the Soc. for Exper. Biol. and Med.*, vol. 20, pp. 369-370. Also *J. of Am. Med. Assoc.*, vol. 81, pp. 15-17.
- HEUSER, CHESTER H. 1914 The form of the stomach in mammalian embryos. *Proc. Am. Assoc. of Anatomists in Anat. Record*, vol. 8, no. 2.
- HEWER, EVELYN E. 1914 The effect of thymus feeding on the activity of the reproductive organs in the rat. *J. Physiol.*, vol. 47, pp. 479-490.
- 1916 The structure of the thymus gland and of the reproductive organs in white rats, together with some observations on the breeding capacity of these animals. *J. Physiol.*, vol. 50, pp. 434-437.
- 1916 a The direct and indirect effects of X-rays on the thymus gland and reproductive organs of white rats. *J. Physiol.*, vol. 50, pp. 438-458.
- HEWETT, G. M. A. 1904 The rat. Adam and Charles Black. London.
- HEWITT, J. A. 1914 The influence on metabolism of administration of small amounts of thyroid gland and of anterior lobe of pituitary. *Quart. J. Exper. Physiol.*, vol. 8, pp. 113-123.
- 1914 a The influence on metabolism of administration of small amounts of thyroid gland and of posterior lobe of pituitary. *Quart. J. of Exper. Physiol.*, vol. 8, pp. 297-302.
- 1920 The effect of administration of small amounts of thyroid gland on the size and weights of certain organs in the male white rat. *Quart. J. Exper. Physiol.*, vol. 12, pp. 347-354.
- HEYMANN, FELIX 1904 Zur Einwirkung der Castration auf den Phosphorgehalt des weiblichen Organismus. *Arch. Gynäkol.*, Bd. 73, S. 366-405. Also *Zeit. physiol., Chem.*, Bd. 41, S. 246-258.
- HILARIO, JOSÉ S. 1915 Castration exerts no influence upon the growth of transplanted or spontaneous tumors in mice and rats. *J. of Exper. Med.*, vol. 22, pp. 158-173.
- HILDEBRANDT, F. 1922 Ueber Veränderungen des Stoffwechsels nach chronischer Morphinzufuhr. *Arch. exp. Path. Pharm.*, Bd. 92, S. 68-95. Abstracted in *Physiol. Abstracts*, vol. 7, p. 247.
- HILL, A. M. 1913 The effects of high external temperatures on the metabolism of rats. *J. Physiol.*, vol. 46, pp. xxxi-xxxii.
- HILL, A. V. AND HILL, A. M. 1913 Calorimetric experiments on warm-blooded animals. *J. Physiol.*, vol. 46, pp. 81-103.
- HILL, LEONARD AND MACLEOD, J. J. R. 1903 The influence of compressed air on the respiratory exchange. *J. Physiol.*, vol. 29, pp. 492-510.
- HILTON, WILLIAM A. 1902 The morphology and development of intestinal folds and villi in vertebrates. *Am. J. of Anat.*, vol. 1, pp. 459-504.
- HIRSCHFELDER, A. D., HART, M. C. AND KÜCCERA, F. J. 1920 Mercury saligenin, a new antiseptic. *Proc. of the Soc., for Exper. Biol. and Med.*, vol. 18, pp. 76-77.
- HOAG, LYNNE A. 1918 Histology of the sensory root of the trigeminal nerve of the rat (*Mus norvegicus*). *Anat. Rec.*, vol. 14, pp. 165-182.
- HOAGLAND, RALPH 1922 A self-feeder for rats. *J. of Lab. and Clin. Med.*, vol. 7, pp. 687-689.
- HÖBER, RUDOLF 1911 *Physikalische Chemie der Zelle und der Gewebe*. Wilhelm Engelmann. Leipzig. 3rd Ed., p. 254. *Analysen der Plasmahautstruktur bei den Blutkörperchen*.
- HOFFMAN, CHARLES 1923 Reproduction of animals on an exclusive diet of bread. *Industrial and Engineering Chemistry*, vol. 15, pp. 1225-1232.
- HOFMEISTER, FRANZ 1922 Studien über die qualitative Unterernährung. I. Mitteilung. Die Rattenberiberi. *Biochem. Zeitschr.*, Bd. 128, S. 540-556.
- 1922 a Studien über qualitative Unterernährung. II. Mitteilung. Der experimentelle Nachweis des Antineuritins. *Biochem. Zeitschr.*, Bd. 129, S. 477-486.
- HOGAN, ALBERT G. 1916 The nutritive properties of corn. *J. Biol. Chem.*, vol. 27, pp. 193-208.
- 1917 Corn as a source of protein and ash for growing animals. *J. Biol. Chem.*, vol. 29, pp. 485-493.
- 1917 a The effect of high temperatures on the nutritive value of foods. *J. Biol. Chem.*, vol. 30, pp. 115-123.
- 1918 The nutritive properties of kafrin. *J. Biol. Chem.*, vol. 33, pp. 151-159.
- HOHLBAUM, JOS. 1912 Beiträge zur Kenntnis der Epithelkörperchenfunktionen. *Beitr. z. path. Anat. u. z. allg. Path.*, Bd. 53, S. 91-104.
- HOFMEIER, F. 1901 Ueber Aenderungen der Fermentmengen im Mageninhalt. *Inaug.-Diss. Tübingen*.

- HOLLISTER, N. 1916 The generic names *Epimys* and *Rattus*. Proc. of the Biol. Soc. of Wash., vol. 29, pp. 125-128.  
1916 a The type species of *Rattus*. Proc. of the Biol. Soc. of Wash., vol. 29, pp. 205-208.
- HOLLMANN, HARRY T. 1912 The cultivation of an acid-fast bacillus from a rat suffering with rat leprosy (a preliminary report) Pub. health rep. U. S. Mar. Hosp. Serv., vol. 27, part 1, pp. 69-70.
- HOLT, CAROLINE M. 1917 Studies on the olfactory bulbs of the albino rat—in two parts. I. Effect of a defective diet and of exercise. II. Number of cells in bulb. Jour. Comp. Neur., vol. 27, pp. 201-259.
- HOME, SIR EVERED 1807 Observations on the structure of the stomach of different animals. Phil. Trans. Roy. Soc., part 1, Plates V-XIII, p. 150. The common rat.
- HOMMA, EHISHI 1921 Pathologische und biologische Untersuchungen über die Eosinophilzellen und die Eosinophilie. Archiv für Pathol. Anat. u. Physiol. u. für klin. Med., Bd. 233, S. 11-51. Rat—S. 14 and 24.
- HÖNIGSCHMIED, JOH. 1873 Beiträge zur mikroskopischen Anatomie über die Geschmacksorgane der Säugethiere. Zeitschr. f. wiss. Zool., Bd. 23, S. 414-434.
- HOPKINS, F. G. 1912 Feeding experiments illustrating the importance of accessory factors in normal dietaries. J. Physiol., vol. 44, pp. 425-460.
- HOPKINS, F. G. AND NEVILLE, ALLEN 1913 A note concerning the influence of diets upon growth. Biochem. J., vol. 7, pp. 97-99.
- HOPKINS, F. G., AND CHICK, H. 1919 Accessory factors in food. Lancet, vol. 2, p. 28.
- HOPKINS, F. G. 1920 Note on the vitamine content of milk. Biochem. J., vol. 14, pp. 721-724.  
1920 a The effects of heat and aeration upon the fat-soluble vitamine. Biochem. J., vol. 14, pp. 725-739.
- HOPKINS, F. G. AND DIXON, M. 1922 On glutathione. II. A thermostable oxidation-reduction system. J. of Biol. Chem., vol. 54, pp. 527-563.
- HOPWOOD, A. T. 1922 An interesting case of *Cysticercus fasciolaris* infesting the brown rat. Parasitology, vol. 14, p. 14.
- HORTON, JESSIE M. 1905 The anthracidal substance in the serum of white rats. J. of Infect. Dis., vol. 3, pp. 110-115.
- HOSHIMOTO, II. 1920 The influence of thyroid feeding upon the physiological action of the pancreas. Endocrinology, vol. 4, pp. 56-62.
- HOSKINS, E. R. 1916 The growth of the body and organs of the albino rat a affected by feeding various ductless glands (thyroid, thymus, hypophysis and pineal). J. Exper. Zool., vol. 21, pp. 295-346.
- HOSKINS, MARGARET M. 1923 The histology of the parathyroid gland of the albino rat. Proc. Am. Assoc. of Anatomists in Anat. Record, vol. 25, pp. 134-135.
- HOSKINS, R. G. AND HOSKINS, AUGUSTA D. 1916 The effects of suprarenal feeding on the white rat. Am. J. Physiol., vol. 40, pp. 147-148.
- HOSSACK, W. C. 1906 Preliminary note on the rats of Calcutta. Journ. Proc. Asiat. Soc., Bengal, vol. 2, pp. 183-186.  
1907 An account of the rats of Calcutta. Mem. Ind. Museum, vol. 1, no. 1. Pl. I-VIII. Elaborate tables of measurements—very complete. Several colored plates.  
1907 a Aids to the identification of rats connected with plague in India. Allahabad, Pioneer Press, 10 pp.  
1907 b The original home of *Mus decumanus*. Records of the Indian Museum, Calcutta, vol. 1, pp. 275-276. Discussion of wild coloration.
- HOVEN, HENRI 1914 Histogenèse du testicule des mammifères. Anat. Anz., T. 47, pp. 90-109. (Based chiefly on the rat.)
- HOYER, H. 1890 Ueber den Nachweis des Mucins in Geweben mittelst der Färbemethode. Arch. f. mikr. Anat., Bd. 36, S. 310-374. Rat included among mammals examined.
- HUBBERT, HELEN B. 1914 Time versus distance in learning. J. Animal Behavior, vol. 4, pp. 60-69.  
1915 Elimination of errors in the maze. J. Animal Behavior, vol. 5, pp. 66-72.  
1915 a The effect of age on habit formation in the albino rat. Behavior Monographs, vol. 2, no. 6, pp. 1-55.
- HUBBERT, HELEN B. AND LASHLEY, K. S. 1917 Retroactive association and the elimination of errors in the maze. J. of Animal Behavior, vol. 7, pp. 130-138.
- HUBER, G. CARL 1906 The arteriolae rectae of the mammalian kidney. Am. J. Anatomy, vol. 6, pp. 391-406. Rat—page 402.  
1915 The development of the albino rat from the end of the first to the tenth day after insemination. Anat. Record, vol. 9, pp. 84-88.  
1915 a The development of the albino rat (*Mus norvegicus albinus*). Part I. From the pronuclear stage to the stage of mesoderm anlage; end of the first to the end of the ninth day. J. of Morphology, vol. 26, pp. 247-358.  
1915 b The development of the albino rat (*Mus norvegicus albinus*). Part II. Abnormal ova. End of the first to the end of the ninth day. J. of Morphology, vol. 26, pp. 359-386.
- HULL, T. G. AND RETTGER, LEO F. 1914 The influence of milk and carbohydrate feeding on the intestinal flora of white rats. Centralbl. f. Bakteriol. und Parasitenkunde, vol. 75 (originale), pp. 219-229.
- HUME, E. M. AND SMITH, H. H. 1923 The effect of air, which has been exposed to the radiations of the

- mercury-vapour quartz lamp, in promoting the growth of rats, fed on a diet deficient in fat-soluble vitamins. *Biochem. J.*, vol. 17, pp. 364-372.
- HUNT, REID, AND SEIDELL, A. 1909 Studies on thyroid. I. The relation of iodine to the physiological activity of thyroid preparations. *Bull. no. 47 Hyg. Lab. U. S. Pub. Health and Mar. Hosp. Serv., Wash.*
- HUNT, REID 1910 The effects of a restricted diet and of various diets upon the resistance of animals to certain poisons. *Bull. no. 69, Hyg. Lab. U. S. Pub. Health and Mar. Hosp. Serv., Wash., pp. 3-93.*
- HUNTER, A., GIVENS, M. H. AND GUION, C. M. 1914 Studies in the comparative biochemistry of purine metabolism. I. The excretion of purine catabolites in the urine of marsupials, rodents and carnivora. *J. Biol. Chem.*, vol. 18, p. 387.
- HUNTER, WALTER S. 1912 A note on the behavior of the white rat. *J. Animal Behavior*, vol. 2, pp. 137-141.
- 1913 The delayed reaction in animals and children. *Behavior Monographs*, vol. 2, no. 1, serial number 6, pp. 1-86.
- 1914 The auditory sensitivity of the white rat. *J. Animal Behavior*, vol. 4, pp. 215-222.
- 1915 The auditory sensitivity of the white rat. *J. Animal Behavior*, vol. 5, pp. 312-329.
- HUNTER, WALTER S. AND YARBROUGH, JOS. U. 1917 The interference of auditory habits in the white rat. *J. of Animal Behavior*, vol. 7, pp. 49-65.
- HUNTER, WALTER S. 1918 Some notes on the auditory sensitivity of the white rat. *Psychobiology*, vol. 1, pp. 339-351.
- 1920 The temporal maze and kinaesthetic sensory processes in the white rat. *Psychobiology*, vol. 2, pp. 1-17.
- 1922 Studies of the reliability of the problem box and the maze with human and animal subjects. II. Correlation studies with the maze in rats and humans. *Comp. Psychol. Monographs*, vol. 1, serial no. 1.
- HURLER, K. 1912 Vergleichende Untersuchungen über den *Bacillus paratyphosus B*, den *Bacillus enteritidis* Gärtner und die Rattenbacillen: *Ratibacillus*, *Bacillus ratti* Danysz, *Bacillus ratti* Dunbar und *Bacillus ratti* Issatschenko. *Centralbl. f. Bakteriol.*, 1. Abt., Jena, Bd. 63, S. 341-372.
- HYRTL, JOSEPH 1815 Vergleichend-anatomische Untersuchungen über das innere Gehörorgan des Menschen und der Säugethiere. Pp. 1-139, 9 plates. Friedrich Ehrlich. Prag. Diameters of the several semi-circular canals with their greatest distance from the vestibule for *M. decumanus*.
- IBSEN, HEMAN L. 1920 Linkage in rats. *Am. Naturalist*, vol. 54, pp. 61-67.
- 1922 Some genetic experiments with guinea-pigs and rats. *Record of Proc. of Am. Soc. of Animal Production, Annual Meeting*, pp. 99-101.
- IDO, Y., HOKI, R., ITO, H. AND WANI, H. 1917 The rat as a carrier of spirochaeta icterohaemorrhagiae, the causative agent of Weil's disease (spirochaetosis icterohaemorrhagica). *J. of Exper. Med.*, vol. 26, pp. 341-353.
- IDO, Y., ITO, H., WANI, H. AND OKUDA, K. 1917 Circulating immunity principles in rat-bite fever. *J. of Exper. Med.*, vol. 26, pp. 377-385.
- INABA, R. 1911 Über die Zusammensetzung des Tierkörpers. *Archiv für Anat. und Physiol. (Physiol. Abteilung)*. S. I-8.
- INDIA PLAGUE COMMISSION 1908 Etiology and epidemiology of plague, p. 9. Calcutta.
- IRISAWA, T. 1897 Ueber den Rattenbiss (Japanese text). *Ztschr. d. med. Gesellsch. zu Tokyo*, Bd. 11, S. 1054-1059.
- ISELIN, HANS 1908 Wachstumshemmung infolge von Parathyreidektomie bei Ratten: ein Beitrag zur Kenntnis der Epithelkörperchen-Funktion bei jungen Ratten. *Deutsche Ztschr. f. Chir.*, Bd. 93, S. 494-500.
- 1911 Untersuchungen über die Folgen der operativen Entfernung der Epithelkörperchen bei jugendlichen Tieren und über die Leistungsfähigkeit der Epithelkörperchenverpflanzung bei bereits ausgebildeter Tetanie. *Neurol. Centralb.*, S. 220.
- ISHII, O. 1920 Observations on the sexual cycle of the guinea pig. *Biol. Bull.*, vol. 38, pp. 237-250. Allusions to the rat.
- 1922 Observations on the sexual cycle of the white rat. *Anat. Rec.*, vol. 23, pp. 311-314.
- ISHIWARA, K., OHTAWARA, T. AND TAMURA, K. 1917 Experimental rat-bite fever. *J. of Exper. Med.*, vol. 25, pp. 45-64.
- ITAGAKI, M. 1917 The influence of corpus luteum extracts upon plain muscle, especially that of the uterus. *Quart. J. Exper. Physiol.*, vol. 11, pp. 1-25.
- 1917 a On the action of various extracts obtained from the cow's ovaries upon the muscular tissue of the uterus, intestine, and blood vessels. *Quart. J. Exper. Physiol.*, vol. 11, pp. 27-38.
- 1917 b The action of certain gland extracts and drugs upon the uterus of the rat. *Quart. J. Exper. Physiol.*, vol. 11, pp. 39-46.
- IVANOFF, ELIE 1900 La fonction des vésicules séminales et de la glande prostatique dans l'acte de la fécondation. *J. de Phys. et de Path. gen.*, T. 2, pp. 95-100.
- 1907 De la fécondation artificielle chez les mammifères. *Arch. des Sc. Biol.*, T. 12, pp. 377-511.
- IVANOFF, E. J. 1903 Über künstliche Befruchtung von Säugetieren. *Biol. Centralbl.*, Bd. 23, S. 640-646.
- JACKSON, C. M. 1912 On the recognition of sex through external characters in the young rat. *Biol. Bull.*, vol. 23, pp. 171-174.

- JACKSON, C. M. AND LOWREY, L. G. 1912 On the relative growth of the component parts (head, trunk and extremities) and systems (skin, skeleton, musculature and viscera) of the albino rat. *Anat. Record*, vol. 6, pp. 449-474.
- JACKSON, C. M. 1913 Postnatal growth and variability of the body and of the various organs in the albino rat. *Am. J. Anat.*, vol. 15, pp. 1-68.
- 1915 Effects of acute and chronic inanition upon the relative weights of the various organs and systems of adult albino rats. *Anat. Record*, vol. 9, pp. 90-91. Fall paper: *Am. J. Anatomy*, vol. 18, pp. 75-116.
- 1915 a Changes in young albino rats held at constant body weight by underfeeding for various periods. *Anat. Record*, vol. 9, pp. 91-92.
- 1915 b Changes in the relative weights of the various parts, systems and organs of young albino rats held at constant body weight by underfeeding for various periods. *J. Exper. Zool.*, vol. 19, pp. 99-156.
- 1916 Effects of inanition upon the structure of the thyroid and parathyroid glands of the albino rat. *Am. Jour. Anat.*, vol. 19, pp. 305-352.
- 1917 Effects of inanition and refeeding upon the growth and structure of the hypophysis in the albino rat. *Am. J. Anat.*, vol. 21, pp. 321-358.
- JACKSON, C. M. AND STEWART, C. A. 1918 The effects of underfeeding and refeeding upon the growth of the various systems and organs of the body. *Minnesota Medicine*, November.
- 1919 Recovery of normal weight in the various organs of albino rats on refeeding after underfeeding from birth for various periods. *Am. J. of Diseases of Children*, vol. 17, pp. 329-352.
- JACKSON, C. M. 1919 The postnatal development of the suprarenal gland and the effects of inanition upon its growth and structure in the albino rat. *Am. Jour. Anat.*, vol. 25, pp. 221-289.
- JACKSON, C. M. AND STEWART, C. A. 1920 The effects of inanition in the young upon the ultimate size of the body and of the various organs in the albino rat. *Jour. Exp. Zool.*, vol. 30, pp. 97-129.
- JACKSON, C. M. 1921 The effects of various types of inanition upon growth and development with special reference to the skeleton. *Proc. of Am. Assoc. of Anatomists in Anat. Record*, vol. 21, pp. 68-69.
- JACKSON, C. M. AND CARLETON, RACHEL 1922 Organ weights in albino rats with experimental rickets. *Proc. of the Soc. for Exper. Biol. and Med.*, vol. 20, p. 181.
- 1923 The effect of experimental rickets upon the weights of the various organs in albino rats. *Am. J. of Physiol.*, vol. 65, pp. 1-14.
- JACOB, LUDWIG 1906 Fütterungsversuche mit einer aus den einfachen Nahrungsstoffen zusammengesetzten Nahrung an Tauben und Ratten. *Zeit. Biol.*, Bd. 48 (N. F. 30) S. 19-62.
- JACOBSON, L. 1817 Ueber die Thymus der Winterschläfer. *Deut. Arch. f. d. Physiol.*, Bd. 3, S. 151-154.
- JADASSOHN, J. 1913 Leprosy. in (Kolle, Wilhelm und Wassermann, A. von, (eds.) *Handbuch der pathogenen Mikroorganismen*. Bd. 5, part 2, S. 791-930). S. 821, *Rattendeprobacillus*.
- JAFFE, H. L. AND MARINE, DAVID 1923 The effect of suprarenalectomy in the rat on agglutinin formation. *Proc. of the Soc. for Exper. Biol. and Med.*, vol. 21, pp. 64-66.
- JELLINEK, AUGUSTE 1923 Die Replantation von Augen. VII. Dressurversuche an Ratten mit optisch verschiedenen Dressurgefäßen. *Archiv für Mikr. Anat. und Ent.*, Bd. 99, S. 82-103.
- JENCKS, ZALIA 1922 Studies in the regeneration of blood. *Am. J. of Physiol.*, vol. 59, pp. 240-253.
- JENSEN, C. O. 1908 Uebertragbare Rattensarkome. *Ztschr. f. Krebsforschung*, Bd. 7, S. 45.
- JENSEN, O. S. 1887 Untersuchungen über die Samenkörper der Säugethiere, Vögel und Amphibien. *Arch. f. mikr. Anat.*, Bd. 30.
- JEWETT, R. M. 1916 Studies in the blood relationship of animals as displayed in the compositions of the serum proteins. V. The percentage of non-proteins in the sera of certain animals and birds. *J. Biol. Chem.*, vol. 25, pp. 22.
- JOANNOVIC, GEORG 1912 Ueber das Verhalten transplantierter Karzinome in künstlich anämischen Mäusen. *Wiener Klin. Wochenschr.*, Bd. 25, S. 37-39.
- JOB, THESLE T. 1915 The adult anatomy of the lymphatic system in the common rat (*Epimys norvegicus*). *Anat. Record*, vol. 9, pp. 447-458.
- 1918 Lymphatico-venous communications in the common rat and their significance. *Am. Jour. Anat.*, vol. 24, pp. 467-491.
- 1922 Studies on lymph nodes. I. Structure. Introductory paper. *Am. Jour. Anat.*, vol. 31, pp. 125-137.
- JOHNS, C. O., FINKS, A. J. AND PAUL, M. S. 1919 Studies in nutrition. I. The nutritive value of coconut globulin and coconut press cake. *J. Biol. Chem.*, vol. 37, pp. 497-502.
- JOHNS, C. O. AND FINKS, A. J. 1920 Studies in nutrition. II. The rôle of cystine in nutrition as exemplified by nutrition experiments with the proteins of the navy bean, *phaseolus vulgaris*. *J. of Biol. Chem.*, vol. 41, pp. 379-399.
- 1920 a Studies in nutrition. IV. The nutritive value of peanut flour as a supplement to wheat flour. *J. of Biol. Chem.*, vol. 42, pp. 569-579.
- JOHNS, C. O., FINKS, A. J. AND PAUL, M. S. 1920 Studies in nutrition. III. The nutritive value of commercial corn gluten meal. *J. of Biol. Chem.*, vol. 41, pp. 391-399.
- JOHNSTON, J. B. 1913 The morphology of the septum, hippocampus, and pallial commissures in reptiles



- and mammals. *Jour. Comp. Neur.*, vol. 23, pp. 371-478. Rat figures 56-64, 89 and 93. Rat p. 394, pp. 406-410.
- 1923 Further contributions to the study of the evolution of the forebrain. *Jour. Comp. Neur.*, vol. 35, pp. 337-481, p. 353—Fig. 19—albino rat.
- JOLLY, J. ET STINI, J. 1905 Masse totale du sang chez le rat blanc. *Compt. rend. Soc. de biol., Paris*, T. 58, pp. 835-837.
- JOLLY, J. 1906 Variations, du nombre des globules rouges du sang au cours du développement. *C. R. Soc. Biol. Paris*, T. 60, pp. 564-566.
- 1906 a Sur l'évolution des cellules de la moelle osseuse au cours du développement. *C. R. Soc. Biol., Paris*, T. 60, pp. 634-636.
- 1909 Variations de l'hémoglobine, du nombre des globules rouges et de la valeur globulaire aux différentes périodes de la vie, chez le rat blanc. *C. R. Soc. Biol., Paris*, T. 66, pp. 136-139.
- 1919 Sur les modifications morphologiques qui se passent dans le sang des mammifères au moment de la naissance. *C. R. Soc. Biol., Paris*, T. 82, pp. 800-802.
- 1923 *Traité technique d'hématologie*. 2 vols. A. Maloine et Fils, Paris.
- JOLYET ET CHAKER 1875 De l'acte de ronger étudié chez les rats. *C. R. et Mem. Soc. Biol., Paris, Ann.* 1875, pp. 73-74. Lateral motion of inferior incisors.
- JONES, F. S., AND ROUS, PEYTON 1917 The phagocytic power of connective tissue cells. *J. of Exper. Med.*, vol. 25, pp. 189-193.
- JONES, F. S. 1922 An organism resembling bacillus actinoides isolated from pneumonic lungs of white rats. *J. of Exper. Med.*, vol. 35, pp. 361-366.
- 1922 a The source of the microorganisms in the lungs of normal animals. *J. of Exper. Med.*, vol. 36, pp. 317-328.
- JORDAN, H. E. 1921 The comparative histology of the enamel organ of the mammalian tooth, with special reference to its blood supply. *Am. J. Anat.*, vol. 29, pp. 379-398.
- 1923 The significance of the blood vessels within the enamel organ of the molar teeth of the albino rat. *Anat. Rec.*, vol. 25, pp. 291-300.
- JORDAN, H. E. AND HELVESTINE, FRANK 1923 Ciliogenesis in the epididymis of the white rat. *Anat. Rec.*, vol. 25, pp. 7-15.
- JUNGANO 1909 Sur la flore anaérobie du rat. *Comp. rend. Soc. de biol.*, T. 66, p. 112.
- JÜRGENS, G. 1903 Beitrag zur Biologie der Ratten-trypanosomen. *Arch. f. Hyg.*, Bd. 42, S. 265.
- KANEKO, R. AND OKUDA, K. 1917 A contribution to the etiology and pathology of rat-bite fever. *J. of Exper. Med.*, vol. 26, pp. 363-375.
- KANTHACK, A. A. AND HARDY, W. B. 1894 The morphology and distribution of the wandering cells of mammalia. *J. Physiol.*, vol. 17, pp. 81-119.
- KATZENSTEIN, J. 1903 Ueber die elastischen Fasern im Kehlkoepfe mit besonderer Berücksichtigung der funktionellen Struktur und der Function der wahren und falschen Stimmrippe. *Arch. f. Laryngol. u. Rhinol.*, Bd. 13, S. 329-352, pl. XVIII-XIX.
- KAUFFMAN, A. B., CREEKMUUR, F. AND SCHULTZ, O. T. 1923 Changes in the temporal bones in experimental rickets. *J. of Am. Med. Assoc.*, vol. 80, pp. 681-685.
- KEITH, ARTHUR AND FLACK, MARTIN 1907 The form and nature of the muscular connections between the primary divisions of the vertebrate heart. *J. of Anat. and Physiol.*, vol. 41, pp. 172-189.
- KEITH, M. H. AND MITCHELL, H. H. 1923 The effect of exercise on vitamin requirements. *Am. J. of Physiol.*, vol. 63, pp. 128-138.
- KELLER, OTTO 1909 Die Antike Tierwelt. I. Säugtiere. pp. 203-205. Engelmann, Leipzig.
- KELLER-ZSCHOKKE, J. 1892 *Mus rattus* noch in der Schweiz. *Zool. Garten*, 33 Jhg. no. 2, S. 60.
- KEMPE, H. A. E. 1903 Over het Genitaalstreng-epitheel van de witte rat en over de morphologische betekenis van het Hymen. *Proefschrift, Leiden*.
- KENNEDY, CORNELIA AND DUTCHER, R. A. 1922 Vitamine studies. IX. The influence of the diet of the cow upon the quantity of vitamins A and B in the milk. *J. of Biol. Chem.*, vol. 50, pp. 339-359.
- KENNEDY, CORNELIA AND PALMER, L. S. 1922 Yeast as a source of vitamine-B for the growth of rats. *J. Biol. Chem.*, vol. 54, pp. 217-232.
- KENT, STANLEY 1893 Researches on the structure and function of the mammalian heart. *J. Physiol.*, vol. 14, pp. 233-254. Connection between atrium and ventricle in newborn rats.
- KESSEL, JOHN F. 1923 Experimental infection of culture rats and mice with the common intestinal amebae of man. *Proc. of the Soc. for Exper. Biol. and Med.*, vol. 21, pp. 110-111.
- KING, HELEN D. 1910 The effects of various fixatives on the brain of the albino rat, with an account of a method of preparing this material for a study of the cells in the cortex. *Anat. Record*, vol. 4, pp. 214-244.
- 1911 The effects of pneumonia and of post-mortem changes on the percentage of water in the brain of the albino rat. *J. Comp. Neur.*, vol. 21, pp. 147-154.
- 1911 a The effects of semi-spaying and of semi-castration on the sex ratio of the albino rat (*Mus norvegicus albinus*). *J. Exper. Zool.*, vol. 10, pp. 381-392.
- 1911 b The sex ratio in hybrid rats. *Biol. Bull.*, vol. 21, pp. 104-112.
- 1913 Some anomalies in the gestation of the albino rat (*Mus norvegicus albinus*). *Biol. Bull.*, vol. 24, pp. 377-391.
- 1913 a The effects of formaldehyde on the brain of the albino rat. *J. Comp. Neur.*, vol. 23, pp. 283-314.
- 1915 On the weight of the albino rat at birth and the factors that influence it. *Anatomical Record*, vol. 9, pp. 212-231.

- 1915 a Growth and variability in the body weight of the albino rat. *Anat. Record*, vol. 9, pp. 751-776.
- KING, HELEN D AND STOTSENBURG, J. M. 1915 On the normal sex ratio and the size of the litter in the albino rat (*Mus norvegicus albinus*). *Anatomical Record*, vol. 9, pp. 403-420.
- KING, HELEN D. 1916 On the postnatal growth of the body and of the central nervous system in albino rats that are undersized at birth. *Anat. Record*, vol. 11, pp. 41-52.
- 1916 a The relation of age to fertility in the rat. *Anat. Record*, vol. 11, pp. 269-287.
- 1918 Studies on inbreeding. I. The effects of inbreeding on the growth and variability in the body weight of the albino rat. *Jour. Exp. Zool.*, vol. 26, pp. 1-51.
- 1918 a Studies on inbreeding. II. The effects of inbreeding on the fertility and on the constitutional vigor of the albino rat. *Jour. Exp. Zool.*, vol. 26, pp. 335-378.
- 1918 b Studies on inbreeding. III. The effects of inbreeding, with selection, on the sex ratio of the albino rat. *Jour. Exp. Zool.*, vol. 27, pp. 1-35.
- 1919 Studies on inbreeding. IV. A further study of the effects of inbreeding on the growth and variability in the body weight of the albino rat. *Jour. Exp. Zool.*, vol. 29, pp. 135-175.
- 1921 A comparative study of the birth mortality in the albino rat and in man. *Anat. Rec.*, vol. 20, pp. 321-354.
- 1923 The growth and variability in the body weight of the Norway rat (*Mus norvegicus*). *Anat. Record*, vol. 25, pp. 79-94.
- 1923 a Is inbreeding injurious? *Scientific Papers of the Second Internat. Congress of Eugenics held at N. Y.*, Sept. 1921, vol. 1, pp. 270-277.
- 1923 b A new occurrence of the black-eyed yellow mutation in rats. *Science*, vol. 58, pp. 250-251, Sept. 28th.
- 1924 Litter production and the sex ratio in various strains of rats. *Anat. Rec.*, vol. 27, pp. 337-366.
- KING, JESSIE L. 1910 The cortico-spinal tract of the rat. *Anat. Rec.*, vol. 4, pp. 245-252.
- KINNEY, ETHEL M. AND McCOLLUM, E. V. 1923 A study of the rate of deposition and paths of absorption of strontium in the rat. *J. of Pharmacol. and Exper. Therapeutics*, vol. 21, p. 165.
- KIRKHAM, WILLIAM B. 1910 Ovulation in mammals, with special reference to the mouse and rat. *Biol. Bull.*, vol. 18, pp. 245-251.
- KIRKHAM, WILLIAM B. AND BURR, H. S. 1913 The breeding habits, and maturation of eggs and ovulation of the albino rat. *Am. J. Anat.*, vol. 15, pp. 291-317. Six excellent plates illustrating the egg in various phases.
- KISTER 1906 Kasuistische Mitteilungen zur Frage der Rattenpestdiagnose. *Contrabl. f. Bakteriol.*, 1 Abt., Jena, Bd. 41, S. 780; 858; Bd. 42, S. 91.
- KITAGAWA, J. AND MUKOYAMA, T. 1918 Ein Fall von Rattenbisskrankheit, welche von Kratzwunde der Eule infiziert ist. *Verhandl. d. jap. path. Gesellsch.*, Tokyo, Bd. 8, S. 125.
- KITTELSON, JOHN A. 1917 The postnatal growth of the kidney of the albino rat, with observations on an adult human kidney. *Anat. Rec.*, vol. 13, pp. 385-408.
- 1920 Effects of inanition and refeeding upon the growth of the kidney of the albino rat. *Anat. Rec.*, vol. 17, pp. 281-297.
- KLEBS, E. 1891 Zur vergleichenden Anatomie der Placenta. *Archiv. f. mikr. Anat.*, Bd. 37, S. 335-356.
- KLEIN, EDWARD UND VERSON, E. 1871 Der Darmkanal. In *Stricker's Handbuch der Lehre von den Menschen und der Tiere*. See "Magen," S. 395.
- KLEIN, E. 1875 The anatomy of the lymphatic system. II. The lung. *Smith, Elder & Co.*, London, 88 pages, 6 plates. Observations mainly on guinea pig. Rat among other animals used.
- 1901-1902 The identity of the bacillus Gärtner with the rat bacillus of Danysz. *Tr. Path. Soc. Lond.*, 1901-1902, vol. 53, p. 342.
- 1902-1903 Report on the pathology and etiology of rat plague and other infectious rat diseases. *Rep. Med. Off. Local Gov. Bd. 1902-3*, Lond., 1904, 399; 688.
- 1906 A new microbe, pathogenic for rodents, *Bacillus equi*. *Vet. J. Lond.*, n.s., vol. 13, pp. 199-202.
- KLIENEBERGER, CARL AND CARL WALTER 1912 Die Blut-Morphologie der Laboratoriums-Tiere. J. A. Barth. Leipzig.
- KNAPP, PAUL. 1908 Experimenteller Beitrag zu Ernährung von Ratten mit künstlicher Nahrung und zum Zusammenhang von Ernährungsstörungen mit Erkrankungen der Conjunctiva. *Zeit. exp. Path. u. Ther.*, Bd. 5, S. 147-169.
- KOCH, MATHILDE L. 1913 Contributions to the chemical differentiation of the central nervous system. I. A comparison of the brain of the albino rat at birth with that of the fetal pig. *J. Biol. Chem.*, vol. 14, pp. 267-279.
- KOCH, MATHILDE L. AND VOEGLIN, CARL 1916 Chemical changes in the central nervous system as a result of restricted vegetable diet. *U. S. Pub. Health Service-Treasury Dept. Hygienic Labor.*, Bull. no. 103, pp. 135.
- KOCH, R. 1895 Reise-Berichte über Rinderpest, Bubonepest in Indien und Afrika, Tsetse oder Surrakrankheit Texasfieber, tropische malaria u. Schwarzwasserfieber. J. Springer. Berlin. 136 pp. Trypanosomes—rat.

- KOCH, W. AND MANN, S. A. 1909 A chemical study of the brain in healthy and diseased conditions, with especial reference to dementia praecox. *Archives of Neurol. and Psychiatry (Mott)* vol. 4, pp. 201-204.
- KOCH, WALDEMAR AND KOCH, MATHILDE L. 1913 Contributions to the chemical differentiation of the central nervous system. II. A comparison of two methods of preserving nerve tissue for subsequent chemical examination. *J. Biol. Chem.*, vol. 14, pp. 281-282.  
1913 a Contributions to the chemical differentiation of the central nervous system. III. The chemical differentiation of the brain of the albino rat during growth. *J. Biol. Chem.*, vol. 15, pp. 423-448.
- KOCHER, R. A. 1916 The effect of activity on the histological structure of nerve cells. *Jour. Comp. Neur.*, vol. 26, pp. 341-357. (Dog, cat, rat, pigeon, sparrow, frog).
- KOEPERT, OTTO 1904 Nochmals der Rattenkönig. *Natur u. Hauss.*, Bd. 12, S. 118-119.
- KOGANEL, J. 1885 Untersuchungen über den Bau der Iris des Menschen und der Wirbelthiere. *Archiv. f. mikr. Anat.*, Bd. 25, S. 1-48. Rat, S. 16.
- KOHLMEYER, O. 1906 Topographie des elastischen Gewebes in der Gaumenschleimhaut der Wanderratte, *Mus decumanus*. *Zeitschr. wiss. Zool.*, Bd. 51, S. 145-190.
- KOHMAN, EMMA A. 1920 The experimental production of edema as related to protein deficiency. *Am. J. Physiol.*, vol. 51, pp. 378-405.
- KOJIMA, M. 1916 Preliminary communication on the effects of thyroid feeding upon the pancreas. *Proc. of the Royal Soc. of Edinburgh*, Session 1915-16, vol. 36, part III (No. 15) pp. 240-242.  
1917 Studies on the endocrine glands. I. The relations between the pancreas and thyroid and parathyroid glands. *Quart. J. Exper. Physiol.*, vol. 11, pp. 255-318.  
1917 a Studies on the endocrine glands. II. The relations of the pituitary body with the thyroid and parathyroid and certain other endocrine organs in the rat. *Quart. J. Exper. Physiol.*, vol. 11, pp. 319-338.  
1917 b Studies on the endocrine glands. III. The effects on the thyroid and parathyroid of the rat of administered thyroid extract and certain other autacoids and salts. *Quar. J. Exper. Physiol.*, vol. 11, pp. 339-345.  
1917 c Studies on the endocrine glands. V. Effects upon metabolism of castration, of thyroidectomy, of parathyroidectomy, and of thyroid and parathyroid feeding. *Quart. J. Exper. Physiol.*, vol. 11, pp. 351-380.
- KOLAZY, JOSEF 1871 Ueber die Lebensweise von *Mus rattus*, varietas, alba. *Verhandl. Zool. Bot. Gesellsch. Wien*, S. 731-734. Unusually good account.
- KÖLLIKER, ALBERT 1879 Entwicklungsgeschichte des Menschen und der höheren Thiere. Wilhelm Engelmann. Leipzig.
- KOLMER, J. A. AND YUI, C. V. AND TYAU, E. S. 1913 Concerning the activity and fixability of the complement in rat serum. *J. Med. Research*, vol. 28 (n.s. vol. 23), pp. 483-495.
- KOLMER, JOHN A. 1921 Route of administration of drugs in relation to toxicity in chemotherapeutic investigations with special reference to intrapleural injections of ethylhydrocuprein hydrochlorid. *J. of Pharmacol. and Exper. Therapeutics*, vol. 17, pp. 431-443.
- KOLSTER, RUD 1901 Vergleichend anatomische Studien über den M. pronator teres der Säugetiere. *Anat. Hefte*, Bd. 17, S. 673-834. *Mus. rattus*, p. 714.
- KOMINE, S. 1919 Metabolic activity of the nervous system. III. On the amount of non-protein nitrogen in the brain of albino rats during twenty-four hours after feeding. *Jour. Comp. Neur.*, vol. 30, pp. 397-410.  
1919 a Metabolic activity of the nervous system. IV. The content of non-protein nitrogen in the brain of the rats kept in a state of emotional and physical excitement for several hours. *Jour. Comp. Neur.*, vol. 31, pp. 69-82.
- KÖNIGSFEIN, H. 1907 Die Veränderungen der Genitalschleimhaut während der Gravidität und Brunst bei einigen Nagern. *Arch. f. d. ges. Physiol.*, Bd. 119, S. 553-570.
- KOPPÁNYI, THEODOR 1923 Die Replantation von Augen. II. Haltbarkeit und Funktionsprüfung bei verschiedenen Wirbeltierklassen. *Archiv für mikr. Anat. und Ent.*, Bd. 99, S. 15-42.  
1923 a Die Replantation von Augen. III. Die Physiologie der replantierten Säugeraugen. *Archiv für mikr. Anat. und Ent.*, Bd. 99, S. 43-59.  
1923 b Die Replantation von Augen. IV. Über das Wachstum der replantierten Augen. *Archiv für mikr. Anat. und Ent.*, Bd. 99, S. 60-63.
- KORENCHESKY, V. 1921 Experimental rickets in rats. *Brit. Med. Journ.*, vol. 2, p. 547.  
1922 Experimental rickets in rats. *N. Y. Med. J.*, vol. 115, p. 612.  
1922 a The influence of parathyroidectomy on the skeleton of animals normally nourished, and on rickets and osteomalacia produced by deficient diet. *J. Path. and Bacteriol.*, vol. 25, pp. 366-392.  
1923 The influence of the mother's diet during pregnancy and lactation upon the growth, general nourishment, and skeleton of offspring. *Abstracts of Communications to XIth Internat. Physiol. Congress, Edinburgh, July 23-27th.*
- KORENCHESKY, V. AND CARR, MARJORIE 1923 Influence of a milk diet on the skeleton. *Biochem. J.*, vol. 17, pp. 187-203.

- 1923 a The influence of the antenatal feeding of parent rats upon the number, weight and composition of the young at birth. *Biochem. J.*, vol. 17, pp. 597-599.
- KOROLKOW, P. 1892 Die Nervenendigungen in den Speicheldrüsen. *Rev. d. sc. nat. de St. Petersburg Ann.* 3, pp. 109-112 (Russian). In German in *Anat. Anz.*, Bd. 7, S. 580-582, 1 fig., white rat.
- KŌSAKA, K. AND HIRAIWA, K. 1915 Zur Anatomie der Sehnervenbahnen und ihren Zentren. *Folia Neurol.*, Bd. 9, S. 367-389.
- KŌSAKA, K. AND SEKI, M. 1921 Electric charges of the red blood corpuscles. *Okayama-Igakkwai Zasshi* (Communication of the Okayama Med. Soc.) No. 372.
- KRAMER, B. AND HOWLAND, J. 1922 Factors which determine the concentration of calcium and of inorganic phosphorus in the blood serum of rats. *Johns Hopkins Hosp. Bull.*, vol. 33, p. 313.
- KRAUSE, WILHELM 1870 Die Nervenendigung in der Zunge des Menschen, *Göttinger Nachr.*, S. 423-426. 1876 Allgemeine und mikroskopische Anatomie. *Handbuch der menschlichen Anatomie*, Bd. 1. Harbover, 1876. (Vol. 1 of KRAUSE, CARL F. T. *Handbuch der menschlichen Anatomie*, 3 Aufl.).
- KREIDL, A. AND YANASE, J. 1907 Zur Physiologie der Cortischen Membran. *Zentralbl. f. Physiol.*, Bd. 21.
- KREIDL, A. UND NEUMANN, A. 1908 Zur Frage der Lagerinnung im Säuglingsmagen. *Zentralbl. f. Physiol.*, Bd. 22, S. 133-136. (See S. 136.)
- KUDO, TOKUYASU 1921 Studies on the effects of thirst. I. Effects of thirst on the weights of the various organs and systems of adult albino rats. *Am. Jour. Anat.*, vol. 28, pp. 399-430. 1921 a Studies on the effects of thirst. II. The effects of thirst upon the growth of the body and of the various organs in young albino rats. *Jour. Exp. Zool.*, vol. 33, pp. 435-461.
- KULYOSHA, G. S. 1899 O patologo-anatomicheskikh izmeneniyakh vizivayemikh v organakh mishei i kris mishe-i krisoebivayushtshimi batsillami. (Pathological alterations in the organs of mice and rats by bacilli that kill these animals. *Arch. vet. nauk, St. Petersburg.*, vol. 29, 2 sect., pp. 309-321.
- KUNKEL, B. W. 1919 Instinctive behavior in the white rat. *Science, n. s.*, vol. 50, Sept. 26th, pp. 305-306.
- KUPFFER, C. W. VON. 1876 Ueber Sternzellen in der Leber. *Arch. f. mikr. Anat.*, Bd. 12, part 2, S. 352-358. Results verified on rat.
- KURAMITSU, C. AND LOEB, LEO 1921 The involution of the uterine following labor and the influence of castration and suckling on the process of involution. *Am. J. Physiol.*, vol. 55, pp. 422-442. 1921 a The effect of suckling and castration on the lactating mammary gland in rat and guinea-pig. *Am. J. Physiol.*, vol. 56, pp. 40-59.
- KURIYAMA, SHIGENOBU 1917 The influence of thyroid feeding upon carbohydrate metabolism. *Am. J. Physiol.*, vol. 43, pp. 481-496.
- KURIYAMA, SHIGENOBU AND MENDEL, L. B. 1917 The physiological behavior of raffinose. *J. Biol. Chem.*, vol. 31, pp. 125-147. Rat pp. 136-138.
- KURIYAMA, SHIGENOBU 1918 The influence of thyroid feeding upon carbohydrate metabolism. I. The storage and mobilization of the liver glycogen in thyroid-fed animals. *J. Biol. Chem.*, vol. 33, pp. 193-205. 1918 a The influence of thyroid feeding upon carbohydrate metabolism. II. The epinephrine content of the adrenals of thyroid-fed rats. *J. Biol. Chem.*, vol. 33, pp. 215-227. 1918 b The influence of thyroid feeding upon carbohydrate metabolism. III. The acidosis in experimental hyperthyroidism and its relation to epinephrine in the blood and the decrease of liver glycogen. *J. Biol. Chem.*, vol. 33, pp. 215-227. 1918 c The adrenals in relation to carbohydrate metabolism. II. The influence of adrenalectomy upon the glycogenetic power of the liver. *J. Biol. Chem.*, vol. 31, pp. 287-297. 1918 d The adrenals in relation to carbohydrate metabolism. III. The epinephrine content of the adrenals in various experimental conditions. *J. Biol. Chem.*, vol. 34, pp. 299-333.
- KUSAMA, S., KASAI, K. AND KOBAYASHI, R. 1918 Ueber den ungeschlechtlichen und geschlechtlichen Entwicklungskreis einer Art Rattenleukozytogrammaria. *Verhandl. d. jap. path. Gesellsch.*, Tokyo, Bd. 8, S. 137. 1919 The leucozytogrammaria of the wild rat, with special reference to its life history. *Kitasato Arch. Exper. Med.*, Tokio, vol. 3, pp. 103-122. 1919 a The rat-bite fever spirochaete, with a comparative study of human, wild rat and field vole strains. *Kitasato Arch. Exper. Med.*, vol. 3, pp. 131-150.
- LAGERLÖF, SELMA 1907 The wonderful adventures of Nils. *Grosset and Dunlap, N. Y.* Contest between the old black rats and the Norway rat given on pp. 110-130. p. 114 says "Norway" arrived at Malmo on a sloop from Lybia about 100 (?) years ago.
- LAGUESSE AND CASTELLANT 1898 Mécanisme de la sécrétion dans les glandes de Brunner du rat. *Compt. Rend. de la Soc. de Biol.* (10th ser), T. 5, pp. 327-328.
- LAKE, GLEASON C. 1918 On the toxicity of emetine hydrochloride, with special reference to the comparative toxicity of various market preparations. *Hygienic Lab. Bull.* no. 113, U. S. Pub. Health Service.

- LAMBERT, R. A. 1911 The influence of mouse-rat parabiosis on the growth in rats of a transplantable mouse sarcoma. *J. Exp. Med.*, vol. 13, pp. 257-262.
- LAMBERT, R. A. AND YUDKIN, A. M. 1923 Changes in the paraocular glands accompanying the ocular lesions which result from a deficiency of vitamine A. *J. of Exper. Med.*, vol. 38, pp. 25-32.
- LANDER, P. E. 1915 On the cholesterol content of the tissues of growing rats when under various diets. *Biochem. J.*, vol. 9, pp. 78-96.
- LANE-CLAYTON, JANET E. 1907 On ovogenesis and the formation of the interstitial cells of the ovary. *J. Obst. and Gynaec.*, vol. 11, pp. 205-214.  
1909 Observations on the influence of heating upon the nutrient value of milk as an exclusive diet for young animals. *J. Hyg.*, vol. 9, pp. 233-238.
- LANE, H. H. 1917 The correlation between structure and function in the development of the special senses of the white rat. Diss. presented to the Faculty of Princeton Univ. in Candidacy for the degree of Doctor of Philosophy.
- LANGBE, L. B. AND SIMMONDS, NINA 1923 Experimental tuberculosis in rats on varied diets. *Am. Review of Tuberculosis*, vol. 7, p. 49.
- LANGHANS, TH. AND WEGELIN, C. 1919 Goitre in the white rat (*Der Kropf der Weissen Ratte*). Bern. Reviewed by J. Koopman in *Endocrinology*, vol. 4, p. 234.
- LANGLEY, J. N. 1879 On the structure of serous glands in rest and activity. *Proc. Roy. Soc., London*, vol. 29, pp. 377-382.
- LANGLEY, J. N. AND SEWALL, H. 1879 On the changes in pepsin-forming glands during secretion. *J. Physiol.*, vol. 2, pp. 281-301; *Proc. Roy. Soc., London*, vol. 29, p. 383.
- LANGLEY, J. N. 1882 On the histology of the mammalian gastric glands, and the relation of pepsin to the granules of the chief cells. *J. Physiol.*, vol. 3, p. 260-291.
- LANGLOIS, J. P. AND LOIR, A. 1902 La résistance des rats et des insectes à l'acide carbonique et à l'acide sulfureux. *Compt. rend. Soc. de biol.*, T. 54, pp. 414-415.
- LANTZ, DAVID E. 1909 The brown rat in the United States. U. S. Dept. of Agr., Biol. survey, Bull. no. 33, Washington, D. C., pp. 12-13.  
1910 Natural history of the rat. Found in "The rat and its relation to the public health," pp. 15-27. Treasury Dept. Health and Mar.-Hospit. Service of the U. S., Washington, D. C. Government Printing Office.
- LAPICQUE, LOUIS 1907 Différence sexuelle dans le poids de l'encéphale chez les animaux. *Rat et moineau*. *C. R. Soc. Biol., Paris*, T. 63, pp. 746-748.
- LAPICQUE, LOUIS AND GIRARD, P. 1907 Sur le poids de l'encéphale chez les animaux domestiques. *Société de Biol.*, T. 62, p. 1015.
- LAPICQUE, LOUIS AND LEGENDRE, R. 1911 Sur les rats noirs du Jardin des Plantes. *Bull. du Muséum d'histoire naturelle*, no. 6, pp. 1-5.
- LARSON, JOHN A. 1919 On the functional correlation of the hypophysis and the thyroid. *Am. J. Physiol.*, vol. 49, pp. 55-89.  
1920 Further evidence on the functional correlation of the hypophysis and the thyroid. *Am. J. Physiol.*, vol. 53, pp. 89-100. Note peculiar loss of hair—p. 99.
- LARSON, W.P., AND BELL E. T. 1915 A study of the pathogenic properties of *Facillus proteus*. *J. of Exper. Med.*, vol. 21, pp. 629-644.
- LASHLEY, K. S. 1912 Visual discrimination of size and form in the albino rat. *J. Animal Behavior*, vol. 2, pp. 310-331.  
1917 The criterion of learning in experiments with the maze. *J. Animal Behavior*, vol. 7, pp. 66-70.  
1917 a The effects of strychnine and caffeine upon the rate of learning. *Psychobiology*, vol. 1, pp. 141-169.
- LASHLEY, K. S. AND FRANZ, S. I. 1917 The effects of cerebral destruction upon habit-formation and retention in the albino rat. *Psychobiology*, vol. 1, pp. 71-139.
- LASHLEY, K. S. 1918 A simple maze: with data on the relation of the distribution of practice to the rate of learning. I. A test of the validity of results obtained with the simple maze. *Psychobiology*, vol. 1, pp. 353-367.  
1920 Studies of cerebral function in learning. *Psychobiology*, vol. 2, pp. 55-135.  
1921 Studies of cerebral function in learning. II. The effects of long continued practice upon cerebral localization. *J. of Comp. Psychol.*, vol. 1, pp. 453-468.  
1921 a Studies of cerebral function in learning. III. The motor areas. *Brain*, vol. 44, pp. 255-285.  
1922 Studies of cerebral function in learning. IV. Vicarious function after destruction of the visual areas. *Am. J. Physiol.*, vol. 59, pp. 44-67.
- LAUBER, HANS 1901 Beiträge zur Anatomie des vorderen Augenabschnittes der Wirbeltiere. *Anat. Hefte*, Bd. 18, S. 371-453. *Mus rattus*, S. 427.
- LAYERAN, A. AND MESNIL, F. 1900 Sur l'agglutination des trypanosomes du rat par divers sérums. *C. R. Soc. de Biol.*, Nov. 19, p. 939.  
1900 a De la longue conservation à la glacière des trypanosomes du rat et de l'agglomération de ces parasites. *C. R. Soc. de Biol.*, Oct. 6, p. 816.  
1900 b Sur le mode de multiplication du trypanosome du rat. *C. R. Soc. de Biol.*, Nov. 17, p. 976.  
1901 Recherches morphologiques et expérimentales sur le trypanosome des rats. *Ann. de l'Institut Pasteur*, T. 15, pp. 673-713.
- LEBOEUF, A. 1912 Existence de lepra murium (lèpre des rats) en Nouvelle Calédonie. *Bull. Soc. path. exot.*, T. 5, pp. 463-465.

- LEE, FREDERIC S. 1910 The nature of fatigue. *Popular Science Monthly*, February, pp. 182-195. See fig. 4.
- LEEUWENHOECK, ANT. 1693 On the testicles of a rat and the animalcules therein contained; with some observations of small animals found in oysters and in the sap of vines. *Phil. Trans.*, vol. 17, pp. 593-594.
- LEFROY, SIR JOHN HENRY 1882 *The History of the Bermudæ or Summer Islands, 1600—* By Capt. John Smith (?) Pub. of the Hakluyt Soc., London.
- LEISCHNER, H. 1907 Ueber Epithelkörperchen-Transplantationen und deren praktische Bedeutung in der Chirurgie. *Arch. f. klin. Chir.*, Bd. 84, S. 208-222.
- LEISCHNER, H. AND KOHLER, R. 1911 Ueber homioplastische Epithelkörperchen und Schilddrüsenverpflanzung. *Arch. f. klin. Chir.*, Bd. 94, S. 169-185.
- LEMOINE, EMMANUEL 1906 Aorte du rat (blane, adulte) (see his *Sur la charpente conjonctive du muscle lisse*—pp. 48-54).
- LINHOSSÉK, M. VON 1889 Ueber die Pyramidenbahnen im Rückenmarke einiger Säugetiere. *Anat. Anz.*, Bd. 4, S. 208-219.  
1898 Untersuchungen über Spermatogenese. *Arch. f. mikr. Anat.*, Bd. 54, S. 215-318.
- LIOPOLOD, JEROME S. AND REUSS, A. VON 1908 Ueber die Beziehungen der Epithelkörperchen zum Kalkbestand des Organismus. *Wien. klin. Wchnschr.* S. 1243-1246.
- LIVENE, P. A. AND MUHLFELD, MARIE 1923 On the identity or non-identity of antineuritic and water-soluble B vitamins. *J. of Biol. Chem.*, vol. 57, pp. 341-349.
- LEVI, GIUSEPPE 1908 I Gangli Cerebrospinali. *Studi di Istologia comparata e di Istogenesi. Ital. Anat. ed Embr.*, T. 7. *Mus decumanus*—pp. 155, 156. Tables pp. 199, 200 and 201.
- LEVIN, ISAAC 1907 The reactive power of the white rat to tissue implantation. *Medical Record*, vol. 72.  
1908 The reactive power of the white rat to tissue implantation (Second communication.) *Proc. Soc. Exper. Biol. and Med.*, vol. 5, pp. 41-43.  
1910 Immunity to the growth of cancer induced in rats by treatment with mouse tissue. *Proc. Soc. Exper. Biol. and Med.*, 38th meeting, April 20.  
1910 a Resistance to the growth of cancer induced in rats by injection of autolyzed rat tissue. *Proc. Soc. Exper. Biol. and Med.*, February 16.  
1911 The relation of the reactive stroma formation to the transplantability of the cancers of the white rat. *J. Exp. Med.*, vol. 13, pp. 604-615.
- LEVINE, VICTOR E., MCCOLMUM, E. V. AND SIMMONDS, NINA 1922 Glacial acetic acid as a solvent for the anti-neuritic substance, water-soluble B. *J. of Biol. Chem.*, vol. 53, pp. 7-11.
- LEWIS, C. 1912 Ueber Immunisierung mit Blutserum von spontan geheilten Tumorratten. *Zeitschr. f. Krebsforsch.*, Bd. 11, S. 334.  
1912 a Immunisierungs und Heilversuche mit Autolysaten bei Rattentumoren. *Zeitschr. f. Krebsforsch.* Bd. 11, S. 317.
- LEWIS, D. D. AND MILLER, J. L. 1913 The relation of the hypophysis to growth, and the effects of feeding anterior and posterior lobe. *Arch. Int. Med.*, vol. 12, pp. 137-144.
- LEWIS, FREDERIC T. 1915 The comparative embryology of the mammalian stomach. *Proc. of Am. Assoc. of Anatomists in Anat. Record*, vol. 9, pp. 102-103.
- LEWIS, HOWARD B. AND ROOT, LUCIE E. 1920 Amino-acid synthesis in the animal organism. Can nor-leucine replace lysine for the nutritive requirements of the white rat? *J. of Biol. Chem.*, vol. 43, pp. 79-87.
- LEWIS, JOHN T. 1923 Extirpation of adrenal glands in albino rats. *Am. J. of Physiol.*, vol. 64, pp. 503-505.  
1923 a Sensibility to intoxication in albino rats after double adrenalectomy. *Am. J. of Physiol.*, vol. 64, pp. 506-511.
- LEWIS, PAUL A. AND MARGOT, ARTHUR G. 1914 The function of the spleen in the experimental infection of albino mice with bacillus tuberculosis. *J. Exp. Med.*, vol. 19, pp. 187-194.
- LEWIS, THOMAS 1902 The structure and function of the hemolymph glands and spleen. *Intern. Monatsschr. f. Anat. u. Phys.*, Bd. 20.
- LEWIS, W. BEVAN 1881 On the comparative structure of the brain in rodents. *Phil. Trans.*, 1882, pp. 699-749.
- LEYDIG, F. 1850 Zur Anatomie der männlichen Geschlechtsorgane und Analdrüsen der Säugetiere. *Ztschr. f. wiss. Zool.*, Bd. 2, S. 1-57, Taf. I-IV.  
1854 Kleinere Mitteilungen zur tierischen Gewebelehre. *Arch. f. Anat. u. Entwicklungsgesch.*, S. 296-348, pl. XII and XIII. *Mus decumanus*, S. 341-345.  
1857 *Lehrbuch der Histologie des Menschen und der Tiere.* Frankfurt a.M. 553 pp. See p. 374.
- LIEBE, K. TH. 1891 Zu dem Vorkommen der Hausratte (*Mus rattus*). *Zoolog. Garten*, 31 Jhg., S. 156-157.
- LINDNER, FR. 1891 Notiz über das Vorkommen der Hausratte (*Mus rattus*). *Zoolog. Garten* 31 Jhg., S. 155-156.
- LINNAEUS, C. 1746 *Fauna Suecica.* Stockholm.  
1758 *Systema naturae*, etc. Tome 1, Editio 10, p. 61, *M. rattus*—5 references.  
1766 *Systema naturae*, etc. Tome 1, Editio 12 (*Mus rattus* only).
- LINSER, PAUL 1900 Ueber den Bau und die Entwicklung des elastischen Gewebes in der Lunge. *Anat. Hefte*, H. 42143 (Bd. 13, H. 2/3) S. 307-335.

- LISLE, A. DE, 1865 De l'existence d'une race nègre chez le Rat ou de l'identité spécifique du *Mus rattus* et du *Mus alexandrinus*. Ann. d. sc. nat. Zool., 5th series, T. 4, pp. 173-222.
- LITTON, W. G. 1905 Plague, rats and fleas. J. Bombay Nat. Hist. Soc., vol. 16, p. 253.  
1905 a The rats of India. Indian M. Gaz., Calcutta, vol. 40, pp. 130-132.
- LITTLE, C. C. 1917 Evidence of multiple factors in mice and rats. Am. Naturalist, vol. 51, pp. 457-480.
- LIVINI, FERD. 1896 Intorno alla struttura della trachea. Monitore zool. ital. Anno 7. *Mus decumanus*, p. 103.
- LLOYD, B. J. 1908 The rat and his parasites: his rôle in the spread of disease, with special reference to bubonic plague. Calif. State J. Med., San Fran., vol. 6, pp. 4-7.
- LLOYD, R. E. 1908 Remarkable cases of variation, I. Records Indian Museum, vol. 2, p. 29.  
1909 The races of Indian rats. Records of Indian Museum, vol. 3, pp. 1-109.  
1909 a The relation between fertility and normality in rats. Records Indian Museum, vol. 3, pp. 261-265.  
1910 Further observations on the races of Indian rats. Records of the Indian Museum, Calcutta, vol. 5, pt. II, pp. 105-115. Peculiar large groups.  
1911 The inheritance of fertility. Biometrika, vol. 8, pp. 244-247.  
1912 The growth of groups in the animal kingdom. London. 1 colored plate of three color varieties of *Mus rattus*.
- LOEB, LEO 1901 On transplantation of tumors. J. Med. Research, vol. 5 (n.s. vol. 1—continuation of the Journ. of the Boston Soc. of Med. Sciences, pp. 28-38).  
1902 Further investigations in transplantations of tumors. J. Med. Research, n.s. vol. 3, pp. 44-73.  
1902 a Ueber Transplantationen eines Sarcoms der Thyreoidea bei einer weissen Ratte. Arch. f. path. Anat., vol. 167, pp. 175-191.  
1903 Mixed tumors of the thyroid gland. Am. J. Med. Sc., vol. 125, pp. 243-256.  
1903 a Ueber Transplantation von Tumoren. Arch. f. path. Anat., Bd. 172, S. 345-368.  
1904 Ueber das endemische Vorkommen des Krebses beim Tiere Centralbl. f. Bakteriol. u. Parasitenk., Bd. 37, S. 235-245.  
1907 Observations on the inoculability of tumors and on the endemic occurrence of cancer. Internat. Clin., vol. 3, series 17, pp. 114-130.  
1913 Venom of heloderma. Carnegie Inst., Wash. D. C., Pub. no. 177, pp. 250.  
1916 Observations on the mode of origin of the fibroadenoma of the mammary gland in the rat and on the delayed retrogression of the mammary gland after the period of lactation. J. of Cancer Research, vol. 1, pp. 415-425.
- LOEB, LEO AND FLEISHER, MOYER S. 1916 Transplantation of benign tumors. J. of Cancer Research, vol. 1, pp. 427-459.
- LOEB, LEO 1917 Tissue growth and tumor growth. J. of Cancer Research, vol. 2, pp. 135-150.  
1918 The grafting of tissues into nearly related individuals in the rat and the mode of inheritance of individuality-differentials. J. of Med. Research, vol. 38, (n.s. vol. 33), pp. 393-420.  
1918 a An analysis of the behavior of organs after transplantation in the rat and of the power of resistance of the constituents of various organs. J. of Med. Research, vol. 39 (n.s. vol. 34), pp. 189-216.  
1920 Heterotransplantation of the thyroid gland. J. of Exper. Med., vol. 31, pp. 765-784.  
1921 Heterotransplantation of kidney. J. of Med. Research, vol. 42, pp. 137-146.
- LOEB, LEO AND KURAMITSU, C. 1921 The influence of lactation on the sexual cycle in the rat and guinea pig. Am. J. Physiol., vol. 55, pp. 443-449.
- LOEB, LEO 1923 Types of mammalian ovary. Proc. of Soc. for Exper. Biol. and Med., vol. 20, pp. 446-448.
- LOEW, O. 1903 Die Chemotaxis der Spermatozoen im weiblichen Genitaltract. Sitzungsber. d. Wiener Akad. Math.-naturw. Cl. exi.
- LOEWENTHAL, N. 1894 Zur Kenntnis der Glandula infraorbitalis einiger Säugetiere. Anat. Anz., Bd. 10, S. 123-130.  
1894 a Zur Kenntnis der Glandula submaxillaris einiger Säugetiere. Anat. Anz. Bd., 9, S. 223-229. White rat, pp. 224-225.  
1897 Note sur la structure fine des glandes de Cowper du rat blanc. Bibliogr. Anat., T. 4, pp. 168-170. (1 text fig.)  
1900 Drüsenstudien. II. Die Gl. infraorbitalis und eine besondere der Parotis anliegende Drüse bei der weissen Ratte. Arch. f. mikr. Anat., Bd. 56, S. 535.  
1908 Drüsenstudien. III. Die Unterkieferdrüse des Igels und der weissen Ratte. Arch. mikr. Anat. Bd. 71, S. 588-666.
- LOGHEM, J. J. VAN 1908 Some notes on the morphology of *Spirochaeta duttoni* in the organs of rats. Ann. trop. Med. Parasit., vol. 1, pp. 521-525.
- LOGHEM, J. J. VAN AND SWELLENGREBEL, N. H. 1914 Kontinuierliche und metastatische Pestverbreitung. Ztschr. f. Hyg. u. Infektionskrankh., Bd. 77, S. 460.
- LOISEL, GUSTAVE 1904 Sur les sécrétions chimiques de la glande génitale mâle (A propos d'une prétendue glande interstitielle du testicule). Compt. rend. Soc. de Biol., T. 56, pp. 27-30.
- LOMBROSO, UGO AND BOLAFFIO, MICHELE 1909 La Parabiosi e la Questione dei Fattori che determinano la Funzione mammaria e l'insorgenza del travaglio di parto. Atti della Soc. Ital. di Ostet. e Gin., T. 15.

- LONG, J. A. 1912 The living eggs of rats and mice with a description of apparatus for obtaining and observing them. Univ. of Calif. Publ., Zool. Ser., vol. 9, pp. 105-136.
- 1916 Hygienic cages for rats and mice. Anat. Rec., vol. 11, pp. 103-106.
- LONG, J. A. AND QUINSO, J. E. 1916 The ovulation period in rats. Science, vol. 44, December 1st.
- LONG, J. A. 1919 The oestrous cycle in rats. Proc. Am. Soc. of Zool., in Anat. Rec., vol. 15, p. 352.
- LONG, J. A. AND EVANS, H. N. 1920 A characteristic sign of pregnancy in the rat detectable from the thirteenth to the sixteenth day. Proc. of the Am. Assoc. of Anatomists in Anat. Record, vol. 18, p. 249.
- LONG, J. A. AND EVANS, H. M. 1922 The oestrous cycle in the rat and its associated phenomena. Experimental studies in the physiological anatomy of reproduction. Memoirs of the Univ. of Cal., vol. 6.
- LONGCOPE, W. T. 1922 Insusceptibility to sensitization and anaphylactic shock. J. of Exper. Med., vol. 36, pp. 627-643.
- LONGMAN, HEBER A. 1916 Notes on classification of common rodents with list of Australian species. Commonwealth of Australia—Quarantine Service. Service Pnb. no. 8.
- LÖNNBERG, EINAR 1906 Contributions to the fauna of South Georgia. I. Taxonomic and biological notes on vertebrates. Kungl. Svenska Vetenskapssakademien Handlingar, Bd. 40.
- LÖNS, H. 1908 *Mus rattus* in Celle. Jahresber. nat. Ges., Hannover, pp. 41-42.
- LOVÉN, C. 1868 Bidrag till kännedomen om tungans smakpapiller. Med. Arch. Stockholm, vol. 3, 1866-1867. Trans. Beiträge zur Kenntnis vom Bau der Geschmackswürzchen der Zunge. Arch. f. mikr. Anat., vol. 4, pp. 96-110.
- LOWREY, LAWSON G. 1913 The growth of the dry substance in the albino rat. Anat. Record, vol. 7, pp. 143-168.
- LÖWY, ROBERT 1910 Zur Frage der superfiziellen Körnerschichte und Markscheidenbildung des Kleinhirns. Ihre Beziehungen zum Lokalisationsproblem und zur Gehfähigkeit. Arbeiten aus dem Neurol. Institute an der Wiener Universität, Bd. 18, S. 251-293. *Mus Rattus* S. 263-264.
- LUKE, I. A. 1917 Faunal conditions in South Georgia Islands. Science, vol. 45, no. 1169, May 25th, pp. 502-503.
- LUND, CHARLES C., SHAW, LOUIS A. AND DRINKER, CECIL K. 1921 Quantitative distribution of particulate material (manganese dioxide) administered intravenously to the dog, rabbit, guinea-pig, rat, chicken and turtle. J. Exp. Med., vol. 33, pp. 231-238.
- LUSK, GRAHAM 1919 The elements of the science of nutrition. W. B. Saunders Co., Phila., p. 414.
- LYMAN, J. F. 1917 Metabolism of fats. II. The effect of feeding free palmitic acid, glyceryl palmitate, and ethyl palmitate on the depot fat in the white rat. J. Biol. Chem., vol. 32, pp. 13-16.
- LYNCH, KENNETH M. 1915 The rat a carrier of a dysenteric ameba. J. of Am. Med. Assoc., vol. 65, pp. 2232-2234.
- 1915 a The trichomonas as a parasite of man and certain lower animals. Tr. Pan-American Med. Cong.
- MACARTHUR, C. G. AND JONES, O. C. 1917 Some factors influencing the respiration of ground nervous tissue. J. Biol. Chem., vol. 32, pp. 259-274. Rat p. 272
- MCCANN, GERTRUDE F. AND BARNETT, MARION 1922 Experimental rickets in rats. IX. The distribution of phosphorus and calcium between the skeleton and soft parts of rats on rachitic and non-rachitic diets. J. of Biol. Chem., vol. 54, pp. 203-212.
- MCCARRISON, ROBERT 1914 The pathogenesis of experimentally produced goitre. Indian J. Medical Research, vol. 2, pp. 183-213.
- 1914 a Experimental researches on the etiology of endemic goitre. Indian J. Medical Research, vol. 2, pp. 214-226.
- MCCARTNEY, J. L. 1923 Studies on the mechanism of sterilization of the female by spermotoxin. Am. J. of Physiol., vol. 63, pp. 207-217.
- 1923 a Further observations on the antigenic effects of semen. Mechanism of sterilization of female rat from injections of spermatozoa. Am. J. of Physiol., vol. 66, pp. 404-407.
- MCCLENDON, J. F. 1922 Calcium phosphate metabolism showing the prevention of rickets by feeding clear grades of flour. Proc. of the Soc. for Exper. Biol. and Med., vol. 19, pp. 356-359.
- 1922 a The diagnostic value of phosphate metabolism in experimental rickets. Proc. of the Soc. for Exper. Biol. and Med., vol. 19, pp. 412-413.
- 1922 b Calcium phosphate metabolism in the diagnosis of rickets. Am. J. of Physiol., vol. 61, pp. 373-379.
- MCCLENDON, J. F. AND WILLIAMS, AGNES 1923 Experimental goitre and iodine in natural waters in relation to distribution of goitre. Proc. of Soc. for Exper. Biol. and Med., vol. 20, pp. 286-287.
- MCCLENDON, J. F. AND SHUCK, C. 1923 The presence of anti-ophthalmic vitamin and the absence of anti-rachitic vitamin in dried spinach. Proc. of the Soc. for Exper. Biol. and Med., vol. 20, p. 288.
- MCCOLLUM, E. V. 1909 Nuclein synthesis in the animal body. Am. J. Physiol., vol. 25, pp. 120-141. Also in Research Bull. no. 8, Univ. of Wis. Agr. Exper. Station, May, 1910.
- MCCOLLUM, E. V. AND DAVIS, MARGUERITE 1913 The influence of the composition and amount of the



- mineral content of the ration on growth. *J. Biol. Chem.*, vol. 14, no. 2.
- 1913 a The necessity of certain lipins in the diet during growth. *J. Biol. Chem.*, vol. 15, pp. 167-175.
- 1914 Further observations on the physiological properties of the lipins of the egg yolk. *Proc. Soc. Exper. Biol. and Med.*, vol. 11, p. 101.
- 1914 a Observations on the isolation of the substance in butter fat which exerts a stimulating influence on growth. *J. Biol. Chem.*, vol. 19, pp. 245-250.
- 1915 The influence of the plane of protein intake on growth. *J. Biol. Chem.*, vol. 20, pp. 415-428.
- 1915 a Nutrition with purified food substances. *J. Biol. Chem.*, vol. 20, pp. 641-658.
- 1915 b The influence of certain vegetable fats on growth. *J. Biol. Chem.*, vol. 21, pp. 179-182.
- 1915 c The influence of the composition and amount of the mineral content of the ration on growth and reproduction. *J. Biol. Chem.*, vol. 21, pp. 615-643.
- 1915 d The nature of the dietary deficiencies of rice. *J. Biol. Chem.*, vol. 23, pp. 181-230.
- 1915 e The essential factors in the diet during growth. *J. Biol. Chem.*, vol. 23, pp. 231-246.
- 1915 f The cause of the loss of nutritive efficiency of heated milk. *J. Biol. Chem.*, vol. 23, pp. 247-254.
- McCOLLUM, E. V., SIMMONDS, N. AND PITZ, W. 1916 The distribution of the fat soluble A, the growth-promoting substance of butter fat, in the naturally occurring foodstuffs. *Proc. of Soc. for Exp. Biol. and Med.*, vol. 13, pp. 123-143.
- 1916 a The nature of the dietary deficiencies of the wheat embryo. *J. Biol. Chem.*, vol. 25, pp. 105-131.
- 1916 b The relation of the unidentified dietary factors, the fat-soluble A, and water-soluble B, of the diet to the growth-promoting properties of milk. *J. Biol. Chem.*, vol. 27, pp. 33-43.
- 1916 c Dietary deficiencies of the maize kernel. *J. Biol. Chem.*, vol. 28, pp. 153-165.
- 1916 d The effects of feeding the proteins of the wheat kernel at different planes of intake. *J. Biol. Chem.*, vol. 28, pp. 211-229.
- 1916 e Is lysine the limiting amino-acid in the proteins of wheat, maize or oats? *J. Biol. Chem.*, vol. 28, pp. 483-499.
- 1916 f The vegetarian diet in the light of our present knowledge of nutrition. *Am. J. Physiol.*, vol. 41, pp. 333-375.
- McCOLLUM, E. V. 1917 The supplementary dietary relationship among our natural foodstuffs. *J. Am. Med. Assoc.*, vol. 68, pp. 1379-1386.
- McCOLLUM, E. V. AND PITZ, W. 1917 The "vitamine" hypothesis and deficiency diseases. *J. Biol. Chem.*, vol. 31, pp. 229-253.
- McCOLLUM, E. V., SIMMONDS, N. AND PITZ, W. 1917 The nature of the dietary deficiencies of the oat kernel. *J. Biol. Chem.*, vol. 29, pp. 341-354.
- 1917 a The dietary deficiencies of the white bean, *Phaseolus vulgaris*. *J. Biol. Chem.*, vol. 29, pp. 521-536.
- 1917 b The supplementary dietary relationship between leaf and seed as contrasted with combinations of seed with seed. *J. Biol. Chem.*, vol. 30, pp. 13-32.
- McCOLLUM, E. V. AND SIMMONDS, N. 1917 A biological analysis of pellagra-producing diets. I. The dietary properties of mixtures of maize kernel and bean. *J. Biol. Chem.*, vol. 32, pp. 29-61.
- 1917 a A biological analysis of pellagra-producing diets. II. The minimum requirements of the two unidentified dietary factors for maintenance as contrasted with growth. *J. Biol. Chem.*, vol. 32, pp. 181-194.
- 1917 b A biological analysis of pellagra-producing diets. III. The values of some seed proteins for maintenance. *J. Biol. Chem.*, vol. 32, pp. 347-368.
- McCOLLUM, E. V. 1918 The newer knowledge of nutrition. The use of foods for the preservation of vitality and health. The Macmillan Co., N. Y.
- McCOLLUM, E. V. AND SIMMONDS, N. 1918 A study of the dietary essential, water-soluble B, in relation to its solubility and stability towards reagents. *J. Biol. Chem.*, vol. 33, pp. 55-89.
- 1918 a A biological analysis of pellagra-producing diets. IV. The causes of failure of mixtures of seeds to promote growth in young animals. *J. Biol. Chem.*, vol. 33, pp. 303-311.
- 1918 b The nursing mother as a factor of safety in the nutrition of the young. *Am. J. Physiol.*, vol. 46, pp. 275-313.
- McCOLLUM, E. V., SIMMONDS, N. AND PARSONS, H. T. 1918 A biological analysis of pellagra-producing diets. V. The nature of the dietary deficiencies of a diet derived from peas, wheat flour, and cottonseed oil. *J. Biol. Chem.*, vol. 33, pp. 411-423.
- 1918 a The dietary properties of the potato. *J. Biol. Chem.*, vol. 36, pp. 197-210.
- 1919 Supplementary relationships between the proteins of certain seeds. *J. Biol. Chem.*, vol. 37, pp. 155-178.
- 1919 a The dietary properties of the pea (*Vicia sativa*). *J. Biol. Chem.*, vol. 37, pp. 287-301.
- 1919 b A biological analysis of pellagra-producing diets. VI. Observations on the faults of certain diets comparable to those employed by man in pellagrous districts. *J. Biol. Chem.*, vol. 38, pp. 113-146.
- McCOLLUM, E. V., SIMMONDS, NINA AND PARSONS, H. T. 1921 Supplementary protein values in foods. I. The nutritive properties of animal tissues. *J. of Biol. Chem.*, vol. 47, pp. 111-137.
- 1921 a Supplementary protein values in foods. II. Supplementary dietary relations between animal tissues and cereal and legume seeds. *J. of Biol. Chem.*, vol. 47, pp. 139-173.

- 1921 b Supplementary protein values in foods. III. The supplementary dietary relations between the proteins of the cereal grains and the potato. *J. of Biol. Chem.*, vol. 47, pp. 175-206.
- 1921 c Supplementary protein values in foods. IV. The supplementary relations of cereal grain with cereal grain; legume seed with legume seed; and cereal grain with legume seed; with respect to improvement in the quality of their proteins. *J. of Biol. Chem.*, vol. 47, pp. 207-234.
- 1921 d Supplementary protein values in foods. V. Supplementary relations of the proteins of milk for those of cereals and of milk for those of legume seeds. *J. of Biol. Chem.*, vol. 47, pp. 235-247.
- McCOLLUM, E. V., SIMMONDS, NINA, PARSONS, H. T., SHIPLEY, P. G., AND PARK, E. A. 1921 Studies on experimental rickets. I. The production of rachitis and similar diseases in the rat by deficient diets. *J. of Biol. Chem.*, vol. 45, pp. 333-341.
- McCOLLUM, E. V., SIMMONDS, NINA, SHIPLEY, P. G. AND PARK, E. A. 1921 Studies on experimental rickets. IV. Cod liver oil as contrasted with butter fat in the protection against the effects of insufficient calcium in the diet. *Proc. of the Soc. for Exp. Biol. and Med.*, vol. 18, pp. 275-277.
- 1921 a Studies on experimental rickets. VI. The effects on growing rats diets deficient in calcium. *Am. Jour. Hyg.*, of vol. 1, p. 492.
- 1921 b Studies on experimental rickets. VIII. The production of rickets by diets low in phosphorus and fat-soluble A. *J. of Biol. Chem.*, vol. 47, pp. 507-527.
- 1921 c A delicate biological test for calcium-depositing substances. *Proc. of the Soc. for Exper. Biol. and Med.*, vol. 19, pp. 123-125.
- McCOLLUM, E. V., AND SIMMONDS, NINA 1922 The potency of commercial vitamin preparations. *J. of the Am. Med. Assoc.*, vol. 78, pp. 1953-1957.
- McCOLLUM, E. V., SIMMONDS, NINA AND KINNEY, E. M. 1922 The relation of nutrition to tooth development and tooth preservation. I. A preliminary study of gross maxillary and dental defects in 220 rats on defective and deficient diets. *Johns Hopkins Hospt. Bull.*, vol. 33, p. 202.
- 1922 a Studies on experimental rickets. XVII. The effects of diets deficient in calcium and in fat-soluble A in modifying the histological structure of the bones. *Am. J. of Hygiene*, vol. 2, pp. 97-106.
- McCOLLUM, E. V., SIMMONDS, NINA AND BECKER, J. E. 1922 On a type of ophthalmia caused by unsatisfactory relations in the inorganic portion of the diet. An ophthalmia not due to starvation for fat-soluble A, and not curable by its administration. *J. of Biol. Chem.*, vol. 53, pp. 313-321.
- 1922 a Studies on experimental rickets. XXI. An experimental demonstration of the existence of a vitamin which promotes calcium deposition. *J. of Biol. Chem.*, vol. 53, pp. 293-312.
- McCOLLUM, E. V., SIMMONDS, NINA, SHIPLEY, P. G., AND PARK, E. A. 1922 Studies on experimental rickets. XII. Is there a substance other than fat-soluble A associated with certain fats which plays an important rôle in bone development? *J. of Biol. Chem.*, vol. 50, pp. 5-30.
- 1922 a Studies on experimental rickets. XVI. A delicate biological test for calcium-depositing substances. *J. of Biol. Chem.*, vol. 51, pp. 41-49.
- 1922 b Studies on experimental rickets. XXII. Conditions which must be fulfilled in preparing animals for testing the anti-rachitic effect of individual foodstuffs. *Johns Hopkins Hospt. Bull.*, vol. 33, page 296.
- McCOLLUM, E. V., SIMMONDS, N., BECKER, J. E. AND SHIPLEY, P. G. 1922 Studies on experimental rickets. XXIII. The production of rickets in the rat by diets consisting essentially of purified food substances. *J. of Biol. Chem.*, vol. 54, pp. 249-252.
- McCoy, GEORGE W. 1908 Distribution of the leprosy-like disease of rats in San Francisco, Cal. *Pub. Health Rep. U. S. Mar. Hosp. Serv.*, Wash., vol. 23, p. 1601.
- 1908 a Pathological conditions found in rats; observations based upon examination of 50,000 rats in the laboratory of the Public Health and Marine Hospital Service, San Francisco, Cal. *Pub. Health Rep. U. S. Mar. Hosp. Serv.*, Wash., vol. 23, pp. 1365-1371.
- 1909 The keeping and handling of rats for laboratory purposes. *N. Y. Med. J.*, vol. 89, p. 275.
- 1909 a A preliminary report on tumors found in wild rats. *Jour. Med. Research*, vol. 16, n.s., pp. 285-296.
- 1910 Plague infection in rats. Found in "The rat and its relation to the public health," pp. 29-48. *Treasury Dept. Publ. Health and Mar. Hospt. Service of the U. S. Government Printing Office*, Wash., D. C.
- 1910 a Organic diseases of the rat, including tumors. Found in "The rat and its relation to the public health," pp. 59-68. *Treasury Dept. Publ. Health and Mar. Hospt. Service of the U. S. Government Printing Office*, Wash., D. C.
- MACCURDY, HANSFORD AND CASTLE, W. E. 1907 Selection and cross-breeding in relation to the inheritance of coat pigments and coat-patterns in rats and guinea-pigs. *Carnegie Inst.*, Wash., Pub. no. 70.
- MACDONALD, MARGARET B. AND McCOLLUM, E. V. 1921 The "Bios" of Wildiers and the cultivation of yeast. *J. of Biol. Chem.*, vol. 46, pp. 525-527.
- MACDONALD, MARGARET B. 1922 The synthesis of water-soluble B by yeast grown in solutions of purified nutrients. *J. of Biol. Chem.*, vol. 54, pp. 243-248.
- MACDOWELL, E. C. AND VICARI, E. M. 1917 On the growth and fecundity of alcoholized rats. *Proc. of the Nat. Acad. of Sciences*, vol. 3, pp. 577-579.

- MACDOWELL, E. C. 1919 The influence of parental alcoholism upon habit formation in albino rats. *Proc. of the Soc. for Exp. Biol. and Med.* vol. 16, pp. 125-126.
- MACDOWELL, E. C. AND VICARI, E. M. 1921 Alcoholism and the behavior of white rats. I. The influence of alcoholic grandparents upon maze-behavior. *Jour. Exp. Zool.*, vol. 33, pp. 209-292.
- MACDOWELL, E. C. 1921 Alcohol and white rats: a study of fertility. *Proc. of the Soc. for Exper. Biol. and Med.*, vol. 19, pp. 69-71.
- MACDOWELL, E. C. 1922 The influence of alcohol on the fertility of white rats. *Genetics*, vol. 7, pp. 117-141.
- 1922 a Alcoholism and the growth of white rats. *Genetics*, vol. 7, pp. 427-445.
- 1922 b Experiments with alcohol and white rats. *Am. Naturalist*, vol. 56, pp. 289-311.
- 1923 Alcoholism and the behavior of white rats. II. The maze-behavior of treated rats and their offspring. *Jour. Exp. Zool.*, vol. 37, pp. 417-456.
- 1924 Experiments with rats on the inheritance of training. *Science*, vol. 59, pp. 302-303, March 28th.
- MACGILLAVRY, T. H. 1875 Les dents incisives du *Mus decumanus*. *Arch. Néerl. Sc., exact. et nat.*, Harlem, T. 10, 1 pl. Same as paper in Dutch, 1876.
- 1876 De snijtanden von *M. decumanus*. *Vers. en mededel. der Kon. Akad. v. Wetensch.*, II. R. 9 Amsterdam. 1 pl.
- McMASTER, P. D. 1922 Do species lacking a gall bladder possess its functional equivalent? *J. of Exper. Med.*, vol. 35, pp. 127-146.
- McMUNN, CHARLES A. 1884 On myohaematin, an intrinsic muscle-pigment of vertebrates and invertebrates, on histohaematin and on the spectrum of the suprarenal bodies. *Proc. of Physiol. Soc. in J. of Physiol.*, vol. 5, pp. xxiv-xxvi.
- MACALLUM, A. BRUCE 1919 The relation of vitamins to growth of young animals. *Trans. of the Royal Canadian Institute*, Toronto, pp. 175-241.
- MACCALLUM, D. B. 1923 The distribution of blood vessels in the mammalian kidney. *Proc. Am. Assoc. of Anatomists in Anat. Record*, vol. 25, pp. 143-144.
- MACHT, D. I. AND MORA, C. F. 1920 Effect of the anesthetization on the subsequent behavior and intelligence of albino rats. *Proc. Soc. Exper. Biol. and Med.*, vol. 17, p. 61.
- 1920 a Effect of opiates on memory and behavior of albino rats. *Proc. of the Soc. for Exper. Biol. and Med.*, vol. 17, pp. 163-164.
- MACHT, D. I. AND BLOOM, WILLIAM 1920 Effect of antipyretics on memory and behavior of albino rats. *Proc. of Soc. for Exper. Biol. and Med.*, vol. 18, pp. 27-28.
- 1920 a A pharmacological analysis of the cocaine effect on the behavior of rats in the circular maze. *Archives Internat. de Phar. et de Thérapie*, vol. 25, pp. 379-390.
- 1921 Comparative study of ethanol, caffeine and nicotine on behavior of albino rats. *Proc. of the Soc. for Exper. Biol. and Med.*, vol. 18, pp. 99-100.
- 1921 a The effect of prostatectomy on the behavior and learning of albino rats. *Proc. of the Soc. for Exper. Biol. and Med.*, vol. 18, pp. 100-101.
- MACHT, D. I., BLOOM, W. AND TING, G. C. 1921 Comparative study of ethanol, caffeine and nicotine on the behavior of rats in a maze. *Am. J. Physiol.*, vol. 56, pp. 264-272.
- MACHT, D. I. AND TING, GIU CHING 1922 The effect of some polyhydric alcohols on the behavior of rats in the circular maze. *Am. J. Physiol.*, vol. 60, pp. 496-499.
- MACHT, D. I. AND ULRICH, J. L. 1922 Physiological and pharmacological studies of the prostate gland. V. Effect of prostatectomy on integration of muscular movements. *J. of Urology*, vol. 8, pp. 99-104.
- MACHT, D. I. AND FINESILVER, E. M. 1922 The effect of splenectomy on integration of muscular movements in the rat. *Am. J. of Physiol.*, vol. 62, pp. 525-530.
- MACHT, D. I. 1923 Toxicity of atropin on rats. *J. Pharm. and Exp. Ther.*, vol. 22, p. 25.
- MACHT, D. I. AND TEAGARDEN, E. J. 1923 The effect of ultra-violet rays on rats in the circular maze. *Proc. of the Soc. for Exper. Biol. and Med.*, vol. 20, p. 387.
- MACKEY, H. M. M. 1921 The effect on kittens of a diet deficient in animal fat. *Bio-Chem. J.*, vol. 15, p. 25.
- MACKLIN, C. C. 1917 Notes on the preparation of bones from madder-fed animals. *Anat. Rec.*, vol. 12, pp. 403-405.
- 1917 a Studies in calcification by the use of vital dyes. *J. of Med. Research*, vol. 36 (new series vol. 31), pp. 493-507.
- 1919 The development and function of macrophages in the repair of experimental bone-wounds in rats vitally stained with trypan-blue. *Extract from Pub. 272 of the Carnegie Inst. of Washington*, pp. 1-48. *Con. to Embryology* no. 27.
- MACKLIN, C. C. AND MACKLIN, M. T. 1920 A study of brain repair in the rat by the use of trypan blue; with special reference to the vital staining of the macrophages. *Archives of Neurol. and Psychiatry*, vol. 3, pp. 353-395.
- MACLEOD, J. J. R. 1907 Observations on the excretion of carbon dioxide gas and the rectal temperature of rats kept in a warm atmosphere which was either very moist or very dry. *Am. J. Physiol.*, vol. 18, pp. 1-13.

- MACOMBER, DONALD 1923 The threshold of fertility in rats and its relation to diet deficiency. *Am. Naturalist*, vol. 57, pp. 519-531.
- MAEDER, LEROY M. A. 1922 Changes in the mammary gland of the albino rat (*Mus norvegicus albinus*) during lactation and involution. *Am. Jour. Anat.*, vol. 31, pp. 1-26.
- MAJOR, C. J. FORSYTH *Mus rattus* remains at Molina di Anosa—near Pisa. Quoted at length by Baumgart, 1904, p. 8.
- MALLORY, F. B. AND ORDWAY, THOMAS 1909 Lesions produced in the rat by a typhoid-like organism—Danysz virus. *J. Am. Med. Assoc.*, vol. 52, p. 145.
- MANN, F. C., BRINHALL, S. D. AND FOSTER, J. P. 1920 The extrahepatic biliary tract in common domestic and laboratory animals. *Anat. Rec.*, vol. 18, pp. 47-66. Rat—page 63.
- MANN, F. C. 1920 A comparative study of the anatomy of the sphincter at the duodenal end of the common bile-duct with special reference to species of animals without a gall bladder. *Anat. Rec.*, vol. 18, pp. 355-360. Hepatic duct of rat—Figs. 3 and 4.
- MANOUVRIER, L. 1905 Un rapt de progéniture entre femelles de rat blanc. *Bull. de l'Inst. gén. psychol.*, T. 5, pp. 165-169.
- MARCHOUX, E. 1910 Les migrations du bacille de la lèpre. *Lepra*, vol. 11, pp. 57-60. (II. Internationale wissenschaftliche Lepra-Konferenz abgehalten vom 16 bis 19 August, 1909, in Bergen. III. Band. Leipzig.)
- 1911 Culture d'un bacille acido-résistant provenant du mucus nasal des lépreux. (Note préliminaire. *Bull. Soc. path. exot.*, T. 4, pp. 89-91.
- 1911 and 1912 Human leprosy and rat leprosy; a discussion of their respective problems. *Tr. Soc. Trop. M. and Hyg.*, vol. 5, pp. 184-189.
- 1912 Rôle des infections secondaires dans le développement de la lèpre du rat. *Bull. Soc. path. exot.*, T. 5, pp. 466-468.
- MARCHOUX, E. AND SORÉL, F. 1912 *Lepra murium*; infection et maladie ne sont pas synonymes. *Compt. rend. Soc. de Biol.*, T. 72, pp. 169-171.
- 1912 a Lèpre des rats; comparaison avec la lèpre humaine. *Compt. rend. Soc. de Biol.*, T. 72, pp. 214-217.
- 1912 b Lèpre des rats; inoculation expérimentale. *Compt. rend. Soc. de Biol.*, T. 72, pp. 269-272.
- 1912 c Recherches sur la lèpre. 1<sup>er</sup> mémoire: La lèpre des rats (*lepra murium*). *Ann. de l'Inst. Pasteur*, T. 26, pp. 675-700.
- MARINE, DAVID 1915 Observations on the etiology of goitre in brook trout. IV. The effect of feeding with fresh and stale liver. *J. Exp. Med.*, vol. 21, pp. 452-454. Rats—page 453
- MARINUS, C. J. 1919 The effect of feeding pars tuberosa and pars anterior propria of bovine pituitary glands upon the early development of the white rat. *Am. J. Physiol.*, vol. 49, pp. 238-247.
- MARK, E. L. AND LONG, J. A. 1912 Studies on early stages of development in rats and mice. No. 3. The living eggs of rats and mice with a description of apparatus for obtaining and observing them. *Univ. Cal. Pub. Zool.*, vol. 9, pp. 105-136.
- MARSHALL, F. H. A. AND JOLLY, W. A. 1907 Results of removal and transplantation of ovaries. *Tr. Roy. Soc., Edinb.*, vol. 45, pp. 589-597.
- 1908 On the results of heteroplastic ovarian transplantation as compared with those produced by transplantation in the same individual. *Quart. J. Exper. Physiol.*, vol. 1, pp. 115-120.
- MARSHALL, JOHN S. 1920 An experimental study, with certain "vital dyes," of the persistent teeth of the albino rat. *J. of Dental Research*, vol. 2, pp. 1-14.
- 1921 A study of the rate of the interstitial growth of the persistent teeth of the albino rat, as shown by vital dyes. *J. of Dental Research*, vol. 3, pp. 241-262. 3 plates.
- MARTIN, CHARLES J. 1895 On the physiological action of the venom of the Australian black snake (*Pseudechis porphyriae*). *J. and Proc. Roy. Soc. of New South Wales, Sydney*, vol. 29, pp. 146-277. Rat among test animals.
- MARTIN, H. N. AND MOALE, W. A. 1844 Handbook of vertebrate dissection. Part III. How to dissect a rodent. Macmillan & Co., N. Y. *Mus decumanus* the rodent used.
- MARTINI, E. 1901 Ueber Inhalationspest der Ratten. *Ztschr. f. Hyg.*, Bd. 38, S. 332.
- MARTINOTTI, GIOVANNI 1899 Le reti nervose del fegato e della milza scoperte dal Prof. G. Rattone. *Gior. d. r. Accad. di med. di Torino, Anno 54*, vol. 37, pp. 15-30.
- MARUYAMA, S. 1901 Two cases of poisoning by rats. *Chiugai Iji Shinpo, Tokio*, vol. 22, pp. 289-295.
- MATTHES, M. AND MARQUARDSEN, E. 1898 Über die Reaktion des Dünndarminhaltes. *Verhandl. des Congresses für innere Med. XVI. Wiesbaden*, S. 358-365.
- MATTILL, H. A. AND CONKLIN, RUTH E. 1920 The nutritive properties of milk, with special reference to reproduction in the albino rat. *J. Biol. Chem.*, vol. 44, pp. 137-158.
- MATTILL, H. A. 1921 The influence of fasting and of vitamin B deprivation on the non-protein nitrogen of rat's blood. *Science, N. S.*, vol. 54, no. 1391, August 26th.
- 1923 The utilization of carbohydrate by rats deprived of vitamin B. *J. of Biol. Chem.*, vol. 55, pp. 717-727.
- 1923 a The effect of fasting and of vitamin B deprivation on the chemical composition of rats' blood. *Proc. of the Soc. for Exper. Biol. and Med.*, vol. 20, pp. 537-538.

- MATTILL, H. A. AND STONE, N. C. 1923 The nutritive properties of milk with special reference to reproduction in the albino rat. II. J. of Biol. Chem., vol. 55, pp. 443-455.
- MATTILL, H. A. AND CARMAN, J. S. 1923 The degeneration of the testis of rats on a milk diet. Proc. of the Soc. for Exper. Biol. and Med., vol. 20, p. 420.
- MAVROJANNIS 1903 L'action cataleptique de la morphine chez les rats. Contribution à la théorie toxique de la catalepsie. Compt. rend. Soc. de Biol., T. 55, p. 1092.
- MAXIMOW, ALEXANDER 1910 Untersuchungen über Blut und Bindegewebe. III. Die embryonale Histogenese des Knochenmarks der Säugetiere. Arch. f. mikr. Anat., Bd. 76, S. 1-113. Table 3, figs. 29-33. Table 4, fig. 40.
- MAYER, ANDRÉ AND SCHAEFFER, GEORGES 1914 Recherches sur les constantes cellulaires. Teneur des cellules en eau. J. de Physiol. et de Pathol. Générale, T. 16, pp. 1-16, and 23-38. Also work on the rat's brain.
- MAYER, F. J. C. 1843 Ueber die Zunge als Geschmackorgan. Nov. Act. Acad. C. L.-C. nat. cur., Bd. 20, S. 721-748. 4 pl. Mentions *Mus rattus* among other forms.
- MAYER, S. 1891 Adenologische Mitteilungen. Anat. Anz., Bd. 10, S. 177-191. Rat, S. 179.
- MAYNARD, L. A., FRONDA, F. M., AND CHEN, T. C. 1923 The protein efficiency of combinations of cornmeal and certain other feedingstuffs, notably rice bran. J. of Biol. Chem., vol. 55, pp. 145-155.
- MAZZARELLI, G. F. 1890 Sulla struttura dello stomaco del *Mus decumanus* Pall, var. alba, e del *Mus musculus* L. Internat. Monatschr. Anat. Phys. vol. 7, pp. 91-96, T. 8 (1) pl. VIII, figs. 1, 3 and 4. *M. decumanus* var. alba.
- MEDIGRECEANU, F. 1910 Ergebnisse eines Fütterungsversuches bei Ratten die überimpfte Tumoren trugen. Berlin, klin. Wochenschr., No. 17.
- 1910 a On the relative sizes of the organs of rats and mice bearing malignant new growths. Roy. Soc. Proc., B., vol. 82, p. 286.
- MEEK, ALEXANDER 1899 On the post-embryonal history of voluntary muscles in mammals. J. Anat. and Physiol., vol. 33, p. 601.
- MEEK, WALTER J. 1907 A study of the choroid plexus. J. Comp. Neur. and Psychol., vol. 17, no. 3, pp. 286-306.
- MEKLEJOHN, JEAN 1914 On the innervation of the nodal tissue of the mammalian heart. J. of Anat. and Physiol., vol. 48, pp. 1-18.
- 1914 a On the topography of the intracardiac ganglia of the rat's heart. Journ. Anat. and Physiol. vol. 48, pp. 378-390.
- MEINARDUS, OTTO 1882 Der historische Kern der Hameler Rattenfängersage. Ztschr. des Historischen Vereins für Niedersachsen. Hahn'sche Buchhandlung. Hannover.
- MELISSINOS, KONST. 1907 Die Entwicklung des Eies der Mäuse (*Mus musculus* var. alba u. *Mus rattus* albus) von den ersten Furchungs-Phänomenen bis zur Festsetzung der Allantois an der Ectoplacentarplatte. Arch. f. mikr. Anat., Bd. 70, S. 577-648.
- MELLANBY, EDWARD 1908 Creatin and creatinin. J. Physiol., vol. 36, pp. 417-437. Rat, p. 47.
- MELLANBY, E. 1919 An experimental investigation on rickets. Lancet, vol. 1, pp. 407-412.
- MELLER, J. 1923 Bemerkungen zur Frage der Überpflanzung von Rattenaugen. Zeitschr. für Augenheilkunde, Bd. 50.
- MENDEL, L. B. AND DANIELS, AMY L. 1912 The behavior of fat-soluble dyes and stained fat in the animal organism. J. Biol. Chem., vol. 13, p. 71.
- MENDEL, L. B. 1913 The rôle of proteins in growth. Trans. XV Internat. Congress on Hyg. and Demography.
- 1922 Experimental evidence of the lack of vitamin B in nutrition. Trans. of the Congress of Am. Physicians and Surgeons, vol. 12, pp. 15-22.
- MEREZHKOVSKI, S. S. 1903 O sudbie v Rossii i Japonii batsilla predlozhennavo mnoyu dlya istrebleniya mishei. (Fate in Russia and Japan of the bacillus proposed by me for the extermination of rats.) Arch. vet. nauk., St. Petersburg., vol. 33, pp. 825-848.
- MERESHKOWSKY, S. S. AND SARIN, E. 1909 Ueber das Ratin II. Centralbl. f. Bakteriöl., 1 Abt., Jena, Bd. 51, S. 6-10.
- MERESHKOWSKY, S. S. 1912 Der Einfluss der Passagen durch graue Ratten (*Mus decumanus*) auf die Virulenz des *Bacillus Danysz*. Centralbl. f. Bakteriöl., Bd. 64, S. 3-68.
- 1912 a Die Wirkung der 186.-515. in 10 proz. Nöhnereweissdekot erwachsenen Generationen des *Bacillus Danysz* auf graue Ratten (*Mus decumanus*). Centralbl. f. Bakteriöl., 1 Abt., Bd. 65, S. 482-488.
- MESSER 1889 Das Vorkommen der Hausratte, *Mus rattus*, in Bremen. Zoolog. Garten, 30 Jahrg., S. 26-27.
- MESSERLI, F. 1914 Contribution à l'étude de l'étiologie du goitre endémique. Goitres expérimentaux produits chez des rats blancs par alimentation avec de l'eau d'une zone à goitre. Centralbl. f. Bacteriol. u. Parasitenkunde (originale), T. 75, pp. 211-219.
- METSCHNIKOFF AND ROUX 1891 Sur la propriété bactéricide du sang de rat. Ann. de l'Inst. Pasteur no. 8, p. 479. Also Centralbl. f. Bacteriol., T. 10, p. 756.
- MEVES, F. 1898 Ueber das Verhalten der Centralkörper bei der Histogenese der Samenfäden von Mensch und Ratte. Verhandl. d. anat. Gesellschaft. 12 Vers., S. 91-98. Diss. S. 98-100.

- MEYER, A. W. 1913 Haemal nodes in some carnivora and rodents. *Anat. Anz.*, vol. 45, pp. 257-271.
- MEYER, NICHOLAUS 1800 *Prodromus Anatomiae Murium*. Inaug.-Diss. Jena, 40 pp., 2 pl. (50 figs.). Copper plates based on mouse—figures enlarged by G. Givès teeth and ear bones. Dedicated to Goethe.
- MEYERHEIM, MARTIN 1898 *Beiträge zur Kenntnis der Entwicklung der Schneidezähne bei Mus decumanus*. Inaug. Diss. Universität Leipzig. Pöschel & Trepte, Leipzig.
- MEYERSON, F. 1913 Die Dicke der spinalen Trigeminalswurzel bei verschiedenen Säugern. *Folia Neuro-Biol.*, Bd. 7, S. 217-220.
- MIDDENDORF, A. V. 1875 Reise in den äussersten Norden und Osten Sibiriens. Bd. 4 Uebersicht der Natur Nord und Ost-sibiriens. Teil. 2. St. Petérsburg, Kommission d. Akademie.
- MILTENS, H. 1908 Zur Kenntnis des Thymusreticulum und seiner Beziehungen zu dem der Lymphdrüsen nebst einigen Bemerkungen über die Winterschlagdrüse. *Jenaische Ztschr. f. Naturw.*, Bd. 44, S. 149-192.
- MIGNON, HELEN L. 1923 Biological food tests. IV. The protein and the vitamin A content of the English walnut. *Am. J. of Physiol.*, vol. 66, pp. 215-231.
- MILLAIS, J. G. 1904 *Mammals of Great Britain and Ireland*. 4<sup>o</sup>. Pp. 203-232. Excellent colored plates for *Mus norvegicus* and *Mus rattus*.  
1905 The true position of *Mus rattus* and its allies. *Ipl.*, 2 figs. *The Zoologist*, ser. 4, vol. 9, pp. 201-207. Figures of *Mus rattus ater*.
- MILLER, GERRIT S., JR. 1910 The generic name of the house rat. *Proc. Biol. Soc. Wash.*, vol. 23, pp. 57-60.
- MILLER, HARRY G. 1923 Potassium in animal nutrition. II. Potassium in its relation to the growth of young rats. *J. of Biol. Chem.*, vol. 55, pp. 61-78.
- MILLER, NEWTON 1911 Reproduction in the brown rat (*Mus norvegicus*). *Am. Naturalist*, vol. 45, pp. 623-635.
- MILLER, S. P. 1922 Effects of various types of inanition upon the mitochondria in the gastro-intestinal epithelium and in the pancreas of the albino rat. *Anat. Rec.*, vol. 23, pp. 205-210.
- MILLER, W. S. 1893 The structure of the lung. *J. Morphol.*, vol. 8, pp. 165-188. 3 plates and other illustrations in text. Rat used with other mammals.
- MILLER, W. W. 1908 Hepatozoon perniciosum (N. G., N. Sp.); a haemogregarine pathogenic for white rats; with a description of the sexual cycle in the intermediate host, a mite (*Lelaps echidninus*). *Hygienic Lab. Bull.* No. 46, Government Printing Office—Washington, D. C.
- MILLS, C. A., DORST, S. E., MYNCHENBERG, G. AND NAKAYAMA, J. 1923 Absorption from the intestine and excretion through the kidney of an unaltered complex protein substance, tissue fibrinogen. *Am. J. of Physiol.*, vol. 63, pp. 484-498.
- MILLS, WESLEY 1897 The functional development of the cerebral cortex in different groups of animals. *Trans. R. Soc. Canada*, vol. 2, Sect. IV, pp. 3-18.
- MILNE-EDWARDS See EDWARDS, MILNE.
- MINCHIN, E. A. AND THOMSON, J. D. 1911 On the occurrence of an intracellular stage in the development of trypanosoma *Lewisii* in the rat-flea. *Brit. M. J.*, Lond., vol. 2, pp. 361-364.  
1915 The rat trypanosome, *Trypanosoma lewisi*, in its relation to the rat-flea, *Ceratophyllus fasciatus*. *Quart. Jour. Micro. Science*, vol. 60, pp. 463-692.
- MINGAZZINI, G. 1901 La secrezione interna nell'assorbimento intestinale. *Ricerca Lab. Anat. Roma e altri Lab. Biologica*, T. 8, pp. 115-130.
- MINOT, C. S. 1900 On a hitherto unrecognized form of blood circulation without capillaries in the organs of vertebrata. *Proc. of Boston Soc. of Nat. Hist.*, vol. 29, pp. 185-215. p. 207, Suprarenal capsule—rat.
- MITCHELL, HELEN S. AND MENDEL, L. B. 1921 The choice between adequate and inadequate diet, as made by rats and mice. *Am. J. Physiol.*, vol. 58, pp. 211-225.
- MITCHELL, HELEN S. 1922 Reproduction on "synthetic" diets when purified agar is added to the mixture. *Am. J. of Physiol.*, vol. 62, pp. 557-558.
- MITCHELL, H. H., SHONLE, H. A. AND GRINDLEY, H. S. 1916 The origin of the nitrates in the urine. *J. Biol. Chem.*, vol. 24, pp. 461-490. Rat pp. 484-485.
- MITCHELL, H. H. 1918 The influence of protein feeding on the concentration of amino-acids and their nitrogenous metabolites in the tissue. *J. Biol. Chem.*, vol. 36, pp. 501-520.
- MITCHELL, H. H., NEVENS, W. B. AND KENDALL, F. E. 1922 The relation between the endogenous catabolism and the non-protein constituents of the tissues. *J. of Biol. Chem.*, vol. 52, pp. 417-437.
- MITCHELL, O. W. II. 1912 *Bacillus muris* as the etiological agent of pneumonitis in white rats and its pathogenicity for laboratory animals. *J. Infect. Dis.*, vol. 10, pp. 17-23.
- MITCHELL, O. W. H., AND GROUP, GEORGE A. 1919 Experimental study of the rat as a typhoid carrier. Paper given at the Congress of Am. Physicians and Surgeons, Atlantic City, June 17th (not published).
- MITCHELL, P. C. 1911 Longevity. (Rat, 5-6 years.) *Encyc. Britannica*, 11th ed., vol. 16, p. 976 (middle of first column).
- MIURA, M. AND TORIYAMA, N. 1897 Ueber den Rattenbiss (Japanese text). *Ztschr. d. med. Gesellsch. zu Tokyo*, Bd. 11, S. 1059-1064.

- MIYAJIMA, M. 1902 Addendum to the records concerning the bubonic plague at Yokohama. (Review of statements found in various natural history books and also Chinese classics.) Reprinted from Reports made by the Bureau for Destruction of Rats, 38 pages in Japanese.
- MIYAKE, H. 1899 Ueber die Rattenbisskrankheit. Mitt. a. d. Grenzgeb. d. Med. u. Chir., Jena. Bd. 5, S. 231-262.
- MOJSISOVICS, VON MOJSVÁR 1897 Das Tierleben der österr.-ungar. Tiefseefisch. Wien, Hölder, 1897.
- MOLL, ARTHUR M. 1911 Animal parasites of rats at Madison, Wisconsin. Journ. Parasitology, vol. 4, pp. 89-90.
- MONTANE, M. 1889 De la cytodierèse dans le testicule du rat. Compt. rend. Soc. de biol., Paris, T. 1, 9th series.
- MONTGOMERY, M. L. 1923 The effect of the ablation of the superior cervical sympathetic ganglia upon the continuance of life. Endocrinology, vol. 7, pp. 74-80.
- MOORE, BENJAMIN, NIERENSTEIN, M. AND TODD, J. L. 1907 On the treatment of trypanosomiasis by atoxyl (an organic arsenical compound), followed by a mercuric salt (mercuric chloride) being a biochemical study of the reaction of a parasitic protozoon to different chemical reagents at different stages of its life history. Bio-Chemical I., vol. 2, pp. 300-324.
- MOORE, CARL R. 1919 On the physiological properties of the gonads as controllers of somatic and psychical characteristics. I. The rat. Jour. Exp. Zool., vol. 28, pp. 137-161.
- 1919 a On the physiological properties of the gonads as controllers of somatic and psychical characteristics. II. Growth of gonadectomized male and female rats. Jour. Exp. Zool., vol. 28, pp. 459-467.
- 1921 On the physiological properties of the gonads as controllers of somatic and psychical characteristics. III. Artificial hermaphroditism in rats. Jour. Exp. Zool., vol. 33, pp. 129-171.
- 1921 a Sex gland transplantation and the modifying effect in rats and guinea pigs. Proc. Am. Soc. of Zool. in Anat. Record, vol. 20, p. 194.
- 1923 Cryptorchidism experimentally produced. Proc. of Am. Soc. of Zool. in Anat. Record, vol. 24, p. 383.
- 1923 a On the relationship of the germinal epithelium to the position of the testis. Proc. Am. Assoc. of Anatomists in Anat. Record, vol. 25, pp. 142-143.
- MORESCHI, C. 1909 Beziehungen zwischen Ernährung und Tumorzustand. Zeitschr. f. Immunitätsforschung, Bd. 2, S. 651-685.
- MORGAN, AGNES F. 1923 Biological food tests. I. Vitamin A in some citrus fruit products. Am. J. of Physiol., vol. 64, pp. 522-537.
- 1923 a Biological food tests. II. Vitamin A in skim milk. Am. J. of Physiol., vol. 64, pp. 538-546.
- MORGAN, AGNES F. AND STEPHENSON, H. D. 1923 Biological food tests. III. Changes in vitamins A and B of the globe artichoke due to various canning and drying processes. Am. J. of Physiol., vol. 65, pp. 491-502.
- MORGAN, AGNES F., NEWBECKER, B. M. AND BRIDGE, ELIZABETH 1923 Biological food tests. V. The biological value of almond proteins and of almond oil. Am. J. of Physiol., vol. 67, pp. 173-192.
- MORGAN, T. H. 1909 Breeding experiments with rats. Am. Naturalist, vol. 43, pp. 182-185.
- MORGULIS, SERGIUS 1911 Studies of inanition in its bearing upon the problem of growth. I. Arch. f. Ent. d. Organ., vol. 32, pp. 169-268.
- MORGULIS, SERGIUS AND GIES, W. J. 1914 The calcium content in bones and teeth from normal and thymectomized albino rats. Jour. Exp. Med., vol. 20, pp. 499-502.
- MORI, S. 1922 Primary changes in eyes of rats which result from deficiency of fat-soluble A in diet. J. of Am. Med. Assoc., vol. 79, pp. 197-200.
- 1922 a The changes in the para-ocular glands which follow the administration of diets low in fat-soluble A, with notes on the effect of the same diets on the salivary glands and the mucosa of the larynx and trachea. Johns Hopkins Hospit. Bull., vol. 33, p. 357.
- 1923 The pathological anatomy of ophthalmia produced by diets containing fat-soluble A, but unfavorable contents of certain inorganic elements. Am. J. of Hygiene, vol. 3, p. 99.
- MORPHEGO, B. 1898 Über die postembryonale entwicklung der quergestreiften Muskeln von weissen ratten. Anat. Anz., Bd. 15, S. 209-205.
- 1899 Ueber die Verhältnisse der Kernwucherung zum Längenwachstum an den quergestreiften Muskelfasern der weissen Ratten. Anat. Anz., Bd. 16, S. 88-91.
- 1899 a Ueber die Regeneration des quergestreiften Muskelgewebes bei neugeborenen weissen Ratten. Anat. Anz., Bd. 16, S. 152-156.
- 1900 Ueber eine infectiöse Form der Knochenbrüchigkeit bei weissen Ratten. Verhandl. d. deutsch. path. Gesellsch., Bd. 3, S. 40.
- 1900 a Ueber eine infectiöse Form der Osteomalacie bei weissen Ratten. Beitr. z. path. Anat. u. z. allg. Path., Bd. 28, S. 620.
- 1901 Ueber eine infectiöse Form von Knochenweichung bei weissen Ratten. Verhandl. d. Versamml. d. Gesellsch. f. Kinderh. deutsch. Natur f. u. Aerzte, Bd. 72.
- 1902 Durch Infection hervorgerufene malacische und rachitische Skelet-veränderungen an jungen weissen Ratten. Centralbl. f. allg. Path. u. path. Anat., Bd. 13, S. 113-119.

- 1905 Studio sull'inizio del processo rachitico nei ratti albini. *Sperimentale*, T. 59, p. 609.
- 1906 Sulla localizzazione del processo di osteomalacia dei topi albini, in rapporto col tiro dei muscoli. *Arch. p. le sc. med.*, T. 30, p. 551.
- 1906 a Sull'osteomalacia e sulla rachitide dei topi albini e sui rapporti fra le due malattie. *Gior. d. r. Accad. di med. di Torino*, T. 12, p. 17.
- 1907 L'ostéomalacie et le rachitisme expérimentaux. *Arch. de méd. expér. et d'anat. path.*, T. 19, p. 119.
- 1907 a Studio sperimentale sull'osteomalacia e sulla rachitide. *Arch. p. le sc. med.*, T. 31, p. 1.
- 1907 b Ueber die infektiöse Osteomalacie und Raehitis der weissen Ratten. *Verhandl. d. deutsch. path. Gesellsch.*, Bd. 11, S. 282.
- 1908 Sulla trasmissione della osteomalacia umana ai topi bianchi. *Gior. d. r. Accad. di med. di Torino*, T. 71, p. 3.
- 1923 Nerve regeneration from one into the other of two rats united in Siamese pairs. *J. of Physiol.*, vol. 58, pp. 98-100.
- MORRELL, G. HERBERT 1872 Supplement to the anatomy of the mammae, containing dissections of the sheep's heart and brain, rat, sheep's head and ox's eye. Longman & Co., London, pp. 153-269.
- MORRIS, J. L. 1914 Protein metabolism of the rat, with special reference to tumor problems. *J. Biol. Chem.*, vol. 14, pp. 509-516.
- MORRIS, J. L. AND REES, H. M. 1923 The effect of diuresis on excretion of uric acid. *Am. J. of Physiol.*, vol. 66, pp. 363-374.
- MOSS, SAMUEL 1835 Notes on the habits of a domesticated white rat and a terrier dog (Flora) that lived in harmony together. *London Mag. Nat. Hist.*, vol. 9.
- MOTTRAM, J. C. AND RUSS, S. 1921 Lymphopenia following exposures of rats to "soft" X-rays and the  $\beta$ -rays of radium. *J. of Exper. Med.*, vol. 34, pp. 271-273.
- MOTTRAM, J. C., CRAMER, W. AND DREW, A. H. 1922 Vitamins, exposure to radium and interstitial fat absorption. *British J. of Exper. Pathol.*, vol. 3, pp. 179-181.
- MOTTRAM, J. C. AND CRAMER, W. 1923 On the general effects of exposure to radium on metabolism and tumor growth in the rat, and the special effects on testis and pituitary. *Quart. J. of Exper. Physiol.*, vol. 13, pp. 209-226.
- MOULTON, C. R. 1923 Age and chemical development in mammals. *J. of Biol. Chem.*, vol. 57, pp. 79-97.
- MOURET, J. 1895 Contribution à l'étude des cellules glandulaires (pancréas). *J. de l'anat. et physiol.* Ann. 31, pp. 221-236, 1 pl. Mainly on frog and salamander. Rat among the mammals examined.
- MUDGE, G. P. 1908 On some features on the hereditary transmission of the self black and the Irish coat characters in rats. *Proc. R. Soc. London*, vol. 80 B, pp. 97-121.
- 1908 a On some features in the hereditary transmission of the albino character and the black piebald coat in rats. *Proc. R. Soc. London*, vol. 80 B, pp. 388-393.
- 1909 Note on the chemical nature of albinism. *J. Physiol.*, vol. 38, p. lxxvii.
- 1910 Article "Albino." *Eneye. Brit.* vol. 1, p. 510 at the bottom, 11th ed. Recognizes 13 genetic types of the albino rat.
- MUELLER, CLAUS 1902 Über die Tyson'schen Drüsen beim Menschen und einigen Säugetieren. Inaug.-Diss. Friedrichs-Universität, Halle-Wittenberg.
- MÜLLER, JOHANNES 1830 De glandularum scernentium structura penitiori earumque prima formatione in homine atque animalibus. Leipzig, 131 pp., 17 pl.
- MÜSCH, FRANCIS 1896 Die Topographie der Papillen der Zunge des Menschen und der Säugethiere. *Morphol. Arb.*, Bd. 6, S. 605-690, 2 pl., 53 text figs. *Rat*, S. 615, 616.
- MURPHY, JAMES B. 1914 Heteroplastie tissue grafting effected through Roentgen-ray lymphoid destruction. *Journ. Am. Med. Assoc.*, vol. 62, p. 1459.
- MURPHY, JAMES B. AND MORTON, J. J. 1915 The lymphocyte in natural and induced resistance to transplanted cancer. *J. of Exper. Med.*, vol. 23, pp. 204-211.
- MURPHY, JAMES B. AND STURM, ERNEST 1919 Effect of dry heat on the blood count in animals. III. Studies on lymphoid activity. *J. of Exper. Med.*, vol. 29, pp. 1-15. For rat see text-fig. 5, 6, 7.
- MURPHY, J. B., HUSSEY, R. G., STRUM, E. AND NAKAHARA, W. 1921 Effect of induced cellular reaction on the fate of cancer grafts. IV. Studies on lymphoid activity. *J. of Exper. Med.*, vol. 33, pp. 315-326.
- MURPHY, J. B., LIU, J. H. AND STURM, E. 1922 Studies on X-ray effects. IX. The action of serum from X-rayed animals on lymphoid cells in vitro. *J. of Exper. Med.*, vol. 35, pp. 373-384.
- MURPHY, J. B. AND STURM, ERNEST 1923 Conditions determining the transplantability of tissues in the brain. *J. of Exper. Med.*, vol. 38, pp. 183-198.
- MURPHY, ROBERT C. 1917 Faunal conditions in South Georgia. *Science*, n. s., vol. 46, no. 1179, August 3rd, pp. 112-113.
- MURRAY, ANDREW 1866 Geographical distribution of mammals. London, Day and Son. 4°.
- MURRAY, J. A. 1922 Vitamins and cancer. 20th Annual Report of the Imperial Cancer Research Fund, pp. 4-6.
- MYERS, BURTON D. 1916 Histological changes in testes following vasectomy. *Proc. of Am. Assoc. of Anatomists in Anat. Record*, vol. 10, pp. 228-229.
- MYERS, FRANK J. AND MYERS, J. A. 1921 Studies on the mammary gland. VIII. Gross changes in the



mammary gland in the female albino rat during the period of involution. Proc. Am. Assoc. of Anatomists in Anat. Record, vol. 21, p. 4.

MYERS, J. A. 1916 Studies on the mammary gland. I. The growth and distribution of the milk-ducts and the development of the nipple in the albino rat from birth to ten weeks of age. Am. J. Anat., vol. 19, pp. 353-389.

1917 Studies on the mammary gland. II. The fetal development of the mammary gland in the female albino rat. Am. J. Anat., vol. 22, pp. 195-223.

1917 a Studies on the mammary gland. III. A comparison of the developing mammary gland in male and female albino rats from the late fetal stages to ten weeks of age. Anat. Record, vol. 13, pp. 205-226.

1919 Studies on the mammary gland. IV. The histology of the mammary gland in male and female albino rats from birth to ten weeks of age. Am. Jour. Anat., vol. 25, pp. 395-436.

1919 a Studies on the mammary gland. V. The effects of inanition on the mammary gland in male and female albino rats from birth to ten weeks of age. Am. J. Dis. Children, vol. 17, pp. 311-328.

1919 b Studies on the mammary gland. VI. The development of the mammary gland from its earliest appearance until the period of pregnancy. Am. J. Dis. Children, vol. 18, pp. 4-13.

MYERS, J. A., AND MYERS, F. J. 1921 Studies on the mammary gland. VII. The distribution of the subcutaneous fat and its relation to the developing mammary glands in male and female albino rats from birth to ten weeks of age. Anat. Rec., vol. 22, pp. 353-362.

MYERS, VICTOR C. AND FINE, MORRIS S. 1915 The metabolism of creatine and creatinine. 9th paper. The creatine content of the muscle of rats fed on isolated proteins. J. Biol. Chem., vol. 21, pp. 389-393.

MYERS-WARD, C. F. 1898 Preliminary note on the structure and function of the epididymis and vas deferens in the higher mammalia. J. of Anat. and Physiol., vol. 32, pp. 135-140.

NAGATOMI AND MIYAKE 1898 The second report of cases of rat bite. Chiugai Iji Shinpo, Tokio, vol. 19, no. 429, pp. 1-15; no. 430, pp. 16-21.

NAMIYE, MOTOKITSU 1909 Report on the results of an investigation on the rat. (Besides systematic accounts and physical measurements, gives some observations on the sex ratio, stomach contents and enemies of the rat.) IN JAPANESE. J. of Bacteriology, no. 160, pp. 119-137.

NELSON, V. E., FULMER, E. I. AND CESSNA, R. 1921 The nutritional requirements of yeast. III. The synthesis of water-soluble B by yeast. J. Biol. Chem., vol. 46, pp. 77-81.

NELSON, V. E., LAMB, A. R. AND HELLER, V. G. 1922 The effect of vitamin deficiency on various species of animals. II. Observations on the comparative vitamin A requirement of rabbits, rats, swine and chickens. Am. J. of Physiol., vol. 59, pp. 335-345.

NELSON, V. E., HELLER, V. G., AND FULMER, E. I. 1923 Studies on yeast. VII. The dietary properties of yeast. J. of Biol. Chem., vol. 57, pp. 415-424.

NERKING, JOSEPH 1909 Narkose und Lezithin. Münch. med. Wochenschr., 56, II, pp. 1475-1478.

NICHOLLS, EDITH E. 1922 A study of the spontaneous activity of the guinea pig. J. of Comp. Psychol., vol. 2, pp. 303-330.

NICHOLSON, F. M. 1923 The changes in amount and distribution of the iron-containing proteins of nerve cells following injury to their axones. Jour. Comp. Neurol., vol. 36, pp. 36-87.

NICHOLSON, G. W. 1912 A transplantable carcinoma of the kidney of a white rat. J. of Pathol. and Bacteriol., vol. 17, pp. 329-346.

NICOLAÏER, ARTHUR 1902 Ueber die Umwandlung des Adenins im thierischen organismus. Ztschr. Klin. Med., Bd. 45, S. 359-374.

NICOLAS, A. 1890 Sur les cellules à grains du fond des glandes de Lieberkühn. Bull. des séances de la Soc. des Sciences de Nancy, An. 2, pp. 45-49.

NIEMES, P. AND WACKER, L. 1922 Ein Beitrag zur Kenntnis der Ergänzungsnährstoffe. Archiv für Exper. Pathol. und Pharmakol., Bd. 93, S. 241-268.

NIERENSTEIN, M. 1912 Biochemische und chemo-therapeutische Arbeitsmethoden mit Trypanosomen. Abderhalden, Emil—Handbuch der Biochemischen Arbeitsmethoden, Bd. 5, H. 2, S. 1371-1381. "Ratten—Für chemo-therapeutische Zwecke Ratten sehr zu empfehlen, sie vertragen verhältnismässig hohe Dosen und sind ziemlich leicht am Leben zu erhalten."

NITTONO, KENJI 1920 On the growth of the neurons composing the Gasserian ganglion of the albino rat—between birth and maturity. Jour. Comp. Neurol., vol. 32, pp. 231-269.

1923 On bilateral effects from the unilateral section of branches of the nervus trigeminus in the albino rat. Jour. Comp. Neurol., vol. 35, pp. 133-161.

NOË, JOSEPH 1900 La réparation compensatrice après le jeûne. Comptes Rend. Soc. Biol., Paris, T. 52.

NOGUCHI, HIDEYO 1917 Spirochaeta icterohaemorrhagiae in American wild rats and its relation to the Japanese and European strains. J. Exper. Med., vol. 25, pp. 753-763.

1919 Etiology of yellow fever. VIII. Presence of a leptospira in wild animals in Guayaquil and its relation to Leptospira icterohaemorrhagiae and Leptospira icteroides. J. of Exper. Med., vol. 30, pp. 95-107.

- NOVAK, J., AND EISINGER, K. 1923 Über künstlich bewirkte Teilung des unbefruchteten Säugetierieres Archiv für Mikr. Anat. und Ent., Bd. 98, S. 10-47.
- NOYES, H. M., SUGIURA, K. AND FALK, K. G. 1923 Studies on enzyme action. XXII. The lipolytic actions of various tissue and tumor extracts at different hydrogen ion concentrations. *J. of Biol. Chem.*, vol. 55, pp. 653-669.
- OHLSNER, A. J. AND THOMPSON 1910 Surgery and pathology of the thyroid and parathyroid glands. C. V. Mosby Pub. Co., St. Louis.
- OGATA, SUKEMASA 1921 The activity of the isolated uterus. *J. of Pharmacol. and Exper. Therapeutics*, vol. 18, pp. 185-200.
- OGATA, T. AND OGATA, A. 1917 Henle's reaction of the chromaffin cells in the adrenals, and the microscopic test for adrenalin. *J. of Exper. Med.* vol. 25, pp. 807-817.
- OHLMACHER, A. P. 1897 A modified fixing fluid for general histological and neuro-histological purposes. *J. Exper. Med.*, vol. 11.
- OLDS, W. H. 1910 The effects of thyroidectomy on the resistance of rats to morphine poisoning. *Am. J. Physiol.*, vol. 26, pp. 354-360.
- OLIVER, JEAN 1915 The histogenesis of chronic uranium nephritis with especial reference to epithelial regeneration. *J. of Exper. Med.*, vol. 21, pp. 425-451.
- 1921 Mechanism of urea excretion. *J. of Exper. Med.*, vol. 33, pp. 177-186.
- 1922 The relative therapeutic efficiency of arsenphenamine and gelatin-arsphenamine. *Proc. of the Soc. for Exper. Biol. and Med.*, vol. 20, pp. 56-59.
- OPHÜLS, W. 1911 Spontaneous nephritis in wild rats. *Proc. Soc. Exper. Biol. and Med.*, 42nd meeting February 15.
- OPIE, E. L. AND ALFORD, L. B. 1915 The influence of diet upon necrosis caused by hepatic and renal poisons. *J. of Exper. Med.*, vol. 21, pp. 1-20.
- 1915 a The influence of diet upon necrosis caused by hepatic and renal poisons. Part II. Diet and the nephritis caused by potassium chromate, uranium nitrate, or chloroform. *J. of Exper. Med.*, vol. 21, pp. 21-37.
- OPPEL, ALBERT 1896-1914 *Lehrbuch der vergleichenden mikroskopischen Anatomie der Wirbeltiere*. 8 vols. Gustav Fischer—Jena.
- OPPENHEIMER, E. H. AND SPAETH, R. A. 1922 The relation between fatigue and the susceptibility of rats towards a toxin and an infection. *Amer. Jour. Hyg.*, vol. 2, pp. 51-66.
- ORDWAY, THOMAS AND MORRIS, J. LUCIEN 1913 The protein metabolism in certain tumor-bearing rats. *J. Med. Research*, vol. 28 (N. S. vol. 23), pp. 301-308.
- ORI, A. 1912 Pseudotuberculosis nei topi (*M. decumanus*) catturati nel porto di Venezia. *Igiene mod.*, Genova, v. pp. 233-242.
- ORTON, C. R., MCCOLLUM, E. V. AND SIMMONDS, NINA 1922 Observations on the presence of the anti-neuritic substance, water-soluble B, in chlorophyll-free plants. *J. of Biol. Chem.*, vol. 53, pp. 1-6.
- OSBORNE, T. B. AND MENDEL, L. B. 1911 Feeding experiments with mixtures of isolated food substances. *Am. J. Physiol.*, vol. 27, p. xxvi.
- 1911 a Feeding experiments with isolated food substances. *Carnegie Inst. Wash. Pub.* 156, parts I and II.
- 1911 b The rôle of different proteins in nutrition growth. *Science*, vol. 34, pp. 722-732.
- 1912 The rôle of proteins in growth. *Proc. Am. Soc. Biol. Chem., J. Biol. Chem.*, vol. 11, p. xxii.
- 1912 a Maintenance and growth. *Proc. Am. Soc. Biol. Chem., J. Biol. Chem.*, vol. 11, p. xxxvii.
- 1912 b Feeding experiments with fat-free food mixtures. *Proc. Soc. Exper. Biol. and Med.*, vol. 9, p. 73. Also *J. Biol. Chem.*, vol. 12, pp. 81-89.
- 1912 c Growth and maintenance on purely artificial diets. *Proc. Soc. Exper. Biol. and Med.*, vol. 9, p. 72.
- 1912 d Ein Stoffwechsellkäfig und Fütterungsvorrichtungen für Ratten. *Ztschr. biol. Techn. u. Methodik*, Bd. 2, S. 313-318.
- 1912 e Beobachtungen über Wachstum bei Fütterungsversuchen mit isolierten Nahrungs-substanzen. *Ztschr. f. Physiol. Chem.*, Bd. 80, S. 307-370.
- 1912 f The rôle of gliadin in nutrition. *J. Biol. Chem.*, vol. 12, pp. 473-510.
- 1912 g Maintenance experiments with isolated proteins. *J. Biol. Chem.*, vol. 13, pp. 233-276.
- OSBORNE, T. B. 1913 The nutritive value of the proteins of maize. *Science*, N. S., vol. 37, pp. 185-191.
- OSBORNE, T. B. AND MENDEL, L. B. 1913 Feeding experiments relating to the nutritive value of the proteins of maize. *Proc. Am. Soc. Biol. Chem.* in *J. Biol. Chem.*, vol. 14, p. xxxi.
- 1913 a The relation of growth to the chemical constituents of the diet. *J. Biol. Chem.*, vol. 15, pp. 311-26.
- 1913 b The influence of butter-fat on growth. *J. Biol. Chem.*, vol. 16, pp. 423-437. Also in *Proc. Soc. Exper. Biol. and Med.*, vol. 11, pp. 14-15.
- 1914 Some problems of growth. *Am. J. Physiol.*, vol. 33, p. xxviii.
- 1914 a Amino acids in nutrition and growth. *J. Biol. Chem.*, vol. 17, p. 325.
- 1914 b Influence of cod liver oil and some other fats on growth. *J. Biol. Chem.*, vol. 17, p. 401.
- 1914 c Nutritive properties of proteins of the maize kernel. *J. Biol. Chem.*, vol. 18, pp. 1-16.
- 1914 d The suppression of growth and the capacity to grow. *J. Biol. Chem.*, vol. 18, pp. 95-106.

- 1914 e The contribution of bacteria to the feces after feeding diets free from indigestible components. *J. Biol. Chem.*, vol. 18, pp. 177-182.
- 1915 The influence of beef-fat on growth. Given at Soc. for Exper. Biol. and Med., 64th Meeting, Jan. 20, 1915.
- 1915 a The comparative nutritive value of certain proteins in growth, and the problem of the protein minimum. *J. Biol. Chem.*, vol. 20, pp. 351-378.
- 1915 b Further observations of the influence of natural fats upon growth. *J. Biol. Chem.*, vol. 20, pp. 379-390.
- 1915 c Protein minima for maintenance. *J. Biol. Chem.*, vol. 22, pp. 241-258.
- 1915 d The resumption of growth after long continued failure to grow. *J. Biol. Chem.*, vol. 23, pp. 439-454.
- OSBORNE, T. B. AND WAKEMAN, ALFRED J. 1915 Does butter-fat contain nitrogen and phosphorus? *J. Biol. Chem.*, vol. 21, pp. 91-94.
- OSBORNE, T. B. AND MENDEL, L. B. 1916 Acceleration of growth after retardation. *Am. J. Physiol.*, vol. 40, pp. 16-20.
- 1916 a Some practical applications of feeding experiments with albino rats. *Am. J. Physiol.*, vol. 40, pp. 147-148.
- 1916 b The stability of the growth-promoting substance in butter fat. *J. Biol. Chem.*, vol. 24, pp. 37-39.
- 1916 c The amino-acid minimum for maintenance and growth, as exemplified by further experiments with lysine and tryptophane. *J. Biol. Chem.*, vol. 25, pp. 1-12.
- 1916 d A quantitative comparison of casein, laetalbumin, and edestin for growth or maintenance. *J. Biol. Chem.*, vol. 26, pp. 1-23.
- 1916 e The growth of rats upon diets of isolated food substances. *Biochemical J.*, vol. 10, p. 534.
- 1917 The relative value of certain proteins and protein concentrates as supplements to corn gluten. *J. Biol. Chem.*, vol. 29, pp. 69-92.
- 1917 a The use of cotton seed as food. *J. Biol. Chem.*, vol. 29, pp. 289-317.
- 1917 b The incidence of phosphatic urinary calculi in rats fed on experimental rations. *J. Am. Med. Assoc.*, vol. 69, pp. 32-33.
- 1917 c The rôle of vitamins in the diet. *J. Biol. Chem.*, vol. 31, pp. 149-163.
- 1917 d Nutritive factors in animal tissues. I. *J. Biol. Chem.*, vol. 32, pp. 309-323.
- 1917 e The use of soy bean as food. *J. Biol. Chem.*, vol. 32, pp. 369-387.
- OSBORNE, T. B., MENDEL, L. B. AND FERRY, E. L. 1917 The effect of retardation of growth upon the breeding period and duration of life of rats. *Science*, N. S., vol. 45, no. 1160, March 23rd, pp. 294-295.
- OSBORNE, T. B. AND MENDEL, L. B. 1918 Nutritive factors in animal tissues. II. *J. Biol. Chem.*, vol. 34, pp. 17-27.
- 1918 a The inorganic elements in nutrition. *J. Biol. Chem.*, vol. 34, pp. 131-139.
- 1918 b Nutritive factors in plant tissues. I. The protein factor in the seeds of cereals. *J. Biol. Chem.*, vol. 34, pp. 521-535.
- 1918 c Milk as a source of water-soluble vitamins. *J. Biol. Chem.*, vol. 31, pp. 537-551.
- 1918 d The choice between adequate and inadequate diets, as made by rats. *J. Biol. Chem.*, vol. 35, pp. 19-27.
- 1918 e Continuation and extension of work on vegetable proteins. Year Book No. 17 of the Carnegie Institution of Washington, pp. 302-310.
- OSBORNE, T. B., MENDEL, L. B. AND FERRY, E. L. 1919 A method of expressing numerically the growth-promoting value of proteins. *J. Biol. Chem.*, vol. 37, pp. 223-229.
- OSBORNE, T. B., WAKEMAN, A. J. AND FERRY, E. L. 1919 Preparation of protein from water-soluble vitamins. *J. Biol. Chem.*, vol. 39, pp. 35-46.
- OSBORNE, T. B. AND WAKEMAN, A. J. 1919 Extraction and concentration of the water-soluble vitamins from brewers' yeast. *J. Biol. Chem.*, vol. 40, pp. 383-394.
- OSBORNE, T. B. AND MENDEL, L. B. 1919 The extraction of "fat-soluble vitamins" from green foods. *Proc. of the Soc. for Exper. Biol. and Med.*, vol. 16, pp. 95-99.
- 1919 a The vitamins in green foods. *J. Biol. Chem.*, vol. 37, pp. 187-200.
- 1919 b The nutritive value of the wheat kernel and its milling products. *J. Biol. Chem.*, vol. 37, pp. 557-601.
- 1919 c The nutritive value of yeast protein. *J. Biol. Chem.*, vol. 38, pp. 223-227.
- 1919 d Nutritive factors in plant tissues. II. The distribution of water-soluble vitamins. Preliminary report. *J. Biol. Chem.*, vol. 39, pp. 29-34.
- 1919 e Work on vegetable proteins. Extract from Year Book No. 18, Carnegie Institution of Wash., pp. 352-360.
- 1920 Nutritive value of the proteins of the barley, oat, rye and wheat kernels. *J. Biol. Chem.*, vol. 41, pp. 275-306.
- 1920 a Nutritive factors in plant tissues. III. Further observations on the distribution of water-soluble vitamins. *J. Biol. Chem.*, vol. 41, pp. 451-468.
- 1920 b Milk as a source of water-soluble vitamins. II. *J. Biol. Chem.*, vol. 41 pp. 515-523.
- 1920 c Nutritive factors in plant tissues. IV. Fat-soluble vitamins. *J. Biol. Chem.*, vol. 41, pp. 549-565.
- 1920 d The occurrence of water-soluble vitamins in some common fruits. *J. Biol. Chem.*, vol. 42, pp. 465-489.
- 1920 e Skimmed milk as a supplement to corn in feeding. *J. Biol. Chem.*, vol. 44, pp. 1-4.

- 1920 f Growth on diets poor in true fats. *J. Biol. Chem.*, vol. 45, pp. 145-152.
- 1921 A critique of experiments with diets free from fat-soluble vitamine. *J. Biol. Chem.*, vol. 45, pp. 277-288.
- 1921 a Does growth require preformed carbohydrate in the diet? *Proc. of the Soc. for Exper. Biol. and Med.*, vol. 18, no. 5.
- 1921 b Growth on diets containing more than ninety per cent protein. *Proc. of the Soc. for Exper. Biol. and Med.*, vol. 18, pp. 167-168.
- 1921 e Feeding experiments with mixtures of food-stuffs in unusual proportions. *Proc. of the Nat. Acad. of Sciences*, vol. 7, pp. 157-162.
- 1921 d Ophthalmia and diet. *J. of Am. Med. Assoc.*, vol. 76, pp. 905-908.
- 1921 e Continuation and extension of work on vegetable proteins. Year Book No. 20 of the Carnegie Institution of Washington, pp. 432-441.
- OSBORNE, T. B. AND LEAVENWORTH, C. S. 1921 The effect of alkali on the efficiency of the water-soluble vitamine B. *J. of Biol. Chem.*, vol. 45, pp. 423-426.
- OSBORNE, T. B., MENDEL, L. B. AND CANNON, H. C. 1921 Milk as a source of water-soluble vitamin III. *Bio-Chem. J.*, vol. 16, pp. 363-367.
- 1922 a Quantitative aspects of the rôle of vitamine B in nutrition. *J. of Biol. Chem.*, vol. 54, pp. 739-752.
- 1922 b Milk as a source of water-soluble vitamin III. *Bio-Chem. J.*, vol. 16, pp. 363-367.
- OSBORNE, T. B. AND MENDEL, L. B. 1922 Continuation and extension of work on vegetable proteins. Carnegie Institution of Washington, Year Book No. 21, pp. 373-381.
- 1922 a Further observations on the distribution of vitamin B in some vegetable foods. *J. of Am. Med. Assoc.*, vol. 78, pp. 1121-1122.
- 1922 b Vitamin A in oranges. *Proc. of Soc. for Exper. Biol. and Med.*, vol. 19, pp. 187-188.
- OSBORNE, T. B., MENDEL, L. B. AND CANNON, H. C. 1923 Eggs as a source of vitamin B. *J. of Am. Med. Assoc.*, vol. 80, pp. 302-303.
- OSBORNE, T. B., MENDEL, L. B., PARK, E. A. AND DARROW, D. 1923 Kidney hypertrophy produced by diets unusually rich in protein. *Proc. of Soc. for Exper. Biol. and Med.*, vol. 20, pp. 452-453.
- OSBORNE, T. B., MENDEL, L. B. AND PARK, E. A. 1923 Experimental production of rickets with diets of purified food substances. *Proc. of Soc. for Exper. Biol. and Med.*, vol. 21, pp. 87-90.
- OSBORNE, T. B. AND MENDEL, L. B. 1923 The effect of diet on the content of vitamine B in the liver. *J. of Biol. Chem.*, vol. 58, pp. 363-367.
- 1923 a Continuation and extension of work on vegetable proteins. Year Book of Carnegie Institution of Washington, No. 22, pp. 340-346.
- OSLUND, ROBERT 1923 On the factors in testicular degeneration following ligation or vasectomy. *Proc. Am. Assoc. of Anatomists in Anat. Record*, vol. 25, pp. 145-146.
- 1924 A study of vasectomy on rats and guinea pigs. *Am. J. of Physiol.*, vol. 67, pp. 422-443.
- OSTERUD, H. L. 1921 The postnatal growth and development of the female reproductive tract in the albino rat. *Proc. Am. Assoc. of Anatomists in Anat. Record*, vol. 21, pp. 75-76.
- OUDEMANS, J. TH. 1892 Die accessorischen Geschlechtsdrüsen der Säugetiere. Haarlem, 96 pp. 16 pl. 4<sup>r</sup>.
- OVALLE, ALONSO DE 1646 An historical relation of the Kingdom of Chili, 1646. Translated from Spanish into English, London, 1703, in A. & J. Churchill's "A collection of voyages and travels." vol. 3, London, 1704. p. 44 rat or pericote.
- OWEN, RICHARD 1840-1845 Odontography; or a treatise on the comparative anatomy of the teeth; their physiological relations, mode of development, and microscopic structure in the vertebrate animals. 2 v., xix, 74, 655 pp; atlas, 37 pp. 150 pl. roy. 8°. London, H. Baillière.
- 1868 On the anatomy of vertebrates. London. 1866-1868. Vol. 3, Mammals, 1868. Mus decumanus, alimentary canal, p. 421 and fig. 317; No gall bladder, p. 485; Low type of pancreas, p. 493 and fig. 380 (Hyde Salter).
- PACINI, A. J. P. AND RUSSELL, D. W. 1918 The presence of a growth-producing substance in cultures of typhoid bacilli. *J. Biol. Chem.*, vol. 34, pp. 43-49.
- PALLADIN, A. V. AND RISKALTOCHOUK, A. 1916 The influence of the carbohydrate and protein deprivation upon endogenous protein metabolism in rats. *Pub. of the Bureau of Zootechny of the Agr. Ministry, Russia*, vol. 14.
- PALLAS, PIETRO 1778 *Novae species Quadrupedum e Glirium ordine*. Erlangen. 1831 *Zoographica Rosso-Asiatica Sistens omnium animalium in extenso imperio rossico et adjacentibus maribus observatorium recensionem domicilia, mores et descriptiones, anatomien atque icones plurimorum*. Petropoli, vol. 1, p. 164.
- PALMER, LEROY S. AND KENNEDY, CORNELIA 1921 The relation of plant carotinoids to growth and reproduction of albino rats. *J. of Biol. Chem.*, vol. 46, pp. 559-577.
- 1923 Growth and reproduction of rats on whole milk as the sole diet. *Proc. of Soc. for Exper. Biol. and Med.*, vol. 20, pp. 506-508.
- PANETH, J. 1888 Ueber die secernierenden Zellen des Dünndarm-Epithels. *Arch. f. mikr. Anat.*, Bd. 31, S. 113-191, 3 pl. Mainly Triton and mouse. Rat: see figs. 30, 31, pl. X.
- 1888 a Ein Beitrag zur Kenntniss der Lieberkühn'schen Krypten. *Centralbl. f. Physiol.*, Bd. 1, S. 255-256.

- PAPEZ, J. W. 1923 The thalamic end of the medial lemniscus, Marchi method. *Proc. Am. Assoc. of Anatomists in Anat. Record*, vol. 25, p. 146.
- 1923 a The mammillary peduncle, Marchi method. *Proc. Am. Assoc. of Anatomists in Anat. Record*, vol. 25, p. 146.
- 1923 b The rubrospinal tract, Marchi method. *Proc. Am. Assoc. of Anatomists in Anat. Record*, vol. 25, p. 147.
- PAPPENHEIMER, ALVIN M. 1913 Further studies of the histology of the thymus. *Am. J. Anat.*, vol. 14, pp. 299-332.
- 1914 The effects of early extirpation of the thymus in albino rats. *J. Exp. Med.*, vol. 19, pp. 319-336.
- 1914 a Further experiments upon the effects of extirpation of the thymus in rats, with special reference to the alleged production of rachitic lesions. *J. of Exp. Med.*, vol. 20, pp. 477-496.
- 1914 b Ueber Thymusausschaltung bei weissen Ratten. *Centrabl. f. allg. Path. u. path. Anat.*, Bd. 25, S. 249.
- 1917 Experimental studies upon lymphocytes. I. The reactions of lymphocytes under various experimental conditions. *J. Exper. Med.*, vol. 25, pp. 633-650.
- 1917 a Experimental studies upon lymphocytes. II. The action of immune sera upon lymphocytes and small thymus cells. *J. of Exper. Med.*, vol. 26, pp. 163-179.
- PAPPENHEIMER, A. M., McCANN, G. F., ZUCKER, T. F. AND HESS, A. F. 1921 The effect of various modifications of a diet producing rickets in rats. *Proc. of Soc. for Exp. Biol. and Med.*, vol. 18, pp. 267-270.
- PAPPENHEIMER, A. M., McCANN, G. F. AND ZUCKER, T. F. 1922 Experimental rickets in rats. IV. The effect of varying the inorganic constituents of a rickets-producing diet. *J. of Exper. Med.*, vol. 35, pp. 421-446.
- 1922 a Experimental rickets in rats. V. The effect of varying the organic constituents of a rickets-producing diet. *J. of Exper. Med.*, vol. 35, pp. 447-466.
- PAPPENHEIMER, A. M. 1922 Experimental rickets in rats. VI. The anatomical changes which accompany healing of experimental rat rickets, under the influence of cod liver oil or its active derivatives. *J. of Exper. Med.*, vol. 36, pp. 335-355.
- PAPPENHEIMER, A. M. AND LARIMORE, L. D. 1923. The occurrence of gastric lesions in rats, and their possible relation to dietary deficiency. *Proc. of the Soc. for Exper. Biol. and Med.*, vol. 21, pp. 141-142.
- PARK, E. A., SHIPLEY, P. G., McCOLLUM, E. V. AND SIMMONDS, NINA 1922 Is there more than one kind of rickets? *Proc. of the Soc. for Exper. Biol. and Med.*, vol. 19, pp. 149-154. Also: *Amer. Journal of Diseases of Children*, vol. 23—p. 91.
- PARSONS, HELEN T. 1920 The antiscorbutic content of certain body tissues of the rat. The persistence of the antiscorbutic substance in the liver of the rat after long intervals on a scorbutic diet. *J. Biol. Chem.*, vol. 44, pp. 587-602.
- PATERSON, A. M. 1890 Development of the sympathetic nervous system in mammals. *Philos. Trans. of the Royal Soc. of London (B)*, pp. 159-186. Plates 22-30. Rat figures 1, 4, 5, 7, 9, 11, 12, 13, 14, 14a, 18, 20.
- PATERSON 1901 The sternum: Its early development and ossification in man and mammals. *J. of Anat. and Physiol.*, vol. 35, pp. 21-32.
- PAUL, C. B. 1906 On the influence of an excessive meat diet on the male reproductive organs. *J. Physiol.* vol. 34, pp. xiv-xv.
- PEARCE, BINNIE D. 1917 A note on the interference of visual habits in the white rat. *J. Animal Behavior*, vol. 7, pp. 169-177.
- PEARCE, LOUISE AND BROWN, WADE H. 1918 Experimental trypanosomiasis: its application in chemotherapeutic investigations. *J. of Exper. Med.*, vol. 28, pp. 109-147.
- 1919 Chemotherapy of trypanosome and spirochete infections. *Biological series 11. The therapeutic action of N-Phenylglycineamide-p-arsonic acid in experimental trypanosomiasis of mice, rats and guinea pigs.* *J. of Exper. Med.*, vol. 30, pp. 437-453.
- 1921 Therapeutic action of N-phenylglycineamide-p-arsonic acid (trypanamide) upon experimental infections of *Trypanosoma rhodesiense*. *J. of Exper. Med.*, vol. 33, pp. 193-200.
- PEARSON, KARL 1910 Darwinism, biometry and some recent Biology I. *Biometrika*, vol. 7, part 3, pp. 368-385.
- 1911 Remarks on Professor Lloyd's note on inheritance of fertility. *Biometrika*, vol. 8, pp. 247-249.
- PECHSTEIN, L. A. 1921 Massed vs. distributed effort in learning. *Jour. Educ. Psychol.*, vol. 12, pp. 92-97.
- PEDOTTI, F. 1921 Untersuchungen über den Einfluss des Calciummangels in der Nahrung auf den respiratorischen Grundumsatz. *Biochem. Zeitschr.*, Bd. 123, S. 272-283.
- PEISER, J. 1903 Ueber die Beeinflussung der Schilddrüse durch Zufuhr von Schilddrüsensubstanz. *Zeitschr. f. exper. Path. u. Therap.*, Bd. 3, S. 515-529.
- PEMBREY, M. S. 1895 The effect of variations in external temperature upon the output of carbonic acid and the temperature of young animals. *J. Physiol.*, vol. 18, pp. 363-379.
- PEMBREY, M. S. AND SPRIGGS, E. I. 1904 The influence of fasting and feeding upon the respiratory and nitrogenous exchange. *J. Physiol.*, vol. 31, pp. 320-345.
- PENNANT, THOS. 1781 History of quadrupeds 2 vols. London. Vol. II. Rats. *M. rattus* introduced into South America in 1544—time of Viceroy Blasco Menez. (Menez—a misprint for Núñez.)

- PETERS, ALBERT 1890 Beitrag zur Kenntniss der Harder'schen Drüse. *Arch. f. mikr. Anat.*, Bd. 36, S. 192-203.
- PETERSON, JOSEPH 1917 The effect of length of blind alleys on maze learning: An experiment on twenty-four white rats. *Behavior Monographs*, vol. 3, no. 4, serial number 15, Johns Hopkins Univ.
- 1917 a Frequency and recency factors in maze learning by white rats. *J. Animal Behavior*, vol. 7, pp. 338-364.
- PETRIE, G. F. 1910 Rats and plague. *Nature*, vol. 85, pp. 15-16. Historical: Late association circa 1800 of rat with plague.
- PHILIPPEAUX, J. M. 1856 Note sur l'extirpation des capsules surrénales chez les rats albinos (*Mus rattus*). *Comptes Rendus hebdomadaires des séances de l'Acad. des Sciences*, T. 43, pp. 904-906.
- 1867 Etudes expérimentales sur la greffe animale et sur la régénération de la rate chez les mammifères et des membres chez les salamandres aquatiques. *Ann. Sc. nat.* (5) Zool. VII, pp. 5-11.
- PING, CHI 1921 On the growth of the largest nerve cells in the superior cervical sympathetic ganglion of the albino rat—from birth to maturity. *Jour. Comp. Neur.*, vol. 33, pp. 281-311.
- 1921 a On the growth of the largest nerve cells in the superior cervical sympathetic ganglion of the Norway rat. *Jour. Comp. Neur.*, vol. 33, pp. 313-338.
- PITTS 1898 Article "Animal heat" in Schäfer's Text Book of Physiol., vol. 1, p. 790.
- PLANT, JAMES S. 1919 Factors influencing the behavior of the brain of the albino rat in Müller's fluid. *Jour. Comp. Neur.*, vol. 30, pp. 411-422.
- PLIMMER, H. G. AND THOMSON, J. D. 1908 Further results of the experimental treatment of trypanosomiasis in rats: being a progress report of a Committee of the Royal Society. *Proc. R. Soc. London*, vol. 80 B, pp. 1-12.
- PLOSCHKO, ADAM AND V. ARNSTEIN 1897 Die Nervenendigungen und Ganglien der Respirationsorgane. *Anat. Anz.*, Bd. 13, S. 12-22. 1 fig. Rat.
- PODWYSZOZKI, W. 1878 Anatomische Untersuchungen über die Zungendrüsen des Menschen und der Säugethiere (both *M. decumanus* and *M. rattus*). *Inaug.-Diss.* Dorpat., 144 pp., 2 pl.
- 1886 Experimentelle Untersuchungen über die Regeneration der Drüsengewebe. I. Die Regeneration des Lebergewebes. II. Die Regeneration des Nierenepithels. III. Die Regeneration an den Meibomischen Drüsen. IV. Die Regeneration an den Speicheldrüsen. *Zglgler's Beiträge zur pathol. Anat.* Bd. I.
- POLJAKOFF, P. 1888 Ueber eine neue Art von fettbildenden Organen im lockern Bindegewebe. *Arch. f. mikr. Anat.*, Bd. 32, S. 123-182.
- POLL, HEINRICH 1898 Ueber das Schicksal der verpflanzten Nebenniere. *Centrabl. f. Physiol.*, Bd. 12, S. 321-326.
- 1899 Veränderungen der Nebenniere bei Transplantation. *Arch. f. mikr. Anat.*, Bd. 54, S. 440-481.
- PONTIER AND GÉRARD, G. 1900 De l'entre-croisement des pyramides chez le rat. Leur passage dans le faisceau du Burdach (note préliminaire). *Bibliogr. anat.* Nancy, T. 8, pp. 186-190, Ten figures—sections of the bulb.
- POPPE, K. 1913 Pseudotuberkulose. in (KOLLE, WILHELM AND WASSERMANN, A. v (eds). *Handbuch der pathogenen Mikro-organismen*, 2nd ed. enl. Bd. 5, Heft 2, S. 779-781.
- POUND, C. J. 1905 On trypanosoma and their presence in the blood of Brisbane rats. *Proc. R. Soc. Queensland*, vol. 19, pp. 33-38.
- POWERS, G. F., PARK, E. A., SHIPLEY, P. G. AND MCCOLLUM, E. V. 1922 Study on experimental rickets. XIX. The prevention of rickets in the rat by means of radiation with the mercury vapor quartz lamp. *Johns Hopkins Hosp. Bull.*, vol. 33, page 125.
- POWERS, G. F., PARK, E. A. AND SIMMONDS, NINA 1922 The influence of light and darkness upon the development of xerophthalmia in the rat. *Proc. of the Soc. for Exper. Biol. and Med.*, vol. 20, pp. S1-S1.
- POWERS, G. F., PARK, E. A., SHIPLEY, P. G., MCCOLLUM, E. V. AND SIMMONDS, N. 1922 The prevention of the development of rickets in rats by sunlight. *J. Am. Med. Assoc.*, vol. 78, p. 159. Also *Proc. Soc. Exper. Biol. and Med.*, vol. 19, p. 43.
- POWERS, G. F., PARK, E. A., SIMMONDS, N. 1923 The influence of radiant energy upon the development of xerophthalmia in rats: A remarkable demonstration of the beneficial influence of sunlight and out-of-door air upon the organism. *J. of Biol. Chem.*, vol. 55, pp. 575-597.
- PRATT, B. H. AND LONG, J. A. 1917 The period of synopsis in the egg of the white rat, *Mus norvegicus albinus*. *J. of Morphol.*, vol. 29, pp. 411-459.
- PREYER, W. 1866 Quantitative Bestimmung des Farbstoffs im Blute durch das Spectrum. *Annalen der Chemie u. Pharmacie*, Bd. 140, S. 187-200. Rat, s. 198.
- 1871 Die Blutkrystalle. Mauke's Veriag, Jena. *Rat*: S. 3, 13, 16, 38, 127.
- PRIESTLEY, H. 1913 Rat leprosy in North Queensland. *Australian Med. Gazette*, Nov. 1, Townsville, Queensland.
- PRINCE, A. L. 1917 Applications of gas analysis. III. An apparatus for the study of the respiratory exchange in small animals. *J. Biol. Chem.*, vol. 32, pp. 333-336.

- PRODROMUS, THEODORUS. See KELLER, OTTO, '09.
- PRZIBRAM, HANS. 1907 Demonstrationen über Vererbung bei Säugetieren. *Zentralbl. f. Physiol.*, Bd. 21, S. 257.
- 1910 Uebertragungen erworbener Eigenschaften bei Säugetieren. Versuche mit Hitze-Ratten. *Verh. Ges. deutsch. Nat. Aerzte Vers.* 81, Tl. 2, Hälfte 1, S. 179-180.
- 1911 Albinismus bei Inzucht. *Verhandl. d. naturf. Ver. in Brünn*, Bd. 49 (Festband für Mendel).
- 1912 Ueber das Vorkommen der Hausratte (*Mus rattus* L.) in Oesterreich. *Wochenschr. Das österreichische Sanitätswesen*, no. 16, S. 297-299.
- 1917 Die Umwelt des Keimplasmas. VI. Direkte Temperaturabhängigkeit der Körperwärme bei Ratten (*Mus decumanus* und *M. rattus*). *Archiv für Ent. der Organismen*, Bd. 43, S. 37-46.
- 1922 Autophorie transplantation, its theory and practice. *Am. Naturalist*, vol. 56, pp. 548-559.
- 1922 a Direkte Temperaturabhängigkeit der Schwanzlänge bei Ratten (*Mus decumanus* und *M. rattus*). (Die Umwelt des Keimplasmas XI.) *Akad. der Wissenschaften in Wien. Akad. Anzeiger* No. 24-25.
- 1922 b Die Schwanzlänge bei Ratten (*Mus decumanus* und *M. rattus*) als fakultatives Geschlechtsmerkmal (Die Umwelt des Keimplasmas XII.) *Akad. der Wissenschaften in Wien-Akad. Anzeiger* No. 24-25.
- 1922 c Die Schwanzlänge der Nachkommen temperaturmodifizierter Ratten (*Mus decumanus* und *Mus rattus*). (Die Umwelt des Keimplasmas XIII.) *Akad. der Wissenschaften in Wien-Akad. Anzeiger* No. 24-25.
- 1922 d Das Anwachsen der relativen Schwanzlänge und dessen Temperatur-quotient bei den Ratten (*Mus decumanus* und *M. rattus*). (Die Umwelt des Keimplasmas XIV.) *Akad. der Wissenschaften in Wien-Akad. Anzeiger*, No. 24-25.
- 1922 e Form und Formel im Tierreiche. Beiträge zu einer quantitativen Biologie I-XX. Franz Deuticke, Leipzig und Wien.
- PRZIBRAM, HANS AND WIESNER, B. P. 1922 Erhöhung der Körpertemperatur junger Wanderratten (*Mus decumanus*) über den Normalwert und ihr Einfluss auf die Schwanzlänge. (Die Umwelt des Keimplasmas X.) *Akad. der Wiss. in Wien-Akad. Anzeiger* No. 24-25.
- PRZIBRAM, HANS. 1923 Temperatur und Temperaturen im Tierreiche. Beiträge zu einer quantitativen Biologie XXI-XXX. Franz Deuticke, Leipzig und Wien.
- 1923 a Temperaturmodifizierte Ratten und deren Nachkommen. *Zeitschr. für induktive Abstammungs- und Vererbungslehre*, Bd. 30, S. 290-291.
- 1923 b Die Methode autophorer Transplantation (Zugleich: Die Replantation von Augen I.) *Archiv für Mikr. Anat. und Ent.*, Bd. 99, S. 1-14.
- QUINQUAUD. 1873 Sur les variations de l'hémoglobine dans la série zoologique. *Compt. rend. de l'Acad. de Science, Paris*, T. 77, pp. 487-489.
- RABINOWITSCH, L. AND KEMPNER, W. 1899. Beitrag zur Kenntnis der Blutparasiten, speciell der Ratten-trypanosomen. *Zeitschr. f. Hyg.*, Bd. 30, S. 251.
- RABINOWITSCH, LYDIA. 1903 Ueber eine durch säurefeste Bakterien hervorgerufene Hauterkrankung der Ratten. *Centralbl. f. Bakteriol.*, 1 Abt., Jena, Bd. 33, S. 577-580.
- RAZISS, G. W., KOLMER, J. A. AND GAYRON, J. L. 1919 Chemotherapeutic studies on organic compounds containing mercury and arsenic. *J. of Biol. Chem.*, vol. 40, pp. 533-552.
- RAMÓN Y CAJAL, S. See CAJAL, S. RAMON Y.
- RAMSTRÖM, M. 1905 Untersuchungen und Studien über die Innervation des Peritoneum der vorderen Bauchwand. *Anat. Hefte*. Bd. 29, S. 351-443. *Mus decumanus*, p. 372.
- RANSON, S. W. 1903 On the medullated fibers crossing the site of lesions in the brain of the white rat. *J. Comp. Neur.*, vol. 13, pp. 185-207.
- 1904 Retrograde degeneration in the corpus callosum of the white rat. *J. Comp. Neur. and Psychol.*, vol. 14, pp. 381-389.
- 1906 Retrograde degeneration in the spinal nerves. *J. Comp. Neur. and Psychol.*, vol. 16, pp. 3-31.
- 1909 Alterations in the spinal ganglion cells following neurotony. *J. Comp. Neur.*, vol. 19, pp. 125-152.
- 1913 The fasciculus cerebrosplinalis in the albino rat. *Am. J. Anat.*, vol. 14, p. 411.
- 1914 A note on the degeneration of the fasciculus cerebro-splinalis in the albino rat. *J. Comp. Neur.*, vol. 24, pp. 503-507.
- 1914 a The tract of Lissauer and the substantia gelatinosa rolandi. *Am. J. Anat.*, vol. 16, pp. 97-126.
- 1914 b Transplantation of the spinal ganglion, with observations on the significance of the complex types of spinal ganglion cells. *Jour. Comp. Neur.*, vol. 24, pp. 547-558.
- RANVIER, L. A. 1883 De l'existence et de la distribution de l'écididine dans la muqueuse bucco-oesophagienne des Mammifères. *C. R. de l'Acad. des Sc. Paris*, T. 97, pp. 1377-1379.
- 1884 Les membranes muqueuses et le système glandulaire. *J. de microg.*, T. 8, pp. 29-38; 77-86; 142-150; 194-200; 310-317; 419-422.
- 1885 Les membranes muqueuses et le système glandulaire. Le foie (Rat). *J. de microg.*, T. 9, pp. 6-14; 55-63; 103-109; 155-163; 194-201; 240-247; 287-295; 334-343; 389-396; 438-445; 480-482.
- 1886 Les membranes muqueuses et le système glandulaire. Le foie. *J. de microg.*, T. 10, pp. 5-10; 55-58; 160-166; 211-214; 355-362; 443-447.

- 1886 a Étude anatomique des glandes connues sous les noms de sous-maxillaire et sublinguale, chez les mammifères. Arch. de physiol. norm. et path., ser. 3, T. 8, pp. 223-256. M. decumanus, p. 224, fig. 1.
- 1887 Le mécanisme de la sécrétion. M. decumanus, see p. 530. J. de microg., T. 11, pp. 527-534.
- 1888 Le mécanisme de la sécrétion. J. de microg., T. 12, pp. 3-11; 33-41; 65-73; 104-111; 165-173; 212-218; 243-250; 298-303; 329-335; 364-368; 389-393.
- 1894 Des chylières du rat et de l'absorption intestinale. Compt. rend. acad. d. sc. Paris, T. 118, pp. 621-626.
- RANVIER, L. 1896 Des lymphatiques de la villosité intestinal chez le rat et le lapin. C. R. l'Acad. d. Sc. Paris, T. 123, pp. 923-925.
- RAPP, W. V. 1839 Ueber die Tonsillen. Arch. f. Anat. Physiol., n. wiss. Med., S. 189-199. Pl. VII and VIII. Absence of tonsils.
- RASMUSSEN, A. T. 1922 The glandular status of brown multilocular adipose tissue. Endocrinology, vol. 6, pp. 760-770.
- 1923 The so-called hibernating gland. J. of Morphol., vol. 38, pp. 147-205.
- RATTONE, G. AND MONDINO, C. 1888 Sulla circolazione del sangue nel fegato. Giorn. di sc. nat. ed econ., vol. 19, pp. 125-136, 2 pl.
- 1888 a Sur la circulation du sang dans le foie. Arch. ital. de biol., T. 9, fasc. 1, pp. 13-15.
- 1889 Sur la circulation du sang dans le foie. Arch. ital. de biol., vol. T. 12, pp. 156-177, 2 pl. (Abrégé d'un travail duquel la 1<sup>o</sup> partie a été publiée à Palerme, la 2<sup>o</sup> dans l'Arch. per le sc. med., Torino, T. 13, no. 3.) Rat among animals used.
- 1889 a Sulla circolazione del sangue nel fegato, pt. 2. Arch. per le sc. med., vol. 13, pp. 45-72, 1 pl.
- RAUTHER, MAX 1903 Ueber den Genitalapparat einiger Naget u. Insektivoren, insbesondere die accessorischen Genitadrüsen derselben. Jenaische Ztsch. f. Naturw., Bd. 38, S. 377-472. 3 pl.
- READ, B. E. 1919 Behavior of Sudan III in the animal organism. J. Biol. Chem., vol. 37, pp. 121-135. Rat—p. 132.
- REED, DOROTHY M. 1909 The bacillus pseudo-tuberculosis murium; its streptothrix forms and pathogenic action. Found in Contributions to the science of medicine dedicated by his pupils to William H. Welch. Johns Hopkins Press—Baltimore.
- REED, HOWARD S. 1921 The rate of growth following an initial period of suppression. Am. Naturalist, vol. 55, pp. 539-555.
- REEVES, CORA D. 1917 Moving and still lights as stimuli in a discrimination experiment with white rats. J. Animal Behavior, vol. 7, pp. 160-168.
- REGAUD, CL. 1899 Origine, renouvellement et structure des spermatogonies chez le rat. (3rd communication préliminaire.) Verh. der Anat. Gesellsch. Ergänzungsheft z. 16th Bd., S. 42-57. Mus decumanus.
- 1900 Note sur le tissu conjonctif du testicule chez le rat. Compt. rend. Soc. de Biol., T. 52, pp. 26-27.
- 1900 a Dégénérescence des cellules séminales chez les mammifères en l'absence de tout état pathologique. Compt. rend. Soc. de Biol., Paris, T. 52; pp. 268-270.
- 1900 b Note sur certaines différenciations chromatique observées dans le noyau des spermatocytes du rat. Compt. rend. Soc. de biol., Paris, T. 52, pp. 698-700.
- 1900 c La sécrétion liquide de l'épithélium séminal; son processus histologique. Compt. rend. Soc. de Biol., T. 52, pp. 912-914.
- 1900 d Les phases et les stades de l'onde spermatogénétique chez les mammifères (rat). Classification rationnelle des figures de la spermatogenèse. Compt. rend. Soc. de biol., Paris, T. 52, pp. 1039-1042.
- 1900 e Direction hélicoïdale du mouvement spermatogénétique dans les tubes séminifères du rat. Compt. rend. Soc. de biol., Paris, T. 52, pp. 1042-1044.
- 1900 f Les phénomènes sécrétoires du testicule et la nutrition de l'épithélium séminal. Compt. rend. Soc. de biol., Paris, T. 52, pp. 1102-1104.
- 1901 Pluralité des karyokinèses des spermatogonies chez les mammifères (rat). Compt. rend. Soc. de biol. Paris, T. 53, pp. 56-58.
- 1901 a Division directe ou bourgeonnement du noyau des spermatogonies, chez le rat. Compt. rend. Soc. de biol., Paris, T. 53, pp. 74-76.
- 1901 b Variations de la chromatine nucléaire au cours de la spermatogenèse. Compt. rend. Soc. de biol., Paris, T. 53, pp. 224-226.
- 1901 c Sur le mode de formation des chromosomes pendant les karyokinèses des spermatogonies, chez le rat. Compt. rend. Soc. de biol., Paris, T. 53, pp. 406-307.
- 1901 d Note sur les cellules glandulaires de l'épididyme du rat. Compt. rend. Soc. de biol., Paris, T. 53, pp. 616-618.
- 1902 Sur l'existence de cellules séminales dans le tissu conjonctif du testicule et sur la signification de ce fait. Compt. rend. Soc. de biol., Paris, T. 54, pp. 745-747.
- 1903 Quelques faits nouveaux relatifs aux phénomènes de sécrétion de l'épithélium séminal du rat. Compt. rend. de l'Ass. d. anat. Nancy, S. 5, pp. 179-186. Bibliographie anatomique Suppl. 1903.
- REGAUD, CL. AND TOURNADE, A. 1903 Note histologique sur les phénomènes regressifs déterminés dans le testicule par l'oblitération du canal déférent. Compt. rend. Soc. de biol., T. 55, pp. 1662-1664.
- REGAUD, CL. 1904 Variations histochimiques du filament axile pendant le développement des spermies, chez le rat. C. R. Ass. Anat. Sess. 6, p. 292.
- REGNAULT, F. 1891 Diagnostic histologique différentiel entre les oeufs de ver et les sporozoaires dans



- une maladie du rat. Bull. Soc. anat. de Par., T. 66, p. 588.
- REHN, JAMES A. G. 1900 An older name for the Norway rat. Proc. Biol. Soc. Wash., vol. 13, p. 167. *Mus decumanus* (Pall) to *Mus* (*Epinys*) *norvegicus* (Erleben). Merely a three line note.
- REICHARDT, MARTIN 1906 Ueber die Untersuchung des gesunden und kranken Gehirnes mittels der Wage. Arb. a. d. psychiat. Klin. zu Würzburg, part 1, p. 52.
- REICHERT, E. T. AND BROWN, A. P. 1909 The differentiation and specificity of corresponding proteins and other vital substances in relation to biological classification and orgaic evolution: The crystallography of hemoglobins. Carnegie Inst. of Wash., Wash., D. C., pp. 229-237. The blood of the rat.
- REMLINGER, P. 1901 Rage expérimentale de la souris et du rat. Compt. rend. Soc. de biol., T. 56, p. 42.
- RENAUT, J. 1904 Les cellules fixes des tendons de la queue du jeune rat sont toutes ces cellules connectives rhagiocérines. C. R. Soc. Biol. Paris, T. 56, pp. 1067-1069.
- RENSON, GEO. 1882 De la spermatogenèse chez les mammifères. Arch. de biol., T. 3, pp. 291-334.
- REPORTS ON PLAGUE INVESTIGATIONS IN INDIA 1907 Issued by the Advisory Committee appointed by the Secretary of State for India, the Royal Society and the Lister Institute. J. Hyg., vol. 6, pp. 421-536; vol. 7, pp. 324-476; pp. 694-986.
- REITTERER, ED. 1905 Des névries interarticulaires du genou du Cobaye et du Rat. C. R. Soc. Biol. Paris, T. 58, pp. 44-47.
- RETTGER, LEO F. 1915 The influence of milk feeding on mortality and growth, and on the character of the intestinal flora. J. of Exper. Med., vol. 21, pp. 365-388.
- RETTGER, LEO F. AND CHEPLIN, H. A. 1921 A treatise on the transformation of the intestinal flora with special reference to the implantation of *Bacillus acidophilus*. Yale University Press—New Haven. page 11—Feeding and implantation experiments with white rats.
- RETZIUS, A. 1841 Ueber den Bau des Magens bei den in Schweden vorkommenden Wühlmäusen (*Leomus Nilss.*, *Hypodacus Jllig.*) (A. d. Schwed. von F. C. H. Creplin.) Taf. XIV, fig. 2-9. Archiv. für Anat. u. Physiol., S. 403-420. Comparisons with *Mus decumanus*.
- RETZIUS, GUSTAF 1893 Biologische Untersuchungen. Neue Folge V. 2. Studien über Ependym und Neuroglia, pp. 9-15. 5. Weiteres über die Endigungsweise des Gehirnnerven. S. 35-39. Samson & Wallin. Stockholm.
- 1894 Biologische Untersuchungen. Neue Folge VI, 1. Die Neuroglia der Neurohypophyse der Säugetiere. S. 1-28. Samson & Wallin, Stockholm.
- 1909 Biologische Untersuchungen. 14. Die Spermien der Nagetiere. Taf. XI-XLVIII. Taf. XLIX, fig. 13-20, pp. 133-162. p. 160, *Mus norvegicus* Erxl. (*Mus decumanus* Pall) Neue Folge, XIV. Gustav Fischer, Jena.
- REVILLIOD, P. 1908 Influence du régime alimentaire sur la croissance et la structure du tube digestif. Revue suisse de Zool., T. 16, p. 241.
- REYNOLDS, EDWARD AND MACOMBER, DONALD 1921 Defective diet as a cause of sterility. A study based on feeding experiments with rats. J. Am. Med. Assoc., vol. 77, pp. 169-175.
- 1921 a Certain dietary factors in the causation of sterility in rats. Am. J. of Obstet. and Gynec., vol. 2.
- REYNOLDS, F. H. AND SCHOENING, H. W. 1918 An improved method for recovering trypanosomes from the blood of rats for antigen purposes in connection with complement fixation. J. of Agr. Research, vol. 14, pp. 573-576.
- RICHARDSON, ANNA E. AND GREEN, HELEN S. 1916 Nutrition investigations upon cottonseed meal. J. Biol. Chem., vol. 25, pp. 307-318.
- 1917 Nutrition investigations upon cottonseed meal. II. J. Biol. Chem., vol. 30, pp. 243-258.
- 1917 a Nutrition investigations upon cottonseed meal. III. Cottonseed flour. The nature of its growth-promoting substances, and a study in protein minimum. J. Biol. Chem., vol. 31, pp. 379-388.
- RICHARDSON, FLORENCE 1909 A study of sensory control in the rat. Psych. Monographs, vol. 12, no. 1, pp. 1-124.
- RICHARDSON, W. D. 1921 The distributor of vitamins in natural foodstuffs. Science, N. S., vol. 54, no. 1401, November 4th.
- RICHET, CHARLES 1891 De la mesure des combustions respiratoires. Arch. de physiol. norm. et path., 5th Series, vol. 3, pp. 74-86.
- RICHTER, CURT P. 1922 A behavioristic study of the activity of the rat. Comp. Psychol. Monographs, vol. 1, serial no. 2, Baltimore.
- RITZEMA-BOS, J. 1891 Zur Frage der Vererbung von Traumatismen. Biol. Centralbl., Bd. 11.
- 1893 Onderzoekingen aangaande de gevolgen van de teelt in bloedverwantschap. Handelingen van het Vierde Nederlandsch Natuur en Geneeskundig Congres, te Houden te Groningen, op den 7th en 8th April, pp. 195-199.
- 1894 Untersuchungen über die Folgen der Zucht in engster Bluterwandschaft. Biol. Centralbl., Bd. 14, S. 75-81.
- ROBERTSON, T. B. 1908 On the normal rate of growth of an individual and its biochemical significance. Arch. f. Entwicklungs-mechn. d. Organ., vol. 25, pp. 571-614.
- 1912 Studies in the blood relationship of animals as displayed in the composition of the serum proteins.

- I. A comparison of the serum of the horse, rabbit, rat and ox with respect to their content of various proteins in the normal and in the fasting condition. *J. Biol. Chem.*, vol. 13, p. 325.
- ROBERTSON, T. B. AND BURNETT, T. C. 1913 The influence of lecithin and cholesterol upon the growth of tumors. *J. Exper. Med.*, vol. 17, pp. 344-352.
- 1915 The influence of the anterior lobe of the pituitary body upon the growth of carcinomata. *J. Exper. Med.*, vol. 21, pp. 280-287.
- 1916 The influence of tethelin, and of other alcohol-soluble extractives from the anterior lobe of the pituitary body, upon the growth of carcinomata in rats. *J. of Exper. Med.*, vol. 23, pp. 631-639.
- ROBINSON, ARTHUR 1889 Observations on the early stages in the development of the lungs of rats and mice. *J. of Anat. u. Physiol.*, vol. 23, pp. 224-241.
- 1892 Some points in the early development of *Mus musculus* and *Mus decumanus*; the relation of the yolk-sac to the decidua and the placenta. *Rep. Brit. Assoc. Adv. Sc.*, 61st Meeting, Cardiff, pp. 690-691.
- 1892 a Observations upon the development of the spinal cord in *Mus musculus* and *Mus decumanus*. *Rep. Brit. Assoc. Adv. Sc.*, 61st meeting, Cardiff, pp. 691-692.
- 1892 b The nutritive importance of the yolk-sac. *J. of Anat. and Phys.*, vol. 26, pp. 308-323.
- 1892 c Observations upon the development of the segmentation cavity, the archenteron, the germinal layers, and the amnion in mammals. *Quart. J. Mic. Sc.*, vol. 33, n. s.
- 1896 On the formation and structure of the optic nerve, and its relation to the optic stalk. *J. Anat. and Physiol.*, vol. 30, pp. 319-333.
- 1904 Lectures on the early stages in the development of mammalian ova and on the differentiation of the placenta in different groups of mammals. *J. Anat. and Physiol.*, vol. 38, pp. 186-204.
- ROBINSON, G. H. 1913 The rats of Providence and their parasites. *Am. J. Pub. Health.*, vol. 3, pp. 773-776.
- ROBISON, ROBERT 1923 The possible significance of hexosephosphoric esters in ossification. *Bio-Chem. J.*, vol. 17, pp. 286-293.
- RODWELL, JAMES 1858 The rat: its history and destructive character. G. Routledge & Co., London.
- ROFFO, A. H. 1918 Sobre transmisión del epiteloma pavimentoso de la rata blanca. *Revista del Instituto Bacteriologico*, Buenos Aires, T. 1, pp. 155-160.
- 1920 Sur le rôle du facteur "race" dans la transmission du cancer chez le rat. Transformation progressive d'une race non réceptive en réceptive. *Compt. rend. Soc. de biol.*, Paris, T. 83, pp. 968-970.
- ROHDE, ALICE, AND JONES, WALTER 1909 The purine ferments of the rat. *J. Biol. Chem.*, vol. 7, p. 237.
- ROHDENBURG, G. L. AND BULLOCK, F. D. 1916 Transplantable sarcomata of the rat liver arising in the walls of parasitic cysts. *J. of Cancer Research*, vol. 1, p. 87.
- ROHDENBURG, G. L. 1920 The isocagglutinins and isohemolysins of the rat. *Proc. of the Soc. for Exp. Biol. and Med.*, vol. 17, p. 82.
- ROLLESTON, GEORGE A. 1870 Forms of animal life; being outlines of zoological classification based upon anatomical investigation and illustrated by descriptions of specimens and figures. Clarendon Press—Oxford. *Mus decumanus*, dissection of, 1-4; nervous system, 1; digestive system, 1, 3; circulatory system, 1, 2; reproductive system, 3; skeleton of, 4-9; plate and description, 260-263.
- ROMEIS, B. 1921 Zur Verjüngungshypothese Steinachs. *Münch. med. Wochenschr.*, No. 20.
- 1922 Geschlechtszellen oder Zwischenzellen? *Klin. Wochenschr.*, Bd. 1, No. 19-21.
- RÖMER, F. 1896 Studien über das Integument der Säugethiere. I. Entwickel. d. Schuppen u. Haare am Schwanz u. an d. Füssen v. *Mus decumanus* und einigen anderen Muriden. *Jenaische Zeitschr. f. naturw.*, Bd. 23, S. 604-622. Two plates mainly from *M. n. albinus*.
- ROSE, MARY S. AND MACLEOD, GRACE 1922 The almond as a source of the A vitamin. *Proc. of the Soc. for Exper. Biol. and Med.*, vol. 19, pp. 391-393.
- ROSENAU, M. J. 1901 An investigation of a pathogenic microbe (*B. typhi murium* Danyz) applied to the destruction of rats. *Bull. no. 5, Hyg. Lab.*, U. S. Mar. Hosp. Serv. Wash.
- ROSENFELD, CARL 1899 Zur vergleichenden Anatomie des *Musculus tibialis posterioris*. *Anat. Hefte*, Bd. 11, S. 361-388. *Mus rattus*, S. 364.
- ROTH, A. H. 1905 The relation between the occurrence of white rami fibers and the spinal accessory nerve. *J. Comp. Neur. and Psychol.*, vol. 15, pp. 482-493.
- ROTH, GEORGE B. 1918 An experimental investigation of the toxicity of certain organic arsenic compounds. *Hygienic Lab. Bull. no. 113*, U. S. Pub. Health Service.
- ROTHSCHILD, N. C. 1906 Note on the species of fleas found upon rats, *Mus rattus* and *Mus decumanus*, in different parts of the world, and on some variations in the proportion of each species in different localities. *J. Hyg.*, Cambridge, vol. 6, pp. 483-485.
- ROUDSKY, D. 1911 Sur la possibilité de rendre le *T. lewisii* virulent pour d'autres rongeurs que le rat. *Compt. Rend. Acad. Sci.*, T. 152, pp. 56-58.
- ROUS, PEYTON 1911 The rate of tumor growth in underfed hosts. *Proc. of Soc. for Exper. Biol. and Med.*, vol. 8, pp. 128-130.
- 1914 The influence of diet on transplantable and spontaneous mouse tumors. *J. Exp. Med.*, vol. 20, p. 433.

- ROUS, PEYTON AND JONES, F. S. 1916 The protection of pathogenic micro-organisms by living tissue cells. *J. of Exper. Med.*, vol. 23, pp. 601-612.
- ROUS, PEYTON AND ROBERTSON, O. H. 1917 The normal fate of erythrocytes. I. The findings in healthy animals. *J. Exper. Med.*, vol. 25, pp. 651-666.
- ROUS, PEYTON AND McMASTER, PHILIP D. 1924 The liver requirement of the fasting organism. *J. of Exper. Med.*, vol. 39, pp. 425-445.
- ROWLAND, SYDNEY 1911 Preliminary observations on the protective and curative value for rats of the serum of a horse immunised with a toxic nucleoprotein extracted from the plague bacillus. *J. of Hyg., Plague Suppl.* 1, 6th Report of Plague Investigations in India, pp. 11-19.
- RUBEL, O. 1890 Ueber den Oesophagus des Menschen und der Hausthier. *Ztschr. f. wissenschaft. Mikr.* Bd. 7, S. 224-225.
- RUGER, G. J. AND RUGER, H. A. 1917 Experiments with the white rat and the Hampton Court maze. *J. Philos. Psychol.*, vol. 14, p. 329.
- RUGER, H. A. 1918 Some experiments in the transfer of habits in the white rat. *Proc. Am. Psychol. Assoc. in Psychol. Bull.*, vol. 15, p. 42.
- RUSS, S. AND CHAMBERS, HELEN 1913 On the action of radium rays upon the cells of Jensen's rat sarcoma. *Proc. Roy. Soc. Lond.*, vol. 86, series B, pp. 482-489.
- RUSSELL, B. R. G. 1923 The experimental production of tar-sarcoma in mice and rats. Eighth *Scienc. Report of the Imperial Cancer Research Fund*; also in *J. of Pathol. and Bacteriol.*, vol. 25, 1922.
- 1923 a Experimental osteo-sarcoma of rat. Eighth *Scienc. Report of the Imperial Cancer Research Fund*.
- RUZICKA, V. 1922 Hysteresis des Protoplasmas und das Problem der Verjüngung. *Deutsche Med. Wochenschr.*, Bd. 48, p. 931.
- RYDER, J. A. 1888 A theory of the origin of placental types, and on certain vestigiary structures in the placenta of the mouse, rat and field mouse. *Am. Naturalist*, vol. 21, pp. 750-784.
- RYWOSCH, D. 1907 Vergleichende Untersuchungen über die Resistenz der Erythrocyten einiger Säugethiere gegen hämolytische Agentien. *Arch. f. d. ges. Physiol.*, Bd. 116, S. 229-251.
- SABRAZÉS, J. AND MURATET 1905 Fréquence des Trypanosomes chez *Mus rattus*. Rareté chez *Mus decumanus* et chez *Mus musculus*. Résistance du *decumanus* et du rat blanc à l'infestation naturelle. *C. R. Soc. Biol. Paris*, T. 59, pp. 441-443.
- SAFFORD, M. VICTOR 1918 Rats and disease not less important than rats and waste. *The Sunday Herald*, Boston, July 28th.
- SALANT, W., RIEGER, J. B. AND TREUTHARDT, E. L. 1914 Absorption and fate of tin in the body. *J. Biol. Chem.*, vol. 17, pp. 265-273. Rat—page 272.
- SALKIND, J. 1915 Contributions histologiques à la biologie comparée du thymus. *Arch. de Zool. Exper. T.* 55. Restoration of thymus structure.
- SALTER, H. H. 1859 Pancreas. (Article in R. B. Todd's "The Cyclopaedia of anatomy and physiology.") Vol. 5 (suppl. vol.), pp. 81-114, London. Several text figures for the rat.
- SAND, KUND 1919 Experiments on the internal secretion of the sexual glands, especially on experimental hermaphroditism. *J. of Physiol.*, vol. 53, pp. 257-263.
- SANDRI, O. 1908 Contribution à l'anatomie et à la physiologie de l'hypophyse. Résumé de l'auteur. *Riv. di pat. nerv. e ment.*, T. 13, pp. 518-550. *Arch. ital. de Biol.*, vol. 51, pp. 337-348. Growth of rats fed with hypophysis.
- SANGIORGI, G. 1914 *Toxoplasma ratti*, n. sp. *Gior. d. r. Accad. di med. di Torino*, 4 s., T. 20, pp. 353-355.
- SANTOS, FRANCISCO O. 1922 Some plant sources of vitamins B and C. *Am. J. Physiol.*, vol. 59, pp. 310-334.
- SAVIOTTI, GIOVANNI 1869 Untersuchungen über den feineren Bau des Pancreas. *Arch. f. mikr. Anat.*, Bd. 5, S. 404-414, pl. XXIII and XXIV.
- SCAMMON, RICHARD E. 1916 On the development of the biliary system in animals lacking a gall-bladder in post-natal life. *Anat. Rec.*, vol. 10, pp. 543-553. Rat p. 553.
- SCHAEFFER, ANNA 1911 Vergleichend histologische Untersuchungen über die interstitielle Eierstockdrüse. *Arch. f. Gynäk.*, Bd. 94, S. 491-541.
- SCHÄFER, E. A. 1898 (see GAMGEE, A.) Rat, haemoglobin of. *Text-book of Physiol.*, vol. 1, pp. 193, 194 and 206.
- 1900 Rat, motor area of. *Text-book of Physiol.*, vol. 2, p. 732.
- 1900 a Rat, muscle spindles of. *Text-book of Physiol.*, vol. 2, p. 1008.
- 1908 Present condition of our knowledge regarding the functions of the suprarenal capsules. *Brit. M. J.*, May 30 and June 6, pp. 1-10.
- 1909 The functions of the pituitary body. *Proc. Roy. Soc.*, vol. 81, p. 453.
- 1911 Die Funktionen des Gehirnanhanges (Hypophysis cerebri). *Berner Universitätschriften*, Theil 3.
- 1912 The effects upon growth and metabolism of the addition of small amounts of ovarian tissue, pituitary, and thyroid to the normal dietary of white rats. *Quart. J. Exper. Physiol.*, vol. 5, pp. 203-223.
- SCHÄFF, E. 1891 Schwärzliche Varietät von *Mus decumanus*. *Sitzgsber. Ges. Naturf. fr. Berlin*, no. 4, S. 61.

- SCHAMBERG, J. F., KOLMER, J. A. AND RAIZISS, G. W. 1920 Comparative studies of the toxicity of arsphe-  
namine and neo-arsphenamine. *Am. J. of the Med.*  
*Sciences*, vol. 160, pp. 1-11. Tests on rats.
- SCHERN, K. 1909 Ueber eine durch den Bazillus  
enteritidis (Gärtner) hervorgerufene Rattenseuche.  
*Arb. a. d. k. Gsndtsamte, Berl.*, Bd. 30, S. 575-583.
- SCHICKELE, G. 1899 Beiträge zur Morphologie und  
Entwicklung der normalen und überzähligen  
Milchdrüsen. *Zeitschr. f. Morphol. und Anthropol.*,  
Bd. 1, Heft 3.
- SCHIFF, J. MORITZ 1859 Untersuchungen über die  
Zuckerbildung in der Leber und den Einfluss des  
Nervensystems auf die Erzeugung des Diabetes.  
Würzburg.
- 1884 Bericht über eine Versuchsreihe betreffend  
die Wirkungen der Exstirpation der Schilddrüse.  
*Arch. f. exper. Path. u. Pharmakol.*, Bd. 18, S.  
24-34.
- 1884 a Résumé d'une nouvelle série d'expériences  
sur les effets de l'ablation des corps thyroïdes. *Rev.*  
*méd. de la Suisse-Rom.*, Genève, S. 4, pp. 425-445.
- SCHILLING, C. 1900 Ueber eine bei Ratten vorkom-  
mende Seuche. *Arb. a. d. k. Gsndtsamte, Berl.*,  
Bd. 18, S. 108-113.
- SCHMIDT, F. TH. 1863 Das folliculäre Drüsengewebe  
der Schleimhaut der Mundhöhle und des Schlundes  
bei dem Menschen und den Säugetieren. *Ztschr.*  
*f. wiss. Zool.*, Bd. 13, S. 221-302, pl. XIV-XVI.
- SCHOTTMÜLLER, H. 1914 Zur Aetiologie und Klinik  
der Bisskrankheit (Ratten, Katzen, Eichhörnchen-  
Bisskrankheit). *Dermat. Wehnschr.*, Bd. 58,  
Suppl., S. 77-103.
- SCHULTZE, OSCAR 1897 Grundriss der Entwick-  
lungsgeschichte des Menschen und der Säugethiere.  
Wilhelm Engelmann, Leipzig, p. 110 plate 111-  
Durchschnitt der Fruchtblase der Ratte (Duval).
- SCHULZE, F. E. 1871 Die Lungen. In Stricker's  
*Handbuch der Lehre von den Geweben des Men-*  
*schens und der Tiere.* Leipzig. S. 464-477. S. 465,  
diameter of alveolar passages, 0.1 mm. in rat.
- SCHÜRMAN, W. 1908 Ueber eine durch Milben her-  
vorgerufene Erkrankung von Ratten. *Centralbl.*  
*Bakt. Parasit. Abt. I, Orig.*, Bd. 48, S. 167-172.
- SCHWALBE, G. 1872 Beiträge zur Kenntniss der  
Drüsen in den Darmwandungen in's Besondere  
der Brunner'schen Drüsen. *Arch. f. mikr. Anat.*,  
Bd. 8, S. 92-146, pl. V.
- SCHWARTZE, ERICH W. 1920 Toxicity of barium  
carbonate to rats. U. S. Dept. of Agr., Bull. No.  
915, page 10—average intake of food 1/100 of the  
body weight.
- 1921 Some observations upon the behavior of a  
fixed oil (peanut oil) injected intraperitoneally.  
*J. of Pharmacol. and Exper. Ther.*, vol. 17, pp.  
115-119.
- 1922 The relative toxicity of strychnine to the  
rat. U. S. Dept. of Agr., Bull. No. 1023, Janu-  
ary 9th.
- 1922 a Observations upon the resistance of the  
rat to consecutive injections of strychnine. *J. of*  
*Pharmacol. and Exper. Therapeutics*, vol. 19, pp.  
49-58.
- 1922 b Functional evidence of the phylogeny of  
the nervous system as shown by the behavior and  
resistance of the developing rat to strychnine. *J.*  
*of Pharmacol. and Exper. Therapeutics*, vol. 19,  
pp. 273-291.
- 1922 c The so-called habituation to "arsenic;"  
variation in the toxicity of arsenious oxide. *J. of*  
*Pharmacol. and Exper. Therapeutics*, vol. 20,  
pp. 181-203.
- SCHWARTZE, E. W. AND ALSBERG, C. L. 1923 Studies  
on the pharmacology of cadmium and zinc with  
particular reference to emesis. *J. of Pharmacol.*  
*and Exper. Therapeutics*, vol. 21, pp. 1-27.
- SCHWARZ, O. 1910 Ueber Stoffwechselstörungen nach  
der Exstirpation bei den Nebennieren. *Arch. f.*  
*d. ges. Physiol.*, Bd. 134, S. 259-288.
- SCOTT, J. M. D. 1923 Studies in anaemia. I. The  
influence of diet on the occurrence of secondary  
anaemia following repeated haemorrhages in rats.  
*Biochem. J.*, vol. 17, pp. 157-165.
- 1923 a Studies in anaemia. II. *Biochem. J.*, vol.  
17, pp. 166-169.
- SCOTT, J. M. D. AND BARCROFT, J. 1923 Experimental  
anaemia. Abstracts of Communications to the  
X1th Internat. Physiol. Congress held at Edinburgh,  
July 23rd-27th.
- SCOTT, KATHARINE J. AND EVANS, H. M. 1921 Rela-  
tion of nutrition to the oestrous cycle. *Proc. of*  
*Am. Assoc. of Anatomists in Anat. Record*, vol.  
21, pp. 80-81.
- SCOTT, W. J. M. 1923 The influence of the adrenal  
glands on resistance. I. The susceptibility of  
adrenalectomized rats to morphine. *J. of Exper.*  
*Med.*, vol. 38, pp. 543-560.
- SELENKA, EMIL 1883 Studien über Entwick-  
lungsgeschichte der Thiere. I. Keimblätter und Primi-  
tivorgane der Maus. C. W. Kreidel, Wiesbaden.
- 1884 Studien über Entwicklungsgeschichte der  
Thiere., 3. Die Blätterumkehrung im Ei der Nage-  
thiere. C. W. Kreidel, Wiesbaden.
- SELL, MARIANA T. AND NELSON, E. M. 1921 Vitamines  
in milk. *Science, n.s.*, vol. 54, August 26th.
- SEVERIN, FRIEDRICH 1885 Untersuchungen über das  
Mundepithel bei Säugetieren mit Bezug auf Ver-  
hornung, Regeneration und Art der Nerven-  
endigung. *Arch. f. mikr. Anat.*, Bd. 26, S. 81-88, 1 pl.  
Rat included among mammals examined.
- SHADWELL, ARTHUR AND HENNESSY, HARRIET L.  
1911 Plague-Dissemination. *Encyclopaedia Bri-*

- tannica, 11th ed., vol. 21, pp. 703-701. Rat: pp. 703-701.
- SHANKS, W. F. 1923 The excretion of cholin in the urine. *J. of Physiol.*, vol. 58, pp. 230-233.
- SHEETS, OLIVE AND FUNK, CASIMIR 1922 The effect of ultra-violet rays on rats, deprived of vitamin A in their diet. *Proc. of the Soc. for Exper. Biol. and Med.*, vol. 20, pp. 80-81.
- SHERBORN, C. DAVIES 1897 On the dates of the natural history portion of Savigny's "Description de l'Égypte." *Proc. Zool. Soc. of London, 1897*, pp. 285-288.
- SHERMAN, H. C., MACLEOD, F. L. AND KRAMER, M. M. 1920 Preliminary experiments with the fat-soluble vitamin (vitamin A). *Proc. of the Soc. for Exper. Biol. and Med.*, vol. 18, pp. 41-43.
- SHERMAN, H. C. AND PAPPENHEIMER, A. M. 1921 A dietetic production of rickets in rats and its prevention by an inorganic salt. *Proc. of the Soc. for Exper. Biol. and Med.*, vol. 18, pp. 193-197.
- 1921 a Experimental rickets in rats. I. A diet producing rickets in white rats, and its prevention by the addition of an inorganic salt. *J. of Exper. Med.*, vol. 34, pp. 189-198.
- SHERMAN, H. C., ROUSE, M. E., ALLEN, B. AND WOODS, ELLA 1921 Growth and reproduction upon simplified food supply I. *J. of Biol. Chem.*, vol. 46, pp. 503-519.
- SHERMAN, H. C. AND CROCKER, JOSEPHINE 1922 Growth and reproduction upon simplified food supply. III. The efficiency of growth as influenced by the proportion of milk in the diet. *J. of Biol. Chem.*, vol. 53, pp. 49-52.
- SHERMAN, H. C. AND MCHLFIELD, MARIE 1922 Growth and reproduction upon simplified food supply. II. Influence of food upon mother and young during the lactation period. *J. of Biol. Chem.*, vol. 53, pp. 41-47.
- SHERMAN, H. C. AND SMITH, S. L. 1922 The vitamins. *Chem. Cat. Co., N. Y.*, 273 pp.
- SHERMAN, H. C. AND GROSE, M. R. 1923 A quantitative study of the destruction of vitamin B by heat. *Proc. of the Soc. for Exper. Biol. and Med.*, vol. 21, pp. 11-13.
- SHERMAN, H. C. AND KRAMER, M. M. 1923 Experiments on vitamin A. *Proc. of the Soc. for Exper. Biol. and Med.*, vol. 20, pp. 201-202.
- SHERINGTON, C. S. AND COPEMAN, S. M. 1893 Variations experimentally produced in the specific gravity of the blood. *J. Physiol.*, vol. 14, p. 54.
- SHIMIDZU, YOSHITAKA 1920 On the permeability of the placenta for adrenalin in the pregnant rabbit and albino rat. *Am. J. Physiol.*, vol. 52, pp. 377-394.
- 1922 On the permeability to dyestuffs of the placenta of the albino rat and the white mouse. *Am. J. of Physiol.*, vol. 62, pp. 202-224.
- SHIPLEY, A. E. 1908 Rats and their animal parasites. *J. Economic Biol.*, vol. 3, pp. 61-83.
- SHIPLEY, P. G., PARK, E. A., POWERS, G. F., MCCOLLUM, E. V. AND SIMMONDS, NINA 1921 The prevention of the development of rickets in rats by sunlight. *Proc. of the Soc. for Exper. Biol. and Med.*, vol. 19, pp. 43-47.
- SHIPLEY, P. G., PARK, E. A., MCCOLLUM, E. V., SIMMONDS, N. AND PARSONS, H. T. 1921 Studies on experimental rickets. II. The effect of cod liver oil administered to rats with experimental rickets. *J. Biol. Chem.*, vol. 45, pp. 343-348.
- SHIPLEY, P. G., MCCOLLUM, E. V., AND SIMMONDS, NINA 1921 Studies on experimental rickets. IX. Lesions in the bones of rats suffering from uncomplicated beriberi. *J. Biol. Chem.*, vol. 49, pp. 399-410.
- SHIPLEY, P. G., PARK, E. A., MCCOLLUM, E. V. AND SIMMONDS, NINA 1921 Studies on experimental rickets. V. The production of rickets by means of a diet faulty in only two respects. *Proc. of the Soc. for Exp. Biol. and Med.*, vol. 18, pp. 277-280.
- 1921 a The function of the organic factor as exemplified by cod liver oil. XIII. *Trans. of the Am. Pediatric Soc.*, 33rd session, June 2, 3 and 4.
- 1922 Studies on experimental rickets. X. Rickets and rickets-like disease produced in rats by deficient diets. *Dental Cosmos—March*.
- 1922 a Studies on experimental rickets. XX. The effects of strontium administration on the histological structure of the growing bones. *Johns Hopkins Hosp. Bull.*, vol. 33, page 216.
- SHIPLEY, P. G. 1922 Faulty diet and its relation to the structure of bone. *Jour. Amer. Med. Assoc.*, vol. 79, pp. 1563.
- 1922 a The relation of the diet to rickets. *Trans. of the Congress of Am. Physicians and Surgeons*, vol. 12, pp. 31-36.
- SIMMONS, RIETTA 1924 The relative effectiveness of certain incentives in animal learning. *Comparative Psychol. Monographs*, vol. 2, serial no. 7, pp. 1-79.
- SINGER, J. AND MÜNZER, E. 1885 Beiträge zur Kenntnis der Schiervenenkreuzung. *Denkschr. d. k. Akad. d. Wissensch. Math.-naturw. Cl.*, Bd. 55, abth 2, Wien.
- SIPERSTEIN, D. M. 1921 The effects of acute and chronic inanition upon the development and structure of the testis in the albino rat. *Anat. Rec.*, vol. 20, pp. 355-381.
- SISSON, WARREN R. AND FINNEY, J. M. T. 1920 Effect of feeding the pineal body upon the development of the albino rat. *J. of Exper. Med.*, vol. 31, pp. 335-346.
- SITTENFIELD, M. J. 1912 Influence of anemia and hyperemia on the growth of sarcoma in the white

- rat. *Proc. Soc. Exper. Biol. and Med.*, vol. 9, pp. 56-57.
- SLONAKER, J. R. 1907 The normal activity of the white rat at different ages. *J. Comp. Neur. and Psychol.*, vol. 17, pp. 342-359.
- 1912 The normal activity of the albino rat from oirth to natural death, its rate of growth and the duration of life. *J. Animal Behavior*, vol. 2, pp. 20-42.
- 1912 a The effect of a strictly vegetable diet on the spontaneous activity, the rate of growth, and the longevity of the albino rat. *Leland Stanford Jr. Univ. Pub., Univ. Series*.
- 1918 The care and breeding of albino rats. *Science*, N. S., vol. 47, June 14th, pp. 594-596.
- SLONAKER, J. R. AND CARD, T. A. 1918 The effect of omnivorous and vegetarian diets on reproduction in the albino rat. *Science*, vol. 47, pp. 223-224, March 1st.
- SLONAKER, J. R. AND CARD, THOMAS A. 1923 The effect of a restricted diet. I. On growth. *Am. J. of Physiol.*, vol. 63, pp. 503-512.
- 1923 a Effect of a restricted diet. II. On pubescence and the menopause. *Am. J. of Physiol.*, vol. 64, pp. 35-43.
- 1923 b The effect of a restricted diet. III. On the number of litters and young born. *Am. J. of Physiol.*, vol. 64, pp. 167-180.
- 1923 c The effect of a restricted diet. IV. On the age of greatest productivity. *Am. J. of Physiol.*, vol. 64, pp. 203-209.
- 1923 d The effect of a restricted diet. V. On mortality, cannibalism and the sex ratio. *Am. J. of Physiol.*, vol. 64, pp. 297-310.
- SMALL, W. S. 1899 Notes on the psychic development of the young white rat. *Am. J. Psychol.*, vol. 11, pp. 80-100.
- 1900 An experimental study of the mental processes of the rat. *Am. J. Psychol.*, vol. 11, pp. 133-164.
- 1901 Experimental study of the mental processes of the rat, II. *Am. J. Psychol.*, vol. 12, pp. 206-239.
- SMITH, ARTHUR H. 1921 A remedy for mange in white rats. *Science*, N. S., vol. 54, no. 1399, October 21st, p. 378.
- SMITH, ARTHUR H. AND ASCHAM, LEAH 1922 Relation of splenectomy to growth and appetite in the rat. *Am. J. Physiol.*, vol. 60, pp. 250-254.
- SMITH, ARTHUR H. AND CAREY, ELIZABETH 1923 Growth on diets high in carbohydrate and high in fat. *J. of Biol. Chem.*, vol. 58, pp. 425-433.
- SMITH, CHRISTIANNA 1920 A study of the lipid content of the kidney tubule. *Am. J. Anat.*, vol. 27, pp. 69-97. *Rat*-p. 88.
- SMITH, C. S. 1923 The alleged effects on body growth and gonad development of feeding pituitary gland substance to normal white rats. *Am. J. of Physiol.*, vol. 65, pp. 277-281.
- SOBOTTA, J. 1910 Über das Verhalten der Spermatozoen im uterus der Säugetiere. Nach den Befunden bei Nagetieren (Maus, Ratte). *Zeitschr. f. Morph. u. Anthrop.*, Bd. 13, S. 201-208.
- SOBOTTA, J. AND BURCKHARD, G. 1910 Reifung und Befruchtung des Eies der weissen Ratte. *Anat. Hefte*, I. Abt., 127 heft (42 band, heft 2), S. 433-492.
- SOLGER, B. 1889 Säugethier-Mitosen im histologischen Kursus. *Archiv f. mikr. Anat.*, Bd. 33, S. 517-518.
- SOLLMANN, TORALD 1921 Studies of chronic intoxications on albino rats. V. Arsenic trioxid. *J. of Pharmacol. and Exper. Therapeutics*, vol. 18, pp. 43-49.
- SOUlié, A. H. 1903 Recherches sur le développement des capsules surrénales chez les vertébrés supérieurs. *J. de l'Anat. et Physiol.*, T. 39, pp. 197-293; 390-525; 492-533; 634-664.
- SOUZA, GERALDO DE PAULA AND McCOLLUM, E. V. 1920 A study of the factors which interfere with the use of yeast as a test organism for the anti-neuritic substance. *J. of Biol. Chem.*, vol. 44, pp. 113-129.
- SPAIN, KATE C. 1915 The relation between the structure of the epidermis of the rat and the guinea pig, and the proliferative power of normal and regenerating epithelial cells of the same species. *J. of Exper. Med.*, vol. 21, pp. 193-202.
- SPENCER, L. T. 1923 Central inhibition in the albino rat. *J. of Comp. Psychol.*, vol. 3, pp. 389-403.
- SPIZKA, E. C. 1886 The comparative anatomy of the pyramid tract. *J. Comp. M. and S.*, vol. 7, p. 46.
- SPRIGGS, E. I. 1907 The effect of a meat diet upon the coat of rats, with and without a supply of lime. *J. of Physiol.*, vol 36, p. xvii in *Proc. of Physiol. Soc.*, July 20th, 1907.
- STAHR, HERMANN 1903 Ueber die Ausdehnung der Papilla foliata und die Frage einer einseitigen "kompensatorischen Hypertrophie" im Bereiche des Geschmacksorgans. *Arch. f. Entwicklgsmechn. d. Organ.*, Bd. 16, S. 179-199.
- STAMMERS, A. D. 1921 Feeding experiments in connection with vitamins A and B. (1) The value of steam-distilled palm kernel oil as a control fat. (2) Wheat bran as a source of vitamins A and B. *Biochem. J.*, vol. 15, pp. 489-493.
- 1922 Feeding experiments in connection with vitamins A and B. 111. Milk and the growth-promoting vitamin. IV. The vitamin A content of refined codliver oil. *Biochem. J.*, vol. 16, pp. 659-667.
- STEENBOCK, H. 1918 Vitamines and nutrition. *The Scientific Monthly*, vol 7, pp. 179-188.
- STEENBOCK, H., BOUTWELL, P. W. AND KENT, H. E. 1918 Fat-soluble vitamine I. *J. Biol. Chem.* vol. 35, pp. 517-526.

- STEENBOCK, H., KENT, H. E. AND GROSS, E. G. 1918 The dietary qualities of barley. *J. Biol. Chem.*, vol. 35, pp. 61-74.
- STEENBOCK, H. AND GROSS, E. G. 1919 Fat-soluble vitamine. II. The fat-soluble vitamine content of roots, together with some observations on their water-soluble vitamine content. *J. Biol. Chem.*, vol. 40, pp. 501-532.
- 1920 Fat-soluble vitamine. IV. The fat-soluble vitamine content of green plant tissues together with some observations on their water-soluble vitamine content. *J. of Biol. Chem.*, vol. 41, pp. 149-162.
- STEENBOCK, H. AND BOUTWELL, P. W. 1920 Fat-soluble vitamine. III. The comparative nutritive value of white and yellow maizes. *J. of Biol. Chem.*, vol. 41, pp. 81-96.
- 1920 a Fat-soluble vitamine. V. Thermostability of the fat-soluble vitamine in plant materials. *J. of Biol. Chem.*, vol. 41, pp. 163-171.
- 1920 b Fat-soluble vitamine. VI. The extractability of the fat-soluble vitamine from carrots, alfalfa, and yellow corn by fat solvents. *J. of Biol. Chem.*, vol. 42, pp. 131-152.
- STEENBOCK, H., SELL, MARIANA T. AND BUELL, MARY V. 1921 Fat-soluble vitamine. VII. The fat soluble vitamine and yellow pigmentation in animal fats with some observations on its stability to saponification. *J. of Biol. Chem.*, vol. 47, pp. 89-109.
- STEENBOCK, H., SELL, MARIANA T. AND BOUTWELL, P. W. 1921 Fat-soluble vitamine. VIII. The fat soluble vitamine content of peas in relation to their pigmentation. *J. of Biol. Chem.*, vol. 47, pp. 303-308.
- STEENBOCK, H. AND SELL, MARIANA 1922 Fat-soluble vitamine. X. Further observations on the occurrence of the fat-soluble vitamine with yellow plant pigments. *J. of Biol. Chem.*, vol. 51, pp. 63-76.
- STEENBOCK, H. 1923 A satisfactory ration for stock rats. *Science*. N. S., vol. 58, pp. 449-450, November 30th.
- STEENBOCK, H., SELL, M. T. AND NELSON, E. M. 1923 Vitamine B. I. A modified technique in the use of the rat for determinations of vitamine B. *J. of Biol. Chem.*, vol. 55, pp. 399-410.
- 1923 a Fat-soluble vitamine. XI. Storage of the fat-soluble vitamine. *J. of Biol. Chem.*, vol. 56, pp. 327-343.
- STEENBOCK, H., SELL, M. T. AND JONES, J. H. 1923 Vitamine B. II. Storage of vitamine B by the rat. *J. of Biol. Chem.*, vol. 55, pp. 411-419.
- 1923 a Fat-soluble vitamine. XII. The fat-soluble vitamine content of millets. *J. of Biol. Chem.*, vol. 56, pp. 345-354.
- STEENBOCK, H. AND NELSON, E. M. 1923 Fat-soluble vitamine. XIII. Light in its relation to ophthalmia and growth. *J. of Biol. Chem.*, vol. 56, pp. 355-373.
- STEENBOCK, H., HART, E. B., SELL, M. T. AND JONES, J. H. 1923 The availability of calcium salts. *J. of Biol. Chem.*, vol. 56, pp. 375-386.
- STEENBOCK, H., JONES, J. H. AND HART, E. B. 1923 Fat-soluble vitamins. XVI. Stability of the antirachitic vitamin to saponification. *J. of Biol. Chem.*, vol. 58, pp. 383-393.
- STEFFAN, P. 1921 Beobachtungen über den Verlauf der künstlichen Infektion der Ratte mit T. lewisi. *Archiv. Schiffs, Trop.-Hyg.*, Bd. 25, S. 241-247.
- STEFFENHAGEN, K. 1910 Untersuchungen über das Rattenvertilgungsmittel Liverpoolvirus. *Arb. a. d. k. Gsndtsamte Berl.*, Bd. 36, S. 198-220.
- STEINACH, E. 1894 Untersuchungen zur vergleichenden Physiologie der männlichen Geschlechtsorgane, insbesondere der accessorischen Geschlechtsdrüsen. *Arch. f. d. ges. Physiol.*, Bd. 56, S. 304-338.
- 1910 Geschlechtstrieb und echt sekundäre Geschlechtsmerkmale als Folge der innersekretorischen Funktion der Keimdrüsen.
- I. Präexistente und echt sekundäre Geschlechtsmerkmale.
- H. Über die Entstehung des Umklammerungsreflexes bei Fröschen.
- III. Entwicklung der vollen Männlichkeit in funktioneller und somatischer Beziehung bei Säugern als Sonderwirkung des inneren Hodensekretes. *Zentralbl. f. Physiol.*, Bd. 24, S. 551-566.
- 1911 Umstimmung des Geschlechtscharakter bei Säugetieren durch Austausch der Pubertätsdrüsen. *Zentralbl. f. Physiol.*, Bd. 25, S. 723-725.
- 1912 Willkürliche Umwandlung von Säugetiermännchen in Tiere mit ausgeprägt weiblichen Geschlechtscharakteren und weiblicher Psyche. *Arch. f. d. ges. Physiol.*, Bd. 144, S. 71-108.
- 1913 Feminierung von Männchen und Maskulierung von Weibchen. *Zentralbl. f. Physiol.*, Bd. 27, S. 717-723.
- STEINACH, E., AND HOLZKNECHT, G. 1916 Erhöhte Wirkungen der inneren Sekretion bei Hypertrophie der Pubertätsdrüsen. *Archiv für Entwicklungsmechanik*, Bd. 42, S. 490-507.
- STENDELL, W. 1913 Zur vergleichenden Anatomie und Histologie der Hypophysis cerebri. *Arch. f. mikr. Anat.*, Bd. 82, S. 289-332.
- 1914 Die Hypophysis cerebri. *Oppel's Lehrb. d. vergl. mikr. Anatomie*, 8 Theil, Jena.
- STEPHENSON, MARJORY 1920 A note on the differentiation of the yellow plant pigments from the fat-soluble vitamine. *Biochem. J.*, vol. 14, pp. 715-720.
- STEPHENSON, MARJORY AND CLARK, A. B. 1920. A contribution to the study of keratomalacia among rats. *Biochem. J.*, vol. 14, p. 502.
- STERZI, GIUSEPPE 1904 Die Blutgefasse des Rückenmarks. *Anat. Hefte*, Bd. 24, S. 5-364. *Mus cucumardus*, S. 169.

- STEVENS, FRANKLIN A. 1923 The rate of growth of virulent and avirulent streptococci in serum media. *Proc. of the Soc. for Exper. Biol. and Med.*, vol. 21, pp. 82-83.
- STEVENSON, PAUL H. 1921 The extrahepatic biliary tract of the camel. *Anat. Record*, vol. 22, pp. 85-96.
- STEWART, CHESTER A. 1916 Growth of the body and of the various organs of young albino rats after inanition for various periods. *Biol. Bull.*, vol. 31, pp. 16-51.
- 1918 Changes in the relative weights of the various parts, systems, and organs of young albino rats underfed for various periods. *Jour. Exp. Zool.*, vol. 25, pp. 301-353.
- 1918 a Weights of various parts of the brain in normal and underfed albino rats at different ages. *Jour. Comp. Neur.*, vol. 29, pp. 511-528.
- 1919 Changes in the weights of the various parts, systems and organs in albino rats kept at birth weight by underfeeding for various periods. *Am. J. Physiol.*, vol. 48, pp. 67-78.
- STEWART, COLIN C. 1898 Variations in daily activity produced by alcohol and by changes in barometric pressure and diet, with a description of recording methods. *Am. J. Physiol.*, vol. 1, pp. 40-56.
- STEWART, DOROTHY R. 1923 The heredity of the "white hooded" albino rat. *Anat. Record (Proc. of Am. Soc. of Zool.)* vol. 24, pp. 17-118.
- STEWART, FRED W. 1920 The development of the cranial sympathetic ganglia in the rat. *Jour. Comp. Neur.*, vol. 31, pp. 163-127.
- 1920 a On the origin of the ganglion cells of the nervus terminalis of the albino rat. *Jour. Comp. Neur.*, vol. 32, pp. 99-108.
- 1923 An histogenetic study of the respiratory epithelium. *Anat. Record*, vol. 25, pp. 181-200.
- STEWART, G. N. AND ROGOFF, J. M. 1918 The relation of the adrenals to piqure hyperglycemia and to the glycogen content of the liver. *Am. J. Physiol.*, vol. 46, pp. 90-116. Rats—p. 113.
- STIEDA, L. 1869 Studien über das centrale Nerven-system der Vögel und Säugetheire. *Ztschr. f. wissensch. Zööl.* Bd. 19, S. 68.
- STILES, CH. W. AND CRANE, C. G. 1910 The internal parasites of rats and mice in their relation to diseases of man. Found in "The rat and its relation to the public health," pp. 87-110. Treasury Dept. Pub. Health and Mar.-Hosp. Service of the U. S. Government Printing Office, Wash., D. C.
- STILES, CH. W. AND HASSALL, ALBERT 1910 Compendium of animal parasites reported for rats and mice (Genus *Mus*). Found in "The rat and its relation to the public health," pp. 111-122. Treasury Dept. Pub. Health and Mar.-Hosp. Service of the U. S. Government Printing Office, Wash., D. C.
- STIRLING, W., AND BRITO, P. S. 1882 On the digestion of blood by the common leech, and on the formation of haemoglobin crystals. *J. of Anat. and Physiol.* vol. 16, p. 454.
- STIRLING, W. 1883 A simple method of demonstrating the nerves of the epiglottis. *J. Anat. and Physiol.*, vol. 17, p. 203. Rats included in mammals observed. 1883 a The trachealis muscle of man and animals. *J. Anat. and Physiol.*, vol. 17, pp. 204-206.
- STOLAND, O. O. 1912 The relative toxicity of dog's normal and hypertrophied thyroids to animals susceptible to thyroid feeding. *Am. J. Physiol.*, vol. 30, pp. 37-41.
- STONE, CALVIN P. 1922 The congenital sexual behavior of the young male albino rat. *J. of Comp. Psychol.*, vol. 2, pp. 95-153.
- 1923 Further study of sensory functions in the activation of sexual behavior in the young male albino rat. *J. of Comp. Psychol.*, vol. 3, pp. 169-473.
- STONE, WITMER AND STOKES, JOHN F. G. 1917 The Hawaiian rat. Occasional papers of the Bernice Pauahi Bishop Museum of Polynesian Ethnology and Natural History, vol. 3, no. 4, pp. 253-274.
- STOTSENBERG, J. M. 1909 On the growth of the albino rat (*Mus norvegicus* var. *albus*) after castration. *Proc. Assoc. Am. Anat. in Anat. Record*, vol. 3, pp. 233-244.
- 1913 The effect of spaying and semi-spaying young albino rats (*Mus norvegicus albinus*) on the growth in body weight and body length. *Anat. Record*, vol. 7, pp. 183-191.
- 1915 The growth of the fetus of the albino rat from the thirteenth to the twenty-second day of gestation. *Anat. Rec.*, vol. 9, pp. 667-682.
- 1917 Observations on the influence of isolated ovaries on the body growth of the albino rat (*Mus norvegicus albinus*) *Anat. Record*, vol. 12, pp. 259-263.
- 1923 On the weight of the ovaries in the albino rat during gestation and normal lactation: also in females deprived of their new-born litters. *Am. J. of Physiol.*, vol. 65, pp. 77-89.
- STREHL, HANS AND WEISS, OTTO 1901 Beiträge zur Physiologie der Nebenniere. *Archiv f. d. ges. Physiol.*, Bd. 86, S. 107-121.
- STRONG, R. M. 1921 The order, time, and rate of ossification of the skeleton. II. Mammals. *Proc. of Am. Assoc. of Anatomists in Anat. Record*, vol. 24, page 86.
- 1924 The order, time and rate of ossification of the albino rat skeleton. *Am. J. of Anatomy*, vol. 34.
- STUTZMANN, J. 1898 Die accessorischen Geschlechtsdrüsen von *Mus decumanus* und ihre Entwicklung. *Diss. Leipzig*.
- SUGITA, NAOKI 1917 Comparative studies on the growth of the cerebral cortex. I. On the changes in size and shape of the cerebrum during the postnatal growth of the brain—albino rat. *Jour. Comp. Neur.*, vol. 28, pp. 435-510.



- 1917 a Comparative studies on the growth of the cerebral cortex. II: On the increase in the thickness of the cerebral cortex during the postnatal growth of the brain—albino rat. *Jour. Comp. Neur.*, vol. 28, pp. 511-591.
- 1918 Comparative studies on the growth of the cerebral cortex. III. On the size and shape of the cerebrum in the Norway rat (*Mus norvegicus*), and a comparison of these with the corresponding characters in the albino rat. *Jour. Comp. Neur.*, vol. 29, pp. 1-9.
- 1918 a Comparative studies on the growth of the cerebral cortex. IV. On the thickness of the cerebral cortex in the Norway rat (*Mus norvegicus*) and a comparison of the same with the cortical thickness in the albino rat. *Jour. Comp. Neur.*, vol. 29, pp. 11-39.
- 1918 b Comparative studies on the growth of the cerebral cortex. V. Part I. On the area of the cortex and on the number of cells in a unit volume, measured on the frontal and sagittal sections of the albino rat, together with the changes in these characters according to the growth of the brain. Part II. On the area of the cortex and on the number of cells in a unit volume, measured on the frontal and sagittal sections of the brain of the Norway rat (*Mus norvegicus*), compared with the corresponding data for the albino rat. *Jour. Comp. Neur.*, vol. 29, pp. 61-117.
- 1918 c Comparative studies on the growth of the cerebral cortex VI. Part I. On the increase in size and on the developmental changes of some nerve cells in the cerebral cortex of the albino rat during the growth of the brain. Part II. On the increase in size of some nerve cells in the cerebral cortex of the Norway rat (*Mus norvegicus*), compared with the corresponding changes in the albino rat. *Jour. Comp. Neur.*, vol. 29, pp. 119-162.
- 1918 d Comparative studies on the growth of the cerebral cortex. VII. On the influence of starvation at an early age upon the development of the cerebral cortex—albino rat. *Jour. Comp. Neur.*, vol. 29, pp. 177-240.
- 1918 e Comparative studies on the growth of the cerebral cortex. VIII. General review of data for the thickness of the cerebral cortex and the size of the cortical cells in several mammals, together with some postnatal growth changes in these structures. *Jour. Comp. Neur.*, vol. 29, pp. 241-278.
- SUGIURA, K. AND BENEDICT, S. R. 1918 The nutritive value of the banana. *J. Biol. Chem.*, vol. 36, pp. 171-189.
- 1919 The nutritive value of the banana. II. *J. Biol. Chem.*, vol. 40, pp. 449-468.
- SUGIURA, K., NOYES, H. M. AND FALK, K. G. 1923 Studies on enzyme action. XXIV. The kinetics of the ester-hydrolyzing actions of some tissue and tumor extracts. *J. of Biol. Chem.*, vol. 56, pp. 903-920.
- SUITSU, NOBUHARU 1920 Comparative studies on the growth of the corpus callosum. I. On the area of the corpus callosum measured on the sagittal section of the albino rat brain. *Jour. Comp. Neur.*, vol. 32, pp. 35-60.
- SULZER, F. G. 1774 Versuch einer Naturgeschichte des Hamsters. Göttingen.
- SUNDWALL, JOHN AND FRANCIS, EDWARD 1917 Studies in pellagra: I. Tissue alteration in malnutrition and pellagra. II. Cultivation experiments with the blood and spinal fluid of pellagrins. III. Further attempts to transmit pellagra to monkeys. Treasury Dept., U. S. Pub. Health Service, Hygienic Lab. Bull. no. 106. Rats, pp. 18-27.
- SURE, BARNETT 1920 Amino-acids in nutrition. I. Studies on proline: Is proline a growth-limiting factor in arachin (globulin from the peanut)? *J. of Biol. Chem.*, vol. 43, pp. 443-456.
- 1920 a Amino-acids in nutrition. II. The nutritive value of lactalbumin: cystine and tyrosine as growth-limiting factors in that protein. *J. of Biol. Chem.*, vol. 43, pp. 457-468.
- 1921 Amino-acids in nutrition. III. Is proline a growth-limiting factor in the proteins of peas (*Vicia sativa*)? What nucleus in Zein is responsible for supplementing these proteins? *J. of Biol. Chem.*, vol. 46, pp. 443-452.
- 1922 Amino-acids in nutrition. IV. A modified biological method of studying amino-acid deficiencies in proteins. Cystine as a growth-limiting factor in the proteins of the Georgia velvet bean (*Stizolobium deeringianum*). *J. of Biol. Chem.*, vol. 50, pp. 103-111.
- 1922 a Amino-acids in nutrition. V. Nutritive value of edestin (globulin from hemp seed) cystine and lysine as growth-limiting factors in that protein. *Am. J. of Physiol.*, vol. 61, pp. 1-13.
- SUTTER, MONROE 1919 On the behavior of the mammary epithelial cell towards vital dyes in various functional epochs of its life cycle. *Proc. Am. Assoc. of Anatomists in Anat. Record*, vol. 16, pp. 164-165.
- 1921 Cyclic changes in the mammary gland of the rat associated with the oestrous cycle. *Proc. of Am. Assoc. of Anatomists in Anat. Record*, vol. 21, p. 59.
- SUZUKI 1904 Two kinds of unknown pathogenic bacilli found in rats. *Saitake Gaku Zasshi*, Tokyo, pp. 41-46.
- SUZUKI, YOSHIO 1920 Observations on a sex difference in the presence of natural hemolysin in the rat. *Am. J. Physiol.*, vol. 53, pp. 483-487.
- SWAIN, ROBERT E. AND BATEMAN, W. G. 1909 The toxicity of thallium salts. *J. Biol. Chem.*, vol. 7, pp. 137-151.
- SWEET, J. E., CORSON-WHITE, E. P. AND SAXON, G. J. 1913 The relation of diets and of castration to the transmissible tumors of rats and mice. *J. Biol. Chem.*, vol. 15, p. 181.

- 1915 Further studies on the relation of diet to transmissible tumors. *J. Biol. Chem.*, vol. 21, pp. 309-318.
- SWELLENGREBEL, N. H. AND HOESEN, H. W. 1915 Ueber bei der Diagnose der Rattenpest Schwierigkeiten bereitende Bakterien. *Centralbl. für Bakteriologie und Parasitenkunde*, Bd. 75, (originale) S. 456-466.
- SYMES, W. L. AND GARDNER, J. A. 1915 The toxicity of sodium pyrophosphate administered in food; with a note on toxic cotton seed meal. *Biochem. J.*, vol. 9, pp. 9-16.
- SYZYMSKI, J. S. 1914 Lernversuche bei weissen Ratten. *Arch. f. d. ges. Physiol.*, Bd. 158, S. 386-418.
- 1918 Versuche über den Lernvorgang bei den weissen Ratten während der Ruhe bzw. Aktivitätsperioden. *Arch. f. d. ges. Physiol.*, Bd. 171, S. 311-316.
- 1918 a Die Verteilung der Ruhe und Aktivitätsperioden bei weissen Ratten und Tadmäusen. *Arch. f. d. ges. Physiol.*, Bd. 171, S. 324-347.
- 1918 b Versuche über die Wirkung der Faktoren, die als Antrieb zum Erlernen einer Handlung dienen können. *Archiv. f. d. ges. Physiol.*, (Pflüger's) Bd. 171, S. 374-385.
- 1918 c Einige Bemerkungen über die biologische Bedeutung akustischer Reize. *Archiv. f. d. ges. Physiol.*, (Pflüger's) Bd. 171, S. 363-373.
- TAFANI, A. 1889 La fécondation et la segmentation. Etudiées dans les oeufs des rats. *Arch. Ital. de Biol.*, T. 11.
- 1889 a I primi momenti dello sviluppo dei mammiferi. Studi di morfologia normale e patologica eseguiti sulle uova dei topi. *Atti d. T. Accad. d. Lincei*, Roma. Ser. 4, Rendiconti, vol. 5, semestre 1, pp. 119-125.
- TAKENOCHI, M. 1919 On the resistance of the red corpuscles of albino rats at different ages to hypotonic solutions of sodium chloride. *Anat. Rec.*, vol. 17, pp. 45-57.
- 1919 a Studies on the reputed endocrine function of the thymus gland (albino rat). *Jour. Exp. Zool.*, vol. 29, pp. 311-342.
- TALIAFERRO, W. H. 1921 Variation and inheritance in size in *Trypanosoma lewisi*. I. Life-cycle in the rat and a study of size and variation in "pure line" infections. *Proc. of the Nat. Acad. of Sciences*, vol. 7, pp. 138-143.
- 1921 a Variation and inheritance in size in *Trypanosoma lewisi*. II. The effects of growing "pure lines" in different vertebrate and invertebrate hosts and a study of size and variation in infections occurring in nature. *Proc. of the Nat. Acad. of Sciences*, vol. 7, pp. 163-168.
- TALIAFERRO, W. H. AND TALIAFERRO, I. G. 1922 The resistance of different hosts to experimental trypanosome infections with especial reference to a new method of measuring this resistance. *Am. J. of Hygiene*, vol. 2, pp. 264-319.
- TALIAFERRO, W. H. 1923 A study of size and variability, throughout the course of "pure line" infections, with *Trypanosoma lewisi*. *J. of Exper. Zool.*, vol. 37, pp. 127-168.
- TANDLER, J. 1899 Zur vergl. Anat. der Kopfarterien bei den Mammalia. (1898.) *Denkschr. der kais. Akad. der Wissensch. in Wien*, Bd. 67, S. 729; *Mus rattus—albino among those examined*.
- 1902 Zur Entwicklungsgeschichte der Kopfarterien bei den Mammalia. *Morphol. Jahrb.*, Bd. 30, S. 275-373.
- TANGL, F. 1913 Calorimetrie der Nierenarbeit. *Biochem. Ztschr.*, Bd. 53, S. 36-49.
- TARTAKOVSKI, M. G. 1902 Ob odnoi infektsionnoi bolezni kirls. (An infectious disease of rats). *Arch. vet. nauk. St. Petersburg.*, vol. 32, pt. 2, pp. 9-16.
- TATE, G. AND CLARK, A. J. 1922 The action of potassium and calcium upon the isolated uterus. *Archives Internat. de Pharmacodynamie et de Thérapie*, T. 26, pp. 103-111.
- TAYLOR, H. D., WITHERBEE, W. D. AND MURPHY, J. B. 1919 Studies on X-ray effects. I. Destructive action of blood cells. *J. Exper. Med.*, vol. 29, pp. 53-73. For rat see text-fig. 3.
- TAYLOR, KENNETH 1915 Observations upon a rat sarcoma treated with emulsions of embryonic tissues. *Proc. of Soc. for Exper. Biol. and Med.*, vol. 12, pp. 216-218.
- TAYLOR, K. 1916 Studies on the blood of the albino rat. Its normal cellular constituents. Their reaction to sarcoma growth and to benzene treatment. *Proc. Soc. Exp. Biol. and Med.*, vol. 13, pp. 131-134.
- TELLO, FRANCISCO 1906 Terminaciones sensitivas en los pelos y otros organos. *Rev. trimestr. Microgr.*, vol. 9, pp. 49-77, fig. 1.
- TENBROECK, CARL 1918 The survival of the hog-cholera virus in laboratory animals, particularly the rat. *J. of Exp. Med.*, vol. 28, pp. 749-757.
- TERRA, PAUL DE 1911 Vergleichende Anatomie des menschlichen Gebisses und der Zähne der Vertebraten. *Jena. Fischer*, p. 301, fig. 125. Teeth of *M. norvegicus*.
- TERRY, BENJAMIN T. 1905 An epidemic of trypanosomiasis among white rats. *Trans. Chicago Path. Soc.*, pp. 1-4.
- THOMPSON, J. A. 1906 On the epidemiology of plague. *J. Hyg.*, vol. 6, pp. 537-569.
- THOMSON, J. D. AND CUSHNY, A. R. 1910 On the action of antimony compounds in trypanosomiasis in rats: being a report to a sub-committee of the Tropical diseases Committee of the Royal Society. *Proc. Royal Soc. London, Series B*, vol. 82, pp. 249-256.

- TIDSWELL, F. AND CLELAND, J. B.** 1912 Leprosy-like disease in rats. Rep. Gov. Bur. Microbiol., Sydney, vol. 2, p. 49-51.
- TILESTON, WILDER** 1916 The etiology and treatment of rat-bite fever. J. Am. Med. Assoc., vol. 66, pp. 995-998.
- TILNEY, FREDERICK** 1911 Contribution to the study of the hypophysis cerebri with especial reference to its comparative histology. Memoirs of The Wistar Institute of Anatomy and Biology, no. 2, p. 47. *Mus decumanus* (figs. 34 and 35).  
1913 An analysis of the juxta-neural epithelial portion of the hypophysis cerebri, with an embryological and histological account of a hitherto undescribed part of the organ. Internat. Monatschr. f. Anat. u. Physiol., vol. 30, pp. 258-293, Pl. V-XIX and 3 fig. Rat among other animals studied.
- TILNEY, FREDERICK AND CASAMAJOR, LOUIS** 1917 The development of the hemal channels in the central nervous system of the albino rat. Proc. of Am. Assoc. of Anatomists in Anat. Record, vol. 11, pp. 425-428.
- TILNEY, FREDERICK AND RILEY, H. A.** 1921 The form and functions of the central nervous system. Paul B. Hoeber, N. Y. Rat: pages 27, 31, 32, 34, 35, 43, 46 and 47.
- TIRABOSCHI, CARLO** 1902 Gli animali propagatori della peste bubbonica. 3 Nota. Caratteri distintivi del *Mus decumanus* Pall. e *Mus rattus* L. Diffusione del *Mus rattus* in Italia. Boll. Soc. zool. ital. Ann. 11, pp. 173-177.  
1904 Gli animali propagatori della peste bubbonica. 4a Nota. I ratti e i loro ectoparassiti. Boll. Soc. zool. ital. Ann. 13, pp. 88-97.  
1904 a Les rats, les souris et leurs parasites cutanés dans leurs rapports avec la propagation de la peste bubonique. Arch. Parasitol., vol. 8, pp. 161-349.
- TODD, T. WINGATE** 1923 The pubic symphysis of the guinea-pig in relation to pregnancy and parturition. Am. J. of Anatomy, vol. 31, pp. 345-357. Rat, page 354.
- TOEPFER, KARL AND FLEISCHMANN, A.** 1891 Die Morphologie des Magens der Rodentia. Morphol. Jahrb., Bd. 17, S. 380-416.
- TOPSELL, EDWARD** 1658 History of four-footed beasts. No place. No publisher. Rat, p. 403.
- TOTANI, G.** 1916 Feeding experiments with a dietary in which tyrosine is reduced to a minimum. Biochem. J., vol. 10, pp. 382-398.
- TOURNADE, A.** 1903 Effets testiculaires variables de l'interruption du canal déférent, suivant qu'elle est ou non oblitérante. Etude expérimentale sur le rat. Compt. rend. Soc. de biol., T. 55, pp. 1660-1662.  
1913 Sur les délais de régénération du vague chez le rat blanc. C. R. Soc. Biol., Paris, T. 74, pp. 956-957.
- TOUSSENEL, A.** 1852 Passional zoology; or spirit of the beasts of France. Translated by M. Edgeworth Lazarus, M.D. Fowler and Wells, N. Y. Rat, pp. 143-149.
- TOVERUD, GUTTORM** 1923 The influence of diet on teeth and bones. J. of Biol. Chem., vol. 58, pp. 583-600.
- TOYAMA, IKUZO** 1919 Relative abundance of serum proteins in albino rats at different ages. J. Biol. Chem., vol. 38, pp. 161-166.
- TOYOFUKU, TOMAKI** 1910 Ueber das Vorkommen von Kiemenknorpel in der Thymus der Ratte. Anat. Anz., Bd. 37, S. 573-575.  
1911 Ueber die parathyreoprive Veränderung des Rattenzahnes. Frankfurt. Ztschr. f. Path., Bd. 7, S. 249-294.
- TRAUTMANN, A.** 1912 Ueber Massenausbreitung von *Bacillus enteritidis*, Gärtner. Arch. f. Hyg., Bd. 76, S. 206-209.
- TRAUTMANN, H.** 1906 Bakterien der Paratyphusgruppe als Rattenschädlinge und Rattensvertilger zugleich ein Beitrag zur Differential diagnose der Rattenpest. Ztschr. f. Hyg., u. Infektionskrankh., Leipzig, Bd. 4, S. 104-129.  
1912 Zurückweisung der Versuche Mereschowsky's: Ueber die Anwendung des Trautmännchen Verfahrens zur Virulenzsteigerung des *Bacillus Danysz*. Centrallbl. f. Bakteriol., I Abt., Bd. 65, S. 58-60.
- TROMMSDORF, R.** 1909 Ueber biologische Eiweissdifferenzierung bei Ratten und Mäusen. Arb. a. d. k. Gsndtsamte, Berl., Bd. 32, S. 560-567.
- TROUSSART, E. L.** 1881 *Epimys*—subgenus—including *Rattus* and *Norvegicus*. Bull. Soc. d'Etudes Sci. d'Angers, vol. 10, p. 117.  
1897 Catalogue mammalium tam viventium quam fossilium. Nova Editio (Prima completa) Berolini. See Fasciculus III. Rodentia II, p. 471 et seq.  
1910 Faune des mammifères d'Europe. Berlin. Friedländer.
- TSUJI, K.** 1920 On the function of thyroid gland with special reference to the effect of variations of diet upon it. Acta Scholae Med. Univ. Imp. Kioto, vol. 3, pp. 713-729.
- TUCKERMAN, FREDERICK** 1892 Further observations on the gustatory organs of the Mammalia. J. Morphol., vol. 7, pp. 69-94. *Mus decumanus*, pp. 73-75.
- TULLBERG, TYCHO** 1900 Ueber das System der Nagethiere. Nova Acta Reg. Soc. Sc. Upsaliensis Ser. 3, Bd. 18, S. 1-514. *Mus decumanus*, S. 254-257.
- TUNNICLIFF, RUTH** 1916 Streptothrix in bronchopneumonia of rats similar to that in rat-bite fever. J. Infect. Diseases, vol. 19, pp. 767-772.
- TURNER, JOHN** 1904 On the primary staining of the rat's brain by methylene blue. Brain, vol. 27, pp. 64-83.

- UHLHUTH, PAUL AND WEIDANZ, O. 1909 Mitteilungen über einige experimentelle Krebsforschungen. Arb. a. d. k. Gsundtsamte, Bd. 30, S. 434-444.
- ULRICH, JOHN L. 1913 The number and distribution of trials in learning in the white rat. Behavior Monographs, vol. 2, no. 5, serial number 10, pp. 1-51.
- 1920 Integration of movements in learning in the albino rat. Psychobiology, vol. 2, pp. 375-447.
- 1920 a Integration of movements in learning in the albino rat. A study of the adjustment of an organism to an environment. Psychobiology, vol. 2, pp. 455-500.
- UNDERHILL, FRANK P. 1915 The physiology of the amino acids. Yale Univ. Press—New Haven.
- UNDERHILL, FRANK P. AND KAPSINOW, ROBERT 1922 The comparative toxicity of ammonium salts. J. of Biol. Chem., vol. 54, pp. 451-457.
- UNO, TOSHIO 1922 Effect of general excitement and of fighting on some ductless glands of male albino rats. Am. J. of Physiol., vol. 61, pp. 203-214.
- URIARTE, L. 1905 Sur la classification des pulicides des rats; rectification à une note antérieure. Compt. rend. Soc. de biol., Par. T. 58, p. 98.
- USKOW, N. 1883 Ueber die Entwicklung des Zwerchfells, des Pericardiums und des Coeloms. Archiv. f. mikr. Anat., Bd. 22, S. 143-219. Rat, S. 191 and 192.
- UTSURIKAWA, NENZO 1917 Temperamental differences between outbred and inbred strains of the albino rat. J. of Animal Behavior, vol. 7, pp. 111-129.
- VAN ALSTYNE, ELEANOR AND BEEBE, S. P. 1913 Diet studies in transplantable tumors. I. The effect of non-carbohydrate diet upon the growth of transplantable sarcoma in rats. J. Med. Research, vol. 29 (U.S. vol. 24), pp. 217-232. White rats, 10 tables.
- VAN DER VLOET 1906 Ueber den Verlauf der Pyramidenbahn bei niederen Säugetieren. Anat. Anz., Bd. 29, S. 113.
- VAN HOOF, LUCIEN 1911 La spermatogénèse dans les mammifères. I. L'évolution de l'élément chromatique dans la spermatogénèse du rat. La Cellule, T. 27, pp. 291-345.
- 1912 La spermatogénèse dans les mammifères. II. Le synopsis dans les spermatoocytes des mammifères. La Cellule, T. 27, pp. 351-380.
- VEGA, GARCILASO DE LA (1535-1616) 1688 The royal commentaries of Peru, 1609-1617. Rendered into English by Sir Paul Rycaut. Portrait of Rycaut and 10 plates. London.
- VIGNES, H. 1913 Influence de la masse hibernale du rat sur quelques ferments de l'organisme. Compt. rend. Soc. de biol., T. 75, p. 418.
- VINCENT, S. B. 1912 The function of the vibrissae in the behavior of the white rat. Behavior Monographs, vol. 1, no. 5, Johns Hopkins University.
- 1913 The tactile hair of the white rat. J. Comp. Neurol., vol. 23, pp. 1-27.
- 1915 The white rat and the maze problem. I. The introduction of a visual control. J. of Animal Behavior, vol. 5, pp. 1-24.
- 1915 a The white rat and the maze problem. II. The introduction of an olfactory control. J. of Animal Behavior, vol. 5, pp. 140-157.
- 1915 b The white rat and the maze problem. III. The introduction of a tactual control. J. of Animal Behavior, vol. 5, pp. 175-184.
- 1915 c The white rat and the maze problem. IV. The number and distribution of errors a comparative study. J. of Animal Behavior, vol. 5, pp. 367-374.
- VINCENT, SWALE 1897 The effects of subcutaneous injections of extracts of suprarenal capsules. J. Physiol., vol. 21, Proc. of Physiol. Soc. p. xxv.
- 1897 a On the general physiological effects of extracts of the suprarenal capsules. J. Physiol., vol. 22, pp. 111-120.
- 1897 b On the haemolymph glands of some vertebrates. J. of Anat. and Physiol., vol. 31, pp. 176-198.
- VINCENT, SWALE AND JOLLY, W. A. 1905 Some observations upon the function of the thyroid and parathyroid glands. J. Physiol., vol. 32, pp. 65-88.
- 1906 Further observations upon the functions of the thyroid and parathyroid glands. J. Physiol., vol. 34, pp. 295-305.
- VINCENT, SWALE 1910 The chromophil tissues and the adrenal medulla. Proc. Roy. Soc., Lond., S. B., vol. 82, pp. 502-515.
- 1912 Internal secretion and the ductless glands. Edward Arnold, London.
- VINCENT, SWALE AND CAMERON, A. T. 1920 A note on an inhibitory respiratory reflex in the frog and some other animals. Jour. Comp. Neur., vol. 31, pp. 283-292.
- VINCENT, SWALE AND HOLLENBERG, M. S. 1920 Changes in the adrenal bodies and the thyroid resulting from inanition. Proc. of the Physiol. Soc. in J. of Physiol., vol. 54, pp. lxix-lxxi.
- VOEGTLIN, C. AND LAKE, G. C. 1919 Experimental mammalian polyneuritis produced by a deficient diet. Pub. Health Rep., Washington, vol. 34.
- VOEGTLIN, C. AND SMITH, H. W. 1920 Quantitative studies in chemotherapy I and II. The trypanocidal action of arsenic and antimony compounds. Pub. Health Rep., Washington, vol. 35, pp. 2264-2273. J. of Pharmacol. and Exp. Therapeutics, vol. 15, pp. 453-473; pp. 475-493.
- VOEGTLIN, C., LEONARD, C. S. AND DYER, HELEN A. 1923 On the physiological and pharmacological importance of glutathione and certain other sulphy-

- dryl compounds. Abstracts of Communications to the XIth Internat. Physiol. Congress held at Edinburgh, July 23rd-27th.
- VOEGLIN, CARL AND DUNN, EDITH R. 1923 Standardization of insulin. I. Toxicity of insulin for white rats as influenced by temperature of room in which animals are kept. Reprint No. 855 from the Public Health Reports, pp. 1747-1749, Government Printing Office, Wash., D. C.
- WADA, TOKUJIRO 1923 Anatomical and physiological studies on the growth of the inner ear of the albino rat. *Am. Anat. Mem.* No. 10, (The Wistar Institute).
- WAGNER, J. HENRI 1915 The American pet stock standard of perfection and official guide of the American Fur Fanciers' Association. American Fur Fanciers' Assoc., Washington, D. C. Rats, pp. 44-48.
- WAGNER, RUDOLPH 1841 *Icones zootomicae. Handatlas zur vergleichenden Anatomie nach fremden und eigenen Untersuchungen*, xvi, 44 pp., 35 pl., fol. L. Voss, Leipzig. Achte Tafel, p. 9, fig. XI. Brain of *M. decumanus*.
- WALKER, G. 1910 The nature of the secretion of the vesiculae seminales and of an adjacent glandular structure in the rat and guinea pig, with special reference to the occurrence of histone in the former. *Johns Hopkins Hosp. Bull.*, vol. 21, pp. 185-192. 1910 a A special function discovered in a glandular structure hitherto supposed to form a part of the prostate gland in rats and guinea pigs. *Johns Hopkins Hosp. Bull.*, vol. 21, pp. 182-185. 1911 The effect on breeding of the removal of the prostate gland or the vesiculae seminales, or of both; together with observations on the condition of the testes after such operations on white rats. *Johns Hopkins Hosp. Reports*, vol. 16, pp. 223-255.
- WALKER, MAY L. 1923 The effect of section of the cervical sympathetic nerve on certain glands of internal and external secretion. Abstracts of Communications to the XIth Internat. Physiol. Congress held at Edinburgh, July 23rd-27th.
- WALLER, R. 1693 Some observations in the dissection of a rat (with illustrations). *Phil. Trans.*, vol. 17, pp. 594-596.
- WANG, CHI CHE 1921 The composition of Chinese edible birds' nests and the nature of their proteins. *J. of Biol. Chem.*, vol. 49, pp. 429-439.
- WANG, G. H. 1923 The relation between "spontaneous" activity and oestrous cycle in the white rat. *Comp. Psychol. Monographs*, vol. 2, serial no. 6.
- WARD, HENRY L. 1906 Observation on a pied rat. *Bull. Wis. Nat. Hist. Soc., n.s.*, vol. 4, pp. 37-38.
- WARDEN, CARL J. 1923 The distribution of practice in animal learning. *Comp. Psychol. Monographs*, vol. 1, serial no. 3.
- WARREN, JOHN 1915 On the early development of the inguinal region in mammalia. *Anat. Record*, vol. 9, pp. 131-133. 1917 The development of the paraphysis and pineal region in mammalia. *J. Comp. Neur.*, vol. 28, pp. 75-135. Rat pp. 95-96.
- WARREN, S. L. AND WHIPPLE, G. H. 1923 Roentgen ray intoxication. IV. Intestinal lesions and acute intoxication produced by radiation in a variety of animals. *J. of Exper. Med.*, vol. 38, pp. 741-752.
- WASCHETKO, N. 1914 Zur Frage von dem physiologischen Wachstum der Niere. *Centralbl. allg. Pathol.*, Bd. 25, No. 11.
- WASIELEWSKI, V. AND SENN, G. 1900 Beiträge zur Kenntnis der Flagellaten des Rattenblutes. *Zeitschr. f. Hyg.*, Bd. 33, S. 344.
- WASON, ISABEL M. 1921 Ophthalmia associated with a dietary deficiency in fat soluble vitamin (A). *J. Am. Med. Assoc.*, vol. 76, pp. 908-912.
- WATNEY, H. 1874 Note on the minute anatomy of the alimentary canal. *Proc. Royal Soc., London*, vol. 22, pp. 293-294. Rat included among animals studied.
- WATSON, B. P. 1907 The effect of a meat diet on fertility and lactation. *Proc. Roy. Soc. Edinb.*, vol. 27, part 1, pp. 6-10.
- WATSON, CHALMERS 1904 Stimulation of the thyroid and parathyroid glands by a proteid dietary (raw meat). *J. Physiol.*, vol. 31, Proc. of the Physiol. Soc., p. v. 1905 On the influence of a meat diet on the thyroid and parathyroid glands. *J. Physiol.*, vol. 32, Proc. of the Physiol. Soc., pp. xvi-xvii. 1906 The influence of a meat diet on the thyroid gland in the second generation of meat fed rats. *J. Physiol.*, vol. 34, Proc. of the Physiol. Soc., p. xxix. 1906 a The influence of diet on growth and nutrition. *J. Physiol.*, vol. 34, pp. 111-132. 1906 b Preliminary note regarding an experimental investigation into the effects of varying diets upon growth and nutrition. *Proc. Roy. Soc., Edinb.*, vol. 26, part 1, pp. 87-94.
- WATSON, CHALMERS, AND CAMPBELL, M. 1906 The minute structure of the uterus of the rat with a note on the influence of a meat diet on it. *J. Physiol.*, vol. 34, Proc. of Physiol. Soc., p. xvi.
- WATSON, CHALMERS, AND LYON, G. 1906 A preliminary note on the influence of a meat diet on the kidneys. *J. Physiol.*, vol. 31, Proc. of the Physiol. Soc., p. xix-xxi.
- WATSON, CHALMERS 1907 A note on the adrenal gland in the rat. *J. Physiol.*, vol. 35, pp. 230-232. 1907 a The influence of a meat diet on the kidneys. *Internat. Monatschr. f. Anat. u. Physiol.*, vol. 24, pp. 197-208. 1907 b The effects of captivity on the adrenal glands in wild rats. *J. Physiol.*, vol. 35, Proc. of Physiol. Soc., pp. xlix-l.

- 1907 c The influence of an excessive meat diet on the osseous system. *Proc. Roy. Soc. Edinb.*, vol. 27, part 1 (no. 1).
- 1907 d The influence of diet on the liver. *Lancet*, October 12. Weight of liver in Norway rat reduced by diet poor in nitrogen.
- 1907 e On changes in the structure of the thyroid gland in wild rats under the influence of altered dietetic conditions. *J. of Physiol.*, vol. 36, *Proc. of the Physiol. Soc.*, pp. i-ii.
- 1907 f Effect of oatmeal diet on the thyroid gland. *Brit. Med. J.*, vol. 1.
- 1909 A note on the minute structures of the thyroid gland in the rat. *Quart. J. Exper. Physiol.*, vol. 2, pp. 383-387.
- 1910 The influence of diet on the structure of the tissues. Reprint of the Appendix from the new work on "Food and Feeding in Health and Disease" (Chalmers Watson, November, 1910). Oliver and Boyd, London.
- 1912 The influence of diet on the thyroid gland. *Quart. J. Exper. Physiol.*, vol. 5, pp. 229-232.
- WATSON, G. W. AND GIBBS, J. H. 1906 The influence of an excessive meat diet on the development and structure of the teeth. *J. Physiol.*, vol. 34, *Proc. of Physiol. Soc.*, pp. xvii-xviii.
- WATSON, JOHN B. 1905 Animal education. *Con. from the Psychol. Lab. Univ. of Chicago*, vol. 4, no. 2, pp. 5-122. Plates showing medullation of the nervous system at various ages.
- 1905 a The effect of the bearing of young upon the body weight and the weight of the central nervous system of the female white rat. *J. Comp. Neur. and Psychol.*, vol. 15, pp. 514-524.
- 1907 Kinaesthetic and organic sensations; their rôle in the reactions of the white rat to the maze. *Monograph Suppl., Psychol. Review*, vol. 8, pp. 1-100.
- WATSON, JOHN B. AND WATSON, MARY I. 1913 A study of the responses of rodents to monochromatic light. *J. Animal Behavior*, vol. 3, pp. 1-14.
- WATSON, JOHN B. 1914 Behavior. An introduction to comparative psychology. Henry Holt & Co., N. Y. *Rat*, pp. 129-131, 198, 210-219, 235, 237-238, 292, 348, 384-385, 423-425.
- 1917 The effect of delayed feeding upon reaction. *Psychobiology*, vol. 1, pp. 51-59.
- WEBER, H. VON 1914 A bacteriological study of a rat epidemic. *Proc. N. Y. Pathol. Soc.*, vol. 13, pp. 97-103.
- WEBER, S. E. 1894 The genus *Hymenolepis* in rats; their relation to public health and the close relationship of the *Hymenolepis nana* of man with the *Hymenolepis murina* of the rat. *Proc. U. S. Vet. Med. Assoc.* 1893, Phila., 1894, xxx, pp. 271-294.
- WEBSTER, J. G. 1892 Melanic variety of the rat (*Mus decumanus*, Pallas). *Ann. of Scott. Nat. Hist.*, vol. 1, p. 134.
- WEICHELBAUM 1909 Über die Veränderungen der Zähne bei Rachitis weisser Ratten. *Verhandl. d. deutsch. path. Gesellsch.*, Bd. 13, S. 49.
- WEIDENREICH, FRANZ 1902 Mikroskopische und Makroskopische Präparate von Blutlymphdrüsen von Schaf, Ratte und Schwein. *Anat. Anz., Suppl.* to Bd. 21, S. 259-260.
- 1909 Die Leucocyten und verwandte Zellformen. *Ergeb. der Anat. u. Entwsgsch.*, Bd. 19, S. 653.
- WEIL, RICHARD 1913 The intravascular implantation of rat tumors. *J. Med. Research*, vol. 28 (n.s. vol. 23) pp. 497-508. 2 plates.
- 1916 Chemotherapeutic experiments on rat tumors. *J. of Cancer Research*, vol. 1, p. 95.
- WEISBACH, A. 1868 Der Wassergehalt des Gehirns nach Alter, Geschlecht und Krankheiten. *Med. Jahrbücher*, Bd. 16, S. 1-76.
- WEISS, ARMIN 1900 Ein postoccipitaler Wirbelkörper bei Rattenembryonen. *Centralbl. f. Physiol.*, Bd. 14, S. 93-96.
- 1901 Die Entwicklung der Wirbelsäule der weissen Ratte, besonders der vordersten Halswirbel. *Ztschr. f. wissensch. Zool.*, Bd. 69, S. 492-532.
- WELKER, WILLIAM H. AND WILLIAMSON, C. 1920 Hemoglobin. I. Optical constants. *J. of Biol. Chem.*, vol. 41, pp. 75-79.
- WHERRY, W. B. 1903 Further notes on rat leprosy and on the fate of human and rat lepra bacilli in flies. *J. Infect. Dis., Chicago*, vol. 5, pp. 507-518.
- 1903 a Notes on rat leprosy and on the fate of human and rat lepra bacilli in flies. *Public Health Rep. U. S. Mar. Hosp. Serv.*, Wash., vol. 23, pp. 1481-1487.
- 1903 b Experiments on the use of bacillus pestis-caviae as a rat virus. *J. Infect. Dis., Chicago*, vol. 5, pp. 529-533.
- 1903 c The leprosy-like disease among rats on the Pacific Coast. *J. Am. Med. Assoc., Chicago*, vol. 1, p. 1903.
- WHITE, F. W. 1914 Variations in the sex ratio of *Mus Rattus* associated with an unusual mortality of adult females. *Proc. Royal Soc. London*, vol. 87, p. 335.
- WHITE, MOSES C. 1901 Article "Blood stains" in reference Handbook of the Medical Sciences. Wm. Wood & Co., N. Y., vol. 2, pp. 84 and 86.
- WHITING, P. W. AND KING, HELEN D. 1918 Ruby-eyed dilute gray, a third allelomorph in the albino series of the rat. *Jour. Exp. Zool.*, vol. 26, pp. 55-64.
- WIDAKOWICH, VICTOR 1909 Ueber die erste Bildung der Körperform bei Entypie des Keimes. Beiträge zur Entwicklungsgeschichte der Ratte. *Ztschr. f. wissensch. Zool.*, Bd. 94, S. 240-298.
- 1910 Über die gesetzmässige Orientierung der Eier im Uterus der Ratte. *Zentralbl. für Physiol.*, Bd. 24, S. 304-305.

- 1910 a Beschreibung des Modelles einer Doppelbildung der Ratte im Stadium des Primitivstreifens. *Zentralbl. für Physiol.*, Bd. 24, S. 305.
- WIEDERSHEIM, ROBERT 1897 Comparative anatomy of vertebrates. Parker's translation, 2nd Ed., London.
- 1903 Ueber ein abnormes Rattengebiss *Anat. Anz.*, Bd. 22, S. 569-573.
- WIEDERSPERG, GUSTAV VON 1885 Beiträge zur Entwicklungsgeschichte der Samenkörper. *Archiv für mikr. Anat.*, Bd. 25, S. 113-136. *Rat.*, S. 117, 118, 119.
- WIENER, E. 1902 Zur Entstehung von Rattenepizootien. *Centralbl. für Bakteriologie*, 1 Abt., Jena, Bd. 32, S. 23-28.
- 1902 a Ueber den Bazillus Danyz. München. *med. Wehnschr.*, Bd. 49, S. 401-402.
- 1903 Weitere Bemerkungen zur Entstehung von Rattenepizootien. *Centralbl. für Bakteriologie*, Bd. 34, S. 406-411.
- WIESEL, JOSEF 1899 Ueber accessorische Nebennieren am Nebenhoden beim Menschen und über Kompensations-hypertrophie dieser Organe bei der Ratte. *Sitz.-Ber. d. Akad. d. Wiss. in Wien. Math. naturw. Kl.*, Bd. 108, Abt. 3, S. 257-280. 1 plate.
- 1899 a Ueber Compensations-Hypertrophie der accessorischen Nebennieren bei der Ratte. *Centralbl. für Physiol.*, Bd. 12, S. 780-783.
- WIESNER, BERTOLD P. 1923 Die Funktionsfähigkeit autophor transplantierter Ovarien bei Ratten *Archiv für Mikr. Anat. und Ent.*, Bd. 99—S. 140-149.
- WILLACH, PAUL 1888 Beiträge zur Entwicklung der Lunge bei Säugethieren. 23 pp., 8°. Osterwieck, Harz; A. W. Zickfeldt.
- WILBERG, M. A. 1914 Die natürliche Resistenz einiger Tiere dem Atropin gegenüber. *Biochem. Zeitschr.*, Bd. 66, S. 389-407.
- WILLIAMS, J. LEON 1896 On the formation and structure of dental enamel. *The Dental Cosmos*, vol. 33, pp. 101-127.
- WILLIAMS, ROGER J. 1921 Vitamines and yeast growth. *J. Biol. Chem.*, vol. 46, pp. 113-118.
- WILSON, J. WALTER 1922 The relation of photosynthesis to the production of vitamine A in plants. *J. of Biol. Chem.*, vol. 51, pp. 455-459.
- WILTBANK, R. T. 1919 Transfer of training in white rats upon various series of mazes. *Behavior Monographs*, vol. 4, serial no. 17, Johns Hopkins University.
- WINKLER, CORNELIS 1918 Sur l'innervation des canaux semi-circulaires dans le labyrinthe du rat nouveau-né Cornelis Winkler's Opera Omnia, T. 5, pp. 723-730. De Erven F. Bohn—Haarlem.
- WUOLOM, WILLIAM H. 1915 Diet and tumor growth. *J. of Exper. Med.*, vol. 22, pp. 766-779.
- 1916 Intratesticular implantation of the Flexner-Jobling rat carcinoma. *J. Exp. Med.*, vol. 23, pp. 189-198.
- WOITHE 1907 Vorrichtungen zum gefahrlosen Befestigen und Aufspannen wilder Ratten. *Centralbl. für Bakteriologie*, 1 Abt., Jena, Bd. 44, S. 709-719.
- WOLBACH, S. B. AND HONEIL, JAMES A. 1914 A critical review of the bacteriology of human and rat leprosy. *J. Med. Research*, vol. 29 (n.s. vol. 24), pp. 367-423.
- WOLBACH, S. B., CHAPMAN, W. H. AND STEVENS, H. W. 1915 Concerning the filterability of trypanosomes. *J. of Med. Research*, vol. 33 (N. S. vol. 28) pp. 107-117.
- WOLDRICH, JOH. 1880-1884 Diluviale Fauna von Zudslawitz bei Winterberg in Böhmerwalde. *Sitzber. d. k. Akad. d. Wiss.* 3 parts, 1889-1881-1884.
- WOLFERTH, C. C. 1917 Blood changes in albino rats following removal of the spleen. *Archives of Internal Med.*, vol. 19, pp. 105-116.
- WOOLLEY, PAUL G. AND WHERRY, WM. B. 1911 Notes on twenty-two spontaneous tumors in wild rats (*M. norvegicus*). *Jour. Med. Research*, vol. 20, n. s., pp. 205-215.
- WOOLLEY, P. G., DEMAR, AMIE AND CLARK, DAISY 1915 Further experiments on the effects of long continued intraperitoneal injections of proteins. *J. of Exper. Med.*, vol. 22, pp. 114-121.
- WORMLEY, T. G. 1888 *Microchemistry of poisons*. 2d ed. Phila.
- WRIGHT, SEWALL 1917 Color inheritance in the rat. *J. of Heredity*, vol. 8, pp. 426-430.
- WYLIE, HARRY H. 1919 An experimental study of transfer of response in the white rat. *Behavior Monographs*, vol. 3, no. 5, serial no. 16—Johns Hopkins Univ.
- WYSS, HANS VON 1870 Die becherförmigen Organe der Zunge. *Arch. für mikr. Anat.*, Bd. 6, S. 237-260. *Rat.*, S. 255-256.
- X**YLANDER 1906 Ein bei Ratten gefundenes Bakterium der Friedländerschen Gruppe. *Arb. a. d. k. Gsndltsamte*, Berl., Bd. 24, S. 196-219.
- Y**ARBOUGH, JOSEPH U. 1921 The influence of the time interval upon the rate of learning in the white rat. *Proc. Am Psychol. Assoc. in Psychol. Bull.*, vol. 18, pp. 101-102.
- YATSU, NAOHIDE 1921 On the changes in the reproductive organs in heterosexual parabiosis of albino rats. *Anat. Rec.*, vol. 21, pp. 217-228.
- YERKES, ADA W. 1916 Comparison of the behavior of stock and inbred albino rats. *J. of Animal Behavior* vol. 6, pp. 267-296.
- YERKES, ROBERT M. 1913 The heredity of savageness and wildness in rats. *J. Animal Behavior*, vol. 3, pp. 286-296.
- YOKOGAWA, SADAMU 1922 The development of *Heligmosomum muris* Yokogawa, a nematode from the intestine of the wild rat. *Parasitology*, vol. 14, pp. 127-165.

- YUDKIN, ARTHUR M. 1922 Ocular manifestations of the rat which result from deficiency of vitamin A in the diet. *J. of the Am. Med. Assoc.*, vol. 79, pp. 2206-2208.
- YUDKIN, A. M. AND LAMBERT, R. A. 1922 Location of the earliest changes in experimental xerophthalmia of rats. *Proc. of the Soc. for Exper. Biol. and Med.*, vol. 19, p. 375.
- 1922 a Lesions in the lacrimal glands of rats in experimental xerophthalmia. *Proc. of the Soc. for Exper. Biol. and Med.*, vol. 19, pp. 376-377.
- 1923 Pathogenesis of the ocular lesions produced by a deficiency of vitamin A. *J. of Exper. Med.*, vol. 38, pp. 17-24.
- ZAWARYKIN, TH. 1883 Ueber die Fettresorption im Dünndarm. *Arch. f. d. ges. Physiol.*, Bd. 31, S. 231-240.
- ZIEHEN, TH. 1906 Morphogenie des Centralnervensystems der Säugetiere. Gewichtszunahme von Gehirn und Rückenmark im Fötalleben. *Handbuch der verg. und exper. Entwicklungslehre der Wirbeltiere*, Bd. 2, S. 388-390. Short table for *Mus decumanus* on page 390.
- ZILINBERG-PAUL, OTTILIE 1909 Fortgesetzte Untersuchungen über das Verhalten des Darmepithels. III. Mitteil. (Rat.) *Ztschr. f. Biol.*, Bd. 52, S. 327-354, pl. VI.
- ZILVA, S. S. 1919 The action of ultra-violet rays on the accessory food factors. *Biochem. J.*, vol. 13, pp. 164-171.
- 1919 a The influence of deficient nutrition on the production of agglutinins, complement and amboceptor. *Biochem. J.*, vol. 13, pp. 172-194.
- 1920 The extraction of the fat-soluble factor of cabbage and carrot by solvents. *Biochem. J.*, vol. 14, pp. 494-501.
- 1920 a The action of ozone on the fat-soluble factor in fats. *Biochem. J.*, vol. 14, p. 740-741.
- ZILVA, S. S. AND MURRA, M. 1921 The quantitative estimation of the fat-soluble factor. *Biochem. J.*, vol. 15, pp. 654-659.
- ZINSSER, HANS AND CAREY, EDWARD G. 1912 A contribution to the study of rat leprosy. *J. Am. M. Ass.*, vol. 58, pp. 692-695.
- ZLOCISTI, T. 1917 Skorbutische Hornhautgeschwüre. *Klin. Monatsb. f. Augenh.*, Bd. 59, S. 572-583.
- ZOJA, F. AND R. 1891 Intorno ai plastiduli fucisnofili (bioplastuli dell'Altmann). *Mem. Ist. Sc. Milano*, Tomo 16, pp. 237-270 (pp. 42, 51, 53-56).
- ZUCKER, T. F. AND GUTMAN, MARGARET 1922 Distribution of phosphorus in the blood. *Proc. of the Soc. for Exper. Biol. and Med.*, vol. 20, pp. 133-136.
- 1923 The various forms of phosphoric acid in the blood. *Proc. of the Soc. for Exper. Biol. and Med.*, vol. 20, pp. 372-375.
- ZUCKER, T. F., JOHNSON, W. C. AND BARNETT, MARION 1922 The acid base ratio of the diet in rickets production. *Proc. of the Soc. for Exper. Biol. and Med.*, vol. 20, pp. 20-22.
- ZUCKER, T. F. AND BARNETT, MARION 1923 Observations on the distribution of antirachitic substances. *Proc. of the Soc. for Exper. Biol. and Med.*, vol. 20, pp. 375-378.
- ZUCKERKANDL, E. 1903 Die Entwicklung der Schilddrüse und der Thymus bei der Ratte. *Anat. Hefte*, Bd. 21, S. 3-28.
- 1909 Zur Entwicklung des Balkans. *Arb. aus dem Neurol. Institute*, Bd. 17, S. 373-409.
- ZUMSTEIN, J. J. 1890 Ueber den Bronchialbaum des Menschen und einiger Säugetiere. *Sitzungsber. d. Gesellsch. z. Beförd. d. ges. Natur. zu Marburg*. Jahrg., 1889, S. 25-29. (Sitz. vom 26. März. 1889. Rat among mammals used.
- 1891 Ueber die Unterkieferdrüse einiger Säuger, 1 Anat. Teil. *IIabilitationsschrift*, Marburg, 32 pp.
- ZUNTZ, L. 1919 Experimentelle Untersuchungen über den Einfluss der Ernährung des Muttertieres auf die Frucht. *Archiv für Gynaekologie*, Bd. 110, S. 244-273.



## INDEX

*In the index the page numbers are given for the Albino data without prefix.*

*The page numbers for the Norway data are preceded by N.*

*When Tables, Charts or Figures are noted, the reference is in brackets and T., C., or Fig. respectively, are used before the serial number of the item.*

*Many references to parts, systems and organs are entered under Growth, or its sub-captions.*

### Activity (See also Exercise)

Distribution of, 16, 17, 31 (T. 1).

Relation to oestrous cycle, 17.

### Adipose Tissue, 55 (T. 166).

### Age

Equivalent ages, 16, 31.

Determination of age, 17.

Characters, functions of, 2, 17, 275 (T. 157).

Of opening eyes, 15 (N. 338).

Of hearing, 15.

Of independence, 16.

Of sexual maturity, 155 (T. 113) (N. 339).

Span of life, 17, 18.

Body weight on, 172-178 (T. 118-121) (C. 20-22).

Thymus on, 224, 260 (T. 151-152) (C. 48).

Percentage of water on (See also Growth in terms of water and solids).

Refractive index of serum, 64 (T. 25) (C. 5).

### Albino rat (See Rat)

### Alimentary Tract

Growth of, 214 (T. 146) (C. 38).

### Analytical Constants

Ganglion spirale, 97 (T. 56).

### Anatomy

Embryology, 37-42 (T. 10-12) (C. 1).

Bones—Connective tissue, 43-55 (T. 13-20) (Fig. 1).

### Anatomy (continued)

Muscles, 55 (T. 21).

Blood vessels and lymphatics, 55-61 (T. 22-24) (C. 2, 3) (Fig. 2).

Blood, 61-75 (T. 25-41) (C. 4-6).

Lymph nodes, 75 (T. 42).

Nervous system, 76-119 (T. 43-79a) (C. 7-13) (Fig. 3-11).

Sense organs, 119-121 (T. 80-82).

Integument, 121 (T. 83).

Thoracic and Abdominal Viscera, 122 (T. 153-156) (C. 49, nos. 1-21).

Uro-Genital system, 123 (T. 85).

Gastro-Intestinal System (T. 84, 85).

Exocrine glands, 124.

Endocrine glands, 124-128 (T. 86-88a) (C. 14).

### Axis of Nerve Fiber (See Nerves)

### Behavior

Under natural conditions (Caged), 31.  
Sounds, 31.

Under experimental conditions, 31.

Activity and exercise, 31.

Alcohol and drugs, 31.

Lesions of brain and sense organs, 31.

Care of rats, 31.

### Bio-chemistry, 150.

### Biology

Life history, 15-17 (T. 1).

Span of life, 17, 18.

Puberty, 18, 19 (T. 2, 2a, 3, 4).

Gestation period, 20, 21.

**Biology** (*continued*)

- Superfecundation—Superfetation, 21.
- Parturition, 21.
- Fertility and birth weight, 21-27 (T. 5-8).
- Sex ratio, 27, 28 (T. 5, 6).
- Recognition of sex, 28 (T. 9).
- Body weight according to sex, 29, 30.
- Behavior, 30, 31.
- Comparison with man, 31, 32.

**Blood-Vessels and Lymphatics**

- Area of aorta, 56 (T. 22).
- Vascularity of nervous system, 56-61 (T. 23-24) (C. 2) (Fig. 2).
- Vascularity of the cortex, 57-61 (T. 24) (C. 3) (Fig. 2)

**Blood**

- Composition, 141.
- Volume of, 198 (T. 136).
- Growth of, 213 (T. 146) (C. 37).
- Percentage of water in, 61 (T. 25): N. 378 (T. 208).
- Specific gravity, 61.
- Percentage of water in serum, 61 (T. 27) (C. 4).
- On refractive index, 64-65.
- Resistance of red cells, 61 (T. 26).
- Refractive index, serum, 64-67 (T. 27-29) (C. 5-6): N. 378 (T. 209).
- On temperature, 66-67.
- Serum constitution, 68 (T. 29) (C. 6).
- Blood elements.
  - Number, 68-70 (T. 31-33, 38-41).
  - Size, 71 (T. 35-37).
  - Blood picture, 71-75 (T. 38-41).
  - Platelets, 70 (T. 34).
  - Wandering cells, 72 (T. 37).
  - Haemoglobin, 68, 199 (T. 30, 31, 136, 137).
  - Oxygen capacity, 198 (T. 136).

**Body Length** (*See also Growth*)

- On body weight, 202 (T. 144) (C. 27): N. 346 (T. 187) (C. 61).
- Tail length on, 205 (T. 144) (C. 29): N. 347 (T. 187) (C. 63).
- Body weight per millimeter, 178, 206 (T. 122) N. 347 (T. 188).

**Body Temperature**, 151-152 (T. 110, 111).**Body Weight** (*See also Growth*)

- On age, post-natal, 174-177 (T. 120, 157) (C. 21, 22) N. 342 (T. 185) (C. 59, 60).
- On body length, 203 (T. 144) (C. 28) N. 346 (T. 187) (C. 62).
- According to sex, 29-30.
- Minimum, 30.
- Modified by external conditions, 179.
- Gross, 182.
- Net, 182.
- Variations at birth, 224 (T. 141, 142).

**Bones** (*See also Skeleton*)

- List of bones, 43 (T. 13).
- Ossification (ages of), 43 (T. 14).
- Fusion of Epiphyses, 48 (T. 15, 15a).
- Limb bones.
  - Weights of, 187 (T. 128-130).
  - Lengths of, 187 (T. 131).
  - Shrinkage on drying, 195 (T. 132).
- Transformation of bone weights, 187 (T. 127).
- Percentage of water, 301-308 (T. 162-164) (C. 53, 54).
- Chemical composition, 316 (T. 174-177).

**Brain**

- Callosum, 78 (T. 46) (C. 8).
- Cell division in, 76 (T. 43, 44).
- Composition—chemical, 136 (T. 91-93) (C. 15, 16).
- Cortex, 79-90: N. 362-370.
  - Diameters of cells and nuclei, 85 (T. 49) (C. 10) (Fig. 9-10): N. 367 (T. 199, 200) (C. 67).
  - Number of cells, 83 (T. 48) (Fig. 9): N. 366 (T. 198).
  - Thickness, 79 (T. 47) (C. 9) (Fig. 4-8): N. 362 (T. 195) (C. 66).
  - Volume, 84 (T. 48): N. 364 (T. 197).
- Growth of, 206 (T. 144).
- Growth of parts, 207 (T. 140).
- Linear dimensions, 77 (T. 45) (C. 7) (Fig. 3, 3a): N. 360 (T. 193) (C. 65) (Fig. 12, 13).
- Methods of fixation, 108 (T. 72-77).

**Brain** (*continued*)

- Myelin and myelination, 116 (T. 79)  
118 (T. 79a).
- Olfactory bulbs, 90.
- Swelling reactions, 114 (T. 78).
- Specific gravity, 76.
- Water—percentage of, 308 (T. 157):  
N. 378 (T. 210, 211).
- Weight on age, 275 (T. 157).

**Calorimetry**, 152 (T. 112).**Captivity**, N. 382-386 (T. 212).**Castration**, 179.**Cell Division** (*See Mitosis*)**Cell Size** (*See also respective organs*)

- Erythrocytes, 71 (T. 35-35a).
- Wandering cells, 71 (T. 36).
- In hypophysis, 124 (T. 87).
- In peritoneal fluid, 71 (T. 37).
- In liver, 122 (T. 84).
- In pancreas, 122 (T. 84).
- In brain.
  - Purkinje cells, 90 (T. 50).
  - Cerebral cortex, 85 (T. 49) (C. 10)  
N. 367 (T. 199) (C. 67).
  - In spinal cord, 105 (T. 68).
  - In ganglia.
    - Cranial.
      - Gasserian, 93 (T. 54).
      - Spiral, 95 (T. 55, 56) (C. 11).
      - Vestibular, 96 (T. 57) (C. 12).
    - Spinal, 97 (T. 59-60, 67).
    - Sympathetic, 107 (T. 71): N. 367  
(T. 201, 202).

**Characters Functions of Age**, 2, 17, 275  
(T. 157).**Chromosomes**

- Number of, 38.

**Circulation**, 141.**Classification and Nomenclature**, 4-7.**Comparison**

- with Man, 31-32, 132-134.

**Composition**

- Chemical (*See Water percentage of*).  
of entire body, 312 (T. 166, 168-170)  
(C. 56).
- Bones, 316-320 (T. 174-177).
- Blood, 315 (T. 171, 172).
- Teeth, 320 (T. 177).
- Milk, 316 (T. 173).
- Organs, 315 (T. 171).
- Brain, 320 (T. 178, 179) (C. 57).
- Spinal cord, 320 (T. 178).

**Controls**, X-XII.**Coat Color**, 34.**Correlation-Coefficients of**, 224 (T. 143).**Cranium**

- Capacity, 52 (T. 16).
- Definition of, 195.
- Displacement of teeth, 54.
- On mandible, 197 (T. 135).
- Measurements of, 49 (T. 16, 17) (Fig. I).
- Percentage of water, 301 (T. 161).
- Sutures, 47.
- Teeth, 52-54 (T. 18-19).
- Weight of, 195 (T. 133-135) (C. 26):  
N. 357 (T. 191).

**Distribution** (Geographic), 7-12.**Domestication**, 382-386.**Dry Substance** (*See Percentage of water*)**Ear**

- Opening of, 15.
- Age of hearing, 15, 140.
- Measurements of organ of Corti, 119-121  
(T. 81, 82).

**Early Records and Migrations**, 7.**Embryology**

- Spermatogenesis, 37.
- Oögenesis and fertilization, 38 (T. 10)  
(C. 1).
- Earlier stages, 38 (T. 11, 12).
- Volumes of ova and embryos, 38, 41  
(T. 11, 12).

**Embryology** (*continued*)

- Later stages, 42.
- Monsters, 42.
- Growth of fetus, 173 (T. 118, 119) (C. 20).

**Endocrine System**, 124, 158.

- Percentage of water, 124 (T. 86).

**Exercise** (*See also activity*)

- Under cage conditions, 18.
- Miles run, 17 (T. 1).
- Effects of, 18.

**Exocrine Glands**, 124.**Exocrine System**, 158.**Eyes**

- Age of closing, 17.
- Age of opening, 15: N. 338.
- Weight of, 207 (T. 144) (C. 31): N. 375 (T. 203).
- Weight of lenses, 259 (T. 149).

**Fat**, 55, 313 (T. 166).

- Fatty acids, 199 (T. 138).

**Feces**

- Weight of, 144-145 (T. 99-100).

**Feeding**

- Endocrine glands.
- Hypophysis, 166.
- Suprarenal, 166.
- Thyroid, 166.

**Fertility**

- Influence of,
- Weight of mother, 27 (T. 7, 8).
- Food and other conditions, 21.
- Mortality at birth, 26.

**Fetus**

- Crown-rump length, 172 (T. 119).
- Weight increase after 13th day, 172 (T. 118) (C. 20).

**Food Intake**, 150 (T. 107-109).**Formulas**

- Formula (1), 65.

**Formulas** (*continued*)

- Formula (2), 67.
- Formula (3), 67.
- Formula (4-61), 275, 282-297.

**Fossil Remains**

- Mus Rattus, 7 (note 1).

**Ganglia** (*See Cells*)**Gastro-intestinal System**, 122.

- Missing organs, 122.

**Genetics**

- Inbreeding, 34.
- Coat color, 34.
- Color pattern, 35.
- Inheritance.
- of brain weight, 35.
- of suprarenal weight, 35.
- of body weight, 35.
- Mutations, 35.
- Acquired characters, 36.

**Gestation Period**, 20: N. 336.

- Lengthening of, 21.

**Glands** (*See under names of*)**Growth**

- Of entire body.
- in weight on length, 203 (T. 144) (C. 28): N. 346 (T. 187) (C. 62).
- in length on weight, 202 (T. 144) (C. 27): N. 346 (T. 187) (C. 61).
- Tail length on body length, 205 (T. 144) (C. 29): N. 347 (T. 187) (C. 63).
- Effect of temperature, 205 (T. 139)
- Weight-length ratio, 178, 206 (T. 122): N. 347 (T. 188).
- Modifications of, 179.
- Of entire body on age.
- Before birth, 172 (T. 118, 119) (C. 20).
- Birth to maturity, 174-177 (T. 120, 157) (C. 21, 22): N. 342 (T. 185) (C. 59, 60).
- "Standard" growth curve, 275 (T. 157) (C. 21, 22).
- Of parts on body weight.
- Head, trunk and limbs, 181 (T. 123): N. 355 (T. 189).

**Growth** (*continued*)

- Of systems on body weight.  
 Integument, Musculature, Skeleton (ligamentous), Viscera, 183 (T. 124, 125): N. 356 (T. 190).  
 Skeleton (cartilaginous), 184-187 (T. 126) (C. 23, 24).  
 Correction for maceration, 187 (T. 127).
- Of organs on body length and weight.  
 Alimentary tract, 214 (T. 146) (C. 38).  
 Blood weight (volume), 198, 213 (T. 136, 146) (C. 37).  
 Limb bones, 187-195 (T. 126-132) (C. 25, 25a).  
 Brain, 206 (T. 144) (C. 30): N. 358 (T. 187) (C. 64).  
 Parts of, 207 (T. 140).  
 Cranium, 195-197 (T. 133-135) (C. 26).  
 Epididymides, 223 (T. 147) (C. 47).  
 Eyeballs, 207 (T. 144) (C. 31): N. 375 (T. 203).  
 Fat, 199, 313 (T. 138, 166).  
 Heart, 208 (T. 145) (C. 32).  
 Hypophysis, 218 (T. 148) (C. 43): N. 376 (T. 205) (C. 69).  
 Kidneys, 210 (T. 145) (C. 33).  
 Lens, 259 (T. 149).  
 Liver, 210 (T. 145) (C. 34).  
 Lungs, 212 (T. 146) (C. 36).  
 Mandibles, 197 (T. 135).  
 Ovaries, 222, 260 (T. 146, 150) (C. 45): N. 377 (T. 207) (C. 72).  
 Pancreas, 216 (T. 147) (C. 40).  
 Pineal, 260 (T. 149).  
 Prostate, 258 (T. 149).  
 Spinal cord, 206 (T. 144) (C. 30): N. 360 (T. 187) (C. 64).  
 Spleen, 212 (T. 145) (C. 35).  
 Stomach, 215 (T. 147) (C. 39).  
 Submaxillaries, 217 (T. 147) (C. 41).  
 Suprarenals, 219 (T. 148) (C. 44): N. 377 (T. 206) (C. 70).  
 Testes, 223 (T. 146) (C. 46): N. 377 (T. 207) (C. 71).  
 Teeth, 53, 54 (T. 18).  
 Thymus (on age), 224, 260 (T. 151) (C. 48).

**Growth** (*continued*)

- Thymus (on body length), 224, 260 (T. 152).  
 Thyroid, 218 (T. 148) (C. 42): N. 376 (T. 204) (C. 68).  
 Tubes (Fallopian), 260 (T. 150).  
 Uterus, 260 (T. 150).  
 Vagina, 260 (T. 150).  
 Viscera combined, 263, 264 (T. 153).  
 Variability, 224 (T. 142).  
 In terms of water and solids:  
 Body as a whole, 299 (T. 158-159) (C. 50).  
 In systems and organs, 299 (T. 158, 159) (C. 50).  
 Skeleton and its parts 301-308 (T. 160-164) (C. 51-54).  
 Brain, 275, 308 (T. 157) (C. 55).  
 Spinal cord, 275 (T. 157) (C. 55).  
 Effect of disease, 309.  
 Corrections, 309 (T. 165).  
 In chemical constituents.  
 Body as a whole, 312 (T. 166) (C. 56).  
 In young, 313, 314 (T. 167-169).  
 Organs, 315 (T. 171).  
 Osseous system, 316-320 (T. 174-177).  
 Teeth, 320 (T. 177).  
 Nervous system, 320-326 (T. 178-183) (C. 57-58).

**Heart**

- Growth of, 208 (T. 145) (C. 32).

**Haemoglobin**, 198, 199 (T. 136, 137).**Hypophysis**

- Cells of, 125 (T. 87).  
 Growth of, 218 (T. 148) (C. 43): N. 376 (T. 205) (C. 69).  
 Percentage of water, 124 (T. 86).  
 Under excitement, 165.  
 Influence of diet, 165.  
 In starvation, 165.  
 Weights of lobes, 125 (T. 88).

**Inbreeding**, 34.**Independence**

- Attainment of, 16.

- Inheritance**, 35.
- Integument**  
 Area of skin, 121 (T. 83).  
 Fat, 121.  
 Growth of, 183 (T. 124, 125).  
 Hair arrangement, 122.  
 Moulting, 35, 141.
- Intestinal Tract**  
 Growth of, 264 (T. 153, 156) (C. 49-(12)).
- Impregnation**  
 Time of, 19.
- Kidneys**  
 Anatomy, 123 (T. 85).  
 Growth of, 210 (T. 145) (C. 33).
- Lactation Period**, 15, 16: N. 338.
- Life History**, 15: N. 335.  
 Span of life, 17: N. 336.
- Litters**  
 Size of, 24 (T. 5, 6): N. 336.  
 Number of, 24 (T. 5, 6) 157: N. 336.  
 Second; the best, 25.
- Liver**  
 Growth of, 210 (T. 145) (C. 34).  
 Cells and nuclei-diameters, 122 (T. 84).  
 Percentage of glycogen in, 143 (T. 97, 98).
- Lungs**  
 Growth of, 212 (T. 146) (C. 36).  
 Lung disease, 327.
- Lymph Nodes**, 75 (T. 42).
- Mammary Glands**  
 Number of, 124.  
 Phases of, 124.  
 Variations in number, 42.
- Mandibles**, 197 (T. 135).
- Maturity sexual**  
 Age of, 18.  
 Shift of, 18.
- Menopause**, 180.
- Metabolism**, 142-151 (T. 97-109).  
 Nitrogen excretion, 144-148 (T. 99-105).  
 Protein, 144-148 (T. 99-105).  
 Salts, 148 (T. 106).
- Methods**  
 Statistical, 202.  
 of dissection (*See Growth, of organs*).  
 for fixation of brain, 108-114 (T. 72-77).  
 of weighing, 203, 206.  
 of measuring, 202.
- Migrations**, 7-12.
- Milk**  
 Composition, 315 (T. 173).
- Mitosis**  
 in brain, 76 (T. 43, 44).  
 in spinal cord, 76 (T. 43, 44).
- Modification of Body Growth**  
 Experimental, 179.  
 Method of measuring, X.
- Moulting**, 35, 141.
- Muscles**  
 Number of fibers and nuclei, 55 (T. 21).
- Muscles and Nerves**, 135.
- Myelin Formation**, 116-118 (T. 79, 79a).
- Myelin Sheath** (*See Nerves*).
- Mutations**, 35.
- Nerves**  
 Cranial: nerves and ganglia.  
 Number of fibers.  
 N. Cochlearis: N. 95.  
 N. Oculo-motorius, 90, (T. 51).  
 Diameters of fibers and axis-sheath  
 relation.  
 Oculo-motor, 90 (T. 51).  
 Trigemini, 90 (T. 52, 53).  
 Spinal nerves, 100 (T. 64, 66-69).  
 Of ganglion cells.  
 Gasserian, 90 (T. 54).  
 Spirale, 95 (T. 55, 56).  
 Vestibulare, 96 (T. 57).

**Nerves** (*continued*)

## Spinal nerves and ganglia.

## Fibers.

- Number and axis-sheath relation, 97, 100 (T. 58) 101 (T. 61) 102 (T. 62) 103 (T. 64) 104 (T. 65).
- Area of fibers, 102, 104 (T. 64, 66, 69)
- Diameter of fibers, 100 (T. 61, 67, 68).
- Axis-sheath relation, 102 (T. 64) 104 (T. 66) 107 (T. 69).
- Distal excess, 102 (T. 63).

## Cells.

- Number of ganglion cells, 102 (T. 61, 62).
- Diameters of ganglion cells, 98 (T. 59, 60) 105 (T. 67).
- Diameters of spinal cord cells, 106 (T. 68).

## Peripheral nerves.

- Number of fibers (N. peronealis), 104 (T. 65).
- Axis-sheath relation, 104 (T. 66).
- Degeneration and regeneration, 139.

## Sympathetic.

- Fibers less than  $4\mu$ , 107 (T. 70).
- Ganglion cells.
  - Superior cerveal sympathetic, 107 (T. 71).
- Nucleus-plasma ratio, 108 (T. 71).

**Nervous System**

- Anatomy, 76-119.
- Technical methods, 108-114 (T. 72-77).
- Growth of, 206 (T. 144) (C. 30).
- Physiology of, 136-139 (T. 91-93) (C. 15, 16).

**Nitrogen** (*See Metabolism*)**Norway Rat** (*See also Rat*)

- Domestication of, 382-386.
- Compared with Albino: N. 339, 358, 361, 362, 366, 367, 382-386 (T. 192, 194, 196, 198, 200, 212).

**Nutrition**, 151.**Nystagmus**, 141 (T. 94).

**Oestrus Cycle**, 18 (T. 2, 2a, 3) 153, 155 (T. 113).

**Oögenesis**, 38 (T. 10).

**Organs** (*See Growth of organs*)

- With early rapid growth, 206-208.
- With nearly uniform growth, 208-221.
- With a sinuous graph of growth, 222-224.

**Ossification**

- First centers of, 43 (T. 14).
- Rat and man, 46, 47 (T. 14a).
- Fusion of epiphyses, 48, 49 (T. 15, 15a).

**Ovulation**

- Puberty, 18.
- Period of, 19.
- Menopause, 19.

**Ovum**

- Ova—Distance from fimbria, 38 (T. 11).
- Ova—Diameter, 38.
- Ova—Volume, 41 (T. 12).
- Ova—Number on age, 38 (T. 10) (C. 1).
- Ova—Number per ovulation, 24.
- Ova—Death rate of, 24.

**Ovaries**

- Growth of, 222 (T. 146) (C. 45).
- Hypertrophy of surviving, 180.
- During gestation, 155 (C. 17).
- During lactation, 155 (C. 18).
- After removal of young, 157.
- Spaying, 179.

**Pancreas**

- Growth of, 216 (T. 147) (C. 40).
- Islets of Langerhans, 126 (T. 88a).
- Size of cells and nuclei, 123 (T. 84).

**Parathyroids** (*See Thyroid*)**Parts of Body** (Larger Divisions)

- Fore limbs, Hind limbs, Head, Trunk, 181 (T. 123): N. 355 (T. 189).

**Parturition**, 21.**Pathology**, 327-328.

- Rat diseases, 327.

**Pelvis**, 48.

**Peritoneal Fluid**

Cells of, 71 (T. 37).

**Physiology**, 132-171 (T. 89-117)(C. 15-19).

Blood: lymph, 141.  
 Body temperature, 151.  
 Calorimetry, 152.  
 Circulation, 141.  
 Endocrine system, 158.  
 Exocrine system, 158.  
 Feeding endocrine glands, 166.  
 Feeding exocrine glands, 158.  
 Hypophysis, 165.  
 Metabolism, 142.  
 Muscles and nerves, 135.  
 Nervous system, 136.  
 Nutrition, 151.  
 Rat compared with man, 132.  
 Reproduction, 153.  
 Respiration, 142.  
 Special senses, 139.

**Pineal Gland**, 165, 260 (T. 149).

**Placenta**, 21.

**Placental Sign**, 155.

**Prostate Gland**, 258 (T. 149).

**Puberty**, 18.

**Pulmonary System**, 123 (T. 146).

**Rat**

Norway.

Arrival in Europe: N. 10.

Classification: N. 4-7.

Melanic variety: N. 11 (note 5).

Similar to European form: N. 340.

Albino = "white" rat.

= *Mus norvegicus albinus*, 4.

As a laboratory animal XII, XIV.

Coat color, 6, 34.

Compared with man, 31, 132 (T. 89, 90).

Extracted, 6.

Gametic purity, 7.

Inbred, 34.

Origin of albino variety, 11.

Similar to European form, 12.

**Rat** (*continued*)

House rat.

*Mus rattus rattus*.

(English black rat), 8, 9.

*Mus rattus alexandrinus*.

(Ship or roof rat), 8, 9.

Albino of *M. rattus*, 5, 11.

Wrongly identified, 11.

*Rattus* × *norvegicus*: infertile, 11  
 (note 5).

Arrival in U. S., 10.

**Rattenkoenig**, 12 (References)

**Records of Early Migrations**

*Mus norvegicus*, 9-10.

*Mus rattus*, 7-9.

**References to Literature**

Introduction, 387, 388.

by authors, 389-458.

by subjects (and chapters).

Albino.

Biology, 32, 33.

Genetics, 36.

Anatomy, 128-131.

Physiology, 166-171.

Body growth on age, 180.

Growth of parts and systems, 200.

Growth on length and on age, 297-298.

Growth in terms of water and solids,  
 311.

Growth of chemical constituents, 326.

Pathology, 328-331.

Norway.

Life history, 341.

Growth on length, 357.

Growth of organs, 377.

Growth in terms of water and solids,  
 381.

**Refractive Index**, 64-67 (T. 27, 29) (C. 5-6):  
 N. 378 (T. 209).

**Removal of**

Parathyroids, 160-165 (T. 117).

Thyroid and parathyroids, 160-165  
 (T. 117).



- Reproduction and Sex Organs**, 153-155 (T. 113).  
 Male, 124 (T. 146, 147, 149) 158: N. 377 (T. 207) (C. 71).  
 Female, 146 (T. 146, 150) 158.  
 Placenta, 158.  
 Weight of ovaries, 155-157 (C. 17, 18) 260 (T. 150): N. 377 (T. 207) (C. 72).  
 Weight of Tubes, 260 (T. 150).  
 Weight of Uterus, 260 (T. 150).  
 Weight of Vagina, 260 (T. 150).
- Respiration**, 142 (T. 95, 96).
- Runts**, 30.
- Salts, Distribution of**, 314-316 (T. 168-170; 172-177).
- Scapula**, 48.
- Semi-circular Canals**, 139, 141 (T. 94).
- Senescence**, 180.
- Sense Organs**  
 Dermal, 139.  
 Ear, 119-121 (T. 81-82) 140.  
 Semicircular canals, 139, 141 (T. 94).  
 Eye, 119 (T. 80).  
 Weight of, 207 (T. 144) (C. 31).  
 Olfactory, 140.  
 Taste, 140.
- Serum** (*See Blood*)
- Sex**  
 Ano-genital distance, 28 (T. 9).  
 Recognition of—in young, 28 (T. 9).  
 In relation to.  
 Body length, 203.  
 Tail length, 205.  
 Weight of body, 29.  
 Weight of brain, 206.  
 Weight of spinal cord, 207.  
 Weight of hypophysis, 218 (C. 43).  
 Weight of pancreas, 216 (C. 40).  
 Weight of suprarenals, 219 (C. 44).
- Sex Organs**  
 Male, 124 (T. 146, 147, 149) 158.  
 Female, 124 (T. 146, 150) 158, 260.
- Sexual Maturity**, 17, 18, 37.
- Sexual Behavior**, 155.
- Sex Ratio**, 27: N. 337 (T. 184).  
 in later litters, 28.  
 according to season, 28.
- Skeleton** (*See also Bones*)  
 List of bones, 43 (T. 13).  
 Cartilagenous skeleton, 184 (T. 126) (C. 23, 24) 301 (T. 160) (C. 51).  
 Ligamentous skeleton, 183 (T. 124, 125) 299 (T. 158, 159): N. 356 (T. 190) (C. 50).
- Skin** (*See Integument*)
- Skull** (*See Skeleton: Cranium*)
- Span of Life**, 17: N. 336.
- Special Senses** (*See also Sense Organs*)  
 Equilibrium, 139, 141 (T. 94).  
 Hearing, 140.  
 Sight, 140.  
 Smell, 140.  
 Taste, 140.  
 Touch, 139.
- Specific Gravity**  
 Blood, 61.  
 Brain, 76.
- Spermatogenesis**, 37.
- Spinal Cord**  
 Cells, 105 (T. 67) (Fig. 11).  
 Composition, chemical, 320 (T. 178, 179) (C. 57).  
 Growth of, 206 (T. 144) (C. 30): N. 360 (T. 187) (C. 64).  
 Mitosis in, 76 (T. 43, 44).  
 Physiology, 139.  
 Water, percentage of, 308 (T. 157) (C. 55): N. 378 (T. 210, 211).
- Still-born**, 157.
- Submaxillaries**, 217 (T. 147) (C. 41).
- Superfecundation**, 21.
- Superfetation**, 21.

**Suprarenals**

- In starvation, 159.
- In pregnancy, 158 (T. 115).
- Left, heavier, 126.
- Percentage of water, 124 (T. 86).
- Sex difference, 126, 219 (T. 148) (C. 44).
- Volumes of divisions, 126 (C. 14).
- Weight of, 219 (T. 148) (C. 44): N. 377 (T. 206) (C. 70).

**Swelling Reactions: Brain**, 114 (T. 78).**Swimming**, 15.**Systems**

- (Weighed), 183-188: N. 356, 357.
- Integumentary, 183 (T. 124, 125): N. 356 (T. 190).
- Muscular, 183 (T. 124, 125): N. 356 (T. 190).
- Skeletal, 183 (T. 124, 125) 184 (T. 126) (C. 23, 24): N. 356 (T. 190).
- Visceral, 183 (T. 124, 125): N. 356 (T. 190).

**Tables (Nos. 1-212).**

- Reference Tables:
  - Growth on Age.
    - Chap. 5—(T. 118-122).
    - Chap. 12—Norway (T. 185, 186).
  - Growth on Length.
    - Chap. 6—(T. 125, 126, 128-131, 133-135).
    - Chap. 13—Norway (T. 187-191).
  - Growth of Parts and Organs.
    - Chap. 7—(T. 141-154, 157, 157a).
    - Chap. 14—Norway (T. 192-207).
  - Growth in Water and Solids.
    - Chap. 8—(T. 158-165).
    - Chap. 15—Norway (T. 210, 211).

**Tameness**, 134.**Technique**

- for body length, 202.
- for body weight, 203.
- for physiological, 134.
- for preparation of organs (*See under Growth: Of Organs*).
- for tail length, 202.

**Teeth**

- Dentine, 54.
- Eruption, 52.
- Formula for, 52.
- Incisors, 53 (T. 18).
  - After parathyroidectomy, 54.
  - Development, 53.
  - Displacement of, 54.
  - Enamel, 54 (T. 19).
  - Form, 53.
  - Growth of, 53 (T. 18, 19).
  - Measurements, 54.

**Temperature of Body**, 151, 152 (T. 110-111).

- Effect on tail length, 205 (T. 139).

**Testes**

- Descent of, 38.
- Growth of, 223 (T. 146) (C. 46): N. 377 (T. 206) (C. 71).

**Thymus**

- Weight of, 224, 260 (T. 151, 152).

**Thyroid (and Parathyroids)**, 126.

- Effects of removal, 160-165 (T. 117).
- Extract.
  - on intestine, 159 (T. 116) (C. 19).
  - on creatinine-creatinine balance, 160.
- Percentage of water, 124 (T. 86).
- Weight of, 218 (T. 148) (C. 42): N. 376 (T. 204) (C. 68).

**Toxicology**, 328.**Urine**

- Volume, 144 (T. 99).
- Weight of nitrogen in, 144 (T. 99) 145 (T. 100-106).

**Uro-genital System**, 123

- (T. 145, 146, 149, 150).

**Uterus**

- Contraction rate, 158 (T. 114).
- Weight of, 260 (T. 150).

**Vagina**

- Opening, 18, 153 (T. 113).

**Vagina** (*continued*)

- Vaginal plug, 155.
- Vaginal smears, 19 (T. 3).
- Weight of, 260 (T. 150).

**Variability**, Coefficients of.

- for body weight, 224 (T. 141) 343 (T. 186).
- for organ weights, 224 (T. 142).
- for cranial measurements, 49 (T. 16).

**Vascularity**

- Central nervous system, 56 (T. 23) (C. 2).
- Cortex, 57 (T. 24) (C. 3) (Fig. 2).

**Vertebrae**

- Percentage of water, (T. 161).

**Viscera**—Term viscera, 264 (Note 9).

- Thoracic and abdominal, 122 (T. 153-156) (C. 49, nos. 1-21).
- Weight of, 264 (T. 153).
- Relative percentage weights of, 264 (T. 154, 155) (C. 49-1).
- Relative percentage weights of individual viscera, 264 (T. 156) (C. 49, 2-21)

**Water—Percentage of**

- Blood, 61 (T. 25): N. 378 (T. 208).
- Bones of limbs, 301 (T. 162-163) (C. 53, 54).
- Brain, 308 (T. 157) (C. 55): N. 378 (T. 210, 211).
- Cord 308 (T. 157) (C. 55): N 378 (T. 210, 211).
- Cranium, 301 (T. 161) (C. 52).
- In entire body, 299 (T. 159) 312 (T. 166) (C. 56).
- Glands, 124 (T. 86).
- Organs, 299 (T. 159).
- Serum, 61 (T. 27) (C. 4).
- Systems, 299 (T. 159) 301 (T. 160) (C. 51).

**Weaning: Time of, 15.****Weight of Body** (*See Growth*)**Weight at Birth**, 26 (T. 7, 8): N. 337.

- According to size of litter, 26.
- According to characters of mother.
  - According to age, 27 (T. 7).
  - According to disease, 26.
  - According to weight, 27 (T. 8).
  - According to undergrowth, 27.

**Weight-Length Ratio**, 178 (T. 122): N. 347 (T. 188).







